

INCONTINENCE

6th Edition 2017

EDITORS

PAUL ABRAMS - LINDA CARDOZO

ADRIAN WAGG - ALAN WEIN



6th International Consultation on Incontinence,
Tokyo, September 2016

 ICS

ICUD

CONTENTS

Preface	i
6 th ICI Group Photo	ii
Faculty	iii
Evidence – Based Medicine Overview of the Main Steps for Developing and Grading Guideline Recommendations	x
1. Epidemiology of Urinary Incontinence (UI) and Other Lower Urinary Tract Symptoms (LUTS), Pelvic Organ Prolapse (POP) and Anal Incontinence (AI)	1
2. Cell Biology	143
3. Neural Control	259
4. Pathophysiology of Urinary Incontinence, Faecal Incontinence and Pelvic Organ Prolapse	361
5A. Initial Assessment of Urinary Incontinence in Adult Male and Female Patients	497
5B. Patient-reported Outcome Assessment	541
6. Urodynamic Testing	599
7. Imaging, Neurophysiological Testing and Other Tests	671
8. Pharmacological Treatment of Urinary Incontinence	805
9. Diagnosis and management of urinary incontinence in childhood	959
10. Neurologic Urinary and Faecal Incontinence	1093
11. Incontinence in Frail Older Persons	1309
12. Adult Conservative Management	1443
13. Surgical Treatment of Urinary Incontinence in Men	1629
14. Surgery for Urinary Incontinence in Women	1741
15. Pelvic Organ Prolapse Surgery	1855
16. Assessment and Conservative Management of Faecal Incontinence and Quality of Life in Adults	1993
17. Surgery for Faecal Incontinence	2087
18. Fistula	2143
19. Bladder Pain Syndrome	2203
20. Management Using Continence Products	2303
21. Primary Prevention, Continence Promotion, Models of Care and Education	2427
22. Economics of Urinary & Faecal Incontinence, and Prolapse	2479
23. Research	2513
Recommendations of the International Scientific Committee: Evaluation and Treatment of Urinary Incontinence, Pelvic Organ Prolapse and Faecal Incontinence	2549

© ICUD ICS 2016

All rights reserved. No part of this publication may be reproduced, stored in a retrieval system, or transmitted in any form or by any means, electronic, mechanical, photocopying, recording, or otherwise, without prior permission of the publisher.

Accurate indications, adverse reactions, and dosage schedules for drugs are provided in this book, but it is possible that they may change. The reader is urged to review the package information data of the manufacturers of the medications mentioned.

The Publishers have made every effort to trace the copyright holders for borrowed material. If they have inadvertently overlooked any, they will be pleased to make the necessary arrangements at the first opportunity.

ISBN: 978-0-9569607-3-3



www.ics.org

ICUD

www.icud.info

PREFACE

The 6th International Consultation on Incontinence was held in Tokyo in September 2016, made possible by the generous support of the International Continence Society. The first four ICI Consultations were held as stand-alone meetings. The 5th ICI was held during the annual meeting of EAU, and this made possible the attendance of a wider range of participants than had previously occurred. Holding the 6th Consultation at the ICS meant that many more of those most closely associated with the care of sufferers with incontinence were able to contribute to the Consultation. They were able to participate in the open sessions where the chair of each committee presented to the audience the principle findings of their committee.

The 23 committees included more than 150 experts from every corner of the globe: all selected according to their pre-eminence in their topic area within the overall subject of incontinence. The committees prepared their chapters making full use of modern technology and in particular email discussions. Hence they arrived at the 6th ICI with their committees' work in final draft. The principle of the Consultation is to present the final draft to a wider audience and then to finalise the chapter following the discussions at the Consultation. The Consultation again included the important conditions often associated with urinary incontinence, namely faecal incontinence, pelvic organ prolapse, bladder pain syndrome and obstetric fistula.

Whilst some conditions afflict either men or women, many conditions affect both sexes. The Consultation dealt with functional pelvic disorders, usually of a benign nature, although some patient's problems emanate from treatment of malignancy, for example, stress incontinence after a radical prostatectomy for prostate cancer. However, the principles of management are similar in both men and women, in most conditions.

This book, produced by the huge efforts of the 23 committees has once again vigorously examined and summarised the latest scientific evidence, and remains a unique publication and reference source. The reference source is invaluable to all those who commit their professional lives to men and women suffering from these often miserable conditions. The conditions we deal with are not "glamorous" medicine and remain "Cinderella" subjects. However, we have seen the emphasis move towards measuring outcomes by assessing improved quality of life. As the population ages then maintaining or improving quality of life in the latest stages of all our lives will attract greater attention. Hence the work of the ICI remains vitally important to the many millions of women and men who suffer from these conditions.



Paul Abrams

On a personal note, it has been a great privilege to be involved with the ICI Consultations for 20 years. Now seems the right time to step down as chair, however it is the intention that there should be a 7th ICI in 2020. The first Consultation in 1998 resulted from my earlier involvement with the International Consultation on Urological Diseases (ICUD) in Consultations on benign prostate disease in 1993 and 1995. Professor Saad Houry, a founder of ICUD, provided the encouragement and practical support that made the first and subsequent Consultations possible: we owe a great debt to him and the other founding fathers of the ICUD for their support. Alan Wein, Linda Cardozo and I shared the responsibilities for the first five ICIs, and we were joined by Adrian Wagg for this 6th ICI. It has been a tremendous honour to work with Alan and Linda, and latterly with Adrian. It has also been an honour to work with so many experts, who over the last 20 years, have willingly given their time to provide the scientific substance to these six publications that have been termed as "the" reference books on the subject. I am sure that this 6th book will be as valued as the previous five.

Paul Abrams, Chair of the 6th International Consultation on Incontinence.

April 2017



Editors, Committee Chairs and Committee Members at the 6th International Consultation on Incontinence, 2016, Tokyo

FACULTY

EDITORS

Abrams, Paul	UK
Cardozo, Linda	UK
Wagg, Adrian	Canada
Wein, Alan	USA

MEMBERS OF THE COMMITTEES

(ALPHABETICAL ORDER – CHAIRMEN IN BOLD PRINT)

12	Adeyuyi, Temitope	UK	13	Bruschini, Homero	Brazil
1	Altman, Daniel	Sweden	20	Buckley, Brian	The Philippines
7	Amarenco, Gerard	France	12	Burgio, Kathy	USA
8	Andersson, Karl-Erik	USA	3	Burnstock, Geoff	UK
10	Apostolidis, Apostolos	Greece	9	Canning, Doug	USA
14	Athanasίου, Stavros	Greece	8	Cardozo, Linda	UK
9	Austin, Paul	USA	1	Cartwright, Rufus	UK
13	Averbeck, Márcio	Brazil	23	Cartwright, Rufus	UK
18	Badlani, Gopal	USA	5	Castro Diaz, David	Spain
9	Bael, An	Belgium	19	Cervigni, Mauro	Italy
15	Baessler, Kaven	Germany	9	Chase, Janet	Australia
15	Barber, Matthew	USA	11	Chen, Liang Kung	Taiwan
23	Bavendam, Tamara	USA	15	Cheon, Cecilia	Hong Kong
20	Beeckman, Dimitri	Belgium	2	Chess-Williams, Russell	Australia
16	Berghmans, Bary	The Netherlands	16	Chiarioni, Guiseppe	Italy
16	Bharucha, Adil	USA	14	Choo, Myung-Soo	Korea
3	Birder, Lori	USA	21	Cockerell, Rowan	Australia
16	Bliss, Donna	USA	13	Comiter, Craig	USA
3	Blok, Bertil	The Netherlands	15	Consten, Esther	The Netherlands
23	Bø, Kari	Norway	15	Cooper, Kevin	UK
23	Boone, Tim	USA	14	Cosson, Michel	France
12	Booth, Jo	UK	5	Costantiini, Elisabetta	Italy
5	Bosch, Ruud	The Netherlands	20	Cottenden, Alan	UK
12	Bradley, Cate	USA	5	Cotterill, Nikki	UK
18	Browning, Andrew	Tanzania	3	Cruz, Francisco	Portugal
23	Brubaker, Linda	USA	8	Cruz, Francisco	Portugal

6	De Gennaro, Mario	Italy	2	Kanai, Anthony	USA
18	De Ridder, Dirk	Belgium	10	Kessler, Thomas	Switzerland
22	de Wachter, Stefan	Belgium	7	Khullar, Vik	UK
15	Deffieux, Xavier	France	11	Kirschner-Hermanns, Ruth	Germany
4	DeLancey, John	USA	20	Kitson-Reynolds, Ellen	UK
7	Derpapas, Alex	Greece	23	Klausner, Adam P.	USA
15	DeTayrac, Renaud	France	17	Knowles, Charles	UK
15	Dietz, Viviane	The Netherlands	5	Kocjancic, Ervin	USA
19	Dinis, Paulo	Portugal	4	Koelbl, Heinz	Germany
14	Dmochowski, Roger	USA	11	Kuchel, George	USA
7	Doumouchtsis, Stergios K	UK	3	Kuo, Hann-Chorng	Taiwan
10	Drake, Marcus	UK	6	Kuo, Hann-Chorng	Taiwan
22	Dudding, Thomas	UK	1	Lapitan, Marie Carmela M.	The Philippines
12	Dumoulin, Chantale	Canada	4	Laterza, Rosa	Germany
10	Emmanuel, Anton	UK	17	Laurberg, Soren	Denmark
16	Emmanuel, Anton	UK	8	Lee, Kyu-Sung	Korea
5	Espuña-Pons, Montse	Spain	17	Lehur, Paul-Antoine	France
20	Fader, Mandy	UK	5	Lemos, Nucleio	Brazil
7	Fernando, Ruwan	UK	19	Lin, Alex	Tapei
6	Finazzi Agro, Enrico	Italy	18	Loposso, Matthieu	Congo
2	Fry, Chris	UK	4	Lowry, Ann	USA
10	Gajewski, Jerzy	Canada	10	Madersbacher, Helmut	Austria
6	Gammie, Andrew	UK	17	Madoff, Rob	USA
13	Goldman, Howard	USA	16	Maeda, Yasuko	UK
14	Gomelsky, Alex	USA	17	Maeda, Yasuko	UK
14	Gomes, Cristiano	Brazil	15	Maher, Christopher	Australia
21	Griebling, Tomas	USA	10	Mangera, Altaf	UK
3	Griffiths, Derek	USA	11	Markland, Alayne	USA
15	Gutman, Robert	USA	17	Matzel, Klaus	Germany
12	Hagen, Suzanne	UK	2	McCloskey, Karen	UK
10	Hamid, Rizwan	UK	17	Mellgren, Anders	USA
19	Hanno, Philip	USA	1	Milsom, Ian	Sweden
13	Hanus, Tomas	Czech Republic	16	Mimura, Toshiki	Japan
6	Hashim, Hashim	UK	17	Mimura, Toshiki	Japan
2	Hashitani, Hiraku	Japan	14	Monga, Ash	UK
10	Heesakkers, John	The Netherlands	22	Moore, Kate H.	Australia
13	Herschorn, Sender	Canada	20	Moore, Katherine	Canada
12	Hunter, Kathleen	Canada	12	Morin, Melanie	Canada
4	Igawa, Yasuhiko	Japan	12	Morkved, Siv	Norway
12	Imamura, Mari	UK	9	Mosiello, Giovanni	Italy
11	Johnson II, Theodore	USA	18	Mourad, Sherif	Egypt
6	Kakizaki, Hidehiro	Japan	18	Muleta, Mulu	Ethiopia

11	Murphy, Catherine	UK	16	Taylor, Stuart	UK
14	Nager, Charles	USA	9	Tekgul, Serdar	Turkey
1	Nelson, Richard	UK	12	Thakar, Ranee	UK
21	Newman, Diane	USA	1	Tikkanen, Kari A.O.	Finland
14	Ng, Roy	Singapore	14	Tomoe, Hikaru	Japan
19	Nickel, Curtis	Canada	6	Toozs-Hobson, Philip	UK
9	Nijman, Rien	The Netherlands	7	Tubaro, Andrea	Italy
20	Nishimura, Kaoru	Japan	19	Ueda, Tomohiro	Japan
19	Nordling, Jorgen	Denmark	2	Vahabi, Bahareh	UK
16	Northwood, Melissa	Canada	17	Vaizey,Carolynn	UK
23	Nygaard, Ingrid	USA	9	van der Walle, Johan	Belgium
17	O'Connell, Ronan	Ireland	21	van Houten, Paul	The Netherlands
11	Orme, Susie	UK	15	van Iersel, Jan	The Netherlands
11, 20	Ostaszkiwicz, Joan	Australia	9	van Laeke, Erik	Belgium
21	Palmer, Mary	USA	19	van Ophoven, Arndt	Germany
10	Panicker, Jalesh	UK	17	Varma, Madhulika	USA
16	Peden-McAlpine, Cynthia	USA	7	Vodusek, David	Slovenia
4	Rademakers, Kevin	The Netherlands	9	von Gontard, Alexander	Germany
10	Radziszewski, Piotr	Poland	11	Wagg, Adrian	Canada
16	Rafiee, Hameed	UK	22	Wagner, Todd H.	USA
21	Rantell, Ange	UK	12	Wallace, Sheila	UK
5	Robinson, Dudley	UK	20	Watson, Jo	UK
16	Rock-Wood, Todd	USA	8	Wein, Alan	USA
6	Rosier, Peter F.W.M.	The Netherlands	16	Whitehead, William	USA
14	Rovner, Eric	USA	20	Wilde, Mary	USA
10	Sakakibara, Ryuji	Japan	12	Williams, Kate	UK
4	Salvatore, Stefano	Italy	9	Wood, Dan	UK
14	Sand, Peter	USA	13	Woodhouse, Christopher	UK
16	Santoro, Giulio	Italy	11	Wyman, Jean	USA
7	Sekido, Noritoshi.	Japan	10	Wyndaele, Jean Jacques	Belgium
4	Serati, Maurizio	Italy	5	Yoshida, Masaki	Japan
7	Shobeiri, Seyed Abbas	USA	3	Yoshimura, Naoki	USA
4, 10	Sievert, Karl-Dietrich	Germany			
1	Sjöström, Sofia	Sweden			
18	Stanford, Edward	USA			
22	Subak, Leslee L.	USA			
8	Sahai, Arun	UK			
4	Sultan, Abdul	UK			
15	Sung, Vivian	USA			
11	Szonyi, George	Australia			
2	Takeda, Masayuki	Japan			
5	Tarcan, Tufan	Turkey			

MEMBERS OF THE COMMITTEES

(BY COMMITTEE – CHAIRMEN IN BOLD PRINT)

1. Epidemiology of Urinary Incontinence (UI) and Other Lower Urinary Tract Symptoms (LUTS), Pelvic Organ Prolapse (POP) and Anal Incontinence (AI)

Altman, Daniel	Sweden
Cartwright, Rufus	UK
Lapitan, Marie Carmela M.	The Philippines
Milsom, Ian	Sweden
Nelson, Richard	UK
Sjöström, Sofia	Sweden
Tikkinen, Kari A.O.	Finland

2. Cell Biology

Chess-Williams, Russell	Australia
Fry, Chris	UK
Hashitani, Hiraku	Japan
Kanai, Anthony	USA
McCloskey, Karen	UK
Takeda, Masayuki	Japan
Vahabi, Bahareh	UK

3. Neural Control

Birder, Lori	USA
Blok, Bertil	The Netherlands
Burnstock, Geoff	UK
Cruz, Francisco	Portugal
Griffiths, Derek	USA
Kuo, Hann-Chorng	Taiwan
Yoshimura, Naoki	USA

4. Pathophysiology of Urinary Incontinence, Faecal Incontinence and Pelvic Organ Prolapse

DeLancey, John	USA
Igawa, Yasuhiko	Japan
Koelbl, Heinz	Germany
Laterza, Rosa	Germany
Lowry, Ann	USA

Rademakers, Kevin	The Netherlands
Salvatore, Stefano	Italy
Serati, Maurizio	Italy
Sievert, Karl-Dietrich	Germany
Sultan, Abdul	UK

5A. Initial Assessment of Urinary Incontinence in Adult Male and Female Patients

5B. Patient-reported Outcome Assessment

Bosch, Ruud	The Netherlands
Castro Diaz, David	Spain
Costantiini, Elisabetta	Italy
Cotterill, Nikki	UK
Espuña-Pons, Montse	Spain
Kocjancic, Ervin	USA
Lemos, Nucleio	Brazil
Robinson, Dudley	UK
Tarcan, Tufan	Turkey
Yoshida, Masaki	Japan

6. Urodynamic Testing

De Gennaro, Mario	Italy
Finazzi Agro, Enrico	Italy
Gammie, Andrew	UK
Hashim, Hashim	UK
Kakizaki, Hidehiro	Japan
Kuo, Hann-Chorng	Taiwan
Rosier, Peter F.W.M.	The Netherlands
Toozs-Hobson, Philip	UK

7. Imaging, Neurophysiological Testing and Other Tests

Amarenco, Gerard	France
Derpapas, Alex	Greece
Doumouchtsis, Stergios K	UK
Fernando, Ruwan	UK

Khullar, Vik	UK
Sekido, Noritoshi.	Japan
Shobeiri, Seyed Abbas	USA
Tubaro, Andrea	Italy
Vodusek, David	Slovenia

Sakakibara, Ryuji	Japan
Sievert, Karl-Dietrich	Germany
Wyndaele, Jean Jacques	Belgium

8. Pharmacological Treatment of Urinary Incontinence

Andersson, Karl-Erik	USA
Cardozo, Linda	UK
Cruz, Francisco	Portugal
Lee, Kyu-Sung	Korea
Sahai, Arun	UK
Wein, Alan	USA

9. Diagnosis and Management of Urinary Incontinence in Childhood

Austin, Paul	USA
Bael, An	Belgium
Canning, Doug	USA
Chase, Janet	Australia
Mosiello, Giovanni	Italy
Nijman, Rien	The Netherlands
Tekgul, Serdar	Turkey
van der Walle, Johan	Belgium
van Laeke, Erik	Belgium
von Gontard, Alexander	Germany
Wood, Dan	UK

10. Neurologic Urinary and Faecal Incontinence

Apostolidis, Apostolos	Greece
Drake, Marcus	UK
Emmanuel, Anton	UK
Gajewski, Jerzy	Canada
Hamid, Rizwan	UK
Heesakkers, John	The Netherlands
Kessler, Thomas	Switzerland
Madersbacher, Helmut	Austria
Mangera, Altaf	UK
Panicker, Jalesh	UK
Radziszewski, Piotr	Poland

11. Incontinence in Frail Older Persons

Chen, Liang Kung	Taiwan
Johnson II, Theodore	USA
Kirschner-Hermanns, Ruth	Germany
Kuchel, George	USA
Markland, Alayne	USA
Murphy, Catherine	UK
Orme, Susie	UK
Ostaszkiwicz, Joan	Australia
Szonyi, George	Australia
Wagg, Adrian	Canada
Wyman, Jean	USA

12. Adult Conservative Management

Adewuyi, Temitope	UK
Booth, Jo	UK
Bradley, Cate	USA
Burgio, Kathy	USA
Dumoulin, Chantale	Canada
Hagen, Suzanne	UK
Hunter, Kathleen	Canada
Imamura, Mari	UK
Morin, Melanie	Canada
Morkved, Siv	Norway
Thakar, Ranee	UK
Wallace, Sheila	UK
Williams, Kate	UK

13. Surgical Treatment of Urinary Incontinence in Men

Averbeck, Márcio	Brazil
Bruschini, Homero	Brazil
Comiter, Craig	USA
Goldman, Howard	USA
Hanus, Tomas	Czech Republic
Herschorn, Sender	Canada
Woodhouse, Christopher	UK

14. Surgery for Urinary Incontinence in Women

Athanasίου, Stavros	Greece
Choo, Myung-Soo	Korea
Cosson, Michel	France
Dmochowski, Roger	USA
Gomelsky, Alex	USA
Gomes, Cristiano	Brazil
Monga, Ash	UK
Nager, Charles	USA
Ng, Roy	Singapore
Rovner, Eric	USA
Sand, Peter	USA
Tomoe, Hikaru	Japan

15. Pelvic Organ Prolapse Surgery

Baessler, Kaven	Germany
Barber, Matthew	USA
Cheon, Cecilia	Hong Kong
Consten, Esther	The Netherlands
Cooper, Kevin	UK
Deffieux, Xavier	France
DeTayrac, Renaud	France
Dietz, Viviane	The Netherlands
Gutman, Robert	USA
Maher, Christopher	Australia
Sung, Vivian	USA
van Iersel, Jan	The Netherlands

16. Assessment and Conservative Management of Faecal Incontinence and Quality of Life in Adults

Berghmans, Bary	The Netherlands
Bharucha, Adil	USA
Bliss, Donna	USA
Chiarioni, Guiseppe	Italy
Emmanuel, Anton	UK
Maeda, Yasuko	UK
Mimura, Toshiki	Japan
Northwood, Melissa	Canada
Peden-McAlpine, Cynthia	USA
Rafiee, Hameed	UK

Rock-Wood, Todd	USA
Santoro, Giulio	Italy
Taylor, Stuart	UK
Whitehead, William	USA

17. Surgery for Faecal Incontinence

Knowles, Charles	UK
Laurberg, Soren	Denmark
Lehur, Paul-Antoine	France
Madoff, Rob	USA
Maeda, Yasuko	UK
Matzel, Klaus	Germany
Mellgren, Anders	USA
Mimura, Toshiki	Japan
O'Connell, Ronan	Ireland
Vaizey, Carolynn	UK
Varma, Madhulika	USA

18. Fistula

Badlani, Gopal	USA
Browning, Andrew	Tanzania
De Ridder, Dirk	Belgium
Loposso, Matthieu	Congo
Mourad, Sherif	Egypt
Muleta, Mulu	Ethiopia
Stanford, Edward	USA

19. Bladder Pain Syndrome

Cervigni, Mauro	Italy
Dinis, Paulo	Portugal
Hanno, Philip	USA
Lin, Alex	Tapei
Nickel, Curtis	Canada
Nordling, Jorgen	Denmark
Ueda, Tomohiro	Japan
van Ophoven, Arndt	Germany

20. Management Using Continence Products

Beeckman, Dimitri	Belgium
Buckley, Brian	The Philippines
Cottenden, Alan	UK

Fader, Mandy	UK
Kitson-Reynolds, Ellen	UK
Moore, Katherine	Canada
Nishimura, Kaoru	Japan
Ostaszkiwicz, Joan	Australia
Watson, Jo	UK
Wilde, Mary	USA

21. Primary Prevention, Continence Promotion, Models of Care and Education

Cockerell, Rowan	Australia
Griebing, Tomas	USA
Newman, Diane	USA
Palmer, Mary	USA
Rantell, Ange	UK
van Houten, Paul	The Netherlands

22. Economics of Urinary & Faecal Incontinence, and Prolapse

de Wachter, Stefan	Belgium
Dudding, Thomas	UK
Moore, Kate H.	Australia
Subak, Leslee L.	USA
Wagner, Todd H.	USA

23. Research

Bavendam, Tamara	USA
Bø, Kari	Norway
Boone, Tim	USA
Brubaker, Linda	USA
Cartwright, Rufus	UK
Klausner, Adam P.	USA
Nygaard, Ingrid	USA

EVIDENCE – BASED MEDICINE OVERVIEW OF THE MAIN STEPS FOR DEVELOPING AND GRADING GUIDELINE RECOMMENDATIONS

INTRODUCTION

The International Consultation on Urological Diseases (ICUD) is a non-governmental organization registered with the World Health Organisation (WHO). In the last ten years Consultations have been organised on BPH, Prostate Cancer, Urinary Stone Disease, Nosocomial Infections, Erectile Dysfunction and Urinary Incontinence. These consultations have looked at published evidence and produced recommendations at four levels; highly recommended, recommended, optional and not recommended. This method has been useful but the ICUD believes that there should be more explicit statements of the levels of evidence that generate the subsequent grades of recommendations.

The Agency for Health Care Policy and Research (AHCPR) have used specified evidence levels to justify recommendations for the investigation and treatment of a variety of conditions. The Oxford Centre for Evidence Based Medicine have produced a widely accepted adaptation of the work of AHCPR. (June 5th 2001 <http://minerva.minervation.com/cebmdocs/levels.html>).

The ICUD has examined the Oxford guidelines and discussed with the Oxford group their applicability to the Consultations organised by ICUD. It is highly desirable that the recommendations made by the Consultations follow an accepted grading system supported by explicit levels of evidence. The ICUD proposes that future consultations should use a modified version of the Oxford system which can be directly 'mapped' onto the Oxford system.

- 1. 1st Step: Define the specific questions or statements that the recommendations are supposed to address.**
- 2. 2nd Step: Analyse and rate (level of evidence) the relevant papers published in the literature.**

The analysis of the literature is an important step in preparing recommendations and their guarantee of quality.

2.1. What papers should be included in the analysis?

- Papers published, or accepted for publication in the peer reviewed issues of journals.
- The committee should do its best to search for papers accepted for publication by the peer reviewed journals in the relevant field but not yet published.
- Abstracts published in peer review journals should be identified. If of sufficient interest the author(s) should be asked for full details of methodology and results. The relevant committee members can then 'peer review' the data, and if the data confirms the details in the abstract, then that abstract may be included, with an explanatory footnote. This is a complex issue – it may actually increase publication bias as "uninteresting" abstracts commonly do not progress to full publication.
- Papers published in non peer reviewed supplements will not be included.

An exhaustive list should be obtained through:

- I. the **major databases** covering the last ten years (e.g. Medline, Embase, Cochrane Library, Biosis, Science Citation Index)
- II. the **table of contents** of the major journals of urology and other relevant journals, for the last three months, to take into account the possible delay in the indexation of the published papers in the databases.

It is expected that the highly experienced and expert committee members provide additional assurance that no important study would be missed using this review process.

2.2. How papers are analysed?

Papers published in peer reviewed journals have differing quality and level of evidence.

Each committee will rate the included papers according to levels of evidence (see below).

The level (strength) of evidence provided by an individual study depends on the ability of the study design to minimise the possibility of bias and to maximise attribution.

is influenced by:

- **the type of study**
 - The hierarchy of study types are:
 - Systematic reviews and meta-analysis of randomised controlled trials
 - Randomised controlled trials
 - Non-randomised cohort studies
 - Case control studies
 - Case series
 - Expert opinion
- **how well the study was designed and carried out**

Failure to give due attention to key aspects of study methodology increase the risk of bias or confounding factors, and thus reduces the study's reliability.

The use of **standard check lists** is recommended to insure that all relevant aspects are considered and that a consistent approach is used in the methodological assessment of the evidence.

The objective of the check list is to give a quality rating for individual studies.

- **how well the study was reported**

The ICUD has adopted the CONSORT statement and its widely accepted check list. The CONSORT statement and the checklist are available at

<http://www.consort-statement.org>

2.3. How papers are rated?

Papers are rated following a «**Level of Evidence scale**».

ICUD has modified the Oxford Center for Evidence-Based Medicine levels of evidence.

The levels of evidence scales vary between types of studies (ie therapy, diagnosis, differential diagnosis/symptom prevalence study).

the **Oxford Center for Evidence-Based Medicine Website:**

<http://minerva.minervation.com/cebm/docs/levels.html>

3. 3rd Step: Synthesis of the evidence

After the selection of the papers and the rating of the level of evidence of each study, the next step is to compile a summary of the individual studies and the overall direction of the evidence in an **Evidence Table**.

4. 4th Step: Considered judgment (integration of individual clinical expertise)

Having completed a rigorous and objective synthesis of the evidence base, the committee must then make a judgement as to the grade of the recommendation on the basis of this evidence. This requires the exercise of judgement based on clinical experience as well as knowledge of the evidence and the methods used to generate it. Evidence based medicine requires the integration of individual clinical expertise with best available external clinical evidence from systematic research. Without the former, practice quickly becomes tyrannised by evidence, for even excellent external evidence may be inapplicable to, or inappropriate for, an individual patient: without current best evidence, practice quickly becomes out of date. Although it is not practical to lay our "rules" for exercising judgement, guideline development groups are asked to consider the evidence in terms of quantity, quality, and consistency; applicability; generalisability; and clinical impact.

5. 5th Step: Final Grading

The grading of the recommendation is intended to strike an appropriate balance between incorporating the complexity of type and quality of the evidence and maintaining clarity for guideline users.

The recommendations for grading follow the Oxford Centre for Evidence-Based Medicine.

The levels of evidence shown below have again been modified in the light of previous consultations. There are now 4 levels of evidence instead of 5.

The grades of recommendation have not been reduced and a "no recommendation possible" grade has been added.

6. Levels of Evidence and Grades of Recommendation Therapeutic Interventions

All interventions should be judged by the body of evidence for their efficacy, tolerability, safety, clinical effectiveness and cost effectiveness. It is accepted that at present little data exists on cost effectiveness for most interventions.

6.1. Levels of Evidence

Firstly, it should be stated that any level of evidence may be positive (the therapy works) or negative (the therapy doesn't work). A level of evidence is given to each individual study.

- **Level 1** evidence (incorporates Oxford 1a, 1b) usually involves meta-analysis of trials (RCTs) or a good quality randomised controlled trial, or 'all or none' studies in which no treatment is not an option, for example in vesicovaginal fistula.
- **Level 2** evidence (incorporates Oxford 2a, 2b and 2c) includes "low" quality RCT (e.g. < 80% follow up) or metaanalysis (with homogeneity) of

good quality prospective 'cohort studies'. These may include a single group when individuals who develop the condition are compared with others from within the original cohort group. There can be parallel cohorts, where those with the condition in the first group are compared with those in the second group.

- **Level 3** evidence (incorporates Oxford 3a, 3b and 4) includes:

good quality retrospective 'case-control studies' where a group of patients who have a condition are matched appropriately (e.g. for age, sex etc) with control individuals who do not have the condition.

good quality 'case series' where a complete group of patients all, with the same condition/disease/therapeutic intervention, are described, without a comparison control group.

- **Level 4** evidence (incorporates Oxford 4) includes expert opinion where the opinion is based not on evidence but on 'first principles' (e.g. physiological or anatomical) or bench research. The Delphi process can be used to give 'expert opinion' greater authority. In the Delphi process a series of questions are posed to a panel; the answers are collected into a series of 'options'; the options are serially ranked; if a 75% agreement is reached then a Delphi consensus statement can be made.

6.2. Grades of Recommendation

The ICUD will use the four grades from the **Oxford system**. As with levels of evidence the grades of evidence may apply either positively (do the procedure) or negatively (don't do the procedure). Where there is disparity of evidence, for example if there were three well conducted RCT's indicating that Drug A was superior to placebo, but one RCT whose results show no difference, then there has to be an individual judgement as to the grade of recommendation given and the rationale explained.

- **Grade A** recommendation usually depends on consistent level 1 evidence and often means that the recommendation is effectively mandatory and placed within a clinical care pathway. However, there will be occasions where excellent evidence (level 1) does not lead to a Grade A recommendation, for example, if the therapy is prohibitively expensive, dangerous or unethical. Grade A recommendation can follow from Level 2 evidence. However, a Grade A recommendation needs a greater body of evidence if based on anything except Level 1 evidence
- **Grade B** recommendation usually depends on consistent level 2 and or 3 studies, or 'majority evidence' from RCT's.
- **Grade C** recommendation usually depends on level 4 studies or 'majority evidence' from level 2/3 studies or Delphi processed expert opinion.

- **Grade D** "No recommendation possible" would be used where the evidence is inadequate or conflicting and when expert opinion is delivered without a formal analytical process, such as by Delphi.

7. Levels of Evidence and Grades of Recommendation for Methods of Assessment and Investigation

From initial discussions with the Oxford group it is clear that application of levels of evidence/grades of recommendation for diagnostic techniques is much more complex than for interventions.

The ICUD recommend, that, as a minimum, any test should be subjected to three questions:

1. Does the test have good technical performance, for example, do three aliquots of the same urine sample give the same result when subjected to 'stix' testing?
2. Does the test have good diagnostic performance, ideally against a "gold standard" measure?
3. Does the test have good therapeutic performance, that is, does the use of the test alter clinical management, does the use of the test improve outcome?

For the third component (therapeutic performance) the same approach can be used as for section 6.

8. Levels of Evidence and Grades of Recommendation for Basic Science and Epidemiology Studies

The proposed ICUD system does not easily fit into these areas of science. Further research needs to be carried out, in order to develop explicit levels of evidence that can lead to recommendations as to the soundness of data in these important aspects of medicine.

CONCLUSION

The ICUD believes that its consultations should follow the ICUD system of levels of evidence and grades of recommendation, where possible. This system can be mapped to the Oxford system.

There are aspects to the ICUD system that require further research and development, particularly diagnostic performance and cost effectiveness, and also factors such as patient preference.

P. Abrams, S. Khoury

The full paper can be accessed through the ICUD website (www.icud.info)

INCONTINENCE

6th Edition 2017 Volume 1

EDITORS

PAUL ABRAMS - LINDA CARDOZO

ADRIAN WAGG - ALAN WEIN



6th International Consultation on Incontinence,
Tokyo, September 2016



ICUD

EPIDEMIOLOGY OF URINARY INCONTINENCE (UI) AND OTHER LOWER URINARY TRACT SYMPTOMS (LUTS), PELVIC ORGAN PROLAPSE (POP) AND ANAL (AI) INCONTINENCE

Chair

I. MILSOM (Sweden)

Members

D. ALTMAN (Sweden)
R. CARTWRIGHT (UK)
M.C. LAPITAN (The Philippines)
R. NELSON (UK)
S. SJÖSTRÖM (Sweden)
K. A.O. TIKKINEN (Finland)

CONTENTS

LIST OF ABBREVIATIONS	4	6. Incidence of nocturia.....	57
I. INTRODUCTION	5	7. Risk factors for nocturia	57
II. BASIC EPIDEMIOLOGICAL CONSIDERATIONS	5	8. Summary points	61
III. EPIDEMIOLOGY OF ENURESIS AND URINARY INCONTINENCE IN CHILDREN	6	9. Future needs.....	61
1. General comments and definitions.....	6	VII. EPIDEMIOLOGY OF PELVIC ORGAN PROLAPSE	61
2. Prevalence of nocturnal enuresis (NE)....	7	1. General comments and definitions	61
3. Potential risk factors for NE	11	2. Prevalence of POP.....	62
4. Prevalence of functional incontinence in children	12	3. Incidence.....	63
5. Potential risk factors for day wetting.....	15	4. Risk factors.....	64
6. Summary points	16	5. Summary points	67
IV. EPIDEMIOLOGY OF URINARY INCONTINENCE IN WOMEN	17	VIII. THE GENETIC EPIDEMIOLOGY OF URINARY INCONTINENCE AND PELVIC ORGAN PROLAPSE IN ADULT WOMEN	68
1. General comments and definitions.....	17	1. Family Studies	68
2. Prevalence	18	2. Twin Studies	72
3. Incidence and Remission	25	3. Segregation Analyses	73
4. Potential risk factors.....	25	4. Linkage Studies	73
5. Summary points	35	5. Gene Association Studies	73
V. EPIDEMIOLOGY OF URINARY INCONTINENCE IN MEN	35	6. Summary points	74
1. General Comments	35	IX. EPIDEMIOLOGY OF FAECAL INCONTINENCE	74
2. Prevalence	36	1. General comments and definitions	74
3. Potential risk factors for UI	44	2. Prevalence	78
4. Summary points:.....	49	3. INCIDENCE.....	78
VI. EPIDEMIOLOGY OF OVERACTIVE BLADDER AND NOCTURIA	49	4. RISK FACTORS.....	79
1. General comments and definitions.....	49	5. Prevention	83
2. Prevalence of overactive bladder	50	6. Summary points	83
3. Incidence of overactive bladder.....	54	7. Future needs.....	84
4. Potential riskfactors for overactive bladder	54	X. WHY DO PREVALENCE ESTIMATES DIFFER?	84
5. Prevalence of nocturia.....	56	1. General problems in survey research...	84
		2. Different definitions and measurement	84
		3. Summary points:	85

XI. HELP SEEKING BEHAVIOUR	85
<hr/>	
1. Urinary incontinence	85
2. Faecal incontinence and pelvic organ prolapse	86
3. Summary points:.....	86
XII. EPIDEMIOLOGY AND CLINICAL WORK: FROM RESPONDENT TO PATIENT	86
<hr/>	
1. Worldwide Estimates of Lower Urinary Tract Symptoms	86
2. Summary points:.....	90
XIII. RECOMMENDATIONS FOR FURTHER RESEARCH	90
<hr/>	
1. Urinary incontinence	90
2. Faecal incontinence and pelvic organ prolapse	92
REFERENCES	93

EPIDEMIOLOGY OF URINARY INCONTINENCE (UI) AND OTHER LOWER URINARY TRACT SYMPTOMS (LUTS), PELVIC ORGAN PROLAPSE (POP) AND ANAL (AI) INCONTINENCE

*I. MILSOM (SWEDEN)
D. ALTMAN (SWEDEN), R. CARTWRIGHT (UK), M.C. LAPITAN (THE PHILIPPINES),
R. NELSON (UK), S. SJÖSTRÖM (SWEDEN), K. TIKKINEN (FINLAND)*

LIST OF ABBREVIATIONS

ADHD	Attention Deficit Hyperactivity Disorders	LOE	Level of Evidence
ADL	Activity of Daily Living	LUT	Lower Urinary Tract
AI	Anal Incontinence	LUTS	Lower Urinary Tract Symptoms
BMI	Body Mass Index	MDS	Minimum Data Set
CS	Caesarean section	MMSE	Mini Mental Status Examination
CAT	Childrens Apperception Test	MNE	Monosymptomatic Nocturnal Enuresis
CBCL	Childs Behaviour Check List	MRI	Magnetic Resonance Imaging
CI	Confidence Interval	NE	Nocturnal Enuresis
DV	Dysfunctional Voiding	NMNE	Non-Monosymptomatic Nocturnal Enuresis
EEG	Electroencephalogram	OAB	Overactive Bladder
FI	Faecal Incontinence	ODD	Opposite Deficient Disorder
GWAS	Genome-wide association studies	OR	Odds Ratio
IBD	Irritable Bowel Disorder	OSA	Obstructive Sleep Apnoea
ICCS	The International Childrens Continence Society	POP	Pelvic Organ Prolapse
ICI	International Consultation on Incontinence	POPQ	The ICS Pelvic Organ Prolapse Quantification Examination
ICS	International Continence Society	PSA	Prostate Specific Antigen
IUGA	International Urogynaecological Association	RR	Relative Risk
		SUI	Stress Urinary Incontinence
		TAH	Transabdominal Hysterectomy
		TURP	Trans Urethral Resection of Prostate

UI	Urinary incontinence
UTI	Urinary Tract Infection
VD	Voiding postponement
VH	Vaginal hysterectomy

I. INTRODUCTION

In this report we focus on the epidemiology (distribution and determinants) of urinary incontinence (UI), lower urinary tract symptoms (LUTS), pelvic organ prolapse (POP) and anal incontinence (AI). We also discuss important topics such as differences between epidemiological and clinical approaches to health problems, help seeking behaviour, and methodological issues for this research.

We have included a section on overactive bladder (OAB) and nocturia which are commonly occurring LUTS. A worldwide estimation of the current and future number of individuals with LUTS [1,2] including urinary incontinence and overactive bladder is also included at the end of this chapter.

The epidemiological population under study for this review will mainly be community dwelling non-institutionalised persons. The review will include discussion of the prevalence, incidence, natural history, and presence of racial and ethnic differences. We also review correlates and potential risk factors that have been revealed in epidemiological studies. Progress has clearly been made during the four years since our previous report when the 5th International Consultation on Incontinence (5th ICI) was published. Some new important areas have been studied with increasing regularity and quality. We have searched the literature for relevant new articles, thus reviewing a large number of high-quality and population based studies, as well as clinical trials that might include relevant epidemiological data. Because of an abundant number of studies, only a small fraction can be presented in a text like this. Other studies not presented here may have equally useful information, but lack of space precluded their inclusion.

Summary points:

- This review includes discussion of the prevalence, incidence, natural history, and presence of racial and ethnic differences in the epidemiology of UI, OAB, nocturia, POP and AI.
- Correlates and potential risk factors that have been revealed in epidemiological studies are also reviewed.

II. BASIC EPIDEMIOLOGICAL CONSIDERATIONS

Epidemiology is the scientific study of the distribution and determinants of disease in people. Descriptive epidemiology is the description of disease prevalence, incidence, (and mortality) by persons, place and time, while the term analytical epidemiology describes the search for determinants of disease risk. The discovery of risk factors and protective factors may then in turn lead to primary or secondary prevention.

In order to collect knowledge about risk factors or natural history, observational studies are needed. Cohort studies and case-control studies are the most common. However, caution is always needed when interpreting the results from such studies, as associations found in epidemiological studies may not be the same as causes. Longitudinal study designs and appropriate control for confounding factors are preferred, as these increase the validity of epidemiologic studies. For practical and ethical reasons, experimental designs are seldom used.

Recommendations and conclusions should always be based on the best available evidence. Studies of interventions, and studies of risk factors generally cannot be randomised because they relate to inherent human characteristics or practices, and exposing subjects to harmful risk factors is unethical. No uniform guidelines for assessing the results of observational studies exist, and the level of evidence for risk factors from observational studies should be judged on the soundness of the exclusion of alternative explanations by statistical and other controls. But some initiatives for how to report meta-analyses of observational studies have been taken [3].

Studies of disease frequency should rely on a very specific definition of the condition under investigation. The absence of unifying definitions for the conditions reviewed here is a fundamental problem which has not been resolved. Definitions used and problems associated with them are discussed in the subsections for the particular populations below.

Prevalence is defined as the probability of experiencing a symptom or having a condition or a disease within a defined population and at a defined time point. The concept is important for establishing the distribution of the condition in the population and for projecting the need for health and medical services.

Incidence is defined as the probability of developing the condition under study during a defined time period. Incidence is usually reported for a one-, two- or five-year time interval.

III. EPIDEMIOLOGY OF ENURESIS AND URINARY INCONTINENCE IN CHILDREN

1. GENERAL COMMENTS AND DEFINITIONS

Even in many of the recent studies reviewed analyses are very simple. Often only proportions or percentages are used to describe differences in different subgroups. Many analyses do not control for confounders (by stratification or multivariate analysis techniques). There is an obvious need for more advanced epidemiological analyses of risk factors and comorbidity, and strength of associations should be determined by relative risks and odds ratios.

The relative risk (RR) estimates the magnitude of an association between exposure and a condition, and indicates the likelihood of having the condition in the exposed group relative to those who are not exposed (e.g. do not have the risk factor). A RR of 1.0 indicates that the rates in the exposed and non-exposed groups are identical and thus that there is no association between the exposure and the condition in that specific dataset. A value greater than 1.0 indicates a positive association or an increased risk. A RR of 2.5 for UI indicates that there is a 2.5 times increased risk or that the persons in question are 150 percent more likely to have incontinence than those without the risk factor.

The odds ratio (OR) is the odds for having a risk factor in persons with a condition divided by the odds among those without the condition. An OR of 2.5 for UI may be interpreted as meaning that in this sample the odds in favour of having incontinence are 2.5 times higher among those with the risk factor than among those without.

For a condition with high prevalence, like UI or POP, OR and RR will not be identical, but in practice the results can be interpreted similarly. Results should always be given with a 95% confidence interval (CI).

Words like well established and established may be used about risk factors and findings with a high level of evidence in the literature. For less documented findings words like "indications of" or "data are suggestive" may be used.

Summary points:

- Descriptive epidemiology reports disease incidence, prevalence (and mortality) by persons, place and time.
- Analytical epidemiology searches for determinants of disease risk. There is a need for good longitudinal cohort studies.
- Variations in definitions and measurement issues are fundamental, and lead to problems with assessing the findings in epidemiological studies.
- There is a need for more advanced epidemiological analyses of risk factors and comorbidity using multivariable techniques, and strength of associations should be determined by relative risks and odds ratios.

The International Children's Continence Society (ICCS) has issued recommendations regarding terminology of bedwetting or nocturnal enuresis (NE) in 2006 with a stand alone updated document in 2014[4]. NE is the term for all urinary incontinence during sleep taking place in discrete episodes, regardless of the presence or absence of concomitant daytime symptoms. Monosymptomatic nocturnal enuresis (MNE) denotes bedwetting without any other lower urinary tract (LUT) symptoms, and non-monosymptomatic nocturnal enuresis (NMNE) should be used for those with any concomitant LUT symptom.

NE is caused by relative nocturnal polyuria [5] and/or nocturnal bladder over-activity [6], combined with the lack of arousal at the time when the bladder needs to be emptied. The most important cause is, of course, the lack of arousal, otherwise the child would have had nocturia.

Any other leakage of urine in children during both the day and night is referred to as urinary incontinence (UI), just as it is in the adult population. UI can be continuous or intermittent. Continuous leakage in children is often caused by a congenital malformation, such as ectopic ureter or exstrophy epispadias complex. Other causes of continuous leakage can be neurogenic bladder in children with spina bifida, tethered cord or other spinal or sacral malformations. Daytime UI with no obvious cause, i.e. without neurological or congenital anatomic alterations, is often seen together with other urinary symptoms such as frequency, urgency and infections. Altogether these symptoms are referred to as functional LUT dysfunction, which is the term used to describe the entire spectrum of functional filling-voiding disturbances[4]. Several sub-classifications have been used for children who present with varying degrees of "functional" urinary symptoms. Some are based on urodynamic patterns, others on clinical presentation.

According to definitions by the ICCS[4], based on symptoms and flow-residual studies rather than invasive urodynamic investigations, incontinence as a result of a filling-phase dysfunction, is in most cases due to an overactive bladder (OAB), which can also be referred to as "urge syndrome" and "urge incontinence". Children with OAB usually have detrusor overactivity, but this label cannot be applied to them without cystometric evaluation. When incontinence is

the result of a voiding-phase dysfunction, the diagnosis is often dysfunctional voiding (DV), which is induced by increased activity in the sphincter and pelvic floor during voiding. It is subdivided into staccato and fractionated voiding, and the terms cannot be applied unless repeat uroflow measurements have been performed. Voiding postponement (VD) is another common LUT dysfunction causing UI in children, but differs from the other since it is induced by a habitually postponement of voiding and not a LUT dysfunction per se.

NE and UI due to functional LUT dysfunction are the wetting problems addressed in this chapter. Both can be either primary (the child has not been dry for more than six months) or secondary (the wetting has recurred after a dry period lasting more than six months). If the complaints are secondary, they may signify psychological, neurological or even structural anomalies and therefore require careful consideration.

The healthy infant is socially incontinent but physiologically continent, because micturitions (about once every hour) are discrete and there is no leakage of urine between micturition [7]. Bladder control develops during the first four to six years of life and is a highly complex process, which is still not fully understood. Most children are toilet trained by the age of three years, although there is huge social and cultural variation. By the age of five years, the child is normally able to void at will and to postpone voiding in a socially acceptable manner [8]. By this age, night-time and daytime involuntary wetting becomes a social problem and a cause for therapeutic intervention.

2. PREVALENCE OF NOCTURNAL ENURESIS (NE)

As bladder control is something that develops over time, longitudinal studies are the best way of defining the dynamics of this process. Studies giving us the

prevalence for all children between five and 15 years of age, for example, are not appropriate, as all the developmental stages are clustered together. It is therefore better to give the prevalence for an age cohort, such as seven-year-olds. Furthermore, random sampling should preferably be used in order to be able to say anything about the population. These problems associated with understanding epidemiology were summarised by Krantz [9], who also reviewed the epidemiological studies that had been published by 1993.

One explanation for the variation in prevalence in different studies is the fact that some studies include only monosymptomatic enuresis (MNE), whereas others also include what is defined as nonmonosymptomatic enuresis (NMNE). Another explanatory factor is that the frequency of enuretic episodes differs or is not taken into account in some studies. Moreover, most epidemiological studies link primary and secondary enuresis together.

2.1. Prevalence of all night wetting (MNE+NMNE) according to age

Longitudinal cohort studies should be the ideal when analysing epidemiology in childhood NE, as there is a successive reduction in prevalence. Only a few of these studies are available [10-16] and cross-sectional studies at different ages therefore have to be used.

Most studies investigate cohorts of children in an age span of six to 12 years of age, for example, and give the prevalence for the entire group. Some of them also give the age-related prevalence [13,17-34] which is summarised in Table 1. Cross-sectional studies of a specific age are also included [16,35-41] in Table 1.

Table 1: Prevalence of nocturnal enuresis (NE) (= Monosymptomatic nocturnal enuresis (MNE) + Non-monosymptomatic nocturnal enuresis (NMNE) together) according to age

Author	Year	Prevalence of NE (%)		
		7 years	11-12 years	16-17 years
Ferguson [12]	1986	10.3		
Järvelin [36]	1988	8		
Hellström [35, 37]	1990,1995	9.5		0.5
Swithinbank [38, 39]	1994,1998		4.7	1.1
Serel [21]	1997	15.1	4	
Chiozza [17]	1998	6.8	2	
Spee-van der Wekke [19]	1998	8	4.6	
Lee [22]	2000	16.4	4.5	

Author	Year	Prevalence of NE (%)		
		7 years	11-12 years	16-17 years
Cher [20]	2002	9.3	1.7	
Kanaheswari [26]	2003	10.3	3.3	
Soderstrom [24]	2004	7.0	2.6	
Kajiwara [23]	2006	10.1	3.7	
Yeung [25]	2006	10.1	2.0	1.7
Butler[15]	2008	14.2		
Su [27]	2011		1.9	
Yousef [28]*	2011	31.5	10	8.7
Aloni [29]*	2012	34.5	13.3	
Yazici [30]	2012	13.4	4.8	
Srivastava [31]	2012	15.5	4.1	
Fockema [40]	2012	12.3		
Aljenfri [32]*	2013	45.4	28.4	
Akil [41]*	2014	24.3		
Mota [16]	2015	10.6		
Sarici [33]	2015	17.2	2.6	
Doganer [34]	2015	14.1	3.8	

***Smaller study populations (Total N in study 415-832) not included in meta analyses of total prevalence.**

In most studies (Table 1), the prevalence for seven-year-olds was between 7% and 10%. In two studies, the prevalence was higher; 15.1% and 16.4% for Turkish [21] and Korean [22] children respectively, despite the fact that the inclusion criteria were very similar in all the studies dealing with seven-year-olds (NE=night wetting once/month or more). Recently two

cross sectional epidemiological studies from Yemen have showed markedly higher frequencies with 31%-45% NE among children six to eight years declining to 8.7% in adolescents 15 year or older[28, 32]. These two studies have smaller study populations compared to other studies cited and selection bias can therefore not be ruled out, but the findings are

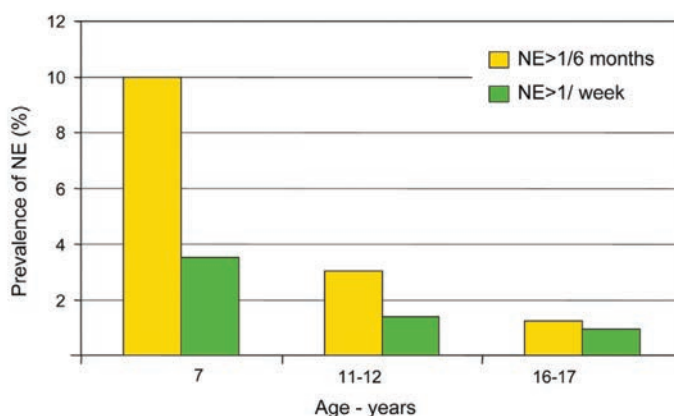

Figure 1: Prevalence of nocturnal enuresis (NE) by frequency of enuretic episodes and age. The data were obtained from metaanalyses of the epidemiological studies included in table III.1. NE>1 episode/6months: at 7 years [17, 20, 22-26, 35,36], 11-12 years [17, 20, 22-26,38] and 16-17 years [25,37,39]. NE>1 episode/week: at age 7 years [24, 25, 35,36], 11-12 years [24, 25,38] and 16-17 years [25,37].

interesting. The studies by Hellström [33] differ in NE criteria (once/3 months or more) and Järvelin [36] (once/6 months or more). The prevalence of more frequent wetting (once/week or more) was lower compared to the prevalence for all wetting (once/month or more) by age, which have been illustrated in Fig.1.

In 15 studies at age seven years [15-17, 20, 22-25, 30-31,33-37] (Table 1) the numbers of both non-enuretic and enuretic children were given and the definitions for enuresis were similar (MNE and NMNE, wetting once/1-3 months or more). A prevalence of 10.8% was obtained by metaanalyses of these studies (cohort of 22140 seven-year-old children, of whom 2392 were enuretic). Only a few studies included groups of children that were chosen at random from the population [17, 22, 25, 29 36].

At age 11-12 years, the prevalence of NE had decreased and from the studies shown in Table 1 the prevalence varied between 1.7% and 4.8%. In nine of the studies, the number of non-enuretics and enuretics were available and the definition of NE was similar (once/month or more), apart from Swithinbank's [38] study (once/three months or more). In these studies, the total number of children included was 11660, while the number of children with NE was 404, giving a prevalence of 3.5%. So, of those children with NE at age seven years, almost 15% spontaneously grow out of the wetting every year. In a recent Japanese study a higher resolution rate was reported in children with MNE compared to NMNE in children seven to 12 years of age (21% and 15%, respectively) [23]. Similar results was found in a study from Hong Kong in which the proportion of children with NMNE was significantly greater in adolescent boys than in boys aged five to ten years (32% vs 14.6%), even if the total prevalence of NE was decreasing as in other studies [25].

The variation in the prevalence of NE at 11-12 years between the studies is less than that seen at age seven years. The highest prevalence is no longer found in Turkey or Korea, as was the case at age seven years, but instead also comes from a non-randomised cross-sectional study of 11 to 12-year-old schoolchildren (n = 1145) in the UK (4.7%). It can be suggested that the high prevalence seen in the studies from Turkey and Korea at age seven is not due to differences in genetic predisposition, but rather to phenotypic differences, such as the age of toilet training and the subsequent attainment of bladder control, socio-economic status, or cultural differences.

At age 16-17, three cross-sectional studies show a further reduction in prevalence to 0.5-1.7%. Two of the studies re-investigate children who had previously been studied; at age seven years [37] and 11-12 years [38] respectively. The prevalence when the cohorts were added together was 1.3% (cohort=3819, NE=51) [25, 37, 39], which gives a spontaneous cure rate of 11% a year among those who wet at age 11-12 years.

In a study of 13,081 adults randomly sampled in the Netherlands[42], an overall prevalence of NE of 0.5% was found. There was no significant difference between age groups. Primary NE was reported by 50% of the men and 19% of the women, indicating that a small group of the enuretic children remain enuretic as adults.

2.2. Prevalence of monosymptomatic enuresis (MNE)

Very few studies make a distinction between MNE and NMNE and it is therefore difficult to obtain relevant figures for MNE (Table 2). In two studies from Scandinavia dealing exclusively with seven-year-olds, there was agreement between the studies; 6.4% [36] and 7.4% [35]. A Japanese study gave similar figures for MNE; 6.2% at age 7 years. In this latter study MNE corresponded to approximately 60% of all NE in ages from seven to 12 years [23]. When comes to studies in which all ages were mixed (5 -12 years), eight studies were identified in which those without daytime voiding problems could be identified. However, the difference in prevalence of MNE varied in these studies from 3.5% to 15%.

Table 2: Prevalence of Monosymptomatic nocturnal enuresis (MNE) at age seven years and overall (including all ages).

Author	Year	Prevalence of MNE (%)	
		Age 7 years	All ages included
Järvelin [36]	1988	6.4	
Hellström [35]	1990	7.4	
Yeung [18]	1996		3.5
Bower [43]	1996		15.0
Neveus [45]	1999		6.9
Kanaheswari [26]	2003	9.0	6.2
Lee [22]	2006	13.6	9.4
Kajiwara [23]	2006	6.2	3.5
Srivastava [31]	2011	15.5	12.6
Fockema [40]	2012	11.3	14.4
Mota [16]	2015	9.8	

2.3. Prevalence of NE versus gender

Almost all epidemiological studies of NE report a higher prevalence in boys than in girls, with the most reported ratio of 2:1 in western countries [16-24, 27, 30, 31, 35, 36, 38, 43-55]. It appears that the gender difference diminishes with age and becomes less visible and less proven among older children [37, 39,46] (Fig.2).

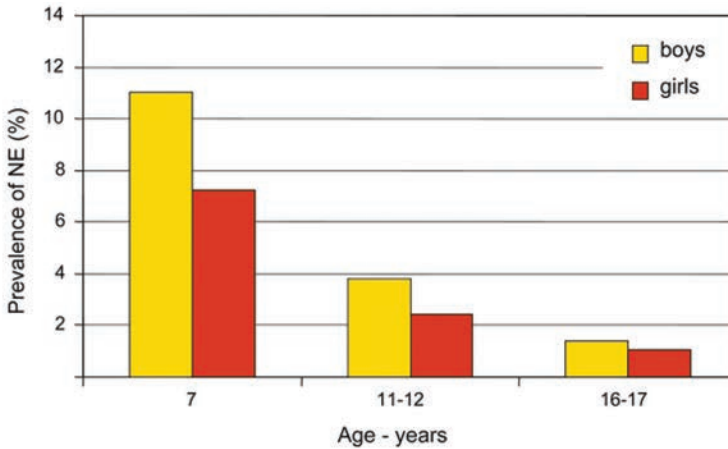

Figure 2: Prevalence of nocturnal enuresis (NE) >1 episode/6months, by gender and age. The prevalence data were obtained from metaanalyses of the following epidemiological studies: at age 7 [17, 23-25, 35,36], age 11-12 [17, 23-25,38] and age 16-17 [25, 37,39].

2.4. Prevalence of NE versus ethnicity

In a study from The Netherlands [19], a higher prevalence was reported in the Turkish/Moroccan group (14%) than in the Dutch children (6%) (OR 3.76 (95%CI 1.98-7.12)). An equally high prevalence was found in a Turkish study of children with NE [21] at age seven years (15.1%). In a study from Korea [22], the same high prevalence at age 7 years was identified (16.4%). However, other studies from South-East Asia had comparable [20, 23, 25] or even lower levels of prevalence to those in western countries. In fact, two Chinese studies have shown a low prevalence of nocturnal enuresis [18, 47], 3.6% and 4.3% for children aged 4-12 and 6-16 respectively, which they attribute to earlier nocturnal urinary control in Chinese children, due to earlier toilet training.

2.5. Prevalence of NE versus frequency of wet nights and age

Yeung et al [25] showed in a large epidemiological study that the relative proportion of subjects with frequent bed-wetting increased with age. Overall 82% of the adolescence had >3 wet nights/week versus enuretic children aged 5-10 (42%) (Fig.3). Such a relationship is also evident in fig 1, in which the proportion of children with severe NE increase with age, even if the total number decrease. Further support for severe NE to remain in a higher proportion as compared to children with infrequent bedwetting was results in a recent study [15]. Findings in epidemiological studies also show a correlation between severity of the NE and NMNE [15, 17, 48], meaning that NE in

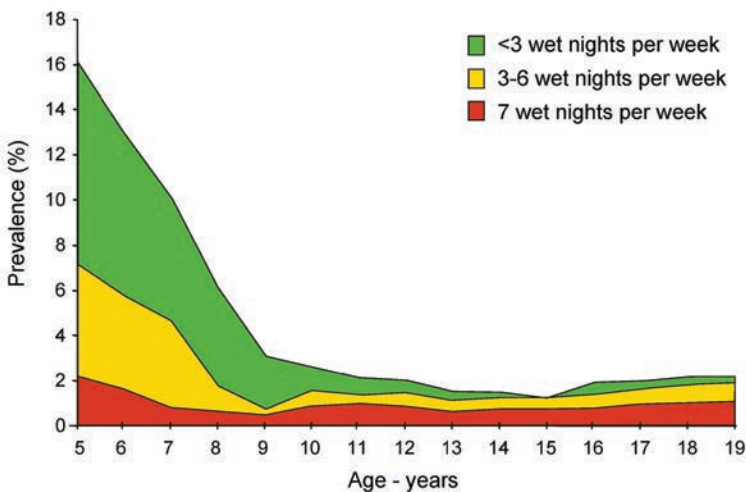

Figure 3: Prevalence of nocturnal enuresis by frequency of enuretic episodes and age. Data from [25].

adolescents often are combined with LUT dysfunction.

3. POTENTIAL RISK FACTORS FOR NE

Several risk factors have been established or suggested by epidemiological studies and the most important ones will be discussed here.

3.1. Daytime UI and LUT dysfunction

Daytime UI, a symptom of LUT dysfunction, has in epidemiological studies been shown to be the strongest predictor for NE (OR 4.8 (2.9-7.9) and has been identified in a third of the patients (NMNE) [48]. However, poor concordance was revealed (κ 0.25), which confirmed the two to be separate entities that should be evaluated and treated separately.

3.2. Family history

NE is a hereditary disorder and this has been demonstrated in many studies (for example, [17, 18, 21, 30, 31, 33, 34, 36, 43, 45, 49]). The mode of inheritance appears to be autosomal dominant. Järvelin [36] showed that, if both parents were enuretics as children, the RR (95% CI) for the child to have NE was 16 (6.3-20.1), while if only one was enuretic, the RR was 7.8 (5.1-9.8). It has recently been shown that the risk for the child to have hereditary NE is increased with the severity of the enuresis. Children with severe NE (>2 episodes/week) were combined with odds ratio for maternal NE 3.63 (2.56-5.14), whereas mild and moderate NE (<2 episodes/week) had 2.14 (1.74-2.64) [50]. The association with paternal NE was less pronounced, but a similar increased association to severe NE was observed. Using molecular genetic methods, foci have been found on chromosomes 13, 12, 8 and 22 [51, 52]. A picture of pronounced heterogeneity for both genotype and phenotype emerges [53]. Time to spontaneous resolution of MNE also seems to be familial with a positive correlation between the age of cessation of MNE of the child and their mothers and fathers[54]

3.3. Psychopathology

There are evident connections between childhood enuresis and mental well-being [13, 14, 47, 49, 55-58]. The children are increasingly negatively affected by their NE with increasing age[59]. Evidence is accumulating to show that psychological consequences are probably caused by the enuresis and not a cause of primary NE, which has been thought for a long time [56]. The findings presented by Feehan [14] support this latter statement, as he only found an association between psychopathology and secondary NE, while children with primary NE did not display a connection of this kind.

3.4. Developmental delay and ADHD

Children with developmental delay and mental retardation have been shown to have a higher prevalence of NE [12, 19, 36, 60]. Spee-van der Wekke [19] found that children who were given special education in school, including both those with and without mental retardation, had an OR of 3.74 (95%CI 2.32-6.03) for NE.

Perinatal events such as preeclampsia and low birth weight, possibly involving an increased risk of minor neurological dysfunction, have also been shown to be associated with NE [12, 36, 49]. A connection between NE and minor neurological dysfunction of this kind has also been shown by Luning [61] in 12-year-old enuretic children. Furthermore, children with attention deficit hyperactivity disorders (ADHD) are more likely to have enuresis than the general child population [57, 62-64]. The other way around was also confirmed in a case control study by Yosefichaijan finding a threefold increase of ADHD in children with MNE compared to control group[65]

3.5. Sleep and arousal

The main pathology behind NE in children is the inability to wake up to the sensation of a full bladder. Parents often say that their enuretic child "sleeps very deeply". Some recent studies support this view. By using auditory signals [66], computerised EEG [67] or questionnaires [45], a defect in arousal has been largely validated. In the study by Neveus [45], the odds ratios were significantly high for a high arousal threshold (2.7), pavour nocturnus (2.4) and confusion when awoken from sleep (3.4). Computerised EEG energy analysis has indicated both greater depth of sleep and impaired arousal in enuretics [68]. Difficulty arousal from sleep has also been shown in children with NE compared to children with isolated day-wetting problems and controls, by using a scoring system in a questionnaire [69].

3.6. Socio-cultural factors

Differences in the prevalence of NE [18, 21, 22, 47, 70] at early ages in different parts of the world are probably partly due to socio-cultural differences and not to differences in genetic predisposition [19]. It has been suggested that socio-economic status correlates with NE in some studies [17, 57], whereas in others no correlation was found [9]. Habits like tea-drinking in the evenings have also been identified as a risk-factor for NE[28,32].

3.7. Other risk factors

Obstructive sleep apnoea (OSA) has been associated with enuresis in some patients [71]. In an epidemiological study association between severe OSA and NE in girls was shown [27], but when including both sexes and all forms of OSA no difference was seen. In another study dealing with OSA patients versus controls, a significant correlation between NE and OSA was found (OR 5.1 (2.4-10.7) [72]. Removal of

large adenoids or tonsils causing upper airway obstruction in children with NE significantly reduced or cured NE [73]. Constipation (see co-morbidity below) may cause secondary NE or make primary NE persist [74]. Encopresis was shown as a risk factor for NE in an epidemiological study (OR 2.7 (1.6-4.4)), while no association with constipation could be identified [48]. The correlation between encopresis and NE was also confirmed in an epidemiological study from Brazil [16]. Children with Sickle Cell Disease are found to have increased prevalence of NE with studies reporting prevalence of 30-32% in paediatric populations with Sickle Cell Disease [75, 76]. Sexual abuse must also be included among the factors that may lead to NE [77], with increased prevalence of enuresis, compared to expected for age, in children referred for allegations of sexual abuse[78] Organic conditions such as infravesical obstruction and neuropathic bladder may also present as NE. In most cases, however, additional symptoms are present to make detection possible. Type1 diabetes was reported to be a risk factor for secondary MNE due to the polyuria seen at presentation [79]

urodynamic study of 1,000 patients with functional LUT dysfunction, approximately two-thirds had an overactive bladder and one-third had dysfunctional voiding [80]. Based on clinical information, another study comprising 226 children revealed that 76% were considered to have an overactive bladder and only 1% dysfunctional voiding. The difference illustrates that different inclusion criteria influence the rate of prevalence [81].

When considering the total prevalence of UI (all frequencies of UI included) (Table 3), there was a variation between 3.2% and 11.2% in different studies at the age of seven years. In the earliest studies the prevalence was lower (3.2%-5.0%), whereas in the studies performed later in the 2000 [16, 22, 24, 82-84], the prevalence was higher 6.3%-11.2%. One explanation for the difference was probably an increased recognition of the problem in the population through information via media etc. At 11-13 years the reported prevalence varied between 0.9% and 12.5%. Swithinbank's study [38] showed a very high prevalence (12.5%) and differed most from the rest (0.9%-4.2%). The difference could probably partly be explained by different limits for frequency of UI (occasionally [38] vs once/month or more). The fact that the studies were performed in different parts of the world was also a possible explanatory factor (UK, Turkey and Korea).

4. PREVALENCE OF FUNCTIONAL INCONTINENCE IN CHILDREN

In children with functional LUT dysfunction, the OAB is far more common than dysfunctional voiding. In a

Table 3: Day urinary incontinence (UI) (including mixed day/night).

Author (ref)	Sample size	Prevalence (%)			
		<1/week	>1/week	Total day+night	day only
Children aged 7 years:					
Järvelin [36]	Total: 2892 Boys:1444 Girls: 1445			3.2 ¹ 2.7 3.7	1.8 1.3 2.3
Hellström [35]	Total: 3555 Boys: 1834 Girls: 1721	2.3 1.7 2.9	2.5 2.1 3.1	4.9 ² 3.8 6.0	2.7 1.7 3.7
Bloom [93]	Total: 101			5.0 ⁴	
Lee [22]	Total: 1325			6.7 ³	3.9
Kajiwara [82]	Total: 984 Boys: 532 Girls: 452			9.0 ³ 9.2 8.9	9.0 9.2 8.9
Söderström [24]	Total: 715 Boys: 367 Girls: 348	3.0 3.2	3.8 2.6	6.3 ³ 6.8 5.8	
Joinson [83]	Total: 8213 Boys: 4222 Girls: 3991			7.8 ³ 6.9 8.8	
Swithinbank [84]	Total: 13973 Boys: 7217	6.4 6.0	0.9 0.7	7.3 6.8	3.3

Author (ref)	Sample size	Prevalence (%)			
		<1/week	>1/week	Total day+night	day only
	Girls: 3991	7.0	1.2	8.8	5.8
Akil [41]	Total: 416				13.5
Mota [16]	Total: 3601 Boys: 1872 Girls: 1729			11.2 ³ 10.3 12.2	8.1 7.1 9.1
Doganer [34]	Total: 958			4.3	
Children aged 11-13 years:					
Bloom [93]	Total: 165			1.2 ⁴	
Swithinbank [38]	Total: 1171 Boys: 510 Girls: 661	11.9 7.0 15.7	0.6 0.2 0.9	12.5 ⁵ 7.2 16.6	
Lee [22]	Total: 913			1.1 ³	0.9
Kajiwara [82]	Total: 761 Boys: 366 Girls: 395			2.5 ³ 1.0 3.9	
Söderstrom [24]	Total: 763 Boys: 398 Girls: 342			4.2 ³ 4.1 4.3	
Doganer [34]	Total 342			0.9	
Children aged 15-17 years:					
Bloom [93]	Total: 81			1.2 ⁴	
Hellström [37]	Total: 651 Boys: 344 Girls: 307	1.5 0.3 2.9	0.3 0.0 0.7	1.8 ² 0.3 3.6	1.8 0.3 3.6
Swithinbank [39]	Total: 940 Boys: 411 Girls: 529			3.0 ² 0.9 4.7	

The frequency of UI decreased with age (Table 3), which was clearly demonstrated in the subjects with

frequent episodes of UI (>1/week) (Fig.4). The prevalence at 7 years, 11-13 years and 15-17 years was

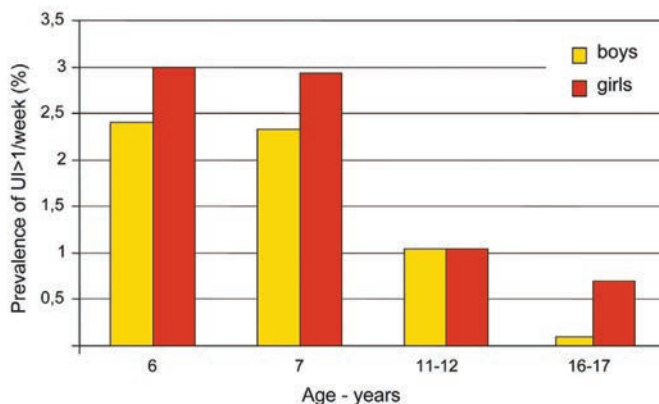

Figure 4: Prevalence of day UI (including mixed day/night) >1 episode/week by age and gender. Data are from: at age 6 years [88], 7 years [24,35], 11-12 years [24,38] and 16-17 years [37].

2.6%, 1.1% and 0.3% respectively. There were only two authors who investigated the same cohort of children on two occasions; Hellström [35, 37] in Sweden and Swithinbank [38, 39] in the UK. According to the studies by Hellström, the reduction from seven years to 17 years was 0.2% per year in those with wetting at least once a week and 0.3% when including all kinds of wetting. Swithinbank reported a far higher frequency for all kinds of wetting at age 11-12 years but not at 15-16 years and the reduction in his cohort of children was therefore approximately 2% per year.

UI was more common in girls in most studies, especially in the older age groups (Table 3, fig.4). From the prevalence found in the different studies, daytime UI could be suggested to be 1.5 times more common in girls than in boys at age seven years, whereas at age 16 years the difference was even more pronounced: 5-10 times more common in girls than in boys (Table 3). Overall in a population based study in 2856 children between 4.8-12.8 years, female gender was an independent risk factor for UI (OR 5.4 (2.6-11.1) [85]).

4.1. Prevalence of overactive bladder (OAB)

In a Japanese study [82], the prevalence in children between 7 and 12 years of age, OAB was seen in 17.8%, with no significant difference between boys and girls. There was a gradual decrease in prevalence from 19.8% at the age of 7 years to 12.8% at 12 years.

4.2. Comorbidity

4.2.1 Prevalence of NE

NE in combination with UI is denoted as NMNE as mentioned above. NE has been identified as an independent risk-factor for day-UI (OR 7.2 (3.4-15.2))

[85]. Association of NE to day UI was more often reported in children with frequent UI (≥ 2 episodes/week), as compared to infrequent UI (< 2 episodes/week) at 7.5 years [84]. In boys NE was seen in 70-80% of those with frequent day UI compared to about 50% in those with infrequent. Corresponding figures for girls was about 55% and 30%, respectively.

4.2.2 Prevalence of Bowel problems

Urinary and faecal incontinence often coexist in different combinations. Constipation in childhood is a very common condition and when functional fecal incontinence is seen, constipation is often the cause. The term encopresis can be used synonymously with functional fecal incontinence. An increasing number of epidemiological studies reporting the frequency of bowel problems are accumulating, either in terms of constipation or functional fecal incontinence, in children with daytime wetting. Table 4 shows that the prevalence of bowel problems in day-wetting children approximately corresponded to a third of the children (21%-35%) [24, 69, 82, 83, 85, 86], with even higher prevalence in the subgroup with dysfunctional voiding (43%) [86]. A significant association between day-wetting and bowel problems was shown [24]. These results support the new treatment concept of day-wetting children, with treatment of bowel problems as the first step. MNE, on the other hand, seldom have bowel problems (0%-1%), whereas in NMNE it is more common (16%-24%) [69, 86].

In an epidemiological study from Japan including 5282 children, ages between 7-12 years, 81.5% were reported to have daily bowel movements. A significant higher prevalence of NMNE was found in those with constipation, compared to among those with regular daily bowel movements (3.4% vs 2.2%) [23].

Table 4: Comorbidities. The prevalence of concomittant bowel problems in children with day-wetting and nocturnal enuresis.

Author	Number children bowel problems in day-wetting group	OR (95%CI)	Number children bowel problems in NE	OR (95%CI)
Söderstrom 2004 [24]	35%	7.2 (4.1-12.7)		1.2 (0.6-2.5) ² 2.0 (0.6-6.3) ³
Kajiwara 2004 [82]	33%			
Von Gontard 2004 [87]	25% ⁴		0%-16% ¹	
Chandra 2004 [69]	24%		1%-24% ¹	
Joinson 2006 [83]	33%			
Sureshkumar 2009 [85]	21%	3.3 (1.4-7.7) ²		
Fockema 2012 [40]			15.8%	
Sarici 2015 [33]			13.2%	1.52 (0.92-2.5) ³

¹ low value represents MNE, high value NMNE, ²OR for fecal incontinence, ³ OR for constipation, ⁴ Subgrouping of daywetting in OAB, VP and DV the prevalences are: 18%, 25% and 43%, respectively.

5. POTENTIAL RISK FACTORS FOR DAY WETTING

5.1. Family history

Day wetting, also including those subjects with mixed day and night wetting, has been shown to be correlated to hereditary factors, in parallel to what is known

about children with NE. However, the number of studies is limited (Table 5). Like for NE hereditary factors have been shown to be more pronounced in those with severe UI (>2 episodes/week), especially when paternal day UI is present (Table 5) [50,87].

Table 5: Day wetting vs family history (including mixed day/night wetting).

Author	RR (95% CI)	OR (95% CI)	Positive history (%)
Järvelin [49]			
-enuresis in mother	10.1 (3.4-29.3)		
-enuresis in father	5.9 (1.9-17.8)		
Sureshkumar [88]			
-daytime wetting in male sibling		5.3 (1.6-18.2)	
-daytime wetting in paternal lineage		9.3 (3.2-27.3)	
Chiozza [17]*			
-enuresis in parents		12.3	
Bower [43]			
-family history of enuresis			70%**
Neveus [45]			
-family history		2.0 (1.1-3.7)	
Von Gontard [50]			
<2 episodes/week			
-maternal NE		1.2 (0.9-1.6)	
-paternal NE		1.3 (0.9-1.8)	
-maternal day UI		2.6 (1.4-5.1)	
-paternal day UI		5.5 (2.4-12.5)	
>2 episodes/week			
-maternal NE		2.1 (1.2-4.0)	
-paternal NE		2.1 (1.0-4.3)	
-maternal day UI		3.3 (0.8-13.7)	
-paternal day UI		10.1(2.3-44.1)	

*Only children with mixed day and night wetting, **compared with 45% in dry children

5.2. Psychopathology

Children under stress as a result of marital separation, for example, have a higher incidence of diurnal or mixed UI, according to some authors [17, 49, 88]. Moreover, psychopathology investigated by Järvelin [49] using the Children's Apperception Test (CAT) revealed a significant increase in the signs of repression, including an inability to express one's emotions

and feelings ($p = 0.027$), when comparing day wetting children with controls. Neveus [45] found that day-wetting children had more difficulty falling asleep (OR 2.4, CI 1.4-4) and he interpreted them as "anxious children". Lettgren [89] found a significant increase in attention problems and delinquent behaviour in a certain form of day-wetting children (voiding postponement) using the Child Behaviour Check List (CBCL,

Achenbach). In a recent paper [90] similar results were found with the highest rate of psychiatric comorbidity in children with UI due to voiding postponement and the lowest in children with MNE. In the group with encopresis 65% were considered to have severe behavioural problems [86], meaning that children with both wetting and bowel problems are at the highest risk for psychopathology.

In a population-based study investigating psychological problems associated with day UI, 8213 children were included of whom 643 suffered from daytime wetting at median age 7.5 years [83]. Overall the results indicated a rate of psychological problems that was twice the rate reported for children with no daytime wetting, particular notable was the increase in externalizing problems. After adjustment for developmental delay, gender, stressful life events, variables associated to family sociodemographic background and soiling, there was still an independent association of daytime wetting and behaviour problems (OR 2.04, CI 1.67-2.51). In another epidemiological study UI was found to be associated with parental concerns about the child's social behaviour (OR 3.4 (1.4-8.3), [85]. It is not clear whether the behavioural problems described in these studies are a cause or a consequence of daytime wetting.

5.3. Minor neurological dysfunction and developmental delay

Children with minor neurological dysfunction have also been shown to have an increased rate of day wetting. Duel [62] found that children with ADHD are three times more likely to have day UI than controls ($p < 0.0005$). Von Gontard and Niemczyk also found children with daytime urinary incontinence to have significantly higher risk for ADHD and opposite deficient disorder (ODD) symptoms [91, 92]. Also in children with delayed maturation or with mental retardation, the risk of day wetting is increased (OR 1.9 and 4 respectively), according to studies by Järvelin [36]. Perinatal events, which can also be suggestive of minimal brain dysfunction, have also been shown to be over-represented in day-wetting children. For example, Järvelin [49] found that the children of mothers who had suffered from toxemia had an RR of 8.5 (CI 1.4-51.9) for day UI.

5.4. Other risk factors for day UI

Sometimes, functional day UI is difficult to distinguish from UI due to organic anomalies. The most prominent examples are the adolescent form of posterior urethral valves in boys and ectopic ureter and epispadias in girls.

In many papers, UTI is regarded as a risk factor for day UI. Järvelin [49] found an RR of 8.6 (2.3-32.3) for UTI in day UI children. Neveus [45] was able to demonstrate similar connections; OR 2.3 (1.3-3.9) and similar results were seen in Sureshkumar study [85]; OR 5.6 (2.0-15.6). However, these infections should probably be regarded as a consequence of

the functional bladder disturbance with UI and not the other way round as a cause of the UI.

6. SUMMARY POINTS

6.1. Nocturnal enuresis (NE)

- The prevalence of NE at age seven seems to be around 11% for most countries, at age 11-12 years around 3.5% and at age 16 around 1.3%.
- The spontaneous cure rate seems to be around 15% annually between 7 and 12 years, and 11% annually between 12 and 17 years
- In an adult population the prevalence of NE seems to be 0.5%. The prevalence was 0.1% when including only those with a history of NE during childhood. Thus the risk for NE as adult if having the condition at 7 years of age can be calculated to 1%.
- Potential risk factors for NE in children include OAB, polyuria, family history, psychopathology, developmental delay, mental retardation, socio-cultural factors, sleep and arousal problems, sleep apnoea, constipation, sexual abuse and organic conditions such as infravesical obstruction.

6.2. Functional incontinence

- Children who are and remain dry in the day seem to attain their diurnal continence between age four and five years
- Diurnal UI, or combined diurnal and nocturnal UI, in children is caused by overactive bladder in the great majority of cases.
- Prevalence for functional UI decrease with age. At age 7 years prevalence figures varies between 3.2% and 9%, with the highest prevalence in recent studies. At age 15-17 years the corresponding prevalence is 1.2-3%.
- Variation in prevalence figures is mainly dependent on differences in frequency of incontinence episodes in the studies.
- Potential risk factors for diurnal UI in children include bowel problems such as constipation and functional fecal incontinence, family history, psychopathology, socio-cultural factors, minor neurological dysfunction, developmental delay, organic anomalies such as infravesical obstruction in boys and sexual abuse.

IV. EPIDEMIOLOGY OF URINARY INCONTINENCE IN WOMEN

1. GENERAL COMMENTS AND DEFINITIONS

This section presents a narrative account of a targeted selection of high quality studies that illustrate what is currently understood about the prevalence, incidence, and risk factors for urinary incontinence (UI) including its common subtypes, stress UI, urgency UI, and mixed UI.

A large majority of epidemiological studies have either not considered subtypes of UI, or only reported on stress UI (complaint of involuntary loss of urine on effort or physical exertion), urgency UI (complaint of involuntary loss of urine associated with urgency), and mixed UI (complaint of involuntary loss of urine associated with urgency and also with effort or physical exertion or on sneezing or coughing). A small number of studies have reported prevalence and risk factors for adult nocturnal enuresis (complaint of involuntary urinary loss of urine which occurs during sleep). With a lack of validated questionnaire items for less common subtypes, the current literature is almost silent regarding the population prevalence and risks for postural incontinence, continuous incontinence, insensible incontinence, and coital inconti-

Table 6: Stress incontinence and urgency incontinence items from a range of validated questionnaires widely used in epidemiologic research

Questionnaire	Validation Paper	Stress Incontinence Item	Urgency Incontinence Item
King's Health Questionnaire	Kelleher et al., 1997[276]	Urinary leakage with physical activity e.g. coughing, running	Urinary leakage associated with a strong desire to pass urine
BFLUTS & ICIQ-FLUTS	Jackson et al, 1996[118]	Does urine leak when you are physically active, exert yourself, cough or sneeze?	Does urine leak before you can get to the toilet?
Dan-PSS (English version)	Schou et al, 1993[277]	Do you experience leakage of urine when you physically exert yourself (e.g. coughing, sneezing, lifting)?	Is the compulsion to pass urine so strong that urine starts to flow before you reach the toilet?
OAB-q	Coyne et al, 2002[278]	N/A	Urine loss associated with a strong desire to urinate
Urogenital Distress Inventory	Shumaker et al, 1994 [279]	Do you experience urine leakage related to physical activity, coughing or sneezing?	Do you experience urine leakage related to the feeling of urgency?
EPIQ	Lukacz et al, 2005 [280]	Do you experience urine leakage related to activity, coughing, or sneezing?	Do you experience urine leakage related to a feeling of urgency?
PFDI	Barber et al, 2005 [281]	Do you usually experience urine leakage related to laughing, coughing, or sneezing?	Do you usually experience urine leakage associated with a feeling of urgency; that is, a strong sensation of needing to go to the bathroom?

Current terminology for female UI is drawn from the 2010 IUGA/ICS joint terminology report [2], but in most instances is entirely compatible with current terminology for men [1], and children [4]. In considering the epidemiology of female UI, researchers have mainly addressed the epidemiology of the symptom of UI, defined as the complaint of involuntary loss of urine. There remains a paucity of work at a population or community level concerning either the sign of UI, defined as observation of involuntary loss of urine on examination, or on the formal laboratory diagnoses of urodynamic stress incontinence or detrusor overactivity.

ence, although they are sometimes grouped as "other incontinence". Finally, there remains a separate category of incontinence, so called "functional incontinence", more typical of institutionalised older adults, for whom physical or cognitive impairment limits their ability to use a toilet.

There are a large number of urinary symptom questionnaires employed in epidemiological research all with varying evidence of validity (discussed elsewhere). Most questionnaires were initially developed using secondary care, i.e. hospital and institutional samples, with criterion validity demonstrated in comparison to bladder diaries, pad tests, or urodynamic

diagnoses. Quite widely varying terminology is used in the items assessing stress incontinence and urgency incontinence in different questionnaires (see Table 6), and some items do not capture all aspects of the standardised definitions. Even the surrounding context for the items is known to strongly affect prevalence estimates [94-95], and small variations in terminology from different questionnaires may have similar effects.

The optimal assessment of incontinence subtypes remains controversial [96-97], but it is clear that self-report of symptoms differs systematically from detailed clinical evaluation. In particular, for women, mixed incontinence is more common than would be expected by chance, at least using questionnaire evaluation [98], and is reproduced less frequently using urodynamics [99-100]. Stress and urgency incontinence have different treatment options, and are presumed to have different underlying pathophysiology. Caution is therefore needed when comparing epidemiological studies that either do or do not report a separate mixed incontinence subgroup, and when generalising from population level data on mixed incontinence to clinical practice.

Self-report of incontinence symptoms should reflect the woman's own experience of incontinence, but may bear little relationship to felt or expressed need for treatment. Across multiple measures, incontinence severity is shown to be only a moderate predictor of incontinence specific quality of life impairment [101-102]. It is important therefore to characterise both the severity of symptoms, through frequency of leakage and/or quantity of loss, and the perceived bother or impact on activities. Most questionnaires in contemporary use, including the ICIQ-SF, ICIQ-FLUTS and DAN-PSS, therefore ask patients to report both the frequency of UI, and its perceived bother. Cautious interpretation should be made of high prevalence rates obtained with case definitions that do not incorporate some measure of symptom bother or impact.

Incontinence is a stigmatising condition in many populations [103], which creates a high risk for respondent bias in incontinence epidemiology [104-105]. Perhaps because of stigma, incontinence is also associated with low rates of presentation for care. Surveys assessing incontinence in healthcare settings may therefore also be highly prone to both medical surveillance bias, in which presentation to care for other reasons results in a diagnosis of incontinence; and Berkson bias [106], in which selection of cases from within hospitals tends to reduce generalisability to the population, and may suggest associations with spurious risk factors. We therefore focus on community or population based samples with response rate over 60% [107]. To further minimise differential effects of such biases, where possible we report outcomes stratified by age, by type of incontinence, and by major subgroups of interest.

The majority of work reviewed in previous editions of this chapter, originated from the OECD countries. There have been many recent studies from both BRIC and developing countries [108], which are now reviewed. Subsequent discussion excludes however the epidemiology of obstetric vesico-vaginal fistula, which is covered in a later chapter.

Table 1 Stress incontinence and urgency incontinence items from a range of validated questionnaires widely used in epidemiologic research

2. PREVALENCE

Among general population studies unadjusted prevalence estimates for the most inclusive definitions of UI ('ever' 'any' or 'at least once in the past 12 months') have ranged from 5% to 69% [109], with most studies reporting a prevalence of any UI in the range of 25% to 45%. This enormous variation between studies is seen both within and between countries, and with few studies reporting age standardised rates, largely precludes meaningful comparison between countries. If there is variation in true prevalence rates between countries, it is obscured by cultural differences in the perception of UI and willingness to report UI, as well as methodological differences [110], including in the wording of questionnaire items, in the method of administration of questionnaires, and perhaps most importantly, with differences in case definitions employed [111-112].

Very few studies have used the same survey tools and methods to report female UI general population prevalence in more than one country (Table 7). Three studies have attempted to assess the relative prevalence in western nations [113-115]. Across all countries surveyed, all these three studies find that SUI is the most common subtype, followed by MUI, and then UUI. Hunskaar and colleagues surveyed 29,500 women in France, Germany, the UK and Spain [114]. By demonstration of similar age trends across all countries, they suggested both lower overall prevalence of incontinence in Spain, and a relative excess of urgency incontinence in France. The EPIC (Epidemiology of Incontinence) and EpiLUTS (Epidemiology of Lower Urinary Tract Symptoms) studies [113, 115], used similar questionnaire items explicitly based on standard definitions. However, there was inconsistency between studies. The EpiLUTS study found similar prevalence of each UI subtype in the US, UK, and Sweden, while the EPIC study reported a more than 3-fold variation in prevalence between countries, with Sweden having a prevalence of 29.5% and Italy only 9.3%. The disparity in results could be explained by differences in sampling methods, or different response rates (58%, 33% and 59% respectively).

A further study set in Senegal, Mauritania, and Chad, reports substantial variation in prevalence across countries, even after age stratification [116]. Finally, in a recent survey using identical methods across

Russia, the Czech Republic and Turkey (n = 3,130) [117], there was noted similar prevalences in Russia and Czech Republic, but an excess of urinary storage symptoms (including UI) in Turkey. Again, it is unclear whether such differences are due to linguistic differences in questionnaires, differences in response proportion, or true cultural or biological differences. The lack of consistency in between country comparisons, even for large surveys set in western nations, makes it impossible to assess the extent of true variation between countries. It also remains difficult to establish stable, meaningful prevalence rates for female UI, when there is no consensus about what constitutes significant UI. Again, extreme caution is needed in making direct comparison of crude prevalence rates.

Although between study comparisons of female UI prevalence are largely unrewarding, we can meaningfully compare within study distributions of UI by age and UI subtype. Table 3 summarises prevalence estimates by age for female UI from community or population based studies with response rate >60%, over the period January 2008 through December 2011. Again a 10 fold variation in unadjusted prevalence rates is evident between studies, so where available, overall prevalence rates are given by UI subtype, while age trends are depicted with sparklines. These depict the variation in age specific prevalence across the full age range of each study.

Table 7: Population prevalence rates for female UI from studies sampling in more than one country.

Reference	Method	Age	Country	Sample		Prevalence		
Hunškaar (Hunškaar et al., 2004)	Postal	18+	France	3,881	All UI SUI UII MUI	44 13.6 11.9 15.0		
			Germany	3,824	All UI SUI UII MUI	41 16.4 6.6 15.6		
			Spain	6,444	All UI SUI UII MUI	23 9.0 4.8 6.0		
			UK	2,931	All UI SUI UII MUI	42 17.2 6.7 14.3		
Niang (Niang et al., 2010)	Postal	16+			Age	<30	30-59	60+
			Senegal	682	All UI	31.4	30.9	25.0
			Mauritania	740	All UI	8.0	13.2	22.7
			Chad	648	All UI	8.7	17.5	95.0
Irwin (Irwin et al., 2006)	Direct or phone interview	18+	Sweden	19,165	All UI	29.5		
			Italy		All UI	9.3		
			Canada		All UI	13.0		
			Germany		All UI	11.4		
			UK		All UI	14.9		
Coyne (Coyne, Margolis, Kopp, & Kaplan, 2012)	Web Based	40+	US	10,584	All UI SUI UII MUI	67.0 23.1 6.7 21.1		
			UK	3,983	All UI SUI UII MUI	69.0 28.6 7.1 19.6		
			Sweden	1,293	All UI SUI	67.1 26.9		

Reference	Method	Age	Country	Sample		Prevalence
					UII MUI	7.9 16.

Table 8: Population based studies with response rate >60%, reporting prevalence of female UI by age, published Jan 2008-July 2016.

Reference	Country	Sample Size	Survey Method	Age Range	Overall Prevalence (%)		Age Trend
					SUI	UII	
Espuna-Pons(España-Pons, Brugulat Guiteras, Costa Sampere, Medina Bustos, & Mompert Penina, 2009)	Spain	9,063	Postal	15+	All UI	12.2	
Herschorn (Herschorn, Gajewski, Schulz, & Corcos, 2007)	Canada	518	Telephone	18-90	SUI UII	25.5 9.3	
Tahtinen ⁶⁴	Finland	2,002	Postal	18-79	SUI UII	11.2 3.1	
Tennstedt(Tennstedt, Link, Steers, & McKinlay, 2008)	US	3,205	Direct Interview	30-79	All UI SUI UII MUI Other UI	10.4 2.8 1.1 5.9 0.7	
Lee(K.-S. Lee, Sung, Na, & Choo, 2008)	South Korea	13,484	Direct Interview	19+	All UI SUI UII MUI Other UI	24.4 11.9 1.9 10.2 0.5	
Zhu(Zhu, Lang, Wang, Han, & Huang, 2008)	China	5,300	Direct Interview	20+	All UI SUI UII MUI	38.5 22.9 2.8 12.4	
Nygaard (Nygaard et al., 2008)	US	1,961	Direct Interview	20+	All UI	15.7	
Martinez-Agullo(Martinez Agulló et al., 2009)	Spain	3,090	Direct Interview	25-64	All UI	4.0	
Bodhare(Bodhare, Valsangkar, & Bele, 2010)	India	552	Direct Interview	35+	All UI	9.6	
Ojengbede(Ojengbede, Morhason-Bello, Adedokun, Okonkwo, & Kolade, 2011)	Nigeria	5,001	Direct Interview	15+	All UI SUI UII MUI	2.8 2.3 1.0 0.6	

Reference	Country	Sample Size	Survey Method	Age Range	Overall Prevalence (%)		Age Trend
Ahmadi(Ahmadi et al., 2010)	Iran	800	Direct Interview	40-95	All UI	38.4	
Liapis(Liapis, Bakas, Liapi, Sioutis, & Creatsas, 2010)	Greece	2,000	Direct Interview	20-80	All UI SUI UUI MUI Other UI	27.0 11.9 3.0 11.1 1.1	
Amaro(Amaro et al., 2009)	Brazil	685	Postal	22-96	All UI	27.0	
Lopez(López, Ortiz, & Vargas, 2009)	Puerto Rico	276	Direct Interview	21-64	All UI SUI UUI MUI	34.8 16.7 4.0 14.1	
Correia(Correia, Dinis, Rolo, & Lunet, 2009)	Portugal	1,483	Telephone	40+	All UI	21.4	
Slieker-ten Hove(Slieker-ten Hove et al., 2010)	Netherlands	1,397	Postal	45-84	All UI SUI UUI MUI	58.8 30.6 6.1 23.2	
Ge(Ge et al., 2011)	China	3,058	Direct Interview	20-96	All UI SUI UUI MUI	22.1 12.9 1.7 7.5	
Botlero(Botlero et al., 2008)	Aus	504	Postal	24-80	All SUI UUI MUI	6.8 4.8 0.7 1.3	
Wennberg (Wennberg, Molander, Fall, Edlund, Peekker, & Milsom, 2009b)	Sweden	1,023	Postal	20+	1991 All 2007 All	14.7 27.8	
Franzen (Franzén, Johansson, Andersson, Pettersson, & Nilsson, 2009)	Sweden	4,609	Postal	18-79	All	28.9	
Zhu(Zhu et al., 2009)	China	19,024	Direct Interview	20-99	All SUI UUI MUI	30.9 18.9 2.6 9.4	

Reference	Country	Sample Size	Survey Method	Age Range	Overall Prevalence (%)		Age Trend
					All	Subtype	
Lasserre (Lasserre et al., 2009)	France	2,183	Direct Interview	18+	All	26.8	
					SUI	12.1	
					UI	2.9	
					MUI	11.2	
Onur(Onur, Deveci, Rahman, Sevindik, & Acik, 2009)	Turkey	2,275	Direct Interview	17-80	All	46.3	
					SUI	21.3	
					UI	19.9	
					MUI	16.7	
Zumrutbas(Zumrutbas et al., 2014)	Turkey	919	Direct Interview	18+	All	38.7	
					SUI	21.2	
					UI	8.2	
					MUI	2.6	
Kwon(C. S. Kwon & Lee, 2014)	South Korea	9,873	Direct Interview	20+	All	7.9	
Liu(B. Liu, Wang, Huang, Wu, & Wu, 2014)	China	5,433	Direct Interview	20-100	SUI	14.0	
					UI	3.0	
					MUI	6.3	
Wu(J. M. Wu et al., 2014)	US	8,368	Direct Interview	20+	All	17.1	
Ebbesen(Ebbesen, Hunskaa, Rortveit, & Hannestad, 2013)	Norway	21,804	Postal	20+	All	29.0	
Osuga(Osuga, Okamura, Ando, & Shimokata, 2013)	Japan	1,218	Postal	40+	All	6.6	
					SUI	5.4	
					UI	3.2	
					MUI	2.1	
Hornig(Hornig et al., 2013)	Taiwan	4,661	Direct Interview	35+	All	22.0	
Brito(Brito et al., 2012)	Mexico	1,180	Direct Interview	45-65	SUI	15.3	

As in the studies comparing prevalence between countries, absolute prevalence rates vary widely in recent cross-sectional work. However, the distribution of UI subtypes is consistent. Isolated stress incontinence accounts for approximately half of all incontinence, with most studies reporting 10-39% prevalence. With few exceptions, mixed incontinence is found to be next most common, with most studies report 7.5-25% prevalence. Isolated urgency incontinence is uncommon, with 1-7% prevalence, and where recorded at all, other causes of incontinence occur with approximately 0.5-1% prevalence. In summary, current data provide very disparate estimates of population prevalence for UI in women. Approximately 10% of all adult women report leakage at least weekly. Occasional leakage is much more common,

affecting 25%-45% of all adult women. Prevalence rates from cross-sectional studies uniformly demonstrate an association with age, which is explored in more detail in the subsequent section on risk factors.

Table 9: Studies reporting incidence and/or remission for UI in women.

Study	Country	Period (years)	♀ Sample Size	Loss to Follow Up (%)	Baseline Age	Case Definition	Prevalence at baseline (%)	Prevalence at follow up (%)	Annual Incidence (%)	Annual Remission (%)
Samuelsson et al. [213]	Sweden	5	457	16.4	20-59	Any UI	23.5	27.5	2.9	5.9
Hagglund et al. [306]	Sweden	4	338	26.6	20-50	Any UI	45.6	47.5	4.2	4.0
Wehrberger et al. [307]	Austria	6.5	925	52.3	20+	Any UI Weekly UI	32.0 n/a	43.3 n/a	3.9 2.1	2.9 n/a
Townsend et al. [134]	US	2	64,650	18.4	36-55	Monthly UI Weekly UI	52.5 n/a	48.3 n/a	6.9 1.9	7.0 n/a
Dalosso et al. [145]	UK	1	6,424	48.9	40+	Monthly SUI	17.3	n/a	8.3	n/a
McGrother et al. [308]	UK	1	12,036	20.2	40+	Any UI	34.2	n/a	8.8	25.2
Donaldson(et al. [309]	UK	3	12,750	33.0	40+	Any SUI	16.9	n/a	6.1-7.3	33.7-34.9
Waetjen et al. [147]	US	5	3,301	18.1	40-55	Monthly UI Weekly UI Monthly SUI Monthly UUI Monthly MUI Other UI	46.7 15.3 32.2 9.2 13.8 2.7	n/a	11.1 1.2 5.0 3.2 2.4 0.5	n/a
Liu et al. [310]	Australia	2	2,272 (♂&♀)	13.9	65+	Any SUI Any UUI	12.1 38.4	15.4 37.4	15.4 18.8	n/a n/a
Goode et al. [283]	US	3	490	5.0	65+	Monthly UI	0.41	n/a	9.7	13.0
Ostbye et al. [238]	Canada	10	5,332	60.2	65+	Any UI	19.5	28.8	1.8	n/a
Wennberg et al. [124]	Sweden	16	2,911	51.6	20+	Any UI	14.6	27.8	1.3	2.1

Study	Country	Period (years)	♀ Sample Size	Loss to Follow Up (%)	Baseline Age	Case Definition	Prevalence at baseline (%)	Prevalence at follow up (%)	Annual Incidence (%)	Annual Remission (%)
Moller(et al . [311]	Denmark	1	2,860	20.1	40-60	Weekly SUI Weekly UUI	13.1 7.3	11.0 6.7	4.0 2.7	41.4 42.0
Hotledahl & Hunskaar [312]	Norway	1	507	3.6	50-74	Monthly UI	30.6	29.8	0.9	1.4
Byles et al. [263]	Australia	9	12,432	42.4	70-75	Sometimes UI	20.7	27.3	1.62	n/a
Lifford et al. [212]	US	2	58,703	10.4	54-79	Monthly UI Weekly UI	45.2 n/a	51.6 n/a	4.6 1.8	6.6 4.4
Jackson et al. [312]	US	2	1,017	19.0	55-75	Any UI	66.0	63.1	9.6	7.1
Nygaard & Lemke [313]	US	6	2,025	n/a	65+	Any SUI Any UUI	40.3 36.3	n/a n/a	4.77 4.75	5.02 3.68
Gavira Iglesias et al. [314]	Spain	5	486	34.9	65+	Any UI	41.0	54.0	7.2	2.8
Herzog et al [258]	US	2	1,154	30.2	60+	Any UI	37.7	52.7	15.8	7.5
Burgio et al. [315]	US	3	541	61.9	42-50	Monthly UI	30.7	n/a	2.7	n/a
Melville et al. [216]	US	6	5,820	18.1	57-67	Monthly UI	13.5	n/a	3.5	n/a
Jahanlu & Hunskaar [137]	Norway	10	2,331	13.0	40-44	Any UI	38.9	43.9	4.9	n/a
Legendre et al. [316]	France	12	4,127	7.4	46-50	Any UI	24.5	34.7	3.3	6.2
Botlero(Botlero, Davis, Urquhart, & Bell, 2011)	Australia	2	506	12.6	26-82	Any UI	41.6	44.6	8.5	8.4

3. INCIDENCE AND REMISSION

Many prospective longitudinal studies have examined UI in women, either in the general population, or focused on pregnancy, menopause or old age. However, interpretation and comparison of incidence and remission rates is fraught with difficulties. Incontinence is not intuitively a condition, with fluctuating severity, indeed the popular perception in both the medical community and the general public, is of a chronic condition. However misclassification due to the unreliability of symptom assessment tools may cause the appearance of symptom fluctuation. Measuring the short term test re-test reliability for the BFLUTS questionnaire [118], the DAN-PSS [119], the IIQ [120], or any of the other commonly used questionnaires suggests that only 80-85% of item responses are stable over even a brief retest period. Thus even when a longitudinal study is able to use the exact same item for assessment across even relatively long periods of follow up, the effect of misclassification due to questionnaire unreliability may obscure a true effect of incidence or remission. Even non-differential misclassification bias, can have serious consequences both for estimates of absolute cumulative incidence, and relative incidence risk, and such effects are largest for conditions such as UI, with high prevalence and low incidence [121]. Other methodological differences may also cause wide variation. Questionnaires that use different recall periods (e.g. any leakage in last week, any leakage in last year, any leakage ever) will produce different estimates of incidence and remission. Due to changes in standard definitions, many studies have also used different case definitions at baseline and follow-up. Finally, although loss to follow up itself is very variable between studies, differential loss to follow-up is observed in almost all studies, and must substantially decrease generalisability.

Annual incidence rates for broad definitions of UI (“monthly” or “any”) range from 0.9% to 18.8%, while rates for weekly UI show less variation at 1.2-4.0%. There is a significant negative correlation between the length of a study and its reported annualized incidence rate, suggesting that short studies of 1-2 years overestimate incidence due to a dominating effect of misclassification. Limiting comparisons to studies with >5yr follow up suggests incidence of 1.3-4.9% even for inclusive definitions of UI. Fewer studies have reported remission rates, and again estimates vary widely between 1.2 and 42%. Again limiting the comparison to longer studies of >5yrs suggests rates of 2.1 to 5.0%. Overall these results are compatible with findings from cross-sectional studies, with modest increases in UI prevalence across the whole female population of 0.5-1% per year. Although the extent of cohort effects has rarely been reported, current data suggests that earlier cohorts are less likely both to report incontinence [122-123], and to seek care for it [124].

4. POTENTIAL RISK FACTORS

This section summarises the most important reported demographic, social, environmental, and lifestyle correlates of urinary incontinence in women. Familial risk factors for incontinence and prolapse are considered together in the section on genetic epidemiology.

While a majority of previously cited studies have reported associations with incontinence, great caution is again needed in assigning these as causal risk factors. As already seen, a large majority of studies are cross-sectional in design, providing no evidence of causation, since the temporal association of the putative risk factor and the onset of incontinence cannot be assessed. Where possible we therefore try to focus on risk factors for incident UI, from longitudinal studies. Again though, with the exceptions of mode of delivery, menopause hormone therapy, and weight loss, there remains a dearth of interventional studies. Even the highest quality observational studies may suffer from residual or unmeasured confounding, further limiting conclusions about causality.

4.1. Age

The age distribution for incontinence of all causes reported in the widely cited EPINCONT study [125], depicts a steady increase in moderate and severe incontinence throughout the adult lifespan, but with a distinct peak in slight incontinence around the time of the menopause. Other large studies have, however, reported a steady increase in prevalence for both slight and severe UI, without a distinct menopausal peak [126]. The timing and causes of a fifth and sixth decade peak has been explored in a number of high quality longitudinal studies of menopausal transition, discussed subsequently. Where such a peak is identified from cross-sectional studies, it is most pronounced for stress incontinence [114-115]. Across most cross-sectional studies isolated stress incontinence declines into old age, as mixed incontinence becomes relatively more common [125,128]. Besides methodological differences, disparity in age ranges, severity thresholds, and proportion of each subtype of incontinence probably therefore explains the modest differences in age trends seen in Table 3. These age trends, drawn from cross-sectional studies, may in any case be biased by cohort or period effects.

While most cross-sectional studies find an increase in prevalence into old age, some high quality studies have identified a peak in all cause incontinence, with a decline in the eighth and ninth decade [129]. Such a large disparity might be explained by sampling strategies that include or exclude institutionalized adults. The epidemiology of UI in this vulnerable group deserves special attention, and of course remains of key interest to geriatricians. The epidemiology of incontinence in nursing home residents has been the subject of one systematic review [130]. Only one primary study provides data from more than one country, allowing cross-border comparisons. From a population

of 279,191 elderly people in care homes, from Denmark, France, Iceland, Italy, Japan, Sweden, and the US, the prevalence of female urinary incontinence was relatively stable at 42.0-72.5% [131], with much of that variation accounted for by differences in age structure, and proportion of residents with functional or cognitive impairment. Indeed variability in prevalence estimates for female care home residents across the entire literature is much less than for the general population [130], ranging from 42.0% in Japan [129] through to 78.4% in the US (using a much more inclusive definition) [132]. Urinary incontinence is associated with nursing home admission from the community [133]. This may in part explain the apparent steeper increase in prevalence with age in nursing homes compared to community dwelling samples [132]. Loss to follow up certainly limits our ability to accurately assess age trends in the elderly from cross-sectional studies.

Given the difficulties in establishing robust incidence estimates, most longitudinal studies do not provide good evidence of age trends in incidence. Studies have variably reported no change in incidence with age, or a stable incidence in middle age, with a sharp increase in old age. However, the large Nurse's Health Study cohort [134] provided good evidence of a decrease in incidence of stress UI following the menopause, which has more recently been explored in analyses of the SWAN study [135], the 1946 British Birth Cohort [127], and the Hordaland Women's Cohort [136-137]. All these studies provide consistent evidence of a peak in incontinence at the time of the menopause, with pre- and peri-menopausal status being associated with increased incidence of UI and decreased remission of UI compared to post-menopause. As will be discussed in the section on menopausal replacement therapy, part of this peak may be iatrogenic. Consistent with evidence from cross-sectional studies [114,125], the peak is attributable mainly to mild stress incontinence.

While the association between age and female UI is clearly important for planning healthcare resource allocation, in many studies this is not an independent association. Other risk factors associated with age, including parity, co-morbidities, and BMI attenuate the association with UI [126], and additional adjustment for relevant co-morbidities typically eliminates the association [138]. Confounding factors adequately explain the association between age and UI, and therefore UI in women should not be considered as an intrinsic consequence of the aging process itself.

4.2. Obesity and Adiposity

Obesity is perhaps the most clearly established risk factor for UI in women. There is a wealth of cross-sectional, longitudinal, and interventional data demonstrating positive association between BMI and UI, which has been subject of several systematic reviews [139-140]. Across a wide range of studies obese women have approximately double the risk of UI. A typical pattern of association, taken from the large Nurses' Health Study II [141] (n = 83,355) is demonstrated in Figure 2. The ORs for UI by severity are plotted against BMI, from underweight through to obese. Although the Nurses' Health Study II is limited to middle aged women, such findings are consistent across all age groups, both within studies [142], and between studies [139]. This association is quite minimally attenuated by adjustment for other risks for UI.

Data from the EPINCONT survey also demonstrate the same positive association between BMI and more severe incontinence. Additionally they indicate that such associations hold for the major subtypes of incontinence (Figure 3), but are most pronounced for mixed UI, and relatively modest for UUI. Similar findings were reported for data from the Heart and Estrogen/Progestin Replacement Study [143] and the 1946 British Birth Cohort [144], with the associations

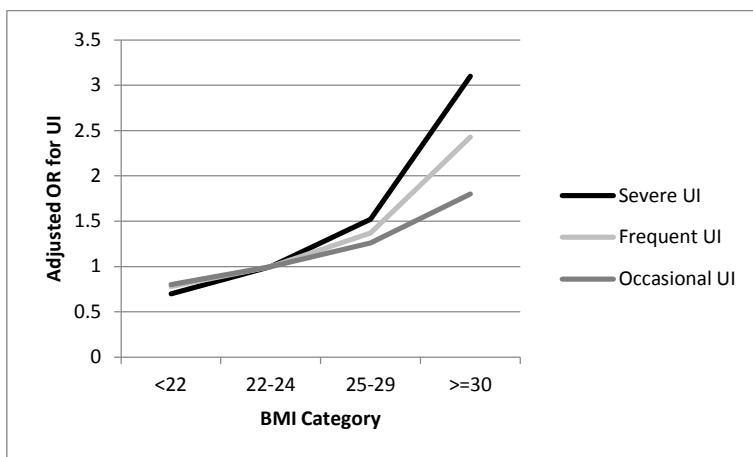

Figure 5: Associations between BMI and UI severity from the Nurses' Health Study II. Original figure created based on data reported in Danforth et al. [141].

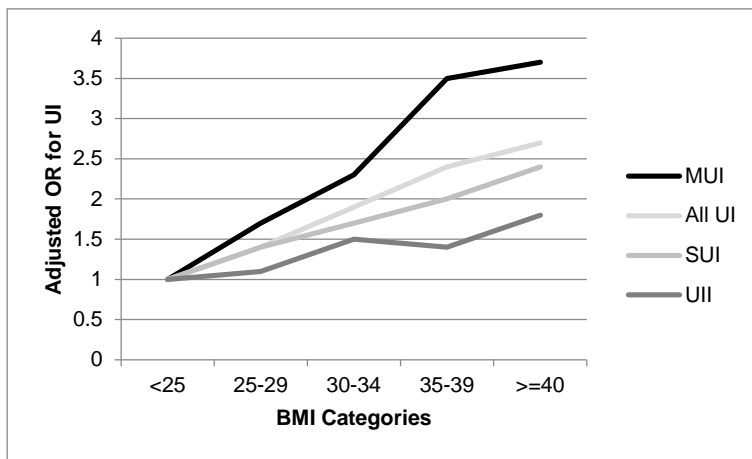

Figure 6: Associations between BMI and UI subtype from the EPINCONT study. Original figure created based on data reported in Hannestad et al. [148].

with BMI being greater for stress or mixed UI compared with urgency UI.

The temporal association between BMI and UI is also established with data from the 1946 British Birth Cohort, SWAN, MRC Incontinence [145] and the Nurses' Health II studies demonstrating that earlier onset of obesity is associated with increased risk for UI in middle age [127], and that both higher BMI and greater weight gain are associated with increased risk of incident UI [145-147]. Although again it is hard to compare between studies, it appears that BMI may be a greater risk factor for incident UI than for prevalent UI adding credence to the association [147]. As for cross-sectional studies, the association is stronger for incident stress UI and mixed UI, compared with incident urgency UI [145, 147].

There is adequate evidence [149-150], that obesity increases intra-abdominal pressure, predisposing to stress incontinence, while metabolic syndrome associated with obesity predisposes to urgency incontinence [151- 154]. Consistent with this, waist circumference and waist to hip ratio appeared to be associated only with stress UI, and not with urgency UI in the SWAN [147] and HERS studies [143]. More recent data from BACH [155] and KNHNES [156] indicate that measures of central adiposity are also correlated with urgency UI.

Finally, intervention studies for weight reduction have reported that even modest weight loss is associated

with improvement or resolution of both stress and urgency UI, with the probability of resolution correlated to the degree of weight loss [149,157-160]. Despite the complex interplay between weight and other risk factors for UI, we still have robust evidence to support a causal role of BMI in the development of UI.

4.3. Parity, pregnancy & mode of delivery

Parity is considered by the laity as among the most important risk factors for UI. This is reflected in almost all large cross-sectional surveys (Figure 4). Some early studies reported a threshold effect at one delivery and little or no additional risk with increasing parity [161-163], but in most subsequent work, increasing parity is associated with increased risk of UI. A single delivery is typically associated with adjusted OR of around 1.3-1.6 for UI, and further deliveries linearly increasing the risk up to an adjusted OR of 1.5-2.0 [126,141,147,164].

As expected these effects are strongest in the third and fourth decades, with substantial attenuation through middle age, and in many studies no persistent effect in old age [142,164-166], as other risk factors come to dominate. Although the EPINCONT [164] and SWAN [147] studies reported only association between parity and stress or mixed UI, other studies have also suggested, a reduced but significant association with urgency UI [167-168].

Table 10. Prevalence of urinary incontinence in the first post-partum year among primiparous women by type of delivery

VD=all vaginal deliveries; SVD=spontaneous vaginal delivery; IVD=instrumental vaginal delivery (forceps and/or vacuum); CS=all Caesarean Sections; eICS=elective Caesarean Section (prior to labor); emCS= emergency Caesarean Section (after onset of labor)

- **Prevalence estimates restricted to women with no UI prior to pregnancy**

Reference	Country	Type of delivery	N	Type of UI	Severity of UI	Prevalence (%) by months post-partum		
						1 to 3 months	4 to 6 months	7 to 12 months
Chaliha et al. [317]	UK	VD	289	All Stress	Any	15 13		
		CS	131	All Stress	Any	9 8		
Eason et al. [186]	Canada	VD	467	All	Any ≥Weekly Daily	31 10 3		
		CS	104	All	Any ≥Weekly Daily	12 2 1		
Eftekhari et al. [318]*	Iran	VD	357	Stress	Any		16	
		CS eICS emCS	345	Stress	Any		12 11 25	
Ekstrom et al. [319]	Sweden	VD	197	Stress Urge	Any	20 4		15 6
		eICS	192	Stress Urge	Any	4 3		5 5
Pregazzi et al. [193]	Italy	VD	379	Stress Urge	Any	8 6		
		SVD	218	Stress Urge	Any	16 1		
Farrell et al. [190] *	Canada	SVD	313	All	Any	23	22	
		CS eICS emCS	125 27 98	All	Any	8 4 9	10 5 12	
Groutz et al [320]*	Israel	SVD	145	Stress	Fortnightly			10
		eICS emCS	118 100	Stress	Fortnightly			3 12
Glazener et al. [200]*	New Zealand, UK	VD SVD IVD	2805 19548 51	All	Any	32, 29 31, 28 33, 30		
		CS	569	All	Any	16, 12		
Schytt et al. [321]	Sweden	VD SVD IVD	750 617 133	SUI	Any			20 19 22
		CS eICS emCS	165 43 122	Stress	Any			9 0 11

Reference	Country	Type of delivery	N	Type of UI	Severity of UI	Prevalence (%) by months post-partum		
						1 to 3 months	4 to 6 months	7 to 12 months
Borello-France et al. [185]	USA	VD	356	All Stress Urge Mixed	Any	35 17 4 15	31 14 3 14	
		eICS	116	All Stress Urge Mixed	Any	25 11 4 10	23 14 1 8	

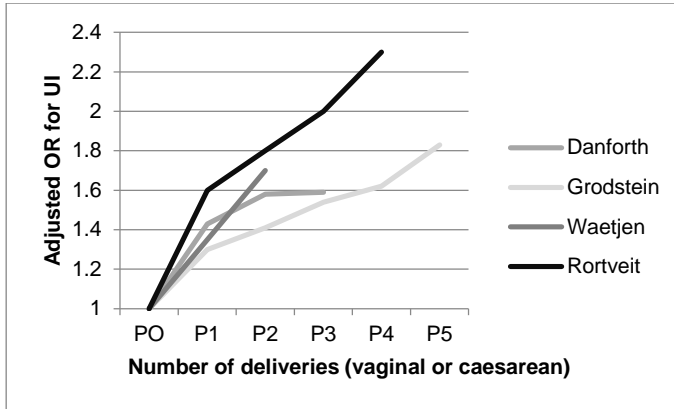

Figure 7: Adjusted OR for UI from selected large cross-sectional surveys. Figure created for this chapter combining data in: (Danforth et al., 2006 [141]; Grodstein et al., 2003 [126]; Rortveit et al., 2001 [164]; Waetjen et al., 2007 [147]).

There is a substantial difference in effect between vaginal delivery and caesarean delivery, that has also been the subject of two systematic reviews [169-170]. Over short term follow-up meta-analysis of data from four large cross-sectional studies [171-174], suggested a significant protective effect of caesarean on stress UI (OR 0.56) and mixed UI (OR 0.70). For long term follow up, meta-analysis of 15 studies again found almost double the risk of stress incontinence after any vaginal delivery (spontaneous, or assisted) compared to any caesarean section (adjusted OR 1.85, absolute risk difference 8.2%), with a smaller effect on urgency incontinence (adjusted OR 1.30, risk difference 2.6%). In meta-regression of long term studies the effects on stress incontinence were much more pronounced for younger women, further adding to our confidence in assigning a causal role for vaginal delivery.

Generally across all observational studies, women delivering exclusively by caesarean have similar prevalence for UI as age matched nulliparous women. While the existing interventional studies remain significantly underpowered, the same direction of effect for caesarean is still seen [175].

Pregnant women, and those in the early post-partum period are typically excluded from population-based studies of UI, but a large body of work considers the specific epidemiology of UI in and around pregnancy. A systematic review including 33 population-based studies, each with response rate over 50% [105], concluded that the prevalence of UI in the first three months post-delivery was 30%, with infrequent stress UI being the most common. The difference in UI rates between women delivering vaginally and those delivering by caesarean is evident immediately after delivery. As demonstrated in Table 5 (adapted from Abrams et al 2009 [109]), there is a gradual decrease in prevalence during the first post-partum year.

Despite the protective effect of caesarean, for many women the onset of incontinence is during pregnancy itself. The point prevalence of UI is low in the first trimester, rising rapidly in the second trimester and increasing slightly in the 3rd trimester [176-177]. In the population based Norwegian Mother and Child Cohort Study, (n = 43,279), the prevalence of stress incontinence from before to during pregnancy, rose from 9% to 31% in nulliparous women, and from 24% to 42% in parous women [178]. In contrast, mixed incontinence showed a similar rise in both groups (from

6% to 16% and from 8% to 20%, respectively). Urgency incontinence remained virtually unchanged in both groups at less than 5%. In follow up of these women, the onset of incontinence during pregnancy was strongly predictive of post-partum UI (adjusted RR 2.3, 95% CI 2.2-2.4), with little modification by mode of delivery. Such an effect seems to persist into long term follow up [179-182], even for women who return to full continence in the immediate post-partum period. It seems that the temporary physiological changes during pregnancy may reveal women with a predisposition to incontinence in later life, in a manner analogous to gestational diabetes [183].

There are other suggested potentially modifiable obstetric risk factors, including induction of labour, forceps delivery, and use of episiotomy. Regardless of conflicting observational evidence of an effect of episiotomy (for example references 184-187), there are a large number of interventional studies that have not shown either harm or benefit [188]. Similarly while forceps delivery has conflicting evidence from observational studies (for example references 187,189-191), within the context of the second stage of labour, maternal urinary incontinence is of secondary importance in decision making regarding choice of delivery instrument [192]. In a similar vein, while induction and augmentation of labour, and use of epidural anaesthesia have each been identified as being associated with both early postpartum and persistent UI [193-196], it is doubtful whether this should have any effect on current obstetric practice.

Many other suggested obstetric risk factors, including age at first delivery, and birth weight, are perhaps not meaningfully modifiable. Several studies have suggested that older age at either first or last birth is associated with UI [144, 197-199], although more recent data from the RRISK study suggested a U shaped distribution [195], with very young mothers also at increased risk. Inadequate adjustment for socio-economic class may explain all these effects. Numerous studies have suggested that greater birth weight at a single delivery, or maximum weight of infant across all deliveries may also be associated with UI [162,165,195,200-202]. Although elective caesarean would be protective, birth weight is still challenging to predict, and again pragmatic randomised interventional trials are needed before making clinical recommendations.

4.4. Menopausal Replacement Therapy

Menopausal oestrogen replacement therapy was once widely prescribed as a treatment for urinary incontinence during or after menopause, on the basis of rather heterogeneous data from clinical trials [203], and inconsistent associations in cross-sectional studies [196,204]. While current evidence overall continues to support prescribing of topical oestrogen [205], the Nurse's Health Study [206], the Heart Estrogen/Progestin Replacement Study (HERS) [207], and

Women's Health Initiative (WHI) Hormone Replacement Trial [208] all provided strong evidence that oral oestrogens, with or without combined progestogens were associated with increased incident UI. In the placebo controlled HERS trial, women randomised to conjugated oral oestrogen plus medroxyprogesterone were more likely to experience worsening of their incontinence over 4 years (39% vs. 27%, $p < .001$) [207]. In the randomised WHI trial, continent women receiving oestrogen, with or without progestogen, were approximately twice as likely compared to women receiving placebo to have developed stress incontinence at 1 year (16% vs. 9%, $p < .0001$) [208]. The risks of mixed and urge incontinence were also significantly increased, though more modestly. Further trials including oestrogen arms have subsequently been reported during development of selective oestrogen receptor modulators (SERMs), confirming these findings [209]. Some SERMs have themselves been associated with an increased risk of UI [210] (Albertazzi & Sharma, 2005), although raloxifene appears safe [209].

4.5. Hysterectomy

Hysterectomy is among the most common major procedures performed for women in Western nations. Many women date the onset of incontinence to a hysterectomy, but uncontrolled case series and small randomised trials have produced conflicting results. Evidence from large population-based observational studies has increasingly suggested a causal link, although the underlying pathophysiological mechanism is poorly understood.

Among a sample of 1,517 Taiwanese women aged 65 years and over, hysterectomy was associated with OR 1.8 for UI, with no difference between abdominal and vaginal hysterectomy [211]. Earlier trials had, however, suggested either no effect [212-213], or rather more modest effects [214]. Where an association is found, it is strongest with case definitions consistent with "severe UI" [141,215-216], perhaps reflecting high rates of mild UI in controls. Using a sample of more than 900,000 women from the Swedish Population Register, abdominal hysterectomy for benign disease was associated with a hazard ratio of 2.1 for subsequent stress UI surgery, while vaginal hysterectomy for prolapse was associated with a hazard ratio of 6.3 [217]. Similar results were observed comparing hysterectomy and endometrial ablation in the Scottish Morbidity Returns database [218]. Recent data from a randomised trial of levonorgestrel-IUS versus hysterectomy [219] does confirm this effect. In follow up of 236 women, increased incidence of stress UI (OR 1.83 95%CI 1.01-3.22) was first apparent at 10 year follow, with significantly higher rates of treatment for both stress and urgency UI.

Overall hysterectomy appears to be associated with development of subsequent incontinence symptoms, and particularly with the need for stress UI surgery.

One potential mechanism is loss of pelvic floor support at the time of surgery. The data from observational studies should still be considered cautiously, as findings may be influenced by both healthy responder bias and medical surveillance bias, the latter of which may also affect unblinded interventional studies.

4.6. Diet

Many dietary constituents including coffee, tea, alcohol and carbonated beverages have all implicated in the pathogenesis of UI. Dietary data are difficult to obtain reliably [220], and women may change dietary intake in response to UI, making cross-sectional studies of diet and UI difficult to interpret.

The consumption of coffee or other caffeinated drinks as a risk factor for UI has been most widely studied. While some studies report a positive association associated with an increased risk of UI [221-224], others have either report no association [225-227], or a protective effect [145,228]. Even within the large EPINCONT study there were conflicting findings regarding coffee, with a positive association with mixed UI, but a negative association with stress UI [148]. The WHI study demonstrated a dose-dependent positive association between caffeinated coffee and urge UI, but not for decaffeinated coffee or for other UI subtypes [229]. The EPINCONT study suggested a positive association between tea drinking and stress UI or mixed UI [148], while analysis of the Swedish Twin Registry Cohort showed an association only with overactive bladder [228]. The Leicester MRC Incontinence study is one of two studies to have used food frequency questionnaires, and found no association with tea [145]. It is unclear whether tea consumption contributed significantly to the overall association between UI and dietary caffeine in the WHI study [229]. At a population level the overall picture is therefore unclear, despite suggestive evidence of improvements in symptoms reported from interventional trials of caffeine reduction [230].

Anecdotally, alcohol consumption may be acutely associated with urinary urgency and urgency incontinence. A positive association between alcohol consumption and UI has been reported by some studies [231], but is found to be either protective [145, 232], or of no significance [148] in other studies. Differences between studies may reflect confounding associations between age and alcohol consumption.

The most comprehensive assessment of diet as a risk factor for UI comes from the Leicester MRC study [145]. Besides effects reported above, this study also found increased incidence of stress UI with increased intake of carbonated drinks, and reduced incidence of overactive bladder with increased intake of bread, potato and vegetable consumption. While these effects certainly provide interesting avenues for further research, there is no evidence of a causal association, and instead these dietary components may be surrogates for other unidentified socioeconomic risks. Overall there is a lack of consistency in reports of dietary associations with UI that most likely reflects methodological limitations rather than differences between populations.

4.7. Socio-economic status

Socio-economic status (SES) is strongly correlated with many of the other risk factors for UI including parity, BMI, diabetes, depression, smoking and timing of menopause. Higher SES is consistently associated with increased care seeking for UI, but there is conflicting evidence of association between SES and UI prevalence, or its bothersomeness. While many studies do include some measure of SES as a potential confounder, its effect is frequently not reported. Table 6 summarises some of the major studies that have reported associations, to highlight inconsistencies both by SES definition and UI definition. In the table a positive association is cited where women of higher SES, i.e. higher income/more education, report a greater prevalence of UI.

Table 11. Selected studies reporting associations between socioeconomic status and UI in women. Directions of effect summarized across multiple measures of SES. Positive association reported where statistically significant association (OR or RR) of more UI among women of higher social status, and vice versa for negative association.

Reference	Country	♀ Sample	SES Measure	Incontinence Definition	Direction of Association
Huang et al. [322]	US	2,109	Educational level	Bothersome UI*	Negative
Sampsel et al. [235]	US	3,302	Educational level Financial strain	Any UI Bothersome UI*	Positive Negative
Waetjen et al. [147]	US	2,702	Educational level Social Support	Monthly UI Monthly UUI	Negative Positive
Kraus et al. [323]	US	654	Occupation	Bothersome UI*	Negative

Reference	Country	♀ Sample	SES Measure	Incontinence Definition	Direction of Association
Tennstedt et al. [238]	US	3,205	Composite Index	Weekly UI	Nil
Melville et al. [175]	US	3,506	Educational level Income	Monthly UI Monthly UI	Negative Negative
Saadoun et al. [324]	France	2,640	Educational level Occupation	Monthly UI Monthly UI	Nil Nil
Roe & Doll [325]	UK	2,699	Occupation	Monthly UI	Nil
Kuh et al. [144]	UK	1,333	Educational level Educational level	Monthly SUI Monthly UUI	Positive Nil
Coyne et al. [249]	US/UK/ Sweden	15,861	Educational level Occupation	Monthly UI Monthly UI	Negative Negative
Ge et al. [236]	China	3,058	Educational level Occupation	Monthly UI Monthly UI	Negative Negative

**Defined using either quality of life questionnaire, or symptom bother rating.*

4.8. Smoking

Data from observational studies on smoking are also quite inconsistent. It has been reported to be an independent risk factor for UI in women in some cross-sectional studies [145,148, 233-235] but not in many others [138,236]. Within studies that do find an association, former smokers have a risk intermediate between never smokers and current smokers, and some dose response effect is evident, adding plausibility.

However, with one exception longitudinal studies have consistently failed to find a significant association between either past or current smoking and incident UI in multivariate analysis [147,212,213,237,238]. Only in the Leicester MRC study [145] was current smoking associated with increased risk for incident stress UI. The conflicting data from cross-sectional studies and lack of association between smoking and incident UI in most prospective studies suggests that smoking is probably not a causal risk factor for UI.

4.9. Exercise

Evaluating associations between physical activity and incontinence remains complex. It is clear that high impact exercise such as gymnastics [239-240], or trampolining [241-242] leads to stress UI, with a dose dependent deleterious effect. However, women who suffer with UI, and particularly stress UI, may feel less able to engage in such sports [243]. Furthermore with increasing interest in core training as a treatment for UI [244], there are theoretical reasons to believe that low impact exercise might have a direct therapeutic effect. With these competing mechanisms at play, unsurprisingly cross-sectional studies have again produced conflicting evidence (see for example references 138, 245-246). However, among cross-sectional

studies, comparison of low impact and high impact exercise is suggestive that as hypothesised, high impact sports might be harmful, while low impact sports might be protective [148,247].

Evidence from longitudinal studies overall suggests that exercise does have a protective effect against incident UI, but perhaps only mediated via an effect on weight. In the Leicester MRC study, women who reported that they exercised less frequently were at increased risk for both incident stress UI and overactive bladder (OAB) in a model that adjusted for physical functioning, although notably this association was eliminated in a full model, adjusting for obesity [145]. In a study of 4,291 older women exercise at baseline was not associated with incident UI at 10 year follow up after multivariate adjustment [238]. Perhaps the strongest evidence comes from the Nurses' Health Study [248]. In this population of US nurses aged 54-79, a higher level of physical activity across 14 years of follow-up, was associated with a reduced risk of UI overall, and specifically stress UI, although after adjustment for BMI and other factors, the overall effect was small.

4.10. Comorbidities: Diabetes, Urinary Tract Infection, Cognitive Impairment, Ischaemic Heart Disease, Physical Impairment, and Depression

In cross-sectional studies many different comorbidities have been associated with UI in univariate analysis [204, 249-250]. However, in most cases these have no explicatory power, being neither a cause nor consequence of UI, but only associated with other known or unknown mediators of UI, or differentially diagnosed due to medical surveillance bias. In this section, we therefore concentrate on studies that are able to adjust for a wide range of confounders, and again give priority to associations of incident UI.

Many cross-sectional studies have reported urinary incontinence to be more common in women with either type 1 or type 2 diabetes, than among women with normal glucose levels, even after extensive adjustment for known risk factors [147,172,212,249,251-252]. There are conflicting data regarding a dose dependent association, e.g. between HbA1C and UI severity [251,253]. Longitudinal evidence is also conflicting. In the Nurses' Health Study cohort [254], Type 2 diabetes was a slight but significant predictor of incident UI (RR=1.21), and the magnitude of the association was seen to increase both with duration of diabetes and with severity of incontinence. Despite significant associations with prevalent UI in the SWAN study, no association with either incident UI [147], or worsening UI was found [147]. Perhaps the best evidence however comes from recent analyses of women enrolled in the Epidemiology of Diabetes and its Complications study. Over 7 years of follow up, more than 10 years after a diagnosis of type 1 diabetes, HbA1C was shown to be a powerful predictor of incident incontinence (odds ratio 1.41, per % HbA1c increase), even after careful adjustment. There are plausible pathophysiological mechanisms by which diabetes might induce incontinence, and it seems likely based on the totality of current evidence that it truly has a causal role.

Acute urinary tract infection (UTI) is a direct cause of transient UI [255], but caution is required regarding a causal association with chronic UI. UTIs are often diagnosed and treated based on symptoms alone, and there may therefore be a risk of misclassification between exposure and outcome. Many cross-sectional studies have found that women with UI are more likely to report having had one or more lifetime UTIs [225,256,-258], and longitudinal data suggest both that UI can cause UTI, and that UTI can lead to UI. Two prospective studies found that baseline UI was a risk for incident UTI [255,259], among middle aged and elderly women, and in the Leicester MRC study, a history of UTI was associated with both incident stress UI (OR 1.9) and incident overactive bladder (OR 2.1) in women aged >40 [250].

Prevalent UI has a clear association with dementia [260-261], but until recently longitudinal studies did not identify an association with incident UI. One longitudinal study of 6,349 community dwelling women found that a decrease in mental functioning as measured by the modified mini mental status exam (MMSE) was not associated with increased frequency of UI over 6 years, but did predict a greater impact [262]. Despite strong associations with baseline UI in the Canadian Study of Health and Aging, moderate or severe cognitive impairment, again defined by the modified MMSE, was not associated with incident UI over 10 years [238]. However, in a sample of 12,432 women aged 70-75, followed up for 9 years, the Australian Longitudinal Survey of Women's Health did demonstrate an association with diagnosed dementia (OR 2.34) [263]. In a 9 year follow up

of 1,453 women aged 65 years and over enrolled in an US HMO, diagnosed dementia was strongly associated with incident diagnosis of UI (RR 3.0 95%CI 2.4-3.7) [264]. Given the strength and consistency of associations with prevalent and incident UI, and given that treatment for reversible dementias can improve UI [265-266], a causal role seems certain.

Ischaemic heart disease is associated with many risk factors for UI, but perhaps because of Neyman's bias, caused by exclusion of participants who have died, cross-sectional studies have often failed to identify an association with UI itself even in univariate analysis [204,267]. The BACH study reported a strong association only among black participants (OR 2.52) in multivariate analysis [138]. In the Leicester MRC study [250], a history of ischaemic heart disease was associated with baseline stress UI and OAB only in univariate analysis, and with no association with incident symptoms. In contrast, the Nurses' Health Study found that coronary heart disease was associated with incident weekly UI (OR 1.46), and incident severe UI (OR 1.79) [212]. If ischaemic heart disease is a risk factor for incident UI, its effects might be mediated by cardiac failure [264], or polypharmacy [268-269].

Several cross-sectional studies have documented an association between depression and incontinence [147,172,214,270,271,272]. In the SWAN study, depression was not associated with incident UI, but in the UAB Study of Aging, in a sample of 490 women aged 65 years and older, baseline depression was weakly associated with incident UI (OR 1.2) over 3 years of follow-up [273]. Similarly in the Health and Retirement Study participants (n = 5,820), major depression was a modest predictor of incident UI (OR 1.46) over six years of follow-up, and including extensive adjustment for confounders. Baseline incontinence did not predict incident depression in the same study. In a follow up of women aged 65 years and older enrolled in an HMO, diagnosed depression was also associated with incident diagnosed UI over 9 years (OR 1.6) [264]. Although it seems plausible that the stigma of UI leads to depression (for example by reducing a woman's social network), current evidence supports causality in the opposite direction, most likely as depression increases the bother of UI symptoms.

Functional impairments, particularly mobility limitations, a history of falls, arthritis, dizziness, use of a walking aid, and poor lower extremity strength, have been correlated with UI in many community-based and nursing home studies [138,261,270,272]. In the Nurse's Health Study osteoarthritis and functional limitations were plausibly associated only with incident urge UI (RR 1.86 and 2.10 respectively), not with incident stress UI or mixed UI [254]. In a study of 2,025 older women, improvement in Activities of Daily Living was associated with remission of urge UI at 3 year follow up [272]. Other longitudinal studies have shown similar findings [262,273]. It remains unclear

whether UI is a direct consequence of difficulties in getting to the bathroom and/or removing clothing, or whether mobility limitations and UI may both be consequences of general frailty in older age or of an underlying systemic illness.

4.11. Ethnic Variation

Ethnic variation in any disease provides only limited evidence for any underlying genetic predisposition. Environmental or cultural differences rather than genetic differences may explain differences in prevalence between populations. As there are very wide variations in UI prevalence between studies, meaningful comparison by race and ethnicity can be made only where such data has been reported within one study. Almost all population-based studies comparing the prevalence of UI among women from one or more racial or ethnic groups originate from the US, which may limit generalisability of conclusions. Results are summarised in table 7. In general, across all studies, white women have a higher prevalence of UI, and in particular stress UI than all other groups.

The starkest and most consistent contrast is in rates of stress UI for black and white women. In most studies, black women have half the prevalence of stress UI compared to white women, with differences persisting after adjustment for age, parity and BMI. In comparing prevalence of mixed and urge UI for white and black women, there is less consistency. Most studies suggest similar prevalence of urge UI and mixed UI, however, the BACH survey found very high rates of mixed UI [138] among black women, while the EPI study reported very high rates of pure urgency UI [257]. These cross-sectional data are supplemented by longitudinal studies. In SWAN [147], black women were at half the risk of incident stress UI, but nearly double the risk of incident urgency UI. In the Nurse Health Studies [274], black women had lower risk of both overall UI, and stress UI after adjustment. The consistency of this difference across both cross-sectional and longitudinal studies, employing different case definitions suggests a real difference in prevalence rather than simply reporting bias.

Table 12. Population-based studies reporting ethnic variation in incontinence prevalence.

Reference	Age	Sample Size	Case Definition	Prevalence (%)			
				White	Hispanic	Black	Asian
Fultz et al. [326]	70+	3,991	Any UI	23	-	16	-
Nygaard et al [272]	50-69	5,701	Any UI	17	10	10	-
Nygaard et al. [286]	20+	1,961	Monthly UI	16	16	14	-
Burgio et al. [315]	42-50	541	Monthly UI	32	-	18	-
Grodstein et al [206]	50-75	82,936	Monthly UI	35	28	21	26
			Weekly UI	18	16	10	13
Danforth et al. [141]	37-54	85,670	Monthly UI	18	19	14	14
			Weekly UI	26	26	22	18
Sampselle et al. [235]	42-52	3,258	Any UI	66	42	50	52
Waetjen et al. [147]	42-52	3,002	Monthly UI	57	28	39	39
			Weekly UI	20	11	13	9
			Monthly SUI	32	21	13	27
			Monthly UUI	8	1	12	4
			Monthly MUI	16	5	13	7
Anger et al. [275]	60+	23,477,726	Any UI	41	31	20	-
			Monthly UI	35	27	17	-
			Weekly UI	25	25	15	-
			Daily UI	15	8	11	-
Jackson et al. [267]	70-79	1,558	Weekly UI	27	-	14	-
			Weekly SUI	12	-	5	-
			Weekly UUI	11	-	7	-
Dooley et al. [327]	20+	4,229	Any UI	53	50	38	-
			Any SUI	27	26	12	-
			Any UUI	8	8	11	-
			Any MUI	19	17	15	-
Fenner et al. [258]	35-64	2,814	Monthly UI	33	-	15	-

Reference	Age	Sample Size	Case Definition	Prevalence (%)			
				White	Hispanic	Black	Asian
			Weekly UI Monthly SUI Monthly UUI Monthly MUI	21 13 4 7		9 4 4 4	
Markland(Markland et al., 2009)	65+	421	Any UI	45	29	-	-
Markland et al. [270]	65+	490	Monthly UI	41		25	
Tennstedt et al. [238]	30-79	3,205	Weekly SUI Weekly UUI Weekly MUI Weekly Other UI	35 13 44 7	14 11 69 6	9 3 82 5	-
Thom et al. [328]	40-69	2109	Monthly UI Weekly UI Daily UI Weekly SUI Weekly UUI Weekly MUI	45 30 12 15 9 3	51 36 17 18 10 5	37 25 12 8 14 2	34 19 9 8 7 3

Typically smaller groups of East Asian or Hispanic women have been included in these studies, which precludes clear conclusions. Broadly though, Asian women report lower prevalence of both stress and urge UI. There is less consistency in comparisons of Hispanic and non-Hispanic white women, with some studies reporting higher, and others lower overall prevalence. This heterogeneity may be explained, at least in part, by differences in prevalence among sub-populations, with Mexican-American women being at higher risk than other Hispanic women [275], or differences in extent of adjustment for covariates.

These studies therefore clearly demonstrate wide variation in self-report of incontinence, and particularly stress incontinence between women of different ethnicities. There may be substantial differences between women of different ethnicities in major risk factors for incontinence, including BMI, and perhaps parity, which might explain differences in incontinence. However, variation in prevalence might also reflect true differences in genetic susceptibility, particularly since in some studies the wide disparity in rates persists even after adjustment for the major known environmental risk factors.

5. SUMMARY POINTS

Despite a vast literature, there remain many uncertainties about the aetiology of UI. Despite wide consensus on the definitions of the symptoms of incontinence and its subtypes, there is no universally accepted threshold for clinically or biologically significant incontinence, and no objective tests that can be applied in the community. For these reasons, even

the prevalence of incontinence is not well established, and the incidence and remission are even less clear.

Despite a number of high quality longitudinal studies, the literature on risk factors for incontinence is very heterogeneous. Among young and middle-aged women, only age, BMI, parity and mode of delivery are unambiguously associated with incontinence, and for all of these, the association with stress UI is greater than with urgency UI.

V. EPIDEMIOLOGY OF URINARY INCONTINENCE IN MEN

1. GENERAL COMMENTS

The epidemiology of UI in men has not been investigated to the same extent as for females. However, progress has been made during recent years, particularly in the reporting of population-based studies of urinary incontinence among men and more specifically, of urinary incontinence associated with prostatictomy. In addition, more reports have been published on the risk factors for the development of UI in men.

In almost all community based studies, the prevalence rates of UI continue to be reported to be less in men than in women by a 1:2 ratio. The type and age distribution of UI appear to be different between the sexes, and risk factors, although less investigated in men, seem to be different from women. It is also important not to consider UI as an isolated problem in men, but rather as a component of a multifactorial

problem. Often other urogenital symptoms (LUTS) such as weak stream, hesitancy, and dribbling, or erectile dysfunction, exist.

Post-prostatectomy incontinence has been studied and reported with increasing regularity in the last few years. Since radical prostatectomy is being performed with increased frequency, and incontinence is one of the main complications of the procedure, a specific review of UI in the postprostatectomy patient population is presented in this section. In addition to epidemiological studies, we included clinical trial data on postprostatectomy incontinence.

2. PREVALENCE

Several surveys from the general population have been conducted to determine the prevalence of UI in men (Table V.1). Prevalences ranging from 1 – 39% have been published. The wide span of results may be explained by the variation in the population studied, the definition of incontinence used and the methods used in the surveys. A systematic review of 21 studies reported a prevalence of UI in older men ranging from 11-34% (median = 17, pooled mean = 22%), while that among middle-aged and younger men was from 3% to 5% (median = 4% , pooled mean = 5%). In the same review, the prevalence of daily UI in men ranged from 2-11% (median = 4%, pooled mean = 5%) [112]. A more recent systematic review of 69 prevalence studies on UI in community-dwelling men showed pooled overall prevalence rates from 4.81% to 32.17%, with prevalence increasing with age. [329]. A wide definition of UI, older age, inclusion of institutionalized men, and the use of self-reporting methods tend to result in higher prevalence rates [112,330,331]. For any definition of UI, there is a steady increase in prevalence with increasing age (Table 13).

Table 13: Examples of prevalence studies of UI among men

A. General Population Sampling, all adult age groups

Author and year [ref]	N	Response rate (%)	Country	Population (age)	Definition of UI used	Method of assessment	Prevalence (%)
Wu 2015 [349]	3604	88.9%	USA	≥50 yrs	At least weekly leakage or (of any volume) or monthly leakage (of volumes more than just drops)	Interviewer administered questionnaire	6.4 (5.4-7.5)
Kim 2014 [411]	1842	26.8%	Korea	≥40	Any UI by EPIC questionnaire; based on ICS definitions	Interviewer administered questionnaire (EPIC questionnaire)	9.1 (7.8-10.5)
Kogan 2014 [117]	1516		Russia, Czech Republic, Turkey	≥18	Any UI by EPIC questionnaire; based on ICS definitions	Structured telephone interviews	7
Zumrutbas 2014 [301]	636	74%	Turkey	≥18 yrs	ICIQ-SF The frequency and amount of UI were determined by the relevant questions of ICIQ-SF in the questionnaire.	Self-administered questionnaire	9.9
Osuga 2013 [303]	1198	Respondents members of longitudinal cohort study; 32% response rate to initial invitation to join cohort	Japan	≥40	involuntary loss of urine ≥ times per week.	Self-administered questionnaire (missing data followed up by interviewer)	3.3
Yoshimura 2013 [338]	3224		Japan	≥30 yrs	ICIQ-SF Definitions: Mild UI = once or less per week;	Self-administered questionnaire (missing data followed up by interviewer)	Any UI : 13.7 Mild UI : 10.4 Moderate UI : 1.4 Severe UI : 1.9

Author and year [ref]	N	Response rate (%)	Country	Population (age)	Definition of UI used	Method of assessment	Prevalence (%)
					Moderate UI = two or three times per week; Severe UI = once or more per day.		
Lee 2011 [412]	888	22.2%	Korea	>=18	Involuntary urinary leakage	Telephone interview using a questionnaire	2.9% (other UI = 1.3, SUI = 0.9)
Markland 2011 [413]	9071	-	US	>=20	Positive response to SUI/UUI/Other	Personal interview	13.9% SUI = UUI = 8.3% (7.6-9.0)
De Souza 2010 [414]	?		Brazil	>=18			6.2%
Malmsten 2010 [343]	4072	80	Sweden	45-103			
Markland 2010 [340]	5297	-	US	>=20	Score of 3 or greater on a validated incontinence severity index (moderate to severe leakage)	interview	4.5 (3.8-5.4)
Correia 2009 [415]	451	59.6%	Portugal	>=40	at least one episode of urine leakage in the previous month	Structured telephone interviews	7.65 (95% CI 4.8-10.4)
Espuna-Pons 2009 [416]	15,929		Spain	>=15		questionnaire	3.6%
Diokno 2007 [333]	21,590	66.5	US	>=18	Involuntary leakage or loss of urine in the past 30 days	Postal questionnaire	12.7%
Irwin 2006 [417]	19165	33%		>=18	ICS 2002 definition	Telephone interview	5.4 (1.9-5.9)
McGrother 2004 [308]	92491	60.2		>=40	In the last year, did you ever leak urine when you don't mean to?	Postal questionnaire	14.2
Boyle 2003 [339]	4 979	28-72%	France, Netherlands, UK, Korea	40-79	Lack of control over bladder function which caused urine leakage at times	Self-administered questionnaire	7 (France), 16 (The Netherlands), 14 (UK), 4 (Korea)

Author and year [ref]	N	Response rate (%)	Country	Population (age)	Definition of UI used	Method of assessment	Prevalence (%)
Brocklehurst 2003 [418]	1883	-		>=30	Ever suffered from bladder problems such as leaking, wet pants, damp pants	Interview	6.6% overall, 3.8% incontinent in the previous year, 2.8% in the previous 2 months
Engstrom 2003 [419]	?	86		40-80		Self-administered questionnaire	2 (SUI)
Finkelstein 2002 [353]	25400	88.7	Canada	>=30	urinary incontinence diagnosed by a health professional	interview	1.4 (per 100 population)
Parrazzini 2002 [420]	9613	97.5		>=50	Involuntarily leaked in the past 3 months		8.3 (7.7-8.9)
Van Oyen 2002 [245]	7 266	-		> =15			1.4
Schmidbauer 2001 [231]	1 236	-		Mean 49			5
Maral 2001 [334]	1 000	90		> = 15			1 (SUI), 3 (UUI)
Bortolotti 2000 [225]	2 721	-		> 50	Any urine loss in the last year	Telephone interview	3 32 (last year), 14 (weekly)
Roe 2000 [202]	12529	53	US				5.3
Smoger 2000 [421]	840	85		25-93, VA clinic	Incontinence in the past 12 months	Self administered questionnaire	32.3
Ueda 2000 [332]	3 500	52.5	Japan	> 40		Mailed self-administered questionnaire	10.5 (UUI)
Roberts 1999 [422]	778	-		> 50			25.6 (95CI 22.5-28.8)
Roberts 1998 [423]	2 150	-		> 40	Urinary leakage in the previous 12 months	self	18
Schulman 1997 [424]	2 499	-		> 30			5.2
Malmsten 1997 [342]	10 458	74		> 45			9

Author and year [ref]	N	Response rate (%)	Country	Population (age)	Definition of UI used	Method of assessment	Prevalence (%)
Legace 1993 [425]	2830	86%		>-20	Any urine loss in the past 12 months	Self-administered questionnaire	11 (9-13)
Obrien 1991 [426]	2496	79				Self administered questionnaire	7.4 (95CI 6.4 – 8.4)

B. General Population Sampling, Older Group

Author and year [ref]	N	Response rate (%)	Country	Population (age)	Definition of UI used	Method of assessment	Prevalence (%)
Vasilopoulos 2014 [427]	1514		USA	62-90 yrs, community dwelling	Any UI in last 12 months.	Self-administered and interview administered questionnaires	62-69 : 25.8 (SE 2.3) 70-79 : 38.4 (SE 3.0) 80-90 : 40.5 (SE3.6)
Ramage-Morin 2013 [428]	6639	92.1%	Canada	>=65	UI diagnosed by a health professional and had lasted, or was expected to last, at least six months	Structured telephone interviews	All men : 9.2 (8.3-10.2) 65-74 yrs : 6.4 (5.4-7.7) 75-84 yrs : 11.6 (9.8-13.6) ≥85 years : 18.7 (15.4-22.6)
Osuga 2013 [303]			Japan		involuntary loss of urine ≥ times per week.	Self-administered questionnaire (missing data followed up by interviewer)	60-69 : 2.9 70-79 : 5.3 ≥80 : 15.1
Wehrberger 2012 [429]	96	68%	Austria	85 yrs	UI definition: any involuntary urine loss during the past 4 weeks	Self-administered postal questionnaire	26.0
Kwong 2010 [430]	1705	47	Australia	>=70	Urinary leakage at least 2x/week over the past 4 weeks	Self administered questionnaire	14.8%
Smith 2010 [431]	572		US (Latinos)	older			26.9%
Correia 2009 [233]			Portugal	>= 60	of at least	Structured telephone interviews	60-69 yrs : 8.6 (95%CI 2.4-14.8)

Author and year [ref]	N	Response rate (%)	Country	Population (age)	Definition of UI used	Method of assessment	Prevalence (%)
					one episode of urine leakage in the previous month		70-79 yrs : 13.2 (95%CI6.3 – 20.0) ≥80 years : 21.6 (95%CI6.9-36.3)
Yu 2009 [432]	743		China (rural)	≥60		Face to face interview	33.38%
Janssen 2007 [409]		57%		≥ 65	Leaked or lost control of urine in the past year	Interview	13.1%
Dios-Diz 2003 [433]	350	-		> 64	-	-	? (95CI: 15-28)
Landi 2003 [344]	5372			≥ 85	MDS urinary incontinence scale of ≥1	Health care professional assessment	49%
Stoddart 2001 [434]	1 000	79		> 65	Incontinence in the previous month		23
Aggazzotti 2000 [435]	893	90		> 65, Community and residential homes	Involuntary loss of urine at least 2x/month	Questionnaire, review of clinical record	39.2
Gavira-Iglesias 2000 [436]	827	-		≥ 65	-	-	29 (25-38 95CI)
Smoger 2000 [421]	840	85		25-93, VA clinic	Incontinence in the past 12 months	Self administered questionnaire	32.3
Damian 1998 [335]	589 (including women)	78		≥ 65	Current experience of difficulty in controlling urine or urine escaping involuntarily	Interview	15
Umlauf 1996 [352]	1 490	53		Elderly	Uncontrolled urinary leakage of any amount the month before	Mailed self administered questionnaire	29
Nuotio 2003 [271]	171	-		≥ 70			24 (UII)
Thom 1997 [264]	1420	NA		≥65		Review of database	5.3
Herzog 1990 (MESA study) [258]		66% - 72%		≥60	In the past 12 months about on how many days have	Interview	18.9%

Author and year [ref]	N	Response rate (%)	Country	Population (age)	Definition of UI used	Method of assessment	Prevalence (%)
					you lost any urine, even a small amount beyond control		
Diokno 1986 [350]	805	65.1	US	60 older			

Due to differences in pathological anatomy and pathophysiology of UI in men and women, there is a different distribution in incontinence subtypes. Recent studies confirmed our previous reports of the predominance of urge incontinence (40-80%), followed by mixed forms of UI (10-30%), and stress incontinence

(<10%) [258]. The pooled prevalence rates in a systematic review confirmed that such distribution pattern across the different types of UI is consistent across the different age groups [329].

Table 15: Relative proportion of types of urinary incontinence in men.

Author Year	Population	Age group	UUI	SUI	MUI	Others
Shamliyan 2009 [329]	*	19-44 y	68.2	16.3	15.5	-
		45-64	59.3	28.9	11.7	
		65+	54.2	8.0	17.9	
		80+	65.9	0	34.1	
Diokno 2007 [333]	21,590	>=18	44.6	24.5	18.8	12.1
		18-34	30.0	38.1	14.8	17.1
		35-44	35.4	35.8	12.6	16.2
		45-54	38.9	30.8	16.5	13.8
		55-64	46.8	19.3	21.0	13.0
		65-74	53.8	16.7	22.6	6.9
		75+	56.3	13.2	22.4	8.1
Herschorn 2007 [284]	482	>=18 y	58	27	15	-
Irwin 2006 [115]	19,165	>=18 y	22.2	11.1	11.1	53.7
Nuotio 2003 [271]	171	>70	70.8	8.3	25.0	
Chaojie 2002 [442]	2087 (total)	>=70 y	17.4	11.9		
			30.4	20.7		
Damian 1998 [335]	589	>=65 y	52.2	10.6	16.1	21.1
Diokno 1986 [350]		>= 60 y	34.9	7.9	28.9	28.3

The higher percentages of the urgency and mixed types of incontinence are more significant in studies involving older people. In fact, the increasing prevalence of any UI by age in men is largely due to the contribution of urgency UI rather than stress incontinence. One study demonstrated an increasing rate of urgency UI from 0.7% between age 50-59, 2.7% between 60-69 and 3.4% for 70 years and older respondents. Stress UI was steady at 0.5%, 0.5% and 0.1% for the above groups respectively [332]. A similar trend of increasing proportions of urge and mixed UI with increasing age is demonstrated in the large population-based study in the US [333], and a smaller population-based Canadian study [284]. On the other hand, Maral and coworkers reported increasing prevalence also of SUI with age, from 0.9% between age 35-44, to 1.2% between 45-54, 3.8% between 55-64, and 4.9% at age 65 and older [334].

Most studies report a significant fraction of other/unclassified type of UI. One study reported that a majority of men with UI had overflow and functional types of incontinence [225], while another found constant dribbling in 7% of their respondents [335]. Terminal dribbling or postvoid dribbling is another type of leak-

age in men that is difficult to assign to the conventional subtypes of UI. In an Australian survey, 12% of respondents reported frequent terminal dribbling [336].

When it comes to severity, the distribution in men follows that of the women. Estimates for severe UI in older women tend to be about twice as high as for older men [258]. Available data have shown that overall prevalence of UI in men is largely due to mild UI. Men reporting moderate to severe UI are significantly less than those reporting mild UI [337,338].

Very few studies have studied the impact of race or ethnicity on the prevalence of UI among men. A four-country study presented lower prevalences of reported UI among men from Korea (4%) and France (7%) than in men from Britain (14%) and Denmark (16%) [339]. On the other hand, unpublished data from the MESA study did not indicate differences in prevalence among white male respondents compared to African American respondents. Similarly, the National Health and Nutrition Examination Survey did not find any difference in prevalence of UI by racial/ethnic group [340].

Literature on the incidence of male UI is very scarce. No recent studies have reported on this issue. The MESA study [258] found a one-year incidence rate for men older than 60 years at 9-10%. In a population-based survey in the UK among men with at least 40 years of age, the one-year incidence of UI was noted to be 3.8% [341]. A review of a health organisation database of males at least 65 years old revealed an UI incidence of 23.8 per 1000 person years. Malmsten [342] analysed the age of onset of UI for each age cohort. Mean debut age for all men was 63 years. The mean duration was about 8-10 years in the cohorts. A longitudinal population based study in Sweden showed that 8.6% (212/2471) of those without UI at the initial survey was found to have UI at the survey done 11 years later [343].

Substantial remission rates for UI in males were noted by the MESA study, higher among men (27-32%) than women (11-13%) [258]. A similarly high one-year remission rate of 39.6% was noted among British males [341]. In the Swedish longitudinal study, 47.8% (55/115) of those found to have UI at the initial survey did not present with the problem at the time of the follow up survey 11 years later [343].

One possible explanation for the difference in the published incidence and remission rates in men compared to women, is the predominance of urge type incontinence among men, and its close relation to overactive bladder with and without UI. Another factor is the close association between urge UI and prostate gland disease, infections, or bowel dysfunction, all of which are relatively amenable to treatment or may improve even without treatment.

3. POTENTIAL RISK FACTORS FOR UI

There is relative little research concerning conditions and factors that may be associated with UI in men, and clear risk factors are more seldom scientifically documented. However, a few available studies have identified potential risk factors, which are described below.

3.1. Age

As in women, increasing age is correlated with increasing prevalence of UI (Table V.2). Multivariate analysis in several studies has shown that age is an independent risk factor for incontinence [333,338,344-349]. Compared to women, however, there seems to be a more steady increase in prevalence in men with increasing age. The National Health and Nutrition Examination Survey in the US reported an odds ratio for moderate to severe UI of 1.8 (95%CI 1.6-2.0) for every 10-year increase in age in a cohort of 5,297 men 20 years or older [340].

3.2. Lower Urinary Tract Symptoms (LUTS) and Infections

In postal and telephone surveys of community-living incontinent men, a majority has experienced a variety of other medical conditions, many of which may cause or aggravate UI. LUTS like urgency, nocturia, feeling of incomplete voiding and reduced flow are typically associated with UI [231,350-352]. In one study, UI was reported by 15% of men without voiding symptoms, frequency or urgency and by 34% of those with such symptoms [350].

Studies have also reported that urinary tract infections and cystitis are strongly associated with male UI [332,335], with an odds ratio of 3.7 for UI in men reporting cystitis [332] and an odds ratio of 12.5 among men with recurrent infections [225]. The metaanalysis of 5 studies including the previously mentioned studies showed a significantly higher risk of UI among men with UTI, with a pooled odds ratio of 3.6 (95% CI 2.17-6.00) [329]. It should be noted that most reports indicating a positive association between UTI and incontinence involved men aged older than 60 years.

3.3. Functional and Cognitive Impairment, Physical Activity

Mobility problems such as use of a wheelchair or aids to walking, as well as diagnosed arthritis or rheumatism or having a fall the last year, were significantly greater among incontinent than continent men [204,335]. The Canadian National Population Health Study involving 25,400 men found that those afflicted with arthritis were more likely to have UI with an odds ratio of 1.59 (95% CI 1.07-2.38) [353]. The same study demonstrated that men with back problems were 2x more likely to have UI (OR 2.1, 95%CI 1.50-2.93). A Japanese study on community dwelling men noted that UI is more likely among men whose activities of daily living (ADL) are impaired, specifically those who are unable to change clothes and unable to walk outside, with odds ratio of 17.4 and 4.36 respectively [332]. A Canadian study found odds ratios of 1.8 and 6.4 for partially and totally immobile men aged 65+, respectively, for daily UI compared to those with normal ambulatory function. Similarly, the Silver Network Home Care project among the frail older persons in Italy showed that those with higher ADL scores (i.e., greater functional impairment) had 2-4x higher odds of having UI [344]. A survey of nursing home residents in Wisconsin identified dementia and poor ADL as risk factors for the occurrence of UI [346]. In general, most studies find similarities between men and women (see subsection on women) for functional and cognitive impairment as risk factors for UI.

Corollary to this, the association between physical activity and UI has been studied by Kikuchi and co workers among the elderly, community-based population in Japan [354]. They found that men with middle level

physical activity was associated with a lower UI prevalence compared to those with low level physical activity, with an odds ratio of 0.38 (0.17-0.78). High level physical activity showed similar relations but was not statistically significant.

3.4. Neurological disorders

Many specific neurological diseases may lead to UI [355]. Detrusor hyper-reflexia is seen commonly in meningo-myelocele patients and in spinal injuries, Parkinson's disease and multiple sclerosis. Areflexic bladder dysfunction due to a cauda equina lesion or diabetes might cause overflow or a paralysed pelvic floor and hence stress incontinence. A metaanalysis of five studies showed that men who suffered stroke were at an increased risk for UI with a pooled odds ratio of 2.68 (95% CI 1.31-5.45) [329]. Men who had suffered a stroke were at increased risk for incontinence with an odds ratio of 7.1 [332]. The Canadian National Population Health Survey showed that stroke in men increased their odds of having UI by 8x (OR = 8.26, 95%CI 3.63-18.8) [353]. A case control study by Jorgensen [356], age-matched long-term stroke male survivors with controls showed a higher prevalence of UI among stroke survivors compared to controls (17% vs 9%). In addition, among UI sufferers, the stroke survivors were found to have higher frequency and more leakage than controls. In a study of 235 stroke patients, the occurrence of UI correlated with motor weakness (OR 5.4), visual defects (OR 4.8, and dysphagia (OR 4.0) [357].

3.5. Diabetes

The results of studies on the association of diabetes mellitus with UI are conflicting. Several reports have not found diabetes as a factor significantly associated with UI in men. This includes the Canadian population-based study involving more than 25,000 men showing no increased risk for UI among men with diabetes [353]. However, the Japanese survey found that diabetics had twice the odds of having UI than non-diabetics [338]. An earlier review reporting the

pooled analysis of 6 studies showed that diabetic men were significantly more likely to have UI with an odds ratio of 1.36 (95%CI 1.14-1.61) [329].

3.6. Alcohol

Two recent reports showed significant association between alcohol consumption and UI in men. A Japanese survey showed an odds ratio of 1.84 (95%CI 1.2-2.82) [338], and a survey among Chinese men showed an odds ratio of 1.42 (95% 1.1-1.8) [348].

3.7. Prostatectomy

A well known iatrogenic cause of male incontinence is prostatectomy, but the attributable risk for this factor in the population of men with UI is varied. In a Norwegian survey of elderly men with UI almost a third had undergone prostatectomy. [351].

In a cross sectional study among men in Vienna, Schmidbauer and associates identified previous prostatectomy to be associated with UI [231].

TURP seems to be followed by an incidence of stress incontinence of about 1%. A randomised controlled trial comparing TURP, laser prostatectomy and evaporation of the prostate for benign disease showed comparable incontinence rates immediately and up to 12 months postoperatively [358].

Radical prostatectomy seems to induce UI at a much higher rate than TURP. The overall prevalence of post-radical prostatectomy incontinence ranges from 2 to nearly 60% (Table V. 4). This wide range may be explained by many factors, including differences in study characteristics, population characteristics, study site, the definition used, and the timing of assessment of continence in relation to the surgery. The era in development of the procedure has also been found to be associated to the prevalence rates [359], as well as the various procedural modifications of the surgery (see below).

Table 16: Examples of studies on the prevalence of post-prostatectomy incontinence.

Author/Ref	Procedure	N	Follow up (months)	Definition	Prevalence (%)
Gavin 2015 [443]	RP	934	≥24 (2-18 yrs)	Unknown	27.8 (24.9–30.8)
Kopp 2014 [444]	RP	362	Mean 6.3 (SD 4.8) years since diagnosis	Any UI UI < 1 /week UI 1 /week UI 1 /day Pad use	79.0 21.8 15.5 41.7 21.7
Resnick 2013 [445]	RP	1164 842	24 60 180 (5 yrs)	"No control or frequent leakage"	9.6 13.4 18.3
Peterson 2011 [446]	RP	1618	> 12	Self report of UI in every followup	9.7

Author/Ref	Procedure	N	Follow up (months)	Definition	Prevalence (%)
Wolin 2010 [447]	RP	165	13 mo	Use of pads	22
Hu 2003 [359]	RP	12 079	> 36		4-20
Augustin 2002 [448]	RP		12	Any protection	27
Sebesta 2002 [449]	RP	674	> 24	Use of pads	32
Potosky 2000 [450]	RP		24		10
Arai 1999 [451]	RP	60	12	Use of pads	3-19
Bishoff 1998 [375]	RP	907			
Egawa 1997 [452]	RP	94	18	Use of pads	27
Peterson 2012 [387]	RRP	1616	> 1 year Median 50.7 months (range 12–216 months) since surgery	Patient reported, "do you ever leak urine?"	90.3
Demirkesen 2007 [453]	RRP	72	>12	More than once a day leakage	8
Kundu 2004 [454]	RRP	2737	>= 18	Use of pads	7
Salomon 2003 [455]	RRP	205	12	Use of pads	34
Moinzadeh 2003 [371]	RRP	200	12-15	Use of pads	2 1
Maffezzini 2003 [456]	RRP	300	?		9 SUI 2 UI ??
Deliveliotis 2002 [457]	RRP	149	12		6-8
Benoit 2000 [458]	RRP	25 651	12		8
Walsh 2000 [370]	RRP	64	12-18		7
Poon 2000 [381]	RRP	220	Mean >12		3-7
Catalona 1999 [399]	RRP	1 870	>12		8
Horie 1999 [369]	RRP	104	12	Use of pads	22
Goluboff 1998 [368]	RRP	480	12	Any UI Daily or pad use Continuous	57 7 1
Weldon 1997 [367]	RRP	220	18		5
Lowe 1996 [366]	RRP	180	12	Any protection	12.
Gray 1999 [391]	RRP/RPP	209	Median 32		25
Olsson 2001 [360]	Lap RP	228	12	Use of pads	21.6
La Fontaine 2000 [459]	Lap RP	522	Mean 31	Use of pads	15
Galli 2006 [460]	Lap RP	150	12	Use of pads	8.3
Novara 2011 [461]	RARP	242	12		11
Novara 2010 [397]	RARP	308	12		10
Lee 2010 [365]	RARP	107	Mean 7.6	Use of pads	9

Author/Ref	Procedure	N	Follow up (months)	Definition	Prevalence (%)
Reynolds 2010 [462]	RARP	1005	24	Use of pad	10
Van Hemerlrijck 2012 [463]	RRP RARP	1377	12	Unknown	54 48
Nilsson 2011 [398]	RRP RARP	1288	> 1 year Median 2.2 years (range 1-5 years) since surgery	Using > 1 pad / day	10.5
Shikanov 2010 [464]	RARP	1436	12 mo	Use of pads	31
Martin 2011 [465]	RARP	315	12 mo	Use of pads	22
Xylinas 2011 [466]	RARP	500	12 mo	Use of pads	22
Link 2008 [467]	RARP	1847	12 mo	Use of > 1 pad daily	7.5

RRP: radical retropubic prostatectomy

RPP : radical perineal prostatectomy

RP: radical prostatectomy, unspecified or combined

Lap RRP: laparoscopic retropubic prostatectomy

RARP : Robotic-assisted radical prostatectomy

Post-prostatectomy incontinence rates elicited from symptoms reported by patients are generally 2-3x higher than those from physicians' observations. Studies that have performed both assessments in the same population confirm this observation that doctors underestimate postprostatectomy incontinence by as much as 75% [360-363]. A higher incontinence rate is also seen after self-reported questionnaire assessment compared to pad testing [364-365].

Incontinence rates after prostatectomy seem to steadily decline with time and plateau 1 - 2 years after surgery [366-371] (Table V.5). This emphasises

the need of a long follow-up period to establish continence status postprostatectomy. An actuarial study among 647 postprostatectomy men estimated UI rate of 13% at one year and 7% at two years postsurgery [372]. The Prostate Cancer Outcomes Study reported that the 5-year postprostatectomy incontinence rate among 1, 288 men was 14%, which was higher than the 10% rate reported after 2 years [373]

Table 17: Examples of studies on postprostatectomy UI rates at different times of assessment.

Study	Type of Prostatectomy	N	UI Rates by Time of Assessment of Continence (%)				
			1 mo	3 mo	6 mo	12 mo	24 mo
Springer 2013 [468]	RRP (nerve sparing)	128	71.9		26.6	10.6	
Penson 2008 [378]	RP	1213	-	-	33	18	15
Moore 2007 [396]	RP	228		43		15%	
Harris 2007 [469]	RPP	210	48	29	15	6	-

Study	Type of Prostatectomy	N	UI Rates by Time of Assessment of Continence (%)				
			1 mo	3 mo	6 mo	12 mo	24 mo
Moinzadeh 2003 [371]	RRP		-	18	9	1.5	-
Jonler 1996 [470]	RRP	24	87	67	63	-	-
Jacobsen 2007 [471]	RRP, Lap RRP		-	42 (RRP), 70.4 (lapRRP ¹), 60 (lapRRP ²)	-	12.8 (RRP), 20.7 (lapRRP ¹) 14.5 (lapRRP ²)	-
Ates 2007 [472]	Lap RRP	939		30.2		11.8	8.3
Galli 2006 [460]	Lap RRP	150	45	26.2	12.1	8.3	-
Link 2005 [473]	Lap RRP	122	-	83.0 ¹ 49.0 ²	47.8 ¹ 10.1 ²	33.3 ¹ 6.6 ²	-
Springer 2013 [468]	Lap RRP	125	60		31.6	3.2	
Patel 2011 [357]	RARP	1111		14% ¹	6 ¹	4 ¹	
Finley 2009 [474]	RARP			31% ¹			
Greco 2009 [475]	RARP			35 ²	21 ²	11 ²	

The technique of radical prostatectomy impacts on UI rates. Modifications associated with lower UI rates include the perineal approach [374-375] and preservation of neurovascular bundle [376- 379]. Bladder neck preservation affords earlier return to continence compared with bladder neck resection, but with similar UI rates after one year [380-381]. One study showed earlier recovery of UI after tennis racquet reconstruction and bladder neck preservation compared with bladder neck resection with puboprostatic ligament preservation, but with similar UI rates at one year [366,382-384]. However, continence status assessed more than 12 months after surgery showed even lower rates of UI after bladder neck preservation (11.6%) compared to resection (4.9%) in one study [366]. Bladder neck intussusception was found to be associated with earlier return to continence in several prospective studies [385]. The literature on the impact of neurovascular preservation on postprostatectomy continence rates is conflicting [386-387].

With the increasing performance of minimally invasive surgery, several studies have investigated the impact of these forms of surgery on postoperative continence rates. Several systematic reviews with metaanalysis of studies comparing continence rates for open, laparoscopic and robotic radical prostatectomy, similarly, did not show any significant difference in the postoperative continence rates between the 3 techniques [388-390]. However, a prospective study

of 239 men showed that UI after laparoscopic procedures seems to be higher initially but approximates that of open techniques by one year. A more recent systematic review that focused on robotic radical prostatectomy showed better continence recovery after robotic prostatectomy compared with open retroperitoneal prostatectomy (OR : 1.53, p = 0.03) or laparoscopic radical prostatectomy (OR : 2.39, p = 0.06) [390].

Older age at time of surgery has been found to be associated with a higher prevalence of post-prostatectomy UI [368,377,391-398], with one study showing a doubled risk for every 10 years of age beginning at age 40 [399]. Another showed that age at surgery predicted% per year [398]. However, other studies failed to demonstrate that age is an independent predictor for incontinence [400-401]. Several studies suggested that rather than absolutely affecting final continence, elderly men need a longer time to achieve continence after surgery [402-403].

Similarly, patient weight and body mass index have been identified as a risk factor for postoperative incontinence [377, 404] or as a predictor of a longer interval before return to continence [368]. One cohort study showed that men who were not obese and were active were 26% less likely to be incontinent at 58 weeks postoperative (RR 0.74, 95% CI 0.52-1.06) [394].

Other factors have been found to be associated with a higher prevalence of post-prostatectomy UI, although not consistently. Such factors include prior TURP, preoperative lower urinary tract symptoms, obesity, clinical stage, PSA, prostate volume and Gleason score [365,377,392-393,396,405]. A retrospective analysis of 156 patients who had undergone preoperative MRI of the prostate and were followed up post-prostatectomy showed that time to return to continence was associated with the variation in the shape of the prostatic apex. The prostatic apex that does not overlap with the membranous urethra was found to be significantly associated with an early return of continence. The 5-year cohort study of the Prostate Cancer Outcomes Study found that among prostatectomy patients, race and ethnic differences was related to urinary incontinence, with African-Americans having better recovery compared to non-hispanic whites and Hispanics [406].

Adjuvant radiotherapy has not been found to affect post-prostatectomy incontinence rates when assessed beyond 1 year [407-408].

3.8. Factors of Unclear Association with UI in Men

A 9 year study of Janssen [409] showed increasing rates of UI with increasing BMI among the older men and women. However, multivariate analysis failed to show increased BMI (overweight and obese levels) as an independent risk factor for the development of UI.

In a study including a younger population in Australia, obesity was noted to be associated with UI with an odds ratio of 3.2 (1.2-9.0) [410]. In this study, however, being merely overweight was not associated with UI.

Several studies in the older persons have shown an association between physical activity and UI among women that is not seen among men [339,354].

4. SUMMARY POINTS:

- The epidemiology of UI in men has not been investigated to the same extent as for females. But it appears that UI is at least twice as prevalent in women as compared with men. There seems to be a more steady increase in prevalence with increasing age than for women.
- Most studies find a predominance of urgency UI, followed by mixed forms of UI and stress UI the least. Most studies have a large fraction of other/unclassified types.
- Literature on incidence and remission of male UI is still very scarce.
- Clear risk factors are more seldom scientifically documented, but several medical correlates have been reported. Established risk factors predisposing men to UI include increasing age,

presence of lower urinary tract symptoms (LUTS), urinary tract infections, functional and cognitive impairment, diabetes, alcohol intake, neurological disorders, and prostatectomy.

- Substantial gains have been achieved on the study of the epidemiology of UI in men compared to the previous years. The conduct of more population-based prevalence studies permitted a better understanding of the problem of UI among men.
- UI after radical prostatectomy is frequent, ranging from 2-57%. Rates steadily decline from the time of surgery and plateaus at 1 to 2 years post-operatively.
- Factors affecting post-prostatectomy UI include the age at surgery, obesity, type of prostatectomy, and certain modifications in the technique.
- There is not enough evidence to demonstrate any significant difference in continence rates between open, laparoscopic and robotic-assisted radical prostatectomy.
- Comparative studies of surgical procedures to address prostate disease and their various modifications should be performed to better assess their impact on postoperative continence rates.

VI. EPIDEMIOLOGY OF OVERACTIVE BLADDER AND NOCTURIA

1. GENERAL COMMENTS AND DEFINITIONS

Overactive bladder (OAB) and nocturia have been neglected topics in the medical literature [476-478]. Earlier research on epidemiology of urinary symptoms focused either on lower urinary tract symptoms (LUTS) suggestive of benign prostatic hyperplasia (BPH) in men or on urinary incontinence in women [479]. However, there has been increased research interest in OAB and nocturia during last two decades [477-478, 480].

OAB can be bothersome [481-483], and is associated with comorbidity [484], impaired quality of life [483], and reduced emotional well-being and work productivity [485]. Nocturia is a common cause for sleep maintenance insomnia [486-488]. Nocturia can be bothersome [489-496], and is associated with impaired mental health, physical health and quality of life [496-498]. Both OAB and nocturia have been reported to be associated with increased risk of falls and fractures [499-506] and nocturia also with mortality [505, 507-510]. Indeed, urinary urgency and urgency incontinence, the cornerstone symptoms of

OAB, and nocturia are among the most bothersome urinary symptoms both at individual and population-level [511].

In general, the definition of any condition is a critical factor in evaluating its epidemiology: OAB and nocturia are not exceptions to this rule [478, 512]. To facilitate discussion and research related to LUTS, the International Continence Society (ICS) has produced standardisation reports [513-514]. We will use the ICS definitions as basis of this chapter. However, we acknowledge that these definitions are not perfect and we encourage further research and discussion [480, 512-516].

OAB is a term to describe the clinical problem of urgency and urge incontinence from a symptomatic rather than from a urodynamic perspective. Previously various terms, such as 'irritable bladder' or 'unstable bladder' have been used. According to the ICS, OAB is a symptom-defined condition characterised by urinary urgency, with or without urgency urinary incontinence, usually with increased daytime frequency and nocturia [513-514]. The ICS defines *urinary urgency* as sudden compelling desire to pass urine, and the term OAB is appropriate if there is no proven infection or other obvious pathology [513].

It has been known for a long time that among healthy people urine production is lower during the night than during the day [517]. Urologists have traditionally defined nocturia as frequency of urination at night without reference to urine amount, while internists have assumed that nocturia results from an increased amount of urine produced with less focus on other urinary symptoms [518]. By the ICS definitions, *nocturia* refers to waking at night one or more times to void, and *nocturnal polyuria* (NP) to the production of an abnormally large volume of urine during sleep [519]. Nocturnal urinary incontinence or nighttime bed wetting (enuresis) differs from nocturia.

According to the ICS, as stated earlier, nocturia is also a component of OAB. However, there is a debate on the definitions, especially regarding urinary urgency and OAB [480, 516, 520-530].

Sometimes OAB has been divided into 'OAB wet' (OAB with urgency urinary incontinence) and 'OAB dry' (OAB without urgency urinary incontinence). In this part of the chapter we focus on the epidemiology of OAB – without distinction between OAB 'wet' and 'dry' – and nocturia. 'OAB wet' (i.e., urgency urinary incontinence) is covered separately in urinary incontinence sections (epidemiology of UI in women and epidemiology of UI in men).

2. PREVALENCE OF OVERACTIVE BLADDER

Prevalence estimates from as low as 2% [531] up to 53%[532] have been reported. Many studies on OAB

have reported prevalence estimates between 10% and 20% [533-539] and the most cited articles estimate a prevalence of between 12% and 17% [533, 535, 540]. However, many of the studies have been limited by not measuring bothersomeness.

In Table 1, we have reviewed all population-based studies assessing prevalence of OAB in adults of both genders. To identify these studies, a Medline search (English-language articles published before June 2016) was carried out on with the strategy (Overactive bladder.mp) or (OAB\$.mp) and (prevalence.mp). Non-population-based (i.e. based on doctor attendances or similar) studies or studies not conducted among both sexes are not included in Table 18.

Among these population-based studies identified, different populations, different sample selection and different data collection methods were often used (Table 1). Sample sizes varied between 913 and 162,906, median being 3,366 individuals. Nine (39%) out of 23 studies did not report any response proportion. Among those 14 studies which reported, as many as eight (58%) had response proportion less than 50%. There was significant heterogeneity in symptom assessment, exclusion criteria, case definitions (some studies used grading of symptom severity whereas others did not), and in the time period during which the occurrence of symptoms was asked (Table 1). Hence, dissimilarities in study procedures likely explain the differences in prevalence estimates. Overall, median prevalence estimate of the studies is 16.5% (range 2-35% in men, and 3-41% in women) (Table 1). However, estimates of the prevalence of OAB have been smaller in many recent studies compared to earlier estimates (Table 1).

Table 18: Overview of published population-based studies assessing prevalence of OAB in both sexes (PubMed indexed English-language articles as of June 2016, in chronological order).

Origin	Data collection method	Sample source	Respondents (response proportion, %)	Age range (years)	2002 ICS Consensus Definition of OAB	Definition of normal - abnormal occurrence	Time period	Prevalence, %: Men/women
European [533]	Telephone interview / in person interview ^a	Telephone registry / electoral census ^a	16,776 (unreported)	40 – 75+	N/A	N/A	Undefined	16 / 17
USA [535]	Telephone interview	Telephone registry	5,204 (44.5) ^b	18 – 75+	N/A	N/A	Past 4 weeks	16 / 17
Canada [541]	Telephone interview	Telephone registry	3,249 (43.4) ^c	35 – 75+	N/A	N/A	Past month	15 / 21
Japan [537]	Mailed questionnaire	Not reported	4,570 (45.3)	40 – 100	N/A	N/A	Past month	14 / 11
Brazil [542]	Unreported	Not reported	913 (unreported)	15 – 55	Yes	Unreported	Undefined	14 / 23
Taiwan [543]	Questionnaire administered by nurse	Population registry	1,921 (67.0)	30 – 79	No	N/A	Past 4 weeks	16 / 18
International [540]	Telephone interview	Telephone registry	19,165 (33.0)	18 – 70+	Yes	No – Yes	Undefined	11 / 13
Finland [544]	Mailed questionnaire	Population registry	3,727 (62.4)	18 – 79	Yes	Rarely – often	Past 2 weeks	7 / 9
Korea [545]	Telephone interview	Telephone registry	2,005 (13.8)	40 – 89	No	N/A	Past 4 weeks	21 / 31
Canada [546]	Telephone interview	Telephone registry	1,000 (unreported)	18 – 90	No	N/A	Undefined	13 / 15
USA [547]	Mailed questionnaire / Telephone interview	Consumer panel	162,906 (62.7)	18 – 85+	No	N/A	Undefined	24 / 29
Portugal [548]	Telephone interview	Telephone registry	1,934 (59.6)	40 – 80+	No	N/A	Past 4 weeks	35 / 29

Origin	Data collection method	Sample source	Respondents (response proportion, %)	Age range (years)	2002 ICS Consensus Definition of OAB	Definition of normal - abnormal occurrence	Time period	Prevalence, %: Men/women
International [482]	Web-based interview	Consumer/ voter panel	30,000 (49.5) ^d	40 – 99	Yes	Rarely – sometimes (Sometimes – often)	Past 4 weeks	22 / 36 (5 / 11)
USA [549]	Web-based interview	Consumer/ voter panel	2,000 (42.1) ^e	40+	Yes	Rarely – sometimes	Past 4 weeks	26 / 41
USA [550]	In person interview	Community registry	3,483 (63.3) ^h	30 – 79	No ⁱ	N/A	Past month ⁱ	9 / 14
Korea [551]	Telephone interview	Telephone registry	2,000 (22.1)	18 – 96	Yes	Unreported	Undefined	10 / 14
Korea [552]	Telephone interview	Post/address registry	2,000 (unclear)	30 – 60+	No	N/A	Past week ^l	19 / 27
China [553]	Interviewer assisted	Unreported	14,844 (69.0)	18 – 70+	Yes	<1 a week – ≥1 a week	Past week	6 / 6
USA [554]	Web-based interview	Consumer/ voter panel	10,000 (unknown) ^f	18 – 70	No	N/A	Past 4 weeks	16 / 30
Japan [555]	Web-based interview	Consumer/ voter panel	Unknown	20 – 60+	No	N/A	Past week ^l	10 / 9
Brazil [556]	In person interview	Local census tract	3,000 (unclear)	30 – 70+	Yes	Unreported	Undefined	5 / 10
China [557]	In person interview	Local census tract	9,805 (unclear)	40 – 70+	No	N/A	Past week	3 / 2
International [558]	Telephone interview	Unreported	3,130 (unknown) ^g	18 – 60+	Yes	No – Yes	Undefined	18 / 28

a. *In the European study, in five out of six countries, telephone interview was used (excluding Spain, where direct interviews were conducted due to lower proportion of households with telephone). Study sample was obtained from telephone number listings (except Spain, where electoral census data was used).*

- b. *Out of 11,740 participants (of 17,231 households contacted), 5,539 were considered ineligible. To calculate response rate, the number of respondents was divided by eligible participants (the former response rate). If same proportion of non-participants, as there were ineligible among participants (47%), were also considered ineligible, response rate was greater (the latter response rate).*
- c. *Out of 7,487 individuals, 3,239 completed the questionnaire (response proportion 43.4%).*
- d. *Invitation to complete email survey was sent to 88,150 members of the Internet-based panel. Of the members, 51,546 responded but 7,947 were excluded due to high rates of missing or inconsistent data, or discontinuation of the survey. Finally, 30,000 participants were randomly selected from the pool of respondents with completed surveys.*
- e. *Invitation to complete email survey was sent to 5,002 members of the Internet-based panel. Of the members, 3,058 responded, but only 2,106 members completed the survey. Finally, 2,000 participants were randomly selected from the pool of respondents with completed surveys.*
- f. *Invitation to complete email survey was sent to 38,469 members of the Internet-based panel. Of the members, 18,591 responded, but number of members completing the survey was not reported. Finally, 10,000 participants were selected from the pool of respondents with completed surveys.*
- g. *Authors reported that a large proportion of individuals asked to participate declined. However, the number of individuals asked to participate was not reported.*
- h. *Out of 5,503 individuals, 63.3% completed the questionnaire (n=3,483).*
- i. *In this study, individuals “were considered to have urgency if they reported difficulty postponing urination, had a strong urge to urinate (fairly often, usually or almost always) in the last month or a strong urge to urinate in the last 7 days (4 or more times).”*
- j. *Time period was not reported in the article. However, authors cited the original OABSS articles, which states that “patients were instructed to circle the score that best applied to their urinary condition during the past week” (Homma et al. Urology 2006).*
- k. *ICS, International Continence Society; OAB, overactive bladder; UTI, urinary tract infection.*
- l. *Cut-off point (threshold) used for normal vs. abnormal symptom occurrence. Reviewed only for studies using current ICS definition of OAB.¹*
- m. *Time period during which the occurrence of symptoms was asked.*

Only a few population-based studies have evaluated OAB prevalence using the ICS definition *and* reported bother. Assessing perceived bother associated with OAB substantially decreases the prevalence estimates. In the FINNO Study (conducted in Finland among women and men aged 18-79) [483], as many as 54% of men and 57% reported *any* (at least rarely) urinary urgency. However, prevalence of at least moderate bother from urgency was 7% for men and 9% for women. Overall, more than 96% of individuals with *rare* urgency reported no or small bother from it whereas 65% of individuals with urgency *often* and more than 70% with urgency *always* reported moderate or major bother (scale: none-small-moderate-major) [483]. These results are in concordance with two international studies [481-482]. In the EpiLUTS study (conducted in the US, UK and Sweden among people aged 40-99) [482], 22.4% of men and 35.7% of women reported urinary urgency at least sometimes (in scale: never-rarely-sometimes-often-almost-always) (Table 1). However, prevalence estimates were substantially lower when bother was taken into account. Only 6% of men and 12% of women reported “quite a bit” or more bother from urgency (in scale: not at all-a little bit-somewhat-quite a bit-a great deal) [482]. Bother analysis from the EPIC Study [481, 540] showed also that infrequent urinary urgency is not considered as very bothersome by most individuals. Out of OAB cases, 46% did not report symptom bother from it [6]. All these results suggest that i) bother measurement is essential in estimating the clinically relevant prevalence of OAB, and ii) most studies have overestimated the prevalence of patient-important OAB [480-483] (Table 1).

3. INCIDENCE OF OVERACTIVE BLADDER

The natural history of OAB has been systematically reviewed little more than 5 years ago (English articles published between January 1, 1990, and September 20, 2009) [559]. Authors identified 7 longitudinal studies of OAB. OAB incidence varied between 3.7% and 8.8%; and included studies provided evidence for dynamic nature of OAB [549]. Indeed, longitudinal studies have confirmed that OAB prevalence increases with age but also that OAB is a dynamic condition [560-566].

In a population-based study (conducted in between 1991 and 2007 in Gothenburg, Sweden) [562], the number of women with OAB with urgency incontinence (“OAB wet”) increased from 6% to 16%, however, the proportion of women with OAB without UUI (OAB dry) did not differ significantly (11% vs. 10%). Among women with OAB dry in 1991, 23% remained OAB dry, 28% reported symptom progression to OAB wet and approximately half reported remission of OAB by 2007, supporting the concept of the dynamic

nature of OAB. The rate of remission of OAB symptoms was greater for women who were OAB dry (49%) compared with those who were OAB wet (26%).

Finding that OAB is a dynamic condition was also reported in Australian and Japanese studies [565-566]. In the CHAMP study conducted among 1,705 men aged 70 or more living in a defined region of metropolitan Sydney [565], one in three older men with OAB had sustained remission of symptoms without medical or surgical interventions. Of the men with OAB at baseline, 29% received treatment for OAB or benign prostatic enlargement over 5 years. In the Japanese longitudinal community-based “Fujiwarakyo study” among more than four thousand men and women aged 65 years or more [566], the incidence rate of OAB was 12% and remission rate 30%.

4. POTENTIAL RISKFACTORS FOR OVERACTIVE BLADDER

The causes and risk factors of urinary urgency and/or OAB are not well studied. Available studies, that have identified potential risk factors, are summarised below.

4.1. Age

In numerous cross-sectional studies older individuals reported more OAB than younger ones (Table 1). Furthermore, longitudinal studies have confirmed that OAB increases with age [559]. Besides increasing age, also having urgency in childhood predicts having urgency in later life [567-568].

4.2. Gender

In Table 1, we summarised population-based studies assessing prevalence of OAB among both. In most studies, OAB was more common among women (Table 1). In only three (13%) out of 23 studies, the prevalence estimate of OAB was larger for men than for women. However, these three studies [537, 548, 557] did not include younger age groups, and typically **OAB is more common among women than men especially in younger ages.**

4.3. Obesity

In a British, prospective study, obesity was a risk factor for the onset of an OAB (OR 1.5, 1.0-2.1) in women [484] but not among men [561]. Ten studies were included in a recent systematic review examining the link between OAB and obesity [569]. There was a statistically significant link between obesity (measured by BMI) and OAB in eight studies. However, four of the studies that found a positive correlation were found of low methodological quality. BMI. Three studies examined the relationship between OAB with waist circumference, two found relationship whereas one did not. Overall, unfortunately most

studies were cross-sectional and did not often adjust for major confounders.

4.4. Life style

In a prospective study among British women, neither alcohol, coffee nor tea consumption were risk factors for the onset of OAB (defined as having either urgency, UUI, or a combination of these) but use of carbonated drinks was [484]. Among men, neither tea, coffee nor wine consumption were associated with onset of OAB, but a negative association between beer intake at baseline and subsequent OAB onset was found [561]. However, this may be explained by a *systematic misclassification error* (individuals decrease or cease alcohol consumption due to ill health) [570-571], *residual confounding* (moderate drinkers have many other favouring lifestyle factors) [572-573], or direct biological effects. In a Swedish population-based study in young female twins [574], tea (but not coffee) drinking was associated with an increased risk for both OAB and nocturia. However, after controlling for confounders (including zygosity of twins) these associations did not remain significant. Concurring with these studies, among non-care seeking women [575], coffee or alcohol consumption was not associated with OAB. In a population-based study among women in Southern Sweden [576], OAB was not associated with alcohol consumption.

In a prospective British study, smoking was a risk factor for the onset of an OAB (defined as having either urgency, UUI, or a combination of these) in women but not in men [561]. In a population-based study among Finnish women aged 18-79 [577], urgency was approximately three times more common among current and twice as common among former than never smokers. Parallel associations for urgency with smoking intensity suggested a dose-response relationship [577]. Other supporting findings have also been reported [578-581]. However, some other studies did not find smoking as a risk factor for urgency [548, 574, 576].

A prospective study among British men did not provide evidence of any specific dietary patterns as a risk factor for onset of OAB [561]. Furthermore, physical activity was not significantly associated with OAB onset in men [561]. Contradictory results were found among non-care seeking women [575] where physical activity was associated with decreased OAB.

4.5. Race/Ethnicity and socioeconomic status

Evidence regarding the role of race/ethnicity on OAB prevalence is limited. In a small Taiwanese study [582], higher prevalence of urgency (7.7% vs. 4.3%, $p=0.02$), was found in indigenous woman than in non-indigenous women. In the US part of the EpiLUTS study [578], OAB was reported by 26% of White, 33% of Black, 27% of Asian and 28% of Hispanic men. In the multivariate analysis, OAB was significantly more common among African-American (OR 2.0, $p<.001$)

and Hispanic (OR 1.7, $p<.001$) male participants. The authors reported no statistically significant differences among women after multivariate analysis, despite wide variation in crude prevalence (27% for Asian women, 43% for White, 46% for African-American and 42% for Hispanic) [578]. Hospital-based studies have reported no difference in the prevalence of OAB by race/ethnicity [583-584].

4.6. Reproductive factors and pelvic surgery

Urinary urgency is a common symptom during pregnancy [585]. In a Taiwanese study [586], only 1% of women reported having urgency before pregnancy, whereas corresponding estimates were 16% in the first, 25% in the second, and 31% in the third trimester. Other studies have also found increasing prevalence of urgency with advanced gestational age [587-588]. However, in a Nigerian study, women in 3rd trimester did not report more urgency than women in 2nd trimester [589]. Although one quarter of pregnant women reported urgency, it was associated with moderate or severe bother for only 5% of symptomatic women.

The association between parity and urinary urgency is controversial. Some studies reported no association for parity with urgency or OAB [484, 575, 590-591], whereas others found increased prevalence of urgency among parous women [582, 592-595]. However, there were substantial differences in methods between these studies. Regarding mode of delivery, most studies demonstrated no effect on prevalence of urgency or OAB [548, 590, 594-597]. On the other hand, contrary findings have also been reported [598-599]. In a Swedish prospective study, weekly urgency was reported in late pregnancy by 2.6% of women in the elective vaginal delivery and by 2.7% of the women in the elective cesarean section group [598]. Corresponding figures were 7.9% for vaginal delivery and 2.7% for cesarean section groups at 9 months post-partum [125] concurring with the results of a cross-sectional US study [599]. In a recent US study [581], for women with a history of at least one operative vaginal birth, the adjusted odds of OAB was more than quadrupled (OR 4.9, 95% CI 2.2-11; women who had delivered all their children by pre-labour cesarean as reference).

The association between the postmenopausal period and increased urgency or OAB has been reported in several studies [553, 592, 594-595, 600-601]. Impact of hormone therapy on OAB is unclear. The Cochrane Incontinence Group review of urinary incontinence and oestrogens (urgency or nocturia not as the primary objective of the study) found that there were less nocturnal voids and urgency episodes among women treated with local (but not systemic) oestrogen [602]. There were no significant differences in OAB prevalence among women using either oral contraceptives or a levonorgestrel-releasing intrauterine device, in comparison to noncontraceptive users in a population-based study among young, Swedish women [603].

Radical hysterectomy is related to increased prevalence of pelvic floor problems [604]. For instance, patients treated for cervical cancer reported urgency 2-3 times more often than the matched controls: 36% of those with history of radical hysterectomy and pelvic lymph node dissection, 49% of those with surgery and adjuvant radiotherapy, and 48% of those with primary radiotherapy reported experiencing urgency [605]. However, the relationship between urgency and hysterectomy for benign indications is less clear. Many studies did not find significant association of hysterectomy with urgency [590-591, 606-611]. However, some studies reported less [601, 612-615] and some more [548, 584-585, 616] urinary urgency after hysterectomy. No differences by route of hysterectomy on urgency have been found [611, 615-618]. Both prolapse surgery and stress incontinence surgery are associated with risk of (de novo) urgency or urgency incontinence in both hospital based, and population based studies [580, 591, 619-620].

4.7. Specific conditions

There is a paucity of studies concerning conditions and co-morbidities that may be associated with OAB, and clear causal risk factors are even less often documented. Few available studies have identified potential risk factors, which are described below.

4.8. Benign prostatic hyperplasia

Instead of OAB/urgency, observational, clinic-based studies have assessed the relationship between detrusor overactivity and benign prostatic hyperplasia/obstruction. Although patients with detrusor overactivity are less likely to get symptom improvement after BPH surgery than those without detrusor overactivity, many patients report less urgency after BPH surgery [621]. Similar findings were reported in a prostatectomy study among men aged 47-85, 32% (n=49) reported urgency pre-operatively and 13% post-operatively (n=20) [622]. In another study, detrusor overactivity was present in 68% of patients (n=21) at baseline and in 31% (n=10) at follow-up (mean 2 years) in the prostatectomy group [623]. However, many patients remain symptomatic after prostate surgery, and prognostic factors for success remain largely unknown [624].

4.9. Pelvic organ prolapse.

In community-based studies [584, 625-626], pelvic organ prolapse was associated with 2-6 times higher risk of having urgency incontinence. Concurrent with this findings, hospital based studies have also found pelvic organ prolapse as a risk factor for urgency incontinence, and in interventional studies urgency incontinence is often (but not always) relieved [628].

4.10. Mental health

In the BACH survey [629], urinary frequency, urgency, and nocturia were associated with previously experienced sexual, physical, and emotional abuse

for both genders and for all ethnic groups of the study (White, Black, Hispanic). Concurring results were found in a German, clinic-based study where 31% of women with OAB reported almost twice as often earlier physical or sexual abuse as did the women with stress urinary incontinence (18%) or women without urinary symptoms (18%) [630]. In an Iranian study, individuals with OAB had a higher prevalence of anxiety (28.2 vs. 8.8%; p=0.001) and depression (38.2 vs. 18.2%; P = 0.02) [538] agreeing with finding from multinational EpiLUTS study and longitudinal Japanese where increased depression and anxiety were found among individuals with OAB [566, 631]. Furthermore, postpartum depression has also been reported to be associated with urgency incontinence [632].

4.11. Other conditions

In the BACH survey [633], urgency was associated with almost double the risk of hypertension and heart disease in women and with more than double the risk of diabetes in men. However, In a Japanese study among the elderly, OAB was not associated with diabetes or kidney disease but was associated with depression, alcohol use, and increasing BMI [634]. In a UK prospective cohort study within a random sample of 19,241 women aged 40 or more identified from Health Authority lists of 108 general practices [484], predictors of OAB included bowel urgency, imbalance, osteoporosis, ankle swelling, diabetes, DVT and cystitis [484]. Urgency/OAB has also been reported to common among patients with irritable bowel syndrome [635-636], functional dyspepsia [637], diabetes [638-640], including gestational diabetes [641], stroke [642] and asthma [548].

5. PREVALENCE OF NOCTURIA

Most earlier studies assessing the prevalence of nocturia have been conducted among elderly men [643-651]. They consistently found that nocturia 1) is a very common symptom and 2) increases with ageing. These findings have recently been confirmed in comparative studies conducted in both sexes [489-490, 495, 498, 540, 546, 652-663] (Figure 8).

We have reviewed all population-based studies assessing prevalence of nocturia in adults of both sexes. To identify these studies, a Medline search (English-language articles published before June 2016) was carried out on with the strategy (nocturia.mp) and (prevalence.mp). Non-population-based (i.e. not based on doctor attendances or similar) studies, studies not conducted among both sexes of adults, studies with narrow age range (less than 40 years), or studies with percentage data unavailable are not shown in Figure 1.

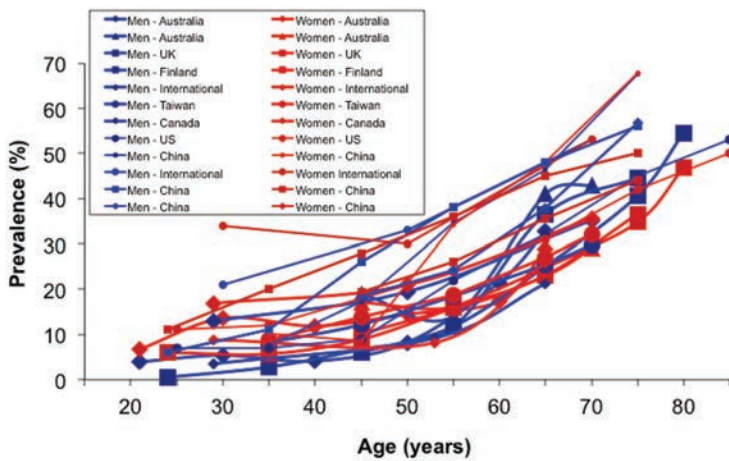

Figure 8: Prevalence of at least two voids per night across age groups by sex in population-based studies conducted among both sexes with wide age-range [489-490, 495, 498, 540, 546, 652-663].

In the FINNO Study, conducted among men and women aged 18 to 79 [656], approximately one out of eight men and women reported at least two voids per night. In addition one third reported one void per night. Young women reported clearly more nocturia than young men, prevalence of nocturia in men and women equalised only in the sixth to seventh decade of life, and in older age groups men had more nocturia than women. Many other studies have supported these findings: higher prevalence of nocturia among young women than young men, and an equalization of prevalence in middle age [495, 498, 540, 546, 660, 664-665] (Figure 1). As the gender difference has been found across different continents (Europe, Asia, Australia and North America) it probably not due to specific country, lifestyle or cultural factors. The reasons for the excess of nocturia among older men remain unknown, but prostatic enlargement is likely to be the predominant factor.

The Krimpen study, conducted in the Netherlands among elderly men [666], is one of the few studies where nocturia was assessed by using frequency-volume charts. One and a half or more voids/night (average of information on two to three nights) was present in 60% of men aged 70-78 years, whereas at least 2.5 voids per night was present in 20%, respectively. These estimations are comparable to questionnaire studies: most elderly people void at least once per night [665] (Figure 1).

6. INCIDENCE OF NOCTURIA

A recent systematic review and meta-analysis summarised the incidence and remission of nocturia [667]. Authors conducted a comprehensive search of PubMed, Scopus, and CINAHL databases and abstracts of major urological meetings until end of August 2015 and found 16 eligible studies [668-683]. Of the 16 included studies, 10 (62%) were at high risk and six (38%) at low risk of bias. Of these 16 studies,

14 (88%) accurately assessed nocturia both at baseline and at follow-up, nine (56%) had little missing data in the follow-up, and eight (50%) used representative source populations. Pooled estimates from 13 studies [670-683] with 114 964 person-years of follow-up demonstrated that annual incidence was strongly associated with age: 0.4% (0–0.8%) for adults aged less than 40 years; 2.8% (1.9–3.7%) for adults aged 40–59 years; and 11.5% (9.1–14.0%) for adults aged at least 60 yr. Of those with nocturia, each year 12.1% (9.5–14.7%) experienced remission.

7. RISK FACTORS FOR NOCTURIA

The causes and risk factors of nocturia are not very well understood [510, 647]. Available studies, that aimed to identify potential risk factors, are summarised below.

7.1. Age

There have been numerous studies showing that elderly subjects have more nocturia than younger people (Figure 1) - age is one, if not the most important correlates of nocturia. For instance, in a community-based US study, less than 5% of those aged 18-24 reported two voids per night while the corresponding figures were approximately 15% and 25% for those aged 45-54 and 65-74 respectively [490]. Besides increasing age, also childhood nocturia and enuresis has been suggested to predict nocturia in later life [567, 683].

7.2. Gender

Although there is no remarkable difference in overall prevalence of nocturia between genders, in more detailed age specific analyses differences have emerged between the genders (Figure 1). Many studies found higher prevalence of nocturia among young

women than young men, and an equalization of prevalence in middle age [495, 509, 540, 546, 639, 656, 665]. Prostatic enlargement has been suggested as predominant factor for potential nocturia excess among elderly men [665].

7.3. Obesity

Several studies have shown the relation between overweight/obesity and nocturia. Obesity was associated with more than three-fold risk of nocturia in a Swedish study among middle-aged women [685], and with more than two fold-risk in the FINNO Study [686]. Confirmatory findings have been reported in numerous studies [687-692]. In the longitudinal TAMUS study among men aged 50 or more [693], obese men had double the risk for nocturia compared with normal weight men. The frequency of nocturia at baseline did not increase the incidence of obesity at follow-up.

7.4. Life style

Most studies have not found an association between nocturia and either alcohol [489, 673, 689, 694-695] or coffee/caffeine [650, 684, 693, 696-697] consumption. In some studies moderate alcohol consumers had less nocturia than abstainers [693, 698-699]. However (as discussed earlier in 'Risk factors of overactive bladder'), these findings may be due to systematic misclassification error or residual confounding [570-573].

Most studies have not found an association between nocturia and smoking [508, 651, 666, 689, 693, 695-696]. Some conflicting results have also been reported: in Swedish and Chinese studies [685, 692] smoking was associated with increased nocturia but in Austrian [489] and Japanese [694] studies, with decreased nocturia.

Physical activity has been reported to be protective against LUTS in men [700-702], and against nocturia in both genders [663, 685]. In an Austrian study [489], no relation was found between nocturia and physical activity. However, exercise programme has been shown to improve nocturia in non-randomised trial [703].

7.5. Race/Ethnicity and socioeconomic status

In several US studies, African Americans were approximately twice as likely to report nocturia as other groups [687, 690, 704-706]. This effect was attenuated, although remained significant [700, 705], with adjustment for socioeconomic status and comorbidity. Furthermore, care-seeking black women reported also more commonly nocturia than other groups [707-708]. Conflicting results were found in a Kaiser Permanente study [709]. In the EpiLUTS study conducted in the USA, UK and Sweden [684] and in a Kaiser Permanente study [710], Blacks and Hispanic had more nocturia when compared to White. Less is

known about the relationship between ethnicity and nocturia outside the US. In small studies in Taiwan [582, 711] and Scotland [712], associations of nocturia and ethnicity have been found. In the Scottish study, nocturnal polyuria was more common in the Caucasian men compared to Asian men.

7.6. Reproductive factors and pelvic surgery

Nocturia is a very common symptom during pregnancy. In all studies most pregnant women report nocturia at least weekly, in many studies most women report having nocturia every night [582-589, 596, 713-714]. Typically the occurrence of nocturia increases during pregnancy. In an Indian study [714], nocturia (defined as more than one void per week) was reported by 50.6% of women before pregnancy (retrospective information), by 58.6% of those in the first, 71.9% in the second and 77.0% in the third trimester. In Finnish and Chinese studies [591, 692], parous women reported slightly more nocturia than nulliparous women, contradicting earlier reports (conducted among perimenopausal women) of no association [593, 715]. The relationship between nocturia and parity could be due to pregnancy itself rather than trauma to the urinary tract during delivery [716] supported by finding of no difference in nocturia between primi- and multiparous women in the same Finnish study [716] and by a finding of no difference between vaginal delivery and caesarean section in a Swedish prospective study [598]. In these studies, the postpartum period was also associated with increased nocturia [591, 598].

In a population-based Swedish study of young women, no difference in nocturia was found among oral contraceptive users and non-users, however, levonorgestrel-releasing intrauterine device (compared with non-contraceptive users), reported less nocturia (OR 0.53, 95% CI 0.32-0.89) [605].

Danish and Finnish population-based studies have reported more than double the risk of nocturia after menopause [591, 593], consistent with other studies [602, 657, 715]. One study attributed this to aging rather than to menopausal transition [717]. In the Finnish and Swedish studies [591, 715], there were indications of increased nocturia among women using menopausal hormone therapy, but the findings were statistically insignificant. In a small randomised trial [718], there was no difference in nocturia among those with menopausal hormone therapy or placebo. Similar findings were reported in a randomised trial of vaginal oestradiol and placebo after sling surgery [719].

The relationship between nocturia and hysterectomy is unclear, with hysterectomy being a protective factor [609, 614, 616], risk factor [593, 710], or not associated with nocturia [591, 603, 610]. Surgery for stress urinary incontinence was not associated with nocturia in a population-based study [591].

7.7. Specific conditions

7.7.1 Benign prostatic hyperplasia and prostate cancer

Benign prostatic hyperplasia (BPH) constitutes a well-recognised risk factor for nocturia [666, 696, 720]. In the FINNO Study [696], half of the subjects with physician-diagnosed BPH reported at least two voids per night; however, only a third of the men with nocturia reported BPH. However, nocturia is the least specific LUTS associated with BPH and medical treatment to relieve BPH has less effect on nocturia than on other LUTS [721-722]. Furthermore, nocturia has been reported as one of the most persistent LUTS following prostate surgery [622, 723]. In a study on men with bothersome LUTS, those receiving finasteride had an effect indistinguishable from placebo [724]. Many men with LUTS express a fear of prostate cancer [725], however, whether LUTS (including nocturia) are suggestive of prostate cancer is not clearly established [726]. In the large HUNT-2 study [727], LUTS severity was positively associated with the subsequent diagnosis of localised prostate cancer but not with advanced or fatal disease. More than 70% of men with physician-diagnosed prostate cancer reported at least two voids/night, while 7% of men with nocturia reported prostate cancer in the FINNO Study [696]. Whether men with nocturia are only more vulnerable to be diagnosed with prostate cancer (due to use of prostate-specific antigen), prostate cancer causes nocturia, or nocturia is a side-effect of various prostate cancer treatments remains unclear [496, 728]. The impact of radical prostatectomy on nocturia has been neutral or negative (i.e. increased nocturia) [729-731].

7.7.2 Nocturnal polyuria

A systematic review and meta-analysis summarised the relationship between nocturia and nocturnal polyuria [731]. Authors conducted a search of PubMed and Embase databases for studies written in English, German, French or Dutch with original data on adult participants in an investigation of the relationship between nocturia and nocturnal polyuria. Fifteen studies met the inclusion criteria. Quality scores of studies were generally high for internal validity but low for external validity. Standardised mean difference of 0.6 (95% CI 0.3-0.9) for nocturnal voids between nocturnal polyuria and nonnocturnal polyuria cases was found. Risk ratio for nocturnal polyuria in individuals with nocturia was 1.41 (1.37-1.44). Authors concluded that "the association between nocturia and nocturnal polyuria is apparent and robust. However, the clinical importance of the association appears to be less obvious than previously suggested based on single studies. The observed high prevalence of nocturnal polyuria, as a result of the International Continence Society definition, may be responsible for this discrepancy." The ICS defines nocturnal polyuria as an increased proportion of the 24-hour output of urine volume occurring at night [513]. However, there is a paucity of studies providing reference values. The

Krimpen study authors suggested that nocturnal urine production exceeding 90 ml/hr is abnormal [666, 733] but concluded that "nocturnal urine production as an explanatory variable for nocturnal voiding frequency is of little value." The fundamental pathogenesis of nocturnal polyuria remains largely unknown.

7.7.3 Overactive bladder

Urinary urgency was a clear risk factor for nocturia in the FINNO Study (OR 7.4, 95% CI 4.5-12 for men, and OR 4.9, 95% CI 3.2-7.7 for women) [696]. However, while half of subjects with urgency also reported at least two voids per night, only one in three with nocturia reported urgency [544]. The finding that most people with nocturia do not report frequent urinary urgency (Figure 2), has been reported also in the EPIC and EpiLUTS studies [482, 540].

7.7.4 Diabetes

An association between diabetes and nocturia has been noted in most [655, 684, 687, 689, 692, 696, 699, 720, 734-741], but not all reports [654, 666, 673]. In the BACH Survey [687] and in a Danish study at ages 60-80 years [689], nocturia was associated with double the risk of diabetes. In these surveys [687, 689], gender differences were not reported. In the FINNO Study [696], diabetes was associated with nocturia after adjustment for other factors only in women. On the contrary, in a Chinese study, association was found for men, but not for women [663].

7.7.5 Hypertension

It has been suggested that essential hypertension and nocturnal polyuria are part of the same pathophysiological process [738]. In Japanese, US and Chinese studies [655, 673, 670, 692], hypertension was associated with nocturia, although effect sizes were modest (ORs between 1.5 and 1.6). In another Chinese study [663], association of nocturia and hypertension was found in women, but not in men. In studies conducted in Europe [654, 656, 696], neither nocturnal polyuria nor nocturia were associated with hypertension. In a secondary analysis from the BACH survey [739], monotherapy with calcium channel blockers in women, and combination therapy with loop diuretics in men was associated with nocturia but no other associations for nocturia with any other anti-hypertensive was found [739]. While the treatment for hypertension may cause [479, 739] or alleviate nocturia [741] in some cases, appropriate methods are of particular importance when trying to assess the relationship between hypertension and nocturia.

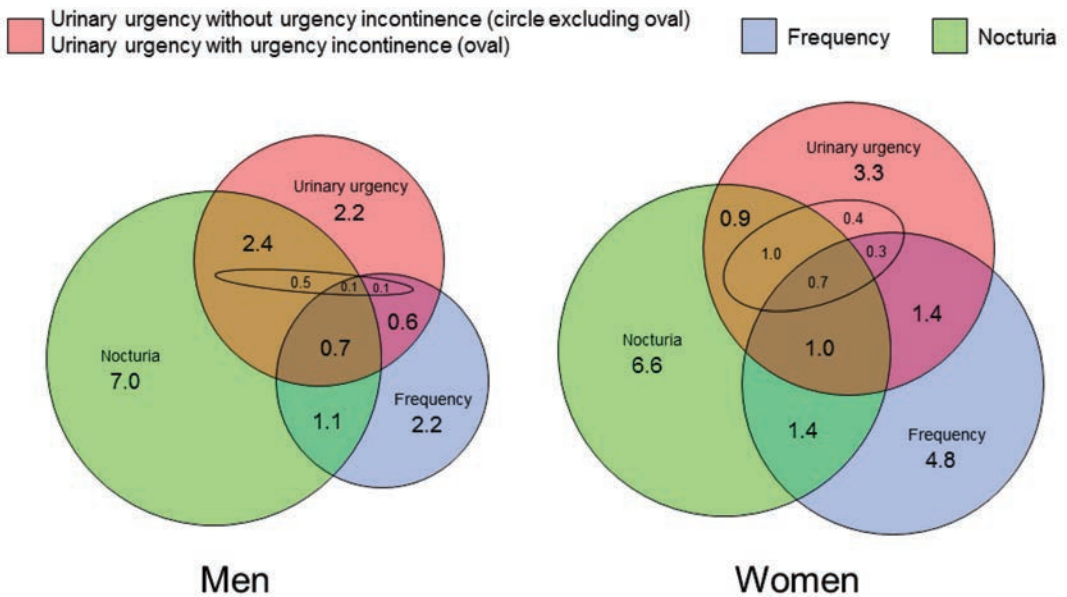

Figure 9: Age-standardized prevalence of nocturia, urinary urgency (with or without urgency incontinence) and urinary frequency among Finnish people aged 18–79 years.

The red circle represents individuals with urinary urgency (often or always in scale: never-rarely-often-always) without urgency incontinence (often or always in scale: never-rarely-often-always) excluding the area of the red oval representing individuals with urinary urgency with urgency incontinence. The blue circle represents individuals with urinary frequency (defined as more than eight voids/day) and the green circle nocturia (defined as at least two voids/night). Age-standardization performed using the age structure of Finland. Modified from Tikkinen KA et al. [544].

7.7.6 Coronary disease

Earlier (male) studies [654-655, 666] did not find a relationship between nocturia and cardiac disease. However, in these studies, an association between cardiac symptoms/disease and nocturia was found in the preliminary analyses before multivariate modelling. In more recent studies [508, 663, 687, 696, 699] coronary disease has been shown to be associated with nocturia.

7.7.7 Depression

In Swedish and US population-based studies [498, 742], depression and antidepressant use were both associated with increased prevalence of nocturia whereas in a Finnish study a relationship was found only among men using antidepressants after adjustment for other factors [696]. In another Finnish study (among men aged 50 or more), those with depressive symptoms at study entry were at almost triple risk for moderate or severe nocturia than those without depressive symptoms but nocturia had no effect on depressive symptoms during 5-year follow-up [743]. In a Kaiser Permanente study [710], increasing anxiety/depression scale was associated with increasing nocturia.

7.7.8 Sleep apnoea and snoring

In clinic-based studies [736, 744-747], nocturia was associated with sleep apnoea. In US studies conducted among community-dwelling older adults, subjects with increased apnea-hypopnea index had greater mean nocturia episodes, nighttime urine production and atrial natriuretic peptide excretion [748-749]. Snoring was one of the three most important nocturia population-level risk factors for both sexes in the FINNO Study [696] concurrent with a Swedish urology clinic study [750].

7.7.9 Neurological diseases

Most patients with multiple sclerosis have bladder dysfunction, which may also lead to nocturia [751-752]. Nocturia was also associated with stroke and cerebrovascular disease [699, 734, 753]. Moreover, in a study among Parkinson's patients, severity of disease was also associated with increased nocturia [754]. Furthermore, a relationship of nocturia with restless legs syndrome has been reported [696].

8. SUMMARY POINTS

- Overactive bladder (syndrome) (OAB) has been defined as urinary urgency, with or without urgency urinary incontinence, usually with increased daytime frequency and nocturia (in the absence of infection or other obvious pathology).
- Prevalence of OAB has been estimated from as low as 2% up to 53%.
- Recent population-based studies have shown that less than 10% of people have OAB with at least moderate bother, suggesting that bother measurement is essential in estimating the clinically relevant prevalence of OAB.
- Longitudinal studies have shown that OAB increases with age, and that OAB is a dynamic condition, with not only substantial progression but also remission rates.
- OAB may be associated with an increased risk of falls, fractures, and impaired quality of life.
- While age is a clear risk factor for urinary urgency and/or OAB, other risk factors have not been that well studied.
- Individuals with benign prostatic hyperplasia, pelvic organ prolapse and mental health problems typically report urinary urgency more often than those without.

- Nocturia is one of – if not the - most common lower urinary tract symptom with similar overall prevalence in both genders.
- The prevalence of nocturia is higher among young women than young men, but the prevalence increases more strongly with age in men.
- The literature on the incidence of nocturia remains relatively sparse. The incidence of nocturia has been shown to increase with age but also remarkable fluctuation has been identified.
- Two episodes of nocturia constitute meaningful nocturia, affecting quality of life and perceived health, while a single episode does not.
- Nocturia has been associated with an increased risk of falls, fractures, and death.
- Risk factors for nocturia include conditions of the lower urinary tract, but also a range of systemic conditions, including but not limited to prostatic hyperplasia, urinary urgency/overactive bladder, obesity, sleep apnoea, parity, and the postmenopausal state.

9. FUTURE NEEDS

- Due to the relatively recent research in OAB and nocturia, most data currently available are cross-sectional, hence, more prospective studies are needed
- Natural history of OAB and nocturia need more research – progression and remission of these symptoms is not yet well understood.
- Better understanding of relationship of different 'overactive bladder symptoms' would be beneficial.
- With prospective studies examining risk factors for incident OAB and nocturia will be possible, however, definition of incident OAB and nocturia may be challenging due to fluctuating character of these symptoms.
- Overall, further studies should be conducted with proper study designs and population-based sampling in order to decrease the risk of bias.

VII. EPIDEMIOLOGY OF PELVIC ORGAN PROLAPSE

1. GENERAL COMMENTS AND DEFINITIONS

Pelvic organ prolapse (POP) refers to loss of support for uterus, bladder, colon or rectum leading to prolapse of one or more of these organs into the vagina. Prolapse is thus a continuous condition when measured by visual inspection of the vaginal wall during valsalva. For clinical purposes, the degree of POP is commonly described as above the introitus, at the introitus, or beyond the introitus with or without valsalva. The International Continence Society first developed a standardised definition for the condition of POP in 1996 [755]. The ICS Pelvic Organ Prolapse Quantification (POPQ) examination defines prolapse by measuring the descent of specific segments of the reproductive tract during valsalva strain relative to a fixed point, the hymen. The POPQ system describes the anatomical findings of pelvic organ prolapse without consideration for symptoms and bother perceived by the woman. Validation of this system has shown it to be highly reliable [756]. The stages of prolapse severity are arbitrarily defined, and there is no clear differentiation between normal anatomic variation and mild POP. For research purposes there is consensus for use of the POPQ system until further evidence might clarify the distinction between normal variation and mild prolapse [757].

Determining POP based on self-reported symptoms is difficult because of the lack of specificity and sensitivity of most symptoms attributed to pelvic organ

prolapse [758] and the fact that prolapse above the level of the hymeneal ring is usually asymptomatic [759]. The only exception appears to be a sensation of bulging into the vaginal [760] which is most strongly associated with prolapse at or below the hymeneal ring [761-762]. A recent study of 110 women found that a question asking about a feeling of something bulging in or dropping out of their vagina had a sensitivity of 84% and a specificity of 94% for POP at or beyond the hymeneal ring on examination [759]. Seeing prolapse would presumably be even more specific, but is too uncommon to be useful as a definition.

than women seeking gynaecological care, and provide important information on the prevalence of POP based on pelvic examination.

The prevalence of POP based on a sensation of a mass bulging into the vagina was remarkably consistent, ranging between 5 and 10 percent. The study by Eva et al., which reported a substantially higher prevalence included in the definition of POP, pelvic heaviness or digital pressure on the perineum or in the vagina to aid with defaecation [769]. The prevalence of observed prolapse in women enrolled in the WHI trial is similar to the prevalence found in the one population-based study that also used pelvic examination [770], although the prevalence of each type of prolapse was higher in the WHI study [762]. In both studies, prolapse occurs most frequently in the anterior compartment, next most frequently in the posterior compartment, and least in the apical compartment.

2. PREVALENCE OF POP

Since the 3rd ICI, several additional studies have reported the prevalence of POP in a general population [763-768]. Reports from the Women's Health initiative (WHI) Oestrogen Plus Progestin Trial, and randomised controlled trial, have been included [763,765-766]. While not actually population-based, the women in the trial were recruited from the community rather

Table 19: Prevalence of pelvic organ prolapse (POP) defined by symptoms or observed on pelvic examination in the general population .

First author	Country	Definition of POP	Ages (years)	N	Prevalence Subgroup: %
Kumari [771]	India	"a mass of flesh in the vagina" or equivalent using local terminology	15+	2990	15-24: 5 25-34: 10 35-44: 8 45-54: 6 55-64: 9 65+: 3
McLennan [772]	Australia	A feeling of something coming down in the vagina	15-97	1546	8
Tegerstedt [767]	Sweden	Validated 5 item questionnaire	30-79	5489	8
Eva [769]	Sweden	Any symptom of pelvic heaviness, genital bulge, or use of fingers in vagina or on perineum for defecation	40 60	641 663	23 28
Samuelsson [770]	Sweden	Standardized pelvic examination	20-59 (mean=39)	487	Any prolapse: 31 To introitus: 2 Cystocele: 16 Rectocele: 14 Uterocel*: 5
Rortveit [768]	USA	Feeling of bulging, pressure or protrusion or visible bulge or protrusion	40-73 (mean=56)	2109	6
Lawrence [764]	USA	Sensation of bulge in vagina or something falling out of vagina with a degree of bother of at least 33 on a 1-100 visual analogue scale (validated)	25-84 (mean= 57)	4103	6
Hendrix [762]	USA	Standardized pelvic examination	50-79 (mean=63)	27,342	Any prolapse: 40 Cystocele: 34

First author	Country	Definition of POP	Ages (years)	N	Prevalence Subgroup: %
					Rectocele: 19 Uterocele*: 14
Handa [763]	USA	Standardized pelvic examination	50-79 (mean=63)	412	Any prolapse: 32 Cystocele any: 25 Cystocele grade 1: 14 Cystocele grade 2: 10 Rectocele any: 13 Rectocele grade 1: 8 Rectocele grade 2: 5 Uterocele any: 4 Uterocele grade 1: 3 Uterocele grade 2: 1
Nygaard [766]	USA	POP-Q**	50-79 (mean=68)	270	Stage 0: 2 Stage 1: 33 Stage 2: 63 Stage 3: 2 Stage 4: 0 ≥ hymeneal ring: 26
Bradley [765]	USA	POP-Q	50-79 (mean=68)	270	≥ hymeneal ring: 24

* *Denominator is women with a uterus*

** *Stages defined as 0: no prolapse, 1: prolapse to 1 cm above hymen, 2: prolapse to between 1 cm above and 1 cm below hymen, 3: prolapse between 1 cm below hymen and 2 cm above introitus, 4: prolapse beyond 2 cm above introitus.*

Note: Studies reported by Handa, Nygaard and Bradley are all subsets from study reported by Hendrix.

Two studies that examined prolapse by race found that Black women had the lowest prevalence and Hispanic women the highest after controlling for multiple other factors in multivariate analysis [762,768]. The study reported by Rortveit et al based on symptoms found adjusted odds ratios of 0.4 (95% CI=0.2-0.8) for Black and 1.3 (95% CI=0.8-2.2) for Hispanic women, with White women as the referent group [768]. Hendrix et al reported adjusted odds ratios of 0.6 (95% CI=0.5-0.8) for Black and 1.2 (95% CI=1.0-1.5) for Hispanic women compared to White women for POP based on genital examination [763].

post-menopausal women with a uterus were examined using the POP-Q at baseline and annually for 3 years. POP was defined as prolapse to or beyond the hymeneal ring. The incidence of new POP was 26% at 1 year and 40% at 3 years, with remission rates of 21% at 1 year and 19% at 3 years [765].

Several studies have reported the annual incidence of surgery for POP in the US and at least one in the UK. A longitudinal study of over 17,000 women in the UK, age 25 to 39 at baseline, reported an annual rate of prolapse surgery of 0.16% [763]. This rate is consistent with the rate of approximately 0.2% per year reported in the US [764-765]. One US study reported an annual incidence rising with age from 0.05% in women age 30-39 to 0.5% in women age 70-79 with an estimated lifetime cumulative risk of surgery from prolapse of 7% to 11% [766]. A recent US study reported similar surgical rates: 0.07% for women 18-39, 0.24% for women age 40-59, and 0.31% for women age 60-79 [765]. Surgical rates drop substantially after age 80 [766-767]. Estimating rates of prolapse surgery has the advantage of using hospital discharge data on procedures, which is highly accurate for the procedure performed, but less accurate for the indications for the procedures, particularly when a procedure may have more than one indication.

3. INCIDENCE

Only two studies could be located that reported the incidence of new POP. Both studies were done on sub-groups of women enrolled in the WHI Oestrogen Plus Progestin Trial. The first study of 412 women enrolled at the University of California, Davis site, used a standardised pelvic examination repeated every 2 years over 8 years [763]. The incidence of new cystocele, rectocele and uterine prolapse was 9%, 6% and 2%, respectively. Annual rates of remission from grade 1 (prolapse to above introitus) was relatively common for each type of POP (24%, 22% and 48%, respectively) but less common from grade 2 or 3 (prolapse to or beyond introitus) (9%, 3% and 0%, respectively). In a second study of 259 women

4. RISK FACTORS

4.1. Bowel dysfunction and pelvic organ prolapse

Women who seek urogynecological care report a high prevalence of bowel symptoms [773]. However, bowel dysfunction is highly prevalent among women in general and it has been estimated that up to 27% of the female population in industrialised countries are affected by constipation [774]. The overall prevalence of constipation and associated symptoms in women with pelvic organ prolapse ranges between 20-53% depending on definition of disorders [775-777]. Although definitions of disease differ between studies it is widely acknowledged that bowel dysfunction is a complex condition with a multifactorial aetiology. Bowel dysfunction comprises a wide variety of symptoms including constipation, rectal emptying difficulties, incomplete defaecation, manually assisted defaecation, faecal urgency and irritable bowel syndrome (IBS). Neurophysiologic assessments have shown that damage to the pelvic floor musculature nerve supply can occur as a result of chronic constipation [778]. Other predisposing factors comprise low socio-economic status, pelvic floor surgery, depressive disorders, thyroid dysfunction, physical disability and inactivity, and food habits [779].

Current epidemiological evidence on the association between bowel dysfunction and pelvic organ prolapse are at odds. A number of studies suggest that women with pelvic organ prolapse are significantly more likely to experience constipation and other symptoms of bowel dysfunction, [768,777,780-782] whereas others show a weak or non-existent association [762,776,783-784]. In a case-control study, manually assisted defaecation was present in 19.7% of women with prolapse compared to 4.4% of control subjects ($p < 0.001$) [777]. In a randomly selected population based study, irritable bowel syndrome and constipation were both strongly associated with pelvic organ prolapse (OR 2.8 95% CI 1.7-4.6, and OR 2.5 95% CI 1.7-3.7 respectively) [768]. Varma et al., [769] suggested that among randomly selected women, with symptomatic pelvic organ prolapse more than doubled the risk for obstructed defaecation (OR 2.3 95% CI 1.5-3.7). A retrospective questionnaire based survey of women with and without prolapse concluded that constipation as a young adult was an important factor in the development of uterovaginal prolapse [780]. In a case-control study, women with prolapse were at increased risk for constipation even after adjustment for dietary fibre intake (OR 2.9, 95% CI 1.1-13.5), when compared to women without prolapse [781]. Also in a low income setting constipation has been identified as a risk factor for symptomatic pelvic organ prolapse [785].

In the cross-sectional Women's Health Initiative (WHI), cystocele and rectocele were only weakly associated with constipation (OR 1.1 95% CI 1.0-1.2) [762]. Similar weak associations between prolapse and bowel dysfunction have been observed in other large cross-sectional studies [776,783-784]. Overall severity and prevalence of bowel dysfunction has shown poor correlation with findings of pelvic organ prolapse at radiological imaging [786-788]. Also at clinical examination, increasing vaginal descent and prolapse severity, show a generally weak (or absent) association with symptoms related to bowel dysfunction [758,775,789-791]. In a substudy of the WHI, no specific bowel symptom was associated with increasing loss of pelvic organ support in any vaginal compartment [784]. When considering compartment-specific pelvic floor defects, most studies suggest that increasing posterior vaginal wall prolapse and perineal descent are correlated to more symptoms of obstructive defaecation [758, 776, 788]. In a cross-sectional study of 260 women with pelvic organ prolapse, women with posterior vaginal wall prolapse were more likely to experience incomplete emptying (41% vs 21%, $P = 0.003$), straining at defaecation (39% vs 19%, $P = 0.002$), and splinting with defecation (36% vs 14%, $P < 0.001$) compared with women without posterior vaginal wall prolapse. But there was no significant association between bowel symptoms and increasing severity of prolapse [792].

The association between bowel dysfunction other than specifically obstructive symptoms and pelvic organ prolapse has been poorly investigated. In a random population-based study of 2109 racially diverse women women with IBS (prevalence = 9.7%) had higher odds of reporting symptomatic pelvic organ prolapse (OR 2.4; 95% CI, 1.4-4.1) compared to those without IBS [793]. It has also been suggested that anal sphincter dysfunction such as paradoxical anal sphincter reaction is more common in patients with a rectocele as compared to women without rectocele at defaecography [794].

4.2. Pelvic surgery and POP

Even though the suggestion that hysterectomy increases the risk for pelvic organ prolapse has wide acceptance, longitudinal studies confirming a temporal association are few and previous studies do not often differentiate between various types of hysterectomy. A number of cross-sectional and retrospective studies implicate hysterectomy as an independent risk factor for pelvic organ prolapse. However, due to a delay of onset, large population samples and a sufficiently long duration of follow-up are required to determine an association with adequate certainty.

In a nationwide cohort study, Altman et al. [795] reported that 3.2% of women who had undergone hysterectomy had pelvic organ prolapse surgery, compared with 2.0% in non-hysterectomised controls, corresponding to a risk of 1.7 (95% CI, 1.6-1.7). In this Swedish study, vaginal hysterectomy had the

highest risk for subsequent prolapse surgery (HR 3.8, 95% CI, 3.1 to 4.8) in comparison to non-hysterectomised controls. These results were corroborated by Cooper et al. in a large study from Scotland showing an increased risk for prolapse surgery among women after hysterectomy, compared to endometrial ablation [796]. These register-based data are largely in agreement with the longitudinal Oxford Family Planning Association study by Mant et al. [797] reporting increased overall incidence rates for prolapse surgery following hysterectomy. Although not separating various hysterectomy techniques, Mant et al. determined that the risk of prolapse following hysterectomy was 5.5 times higher (95% CI 3.1-9.7) in women whose hysterectomy was performed for prolapse as opposed to other benign conditions. In a large register-based survey from Denmark (n=154,882) [798] it was determined that the highest cumulative incidence of subsequent POP surgery 32 years after hysterectomy was found among women where pelvic organ prolapse was the indication for hysterectomy and also that the posterior compartment was the predominant location for prolapse occurrence post-hysterectomy. A history of hysterectomy has also been identified to increase the risk for prolapse in several cross-sectional and retrospective studies [799-800].

Specific risk factors for posthysterectomy prolapse have been assessed in two case-control studies. Both Dällenbach et al. [801] and Forsgren et al. [802] reported that pelvic floor surgery before hysterectomy was the strongest risk factor for developing posthysterectomy pelvic organ prolapse (OR 7.9, 95% CI 1.3-48.2 and OR 2.8, 95% CI 1.0-7.7 respectively). The risk of prolapse repair was 4.7 times higher in women whose initial hysterectomy was indicated by prolapse [801]. Vaginal vault prolapse involves the loss of vaginal apical support and may by definition only occur after hysterectomy [803]. Marchionni et al. [804] reported a 4.4% overall incidence of vaginal vault prolapse after hysterectomy but in women where uterine prolapse was the indication for hysterectomy the incidence was 11.6%. In a register-based study Forsgren et al. [805] showed that the greatest risks for prolapse surgery (HR 4.9, 95% CI 3.4-6.9) were observed subsequent to vaginal hysterectomy for pelvic organ prolapse but having a vaginal hysterectomy also for other indications significantly increased the risk for subsequent pelvic organ prolapse surgery compared to other modes of hysterectomy. Similar observational results were shown by Cooper et al. [796].

It has also been suggested that pelvic surgery other than hysterectomy may predispose women to subsequent genital prolapse including: rectopexy for rectal prolapse (OR 3.1; 95% CI 1.4-6.9) [806]; gynaecological surgery in general (OR = 3.9, 95% CI 1.8-8.8) [807]; and retropubic colposuspension procedures are associated with a near 30% risk of subsequent vaginal vault and posterior vaginal prolapse at long-term evaluations [808-809]. In a prospective cohort

study of 374 women, the 10-year re-operation rate was 17% after traditional prolapse or incontinence surgery [810]. Having undergone pelvic organ prolapse or incontinence surgery prior to the index operation increased the risk of re-operation to 17% compared with 12% for women who underwent a first procedure (p=.04) [810].

4.3. Obstetrical factors and POP

For ethical and practical reasons, randomised controlled trials to study the causal effects of vaginal and caesarean delivery on the pelvic floor will never be performed. Observational studies will therefore remain the main source of knowledge on this subject. Nonetheless it is widely accepted that childbirth is a significant risk factor for pelvic organ prolapse, presumably due to overt or occult pelvic floor tissue trauma. Controversy does, however, remain with regard to the protective effect of caesarean section and if specific obstetrical events should be considered as risk modifiers. Due to a delayed onset of pelvic organ prolapse in relation to giving birth, studies on the subject need a long duration of follow-up as well as large study populations to be able to elucidate the possible causative events. Therefore, the majority of studies on the subject are typically designed a cross-sectional surveys or retrospective cohort or case-control studies. It is, however, encouraging that long term longitudinal data are starting to emerge and in recent years several studies with follow-up periods extending beyond 10 years have been published.

Pregnancy in itself has been identified as a risk factor for stress urinary incontinence. With regard to pelvic organ prolapse, the association is less well substantiated. In a clinical case-control study, all 21 nulliparous non-pregnant women had POP-Q stage 0 or 1, whereas 47.6% of 21 nulliparous pregnant women had pelvic organ descent corresponding to stage II (p<0.001) [811]. Overall POP-Q stage was higher in the third trimester than in the first (p=0.001). Also Sze et al. [812] found that in 94 nulliparous women evaluated at the 36 week antepartum visit and six weeks postpartum, POP-Q staging increased.

A large number of studies identify childbirth as one of the strongest predictors for developing pelvic organ prolapse later in life. [762,768,797,799,813-820]. It is also a recurrent observation that the number of childbirths is associated with the risk of prolapse although there are data to suggest the contrary [821]. In the prospective Oxford Family Planning Association study [797], childbirth was the single strongest risk factor for developing prolapse in women under 59 years of age and the risk increased by every childbirth. Similar findings derived from the WHI, [762] where a parity of one conveyed an overall two-fold risk increase for prolapse compared to having no children, after which each additional childbirth added a 10-20% risk increase. In a case-control study, Tegerstedt et al. [817] found that the risk for symptomatic pelvic organ prolapse increased with number of childbirths and were 3.3-times higher among mothers of

four than among mothers of one. Similarly, Rortveit et al. [768] found that the risk of prolapse increased in women with one (OR 2.8 95% CI 1.1-7.2), two (OR 4.1, 95% CI 1.8-9.5), and three or more (OR 5.3, 95% CI 2.3-12.3) vaginal deliveries compared with nulliparous women. In a questionnaire based cross-sectional study among 2,640 middle-aged women the number of vaginal deliveries was a risk factor for past or present symptomatic prolapse [818].

with data from other long-term studies with more than a decade of follow-up (see below). In women with caesarean deliveries only the incidence rate for POP surgery showed very little variation over time and being notably lower compared to the vaginal delivery cohort 10 years after first birth for the duration of the observational period. There are some reports suggesting that in the long term, caesarean delivery does not provide a significant risk reduction pelvic floor morbidity

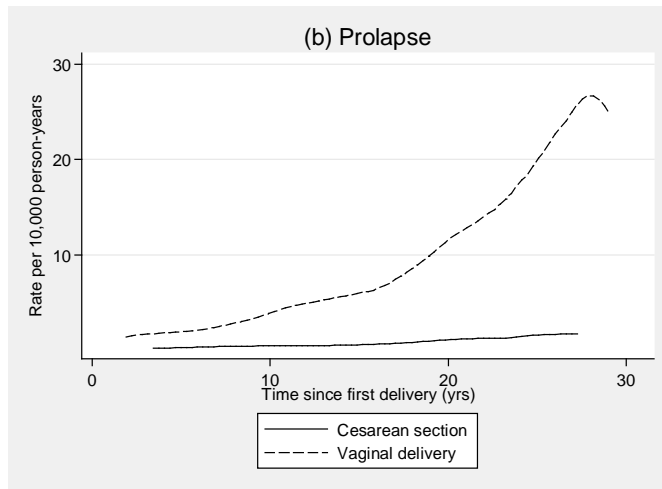

Figure 10: Rate of pelvic organ prolapse surgery in relation to mode of delivery and time from first childbirth [823].

Whether or not caesarean section prevents loss of pelvic organ support has been debated but today the vast majority of studies show that elective caesarean section does indeed decrease the risk of pelvic organ prolapse later in life [813-824].

In 4,458 randomly selected women, vaginal childbirth increased the risk of prolapse by 1.82 (95% CI 1.04-3.19). [66] In a nested case-control study, Uma et al. [816] found that caesarean section was associated with a significantly reduced risk of pelvic floor surgery compared with spontaneous vaginal delivery (OR 0.16, 95% CI 0.05-0.55). In a case-control study, Chiapparino et al. [822] found that women who were delivered by caesarean section were at significantly lower risk for prolapse (OR 0.3 95% CI 0.1-1.0). In a register-based cohort study of women having their first and all subsequent deliveries by caesarean (n = 33,167), and an age-matched sample of women only having vaginal deliveries (n = 63,229) between 1973 and 1983, Leijonhufvud et al. [823] found that women only having vaginal deliveries had a significantly increased overall risk of subsequent prolapse surgery (hazard ratio, 9.2; 95% CI 7.0-12.1) compared with women only having caesarean deliveries. Among women with vaginal deliveries only the incidence rate for prolapse surgery increased steadily, reaching its peak close to three decades after first delivery. This corresponds

compared with vaginal delivery [823-824]. These studies belong to an overwhelming minority and most long-term longitudinal studies published in recent years, with follow-up times ranging between 10 and 23 years, commonly show that caesarean section provides a significant reduction in risk for pelvic organ prolapse. Volløyhaug et al. [824] showed that caesarean delivery was associated with decreased risk of pelvic organ prolapse 15-23 years after first delivery (OR 0.42, 95% CI 0.21-0.86). Compared with women whose births were all spontaneous vaginal deliveries, women who had all births by caesarean section were the least likely to have prolapse (OR 0.11, 95% CI 0.03-0.38) 12 years after first birth according to Glazener et al. [820]. Gyhagen et al. [819] reported that 20 years after birth singleton primiparae with no further births (n = 5236) had a significantly higher prevalence of pelvic organ prolapse after vaginal delivery compared with caesarean section (14.6 versus 6.3%, OR 2.55, 95% CI 1.98-3.28) but was not increased after emergency compared with elective caesarean section.

A number of specific obstetrical events and interventions have been implicated as risk factors for the development of pelvic organ prolapse. In one study, maternal age and use of epidural analgesia was associated with an increased need for pelvic organ prolapse

surgery [814]. Handa et al. [827] found that operative vaginal birth significantly increased the risk for all pelvic floor disorders and pelvic organ prolapse in particular (OR 7.5, 95% CI 2.7-20.9). In a long term longitudinal study Volløysaugh et al. [824] found that operative vaginal delivery was associated with increased risk of pelvic organ prolapse (OR 1.73, 95% CI 1.21-2.48) when compared with non-instrumental vaginal delivery. There were no differences in the risk for pelvic organ prolapse when comparing forceps and vacuum delivery.

In a case-control study, Chiaffarino et al. [822] found that after forceps delivery women had an OR of 3.6 (95% CI 1.0-13.5) for developing pelvic organ prolapse, but after adjustment for vaginal delivery the odds were no longer significant (OR 1.3 95% CI 0.6-3.1). Also Moalli et al. [828] concluded that forceps delivery posed a risk for prolapse and a case-control study found no significant association with maternal age, instrumental delivery (forceps or vacuum), or length of delivery when comparing women with prolapse to randomly selected controls [817]. On the other hand, Uma et al. [816] found no significant association between pelvic organ prolapse and forceps delivery (OR 0.9, 95% CI 0.7-1.2); infant birthweight >4.0 kg (OR 0.9, 95% CI 0.5-1.7); episiotomy (OR 1.46, 95% CI 1.0-2.10); and labour prolonged >12 hours (OR 1.51, 95% CI 1.00, 2.27). Similarly both Gyhagen et al. [819] and Glazener et al. [820] found no significant association of increased risk between instrumental delivery and pelvic organ prolapse compared with spontaneous vaginal delivery.

4.4. Miscellaneous risk factors and POP

A wide variety of risk factors for pelvic organ prolapse, others than those addressed above, have been identified in the literature. Most of these have been investigated as part of larger multivariate analyses based on cross-sectional surveys or retrospective case-control studies. Overall, these associations are largely of level III-IV evidence and further research is needed to disentangle the effects and interactions of environmental risk factors for prolapse.

Several somatic risk factors for pelvic organ prolapse have been identified. Generalised connective tissue disorders such as Ehlers-Danlos disease and Marfans syndrome [829-830] have been linked to an increased risk for pelvic organ prolapse. In a community-based study of prolapse in rural West Africa, chronic anemia was the strongest risk factor for prolapse after parity and age (OR 2.1 95% CI 1.1-3.4) [831] and also chronic obstructive pulmonary disorders. Skeletal abnormalities such as thoracic kyphosis, lumbar lordosis and pelvic dimension changes have been associated with an increased risk for prolapse [832-833]. Women with joint hypermobility have a significantly higher prevalence of genital (and rectal) prolapse in comparison to women with normal mobility [834-835]. Weak associations have also been shown for osteoporosis and rheumatoid arthritis

[825]. Obesity may be associated with increased pelvic floor symptoms and more severe symptomatic prolapse [818-819, 836-837] yet increasing body mass index and obesity has not consistently been identified as risk factors for prolapse as compared to stress urinary incontinence [838-839]. Other factors that have not convincingly demonstrated any significant linkage to prolapse include the presence of chronic obstructive pulmonary disease and diabetes mellitus [785, 800, 839]. Pulmonary impairment has been shown to more common in women with loss of pelvic organ support compared to those without [840]. In a study by Rogowski et al. [841] the diagnosis of metabolic syndrome was associated with the severity of pelvic organ prolapse in urogynecological patients (OR 3.5, 95% CI 1.5-8.2) as compared to those without.

A low educational level (OR 2.16, 95% CI 1.10-4.24) [842] and low annual income [843], are socio-economic factors which have been associated with an increased risk for pelvic organ prolapse. In 21,449 non-hysterectomised Italian women, higher education was associated was a protective factor for uterine prolapse [826]. However, despite significant differences in educational level, smoking habits, alcohol consumption, and socio-economic indices, the prevalence of pelvic organ prolapse did not differ between Croatian urban and rural women [844]. Interestingly, risk factors for pelvic floor disorders including pelvic organ prolapse among women in developing countries were similar to those in industrialised countries (increased age and parity). In a review study across 16 low-income and lower middle-income countries the mean prevalence for pelvic organ prolapse was 19.7% (range 3.4-56.4%) but risk factors were similar to those described in studies from more affluent countries but additionally pelvic organ prolapse and other pelvic floor disorders were associated with other factors including poor nutrition and heavy physical work [845-846].

A physically strenuous occupation has also been shown to influence the risk for pelvic organ prolapse. In a register based study of 28,000 Danish assistant nurses exposed to repetitive heavy lifting, the risk for prolapse was higher among the nurses compared to controls (OR 1.6 95% CI 1.2-2.2) [847]. Women who were laborers/factory workers had significantly more severe prolapse than other job categories ($p < 0.001$) in a cross-sectional study of women presenting for routine gynecological care [848]. Also, hard physical training may increase the risk for prolapse as women attending paratrooper training, were more likely to present stage II prolapse compared to controls (RR=2.7 95% CI 1.4-5.4) [849].

5. SUMMARY POINTS

- Most studies have used a cross-sectional design and there are limited longitudinal data to suggest

a causal relationship between symptoms of obstructed defaecation and pelvic organ prolapse or vice versa.

- Posterior vaginal wall prolapse and perineal descent are the specific pelvic defects most frequently associated with symptoms of obstructive defaecation.
- Current evidence suggests that hysterectomy increases the risk for subsequent pelvic organ prolapse in general
- Vaginal hysterectomy and hysterectomy performed for uterine prolapse are the strongest risk factors for having secondary pelvic floor surgery
- Childbirth is associated with an increased risk of pelvic organ prolapse later in life and increasing number of childbirths is positively associated with the risk.
- Long-term prospective study data consistently show that caesarean section decreases the risk for pelvic organ prolapse and that caesarean section is associated with a decreased risk of subsequent pelvic floor morbidity in comparison to vaginal birth.
- Current understanding of how specific obstetrical interventions influence the risk of pelvic organ prolapse is poor but instrumental delivery may increase the risk of developing pelvic organ prolapse.
- Life style factors and socio-economic indices may be associated with the risk of pelvic organ prolapse in both industrialised and non-industrialised countries.
- A number of somatic diseases and conditions have been linked to the occurrence of prolapse but the cause-effect relationship is undetermined.

VIII. THE GENETIC EPIDEMIOLOGY OF URINARY INCONTINENCE AND PELVIC ORGAN PROLAPSE IN ADULT WOMEN

Geneticists have historically pursued a specific sequence of studies to establish the genetic basis of diseases [850]. The first step was measurement of familial correlations, followed by formal twin or adoption studies. Analysis of segregation patterns in extended pedigrees was used to identify the likely mode of inheritance. This information was used to inform linkage studies, designed to identify putative chromosomal risk loci. Only once these steps were complete

would association studies be attempted. Although it remains relevant to establish the heritability of a trait, this traditional sequence of investigations has been supplanted by the success of Genome-wide association studies (GWAS), with many new discoveries now coming from association studies without the prior steps. Nonetheless here we recapitulate the history of our understanding of urinary incontinence as a complex genetic disease, with multiple genetic and environmental risk factors, and review the studies that formed the basis for the genetic epidemiology of incontinence.

1. FAMILY STUDIES

The existence of both acquired and inherited risk factors for incontinence was first recognised more than 150 years ago (H. Thompson, 1854), by observation of familial aggregation. However, familial aggregation provides limited evidence of heritability, since it fails to control for the effects of shared environmental factors. For incontinence, exposures to all major lifestyle risk factors are likely to be at least partly determined by socio-cultural values that are shared within families. Such effects are at least plausible for family size, smoking, socio-economic status, care seeking behaviour, physical exercise, dietary and drinking habits, and toilet training. As incontinence is considered stigmatizing in all populations, family studies may be at risk of differential misclassification bias. This might be expected to have particular impact on the validity of estimates obtained from studies employing the family history method, and any study with non-random sampling of families, for example those relying on probands recruited in secondary care, or those recruiting volunteers via advertisement. Finally, while age correction of risks is possible, to account for increasing disease prevalence with age, this has typically not been employed in family studies of incontinence.

Although family studies may not provide robust evidence, there have been many studies that examined prevalence of incontinence among relatives of women with incontinence [204, 851-855]. Despite considerable variation in case selection and sampling methods, almost all studies have demonstrated increased risk for urinary incontinence among first degree relatives of probands. This appears to have a plausible biological gradient, with higher risks among relatives of women with severe incontinence.

The most modest estimates come from the EPINCONT study, which is also least likely to be affected by bias, with the direct ascertainment method employed in a large population representative sample [854]. With a total sample of 8,125 pairs of probands and their daughters or younger sisters, they found less than two-fold increased risk of stress UI among daughters of women with stress UI (RR 1.52 95%CI 1.28-1.81), and a non-significant but directionally

consistent increased risk of urge UI among daughters of women with urge UI (RR 1.80 95%CI 0.83-3.92). Similarly, in a survey spanning 11 countries in South and East Asia (n = 5,502), a family history of OAB was also a modest predictor of OAB symptoms including urge incontinence (OR 1.62 95%CI 1.42-1.83)[854]. In the studies that have used multivariate analyses, it appears that these familial risks are attenuated but not eliminated by adjustment for classic risk factors for incontinence including age, parity, and BMI.

Risks seem particularly elevated in relation to incontinence surgery. For example in a registry based study of 3,678,556 Swedish women, surgery for stress UI among sisters was associated with greatly increased odds (OR 6.09 95%CI 5.73-6.48) [857]. This exaggerated association might be a consequence of low rates of presentation for care, such that care seeking rather than the underlying symptoms are particularly familial. In contrast to the twin studies discussed in the next section, family studies have demonstrated much more clearly that stress rather than urge incontinence is familial. This might be a reflection of more stigma around urgency incontinence, or simply lack of statistical power for a rarer condition.

Table 20: Family studies of urinary incontinence among women.

Study	Setting	Design	Age range	n (♀ probands and controls)	Proband phenotype	Family member outcomes	OR or RR (95%CI)
Diokno et al, 1990	Population Based	Family History Method	>60	1,154	Any UI	Either parent with UI as adult	2.04 (1.55-2.68)
						Any sibling with UI as adult	1.85 (1.32-2.60)
					Urge UI	Either parent with UI as adult	1.89 (0.93-3.82)
						Any sibling with UI as adult	0.68 (0.20-2.28)
					Stress UI	Either parent with UI as adult	1.74 (1.12-2.70)
						Any sibling with UI as adult	1.59 (0.92-2.75)
					Mixed UI	Either parent with UI as adult	2.63 (1.91-3.61)
						Any sibling with UI as adult	2.32 (1.58-3.40)
Other UI	Either parent with UI as adult	0.23 (0.06-0.99)					
	Any sibling with UI as adult	0.70 (0.21-2.34)					
Mushkat et al, 1996	Secondary Care	Direct ascertainment	>18	424	Urodynamic Stress UI	Stress UI among all first degree relatives	3.00 (2.06-4.38)
						Stress UI among mothers	3.68 (2.10-6.45)
						Stress UI among sisters	3.39 (1.89-6.08)
						Stress UI among daughters	2.43(0.68-8.65)
Hannestad et al, 2004(Population based	Direct ascertainment	>18	8,771 (mothers) 2,866 (older sisters)	Any UI	Any UI among daughters	1.31(1.19-1.44)* 1.94(1.26-3.00)**
						Any UI among younger sisters	1.59(1.34-1.89)*
					Stress UI	Stress UI among daughters	1.52(1.28-1.81)* 2.98(1.11-8.03)**
						Stress UI among younger sisters	1.77(1.34-2.33)*
					Urge UI	Urge UI among daughters	1.80(0.83-3.92)*
					Mixed UI	Mixed UI among daughters	1.55(1.21-1.99)*

Study	Setting	Design	Age range	n (♀ probands and controls)	Proband phenotype	Family member outcomes	OR or RR (95%CI)
							2.07(0.92-4.64)**
						Mixed UI among younger sisters	1.74(1.08-2.82)*
Elia et al, 2002(Secondary Care	Family history method	>18	667	Any UI	Any UI among any relatives	4.51(2.833-7.20)
Ertunc et al, 2004(Secondary Care	Direct ascertainment	>18	513	Surgery for Stress UI	Stress UI among mothers	3.71(1.84-7.47)
						Stress UI among sisters	2.49(1.49-4.16)
Buchsbaum et al, 2006	Community Based	Direct ascertainment	Post menopause	143	Nulliparous with any UI	Any UI among parous sisters	2.89(1.46-5.70)
Lapitan et al, 2001	Secondary Care	Family history	>18	5,502	OAB	Any family history	1.62(1.42-1.83)
Andrada Hamer et al, 2013)	Population based	Direct ascertainment (registry)	Any age	3,678,556	Surgery for Stress UI	Surgery for Stress UI among sisters	6.09(5.73-6.48) [§]
						Surgery for Stress UI among mothers	2.56 (2.27–2.89) [§]

***RR adjusted for age, BMI, and parity **RR adjusted for age, BMI, and parity and restricted to subgroup of daughters of mothers with severe UI \$ RR adjusted for age and parity. Note: unadjusted risks generally higher across all outcomes, indicative of substantial concordance/correlation in age, BMI, and parity between family pairs.**

Three studies have also assessed family history as a risk factor for incident post-partum incontinence, with some evidence of familial aggregation [317,858-859]. Again, however, estimates from these studies may be compromised by use of the family history method, rather than direct ascertainment. A single large study has assessed correlations between adult incontinence and childhood daytime wetting, using the ALSPAC cohort [860]. Using a sample of 8,145 children aged seven they reported excess risks associated with incontinence in the children for incontinence among their mothers (OR 2.64, 95%CI 1.38-5.07) and particularly among their fathers (OR 5.47, 95%CI 2.39-12.50).

In summary, a family history of incontinence is associated with approximately two to three fold increased risk. Such an effect appears to hold for all subtypes of incontinence, although the evidence is more robust for stress UI. Among adults there is plausible evidence that family history is associated with both earlier onset, and more severe phenotype. Additionally, there is also clear evidence that this familial predisposition stretches right across the lifecourse. These effects are however partly explained by known environmental risk factors, and family studies cannot exclude the risk of further unmeasured confounding from shared environmental risks. For this we should consider evidence from classical twin studies.

2. TWIN STUDIES

Twin studies compare the concordance in a trait or condition between monozygotic (MZ) twins and same-sex dizygotic (DZ) twins, to estimate heritability. Heritability, and here specifically broad-sense heritability, is defined as the proportion of phenotypic variation (VP) that is due to variation in genetic values (VG). For genetically determined traits higher concordance is observed in MZ twins compared to DZ twins, while for entirely environmentally determined traits, concordance should be the same in both types of twin pairs.

This idea is illustrated by consideration of a fully penetrant autosomal single gene disorder, which will display 100% concordance in MZ twins, while in DZ twins will have only 50% concordance for a gene with dominant mode of inheritance. A fundamental assumption of analyses of classic twin studies is that both types of twin pairs share equal environment. This assumption is clearly violated both prenatally, and in later life. This bias can be further investigated in studies of twins reared apart, or in adoption studies, but these designs have not been applied to the study of incontinence. A second central assumption is that MZ twins are genetically identical, which again is violated both by epigenetic effects, and by somatic mutation.

Three major twin resources have been used to assess genetic influences on incontinence: the US

Twins Days festival, the Danish Twin Registry, and the Swedish Twin Registry. The Twins Days festival relies on volunteers, and the resulting recruitment bias is likely to overestimate concordance for many traits for both MZ and DZ twins. In the sample of 1,764, predominantly MZ, middle-aged twins from Twins Days, concordance of symptomatic stress urinary incontinence was 79.5% for MZ and 78.6% for DZ twins [861]. Such a result suggests no significant genetic contribution to stress urinary incontinence at all.

Among a sample of 2,336 twins surveyed as part of four studies from the Danish Twin Register, concordances for both MZ and DZ twins were much lower not only for stress urinary incontinence, but also for urgency and mixed incontinence [862]. With cohorts for middle-aged and elderly women, heritability was calculated separately in each age group. As in the Twins Day sample, genetic factors were not significant for stress incontinence in middle-aged women, but rose to a heritability of 39% in the elderly women. Similarly heritability increased with age for urgency incontinence (42% rising to 49%), and mixed incontinence (27% to 55%).

Women participating in the Swedish Twin Register have provided relevant data as part of two separate analyses [863-864]. Treatment codes corresponding to stress incontinence and prolapse surgery from a nationwide surgical register were used to estimate heritability for a sample of 16,886 twins aged >50. Concordances for surgical treatment were low, but produced heritability estimates of 41% for stress incontinence surgery, and 43% for prolapse surgery. Similarly for female twins aged 20-46 from the same register (evaluable sample 4,550), using self-completed questionnaires, produced an estimate of 34% heritability for stress incontinence. From the same survey, heritability was estimated for urgency incontinence (37%), mixed incontinence (18%), "any" incontinence (51%), nocturia (48%), and urinary frequency (40%). It was however noted that because of sample size limitations, an absence of genetic effects cannot be entirely precluded for stress, urgency, or mixed incontinence.

The mechanism of these probable genetic effects has also been explored in analyses of joint hypermobility and pelvic floor mobility in twins [865-866], which is one pathophysiological correlate of stress incontinence. These data suggest heritability of 59% for oblique bladder neck descent on Valsalva in nulliparous twins aged 18-24, with a shared genetic component to both pelvic floor and elbow mobility.

In summary, twin studies to date have suggested significant heritability for stress incontinence and urgency incontinence with genetic variation potentially contributing up to half of population phenotypic variation. Heritability appears to be highest for urgency incontinence, with apparent heritability increasing with age as environmental factors reduce in importance.

This is consistent with our understanding of childbirth as a major environmental determinant of incontinence. Genetic predisposition to incontinence may manifest at a preclinical stage in pelvic floor hypermobility. Together with data from family studies this provides strong evidence of genetic risk factors for incontinence.

3. SEGREGATION ANALYSES

Despite the large number of family studies of incontinence in adults, there have been few studies to examine segregation among extended pedigrees. Studies of families affected by nocturnal enuresis [865], have however included some adults affected by urgency incontinence. Analysis of different enuretic families has usually suggested autosomal dominant inheritance with high penetrance, but low penetrance and autosomal recessive modes have also been reported. These findings could be a consequence of selection or ascertainment bias. In contrast results from more recent association studies strongly suggest that polygenic inheritance is most likely across the population as a whole.

4. LINKAGE STUDIES

A linkage study can be used to map a condition to one or more genomic loci by demonstrating co-segregation of the trait among an extended family with specific genetic markers. The association between two SNPs is measured using Linkage Disequilibrium (LD) statistics, typically D' or r^2 . With the success of the International HapMap Project [868] and the 1000 Genomes Project [869], LD has been established for the majority of all known common SNPs. Although there are more than 60 million catalogued human SNPs (“[dbsnp-announce] RELEASE: dbSNP Build 138 for Human and Cow,” n.d.), common SNPs less than 10 kb apart are often highly correlated. Thus without a requirement for dense genotyping, linkage studies can successfully identify loci containing a causal genetic variant [870]. Given the power constraints of assembling extended families for study, this technique is most successful for monogenic or oligogenic traits in which the causal variants have large effect sizes. Several linkage studies have been conducted using families of children affected by nocturnal enuresis, and two studies have considered uniquely adult symptoms. Earlier reports suggested a range of loci associated with nocturnal enuresis [867,871], and in the largest attempted replication using a collection of 32 families with at least three members with nocturnal enuresis, there was evidence in favour of a locus at chromosome 22q11 (cumulative logarithm (base 10) of odds (LOD) score 3.63), and weak evidence for loci at 13q13 (cumulative LOD score 1.53) and 12q (cumulative LOD score 1.95) [872]. Allen-Brady and colleagues [873] genotyped women from 32 families, including 70 patients needing surgical

treatment for prolapse. There was strong overlap with other pelvic floor disorders including a high prevalence of treatment for both stress and urgency incontinence. Using a set of 27,157 markers from a pre-designed array, they observed a significant peak at 9q21 (maximum HLOD 3.41), and further suggestive peaks at 9q31 (maximum HLOD 1.90), and 1q42 (maximum HLOD 1.89). Subsequent unpublished work from the same group did not however replicate these findings specifically for stress incontinence surgery [874] but suggested separate loci on chromosomes 2, 4, 8, 10 and 11 (maximum HLOD scores 2.15-2.98). Such problems with replication of linkage studies [875] have been recognised right across medicine, and may be particularly pronounced with multiple common variants each with small true effect sizes.

5. GENE ASSOCIATION STUDIES

A recent systematic review has summarised all prior candidate gene and genome-wide association studies [876]. Replication is an essential step in establishing the validity of genetic associations, and yet meta-analyses were possible for only three polymorphisms.

Variation in the beta-3 adrenoceptor, particularly of the rs4994 SNP, also known as Trp64Arg, has been extensively investigated in association with obesity, type 2 diabetes mellitus, and other metabolic syndrome phenotypes. The beta-3 adrenoceptor is highly expressed in bladder, and mediates detrusor muscle relaxation [877]. A beta-3 adrenoceptor agonist has recently been approved for treatment of overactive bladder symptoms [878-879]. Two conference abstracts [879-881] and one published paper [882] provided relevant information on the common rs4994 missense mutation, of which two could be included in meta-analysis. In the initial report, in a heterogeneous Japanese sample of 13 men and 31 women, with diverse urological pathologies including neurogenic bladder and benign prostatic hyperplasia, the rs4994 SNP was not associated with LUTS (OR 1.20 95%CI 0.32-4.47) [879].

Results were not available stratified by gender, and could not be included in quantitative synthesis. Subsequent reports used larger samples of Japanese women (n=100) [883], and Brazilian women (n=49) [882], and looked specifically at the overactive bladder phenotype, finding a large effect size (pooled OR 2.46 95%CI 1.67-3.60), with no heterogeneity. Despite a lack of information about genotyping QC, and some risk of population stratification, this large effect size confers some protection from bias, providing moderate epidemiological credibility.

rs1800012 also known as the Sp1-binding site polymorphism of collagen, type I, alpha 1, modifies transcription factor binding and gene expression. It has been most extensively studied in association with os-

teoporosis, where the minor allele is modestly associated with reduced bone mineral density and increased fracture risk [884]. Collagen, type I, alpha 1 is a major structural component of the vaginal epithelium and endopelvic fascia [885]. The available data on gene and protein expression in pelvic tissue from women with prolapse or stress incontinence are heterogeneous but suggest increased COL1A1 expression with reduced type 1 collagen content (see a previous comprehensive review [885]).

Two studies of Polish [886] and Greek [887] women reported associations of the same polymorphism with stress incontinence, in both cases using a combined symptomatic and objectively measured case definition. The pooled effect size was large (OR 2.09 95%CI 1.35-3.22) with no heterogeneity ($I^2=0\%$). There was significant deviation from Hardy-Weinberg equilibrium in one sample, and therefore only weak epidemiological credibility for this finding.

Matrix metalloproteinase-1, also known as interstitial collagenase, is one of a number of enzymes that cleave collagen type 1. The MMP1 gene is upregulated in pelvic tissues of women with prolapse [886]. Common variants of this gene have been extensively studied in association with chronic obstructive pulmonary disease [889], cardiovascular disease [890], and a number of cancers including of lung, colon and breast. Two studies tested associations with SUI [891-892], and the pooled effect was non-significant (OR 0.87 95%CI 0.63-1.20), with no heterogeneity.

Finally there remain a number of candidate gene studies of incontinence for which no replication has been reported. Statistically significant associations have been suggested between incontinence and the CAG copy number variant of AR, the androgen receptor [893], between incontinence and the rs6313 polymorphism of HTR2A, the serotonin 2A receptor [894], and between stress incontinence and both the rs2165241 and rs1048661 variants of LOX-L1, lysyl oxidase-like-1 [895]. Following the Venice recommendations [896], these nominally significant but unreplicated associations are all assigned weak epidemiological credibility.

As the first genome wide association studies (GWAS) for incontinence are reported, these results from candidate gene studies are all likely to be overturned. Initial GWAS results from the WHI found no replicable loci for urgency incontinence [897], while a subsequent consortia of European and US studies have reported as a conference abstract one replicated locus for stress incontinence close to the EN1 gene and one for urgency/incontinence close to the EDN1 gene [876]. Notably no previously suggested gene for incontinence was re-identified in either of these studies.

6. SUMMARY POINTS

Family studies and twin studies have provided convincing evidence of genetic predisposition to incontinence, with genetic variation contributing up to half of population phenotypic variability. Heritability is most pronounced for urgency incontinence. Although some families may be affected by severe dominant monogenic forms of incontinence, for the general population no clear mode of inheritance is apparent, consistent with our understanding of both stress and urgency incontinence as complex polygenic conditions. Linkage studies have not yielded consistent results, nor led to identification of any candidate genes. The few available candidate gene studies are underpowered for large genetic effects, but suggest the possibility of ADRb3 as a candidate gene. Emerging results from GWAS are likely to substantially change our understanding of the genetic architecture of these conditions.

IX. EPIDEMIOLOGY OF FAECAL INCONTINENCE

1. GENERAL COMMENTS AND DEFINITIONS

Faecal Incontinence (**FI**) is the involuntary loss of faeces – solid or liquid. Anal Incontinence (**AI**) includes these events as well as the involuntary loss of flatus, which is felt by many patients to be an equally disabling disorder. A third cause of soiling or embarrassment is anal mucoid seepage, a troubling condition that cannot be deferred even by an able sphincter and intact cognition. It is most often caused by an organic colonic disease or dietary sensitivity, and more rarely by faecal impaction. This is the loss of fluid, sometimes faeculent, often following a normal continent defecation. Seepage is an important condition to distinguish from other manifestations of incontinence because most authors that report very high prevalence rates of AI include leakage in their questionnaires. However in these individuals there is often no detectable sphincter abnormality [898]. It is not treatable by any of the standard therapies for incontinence of faeces: such as sphincter repair, neuromuscular re-education or even faecal diversion. It is in fact why we wear underclothes.

1.1. Ascertainment of Anal Incontinence

Older reports of AI prevalence have come from single institutions, and the patients described therein have been subject to referral bias when demographics and aetiology are discussed. The accuracy of AI prevalence estimates may also be diminished by difficulty in ascertaining those figures due to patients' reluctance to report symptoms or to seek treatment [899-

900]. It has been shown that women are more willing to report AI than men [901]. In addition, the character (incontinence of solid faeces, diarrhoea, or flatus, or merely anal seepage) and frequency (daily versus

seen that the prevalence of AI varied from 12.6% to 26.8% for each individual instrument, 4.6% were positive for all three and 13.2% were positive for two of three, which was the authors' definition of AI.

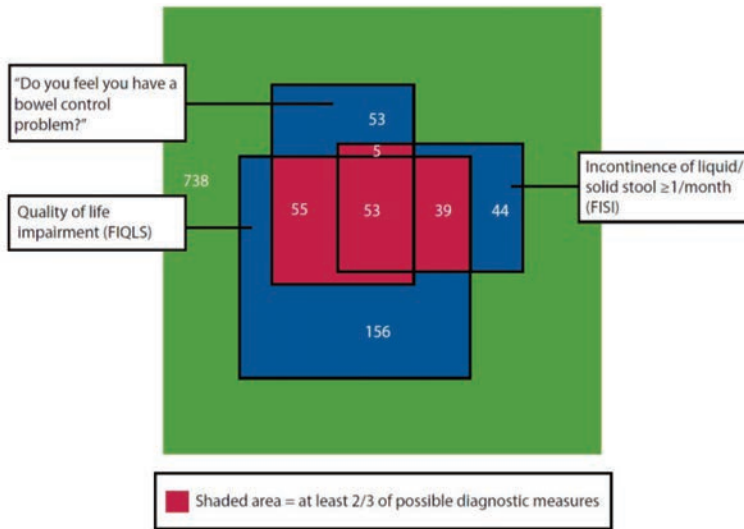

Figure 11: Co-occurrence of fecal incontinence in each of 3 diagnostic measures. FISI = Fecal Incontinence Severity Index; FIQLS = Incontinence Quality of Life Scale

episodic) of reported AI varies greatly in each report. So, prevalence depends heavily on the definition of AI.

Since ICI 5, new studies were sought using a search strategy for Medline and EMBASE and the Cochrane data base of clinical trials from 1966 to April, 2016.

The variation in prevalence of AI seen in a sampling of surveys in **Table 21** further demonstrates how difficult the ascertainment of AI is. The border between occasional dyschezia which may be associated with minor illness, travel or diet and a disabling disease that requires intervention to return a patient to acceptable function is not clearly drawn. Many questionnaires have been developed and “validated” for the detection of AI. At least three were published at the time of the last update of this volume. No systematic review of these many questionnaires has yet to be published. The most insightful of prevalence studies has recently been published from New Zealand [902]. The authors studied adults, not excluding those in custodial care. Acknowledging the difficulty in prevalence estimation, they used three different questionnaires. The first simply asked if the participant had incontinence and if they were troubled by it, the second was a well known quantitative instrument and the third a quality of life instrument specific to faecal incontinence. In the cohort examined there were those who were totally continent, those that exceeded thresholds in all three instruments and were undeniably incontinent and those who had positive responses on only one or two of the questionnaires (**Figure 11**). The authors surmised that two out of three positive responses constituted clinical AI, though the threshold for the quality of life instrument was very high (i.e. perhaps too sensitive). From the Figure 1 it can be

Table 21. Population-based Surveys of Prevalence of Anal Incontinence

COUNTRY (ref)	POPULATION	N	PREVALENCE
U.K. [900]	Community Service	4844	1.90%
France [921]	All >45 years	1100	11%, 6% to faeces, 60% are women
U.S.A. [919]	Market mailing	5430	7% soiling, 0.7% to faeces
U.S.A. [901]	Wisconsin households	6959	2.2%, 63% women
Australia [918]	Household survey	3010	6.8% in men, 10.9% in women, >age 15
Germany [924]	>18 years	500	4.4%-6.7% (by health)
Australia [923]	>18 years	618	11-20% (gender M>F)
Australia [925]	>18 years	651	11.30%
New Zealand [927]	>18 years old	717	8.1% for solid and higher for gas
U.K. [928]	>40 years	10116	1.40%
U.K. [929]	Postpartum women	549	5.50%
Canada [930]	Postpartum women	949	3.1% solid, 25.5% flatus
Denmark [931]	Postpartum women	1726	8.6% in past year, 0.6% to solid stool
Nigeria [932]	Gynecology patients	3963	6.9%, 2.3% to solid stool
United Arab Emirates [933]	Women multips	450	11.3%, 5.5% to solid stool
Canada [934]	Teenage females	228	3.5% flatus, 3% FI
Czech Republic [935]	Gynecology patients	2212	5.6%, 4.4% in the community
Japan [936]	Cystectomy patients	28	60.7% post ureterosigmoidostomy
Sweden [937]	Prostate cancer	864	RR 1.3-4.5
Australia [938]	Diabetics	8657	Increased risk
Holland [939]	Women >60 years	719	4.2% to 16.9% with rising age
U.S.A. [940]	>65 years at home	328	3.7% (M >F)
Japan [941]	>65 years at home	1405	6.6-8.7% (by age).
U.S.A. [942]	>50 years	1440	11.1 – 15.2% (F > M)

COUNTRY (ref)	POPULATION	N	PREVALENCE
U.K. [943]	>65 years at home	2818	3%
Holland [944]	>60 years	3345	6%, (M = F)
Czech Republic [945]	Nursing homes	1162	54.40%
U.S.A. [946]	Nursing homes	18170	47% FI
Canada [947]	Nursing homes	447	46% FI, 44% both UI and FI
France [948]	>18 years	713	30% response rate. 11% gas,0.4% feces, Women>men.
U.S.A. [949]	Women >20 years	2800	53% response rate. Median age onset 55 years. Urgency
France [950]	Women >50 years	2640	85% response rate. 9.5% FI, but includes leakage.
U.S.A. [951]	Women >25 years	4103	37% response rate. 25% AI. Obesity.

2. PREVALENCE

Because therapeutic interventions are not the subject of this chapter, the epidemiology is descriptive and not derived from randomized clinical trials (aside from the pre-partum intervention described below), the level of evidence will be at best 2, and the strongest evidence will come from systematic reviews in which there was a predefined search strategy and application of quality assessment tools that were designed specifically to minimize bias in referral or ascertainment.

2.1. Adults

In an effort to resolve the widely varying reported prevalence figures (**Table 21**), three systematic reviews of the published frequencies have been undertaken in community dwelling adults (above age 15 in the second) [903-905]. All three reviews were based on protocols including: A defined search strategy; Each study presented a PRISMA statement; Prospective continence assessment to minimise recall bias; Response rate > than 50%; a validated continence assessment tool; a representative community based population; appropriate outcome reporting.

Not every study included in these three systematic reviews adhered to these criteria, but the risk of bias in each study was assessed by these criteria and the highest quality studies described separately. None of the three was able to find a study that did prospective cohort assembly and data collection. In general most of the studies were of poor quality. A summary frequency was not calculated in the first review because of the marked clinical heterogeneity between reports. The three reports that the authors judged most free of potential biases had frequencies between 11% and 15%, although only one of these three used a validated assessment instrument [903]. The degree of disability present in these 11%-15% is not known, nor even if a proportion of them had only anal seepage. These high prevalences were obtained in surveys that employed anonymous self-administered questionnaires, which may not allow objective confirmation of AI or assessment of degree of disability associated with AI. The second systematic review found a range of solid and liquid anal incontinence of 0-15.2%, with an average across both genders and all age groups of 4.3% [904]. The third review reported and overall prevalence of 7.7% (95% confidence interval (CI) 2.0-20.7%) of faecal incontinence. Anal incontinence (incorporating flatus) was 15.9% (CI: 2.2-47.6%). Significant risk factors for incontinence in this review were increasing age, diarrhoea and coexisting urinary incontinence (UI). Not significantly associated with FI were obesity, gender and constipation.

One more important study of prevalence not cited in the above reviews was the National Health and Nutrition Examination Survey (NHANES) of the USA. This

is done periodically, the most recent data on continence being from the 2010 NHANES [906]. This has been reported in a number of publications. The population screened is carefully constructed to be representative of the entire non institutionalized or care home dwelling USA population and data collected with validated instruments in the participants own home. The prevalence was found to be 8.4% for FI (CI: 7.2-9.8%). Significant associations with FI included: diabetes, stool frequency (diarrhoea), poor health, and male gender if UI is included in the regression model. Not associated were obesity and parity.

2.2. Children

The reported prevalence of AI in children can be broadly divided into two facets: in those children born with congenital anomalies of the anus and rectum—either congenital aganglionosis (Hirschsprung's Disease) or imperforate anus – and those children without congenital anomalies. Among those children and adults who were born with congenital anomalies, despite surgical correction of the defect, life long defaecation difficulties are common, occurring in roughly half of affected children [907-909]. Problems with psychological health and development because of the defecation disorder is also common in this group, as is a generally depressed quality of life [910]. These disorders are not very rare, occurring in 3 to 5 per 10,000 live births [911].

Among children without congenital defects of the anal canal, bowel control has been found to be complete in one Swiss cohort in 33% by age 1 year, 75% by age two and 97% by age three. Nevertheless in this longitudinal study, a quarter of the boys and one tenth of the girls had a major period of incomplete bowel or bladder control between the ages of 6 and 18. At least annual encopresis occurred in 2-3% of these children, boys more frequently than girls [912]. In the Wisconsin Family Health Survey the prevalence of AI in children from the ages of 5 and 16 years was 12/1367 (0.88%) with the gender distribution being 7 boys and 5 girls (Wisconsin Family Health Survey: unpublished data). The common disorder for all children and then adults in this discussion is faecal retention with overflow and seepage.

3. INCIDENCE

Clinical trials have provided incidence data after a therapeutic intervention, but usually without a preliminary continence assessment. This is best seen in two Cochrane reviews of therapy for anal fissure [913-914]. AI incidence rates varied widely from 0% to 30%, to flatus only, and the duration was unspecified in the trials. Medical therapy was less likely than surgery to cause AI (0.23, 0.02-2.1), and certain operations (anal stretch) were more likely to cause AI than others (sphincterotomy) (4.2, 1.9-9.4). None of

these trials reported rigorous ascertainment of continence before the onset of disease or therapy.

4. RISK FACTORS

4.1. Age

Three systematic reviews and NHANES have analyses of the association of age and anal incontinence and found advancing age to be the most consistent of all assessed associations [903-906].

4.2. Gender

Most discussions of the aetiology of AI have been based upon the assumption that women, particularly for individuals under the age of 65 years, are far more at risk for AI than men. Injury to the pudendal nerve or sphincter muscle from prior obstetric trauma is described as the primary risk factor [915-917], followed by irritable bowel syndrome (a disease thought to be

more prevalent in women) [918], and other aetiologies such as diabetes a distant third [919]. Yet each population based-survey of the prevalence of AI has shown a surprisingly high prevalence in males (**Table 17**).

Of the two systematic reviews that looked specifically at prevalence, only two assessed the role gender played and in that review gender was not associated with incontinence in any age group [904-905]. In NHANES when UI is included in the regression model, male gender was a significant risk factor [906]. In the search for this updated review, 26 publications assessed prevalence of AI, two in both genders and 24 only in women. Clearly, aetiologies other than childbirth must be sought. This represents a rather gross imbalance in research on this topic.

4.3. Obesity

Four reports have demonstrated an increased risk of AI in obese women, a Kaiser cohort, a cross sectional survey in a specialty clinic and two case control studies [952-955]. One longitudinal study found a reduction in anal leakage (again not necessarily a direct correlate with incontinence) in women after bariatric surgery and weight loss, although other factors including diet and activity change may have been responsible for the improvement [956]. However One systematic review and NHANES found no association of FI with obesity [905-906]. Another review from Kaiser data also showed no association of FI with obesity [957].

4.4. Childbirth and mode of delivery

A meta-analysis of published reports that assessed anal sphincter integrity after vaginal delivery and correlated this with continence stated that 77%-83% (depending on parity) of anal incontinence in parous women was due to sphincter disruption [958]. Another systematic review that looked only at post partum factors in prospective cohorts found that the only

predictor of AI was 3rd-4th degree sphincter rupture during birth [959]. Three things are implied by the conclusion or the first review: first, that incontinence in men, children, of elderly onset (or even in middle aged women) and in nulliparous women, or women having caesarean delivery (CD) has a completely different cause than in women who have ever delivered vaginally (VD). There is scant epidemiologic evidence that this is the case [960]. Second, it is implied that sphincter repair would be effective treatment for anal incontinence in almost all parous women. Yet repair of a disrupted sphincter has less than a perfect track record. Even more importantly, there is a reported rapid decay in function after repair that is far too great to be explained by age alone [961-968]. Third, if direct trauma to the anal sphincter (and not intra-pelvic nerves) were the major cause of anal incontinence, then CD should be effective in preventing incontinence.

However a systematic review has shown that this is not the case [968]. Twenty-one reports have been found eligible for inclusion in the review, encompassing 31,198 women having had 6,028 CD and 25,170 VD as index events prior to anal continence assessment. Only one of these reports demonstrated a significant benefit of CD in the preservation of anal continence. In that report AI rates exceeded 39% in both groups, suggesting a problem with ascertainment. The greater the quality of the report, the closer its odds ratio approached 1.0. This review was updated for this current summary searching Medline, EMBASE and the Cochrane data base of clinical trials from 1966 to April 2016. Ten new studies were added to the meta-analysis and of the older review [971-980] three excluded because their cohorts had less than 250 participants and fewer than 50 reported CDs, leaving 27 included studies. With these new studies now CD was found to be less likely to result in FI than VD (Odds Ratio 0.83, CI; 0.73-0.94. **Figure 12**). However when quality criteria were applied to the studies included, specifically follow-up after delivery of at least six months and adjustment of the Odds Ratio (OR) for at least age (see above) and in most cases also for parity and obesity, the difference in FI risk between CD and VD was not significant (OR 0.93; CI 0.77-1.13, **Figure 13**). The importance of duration of follow up is shown in (**Figure 14**), in which a single cohort was measured for FI at three months post partum, six years and twelve years. The apparent advantage of CD in the 2001 report is clearly gone six and twelve years later. From other studies (**Figure 12**), it is apparent that this equalisation occurs by six months. This entire analysis included 46,724 deliveries, 8901 of which were CD in reports from 1997 to 2011. No difference in risk was seen between emergency (in labour) CD and elective CD.

In another publication increasing parity as an isolated risk factor does increase risk of AI [951], but not in NHANES [906].

1.1 Post Partum Fecal Incontinence

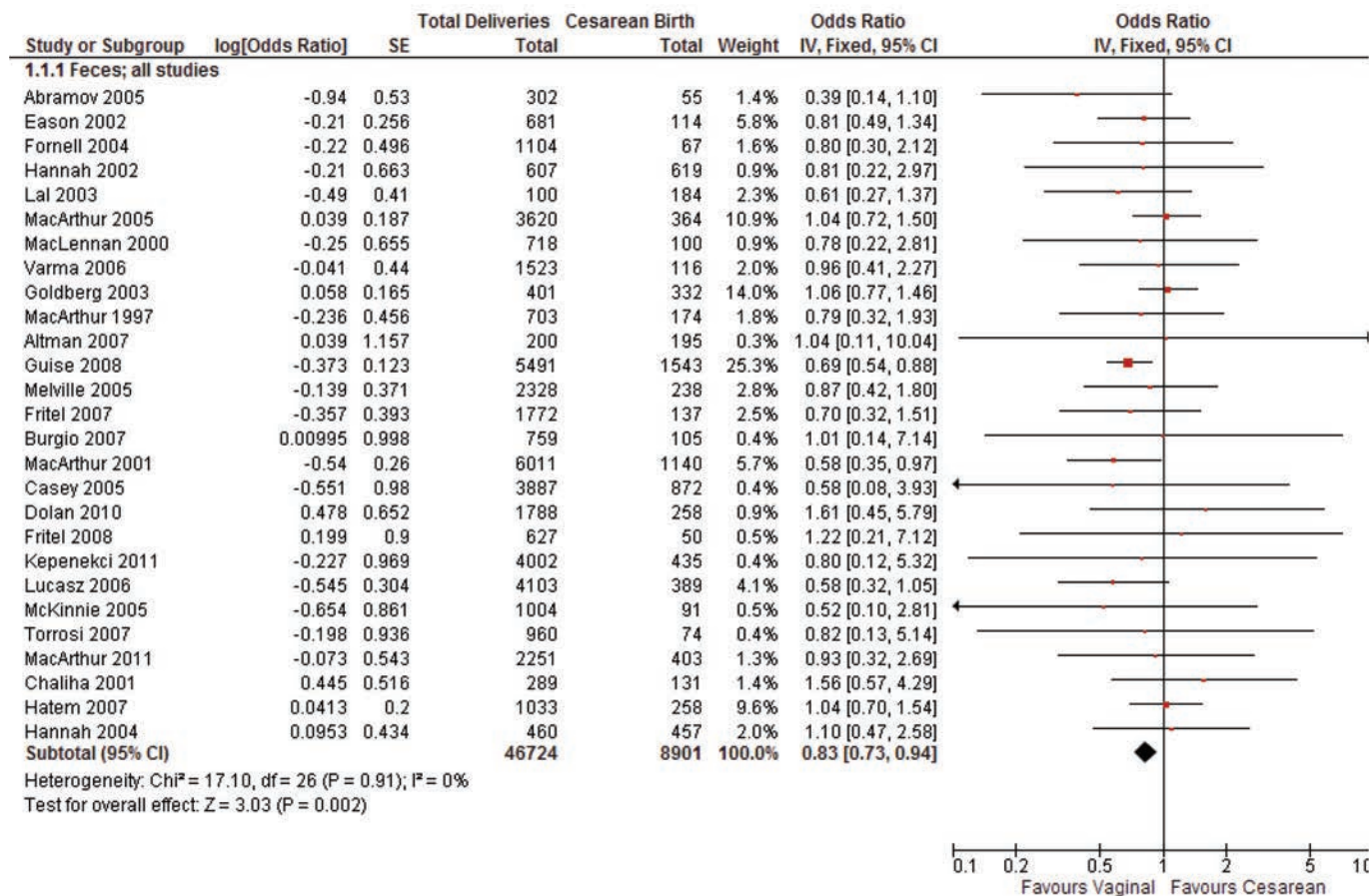

Figure 12. All studies comparing FI risk after CD and VD.

2.1 Incontinence of Feces; 13 best studies

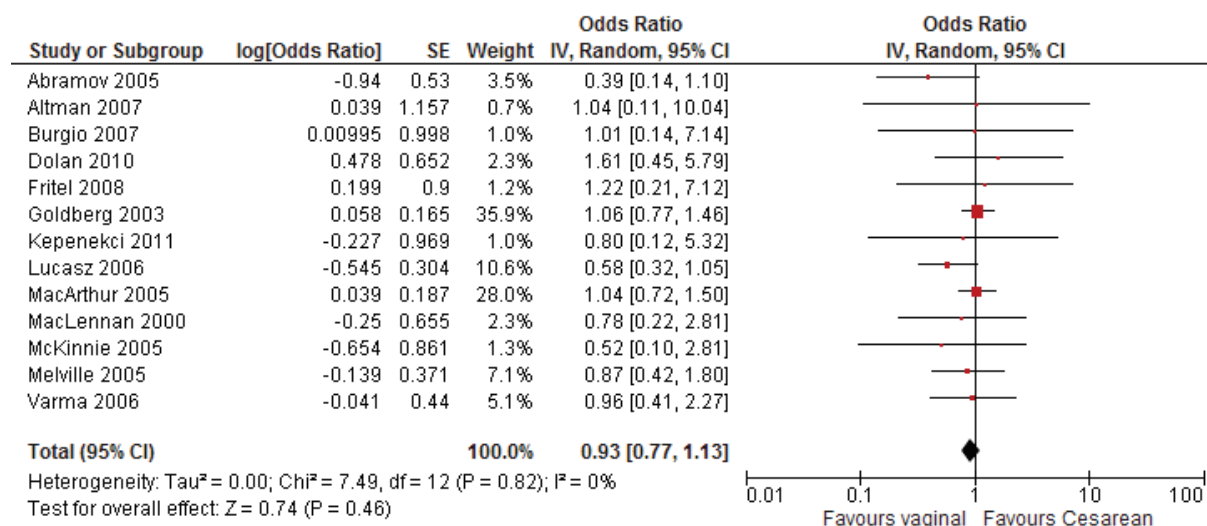

Figure 13: Same comparison as Figure 12 but with studies having at least six month follow-up post part and adjustment for age, parity and in some cases obesity.

2.5 Time Trend - MacArthur

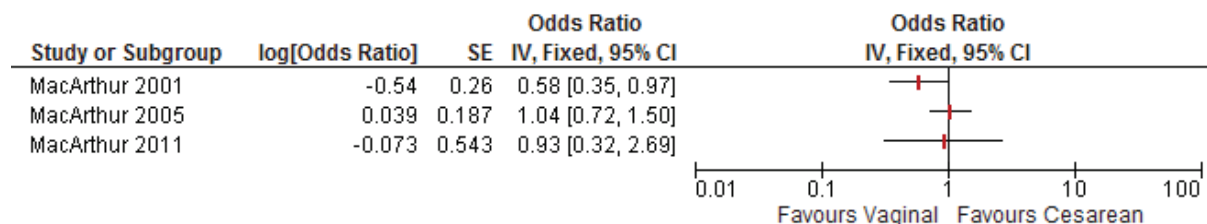

Figure 14: A single cohort reported three times by MacArthur, et al. AI was assessed 3 months post parted (2001), 6 years post part (2005) and 12 years post part (2011).

But why does not CD prevent anal incontinence, especially when associating perineal

trauma with loss of bowel control is not just intuitive, but sometimes visibly obvious? Certain aspects of VD are clearly causally related to anal incontinence: significant laceration, forceps, and some episiotomies [982-983]. However this review demonstrates that other factors need to be explored. One must look to pregnancy and not just labour and delivery as an initiating factor. Further evidence in favour of this comes from the sphincter repair literature cited above. The rapid decay in function suggests that another defect is present besides a gap in the sphincter that remains after the early effects of sphincter repair wear off. Trauma at the pelvic inlet during pregnancy or in early labour [984] is a possible explanation. Sphincter dysfunction has been demonstrated in women who have had CD [985]. Further indirect evidence for the possibility that injury higher in the pelvis may be related to AI in pregnant women can be found in the association between hysterectomy and AI, an association seen more often with abdominal hysterectomy (TAH) than vaginal hysterectomy (VH), and for flatus only [986] (Odds Ratio of TAH vs. VH for faeces: 1.2, 0.3-4.7, Odds Ratio for gas: 18.9, 1.1-327). Pelvic nerve injury during surgery is the postulated reason for this difference. Further support for this is that one of the strongest predictors of FI after birth is FI during the pregnancy [985].

4.5. Nursing home residence

The most common association with AI by far is nursing home residence. A very thorough discussion of this is [988], which combines data from NHANES, The National Study of Residential Care Facilities (NSRCF), the National Home and Hospice Care Study (NHHCS) and the Minimum Data Set (MDS). The prevalence of AI has been reported to be $\approx 7-8\%$ for community-dwelling persons, and may rise with increasing age to greater than 10%, among nursing home residents the prevalence approaches 50% [945-947]. This is partly explained by FI being one of the most common reasons for nursing home admission. In a large survey of 18,000 Wisconsin nursing home residents, risk factors for fecal incontinence (FI) were directly observed by nursing home personnel [946]. Urinary incontinence (UI) was the greatest association with FI (OR = 12.6, 11.5-13.7), followed by the loss of ability to perform daily living activities (6.0, 4.7-7.7), tube feeding (7.6, 5.6-10.4), physical restraints (3.2, 4.7-7.7), diarrhoea (3.3, 2.7-4.2), dementia (1.5, 1.4-1.7), impaired vision (1.5, 1.4-1.7), constipation (1.4, 1.3-1.6), fecal impaction (1.5, 1.1-2.1), stroke (1.3, 1.2-1.5) male gender (1.2, 1.1-1.3), age and body mass index. Inverse associations were noted with heart disease, arthritis and depression.

4.6. Diarrhoea

The importance of diarrhoea or liquid stool in FI cannot be overemphasised. One case series noted that

51% of individuals with chronic diarrhoea were incontinent [899]. In the Wisconsin Family Health Survey of AI [901], 10 of the 25 subjects with FI lived in Milwaukee when the city experienced an outbreak of waterborne disease [989]. Non-infectious causes of diarrhoea must also be considered, such as inflammatory bowel disease [988] and those initiated by sports activities such as running [991-992].

4.7. Surgery

AI originating from surgery would seem fairly insignificant in the general population, since prior anal surgery has not been an apparent risk factor in any of the larger surveys. Several operations nonetheless frequently can result in AI. Examples are midline internal sphincterotomy, lateral internal sphincterotomy, fistulectomy, fistulotomy, ileo-anal reservoir reconstruction, low anterior rectal resection, total abdominal colectomy, and ureterosigmoidostomy. The risk of lateral internal sphincterotomy for anal fissure causing AI was previously thought to be insignificant when compared to midline sphincterotomy. But a recent reappraisal of this operation has shown that the AI risk may be 8% [993]. The risk of AI after fistulotomy has been reported to be as high as 18% to 52% [994]. New approaches to fissure and fistula have recently been developed specifically to lower this risk [994-995]. However incontinence after haemorrhoidectomy has also been reported to be as high as 33%, an operation in which no sphincter is divided [996]. This suggests either that division of the anoderm, not the sphincter may be affecting continence, or that the method of identification used in published surveys is not accurate. As with delivery, assessments done immediately surgery will always show significant seepage which may be misinterpreted as incontinence. Six months is the minimum duration of follow-up needed to obtain reliable risk numbers. Mixing urine and stool has been found to have a predictable effect on anal sphincter control, as does diarrhoea, in patients having uretero-sigmoidostomy after urinary bladder resection [936]. Patients with rectal cancer form a special group in whom cancer issues often distort the continence disturbance that may result from rectal resection [997] or radiotherapy [998].

4.8. Specific neurological and other diseases

Several specific diseases have anecdotally been associated with AI in case series, and mechanisms to explain the associations have been investigated [999]. Examples are diabetes [938], stroke [1000-1001], multiple sclerosis, Parkinson's disease, systemic sclerosis, myotonic dystrophy, amyloidosis, spinal cord injury, impotente anus, Hirschsprung's disease, retarded or interrupted toilet training, proclivencia, and any illness causing diarrhoea (HIV, IBD, radiation, infection). Many of these conditions directly affect patient mobility and ability to perform daily living activities or they cause diarrhoea or faecal impaction.

4.8.1 Constipation

Constipation may alternate with diarrhoea in irritable bowel syndrome making defaecation chaotic and often very urgent. Often retained feces leads to anal seepage that cannot be held. In the New Zealand survey [902], the 2 of 3 rule for categorising an individual as incontinent excluded constipated patients, which was also assessed in their survey, the positive rate fell from 13.2% to just over 9%. This further demonstrates the frequent co-existence of constipation and AI, similar to the frequent coexistence of urinary incontinence and AI.

Because of a paucity of clinical trials that specifically address risk factors and prevention of AI, the strongest available data to identify risk come from cohorts that collected data on potential risk factors prior to the onset of incontinence. Prospectively collected risk assessments for FI have occurred in three nursing home cohorts. Porell combined UI and FI into a single outcome variable and found many positive associations in a cohort of 60,000 nursing home residents in Massachusetts [1002]. Age, African American race, cognitive and ADL impairments predicted the outcome, although specific relative risks for incidence are not presented. Chassange followed 234 previously non-FI residents in France for 10 months, during which 20% had FI episodes, but only 7.5% developed long lasting FI [1003]. The others had acute episodes due to diarrhoea or impaction. The factors associated with the development of long lasting FI were urinary incontinence (UI) (2.9, 1.8-4.6), decreased mobility (1.8, 1.1-3.0), and cognitive defects: either as seen in an MMSE score <15 (2.5, 1.4-4.4) of history of dementia (2.1, 1.2-3.5). Neither gender nor age were risk factors. Nelson reported, in a cohort of 18,000 nursing home residents in Wisconsin, a subgroup of 3,850 continent of both urine and faeces in 1992 and were assessed one year later [1004]. 15% developed FI. Positive associations were seen for ADL loss (3.4, 2.4-4.5), trunk restraints (2.5, 1.7-3.6), dementia (1.7, 1.4-2.0), African American race (2.1, 1.3-3.4) and age (1.02, 1.0-1.0). UI was not investigated as a risk factor because it was felt to be a comorbid condition. In a broadly based cross sectional survey, it was apparent that factors that affect an individual's general health or physical capabilities, independent of age and gender, place that individual at greatest risk for AI [918], though all four are significantly associated with AI [901]. Among obstetrical patients age has also been a consistent association, with less consistent associations noted for chronic bronchitis (OR =6.5, 1.1- 38), symptoms of pelvic prolapse (5.0, 3.0-8.7) and obesity (3.0, 1.0-3.4) [1003]. Defecatory dysfunction has also been assessed in pre-partum women [1006-1008], found to be prevalent and which has led to an important preventive strategy for post partum AI described below.

5. PREVENTION

This discussion is by necessity descriptive, so preventive measures are only relevant insofar as they provide insight into aetiology of incontinence. By far the most frequently applied preventive measure is CD, discussed above. Its lack of effectiveness in preventing anal incontinence provides a valuable insight into the relationship of pregnancy and AI – that the focus may need to be more on the pregnancy rather than the delivery and how it effects

defecation afterwards. A decision analysis study suggests specific obstetrical indication for elective CD that may be cost effective [1009]. Another study related to birth trauma randomized mothers to immediate post-partum anal ultrasound with repair of occult defects in the sphincter and continence assessed in follow-up, demonstrating an improved outcome with this intervention [1010]. Intervention pre partum with pelvic floor exercises has been assessed in a number of randomized trials [1011-1012] for the purpose of diminishing post partum AI. One Cochrane review found this strategy effective [1011]. Sixteen studies were included in the analysis in which 6,181 women participated. Those without prior urinary incontinence were randomized to either pelvic floor training or standard care. At 12 months postpartum the intervention group were half as likely to have AI (RR= 0.52; 0.31-0.87). A subsequent report has not shown this benefit, and has yet to be included in the Cochrane review [1012]. The AHRQ recently published a monograph on prevention of incontinence, though the strategies listed for AI were therapies for existing AI, such as pelvic floor exercises and retraining, rather than established mechanisms for prevention [1013].

6. SUMMARY POINTS

- Anal and urinary incontinence commonly coexist, particularly in the elderly and in nursing home residents (LE 1).
- The prevalence of anal incontinence increases with age, but is present in all age groups in both genders varying from 1.5% in children to more than 50% in nursing home residents (LE 1).
- AI is almost as common in men as in women (LE 2).
- More analyses comparing AI after CS and VD have been published.
- Studies reporting a protective effect of CS have been published.
- Obesity is perhaps the most modifiable risk factor for AI (LE 2) but the data associating obesity with AI are inconsistent.

- Intrapartum pelvic floor education can decrease the risk of subsequent development of AI postpartum (LE 1)
- As populations age, co-morbid disease becomes a significant component of fecal incontinence risk. Surgery, neurological diseases, and stroke are examples.
- Cognitive and ADL impairment are associated with faecal incontinence.
- More population based prevalence surveys have been published.
- Systematic reviews of prevalence, including the role of age and gender, CD and decision analyses for the use of CD in macrosomia have been published, providing necessary integration of data with quality assessment of existing literature.

7. FUTURE NEEDS

- Risk factors for AI in each age group are still poorly defined
- Prevention research, much less policy, are therefore still a great distance away.
- Randomised trials are needed of AI (and UI) in average risk women comparing VD and CD with minimal cross over and sufficient follow-up to adequately assess FI and UI.

X. WHY DO PREVALENCE ESTIMATES DIFFER?

The discussion here relates to UI only, as data and literature for FI and POP are very scarce. However, many of the principal arguments will be relevant to these conditions as well.

1. GENERAL PROBLEMS IN SURVEY RESEARCH

The well documented variation in prevalence estimates is thought to result at least in part from several confounders common to survey and epidemiological research. Herzog and Fultz,[1014] in a review of the prevalence and incidence of UI in community-dwelling populations, proposed that past investigations were plagued by sampling and non-response issues, by self selection and attrition, by definitional, conceptual, and measurement issues. Comprehensive reviews about measurements and methodological aspects of investigating UI are provided. It is clear that there are large methodological challenges to rigorous research in this field. In general, the quality of recent

large studies has undoubtedly improved, but the scientific community must continue to deal with methodological challenges in order to achieve progress.

2. DIFFERENT DEFINITIONS AND MEASUREMENT

A major problem in research on UI has been the use of different definitions and measurements, and this might contribute to the wide range of reported prevalence estimates. The former ICS definition of UI – as a condition in which involuntary loss of urine is a social or hygienic problem and is objectively demonstrable - included objective demonstration of urine loss as one critical component. This aspect limited the ICS definition for community based epidemiological investigations, because objective demonstration of UI is difficult to achieve outside of the clinical setting, and studies which were able to include this aspect in their assessment might have produced different prevalences. In addition, a social or hygienic aspect of the definition was problematic in epidemiological studies because it added a subjective aspect to an objectively defined condition and therefore confounded the investigation of prevalence, incidence, and risk factors. In a previous report we argued for reconsideration of the definition of UI, and we emphasised that the core of the definition should be "any involuntary loss of urine". In accordance with this view, ICS changed its definition in 2002 to UI being "the complaint of any involuntary leakage of urine".

The new definition makes epidemiological research easier. But three consequences should be addressed:

1. Epidemiological studies should not be based on this definition alone, and all studies should include a minimal additional data set, standard confounders, and questions specific to the aim of the study. This is discussed in the Section on Recommendations for further research.
2. The number of persons fulfilling the definition will increase. This should not be interpreted as an increase in the number potential of patients.
3. Public awareness, case finding of health care personnel, and help seeking behaviour may be affected by a new and more extensive definition.

Studies have used different severity levels and time frames for defining UI. A further factor complicating the conceptualisation and measurement of UI in epidemiological studies lies in the nature of the condition. UI is a chronic condition (or set of conditions) that often starts slowly and comes and goes for a considerable time period before it become fully established. If people get used to their UI or notice it less, this can interfere with valid assessment.

XI. HELP SEEKING BEHAVIOUR

1. URINARY INCONTINENCE

Ideally self-report measures are validated by clinical evaluations. However, clinical and even urodynamic investigations should be regarded as other measures, not necessarily as gold standards, because it is known to be difficult to demonstrate all urinary symptoms in the clinical setting.

Low response rates may further bias prevalence estimates. Known differences between responders and non-responders can be compensated during the analysis. The major problems is unknown differences in response rates and other characteristics. Incontinent women may not answer (or deny UI) because of embarrassment or related handicaps. But incontinent women may also find the subject particularly relevant and therefore respond to a greater extent than continent women. At present, we do not know much about how these factors may affect the comparison between incontinent and continent women.

One paper explored the problem of underreporting incontinence and how it can be altered with the use of an introduction to the incontinence questions and probing [178]. Another paper explored the issue of selection bias in mailed surveys. The first wave had a higher prevalence of incontinence than follow-up mailings, and thus individuals with UI tended to respond on the first wave. In an English mailed survey on incontinence and other urinary symptoms, a sample of non-responders were traced, and those eligible were asked questions from the survey [1015]. Compared with the responders, the non-responders overall showed little differences in reporting of urinary symptoms. However, non-responders >70 tended to be of poorer general health, and they reported certain urinary symptoms more frequently.

3. SUMMARY POINTS:

- The lack of epidemiological data from populations underrepresented in research limits the world wide application of the present information.
- Many investigations are plagued by sampling and non response issues, by self selection and attrition. Many early studies were obtained by sampling patients seeking care.
- A major problem is the use of different definitions of incontinence. The new ICS definition makes epidemiological research easier.
- There are large methodological challenges to research in the field of UI. Unless the scientific community deals with these issues, progress will be difficult to make.

A majority of people with UI have not sought help [540]. Reasons given by people for not seeking help include: not regarding incontinence as abnormal or serious, considering incontinence to be a normal part of ageing, having low expectations of treatment and thinking they should cope on their own. Some studies also confirm the notion that embarrassment may be an important reason for not seeking help. There is an association between help seeking and condition-specific factors like duration, frequency and amount, and people's perceptions of the impact of incontinence but other more personal characteristics like individual health care behaviour and attitudes may also play a role.

In a Norwegian study 4.4 % of all women >20 years old in a community consulted their general practitioner for UI during a 3 year period [1016]. Mentioning the symptoms to a physician may not be enough. There are reports of doctors not responding, either by ignoring the statement of symptoms or by providing a dismissive explanation, and people interpreting a lack of response from the doctor as an indication that no treatment is available. In a study of management of incontinence in general practice, 30% of the women who had told their doctor about their symptoms perceived that they were offered no help. It is probable that many primary health care providers lack confidence in managing UI, and that this contributes to under treatment in those seeking help.

Only a small proportion of incontinent community-residing women have had surgery, medication, or exercise regimens. In addition to seeking help from the formal health care system, common responses to symptoms of illness are self-management and self-treatment behaviour. The major method of actively managing UI among community residents is the use of absorbent products.

It is obvious that millions of men and women suffer from their UI, and that for many of them good treatment options are available. However, for many persons with very mild or occasional UI it is probably adequate not to seek help from the health care system. Others are satisfied with just information and understanding about the causes and in many cases self care may be quite appropriate. A Danish study has shown that simple information and advice was adequate "treatment" for 23% of the women attending an open access incontinence clinic [1017]. A Swedish study found that among 136 women with UI, 36% wanted clinical evaluation, and only 24% subsequently started treatment [651].

Both epidemiological and qualitative research in this field should be encouraged in order to understand

cultural, religious, and personal factors for help seeking behaviour world wide. Specifically, other than condition-specific factors should be further explored, e.g. persons' health care behaviour, perceptions and attitudes.

2. FAECAL INCONTINENCE AND PELVIC ORGAN PROLAPSE

There are indications of underreporting also of FI and patients' reluctance to report symptoms or to seek treatment. It has been shown that women are more willing to report FI than men. For POP we have no information.

3. SUMMARY POINTS:

- Recent publications confirm that a majority of people with FI, UI, and POP have not sought help.
- Only a small proportion of urinary incontinent community-residing people have had surgery, medication, or exercise regimens.
- Increasing severity, increasing duration, and urgency/mixed type of UI are related to consulting a health care provider.
- Associations other than condition-specific factors should be further explored in future research, e.g. persons' health care behaviour, perceptions and attitudes.
- Health care personnel should be encouraged to approach persons at risk for FI, UI and POP. People with such symptoms should be assessed so services and treatment can be offered and targeted. The patient's view of management, even denial, should be respected.

XII. EPIDEMIOLOGY AND CLINICAL WORK: FROM RESPONDENT TO PATIENT

We have emphasised some major and important differences between epidemiology and clinical work. These differences may have several implications. A selection process is most often accomplished first by self-selection (help seeking), then a referral system, which provides specialist physicians to a patient population with higher prevalence of disease, more severe disease, and often skewed type distribution, thus obtaining test results with fewer false positives, better diagnostic accuracy, and more efficient use of resources. However, such intended and purposeful selection bias has its drawbacks. There is growing evidence that this selection process introduces bias into

research and hampers our ability to generalise hospital based research back to general or primary care populations. Furthermore, it may result in recommendations and guidelines for diagnosis or therapy derived from tertiary care centres that are inappropriate at the primary care level. Often guidelines, review articles or teaching material do not take into account the varying prevalence and variation in the clinical picture between community and hospital. They may also emphasise use of tests or equipment that are not appropriate or relevant for primary health care, thus leading to over utilisation of referrals. Data from hospitals or specialist level may also overestimate level of burden, costs and number of persons in need of treatment if such data are used for extrapolation back to community level. Therefore it is important that this Consultation uses different algorithms for initial and specialised care (see other relevant chapters).

One study provides substantial empirical evidence to support the existence of selection bias for UI [125]. The analyses were based on three populations of incontinent women: Community level (epidemiological survey), primary care level (prospective study), and secondary care level (university hospital, prospective study). The general practice patients were older and the hospital patients younger than those in the community. From community via general practice to hospital, there was an increase in duration, frequency of leakage, amount of leakage, severity and perceived impact of incontinence. Help-seeking at the primary care level was associated with increasing age and severity, and with urgency symptoms and impact. Referral from general practice to hospital was only associated with lower age and urgency symptoms.

Under the subtitle Severity and Impact we have given examples of how the prevalence estimates for women change dramatically when bothersomeness and severity are considered. Taken together with selection bias, this emphasises caution when epidemiological data are used in a clinical context. It concerns "level of care" in several ways; there is a large transitional zone from healthy to diseased, there is a danger of medicalisation, and there is a danger of treating patients at a higher level than necessary. Risk factors, predictors and correlates discovered in epidemiological studies are probabilistic of nature and may not be decisive in the clinical assessment of an individual patient. In addition, the attributable risk due to some known risk factors may be statistically but not clinically significant.

1. WORLDWIDE ESTIMATES OF LOWER URINARY TRACT SYMPTOMS

In order to effectively plan health care resources it is necessary to estimate the prevalence and incidence of illnesses to know to what extent resources require

to be allocated to a specific illness health care condition. This chapter has dealt with three major global problems, urinary and faecal incontinence as well as pelvic organ prolapse, that affect women and men throughout the world. Irwin and coworkers [539] have published data estimating the current and future worldwide prevalence of lower urinary tract symptoms.

The objective of the study was to estimate the current and future number of people with LUTS, including overactive bladder (OAB) and Urinary Incontinence (UI) utilising the current ICS definitions. Age- and gender-specific prevalence rates from the EPIC study [417] were applied to the worldwide over 20 year old

population (4.2 billion) with males and females stratified into five-year age groups (20-24 to 80+). Projected population estimates for all worldwide regions were based on the United States Census Bureau International Database (IDB).

Estimates were presented for 2008, 2013 and 2018 and are summarised in Tables 21 and 22. Table 21 summarises the estimated number of individuals with certain LUTS symptoms by year and sex in the world population and Table 22 describes the estimated number of individuals of LUTS and OAB over 10 years across the world regions.

Table 22: Estimated Number of Individuals with Certain LUTS By Year & Sex - World Population (In Millions) [539]

LUTS Symptoms	Male 2008	Male 2013	Male 2018	Female 2008	Female 2013	Female 2018
Incontinence						
Any Incontinence	98	109	120	250	275	301
UUI	22	25	27	27	30	33
MUI	11	12	14	43	47	52
SUI	10	12	13	127	140	153
Other1	55	61	66	53	58	64
Storage						
Any Storage Symptom (Noct ₂ ≥1)	1,050	1,151	1,250	1,249	1,363	1,474
Any Storage Symptom (Noct ₂ ≥2)	597	655	713	760	831	901
Noct ≥1	942	1,035	1,127	1,098	1,200	1,301
Noct ≥2	388	427	467	464	509	555
Urgency	205	226	247	249	273	297
Frequency	127	139	152	161	174	186
Voiding Symptoms						
Voiding Symptoms	515	563	610	402	511	473
Intermittency	164	181	198	148	176	175
Slow Stream	156	173	193	122	161	146
Straining	132	145	157	83	120	98
Term Dribble	289	315	340	210	276	245
Post Micturition Symptoms						
Post Mic ₃ Symptoms	332	365	396	297	350	348
Incomplete Emptying	263	288	314	257	290	302
Other Post Mic Incontinence	108	118	129	64	96	76
Any LUTS (Noct ≥1)						
Any LUTS (Noct ≥1)	1,260	1,377	1,490	1,379	1,460	1,623

LUTS Symptoms	Male 2008	Male 2013	Male 2018	Female 2008	Female 2013	Female 2018
Storage + Voiding Symptoms (Noct ≥1)	350	386	422	309	373	367
Storage + Post Mic Symptoms (Noct ≥1)	247	273	299	238	274	282
Voiding + Post Mic Symptoms (Noct ≥1)	205	226	247	158	205	187
Storage + Voiding + Post Mic Symptoms (Noct ≥1)	166	183	202	137	173	163
Any LUTS (Noct ≥2)						
Any LUTS (Noct ≥2)	933	1,020	1,104	994	1,068	1,170
Storage + Voiding Symptoms (Noct ≥2)	247	273	299	237	275	283
Storage + Post Mic Symptoms (Noct ≥2)	188	207	227	190	214	226
Voiding + Post Mic Symptoms (Noct ≥2)	205	226	247	158	205	187
Storage + Voiding + Post Mic Symptoms (Noct ≥2)	130	144	158	119	142	142

Table 23: Estimated Worldwide Number of Individuals with LUTS including OAB and Incontinence by Region (In Millions) [539]

Region	Estimated Number of individuals with any LUTS			Estimated Number of Individuals with OAB			Estimated Number of Individuals with Incontinence		
	2008	2013	2018	2008	2013	2018	2008	2013	2018
World	1,930	2,106	2,277	455	500	545	346	383	420
Africa	203	231	263	46	53	60	33	38	43
North America	167	180	193	40	44	48	32	34	37
South America	111	122	133	26	29	32	20	22	24
Asia	1,166	1,284	1,396	272	302	332	206	231	256
Europe	273	278	280	68	70	71	54	56	57

Estimates and projections featured in this analysis were based on prevalence rates of LUTS described in the EPIC study – based primarily on a European population. The prevalence rates featured in the EPIC study are similar to other prevalence rates of LUTS that were found in others studies across other countries [284,537]

The projections in this report assume the prevalence rates of LUTS will remain throughout the year 2018 for all age and sex groups

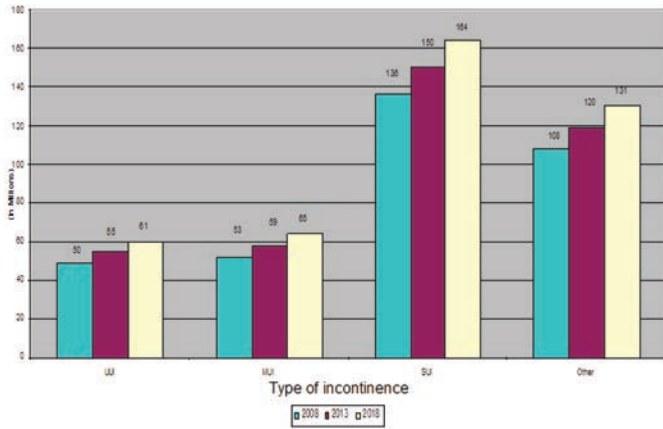

Figure 15: Estimated number of individuals with UI 2008, 2013 and 2018 grouped according to type of incontinence

Prevalence of LUTS will also increase as other factors related to LUTS, such as obesity, increases. The estimated number for present and future years are not true numbers but are based on a projected population configured by the International Database (IDB). The IDB's estimates and projections are drawn by Census Bureau demographers and are based on reviewed censuses, surveys, and vital statistics provided by National Statistics Offices⁹. Data on international migration and refugee movements, public health efforts, socio-political circumstances, and historical events such as natural disasters and conflict are all considered when the IDB calculates the estimates and projections.

It is anticipated that with the overall aging of the population the prevalence of LUTS will also increase

It has been shown that LUTS are burdensome to individuals [202,485] and the likely increase in the number of individuals experiencing LUTS has implications on healthcare resources and overall health burden. This analysis is an estimate of the number of individuals with LUTS based on a conservative prevalence rate, and so the future number of those with certain LUTS may surpass those of this report.

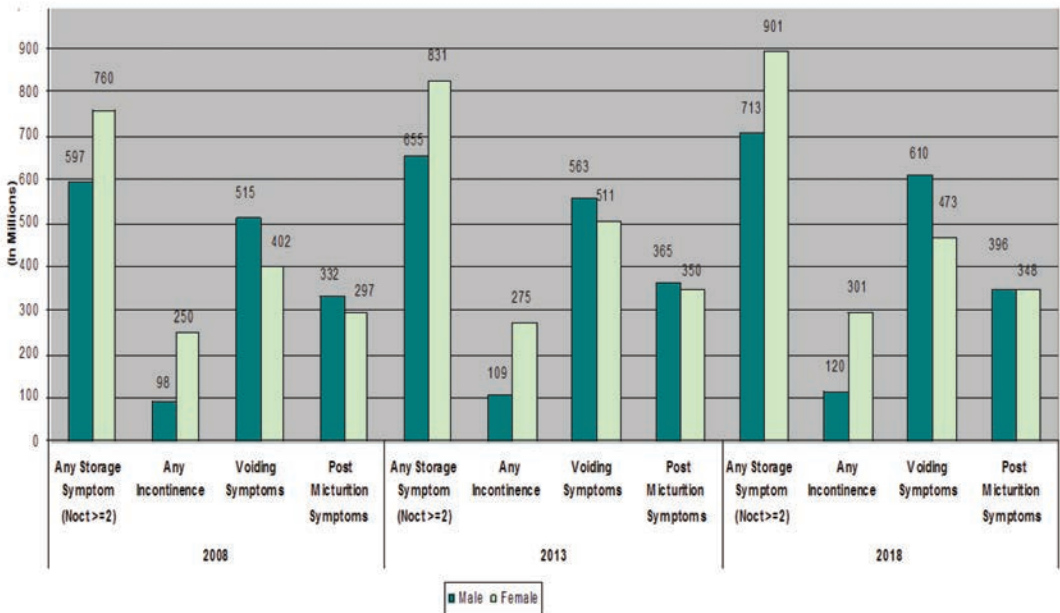

Figure 16: Estimated number of individuals with LUTS 2008, 2013 and 2018 grouped according to gender

Table 24. Summary of major findings regarding the estimated worldwide prevalence figures for lower urinary tract symptoms LUTS [539]

46% of the 4.2 billion of the adult world population (≥ 20 and over) experience any LUTS
455 million individuals or 11% of the world population estimated to experience OAB symptoms
346 million individuals or 8% of the world population estimated to experience some type of UI
SUI is the most common type of incontinence in 2008 and 2018 (Fig 1.)
136 (3%) and 164 (4%) million individuals are estimated to experience SUI in 2008 and in 2018 respectively
49 (1%) and 60 (1%) million individuals are estimated to experience UUI in 2008 and in 2018 respectively
53(1%) and 65 (1%) million individuals are estimated to experience MUI in 2008 and in 2018 respectively
108 (3%) and 131 (3%) million individuals are estimated to experience Other Incontinence in 2008 and in 2018 respectively Assuming LUTS prevalence rates remain stable for the next ten years, 2.3 billion individuals are estimated to experience LUTS by the year 2018 An increase of 18% from 2008
Storage symptoms has the highest burden in both the male and female population than other LUTS (Fig 2.)
Male: estimated 597 million in 2008, 713 million in 2018
Female: estimated 760 million in 2008, 901 million in 2018
Asia region is estimated to carry the highest burden of LUTS. Estimated 1.2 billion individuals in Asia regions may experience any LUTS

2. SUMMARY POINTS:

- The spectrum of severity of anal and urinary incontinence, as well as pelvic organ prolapse, and the symptom profile of patients referred to specialist centres do not necessarily reflect the spectrum of disease seen in the community.
- The selection and referral process may introduce bias into research and hamper the ability to generalise hospital-based research back to primary care populations.
- One should be very careful with calculating numbers of patients in need of therapy based on epidemiological data.

XIII. RECOMMENDATIONS FOR FURTHER RESEARCH

Much biomedical research is observational and the reporting of such research is often inadequate which hampers the assessment of its strengths and weaknesses and of a study's generalisability. The

STROBE (Strengthening of the Reporting of OBservational studies in Epidemiology) statement was introduced [1018]. It is a checklist of items that should be addressed in articles reporting on the three main study designs of analytical epidemiology: cohort, case-control, and cross sectional studies. The use of this checklist is highly recommended.

1. URINARY INCONTINENCE

It is recommended that more sustained research on measurement of UI should be performed including, its types and severity to move the research ahead. Longitudinal study designs are needed to estimate incidence of UI and describe the course of the condition and its different forms and to investigate its risk factors and possible protective factors.

There is still little knowledge with regard to prevalence, incidence, and other epidemiological data in developing countries. A recent review on the global prevalence of urgency urinary incontinence clearly showed that prevalence rates are largely unknown for many countries in the world [1019]. It is recommended that fundamental research regarding prevalence, incidence and other epidemiological data in

developing countries should be encouraged, and tailored to the cultural, economic and social environment of the population under study.

Crude prevalence studies (descriptive epidemiology) from USA and Europe are abundant, and further studies should be done only with recommended and validated questionnaires or in order to combine data from the prevalence study with studies of co-factors and predictors (analytical epidemiology). Control for confounders, stratification, and multivariate techniques should be increasingly used because of the need for more advanced epidemiological analyses of risk factors and comorbidity. Strength of associations should be determined by relative risks and odds ratios, and confidence limits should be given. We have still very little knowledge of the absolute and relative importance of several risk factors, and almost no information about the attributable risk of the factors in society.

Some potential risk and protective factors deserve more attention. For example, the role of pregnancy and childbirth in the development of UI must be studied in a fashion that links population-based methods to clinical assessment of pregnancy, delivery and the birth trauma and follows women over many years. Such a design is necessary because the effect of pregnancy and childbirth may become clear only years later when the woman is older and because the woman will not be able to report the exact nature of the tear or episiotomy, etc. There should be more emphasis on the associations between UI and specific diseases like stroke, diabetes, psychiatric disease and genital prolapse. Genetic components should be investigated.

Primary prevention is the main goal in the management of human disease. An important strategy would

thus be to identify the individuals at risk, and then take measures to reduce the risk among those individuals or in certain risk groups. A predictive modelling system based on risk factors identified in population studies has been put forward [1020]. Primary prevention studies should be encouraged, but the epidemiological basis for choosing appropriate interventions is weak.

In surveys based on questionnaires or interviews symptoms can be registered. There are convincing data suggesting that the different types may reflect quite different pathologies and risk factors. Differentiating the types in future research might therefore prove very fruitful. Methodological work has still to be done in this area, but typical type descriptions should be included in new studies. Likewise, studies of risk factors should include important and known confounders such as age, parity, and weight.

Variations in definitions and measurement issues are fundamental and lead to problems with assessing the findings in epidemiological studies. We need to improve epidemiological studies by including variables that better characterise UI, so that more advanced and informative analyses may be conducted. It is therefore recommended that all epidemiological studies include a minimum data set (Table 24), including elements of screening question, frequency measure, quantity of urine loss, duration, type, and severity. In addition, it is recommended that validated measures of bother/quality of life and urinary symptoms other than UI should be included. We here also refer to the chapter from the committee on symptom and quality of life assessment.

Table 25. Elements in a minimum data set recommended for all epidemiological studies

• Screening question for any involuntary urine loss
• Frequency measure. For example, classification into categories of none, less than once a month, one/several times a month, one/several times a week, every day/nigh, all the time
• Quantity of urine loss for a typical episode. For example, classification into categories of none, drops, small amounts, moderate amounts, much/a great deal
• Duration. For example months, years
• Type. Based on typical description; stress, urge, mixed and other
• Severity. Either by combining existing questions or by a validated index

2. FAECAL INCONTINENCE AND PELVIC ORGAN PROLAPSE

In these areas there is a need for more epidemiological research in all areas; prevalence, incidence, and risk factors. Many of the fundamental methodological issues relevant to UI discussed above are highly relevant to the fields of FI and POP.

The committee emphasises that uniform definitions of FI and POP should be used in studies, and there should be a move towards a standardisation of measurement instruments in community surveys that can be used worldwide. Developing definitions is a scientific process requiring careful conceptualisation of the condition in light of its many clinical presentations and underlying mechanisms. This will require a multi-method approach and consideration of issues such as reliability and validity.

REFERENCES

1. Abrams, P., Cardozo, L., Fall, M., Griffiths, D. Rosier, P., Ulmsten, U. et al. : The standardisation of terminology in lower urinary tract function : report from the standardisation sub-committee of the International Continence Society. *Urology*, 61: 37m 2003.
2. Haylen BT, De Ridder D, Freeman RM, Swift SE, Berghmans B, Lee J, et al. An International Urogynecological Association (IUGA)/International Continence Society (ICS) joint report on the terminology for female pelvic floor dysfunction. *Neurourol. Urodyn.* 2010. p. 4–20.
3. Stroup, D. F., Berlin, J.A., Morton, S. C., Olkin, I., Williamson, G. D., Rennie, D. et al. : Meta-analysis of observational studies in epidemiology: a proposal for reporting. Meta-analysis Of Observational Studies in Epidemiology (MOOSE) group. *JAMA* 283: 2008, 2002.
4. Austin, P.F., et al., The standardization of terminology of lower urinary tract function in children and adolescents: update report from the Standardization Committee of the International Children's Continence Society. *J Urol*, 2014. 191(6): p. 1863-1865 e13.
5. Rittig, S., et al., Abdorminal diurnal rhythm of plasma vasopressin and urinary output in patients with enuresis. *Am J Physiol*, 1989. 25: p. 664-.
6. Yeung, C.K., Chiu, H.N., Sit, F.K., Bladder dysfunction in children with refractory monosymptomatic primary nocturnak enuresis. *J Urol*, 1999. 162: p. 1049-55.
7. Holmdahl, G., et al., Four-hours voiding observation in healthy infants. *Scan J Urol Nephrol*, 1996. 156: p. 1808-1812.
8. Jansson, U.-B., et al., Voiding pattern and acquisition of bladder control from birth to age 6 years - a longitudinal study. *J Urol*, 2005. 174: p. 298 - 293.
9. Kranz, I., et al., On the Epidemiology of Nocturnal Enuresis - A Critical Rewiew of Methods used in descriptive Epidemiological studies on Nocturnal Enuresis. 1994: p. 75-81.
10. McGree, R., et al., A longitudinal study of enuresis from five to nine years. *Aust. Paediatr. J.*, 1984. 20: p. 39-42.
11. Forsythe, W.I. and A. Redmond, Enuresis and spontaneous cure rate - study of 1129 enuretics. *Arch Dis Child*, 1974. 49: p. 259-263.
12. Fergusson, D.M., L.J. Horwood, and F.T. Shannon, Factors Related to the Age of Attainment of Nocturnal Bladder Control: An 8-Year Longitudinal Study. *Pediatrics*, 1986. 87(5): p. 884-890.
13. Fergusson, D.M. and L.J. Horwood, Nocturnal enuresis and behavioral problems in adolescence: a 15-year longitudinal study. *Pediatrics*, 1994. 94(5): p. 662-668.
14. Feehan, M., et al., A 6 year follow-up of childhood enuresis: Prevalence in adolescence and consequences for mental health. *J. Paediatr. Child Health*, 1990. 26: p. 75-79.
15. Butler, R.J. and J. Heron, The prevalence of infrequent bedwetting and nocturnal enuresis in childhood. A large British cohort. *Scandinavian journal of urology and nephrology*, 2008. 42(3): p. 257-64.
16. Mota, D.M., et al., Prevalence of enuresis and urinary symptoms at age 7 years in the 2004 birth cohort from Pelotas, Brazil. *J Pediatr (Rio J)*, 2015. 91(1): p. 52-8.
17. Chiozza, M., L, et al., An Italian epidemiological multicentre study of nocturnal enuresis. *BJU*, 1998. 81.suppl.3: p. 86-89.
18. Yeung, C.K., Nocturnal Enuresis in Hong Kong: Different Chinese Phenotypes. *Scan J Urol Nephrol*, 1996. suppl.31: p. 17-21.
19. Spee- van der Wekke, J., et al., Childhood nocturnal enuresis in the Netherlands. *Urology*, 1998. 51: p. 1022.
20. Cher, T.-W., G.-J. Lin, and K.-H. Hsu, Prevalence of nocturnal enuresis and associated familiar factors in primary school children in Taiwan. *J Urol*, 2002. 168: p. 1142-1146.
21. Serel, T.K., et al., epidemiology of enuresis in Turkish children. *Scan J Urol Nephrol*, 1997. 31: p. 537.
22. Lee, S.D., et al., An epidemiological study of enuresis in Korean children. *BJU Int.*, 2000. 85: p. 869-873.
23. Kajiwara, M., et al., Nocturnal enuresis and overactive bladder in children: An epidemiological study. *Int J Urol*, 2006. 13: p. 36-41.
24. Söderstrom, U., et al., Urinary and faecal incontinence: A population-based study. *Acta Paediatr*, 2004. 93: p. 386-89.
25. Yeung, C.K., et al., differences in characteristics of nocturnal enuresis between children and adolescents: A critical appraisal from a large epidemiological study. *BJU Int.*, 2006. 97(5): p. 1069-73.

26. Kanaheswari, Y., Epidemiology of childhood nocturnal enuresis in Malaysia. *J Paediatr Child Health*, 2003. 39(2): p. 118-123.
27. Su, M.S., et al., Nocturnal enuresis in children: prevalence, correlates, and relationship with obstructive sleep apnea. *The Journal of pediatrics*, 2011. 159(2): p. 238-42 e1.
28. Yousef, K.A., H.O. Basaleem, and M.T. bin Yahiya, Epidemiology of nocturnal enuresis in basic schoolchildren in Aden Governorate, Yemen. *Saudi J Kidney Dis Transpl*, 2011. 22(1): p. 167-73.
29. Aloni, M.N., et al., Nocturnal enuresis in children in Kinshasa, Democratic Republic of Congo. *Acta Paediatr*, 2012. 101(10): p. e475-8.
30. Yazici, C.M., et al., Prevalence of nocturnal enuresis and associated factors in schoolchildren in Western Turkey. *Can J Urol*, 2012. 19(4): p. 6383-8.
31. Srivastava, S., K.L. Srivastava, and S. Shingla, Prevalence of monosymptomatic nocturnal enuresis and its correlates in school going children of Lucknow. *Indian J Pediatr*, 2013. 80(6): p. 488-91.
32. Aljefri, H.M., et al., Nocturnal enuresis among primary school children. *Saudi J Kidney Dis Transpl*, 2013. 24(6): p. 1233-41.
33. Sarici, H., et al., Prevalence of nocturnal enuresis and its influence on quality of life in school-aged children. *J Pediatr Urol*, 2015.
34. Doganer, Y.C., et al., The Prevalence and Sociodemographic Risk Factors of Enuresis Nocturna among Elementary School-age Children. *J Family Med Prim Care*, 2015. 4(1): p. 39-44.
35. Hellström, A.-L., et al., Micturition habits and incontinence in 7-year-old Swedish school entrants. *Eur J Pediatr*, 1990. 149(6): p. 434-437.
36. Järvelin, M.R., et al., Enuresis in Seven-Year-Old Children. *Acta Paediatr Scan*, 1988. 77: p. 148-153.
37. Hellström, A.-L., et al., Micturition habits and incontinence at age 17 - reinvestigation of a cohort studied at age 7. *BJU*, 1995. 76: p. 231-234.
38. Swithinbank, L.V., J.C. Carr, and P.H. Abrams, Longitudinal Study of Urinary Symptoms in Children. *Scan J Urol Nephrol*, 1994. Suppl 163: p. 163-167.
39. Swithinbank, L.V., et al., The natural history of urinary symptoms during adolescence. *BJU*, 1998. 81, Suppl 3: p. 90-93.
40. Fockema, M.W., et al., Enuresis in South African children: prevalence, associated factors and parental perception of treatment. *BJU Int*, 2012. 110(11 Pt C): p. E1114-20.
41. Akil, I.O., D. Ozmen, and A.C. Cetinkaya, Prevalence of urinary incontinence and lower urinary tract symptoms in school-age children. *Urol J*, 2014. 11(3): p. 1602-8.
42. Hirasig, R.A., et al., Enuresis Nocturna in Adults. *Scan J Urol Nephrol*, 1997. 31: p. 533-536.
43. Bower, W.F., et al., The epidemiology of childhood enuresis in Australia. *British Journal of Urology*, 1996. 78: p. 602-606.
44. Gümüş, B., et al., Prevalence of nocturnal enuresis and accompanying factors in children aged 7-11 years in Turkey. *Acta Paediatr*, 1999. 88: p. 1369.
45. Nevéus, T., et al., Depth of sleep and sleep habits among enuretic and incontinence children. *Acta Paediatr*, 1999. 88: p. 748.
46. Watanabe, H. and A. Kawauchi, Nocturnal Enuresis: Social Aspects and Treatment in Japan. *Scan J Urol Nephrol*, 1994. suppl. 163: p. 29-38.
47. Liu, X., et al., Attaining Nocturnal Urinary Control, Nocturnal Enuresis, and Behavioral Problems in Chinese Children Aged 6 Through 16 Years. *J Am Acad Child Adolesc Psychiatry*, 2000. 39(12): p. 1557-1564.
48. Sureshkumar, P., et al., Risk factors for nocturnal enuresis in school-age children. *The Journal of urology*, 2009. 182(6): p. 2893-9.
49. Järvelin, M.R., et al., Aetiological and Precipitating Factors for Childhood Enuresis. *Acta Paediatr Scan*, 1991. 80: p. 361-369.
50. von Gontard, A., J. Heron, and C. Joinson, Family history of nocturnal enuresis and urinary incontinence: results from a large epidemiological study. *The Journal of urology*, 2011. 185(6): p. 2303-6.
51. Eiberg, H., Nocturnal enuresis is linked to a specific gene. *Scan J Urol Nephrol*, 1995. Suppl.173: p. 15.
52. Arnell, H., et al., The genetics of primary nocturnal enuresis: inheritance and suggestion of a second major gene on chromosome 12q. *J Med Genet*, 1997. 34: p. 360.
53. von Gontard, A., et al., Molecular genetics of nocturnal enuresis: clinical and genetic heterogeneity. *Acta Paediatr*, 1997. 87: p. 571.

54. Oguz, U., et al., The Time of Spontaneous Resolution of Monosymptomatic Nocturnal Enuresis (MNE) Is Familial. *Urol Int*, 2015. 94(4): p. 459-63.
55. Moilanen, I., et al., A follow-up of enuresis from childhood to adolescence. *BJU*, 1998. 81,suppl.3: p. 94-97.
56. Schulpen, T., The burden of nocturnal enuresis. *Acta Paediatr*, 1997. 86(9): p. 981-984.
57. van Hoecke, E., et al., Socioeconomic Status as a Common Factor Underlying the Association Between Enuresis and Psychopathology. *J Dev Behav Pediatrics*, 2003. 24(2): p. 109-114.
58. Coppola, G., et al., Psychological correlates of enuresis: a case-control study on an Italian sample. *Pediatric nephrology*, 2011. 26(10): p. 1829-36.
59. Ucer, O. and B. Gumus, Quantifying subjective assessment of sleep quality, quality of life and depressed mood in children with enuresis. *World J Urol*, 2014. 32(1): p. 239-43.
60. Kawauchi, A., et al., Follow-up study of bed-wetting from 3 to 5 years of age. *Urology*, 2001. 58(5): p. 772-776.
61. Lunsing, R.J., et al., Nocturnal enuresis and minor Neurological dysfunction at 12 years: A follow-up study. *Dev Medicine and Child Neurology*, 1991. 33: p. 439-445.
62. Duel, B.P., et al., A survey of voiding dysfunction in children with attention deficit-hyperactivity disorder. *J Urol*, 2003. 170: p. 1521-1524.
63. Robson, W.L.M., et al., Enuresis in children with attention deficit hyperactivity disorder. *Southern Medical Journal*, 1997. 90: p. 503.
64. Elia, J., et al., Nocturnal enuresis: a suggestive endophenotype marker for a subgroup of inattentive attention-deficit/hyperactivity disorder. *The Journal of pediatrics*, 2009. 155(2): p. 239-44 e5.
65. Yousefichaijan, P., et al., Attention deficit hyperactivity disorder in children with primary monosymptomatic nocturnal enuresis: A case-control study. *Saudi J Kidney Dis Transpl*, 2016. 27(1): p. 73-80.
66. Wolfish, N.M., R.T. Pivik, and K.A. Busby, Elevated sleep arousal thresholds in enuretic boys: clinical implications. *Acta Paediatr*, 1997. 86: p. 381-384.
67. Kawauchi, A., et al., Changes in the structure of sleep spindles and delta waves on electroencephalography in patients with nocturnal enuresis. *BJU*, 1998. 81, suppl. 3: p. 72-75.
68. Hunsballe, J.M., Increased delta component in computerized sleep electroencephalographic analysis suggest abnormally deep sleep in primary monosymptomatic nocturnal enuresis. *Scan J Urol Nephrol*, 2000. 34: p. 294.
69. Chandra, M., et al., Prevalence of diurnal voiding symptoms and difficult arousal from sleep in children with nocturnal enuresis. *J Urol*, 2004. 172: p. 311-16.
70. Osungbade, K.O. and F.O. Oshiname, Prevalence and perception of nocturnal enuresis in children of a rural community in southwestern Nigeria. *Trop Doc*, 2003. 33(4): p. 243-236.
71. Baruzzi, A., et al., Atrial natriuretic peptide and catecholamines in obstructive sleep apnoea. *Sleep*, 1991. 14: p. 83.
72. Barone, J.G., et al., Nocturnal enuresis and overweight are associated with obstructive sleep apnea. *Pediatrics*, 2009. 124(1): p. e53-9.
73. Weider, D.J., M.j. Sateia, and R.p. West, Nocturnal enuresis in children with upper airway obstruction. *Otolaryngol Head Neck Surg*, 1991. 105: p. 427-432.
74. Loening-Baucke, V., Urinary Incontinence and Urinary Tract Infection and Their Resolution With Treatment of Chronic Constipation of Childhood. *Pediatrics*, 1997. 100(2): p. 228-232.
75. Figueroa, T.E., et al., Enuresis in sickle cell disease. *J Urol*, 1995. 153(6): p. 1987-9.
76. Portocarrero, M.L., et al., Prevalence of enuresis and daytime urinary incontinence in children and adolescents with sickle cell disease. *J Urol*, 2012. 187(3): p. 1037-40.
77. Forbes, F.C., Children with enuresis. Nowadays, a strong suspicion of sexual abuse would prompt full investigation. *BMJ*, 1998. 316: p. 777.
78. Anderson, B., et al., The prevalence of abnormal genital findings, vulvovaginitis, enuresis and encopresis in children who present with allegations of sexual abuse. *J Pediatr Urol*, 2014. 10(6): p. 1216-21.
79. Ferrara, P., et al., Preliminary data on monosymptomatic nocturnal enuresis in children and adolescents with type 1 diabetes. *Scan J Urol Nephrol*, 2006. 40: p. 238-40.
80. Hoebeke, P., et al., One thousand video-urodynamic studies in children with non-neurogenic bladder sphincter dysfunction. *BJU Int.*, 2001. 87: p. 575-580.

81. Hellerstein, S., Voiding Dysfunction in Pediatric Patients. *Clin Pediatr (Phila)*, 2003. 42(1): p. 43-49.
82. Kajiwara, M., et al., The micturition habits and prevalence of daytime urinary incontinence in Japanese primary school children. *J Urol*, 2004. 171: p. 403-7.
83. Joinson, C., et al., Psychological problems in children with daytime wetting. *Pediatric*, 2006. 118(5): p. 1985-93.
84. Swithinbank, L.V., et al., The natural history of daytime urinary incontinence in children: a large British cohort. *Acta paediatrica*, 2010. 99(7): p. 1031-6.
85. Sureshkumar, P., et al., A population based study of 2,856 school-age children with urinary incontinence. *The Journal of urology*, 2009. 181(2): p. 808-15; discussion 815-6.
86. Von Gontard, A., Hollmann, E., Comorbidity of functional urinary incontinence and enkopresis: Somatic and behavioural associations. *J Urol*, 2004. 171: p. 2644-47.
87. von Gontard, A., J. Heron, and C. Joinson, Family history of nocturnal enuresis and urinary incontinence: results from a large epidemiological study. *J Urol*, 2011. 185(6): p. 2303-6.
88. Sureshkumar P., C.P., Roy L.P, Knight J.F., et al., Daytime urinary incontinence in primary school children: A population-based survey. *The Journal of Pediatrics*, 2001. 137(6): p. 814-818.
89. Lettgren, B., et al., Urge incontinence and voiding postponement in children : somatic and psychosocial factors. *Acta Paediatr*, 2002. 91: p. 978-984.
90. Zink, S., C.M. Freitag, and A. von Gontard, Behavioral comorbidity differs in subtypes of enuresis and urinary incontinence. *J Urol*, 2008. 179: p. 295-8.
91. von Gontard, A., et al., Association of attention deficit and elimination disorders at school entry: a population based study. *J Urol*, 2011. 186(5): p. 2027-32.
92. Niemczyk, J., et al., Prevalence of incontinence, attention deficit/hyperactivity disorder and oppositional defiant disorder in preschool children. *Eur Child Adolesc Psychiatry*, 2015. 24(7): p. 837-43.
93. Bloom, D.A., et al., Toilet habits and continence in children: An opportunity sampling in search of normal parameters. *J Urol*, 1993. 149: p. 1087-1090.
94. Bedretdinova, D., Fritel, X., Panjo, H., & Ringa, V. (2016). Prevalence of Female Urinary Incontinence in the General Population According to Different Definitions and Study Designs. *European Urology*, 69(2), 256–264. <http://doi.org/10.1016/j.eururo.2015.07.043>.
95. Fultz, N. H., & Herzog, A. R. (2000). Prevalence of urinary incontinence in middle-aged and older women: a survey-based methodological experiment. *Journal of Aging and Health*, 12(4), 459–469.
96. Bosch, J. L. H. R., Cardozo, L., Hashim, H., Hilton, P., Oelke, M., & Robinson, D. (2011). Constructing trials to show whether urodynamic studies are necessary in lower urinary tract dysfunction. *Neurourology and Urodynamics*, 30(5), 735–740. <http://doi.org/10.1002/nau.21130>.
97. van Leijsen, S. A. L., Evert, J. S. H.-V., Mol, B. W. J., Vierhout, M. E., Milani, A. L., Heesakkers, J. P. F. A., & Kluivers, K. B. (2011). The correlation between clinical and urodynamic diagnosis in classifying the type of urinary incontinence in women. A systematic review of the literature. *Neurourology and Urodynamics*, 30(4), 495–502. <http://doi.org/10.1002/nau.21047>.
98. Minassian, V. A., Stewart, W. F., & Hirsch, A. G. (2008a). Why do stress and urge incontinence co-occur much more often than expected? *International Urogynecology Journal and Pelvic Floor Dysfunction*, 19(10), 1429–1440. <http://doi.org/10.1007/s00192-008-0647-2>.
99. Digesu, G. A., Salvatore, S., Fernando, R., & Khullar, V. (2008). Mixed urinary symptoms: What are the urodynamic findings? *Neurourology and Urodynamics*, 27(5), 372–375.
100. Sandvik, H., Hunskaar, S., Vanvik, A., Bratt, H., Seim, A., & Hermstad, R. (1995). Diagnostic classification of female urinary incontinence: an epidemiological survey corrected for validity. *Journal of Clinical Epidemiology*, 48(3), 339–343.
101. Lowenstein, L., Dooley, Y., Kenton, K., Rickey, L., FitzGerald, M. P., Mueller, E., & Brubaker, L. (2007). The volume at which women leak first on urodynamic testing is not associated with quality of life, measures of urethral integrity or surgical failure. *J Urol*, 178(1), 193–196. <http://doi.org/10.1016/j.juro.2007.03.031>.

102. Stach-Lempinen, B., Kirkinen, P., Laippala, P., Metsänoja, R., & Kujansuu, E. (2004). Do objective urodynamic or clinical findings determine impact of urinary incontinence or its treatment on quality of life? *Urology*, 63(1), 67–71; discussion 71–2.
103. Elstad, E. A., Taubenberger, S. P., Botelho, E. M., & Tennstedt, S. L. (2010). Beyond incontinence: the stigma of other urinary symptoms. *Journal of Advanced Nursing*, 66(11), 2460–2470.
<http://doi.org/10.1111/j.1365-2648.2010.05422.x>.
104. Klovning, A., Sandvik, H., & Hunskaar, S. (2009). Web-based survey attracted age-biased sample with more severe illness than paper-based survey. *Journal of Clinical Epidemiology*, 62(10), 1068–1074.
<http://doi.org/10.1016/j.jclinepi.2008.10.015>.
105. Thom, D. H., & Rortveit, G. (2010). Prevalence of postpartum urinary incontinence: a systematic review. *Acta Obstetrica Et Gynecologica Scandinavica*, 89(12), 1511–1522.
<http://doi.org/10.3109/00016349.2010.526188>.
106. Vineis, P. (2002). History of bias. *Sozial- Und Präventivmedizin*, 47(3), 156–161.
<http://doi.org/10.1007/BF01591887>.
107. Asch, D. A., Jedrzejewski, M. K., & Christakis, N. A. (1997). Response rates to mail surveys published in medical journals. *Journal of Clinical Epidemiology*, 50(10), 1129–1136.
[http://doi.org/10.1016/S0895-4356\(97\)00126-1](http://doi.org/10.1016/S0895-4356(97)00126-1).
108. Walker, G. J. A., & Gunasekera, P. (2011). Pelvic organ prolapse and incontinence in developing countries: review of prevalence and risk factors. *International Urogynecology Journal*, 22(2), 127–135.
<http://doi.org/10.1007/s00192-010-1215-0>.
109. Abrams, P., Cardozo, L., Khoury, S., & Wein, A. J. (2009). Incontinence.
110. Botlero, R., Urquhart, D. M., Davis, S. R., & Bell, R. J. (2008). Prevalence and incidence of urinary incontinence in women: review of the literature and investigation of methodological issues. *International Journal of Urology : Official Journal of the Japanese Urological Association*, 15(3), 230–234.
<http://doi.org/10.1111/j.1442-2042.2007.01976.x>.
111. Minassian, V. A., Stewart, W. F., & Wood, G. C. (2008b). Urinary incontinence in women: variation in prevalence estimates and risk factors. *Obstetrics and Gynecology*, 111(2 Pt 1), 324–331.
<http://doi.org/10.1097/01.AOG.0000267220.48987.17>.
112. Thom, D. (1998). Variation in estimates of urinary incontinence prevalence in the community: effects of differences in definition, population characteristics, and study type. *Journal of the American Geriatrics Society*, 46(4), 473–480.
113. Coyne, K. S., Sexton, C. C., Kopp, Z. S., Luks, S., Gross, A., Irwin, D., et al. (2009b). Rationale for the study methods and design of the epidemiology of lower urinary tract symptoms (EpiLUTS) study. *BJU International*, 104(3), 348–351.
<http://doi.org/10.1111/j.1464-410X.2009.08425.x>.
114. Hunskaar, S., Lose, G., Sykes, D., & Voss, S. (2004). The prevalence of urinary incontinence in women in four European countries. *BJU International*, 93(3), 324–330.
115. Irwin, D. E., Milsom, I., Hunskaar, S., Reilly, K., Kopp, Z., Herschorn, S., et al. (2006). Population-based survey of urinary incontinence, overactive bladder, and other lower urinary tract symptoms in five countries: results of the EPIC study. *European Urology*, 50(6), 1306–14; discussion 1314–5.
<http://doi.org/10.1016/j.eururo.2006.09.019>.
116. Niang, L., Kane, R., Ndoye, M., Jalloh, M., Labou, I., Diaw, J. J., et al. (2010). [Urinary incontinence in woman: epidemiologic profile in Sub Saharian countries]. *Progrès en Urologie : Journal De l'Association Française D'Urologie Et De La Société Française D'urologie*, 20(13), 1213–1216.
<http://doi.org/10.1016/j.purol.2010.01.014>.
117. Kogan, M. I., Zchoval, R., Özyurt, C., Schäfer, T., & Christensen, N. (2014). Epidemiology and impact of urinary incontinence, overactive bladder, and other lower urinary tract symptoms: results of the EPIC survey in Russia, Czech Republic, and Turkey. *Current Medical Research & Opinion*, 1–12.
<http://doi.org/10.1185/03007995.2014.934794>.
118. Jackson, S., Donovan, J., & Brookes, S. (1996). The Bristol female lower urinary tract symptoms questionnaire: development and psychometric testing. *Br J Urol*. 1996 Jun;77(6):805-12.
119. Hansen BJ, Flyger, H., Brasso, K., & Schou, J. et al. (1995). Validation of the self-administered Danish Prostatic Symptom Score (DAN-PSS-1) system for use in benign prostatic hyperplasia. *Br J Urol*. 1995 Oct;76(4):451-8.
120. Wyman, J. F., Harkins, S. W., Choi, S. C., Taylor, J. R., & Fantl, J. A. (1987). Psychosocial impact of urinary incontinence in women. *Obstetrics and Gynecology*, 70(3 Pt 1), 378–381.

121. Pekkanen, J., Sunyer, J., & Chinn, S. (2006). Nondifferential disease misclassification may bias incidence risk ratios away from the null. *Journal of Clinical Epidemiology*, 59(3), 281–289. <http://doi.org/10.1016/j.jclinepi.2005.07.013>.
122. Ebbesen, M., Hunskaar, S., Rortveit, G., & Hannestad, Y. (2013). Prevalence, incidence and remission of urinary incontinence in women: longitudinal data from the Norwegian HUNT study (EPINCONT). *BMC Urology*, 13(1), 27. <http://doi.org/10.1186/1471-2490-13-27>.
123. Wu, J. M., Vaughan, C. P., Goode, P. S., Redden, D. T., Burgio, K. L., Richter, H. E., & Markland, A. D. (2014). Prevalence and trends of symptomatic pelvic floor disorders in U.S. women. *Obstetrics and Gynecology*, 123(1), 141–148. <http://doi.org/10.1097/AOG.0000000000000057>.
124. Wennberg, A.-L., Molander, U., Fall, M., Edlund, C., Peeker, R., & Milsom, I. (2009a). A longitudinal population-based survey of urinary incontinence, overactive bladder, and other lower urinary tract symptoms in women. *European Urology*, 55(4), 783–791. <http://doi.org/10.1016/j.eururo.2009.01.007>.
125. Hannestad, YS, Rortveit, G., & Sandvik, H. (2000). ScienceDirect - *Journal of Clinical Epidemiology* : A community-based epidemiological survey of female urinary incontinence:: The Norwegian EPINCONT Study. *J Clin Epidemiol*. 2000 Nov;53(11):1150-7.
126. Grodstein, F., Fretts, R., Lifford, K., Resnick, N., & Curhan, G. (2003). Association of age, race, and obstetric history with urinary symptoms among women in the Nurses' Health Study. *American Journal of Obstetrics and Gynecology*, 189(2), 428–434.
127. Mishra, G. D., Cardozo, L., & Kuh, D. (2010). Menopausal transition and the risk of urinary incontinence: results from a British prospective cohort. *BJU International*, 106(8), 1170–1175. <http://doi.org/10.1111/j.1464-410X.2010.09321.x>.
128. Simeonova, Z., Milsom, I., Kullendorff, A. M., Molander, U., & Bengtsson, C. (1999). The prevalence of urinary incontinence and its influence on the quality of life in women from an urban Swedish population. *Acta Obstetrica Et Gynecologica Scandinavica*, 78(6), 546–551.
129. Kwon, C. S., & Lee, J. H. (2014). Prevalence, Risk Factors, Quality of Life, and Health-Care Seeking Behaviors of Female Urinary Incontinence: Results From the 4th Korean National Health and Nutrition Examination Survey VI (2007-2009). *International Neurourology Journal*, 18(1), 31–36. <http://doi.org/10.5213/inj.2014.18.1.31>.
130. Offermans, M. P. W., Moulin, Du, M. F. M. T., Hamers, J. P. H., Dassen, T., & Halfens, R. J. G. (2009). Prevalence of urinary incontinence and associated risk factors in nursing home residents: a systematic review. *Neurourology and Urodynamics*, 28(4), 288–294. <http://doi.org/10.1002/nau.20668>.
131. Sgadari, A., Topinková, E., Bjørnson, J., & Bernabei, R. (1997). Urinary incontinence in nursing home residents: a cross-national comparison. *Age and Ageing*, 26 Suppl 2, 49–54.
132. Adelman, P. K. (2004). Prevalence and detection of urinary incontinence among older Medicaid recipients. *Journal of Health Care for the Poor and Underserved*, 15(1), 99–112.
133. Holroyd-Leduc, J. M., Mehta, K. M., & Covinsky, K. E. (2004). Urinary incontinence and its association with death, nursing home admission, and functional decline. *Journal of the American Geriatrics Society*, 52(5), 712–718. <http://doi.org/10.1111/j.1532-5415.2004.52207.x>
134. Townsend, M. K., Danforth, K. N., Lifford, K. L., Rosner, B., Curhan, G. C., Resnick, N. M., & Grodstein, F. (2007a). Incidence and remission of urinary incontinence in middle-aged women. *American Journal of Obstetrics and Gynecology*, 197(2), 167.e1–5. <http://doi.org/10.1016/j.ajog.2007.03.041>.
135. Waetjen, L. E., Ye, J., Feng, W.-Y., Johnson, W. O., Greendale, G. A., Sampsel, C. M., et al. (2009). Association between menopausal transition stages and developing urinary incontinence. *Obstetrics and Gynecology*, 114(5), 989–998. <http://doi.org/10.1097/AOG.0b013e3181bb531a>.
136. Jahanlu, D., & Hunskaar, S. (2010). The Hordaland women's cohort: prevalence, incidence, and remission of urinary incontinence in middle-aged women. *International Urogynecology Journal*, 21(10), 1223–1229. <http://doi.org/10.1007/s00192-010-1172-7>
137. Jahanlu, D., & Hunskaar, S. (2011). Type and severity of new-onset urinary incontinence in middle-aged women: the Hordaland Women's Cohort. *Neurourology and Urodynamics*, 30(1), 87–92. <http://doi.org/10.1002/nau.20966>.

138. Tennstedt, S. L., Link, C. L., Steers, W. D., & McKinlay, J. B. (2008). Prevalence of and risk factors for urine leakage in a racially and ethnically diverse population of adults: the Boston Area Community Health (BACH) Survey. *American Journal of Epidemiology*, 167(4), 390–399. <http://doi.org/10.1093/aje/kwm356>.
139. Hunskaar, S. (2008). A systematic review of overweight and obesity as risk factors and targets for clinical intervention for urinary incontinence in women. *Neurourology and Urodynamics*, 27(8), 749–757. <http://doi.org/10.1002/nau.20635>.
140. Subak, L. L., Richter, H. E., & Hunskaar, S. (2009a). Obesity and urinary incontinence: epidemiology and clinical research update. *The Journal of Urology*, 182(6 Suppl), S2–7. <http://doi.org/10.1016/j.juro.2009.08.071>.
141. Danforth, K. N., Townsend, M. K., Lifford, K., Curhan, G. C., Resnick, N. M., & Grodstein, F. (2006). Risk factors for urinary incontinence among middle-aged women. *American Journal of Obstetrics and Gynecology*, 194(2), 339–345. <http://doi.org/10.1016/j.ajog.2005.07.051>.
142. Chiarelli, P., Brown, W., & McElduff, P. (1999). Leaking urine: prevalence and associated factors in Australian women. *Neurourology and Urodynamics*, 18(6), 567–577.
143. Brown, J. S., Grady, D., Ouslander, J. G., Herzog, A. R., Varner, R. E., & Posner, S. F. (1999a). Prevalence of urinary incontinence and associated risk factors in postmenopausal women. Heart & Estrogen/Progestin Replacement Study (HERS) Research Group. *Obstetrics and Gynecology*, 94(1), 66–70.
144. Kuh, D., Cardozo, L., & Hardy, R. (1999). Urinary incontinence in middle aged women: childhood enuresis and other lifetime risk factors in a British prospective cohort. *Journal of Epidemiology and Community Health*, 53(8), 453–458.
145. Dallosso, H. M., McGrother, C. W., Matthews, R. J., Donaldson, M. M. K., Leicestershire MRC Incontinence Study Group. (2003). The association of diet and other lifestyle factors with overactive bladder and stress incontinence: a longitudinal study in women. *BJU International*, 92(1), 69–77.
146. Townsend, M. K., Danforth, K. N., Rosner, B., Curhan, G. C., Resnick, N. M., & Grodstein, F. (2007b). Body mass index, weight gain, and incident urinary incontinence in middle-aged women. *Obstetrics and Gynecology*, 110(2 Pt 1), 346–353. <http://doi.org/10.1097/01.AOG.0000270121.15510.57>.
147. Waetjen, L. E., Liao, S., Johnson, W. O., Sampsel, C. M., Sternfeld, B., Harlow, S. D., & Gold, E. B. (2007). Factors associated with prevalent and incident urinary incontinence in a cohort of midlife women: a longitudinal analysis of data: study of women's health across the nation. *American Journal of Epidemiology*, 165(3), 309–318. <http://doi.org/10.1093/aje/kwk018>.
148. Hannestad, Yngvild S, Rortveit, G., Daltveit, A. K., & Hunskaar, S. (2003). Are smoking and other lifestyle factors associated with female urinary incontinence? The Norwegian EPINCONT Study. *BJOG: an International Journal of Obstetrics & Gynaecology*, 110(3), 247–254.
149. Bump, R. C., Sugerma, H. J., Fantl, J. A., & McClish, D. K. (1992). Obesity and lower urinary tract function in women: effect of surgically induced weight loss. *American Journal of Obstetrics and Gynecology*, 167(2), 392–7; discussion 397–9.
150. Richter, H. E., Creasman, J. M., Myers, D. L., Wheeler, T. L., Burgio, K. L., Subak, L. L., for the Program to Reduce Incontinence by Diet and Exercise (PRIDE) Research Group. (2008). Urodynamic characterization of obese women with urinary incontinence undergoing a weight loss program: the Program to Reduce Incontinence by Diet and Exercise (PRIDE) trial. *International Urogynecology Journal*, 19(12), 1653–1658. <http://doi.org/10.1007/s00192-008-0694-8>.
151. Kirby, M. G., Wagg, A., Cardozo, L., Chapple, C., Castro-Diaz, D., De Ridder, D., et al. (2010). Overactive bladder: Is there a link to the metabolic syndrome in men? *Neurourology and Urodynamics*, 29(8), 1360–1364.
152. Kupelian, V., McVary, K. T., Barry, M. J., Link, C. L., Rosen, R. C., Aiyer, L. P., et al. (2009). Association of C-reactive Protein and Lower Urinary Tract Symptoms in Men and Women: Results From Boston Area Community Health Survey. *Urology*, 73(5), 950–957.

153. Tai, H.-C., Chung, S.-D., Ho, C.-H., Tai, T.-Y., Yang, W.-S., Tseng, C.-H., et al. (2010). Metabolic syndrome components worsen lower urinary tract symptoms in women with type 2 diabetes. *The Journal of Clinical Endocrinology and Metabolism*, 95(3), 1143–1150. <http://doi.org/10.1210/jc.2009-1492>.
154. Uzun, H., & Zorba, O. U. (2011). Metabolic Syndrome in Female Patients With Overactive Bladder. *Urology*. 2012 Jan;79(1):72-5. doi: 10.1016/j.urology.2011.08.050. Epub 2011 Oct 19.
155. Link, C. L., Steers, W. D., Kusek, J. W., & McKinlay, J. B. (2011). The association of adiposity and overactive bladder appears to differ by gender: results from the Boston Area Community Health survey. *The Journal of Urology*, 185(3), 955–963. <http://doi.org/10.1016/j.juro.2010.10.048>.
156. Kim, I.-H., Chun, H., & Kwon, J.-W. (2011). Gender differences in the effect of obesity on chronic diseases among the elderly Koreans. *Journal of Korean Medical Science*, 26(2), 250–257. <http://doi.org/10.3346/jkms.2011.26.2.250>.
157. Auwad, W., Steggle, P., Bombieri, L., Waterfield, M., Wilkin, T., & Freeman, R. (2008). Moderate weight loss in obese women with urinary incontinence: a prospective longitudinal study. *International Urogynecology Journal and Pelvic Floor Dysfunction*, 19(9), 1251–1259. <http://doi.org/10.1007/s00192-008-0616-9>.
158. Subak, L. L., Whitcomb, E., Shen, H., Saxton, J., Vittinghoff, E., & Brown, J. S. (2005). Weight loss: a novel and effective treatment for urinary incontinence. *J Urol*, 174(1), 190–195. <http://doi.org/10.1097/01.ju.0000162056.30326.83>.
159. Subak, L. L., Wing, R., West, D. S., Franklin, F., Vittinghoff, E., Creasman, J. M., et al. (2009b). Weight loss to treat urinary incontinence in overweight and obese women. *The New England Journal of Medicine*, 360(5), 481–490. <http://doi.org/10.1056/NEJMoa0806375>.
160. Wing, R. R., West, D. S., Grady, D., Creasman, J. M., Richter, H. E., Myers, D., et al. (2010). Effect of weight loss on urinary incontinence in overweight and obese women: results at 12 and 18 months. *The Journal of Urology*, 184(3), 1005–1010. <http://doi.org/10.1016/j.juro.2010.05.031>.
161. Holst, K., & Wilson, P. D. (1988). The prevalence of female urinary incontinence and reasons for not seeking treatment. *The New Zealand Medical Journal*, 101(857), 756–758.
162. Højberg, K. E., Salvig, J. D., Winsløw, N. A., Lose, G., & Secher, N. J. (1999). Urinary incontinence: prevalence and risk factors at 16 weeks of gestation. *British Journal of Obstetrics and Gynaecology*, 106(8), 842–850.
163. Thomas, T. M., Plymat, K. R., Blannin, J., & Meade, T. W. (1980). Prevalence of urinary incontinence. *British Medical Journal*, 281(6250), 1243–1245.
164. Rortveit, G., Hannestad, Y. S., Daltveit, A. K., & Hunskaar, S. (2001). Age- and type-dependent effects of parity on urinary incontinence: the Norwegian EPINCONT study. *Obstetrics and Gynecology*, 98(6), 1004–1010.
165. Connolly, T. J., Litman, H. J., Tennstedt, S. L., Link, C. L., & McKinlay, J. B. (2007). The effect of mode of delivery, parity, and birth weight on risk of urinary incontinence. *International Urogynecology Journal and Pelvic Floor Dysfunction*, 18(9), 1033–1042. <http://doi.org/10.1007/s00192-006-0286-4>.
166. Miller, Y. D., Brown, W. J., Russell, A., & Chiarelli, P. (2003). Urinary incontinence across the lifespan. *Neurourology and Urodynamics*, 22(6), 550–557. <http://doi.org/10.1002/nau.10023>.
167. Hirsch, A. G., Minassian, V. A., Dilley, A., Sartorius, J., & Stewart, W. F. (2010). Parity is not associated with urgency with or without urinary incontinence. *International Urogynecology Journal*, 21(9), 1095–1102. <http://doi.org/10.1007/s00192-010-1164-7>.
168. Lukacz, E. S., Lawrence, J. M., Contreras, R., Nager, C. W., & Luber, K. M. (2006). Parity, mode of delivery, and pelvic floor disorders. *Obstetrics and Gynecology*, 107(6), 1253–1260. <http://doi.org/10.1097/01.AOG.0000218096.54169.34>.
169. Press, J. Z., Klein, M. C., Kaczorowski, J., Liston, R. M., & Daddelsen, von, P. (2007). Does cesarean section reduce postpartum urinary incontinence? A systematic review. *Birth (Berkeley, Calif.)*, 34(3), 228–237. <http://doi.org/10.1111/j.1523-536X.2007.00175.x>.

170. Tähtinen, R. M., Cartwright, R., Tsui, J. F., Aaltonen, R. L., Aoki, Y., Cárdenas, J. L. et al. (2016). Long-term Impact of Mode of Delivery on Stress Urinary Incontinence and Urgency Urinary Incontinence: A Systematic Review and Meta-analysis. *European Urology*, 70(1), 148–158.
171. MacLennan, A. H., Taylor, A. W., Wilson, D. H., & Wilson, D. (2000). The prevalence of pelvic floor disorders and their relationship to gender, age, parity and mode of delivery. *BJOG: an International Journal of Obstetrics & Gynaecology*, 107(12), 1460–1470.
172. Melville, J. L., Katon, W., Delaney, K., & Newton, K. (2005). Urinary incontinence in US women: a population-based study. *Archives of Internal Medicine*, 165(5), 537–542. <http://doi.org/10.1001/archinte.165.5.537>.
173. Peyrat, L., Haillot, O., Bruyere, F., Boutin, J. M., Bertrand, P., & Lanson, Y. (2002). Prevalence and risk factors of urinary incontinence in young and middle-aged women. *BJU International*, 89(1), 61–66.
174. Rortveit, G., Daltveit, A. K., Hannestad, Y. S., Hunskaar, S., Norwegian EPINCONT Study. (2003b). Urinary incontinence after vaginal delivery or cesarean section. *The New England Journal of Medicine*, 348(10), 900–907. <http://doi.org/10.1056/NEJMoa021788>.
175. Hannah, M. E., Whyte, H., Hannah, W. J., Hewson, S., Amankwah, K., Cheng, M., et al. (2004). Maternal outcomes at 2 years after planned cesarean section versus planned vaginal birth for breech presentation at term: the international randomized Term Breech Trial. *American Journal of Obstetrics and Gynecology*, 191(3), 917–927. <http://doi.org/10.1016/j.ajog.2004.08.004>.
176. Marshall, K., Thompson, K. A., Walsh, D. M., & Baxter, G. D. (1998). Incidence of urinary incontinence and constipation during pregnancy and postpartum: survey of current findings at the Rotunda Lying-In Hospital. *British Journal of Obstetrics and Gynaecology*, 105(4), 400–402.
177. Mørkved, S., & Bø, K. (1999). Prevalence of urinary incontinence during pregnancy and postpartum. *International Urogynecology Journal and Pelvic Floor Dysfunction*, 10(6), 394–398.
178. Wesnes, S. L., Hunskaar, S., Bø, K., & Rortveit, G. (2009). The effect of urinary incontinence status during pregnancy and delivery mode on incontinence postpartum. A cohort study. *BJOG: an International Journal of Obstetrics & Gynaecology*, 116(5), 700–707. <http://doi.org/10.1111/j.1471-0528.2008.02107.x>.
179. Altman, D., Ekström, A., Gustafsson, C., López, A., Falconer, C., & Zetterström, J. (2006). Risk of urinary incontinence after childbirth: a 10-year prospective cohort study. *Obstetrics and Gynecology*, 108(4), 873–878. <http://doi.org/10.1097/01.AOG.0000233172.96153.ad>.
180. Foldspang, A., Hvidman, L., Mommsen, S., & Nielsen, J. B. (2004). Risk of postpartum urinary incontinence associated with pregnancy and mode of delivery. *Acta Obstetrica Et Gynecologica Scandinavica*, 83(10), 923–927. <http://doi.org/10.1111/j.0001-6349.2004.00353.x>.
181. Hvidman, L., Foldspang, A., Mommsen, S., & Nielsen, J. B. (2003). Postpartum urinary incontinence. *Acta Obstetrica Et Gynecologica Scandinavica*, 82(6), 556–563.
182. Viktrup, L., Rortveit, G., & Lose, G. (2006). Risk of stress urinary incontinence twelve years after the first pregnancy and delivery. *Obstetrics and Gynecology*, 108(2), 248–254. <http://doi.org/10.1097/01.AOG.0000226860.01127.0e>.
183. Kim, C., Newton, K., & Knopp, R. (2002). Gestational Diabetes and the Incidence of Type 2 Diabetes. *Diabetes Care*, 1682–1688.
184. Aslan, E., Beji, N. K., Erkan, H. A., Yalcin, O., & Gungor, F. (2009). The prevalence of and the related factors for urinary and fecal incontinence among older residing in nursing homes. *Journal of Clinical Nursing*, 18(23), 3290–3298. <http://doi.org/10.1111/j.1365-2702.2009.02936.x>.
185. Borello-France, D., Burgio, K. L., Richter, H. E., Zyczynski, H., FitzGerald, M. P., Whitehead, W., et al. (2006). Fecal and urinary incontinence in primiparous women. *Obstetrics and Gynecology*, 108(4), 863–872. <http://doi.org/10.1097/01.AOG.0000232504.32589.3b>.
186. Eason, E., Labrecque, M., Marcoux, S., & Mondor, M. (2004). Effects of carrying a pregnancy and of method of delivery on urinary incontinence: a prospective cohort study. *BMC Pregnancy and Childbirth*, 4(1), 4. <http://doi.org/10.1186/1471-2393-4-4>.
187. Yang, X., Zhang, H. X., Yu, H. Y., Gao, X. L., Yang, H. X., & Dong, Y. (2010). The prevalence of fecal incontinence and urinary incontinence in primiparous postpartum Chinese women. *European Journal of Obstetrics, Gynecology, and Reproductive Biology*, 152(2), 214–217. <http://doi.org/10.1016/j.ejogrb.2010.05.031>.

188. Carroli, G., & Mignini, L. (2009). Episiotomy for vaginal birth. *Cochrane Database of Systematic Reviews (Online)*, (1), CD000081. <http://doi.org/10.1002/14651858.CD000081.pub2>.
189. Brown, S. J., Gartland, D., Donath, S., & MacArthur, C. (2011). Effects of prolonged second stage, method of birth, timing of caesarean section and other obstetric risk factors on postnatal urinary incontinence: an Australian nulliparous cohort study. *BJOG: an International Journal of Obstetrics & Gynaecology*, 118(8), 991–1000. <http://doi.org/10.1111/j.1471-0528.2011.02928.x>.
190. Farrell, S. A., Allen, V. M., & Baskett, T. F. (2001). Parturition and urinary incontinence in primiparas. *Obstetrics and Gynecology*, 97(3), 350–356.
191. MacArthur, C., Glazener, C. M. A., Wilson, P. D., Lancashire, R. J., Herbison, G. P., & Grant, A. M. (2006). Persistent urinary incontinence and delivery mode history: a six-year longitudinal study. *BJOG: an International Journal of Obstetrics & Gynaecology*, 113(2), 218–224. <http://doi.org/10.1111/j.1471-0528.2005.00818.x>
192. O'Mahony, F., Hofmeyr, G. J., & Menon, V. (2010). Choice of instruments for assisted vaginal delivery. *Cochrane Database of Systematic Reviews (Online)*, (11), CD005455. <http://doi.org/10.1002/14651858.CD005455.pub2>.
193. Pregazzi, R., Sartore, A., Troiano, L., Grimaldi, E., Bortoli, P., Siracusano, S., & Guaschino, S. (2002). Postpartum urinary symptoms: prevalence and risk factors. *European Journal of Obstetrics, Gynecology, and Reproductive Biology*, 103(2), 179–182.
194. Rortveit, G., Daltveit, A. K., Hannestad, Y. S., & Hunskaar, S. (2003a). Vaginal delivery parameters and urinary incontinence: the Norwegian EPINCONT study. *American Journal of Obstetrics and Gynecology*, 189(5), 1268–1274.
195. Thom, D. H., Brown, J. S., Schembri, M., Ragins, A. I., Creasman, J. M., & Van Den Eeden, S. K. (2011). Parturition events and risk of urinary incontinence in later life. *Neurourology and Urodynamics*, 30(8), 1456–1461. <http://doi.org/10.1002/nau.21166>.
196. Thom, D. H., van den Eeden, S. K., & Brown, J. S. (1997a). Evaluation of parturition and other reproductive variables as risk factors for urinary incontinence in later life. *Obstetrics and Gynecology*, 90(6), 983–989.
197. Foldspang, A., Mommsen, S., & Djurhuus, J. C. (1999). Prevalent urinary incontinence as a correlate of pregnancy, vaginal childbirth, and obstetric techniques. *American Journal of Public Health*, 89(2), 209–212.
198. Persson, J., Wolner-Hanssen, P., & Rydhstroem, H. (2000). Obstetric risk factors for stress urinary incontinence: a population-based study. *Obstetrics and Gynecology*, 96(3), 440–445.
199. Rortveit, G., & Hunskaar, S. (2006). Urinary incontinence and age at the first and last delivery: the Norwegian HUNT/EPINCONT study. *American Journal of Obstetrics and Gynecology*, 195(2), 433–438. <http://doi.org/10.1016/j.ajog.2006.01.023>.
200. Glazener, C. M. A., Herbison, G. P., MacArthur, C., Lancashire, R., McGee, M. A., Grant, A. M., & Wilson, P. D. (2006). New postnatal urinary incontinence: obstetric and other risk factors in primiparae. *BJOG: an International Journal of Obstetrics & Gynaecology*, 113(2), 208–217. <http://doi.org/10.1111/j.1471-0528.2005.00840.x>
201. Gyhagen M, Bullarbo M, Nielsen TF, Milsom I. The prevalence of urinary incontinence 20 years after childbirth: a national cohort study in singleton primiparae after vaginal or caesarean delivery. *BJOG*. 2013 Jan;120(2):144-51. doi: 10.1111/j.1471-0528.2012.03301.x.
202. Roe, B., & Doll, H. (2000). Prevalence of urinary incontinence and its relationship with health status. *Journal of Clinical Nursing*, 9(2), 178–187.
203. Fantl, J. A., Cardozo, L., & McClish, D. K. (1994). Estrogen therapy in the management of urinary incontinence in postmenopausal women: a meta-analysis. First report of the Hormones and Urogenital Therapy Committee. *Obstetrics and Gynecology*, 83(1), 12–18.
204. Diokno, A. C., Brock, B. M., Herzog, A. R., & Bromberg, J. (1990). Medical correlates of urinary incontinence in the elderly. *Urology*, 36(2), 129–138.
205. Cody, J. D., Richardson, K., Moehrer, B., Hextall, A., & Glazener, C. M. (2009). Oestrogen therapy for urinary incontinence in postmenopausal women. *Cochrane Database of Systematic Reviews (Online)*, (4), CD001405. <http://doi.org/10.1002/14651858.CD001405.pub2>.

206. Grodstein, F., Lifford, K., Resnick, N. M., & Curhan, G. C. (2004). Postmenopausal hormone therapy and risk of developing urinary incontinence. *Obstetrics and Gynecology*, 103(2), 254–260. <http://doi.org/10.1097/01.AOG.0000107290.33034.6f>.
207. Grady, D., Brown, J. S., Vittinghoff, E., Applegate, W., Varner, E., Snyder, T., HERS Research Group. (2001). Postmenopausal hormones and incontinence: the Heart and Estrogen/Progestin Replacement Study. *Obstetrics and Gynecology*, 97(1), 116–120.
208. Hendrix, S. L., Cochrane, B. B., Nygaard, I. E., Handa, V. L., Barnabei, V. M., Iglesia, C., et al. (2005). Effects of estrogen with and without progestin on urinary incontinence. *JAMA : the Journal of the American Medical Association*, 293(8), 935–948. <http://doi.org/10.1001/jama.293.8.935>.
209. Goldstein, S. R., Johnson, S., Watts, N. B., Ciaccia, A. V., Elmerick, D., & Muram, D. (2005). Incidence of urinary incontinence in postmenopausal women treated with raloxifene or estrogen. *Menopause (New York, N.Y.)*, 12(2), 160–164.
210. Albertazzi, P., & Sharma, S. (2005). Urogenital effects of selective estrogen receptor modulators: a systematic review. *Climacteric : the Journal of the International Menopause Society*, 8(3), 214–220. <http://doi.org/10.1080/13697130500117946>.
211. Hsieh, C.-H., Chang, W.-C., Lin, T.-Y., Su, T.-H., Li, Y.-T., Kuo, T.-C., et al. (2011). Long-term effect of hysterectomy on urinary incontinence in Taiwan. *Taiwanese Journal of Obstetrics & Gynecology*, 50(3), 326–330. <http://doi.org/10.1016/j.tjog.2011.07.008>.
212. Lifford, K. L., Townsend, M. K., Curhan, G. C., Resnick, N. M., & Grodstein, F. (2008). The epidemiology of urinary incontinence in older women: incidence, progression, and remission. *Journal of the American Geriatrics Society*, 56(7), 1191–1198. <http://doi.org/10.1111/j.1532-5415.2008.01747.x>.
213. Samuelsson, E. C., Victor, F. T., & Svärdsudd, K. F. (2000). Five-year incidence and remission rates of female urinary incontinence in a Swedish population less than 65 years old. *American Journal of Obstetrics and Gynecology*, 183(3), 568–574. <http://doi.org/10.1067/mob.2000.106763>.
214. Moghaddas, F., Lidfeldt, J., Nerbrand, C., Jernström, H., & Samsioe, G. (2005). Prevalence of urinary incontinence in relation to self-reported depression, intake of serotonergic antidepressants, and hormone therapy in middle-aged women: a report from the Women's Health in the Lund Area study. *Menopause (New York, N.Y.)*, 12(3), 318–324.
215. Jackson, S. L., Scholes, D., Boyko, E. J., Abraham, L., & Fihn, S. D. (2006). Predictors of urinary incontinence in a prospective cohort of postmenopausal women. *Obstetrics and Gynecology*, 108(4), 855–862. <http://doi.org/10.1097/01.AOG.0000236446.17153.21>.
216. Melville, J. L., Fan, M.-Y., Rau, H., Nygaard, I. E., & Katon, W. J. (2009). Major depression and urinary incontinence in women: temporal associations in an epidemiologic sample. *American Journal of Obstetrics and Gynecology*, 201(5), 490.e1–7. <http://doi.org/10.1016/j.ajog.2009.05.047>.
217. Forsgren, C., Lundholm, C., Johansson, A. L. V., Cnattingius, S., Zetterström, J., & Altman, D. (2011). Vaginal hysterectomy and risk of pelvic organ prolapse and stress urinary incontinence surgery. *International Urogynecology Journal*. <http://doi.org/10.1007/s00192-011-1523-z>.
218. Bhattacharya, S., Middleton, L. J., Tsourapas, A., Lee, A. J., Champaneria, R., Daniels, J. P., et al. (2011). Hysterectomy, endometrial ablation and Mirena® for heavy menstrual bleeding: a systematic review of clinical effectiveness and cost-effectiveness analysis. *Health Technology Assessment (Winchester, England)*, 15(19), iii–xvi, 1–252. <http://doi.org/10.3310/hta15190>.
219. Heliövaara-Peippo, S., Halmesmäki, K., Hurskainen, R., Teperi, J., Grenman, S., Kivelä, A., et al. (2010). The effect of hysterectomy or levonorgestrel-releasing intrauterine system on lower urinary tract symptoms: a 10-year follow-up study of a randomised trial. *BJOG: an International Journal of Obstetrics & Gynaecology*, 117(5), 602–609. <http://doi.org/10.1111/j.1471-0528.2010.02505.x>.
220. Leatherdale, S. T., & Laxer, R. E. (2013). Reliability and validity of the weight status and dietary intake measures in the COMPASS questionnaire: are the self-reported measures of body mass index. *Int J Behav Nutr Phys Act*. 2013 Apr 5;10:42. doi: 10.1186/1479-5868-10-42.

221. Arya, L. A., Myers, D. L., & Jackson, N. D. (2000). Dietary caffeine intake and the risk for detrusor instability: a case-control study. *Obstetrics and Gynecology*, 96(1), 85–89.
222. Gleason, J. L., Richter, H. E., Redden, D. T., Goode, P. S., Burgio, K. L., & Markland, A. D. (2013). Caffeine and urinary incontinence in US women. *International Urogynecology Journal*, 24(2), 295–302. <http://doi.org/10.1007/s00192-012-1829-5>.
223. Martins, G., Soler, Z. A. S. G., Cordeiro, J. A., Amaro, J. L., & Moore, K. N. (2010). Prevalence and risk factors for urinary incontinence in healthy pregnant Brazilian women. *International Urogynecology Journal*, 21(10), 1271–1277. <http://doi.org/10.1007/s00192-010-1185-2>.
224. Østbye, T., Seim, A., Krause, K. M., Feightner, J., Hachinski, V., Sykes, E., & Hunnskaar, S. (2004). A 10-year follow-up of urinary and fecal incontinence among the oldest old in the community: the Canadian Study of Health and Aging. *Canadian Journal on Aging = La Revue Canadienne Du Vieillissement*, 23(4), 319–331.
225. Bortolotti, A., Bernardini, B., Colli, E., Di Benedetto, P., Giocoli Nacci, G., Landoni, M., et al. (2000). Prevalence and risk factors for urinary incontinence in Italy. *European Urology*, 37(1), 30–35.
226. Hirayama, F., & Lee, A. H. (2012). Is Caffeine Intake Associated With Urinary Incontinence in Japanese Adults? *Journal of Preventive Medicine & Public Health*, 45(3), 204–208. <http://doi.org/10.3961/jpmph.2012.45.3.204>.
227. Townsend, M. K., Resnick, N. M., & Grodstein, F. (2012). Caffeine intake and risk of urinary incontinence progression among women. *Obstetrics and Gynecology*, 119(5), 950–957. <http://doi.org/10.1097/AOG.0b013e31824fc604>.
228. Tettamanti, G., Altman, D., Pedersen, N. L., Bellocco, R., Milsom, I., & Iliadou, A. N. (2011). Effects of coffee and tea consumption on urinary incontinence in female twins. *BJOG: an International Journal of Obstetrics & Gynaecology*, 118(7), 806–813. <http://doi.org/10.1111/j.1471-0528.2011.02930.x>.
229. Jura, Y. H., Townsend, M. K., Curhan, G. C., Resnick, N. M., & Grodstein, F. (2011). Caffeine intake, and the risk of stress, urgency and mixed urinary incontinence. *The Journal of Urology*, 185(5), 1775–1780. <http://doi.org/10.1016/j.juro.2011.01.003>.
230. Wells, M. J., Jamieson, K., Markham, T. C. W., Green, S. M., & Fader, M. J. (2014). The Effect of Caffeinated Versus Decaffeinated Drinks on Overactive Bladder. *Journal of Wound, Ostomy, and Continence Nursing : Official Publication of the Wound, Ostomy and Continence Nurses Society / WOCN*, 41(4), 371–378. <http://doi.org/10.1097/WON.000000000000040>.
231. Schmidbauer, J., Temml, C., Schatzl, G., Haidinger, G., & Madersbacher, S. (2001). Risk factors for urinary incontinence in both sexes. Analysis of a health screening project. *European Urology*, 39(5), 565–570.
232. Teleman, P. M., Lidfeldt, J., Nerbrand, C., Samsioe, G., Mattiasson, A., WHILA study group. (2004). Overactive bladder: prevalence, risk factors and relation to stress incontinence in middle-aged women. *BJOG: an International Journal of Obstetrics & Gynaecology*, 111(6), 600–604. <http://doi.org/10.1111/j.1471-0528.2004.00137.x>.
233. Correja, S., Dinis, P., Rolo, F., & Lunet, N. (2009). Prevalence, treatment and known risk factors of urinary incontinence and overactive bladder in the non-institutionalized Portuguese population. *International Urogynecology Journal*, 20(12), 1481–1489. <http://doi.org/10.1007/s00192-009-0975-x>.
234. Kim, H., Yoshida, H., Hu, X., Yukawa, H., Shinkai, S., Kumagai, S., et al. (2004). [Risk factors associated with onset of urinary incontinence in a community-dwelling elderly population: a 4-year follow-up study]. [Nihon Koshu Eisei Zasshi] *Japanese Journal of Public Health*, 51(8), 612–622.
235. Sampsel, C. M., Harlow, S. D., Skurnick, J., Brubaker, L., & Bondarenko, I. (2002). Urinary incontinence predictors and life impact in ethnically diverse perimenopausal women. *Obstetrics and Gynecology*, 100(6), 1230–1238.
236. Ge, J., Yang, P., Zhang, Y., Li, X., Wang, Q., & Lu, Y. (2011). Prevalence and Risk Factors of Urinary Incontinence in Chinese Women: A Population-Based Study. *Asia-Pacific Journal of Public Health / Asia-Pacific Academic Consortium for Public Health*. <http://doi.org/10.1177/1010539511429370>.

237. Waetjen, L. E., Feng, W.-Y., Ye, J., Johnson, W. O., Greendale, G. A., Sampselle, C. M., et al. (2008). Factors associated with worsening and improving urinary incontinence across the menopausal transition. *Obstetrics and Gynecology*, 111(3), 667–677. <http://doi.org/10.1097/AOG.0b013e31816386ce>.
238. Østbye, T., Seim, A., Krause, K. M., Feightner, J., Hachinski, V., Sykes, E., & Hunskaar, S. (2004). A 10-year follow-up of urinary and fecal incontinence among the oldest old in the community: the Canadian Study of Health and Aging. *Canadian Journal on Aging = La Revue Canadienne Du Vieillessement*, 23(4), 319–331.
239. Nygaard, I. E., Thompson, F. L., Svengalis, S. L., & Albright, J. P. (1994). Urinary incontinence in elite nulliparous athletes. *Obstetrics and Gynecology*, 84(2), 183–187.
240. Simeone, C., Moroni, A., Pettenò, A., Antonelli, A., Zani, D., Orizio, C., & Cosciani Cunico, S. (2010). Occurrence rates and predictors of lower urinary tract symptoms and incontinence in female athletes. *Urologia*, 77(2), 139–146.
241. Eliasson, K., Larsson, T., & Mattsson, E. (2002). Prevalence of stress incontinence in nulliparous elite trampolinists. *Scandinavian Journal of Medicine & Science in Sports*, 12(2), 106–110.
242. Eliasson, K., Edner, A., & Mattsson, E. (2008). Urinary incontinence in very young and mostly nulliparous women with a history of regular organised high-impact trampoline training: occurrence and risk factors. *International Urogynecology Journal and Pelvic Floor Dysfunction*, 19(5), 687–696. <http://doi.org/10.1007/s00192-007-0508-4>.
243. Nygaard, I., Girts, T., Fultz, N. H., Kinchen, K., Pohl, G., & Sternfeld, B. (2005). Is urinary incontinence a barrier to exercise in women? *Obstetrics and Gynecology*, 106(2), 307–314. <http://doi.org/10.1097/01.AOG.0000168455.39156.0f>.
244. Bo, K., Mørkved, S., Frawley, H., & Sherburn, M. (2009). Evidence for benefit of transversus abdominis training alone or in combination with pelvic floor muscle training to treat female urinary incontinence: A systematic review. *Neurourology and Urodynamics*, 28(5), 368–373. <http://doi.org/10.1002/nau.20700>.
245. Van Oyen, H., & Van Oyen, P. (2002). Urinary incontinence in Belgium; prevalence, correlates and psychosocial consequences. *Acta Clinica Belgica*, 57(4), 207–218.
246. Zhu, L., Lang, J., Wang, H., Han, S., & Huang, J. (2008). The prevalence of and potential risk factors for female urinary incontinence in Beijing, China. *Menopause (New York, N.Y.)*, 15(3), 566–569. <http://doi.org/10.1097/gme.0b013e31816054ac>.
247. Eliasson, K., Nordlander, I., Larson, B., Hammarström, M., & Mattsson, E. (2005). Influence of physical activity on urinary leakage in primiparous women. *Scandinavian Journal of Medicine & Science in Sports*, 15(2), 87–94. <http://doi.org/10.1111/j.1600-0838.2004.407.x>
248. Danforth, K. N., Shah, A. D., Townsend, M. K., Lifford, K. L., Curhan, G. C., Resnick, N. M., & Grodstein, F. (2007). Physical activity and urinary incontinence among healthy, older women. *Obstetrics and Gynecology*, 109(3), 721–727. <http://doi.org/10.1097/01.AOG.0000255973.92450.24>.
249. Coyne, K. S., Kaplan, S. A., Chapple, C. R., Sexton, C. C., Kopp, Z. S., Bush, E. N., et al. (2009a). Risk factors and comorbid conditions associated with lower urinary tract symptoms: EpiLUTS. *BJU International*, 103 Suppl 3, 24–32. <http://doi.org/10.1111/j.1464-410X.2009.08438.x>.
250. McGrother, C. W., Donaldson, M. M. K., Hayward, T., Matthews, R., Dallosso, H. M., Hyde, C., Leicestershire MRC Incontinence Study Team. (2006). Urinary storage symptoms and comorbidities: a prospective population cohort study in middle-aged and older women. *Age and Ageing*, 35(1), 16–24. <http://doi.org/10.1093/ageing/afi205>.
251. Ebbesen, M. H., Hannestad, Y. S., Midtjell, K., & Hunskaar, S. (2009). Diabetes related risk factors did not explain the increased risk for urinary incontinence among women with diabetes. The Norwegian HUNT/EPINCONT study. *BMC Urology*, 9, 11. <http://doi.org/10.1186/1471-2490-9-11>.
252. Sarma, A. V., Kanaya, A. M., Nyberg, L. M., Kusek, J. W., Vittinghoff, E., Rutledge, B., et al. (2009). Urinary incontinence among women with type 1 diabetes--how common is it? *The Journal of Urology*, 181(3), 1224–30; discussion 1230. <http://doi.org/10.1016/j.juro.2008.11.024>.

253. Brown, J. S., Vittinghoff, E., Lin, F., Nyberg, L. M., Kusek, J. W., & Kanaya, A. M. (2006). Prevalence and risk factors for urinary incontinence in women with type 2 diabetes and impaired fasting glucose: findings from the National Health and Nutrition Examination Survey (NHANES) 2001-2002. *Diabetes Care*, 29(6), 1307-1312. <http://doi.org/10.2337/dc05-2463>.
254. Lifford, K. L., Curhan, G. C., Hu, F. B., Barbi-eri, R. L., & Grodstein, F. (2005). Type 2 Diabetes Mellitus and Risk of Developing Urinary Incontinence. *Journal of the American Geriatrics Society*, 53(11), 1851-1857. <http://doi.org/10.1111/j.1532-5415.2005.53565.x>.
255. Moore, E. E., Jackson, S. L., Boyko, E. J., Scholes, D., & Fihn, S. D. (2008). Urinary incontinence and urinary tract infection: temporal relationships in postmenopausal women. *Obstetrics and Gynecology*, 111(2 Pt 1), 317-323. <http://doi.org/10.1097/AOG.0b013e318160d64a>.
256. Brown, J., Grady, D., & Ouslander, J. (1999b). Prevalence of urinary incontinence and associated risk factors in postmenopausal women. *Obstet Gynecol.* 1999 Jul;94(1):66-70.
257. Fenner, D. E., Trowbridge, E. R., Patel, D. A., Patel, D. L., Fultz, N. H., Miller, J. M., et al. (2008). Establishing the prevalence of incontinence study: racial differences in women's patterns of urinary incontinence. *The Journal of Urology*, 179(4), 1455-1460. <http://doi.org/10.1016/j.juro.2007.11.051>.
258. Herzog, A. R., & Fultz, N. H. (1990). Prevalence and incidence of urinary incontinence in community-dwelling populations. *Journal of the American Geriatrics Society*, 38(3), 273-281.
259. Caljouw, M. A. A., Elzen, den, W. P. J., Cools, H. J. M., & Gussekloo, J. (2011). Predictive factors of urinary tract infections among the oldest old in the general population. A population-based prospective follow-up study. *BMC Medicine*, 9, 57. <http://doi.org/10.1186/1741-7015-9-57>.
260. Ouslander, J. G., Uman, G. C., Urman, H. N., & Rubenstein, L. Z. (1987). Incontinence among nursing home patients: clinical and functional correlates. *Journal of the American Geriatrics Society*, 35(4), 324-330.
261. Østbye, T., Borrie, M. J., & Hunskaar, S. (2009). The prevalence of urinary incontinence in elderly Canadians and its association with dementia, ambulatory function, and institutionalization. *Norsk Epidemiologi*, 8(2).
262. Huang, A. J., Brown, J. S., Thom, D. H., Fink, H. A., Yaffe, K., Study of Osteoporotic Fractures Research Group. (2007). Urinary incontinence in older community-dwelling women: the role of cognitive and physical function decline. *Obstetrics and Gynecology*, 109(4), 909-916. <http://doi.org/10.1097/01.AOG.0000258277.01497.4b>.
263. Byles, J., Millar, C. J., Sibbritt, D. W., & Chiarelli, P. (2009). Living with urinary incontinence: a longitudinal study of older women. *Age and Ageing*, 38(3), 333-8; discussion 251. <http://doi.org/10.1093/ageing/afp013>.
264. Thom, D., Haan, M., & van den Eeden, S. (1997b). Medically recognized urinary incontinence and risks of hospitalization, nursing home admission and mortality. *Age and Ageing*, 26, 367-374.
265. Akiguchi, I., Ishii, M., Watanabe, Y., Watanabe, T., Kawasaki, T., Yagi, H., et al. (2008). Shunt-responsive parkinsonism and reversible white matter lesions in patients with idiopathic NPH. *Journal of Neurology*, 255(9), 1392-1399. <http://doi.org/10.1007/s00415-008-0928-1>.
266. Pinner, G., Johnson, H., Bouman, W. P., & Isaacs, J. (1997). Psychiatric manifestations of normal-pressure hydrocephalus: a short review and unusual case. *International Psychogeriatrics / IPA*, 9(4), 465-470.
267. Jackson, R. A., Vittinghoff, E., Kanaya, A. M., Miles, T. P., Resnick, H. E., Kritchevsky, S. B., et al. (2004). Urinary incontinence in elderly women: findings from the Health, Aging, and Body Composition Study. *Obstetrics and Gynecology*, 104(2), 301-307. <http://doi.org/10.1097/01.AOG.0000133482.20685.d1>.
268. Ekundayo, O. J., Markland, A., Lefante, C., Sui, X., Goode, P. S., Allman, R. M., et al. (2009). Association of diuretic use and overactive bladder syndrome in older adults: a propensity score analysis. *Archives of Gerontology and Geriatrics*, 49(1), 64-68. <http://doi.org/10.1016/j.archger.2008.05.002>.
269. Palmer, M. H., Hardin, S. R., Behrend, C., Collins, S. K.-R., Madigan, C. K., & Carlson, J. R. (2009). Urinary incontinence and overactive bladder in patients with heart failure. *The Journal of Urology*, 182(1), 196-202. <http://doi.org/10.1016/j.juro.2009.02.115>.

270. Markland, A. D., Goode, P. S., Burgio, K. L., Redden, D. T., Richter, H. E., Sawyer, P., & Allman, R. M. (2008). Correlates of urinary, fecal, and dual incontinence in older African-American and white men and women. *Journal of the American Geriatrics Society*, 56(2), 285–290.
<http://doi.org/10.1111/j.1532-5415.2007.01509.x>.
271. Nuotio, M., Jylhä, M., Luukkaala, T., & Tammele, T. L. J. (2003). Urinary incontinence in a Finnish population aged 70 and over. Prevalence of types, associated factors and self-reported treatments. *Scandinavian Journal of Primary Health Care*, 21(3), 182–187.
272. Nygaard, I., Turvey, C., Burns, T. L., Crischilles, E., & Wallace, R. (2003). Urinary incontinence and depression in middle-aged United States women. *Obstetrics and Gynecology*, 101(1), 149–156.
273. Goode, P. S., Burgio, K. L., Redden, D. T., Markland, A., Richter, H. E., Sawyer, P., & Allman, R. M. (2008). Population based study of incidence and predictors of urinary incontinence in black and white older adults. *The Journal of Urology*, 179(4), 1449–53; discussion 1453–4.
<http://doi.org/10.1016/j.juro.2007.11.069>.
274. Townsend, M. K., Curhan, G. C., Resnick, N. M., & Grodstein, F. (2010). The incidence of urinary incontinence across Asian, black, and white women in the United States. *American Journal of Obstetrics and Gynecology*, 202(4), 378.e1–7.
<http://doi.org/10.1016/j.ajog.2009.11.021>.
275. Anger, J. T., Saigal, C. S., Litwin, M. S., Urologic Diseases of America Project. (2006). The prevalence of urinary incontinence among community dwelling adult women: results from the National Health and Nutrition Examination Survey. *J Urol*, 175(2), 601–604.
[http://doi.org/10.1016/S0022-5347\(05\)00242-9](http://doi.org/10.1016/S0022-5347(05)00242-9).
276. Kelleher CJ, Cardozo LD, Khullar V, Salvatore S. A new questionnaire to assess the quality of life of urinary incontinent women. *Br J Obstet Gynaecol*. 1997 Dec;104(12):1374-9.
277. Schou J, Poulsen AL, Nordling J. The value of a new symptom score (DAN-PSS) in diagnosing uro-dynamic infravesical obstruction in BPH. *Scand J Urol Nephrol*. 1993;27(4):489-92.
278. Coyne K, Revicki D, Hunt T, Corey R, Stewart W, Bentkover J, Kurth H, Abrams P. Psychometric validation of an overactive bladder symptom and health-related quality of life questionnaire: the OAB-q. *Qual Life Res*. 2002 Sep;11(6):563-74.
279. Shumaker SA, Wyman JF, Uebersax JS, McClish D, Fantl JA. Health-related quality of life measures for women with urinary incontinence: the Incontinence Impact Questionnaire and the Urogenital Distress Inventory. Continence Program in Women (CPW) Research Group. *Qual Life Res*. 1994 Oct;3(5):291-306.
280. Lukacz ES, Lawrence JM, Buckwalter JG, Burchette RJ, Nager CW, Luber KM. Epidemiology of prolapse and incontinence questionnaire: validation of a new epidemiologic survey. *Int Urogynecol J Pelvic Floor Dysfunct*. 2005 Jul-Aug;16(4):272-84.
281. Barber MD, Walters MD, Bump RC. Short forms of two condition-specific quality-of-life questionnaires for women with pelvic floor disorders (PFDI-20 and PFIQ-7). *Am J Obstet Gynecol*. 2005 Jul;193(1):103-13.
282. Coyne, K. S., Margolis, M. K., Kopp, Z. S., & Kaplan, S. A. (2012). Racial Differences in the Prevalence of Overactive Bladder in the United States From the Epidemiology of LUTS (EpiLUTS) Study. *Urology*, 79(1), 95–101.
<http://doi.org/10.1016/j.urology.2011.09.010>.
283. Espuña-Pons, M., Brugulat Guiteras, P., Costa Sampere, D., Medina Bustos, A., & Mompert Penina, A. (2009). [Prevalence of urinary incontinence in Catalonia, Spain]. *Medicina Clínica*, 133(18), 702–705.
<http://doi.org/10.1016/j.medcli.2009.06.013>.
284. Herschorn, S., Gajewski, J., Schulz, J., & Corcos, J. (2007). A population-based study of urinary symptoms and incontinence: the Canadian Urinary Bladder Survey. *BJU International*, 0(0), 071003001542002–???.
<http://doi.org/10.1111/j.1464-410X.2007.07198.x>.
285. Lee, K.-S., Sung, H. H., Na, S., & Choo, M.-S. (2008). Prevalence of urinary incontinence in Korean women: results of a National Health Interview Survey. *World Journal of Urology*, 26(2), 179–185.
<http://doi.org/10.1007/s00345-008-0239-2>.
286. Nygaard, I., Barber, M. D., Burgio, K. L., Kenton, K., Meikle, S., Schaffer, J., et al. (2008). Prevalence of symptomatic pelvic floor disorders in US women. *JAMA : the Journal of the American Medical Association*, 300(11), 1311–1316.
<http://doi.org/10.1001/jama.300.11.1311>.

287. Martínez Agulló, E., Ruiz Cerdá, J. L., Gómez Pérez, L., Ramírez Backhaus, M., Delgado Oliva, F., Rebollo, P., et al. (2009). [Prevalence of urinary incontinence and hyperactive bladder in the Spanish population: results of the EPICC study]. *Actas Urológicas Españolas*, 33(2), 159–166.
288. Bodhare, T. N., Valsangkar, S., & Bele, S. D. (2010). An epidemiological study of urinary incontinence and its impact on quality of life among women aged 35 years and above in a rural area. *Indian Journal of Urology : IJU : Journal of the Urological Society of India*, 26(3), 353–358.
<http://doi.org/10.4103/0970-1591.70566>.
289. Ojengbede, O. A., Morhason-Bello, I. O., Adedokun, B. O., Okonkwo, N. S., & Kolade, C. O. (2011). Prevalence and the associated trigger factors of urinary incontinence among 5000 black women in sub-Saharan Africa: findings from a community survey. *BJU International*, 107(11), 1793–1800.
<http://doi.org/10.1111/j.1464-410X.2010.09758.x>.
290. Ahmadi, B., Alimohammadian, M., Golestan, B., Mahjubi, B., Janani, L., & Mirzaei, R. (2010). The hidden epidemic of urinary incontinence in women: a population-based study with emphasis on preventive strategies. *International Urogynecology Journal*, 21(4), 453–459.
<http://doi.org/10.1007/s00192-009-1031-6>.
291. Liapis, A., Bakas, P., Liapi, S., Sioutis, D., & Creatsas, G. (2010). Epidemiology of female urinary incontinence in the Greek population: EURIG study. *International Urogynecology Journal*, 21(2), 217–222.
<http://doi.org/10.1007/s00192-009-1019-2>.
292. Amaro, J. L., Macharelli, C. A., Yamamoto, H., Kawano, P. R., Padovani, C. V., & Agostinho, A. D. (2009). Prevalence and risk factors for urinary and fecal incontinence in Brazilian women. *International Braz J Urol : Official Journal of the Brazilian Society of Urology*, 35(5), 592–7; discussion 598.
293. López, M., Ortiz, A. P., & Vargas, R. (2009). Prevalence of urinary incontinence and its association with body mass index among women in Puerto Rico. *Journal of Women's Health* (2002), 18(10), 1607–1614.
<http://doi.org/10.1089/jwh.2008.1207>.
294. Correia S, Dinis P, Rolo F, Lunet N. Prevalence, treatment and known risk factors of urinary incontinence and overactive bladder in the non-institutionalized Portuguese population. *Int Urogynecol J Pelvic Floor Dysfunct*. 2009 Dec;20(12):1481-9. doi: 10.1007/s00192-009-0975-x.
295. Slieker-ten Hove, M. C. P., Pool-Goudzwaard, A. L., Eijkemans, M. J. C., Steegers-Theunissen, R. P. M., Burger, C. W., & Vierhout, M. E. (2010). Prevalence of double incontinence, risks and influence on quality of life in a general female population. *Neurourology and Urodynamics*, 29(4), 545–550.
<http://doi.org/10.1002/nau.20760>.
296. Wennberg, A.-L., Molander, U., Fall, M., Edlund, C., Peeker, R., & Milsom, I. (2009b). Lower urinary tract symptoms: lack of change in prevalence and help-seeking behaviour in two population-based surveys of women in 1991 and 2007. *BJU International*, 104(7), 954–959.
<http://doi.org/10.1111/j.1464-410X.2009.08534.x>.
297. Franzén, K., Johansson, J.-E., Andersson, G., Pettersson, N., & Nilsson, K. (2009). Urinary incontinence in women is not exclusively a medical problem: a population-based study on urinary incontinence and general living conditions. *Scandinavian Journal of Urology and Nephrology*, 43(3), 226–232.
<http://doi.org/10.1080/00365590902808566>.
298. Zhu, L., Lang, J., Liu, C., Han, S., Huang, J., & Li, X. (2009). The epidemiological study of women with urinary incontinence and risk factors for stress urinary incontinence in China. *Menopause (New York, N.Y.)*, 16(4), 831–836.
<http://doi.org/10.1097/gme.0b013e3181967b5d>.
299. Lasserre, A., Pelat, C., Guérault, V., Hanslik, T., Chartier-Kastler, E., Blanchon, T., et al. (2009). Urinary Incontinence in French Women: Prevalence, Risk Factors, and Impact on Quality of Life. *European Urology*, 56(1), 177–183.
<http://doi.org/10.1016/j.eururo.2009.04.006>.
300. Onur, R., Deveci, S. E., Rahman, S., Sevindik, F., & Acik, Y. (2009). Prevalence and risk factors of female urinary incontinence in eastern Turkey. *International Journal of Urology : Official Journal of the Japanese Urological Association*, 16(6), 566–569.
<http://doi.org/10.1111/j.1442-2042.2009.02311.x>.

301. Zumrutbas, A. E., Bozkurt, A. I., Tas, E., Acar, C. I., Alkis, O., Coban, K., et al. (2014). Prevalence of lower urinary tract symptoms, overactive bladder and urinary incontinence in western Turkey: Results of a population-based survey. *International Journal of Urology : Official Journal of the Japanese Urological Association*, n/a–n/a. <http://doi.org/10.1111/iju.12519>.
302. Liu, B., Wang, L., Huang, S.-S., Wu, Q., & Wu, D.-L. (2014). Prevalence and risk factors of urinary incontinence among Chinese women in Shanghai. *International Journal of Clinical and Experimental Medicine*, 7(3), 686–696.
303. Osuga, Y., Okamura, K., Ando, F., & Shimokata, H. (2013). Prevalence of lower urinary tract symptoms in middle-aged and elderly Japanese. *Geriatrics & Gerontology International*, 13(4), 1010–1017. <http://doi.org/10.1111/ggi.12048>.
304. Horng, S. S., Huang, N., Wu, S. I., Fang, Y. T., Chou, Y. J., & Chou, P. (2013). The epidemiology of urinary incontinence and its influence on quality of life in Taiwanese middle-aged women. *Neurourology and Urodynamics*, 32(4), 371–376. <http://doi.org/10.1002/nau.22302>.
305. Brito, L. G. O., Brito, L. M. O., da Costa Chein, M. B., de Andrade Malheiros, E. S., Duarte, T. B., & Pinto-Neto, A. M. (2012). Stress urinary incontinence in climacteric women in a north-eastern Brazilian municipality: a household survey. *International Urogynecology Journal*, 23(5), 639–645. <http://doi.org/10.1007/s00192-012-1697-z>.
306. Hägglund, D., Walker-Engström, M.-L., Larsson, G., & Leppert, J. (2004). Changes in urinary incontinence and quality of life after four years. A population-based study of women aged 22–50 years. *Scandinavian Journal of Primary Health Care*, 22(2), 112–117.
307. Wehrberger, C., Temml, C., Ponholzer, A., & Madersbacher, S. (2006). Incidence and remission of female urinary incontinence over 6.5 years: analysis of a health screening project. *European Urology*, 50(2), 327–332. <http://doi.org/10.1016/j.eururo.2006.02.010>.
308. McGrother, C. W., Donaldson, M. M. K., Shaw, C., Matthews, R. J., Hayward, T. A., Dallosso, H. M., et al. (2004). Storage symptoms of the bladder: prevalence, incidence and need for services in the UK. *BJU International*, 93(6), 763–769. <http://doi.org/10.1111/j.1464-410X.2003.04721.x>.
309. Donaldson, M. M. K., Thompson, J. R., Matthews, R. J., Dallosso, H. M., McGrother, C. W., Leicestershire MRC Incontinence Study Group. (2006). The natural history of overactive bladder and stress urinary incontinence in older women in the community: a 3-year prospective cohort study. *Neurourology and Urodynamics*, 25(7), 709–716. <http://doi.org/10.1002/nau.20235>.
310. Liu, C., & Andrews, G. R. (2002). Prevalence and incidence of urinary incontinence in the elderly: a longitudinal study in South Australia. *Chinese Medical Journal*, 115(1), 119–122.
311. Møller, L. A., Lose, G., & Jørgensen, T. (2000). Incidence and remission rates of lower urinary tract symptoms at one year in women aged 40–60: longitudinal study. *BMJ (Clinical Research Ed.)*, 320(7247), 1429–1432.
312. Moore EE, Jackson SL, Boyko EJ, Scholes D, Fihn SD. Urinary incontinence and urinary tract infection: temporal relationships in postmenopausal women. *Obstet Gynecol*. 2008 Feb;111(2 Pt 1):317-23. doi: 10.1097/AOG.0b013e318160d64a.
313. Nygaard, I. E., & Lemke, J. H. (1996). Urinary incontinence in rural older women: prevalence, incidence and remission. *Journal of the American Geriatrics Society*, 44(9), 1049–1054.
314. Gavira Iglesias F, Caridad Y Ocerín JM, Guerrero Muñoz JB, López Pérez M, Romero López M, Pavón Aranguren MV. 74. [Five-year follow-up of urinary incontinence in older people in a Spanish rural population]. *Aten Primaria*. 2005 Feb 15;35(2): 67-74.
315. Burgio, K. L., Matthews, K. A., & Engel, B. T. (1991). Prevalence, incidence and correlates of urinary incontinence in healthy, middle-aged women. *The Journal of Urology*, 146(5), 1255–1259.
316. Legendre, G., Ringa, V., Panjo, H., Zins, M., & Fritel, X. (2014). Incidence and remission of urinary incontinence at midlife: a cohort study. *BJOG: an International Journal of Obstetrics & Gynaecology*, 122(6), 816–824. <http://doi.org/10.1111/1471-0528.12990>.
317. Chaliha, C., Kalia, V., Stanton, S. L., Monga, A., & Sultan, A. H. (1999). Antenatal prediction of postpartum urinary and fecal incontinence. *Obstetrics and Gynecology*, 94(5 Pt 1), 689–694.

318. Eftekhar, T., Hajibaratali, B., Ramezanzadeh, F., & Shariat, M. (2006). Postpartum evaluation of stress urinary incontinence among primiparas. *International Journal of Gynaecology and Obstetrics: the Official Organ of the International Federation of Gynaecology and Obstetrics*, 94(2), 114–118. <http://doi.org/10.1016/j.ijgo.2006.04.042>.
319. Ekström, A., Altman, D., Wiklund, I., Larsson, C., & Andolf, E. (2008). Planned cesarean section versus planned vaginal delivery: comparison of lower urinary tract symptoms. *International Urogynecology Journal and Pelvic Floor Dysfunction*, 19(4), 459–465. <http://doi.org/10.1007/s00192-007-0461-2>.
320. Groutz, A., Rimon, E., Peled, S., Gold, R., Pautzner, D., Lessing, J. B., & Gordon, D. (2004). Cesarean section: does it really prevent the development of postpartum stress urinary incontinence? A prospective study of 363 women one year after their first delivery. *Neurourology and Urodynamics*, 23(1), 2–6. <http://doi.org/10.1002/nau.10166>.
321. Schytt, E., Lindmark, G., & Waldenström, U. (2005). Physical symptoms after childbirth: prevalence and associations with self-rated health. *BJOG: an International Journal of Obstetrics & Gynaecology*, 112(2), 210–217. <http://doi.org/10.1111/j.1471-0528.2004.00319.x>.
322. Huang, A. J., Brown, J. S., Kanaya, A. M., Creasman, J. M., Ragins, A. I., Van Den Eeden, S. K., & Thom, D. H. (2006). Quality-of-life impact and treatment of urinary incontinence in ethnically diverse older women. *Archives of Internal Medicine*, 166(18), 2000–2006. <http://doi.org/10.1001/archinte.166.18.2000>.
323. Kraus, S. R., Markland, A., Chai, T. C., Stoddard, A., FitzGerald, M. P., Leng, W., et al. (2007). Race and ethnicity do not contribute to differences in preoperative urinary incontinence severity or symptom bother in women who undergo stress incontinence surgery. *American Journal of Obstetrics and Gynecology*, 197(1), 92.e1–6. <http://doi.org/10.1016/j.ajog.2007.03.072>.
324. Saadoun, K., Ringa, V., Fritel, X., Varnoux, N., Zins, M., & Bréart, G. (2006). Negative impact of urinary incontinence on quality of life, a cross-sectional study among women aged 49–61 years enrolled in the GAZEL cohort. *Neurourology and Urodynamics*, 25(7), 696–702. <http://doi.org/10.1002/nau.20245>.
325. Roe, B., & Doll, H. (1999). Lifestyle factors and continence status: comparison of self-report data from a postal survey in England. *Journal of Wound, Ostomy, and Continence Nursing : Official Publication of the Wound, Ostomy and Continence Nurses Society / WOCN*, 26(6), 312–3, 315–9.
326. Fultz, N. H., Herzog, A. R., Raghunathan, T. E., Wallace, R. B., & Diokno, A. C. (1999). Prevalence and severity of urinary incontinence in older African American and Caucasian women. *The Journals of Gerontology. Series a, Biological Sciences and Medical Sciences*, 54(6), M299–303.
327. Dooley, Y., Kenton, K., Cao, G., Luke, A., Durazo-Arvizu, R., Kramer, H., & Brubaker, L. (2008). Urinary incontinence prevalence: results from the National Health and Nutrition Examination Survey. *The Journal of Urology*, 179(2), 656–661. <http://doi.org/10.1016/j.juro.2007.09.081>.
328. Thom, D. H., Van Den Eeden, S. K., Ragins, A. I., Wassel-Fyr, C., Vittinghof, E., Subak, L. L., & Brown, J. S. (2006). Differences in prevalence of urinary incontinence by race/ethnicity. *J Urol*, 175(1), 259–264. [http://doi.org/10.1016/S0022-5347\(05\)00039-X](http://doi.org/10.1016/S0022-5347(05)00039-X).
329. Shamlivan TA, Wyman JF, Ping R, Wilt TJ, Kane RL. Male urinary incontinence: prevalence, risk factors, and preventive interventions. *Rev Urol* 2009 Summer ; 11(3): 145-65.
330. Koyama W, Koyanagi A, Mihara S, Kawazu S, Uemura T, Nakano H et al. : Prevalence and conditions of urinary incontinence among the elderly. *Methods Inf Med* 1998; 37: 151.
331. Correia S, Dinis P, Rolo F, Lunet N. Prevalence, treatment and known risk factors of urinary incontinence and overactive bladder in the non-institutionalized Portuguese population. *International Urogynecology Journal* 2009; 20(12):1481-9.
332. Ueda T, Tamaki M, Kageyama S, Yoshimura N, and Yoshida O. : Urinary incontinence among community-dwelling people aged 40 years or older in Japan: prevalence, risk factors, knowledge and self-perception. *Int J Urol*. 2000;7: 95.
333. Diokno AC, Estanol MVC, Ibrahim IA, and Balasubramanian M. Prevalence of urinary incontinence in community dwelling men : a cross sectional nationwide epidemiology survey. *Int Urol Nephrol* 39: 129-36, 2007.

334. Maral I, Ozkardes H, Peskircioglu L, and Bumin MA. : Prevalence of stress urinary incontinence in both sexes at or after age 15 years: a cross-sectional study. *J Urol.* 2001; 165: 408.
335. Damian J., Martin-Moreno, J.M., Lobo F., Bonache J., Cervino J., Redondo-Marquez, L., et al.: Prevalence of urinary incontinence among Spanish older people living at home. *Eur. Urol.* 1998; 34: 333.
336. Sladden MJ, Hughes AM, Hirst GH, and Ward JE.: A community study of lower urinary tract symptoms in older men in Sydney, Australia. *Aust N.Z. J. Surg.* 70: 322, 2000.
337. Zumrutbas AE, Bozkurt AI, Tas E, Acar CI, Alkis O, Coban K, Cetinel B, Aybek Z. Prevalence of lower urinary tract symptoms, overactive bladder and urinary incontinence in western Turkey: results of a population-based survey. *International Journal of Urology* 2014; 21(10):1027-33.
338. Yoshimura K, Nakayama T, Sekine A, Matsuda F, Kosugi S, Sugino Y, Yoshimura K, Ogawa O, Nagahama Cohort Research Group. Prevalence of postmicturition urinary incontinence in Japanese men: comparison with other types of incontinence. *International Journal of Urology* 2013 20(9):911-6.
339. Boyle P, Boyle P, Robertson C, Mazzetta C, Keech M, Hobbs FD, Fourcade R, Kiemeny L, Lee C; The UrEpik Study Group. : The prevalence of male urinary incontinence in four centres: the UREPIK study. *BJU Int* 2003; 92 : 943.
340. Markland AD, Goode PS, Redden DT, Borrud LG, Burgio KL. Prevalence of urinary incontinence in men: results from the national health and nutrition examination survey. *J Urol* 2010 Sep; 184(3):1022-7.
341. McGrother CW, Donaldson MM, Shaw C, Matthews RJ, Hayward TA, Dallosso HM, Jagger C, Clarke M, Castleden CM; MRC Incontinence Study Team. Storage symptoms of the bladder: prevalence, incidence and need for services in the UK. *BJU Int.* 2004 Apr;93(6):763-9.
342. Malmsten UG, Milsom I, Molander U, and Norden L.J.: Urinary incontinence and lower urinary tract symptoms: an epidemiological study of men aged 45-99 years. *J Urol.*1997; 158: 1733.
343. Malmsten UG, Molander U, Peeker R, Irwin DE, Milsom I. Urinary incontinence, overactive bladder, and other lower urinary tract symptoms: a longitudinal population-based survey in men aged 45-103 years.*Eur Urol* 2010 Jul 58(1): 149-56.
344. Landi F, Cesari M, Russo A, Onder G, Lattasio F, Bernabe R, Silvernet-HC Study group. Potentially reversible risk factors and urinary incontinence in frail older people living in community. *Age and Ageing* 2003; 32: 194-9.
345. Muscatello DJ, Rissel C, and Szonyi G. Urinary symptoms and incontinence in an urban community prevalence and associated factors in older men and women. *Int Med J* 31:151-160, 2001.
346. Nelson RL, and Furner SE. Risk factors for the development of fecal and urinary incontinence in Winconsin nursing home residents. *Maturitas* 2005; 52: 26-31.
347. Correia S, Dinis P, Rolo F, Lunet N. Prevalence, treatment and known risk factors of urinary incontinence and overactive bladder in the non-institutionalized Portuguese population. *International Urogynecology Journal.* 2009; 20(12):1481-9.
348. Wang Y, Hu H, Xu K, Wang X, Na Y, Kang X. Prevalence, risk factors and the bother of lower urinary tract symptoms in China: a population-based survey. *International Urogynecology Journal.* 26(6):911-9, 2015 Jun.
349. Wu JM, Matthews CA, Vaughan CP, Markland AD. Urinary, fecal, and dual incontinence in older U.S. Adults. *Journal of the American Geriatrics Society* 2015; 63(5):947-53.
350. Diokno, A.C., Brock, B.M., Brown, M.B., and Herzog, R. : Prevalence of urinary incontinence and other urological symptoms in the non-institutionalized elderly. *J. Urol.* 1986; 136: 1022.
351. Hunskaar S.: One hundred and fifty men with urinary incontinence. I. Demography and medical history. *Scan. J. Prim. Health Care* 1992;10: 21.
352. Umlauf MG, AND Sherman SM.: Symptoms of urinary incontinence among older community-dwelling men.*J Wound Ostomy Continence Nurs* 1996; 23: 314.
353. Finkelstein MM. Medical conditions, medications and urinary incontinence. Analysis of a population-based survey. *Can Fam Physician* 2001; 48:96-101.
354. Kikuchi A, Niu K, Ikeda Y, Hozawa A, Nakagawa H, Guo H, Ohmori-Marsuda K, et al. Association between physical activity and urinary incontinence in a community-based elderly population aged 70 years and over. *Eur Urol* 2007; 52: 868-75.
355. Resnick NM and Yalla SV.: Detrusor hyperactivity with impaired contractile function : an unrecognized but common cause of incontinence in elderly patients. *JAMA* 1987; 257: 3076.

356. Jorgensen L, Engstad T, Jaconsen BK. Self-reported urinary incontinence in non-institutionalized long-term stroke survivors : A population-based study. *Arch Phys Med Rehabil.* 2005 Mar;86(3):416-20.
357. Patel VR, Sivaraman A, Coelho RF, et al. Pentafecta: a new concept for reporting outcomes of robot-assisted laparoscopic radical prostatectomy. *Eur Urol* 2011;59:702–7.
358. van Melick HH, van Venrooij GE, Eckhardt MD, and Boon TA.: A randomized controlled trial comparing transurethral resection of the prostate, contact laser prostatectomy and electrovaporization in men with benign prostatic hyperplasia: analysis of subjective changes, morbidity and mortality. *J Urol.*, 169: 1411, 2003.
359. Hu JC, Gold KF, Pashos CL, Mehta SS, and Litwin MS.: Temporal trends in radical prostatectomy complications from 1991 to 1998. *J Urol*, 169: 1443, 2003.
360. Olsson LE, Salomon L, Nadu A, Hoznek A, Cicco A, Saint F, Chopin D, and Abbou CC. : Prospective patient-reported continence after laparoscopic radical prostatectomy. *Urology* 2001; 58: 570.
361. McKammon KA, Kolm P, Main B, and Schellhammer PF: Comparative quality of life analysis after radical retropubic prostatectomy: objective and subjective analysis. *Urology*, 49: 225, 1997.
362. Donnellan SM, Duncan HJ., MacGregor RJ., and Russel, JM. : Prospective assessment of incontinence after radical retropubic prostatectomy: objective and subjective analysis. *Urology* 49: 225, 1997.
363. Ojebey G, Claezon A, Brekkan E, Haggman M, and Norlen BJ: Urinary incontinence and sexual impotence after radical prostatectomy. *Scand. J. Urol. Nephrol.*, 30: 473, 1996.
364. Kuehhas FE, Naegele R, Eckersberger E, Margreiter M, Herwig R, Kazzazi A, Djavan B. Urinary continence after radical prostatectomy: the patient perspective. *Can J Urol.* 2011 Aug;18(4):5811-8.
365. Lee SR, Kim HW, Lee JW, Jeong WJ, Rha KH, Kim JH. Discrepancies in perception of urinary incontinence between patient and physician after robotic radical prostatectomy. *Yonsei Med J* 2010; 51(6) : 883-887.
366. Lowe BA. : Comparison of bladder neck preservation to bladder neck resection in maintaining postprostatectomy urinary incontinence. *Urology* 1996; 48: 889.
367. Weldon VE, Tavel FR, and Neuwirth H. : Continence, potency and morbidity after radical perineal prostatectomy. *J Urol.*, 158: 1470, 1997.
368. Goluboff ET, Saidi JA, Mazer S, Bagiella E, Heitjan DF, Benson MC. Et. Al.: Urinary continence after radical prostatectomy: The Columbia experience. *J. Urol.* 1998;159: 1276.
369. Horie S, Tobisu KI, Fujimoto H, Doi N. and Kakizoe T.: Urinary incontinence after non-nervesparing radical prostatectomy with neoadjuvant androgen deprivation. *Urology*, 1999; 53: 561.
370. Walsh PC, Marschke P, Ricker D and Burnett AL.: Patient-reported urinary continence and sexual function after anatomic radical prostatectomy. *Urology* 2000; 55: 58.
371. Moinzadeh A, Shunaigat AN, and Libertino JA.: Urinary incontinence after radical retropubic prostatectomy: the outcome of a surgical technique. *BJU Int* 2003; 92: 355.
372. Saranchuk JW, Kattan MW, Elkin E, Taurier K, Scardino PT, and Eastham, JA. Achieving optimal outcomes after radical prostatectomy. *J Clin Oncol* 23 (18) : 4146-51, June 2005.
373. Penson DF, McLerran D, Feng Z, Li L, Albertsen PC, Gilliland FD, et al., 5-year urinary and sexual outcomes after radical prostatectomy: results from the Prostate Cancer Outcomes Study. *J Urol.* 2008 May;179(5 Suppl):S40-4.
374. Gray M, Petroni GR, and Theodorescu D.: Urinary function after radical prostatectomy: a comparison of the retropubic and perineal approaches. *Urology*, 53: 881, 1999.
375. Bishoff JT, Motley G., Optenberg SA, Stein CR, Moon KA, Browning SM. Et al.: Incidence of fecal and urinary incontinence following radical perineal and retropubic prostatectomy in a national population. *J. Urol.*, 160: 454, 1998.
376. Wei JT, Dunn RL, Marcovich R, Montie JE, and Sanda MG.: Prospective assessment of patient reported urinary continence after radical prostatectomy. *J Urol.*, 164: 744, 2000.
377. Eastham JA, Kattan MW, Rogers E, Goan JR, Ohoi M, Boone TB, and Scardino PT.: Risk factors for urinary incontinence after radical prostatectomy. *J Urol.*, 156: 1707, 1996.
378. Van Kampen M, De Weerd W, Van Poppel H, Castell Campesino A., Stragier J. and Baert, L.: Prediction of urinary continence following radical prostatectomy. *Urol. Int.*, 60: 80, 1998.

379. Nandipati KC, Raina R, Agarwal A, Zippe CD. Nerve-sparing surgery significantly affects long-term continence after radical prostatectomy. *Urology*. 2007 Dec;70(6):1127-30.
380. Srougi M, Nesrallah LJ, Kauffmann JR, Nesrallah A, and Leite KR.: Urinary continence and pathological outcome after bladder neck preservation during radical retropubic prostatectomy: a randomized prospective trial. *J Urol.*, 165: 815, 2001.
381. Poon M, Ruckle H, Bamshad DBR, Rsai C, Webster R, and Lui P.: Radical retropubic prostatectomy : bladder neck preservation versus reconstruction. *J. Urol.* 2000, 163: 194.
382. Noh C, Kshirsagar A, and Mohler JL.: Outcomes after radical retropubic prostatectomy. *Urology*, 61: 412, 2003.
383. Gaker DL, Gaker LB, Stewart JF et al: Radical prostatectomy with preservation of urinary continence. *J Urol* 1996; 156: 445.
384. Deliveliotis C, Protogerou V, Alargof E, and Varkarakis J.: Radical prostatectomy: bladder neck preservation and puboprostatic ligament sparing--effects on continence and positive margins.
385. Walsh PC, Marschke P, Ricker D and Burnett AL.: Patient-reported urinary continence and sexual function after anatomic radical prostatectomy. *Urology* 2000; 55: 58.
386. Berry T, Tepera C, Staneck D, Barone B, Lance R, Fabrizio M, Given R. Is there correlation of nerve-sparing status and return to baseline urinary function after robot-assisted laparoscopic radical prostatectomy? *J Endourol.* 2009 Mar;23(3):489-93.
387. Peterson AC, Chen Y. Patient reported incontinence after radical prostatectomy is more common than expected and not associated with the nerve sparing technique: results from the Center for Prostate Disease Research (CPDR) database. *Neurourology & Urodynamics* 2012; 31(1):60-3.
388. Romero Otero J, Martínez-Salamanca JI. Critical comparative analysis between open, laparoscopic and robotic radical prostatectomy: urinary continence and sexual function. *Arch Esp Urol.* 2007 Sep;60(7):767-76.
389. Parsons JK, Bennett JL. Outcomes of retropubic, laparoscopic, and robotic-assisted prostatectomy. *Urology*. 2008 Aug;72(2):412-6. Epub 2008 Feb 11.
390. Ficarra V, Novara G, Artibani W, Cestari A, Galfano A, Graefen M, et al. Retropubic, laparoscopic, and robot-assisted radical prostatectomy: a systematic review and cumulative analysis of comparative studies. *Eur Urol.* 2009 May;55(5):1037-63. Epub 2009 Jan 25.
391. Gray M, Petroni GR, and Theodorescu D.: Urinary function after radical prostatectomy: a comparison of the retropubic and perineal approaches. *Urology* 1999; 53: 881.
392. Van Kampen M, De Weerd W, Van Poppel H, Castell Campesino A., Stragier J. and Baert, L.: Prediction of urinary continence following radical prostatectomy. *Urol. Int.*, 60: 80, 1998.
393. Kundu SD, Roehl KA, Eggender SE, Antenor JV, Han M and Catalona WJ. Potency, continence and complications in 3477 consecutive radical retropubic prostatectomies. *J Urol* 2004;172: 2227-2231.
394. Wolin KY, Luly J, Sutcliffe S, Andriole GL, Kibel AS. Risk of urinary incontinence following prostatectomy: the role of physical activity and obesity. *J Urol.* 2010 Feb;183(2):629-33. Epub 2009 Dec 16.
395. Yang BS, Ye DW, Peng JY, Yao XD, Zhang SL, Dai B, et al Analysis of risk factors for urinary continence after radical prostatectomy. *Zhonghua Yi Xue Za Zhi.* 2011 Aug 30;91(32):2239-42.
396. Moore KN, Truong V, Estey E, Voaklander DC. Urinary incontinence after radical prostatectomy: can men at risk be identified preoperatively? *J Wound Ostomy Continence Nurs.* 2007 May-Jun;34(3):270-9.
397. Novara G, Ficarra V, D'elia C, Secco S, Cioffi A, Cavalleri S, Artibani W. Evaluating urinary continence and preoperative predictors of urinary continence after robot assisted laparoscopic radical prostatectomy. *J Urol.* 2010 Sep;184(3):1028-33.
398. Nilsson AE, Schumacher MC, Johansson E, Carlsson S, Stranne J, Nyberg T, Wiklund NP, Steineck G. Age at surgery, educational level and long-term urinary incontinence after radical prostatectomy. *BJU International* 2011; 108: 1572–1577.
399. Catalona WJ, Carvalhal GF, Mager DE, and Smith DS.: Potency, continence and complication rates in 19870 consecutive radical retropubic prostatectomies. *J. Urol.* 1999; 162: 433.
400. Donnellan SM, Duncan HJ., MacGregor RJ., and Russel, JM. : Prospective assessment of incontinence after radical retropubic prostatectomy: objective and subjective analysis. *Urology* 49: 225, 1997.

401. Kao TC., Garner D., Foley J., Seay T., Friedrichs P., Thrasher JB., et al : Multicenter patient self-reporting questionnaire on impotence, incontinence and stricture after radical prostatectomy. *J. Urol.*, 163: 858, 2000.
402. Horie S, Tobisu KI, Fujimoto H, Doi N. and Kakizoe T.: Urinary incontinence after non-nervesparing radical prostatectomy with neoadjuvant androgen deprivation. *Urology*, 1999; 53: 561.
403. Majoros A, Bach D, Keszthelyi A, Hamvas A, Mayer P, Riesz P. Analysis of risk factors for urinary incontinence after radical prostatectomy. *Urol Int*. 2007;78(3):202-7.
404. Konety BR, Sadetsky N, Carroll PR et al: Recovery of urinary continence following radical prostatectomy: the impact of prostate volume—analysis of data from the CaPSURE database. *J Urol* 2007; 177: 1423.
405. Moul JW, Mooneyhan RM, Kao TC, McLeod DG, and Cruess DF.: Preoperative and operative factors to predict incontinence, impotence and stricture after radical prostatectomy. *Prostate Cancer Prostatic Dis*. 998; 1: 242.
406. Johnson TK, Gilliland FD, Hoffman RM, Deapen D, Penson DF, Stanforn J>, e tal. Racial/ethnic differences in functional outcomes in the 5 years after diagnosis of localized prostate cancer. *J Clin Oncol* 22(20) : 4193-4201, Oct 2004.
407. Formenti SC, Lieskovsky G, Skinner D, Tsao-Wei DD, Groshen S, and Petrovich Z.: Update on impact of moderate dose of adjuvant radiation on urinary continence and sexual potency in prostate cancer patients treated with nerve-sparing prostatectomy. *Urology*, 56: 453, 2000.
408. Hofmann T, Gaensheimer S, Buchner a, Rohloff R, Schilling A. An unrandomized prospective comparison of urinary continence, bowel symptoms and the need for further procedures in patients with and with no adjuvant radiation after radical prostatectomy. *BJU Int* 2003; 92 (4) : 360-4.
409. Janssen I. Morbidity and mortality risk associated with an overweight BMI in older women and men. *Obesity* 17: 1827-80, 2007.
410. Muscatello DJ, Rissel C, and Szonyi G. Urinary symptoms and incontinence in an urban community prevalence and associated factors in older men and women. *Int Med J* 31:151-160, 2001.
411. Kim TH, Han DH, Lee K-S. The Prevalence of Lower Urinary Tract Symptoms in Korean Men Aged 40 Years or Older: A Population-Based Survey. *Int Neurourol J* 2014;18:126-132.
412. Lee YS, Lee KS, Jung JH, Han DH, Oh SJ, Seo JT, Lee JG, Park HS, Choo MS Prevalence of overactive bladder, urinary incontinence, and lower urinary tract symptoms: results of Korean EPIC study. *World J Urol* 2011 Apr; 29(2): 185-90.
413. Markland AD, Richter HE, Fwu CW, Eggers P, Kusek JW. Prevalence and trends of urinary incontinence in adults in the United States,2001 to 2008. *J Urol* 2011 Aug; 186(2): 589-93.
414. de Souza Santos CR, Santos VL. Prevalence of urinary incontinence in a random sample of the urban population of Pouso Alegre, Minas Gerais, Brazil. *Rev Lat Am Enfermagem*. 2010 Sep-Oct;18(5):903-10.
415. Correia S, Dinis P, Rolo F, Lunet N. Prevalence, treatment and known risk factors of urinary incontinence and overactive bladder in the non-institutionalized Portuguese population. *International Urogynecology Journal* 2009; 20(12):1481-9.
416. Espuña-Pons M, Brugulat Guiteras P, Costa Sampere D, Medina Bustos A, Mompar. Prevalence of urinary incontinence in Catalonia, Spain. *Penina A. Med Clin (Barc)*. 2009 Nov 14;133(18):702-5.
417. Irwin DE, Milsom I, Hunskaar S, Reilly K, Kopp Z, Herschorn S, et al., Population-based survey of urinary incontinence, overactive bladder and other lower urinary tract symptoms in five countries : Results of the EPIC study. *Eur Urol* 2006; 50: 1306-15.
418. Brocklehurst JC. Urinary incontinence in the community – analysis of a MORI poll. *BMJ* 1993; 306: 832-4.
419. Engstrom G, Walker-Engstrom ML, Loof L, Leppert J. : Prevalence of three lower urinary tract symptoms in men - a population-based study. *Fam Pract*, 20 : 7, 2003.
420. Parrazzini F, Lavezzari M, and Artibani W. Prevalence of overactive bladder and urinary incontinence. *J Fam Pract* 5:1072-4, 2002.
421. Smoger SH, Felice TL, and Kloecker GH. : Urinary incontinence among male veterans receiving care in primary care clinics. *Ann Intern Med*. 2000; 132: 547.
422. Roberts RO, Jacobsen SJ, Reilly WT, Pemberton JH, Lieber MM, and Talley NJ.: Prevalence of combined fecal and urinary incontinence: a community-based study. *J Am Geriatr Soc*.1999; 47: 837.

423. Roberts RO, Jacobsen SJ, Rhodes T, Reilly WT, Girman CJ, Talley NJ, and Lieber MM. : Urinary incontinence in a community-based cohort: prevalence and healthcare-seeking. *J Am Geriatr Soc* 1998; 46: 467.
424. Schulman C, Claesm H, and Mattijs J: Urinary incontinence in Belgium: a population-based epidemiological survey. *Eur. Urol.*1997; 32: 315.
425. Lagace EA, Hansen W, and Hickner JM. Prevalence and severity of urinary incontinence in ambulatory adults : an UPRNet study. *J fam Pract* 1993; 36(6): 610-5.
426. O'Brien J, Austin M, Sethi P, and O'Boyle P : Urinary incontinence : prevalence , need for treatment, and effectiveness of intervention by nurse. *BMJ* 1991;303: 1308-12.
427. Vasilopoulos T, Kotwal A, Huisingh-Scheetz MJ, Waite LJ, McClintock MK, Dale W. Comorbidity and chronic conditions in the National Social Life, Health and Aging Project (NSHAP), Wave 2. *Journals of Gerontology Series B-Psychological Sciences & Social Sciences.* 2014; 69 Suppl 2:S154-65.
428. Ramage-Morin PL, Gilmour H. Urinary incontinence and loneliness in Canadian seniors. *Health Reports.* 24(10):3-10, 2013 Oct.
429. Wehrberger C, Madersbacher S, Jungwirth S, Fischer P, Tragl KH. Lower urinary tract symptoms and urinary incontinence in a geriatric cohort - a population-based analysis. *BJU International* 2012; 110(10):1516-21.
430. Correia PW, Cumming RG, Chan L, Seibel MJ, Naganathan V, Creasey H, Le Couteur D, Waite LM, Sambrook PN, Handelsman D. Urinary incontinence and quality of life among older community-dwelling Australian men: the CHAMP study. *Age Ageing.* 2010 May;39(3):349-54.
431. Smith AL, Wang PC, Anger JT, Mangione CM, Trejo L, Rodríguez LV, Sarkisian CA. Correlates of urinary incontinence in community-dwelling older Latinos. *J Am Geriatr Soc* 2010 Jun; 58(6):1170-6.
432. Yu PL, Shi J, Liu XR, Xia CW, Liu DF, Wu ZL, Sun ZQ. *Zhonghua Liu Xing Bing Xue Za Zhi.* 2009 Aug;30(8):766-71.
433. Dios-Diz JM, Rodriguez-Lama M, Martinez-Calvo JR, Rodriguez-Perez C, Melero-Brezo M, Garcia-Cepeda JR. : [Prevalence of urinary incontinence in the population aged more than 64 years in Galicia, Spain]. *Gac Sanit* 2003; 17 : 409.
434. Stoddart H, Donovan J, Whitley E, Sharp D, and Harvey I. : Urinary incontinence in older people in the community: a neglected problem? *Br J Gen Pract.* 2001; 51: 548.
435. Aggazzotti G, Pesce F, Grassi D, Fantuzzi G, Righi E, De Vita D, Santacroce S., and Artibani W.: Prevalence of urinary incontinence among institutionalized patients: a cross-sectional epidemiologic study in a midsized city in northern Italy. *Urology,* 56: 245, 2000.
436. Gavira Iglesias FJ, Caridad y Ocerin JM, Perez del Molino Martin J, Valderrama Gama E, Lopez Perez M, Romero Lopez M, et al. : Prevalence and psychosocial impact of urinary incontinence in older people of a Spanish rural population. *J Gerontol A Biol Sci Med Sci.* 2000; 55 : M207.
437. Marriapan P and Chong WL. Prevalence and correlations of lower urinary tract symptoms, erectile dysfunction and incontinence in men from a multiethnic Asian population : results of a regional population-based survey and comparison with industrialized nations. *BJU Int* 98: 1264-8, 2006.
438. Finkelstein MM. Medical conditions, medications and urinary incontinence. Analysis of a population-based survey. *Can Fam Physician* 2001; 48:96-101.
439. Temml, C., Haidinger, G., Schmidbauer, J., Schatzl, G., and Madersbacher, S.: Urinary incontinence in both sexes: Prevalence rates and impact on quality of life and sexual life. *NeuroUrol. Urodyn.* 2000; 19: 259.
440. O'Brien J, Austin M, Sethi P, and O'Boyle P : Urinary incontinence : prevalence , need for treatment, and effectiveness of intervention by nurse. *BMJ* 1991;303: 1308-12.
441. Yarnell JW, and St Lege AS.: The prevalence, severity and factors associated with urinary incontinence in a random sample of the elderly. *Age Ageing* 1979; 8: 81.
442. Chaojie L, and Andrews GR. Prevalence and incidence of urinary incontinence in the elderly : a longitudinal study in South Australia. *Chinese Med J* 2002; 115(1) : 119-22.
443. Gavin AT, Drummond FJ, Connelly C, O'Leary E, Sharp L, Kinnear HR. Patient reported 'ever had' and 'current' long-term physical symptoms after prostate cancer treatments. *BJU Int* 2015; 116:397-406.
444. Kopp RP, Marshall LM, Wang PY, Bauer DC, Barrett-Connor E, Parsons JK, Osteoporotic Fractures in Men MrOS Research Group. The burden of urinary incontinence and urinary bother among elderly prostate cancer survivors. *European Urology.* 2013; 64(4):672-9.

445. Resnick MJ, Koyama T, Fan KH, Albertsen PC, Goodman M, Hamilton AS, Hoffman RM, Potosky AL, Stanford JL, Stroup AM, Van Horn RL, Penson DF. Long-term functional outcomes after treatment for localized prostate cancer. *New England Journal of Medicine* 2013; 368(5):436-45.
446. Peterson AC, Chen Y. Patient reported incontinence after radical prostatectomy is more common than expected and not associated with the nerve sparing technique: Results from the Center for Prostate Disease Research database. *Neurourol Urodyn.* 2012 Jan;31(1):60-3.
447. Wolin KY, Luly J, Sutcliffe S, Andriole GL, Kibel AS. Risk of urinary incontinence following prostatectomy: the role of physical activity and obesity. *J Urol.* 2010 Feb;183(2):629-33. Epub 2009 Dec 16.
448. Augustin H, Pummer K, Daghofer F, Habermann H, Primus G, and Hubmer G. : Patient self-reporting questionnaire on urological morbidity and bother after radical retropubic prostatectomy. *Eur Urol.* 2002; 42: 112.
449. Sebesta M, Cespedes RD, Luhman E, Optenberg S, and Thompson IM.: Questionnaire-based outcomes of urinary incontinence and satisfaction rates after radical prostatectomy in a national study population. *Urology* 2002; 60: 1055.
450. Potosky, A.L., Legler, J., Albertsen, P.C., Stanford, J.L., Gilliland, F.D., Hamilton, A.S., Eley, J.W., Stephenson, R.A., Harlan, L.C.: Health outcomes after prostatectomy or radiotherapy for prostate cancer : results from the Prostate Cancer Outcomes Study. *J Natl Cancer Inst,* 2000; 92: 1582.
451. Arai Y, Okubo K, Aoki Y, Maekawa S, Okada T, Maeda H, Ogawa O, and Kato T. : Patient-reported quality of life after radical prostatectomy for prostate cancer. *Int J Urol.* 1999; 6: 78.
452. Egawa S, Minei S, Iwamura M, Uchida T, and Koshiba K. : Urinary continence following radical prostatectomy. *Jpn J Clin Oncol.* 1997; 27: 71.
453. Demirkesen O, Onal B, Tunc B, Alici B, Onder AU, Ozalp AU, Cetinel B.. Assessment of the continence status and patients' satisfaction after retropubic radical prostatectomy: a questionnaire based study. *Int Urol Nephrol.* 2007; 39(2):531-6.
454. Kundu SD, Roehl KA, Eggender SE, Antenor JV, Han M and Catalona WJ. Potency, continence and complications in 3477 consecutive radical retropubic prostatectomies. *J Urol* 2004;172: 2227-2231.
455. Salomon L, Saint F, Anastasiadis AG, Sebe P, Chopin D, Abbou CC.: Combined reporting of cancer control and functional results of radical prostatectomy. *Eur Urol.*2003; 44: 656.
456. Maffezzini M, Seveso M, Taverna G, Giusti G, Benetti A, and Graziotti P.: Evaluation of complications and results in a contemporary series of 300 consecutive radical retropubic prostatectomies with the anatomic approach at a single institution. *Urology,* 2003; 61: 982, 2003.
457. Deliveliotis C, Protogerou V, Alargof E, and Varkarakis J.: Radical prostatectomy: bladder neck preservation and puboprostatic ligament sparing--effects on continence and positive margins. *Urology* 2002; 60: 855.
458. Benoit RM, Naslund MJ, and Cohen JK.: Complications after radical retropubic prostatectomy in the medicare population. *Urology* 2000; 56: 116.
459. LaFontaine P, Chan D, Partin AW, Gurganus R, Hortopan SC, and Marshall FF. : Minilaparotomy radical retropubic prostatectomy: updated technique and results. *Semin Urol Oncol.* 2000; 18: 19.
460. Galli S, Simonato A, Bozzola A, Gregori A, Lissiani A, Scaburri A, Gabardi F. Oncologic outcome and continence recovery after laparoscopic radical prostatectomy: 3 years' follow-up in a "second generation center". *Eur Urol* 2006; 49 : 859-865.
461. Novara G, Ficarra V, D'Elia C, Secco S, Cavalieri S, Artibani W. Trifecta outcomes after robot-assisted laparoscopic radical prostatectomy. *BJU Int.* 2011 Jan;107(1):100-4.
462. Reynolds WS, Shikanov SA, Katz MH, Zagaja GP, Shalhav AL, Zorn KC. Analysis of continence rates following robot-assisted radical prostatectomy: strict leak-free and pad-free continence. *Urology.* 2010 Feb;75(2):431-6. Epub 2009 Oct 24.
463. Van Hemelrijck M, Wigertz A, Sandin F, Garmo H, Hellstrom K, Fransson P, Widmark A, Lambe M, Adolfsson J, Varenhorst E, Johansson JE, Stattin P, NPCR and PCBaSe Sweden. Cohort Profile: the National Prostate Cancer Register of Sweden and Prostate Cancer data Base Sweden 2.0. *International Journal of Epidemiology* 2013; 42(4):956-67.
464. ShikanovS,DesaiV,Razmaria A,ZagajaGP, ShalhavAL. Robotic radical prostatectomy for elderly patients: probability of achieving continence and potency 1 year after surgery. *J Urol* 2010;183:1803-7.

465. Martin AD, Nakamura LY, Nunez RN, Wolter CE, Humphreys MR, Castle EP. Incontinence after radical prostatectomy: a patient centered analysis and implications for preoperative counseling. *J Urol* 2011;186:204–8.
466. Xylinas E, Durand X, Ploussard G, Campeggi A, Allory Y, Vordos D, Hoznek A, Abbou CC, de la Taille A, Salomon L. Evaluation of combined oncologic and functional outcomes after robotic-assisted laparoscopic extraperitoneal radical prostatectomy: trifecta rate of achieving continence, potency and cancer control. *Urol Oncol*. 2013 Jan;31(1):99-103. doi: 10.1016/j.urolonc.2010.10.012. Epub 2011 Jun 29.
467. Link BA, Nelson R, Josephson DY, et al. The impact of prostate gland weight in robot assisted laparoscopic radical prostatectomy. *J Urol* 2008;180:928–32.
468. Springer C, Inferrera A, Pini G, Mohammed N, Fornara P, Greco F. Laparoscopic versus open bilateral intrafascial nerve-sparing radical prostatectomy after TUR-P for incidental prostate cancer: surgical outcomes and effect on postoperative urinary continence and sexual potency. *World Journal of Urology* 2013; 31(6):1505-10.
469. Harris MJ. The anatomic radical perineal prostatectomy : An outcomes-based evolution. *Eur Urol* 2007; 52 : 81-88.
470. Jonler M, Madsen FA, Rhodes PR, Sall M, Messing EM, Brusketwitz RB. A prospective study of quantification of urinary incontinence and quality of life in patients undergoing radical retropubic prostatectomy. *Urology* 48 : 433-40, 1996.
471. Jacobsen NB, Moore KN, Estey E, and Voaklander D. Open versus laparoscopic radical prostatectomy : A prostective comparison of postoperative urinary incontinence rates. *J Urol*, 177 : 615-619, Feb 2007.
472. Ates M, Teber D, Gozen AS, Tefekli A, Hruza M, Sugiono M, et al A new postoperative predictor of time to urinary continence after laparoscopic radical prostatectomy: the urine loss ratio. *Eur Urol*. 2007 Jul;52(1):178-85. Epub 2006 Dec 21.
473. Link RE, Su LM, Sullivan W, Bhayani S, and Pavlovich CP. Health related quality of life before and after laparoscopic radical prostatectomy. *J Urol* 173 : 173-9, January 2005.
474. Finley DS, Osann K, Chang A, Santos R, Skarcky D, Ahlering TE. Hypothermic robotic radical prostatectomy: impact on continence. *J Endourol* 2009;23:1443–50.
475. Greco KA, Meeks JJ, Wu S, Nadler RB. Robot-assisted radical prostatectomy in men aged > or =70 years. *BJU Int* 2009;104:1492–5.
476. Barker JC, Mitteness LS. Nocturia in the elderly. *Gerontologist* 1988; Feb;28(1):99-104.
477. Cartwright R, Renganathan A, Cardozo L. Current management of overactive bladder. *Curr Opin Obstet Gynecol* 2008; Oct;20(5):489-95.
478. Tikkinen KAO. Epidemiology of Nocturia - Results from the FINNO Study [dissertation]. Tampere, Finland: Tampere University Press; 2010. Available at: <http://acta.uta.fi/pdf/978-951-44-8020-1.pdf>
479. Weiss JP, Blaivas JG. Nocturia. *J Urol* 2000; Jan;163(1):5-12.
480. Tikkinen KA, Auvinen A. Does the imprecise definition of overactive bladder serve commercial rather than patient interests? *Eur Urol* 2012; Apr;61(4):746-8.
481. Irwin DE, Milsom I, Kopp Z, Abrams P, EPIC Study Group. Symptom bother and health care-seeking behavior among individuals with overactive bladder. *Eur Urol* 2008; May;53(5):1029-37.
482. Coyne KS, Sexton CC, Thompson CL, Milsom I, Irwin D, Kopp ZS, et al. The prevalence of lower urinary tract symptoms (LUTS) in the USA, the UK and Sweden: results from the Epidemiology of LUTS (EpiLUTS) study. *BJU Int* 2009; Aug;104(3):352-60.
483. Vaughan CP, Johnson TM,2nd, Ala-Lipasti MA, Cartwright R, Tammela TL, Taari K, et al. The prevalence of clinically meaningful overactive bladder: Bother and quality of life results from the population-based FINNO Study. *Eur Urol* 2011; Jan 25;59(4):629-36.
484. McGrother CW, Donaldson MM, Hayward T, Matthews R, Dallosso HM, Hyde C, et al. Urinary storage symptoms and comorbidities: a prospective population cohort study in middle-aged and older women. *Age Ageing* 2006; Jan;35(1):16-24.
485. Coyne KS, Sexton CC, Irwin DE, Kopp ZS, Kelleher CJ, Milsom I. The impact of overactive bladder, incontinence and other lower urinary tract symptoms on quality of life, work productivity, sexuality and emotional well-being in men and women: results from the EPIC study. *BJU Int* 2008; Jun;101(11):1388-95.
486. Middelkoop HA, Smilde-van den Doel DA, Neven AK, Kamphuisen HA, Springer CP. Subjective sleep characteristics of 1,485 males and females aged 50-93: effects of sex and age, and factors related to self-evaluated quality of sleep. *J Gerontol A Biol Sci Med Sci* 1996; May;51(3):M108-15.

487. Bing MH, Moller LA, Jennum P, Mortensen S, Skovgaard LT, Lose G. Prevalence and bother of nocturia, and causes of sleep interruption in a Danish population of men and women aged 60-80 years. *BJU Int* 2006; Sep;98(3):599-604.
488. Bliwise DL, Foley DJ, Vitiello MV, Ansari FP, Ancoli-Israel S, Walsh JK. Nocturia and disturbed sleep in the elderly. *Sleep Med* 2009; May;10(5):540-8.
489. Schatzl G, Temml C, Schmidbauer J, Dolezal B, Haidinger G, Madersbacher S. Cross-sectional study of nocturia in both sexes: analysis of a voluntary health screening project. *Urology* 2000; Jul;56(1):71-5.
490. Coyne KS, Zhou Z, Bhattacharyya SK, Thompson CL, Dhawan R, Versi E. The prevalence of nocturia and its effect on health-related quality of life and sleep in a community sample in the USA. *BJU Int* 2003; Dec;92(9):948-54.
491. Fiske J, Scarpero HM, Xue X, Nitti VW. Degree of bother caused by nocturia in women. *Neurourol Urodyn* 2004;23(2):130-3.
492. Liew LC, Tiong HY, Wong ML, Png DC, Tan JK. A population study of nocturia in Singapore. *BJU Int* 2006; Jan;97(1):109-12.
493. Yu HJ, Chen FY, Huang PC, Chen TH, Chie WC, Liu CY. Impact of nocturia on symptom-specific quality of life among community-dwelling adults aged 40 years and older. *Urology* 2006; Apr;67(4):713-8.
494. Lowenstein L, Brubaker L, Kenton K, Kramer H, Shott S, FitzGerald MP. Prevalence and impact of nocturia in a urogynecologic population. *Int Urogynecol J Pelvic Floor Dysfunct* 2007; Sep;18(9):1049-52.
495. Choo MS, Ku JH, Park CH, Lee YS, Lee KS, Lee JG, et al. Prevalence of nocturia in a Korean population aged 40 to 89 years. *Neurourol Urodyn* 2008;27(1):60-4.
496. Tikkinen KA, Johnson TM, 2nd, Tammela TL, Sintonen H, Haukka J, Huhtala H, et al. Nocturia frequency, bother, and quality of life: how often is too often? A population-based study in Finland. *Eur Urol* 2010; Mar;57(3):488-96.
497. Asplund R, Marnetoft SU, Selander J, Akerstrom B. Nocturia in relation to somatic health, mental health and pain in adult men and women. *BJU Int* 2005; Apr;95(6):816-9.
498. Kupelian V, Wei JT, O'Leary MP, Norgaard JP, Rosen RC, McKinlay JB. Nocturia and quality of life: results from the Boston area community health survey. *Eur Urol* 2012; Jan;61(1):78-84.
499. Stewart RB, Moore MT, May FE, Marks RG, Hale WE. Nocturia: a risk factor for falls in the elderly. *J Am Geriatr Soc* 1992; Dec;40(12):1217-20.
500. Brown JS, Vittinghoff E, Wyman JF, Stone KL, Nevitt MC, Ensrud KE, et al. Urinary incontinence: does it increase risk for falls and fractures? Study of Osteoporotic Fractures Research Group. *J Am Geriatr Soc* 2000; Jul;48(7):721-5.
501. Temml C, Ponholzer A, Gutjahr G, Berger I, Marszalek M, Madersbacher S. Nocturia is an age-independent risk factor for hip-fractures in men. *Neurourol Urodyn* 2009;28(8):949-52.
502. Asplund R. Hip fractures, nocturia, and nocturnal polyuria in the elderly. *Arch Gerontol Geriatr* 2006; Nov-Dec;43(3):319-26.
503. Parsons JK, Mougey J, Lambert L, Wilt TJ, Fink HA, Garzotto M, et al. Lower urinary tract symptoms increase the risk of falls in older men. *BJU Int* 2009; Jul;104(1):63-8.
504. Vaughan CP, Brown CJ, Goode PS, Burgio KL, Allman RM, Johnson TM, 2nd. The association of nocturia with incident falls in an elderly community-dwelling cohort. *Int J Clin Pract* 2010; Apr;64(5):577-83.
505. Nakagawa H, Niu K, Hozawa A, Ikeda Y, Kaiho Y, Ohmori-Matsuda K, et al. Impact of nocturia on bone fracture and mortality in older individuals: a Japanese longitudinal cohort study. *J Urol* 2010; Oct;184(4):1413-8.
506. Moon SJ, Kim YT, Lee TY, Moon H, Kim MJ, Kim SA, et al. The influence of an overactive bladder on falling: a study of females aged 40 and older in the community. *Int Neurourol J* 2011; Mar;15(1):41-7.
507. Asplund R. Mortality in the elderly in relation to nocturnal micturition. *BJU Int* 1999; Aug;84(3):297-301.
508. Bursztyjn M, Jacob J, Stessman J. Usefulness of nocturia as a mortality risk factor for coronary heart disease among persons born in 1920 or 1921. *Am J Cardiol* 2006; Nov 15;98(10):1311-5.
509. Kupelian V, Fitzgerald MP, Kaplan SA, Norgaard JP, Chiu GR, Rosen RC. Association of Nocturia and Mortality: Results From the Third National Health and Nutrition Examination Survey. *J Urol* 2011; Feb;185(2):571-7.
510. Fan Y, Wei F, Lang Y, Qi W. Meta-analysis of nocturia and risk of all-cause mortality in adult population. *Int J Cardiol*. 2015; Sep;195:120-2.

511. Agarwal A, Eryuzlu LN, Cartwright R, Thorlund K, Tammela TL, et al. What is the most bothersome lower urinary tract symptom? Individual- and population-level perspectives for both men and women. *Eur Urol* 2014; Jun;65(6):1211-7.
512. Hunskaar S. Epidemiology of nocturia. *BJU Int* 2005; Sep;96 Suppl 1:4-7.
513. Abrams P, Cardozo L, Fall M, Griffiths D, Rosier P, Ulmsten U, et al. The standardisation of terminology of lower urinary tract function: report from the Standardisation Sub-committee of the International Continence Society. *Neurourol Urodyn* 2002;21(2):167-78.
514. Abrams P, Artibani W, Cardozo L, Dmochowski R, van Kerrebroeck P, Sand P, et al. Reviewing the ICS 2002 terminology report: the ongoing debate. *Neurourol Urodyn* 2009;28(4):287.
515. Weiss JP, Wein AJ, van Kerrebroeck P, Dmochowski R, Fitzgerald MP, Tikkinen KAO, et al. Nocturia: New Directions ICI-RS Think Tank 2010. *Neurourol Urodyn* 2011; Jun;30(5):700-3.
516. Wein A. Symptom-based diagnosis of overactive bladder: an overview. *Can Urol Assoc J* 2011; Oct;5(5 Suppl 2):S135-6.
517. Roberts W. Observations on some of the daily changes of the urine 1860;5:817-825,906-923.
518. Rubin SW, Nagel H. Nocturia in the aged. *J Am Med Assoc* 1951; Oct 27;147(9):840-1.
519. van Kerrebroeck P, Abrams P, Chaikin D, Donovan J, Fonda D, Jackson S, et al. The standardisation of terminology in nocturia: report from the Standardisation Sub-committee of the International Continence Society. *Neurourol Urodyn* 2002;21(2):179-83.
520. Madersbacher H. Overactive bladder: a clinical entity or a marketing hype?. *Eur Urol* 2005; Mar;47(3):273-6.
521. Blaivas JG. Overactive bladder and the definition of urgency. *Neurourol Urodyn* 2007;26(6):757,8; discussion 759-60.
522. Yamaguchi O, Honda K, Nomiya M, Shishido K, Kakizaki H, Tanaka H, et al. Defining overactive bladder as hypersensitivity. *Neurourol Urodyn* 2007; Oct;26(6 Suppl):904-7.
523. Homma Y. Lower urinary tract symptomatology: Its definition and confusion. *Int J Urol* 2008; Jan;15(1):35-43.
524. Dmochowski RR, FitzGerald MP, Wyndaele JJ. Measuring urgency in clinical practice. *World J Urol* 2009; Dec;27(6):739-45.
525. De Wachter S, Hanno P. Urgency: all or none phenomenon?. *Neurourol Urodyn* 2010; Apr;29(4):616-7.
526. Shah JR. Should we treat lower urinary tract symptoms without a definitive diagnosis? No. *BMJ* 2011; Dec 1;343:d6058.
527. 527 Abrams P. Should we treat lower urinary tract symptoms without a definitive diagnosis? Yes. *BMJ* 2011; Dec 1;343:d6038.
528. Zinner NR. OAB. Are we barking up the wrong tree? A lesson from my dog. *Neurourol Urodyn* 2011; Nov;30(8):1410-1.
529. Abrams P. Response to OAB, are we barking up the wrong tree? A lesson from my dog. *Neurourol Urodyn* 2011; Nov;30(8):1409; discussion 1412-4.
530. Herschorn S. Overactive bladder: Symptom complex or separate entity?. *Can Urol Assoc J* 2011; Oct;5(5 Suppl 2):S152-4.
531. Parazzini F, Lavezzari M, Arbitani W. Prevalence of overactive bladder and urinary incontinence. *J Fam Pract* 2002; Dec;51(12):1072-5.
532. Lapitan MC, Chye PL, Asia-Pacific Continence Advisory Board. The epidemiology of overactive bladder among females in Asia: a questionnaire survey. *Int Urogynecol J Pelvic Floor Dysfunct* 2001;12(4):226-31.
533. Milsom I, Abrams P, Cardozo L, Roberts RG, Thuroff J, Wein AJ. How widespread are the symptoms of an overactive bladder and how are they managed? A population-based prevalence study. *BJU Int* 2001; Jun;87(9):760-6.
534. Chen GD, Lin TL, Hu SW, Chen YC, Lin LY. Prevalence and correlation of urinary incontinence and overactive bladder in Taiwanese women. *Neurourol Urodyn* 2003;22(2):109-17.
535. Stewart WF, Van Rooyen JB, Cundiff GW, Abrams P, Herzog AR, Corey R, et al. Prevalence and burden of overactive bladder in the United States. *World J Urol* 2003; May;20(6):327-36.
536. Temml C, Heidler S, Ponholzer A, Madersbacher S. Prevalence of the overactive bladder syndrome by applying the International Continence Society definition. *Eur Urol* 2005; Oct;48(4):622-7.
537. Homma Y, Yamaguchi O, Hayashi K, Neurogenic Bladder Society Committee. An epidemiological survey of overactive bladder symptoms in Japan. *BJU Int* 2005; Dec;96(9):1314-8.
538. Safarinejad MR. Prevalence of the overactive bladder among Iranian women based on the International Continence Society definition: a population-based study. *Int Urol Nephrol* 2009;41(1):35-45.

539. Irwin DE, Kopp ZS, Agatep B, Milsom I, Abrams P. Worldwide prevalence estimates of lower urinary tract symptoms, overactive bladder, urinary incontinence and bladder outlet obstruction. *BJU Int* 2011; Oct;108(7):1132-8.
540. Irwin DE, Milsom I, Hunskaar S, Reilly K, Kopp Z, Herschorn S, et al. Population-based survey of urinary incontinence, overactive bladder, and other lower urinary tract symptoms in five countries: Results of the EPIC Study. *Eur Urol* 2006; Dec;50(6):1306-15.
541. Corcos J, Schick E. Prevalence of overactive bladder and incontinence in Canada. *Can J Urol* 2004; Jun;11(3):2278-84.
542. Teloken C, Caraver F, Weber FA, Teloken PE, Moraes JF, Sogari PR, et al. Overactive bladder: prevalence and implications in Brazil. *Eur Urol* 2006; Jun;49(6):1087-92.
543. Yu HJ, Liu CY, Lee KL, Lee WC, Chen TH. Overactive bladder syndrome among community-dwelling adults in Taiwan: prevalence, correlates, perception, and treatment seeking. *Urol Int* 2006;77(4):327-33.
544. Tikkinen KA, Tammela TL, Rissanen AM, Valpas A, Huhtala H, Auvinen A. Is the prevalence of overactive bladder overestimated? A population-based study in Finland. *PLoS ONE* 2007; Feb 7;2:e195.
545. Choo MS, Ku JH, Lee JB, Lee DH, Kim JC, Kim HJ, et al. Cross-cultural differences for adapting overactive bladder symptoms: results of an epidemiologic survey in Korea. *World J Urol* 2007; Oct;25(5):505-11.
546. Herschorn S, Gajewski J, Schulz J, Corcos J. A population-based study of urinary symptoms and incontinence: the Canadian Urinary Bladder Survey. *BJU Int* 2008; Jan;101(1):52-8.
547. Benner JS, Becker R, Fanning K, Jumadilova Z, Bavendam T, Brubaker L, et al. Bother related to bladder control and health care seeking behavior in adults in the United States. *J Urol* 2009; Jun;181(6):2591-8.
548. Correia S, Dinis P, Rolo F, Lunet N. Prevalence, treatment and known risk factors of urinary incontinence and overactive bladder in the non-institutionalized Portuguese population. *Int Urogynecol J Pelvic Floor Dysfunct* 2009; Aug 14;.
549. Coyne KS, Cash B, Kopp Z, Gelhorn H, Milsom I, et al. The prevalence of chronic constipation and faecal incontinence among men and women with symptoms of overactive bladder. *BJU Int* 2011; Jan;107(2):254-61.
550. Link CL, Steers WD, Kusek JW, McKinlay JB. The association of adiposity and overactive bladder appears to differ by gender: results from the Boston Area Community Health survey. *J Urol* 2011; Mar;185(3):955-63.
551. Lee YS, Lee KS, Jung JH, Han DH, Oh SJ, Seo JT, et al. Prevalence of overactive bladder, urinary incontinence, and lower urinary tract symptoms: results of Korean EPIC study. *World J Urol* 2011; Apr;29(2):185-90.
552. Yoo ES, Kim BS, Kim DY, Oh SJ, Kim JC. The impact of overactive bladder on health-related quality of life, sexual life and psychological health in Korea. *Int Neurourol J* 2011; Sep;15(3):143-51.
553. Wang Y, Xu K, Hu H, Zhang X, Wang X, Na Y, et al. Prevalence, risk factors, and impact on health related quality of life of overactive bladder in China. *Neurourol Urodyn* 2011; Nov;30(8):1448-55.
554. Coyne KS, Sexton CC, Bell JA, Thompson CL, Dmochowski R, et al. The prevalence of lower urinary tract symptoms (LUTS) and overactive bladder (OAB) by racial/ethnic group and age: results from OAB-POLL. *Neurourol Urodyn* 2013; Mar;32(3):230-7.
555. Matsumoto S, Hashizume K, Wada N, Hori J, Tamaki G, et al. Relationship between overactive bladder and irritable bowel syndrome: a large-scale internet survey in Japan using the overactive bladder symptom score and Rome III criteria. *BJU Int* 2013; Apr;111(4):647-52.
556. Moreira ED Jr, Neves RC, Neto AF, Duarte FG, Moreira TL, et al. A population-based survey of lower urinary tract symptoms (LUTS) and symptom-specific bother: results from the Brazilian LUTS epidemiology study (BLUES). *World J Urol* 2013; Dec;31(6):1451-8.
557. Wen JG, Li JS, Wang ZM, Huang CX, Shang XP, Su ZQ, Lu YT, Suo ZH, Wang Y, Qin GJ, Zhang WX, Heesakkers JP. The prevalence and risk factors of OAB in middle-aged and old people in China. *Neurourol Urodyn* 2014; Apr;33(4):387-91.
558. Kogan MI, Zachoval R, Ozyurt C, Schäfer T, Christensen N. Epidemiology and impact of urinary incontinence, overactive bladder, and other lower urinary tract symptoms: results of the EPIC survey in Russia, Czech Republic, and Turkey. *Curr Med Res Opin* 2014; Oct;30(10):2119-30.
559. Irwin DE, Milsom I, Chancellor MB, Kopp Z, Guan Z. Dynamic progression of overactive bladder and urinary incontinence symptoms: a systematic review. *Eur Urol* 2010; Oct;58(4):532-43.

560. Dallosso HM, McGrother CW, Matthews RJ, Donaldson MM, Leicestershire MRC Incontinence Study Group. Nutrient composition of the diet and the development of overactive bladder: a longitudinal study in women. *Neurourol Urodyn* 2004;23(3):204-10.
561. Dallosso HM, Matthews RJ, McGrother CW, Donaldson MM, Shaw C, Leicestershire MRC Incontinence Study Group. The association of diet and other lifestyle factors with the onset of overactive bladder: a longitudinal study in men. *Public Health Nutr* 2004; Oct;7(7):885-91.
562. Wennberg AL, Molander U, Fall M, Edlund C, Peeker R, Milsom I. A longitudinal population-based survey of urinary incontinence, overactive bladder, and other lower urinary tract symptoms in women. *Eur Urol* 2009; Apr;55(4):783-91.
563. Malmsten UG, Molander U, Peeker R, Irwin DE, Milsom I. Urinary incontinence, overactive bladder, and other lower urinary tract symptoms: a longitudinal population-based survey in men aged 45-103 years. *Eur Urol* 2010; Jul;58(1):149-56.
564. Heidler S, Mert C, Temml C, Madersbacher S. The natural history of the overactive bladder syndrome in females: a long-term analysis of a health screening project. *Neurourol Urodyn* 2011; Nov;30(8):1437-41.
565. Noguchi N, Chan L, Cumming RG, Blyth FM, Handelsman DJ, et al. Natural history of non-neurogenic overactive bladder and urinary incontinence over 5 years in community-dwelling older men: The concord health and aging in men project. *Neurourol Urodyn* 2016; Jan 12. [Epub ahead of print].
566. Hirayama A, Torimoto K, Mastusita C, Okamoto N, Morikawa M, et al. Risk factors for new-onset overactive bladder in older subjects: results of the Fujiwara-kyo study. *Urology* 2012; Jul;80(1):71-6.
567. Fitzgerald MP, Thom DH, Wassel-Fyr C, Subak L, Brubaker L, Van Den Eeden SK, et al. Childhood urinary symptoms predict adult overactive bladder symptoms. *J Urol* 2006; Mar;175(3 Pt 1):989-93.
568. Labrie J, de Jong TP, Nieuwhof-Leppink A, van der Deure J, Vijverberg MA, van der Vaart CH. The relationship between children with voiding problems and their parents. *J Urol* 2010; May;183(5):1887-91.
569. Bunn F, Kirby M, Pinkney E, Cardozo L, Chapelle C, et al. Is there a link between overactive bladder and the metabolic syndrome in women? A systematic review of observational studies. *Int J Clin Pract* 2015; Feb;69(2):199-217.
570. Shaper AG, Wannamethee G, Walker M. Alcohol and mortality in British men: explaining the U-shaped curve. *Lancet* 1988; Dec 3;2(8623):1267-73.
571. Fillmore KM, Stockwell T, Chikritzhs T, Bostrom A, Kerr W. Moderate alcohol use and reduced mortality risk: systematic error in prospective studies and new hypotheses. *Ann Epidemiol* 2007; May;17(5 Suppl):S16-23.
572. Naimi TS, Brown DW, Brewer RD, Giles WH, Mensah G, Serdula MK, et al. Cardiovascular risk factors and confounders among nondrinking and moderate-drinking U.S. adults. *Am J Prev Med* 2005; May;28(4):369-73.
573. Jackson R, Broad J, Connor J, Wells S. Alcohol and ischaemic heart disease: probably no free lunch. *Lancet* 2005; Dec 3;366(9501):1911-2.
574. Tettamanti G, Altman D, Pedersen NL, Bellocco R, Milsom I, Iliadou AN. Effects of coffee and tea consumption on urinary incontinence in female twins. *BJOG* 2011; Jun;118(7):806-13.
575. Bradley CS, Kennedy CM, Nygaard IE. Pelvic floor symptoms and lifestyle factors in older women. *J Womens Health (Larchmt)* 2005; Mar;14(2):128-36.
576. Teleman PM, Lidfeldt J, Nerbrand C, Samsioe G, Mattiasson A, WHILA study group. Overactive bladder: prevalence, risk factors and relation to stress incontinence in middle-aged women. *BJOG* 2004; Jun;111(6):600-4.
577. Tahtinen RM, Auvinen A, Cartwright R, Johnson TM, 2nd, Tammela TL, Tikkinen KA. Smoking and bladder symptoms in women. *Obstet Gynecol* 2011; Sep;118(3):643-8.
578. Coyne KS, Margolis MK, Kopp ZS, Kaplan SA. Racial Differences in the Prevalence of Overactive Bladder in the United States From the Epidemiology of LUTS (EpiLUTS) Study. *Urology* 2012; Jan;79(1):95-101.
579. Nuotio M, Jylha M, Koivisto AM, Tammela TL. Association of smoking with urgency in older people. *Eur Urol* 2001; Aug;40(2):206-12.
580. de Boer TA, Slieker-ten Hove MC, Burger CW, Vierhout ME. The prevalence and risk factors of overactive bladder symptoms and its relation to pelvic organ prolapse symptoms in a general female population. *Int Urogynecol J* 2011; May;22(5):569-75.
581. Handa VL, Blomquist JL, Knoepp LR, Hoskey KA, McDermott KC, Munoz A. Pelvic floor disorders 5-10 years after vaginal or cesarean childbirth. *Obstet Gynecol* 2011; Oct;118(4):777-84.

582. Chuang FC, Kuo HC. Prevalence of lower urinary tract symptoms in indigenous and non-indigenous women in Eastern Taiwan. *J Formos Med Assoc* 2010; Mar;109(3):228-36.
583. Cheung WW, Blank W, Borawski D, Tran W, Bluth MH. Prevalence of overactive bladder, its under-diagnosis, and risk factors in a male urologic veterans population. *Int J Med Sci* 2010; Nov 12;7(6):391-4.
584. Lawrence JM, Lukacz ES, Nager CW, Hsu JW, Lubner KM. Prevalence and co-occurrence of pelvic floor disorders in community-dwelling women. *Obstet Gynecol* 2008; Mar;111(3):678-85.
585. Viktrup L. The risk of lower urinary tract symptoms five years after the first delivery. *Neurourol Urodyn* 2002;21(1):2-29.
586. Liang CC, Chang SD, Lin SJ, Lin YJ. Lower urinary tract symptoms in primiparous women before and during pregnancy. *Arch Gynecol Obstet* 2011; Nov 1;.
587. Aslan D, Aslan G, Yamazhan M, Ispahi C, Tinar S. Voiding symptoms in pregnancy: an assessment with international prostate symptom score. *Gynecol Obstet Invest* 2003;55(1):46-9.
588. Sun MJ, Chen GD, Chang SY, Lin KC, Chen SY. Prevalence of lower urinary tract symptoms during pregnancy in Taiwan. *J Formos Med Assoc* 2005; Mar;104(3):185-9.
589. Adaji S, Shittu O, Bature S, Nasir S, Olatunji O. Bothersome lower urinary symptoms during pregnancy: a preliminary study using the International Consultation on Incontinence Questionnaire. *Afr Health Sci* 2011; Aug;11 Suppl 1:S46-52.
590. Parazzini F, Chiaffarino F, Lavezzari M, Giambanco V, VIVA Study Group. Risk factors for stress, urge or mixed urinary incontinence in Italy. *BJOG* 2003; Oct;110(10):927-33.
591. Tikkinen KA, Auvinen A, Tiitinen A, Valpas A, Johnson TM, 2nd, Tammela TL. Reproductive factors associated with nocturia and urinary urgency in women – a population-based study in Finland. *Am J Obstet Gynecol* 2008; Aug;199(2):153.e1-12.
592. Lawrence JM, Lukacz ES, Nager CW, Hsu JW, Lubner KM. Prevalence and co-occurrence of pelvic floor disorders in community-dwelling women. *Obstet Gynecol* 2008; Mar;111(3):678-85.
593. Alling Moller L, Lose G, Jorgensen T. Risk factors for lower urinary tract symptoms in women 40 to 60 years of age. *Obstet Gynecol* 2000; Sep;96(3):446-51.
594. Handa VL, Harvey L, Fox HE, Kjerulff KH. Parity and route of delivery: does cesarean delivery reduce bladder symptoms later in life?. *Am J Obstet Gynecol* 2004; Aug;191(2):463-9.
595. Zhang W, Song Y, He X, Huang H, Xu B, Song J. Prevalence and risk factors of overactive bladder syndrome in Fuzhou Chinese women. *Neurourol Urodyn* 2006;25(7):717-21.
596. Scarpa KP, Herrmann V, Palma PC, Ricetto CL, Morais S. Prevalence of urinary symptoms in the third trimester of pregnancy. *Rev Assoc Med Bras* 2006; May-Jun;52(3):153-6.
597. van Brummen HJ, Bruinse HW, van de Pol G, Heintz AP, van der Vaart CH. The effect of vaginal and cesarean delivery on lower urinary tract symptoms: what makes the difference?. *Int Urogynecol J Pelvic Floor Dysfunct* 2007; Feb;18(2):133-9.
598. Ekstrom A, Altman D, Wiklund I, Larsson C, Andolf E. Planned cesarean section versus planned vaginal delivery: comparison of lower urinary tract symptoms. *Int Urogynecol J Pelvic Floor Dysfunct* 2008; Apr;19(4):459-65.
599. Lukacz ES, Lawrence JM, Contreras R, Nager CW, Lubner KM. Parity, mode of delivery, and pelvic floor disorders. *Obstet Gynecol* 2006; Jun;107(6):1253-60.
600. Rekers H, Drogendijk AC, Valkenburg HA, Riphagen F. The menopause, urinary incontinence and other symptoms of the genito-urinary tract. *Maturitas* 1992; Oct;15(2):101-11.
601. Prasad M, Sadhukhan M, Tom B, Al-TaHER H. The effect of hysterectomy on urinary symptoms and residual bladder volume. *J Obstet Gynaecol* 2002; Sep;22(5):544-7.
602. Cody JD, Richardson K, Moehrer B, Hextall A, Glazener CM. Oestrogen therapy for urinary incontinence in post-menopausal women. *Cochrane Database Syst Rev* 2009; Oct 7;(4)(4):CD001405.
603. Iliadou A, Milsom I, Pedersen NL, Altman D. Risk of urinary incontinence symptoms in oral contraceptive users: a national cohort study from the Swedish Twin Register. *Fertil Steril* 2009; Aug;92(2):428-33.
604. Plotti F, Angioli R, Zullo MA, Sansone M, Altavilla T, Antonelli E, et al. Update on urodynamic bladder dysfunctions after radical hysterectomy for cervical cancer. *Crit Rev Oncol Hematol* 2011; Nov;80(2):323-9.

605. Hazewinkel MH, Sprangers MA, van der Velden J, van der Vaart CH, Stalpers LJ, Burger MP, et al. Long-term cervical cancer survivors suffer from pelvic floor symptoms: a cross-sectional matched cohort study. *Gynecol Oncol* 2010; May;117(2):281-6.
606. Stanton SL, Hilton P, Norton C, Cardozo L. Clinical and urodynamic effects of anterior colporrhaphy and vaginal hysterectomy for prolapse with and without incontinence. *Br J Obstet Gynaecol* 1982; Jun;89(6):459-63.
607. Virtanen H, Makinen J, Tenho T, Kiilholma P, Pitkanen Y, Hirvonen T. Effects of abdominal hysterectomy on urinary and sexual symptoms. *Br J Urol* 1993; Dec;72(6):868-72.
608. Altman D, Lopez A, Falconer C, Zetterstrom J. The impact of hysterectomy on lower urinary tract symptoms. *Int Urogynecol J Pelvic Floor Dysfunct* 2003; Dec;14(6):418-23.
609. Weber AM, Walters MD, Schover LR, Church JM, Piedmonte MR. Functional outcomes and satisfaction after abdominal hysterectomy. *Am J Obstet Gynecol* 1999; Sep;181(3):530-5.
610. de Tayrac R, Chevalier N, Chauveaud-Lambling A, Gervaise A, Fernandez H. Is vaginal hysterectomy a risk factor for urinary incontinence at long-term follow-up?. *Eur J Obstet Gynecol Reprod Biol* 2007; Feb;130(2):258-61.
611. Krogh RA, Neumann GA, Lauszus FF, Guttorm E, Rasmussen KL. Hysterectomy is associated with stress incontinence in women who previously had a transcervical endometrial resection. *Gynecol Obstet Invest* 2007;63(3):121-5.
612. Vervest HA, Kiewiet de Jonge M, Vervest TM, Barents JW, Haspels AA. Micturition symptoms and urinary incontinence after non-radical hysterectomy. *Acta Obstet Gynecol Scand* 1988;67(2):141-6.
613. Carlson KJ, Miller BA, Fowler FJ, Jr. The Maine Women's Health Study: I. Outcomes of hysterectomy. *Obstet Gynecol* 1994; Apr;83(4):556-65.
614. Thakar R, Ayers S, Clarkson P, Stanton S, Manyonda I. Outcomes after total versus subtotal abdominal hysterectomy. *N Engl J Med* 2002; Oct 24;347(17):1318-25.
615. Learman LA, Summitt RL, Jr, Varner RE, McNeeley SG, Goodman-Gruen D, Richter HE, et al. A randomized comparison of total or supracervical hysterectomy: surgical complications and clinical outcomes. *Obstet Gynecol* 2003; Sep;102(3):453-62.
616. El-Toukhy TA, Hefni M, Davies A, Mahadevan S. The effect of different types of hysterectomy on urinary and sexual functions: a prospective study. *J Obstet Gynaecol* 2004; Jun;24(4):420-5.
617. Link CL, Pulliam SJ, McKinlay JB. Hysterectomies and Urologic Symptoms: Results from the Boston Area Community Health (BACH) Survey. *Female Pelvic Med Reconstr Surg* 2010; Jan;16(1):37-47.
618. Phelan S, Kanaya AM, Subak LL, Hogan PE, Espeland MA, Wing RR, et al. Prevalence and risk factors for urinary incontinence in overweight and obese diabetic women: action for health in diabetes (look ahead) study. *Diabetes Care* 2009; Aug;32(8):1391-7.
619. Kershen RT, Appell RA. De novo urge syndrome and detrusor instability after anti-incontinence surgery: current concepts, evaluation, and treatment. *Curr Urol Rep* 2002; Oct;3(5):345-53.
620. Holmgren C, Nilsson S, Lanner L, Hellberg D. Frequency of de novo urgency in 463 women who had undergone the tension-free vaginal tape (TVT) procedure for genuine stress urinary incontinence--a long-term follow-up. *Eur J Obstet Gynecol Reprod Biol* 2007; May;132(1):121-5.
621. Van Venrooij GE, Van Melick HH, Eckhardt MD, Boon TA. Correlations of urodynamic changes with changes in symptoms and well-being after transurethral resection of the prostate. *J Urol* 2002; Aug;168(2):605-9.
622. Abrams PH, Farrar DJ, Turner-Warwick RT, Whiteside CG, Feneley RC. The results of prostatectomy: a symptomatic and urodynamic analysis of 152 patients. *J Urol* 1979; May;121(5):640-2.
623. de Nunzio C, Franco G, Rocchegiani A, Iori F, Leonardo C, Laurenti C. The evolution of detrusor overactivity after watchful waiting, medical therapy and surgery in patients with bladder outlet obstruction. *J Urol* 2003; Feb;169(2):535-9.
624. Housami F, Abrams P. Persistent detrusor overactivity after transurethral resection of the prostate. *Curr Urol Rep* 2008; Jul;9(4):284-90.
625. Miedel A, Tegerstedt G, Maehle-Schmidt M, Nyren O, Hammarstrom M. Symptoms and pelvic support defects in specific compartments. *Obstet Gynecol* 2008; Oct;112(4):851-8.
626. Tegerstedt G, Maehle-Schmidt M, Nyren O, Hammarstrom M. Prevalence of symptomatic pelvic organ prolapse in a Swedish population. *Int Urogynecol J Pelvic Floor Dysfunct* 2005; Nov-Dec;16(6):497-503.

627. Fritel X, Varnoux N, Zins M, Breart G, Ringa V. Symptomatic pelvic organ prolapse at midlife, quality of life, and risk factors. *Obstet Gynecol* 2009; Mar;113(3):609-16.
628. de Boer TA, Salvatore S, Cardozo L, Chapple C, Kelleher C, van Kerrebroeck P, et al. Pelvic organ prolapse and overactive bladder. *Neurourol Urodyn* 2010;29(1):30-9.
629. Link CL, Lutfey KE, Steers WD, McKinlay JB. Is abuse causally related to urologic symptoms? Results from the Boston Area Community Health (BACH) Survey. *Eur Urol* 2007; Aug;52(2):397-406.
630. Jundt K, Scheer I, Schiessl B, Pohl K, Haertl K, Peschers UM. Physical and sexual abuse in patients with overactive bladder: is there an association?. *Int Urogynecol J Pelvic Floor Dysfunct* 2007; Apr;18(4):449-53.
631. Coyne KS, Sexton CC, Kopp ZS, Ebel-Bitoun C, Milsom I, Chapple C. The impact of overactive bladder on mental health, work productivity and health-related quality of life in the UK and Sweden: results from EpiLUTS. *BJU Int* 2011; Nov;108(9):1459-71.
632. Hullfish KL, Fenner DE, Sorser SA, Visger J, Clayton A, Steers WD. Postpartum depression, urge urinary incontinence, and overactive bladder syndrome: is there an association?. *Int Urogynecol J Pelvic Floor Dysfunct* 2007; Oct;18(10):1121-6.
633. Kupelian V, Rosen RC, Link CL, McVary KT, Aiyer LP, Mollon P, et al. Association of urological symptoms and chronic illness in men and women: contributions of symptom severity and duration--results from the BACH Survey. *J Urol* 2009; Feb;181(2):694-700.
634. Ikeda Y, Nakagawa H, Ohmori-Matsuda K, Hozawa A, Masamune Y, Nishino Y, et al. Risk factors for overactive bladder in the elderly population: a community-based study with face-to-face interview. *Int J Urol* 2011; Mar;18(3):212-8.
635. Matsumoto S, Hashizume K, Wada N, Hori J, Tamaki G, et al. Relationship between overactive bladder and irritable bowel syndrome: a large-scale internet survey in Japan using the overactive bladder symptom score and Rome III criteria. *BJU Int* 2013; Apr;111(4):647-52.
636. Persson R, Wensaas KA, Hanevik K, Eide GE, Langeland N, Rortveit G. The relationship between irritable bowel syndrome, functional dyspepsia, chronic fatigue and overactive bladder syndrome: a controlled study 6 years after acute gastrointestinal infection. *BMC Gastroenterol* 2015; Jun;15:66.
637. Matsuzaki J, Suzuki H, Fukushima Y, Hirata K, Fukuhara S, et al. High frequency of overlap between functional dyspepsia and overactive bladder. *Neurogastroenterol Motil* 2012; Sep;24(9):821-7.
638. Fayyad AM, Hill SR, Jones G. Prevalence and risk factors for bothersome lower urinary tract symptoms in women with diabetes mellitus from hospital-based diabetes clinic. *Int Urogynecol J Pelvic Floor Dysfunct* 2009; Nov;20(11):1339-44.
639. Palleschi G, Pastore AL, Maggioni C, Fuschi A, Pacini L, et al. Overactive bladder in diabetes mellitus patients: a questionnaire-based observational investigation. *World J Urol* 2014; Aug;32(4):1021-5.
640. Wen JG, Li JS, Wang ZM, Huang CX, Shang XP, et al. The prevalence and risk factors of OAB in middle-aged and old people in China. *Neurourol Urodyn* 2014; Apr;33(4):387-91.
641. Tettamanti G, Iliadou AN, Pedersen NL, Bellocco R, Altman D. Association between gestational diabetes mellitus and subsequent overactive bladder among premenopausal female twins. *BJOG* 2013; Sep;120(10):1289-95.
642. Tibaek S, Gard G, Klarskov P, Iversen HK, Dehlendorff C, Jensen R. Prevalence of lower urinary tract symptoms (LUTS) in stroke patients: a cross-sectional, clinical survey. *Neurourol Urodyn* 2008;27(8):763-71.
643. Britton JP, Dowell AC, Whelan P. Prevalence of urinary symptoms in men aged over 60. *Br J Urol* 1990; Aug;66(2):175-6.
644. Garraway WM, Collins GN, Lee RJ. High prevalence of benign prostatic hypertrophy in the community. *Lancet* 1991; Aug 24;338(8765):469-71.
645. Chute CG, Panser LA, Girman CJ, Oesterling JE, Guess HA, Jacobsen SJ, et al. The prevalence of prostatism: a population-based survey of urinary symptoms. *J Urol* 1993; Jul;150(1):85-9.
646. Sagnier PP, MacFarlane G, Richard F, Botto H, Teillac P, Boyle P. Results of an epidemiological survey using a modified American Urological Association symptom index for benign prostatic hyperplasia in France. *J Urol* 1994; May;151(5):1266-70.
647. Homma Y, Imajo C, Takahashi S, Kawabe K, Aso Y. Urinary symptoms and urodynamics in a normal elderly population. *Scand J Urol Nephrol Suppl* 1994;157:27-30.

648. Malmsten UG, Milsom I, Molander U, Norlen LJ. Urinary incontinence and lower urinary tract symptoms: an epidemiological study of men aged 45 to 99 years. *J Urol* 1997; Nov;158(5):1733-7.
649. Sommer P, Nielsen KK, Bauer T, Kristensen ES, Hermann GG, Steven K, et al. Voiding patterns in men evaluated by a questionnaire survey. *Br J Urol* 1990; Feb;65(2):155-60.
650. Brieger GM, Yip SK, Hin LY, Chung TK. The prevalence of urinary dysfunction in Hong Kong Chinese women. *Obstet Gynecol* 1996; Dec;88(6):1041-4.
651. Samuelsson E, Victor A, Tibblin G. A population study of urinary incontinence and nocturia among women aged 20-59 years. Prevalence, well-being and wish for treatment. *Acta Obstet Gynecol Scand* 1997; Jan;76(1):74-80.
652. Pinnock C, Marshall VR. Troublesome lower urinary tract symptoms in the community: a prevalence study. *Med J Aust* 1997; Jul 21;167(2):72-5.
653. van Dijk L, Kooij DG, Schellevis FG. Nocturia in the Dutch adult population. *BJU Int* 2002; Nov;90(7):644-8.
654. Rembratt A, Norgaard JP, Andersson KE. Nocturia and associated morbidity in a community-dwelling elderly population. *BJU Int* 2003; Nov;92(7):726-30.
655. Yoshimura K, Terada N, Matsui Y, Terai A, Kinukawa N, Arai Y. Prevalence of and risk factors for nocturia: Analysis of a health screening program. *Int J Urol* 2004; May;11(5):282-7.
656. Tikkinen KA, Tammela TL, Huhtala H, Auvinen A. Is nocturia equally common among men and women? A population based study in Finland. *J Urol* 2006; Feb;175(2):596-600.
657. Zhang X, Zhang J, Chen J, Zhang C, Li Q, Xu T, et al. Prevalence and Risk Factors of Nocturia and Nocturia-Related Quality of Life in the Chinese Population. *Urol Int* 2011; Jan 5;.
658. Pinnock C, Marshall VR. Troublesome lower urinary tract symptoms in the community: a prevalence study. *Med J Aust* 1997; Jul 21;167(2):72-5.
659. Muscatello DJ, Rissel C, Szonyi G. Urinary symptoms and incontinence in an urban community: prevalence and associated factors in older men and women. *Intern Med J* 2001; Apr;31(3):151-60.
660. McGrother CW, Donaldson MM, Shaw C, Matthews RJ, Hayward TA, Dallosso HM, et al. Storage symptoms of the bladder: prevalence, incidence and need for services in the UK. *BJU Int* 2004; Apr;93(6):763-9.
661. Kogan MI, Zacheval R, Ozyurt C, Schäfer T, Christensen N. Epidemiology and impact of urinary incontinence, overactive bladder, and other lower urinary tract symptoms: results of the EPIC survey in Russia, Czech Republic, and Turkey. *Curr Med Res Opin* 2014; Oct;30(10):2119-30.
662. Wang Y, Hu H, Xu K, Zhang X, Wang X, Na Y, Kang X. Prevalence, risk factors, and symptom bother of nocturia: a population-based survey in China. *World J Urol* 2015; May;33(5):677-83.
663. Wen L, Wen YB, Wang ZM, Wen J, Li ZZ, et al. Risk factors of nocturia (two or more voids per night) in Chinese people older than 40 years. *Neurourol Urodyn* 2015; Aug;34(6):566-70.
664. Parsons M, Tissot W, Cardozo L, Diokno A, Amundsen CL, Coats AC, et al. Normative bladder diary measurements: night versus day. *Neurourol Urodyn* 2007;26(4):465-73.
665. Bosch JL, Weiss JP. The prevalence and causes of nocturia. *J Urol* 2010; Aug;184(2):440-6.
666. Blanker MH, Bohnen AM, Groeneveld FP, Bernsen RM, Prins A, Ruud Bosch JL. Normal voiding patterns and determinants of increased diurnal and nocturnal voiding frequency in elderly men. *J Urol* 2000; Oct;164(4):1201-5.
667. Pesonen JS, Cartwright R, Mangera A, Santti H, Griebing TL, et al. Incidence and remission of nocturia: A systematic review and meta-analysis. *Eur Urol* 2016; Aug;70(2):372-81.
668. Lee AJ, Garraway WM, Simpson RJ, Fisher W, King D. The natural history of untreated lower urinary tract symptoms in middle-aged and elderly men over a period of five years. *Eur Urol* 1998;34:325-32.
669. Temml C, Brössner C, Schatzl G, Ponholzer A, Knoop L, Madersbacher S. The natural history of lower urinary tract symptoms over five years. *Eur Urol* 2003;43:374-80.
670. Malmsten UG, Molander U, Peeker R, Irwin DE, Milsom I. Urinary incontinence, overactive bladder, and other lower urinary tract symptoms: a longitudinal population-based survey in men aged 45-103 years. *Eur Urol* 2010;58:149-56.
671. Bulpitt CJ, Dollery CT, Carne S. Change in symptoms of hypertensive patients after referral to hospital clinic. *Br Heart J* 1976;38:121-8.
672. Møller L, Lose G, Jorgensen T. Incidence and remission rates of lower urinary tract symptoms at one year in women aged 40-60: longitudinal study. *BMJ* 2000;320:1429-32

673. Johnson TM 2nd, Sattin RW, Parmelee P, Fultz NH, Ouslander JG. Evaluating potentially modifiable risk factors for prevalent and incident nocturia in older adults. *J Am Ger Soc* 2005;53:1011.
674. Häkkinen JT, Hakama M, Shiri R, Auvinen A, Tammela TL, Koskimäki J. Incidence of nocturia in 50 to 80-year-old Finnish men. *J Urol* 2006;176:2541.
675. Chen FY, Dai YT, Liu CK, Yu HJ, Liu CY, Chen TH. Perception of nocturia and medical consulting behavior among community-dwelling women. *Int Urogynecol J Pelvic Floor Dysfunct*. 2007;18:431-6.
676. Viktrup L, Lose G. Incidence and remission of lower urinary tract symptoms during 12 years after the first delivery: a cohort study. *J Urol* 2008;180:992-7.
677. Wennberg A-L, Molander U, Fall M, Edlund C, Peeker R, Milsom I. A longitudinal population-based survey of urinary incontinence, overactive bladder, and other lower urinary tract symptoms in women. *Eur Urol* 2009;55:783-91.
678. Heidler S, Mert C, Temml C, Madersbacher S. The natural history of the overactive bladder syndrome in females: a long-term analysis of a health screening project. *Neurourol Urodyn* 2011;30:1437-41.
679. Van Doorn B, Blanker MH, Kok ET, Westers P, Bosch JL. Once nocturia, always nocturia? Natural history of nocturia in older men based on frequency-volume charts: the Krimpen study. *J Urol* 2011;186:1956-61.
680. Aoki Y, Matsuta Y, Tsuchiyama K, Matsumoto C, Kusaka Y, Yokoyama O. The association between nocturia and hypertension: a longitudinal study in Japanese men and women. *American Urological Association Annual Meeting 2012*, abstract 290.?
681. Hunter KF, Moore KN, Voaklander D, Hsu ZY. A prospective study of lower urinary tract symptoms and quality of life older women receiving home support. *International Continence Society Annual Meeting 2012*, abstract 192.
682. Hirayama A, Torimoto K, Mastusita C et al. Evaluation of factors influencing the natural history of nocturia in elderly subjects: results of the Fujiwara-kyo Study. *J Urol* 2013;189:980-6.
683. Araujo AB, Yaggi HK, Yang M, McVary KT, Fang SC, Bliwise D. Sleep related problems and urological symptoms: testing the hypothesis of bidirectionality in a longitudinal, population based study. *J Urol* 2014;191:100-6.
684. Madhu C, Coyne K, Hashim H, Chapple C, Milson I, Kopp Z. Nocturia: risk factors and associated comorbidities; findings from the EpiLUTS study. *Int J Clin Pract*. 2015; Dec;69(12):1508-16.
685. Asplund R, Aberg HE. Nocturia in relation to body mass index, smoking and some other lifestyle factors in women. *Climacteric* 2004; Sep;7(3):267-73.
686. Tikkinen KA, Auvinen A, Huhtala H, Tammela TL. Nocturia and obesity: a population-based study in Finland. *Am J Epidemiol* 2006; Jun;163(11):1003-11.
687. Fitzgerald MP, Litman HJ, Link CL, McKinlay JB, BACH Survey Investigators. The association of nocturia with cardiac disease, diabetes, body mass index, age and diuretic use: results from the BACH survey. *J Urol* 2007; Apr;177(4):1385-9.
688. Laven BA, Orsini N, Andersson SO, Johansson JE, Gerber GS, Wolk A. Birth weight, abdominal obesity and the risk of lower urinary tract symptoms in a population based study of Swedish men. *J Urol* 2008; May;179(5):1891,5; discussion 1895-6.
689. Bing MH, Moller LA, Jennum P, Mortensen S, Lose G. Nocturia and associated morbidity in a Danish population of men and women aged 60-80 years. *BJU Int* 2008 Sep;102(7):808-14; discussion 814-5.
690. Burgio KL, Johnson TM, 2nd, Goode PS, Markland AD, Richter HE, Roth DL, et al. Prevalence and correlates of nocturia in community-dwelling older adults. *J Am Geriatr Soc* 2010; May;58(5):861-6.
691. Sarici H, Telli O, Ozgür BC, Doluoglu OG, Eroglu M, Bozkurt S. A population-based study of factors associated with nocturia in reproductive-aged Turkish women. *Korean J Urol* 2014; Jun;55(6):405-10.
692. Zhang L, Zhu L, Xu T, Lang J, Li Z, Gong J, Liu Q, Liu X. A population-based survey of the prevalence, potential risk factors, and symptom-specific bother of lower urinary tract symptoms in adult Chinese women. *Eur Urol* 2015; Jul;68(1):97-112.
693. Shiri R, Hakama M, Häkkinen J, Auvinen A, Huhtala H, Tammela TL, et al. The effects of lifestyle factors on the incidence of nocturia. *J Urol* 2008; Nov;180(5):2059-62.
694. Yoshimura K, Kamoto T, Tsukamoto T, Oshiro K, Kinukawa N, Ogawa O. Seasonal alterations in nocturia and other storage symptoms in three Japanese communities. *Urology* 2007; May;69(5):864-70.

695. Hsieh CH, Chen HY, Hsu CS, Chang ST, Chiang CD. Risk factors for nocturia in Taiwanese women aged 20-59 years. *Taiwan J Obstet Gynecol* 2007; Jun;46(2):166-70.
696. Tikkinen KA, Auvinen A, Johnson TM, 2nd, Weiss JP, Keranen T, Tiitinen A, et al. A systematic evaluation of factors associated with nocturia--the population-based FINNO study. *Am J Epidemiol* 2009; Aug 1;170(3):361-8.
697. Klein BE, Klein R, Lee KE, Bruskwitz RC. Correlates of urinary symptom scores in men. *Am J Public Health* 1999; Nov;89(11):1745-8.
698. Kang D, Andriole GL, Van De Vooren RC, Crawford D, Chia D, Urban DA, et al. Risk behaviours and benign prostatic hyperplasia. *BJU Int* 2004; Jun;93(9):1241-5.
699. Gourova LW, van de Beek C, Spigt MG, Nieman FH, van Kerrebroeck PE. Predictive factors for nocturia in elderly men: a cross-sectional study in 21 general practices. *BJU Int* 2006; Mar;97(3):528-32.
700. Platz EA, Kawachi I, Rimm EB, Colditz GA, Stampfer MJ, Willett WC, et al. Physical activity and benign prostatic hyperplasia. *Arch Intern Med* 1998; Nov 23;158(21):2349-56.
701. Prezioso D, Catuogno C, Galassi P, D'Andrea G, Castello G, Pirritano D. Life-style in patients with LUTS suggestive of BPH. *Eur Urol* 2001;40 Suppl 1:9-12.
702. Rohrmann S, Crespo CJ, Weber JR, Smit E, Giovannucci E, Platz EA. Association of cigarette smoking, alcohol consumption and physical activity with lower urinary tract symptoms in older American men: findings from the third National Health And Nutrition Examination Survey. *BJU Int* 2005; Jul;96(1):77-82.
703. Soda T, Masui K, Okuno H, Terai A, Ogawa O, Yoshimura K. Efficacy of nondrug lifestyle measures for the treatment of nocturia. *J Urol* 2010; Sep;184(3):1000-4.
704. Gopal M, Sammel MD, Pien G, Gracia C, Freeman EW, Lin H, et al. Investigating the associations between nocturia and sleep disorders in perimenopausal women. *J Urol* 2008; Nov;180(5):2063-7.
705. Kupelian V, Link CL, Hall SA, McKinlay JB. Are Racial/Ethnic Disparities in the Prevalence of Nocturia Due to Socioeconomic Status? Results of the BACH Survey. *J Urol* 2009; Feb 20;.
706. Markland AD, Vaughan CP, Johnson TM, 2nd, Goode PS, Redden DT, Burgio KL. Prevalence of nocturia in United States men: Results from the National Health and Nutrition Examination Survey. *J Urol* 2011; Mar;185(3):998-1002.
707. Munro-Faure AD, Beilin LJ, Bulpitt CJ, Coles EC, Dollery CT, Gear JS, et al. Comparison of black and white patients attending hypertension clinics in England. *Br Med J* 1979; Apr 21;1(6170):1044-7.
708. Sze EH, Jones WP, Ferguson JL, Barker CD, Dolezal JM. Prevalence of urinary incontinence symptoms among black, white, and Hispanic women. *Obstet Gynecol* 2002; Apr;99(4):572-5.
709. Lukacz ES, Whitcomb EL, Lawrence JM, Nager CW, Luber KM. Urinary frequency in community-dwelling women: what is normal?. *Am J Obstet Gynecol* 2009; May;200(5):552.e1,552.e7.
710. Hsu A, Nakagawa S, Walter LC, Van Den Eeden SK, Brown JS, et al. The burden of nocturia among middle-aged and older women. *Obstet Gynecol* 2015; Jan;125(1):35-43.
711. Kuo HC. Prevalence of lower urinary tract symptoms in male aborigines and non-aborigines in eastern Taiwan. *J Formos Med Assoc* 2008; Sep;107(9):728-35.
712. Mariappan P, Turner KJ, Sothilingam S, Rajan P, Sundram M, Stewart LH. Nocturia, nocturia indices and variables from frequency-volume charts are significantly different in Asian and Caucasian men with lower urinary tract symptoms: a prospective comparison study. *BJU Int* 2007; Aug;100(2):332-6.
713. Parboosingh J, Doig A. Studies of nocturia in normal pregnancy. *J Obstet Gynaecol Br Commonw* 1973; Oct;80(10):888-95.
714. Sharma JB, Aggarwal S, Singhal S, Kumar S, Roy KK. Prevalence of urinary incontinence and other urological problems during pregnancy: a questionnaire based study. *Arch Gynecol Obstet* 2009; Jun;279(6):845-51.
715. Asplund R, Aberg HE. Development of nocturia in relation to health, age and the menopause. *Maturitas* 2005; Aug 16;51(4):358-62.
716. Lose G, Alling-Moller L, Jennum P. Nocturia in women. *Am J Obstet Gynecol* 2001; Aug;185(2):514-21.
717. Lin TL, Ng SC, Chen YC, Hu SW, Chen GD. What affects the occurrence of nocturia more: menopause or age?. *Maturitas* 2005; Feb 14;50(2):71-7.
718. Cardozo L, Rekers H, Tapp A, Barnick C, Shepherd A, Schussler B, et al. Oestriol in the treatment of postmenopausal urgency: a multicentre study. *Maturitas* 1993; Dec;18(1):47-53.

719. Liapis A, Bakas P, Georgantopoulou C, Creatsas G. The use of oestradiol therapy in postmenopausal women after TVT-O anti-incontinence surgery. *Maturitas* 2010; May;66(1):101-6.
720. Yu HJ, Chen TH, Chie WC, Liu CY, Tung TH, Huang SW. Prevalence and associated factors of nocturia among adult residents of the Matsu area of Taiwan. *J Formos Med Assoc* 2005; Jun;104(6):444-7.
721. Homma Y, Yamaguchi T, Kondo Y, Horie S, Takahashi S, Kitamura T. Significance of nocturia in the International Prostate Symptom Score for benign prostatic hyperplasia. *J Urol* 2002; Jan;167(1):172-6.
722. Yoshimura K, Ohara H, Ichioka K, Terada N, Matsui Y, Terai A, et al. Nocturia and benign prostatic hyperplasia. *Urology* 2003; Apr;61(4):786-90.
723. Bruskevitz RC, Larsen EH, Madsen PO, Dorflinger T. 3-Year Followup of Urinary Symptoms After Transurethral Resection of the Prostate. *J Urol* 1986; Sep;136(3):613-5.
724. Johnson TM, 2nd, Burrows PK, Kusek JW, Nyberg LM, Tenover JL, Lepor H, et al. The effect of doxazosin, finasteride and combination therapy on nocturia in men with benign prostatic hyperplasia. *J Urol* 2007; Nov;178(5):2045,50; discussion 2050-1.
725. Brown CT, O'Flynn E, Van Der Meulen J, Newman S, Mundy AR, Emberton M. The fear of prostate cancer in men with lower urinary tract symptoms: should symptomatic men be screened?. *BJU Int* 2003; Jan;91(1):30-2.
726. Young JM, Muscatello DJ, Ward JE. Are men with lower urinary tract symptoms at increased risk of prostate cancer? A systematic review and critique of the available evidence. *BJU Int* 2000; Jun;85(9):1037-48.
727. Martin RM, Vatten L, Gunnell D, Romundstad P, Nilsen TI. Lower urinary tract symptoms and risk of prostate cancer: the HUNT 2 Cohort, Norway. *Int J Cancer* 2008; Oct 15;123(8):1924-8.
728. Damber JE, Aus G. Prostate cancer. *Lancet* 2008; May 17;371(9625):1710-21.
729. Sanda MG, Dunn RL, Michalski J, Sandler HM, Northouse L, Hembroff L, et al. Quality of life and satisfaction with outcome among prostate-cancer survivors. *N Engl J Med* 2008; Mar 20;358(12):1250-61.
730. Namiki S, Saito S, Ishidoya S, Tochigi T, Ioritani N, Yoshimura K, et al. Adverse effect of radical prostatectomy on nocturia and voiding frequency symptoms. *Urology* 2005; Jul;66(1):147-51.
731. Namiki S, Ishidoya S, Saito S, Satoh M, Tochigi T, Ioritani N, et al. Natural history of voiding function after radical retropubic prostatectomy. *Urology* 2006; Jul;68(1):142-7.
732. Hofmeester I, Kollen BJ, Steffens MG, Bosch JL, Drake MJ, et al. The association between nocturia and nocturnal polyuria in clinical and epidemiological studies: a systematic review and meta-analyses. *J Urol* 2014; Apr;191(4):1028-33.
733. Blanker MH, Bernsen RM, Ruud Bosch JL, Thomas S, Groeneveld FP, Prins A, et al. Normal values and determinants of circadian urine production in older men: a population based study. *J Urol* 2002; Oct;168(4 Pt 1):1453-7.
734. Asplund R. Nocturia in relation to sleep, somatic diseases and medical treatment in the elderly. *BJU Int* 2002; Oct;90(6):533-6.
735. Lee WC, Wu HP, Tai TY, Liu SP, Chen J, Yu HJ. Effects of diabetes on female voiding behavior. *J Urol* 2004; Sep;172(3):989-92.
736. Fitzgerald MP, Mulligan M, Parthasarathy S. Nocturic frequency is related to severity of obstructive sleep apnea, improves with continuous positive airways treatment. *Am J Obstet Gynecol* 2006; May;194(5):1399-403.
737. Sarma AV, Burke JP, Jacobson DJ, McGree ME, St Sauver J, Girman CJ, et al. Associations between diabetes and clinical markers of benign prostatic hyperplasia among community-dwelling Black and White men. *Diabetes Care* 2008; Mar;31(3):476-82.
738. McKeigue PM, Reynard JM. Relation of nocturnal polyuria of the elderly to essential hypertension. *Lancet* 2000; Feb 5;355(9202):486-8.
739. Hall SA, Chiu GR, Kaufman DW, Wittert GA, Link CL, McKinlay JB. Commonly used antihypertensives and lower urinary tract symptoms: results from the Boston Area Community Health (BACH) Survey. *BJU Int* 2011; Sep 27;.
740. Bulpitt CJ, Connor M, Schulte M, Fletcher AE. Bisoprolol and nifedipine retard in elderly hypertensive patients: effect on quality of life. *J Hum Hypertens* 2000; Mar;14(3):205-12.
741. Reynard JM, Cannon A, Yang Q, Abrams P. A novel therapy for nocturnal polyuria: a double-blind randomized trial of frusemide against placebo. *Br J Urol* 1998; Feb;81(2):215-8.

742. Asplund R, Johansson S, Henriksson S, Isacson G. Nocturia, depression and antidepressant medication. *BJU Int* 2005; Apr;95(6):820-3.
743. Hakkinen JT, Shiri R, Koskimaki J, Tammela TL, Auvinen A, Hakama M. Depressive symptoms increase the incidence of nocturia: Tampere Aging Male Urologic Study (TAMUS). *J Urol* 2008; May;179(5):1897-901.
744. Krieger J, Petiau C, Sforza E, Delanoe C, Hecht MT, Chamouard V. Nocturnal pollakiuria is a symptom of obstructive sleep apnea. *Urol Int* 1993;50(2):93-7.
745. Pressman MR, Figueroa WG, Kendrick-Mohamed J, Greenspon LW, Peterson DD. Nocturia. A rarely recognized symptom of sleep apnea and other occult sleep disorders. *Arch Intern Med* 1996; Mar 11;156(5):545-50.
746. Lowenstein L, Kenton K, Brubaker L, Pillar G, Undevia N, Mueller ER, et al. The relationship between obstructive sleep apnea, nocturia, and daytime overactive bladder syndrome in women. *Am J Obstet Gynecol* 2008; May;198(5):598.e1,598.e5.
747. Zebede S, Lovatsis D, Alarab M, Drutz H. Prevalence of obstructive sleep apnea detected by the Berlin Questionnaire in patients with nocturia attending a urogynecology unit. *Int Urogynecol J* 2015; Jun;26(6):881-5.
748. Endeshaw Y. Correlates of self-reported nocturia among community-dwelling older adults. *J Gerontol A Biol Sci Med Sci* 2009; Jan;64(1):142-8.
749. Umlauf MG, Chasens ER, Greevy RA, Arnold J, Burgio KL, Pillion DJ. Obstructive sleep apnea, nocturia and polyuria in older adults. *Sleep* 2004; Feb 1;27(1):139-44.
750. Kinn AC, Harlid R. Snoring as a cause of nocturia in men with lower urinary tract symptoms. *Eur Urol* 2003; Jun;43(6):696-701.
751. Compston A, Coles A. Multiple sclerosis. *Lancet* 2002; Apr 6;359(9313):1221-31.
752. DasGupta R, Fowler CJ. Bladder, bowel and sexual dysfunction in multiple sclerosis: management strategies. *Drugs* 2003;63(2):153-66.
753. Chung MS, Chuang YC, Lee JJ, Lee WC, Chancellor MB, Liu RT. Prevalence and associated risk factors of nocturia and subsequent mortality in 1,301 patients with type 2 diabetes. *Int Urol Nephrol* 2014; Jul;46(7):1269-75.
754. Young A, Home M, Churchward T, Freezer N, Holmes P, Ho M. Comparison of sleep disturbance in mild versus severe Parkinson's disease. *Sleep* 2002; Aug 1;25(5):573-7.
755. Bump, R. C., Mattiasson, A., Bo, K. et al.: The standardization of terminology of female pelvic organ prolapse and pelvic floor dysfunction. *Am J Obstet Gynecol*, 175: 10, 1996.
756. Hall, A. F., Theofrastous, J. P., Cundiff, G. W. et al.: Interobserver and intraobserver reliability of the proposed International Continence Society, Society of Gynecologic Surgeons, and American Urogynecologic Society pelvic organ prolapse classification system. *Am J Obstet Gynecol*, 175: 1467, 1996.
757. Weber, A. M., Abrams, P., Brubaker, L. et al.: The standardization of terminology for researchers in female pelvic floor disorders. *Int Urogynecol J Pelvic Floor Dysfunct*, 12: 178, 2001.
758. Ellerkmann, R. M., Cundiff, G. W., Melick, C. F. et al.: Correlation of symptoms with location and severity of pelvic organ prolapse. *Am J Obstet Gynecol*, 185: 1332, 2001.
759. Lukacz, E. S., Lawrence, J. M., Buckwalter, J. G. et al.: Epidemiology of prolapse and incontinence questionnaire: validation of a new epidemiologic survey. *Int Urogynecol J Pelvic Floor Dysfunct*, 16: 272, 2005.
760. Ghetti, C., Gregory, W. T., Edwards, S. R. et al.: Pelvic organ descent and symptoms of pelvic floor disorders. *Am J Obstet Gynecol*, 193: 53, 2005.
761. Swift, S. E.: The distribution of pelvic organ support in a population of female subjects seen for routine gynecologic health care. *Am J Obstet Gynecol*, 183: 277, 2000.
762. Hendrix, S. L., Clark, A., Nygaard, I. et al.: Pelvic organ prolapse in the Women's Health Initiative: gravity and gravidity. *Am J Obstet Gynecol*, 186: 1160, 2002.
763. Handa, V. L., Garrett, E., Hendrix, S. et al.: Progression and remission of pelvic organ prolapse: a longitudinal study of menopausal women. *Am J Obstet Gynecol*, 190: 27, 2004.
764. Lawrence, J. M., Lukacz, E. S., Nager, C. W. et al.: Prevalence and co-occurrence of pelvic floor disorders in community-dwelling women. *Obstet Gynecol*, 111: 678, 2008.
765. Bradley, C. S., Zimmerman, M. B., Qi, Y. et al.: Natural history of pelvic organ prolapse in postmenopausal women. *Obstet Gynecol*, 109: 848, 2007.
766. Nygaard, I., Bradley, C., Brandt, D.: Pelvic organ prolapse in older women: prevalence and risk factors. *Obstet Gynecol*, 104: 489, 2004.
767. Tegerstedt, G., Hammarstrom, M.: Operation for pelvic organ prolapse: a follow-up study. *Acta Obstet Gynecol Scand*, 83: 758, 2004.

768. Rortveit, G., Brown, J. S., Thom, D. H. et al.: Symptomatic pelvic organ prolapse: prevalence and risk factors in a population-based, racially diverse cohort. *Obstet Gynecol*, 109: 1396, 2007.
769. Eva, U. F., Gun, W., Preben, K.: Prevalence of urinary and fecal incontinence and symptoms of genital prolapse in women. *Acta Obstet Gynecol Scand*, 82: 280, 2003.
770. Samuelsson, E. C., Victor, F. T., Tibblin, G. et al.: Signs of genital prolapse in a Swedish population of women 20 to 59 years of age and possible related factors. *Am J Obstet Gynecol*, 180: 299, 1999.
771. Kumari, S., Walia, I., Singh, A.: Self-reported uterine prolapse in a resettlement colony of north India. *J Midwifery Womens Health*, 45: 343, 2000.
772. MacLennan, A. H., Taylor, A. W., Wilson, D. H. et al.: The prevalence of pelvic floor disorders and their relationship to gender, age, parity and mode of delivery. *BJOG*, 107: 1460, 2000.
773. Raza-Khan F1, Cunkelman J, Lowenstein L, Shott S, Kenton K. Prevalence of bowel symptoms in women with pelvic floor disorders. *Int Urogynecol J*. 2010 Aug;21(8):933-8. doi: 10.1007/s00192-010-1143-z. Epub 2010 May 7.
774. Peppas G, Alexiou VG, Mourtzoukou E, Falagas ME. Epidemiology of constipation in Europe and Oceania: a systematic review. *BMC Gastroenterol*. 2008 Feb 12;8:5. doi: 10.1186/1471-230X-8-5. Review.
775. Jelovsek JE, Barber MD, Paraiso MF, Walters MD. Functional bowel and anorectal disorders in patients with pelvic organ prolapse and incontinence. *Am J Obstet Gynecol* 2005;193:2105-11.
776. Kahn MA, Breitkopf CR, Valley MT, Woodman PJ, O'Boyle AL, Bland DI, Schaffer JI, Grady JJ, Swift SE. Pelvic Organ Support Study (POSST) and bowel symptoms: straining at stool is associated with perineal and anterior vaginal descent in a general gynecologic population. *Am J Obstet Gynecol* 2005;192:1516-22.
777. Morgan DM, DeLancey JO, Guire KE, Fenner DE. Symptoms of anal incontinence and difficult defecation among women with prolapse and a matched control cohort. *Am J Obstet Gynecol* 2007;197:509 e1-6.
778. Snooks SJ, Barnes PR, Swash M, Henry MM. Damage to the innervation of the pelvic floor musculature in chronic constipation. *Gastroenterology*. 1985;89:977-81.
779. Lembo A, Camilleri M. Chronic constipation. *N Engl J Med* 2003;349:1360-8.
780. Spence-Jones C, Kamm MA, Henry MM, Hudson CN. Bowel dysfunction: a pathogenic factor in uterovaginal prolapse and urinary stress incontinence. *Br J Obstet Gynaecol* 1994;101:147-52.
781. Arya LA, Novi JM, Shaunik A, Morgan MA, Bradley CS. Pelvic organ prolapse, constipation, and dietary fiber intake in women: a case-control study. *Am J Obstet Gynecol* 2005;192:1687-91.
782. Varma MG, Hart SL, Brown JS, Creasman JM, Van Den Eeden SK, Thom DH. Obstructive Defecation in Middle-aged Women. *Dig Dis Sci* 2008.
783. Tegerstedt G, Maehle-Schmidt M, Nyren O, Hammarstrom M. Prevalence of symptomatic pelvic organ prolapse in a Swedish population. *Int Urogynecol J Pelvic Floor Dysfunct* 2005;16:497-503.
784. Bradley CS, Kennedy CM, Nygaard IE. Pelvic floor symptoms and lifestyle factors in older women. *J Womens Health (Larchmt)* 2005;14:128-36.
785. Akter F, Gartoulla P, Oldroyd J, Islam RM. Prevalence of, and risk factors for, symptomatic pelvic organ prolapse in Rural Bangladesh: a cross-sectional survey study. *Int Urogynecol J*. 2016 Nov;27(11):1753-1759.
786. Yoshioka K, Matsui Y, Yamada O, Sakaguchi M, Takada H, Hioki K, Yamamoto M, Kitada M, Sawaragi I. Physiologic and anatomic assessment of patients with rectocele. *Diseases of the Colon & Rectum*. 1991;34:704-8.
787. Kelvin FM, Maglinte DD, Hornback JA, Benson JT. Pelvic prolapse: assessment with evacuation proctography (defecography)[comment]. *Radiology*. 1992;184:547-51.
788. Altman D, Lopez A, Kierkegaard J, Zetterstrom J, Falconer C, Pollack J, Mellgren A. Assessment of posterior vaginal wall prolapse: comparison of physical findings to cystodefecoperitoneography. *Int Urogynecol J Pelvic Floor Dysfunct* 2005;16:96-103; discussion 103.
789. Weber AM, Walters MD, Ballard LA, Booher DL, Piedmonte MR. Posterior vaginal prolapse and bowel function. *American Journal of Obstetrics & Gynecology*. 1998;179:1446-9; discussion 1449-50.
790. Bradley CS, Brown MB, Cundiff GW, Goode PS, Kenton KS, Nygaard IE, Whitehead WE, Wren PA, Weber AM. Bowel symptoms in women planning surgery for pelvic organ prolapse. *Am J Obstet Gynecol* 2006.

791. Klingele CJ, Bharucha AE, Fletcher JG, Gebhart JB, Riederer SG, Zinsmeister AR. Pelvic organ prolapse in defecatory disorders. *Obstet Gynecol* 2005;106:315-20.
792. Saks EK, Harvie HS, Asfaw TS, Arya LA. Clinical significance of obstructive defecatory symptoms in women with pelvic organ prolapse. *Int J Gynaecol Obstet*. 2010 Dec;111(3):237-40. doi: 10.1016/j.ijgo.2010.06.025.
793. Wang J, Varma MG, Creasman JM, Subak LL, Brown JS, Thom DH, van den Eeden SK. Pelvic floor disorders and quality of life in women with self-reported irritable bowel syndrome. *Aliment Pharmacol Ther*. 2010 Feb 1;31(3):424-31. doi: 10.1111/j.1365-2036.2009.04180.x.
794. Mellgren A, López A, Schultz I, Anzén B. Rectocele is associated with paradoxical anal sphincter reaction. *Int J Colorectal Dis*. 1998;13(1):13-6.
795. Altman D, Falconer C, Cnattingius S, Granath F. Pelvic organ prolapse surgery following hysterectomy on benign indications. *Am J Obstet Gynecol*. 2008 May;198(5):572.e1-6. doi: 10.1016/j.ajog.2008.01.012. Epub 2008 Mar 20.
796. Cooper K, Lee A, Chien P, Raja E, Timmaraju V, Bhattacharya S. Outcomes following hysterectomy or endometrial ablation for heavy menstrual bleeding: retrospective analysis of hospital episode statistics in Scotland. *BJOG*. 2011 Sep;118(10):1171-9. doi: 10.1111/j.1471-0528.2011.03011.x.
797. Mant J, Painter R, Vessey M. Epidemiology of genital prolapse: observations from the Oxford Family Planning Association Study. *Br J Obstet Gynaecol*, 104: 579, 1997.
798. Lykke R, Blaakær J, Ottesen B, Gimbel H. The indication for hysterectomy as a risk factor for subsequent pelvic organ prolapse repair. *Int Urogynecol J*. 2015 Nov;26(11):1661-5. doi: 10.1007/s00192-015-2757-y.
799. Swift SE, Pound T, Dias JK. Case-control study of etiologic factors in the development of severe pelvic organ prolapse. *Int Urogynecol J Pelvic Floor Dysfunct* 2001;12:187-92.
800. Swift SE. The distribution of pelvic organ support in a population of female subjects seen for routine gynecologic health care. *Am J Obstet Gynecol* 2000;183:277-85.
801. Dallenbach P, Kaelin-Gambirasio I, Dubuisson JB, Boulvain M. Risk factors for pelvic organ prolapse repair after hysterectomy. *Obstet Gynecol* 2007;110:625-32.
802. Forsgren C, Zetterstrom J, Lopez A, Nordenstam J, Anzen B, Altman D. Effects of hysterectomy on bowel function: a three-year, prospective cohort study. *Dis Colon Rectum* 2007;50:1139-45.
803. DeLancey JO. Anatomic aspects of vaginal eversion after hysterectomy. *Am J Obstet Gynecol* 1992;166:1717-28.
804. Marchionni M, Bracco GL, Checcucci V, Carabaneau A, Coccia EM, Mecacci F, Scarselli G. True incidence of vaginal vault prolapse. Thirteen years of experience. *J Reprod Med* 1999;44:679-84.
805. Forsgren C1, Lundholm C, Johansson AL, Cnattingius S, Zetterström J, Altman D. Vaginal hysterectomy and risk of pelvic organ prolapse and stress urinary incontinence surgery. *Int Urogynecol J*. 2012 Jan;23(1):43-8. doi: 10.1007/s00192-011-1523-z. Epub 2011 Aug 18.
806. Altman D, Zetterstrom J, Schultz I, Nordenstam J, Hjern F, Lopez A, Mellgren A. Pelvic organ prolapse and urinary incontinence in women with surgically managed rectal prolapse: a population-based case-control study. *Dis Colon Rectum* 2006;49:28-35.
807. Moalli PA, Jones Ivy S, Meyn LA, Zyczynski HM. Risk factors associated with pelvic floor disorders in women undergoing surgical repair. *Obstet Gynecol* 2003;101:869-74.
808. Wiskind AK, Creighton SM, Stanton SL. The incidence of genital prolapse after the Burch colposuspension. *Am J Obstet Gynecol* 1992;167:399-404; discussion 404-5.
809. Kjolhede P. Genital prolapse in women treated successfully and unsuccessfully by the Burch colposuspension. *Acta Obstet Gynecol Scand* 1998;77:444-50.
810. Denman M, Gregory W, Boyles S, Smith V, Edwards S, Clark A. Reoperation 10 years after surgically managed pelvic organ prolapse and urinary incontinence. *Am J Obstet Gynecol* 2008;198:555.e1-5.
811. O'Boyle AL, Woodman PJ, O'Boyle JD, Davis GD, Swift SE. Pelvic organ support in nulliparous pregnant and nonpregnant women: a case control study. *Am J Obstet Gynecol* 2002;187:99-102.
812. Sze EH, Sherard GB, 3rd, Dolezal JM. Pregnancy, labor, delivery, and pelvic organ prolapse. *Obstet Gynecol* 2002;100:981-6.
813. Sze EH, Jones WP, Ferguson JL, Barker CD, Dolezal JM. Prevalence of urinary incontinence symptoms among black, white, and Hispanic women. *Obstet Gynecol* 2002;99:572-5.

814. Carley ME, Turner RJ, Scott DE, Alexander JM. Obstetric history in women with surgically corrected adult urinary incontinence or pelvic organ prolapse. *Journal of the American Association of Gynecologic Laparoscopists* 1999;6:85-9.
815. Lukacz ES, Lawrence JM, Contreras R, Nager CW, Lubner KM. Parity, mode of delivery, and pelvic floor disorders. *Obstet Gynecol* 2006;107:1253-60.
816. Uma R, Libby G, Murphy DJ. Obstetric management of a woman's first delivery and the implications for pelvic floor surgery in later life. *Bjog* 2005;112:1043-6.
817. Tegerstedt G, Miedel A, Maehle-Schmidt M, Nyren O, Hammarstrom M. Obstetric risk factors for symptomatic prolapse: a population-based approach. *Am J Obstet Gynecol* 2006;194:75-81.
818. Fritel X, Varnoux N, Zins M, Breart G, Ringa V. Symptomatic pelvic organ prolapse at midlife, quality of life, and risk factors. *Obstet Gynecol*. 2009 Mar;113(3):609-16.
819. Gyhagen M, Bullarbo M, Nielsen TF, Milsom I. Prevalence and risk factors for pelvic organ prolapse 20 years after childbirth: a national cohort study in singleton primiparae after vaginal or caesarean delivery. *BJOG*. 2013 Jan;120(2):152-60.
820. Glazener C, Elders A, Macarthur C, Lancashire RJ, Herbison P, Hagen S, Dean N, Bain C, Toozs-Hobson P, Richardson K, McDonald A, McPherson G, Wilson D; ProLong Study Group. Childbirth and prolapse: long-term associations with the symptoms and objective measurement of pelvic organ prolapse. *BJOG*. 2013 Jan;120(2):161-8.
821. Quiroz LH1, Muñoz A, Shippey SH, Gutman RE, Handa VL. Vaginal parity and pelvic organ prolapse. *J Reprod Med*. 2010 Mar-pr;55(3-4):93-8.
822. Chiaffarino F, Chatenoud L, Dindelli M, Meschia M, Buonaguidi A, Amicarelli F, Surace M, Bertola E, Di Cintio E, Parazzini F. Reproductive factors, family history, occupation and risk of urogenital prolapse. *European Journal of Obstetrics, Gynecology, & Reproductive Biology* 1999;82:63-7.
823. Leijonhufvud Å, Lundholm C, Cnattingius S, Granath F, Andolf E, Altman D. Risk of surgically managed pelvic floor dysfunction in relation to age at first delivery. *Am J Obstet Gynecol*. 2012 Oct;207(4):303.e1-7.
824. Volløyhaug I, Mørkved S, Salvesen Ø, Salvesen K. Pelvic organ prolapse and incontinence 15-23 years after first delivery: a cross-sectional study. *BJOG*. 2015 Jun;122(7):964-71.
825. MacLennan AH, Taylor AW, Wilson DH, Wilson D. The prevalence of pelvic floor disorders and their relationship to gender, age, parity and mode of delivery. *BJOG: an International Journal of Obstetrics & Gynaecology* 2000;107:1460-70.
826. Risk factors for genital prolapse in non-hysterectomized women around menopause. Results from a large cross-sectional study in menopausal clinics in Italy. Progetto Menopausa Italia Study Group. *Eur J Obstet Gynecol Reprod Biol* 2000;93:135-40.
827. Handa VL1, Blomquist JL, Knoepp LR, Hoskey KA, McDermott KC, Muñoz A. Pelvic floor disorders 5-10 years after vaginal or cesarean childbirth. *Obstet Gynecol*. 2011 Oct;118(4):777-84.
828. Moalli PA, Jones Ivy S, Meyn LA, Zyczynski HM. Risk factors associated with pelvic floor disorders in women undergoing surgical repair. *Obstet Gynecol* 2003;101:869-74.
829. Carley ME, Schaffer J. Urinary incontinence and pelvic organ prolapse in women with Marfan or Ehlers Danlos syndrome. *American Journal of Obstetrics & Gynecology*. 2000;182:1021-3.
830. McIntosh LJ, Mallett VT, Frahm JD, Richardson DA, Evans MI. Gynecologic disorders in women with Ehlers-Danlos syndrome. *J Soc Gynecol Investig* 1995;2:559-64.
831. Scherf C, Morison L, Fiander A, Ekpo G, Walraven G. Epidemiology of pelvic organ prolapse in rural Gambia, West Africa. *BJOG* 2002;109:431-6.
832. Lind LR, Lucente V, Kohn N. Thoracic kyphosis and the prevalence of advanced uterine prolapse. *Obstet Gynecol* 1996;87:605-9.
833. Nguyen JK, Lind LR, Choe JY, McKindsey F, Sinow R, Bhatia NN. Lumbosacral spine and pelvic inlet changes associated with pelvic organ prolapse. *Obstet Gynecol* 2000;95:332-6.
834. Marshman D, Percy J, Fielding I, Delbridge L. Rectal prolapse: relationship with joint mobility. *Australian & New Zealand Journal of Surgery* 1987;57:827-9.
835. Norton PA, Baker JE, Sharp HC, Warenski JC. Genitourinary prolapse and joint hypermobility in women. *Obstetrics & Gynecology*. 1995;85:225-8.

836. Pandey S1, Bhattacharya S. Impact of obesity on gynecology. *Womens Health (Lond)*. 2010 Jan;6(1):107-17.
837. Washington BB, Erekson EA, Kassis NC, Myers DL. The association between obesity and stage II or greater prolapse. *Am J Obstet Gynecol*. 2010 May;202(5):503.e1-4.
838. Samuelsson EC, Arne Victor FT, Tibblin G, Svardsudd KF. Signs of genital prolapse in a Swedish population of women 20 to 59 years of age and possible related factors. *American Journal of Obstetrics & Gynecology* 1999;180:299-305.
839. Forsman M, Iliadou A, Magnusson P, Falconer C, Altman D. Diabetes and obesity-related risks for pelvic reconstructive surgery in a cohort of Swedish twins. *Diabetes Care*. 2008 Oct;31(10):1997-9.
840. Strinic T, Eterovic D, Dujic Z, Markovic V, Tocilj J. Spirometric disorders in women with genital descensus. *Acta Obstet Gynecol Scand* 1997;76:879-83.
841. Rogowski A, Bienkowski P, Tarwacki D, Dziech E, Samochowiec J, Jerzak M, Baranowski W. Association between metabolic syndrome and pelvic organ prolapse severity. *Int Urogynecol J*. 2015 Apr;26(4):563-8.
842. Nygaard I, Bradley C, Brandt D. Pelvic organ prolapse in older women: prevalence and risk factors. *Obstet Gynecol* 2004;104:489-97.
843. Woodman PJ, Swift SE, O'Boyle AL, Valley MT, Bland DR, Kahn MA, Schaffer JI. Prevalence of severe pelvic organ prolapse in relation to job description and socioeconomic status: a multi-center cross-sectional study. *Int Urogynecol J Pelvic Floor Dysfunct* 2006;17:340-5.
844. Strinic T, Bukovic D, Roje D, Milic N, Pavic M, Turcic P. Epidemiology of pelvic floor disorders between urban and rural female inhabitants. *Coll Antropol* 2007;31:483-7.
845. Walker GJ, Gunasekera P. Pelvic organ prolapse and incontinence in developing countries: review of prevalence and risk factors. *Int Urogynecol J*. 2011 Feb;22(2):127-35.
846. Megabiaw B1, Adefris M, Rortveit G, Degu G, Muleta M, Blystad A, Kiserud T, Melese T, Kebede Y. Pelvic floor disorders among women in Dabat district, northwest Ethiopia: a pilot study. *Int Urogynecol J*. 2013 Jul;24(7):1135-43.
847. Jorgensen S, Hein HO, Gyntelberg F. Heavy lifting at work and risk of genital prolapse and herniated lumbar disc in assistant nurses. *Occup Med (Lond)* 1994;44:47-9.
848. Woodman PJ, Swift SE, O'Boyle AL, Valley MT, Bland DR, Kahn MA, Schaffer JI. Prevalence of severe pelvic organ prolapse in relation to job description and socioeconomic status: a multi-center cross-sectional study. *Int Urogynecol J Pelvic Floor Dysfunct* 2006;17:340-5.
849. Larsen WI, Yavorek T. Pelvic prolapse and urinary incontinence in nulliparous college women in relation to paratrooper training. *Int Urogynecol J Pelvic Floor Dysfunct* 2007;18:769-71.
850. Elston, R. C., Danyu, L., & Gang, Z. (2007). Multistage Sampling for Genetic Studies. *Annual Review of Genomics and Human Genetics*, 8(1), 327–342.
851. Buchsbaum, G. M., Duecy, E. E., Kerr, L. A., Huang, L.-S., & Guzick, D. S. (2005). Urinary incontinence in nulliparous women and their parous sisters. *Obstetrics and Gynecology*, 106(6), 1253–1258.
852. Elia, G., & Bergman, J. (2002). Familial incidence of urinary incontinence. *American Journal of Obstetrics and Gynecology*, 187, 53–55.
853. Ertunc, D., Tok, E., Pata, O., & Dilek, U. (2004). Is stress urinary incontinence a familial condition? *Acta Obstet Gynecol Scand*. 2004 Oct;83(10):912-6.
854. Hannestad, YS, Lie, R. T., Rortveit, G., & Hunskaar, S. (2004). Familial risk of urinary incontinence in women: population based cross sectional study. *BMJ (Clinical Research Ed.)*, 329(7471), 889–891.
855. Mushkat, Y., Bukovsky, I., & Langer, R. (1996). Female urinary stress incontinence - Does it have familial prevalence? *American Journal of Obstetrics and Gynecology*, 174(2), 617–619.
856. Lapitan, M. C., Chye, P. L., Asia-Pacific Continence Advisory Board. (2001). The epidemiology of overactive bladder among females in Asia: a questionnaire survey. *International Urogynecology Journal and Pelvic Floor Dysfunction*, 12(4), 226–231.
857. Andrada Hamer, M., & Persson, J. (2013). Familial predisposition to pelvic floor dysfunction: prolapse and incontinence surgery among family members and its relationship with age or parity in a Swedish population. *European Journal of Obstetrics & Gynecology and Reproductive Biology*, 170(2), 559–562.
858. Torrisi, G., Minini, G., Bernasconi, F., Perrone, A., Trezza, G., Guardabasso, V., & Ettore, G. (2011). A prospective study of pelvic floor dysfunctions related to delivery. *European Journal of Obstetrics, Gynecology, and Reproductive Biology*.
<http://doi.org/10.1016/j.ejogrb.2011.10.010>

859. Torrisi, G., Sampugnaro, E. G., Pappalardo, E. M., D'Urso, E., Vecchio, M., & Mazza, A. (2007). Postpartum urinary stress incontinence: analysis of the associated risk factors and neurophysiological tests. *Minerva Ginecologica*, 59(5), 491–498.
860. Gontard, von, A., Heron, J., & Joinson, C. (2011). Family history of nocturnal enuresis and urinary incontinence: results from a large epidemiological study. *The Journal of Urology*, 185(6), 2303–2306.
861. Nguyen, A., Aschkenazi, S. O., Sand, P. K., Du, H., Botros, S. M., Gamble, T. L., et al. (2011). Nongenetic factors associated with stress urinary incontinence. *Obstetrics and Gynecology*, 117(2 Pt 1), 251–255.
862. Rohr, G., Kragstrup, J., Gaist, D., & Christensen, K. (2004). Genetic and environmental influences on urinary incontinence: a Danish population-based twin study of middle-aged and elderly women. *Acta Obstetrica Et Gynecologica Scandinavica*, 83(10), 978–982.
863. Altman, D., Forsman, M., Falconer, C., & Lichtenstein, P. (2008). Genetic influence on stress urinary incontinence and pelvic organ prolapse. *European Urology*, 54(4), 918–922.
864. Wennberg, A.-L., Altman, D., Lundholm, C., Klint, A., Iliadou, A., Peeker, R., et al. (2011). Genetic influences are important for most but not all lower urinary tract symptoms: a population-based survey in a cohort of adult Swedish twins. *European Urology*, 59(6), 1032–1038.
865. Dietz, H. P., Hansell, N. K., Grace, M. E., Eldridge, A. M., Clarke, B., & Martin, N. G. (2005). Bladder neck mobility is a heritable trait. *BJOG: an International Journal of Obstetrics & Gynaecology*, 112(3), 334–339.
866. Hansell, N. K., Dietz, H. P., Treloar, S. A., Clarke, B., & Martin, N. G. (2004). Genetic covariation of pelvic organ and elbow mobility in twins and their sisters. *Twin Research: the Official Journal of the International Society for Twin Studies*, 7(3), 254–260.
867. Gontard, von, A., Schaumburg, H., Hollmann, E., Eiberg, H., & Rittig, S. (2001). The genetics of enuresis: a review. *The Journal of Urology*, 166(6), 2438–2443.
868. Manolio, T. A., Brooks, L. D., & Collins, F. S. (2008). A HapMap harvest of insights into the genetics of common disease. *The Journal of Clinical Investigation*, 118(118(5)), 1590–1605.
869. Consortium, T. 1. G. P. (2012). An integrated map of genetic variation from 1,092 human genomes. *Nature*, 491(7422), 56–65.
870. Nsengimana, J., & Bishop, D. T. (2011). Design considerations for genetic linkage. [Methods Mol Biol. 2012] - PubMed - NCBI. *Statistical Human Genetics*, 850(Chapter 13), 237–262.
871. Eiberg, H., Schaumburg, H. L., Gontard, von, A., & Rittig, S. (2001). Linkage study of a large Danish 4-generation family with urge incontinence and nocturnal enuresis. *The Journal of Urology*, 166(6), 2401–2403.
872. Loeys, B., Hoebeke, P., Raes, A., & Messiaen, L. (2002). Does monosymptomatic enuresis exist? A molecular genetic exploration of 32 families with enuresis/incontinence. *BJU Int.* 2002 Jul;90(1):76-83.
873. Allen-Brady, K., Norton, P. A., Farnham, J. M., Teerlink, C., & Cannon-Albright, L. A. (2009). Significant linkage evidence for a predisposition gene for pelvic floor disorders on chromosome 9q21. *American Journal of Human Genetics*, 84(5), 678–682.
874. Norton, P., Allen-Brady, K., & Cannon-Albright, L. (n.d.). ?Genetic Determinants of Stress Incontinence in Women. Retrieved August 22, 2014, from <http://www.ics.org/Abstracts/Publish/105/000170.pdf>
875. Göring, H. H., Terwilliger, J. D., & Blangero, J. (2001). Large upward bias in estimation of locus-specific effects from genomewide scans. *American Journal of Human Genetics*, 69(6), 1357–1369.
876. Cartwright, R., Kirby, A. C., Tikkinen, K. A. O., MJacksona, A., Thiagamoorthy, G., Rajan, P., et al. (2015). Systematic review and metaanalysis of genetic association studies of urinary symptoms and prolapse in women. *American Journal of Obstetrics and Gynecology*, 212(2), 199–124.
877. Aizawa, N., Homma, Y., & Igawa, Y. (2012). Effects of mirabegron, a novel β 3-adrenoceptor agonist, on primary bladder afferent activity and bladder microcontractions in rats compared with the effects of oxybutynin. *European Urology*, 62(6), 1165–1173.
878. Chapple, C. R., Kaplan, S. A., Mitcheson, D., Klecka, J., Cummings, J., Drogendijk, T., et al. (2013). Randomized double-blind, active-controlled phase 3 study to assess 12-month safety and efficacy of mirabegron, a β (3)-adrenoceptor agonist, in overactive bladder. *European Urology*, 63(2), 296–305.

879. Khullar, V., Amarenco, G., Angulo, J. C., Cambroner, J., Høye, K., Milsom, I., et al. (2013). Efficacy and tolerability of mirabegron, a $\beta(3)$ -adrenoceptor agonist, in patients with overactive bladder: results from a randomised European-Australian phase 3 trial. *European Urology*, 63(2), 283–295.
880. Honda, K., Nomiya, M., K, S., Shishido, K., & Yamaguchi, O. (2006). Mutation of B 3-adrenoceptor gene: a genetic marker for overactive bladder. *Neurourology and Urodynamics*, 25, 652. Retrieved from <http://icsoffice.org/Abstracts/Publish/44/000120.pdf>
881. Takeda, M., Araki, I., Kamiyama, M., Takihana, Y., & Tanabe, N. (2002). Single Nucleotide Polymorphism of Alpha1a and Beta3-adrenoceptors in urological patients with and without micturition symptoms - possible mechanism for hyperactivity of adrenergic nerve and tailor-made medicine. International Continence Society Meeting, Heidelberg, Germany Retrieved from <http://www.ics.org/Abstracts/Publish/40/000371.pdf>
882. Ferreira, C. E., Fonseca, A. M., Silva, I. D., Girao, M. J., Sartori, M. G., & Castro, R. A. (2011). The relationship between the Trp 64 Arg polymorphism of the beta 3-adrenoceptor gene and idiopathic overactive bladder. *American Journal of Obstetrics and Gynecology*, 205(1), 82 e10–4.
883. Honda, K., Nomiya, M., K, S., Shishido, K., & Yamaguchi, O. (2006). Mutation of B 3-adrenoceptor gene: a genetic marker for overactive bladder. *Neurourology and Urodynamics*, 25, 652. Retrieved from <http://icsoffice.org/Abstracts/Publish/44/000120.pdf>
884. Jin, H., Evangelou, E., Ioannidis, J. P. A., & Ralston, S. H. (2010). Polymorphisms in the 5' flank of COL1A1 gene and osteoporosis: meta-analysis of published studies. *Osteoporosis International*, 22(3), 911–921.
885. Chen, B., & Yeh, J. (2011b). Alterations in connective tissue metabolism in stress incontinence and prolapse. *The Journal of Urology*, 186(5), 1768–1772.
886. Skorupski, P., Król, J., Starega, J., Adamiak, A., Jankiewicz, K., & Rechberger, T. (2006). An alpha-1 chain of type I collagen Sp1-binding site polymorphism in women suffering from stress urinary incontinence. *American Journal of Obstetrics and Gynecology*, 194(2), 346–350.
887. Sioutis, Dimos, Economou, E., Lambrinouadaki, I., Tsamadias, V., Creatsa, M., & Liapis, A. (2011). Sp1 collagen I A1 polymorphism in women with stress urinary incontinence. *International Urogynecology Journal*, 22(7), 835–839.
888. Chen, B., & Yeh, J. (2011a). Alterations in connective tissue metabolism in stress incontinence and prolapse. *The Journal of Urology*, 186(5), 1768–1772.
889. Chen, L., Wang, T., Liu, L., Shen, Y., Wan, C., & Wen, F. (2013). Matrix Metalloproteinase-9 -1562C/T Promoter Polymorphism Confers Risk for COPD: A Meta-Analysis. *PLoS One*, 8(3), e60523–e60523.
890. Li, M., Shi, J., Fu, L., Wang, H., Zhou, B., & Wu, X. (2012). Genetic polymorphism of MMP family and coronary disease susceptibility: A meta-analysis. *Gene*, 495(1), 36–41.
891. Skorupski, P., Jankiewicz, K., Miotla, P., & Marczak, M. (2012). The polymorphisms of the MMP-1 and the MMP-3 genes and the risk of pelvic organ prolapse. *International Urogynecology Journal*.
892. Vishwajit, S., Rohozinski, J., Badlani, G., & Andersson, K.-E. (2013). Association of MMP1 promoter variant with stress urinary incontinence and pelvic organ prolapse in women (pp. 1–2). Presented at the International Continence Society Meeting, San Francisco, USA.
893. Cornu, J. N., Merlet, B., Cussenot, O., Cancel-Tassin, G., Ciofu, C., Amarenco, G., & Haab, F. (2011). Genetic susceptibility to urinary incontinence: implication of polymorphisms of androgen and oestrogen pathways. *World Journal of Urology*, 29(2), 239–242.
894. Noronha, J. A., Schwanke, C. H., Machado, D. C., Braga, R., Lubianca, J. M., Sesti, F. L., et al. (2010). Association between T102C polymorphism of serotonin 2A receptor gene and urinary incontinence in older women. *Journal of Investigative Medicine : the Official Publication of the American Federation for Clinical Research*, 58(1), 32–37.
895. Ozbek, E., Polat, E. C., Ozcan, L., Otunctemur, A., Emrence, Z., & Ustek, D. (2013). TT polymorphism in rs2165241 and rs1048661 region in lysyl oxidase like-1 gene may have a role in stress urinary incontinence physiopathology. *Journal of Obstetrics and Gynaecology Research (Electronic)*, 39(1), 237–242.
896. Ioannidis, J. P., Boffetta, P., Little, J., O'Brien, T. R., Uitterlinden, A. G., Vineis, P., et al. (2007). Assessment of cumulative evidence on genetic associations: interim guidelines. *International Journal of Epidemiology*, 37(1), 120–132.

897. Richter HE, Whitehead N, Arya L, Ridgeway B, Allen-Brady K, Norton P, Sung V, Shepherd JP, Komesu Y, Gaddis N, Fraser MO, Tan-Kim J, Meikle S, Page GP; Pelvic Floor Disorders Network.. Genetic contributions to urgency urinary incontinence in women. *J Urol.* 2015 Jun;193(6):2020-7.
898. Titi M, Jenkins JT, Urie A, Molloy RG. Prospective study of the diagnostic evaluation of faecal incontinence and leakage in male patients. *Colorectal Dis.* 2007;9:647-52.
899. Leigh RJ, Turnberg LA. Faecal incontinence: the unvoiced symptom. *Lancet.* 1982;1:1349-1351.
900. Thomas TM, Egan M, Walgrove A, Meade TW. The prevalence of faecal and double incontinence. *Comm Med.* 1984;6:216-220.
901. Nelson RL, Norton N, Cautley E, Furner S. Community based prevalence of AI. *JAMA.* 1995;274:559-562.
902. Sharma A, Marshjall RJ, MacMillan AK, Merrie AEH, Reid P, Bissett IP. Determining levels of fecal incontinence in the community: a New Zealand cross-sectional study. *Dis. Colon Rectum.* 2011;54:1381-7.
903. Macmillan AK, Merrie AEH, Marshall RJ, Parry BR. The prevalence of faecal incontinence in community dwelling adults: a systematic review. *Dis. Colon & Rectum.*2004.47.1341-49.
904. Pretlove SJ, Thompson PJ, Toozs-Hobson PM, Radley S, Khan KS. Does the mode of delivery predispose women to anal incontinence in the first year postpartum? A comparative systematic review. *BJOG.* 2008 Mar;115(4):421-34. Review. Erratum in: *BJOG.* 2010 Sep;117(10):1307-8.
905. Ng KS, Sivakumaran Y, Nassar N, Gladman MA. Fecal incontinence and associated factors - a systematic review. *Dis. Colon Rectum.* 2015; 58: 12. 1194-1209.
906. Ditah I, Devaki P, Luma HN, Ditah C, Njei B, Jaiyeoba C, Salami A, Ditah C, Ewelukwa O, Szarka L. Prevalence, trends, and risk factors for fecal incontinence in United States adults, 2005-2010. *Clin Gastroenterol Hepatol.* 2014. Apr;12(4):636-43.
907. Bai Y, Chen H, Hao J, Huang Y, Wang W. Long term outcome and quality of life after the Swenson procedure for Hirschprung's disease. *J Pediatric Surg.* 2002;37:639-42.
908. Javid PJ, Barnhart DC, Hirschi RB, Coran AG, Harmon CM. Immediate and long term results of surgical management of low imperforate anus in girls. *J Pediatric Surg.* 1998;33:198-203
909. Rintala RJ, Lindahl H. Is normal bowel function possible after repair of intermediate and high anorectal malformations? *J Pediatric Surg.* 1995;30:491-4.
910. Hartman EE, Oort FJ, Aronson DC, Hanneman JG, van der Zee DC, et al. Critical factors affecting the quality of life of adult patients with anorectal malformations or Hirschprung's Disease. *Am J Gastroent.*2004;xx:907-13.
911. Forrester MB, Merz RD. Descriptive epidemiology of anal atresia in Hawaii, 1986-1999. *Teratology.*2002;66supp.:S12-6.
912. Largo RH, Gianciaruso M, Prader A. Development of intestinal and bladder control from birth until the 18th year of age. *Longitudinal Study. Schweiz Med Wochenschr.* 1978;108:155-60.
913. Nelson RL, Chattopadhyay A, Brooks W, Platt I, Paavana T, Earl S. Operative procedures for fissure in ano. *Cochrane Database Syst Rev.* 2011 Nov 9;11:CD002199.
914. Nelson R. Anal fissure (chronic). *Clin Evid (Online).* 2010 Mar 24;2010. pii:0407.
915. Small KA, Wynne JM. Evaluating the pelvic floor in obstetric patients. *Aust New Zeal Obstet Gynecol.* 1990;30:41-45.
916. Madoff RD, Williams JG, Caushaj PF. Current concepts: Fecal incontinence. *N Engl J Med.* 1992;326:1002-1007.
917. Abou-Zahr C. Obstructed labour. In: Murray CJL, Lopez AD, eds. *Health dimensions of sex and reproduction: the global burden of sexually transmitted diseases, HIV, maternal conditions, perinatal disorders and congenital anomalies.* Cambridge, Mass. Harvard University Press, 1996.
918. Drossman DA. What can be done to control incontinence associated with the irritable bowel syndrome? *Am J Gastroenterol.* 1989;84:355-357.
919. Schiller LR, Santa Ana CA, Schmulen AC, Hender RS, Harford WV, Fordtran JS. Pathogenesis of fecal incontinence in diabetes mellitus. *N Engl J Med.* 1982;307:1666-1671.
920. Campbell AJ, Reinken J, McCosh L. Incontinence in the elderly: prevalence and prognosis. *Age Ageing.* 1985;14:65-70.
921. Denis P, Bercoff E, Bizien MF, Brocker P, Chassagne P, Lamouliatte H et al. Etude de la prevalence de l'incontinence anale chez l'adulte. *Gastroent Clin Biol.* 1992;16:344-350.

922. Drossman DA, Li Z, Andruzzi E, Temple RD, Talley NJ, Thompson WG et al. U.S. household survey of functional gastrointestinal disorders: Prevalence, sociodemography, and health impact. *Dig Dis Sci.* 1993;38:1569-1580. 2001;114:474-477.
923. MacLennan AH, Taylor AW, Wilson DH, Wilson D. The prevalence of pelvic floor disorders and their relationship to gender, age, parity, and mode of delivery. *BJOG.* 2000;107:1460-1470.
924. Giebel GD, Lefering R, Troidl H, Blochl H. Prevalence of fecal incontinence: what can be expected? *Int J Colorectal Dis.* 1998;13:73-77.
925. Lam L, Kennedy M, Chen F. Prevalence of faecal incontinence: obstetric and constipation risk factors: a population based study. *Colorectal Dis.* 1999;1:197-203.
926. Kalantar JS, Howell S, Talley NJ. Prevalence of faecal incontinence and associated risk factors. *Med J Aust.* 2002;176:54-57.
927. Lynch AJ, Dobbs BR, Keating J, Frizelle FA. The prevalence of faecal incontinence and constipation in a general New Zealand population: a postal survey. *NZ Med J.* 2001;114:474-477.
928. Perry S, Shaw C, McGrother C, Mathews RJ, Assassa RP, Dallosso H et al. Prevalence of faecal incontinence in adults aged 40 years or more living in the community. *Gut.* 2002;50:480-484.
929. Chaliha C, Kalia V, Stanton SL, Monga A, Sultan AH. Antenatal prediction of postpartum urinary and fecal incontinence. *Obstet Gynecol.* 1999;94:689-694.
930. Eason E, Labrecque M, Marcoux S, Mondor M. AI after childbirth. *CMAJ.* 2002;166:326-330.
931. Sangalli MR, Floris L, Faltin D, Weil A. AI in women with third or fourth degree perineal tears and subsequent vaginal deliveries. *Aust NZ J Obstet Gynaecol.* 2000;40:244-248.
932. Okonkwo JE, Obionu CN, Okonkwo CV, Obiechina NJ. AI among Igbo women. *Int J Clin Pract.* 2002;56:178-180.
933. Rizk DE, Hassan MY, Shaheen H, Chervian JV, Micallef R, Dunn E. The prevalence and determinants of health care seeking behavior for fecal incontinence in multiparous United Arab Emirates females. *Dis Colon Rectum.* 2001;44:1850-1856.
934. Alnaif B, Drutz HP. The prevalence of urinary and fecal incontinence in Canadian secondary school teenage girls: questionnaire study and review of the literature. *Int J Urogynecol/J Pelvic Floor Dysfunct.* 2001;12:134-137.
935. Faltin DL, Sangalli MR, Curtin F, Morabia A, Weil A. Prevalence of AI and other anorectal symptoms in women. *Int J Urogynecol/J Pelvic Floor Dysfunct.* 2001;121: 117-120.
936. Ishigooka M, Hashimoto T, Izumiya K, Sasagawa I, Nakada T. Incidence of AI after long term follow up of patients treated by ureterosigmoidostomy. *Int Urol Nephrol.* 1993;25:455-460.
937. Adolfsson J, Helgason AR, Dickman P, Steineck G. Urinary and bowel symptoms in men with and without prostate cancer: results from an observational study in the Stockholm area. *Eur Urol.* 1998;33:11-16.
938. Bytzer P, Talley NJ, Leemon M, Young LJ, Jones MP, Horowitz M. Prevalence of gastrointestinal symptoms associated with diabetes mellitus: a population based survey of 15000 adults. *Arch Intern Med.* 2001;161:1989-1996.
939. Kok ALM, Voorhorst FJ, Burger CW, van Houten P, Kenemans P, Jansens J. Urinary and faecal incontinence in community-residing elderly women. *Age Ageing.* 1992;21:211-215.
940. Talley NJ, O'Keefe EA, Zinsmeister AR, Melton LJ. Prevalence of gastrointestinal symptoms in the elderly: a population based study. *Gastroenterol.* 1992;102:895-901.
941. Nakanishi N, Tataru K, Nakajima K, Takabayashi H, Takahashi S, Naramura H et al. Urinary and fecal incontinence in a community-residing elderly population: prevalence, correlates and prognosis. *Nippon Koshu Eisei Zasshi.* 1997;44:192-200.
942. Roberts RO, Jacobsen SJ, Reilly WT, Pemberton JH, Lieber MM, Talley NJ. Prevalence of combined fecal and urinary incontinence: a community-based study. *J Am Geriatr Soc.* 1999;47:837-841.
943. Edwards NI, Jones D. The prevalence of faecal incontinence in older people living at home. *Age Ageing.* 2001;30:503-507.
944. Verhagen TE, Lagro-Janssen AL. Fecal incontinence in community dwelling elderly: findings from a study of prevalence, consultation of physicians, psychosocial aspects and treatment. *Ned Tijdschr Geneesk.* 2001;145:741-745.
945. Tpkonova E, Neuwirth J, Stankova M, Mellanova A, Haas T. Urinary and fecal incontinence in geriatric facilities in the Czech Republic. *Cas Lek Cesk.* 1997;136:573-577.
946. Nelson RL, Furner S, Jesudason V. Fecal incontinence in Wisconsin nursing homes. *Dis Colon Rectum.* 1998;41:1226-1229.

947. Borrie MJ, Davidson HA. Incontinence in institutions: costs and contributing factors. *CMAJ*. 1992;147:322-328.
948. Damon H, Guye O, Seigneurin A, Long F, Faucheron AL, Grandjean JP, Mellier G, Vallancogne G, Fayard O, Henry L, Guyot P, Barth X, Mion F. Prevalence of anal incontinence in adults impact on quality of life. *Gastroenterologie*. 2006;30:37-43.
949. Bharucha AE, Zinsmeister AR, Locke GR, Seide BM, McKeon K, Schleck CD, Melton III J. Risk factors for fecal incontinence: a population-based study in women. *Am J Gastro*. 2006;101:1305-12.
950. Fritel X, Ringa V, Varnoux N, Zins M, Breart G. Mode of delivery and fecal incontinence at mid-life; a study of 2640 women in the Gazel cohort. *Obstet & Gynecol*. 2007;110:31-8.
951. Lawrence JM, Lukasz ES, Nager CW, Hsu JWY, Lubner KM. Prevalence and co-occurrence of pelvic floor disorders in community-dwelling women. *Obstet. & Gynecol*. 2008; 111:678-85.
952. Borello-France D, Burgio KL, Richter HE, Zyczynski H, Fitzgerald MP, Whitehead W, Fine P, Nygaard I, Handa VL, Visco AG, Weber AM, Brown MB. Fecal and urinary incontinence in primiparous women. *Obstet & Gynecol*. 2006;108:863-72.
953. Erekson EA, Sung VW, Myers DL. Effect of body mass index on the risk of anal incontinence and defecatory dysfunction in women. *Am J Obstet & Gynecol*. 2008;198:596-99.
954. Altman D, Falconer C, Rossner S, Melin I. The risk of anal incontinence in obese women. *Int. Urogynecol. J*. 2007;18:1283-9.
955. Bharucha AE, Zinsmeister AR, Schleck CD, Melton LJ 3rd. Bowel disturbances are the most important risk factors for late onset fecal incontinence: a population-based case-control study in women. *Gastroenterology*. 2010 Nov;139(5):1559-66.
956. Burgio KL, Richter HE, Clements RH, Redden DT, Goode PS. Changes in urinary and fecal incontinence symptoms with weight loss surgery in morbidly obese women. *Obstet Gynecol*. 2007;110:1034-40.
957. Whitcomb EL, Lukacz ES, Lawrence JM, Nager CW, Lubner KM. Prevalence and degree of bother from pelvic floor disorders in obese women. *Int Urogynecol J Pelvic Floor Dysfunct*. 2009 March ; 20(3): 289–294.
958. Oberwalder M, Connor J, Wexner SD. Meta-analysis to determine the incidence of obstetric anal sphincter damage. *Brit. J Surg*. 2003;90:1333-7.
959. Bols EM, Hendriks EJ, Berghmans BC, Baeten CG, Nijhuis JG, de Bie RA. A systematic review of etiological factors for postpartum fecal incontinence. *Acta Obstet Gynecol Scand*. 2010 Mar;89(3):302-14. Review.
960. Nelson RL. Epidemiology of fecal Incontinence. *Gastroenterology*. 2004;126 (Suppl. 1): s3-7.
961. Goffeng AR, Andersch B, Andersson M, Berndtsson I, Hulten L, Oreslan T. Objective methods cannot predict anal incontinence after primary repair of extensive anal tears. *Acta Obstet Gynecol Scand*. 1998;77:439-43
962. Guttierrez AB, Madoff RD, Lowry AC, Parker SC, Buie WD, Baxter NN. Long term results of anterior sphincteroplasty. *Dis Colon & Rectum*. 2004;47:727-32
963. Halverson AN, Hull TL. Long-term outcome of overlapping anal sphincter repair. *Dis Colon & Rectum*. 2002;45:345-8
964. Karoui S, Leroi AM, Koning E, Menar JF, Michot F, Dens P. Results of sphincteroplasty in 86 patients with anal incontinence. *Dis Colon & Rectum*. 2000;43:813-20
965. Malouf AJ, Norton CS, Engel AF, Nicholls RJ, Kamm MA. Long-term results of overlapping anterior anal sphincter repair for obstetrical trauma. *Lancet*. 2000;355:260-5
966. Pinta T, Kyaanpaa ML, Salmi T, Jaarvinen HJ, Luukkonen P. Delayed sphincter repair for obstetric ruptures: analysis of failure. *Colorectal Dis*. 2003;5:73-8
967. Rothbart J, Bemelman WA, Meijerink WJ. Long term results of anterior anal sphincter repair for rectal incontinence due to obstetric injury. *Dig. Surg*. 2000;17:390-4
968. Vaizey CJ, Norton C, Thornton MJ, Nicholls RJ, Kamm MA. Long term results of repeat anterior anal sphincter repair. *Dis Colon & Rectum*. 2004;47:858-63.
969. Nelson RL, Furner SE, Westercamp M, Farquhar C. Cesarean delivery for the prevention of anal incontinence. *Cochrane Database Syst Rev*. 2010 Feb 17;(2):CD006756. Review.
970. Burgio KL, Borello-France D, Richter HE, Fitzgerald MP, Whitehead W, Handa VL, Nygaard I, Fine P, Zyczynski H, Visco AG, Brown MB, Weber AM; Pelvic Floor Disorders Network. Risk factors for fecal and urinary incontinence after childbirth: the childbirth and pelvic symptoms study. *Am J Gastroenterol*. 2007 Sep;102(9):1998-2004

971. Casey BM, Schaffer JI, Bloom SL, Heartwell SF, McIntire DD, Leveno KJ. Obstetric antecedents for postpartum pelvic floor dysfunction. *Am J Obstet Gynecol.* 2005 May;192(5):1655-62.
972. Dolan LM, Hilton P. Obstetric risk factors and pelvic floor dysfunction 20 years after first delivery. *Int Urogynecol J.* 2010 May;21(5):535-44.
973. Fritel X, Schaal JP, Fauconnier A, Bertrand V, Levet C, Pigné A. [Pelvic floor disorders four years after first delivery: a comparative study of restrictive versus systematic episiotomy]. *Gynecol Obstet Fertil.* 2008 Oct;36(10):991-7. d
974. Kepenekci I, Keskinilic B, Akinsu F, Cakir P, Elhan AH, Erkek AB, Kuzu MA. Prevalence of pelvic floor disorders in the female population and the impact of age, mode of delivery, and parity. *Dis Colon Rectum.* 2011 Jan;54(1):85-94.
975. Lukacz ES, Lawrence JM, Contreras R, Nager CW, Lubner KM. Parity, mode of delivery, and pelvic floor disorders. *Obstet Gynecol.* 2006 Jun;107(6):1253-60.
976. MacArthur C, Glazener CM, Wilson PD, Lancashire RJ, Herbison GP, Grant AM. Persistent urinary incontinence and delivery mode history: a six-year longitudinal study. *BJOG.* 2006 Feb;113(2):218-24.
977. MacArthur C, Wilson D, Herbison P, Lancashire RJ, Hagen S, Toozs-Hobson P, Dean N, Glazener C; Prolong study group. Urinary incontinence persisting after childbirth: extent, delivery history, and effects in a 12-year longitudinal cohort study. *BJOG.* 2016 May;123(6):1022-9.
978. McKinnie V, Swift SE, Wang W, Woodman P, O'Boyle A, Kahn M, Valley M, Bland D, Schaffer J. The effect of pregnancy and mode of delivery on the prevalence of urinary and fecal incontinence. *Am J Obstet Gynecol.* 2005 Aug;193(2):512-7; discussion 517-8.
979. Torrisi G, Minini G, Bernasconi F, Perrone A, Trezza G, Guardabasso V, Ettore G. A prospective study of pelvic floor dysfunctions related to delivery. *Eur J Obstet Gynecol Reprod Biol.* 2012 Jan;160(1):110-5.
980. Gyhagen M, Bullarbo M, Nielsen TF, Milsom I. Faecal incontinence 20 years after one birth: a comparison between vaginal delivery and caesarean section. *Int Urogynecol J.* 2014 Oct;25(10):1411-8.
981. Gyhagen M, Åkervall S, Milsom I. Clustering of pelvic floor disorders 20 years after one vaginal or one caesarean birth. *Int Urogynecol J.* 2015 Aug;26(8):1115-21.
982. MacArthur C, Glazener CMA, Lancashire R, Herbison P, et al. Faecal incontinence and mode of first and subsequent deliveries: a six year longitudinal study. *Br J Obstet Gynecol.* 2005;112:1075-82.
983. Zetterstrom J, Lopez A, Anzen B, Dolk A, Norman M, Mellgren A. Anal incontinence after vaginal delivery: a prospective study in pariparous women. *Obstet Gynecol.* 1999;106:324-30.
984. Devine JB, Ostergard DR, Noblett KL. Long term complications of the second stage of labor. *Contemp. Obstet Gynecol.* 1999:119-26.
985. Fynes M, Donnelly VS, O'Connell PR, O'Herlihy C. Caesarean section and anal sphincter injury. *Obstet Gynecol* 1998;92:496-500.
986. Altman D, Zetterstrom J, Lopez A, Pollack J, Nordenstam J, Mellgren A. Effect of hysterectomy on bowel function. *Dis. Colon & Rectum.* 2004;47:502-9.
987. Gartland D, MacArthur C, Woolhouse H, McDonald E, Brown SJ. Frequency, severity and risk factors for urinary and faecal incontinence at 4 years postpartum: a prospective cohort. *BJOG.* 2016 Jun;123(7):1203-11.
988. Gorina Y, Schappert S, Bercovitz A, Elgaddal N, Kramarow E. Prevalence of incontinence among older Americans. *Vital Health Stat 3.* 2014 Jun;(36):1-33.
989. MacKenzie WR, Hoxie NJ, Proctor ME, Gradus MS, Blair KA, Petersen DE et al. A massive outbreak in Milwaukee of cryptosporidium infection transmitted through the public water supply. *N Eng J Med.* 1994;331:161-167.
990. Papathanasopoulos AA, Katsanos KH, Tatsioni A, Christodoulou DK, Tsianos EV. Increased fatigability of external anal sphincter in inflammatory bowel disease: significance in fecal urgency and incontinence. *J Crohns Colitis.* 2010 Nov;4(5):553-60.
991. Sullivan SN, Wong C. Runner's diarrhea. Different patterns and associated factors. *J Clin Gastroenterol.* 1992;14:101-104.
992. Vitton V, Baumstarck-Barrau K, Brardjanian S, Caballe I, Bouvier M, Grimaud JC. Impact of high-level sport practice on anal incontinence in a healthy young female population. *J Womens Health (Larchmt).* 2011 May;20(5):757-63.
993. Pernikoff BJ, Eisenstat TE, Rubin RJ, Oliver GC, Salvati EP. Reappraisal of partial lateral internal sphincterotomy. *Dis Colon Rectum.* 1994;37:1291-1295.

994. del Pino A, Nelson RL, Pearl RK, Abcarian H. Island flap anoplasty for treatment of transsphincteric fistula-in-ano. *Dis Colon Rectum*. 1996;39:224-226.
995. Gorfine SR. Treatment of benign anal disease with topical nitroglycerin. *Dis Colon & Rectum*. 1995;38:453-457.
996. Johannsson HO, Graf W, Pahlman L. Long term results of hemorrhoidectomy. *Eur J Surg*. 2002;168:485-9.
997. Denost Q, Laurent C, Capdepon M, Zerbib F, Rullier E. Risk factors for fecal incontinence after intersphincteric resection for rectal cancer. *Dis Colon Rectum*. 2011 Aug;54(8):963-8.
998. Maeda Y, Høyer M, Lundby L, Norton C. Faecal incontinence following radiotherapy for prostate cancer: a systematic review. *Radiother Oncol*. 2011 Feb;98(2):145-53.
999. Wald A. Systemic diseases causing disorders of defecation and continence. *Sem Gastrointest. Dis*. 1995;6:194-202.
1000. Bliss DZ, Johnson S, Savik K, Clabots CR, Gerding DN. Fecal incontinence in hospitalized patients who are acutely ill. *Nursing Res*. 2000;49:101-108.
1001. Nakayama H, Jorgensen HS, Pedersen PM, Raaschou HO, Olsen TS. Prevalence and risk factors of incontinence after stroke: The Copenhagen Stroke Study. *Stroke*. 1997;28:58-62.
1002. Porell F, Caro FG, Silva A, Monane M. A longitudinal analysis of nursing home outcomes. *Health Svc.s Rsch*. 1998;33:835-65.
1003. Chassange P, Landrin I, Neveu C, Czernichow M, Doucet J, Denis P, Bercoff E. Fecal incontinence in the institutionalized elderly: incidence, risk factors and prognosis. *Am J Med*. 1999;106:185-190.
1004. Nelson RL, Furner SE. Prospective cohort study of risk factors for incontinence in Wisconsin Nursing Homes. *Maturitas*. 2005 Sep 16;52(1):26-31. Epub 2005 Jan 19.
1005. Fornell EU, Wingren G, Kjoelhede P. Factors associated with pelvic floor dysfunction with emphasis on urinary and fecal incontinence and genital prolapse: an epidemiological study. *Act. Obstet. Gynecol. Scand*. 2004;83:383-389.
1006. Lewicky-Gaupp C, Cao DC, Culbertson S. Urinary and anal incontinence in African American teenaged gravidas during pregnancy and in the puerperium. *J Ped Adolsc Gynec*. 2008;21:21-6.
1007. von Brummen HJ, Bruinse HW, van de Pol G, Heintz APM, van der Vaart CH. Defecatory symptoms during and after the first pregnancy: prevalences and associated factors. *Int. Urogynec. J*. 2006;17:224-30.
1008. Solans-Demenech M, Sanchez E, Espuna-Pons M. Urinary and anal incontinence during pregnancy and the post-partum: incidence, severity and risk factors. *Obstet Gynec*. 2010;115:618-28.
1009. Culligan PJ, Myers JA, Goldberg RP, Blackwell L, Gohmann SF, Abell TD. Elective cesarean section to prevent anal incontinence and brachial plexus injuries associated with macrosomia – a decision analysis. *Int Urogynecol J*. 2005;16:19-28
1010. Faltin DL, Boulvain M, Floris LA, Irion O. Diagnosis of anal sphincter tears to prevent fecal incontinence; a randomized controlled trial. *Obstet & Gynecol*. 2005;106:6-13.
1011. Hay-Smith J, Mørkved S, Fairbrother KA, Herbison GP. Pelvic floor muscle training for prevention and treatment of urinary and faecal incontinence in antenatal and postnatal women. *Cochrane Database Syst Rev*. 2008 Oct 8;(4):CD007471. Review.
1012. Bø K, Haakstad LA. Is pelvic floor muscle training effective when taught in a general fitness class in pregnancy? A randomised controlled trial. *Physiotherapy*. 2011 Sep;97(3):190-5. Epub 2011 Feb 4.
1013. Shamlivan T, Wyman J, Bliss DZ, Kane RL, Wilt TJ. Prevention of urinary and fecal incontinence in adults. *Evid Rep Technol Assess (Full Rep)*. 2007 Dec;(161):1-379.
1014. Fultz NH, Herzog AR. Prevalence of urinary incontinence in middle-aged and older women: a survey-based methodological experiment. *J Aging Health*. 2000 Nov.;12(4):459–469.
1015. Dallosso HM, Mathews RJ, McGrother CW, Clarke M, Perry SI, Shaw c et al. An investigation into nonresponse bias in a postal survey on urinary symptoms *BJU Int* 2003;91:631- 636.
1016. Seim A, Sivertsen B, Eriksen BC, Hunskaar S. Treatment of urinary incontinence in women in general practice observational study. *BMJ* 1996;312:1459-1462.
1017. Andersen JT, Sander P. Minimal care -A new concept for the management of urinary incontinence in an open access interdisciplinary incontinence clinic. The way ahead? *J Nephrol Suppl* 1996; 179 :55-60.

1018. von Elm E, Altman DG, Egger M, Pocock SJ, Gøtzsche PC, Vandenbroucke JP; STROBE Initiative. Strengthening the Reporting of Observational Studies in Epidemiology (STROBE) statement: guidelines for reporting observational studies. *BMJ*. 2007 Oct 20;335(7624):806-8.
1019. Milsom I, Coyne KS, Nicholson S, Kvasz M, Chen CI, Wein AJ. Global prevalence and economic burden of urgency urinary incontinence: a systematic review. *Eur Urol*. 2014 Jan;65(1):79-95.
1020. Wilson D, Dornan J, Milsom I, Freeman R. UR-CHOICE: can we provide mothers-to-be with information about the risk of future pelvic floor dysfunction? *Int Urogynecol J*. 2014 Nov;25(11):1449-52

Committee 2

CELL BIOLOGY

Chair

C. Fry (UK)

Members

R. Chess-Williams (UK)

H. Hashitani (Japan)

A. Kanai (USA)

K. McCloskey (UK)

M. Takeda (Japan)

B. Vahabi (UK)

Consultants

Lori Birder (USA)

Collaborators

Rita Jabr (UK)

Takahiko Mitsui (Japan)

CONTENTS

ABBREVIATIONS	146	4. The Functional Properties of Detrusor from Postnatal Developing Bladders ..	178
I. INTRODUCTION	148	5. Lower Urinary Tract Congenital Anomalies	179
II. EXCITATION-CONTRACTION COUPLING IN BLADDER SMOOTH MUSCLE	148	VI. THE MUSCULATURE OF THE PELVIC FLOOR AND EXTERNAL URETHRAL RHABDOSPHINCTER	183
1. Detrusor smooth muscle during the storage phase.....	148	1. The Pelvic Floor Muscles.....	183
2. Inhibitory Mechanisms	153	2. Androgens and 'Levator Ani' Function.	186
3. Detrusor Smooth Muscle During Voiding Phase	155	3. The External Urethral Rhabdosphincter	187
4. Non-Detrusor Smooth Muscle Contractile Elements	158	VII. INTEGRATED PHYSIOLOGY OF THE URINARY TRACT - NEW THERAPEUTIC APPROACHES AND CONCEPTS	190
5. Trigone.....	161	1. Relaxin: Treatments for Radiation Cystitis and the Underactive Bladder .	190
III. CELL PHYSIOLOGY OF INTERSTITIAL CELLS IN THE URINARY BLADDER	162	2. LM11A-31—Selective Blockade of p75 Neurotrophin Receptors.	195
1. Interstitial Cells in Smooth Muscle Tissues.....	162	VIII. MOLECULAR TARGETS FOR MANAGING LOWER URINARY TRACT FUNCTION	201
2. Location of Bladder Interstitial Cells ...	162	1. Introduction.....	201
3. Bladder IC Receptors.....	164	2. G Protein-coupled Receptors (GPCR)s.....	202
4. Bladder IC Ion Channels.....	165	3. Ion Channels.....	206
5. Intracellular Ca ²⁺ Signalling.....	167	4. Transporters	214
6. Bladder Interstitial Cells in Disease/Dysfunction of the Bladder	167	5. Clock Genes.....	214
7. Summary of Bladder IC Physiology.....	169	IX. PHYSIOLOGY OF THE ANO-RECTUM	216
IV. TRANSPORT FUNCTIONS OF THE UROTHELIUM	170	1. Functions of the Ano-Rectum.....	216
1. Introduction	170	2. Structure of the Ano-Rectum.....	216
2. The Structure of the Urothelium	170	3. Innervation of the Ano-Rectum	217
3. The Barrier Function of the Urothelium	171	4. Excitatory Neurotransmission.....	218
4. Water and Electrolyte Transport Across the Urothelium.....	173	5. Inhibitory Neurotransmission.....	219
5. Summary.....	175	6. Myogenic Activity in the IAS and Rectum	221
V. THE PATHOLOGY OF FUNCTIONAL DISORDERS OF THE LOWER URINARY TRACT IN PERINATAL SUBJECTS AND CHILDREN.	175	7. Interstitial Cells of Cajal (ICC) and Spontaneous Contractile Activity	222
1. Introduction	175	8. Mucosal Influences on the Anal Sphincter	223
2. Development of the Lower Urinary Tract	175		
3. The Functional Properties of Foetal Detrusor Smooth Muscle.....	176		

X.	RECOMMENDATIONS FOR FUTURE RESEARCH	224
	REFERENCES	225

ABBREVIATIONS

ABMA	α,β -methylene ATP	EDL	externum digitorum longus muscle
ACUU	acute cold-induced urinary urgency	EFS	electrical field stimulation
Ach	acetylcholine	ENaC	epithelial Na ⁺ channel
AJ	adherence (adherens) junction	ENS	enteric nervous system
AMPA	α -amino-3-hydroxy-5-methyl-isoxazole-4-propionic acid	EUS	external urethral sphincter
Ano1	anoctamin-1 (a Ca ²⁺ -activated Cl ⁻ channel)	EMG	electromyogram
AP	action potential	FAAH	fatty acid amide hydrolase
4-AP	4-aminopyridine	GABA	γ -amino butyric acid
AQP	aquaporin	GAG	glycosaminoglycan
ASIC	acid-sensing ion channels	GCaMP	Ca ²⁺ -sensitive green fluorescent protein
ATP	adenosine triphosphate	GPa	giga Pascal (unit of pressure/unit stress)
BDNF	brain-derived neurotrophic factor	GPCR	G-protein coupled receptor
BK	large-conductance, Ca ²⁺ -activated K ⁺ channel	GRK	G-protein coupled receptor kinase
BoNT/A	botulinum toxin A	Gy	Gray, unit of radiation
BOO	bladder outflow obstruction	HCN	hyperpolarisation-activated cyclic nucleotide-dependent channel
CACL	Ca ²⁺ -activated Cl ⁻ current	H₂S	hydrogen sulphide
cAMP	cyclic AMP (cyclic adenosine monophosphate)	Hz	Hertz (unit of frequency: per second)
CCh	carbachol	IAS	internal anal sphincter
cGMP	cyclic guanosine monophosphate	ICC	interstitial cell of Cajal
CGRP	calcitonin gene-related peptide	IC-LP	interstitial cell in the lamina propria
CICR	Ca ²⁺ -induced Ca ²⁺ release	IC-IM	intramuscular interstitial cell
CO	carbon monoxide	ICI	intercontraction interval
COX	cyclooxygenase enzymes	IJP	inhibitory junction potential
CPA	cyclopiazonic acid	InsP₃	inositol trisphosphate
Cx	connexin (gap junction protein family)	JAM	junctional adherence molecule
DFV	discoidal/fusiform vesicles (in urothelium)	KCl	potassium chloride
DIDS	a Cl ⁻ channel blocker	Kit (KIT)	a tyrosine kinase receptor
DO	detrusor overactivity	LP	lamina propria
DRG	dorsal root ganglion	LUT	lower urinary tract
Ds	desmosome	LUTD	lower urinary tract dysfunction
DSD	detrusor sphincter dyssynergia	LVDDC	L-type voltage dependent Ca ²⁺ channels
DSM	detrusor smooth muscle	mRNA	messenger RNA
EAS	external anal sphincter	MLCK	myosin light chain kinase
ECM	extracellular matrix	MLCP	myosin light chain phosphatase
ECP	excitatory junction potential	MM	muscularis mucosae
		MMC	myelomeningocele
		NANC	non-cholinergic, non-adrenergic (innervation)
		NDO	neuropathic detrusor overactivity

NGF	nerve growth factor	RhoA	Member of the rho family of GTP-(guanosine triphosphate-) ases
NMDA	N-methyl-D-aspartate	RLC	(myosin) regulatory light chain
NO	nitric oxide	ROCK	Rho-associated kinase
NOS	nitric oxide synthase	ROS	reactive oxygen species
eNOS	endothelial NOS	RTX	resiniferotoxin
iNOS	inducible NOS	RXFP	relaxin receptor
nNOS	neuronal NOS	SCI	spinal cord injury
NOP	N/OFQ receptor	SK	small conductance Ca ²⁺ and voltage-dependent K ⁺ channel
NSCC	non-selective cation channel	SLC	solute carrier
OAB	overactive bladder	SR	sarcoplasmic reticulum
ODQ	inhibitor of soluble guanylyl cyclase	STZ	streptozotocin
OEtA	oleoyl ethyl amide	TEA	tetraethyl ammonium
p75NTR	a neurotrophin receptor	TEP	transepithelial electrical resistance
P2X	(purinergic) family of cation channels activated by ATP	TJ	tight junction
P2Y	(purinergic) family of receptors activated by nucleotides and other ligands	Trk	a neurotrophin receptor
PACAP	pituitary adenylate cyclase activating peptide	TRP	transient receptor potential (ion channel) family
pBOO	partial bladder outlet obstruction	TTX	tetrodotoxin
PC	pubococcygeus muscle	TVDC	T-type voltage dependent Ca ²⁺ channels
PCNA	proliferating cell nuclear antigen	U	urothelium
PDE	phosphodiesterase POP pelvic organ prolapse	UAB	underactive bladder
PDGFa	platelet derived growth factor subunit a (or α)	UGS	urogenital sinus
PDGFR	platelet derived growth factor receptor	UI	urinary incontinence
PKC (A)	protein kinase C (A)	UP	uroplakin
PRV	pseudorabies virus	UT	urea transporter
PLC	phospholipase C	UUI	urgency UI
PTHrP	parathyroid hormone-related protein	VIP	vasoactive intestinal polypeptide
PUV	posterior urethral valves	VNUT	vesicular nucleotide transporter
RAIR	recto-anal inhibitory reflex	WT	wild-type (mouse)
RAMEN	rapidly-adapting mechano-sensitive enteric neurones	ZO	zonula occludens protein

CELL BIOLOGY

C. FRY (UK)

R. CHESS-WILLIAMS (UK), H. HASHITANI (JAPAN), A. KANAI (USA), K. MCCLOSKEY (UK),
M. TAKEDA (JAPAN), B. VAHABI (UK)

I. INTRODUCTION

The previous edition of this report in the 5th edition of *Incontinence* (2013, pp109-178) covered several topics of current interest including updates on: interstitial cells; detrusor and urethral muscle contractile activation; the structure and function of the urothelium; the physiology of the ano-rectum; and translational topics that included identification of novel targets for bladder dysfunction and the role of biomarkers to help understand more of the pathophysiology of the overactive bladder and detrusor overactivity. This edition aims to update the reader on several of these rapidly-evolving areas, but also introduce some new topics that are important areas for research to understand pathophysiological processes in the lower urinary tract and lower gastro-intestinal tract.

The committee has worked closely with Committee 3 (Neural Biology) as several topics have relevance to them both. This Committee considered new advances in our understanding of excitation-coupling in bladder wall smooth muscle, including the hitherto less-studied trigone, *muscularis mucosae* and perivascular myocytes. Interstitial cells continue to be an area of great activity and their phenotypic influence over other cells has been reconsidered and updated. The urothelium was reconsidered with regard to its barrier and transport functions, whilst its role in transducing sensations, in particular to the nervous system, is considered by Committee 3. In addition, there have been great advances in understanding the (patho)physiology of the ano-rectum and these are also reflected here. The functional interaction of the ano-rectum with the lower urinary tract (LUT) is very close and the cellular mechanisms that control the ano-rectum are equally relevant to LUT function.

Two new areas have been included. Firstly, the skeletal muscle physiology of the pelvic floor muscles and the external urethral sphincter. Derangements in the function of these muscles underlie a number of LUT pathologies but the pathophysiological processes that cause them have been given very little attention in fundamental research. Committee 3 of the previous consultation considered the neural control of these muscles and the aim of this report was to expand on this knowledge and form a more complete

understanding of their (patho) physiology. Secondly a new area has been introduced regarding the physiology of the foetal and neonatal bladder, as well as its development in childhood. In particular the development of detrusor smooth muscle function is described, including consideration of the changes that occur in the presence of congenital anomalies of the lower urinary tract. The functional physiology of this topic is very sparsely pursued although the consequences for children with congenital anomalies are profound.

With respect to translational sciences, the identification of new drug targets for management of LUT disorders has again been given prominence, and novel targets are always being identified. Furthermore, a more holistic approach to such disorders has been taken, as they are generally associated with changes to more than one part of the tract, or indeed due to interaction between different cells in a particular tissue. Examples are provided whereby certain agents and treatments may have complex actions on various cells and tissues of the LUT that together may have a beneficial function.

Overall great advances are being made to understand the fundamental basis of LUT disorders. However, there remains a great deal to be discovered as to how different cells and tissues influence each other's function and how this may impact on the genesis of LUT disorders and offer more targeted therapies.

II. EXCITATION-CONTRACTION COUPLING IN BLADDER SMOOTH MUSCLE

1. DETRUSOR SMOOTH MUSCLE DURING THE STORAGE PHASE

1.1. Relevance of Spontaneous Activity

During the storage phase, intravesical pressure rises remarkably little, thus detrusor smooth muscle (DSM) is often considered to be quiescent or relaxed. Non-voiding contractions were thought as a sign of an

overactive bladder or as artificial due to non-physiological 'fast' filling cystometry. However, it is now more widely accepted that the DSM in normal bladders is spontaneously contractile to maintain a shape with a minimum surface area. This property allows micturition contractions to be generated efficiently upon parasympathetic nerve excitation, irrespective of the intravesical urine volume [1].

In bladder of humans [2,3] and laboratory animals [4,5] *in vivo*, non-voiding contractile activity, termed 'micromotions', develops as localized events that are associated with small rises in intravesical pressure. In rat and guinea pig bladder, non-voiding contractions increase in amplitude and frequency with increases in intravesical volume, suggesting that non-voiding activity may stimulate afferent nerves conveying a sense of bladder fullness [4,5]. In the isolated whole bladder of the guinea pig and pig, the corresponding activity is seen as 'non-propagating' autonomous activity [6,7]. A recent study applying multi-electrode arrays to isolated whole guinea pig bladder demonstrated that spontaneous electrical waves on the bladder surface propagate preferentially in the axial direction for only a limited distance [8], indicating that autonomous activity arises from spontaneous electrical events.

Spontaneous phasic contractions are recorded in DSM strips taken from various species including human, [9,10]. The mechanisms underlying these spontaneous phasic contractions include the firing of spontaneous action potentials that can be detected as surface electrical waves in whole bladder preparations and associated intracellular Ca^{2+} transients (Figure 1 [11]).

Increases in the amplitude, spread and/or changes in the pattern of spontaneous activity, e.g. tetanic contractions, are observed in human overactive bladders with detrusor overactivity [1] or in animal models [12]. A recent study demonstrated that spontaneous 'transient' contractions of detrusor smooth muscle have a much larger influence than their baseline tone on afferent nerve activity during storage phases [13]. Thus, it is reasonable to assume that increased spontaneous contractility causes urinary urgency reported in patients with an overactive bladder. Therefore, understanding the mechanisms regulating the spontaneous excitability of DSM, that plays a critical role in maintaining bladder storage function, is fundamental to establish the basis and therapeutic targets of overactive bladder.

While 'non-voiding' activity in whole bladders has been considered to reflect spontaneous contractile activity of DSM, evidence is accumulating that the 'mucosa' (or muscularis mucosae, see below) is also spontaneously contractile. Because of the close apposition of the 'mucosa' with the urothelium and suburothelial afferent nerves, its spontaneous activity may have a larger impact on afferent nerve activity.

Therefore, the origin of spontaneous 'non-voiding' activity in whole bladders is an important area for future study.

1.2. Origin of Spontaneous Activity

Autonomous activity in isolated whole bladders or spontaneous phasic contractions in muscle strips are not diminished by tetrodotoxin (TTX) nor atropine, indicating that they do not originate from parasympathetic nerve excitation [6,9]. Since the discovery of interstitial cells in the bladder expressing Kit-receptor tyrosine kinase [14], a specific marker for interstitial cells of Cajal (ICC) that act as electrical pacemaker cells in the gastrointestinal tract [15], Kit-positive interstitial cells have been a favorite candidate as pacemaker cells driving detrusor spontaneous activity. This analogy is supported by several 'indirect' pieces of evidence: 1) isolated single interstitial cells are capable of generating spontaneous 'nifedipine'-resistant Ca^{2+} transients; 2) detrusor interstitial cells are preferentially located along the boundary of detrusor muscle bundles where spontaneous detrusor Ca^{2+} transients originate; 3) the number of interstitial cells increases in animal models of overactive bladder or in patients with overactive bladder, 4) imatinib mesylate (Glivec), an inhibitor of Kit-receptor tyrosine kinase suppresses detrusor spontaneous contractile activity as well as their action potentials [10,16]. However, no evidence of electrical coupling of interstitial cells with DSM has been demonstrated. Rather, Ca^{2+} transients recorded from interstitial cells *in situ* occur independently of Ca^{2+} transients in adjacent DSM cells [17]. The 'acute' inhibitory action of imatinib is most likely attributable to its non-specific action on both L-type VDCCs and Ca^{2+} release from intracellular stores rather than inhibition of Kit signaling [18]. Consistently, Glivec exerts no acute effects on spontaneous slow waves in the gastrointestinal tract [19]. Moreover, the distribution of Kit-positive interstitial cells and spontaneous contractile/electrical activity are little affected in bladders taken from W/W^v mice that have partial loss of gastrointestinal ICC and associated dysregulation of its motility [20]. Curiously, a later study using double labelling of Kit-positive cells and PDGFR- α -positive cells (described later) failed to resolve Kit immunoreactivity in the murine bladder using verified antibodies that labelled Kit immunoreactivity in ICC of the colon [21].

Electrophysiological investigations have demonstrated that single DSM cells are capable of generating spontaneous action potentials that are very similar to those recorded in 'multicellular' syncytium of the intact tissue preparations [22,23]. Moreover, isolated DSM cells taken from human bladders with idiopathic detrusor overactivity exhibit aberrant spontaneous activity [9]. Therefore, the origin of spontaneous activity in detrusor is most likely to be the DSM cells themselves, so that their altered properties would contribute to several pathological conditions.

1.3. Voltage-Dependent Ca²⁺ Channels

L-type voltage dependent Ca²⁺ channels Spontaneous action potentials in DSM result from the opening of L-type voltage dependent Ca²⁺ channels (LVDCCs, [17,22]). Ca²⁺ influx during action potential discharge appears to be amplified by triggering Ca²⁺-induced Ca²⁺ release (CICR) via ryanodine receptor Ca²⁺ channels in the sarcoplasmic reticulum (Figure 1A). Thus, individual action potentials are associated with spontaneous Ca²⁺ transients resulting in spontaneous phasic contractions [17]. Ca²⁺ sensitisation by

constitutively active Rho kinase (described later) may augment the 'Ca²⁺-dependent' spontaneous phasic contractions. Bursting action potentials are associated with larger Ca²⁺ transients and corresponding 'summed' phasic contractions (Figure 1B). Since the resting membrane potential of DSM *in situ* ranges between -50 mV and -40 mV which is very close to the activation threshold of LVDCCs, the generation and/or frequency of action potentials is highly sensitive to the membrane potential [24,25].

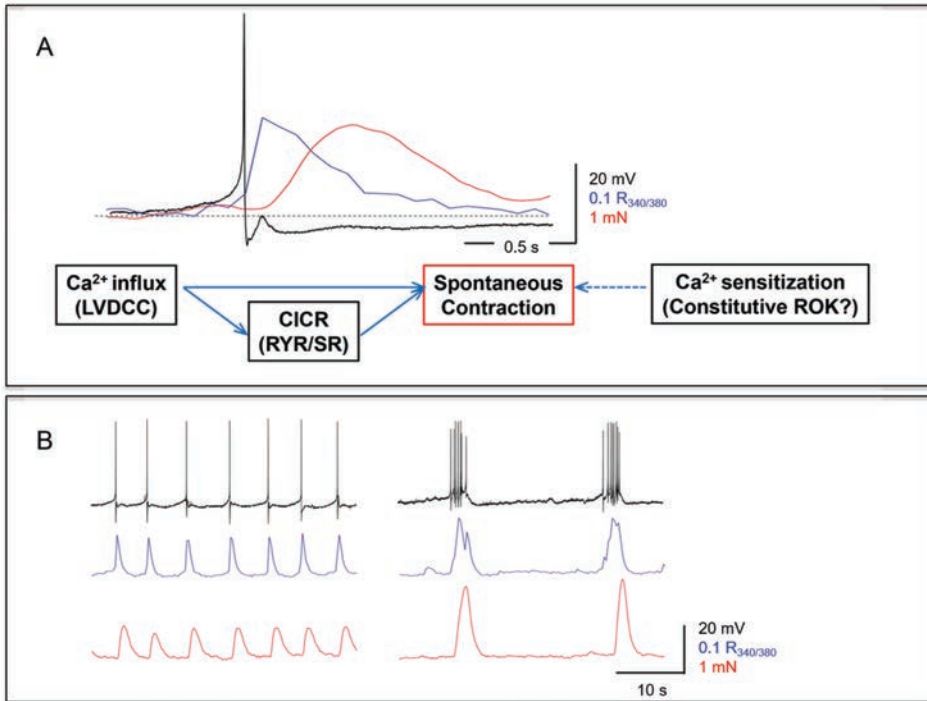

Figure 1. Correlation between spontaneous electrical, intracellular [Ca²⁺] and mechanical activity in detrusor smooth muscle (DSM). A: Ca²⁺ influx via L-type voltage-dependent Ca²⁺ channels (LVDC) during the action potential (black trace) is amplified by Ca²⁺-induced Ca²⁺-release (CICR) to induce a Ca²⁺ transient (blue trace) followed by phasic contraction (red trace). The unit for the Ca²⁺ trace is a fluorescence ratio, R, when illuminated sequentially at 340 and then at 380 nm in a rapid turnover, R_{340/380}. Constitutively active ROCK may augment spontaneous phasic contractions by Ca²⁺-sensitisation. **B:** Compared to individually generated action potentials, bursting action potentials trigger larger Ca²⁺ transients and phasic contractions.

T-type voltage dependent Ca²⁺ channels. The functional role of T-type voltage dependent Ca²⁺ channels (TVDCCs) in the urinary and male genital tracts, including the bladder, is well summarized in a recent review article [26]. TVDCC currents that can be clearly distinguished from LVDC currents have been recorded from DSM cells of human and guinea pig bladders [27,28]. In the gastrointestinal tract, TVDCCs appear to contribute to the upstroke of pacemaker potentials generated by ICC, and thus contribute to the pacemaker mechanism [15]. In DSM of the guinea-pig bladder, Ni²⁺(30 μM), a blocker for TVDCCs slowed the frequency of spontaneous action potentials and corresponding phasic contractions

[28]. A higher concentration of Ni²⁺ (100μM) converted individual action potentials into bursts, and thus increased the amplitude but reduced the frequency of spontaneous phasic contractions. Since the effects of Ni²⁺ (100μM) on action potentials are very similar to those of apamin, a blocker for small conductance Ca²⁺-activated potassium (SK) channels, Ca²⁺ influx through TVDCCs may preferentially access SK channels to stabilise detrusor excitability. In isolated human DSM cells, Ni²⁺ (100μM) blocked ibertoxin-sensitive spontaneous transient outward currents (large conductance Ca²⁺-activated potassium (BK)-STOCs), suggesting the functional coupling of TVCCs with BK channels. Interestingly, Ca²⁺

influx through TVDCCs but not LVDCCs is an essential trigger for the activation of a Ca^{2+} -activated Cl^- current (CACL) in isolated interstitial cells of the guinea-pig prostate [30]. Functional coupling of TVDCCs with Ca^{2+} -activated channels thus varies amongst species, as well as different lower urinary tract tissues.

In DSM cells from bladders with detrusor overactivity, the current density of TVDCCs increases, while LVDCC density is reduced [31] and supports the observation of increased action potential generation in these cells [32]. Since the window current for TVDCCs lies around the resting membrane potential the upregulation of TVDCCs would cause membrane depolarization and/or Ca^{2+} influx, which would increase detrusor contractility by activating LVDCCs or CICR. However, the net outcome of TVDCCs upregulation in terms of detrusor contractility would be determined by the balance between Ca^{2+} influx through TVDCCs and the subsequent activation of Ca^{2+} -activated K^+ channels.

1.4. Ca^{2+} -Activated Chloride Channels

Ca^{2+} -activated Cl^- channels (CACL) function as predominant 'pacemaker' currents in interstitial cells of various smooth muscle tissues, including ICC in the gastrointestinal tract or interstitial cells in the urethra [15,33]. In pig detrusor smooth muscle cells, endothelin-1 induces an inward current that is inhibited by niflumic acid or DIDS, blockers for CACL current, but not by nifedipine [34]. In the rat bladder, immunoreactivity against Anoctamin-1 (Ano1) CACLs, co-localizes in vimentin-positive interstitial cells. Although it was not stated, Ano-1 immunoreactivity appears to be also expressed in DSM bundles [35]. In the same study, niflumic acid or 5-Nitro-2-(3-phenylpropylamino)-benzoic acid reduced the amplitude and frequency of spontaneous phasic contractions, suggesting that Ano1 CACLs may play a role in generating spontaneous phasic activity. An increased expression and function of CACLs in detrusor myocytes isolated from obstructed rat bladder may contribute to greater bladder excitability [36]. It should be noted that spontaneous action potentials in DSM are not blocked by CPA, caffeine or ryanodine [25,37], agents that do prevent spontaneous activity in the urethra arising from spontaneous Ca^{2+} release and subsequent opening of CACLs [38]. Transgenic Ano1 knockout mice display uncoordinated Ca^{2+} transients in their ICC, no electrical slow waves as well as non-rhythmic, uncoordinated spontaneous contractions in their small intestine [39]. Future studies taking an advantage of Ano1 knockout mice should reveal the functional relevance of Ano1 Ca^{2+} -activated Cl^- channels in developing spontaneous activity in DSM.

1.5. TRP Channels

The role of stretch-activated Ca^{2+} permeable TRPV₄ channels in the urothelium in sensing bladder fullness is well established [40]. TRPV₄ channels are also expressed in DSM and may play a role in regulating DSM contractility upon bladder filling [40]. GSK1016790A, a potent TRPV₄ channel agonist, enhanced spontaneous phasic contractions in detrusor muscle strips associated with a rise in the basal tension of the mouse and rat bladders [41,42]. GSK1016790A enhanced spontaneous phasic contractions and also caused a sustained contraction that are suppressed by nifedipine. This suggests that the membrane depolarisation and subsequent activation of LVDCC, rather than the Ca^{2+} influx through TRPV₄ itself, plays a dominant role in the generation of these contractions [41]. The enhanced spontaneous contractile activity upon bladder filling would facilitate afferent discharge, and the sustained contractions may effectively prevent excessive bladder wall distension.

A recent study demonstrated that TRPV₄-positive mice showed markedly higher voiding frequencies [43]. Since the activation of TRPV₄ in the urothelium would cause urothelial release of ATP to trigger a micturition reflex, the higher voiding frequency of TRPV₄^{-/-} mice is rather unexpected. Interestingly, these mice also consistently developed higher frequency non-voiding contractions [33,43]. The higher incidence of non-voiding contractions may be attributed to increased DSM excitability during the storage phase. Thus TRPV₄ may also have an inhibitory role in DSM contractility in addition to having an excitatory function in results which demonstrated functional coupling between TRPV₄ and BK channels in DSM of the guinea-pig bladder [44].

Recently, TRPM₄, Ca^{2+} -activated monovalent cation channels, have been shown to be expressed in DSM of human, rat and guinea-pig bladders and play a role in regulating its excitability and contractility [45,56]. Thus, 9-phenanthrol, a TRPM₄ channel inhibitor, decreased transient inward cation currents and voltage step-induced whole cell currents, as well as attenuated spontaneous phasic contractions.

1.6. Potassium Channels

K^+ channels contribute to action potential repolarisation as well as the resting membrane potential, and thus play a critical role in stabilizing DSM excitability of human and laboratory animals. The role of different types of K^+ channels in regulating detrusor excitability is summarized in a recent review article [47].

In all species studied so far, including human, large conductance Ca^{2+} - and voltage-dependent K^+ (BK) channels play a predominant role in stabilising DSM excitability [48]. Since BK channels contribute to action potential repolarisation, pharmacological blockade of BK channels enhances the amplitude and duration of spontaneous action potentials (Figure 2A,

[24,25,49]). As expected, the blockade of BK channels greatly enhanced spontaneous phasic contractions [50]. In DSM of the guinea-pig [25] but not human or mouse [24,49], BK channels also appeared to contribute to the generation of an action potential 'after-hyperpolarization'. Ca^{2+} influx through LVDCCs upon action potential firing has been shown to facilitate the opening of BK channels. Subsequent Ca^{2+}

release from sarcoplasmic reticulum via CICR also contributed to the activation of BK but not SK channels [51]. Thus, the inhibition of CICR with CPA or ryanodine results in the enhancement of spontaneous action potentials and associated phasic contractions. Consistently, deletion of pore-forming subunits of BK channels in mouse bladder resulted in an overactive phenotype [52].

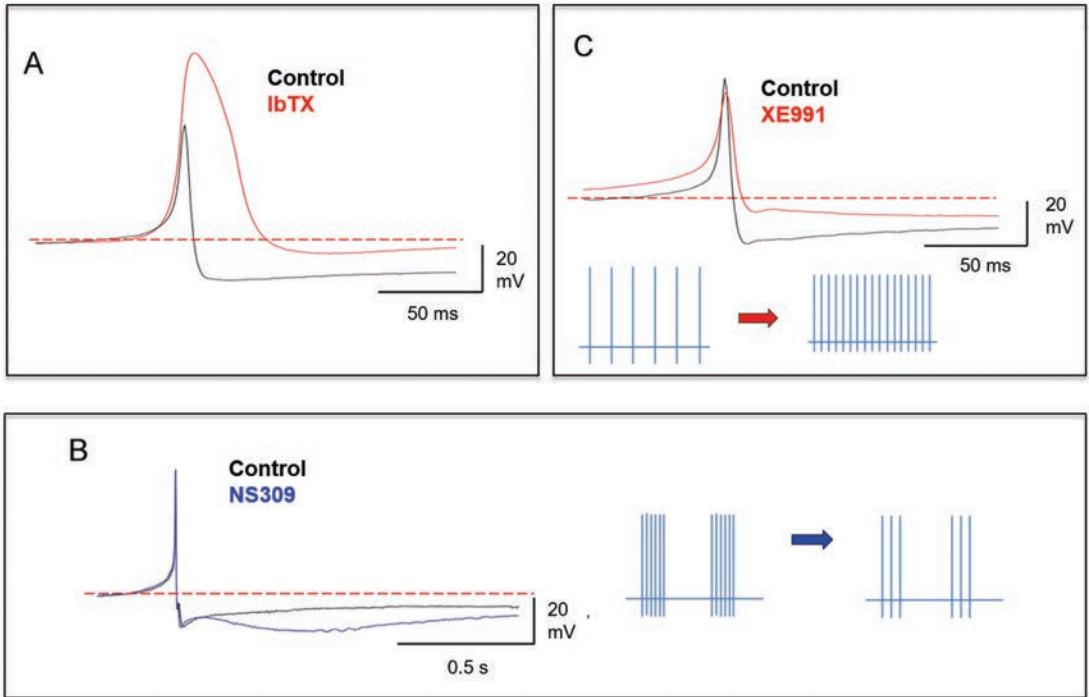

Figure 2. Role of K^+ channels in regulating spontaneous action potentials in detrusor smooth muscle (DSM). **A:** BK channels predominately contribute to action potential (AP) repolarisation to limit the amplitude and duration of the AP. They also generate an after-hyperpolarisation; reduced by BK channel blockade with iberiotoxin (IbTX, red trace, guinea-pig DSM). **B:** Increased SK channel opening (with NS309, blue trace) hyperpolarises the cell and slows AP generation. **C:** Kv7 channel blockade (with XE991, red trace) depolarises the cell and accelerates AP firing.

Of interest, NS11021, a BK channel opener, that suppresses spontaneous phasic contractions, reduced the frequency of spontaneous action potentials without changing the resting membrane potential [53]. Thus the opening of a small number of BK channels that is not associated with a membrane hyperpolarization may be sufficient to block the generation as well as propagation of action potentials. Considering the amplitude of the after-hyperpolarisation (approximately 10 mV), the physiological activation of BK channels during action potential firing appears to be highly efficient.

Small conductance Ca^{2+} -activated K^+ (SK) channels play an important role in determining the pattern of action potential firing, while contributing little to the action potential configuration. Thus, the blockade of SK channels converted individual action potentials into bursts, resulting in increased amplitude of spontaneous contractions (Figure 2B, [24,25]). Recently,

PDGFR α -positive cells (see below) in the bladder, that also predominantly express SK3 protein, may well stabilise detrusor excitability [54,55]. However, changes to the pattern but not frequency of action potential firing is an unlikely result from a simple deletion of a hyperpolarizing input from non-DSM cells. Suppressing SK3 channel expression in mouse bladder was associated with an increase in DSM spontaneous phasic contractions *in vitro*, and bladder over-activity *in vivo* [56]. An essential role of SK2 channel expression in regulating DSM contractility has also been demonstrated using mice lacking SK2 gene expression [57].

SK channel openers, e.g. NS309, SKA-31, suppress spontaneous phasic contractions in a manner sensitive to apamin [58,59]. In isolated DSM cells with resting membrane potentials of about -25mV, these openers caused small apamin-sensitive hyperpolarization

sation. In DSM bundle preparations where physiological membrane potentials, i.e. -50~-40 mV, is maintained, SK channel openers prevent spontaneous action potentials with or without membrane hyperpolarizations [60]. Of interest, SK channel openers dramatically prolong the duration of after-hyperpolarization without increasing their amplitude in a manner sensitive to apamin (Figure 2B). This action of SK channel openers may preferentially suppress tetanic contractions seen in pathological bladders by dispersing bursting action potentials.

Because of their slow inactivation and low-voltage activation thresholds, Kv7 channels are considered to contribute to the resting membrane potential. Kv7 activators, e.g. flupirtine, retigabine or ICA-069673, block spontaneous transient depolarisations (or action potentials) in isolated guinea-pig DSM cells, associated also with membrane hyperpolarisation. In contrast, XE991 (10 μ M), a Kv7 blocker, depolarises the membrane to trigger the generation of spontaneous transient depolarisations [61-63]. Figure 2C Consistently, Kv7 activators suppress spontaneous phasic contractions in a manner sensitive to Kv7 inhibitors. In DSM bundle preparations of the guinea-pig bladder, XE991 also depolarised the membrane and dramatically increased action potential frequency (Figure 2C) [60]. However, flupirtine slowed or prevented spontaneous action potentials without hyperpolarizing the membrane. In mouse DSM, TEA (10 mM) further enhanced the amplitude and duration of iberitotoxin-treated action potentials and also suppressed their after-hyperpolarizations in mouse detrusor smooth muscle [49]. In single DSM of the mouse bladder, slowly-inactivating Kv currents that were blocked by TEA, but not 4-AP, were recorded although the molecular expression of Kv7 was not examined [64].

2. INHIBITORY MECHANISMS

In addition to the intrinsic relaxing mechanisms of K⁺ channels on DSM, several other mechanisms may be involved in stabilising DSM excitability/contractility during the storage phase.

2.1. β -Adrenoceptors

It is widely quoted that noradrenaline released from sympathetic nerves acts on β -adrenoceptors in DSM to directly suppress its contractility during the storage phase [65]. However, this is unlikely as sympathetic nerve fibres predominantly innervate the blood vessels in the bladder wall not DSM in most species, including human [66,67]. This view is consistent with the finding that nerve-evoked relaxation of DSM strips is hardly detected in the presence of α , β -methylene ATP and atropine, while nitrenergic relaxations are detected in trigonal and urethral muscle strips [68]. On the other hand, sympathetic, α -adrenergic constrictions of submucosal arterioles or venules can be readily detected in the rat bladder [69,70]. Thus, the predominant effect of the sympathetic innervation of

the DSM is inhibition of the parasympathetic pathways at spinal and ganglion levels [71].

Nevertheless, exogenously-applied β 3 adrenoceptor agonists effectively suppress spontaneous phasic contractions of DSM. In isolated DSM, β 3 adrenoceptor agonists and PDF4 inhibitors that increase intracellular cAMP levels hyperpolarise the membrane by opening BK channels to relax DSM [72,73]. However, in DSM bundle preparations of the guinea-pig bladder, BRL37344 (10 μ M), a β 3 adrenoceptor agonist, or rolipram (10nM), a PDF4 inhibitor, slowed or prevented action potential firing without hyperpolarizing the membrane [60]. Although a higher concentration of rolipram (100nM) was capable of hyperpolarizing DSM membrane, IbTX, a BK blocker, prevented the rolipram-induced blockade of action potentials but not the hyperpolarization. Since cAMP appears to be capable of reducing DSM contractility by mechanisms other than BK channel opening [74], the relevance of BK channel-induced hyperpolarisation to cAMP-dependent relaxation of DSM is of interest.

2.2. Parathyroid Hormone-Related Protein

Parathyroid hormone-related protein (PTHrP) released from DSM upon stretch may act as an endogenous DSM relaxant during bladder filling [75]. A recent study in the rat bladder demonstrated that PTHrP potently suppressed spontaneous phasic contractions, while exerting only a modest inhibitory effect on carbachol-induced contractions [76]. PTH1R, a PTHrP receptor, predominantly locates in the muscular layers of the bladder wall (Figure 3A, [77,78]) and the concurrent expression of PTHrP in DSM indicated that PTHrP may function as a relaxing factor in an autocrine or paracrine fashion. Bath-applied PTHrP largely suppresses spontaneous contractions, while little affecting CCh-induced contractions, indicating that PTHrP appears important for normal bladder function as well as a therapeutic target for overactive bladder. Endogenous and exogenously administered PTHrP may not disturb neurally-mediated detrusor contractions during the voiding phase, while effectively suppressing spontaneous contractions that could stimulate afferent nerve firing (Figure 3B). In contrast, downregulation of PTHrP-mediated stabilisation of DSM contractility may result in overactive bladder or reduced bladder capacity. Indeed, specimens taken from patients who have undergone bladder augmentation invariably show negative PTH1R staining in their DSM [77]. Because the detrusor has a tenfold higher sensitivity to PTHrP compared to the *muscularis mucosae*, and that they are separated by layers of connective tissue, PTHrP may function as autocrine relaxant of DSM without suppressing mucosa contractility [78].

In other smooth muscles, PTHrP acts via the adenylyl cyclase-cyclic AMP-PKA pathway. However, the involvement of this pathway in detrusor relaxation has not been established. Further studies will be needed to explore the mechanism of PTHrP-induced suppression of spontaneous DSM contractions.

2.3. PDGFR- α /SK3 Positive Cells

Interstitial cells that are labelled specifically with antibodies against platelet-derived growth factor receptor- α (PDGFR α -positive cells) functionally express SK3 channels and thus may stabilise DSM excitability by hyperpolarising them [54,55]. PDGFR α -positive cells have also been identified in the detrusor layer and lamina propria of human and guinea pig bladders [79]. Of interest, PDGFR α -positive cells are a sub-population of vimentin-positive cells and in human

and guinea pig bladders a significant proportion co-expresses Kit immunoreactivity. PDGFR α -positive cells have a close apposition with varicose nerve processes within the DSM and lamina propria, and respond to purines by generating apamin-sensitive hyperpolarization [80, suggesting that PDGFR α /SK3 positive cells may also be involved during purinergic inhibition of detrusor excitability. To date, no evidence of electrical coupling between PDGFR- α /SK3-positive cells and neighbouring DSM cells has been demonstrated.

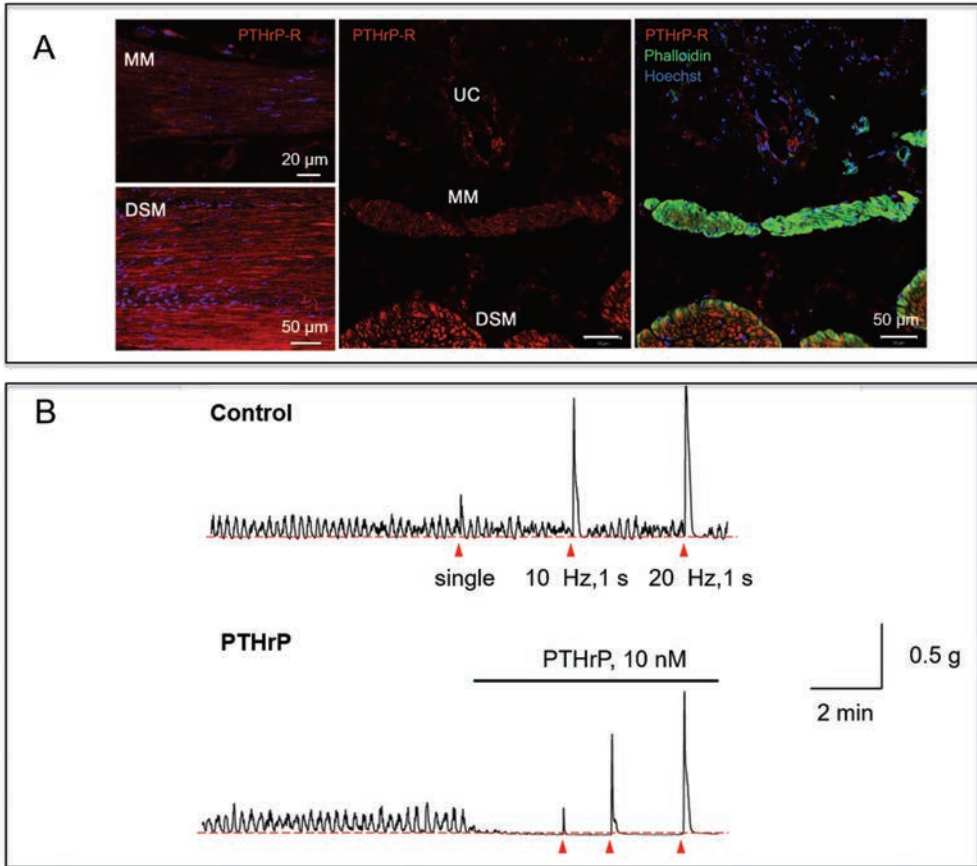

Figure 3. Expression PTHrP-R and function of PTHrP in detrusor smooth muscle (DSM) and muscularis mucosae (MM). A: Guinea-pig bladder; both DSM and MM express PTHrP receptor immunoreactivity, with weaker expression in the urothelium. Phalloidin label (green) for F-actin in cells; Hoescht label (blue) for nuclei (DNA). B: Bath-applied PTHrP (10 nM, abolishes spontaneous phasic contractions (upper trace), whilst leaving nerve-evoked contractions (single or repetitive stimulation) largely unaffected.

2.4. TRPV₄-BK Coupling

The activation of TRPV₄ with GSK, a TRPV₄ agonist, enhances DSM contractility in mouse and rat bladders [41,42]. Thus, TRPV₄ expressed in DSM may be considered to have an excitatory effect on DSM excitability/contractility upon bladder filling. In guinea-pig DSM, GSK (1 nM) evoked a sustained contraction associated with a cessation of spontaneous phasic contractions in a manner sensitive to HC-067047, a TRPV₄ antagonist [44]. Cessation of spontaneous contractions induced by GSK is reversed or

prevented by iberiotoxin or paxilline, BK channel blockers, but not apamin, a SK blocker. GSK abolished spontaneous Ca²⁺ transients, increased basal Ca²⁺ levels and also prevented spontaneous action potential discharge associated with DSM membrane hyperpolarisation (Figure 4A). Iberiotoxin restored spontaneous Ca²⁺ transients and action potentials, and reversed the hyperpolarization. Thus, Ca²⁺ influx through TRPV₄ appears to activate BK channels to suppress spontaneous contractions by inhibiting

LVDCCs (Figure 4B). Since TRPV₄ is a stretch-activated channel, such functional coupling of TRPV₄ with BK channels may ideally function as a self-limiting mechanism for bladder contractility during its storage phase. Of interest, unlike mouse bladder, where

the urothelium has a much stronger expression of TRPV₄ than DSM, in the guinea-pig bladder TRPV₄ expression is stronger in DSM compared to urothelium (Figure 4C).

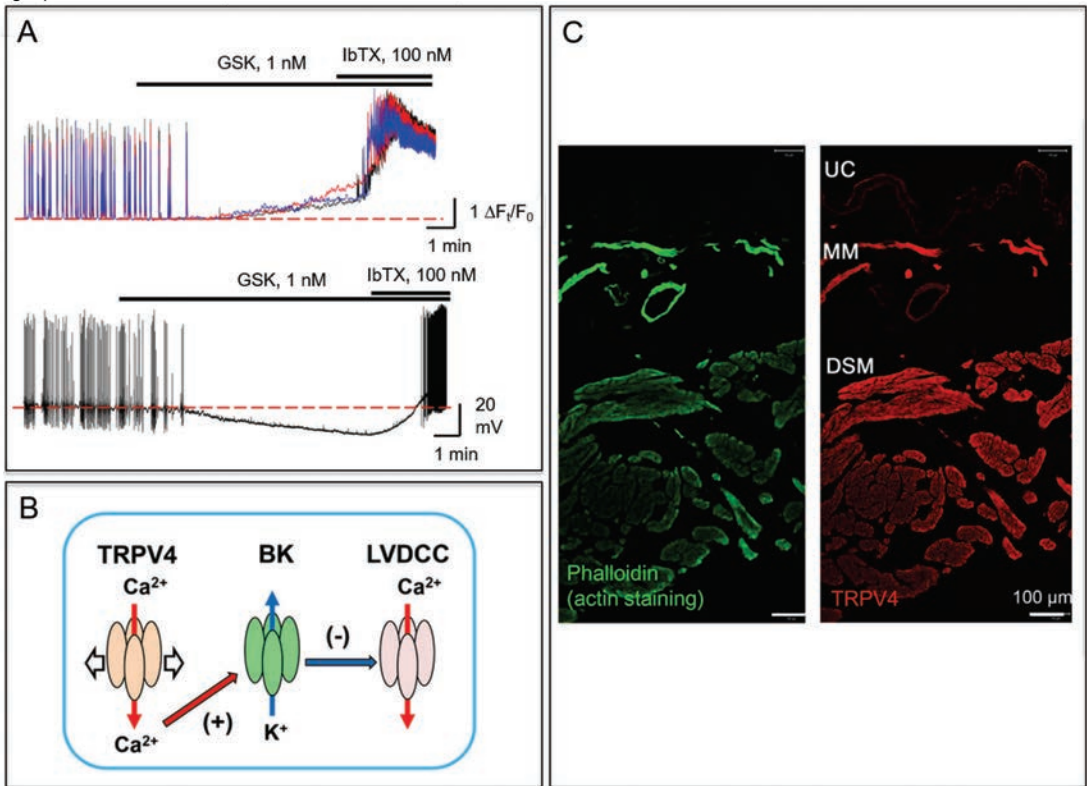

Figure 4. Functional coupling of TRPV₄ with BK in DSM **A:** GSK, a TRPV₄ agonist, caused a cessation of spontaneous Ca²⁺ transients (upper traces from three cells) and action potentials (lower panel). This was followed by a rise of the resting Ca²⁺ concentration and membrane hyperpolarisation. Iberiotoxin (IbTX, 100 nM), a BK channel blocker, restored spontaneous Ca²⁺ transients and action potentials and also reversed the hyperpolarization. **B:** A schematic drawing of the proposed relationship between TRPV₄ and K⁺/Ca²⁺ channels is shown below, whereby upon bladder wall distension, Ca²⁺ influx via stretch-activated TRPV₄ channels activates BK channels to inhibit L-type Ca²⁺ channel activity. **C:** Guinea-pig bladder wall, both DSM and muscularis mucosae (MM) express a strong TRPV₄ immunoreactivity (right panel). A phalloidin label for F-actin is shown in the left panel.

3. DETRUSOR SMOOTH MUSCLE DURING VOIDING PHASE

3.1. Ca²⁺-Dependent Cholinergic Transmission

DSM receives a very high density of parasympathetic (cholinergic) innervation forming 'true' autonomic neuromuscular junctions [67]. Single DSM cells have multiple neuromuscular junctions where their membrane forms very close appositions with a number of nerve varicosities. In normal human DSM, excitatory neuromuscular transmission is exclusively mediated by acetylcholine, while a significant non-cholinergic component is evident during nerve-evoked DSM contraction in other species [9]. Despite a greater density

of M₂ muscarinic receptors than M₃ muscarinic receptors in DSM, neurally-released acetylcholine predominantly acts on M₃ muscarinic receptors accounting for over 95% of the cholinergic contraction [81,82]. This suggests that M₃ muscarinic receptors may be clustered within the neuromuscular junctions. The relative contribution of M₃ and M₂ receptors to the carbachol (CCh)-induced contraction appears not to be altered in obstructed human bladders [83].

M₃ receptors couple to Gq/11 guanine nucleotide binding proteins that stimulate phosphoinositide hydrolysis by phospholipase C (PLC). Thus, a contribution of inositol 1,4,5-trisphosphate (InsP₃)-mediated Ca²⁺ release from the sarcoplasmic reticulum (SR) to cholinergic-mediated DSM contractions has been suggested. However, it has been suggested that M₃ muscarinic receptor-mediated contraction of human

bladder is largely mediated by Ca^{2+} influx through LVDCCs and activation of a Rho-associated kinase (ROCK), while PLC and protein kinase C (PKC) activation are little involved [84] (Figure 5A). The rise of the intracellular Ca^{2+} concentrations upon Ca^{2+} influx through VDCCs will be amplified by Ca^{2+} -induced Ca^{2+} release (CICR) from the SR and activate Ca^{2+} /calmodulin dependent activation of myosin light chain kinase (MLCK) resulting in myosin regulatory light chain (RLC) phosphorylation to initiate DSM contractions. In guinea-pig detrusor, cholinergic nerve stimulation increases the frequency of action potential firing and induces oscillatory Ca^{2+} transients associated

with contractions [37], suggesting the importance of Ca^{2+} influx through LVDCCs in cholinergic contractions. In mouse detrusor when photolysis of caged InsP_3 can promote Ca^{2+} release from the SR, neurally-released ACh triggers bursting action potentials and corresponding Ca^{2+} transients [85]. Moreover, nerve-evoked contractions are greatly suppressed by the blockade of LVDCCs but upon blockade of InsP_3 production or SR Ca^{2+} handling there is little effect, suggesting that InsP_3 -mediated Ca^{2+} release does not participate in cholinergic nerve-mediated contraction.

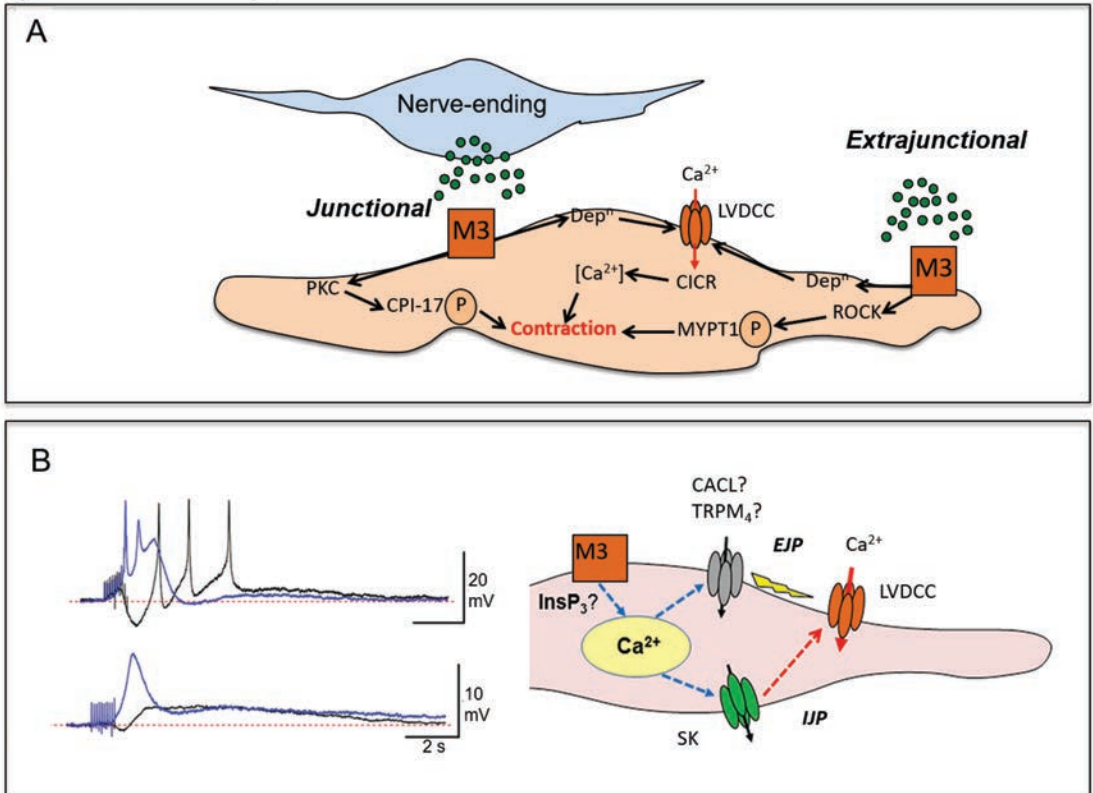

Figure 5. Cholinergic transmission in human detrusor smooth muscle (DSM). A: Junctional and 'extrajunctional' transmission. Receptors that activate depolarisation-induced Ca^{2+} influx and PKC-dependent Ca^{2+} sensitisation by nerve mediated stimulation (left). Bath-applied muscarinic agonists (right) act preferentially on 'extrajunctional' M3 receptors to activate ROCK the signalling pathway as well as depolarisation-induced Ca^{2+} influx. **B: Left traces:** nerve (cholinergic) stimulation evokes an inhibitory junction potential (ICP: black trace) followed by action potential firing. Lower panel: After blockade of SK channels, the IJP is converted to an excitatory junction potential (EJP) to trigger more rapidly an action potential (blue trace). Lower traces: After nifedipine treatment nerve stimulation evokes a small IJP (black trace) that is followed by a slow depolarisation. After blockade of SK channels, an EJP is unmasked (blue trace). M3 receptor stimulation appears concurrently to activate SK channels and Ca^{2+} -activated inward currents. Schematic diagram of the inter-relationship between L-type Ca^{2+} channels (LVDCC), SK channels and muscarinic receptor activation.

In human detrusor, neurally-released ACh evokes an inhibitory junction potential (IJP) that is followed by action potential discharge (Figure 5B). [24]. Blockade of SK but not BK channels abolishes the IJP and unmasks an excitatory junction potential (EJP) which triggers multiple action potentials, suggesting that SK

channels function as a self-limiting mechanism to prevent an excessive increase of intracellular Ca^{2+} and hence limit the contraction of DSM. Ionic conductances underlying the EJPs have not been identified, but it is reasonable to assume that CACL or Ca^{2+} -activated TRPM4 may be involved (Figure 5B). A recent

study using isolated human DSM demonstrated that muscarinic receptor stimulation results in the suppression of BK channel-dependent transients outward currents and membrane depolarization by modulating intracellular Ca^{2+} , but not by directly inhibiting BK channels [86]. Therefore, BK channels that play a predominant role in stabilising DSM excitability may be suppressed during cholinergic transmission, while SK channels may have a counteracting action.

3.2. Ca^{2+} -Sensitisation in Cholinergic Transmission

In addition to the Ca^{2+} -dependent contractile pathway, the stimulation of muscarinic receptors is thought to recruit ROCK- and PKC-dependent Ca^{2+} sensitization of the DSM contraction mechanism [87]. A study using transgenic mice expressing calmodulin sensor MLCK in smooth muscle demonstrated that activation of DSM muscarinic receptors by neurally-released ACh leads to phosphorylation of the 17 kDa PKC-potentiated protein phosphatase 1 inhibitor (CPI-17) to enhance Ca^{2+} sensitivity, but not the myosin-targeting subunit of MLCP (MYPT1). This may suggest that ROCK-mediated Ca^{2+} sensitization is not involved in cholinergic neuromuscular transmission [88]. The involvement of the ROCK signalling pathway in muscarinic DSM contraction has been demonstrated using only high concentrations of bath-applied muscarinic agonists, thus signalling pathways underlying neurally-released transmitters and bath-applied agonists could well be different. In murine gastric fundus, cholinergic motor neurotransmission activates PKC-dependent CPI-17 phosphorylation, while bath-applied carbachol recruits additional ROCK-dependent MYPT1 phosphorylation [89]. Thus, carbachol, as a muscarinic agonist, was proposed to activate 'non-junctional' muscarinic receptors, indicating that focalized (or synaptic-like) neurotransmission, rather than diffuse 'volume' neurotransmission operates in this tissue. Likewise, neurally-released ACh in DSM may access only 'junctional' M3 receptors, while bath-applied muscarinic agonists may preferentially act on 'extrajunctional' M3 receptors (Figure 5A). ROCK inhibitors do suppress spontaneous phasic contractions [90] or high-potassium-induced contractions in guinea-pig DSM [91]. Therefore, constitutively active ROCK may contribute to basal MYPT1 phosphorylation to enhance Ca^{2+} /calmodulin dependent contractility. In rabbit DSM, activation of PKC with phorbol 12,13-dibutyrate induces contraction which involves both PKC and ROCK signalling pathways [92]. CPI-17 is phosphorylated directly by PKC and indirectly via PKC-dependent activation of ROCK, but ROCK mediated-MYPT1 phosphorylation is not involved. A constitutively active isoform of ROCK that appears to be different from that activated by PKC may contribute to the high basal MYPT1 phosphorylation in DSM.

Increased expression of RhoA and ROCK and enhancement of CCh-induced tonic contraction that is sensitive to ROCK inhibitors have been reported in obstructed [93] and ischaemic [94] rat bladders. In

addition, bladder outlet obstruction enhances the ROCK pathway, increasing CCh-induced Ca^{2+} sensitization of permeabilized guinea pig DSM, while diminishing the contribution of the PKC pathway [95]. This suggests that the ROCK pathway plays a larger role in regulating the contractility of pathological DSM.

DSM from diet-induced obese mice displays an overactive bladder phenotype and develops greater contractions irrespective of the stimuli (e.g. with CCh, α , β -methylene ATP or KCl) which are fully reversed by an LVDCC blocker [96] even in the absence of an upregulation of Ca^{2+} -channel (Cav1.2) protein expression. Chronic but not acute metformin treatment improves their insulin sensitivity and normalizes the *in vitro* bladder hypercontractility as well as their cystometric dysfunction. PKC protein expression is higher in DSM from obese mice and reversed upon treatment with an LVDCC blocker or metformin. Thus it appears that insulin resistance and the enhanced Ca^{2+} influx through LVDCC and PKC upregulation are causes of detrusor overactivity by mechanisms yet to be identified. KCl-induced contractions are augmented in DSM taken from hypercholesterolemia rats, but their spontaneous and CCh-induced contractions are not altered [97]. Although the relative contribution of M3/M2 receptors to these CCh-induced contractions are not changed, LVDCCs blockade results in a much larger inhibition of M3-mediated contractions in hypercholesterolemia DSM, whereas ROCK-dependent components are not changed. Therefore, changes in DSM contractility in hypercholesterolemia may also be attributed to altered properties of LVDCCs. Of interest, a study using adiponectin-sense-transgenic (Adip-Sen) mice demonstrated that their DSM exhibit a larger Ca^{2+} dependency of CCh-induced contractions, attributed to an increased expression of the Ca^{2+} -dependent isoform of PKC, PKC α resulting in Ca^{2+} sensitization [98]. Since adiponectin is an endogenous antidiabetic factor that is reduced in individuals with obesity, this finding is apparently contradictory to the observation in metabolic syndrome model animals.

3.3. Purinergic Transmission

Non-cholinergic DSM contractions are mediated by ATP, co-released with ACh from parasympathetic nerves, acting on P2X purinoceptors. In guinea-pig, neurally-released ATP evokes excitatory junction potentials (EJPs) which trigger action potentials and associated Ca^{2+} transients to contract DSM [37]. Purinergic contractions appear to result from Ca^{2+} influx through LVDCCs that is amplified by CICR. A study using transgenic mice expressing calmodulin sensor MLCK in smooth muscles demonstrated that purinergic transmission has a larger contribution to the initial contractile phase during nerve-evoked contractions, while cholinergic transmission is dominantly involved in the sustained phase [88]. Purinergic transmission induces Ca^{2+} /calmodulin dependent activation of

MLCK resulting in myosin RLC phosphorylation without causing CPI-17 phosphorylation, suggesting that purinergic contraction is exclusively Ca^{2+} dependent.

Unlike normal human bladder in which neurally-mediated DSM contractions exclusively rely on the release of ACh, atropine-resistant components can be seen under pathological conditions [98]. Furthermore, a recent study has demonstrated that normal paediatric DSM also exhibits a purinergic contraction that decreases with postnatal development [100]. An *in vitro* contractile study has also demonstrated that exposure of DSM strips to cycles of hypoxia–glucopenia and reoxygenation increases the atropine resistant component of EFS-induced contractions, while not increasing the cholinergic component [101]. The augmentation of purinergic transmission may be attributed to increases in the expression of P2X_1 receptors and/or neural ATP release. This suggests that hypoxia–glucopenia and reperfusion episodes during the micturition cycle may cause increased atropine-resistant responses in detrusor of patients with overactive bladder and bladder outlet obstruction. A mouse model of premature ageing displays an increased frequency of total and small volume micturition. DSM strips taken from senescence-accelerated mice display enhanced nerve-evoked contractions as well as larger atropine-resistant, purinergic contractions [102]. In contrast, DSM of ageing rats exhibits impaired contractility in response to CCh or electrical field stimulation. The decrease of the cholinergic component may be attributed to a lower M3 receptor mRNA expression as well as a higher collagen deposition [103]. These age-related bladder changes are milder in the old rats with long-term caloric restriction than in those fed normal food, suggesting a preventive effect of caloric restriction against age-related functional and morphological bladder changes, and possibly related to a change of pelvic blood supply.

3.4. β -adrenoceptor Mediated Inhibition

As described previously, exogenously-applied β_3 adrenoceptor agonists and PDE4 inhibitors suppress spontaneous phasic contractions of DSM. Considering the therapeutic usefulness of these agents, it is of interest to know if they also suppress neurally-mediated contractions. In human bladder, BRL37344, a β_3 -adrenergic agonist suppressed nerve-evoked contractions in a manner partially sensitive to a BK channel blocker [104]. Although a preferential inhibition of purinergic contractions would be beneficial, BRL37344 reduced both cholinergic and purinergic

contractions. Rolipram, a PDE4 inhibitor that accumulates cAMP, also inhibited neurally-mediated contractions of human DSM that was partially reversed by a BK channel blocker [73]. A recent study using α -toxin permeabilized human DSM demonstrated that cAMP inhibits ROCK-dependent Ca^{2+} -sensitization evoked upon M3 receptor activation, while the PKC pathway appears to be unaffected by cAMP, suggesting that cAMP also recruits Ca^{2+} -independent relaxation of DSM [105].

4. NON-DETRUSOR SMOOTH MUSCLE CONTRACTILE ELEMENTS

4.1. Muscularis Mucosae

The mucosa of guinea-pig and pig bladders contracts spontaneously or in response to electrical field stimulation or bath-applied agonists such as CCh, purines or neurokinins [106-108]. In the guinea pig bladder, the *muscularis mucosae* is a thin layer located between the urothelium and detrusor, displays immunopositivity to α -smooth muscle actin, and is thus considered a source of spontaneous contractions [109]. In the human urinary bladder, the *muscularis mucosae* forms a discontinuous layer that is clearly distinct from the detrusor, and is well recognised as an anatomical landmark for bladder cancer staging. In the bladder of rat, rabbit, cat and dogs, the *muscularis mucosae* is not morphologically evident, perhaps explaining the lack of mucosa contractile activity in these species.

Since the bladder mucosa develops a much larger contraction per unit cross-sectional area than DSM [108], specialised contractile elements such as myofibroblasts or the microvasculature have been suggested to contribute to mucosa contractile function. A recent study examined the contractility of 'isolated' *muscularis mucosae* strips in which the urothelium and suburothelial blood vessels had been removed (Figure 6, [78]). The muscle force generated by 'isolated' *muscularis mucosae* per sectional area was approximately eight times larger compared to that of detrusor. Moreover, the non-*muscularis mucosae* area of the mucosa did not exhibit any spontaneous contractions. Thus, the *muscularis mucosae* appears to be the main contractile element in the mucosa, but the specialised contractile machinery that generates such a large cross-sectional force compared to the detrusor is not yet established.

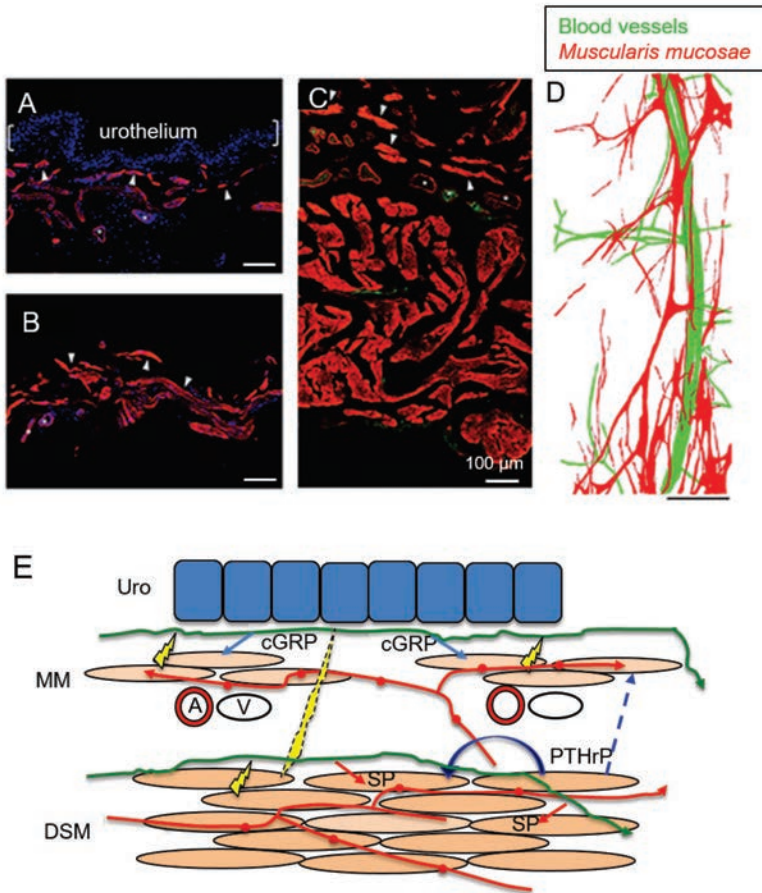

Figure 6. Structural and functional properties of muscularis mucosae. A-C: In bladder cross-sections, muscularis mucosae (white arrow heads) have a close apposition with the urothelium and suburothelial microvessels. D: In whole-mounts, muscularis mucosae runs parallel to the long axis of suburothelial microvessels. E: Spontaneous contractions of muscularis mucosae (MM) may effectively reduce stretching of suburothelial microvessels as well as unfolding of the urothelium (Uro) through release of cGRP and substance P from nerves and PTHrP from detrusor smooth muscle (DSM). A; arterioles, V; venules, DSM;

The mucosa shares a number of common properties with detrusor smooth muscle, but also displays some differences. For example, BK and SK channels play a less prominent role in regulating mucosa spontaneous contractions [100]. Capsaicin enhances spontaneous contractions in the detrusor, while suppressing those of the mucosa [109] or 'isolated' muscularis mucosae [79].

Despite the presence of muscularis mucosae in the bladder of several species including human, its physiological role is not well understood. An early report implied that muscularis mucosae bundles are associated with suburothelial blood vessels in the human bladder. In the guinea-pig bladder, immunohistochemical analysis of whole mount mucosa demonstrated that the muscularis mucosae is preferentially colocalised along the long axis of suburothelial blood vessels, while some is sparsely distributed in non-vascular areas (Figure 6, [77]). Such a morphological relationship between muscularis mucosae and

suburothelial blood vessels may indicate that spontaneous contractions of the muscularis mucosae prevent the vessels from stretching upon bladder wall distension. Contraction of muscularis mucosae may also effectively maintain the folding of the urothelium. In addition, muscularis mucosae may cause larger mechanical stimuli to suburothelial sensory nerves than DSM, and thus may have an important role in sensing bladder fullness in normal and pathological bladders (Figure 6). Even though mice and rats are the most common species used for investigating bladder function their lack of a muscularis mucosae and a non-contractile muscoa, limits their use as a model of human bladder.

4.2. Suburothelial Microvasculature

Ischaemic and reperfusion damage to the cells in the bladder wall has been considered as a major cause of lower urinary tract symptoms associated with ageing and metabolic syndrome [110-112]. Previous

studies have focused on the insufficient blood supply to the bladder due to the occlusion of the iliac artery associated with atherosclerosis, using animal models that have undergone local endothelial injury to induce chronic bladder ischaemia [113-114]. The iliac artery, particularly at its bifurcation, is indeed the site where atherosclerosis preferentially develops upon endothelial dysfunction [115]. Vasorelaxants such as α -adrenoceptor antagonists, β -adrenoceptor agonists and PDE5 inhibitors, improve bladder storage func-

tion without improving the narrowed luminal diameters of the feeding arteries [110]. This suggests that their therapeutic effects can be attributed to their actions on the contractile and/or morphological properties of the microvasculature within the bladder wall. The bladder microvasculature may also be the origin of bladder dysfunction seen in systemic vascular dysfunction models [116,117]. However, current information on the functional characteristics of the bladder microvasculature is limited.

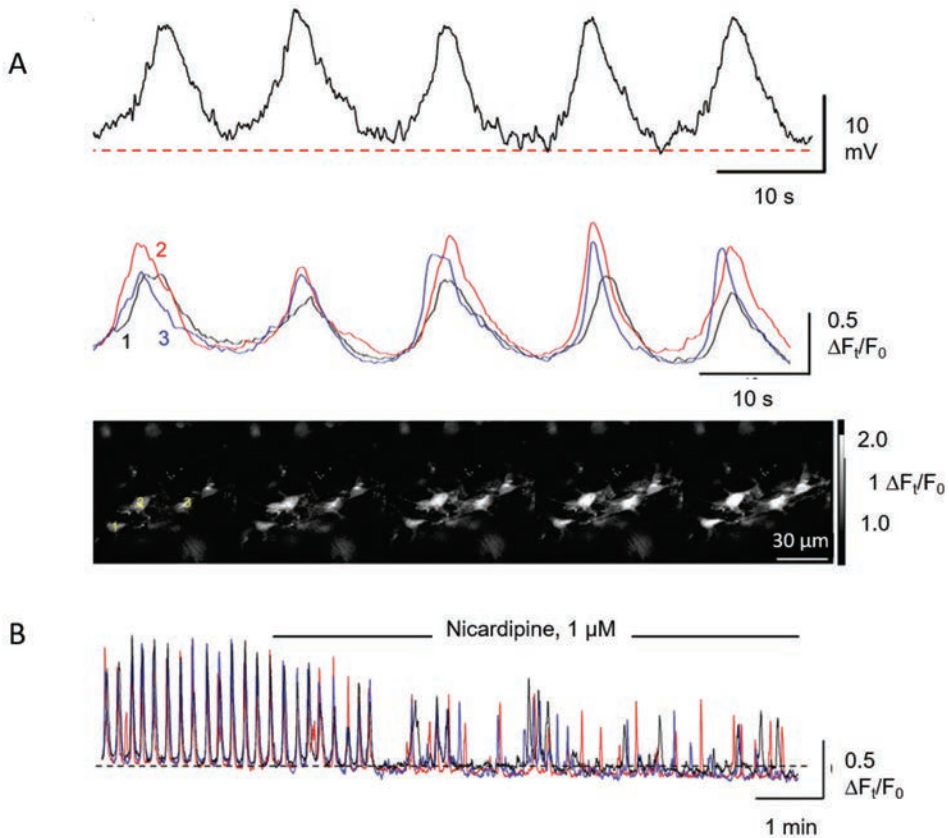

Figure 7. Spontaneous contractions and Ca²⁺ transients in suburothelial venules. *A: Spontaneous depolarisations (upper trace) from a venular pericyte and synchronous Ca²⁺ transients (lower traces) from three associated cells from a network of cells. The pericyte network from where the Ca²⁺ transients are shown below. $\Delta F_t/F_0$ as used in the calibration bars for the Ca²⁺ transients is a positive function of the intracellular [Ca²⁺]. B: blockade of L-type voltage-dependent Ca²⁺ channels (LVDC) with nicardipine suppresses Ca²⁺ transients and disrupts synchrony.*

Blood vessels in the bladder wall are characterised by their torturous arrangement to efficiently accommodate the considerable spatial changes associated with the cyclic stretching and relaxation of the bladder wall during the micturition cycle [118]. Thus, they are capable of maintaining their diameters so that the resistance against blood flow is not increased during the filling phase. Besides this structural characteristic, suburothelial venules in the bladder of rat [67,70] and mouse [119] develop spontaneous phasic constrictions so that the venules may actively facilitate

venular drainage. In the rat bladder, venular constrictions predominately arise through contractions of circumferentially-arranged venular smooth muscle cells, while stellate-shaped pericytes also exhibit spontaneous Ca²⁺ transients and contractions. In the mouse bladder, the contractile mural cells generating spontaneous Ca²⁺ transients are stellate-shaped pericytes, while spindle-shaped smooth muscle cells are distributed only in the proximal, larger venules.

The mechanisms underlying spontaneous venular constrictions are action potentials arising from the

opening of LVDCCs (Figure 7A, [67,119]). Blockade of LVDCCs suppresses venule spontaneous Ca^{2+} transients and also disrupts their synchrony with the contractile mural cells, indicating they play a critical role in maintaining multicellular coupling (Figure 7B). After the blockade of LVDCCs, mural cells are capable of generating asynchronous spontaneous Ca^{2+} transients resulting from InsP_3 -induced Ca^{2+} release from the SR, suggesting that the SR plays a primary role in generating venular spontaneous activity. Subsequent opening of Ca^{2+} -activated chloride channels results in depolarisation triggering the opening of LVDCCs and associated Ca^{2+} influx to cause venular constrictions, (Figure 7A). Spontaneous constrictions of the suburothelial venules are accelerated by neurally-released noradrenaline upon the activation of α -adrenoceptors [70]. After α -adrenoceptor blockade, sympathetic nerve stimulation inhibits spontaneous constrictions that may involve endothelial NO production.

Unlike venules, suburothelial arterioles are quiescent at rest. Noradrenaline released from sympathetic nerves predominantly acts on $\alpha 1A$ -adrenoceptors to constrict arterioles [69]. Consistently, varicose nerve bundles immunoreactive for tyrosine hydroxylase, a marker of sympathetic nerves, are distributed along the side of suburothelial arterioles [120]. This pharmacological profile of suburothelial arterioles may partly explain the improvement of bladder microcirculation and storage function with α -adrenoceptor antagonists in overactive bladder animal models [121,122].

5. TRIGONE

5.1. Spontaneous Activity

Because of its structural connection to the intravesical portion of the ureter, the trigone can play a role in regulating the opening and/or closure of the ureteric orifices. The main mechanism to prevent vesicoureteral reflux is the oblique angle of the insertion of the ureter through the bladder wall, providing a compression valve as the bladder fills. However, periodic trigone contractions may support opening of ureteral orifices to facilitate filling and may also assist compression during contraction.

Spontaneous phasic contractions are present in 71% and 89% of trigone strips from pigs and humans, respectively, compared to 20% of detrusor [9]. The detailed mechanisms underlying the spontaneous contractility were studied in the superficial trigone of the guinea pig bladder, in which the majority of muscle strips generated spontaneous phasic contractions [123]. Smooth muscle cells isolated from the trigon exhibited either discrete or, less often, fused Ca^{2+} transients that were abolished by either a LVDCC blocker or Ca^{2+} free solution, but not by thapsigargin, an inhibitor of SR Ca^{2+} uptake, or FCCP, a mitochondrial uncoupler. Thus, spontaneous Ca^{2+} transients

result from Ca^{2+} influx through LVDCCs, while intracellular Ca^{2+} stores are not fundamentally involved. Spontaneous contractions in trigone strips are also abolished by LVDCC blocker or Ca^{2+} free solution, but not the T-type Ca^{2+} channel blocker, NiCl_2 . Trigonal smooth muscle fire bursting action potentials, although their sensitivity to LVDCC blockers has not been tested [124], suggesting that as in the case of DSM electro-mechanical coupling may be crucial in developing spontaneous contractions. Consistently, in the pig trigone, cromakalim suppresses spontaneous contractions, presumably by opening K_{ATP} channels to hyperpolarise the membrane [125]. Since niflumic acid, a CACL blocker, attenuates trigonal Ca^{2+} transients and muscle contractions, these CACLs may activate LVDCCs by depolarising the membrane. Unlike DSM in which BK and SK channels play major roles in stabilising muscle excitability, the blockade of BK or SK channels little affect spontaneous the Ca^{2+} transients in trigonal smooth muscle cells. Obviously, extensive electrophysiological investigations are required to understand the regulatory mechanisms of trigonal smooth muscle excitability.

Immunolabeling of gap junctions (Cx43) was approximately 5 times greater in the trigone than in detrusor smooth muscle [123]. 18- β -glycyrrhetic acid, a gap junction blocker, reduces the amplitude but increases their frequency of the spontaneous contractions in the trigone, suggesting that intercellular communication may play a role in developing such contractions. Spontaneous electrical activity in the trigone is generated independently from that in the detrusor, indicating that the trigonal syncytium is not continuous with detrusor [126]. Interestingly, electrical activity in the trigone is unchanged during the filling and voiding phases, while the electrical activity in the detrusor is dramatically increased during voiding. More recently, spatiotemporal mapping techniques have also demonstrated that propagating patches of contraction travelled mainly along the anterior and lateral surface of the bladder and did not traverse the trigone [127].

5.2. Neuromuscular Transmission.

Neurally-evoked contractions of the superficial human trigone are predominately mediated by α -adrenergic, in contrast to detrusor, and cholinergic nerves [128]. Trigonal smooth muscle vigorously contracts upon α -adrenergic receptor stimulation but also responds to ACh. After the blockade of α -adrenergic and cholinergic transmission, the trigone exhibits residual non-adrenergic, non-cholinergic (NANC) contractions as well as relaxations.

In the guinea pig superficial trigone, phenylephrine augmented carbachol-induced contractions (4-fold of control) without a corresponding increase in intracellular Ca^{2+} concentration ($[\text{Ca}^{2+}]_i$) [129]. Phenylephrine generated a greater contraction for a given rise of $[\text{Ca}^{2+}]_i$ compared to KCl-induced contractions, suggesting that α -adrenergic activation also recruits Ca^{2+} -sensitisation mechanisms. The PKC inhibitor GF 109203X and the ROCK inhibitor Y-27632 reduced the phenylephrine contractions by 60 and 40 %, respectively, without altering the Ca^{2+} transients. Thus, the synergistic effects of muscarinic and adrenergic receptor activation on trigonal contractility appear to result from an α -adrenergic evoked Ca^{2+} -sensitisation mechanism. Similarly, phenylephrine-induced contractions in rat trigonal smooth muscle are suppressed by ROCK inhibitors [130]. ROCK inhibitors also reduced the basal tone and α, β -mATP-induced contractions, although they only marginally affected KCl-induced contractions. Thus, constitutively active ROCK that facilitates Ca^{2+} -dependent contractions may contribute to the contractile function of trigonal smooth muscle. In comparison to the trigone of young rats, the trigone of old animals display a significant decrease in the contractions evoked by electrical stimulation, high potassium and bethanechol. This suggests that this may be attributable to a decline in depolarisation-induced contractions of the trigone, most likely upon the opening of LVDCCs [131]. The relative contribution of electro- and pharmacomechanical coupling as well as MLCP-based Ca^{2+} -sensitisation to trigonal contractile function remains to be established. In the pig bladder trigone, the presence of an intact urothelium depresses the contractile responses to carbachol or histamine, but not phenylephrine. Phenylephrine-induced contractions of intact urothelium strips are diminished by carbachol or histamine in a manner sensitive to atropine or mepyramine, respectively [132], suggesting that muscarinic or H1 receptor activation in the urothelium may release 'unidentified' relaxing factors.

NOS-immunoreactive nerve fibres distribute within the muscle bundles of pig trigone [133]. Electrical field stimulation of pig trigonal muscle strips induces relaxations, which are inhibited by NG-nitro-L-arginine, a nitric oxide (NO) synthase inhibitor, suggesting a functional nitrergic innervation to trigone. Trigonal relaxation induced by low frequency stimulation was associated with increased formation of cGMP and abolished by ODQ. Neurally-released NO therefore relaxes trigonal smooth muscle by stimulating soluble guanylate cyclase to produce cGMP [134, 135]. Intracellular signalling pathways involved in the nitrergic relaxation of the trigone remains largely unknown. High frequency nerve stimulation triggers NO-independent relaxation that is not impaired by ODQ or blockers of BK, SK or K_{ATP} channels. Capsaicin, chymotrypsin, a VIP receptor inhibitor or β -adrenoceptor antagonists also fail to inhibit the NO-independent relaxation, thus the transmitter or mechanism of this relaxation remains to be identified.

III. CELL PHYSIOLOGY OF INTERSTITIAL CELLS IN THE URINARY BLADDER

1. INTERSTITIAL CELLS IN SMOOTH MUSCLE TISSUES

Interstitial cells (IC) refer to a class of non-muscle cells found in the interstitium of smooth muscle tissues such as the gastrointestinal tract and the urinary tract. In the gut, these cells, first described by the Spanish neuroanatomist Ramon y Cajal and known as Interstitial Cells of Cajal (ICC) act as pacemakers driving peristaltic activity of the smooth muscle and contributing to the transmission of signals from enteric nerves to smooth muscle. In the lower urinary tract (LUT) similar non-muscle cells are present in the bladder and urethra and are typically described in the literature as Cajal-like cells, ICC-like cells, myofibroblasts, ICC, IC or other related terms such as telocytes.

Several review articles have summarised what is known of the localisation and morphology of LUT IC from electron microscopy, histology, immunofluorescence and multiphoton/ confocal microscopy and isolated cell studies [136-142]. The purpose of the present chapter is not to review all of the early literature but to provide an updated review of what we know of the cellular physiology of bladder IC. Importantly, studies of LUT IC in disease have been reviewed and essential gaps in our knowledge are highlighted.

2. LOCATION OF BLADDER INTERSTITIAL CELLS

IC have been studied in the bladder for almost two decades and many independent groups have described a number of classes or subtypes based on their location. IC in the lamina propria (IC-LP, Figure 8) form a network between the urothelium and the detrusor muscularis [14, 143-145] and have been further classified as upper IC-LP and deep IC-LP [146]. Perivascular IC are found surrounding the microvessels in the lamina propria and may belong to the pericyte family [119, 120, 147-149] (Figure 9). Within the detrusor layer, intramuscular IC (IC-IM) lie on the edge of smooth muscle bundles, running in parallel with the bundle axis and a further subtype forms small networks in the interbundle spaces (IC-IM). Serosal IC have also been reported in guinea-pig bladder [150].

While the above describes IC subtypes based on their location, several biomarkers are used to identify IC in tissue specimens, freshly isolated cell suspensions or cell cultures. The receptor tyrosine kinase KIT, encoded by the proto-oncogene c-kit is an established

marker of ICC in the gastrointestinal tract and many studies report KIT-positive IC in the urinary bladder [14,145,147,151-153]. The intermediate filament vimentin, is expressed by many IC, and KIT-positive IC represent a sub-population of vimentin-positive IC. Like the gut, the bladder also contains KIT-negative IC and it seems that the majority of these are vimentin-positive [144-146,154]. Whilst antibody specificity and species differences of KIT epitopes may explain KIT-negative IC, it is more likely that KIT-negative cells are a specific IC subtype and bladder IC are a heterogeneous group of cells with a spectrum of phenotypes ranging from fibroblastic to myoid. Expression of KIT has been suggested to be age-related with higher expression in neonatal bladders than young adult (see section on ageing below).

Platelet-derived growth factor receptor alpha (PDGFR α), another receptor tyrosine kinase, is expressed by a significant proportion of human, guinea-pig and mouse bladder IC providing another biomarker for identification [53,57]. In mouse bladder, PDGFR α -IC are KIT-negative whereas in guinea-pig and human

bladder, some IC are positive for both KIT and PDGFR α while others are only PDGFR α -positive [154]. NTPDase, a member of the ectonucleotidase family has also been demonstrated as a marker of murine bladder IC, colocalising with KIT, vimentin, Ano1 and Cx43 [155]. IC-LP and detrusor IC that are also N-cadherin-positive have also been reported in human bladder, which strongly resemble KIT-positive or vimentin-positive IC in other studies [141]. Finally, CD34 is expressed by some IC in human bladder which were KIT-negative, providing a further means of classification [154].

IC associated with bladder microvessels have been identified with KIT, PDGFR α and vimentin (see also section II.4.2). Like other IC, perivascular IC have a defined ultrastructural phenotype which is distinctive from vascular smooth muscle and other non-muscle cells e.g. fibroblasts, mast cells and myofibroblasts. Interestingly, they make close associations with vascular smooth muscle cells with end-foot like connections and have been proposed to be involved in the local regulation of vascular perfusion of the bladder.

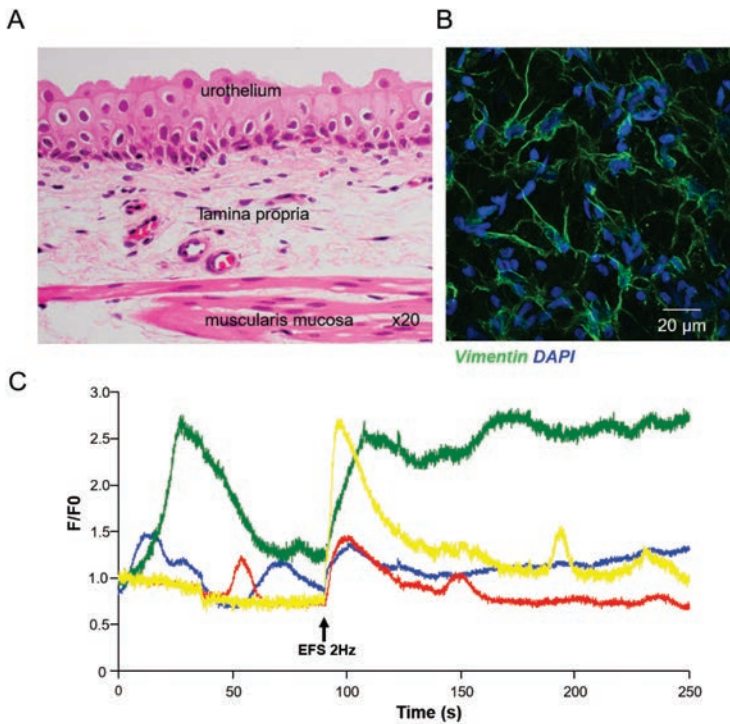
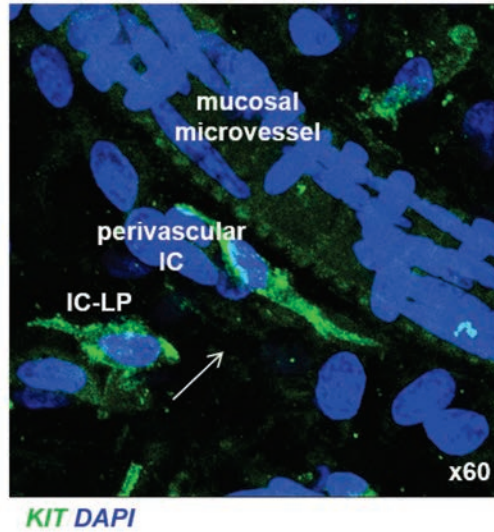

Figure 8. Interstitial cells of the lamina propria. *A: Haematoxylin & eosin stained section of guinea-pig bladder showing the mucosal layer which includes the urothelium, lamina propria and muscularis mucosae. Networks of interstitial cells are present in the lamina propria. B: Confocal image of vimentin-positive (green) interstitial cells in a whole-mount sheet of rat bladder mucosa (nuclei are counterstained with DAPI (blue)). C: Recording of Ca₂₊-signalling activity in four neighbouring interstitial cells in the guinea-pig lamina propria. Electrical field stimulation (EFS) of nerves (2 Hz) synchronized the events in the four cells demonstrating functional innervation. (figure courtesy of Bronagh M McDonnell, Susannah MY Gray and Karen D McCloskey)*

A



B

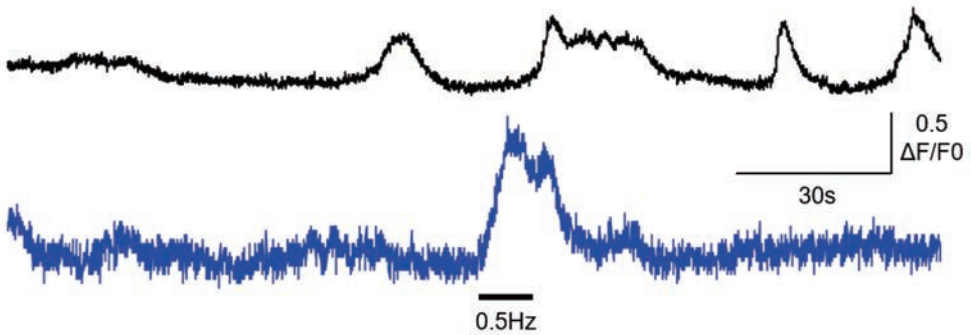

Figure 9. Cell physiology of perivascular interstitial cells. *A: Confocal image of KIT-positive interstitial cell of the lamina propria (IC-LP) and perivascular interstitial cell in the guinea-pig bladder (nuclei counterstained with DAPI (blue)). B: Recording of Ca^{2+} -signalling activity in a perivascular interstitial cell and an adjacent vascular smooth muscle cell in the guinea-pig bladder. Electrical field stimulation of nerves (0.5 Hz) increased the frequency of events in the perivascular interstitial cell and evoked a response in the vascular smooth muscle cell, demonstrating functional innervation. (figure courtesy of Susannah MY Gray and Karen D McCloskey*

3. BLADDER IC RECEPTORS

The physiological properties of bladder IC have been studied with patch-clamp electrophysiology, live-cell Ca^{2+} -imaging with epifluorescence or confocal microscopy and modulator release assays. Perhaps unsurprisingly, bladder IC express many of the receptors and ion channels that are found in urothelial cells, intramural nerves and smooth muscle cells and there is compelling evidence that they are closely involved in processes underpinning filling, voiding and sensing of fullness.

3.1. Muscarinic Receptors

Muscarinic receptors M2 are the dominantly expressed subtype on detrusor smooth muscle compared with M3 in a 3:1 distribution. Nevertheless, M3 are apparently more important than M2 in the modulation of bladder contraction. Detrusor IC functionally express M3 receptors; activation by acetylcholine or its stable analogue carbamylcholine (carbachol) in isolated cells evoked large Ca^{2+} -transients which showed some sensitivity to M2 antagonists but were blocked by M3 antagonists [156]. In cultured murine detrusor IC, cholinergic agonists evoked transient inward currents which were sensitive to the pan-cholinergic antagonist atropine, and the M3-selective antagonist, 4-DAMP [157, 158]; furthermore; M2 and M3 receptors were demonstrated to be expressed on rat bladder KIT positive-IC with immunofluorescence

[159]. Carbachol evoked membrane depolarisation and increased the frequency of spontaneous transient depolarizations in cultured mouse detrusor IC [157]. This was consistent with an *ex vivo* study of guinea-pig bladder tissue where exogenous application of carbachol evoked Ca^{2+} -transients [156]. Furthermore, in a later study, stimulation of intramural nerves in similar preparations with electrical field stimulation (EFS) elicited atropine-sensitive Ca^{2+} -transients, showing that bladder IC were functionally innervated by cholinergic nerves [160].

Freshly dispersed guinea-pig IC-LP are reportedly insensitive to cholinergic agonists although purinergic receptors were expressed on the same cells [158]. The lack of physiological response may be a consequence of the particular cell isolation technique used as guinea-pig IC-LP in situ responded to EFS by firing atropine-sensitive Ca^{2+} -transients [148].

3.2. Purinergic Receptors

ATP is an important neurotransmitter in the bladder, along with acetylcholine. In mouse bladder, contractile responses to EFS are almost 50% atropine-sensitive and 50% PPADS or suramin-sensitive (indicating acetylcholine or ATP respectively as a neurotransmitter). ATP is also a co-transmitter with acetylcholine in rat, guinea-pig, rabbit and sheep however, the situation is rather different in normal human bladder where the EFS response is almost exclusively cholinergic. Purinergic receptors are expressed on human bladder smooth muscle cells, thus either ATP is not co-released with acetylcholine or the purine is completely degraded in the neuromuscular space so that it does not activate the detrusor cell. It has been reported that an ATP-sensitive component of EFS emerges in disease conditions, such as overactive or obstructed bladders (see section II.3.3 above). In the normal bladder, non-neuronal sources of ATP release, including urothelium could activate smooth muscle cells or IC to potentially contribute to mechanisms of sensory transduction or relaxation during filling. Consistent with this notion, cultured human and freshly-dispersed guinea-pig IC-LP respond to ATP and the $\text{P2X}_{1/3}$ agonist, α, β -methylene ATP with Ca^{2+} -signals [147,158] and which were sensitive to the P2X receptor antagonist, TNT-ATP [161]. Moreover, immunofluorescence shows protein expression of P2X_1 , P2X_2 and to a lesser extent, P2X_3 on IC-LP.

Studies with animal tissue demonstrate that IC-LP from guinea-pig and rat bladder generate Ca^{2+} -signals, transient inward currents and transient depolarizations in response to exogenous ATP [41,158,162].

In tissue preparations, IC-LP respond to EFS by generating Ca^{2+} -signals which were sensitive to the pan-purinergic receptor antagonist, suramin [160]. Murine detrusor PDGFR α -positive IC express P2Y_1 receptors which when stimulated by ATP, activate small-conductance Ca^{2+} -activated- K^+ (SK) channels leading to hyperpolarisation [54]. Activation of SK channels in these same cells by UTP (a P2Y_2 and P2Y_4 agonist) has also been reported along with mRNA expression of several P2Y subtypes, including P2Y_2 , P2Y_4 , P2Y_6 , P2Y_{12} , P2Y_{13} , P2Y_{14} , in addition to P2Y_1 [78].

In an electrophysiological study of cultured KIT-positive IC from mouse detrusor, nifedipine-sensitive spontaneous electrical activity has been reported [157], providing confirmation of the essential role of L-type Ca^{2+} -channels [163] in this activity. ATP also depolarised these cells [157] and increased the frequency of spontaneous transient depolarisation firing, demonstrating that release of ATP from neuronal or non-neuronal sources can impact on their electrical excitability.

4. BLADDER IC ION CHANNELS

4.1. Potassium Channels

A number of K^+ -channels are functionally expressed on bladder IC through patch-clamp studies. As discussed above, SK channels are present on murine detrusor PDGFR α -positive IC [54] where large-conductance Ca^{2+} -activated- K^+ channels (BK) are apparently absent. The SK3 channel isoform gene was dominantly expressed compared with SK1, SK2 and SK4. In contrast, guinea-pig detrusor IC, have dominant BK currents with kinetics distinctively different from BK currents in neighbouring smooth muscle cells but with little evidence for SK channels [164] (Figure 10).

Guinea-pig detrusor IC, in addition to BK channels, also express a number of voltage-dependent K^+ channels including the Kv7 family, encoded by KCNQ genes. The Kv7 channels are involved in regulation of the IC resting membrane potential and providing a control mechanism to prevent over-excitability. Inhibition of Kv7 channels resulted in increased duration of spontaneous Ca^{2+} -events, membrane depolarization and increased spontaneous contractions and baseline tone suggesting that IC regulation of contractility may involve Kv7 mediated hyperpolarisation.

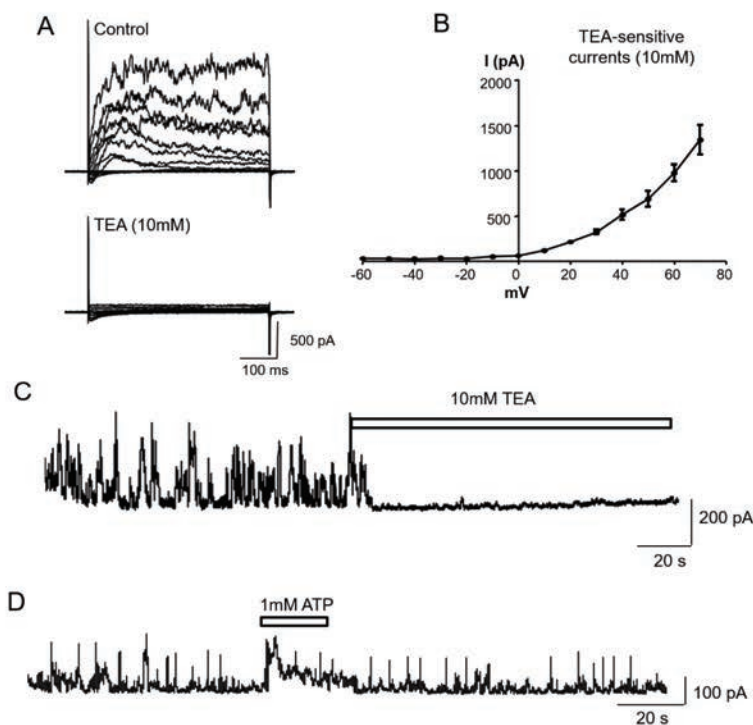

Figure 10. K⁺ currents in interstitial cells (IC) of the detrusor. **A:** Example of detrusor IC (guinea-pig) outward currents in the absence and presence of the pan-K⁺ inhibitor, tetraethylammonium chloride (TEA). **B:** Summary data showing the current-voltage profile of the TEA-sensitive currents. **C:** Spontaneous BK currents (large-conductance, Ca²⁺-activated K⁺) in a detrusor IC, voltage-clamped at +40mV were abolished by TEA. **D:** ATP (1 mM) enhanced spontaneous BK currents (in this example, held at 0mV), consistent with a purinergic-inhibitory mechanism in the guinea-pig bladder. (figure courtesy of Rebecca MJ Cunningham and Karen D McCloskey).

4.2. Calcium Channels

Bladder IC have been reported to express both L-type (CaV1) and T-type (CaV3) Ca²⁺ channels. Guinea-pig detrusor IC have classical nifedipine-sensitive inward Ca²⁺ currents which would provide a depolarising mechanism for the membrane potential. Rat bladder IC were shown, with immunohistochemistry and PCR, to express CaV3.1 (α1G), CaV3.2 (α1H) and CaV3.3 (α1i) channels [165]. This is consistent with an electrophysiological study of L-type currents in guinea-pig bladder detrusor IC which also reported a nifedipine and Ni²⁺-insensitive inward Ca²⁺ current which may be CaV3.1 or CaV3.3 rather than CaV3.2, which is less-sensitive to Ni²⁺ inhibition [163]. In contrast, PDGFRα-positive IC from mouse bladder reportedly do not have inward Ca²⁺ currents [54], highlighting species or cell type differences in physiological properties.

4.3. Hyperpolarisation-Activated Cyclic nucleotide-Dependent (HCN) Channels

Some early papers speculated whether detrusor IC could act as pacemakers, driving the activity of neighbouring smooth muscle cells. This hypothesis, triggered by the known role of gut ICC as pacemakers of

smooth muscle activity and peristalsis, seemed unlikely unless a candidate pacemaker current could be identified. More recent work has demonstrated the presence of currents mediated by HCN channels, (I_h). Gene [166] and protein expression of HCN channels in human and rat IC-LP and detrusor IC by immunofluorescence [167,168] was confirmed with patch-clamp studies. The electrophysiological studies described a slowly-activating but non-inactivating current, also activated by hyperpolarisation, and was sensitive to the pan-HCN inhibitor, ZD7288 [166-168]. ZD7288 reduced baseline Ca²⁺ in isolated IC and diminished spontaneous contractions in strips from rats with detrusor overactivity [166]. This work adds support to the notion of detrusor IC having pacemaker type functions, however, the mechanism linking IC to smooth muscle has not yet been elucidated.

4.4. Chloride Channels

Calcium-activated chloride channels ICl(Ca) are important in guinea-pig IC-LP, providing depolarization when activated by ATP and underpinning spontaneous transient depolarisations [158]. Also an attractive candidate for pacemaking in detrusor IC, there is currently no electrophysiological evidence in support of ICl(Ca) in these cells although gene expression of

Anoctamin-1 (Ano-1), and protein expression of Ano-1 in juvenile rat mucosa and detrusor vimentin-positive-IC has been reported [169]. Application of channel inhibitors to detrusor strips diminished spontaneous activity however one should be mindful of the additional effects of these inhibitors as activators of BK channels and inhibitors of L-type Ca^{2+} channels. which would also bring about similar effects.

4.5. Other Signalling Pathways

One of the first studies to show IC in the bladder demonstrated that the cellular targets of nitric oxide signalling with cGMP immunohistochemistry were non-muscle cells with the multi-branched morphology of ICC [143]. This work was corroborated by a number of other studies reviewed by McCloskey [140,170]. More recently, nitric oxide-guanylyl cyclase has been reported to be present in murine detrusor PDGFR α -positive IC [171]. Of interest, in contrast to the urethra where NO-GC is expressed in smooth muscle cells and its activity leads to relaxation, bladder NO-GC does not contribute to a NO-induced relaxation and currently has an unknown role. Phosphodiesterase type-2 (PDE2) expression on IC-LP and detrusor IC of guinea-pig bladder has also been reported [172]. Phosphodiesterases terminate NO-cGMP signalling by hydrolysing cGMP to 5'-CGMP and are used clinically to treat erectile dysfunction and bladder storage disorders. Furthermore PDE5 inhibition has been described in IC-LP indicating the expression of PDE5 receptors on these cells [173].

Bladder IC may release modulator substances under certain conditions. For example, in a cultured model of pig IC-LP, stretch evoked the release of ATP [161], similar to what is already known of urothelial cells. In addition to ATP, bladder IC also release prostaglandins, an important modulator of bladder contractility [151]. An investigation of the source of prostaglandins in rabbit bladder revealed that KIT-positive/Vimentin-positive IC expressed cyclooxygenases 1 and 2 (COX1 and COX2). Prostaglandins, products of COX were shown in the same study to modulate bladder spontaneous contractions where COX inhibitors diminished contractility. This suggested that one role of bladder IC was to modulate spontaneous activity by release of prostaglandins. Vimentin-positive guinea-pig IC-LP and detrusor IC subtypes express both prostaglandin E receptor type-2 (EP2) and COX1, also highlighting the potential importance of prostaglandin pathways in these cells [174].

5. INTRACELLULAR Ca^{2+} SIGNALLING

IC in gut and the lower urinary tract share features of intracellular Ca^{2+} signalling, which is both spontaneous in nature and in response to stimulation by agonists or neurotransmitter substances. Cultured human IC-LP exhibit spontaneous intracellular Ca^{2+}

transients, representing 55% of the cells observed with the frequency of events and the percentage of active cells enhanced by ATP [161]. IC-LP from guinea-pig bladder also exhibit spontaneous Ca^{2+} -events; a feature of around 50% of cells [158]. These cells also respond to ATP, UTP and a reduced extracellular pH by generating Ca^{2+} -transients [162]. Freshly dispersed guinea-pig detrusor IC exhibit spontaneous Ca^{2+} -transients and in response to cholinergic stimulation [14,156].

Intracellular Ca^{2+} -signalling has also been measured from IC whilst within a multicellular tissue preparation [17]. In guinea-pig preparations it was shown that these signalling events were unlikely to be pacemaking to adjacent smooth muscle bundles, due to their significantly lower frequency and asynchronous appearance with respect to Ca^{2+} transients in detrusor myocytes. Spontaneous Ca^{2+} -signals in IC-LP, IC-IM and perivascular IC have also been characterised *in situ* within guinea-pig bladder wall preparations [148]. Ca^{2+} -events were not temporally synchronised; events sometimes transmitted between adjacent cells but more often, IC-LP fired individually with no corresponding event in adjacent cells. Of interest, stimulation of intramural nerves (cholinergic or purinergic) within the preparations through electrical field stimulation (EFS) synchronised IC-LP activity. A similar scenario was encountered with IC-IM, where adjacent IC-IM were rarely synchronised with each other or with neighbouring smooth muscle cells, but EFS synchronised all cellular activity. Perivascular IC also displayed spontaneous Ca^{2+} -signalling which was not synchronised with that of neighbouring vascular smooth muscle cells; activity of these cell types was also synchronised with EFS. Overall, there is no demonstrable signalling via Ca^{2+} transients between ICs in different layers of the bladder wall and adjacent cells. However, there is good evidence for functional innervation to the three types of ICs discussed above. This latter phenomenon corroborates earlier morphological and ultrastructural studies of nerve-IC interactions [14,145,175].

6. BLADDER INTERSTITIAL CELLS IN DISEASE/DYSFUNCTION OF THE BLADDER

6.1. Spinal Cord Injury

About five weeks after spinal cord injury in rats (full transection at T9/10) there is a striking reduction of vimentin-positive-ICs, five weeks after injury, apparently due to apoptosis and cell death. These bladders had a decompensated, hypoactive phenotype and the lack of IC was commensurate with areas of patchy denervation [176]. This was in agreement with a similar model, six weeks post-SCI, in which there was a significant reduction in KIT-positive IC [177]. This latter study also reported an increase of KIT-positive IC in a model of suprasacral spinal cord transection at S1-3. These observations demonstrate the reliance

of bladder IC number on cellular homeostasis for maintenance and potentially requiring neuronally-released factors, such as stem cell factor.

6.2. Diabetes

The distribution and number of KIT-positive/Cx43-positive IC in human bladder from diabetic patients is decreased in both the lamina propria and detrusor [178]. In a rat model of diabetic cystopathy (treated with streptozotocin, STZ) detrusor IC number is also reduced [41]. Of importance, HCN channel expression in detrusor IC was also reduced, as well as a loss of caveolin-3 which colocalises with HCN – caveolin-3 is a component of the membrane caveolae signalling complex that transduce extracellular signals to intracellular pathways. The consequences of this on bladder spontaneous activity was indicated by reduced sensitivity of diabetic bladder strips to forskolin (which increases cAMP concentrations and activates HCN channels), compared with normal animals. Consistent with a reduced number and activity of ICs in bladders from diabetic subjects, application of the KIT/PDGFR α inhibitor, imatinib mesylate (Glivec) to STZ-induced diabetic rat bladders produced a concentration-dependent decrease of carbachol-induced phasic contractile activity [179]. This was interpreted as an inhibition of KIT-positive ICs decreased contractile activity. However an alternative explanation may be that Glivec decreased the L-type Ca²⁺-current required for the action potential upstroke and contraction in detrusor smooth muscle cells as reported previously [180].

6.3. Bladder Outlet Obstruction

The partial bladder outlet obstruction or pBOO model is widely used as an experimental model of obstruction analogous to benign prostate hypertrophy. The changes to bladder structure and function that result are well understood with respect to smooth muscle and innervation and several groups have studied the fate of IC in this model. As part of a larger study of P2X₃ location and function in rats subjected to pBOO, a significant increase in the intensity of P2X₃ staining in KIT-positive IC was found [153]. This was consistent with a larger peak amplitude of inward current in pBOO IC when activated by the P2X_{1/3} agonist α,β -methylene ATP [153]. In the same model, gene expression of HCN₁₋₄ was increased compared with normal, and a higher current density of I_h, sensitive to ZD7288, was found in patch clamp studies [166].

In addition to changes in receptors and ion channel number and function, there is corroborating evidence that the number of ICs themselves increase after pBOO. The number of IC-LP and detrusor increased in guinea-pig pBOO bladders with an upregulation of IC muscarinic receptor M3 expression [150,181-182]. KIT-positive IC number is also increased in rat bladders with pBOO [183].

6.4. Other Overactive Bladder Studies

Increased P2X₂ and P2X₅ receptor expression in detrusor IC has been measured in tissue from female rats with bladder overactivity, as assessed by cystometrograms [184]. However, mouse PDGFR α -positive cells do not respond to the P2X agonist α,β -methylene ATP suggesting that functional P2X receptors are not present on these cells, at least in normal mouse bladder [78]. Again, this apparent discrepancy may be accounted for in the differences in purinergic physiology in normal and diseased human and rodent bladders. The number of KIT-positive IC from normal and neurogenic paediatric human bladders was compared; the latter from a group of patients with myelomeningocele, the most common cause of neurogenic bladder in children. No difference in the number of KIT-positive IC was found between the two groups [185].

6.5. Ageing and Development

Bladder dysfunction is highly prevalent in the elderly population and there is a consensus that symptoms progress with ageing. Several groups have studied contractility and smooth muscle function in ageing models and others have focussed on IC numbers in neonatal, juvenile, adult and ageing bladders. No differences in the number or location of KIT-positive or vimentin-positive IC-LP and detrusor IC were measured in juvenile and adult pig bladder specimens [10]. However, it was noted in this study that juvenile bladder preparations had enhanced spontaneous contractions which were sensitive to Glivec, whereas activity in adult bladders was relatively insensitive. With IC from neonatal rat bladders KIT-positive and vimentin-positive cells in the mucosa and detrusor were observed [146]. Administration of Glivec to newborn rats for seven days resulted in injury to detrusor IC but the IC-LP were relatively intact. The detrusor IC lesion may explain the lower contraction frequency and an altered response to muscarinic agonists observed in bladder strips. KIT or PDGFR α may therefore be important in the maturation of IC in the detrusor with these cells having physiological roles in the generation of spontaneous and carbachol contractions.

The next few years should see our knowledge of IC in ageing and development models increase as this is a significant gap in our knowledge. The selection of relevant animal models to represent co-morbidities e.g. pBOO, obesity, metabolic syndrome and diabetes should be combined with ageing. In the present review, the papers cited were not designed to elucidate gender differences in IC in either normal or diseased bladders. Current and future studies need to incorporate gender balance into their design so that knowledge is translational to improving the life of women and men with LUTS.

7. SUMMARY OF BLADDER IC PHYSIOLOGY

This section has reviewed the current state of the art of the cellular physiology of bladder IC, an area that has progressed over the last three years. A profile of the receptor, ion channel and Ca^{2+} signalling physiological profile for IC in the mucosa and detrusor layers is emerging (Figure 11). It is clear that bladder IC have the relevant mechanisms to participate in the bladder functions of filling and voiding in addition to sensory transduction and are regulated by intramural nerves. The discovery of pacemaking type currents

adds support to the hypothesis that bladder IC might regulate smooth muscle activity by giving depolarizing input. While it seems unlikely that they directly pace the detrusor smooth muscle, they may provide intermittent depolarisation. Conversely, bladder IC also have mechanisms of hyperpolarisation through a number of K^+ channels, some of which are regulated by ATP and which would provide a brake mechanism to prevent bladder overexcitability, an essential function during filling. Finally, the role of perivascular IC in providing local control of bladder vascular perfusion is an exciting area that may help understand and address the issues relating to bladder ischaemia that are common to many pathophysiologicals.

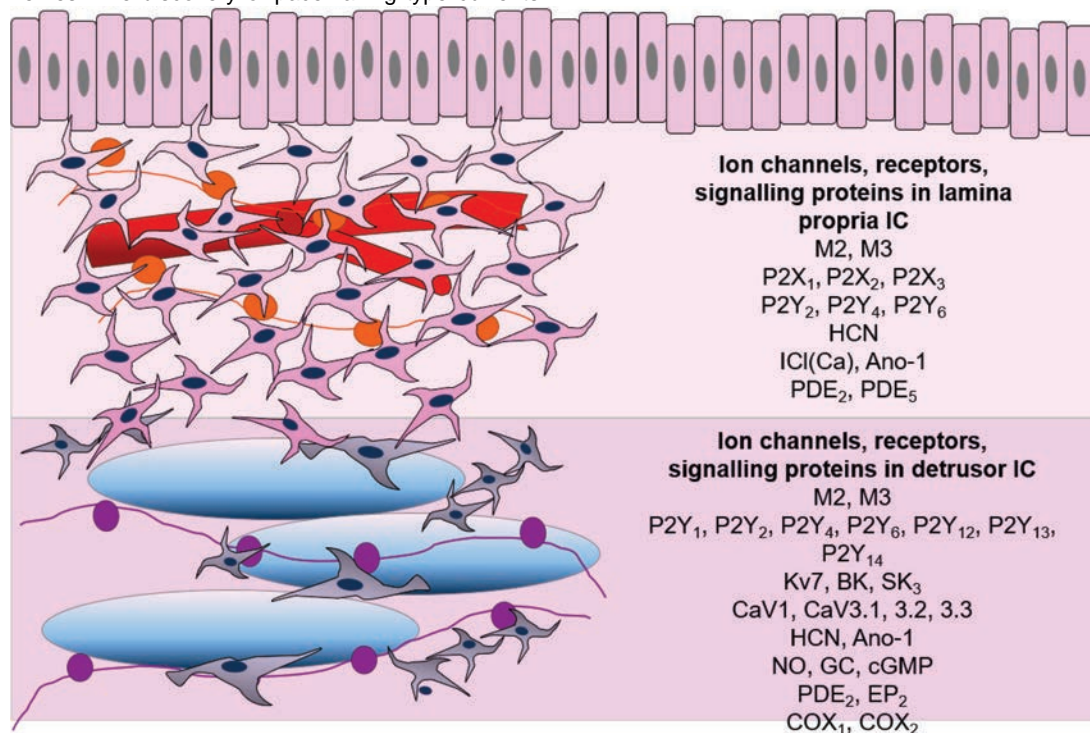

Figure 11. Summary of morphology and physiology of interstitial cells in the bladder wall. Schematic diagram illustrating interstitial cells in the layers of the bladder wall. The ion channels, receptors and signalling proteins described in the article are listed for lamina propria IC and detrusor IC. (figure courtesy of Bronagh M McDonnell and Karen D McCloskey)

IV. TRANSPORT FUNCTIONS OF THE UROTHELIUM

1. INTRODUCTION

The urothelium is the epithelial lining of the renal pelvis, the ureters, the urinary bladder and outflow tract. It lies at the interface between the urinary space and underlying tissues and plays a critical role as a permeability barrier to ion, solute and water flux, as well as pathogens. Whereas once considered a simple high resistance barrier, the urothelium is recognised as having the potential to modify the composition of stored urine [186,187] as well as function as an integral part of a sensory web in which it receives, amplifies, and transmits information about the external milieu to the underlying nervous and muscular systems [188]. Therefore, the urothelium is a dynamic tissue that not only responds to changes in its local environment but can also relay this information to other tissues in the bladder. This section of Chapter 2 will be primarily concerned with transport and permeability functions of the urothelium, the sensory functions will be considered in the following chapter

2. THE STRUCTURE OF THE UROTHELIUM

The urothelium, mainly a transitional epithelium of endodermal origin, typically comprises large umbrella (superficial) cells, intermediate cells and a layer of basal cells. Originally, the urothelium was considered as pseudostratified as studies reported that thin cytoplasmic extensions connected the various cell layers to the basement membrane [189]. However, subsequent studies demonstrated that the urothelium is stratified and the cytoplasmic extensions are rarely observed in the intermediate cell layer [190].

2.1. Basal and Intermediate Cell Layers

Basal cells are germinal in nature with a diameter of 5-10 μ m, and form a single layer that contacts the basement membrane. Although several studies have indicated the existence of progenitor cells within the basal cell layer, their exact topology and identity as well as their role in key processes such as tissue regeneration and repair have not been fully clarified [191]. Although the turnover rate of the urothelium is estimated to be 3-6 months [192] it shows enormous regenerative capability when it is damaged and can restore itself within days of significant damage [193,194]. In a recent study, it was demonstrated that a small subset of basal cells of embryonic origin, characterised by expression of keratin 14, function as stem cell and can participate both in natural and injury-induced bladder regeneration by giving rise to all urothelial cell layers [191].

Intermediate cells are single nucleated, pyriform in shape with a diameter of 10-25 μ m. They lie on the top of the underlying basal cells and can be one to several cell layers thick [195]. They are connected to one another and the overlying umbrella cells by desmosomes and possibly by gap junctions [190,196]. The number of intermediate cell strata differs in various species. In rodents, the intermediate cells are one to two layers thick and in humans up to five layers have been observed [188]. The state of bladder fullness dictates the thickness of this layer with cells appearing in fewer numbers in distended compared to empty bladders. It is believed that the change in the thickness of the intermediate cell layer is achieved by cells sliding past one another during bladder filling. It is unclear whether this "sliding" will result in reversible breakage of cell-cell contacts [188].

The intermediate cell layer is partially differentiated and these cells can express uroplakins (UPs) and discoidal/fusiform-shaped vesicles [188,197]. It has been proposed that the intermediate cells closest to the umbrella cell layer can rapidly differentiate into umbrella cells when the cell barrier is disrupted as a result of senescence, bacterial infection, or experimental manipulation [197-199]. The exact triggers that promotes the rapid differentiation of intermediate cells is unknown, but may include exposure of uncovered intermediate cells to growth factors or other mediators in urine, or loss of cell-cell contacts between intermediate cells and the overlying basolateral surface of umbrella cells [188].

2.2. Umbrella Cell Layer

The permeability barrier function of the urothelium is primarily associated with the superficial umbrella cells which form a single layer of highly differentiated and polarised cells. Umbrella cells have an extremely slow turnover rate with a cell cycle time of 40 weeks in some species [192], which additionally contributes to the impenetrable integrity of the urothelium.

The morphology and shape of the umbrella cells is dependent on the filling state of the bladder. In empty bladders these cells are roughly cuboidal and become highly stretched and are squamous in morphology when the bladder is filled [195,200]. The apical side of umbrella cells is scalloped, comprising of plaques (also known as the asymmetrical unit membrane or AUM) and intervening hinge regions. The membrane associated with hinge and plaque regions is similar to myelin; rich in cholesterol, phosphatidylcholine, phosphatidylethanolamine and cerebroside [188,201]. The polygonal-shaped plaques are ~0.5 μ m in diameter, 12 nm in thickness and are made up ~1000 subunits each. The major constituents of the subunits are a family of uroplakins (UP), which include UPIa, UPIb, UPII, UPIIIa [188,195]. UPIa is a urothelial receptor that binds uropathogenic *Escherichia coli*, which is responsible for more than 90% of urinary tract infections [202]. The hinge areas comprise at least one unique protein, which is called urogingin [203] and it is speculated that due to the

crystalline nature of the plaque regions, receptors and ion channels are localised to the hinge areas [188]. The surface of the umbrella cells is covered by a multi-charged anionic glycosaminoglycan (GAG) layer, which may be important in bacterial anti-adherence and prevention of urothelial damage by large macromolecules. The role of the GAG layer as a barrier to micromolecules is still controversial and there is no definite evidence that the GAG layer acts as the primary barrier between urine and underlying tissues [188].

An additional feature of umbrella cells is the presence of discoidal or fusiform-shaped vesicles (DFV). These vesicles and their associated cyokeratin filaments are responsible for delivery of UPs and other proteins to the apical surface of the cells. It is hypothesised that during bladder filling the umbrella cells recruit these vesicles to fuse with their apical membranes, thereby increasing the overall surface area [204,205]. On voiding, the extra surface membrane is believed to be endocytosed. This replenishes the population of cytoplasmic vesicles, followed by a refolding of the umbrella cell membrane and mucosal surface in preparation for the next filling cycle [204,205].

3. THE BARRIER FUNCTION OF THE UROTHELIUM

The permeability properties of an epithelium define the movement of water and solutes/ions across the

membrane, and the regulation of this movement is vital for homeostasis. Epithelial “tightness” is commonly assessed by measurement of transepithelial electrical resistance (TER), with epithelia displaying a TER $>500 \Omega \cdot \text{cm}^2$ classified as “tight”. Measuring the permeability of different epithelial tissues has revealed that the urothelium is the least permeable epithelium with a TER of 10,000 to $>75,000 \Omega \cdot \text{cm}^2$, making it the tightest and most impermeable epithelial barrier [206].

It has been generally assumed that urine held in the bladder is identical to that excreted by the kidneys. However, recent studies have shown that the composition of urine can change during its passage from renal pelvis to the bladder [186,187,207]. Since the bladder is exposed to very large concentration gradients of ions, pH and solutes, it is not surprising that pathways for transport of Na^+ , K^+ , Cl^- , urea, creatinine and water exist in the urothelium [188]. These pathways, coupled with the large surface area of the urothelium and the long storage times of urine, indicate that depending on the physiological status of the organism, the urothelium may play a vital role in ion, solute and water homeostasis.

The urothelium has two permeation pathways. The paracellular pathway, consisting of intercellular space and tight junctions (TJs) and the transcellular pathway, consisting of the apical and basolateral plasma membranes of the umbrella cells (Figure 12, [206,208]).

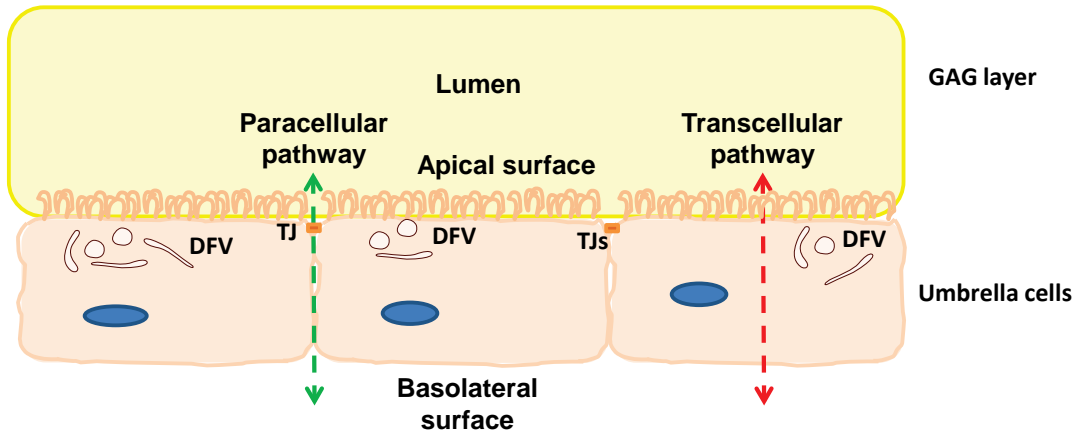

Figure 12. Paracellular and transcellular pathways of the urothelium. The paracellular pathway, consists of intercellular space with tight junctions (TJs) acting as the gatekeepers. The transcellular pathway, represents the route across the cell consisting of the apical and basolateral plasma membranes of the umbrella cells. The apical plasma membrane is represented with urothelial plaques and the glycosaminoglycan (GAG) layer. DFV, discoical fusiform vesicles; N, nucleus; TJ, tight junctions; GAG, glycosaminoglycan layer.

3.1. The Paracellular Pathway

Paracellular transport is passive, consisting of diffusion and osmosis with no directional discrimination [208]. The zone of attachment between adjacent urothelial cells forms a junctional complex composed

of TJs and adherence junctions (AJs), both of which form continuous belts, and desmosomes (Figure 13). Desmosomes form individual circular plaques that are arranged in a row just below the AJs and together with AJs, play an important role in cell-cell adhesion

[188]. However, TJs are the main regulators of paracellular transport.

Tight junctions (TJs), which encircle the apical end of the lateral surface of adjacent umbrella cells, prevent the unregulated flux of ions, organic solutes and water across the paracellular space by forming close apposition of anastomosing filamentous strands between the plasma membranes of neighbouring cells (Figure 13). Epithelia with high resistance were observed to have TJs with more strands than low-resistance epithelia and there is an exponential relationship between the number of TJ strands and passive resistance [208]. It is believed that TJs undergo structural and functional reorganisation to preserve barrier integrity during filling and voiding cycles [209]. The TJs consist of peripherally associated scaffolding proteins, cytoplasmic signalling proteins and transmembrane proteins. Scaffolding proteins such as zonula occludens-1 (ZO-1), link the tight junction associated transmembrane proteins to the prejunctional actin cytoskeleton and may also be important in transducing regulatory signals that control the paracellular barrier [210]. The transmembrane proteins of the TJs include occludins and claudins, the coxsackie/adenovirus-associated receptor, the junctional adhesion molecules and tricellulin [208]. Occludins and claudins form continuous branching fibrils of transmem-

brane particles that completely encircle the apical aspect of the lateral surface of each cell and are responsible for creating a complex barrier with ion and size selectivity [210].

The claudins are 20-25kDa proteins with four transmembrane domains, two extracellular loops and a short -COOH intracellular tail with a PDZ-binding motif that promotes interactions with other proteins, such as ZO-1 (Figure 13, [211]). The specific claudin isoforms associated with the urothelium are now being investigated. The amino acid composition of the extracellular loop of these different isoforms control paracellular permeability by forming anion/cation selective, or occluding pores [209,212-214]. There are currently at least 27 claudin isoforms which are capable of heterophilic or homophilic adhesion between cells [208]. Claudin-4, -8, -12 and possibly -13 have been found in the urothelium of rat, mouse and rabbit bladders [210,215] and claudin-3, -4, -5 and -7 have been found in the human urinary tract [216]. These interspecies differences in expression of claudin isoforms could explain the reason for TER and permeability variances between different species. Claudins are also expressed in the basolateral plasma membrane of superficial, intermediate and basal urothelial cells, but their exact role, organisation and regulation is not fully understood [208].

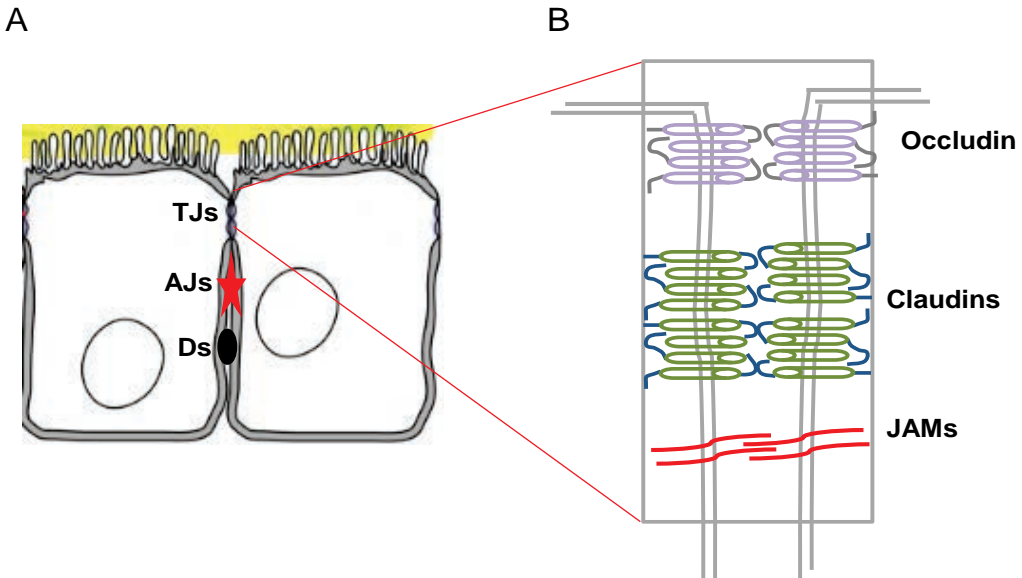

Figure 13 The zone of attachment between adjacent urothelial cells. **A:** This zone forms a junctional complex composed of tight junctions (TJ) and adherence junctions (AJ), both of which form continuous belts, and desmosomes (Ds). **B:** Enlargement of the structure of a tight junction (TJ) between umbrella cells. TJs are made up of three members of transmembrane proteins: junctional adhesion molecules (JAMs), claudins and occludin.

Occludins span the membrane four times and undergo homophilic adhesion between cells (Figure 12, [208]). They were the first transmembrane proteins described and it was assumed they were the key component of TJs until it was demonstrated that oc-

cludin knock-out mice had structurally and functionally normal junctions [217,218]. ZO-1 and occludins are also found in the basolateral surface of the umbrella cells and the plasma membranes of intermedi-

ate and basal cells [210]. The presence of ZO-1, occludin and claudins at cell borders could help cell adhesion, especially during wound healing.

Bladder filling stimulates an expansion of the umbrella cell TJ ring, a process which is rapidly reversed upon voiding. One mechanism that can contribute to the filling induced TJ ring expansion is the insertion of newly synthesized or recycled membrane proteins via exocytosis at the TJs [209]. Indeed, studies in other cell systems have demonstrated that the membrane components of TJs are highly dynamic, even at steady state [219]. It is assumed that as exocytosis controls TJ expansion during filling, endocytosis plays an important role during voiding [209]. An increase of ion permeability across the umbrella cell TJ was also reported during bladder filling which was assumed to be independent of the low capacity, nonselective leak pathway. This increased permeability may alter the function of sensory neurons or muscle cells by altering their ionic milieu and may be an important communication pathway between the urothelial cells and the underlying tissues [209]. Disruption of TJs has been associated with various bladder conditions such as outlet obstruction, spinal cord injury, bacterial cystitis, all of which are characterised by alterations of the urothelium and umbrella cell junctional complex [188].

3.2. The Transcellular Pathway

The total transepithelial resistance is due to parallel arrangement of paracellular and transcellular resistances. The paracellular resistance can be $>100,000 \Omega\text{cm}^2$, whilst the transcellular resistance can vary from 10,000 to $>100,000 \Omega\text{cm}^2$ [220]. The main transcellular permeability barriers are the apical and basolateral plasma membranes of umbrella cells [208]. The apical plasma membrane in various species has a resistance of up to $150,000 \Omega\text{cm}^2$ which is much higher than that of the basolateral plasma membrane, with a resistance of only $1,500 \Omega\text{cm}^2$ [221]. The variability of the transcellular resistance is due to differences of the apical membrane permeability and not the basolateral membrane [220]. It is believed that although uroplakins, which are the major proteins of the apical plasma membrane, may be important in preventing transcellular absorption of water and solutes from the urine, they are not solely responsible for the transcellular barrier function [222]. Uroplakin post-translational modification, which results in functional plaque formation on the apical side of the umbrella cells, as well membrane lipid composition and profile are important factors in regulating the transcellular barrier function [206]. The specific fatty acid membrane composition can alter the lipid profile of the apical plasma membrane, inducing changes in the interparticle and uroplakin distance, which ultimately affects the permeability barrier function as well as the pathway of endocytosed urinary fluid [206]. Transcellular transport can be passive or active, is directional and energy dependent and is facilitated by transporters and channels.

4. WATER AND ELECTROLYTE TRANSPORT ACROSS THE UROTHELIUM

4.1. Water Transport in the Urothelium

The mechanism by which water passes through biological membranes was a matter of debate until the discovery of a large family of transmembrane channel proteins called aquaporins (AQPs) [223]. AQPs are a class of membrane water channels whose primary function is to facilitate the passive transport of water across the plasma membrane in response to osmotic gradients that are created by active transport of solutes. There are currently 13 AQPs (0-12) identified in mammalian tissue. A subset of AQPs is the aquaglyceroporins: AQPs which also facilitate passive transport of glycerol and possibly other small solutes such as urea, glycerol, H_2O_2 and CO_2 . AQPs regulate transepithelial water movement in various tissues, e.g. kidney, and some subtypes are regulated by circulating vasopressin. Recent studies have confirmed the presence in the urothelium of AQP-3, -4, -7 and -9 in human tissue [224], AQP-1, -2 and -3 in rats [225] and AQP-1, -3, -9 and -11 in pigs (Figure 14). This suggests that AQPs may play a regulatory role in urothelial cell volume and osmolarity and also determine the final composition of urine. Indeed this hypothesis is further supported by the expression of AQP1 and AQP3 in the urothelium of the American black bear. This mammal typically hibernates for 4-5 months and does not eat, drink, urinate or defecate during this time. However, it is known to produce and reabsorb urine in equal amounts daily [226,227].

The cellular localisation of AQPs in urothelial cells is an interesting indicator of their functionality. In rats, AQP2 and AQP 3 are found on the basolateral, but not apical, membrane of umbrella cells, as well as the plasma membrane of intermediate and basal cells [225]. The AQPs which are expressed on the apical membrane of umbrella cells may be responsible for the initial water influx and subsequent egress through basolateral AQPs to the intermediate and basal cells. This would allow water to be transported from the bladder lumen, through the urothelial cell layers towards the interstitial space and circulation [188].

The exact function of AQPs in the urothelium is still unclear; however, several roles have been proposed. One possibility is that the AQPs are responsible for regulation of cell tonicity and volume of urothelial cells. Changes to the extracellular osmolarity of urothelial cells is a form of stress which also results in release of transmitters such as ATP, acetylcholine, nitric oxide etc. Release of these transmitters has significant effects on afferent nerves in the mucosa, as well as direct effects on the spontaneous contractile activity of the bladder wall [228,229]. However, the exact role of AQPs in mediating the sensory and con-

tractile functions of the bladder wall, and the mechanisms by which their expression and function in the urothelium is regulated remains unclear.

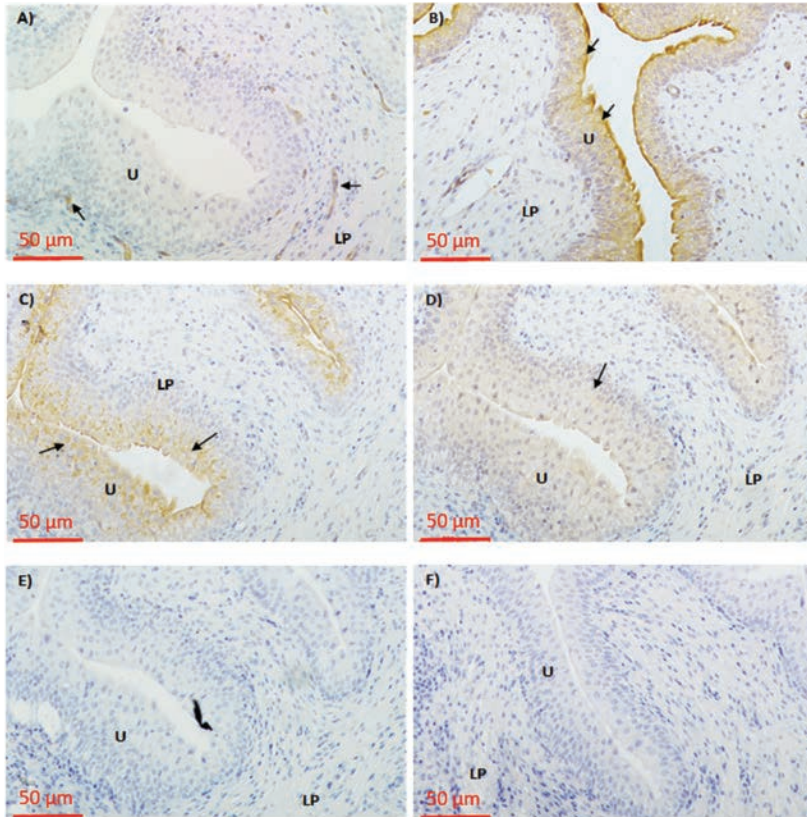

Figure 14 Expression and localisation of AQP proteins in pig urinary bladder **A:** AQP-1 immunoreactivity detected in the mucosal layer localised to capillary and arteriole endothelial cells (arrows). **B:** AQP-3 detected throughout the urothelium (arrows). **C:** AQP-9 immunoreactivity detected only in the umbrella cells of the urothelium (arrows). **D:** AQP-11 immunoreactivity detected throughout the urothelium (arrows). **E:** Negative control; minus primary antibody. **F:** Negative control, scrambled AQP peptide): LP lamina propria; U urothelium. (Manso M, Drake MJ, Fry CH, Vahabi B, unpublished data).

4.2. Solute Transport in the Urothelium

In addition to water, solutes such as urea and creatinine are constantly re-absorbed from the urine (or secreted depending on the local environment) and the net transport of these solutes is regulated by the hydration status [208]. Although possible simple diffusion of urea down its concentration gradient could be considered, the magnitude of the quantity of flux, and its rapidity of movement indicate that transport is facilitated or active in nature [230,231]. There are two subfamilies of urea transporters: UT-A and UT-B [232]. UT-A, is located apically, whereas UT-B is primarily located on the basolateral surface of umbrella cells and the membrane of intermediate and basal cells [188]. This provides a system whereby urea is absorbed apically by UT-A and is then transported through the umbrella cell and exits on the basolateral side via UT-B, allowing for modulation of cell volume and osmolality [233].

4.3. Ion Transport in the Urothelium

Several pathways for ion transport have been described in the urothelium. The apical plasma membrane of urothelium contains Na^+ , K^+ and Ca^{2+} channels, as well as other cation-sensitive channels, whilst the basolateral plasma membrane expresses Cl^- channels, Na^+/H^+ and $\text{Cl}^-/\text{HCO}_3^-$ exchangers, ATPase-dependent pumps as well as Na^+ and K^+ channels [208].

The best understood pathway is mediated by the amiloride-sensitive Na^+ channel (ENaC), which is expressed on the apical membrane of umbrella cells. ENaC facilitates transurothelial Na^+ flux along with Na^+/K^+ -ATPase dependent active transport on the basolateral membrane to provide the net electrochemical gradient that promotes Na^+ absorption. When the bladder is empty and the urothelium is not stretched, Na^+ absorption through ENaC channels is

the primary contributor to transepithelial potential difference of nearly -30mV [234,235]. However, when the urothelium is stretched, amiloride sensitive current significantly increases which is likely the result of increased apical membrane exocytosis of ENaC-containing DFVs [235]. Na^+ entering the cell through ENaC channels then exits across the basolateral membrane via $\text{Na}^+/\text{K}^+\text{-ATPase}$. As Na^+ is extruded from the basolateral membrane, the $\text{Na}^+/\text{K}^+\text{-ATPase}$ brings K^+ into the cell, which then exits the cell across the basolateral membrane through K^+ selective channels. This outward movement of K^+ across the basolateral membrane generates a membrane potential of -55 mV [220]. ENaC is also proposed to play a role in mediating ATP release from the urothelium as well as having a mechanosensory role in modulating stretch-induced exocytosis at the apical membrane of the umbrella cells [188].

Urothelial stretch can also stimulate K^+ and Cl^- secretion. Secretion of Cl^- from urothelial cells has been demonstrated in experimental conditions, but the channel responsible for Cl^- transport is not yet identified. Although pathways for Cl^- entry across the basolateral membrane of umbrella cells, including Cl^- channels and $\text{Cl}^-/\text{HCO}_3^-$ exchanger have been proposed [235], the apical pathway for Cl^- secretion has not yet been described. The pathways for K^+ transport include an apically expressed non-selective cation channel (NSCC) which is mechanosensitive and can also transport Ca^{2+} across the apical surface of umbrella cells [235]. Other K^+ channels in the urothelium include Kir 1.1 (inwardly rectifying K^+ channel), which has recently been found to be expressed on the apical membrane of umbrella cells [236]. The exact function of this channel is unknown, but it could be important in regulating cell volume or transmembrane electrical potential (3). Additional K^+ channels that have been identified in the urothelium include: heparin-binding EGF-modulated inwardly rectifying channel, Kir 2.1; large-conductance Ca^{2+} -activated K^+ channels (BK); small/intermediate-conductance Ca^{2+} -activated K^+ channels (SK/IK); and ATP-sensitive K^+ -channels (K_{ATP}) [237]. These channels have been shown to either modulate K^+ transport or K^+ secretion across the urothelial cells [188].

Other ion channels with a potential sensory role have also been described in the urothelium [238]. These include non-selective transient receptor potential (TRP) channels, which are permeable to Ca^{2+} , Mg^{2+} and Na^+ [239] and purinergic receptors (P2X), a further family of non-selective cation channels.

5. SUMMARY

The urothelium represents an effective blood-urine barrier that prevents, or at least regaultes, reabsorption of toxic metabolites and pathogens from urine. Various specialised features such as surface glycans, membrane lipids and tight junction proteins make the

urothelium one of the tightest barriers. These specialised features of the urothelium allow the urinary tract to accommodate large changes in urine volume, as well as present an effective barrier against urinary tract infections and allow communication between the urothelium and the underlying tissues of the urinary tract. Beyond the role of forming an effective barrier, the presence of AQPs, solute and ion transporters in the urothelium indicates that there are potential pathways for altering the composition of urine, making this tissue an active component of water, salt and solute homeostasis. The specialised features of this tissue must also be considered in the development and application of drugs, especially those given intravesically, for targeted delivery.

V. THE PATHOLOGY OF FUNCTIONAL DISORDERS OF THE LOWER URINARY TRACT IN PERINATAL SUBJECTS AND CHILDREN.

1. INTRODUCTION

The physiology of lower urinary tract tissues from adults with normal and pathological conditions has been the subject of considerable study. However, the same is not true of foetal tissues and those from children or neonatal animals. This is in spite of the fact that several developmental conditions have continuing and profoundly detrimental effects on lower urinary tract function long after the original condition has been surgically managed. Moreover, therapeutic management of less debilitating conditions in children is also hampered by an incomplete knowledge of normal tissue physiology. The purpose of this section is to review current data regarding the cell and tissue physiology of lower urinary tract animal and human tissues, in particular from the bladder, spanning the period from foetal development to childhood and how this relates to normal and abnormal function within the lower urinary tract.

2. DEVELOPMENT OF THE LOWER URINARY TRACT

The urinary organs, kidneys, ureters, the bladder and the urethra, develop early in gestation - after the third week. The kidneys and ureters develop from fused outgrowths of intermediate mesoderm immediately under ectoderm originally from fifth cervical to the third thoracic segments to form a pronephric duct. This grows caudally to open into the cloaca (below) and when the original region atrophies is then called the mesonephric (Wolffian) duct. Ureteric buds from the Wolffian duct grow into nearby mesenchyme to

initiate kidney development – further consideration will not be given here, but see [240,241].

The bladder and urethra derive ultimately from the cloaca, which offers a single orifice in the developing embryo from the hindgut. Soon after, a urogenital membrane (urorectal septum) grows caudally to divide the cloaca into ventral (urogenital sinus) and dorsal (rectum) compartments. The urorectal septum itself consists of two fused mesodermal structures; an upper, frontal fold of Tourneux, and two lateral folds of Rathke, which complete the division between the urogenital sinus and rectum and form the perineum. Malformation of these structures can lead to fistulas between the rectum and either the urethra or bladder. The pelvic organs are supported by connective tissue and the perineal musculature, which form from the mesoderm surrounding the new rectum.

The bladder develops from the anterior part of the urogenital sinus and has a functional outflow in early foetal life through the allantois and thence to the umbilicus. The allantois itself develops as a diverticulum from the yolk sac and has a key role in the formation of umbilical vessels. It is eventually obliterated during development and forms a fibrous cord, the urachus, still connected to the umbilicus. The posterior portion of the urogenital sinus develops into the whole female urethra and the pre-prostatic, prostatic and membranous urethra in males.

During such development, the Wolffian ducts distal to the uretric buds opens into the urogenital sinus near to where the bladder neck will form. This process brings the ureteric bud with it until the ureters themselves separate from the Wolffian ducts and incorporate themselves into a more anterior part of the urogenital sinus that will form the bladder dome. The triangular region bounded by these insertions forms the bladder trigone. Thus the trigone has a mesodermal origin whilst the remainder of the bladder is endodermal in origin. However, the trigone is subsequently covered by endodermal epithelial (urothelial) cells and so has a mixed cellular origin [242,243]. After about developmental week 12 the urothelial cells are overlain by mesenchyme that itself differentiates into: i) a lamina propria adjacent to urothelium composed of connective tissue, that also contains fibroblasts, nerves and blood vessels, and ii) detrusor smooth muscle [244]. Urothelium is necessary to induce mesenchyme to differentiate. Differentiation of mesenchyme into detrusor smooth muscle requires the presence of urothelium via the diffusion of a signalling molecule [244,245]. Subsequent studies have demonstrated the importance of the Sonic Hedgehog pathway in this process [246,247].

The urethra forms itself from the lower part of the urogenital sinus (UGS). In males the prostate and membranous urethra arise from the pelvic part of the UGS while the spongy urethra comes from the phallic part (urethral plate). In females the whole urethra and part of the vagina arise from the pelvic part of the

UGS while the phallic part (urethral plate) forms the vestibule and the labia minora.

3. THE FUNCTIONAL PROPERTIES OF FOETAL DETRUSOR SMOOTH MUSCLE.

At the end of the first trimester the bladder has a reservoir capability with discrete inner and outer longitudinal muscle layers and a circular central layer, along with a discernable trigone area [248]. Increased muscle development occurs until term, when there is also an increase of bladder capacity and discrete micturition episodes [249]. From the first trimester onward bladder compliance increases in keeping with its increasing importance as a urine storage organ, observations matched by a decrease of passive stiffness during development [250]. Measurements in both humans and animal models results show this is not just from increased muscularisation but also from a reduction of resting smooth muscle tone [251,252] as well as from changes to connective tissue whereby collagen content changes from predominantly type-III to an increasing proportion of type-I [253-255].

In humans, urinary bladder innervation is advanced by week 13 when organogenesis is about complete. Parasympathetic innervation and the density of cholinergic receptors increases up to term, but throughout there is a sparse noradrenergic innervation, in contrast to more dense supplies to the ureter and urethra [256-258]. Similar developmental histories are found with bovine and sheep development [259,260]. In addition a nitergic supply to the bladder, as evidenced by nitric oxide (NO) synthase immunoreactivity, develops over a similar time-frame [261], the functional significance of which requires evaluation.

These structural changes are accompanied by development of functional properties of tissue in the bladder wall. Comparison of intracellular signalling pathways associated with Ca^{2+} regulation show that these are fully functional early in development [262]. Cells isolated from foetal sheep bladders in the 2nd and 3rd trimester, at term or from young adults show that the resting intracellular Ca^{2+} concentration is the same in all groups, as were increases of intracellular Ca^{2+} in response to muscarinic receptor agonists, membrane depolarisation and caffeine to release Ca^{2+} from intracellular stores. Responses to a purinergic ($P2X_1$) receptor agonist (ABMA) were somewhat lower in foetal cells, as was a reduced potency to carbachol, suggesting some post-natal function changes did occur. However, it can be concluded that the membrane and intracellular pathways for contractile development are fully developed in foetal detrusor cells (Figure 15). Such cellular changes are mirrored by development of contractile detrusor responses. Between the second and third trimester contractions to muscle depolarisation with high-K superfusate increases, using bovine and sheep preparations, consistent with increased muscularisation. However, contractions to

muscarinic and purinergic agonists increase even more suggesting there is a development also of the intracellular signalling pathways to these agents (250,263) and consistent with the above observations of isolated cells. Later in development – from the onset of the third trimester until term – nerve-mediated contractions progressively develop suggesting an increase of functional innervation to detrusor (250,263). Nerve-mediated relaxation has also been observed in the latter stages of development and shown to be mediated by NO-dependent pathways, due to its abolition by agents that limit the activity of NO-synthase of intracellular cGMP pathways (250,264). The significance of this contractile modality has yet to be identified and the extent to which it is persists in the bladder

after term. Electrically-induced relaxation was present only in the foetal bladder and was suggested as a mechanism to protect the upper tract from excessive increase of bladder pressure [265]. This progressive development, firstly of muscle intracellular signalling systems and then of functional innervation is consistent with the maturation of voiding responses from small, brief contractions in the second trimester to more maintained and effective voiding contractions in the third [266-269]. Radio-telemetry of cystometric recordings in foetal sheep bladders show that in the later stages of development low compliance filling is interspersed with voiding and non-voiding contractions occur [269].

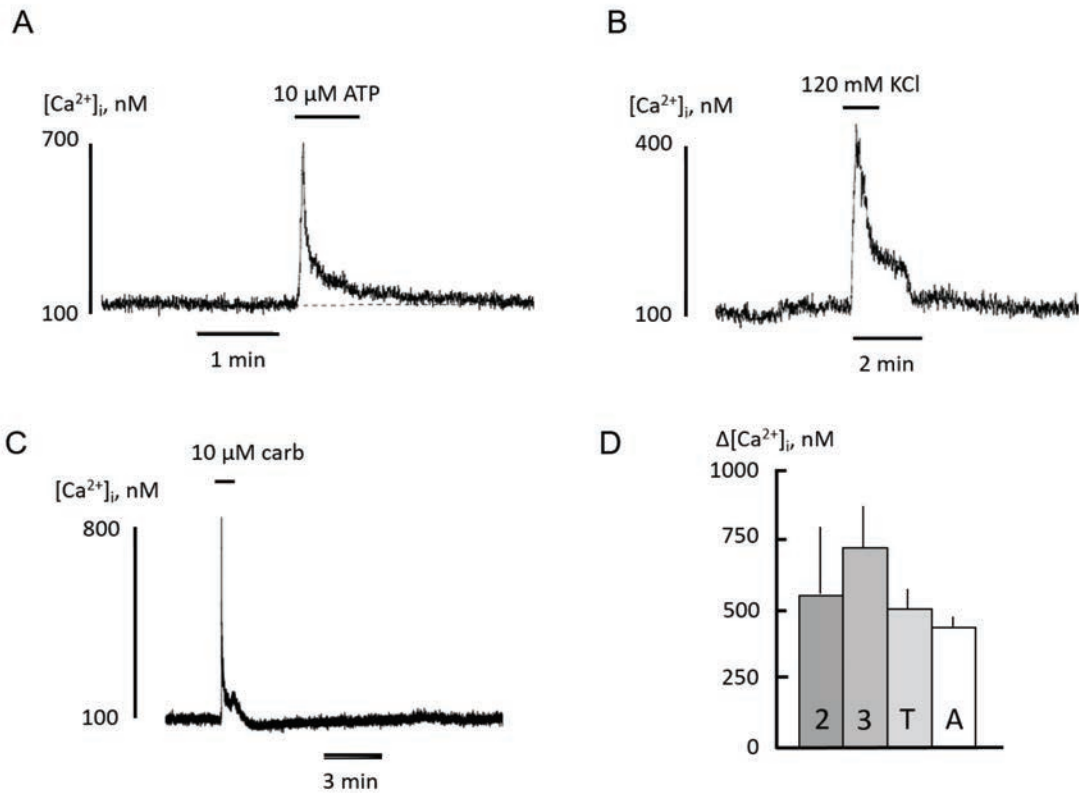

Figure 15 Intracellular Ca^{2+} transients to contractile agonists in foetal sheep detrusor cells. **A:** response to 1 μ M ABMA. **B:** response to a high-K solution. **C:** response to 1 μ M carbachol. **D:** comparison of change of intracellular $[Ca^{2+}]_i$ with carbachol in detrusor myocytes from; mid-second trimester (2), mid-third trimester (3), term (T) fetuses and adult bladders (A).

4. THE FUNCTIONAL PROPERTIES OF DETRUSOR FROM POSTNATAL DEVELOPING BLADDERS

At birth the functional development of the bladder continues, until in humans a broadly adult phenotype is established at about 50 months. Over this time-scale the ratio of detrusor muscle to connective tissue increases [270,271], as does the density of functional innervation, the latter inferred from comparing the force developed by nerve-mediated and agonist-induced contractions [271]. However, in postnatal detrusor from both humans and pigs the intracellular signalling pathways, surface membrane receptor agonists and ion channels are similar to the adult phenotype [271,272] and is consistent with a similar picture in late-term foetal detrusor myocytes [262]. An exception is the low potency to muscarinic receptor agonists, observed in foetal tissue and persisting in the postnatal human and pig detrusor bladder [271,272]. Figure 16 shows a significant positive relationship between force generated by a contractile agonist (carbachol) and the smooth muscle:connective tissue ratio from human detrusor samples collected from normal bladders of children with between 1 and 48 months of age. An interpretation of the data is that an increase of bladder contractile performance is due to the increase of smooth muscle in the detrusor layer and not due to a development of myocyte contractile function.

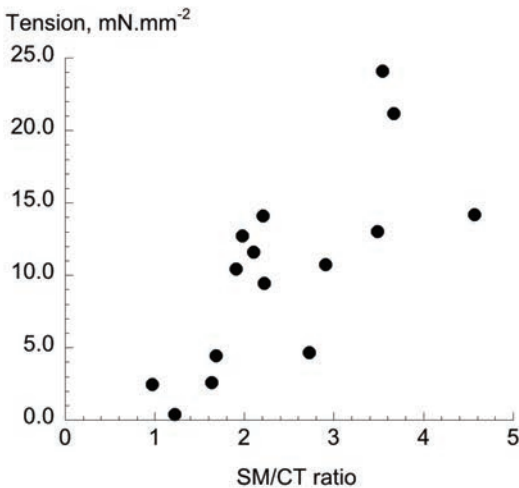

Figure 16. The relationship between carbachol-induced tension and the smooth muscle (SM): connective tissue (CT) ratio. Tissue samples obtained from children with normal bladders aged between 1 and 48 months. (Navroop Johal and Fry CH, unpublished data).

The decrease of connective tissue content in post-natal development is mirrored by a reduction of passive

muscle stiffness [271]. This implies that bladder compliance also increases during post-natal development and is consistent with an increase of maximum (expected) bladder capacity up to adolescence with no change of the increase of detrusor pressure during the filling period [273,274].

A further feature of human postnatal developing detrusor was significant atropine resistance of nerve-mediated contractions in tissue from stable bladders, in contrast to the adult phenotype. Although it diminished with time it still persisted up to postnatal 50 months. In adult tissue atropine resistance has been attributed to reduced breakdown of released ATP by ectoATPases in the neuromuscular junction [275], but it is not known if this is the case in the postnatal bladder. Overall, the reduced potency of muscarinic receptor agonists and atropine resistance in postnatal human detrusor muscle may contribute to the variable effectiveness of anticholinergic agents to treat enuresis and overactive bladder in children [276,277].

An additional feature of postnatal bladders is the generation of large amplitude spontaneous contractions, in contrast to higher frequency, smaller contractions in adult bladder and also reminiscent of large spontaneous contractions in the overactive bladder [278]. These large, neonatal contractions disappear with the development of supraspinal mechanisms to control bladder function [279]. These contractions are resistant to neurotoxins, such as TTX and therefore are unlikely to be nerve-mediated, and originate from the sub-urothelium layer adjacent to detrusor. A proposed mechanism is that acetylcholine and ATP released from the urothelium by external forces such as mechanical stress either diffuse to the muscle layer or use interstitial cells to mediate the response. The latter mechanism has credence as gap junction blockers inhibit neonatal spontaneous contractions, and it is observed that interstitial cells in the suburothelium form a functional electrical syncytium connected by gap junctions formed of connexin43 proteins [280].

4.1. Collagen and its Contribution to Biomechanical Properties of the Bladder Wall

Collagen is an important constituent of the extracellular matrix and its physical properties are important for two reasons. Firstly it contributes to the passive stress-strain characteristics of tissues, including those of the lower urinary tract. When the bladder wall is stretched during filling the increase of wall stress (tension), and hence intravesical pressure, will be greater if the tissue comprising the bladder wall is stiffer. Secondly, force generated by actively contracting muscles will be transmitted through the tissue mass by imparting strain on the extracellular matrix and hence the biomechanical properties of the latter will determine force transmission throughout the muscle mass. Fibrillar collagen is a key component of extracellular matrix and provides structural integrity.

Collagen type-I and type-III are important constituents of lower urinary tract tissues and tissue are often composites of these types in varying proportions [281] - these will be considered here.

Collagen molecule of types -I, -II, -III, -V and -XI form fibrils and is a triple helix protein with length and diameter about 300 and 1.6 nm respectively. These molecules complex to form a fibril with diameter about 100 nm, which themselves coalesce to form fibres with diameters in the micron range [282-284]. Type-I collagen is a trimer of two α 1- and one α 2-chains, whilst type-III is composed of three α 1-chains. Generally type-I collagen is more non-elastic than type-III: it imparts resistance to tensile forces, whilst type-III collagen provides more flexibility [285,286]. Values of the elastic modulus of type-1 collagen varies widely in the literature typically between 1 and 10 GPa [287,288], but sometimes lower [289]. However, these values are several orders of magnitude greater than shear forces [288] and emphasises the load-bearing properties that it has. Type-III collagen lacks 3-hydroxyproline in its molecular structure and may be a reason why it cannot form thick fibrils as can type-I [290]. There are less reliable measurements for the elastic modulus of type-III collagen but from measurements in mixed type-I/-III strands it may be estimated that the elastic modulus is about one-half of type-I collagen [291].

For completeness, collagen type-IV is the key structural protein on basement membranes that act as a substrate for other protein, such as integrins, to form a stable supporting structure. However, they do not impact on the overall stress-strain properties of lower urinary tract tissues.

5. LOWER URINARY TRACT CONGENITAL ANOMALIES

At about the time of completion of organogenesis many congenital problems of the urinary tract and genitalia will start to become manifest. This section will deal with anomalies that generate bladder dysfunctions that occur not just during foetal development but persist throughout childhood and into adult life, and which may cause co-morbid conditions such as renal failure [292]. Whilst the detection of such anomalies and surgical management has greatly improved, their consequences on lower urinary tract function are poorly understood. Several conditions will be described, those that have a more direct influence on bladder function considered in greater detail. Further clinical information on the pathogenesis

- Posterior urethral valves occurs only in boys but is the commonest congenital anomaly occurring in as many as 1:5000 live births [293]. It causes bladder outflow obstruction and up to one third of patients will develop end stage renal failure [294]. Similar, but less common, conditions that

also cause bladder outlet obstruction are anterior urthral valves and syringocele.

- The bladder exstrophy-epispadias-cloacal exstrophy complex. Separation of the cloaca into the urogenital sinus (US) and hindgut occurs at a time when the anterior abdominal wall develops. Rupture of the cloacal membrane before its caudal descent (above) causes several externalisation of organs in the umbilical wall: bladder exstrophy if US and hindgut have separated, or if not cloacal exstrophy if not to expose bladder and hindgut. There is poor bladder contractile function as it does not develop in a closed space to allow intravesical pressures to fully develop [295,296]. Epispadias is incomplete urethral tubularisation but allows the bladder to form normally. Epispadias is common, but the exstrophies are less common than PUV (1 in several tens of thousands [297]).
- Prune belly syndrome: characterised by poor development of the abdominal muscle, undescended testicles and urinary tract problems, such as dilatation of the ureters and hydronephrosis [298]. It is rare, occurring in about 1:40 000 live births
- Relatively unusual conditions such as foetal megacystis - an unusually large bladder for the appropriate trimester [299] - and bladder diverticulum - often presenting as bladder outflow obstruction [300].
- Spina bifida occurs in which vertebral arches of the spinal columns are incomplete or absent. A meningocele is a cyst formed of dura and arachnoid membranes protruding through the defect and of ten externalising. The cyst is called a myelomeningocele if it contains cord tissue. Neurological damage often results in a neurogenic bladder (and bowel) with poor bladder wall compliance and high bladder pressures from increased outflow resistance [301].

5.1. Pathophysiology of Detrusor Function with Foetal Bladder Outflow Obstruction

Many of the above congenital lower urinary tract problems are associated with bladder outflow obstruction (BOO) and this has been attributed as a key aetiological factor in life-long poor urinary tract function in a very high proportion of these patients. Because posterior urethral valves (PUV) is the most common congenital cause of BOO much attention has been directed to its long-term consequences. Vesicoureteral reflux is extremely common at diagnosis of PUV [302], is often associated with hydronephrosis [303] and has a poor prognosis for renal failure that may develop at any stage in childhood or adult life [304,305], however further consideration is beyond the scope of this review. Changes to bladder function are also common and urodynamic observations include: decreased bladder capacity, low compliance,

detrusor overactivity with a hypocontractile phenotype, a significant post-void residual, and day/night incontinence [302]. The implied causal link between these bladder dysfunctions and upper tract problems motivate studies to understand their cellular and tissue origins. Moreover, the time of valve ablation may affect the extent of bladder dysfunction in later life [306], so that it is important to characterise the exact antenatal natural history of bladder dysfunction associated with BOO. The foetal sheep has proved to be a good model to study the effect of BOO [307-311] by partial occlusion of the urethra and complete occlusion of the urachus (Figure 17). Sheep have second and third trimesters between 45-90 and 90-143 days respectively and obstruction is generally undertaken

at 45-75 days, with bladders retrieved for characterisation between several days afterwards until full term.

Obstruction early in the second trimester results in cystic renal lesions [307,312] and in one foetus the appearance of prune-belly syndrome [307]. Obstruction for periods between only five days in utero to term is associated with bladder hypertrophy - increased weight - and increased capacity - when compared to sham-operated controls [310,313-316]. With shorter periods of obstruction wall thickness also increases, but with longer periods this decreases along with a reduced detrusor/extracellular matrix ratio [314,316].

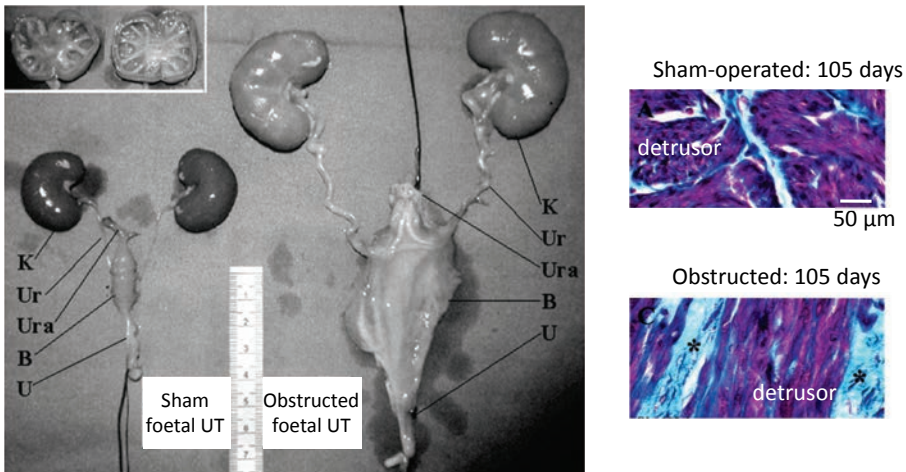

Mean±SD	Sham-operated	Obstructed
Bladder weight, g	1.14 ± 0.25	7.28 ± 4.41
Max capacity, ml	6.4 ± 2.6	52.0 ± 31.7
Peak fill pressure, cmH ₂ O	10.6 ± 1.8	12.2 ± 5.0
Compliance, ml/cmH ₂ O	0.64 ± 0.25	6.69 ± 5.47

Figure 17. The effect of outflow tract obstruction on the foetal bladder. Left: Dissected urinary tracts of foetal sheep (105 days gestation) after a sham-operation or partial outflow tract obstruction 15-days previously. Right: sections through the detrusor layer of the bladder wall of a sham-operated or obstructed foetal bladder – Masson’s Trichrome stain (light blue, extracellular matrix; purple, muscle). The Table below lists changes to the bladder dimensions and ex vivo functional characteristics. (Figure with the courtesy of Peter Cuckow, Nikish Thiruchlevam and Christopher Fry)

A greater compliance during filling is also measured after 30 days obstruction [315,316], associated with reduced passive elasticity of isolated preparations [316]. These changes are accompanied by increased extracellular matrix and reduced matrix metalloproteinase (matrix collagenase) activity [317,318]. Of interest, earlier studies with human bladder from obstructed fetuses showed increased elastin content, but no relative increase of collagen [319,320]. However, there is greatly increased cell turnover that ac-

companies bladder wall remodelling in foetal obstruction, as observed by greater labelling for proliferating cell nuclear antigen in the detrusor layer, if not in the urothelium or lamina propria (PCNA, [316]). Apoptosis is increased, accompanied by increased caspase-3 and BAX expression and decreased Bcl-2, the latter promoting cell survival [316].

A functionally decompensated contractile state of obstructed foetal bladders is indicated by reduced responses to contractile agonists, such as muscarinic

receptor agonists, and nerve-mediated stimulation [314,316]. Furthermore, nerve-mediated contractions are reduced to a greater extent than agonist-induced responses [315,316] indicating a relative denervation as well as a hypocontractile state of the detrusor. This is corroborated by reduced expression in obstructed bladders of neuronal tissue-markers such as S100 protein and protein gene product-9.5 [315]. Of interest is a nerve-mediated nitregic relaxation in foetal bladders that is absent in adult tissue. Such a pathway is absent in detrusor from obstructed foetal bladders [314,316]; it remains to be ascertained if this contributes to the decreased filling compliance of these bladders.

Two factors may thus contribute to the hypocontractile state of obstructed foetal bladders: replacement of detrusor muscle with extracellular matrix and reduction of postganglionic parasympathetic fibres to detrusor. A final possibility is impairment of excitation-contraction coupling in detrusor myocytes. With isolated myocytes from obstructed or sham-operated bladders, intracellular Ca^{2+} transients to membrane depolarisation (raised KCl) or caffeine (release Ca^{2+} from intracellular stores) were similar, but those to muscarinic or purinergic agonists were diminished [321]. This suggests that the membrane and intracellular machinery for Ca^{2+} is not significantly altered in obstructed bladders, but receptor coupling may be diminished.

Thirty days of obstruction, i.e. from mid-2nd to early 3rd trimesters is sufficient to produce a decompensated, hypocontractile, low compliance bladder (Figure 17). Of interest would be to know if a compensated phenotype develops initially and when this changes to a decompensated state. This was addressed by measuring morphological and functional changes after only nine days of obstruction [322,323] by either i) ligation only of the urachus or ii) urachus ligation and partial urethral obstruction. Similar results in both intervention groups reinforced the importance of the urachus in bladder drainage at mid-gestation. Overall, this period of obstruction represented a cusp from compensation to decompensation. Compared to sham-operated controls, there was evidence of bladder remodelling, as evidenced by increased apoptosis (Figure 18), total bladder protein and DNA, but with preserved detrusor density. Hydronephrosis was present but with a lack of cystic lesions in the kidney and preservation of urine osmolality. Bladder compliance was greater in some foetuses, but unchanged or even decreased in others. Agonist-induced contractile function was unaltered and there was no evidence of denervation. Implicit in these findings is that with correct timing reversal of obstruction may allow recovery of urinary tract function, but this would have to occur very early in development. This has been demonstrated with respect to recovery of renal function after deobstruction [324,325], but has not been systematically addressed for bladder function.

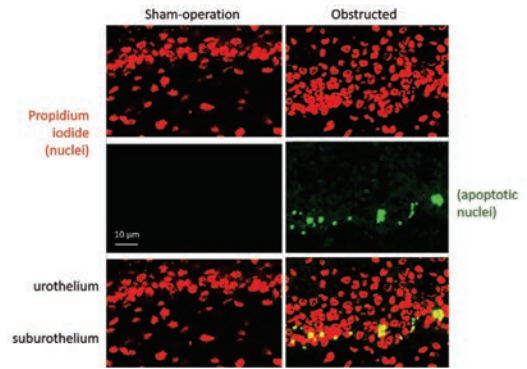

Figure 18. The effect of brief (9-days) obstruction on the initiation of re-modelling in the foetal bladder. Left: sham-operation; right: obstruction. (Figure with the courtesy of Marie-Klaire Farrugia, Adrian Wolf and Christopher Fry)

5.2. Animal Models of Bladder Exstrophy and Spina Bifida.

Morphological investigations of bladder wall samples have been carried out from newborn humans with exstrophy and from sheep with an exstrophy phenotype surgically induced in 70-80 day old foetuses [326-328]. In both cases a decrease of the collagen-to-smooth muscle ratio was recorded: in human samples the increased collagen was due to an increase of type-III, whilst type-I and type-IV contents were unchanged; in sheep samples the collagen I/III ratio was unchanged. A reduction of myelinated and smaller nerve fibres has also been recorded in newborn human exstrophy samples [329]. The exstrophy-epispadias complex results in part from several genetic changes that includes altered expression of P63 protein that leads to poor development of the urothelium. Ulceration and inflammation of the mucosa also occurs in the sheep exstrophy model [330]. However, in contrast to foetal bladder outflow models there has been little description of structural changes that occur and no systematic characterisation of the functional properties of bladder tissues.

Different models of myelomeningocele (MMC) have been developed, including: in foetal sheep surgical exposure of the spinal cord to the amniotic space at 75 days and animal examined at term [331]; oral gavage of retinoic acid to pregnant rats (embryonic day 12, term day 22 [332]). With the surgical-intervention animals a typical neuropathic bladder phenotype presented, some with dilated, thin bladders and others with a contracted, thick-walled bladder. At the microscopic level this was mirrored in a narrow urothelium, and a thin muscle layer with fibrosis between muscle bundles, or a thickened urothelium and muscle layer with no excessive fibrosis. Normal ganglion and nerve development was observed [331,333]. Retinoic acid-induced MMC was studied in days 16-20 foetuses. There was no increase of connective tissue between muscle bundles – in contrast to that seem in

human tissue [334] – and progressive denervation to the muscle bundles [332]. Functionally, nerve-mediated responses were absent and contractures to raised-KCl solutions and to carbachol were attenuated. This model demonstrates a denervated and hypocontractile phenotype.

5.3. Postnatal Detrusor Function from Children with Congenital Abnormalities

Very little work has been carried out on the morphological and functional characteristics of detrusor from children born with congenital anomalies. Longitudinal urodynamic follow-up studies after valve ablation show detrusor overactivity, high compliance significant residual volume and ‘myogenic failure’ in some patients [335-337]. However, it should be noted the term ‘myogenic failure’ refers to an overdistended bladder and does not imply any actual demonstration of reduced muscle contractile function.

Measurements have been made of in vitro contractile function and morphology of detrusor samples from neonates and children up to 1-year old after surgical correction for congenital anomalies such as PUV, bladder exstrophy and MMC. Compared to data from bladders of similarly aged children with no such anomalies and stable bladders, contractile responses to muscarinic agonists and nerve-mediated stimulation were significantly lower in all groups with anomalies (Figure 19A). However, the reduction of the responses by the two modes of stimulation were not significantly different. This suggests that there was no evidence for functional denervation in the detrusor of samples from congenital anomaly bladders. This is consistent with observations of normal nerve profiles in exstrophy bladders after surgical reconstruction [338]. Of interest atropine resistance in these samples was also present, as observed with tissue from neonates with stable bladders.

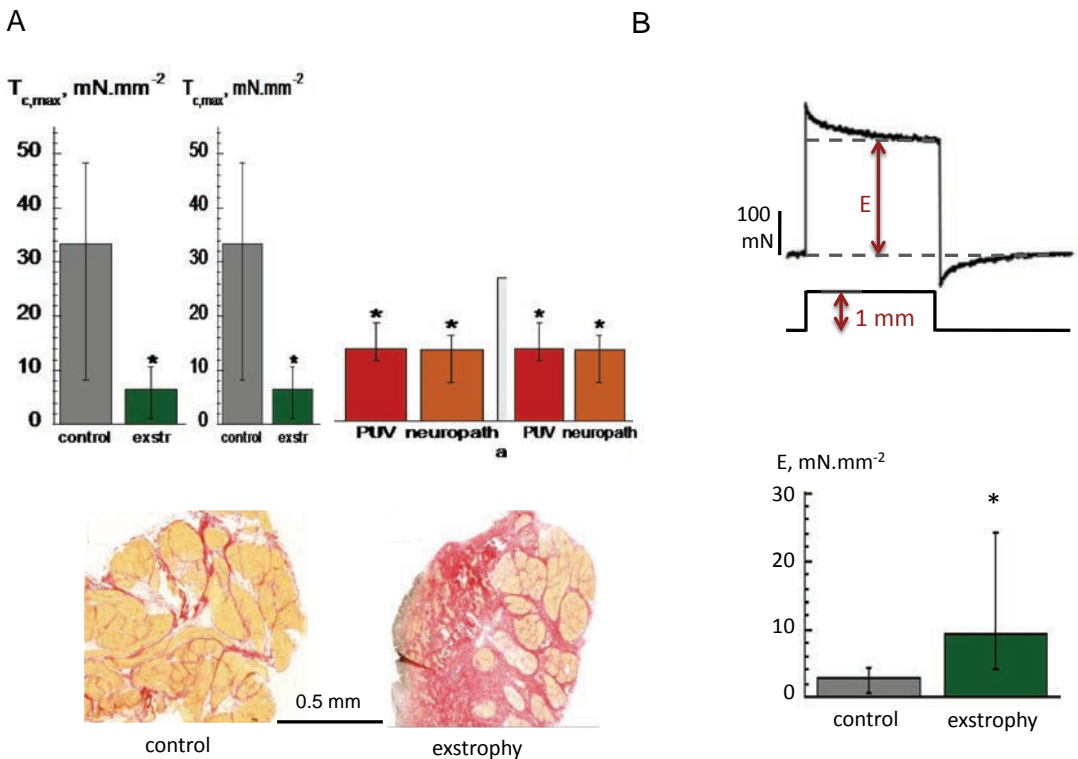

Figure 19. Contractile and biomechanical properties of neonatal bladder with congenital anomalies. A: upper; contractile responses of detrusor to carbachol and the smooth muscle (SM)/connective tissue (CT) ratio in samples from children with normal bladders (control), exstrophy (exstr), posterior urethral valves (PUV) and myelomeningocele (neuropath). Lower; cross-sections of the detrusor layer of samples from a normal bladder and one with bladder exstrophy – van Gieson stain; muscle, orange; connective tissue, red. B: passive tension response to a muscle sample during a rapid stretch for 60 seconds. The steady-state tension, E , is plotted below for samples from control and exstrophy bladders. Data are mean \pm SD, * $p < 0.05$. (Figure by courtesy of Navroop Johal and Christopher Fry)

The reduction of contractile responses was mirrored by a greater proportion of extracellular matrix in the

groups of anomalies, which suggests that the reduction of contractile responses was due, at least in part,

to replacement of muscle with connective tissue (Figure 19B). A reduction of smooth content of tissue from human exstrophy bladders has been recorded previously [339] where it was also shown that the smooth muscle content increased after reconstruction along with improved bladder function.

A remaining question is if loss of contractile function also results from failure of detrusor muscle itself to generate force. This is not a likely contributor in isolated detrusor myocytes intracellular Ca^{2+} responses to muscarinic agonists were similar in those from children with stable bladders and congenital anomalies. This corroborated by finding similar densities of muscarinic receptors in detrusor from normal and exstrophy paediatric bladders [340]

Overall, there is no evidence that contractile bladder dysfunction in neonates with congenital anomalies is caused by reduced contractility of the detrusor muscle itself, or its excitatory innervation. Of more significance is the loss of muscle tissue and its replacement by connective tissue. Strategies to improve bladder function after surgical correction of these different anomalies should concentrate on reversing the decline of the smooth muscle / connective tissue ratio.

VI. THE MUSCULATURE OF THE PELVIC FLOOR AND EXTERNAL URETHRAL RHABDOSPHINCTER

Skeletal muscle components in the pelvic floor and around the urethra provide important roles in providing continence mechanisms as well as some visceral organ support. The previous edition of the consultation [341] provided a detailed account of the neural control of these structures. This report will concentrate on the properties of the muscles themselves with brief resumé of neural control including any advances that may have been made in the intervening

period and where there is direct relevance to understanding the muscle physiology.

1. THE PELVIC FLOOR MUSCLES

The pelvic floor is situated at the base of the pelvis, supports pelvic visceral organs [342] and, as the urethra and ano-rectum penetrate it, may provide a continence mechanism. Furthermore, although not considered here, it is important to support movement and posture, in concert with the musculature of the abdomen and lower back; normal sexual function; and in reciprocal function with the diaphragm breathing. The innermost layer is comprised of the the coccygeus muscles and the the levator ani. The levator ani itself has three components (Figure 20A): the puborectalis; pubococcygeus and iliococcygeus muscles; the last two referred to also as the pubocaudalis and iliocaudalis muscles in many animals.

The ventral portion of this structure has a superficial cover of deep and superficial perineal muscles, the latter fixed to the ischial tuberosities and a midline tendinous perineal body that itself acts as an insertion point for several pelvic floor muscles. Fibres in these muscles run at 90° to the ventral-dorsal orientation of the pelvic diaphragm and help support the pelvic floor and fix the perineal body in the centre. Most superficial in the male are the bulbospongiosus and ischio-cavernosus muscles to anchor and stabilise the penis, or the vestibular bulb in females, and the former also contributes to emptying the urethra at the end of micturition (Figure 20B). In addition, skeletal muscle fibres also comprise the anal and urethral rhabdosphincters that play key roles in continence. To complete the pelvic floor the obturator internus and the piriformis muscles exit the bowl-shaped pelvic floor and attach to the top of the femur and concerned with moving the hip. The previous edition of the consultation [341] discussed importantly the female pelvic floor [343] and here the male counterpart will also be described.

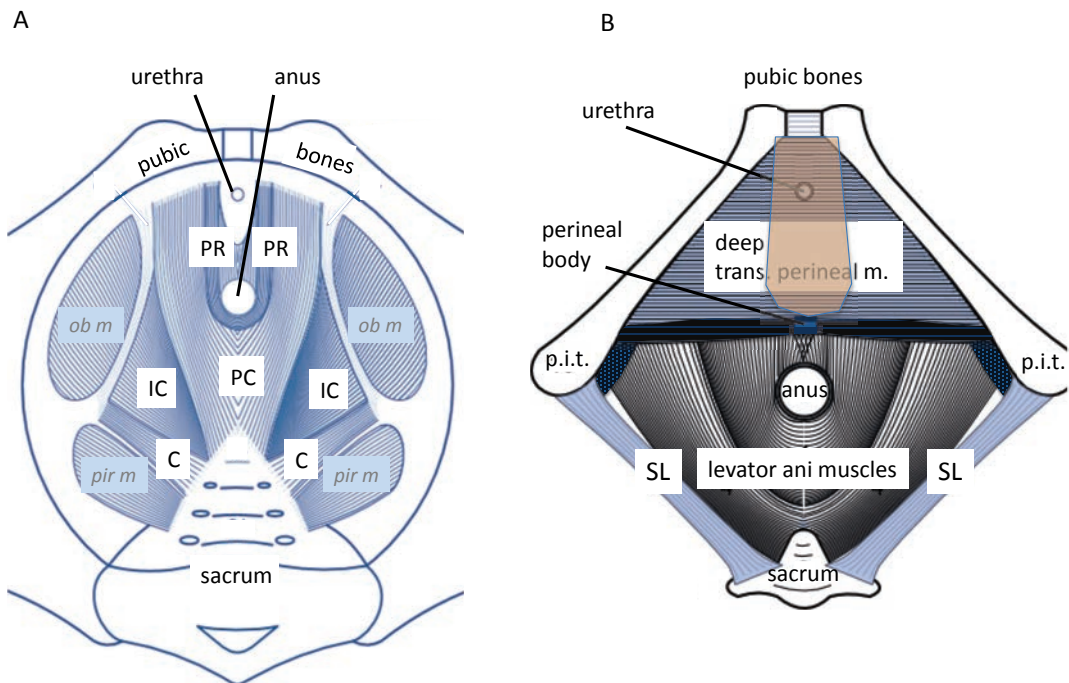

Figure 20. Diagrams of the pelvic floor musculature from above (A) and below (B). A: view from above to show the coccygeus (C), pubococcygeus (PC) and ileococcygeus (IC) muscles. The piriformis (pir m) and obturator internus (ob m) muscles are also shown. B: view from below with the levator ani muscles in the centre and overlain by the deep transverse perineal muscle. The superficial transverse perineal muscle attaches to the perineal body. p.i.t., pelvic iscial tuberosities. Overlain (in orange) is the bulbospongiosus muscle.

1.1. The Levator Ani Musculature

It is well recognised that the levator ani are important for support of the pelvic organ. In women this is corroborated by the orientation of muscle fibres, at least in the pubococcygeus and iliococcygeus muscles: an ability to close penetrating tubular structures such as the vagina, rectum and possibly urethra is also indicated for the puborectalis muscle [344]. Much of the literature concerned with the function of the 'levator ani', in particular the role of androgens, also includes a consideration of the bulbospongiosus muscle. For completeness both will be considered here, although extrapolation of data obtained from the superficial perineal muscles to the deeper layers requires full evaluation.

The levator ani musculature has insertions to bone, as do most other skeletal muscles. Forces from the contraction of muscle fibres and transmitted to a type-IV collagen endomysium, which is turn connects to an epimysium rich in type-I collagen. Leaflets of epimysium aggregate to an intramuscular and extramuscular tendon. Skeletal muscle tendons require some elastin to recover their original length after a contraction [345], aided somewhat by the elasticity of muscle fibres themselves and also the mesh-like structure of collagen fibres [346]. However, levator ani fasciae

are relatively rich in elastin [347], common to other skeletal muscles that insert not just to bone but also to soft tissues. In the case of levator ani this is with the urethral and anal rhabdosphincters and such an elastic junction may reduce damage after a strong muscular contraction of the levator ani. Furthermore, elastin fibres coexist with smooth muscle cells in such skeletal muscle / soft tissue interface and is true of levator ani muscles [347]. These smooth muscle cells do not form muscle bundles but are randomly orientated and so are not likely to form a separate contractile element. Rather they may form a viscous buffer in the connective tissue interface, as many smooth muscle cells in such an environment contract when passively stretched, as would happen in a skeletal muscle contraction [348]. Their individual electrical and mechanical properties have not been characterised.

Muscle fibre types are characterised as (Figure 21):

Type I: Slow twitch, high oxidative capacity, non-fatigable, moderate diameter, red

Type IIA: Fast twitch, very high oxidative capacity, non-fatigable, small diameter, red

Type IIB: Fast twitch, low oxidative capacity, fatigable, large diameter, white

The content of the O₂ acceptor myoglobin is indicated by the red (high) or white (low) colour and further indicates high oxidative capacity. In rats the muscle fibre type is mainly Type-IIB, but small fibre diameter, and suggests that this would not provide much continuous pelvic floor support [349]. In dogs and sheep the majority of fibres were Type-II, but with no further histochemical differentiation, however the lack of fatigue with tetanic stimulation would also suggest type-IIA [350]. By contrast, in human muscle samples from women with or without genitourinary prolapse and/or urinary incontinence, about two-thirds of fibres were Type-I, with the remainder mainly Type-IIB [351]. There was no difference between samples from women with or without these pathologies, nor a dependence on age or parity. There was a similar observation in levator ani samples from men undergoing

radical prostatectomy or cystectomy, with about 67% of Type-I fibres and the remainder now mainly Type-IIA [352]. Of interest in squirrel monkeys the Type-I/II is somewhat intermediate with about 43% if Type-I fibres in the pubococcygeus muscle [353]. Thus, with quadrupeds the need for continuous support for visceral organs will be less, as would be the consequent requirement for maintained contraction of levator ani muscles. With a bipedal stance humans will have a greater requirement for visceral organ support and so require a more non-fatigable muscle component to the pelvic floor. In the squirrel monkey study [353] changes to muscle histology that might be detrimental to function (e.g. fibrosis, increased muscle diameter) were associated with ageing, but not with parity or the presence of pelvic organ prolapse.

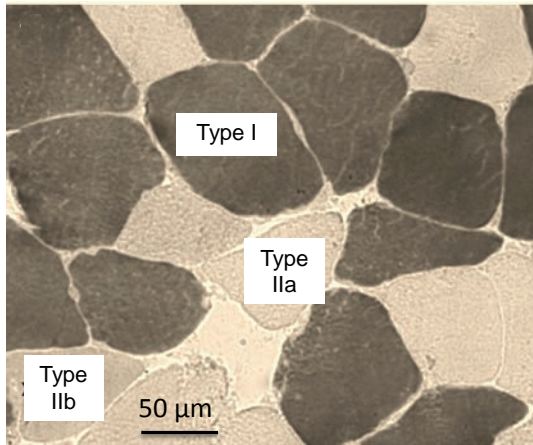

Key facts:
 The different colours of muscle fibres reflects labelling of different myosin ATPase isoforms
 Motoneuron diameter. Larger diameters reflects greater action potential conduction velocity and rate of muscle activation
 Motor unit: the basic functional contractile unit of a skeletal muscle – a motoneurone and the individual muscle fibres it innervates.

Characteristic	Type-I, slow oxidative	Type-IIa, fast oxidative	Type-IIb, fast glycolytic
Contraction rate	Slow	Fast	Very fast
Force generation	Low	High	Very high
Muscle fibre diameter	Small	Medium	Large
Motoneuron diameter	Small	Medium	Large
Motor unit size	Small	Medium	Large
Contraction efficiency	High	Medium	Low
Fatigue resistance	High	Medium	Low
Mitochondria, capillary density	High	Medium	Low
Myoglobin content	High	Medium	Low
Oxidative capacity	High	Medium	Low
Glycolytic capacity	Low	High	High
Myosin ATPase activity	Low	High	High

Figure 21. Skeletal muscle fibre types. Left: Micrograph of a mixed muscle shows Type-I and Type-II differentiated by different ATPase stains. Right: Table showing the structural, physiological and biochemical characteristics of different type muscle fibres.

There is a paucity of work on the contractile or electrophysiological properties of levator ani muscles. Thus, although the fundamental principles of skeletal muscle contraction may be carried over to understand levator ani muscle function it should be remembered that the muscle fibre type differences, outlined above, will impact on aspects such contractile speed and sustainability. In vitro experiments with dog and sheep samples show fused, maintained and repeatable tetanic contractions at 20 Hz stimulation [350] and not different from other type-IIA muscles. In rat tissue resting and action potential characteristics [354] are also similar to those in other slow muscle types [355]. However, the muscle mechanics, biomechanical and electrophysiological properties of these muscles have not been systematically characterised. Therefore, the

factors that influence excitation-contraction coupling and how they may change in pathological conditions cannot be properly evaluated.

In the absence of much direct physiological characterisation of the contractile properties of levator ani muscles, anatomical studies of human cadaveric specimens give some pointers. Comparative measurement of pubococcygeus, illeococcygeus and coccygeus of: muscle fibre length; sarcomere length; and cross-sectional area of muscle within a muscle bundle after correction for collagen content have been made [356,357]. Data were interpreted as muscles with longer fibre length had a greater overall length of shortening, sarcomere length would indicate where on the length-tension curve the muscle was placed at

rest, muscle cross-sectional area an estimate of contractile strength. Fibre length was greatest in pubococcygeus and least in coccygeus, whereas sarcomere length and cross-sectional area were similar. The greater length of pubococcygeus fibres was interpreted as an ability of this muscle to contract despite large changes of abdominal pressure. Surprisingly the sarcomere lengths were very short (about 2 μm) compared to those of other skeletal muscles such as latissimus dorsi (mixed type-I/II [358,359]) or psoas (predominantly type-IIA fibres) muscle [360,361] and implies that the ability of the muscle to contract would not be impaired by considerable lengthening. Estimates of absolute tension developed by these muscles was however, small compared to those above and alone they could not contract sufficiently to offer pelvic floor support with substantial changes of abdominal pressure.

1.2. Innervation of Levator Ani Muscles in Females and Males

In the females of humans, cats, dogs, monkeys and rats the muscles of the levator ani are innervated by the nerve of the same name (LA nerve) that emerges from S3-S5 segments: there is no evidence of a significant contribution from the pudendal nerve [362,363]. The course of the nerve is differs between subjects; in slightly less than half of dissected cadavers the nerve to the levator ani had an external position along the inferior surface of the LA muscle after passing through the coccygeus muscle. In the remainder, the nerve passed over the superior surfaces of the coccygeus and iliococcygeus muscles [364]. It is important to appreciate the course of the LA nerve and its variability to: reduce damage during surgical procedures; to appreciate that the LA and pudendal nerves at the ischial spine are only about 0.5 cm from each other [365], so that pudendal nerve block would probably impact on the LA nerve as well. Also it is important to understand that damage to the nerve in childbirth may predispose to a greater incidence of later pelvic organ prolapse (POP), due to the significant relationships between levels of levator ani damage, parity and POP [366,367]; although a small study of bilateral denervation of the levator ani in squirrel monkeys did not increase POP [368].

Large and small diameter motor neurones are present in the LA nerve that may correspond to α -motor neurones and γ -fibres that innervate muscle spindles that are observed in the levator ani [363,369]. This presumes that monosynaptic stretch reflexes can be evoked in these muscles. Motor neurones processes also project to terminations of muscle spindle and Golgi tendon organs afferents [370], but also to Onuf's nucleus and imply a coordination levator ani and urethral rhabdosphincter musculature. As with motor neurones two populations of afferent nerves are identified, the larger ones possibly conveying proprioceptive information, whilst the smaller ones convey nociceptive sensations.

Reflex control of pelvic floor musculature during micturition is poorly studied. In female rabbits the PC muscle is active during filling, whilst it is quiet during micturition [371]. In a study with male rats PC EMG activity increased during micturition [372]. It is noteworthy that the rabbit, as in humans, exhibits a complete inhibition of sphincter activity during micturition, whilst in the rat there are high frequency increases of sphincter activity that gives a more dyssynergic voiding pattern. However, it highlights the potential difficulty to inter-species comparisons and also that pubococcygeus and iliococcygeus muscles have other functions also, such as controlling tail activity and influencing effectiveness of copulation in rats [373].

Less work is available in males. The pubococcygeus muscle in male rats is innervated by the somato-motor branch of the pelvic nerve that carries both sensory and motor nerves and with motor neurone cell bodies in the lumbrosacral boundary [372,373]. Micturition and raised bladder pressure were associated with an increase of, and possibly activated, pubococcygeus activity. Muscle activity produced reflex inhibition of detrusor function so that voiding was intermittent and oscillations of bladder pressure were superimposed on the raised baseline. The muscle is also attached to the urethral rhabdosphincter thus exerting a control over sphincter competence.

2. ANDROGENS AND 'LEVATOR ANI' FUNCTION.

The contractile properties of levator ani/ bulbospongiosum muscles are susceptible to exposure to androgens. This is of interest to investigate potential steroid hormone-muscle interactions and neuromuscular development, as well as gain insight into the potential side-effects on pelvic floor function of androgen therapy for other conditions. Castration of male rats had no effect on muscle action potentials; however, there was a loss of total muscle weight and prolongation of contraction time indicating a change to contractile machinery [354]. Moreover, castration is associated with a loss of muscle nicotinic receptors and acetylcholinesterase activity, reversed by testosterone treatment [374,375]. Transmitter release from motoneurones to levator ani muscles is regulated by Ca^{2+} influx at the nerve terminal via P/Q-type ($\text{Ca}_v2.1$) as well as N-type ($\text{Ca}_v2.2$) Ca^{2+} channels. Castration induced functional loss of $\text{Ca}_v2.2$ ameliorated by testosterone treatment [376]. However, the frequency and amplitude of miniature-end-plate potentials, representing random transmitter release from the motor synapse are increased by castration and reversed by testosterone administration [375,377]. Thus androgens could act to prevent quantal losses of transmitter during an absence of motor nerve depolarisation, so that with large Ca^{2+} influxes through $\text{Ca}_v2.2$ channels on arrival of the action potential transmitter release is maintained [376].

Androgens, but not estrogens, also affect levator ani function immediately post partum. Innervation of individual motor units changes from a polyneuronal to a mononeuronal phenotype so that motor unit size and innervation reduces to an adult model, a process that is attenuated by androgens [378,379]. Androgen receptors are located on the muscle, motor nerves as well as spinal cord motor nuclei, although the cellular pathways for regulating developmental synapse elimination are unclear [378-381]. How this may relate to reversing the effects of denervation of the pelvic floor during trauma should be investigated.

3. THE EXTERNAL URETHRAL RHABDOSPHINCTER

The skeletal muscle surrounding the urethra forms an incomplete ring in the middle to caudal third of the urethra [382,383]. The muscle is thicker on the ventral and lateral sides of the urethra and on the dorsal surface insert on to the vagina or perineal body, in women or men. It better defined in men, although in both there is a graded transition between smooth and skeletal muscle making a distinctive boundary not easy to identify. In men extension of the male urethral rhabdosphincter covers the distal part of the prostatic capsule by the prostatic apex [384] and here skeletal and smooth muscle fibres intermingle. Various names have been coined for this physiological entity ranging from the external urethral sphincter, rhabdosphincter and urethral striated sphincter. For consistency with the previous consultation it will be referred to here as the urethral rhabdosphincter.

A detailed description of the efferent and afferent innervation of the urethral rhabdosphincter was described in the previous consultation [341] and amplified in a review [363]. The same review also considered in detail the supraspinal control of the urethral rhabdosphincter, including the neurochemistry of the motor neurones in Onuf's nucleus. This report will concentrate more on the physiology and pathophysiology of the skeletal muscle fibres that comprise the urethral rhabdosphincter.

3.1. Muscle Fibre Types of the External Urethral Rhabdosphincter

The muscles fibres are unusual in that they do not attach directly to a skeletal structure so that there is little active shortening on excitation. However, there is attachment to the levator ani muscles that will provide some rigid support as discussed above. The relationship between the urethral rhabdosphincter and other structures in the pelvic floor demonstrates differences between men and women [344]. In females, the striated muscles are embedded in a matrix with many elastic fibrils [385] and is continuous with a perineal membrane to allow connection with the pelvic ischia. In males this attachment to the levator ani is provided by a fairly rigid fascia that contains many smooth muscle cells.

The fibre type of the urethral rhabdosphincter has been determined in human and several animal species. With rabbit, dog and guinea-pig tissue there is a preponderance of fast twitch fibres [386-389]. With one of these studies using canine tissue the fast twitch subset represented about 65% of the total, of which in turn about 80% were type-2B, white, fatigable fibres [386]. This has led to the proposal that the type-I fibres maintain continence at rest, whilst type-II fibres are further recruited when greater resistance is needed to overcome increases of abdominal pressure, as in sneezing or coughing. Most studies used male animals but in the one using males and female animals [387] no differences were seen. With human tissue from males and females slow twitch fibres predominate [390], although in the extension of the urethral rhabdosphincter covering the prostatic capsule and mixed fibre type is recorded similar to that in animal tissues [391].

Electron microscopy demonstrates typical striated muscle sarcomeres with variation of mitochondrial number indicative of oxidative or glycolytic muscle fibres [384]. Classical motor endplates were present with a 40-80 nm neuromuscular cleft. Of interest, less specialised nerve-muscle junctions were also observed, suggestive of autonomic endings with a 50-120 nm neuromuscular cleft, contact slow and fast muscle fibres. From the appearance of vesicles in the nerve endings these were identified as cholinergic, adrenergic or peptidergic endings. However, the concept of a dual somatic and autonomic innervation of the canine prostate was later questioned from anatomical studies that suggested that autonomic nerves merely passed through the skeletal muscle enroute to the urethral smooth muscle [392]. Overall the data are consistent with the urethral rhabdosphincter receiving a motor innervation from the pudendal nerve [382,383], that emerges at S2-4 and runs along the internal obturator and coccygeus muscles and through the pudendal (Alcock's) canal formed from obturator fascia. The lack of muscle spindles, small unmyelinated (γ -afferents) and Golgi tendon organs, is also a feature of urethral rhabdosphincter [391,393], and implies that there are few spinal reflexes that optimise muscle function.

3.2. Electromechanical Properties of External Urethral Rhabdosphincter Muscle

Measurement of electrical activity of the urethral rhabdosphincter with extracellular electrodes is a valuable tool for evaluating normal and abnormal function of the external urethra [394,395]. However, there is very little information about the electrophysiological or contractile properties of urethral rhabdosphincter muscle to help interpret clinical extracellular recording. Isolated canine circular strips of membranous urethra responded to stimuli designed to excite embedded nerves [392]. At low frequencies (5 Hz) twitch contractions were generated and at 20 Hz fused tetanic contractions developed. Twitch rise-time (about

50 ms) was slow for a skeletal muscle contraction, indicative of slow twitch fibres. Responses were unaffected by atropine or phentolamine, consistent with somatic nerve stimulation. With guinea-pig preparations twitch characteristics (twitch duration, twitch-tetanus ratio) were similar to those from a fast twitch muscle such as *externum digitorum longus* (EDL) rather than the slow twitch soleus muscle. No equivalent investigations have been made in human samples. A human urethral rhabdosphincter cell culture model was generated that retained a skeletal cell phenotype; some cells developed spontaneous contractions and more in the presence of acetylcholine [396]. It has not been ascertained if they represent a model of differentiated urethral rhabdosphincter myocytes. Their use as a cell replacement therapy for sphincter incompetence or stress urinary incontinence can add to the range of other cell types for this purpose, including muscle-derived and adipose-derived stem cells [397-399].

Ionic currents have been recorded from human and pig myoblasts after four days of culture. Cells were prepared from biopsies of urethral rhabdosphincter, as well as pig adductor muscles as a comparator [400]. Recording micropipettes contained CsCl, to block outward (K^+) current leaving inward currents for analysis. Inward Na^+ current was measured in both types of pig muscle cells and was of a magnitude that would support an action potential. In pig myocytes an inward Ca^{2+} (in fact a Ba^{2+} current, as Ba^{2+} travel through Ca^{2+} channels) was also recorded with the characteristics of flux through an L-type Ca^{2+} channel. Of interest, with human cells the Ba^{2+} current had characteristics of flux through an L-type and also a T-type channel. The significance of a T-type Ca^{2+} channel in urethral rhabdosphincter skeletal muscle is not known but have been proposed to aid the formation of myotubes [401]. However, because T-type channels are activated at membrane potentials near the resting value they have been proposed to enhance the ability of an excitable cell to generate an action potential.

3.3. Electromyography (EMG) and the External Urethral Rhabdosphincter.

The electromyogram is an extracellular recording and as such gives no information about the electrical properties of individual skeletal muscle cells. Rather, it is a measure of total electrical activity of the muscle fibres and allows the investigator to determine if the muscle mass is electrically active or not. The magnitude of the EMG is a function of the number of muscle fibres contributing electrical signals, but *per se* does not inform about the magnitude of the muscular contraction. Concentric needle EMG recording [402] is generally undertaken and allows measurement of several descriptors of the signals, including amplitude, duration, area, mean firing frequency that may be compared in normal and pathological conditions. In some circumstances single fibre EMG recordings [403,404] are possible to record electrical signals from a single muscle fibre, or a few muscle often from

the same motor unit, that allows more detailed examination of the gross electrical properties of the muscle fibre or the excitability of the motor unit. The pattern of EMG during the micturition cycle can be very different in humans and animals which in part can reflect the various purposes of voiding, such as to completely empty the bladder or intermittent voiding for marking territory. Thus, in humans, during filling a guarding reflex ensures increased EMG activity in humans, decreasing during voiding, whilst in rats there are characteristic bursts of EMG discharge during voiding [405-407]. Bladder outflow obstruction from detrusor-sphincter dyssynergia is associated with increased EMG activity during voiding [408] and could be alleviated by injection of the botulinum toxin into the sphincter [409]. A recent Cochrane review gave a guarded response indicating some improvements of urodynamic parameters with a single injection of botulinum toxin-A [410].

EMG recordings of complex repetitive discharges (myotonia-like activity) have been made from the urethral rhabdosphincter of pre-menopausal women with urinary retention (Fowler's syndrome, [411,412]). This enhanced discharge is reflective of greater contractile activation of the skeletal muscle to generate an increased urethral resistance. The aetiology of the condition is not known but it was reported to be associated in some patients with the presence of polycystic ovaries and more recently it was noted that asymptomatic women with such an EMG activity were in the luteal phase of the menstrual cycle [413] when progesterone levels are highest. Muscle biopsies of women in retention did not show hyperplasia or hypertrophy [414] suggesting that an increase of muscle mass did not account for the larger EMG signal. The authors of the original papers [411,412] tentatively proposed that great EMG may be due to ephaptic transmission of electrical signals between muscle cells so produce large and repetitive responses. However, despite there being no experimental evidence of this unusual phenomenon the idea has gained some traction.

Ephaptic transmission is the direct electrical coupling of excitable cells without synaptic transmission (as in nerves) or through low resistance intercellular junction (as in myocardium). It usually occurs in conditions when the extracellular resistance is high so that local electrical fields in one cell generate a change of membrane potential in another. This is generally in unphysiological conditions but can occur between nerve axons [415,416] and the electrical conditions under which it occurs have been summarised [417]. It has been suggested that abnormal ion channel activity, in particular the Cl^- channel $ClC-1$, in skeletal muscle fibres might modulate muscle fibre excitability and create the appropriate conditions for myotonia [418,419]. Progesterone reduces Cl^- currents through a non-genomic pathway in isolated muscle fibres [420], but it remains to be shown how such channel modulation influences muscle activity.

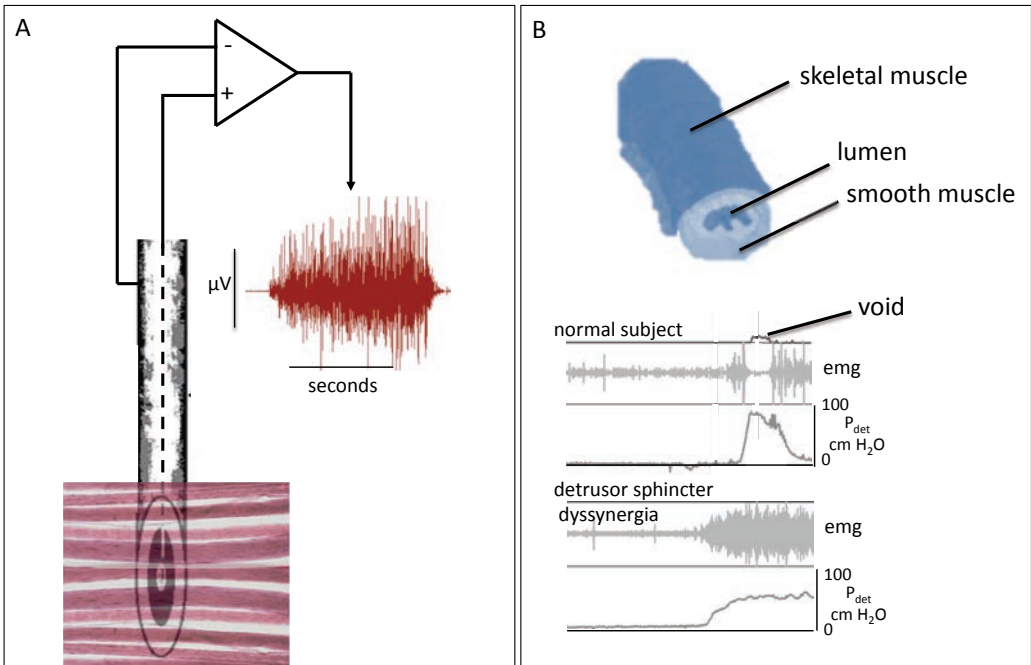

Figure 22. Electromyography (emg) and the external urethral sphincter. *A: the diagram shows a concentric needle electrode with a central electrode shielded from a reference casing electrode. Signals from the two electrodes pass to a differential amplifier and the output is a record of extracellular signals generated by action potentials in adjacent muscle cells. The superimposition on the end of the electrode shows the disposition of muscle fibres from which recordings may be made. B: A diagram of the urethra at the level of the external urethral sphincter to show an outer layer of skeletal muscle from which needle electrode recordings of emg activity may be made. Below is a schematic of an emg recorded from a normal subject and one with detrusor sphincter dyssynergia (DSD). Tracings of subtracted detrusor pressure, P_{det} , are also shown. In the normal subject there is an increase of emg activity at the beginning of contraction (guarding reflex) followed by a period of quiescence to allow voiding. In the DSD patient emg activity is present through out and no voiding here is observed.*

3.4. Ageing, Lower Urinary Tract Pathology & the External Urethral Rhabdosphincter

Because of the central role of the urethral rhabdosphincter in continence there is interest in changes that occur to its structure and function with ageing and also its relation to urinary incontinence, especially stress incontinence. There is considerable evidence that in humans and in animals there is a reduction of muscle mass with age. Dissection of female cadavers showed there is a linear reduction of the volume of tissue occupied by skeletal muscle fibres as well as the total number of cells [421-423]. In one study the volume occupied by muscle fibres ranged from nearly 90% in a neonate to less than 35% at age 90 [423]. Moreover, the loss was uniform along the length of the urethral rhabdosphincter [424]. Transurethral sonography showed an age-dependent decline of muscle thickness with age, as well as a negative correlation between urethral closure pressure and age [425]. A change of fibre-type has also been reported in rabbits with a decline of fast (type-II) fibres declines at the expense of slow (type-I) fibres [426].

Compared to women with normal continence, reduction of urethral rhabdosphincter function is associated with stress incontinence, but not urge incontinence [427]. A decrease of urethral rhabdosphincter volume is also associated with stress incontinence and well as overall poorer pelvic floor function [428]. Transurethral sonography has also revealed defects to the urethral rhabdosphincter in women with stress incontinence that included reduced contractile function, scarring of the tissue, as well as overall thinning [429]. In men, damage to the urethral rhabdosphincter is also associated with incontinence following prostatectomy [430]. Reduction of the membranous urethra length, and an increase of fibrosis were associated with greater incontinence and a longer post-operative recovery time [431].

VII. INTEGRATED PHYSIOLOGY OF THE URINARY TRACT - NEW THERAPEUTIC APPROACHES AND CONCEPTS

1. RELAXIN: TREATMENTS FOR RADIATION CYSTITIS AND THE UNDERACTIVE BLADDER

Relaxin is a 6-kDa hormone, first described in 1926 [432], that is produced mainly by the ovarian corpus luteum to relax the uterus and soften the pubic symphysis during pregnancy [433]. In addition, it is produced in the prostate and testes to enhance sperm motility [434]. It belongs to the insulin superfamily, with seven members exhibiting high structural but low sequence homology; relaxin-1 to -3 and insulin-like peptide-3 to -6 [435]. It is formed as a three-chain pro-hormone, cleaving off one of the chains to form

the active heterodimer with 24 and 29 amino acids linked by disulphide bridges. Relaxin receptors are 7-transmembrane G-protein coupled receptors that activate adenylate cyclase. There are four receptors for relaxins (RXFP1-4), with RXFP1 being the most studied in humans and rodents and for which relaxin-2 has the highest affinity. These receptors have a broad distribution [432]; including smooth muscle, connective tissue, the nervous system, heart and as described here the urinary bladder.

Canonical Wnt signaling is believed to stimulate members of the frizzled receptor family to initiate the translocation of β -catenin from the cell membrane to the nucleus to initiate collagen deposition, remodeling and fibrosis [436]. This can be opposed by relaxin-2 binding to one of its four receptors. Relaxin-2 binding increases PKA which inhibits β -catenin. Furthermore, it can also stimulate pathway leadings to gene transcription and increased expression of extracellular matrix (ECM) metalloproteinases [437], augmentation of voltage-gated Ca^{2+} channel current [438], along with decreased collagen synthesis [439]

(Figure 23).

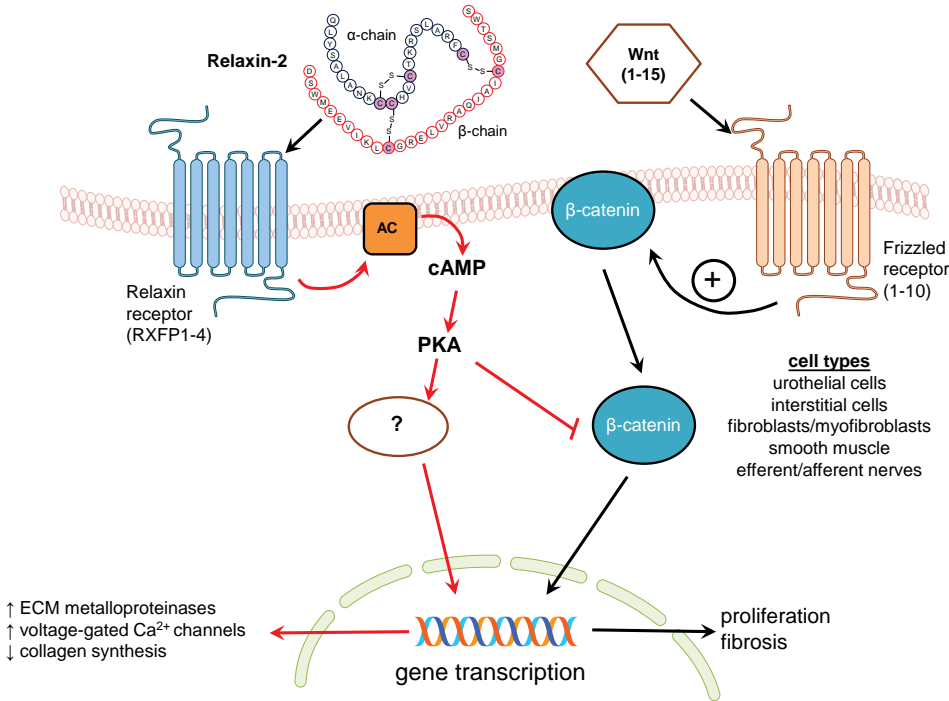

Figure 23. Pathways for relaxin and Wnt signalling regulating bladder wall fibrosis. Activation of the relaxin receptor pathway can increase extracellular matrix (ECM) metalloproteinase expression, to decrease collagen synthesis and elicit an anti-fibrotic effect, as well as increase expression of voltage gated Ca^{2+} channel proteins in muscle cells. Wnt protein, acting through frizzled receptors, activates β -catenin to allow its translocation to the nucleus where it acts as a transcription factor. β -catenin may regulate gene expression that leads to proliferation of fibroblasts, collagen deposition and increased tissue fibrosis. Protein kinase-A (PKA) activation via the relaxin receptor may prevent β -catenin activity, but this interaction has yet to be described in the bladder.

1.1. Radiation Cystitis

This condition can result from irradiation therapy of pelvic organ tumors in men and women that are estimated to account for 36% and 18%, respectively, of new malignancies diagnosed in the United States in 2016 according to the American Cancer Society [440]. While irradiation is a key therapy for treating these malignancies, the radiation dose is limited by the potential for developing radiation cystitis. Accordingly, irradiation therapy is typically fractionated into daily 0.5-2 Gray (1 Gy = 100 Rads) increments until the desired dose is achieved (e.g., 20-60 Gy) [441].

The acute symptoms of radiation cystitis can occur within days and include bladder inflammation, urgency, frequency, dysuria and incontinence [442]. Initiation factors are disruption of the urothelial cell permeability barrier and sensitization of afferent nerves [443]. In addition to DNA damage, irradiation induces Ca^{2+} influx and intracellular release in urothelial cells

that activates nitric oxide synthases. Nitric oxide (NO^{\bullet}), in turn, binds to cytochrome oxidase which can inhibit the mitochondrial respiratory chain. This results in the production of superoxide ($\bullet\text{O}_2^-$) which reacts with NO^{\bullet} to form peroxynitrite (ONO_2^-) which further inhibits respiration and damages proteins, leading to swelling and rupture of the mitochondria, cytochrome c release and urothelial cell apoptosis [444]. The leading candidates responsible for this Ca^{2+} influx are transient receptor potential ankyrin-1 and vanilloid-1 (TRPA_1 and TRPV_1) channels that are highly expressed in urothelial cells [445,446]. TRPA_1 is activated by acrolein, a by-product of fatty acid lipid peroxidation generated in cells by ionising irradiation [447]. Activation of TRPA_1 by acrolein in urothelial cells (and TRPV_1 by capsaicin) results in chemical cystitis with symptomology similar to radiation cystitis [448], as shown in schematic form in (figure 24).

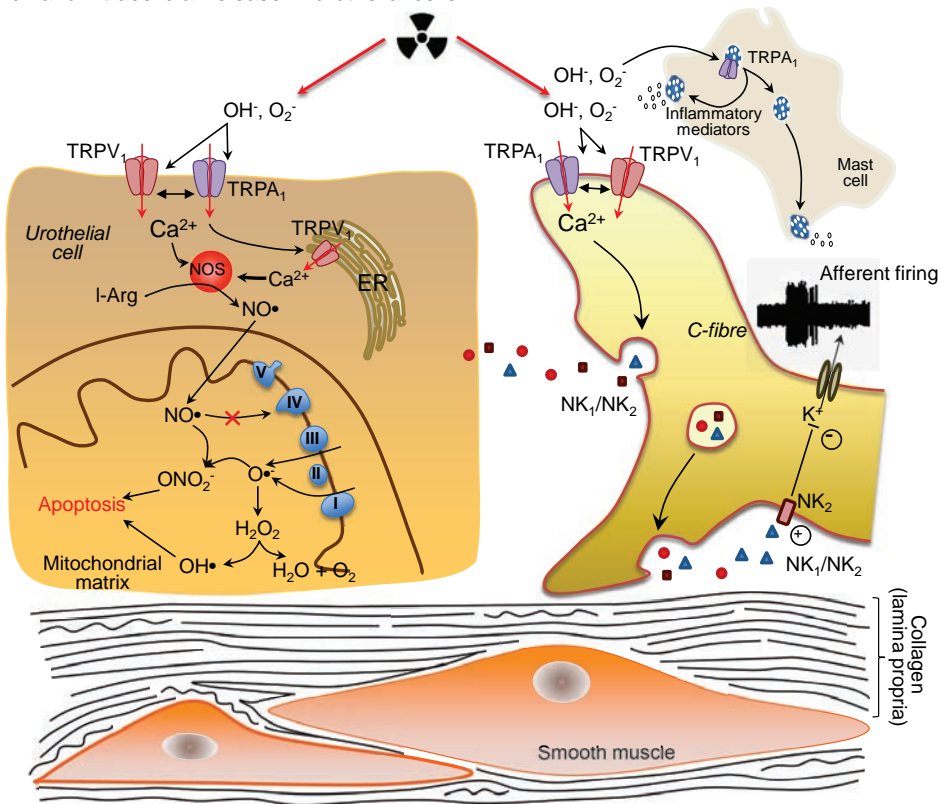

Figure 24. Mechanisms for development of acute and chronic radiation cystitis following exposure to ionizing irradiation. Top left: Urothelial cells are one of the most susceptible to irradiation damage. Oxidative by-products activate TRPA_1 and TRPV_1 channels to cause a sustained intracellular Ca^{2+} rise, activation of nitric oxide synthase (NOS), inhibition of the mitochondrial respiratory chain and, as a consequence, generation of nitrogen and oxygen free radicals from L-arginine (I-Arg). This sequence of events leads to the initiation of apoptotic pathways, disruption of the urothelial barrier and further inflammation in the bladder wall. Top right: TRPA_1/V_1 channels are present on sensory neurons innervating the bladder and these, on activation, cause neuropeptide release and afferent sensitisation, as observed acutely in radiation cystitis. Mast cell TRPA_1 channel activation also induces degranulation and release of inflammatory mediators. Bottom: Self-perpetuating inflammation initiated by ionising irradiation leads to collagen deposition throughout the lamina propria and between muscle cells in the detrusor layer.

Moreover, these channels are highly expressed in mast cells and in sensory nerves innervating the bladder, colon and other pelvic organs, and suggests that irradiation may sensitise afferent nerves. The most radiosensitive cells in the body include lymphocytes and hematopoietic cells of the immune system, the capillary endothelial cells of the gastrointestinal (GI) tract and the urothelial cells of the urinary bladder [444]. Therefore, whole body irradiation >10 Gy can induce considerable morbidities due to a breakdown of the GI tract and urinary bladder barriers in the presence of a compromised immune response.

Chronic radiation cystitis can develop within 6-12 months, with its prevalence reaching ~7% [442]. The consequences include vascular endothelial cell damage, ischemia, collagen deposition and decreased bladder compliance. The main presenting feature for the chronic phase is haematuria which can range from mild to life-threatening and may include urinary retention, secondary to clots obstructing the urethra. It can also greatly reduce bladder compliance and bladder contractile function, due to collagen deposition [442]. Therapy includes transurethral catheterisation with bladder washout and irrigation, laser fulguration, electrocoagulation, pentosan polysulphate and hyperbaric oxygen therapy [449]. These approaches are invasive or time-consuming and often fail to demonstrate optimal efficacy and do not improve bladder compliance for which a new potential treatment is relaxin therapy. Relaxin has undergone phase I clinical trials for treating acute heart failure and scleroderma, validating its safety for use in humans.

A mouse model has been developed to mimic chronic radiation cystitis, whereby a laparotomy is performed so that the bladder may be briefly withdrawn for selective high dose (10 Gy) irradiation (Figure 25A – AJ Kanai unpublished). Delivered to the intact pelvic region such a dose could be lethal ($LD50 \cong 8$ Gy). Nine weeks after selective bladder irradiation animals were unable to void and exhibited overflow incontinence, despite a decrease of intercontraction interval. Figure 25B shows cystometry (red traces) of control animals (upper panel) and irradiated mice (middle panels). The inability of irradiated bladders to empty normally is associated with decreased compliance due to chronic fibrosis (see also Figure 26, below). The corresponding external urethral sphincter (EUS) electromyogram (green traces) shows in normal animals an increase of activity (a guarding reflex) at the initiation of contraction, but then 'bursting' activity that allows voiding – this pattern is characteristic of these rodents. The period around bladder contraction is shown on an extended time-base to the right of each panel. EMG activity in the irradiated animals showed a loss of the guarding reflex and a maintained guarding reflex activity later in the bladder contraction, rather than the bursting activity. However, relaxin administration for two weeks starting at week-7 post-irradiation (400 µg/kg/day infused subcutaneously with implantable ALZET mini-pumps), the cystometrygrams and electromyograms (Figure 25B, lower panel) were similar to those seen in non-irradiated mice, with the return of a normal guarding reflex and bursting activity which permitted voiding. It is important to note that while human and rodent sphincters exhibit a guarding reflex as bladder pressures approach threshold, the sphincter in humans completely relaxes during detrusor contraction.

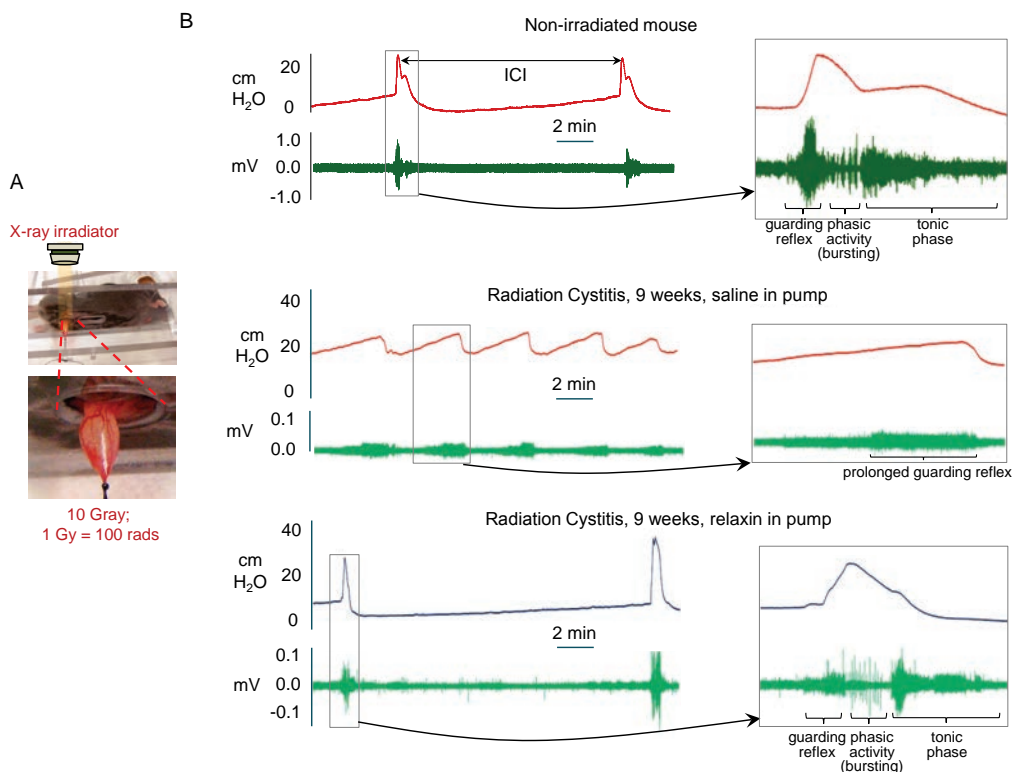

Figure 25. Cystometry and electromyography (EMG) of the external urethral sphincter in irradiated mice with and without relaxin treatment. A. Selective bladder irradiation model. B: Cystometry (upper traces) and EMG (lower traces) in control mice (upper panels), nine weeks following bladder irradiation (middle panels) and nine weeks after irradiation and relaxin treatment (lower panels). An expansion of the time-base is shown in the panels on the right side to show more clearly the EMG activity during the voiding contraction.

In vitro studies of detrusor muscle samples from irradiated mouse bladders with and without relaxin treatment showed large effects on passive and active isometric tension over a range of resting lengths. An increase of passive stiffness with irradiation was reversed by relaxin (Figure 26A). Moreover the reduction of active force after irradiation was reversed by relaxin treatment to the extent that force exceeded that measured in control animals. This additional recovery was observed not only in nerve-mediated (electrical field-stimulated, EFS) contractions but also with the α muscarinic receptor agonist, oxotremorine-M (Figure 26B). Recovery was also observed with contractions elicited by muscle depolarisation, with

high-K solution, or purinergic receptor activation, with α, β methylene-ATP (ABMA), but in these cases recovery was to the control level. Therefore the recovery of function with relaxin is greater for cholinergic pathways compared to other routes of contractile activation. These beneficial effects of relaxin were mirrored by a reduction of the collagen:tissue ratio (Figure 26C) and an increased expression of α_1 subunit protein of the L-type Ca^{2+} ($\text{CaV}_{1,2}$) channel (Figure 26D). This is the first use of relaxin to treat bladder dysfunction due to irradiation damage and thus represents a potentially effective treatment for radiation cystitis.

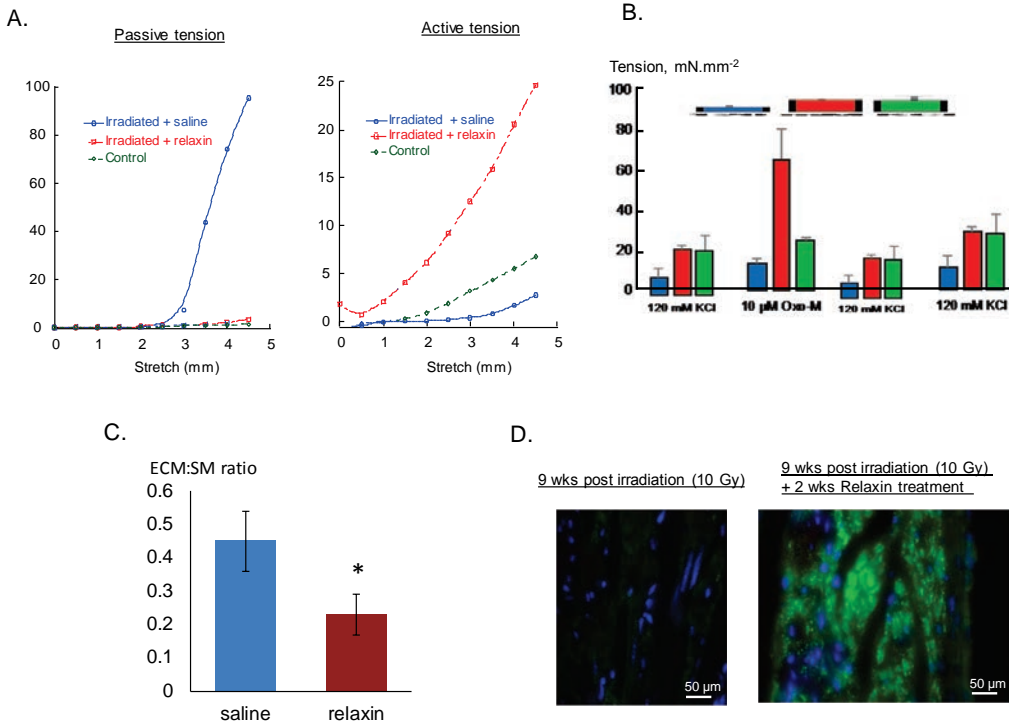

Figure 26. Relaxin treatment for chronic stage radiation cystitis: detrusor contractility and bladder fibrosis in mouse bladders. A: Length-tension curves for passive and active tension from irradiated (9-weeks post exposure) mouse bladders with and without relaxin treatment in comparison to control tissue. B: Contractile responses of isolated detrusor preparations to electrical field stimulation (EFS), the muscarinic receptor agonist oxotremorine-M, the P2X agonist α,β methylene-ATP (ABMA) and depolarisation with 120 mM KCl. Data are shown for irradiated mice - with or without relaxin treatment - as well as a control group (non-irradiated) C: The extracellular matrix (ECM):smooth muscle (SM) ratio of detrusor from irradiated bladders, with saline or relaxin treatment. Mean data \pm SD, * p <0.05. D: Immunohistochemistry of Cav1.2 labelling (green fluorescence, blue; DAPI nuclear stain) in the detrusor from irradiated bladders, with (right) or without (left) relaxin treatment. (Figure with the courtesy of Youko Ikeda and Anthony Kanai).

1.2. Underactive Bladder (UAB) Syndrome and Relaxin Therapy

In addition to radiation cystitis, collagen deposition and decreased bladder compliance can occur with ageing leading to bladder underactivity/UAB syndrome. A majority of the elderly may initially exhibit bladder overactivity/overactive bladder (OAB) syndrome who may be managed by current therapies. However, over time, overactivity may likely revert to underactivity for which there are currently no effective therapeutic agents.

Bladder underactivity, according to the International Continence Society, is a contraction of reduced strength and/or duration, resulting in prolonged voiding and/or failure to achieve complete bladder emptying within a normal time span based on a urodynamic diagnosis. On the other hand, UAB syndrome covers a general condition irrespective of whether the cause is afferent dysfunction, lack of CNS control, or myopathy of the detrusor itself [450,451]. There are several animal models for studying bladder underactivity/UAB [452], including: type I and II diabetic mice

and rats; partial bladder outlet obstruction (pBOO) and bladder overdistension; ischaemia/reperfusion and oxidative stress (due to H_2O_2 instillation); pelvic nerve cut and crush; and ageing typically using 18-24 month old rats. Whilst ageing is perhaps the most physiologically relevant of these models, it is also one of the most difficult to study because of survival, variability and cost issues. Accordingly, in the United States, rats for these studies are typically obtained by qualified investigators through the National Institute on Aging (NIA) of the National Institutes of Health.

In studies using NIA rats, 24 month-old aged animals exhibited a substantial increase of passive tension at a range of lengths over that measured in 9 month-old adults. Active tension was comparable between the two age groups. However, after two weeks of treatment with relaxin (400 μ g/kg/day infused subcutaneously), there was a significant reduction of passive tension (stiffness) in the aged animals and increase of active force increase in both compliance and force generation to a value greater than that in younger animals. These observations are similar to those seen

with irradiated animals and relaxin treatment. However, in this case relaxin treatment did not improve force mediated by cholinergic, purinergic or depolarising pathways (data not shown) but did decrease the collagen:smooth muscle ratio in aged animals. Thus, with aged animals the decrease of collagen content was solely responsible for recovery of muscle performance with relaxin. However, although there was no evidence for upregulation of cellular pathways for force generation by relaxin in aged animals the immunohistochemical expression of the L-type Ca^{2+} channel $\alpha 1\text{C}$ subunit, $\text{CaV}1.2$, in detrusor smooth muscle was changed from a patchy to a more homogeneous pattern after relaxin treatment of aged animals. This also suggests the potential value of relaxin to increase bladder performance due to ageing especially in those with bladder underactivity/UAB syndrome.

2. LM11A-31—SELECTIVE BLOCKADE OF P75 NEUROTROPHIN RECEPTORS.

2.1. Prevention Urothelial Loss, Spinal Cord Atrophy and Detrusor-sphincter-dyssynergia Following Spinal Cord Injury

p75 is a neurotrophin receptor (p75^{NTR}) and a member of the tumor necrosis factor receptor superfamily. Its intrinsic catalytic activity is very low, but partnering with other neurotrophin (TrkA, TrkB and TrkC) and non-neurotrophin receptors (sortilin and Nogo) they produce high-affinity binding sites for neurotrophins and their precursors [453]. When complexed with Trk receptors, p75^{NTR} promotes survival and differentiation increasing the affinity to mature neurotrophins. However, when linked with sortilin, the complex binds pro-neurotrophins activating apoptotic pathways promoting cell death (Figure 27, [454]).

Neurotrophins are a family of proteins, including nerve growth factor (NGF), brain-derived neurotrophic factor (BDNF) and neurotrophins 3 and 4,

which promote neuronal survival and differentiation, modulate synaptic plasticity and play important roles in both developing and mature nervous systems [455]. They are initially synthesized as precursors or pro-neurotrophins consisting of two domains (N-terminal pro- and C-terminal mature) which can be cleaved by intracellular proteases to generate functional forms. They can also be released from cells intact and selectively activate p75^{NTR} at subnanomolar concentrations to induce apoptosis [456].

In the urinary bladder, neurotrophins are released by mast cells, urothelial cells and smooth muscle cells and are believed to contribute to lower urinary tract dysfunctions including overactive bladder and interstitial cystitis/painful bladder syndrome [457-459]. It has been shown that levels of both neurotrophins and their receptors increase dramatically following pathological conditions including spinal cord injury (SCI) [460,461]. This has made neurotrophins a potential therapeutic target for a number of years, but with marginal success possibly due to the indiscriminate inhibition of both the pro (apoptotic) and mature (beneficial) forms by antibodies, antisense approaches or drugs.

Little is known about the time course of the neurotrophin, pro-neurotrophin and their receptor level changes in disease. Investigations using rat urinary bladders revealed increased levels of NGF mRNA in acute (4 days) and chronic (5-6 weeks) SCI, however, the levels of NGF protein were significantly decreased acutely after injury and correlated with mRNA levels only with the reemergence of spinal reflexes [462]. A few studies suggest that pro-neurotrophins may be produced shortly after SCI, with a time course from several hours to 14 days, with a peak around 3 days [463,464]. P75^{NTR} is also upregulated in SCI, unlike Trk receptors that are poorly expressed [464]. Both NGF and p75^{NTR} are decreased nine weeks after induction of diabetes in streptozocin rat bladders [461].

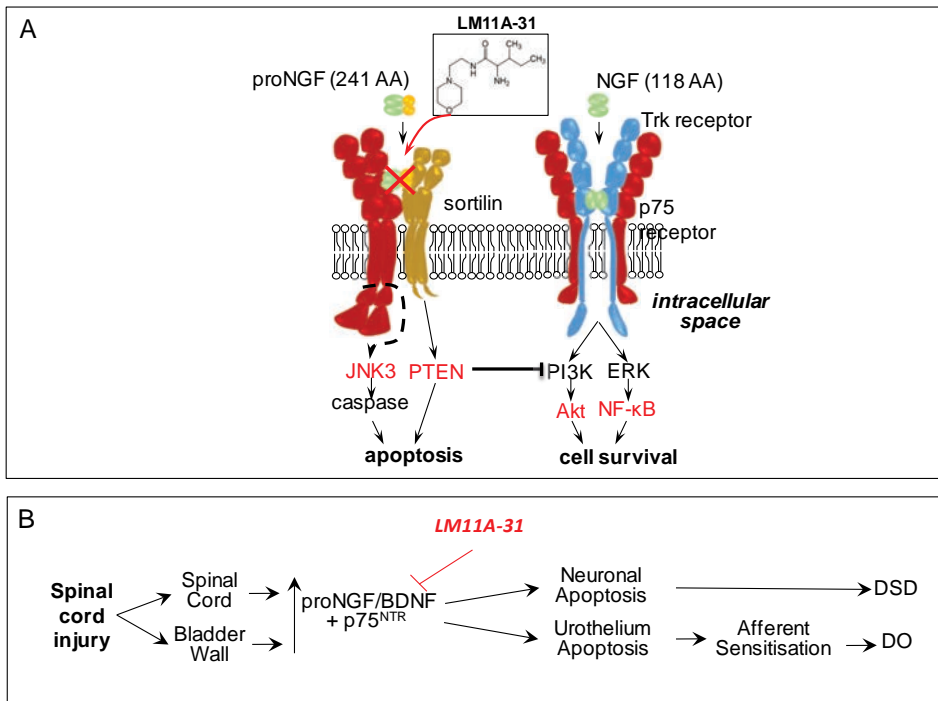

Figure 27. Schematic of p75^{NTR} signaling pathways and their involvement in bladder dysfunction following SCI. A: p75^{NTR} signals through dimerisation with sortilin or TrkA receptors. p75-sortilin complexes preferentially bind proNGF/proBDNF that activate apoptotic signaling cascades. Conversely, p75-TrkA binds to mature neurotrophins to activate cell survival pathways. B: Increased activation of p75^{NTR} by proneurotrophins following SCI causes neuronal and urothelial apoptosis in spinal cord and bladder, respectively, leading to detrusor sphincter dyssynergia (DSD) or detrusor overactivity (DO). LM11A-31 inhibits these pathways. (Figure with the courtesy of Youko Ikeda, Irina Zabbarova and Anthony Kanai)

LM11A-31 is a small molecule first reported in 1985 as an antihypertensive agent by a group at Ciba-Geigy followed by a group at Roche in 1990 for the treatment of infections caused by HIV and other retroviruses [465]. Subsequently, it was demonstrated to interfere with proneurotrophin binding to p75^{NTR}, efficiently crossing the blood-brain barrier and improve motor coordination after spinal cord contusion in mice, partially by increasing myelin sparing [466]. Administered orally, it exhibited no toxicity and did not exacerbate any injury-associated pain. The dose of 100 mg/kg twice daily has been shown to be maximally effective in a variety of endpoints [466].

In separate experiments described here, mice were given 100 mg/kg of LM11A-31 as a single dose daily and the treatment was shown to be significantly beneficial. Although little is known about the metabolism of this drug, only very low plasma concentrations were measured after seven oral doses over three days [466]. Very low oral bioavailability suggests that a significant portion of the drug may be excreted in the urine unchanged, which could result in peripheral effects due to higher drug levels in the bladder.

SCI-induced bladder dysfunction includes two major components, detrusor-sphincter-dyssynergia (DSD) and detrusor overactivity (DO). These are debilitating

problems that carry the risk of complications including urolithiasis, vesicoureteral reflux, hydronephrosis, obstructive uropathy and renal failure. The mainstay treatments are antimuscarinic agents, clean intermittent catheterization and external sphincterotomy which are associated with significant risks of unwanted side effects, infections, haemorrhage and erectile dysfunction. It was proposed that the increase in pro-neurotrophins and activation of p75^{NTR}/sortilin complex in the spinal cord and the bladder following SCI lead to neuronal and urothelial apoptosis that contribute to DO and DSD, respectively (Figure 27B). Therefore, blockade of this pathway should improve bladder function following SCI.

One of the earliest consequences of SCI to the urinary bladder is loss of the urothelial lining which can occur within hours of injury [467]. To determine if proneurotrophins are involved in this process, bladders were isolated from mice, one and ten days after SCI for histological examination, with or without pre-treatment with LM11A-31 (100 mg/kg, one day prior SCI). At day-1 post-SCI there was significant loss of the urothelial layer. At day-10 post-SCI urothelial hyperplasia and detrusor hypertrophy were observed, probably as a consequence of bladder overdistension and outflow tract obstruction (Figure 28A). These

morphological changes were much reduced by pre-treatment with LM11A-31 and daily treatment after injury for the day-10 group. This loss of urothelial integrity at day-1 was confirmed by measurement of transepithelial resistance (TER) using an Ussing chamber system. TER was significantly decreased in bladders of SCI mice day-1 after injury compared to uninjured controls ($700 \pm 200 \Omega \cdot \text{cm}^2$ vs 2500 ± 1000

$\Omega \cdot \text{cm}^2$, respectively, $n \geq 4$). LM11A-31 treatment preserved barrier function in tissue from day-1 post-SCI animals ($2000 \pm 700 \Omega \cdot \text{cm}^2$, $n=4$). This data suggest that proneurotrophins may be involved in urothelial damage and initiating bladder wall remodeling following SCI.

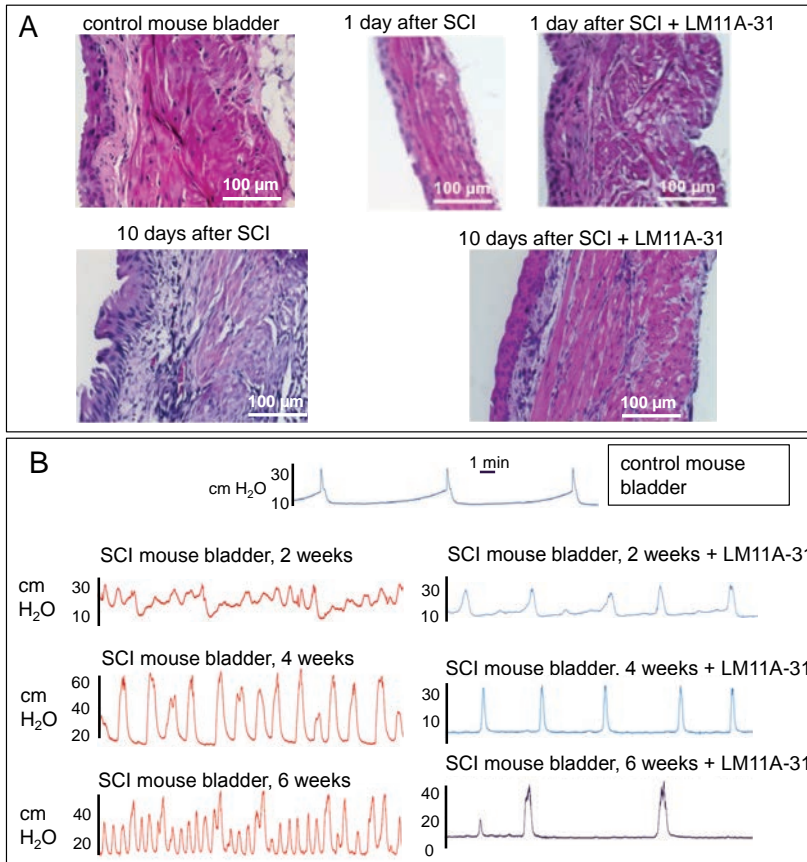

Figure 28. Effect of L11A-31 treatment on bladder wall structure and cystometry after spinal cord injury (SCI). **A:** Effect of L11A-31 on bladder wall structure day-1 and day-10 post-SCI. Haematoxylin and eosin staining. **B:** Cystometry of mouse bladders from 2-week, 4-week and 6-week post-SCI animals with or without treatment with L11A-31. Cystometry from a normal animal is shown above the SCI traces. (Figure with the courtesy of Irina Zabbarova and Anthony Kanai)

SCI in mice causes bladder outlet obstruction due to the loss of supraspinal connections that initiate and coordinate urethral relaxation and detrusor contraction. Following a recovery period, a spino-somato loop develops that initiates reflex bladder contractions in response to perigenital stimulation to help empty the bladder. However, the development of detrusor sphincter dyssynergia (DSD) limits urine expulsion and leads to further retention and damage as in the case of radiation cystitis (see section VII.1, above). Characteristic changes to the external urethral sphincter electromyogram of a loss of guarding response and replacement of later bursting activity with continuous increased activity are similar to that observed with damage through radiation cystitis.

These changes were accompanied by non-voiding contractions and eventually overflow incontinence. Accordingly, cystometric measurements from SCI mice at two, four and six weeks post-injury demonstrated a significant increase in baseline pressure and non-voiding contractions and a decrease of bladder compliance (see Figure 28B, left panels). Daily treatment of mice with LM11A-31 by oral gavage pre-SCI and then post SCI was carried out until cystometry was performed (Figure 28B, right panels). Treated mice exhibited more efficient voiding, longer intercontractile intervals, higher bladder compliance and smaller numbers of non-voiding contractions.

LM11A-31 has also been demonstrated to improve functional recovery following spinal cord contusion by

increasing the number of myelinated axons through preventing oligodendrocyte loss [466]. The effect of LM11A-31 (100 mg/kg/day, starting 1-day prior to SCI) on the spinal cord following T8-T9 transection was examined. There was a significant degree of atrophy at 8-week post SCI. However, the spinal cord of SCI mice treated daily with LM11A-31 (100 mg/kg/day, starting 1-day prior to SCI) had significantly less atrophy and demonstrates a long-term protective effect of p75^{NTR} inhibition in the central nervous system following SCI.

Inhibition of proneurotrophin-p75^{NTR} interaction has been demonstrated to improve functional recovery following spinal cord contusion injury. We have demonstrated that it prevents spinal cord atrophy following transection. This suggests it may prevent neural degeneration centrally to improve motor function as well as reduce DSD which hinders bladder emptying and urine storage. There is also inflammation of the bladder wall following SCI which is believed to arise from a compromised urothelial barrier causing urine infiltration, and does not disappear in chronic patients. Both SCI [468] and inflammation [469] are associated with the increased expression of proneurotrophins and p75^{NTR} in the bladder wall. We have demonstrated that LM11A-31 is effective in maintaining structural integrity of the bladder wall preventing urothelial apoptosis soon after SCI and chronically urothelial proliferation and smooth muscle hypertrophy. This suggests proneurotrophins may be involved in urothelial damage and initiation of bladder wall remodeling following supralumbar SCI.

2.2. Urothelial Cell-afferent Nerve Bidirectional Communication: Feedback Modulation of Bladder Sensory Functions

The urothelial lining of the bladder not only acts as a barrier but has been demonstrated to have a sensory function to detect alterations within the lumen that can be relayed to innervating afferent neurons. Urothelial cells can respond to mechanical distention, as well as changes to osmolality and pH and release a number of signaling molecules including ATP, acetylcholine, NO and prostaglandins [470]. It is believed that the primary role of urothelially-released factors is to act upon sensory neurons innervating the suburothelium in order to modify afferent outflow. This modulatory effect occurs in the bladders of various species and ATP is the best characterized of the urothelial transmitters. Mice with gene deletions for P2X_{2/3} purinergic receptors subtypes had reduced pelvic nerve activity in response to bladder distention and purinergic agonists [226,471,472], suggesting ATP released by

bladder distention stimulates the sensory outflow responsible for signaling the need to void. The release of urothelial ATP also increases in pathologies such as SCI [473], as well as chemical [474] and interstitial cystitis [475,476]. Thus, direct activation and sensitization of sensory nerves by urothelial ATP may be an underlying cause of the bladder overactivity in these conditions.

The communication between the urothelium and afferent nerves is not unidirectional as afferent nerves are capable of releasing a number of neuropeptides and their respective receptors are also localized on the urothelium [477]. It has been demonstrated that urothelial ATP release can be triggered by pituitary adenylate cyclase activating peptide (PACAP) through a PAC1 receptor [478] or by bradykinin through B2 receptors [479]. Additionally, substance P can induce urothelial NO release [480]. The physiological role of neuropeptides on the urothelium is not entirely clear but they have been implicated to have a major role in lower urinary tract (LUT) pathologies [477]. The balance of neuropeptide immuno-reactivity can alter in animal models of cyclophosphamide-induced cystitis [478] and SCI [481]. An increase of excitatory *versus* inhibitory neuropeptides could be responsible for a range of LUT symptoms from bladder overactivity, inflammation or bladder pain (e.g. interstitial cystitis).

There is significant evidence that the urothelium and afferent neurons form an intimate connection to regulate LUT function. However, the mechanisms by which communication between the urothelium and afferents occurs has not been defined nor has their contribution to normal LUT function. To address this, recombinant pseudorabies viruses (PRV) were used to examine the sensory nerve connections to the urothelium. PRV is part of the alpha-herpes virus family and is capable of crossing between synapses and infecting epithelial cells [482]. PRV express fluorescent markers to trace the afferent nerves innervating the bladder wall from L6-S1 dorsal root ganglia (DRG). The L6 and S1 DRG of C57Bl/6 female mice were exposed, each ganglion microinjected with PRV (10⁶ plaque-forming units/ml, 1 µl per ganglion), expressing a Ca²⁺-sensitive green fluorescent protein (GCaMP), and the bladders isolated three-days later for examination by fluorescence microscopy. GCaMP becomes locked in the fluorescent-state following fixation and can be visualised in bladder sections. Accordingly, GCaMP fluorescence was found within nerve fibres throughout the bladder wall and concentrated within the urothelium (Figure 29 A) following DRG injections.

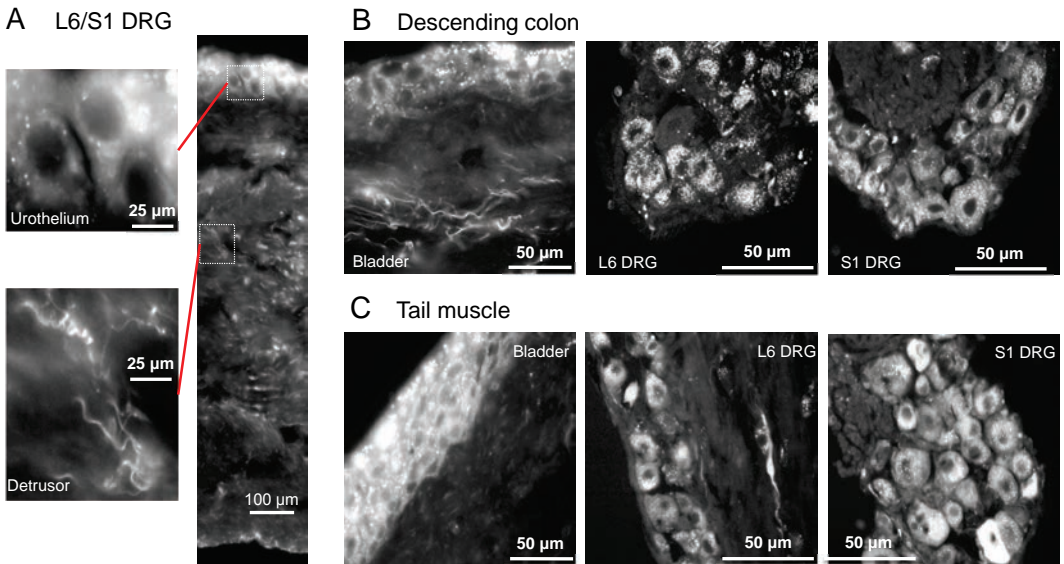

Figure 29. Fluorescent labelling of the urothelium and afferent neurons innervating the mouse urinary bladder. Images were obtained following injection of recombinant PRV-GCaMP (pseudorabies virus with Ca²⁺ indicator) into L6-S1 dorsal root ganglia, descending colon and tail muscle. **A.** Intense GCaMP fluorescence in the urothelium and nerve axons/varicosities throughout the detrusor. **B:** Injection of PRV-GCaMP into the descending colon resulted in a similar pattern of fluorescence in the bladder. GCaMP fluorescence was also found in L6 and S1 DRG following colon injections suggesting cross-infection of the organs occurred via the afferents. **C:** Tail muscle injections also resulted in accumulation of GCaMP in the urothelium and L6/S1 DRG. (Figure with the courtesy of Youko Ikeda, Irina Zabarova and Anthony Kanai)

When PRV-GCaMP was injected into the descending colon or *abductor caudalis dorsalis* (tail) muscle, which share sensory innervation with the bladder, a similar pattern of GCaMP fluorescence was observed within the bladder and there was also robust GCaMP expression in L6 and S1 DRG (Figure 29 B,C). These data suggest that PRV preferentially targets the urothelium, no matter the initial route of infection. The clinical implications is that neurotropic viruses can infect the colon and urinary bladder (e.g. polyomavirus) through co-innervating afferent nerves and become dormant in the DRG or urothelium due to suppression by the immune system. An example of such a virus is the Polyomaviridae family associated with human disease, such as nephropathy, particularly in immunocompromised individuals. There are indeed case reports where increased polyomavirus activity has been attributed to worsening of symptoms of interstitial cystitis patients [483,484]. It may be proposed that stressors can reduce immune suppression of the polyomavirus resulting in symptom “flares” characteristic to interstitial cystitis.

One observation following PRV-GCaMP injections was that fluorescence in the urothelium appeared punctate or localised within vesicles. This raises the possibility of endocytic uptake of GCaMP protein released from afferent nerves by urothelial cells. As a wildtype Becker strain of PRV was used, capable of traveling antero- and retrogradely from the cell body [485], it was not possible to determine if there is truly

an anterograde release mechanism. Therefore, injections into L6-S1 DRG with fluorescent microbeads (0.02-0.04 μm diameter) were carried out which should not cross synapses or enter urothelial cells, unless there is release from afferents in the periphery and uptake by surrounding cells. Surprisingly, microbead injections resulted in fluorescence in nerve processes throughout the detrusor and robust accumulation of fluorescent vesicular structures within the urothelium (Figure 30 A,B). Whether afferent anterograde transport to the urothelium is present under normal conditions in the LUT is still uncertain, as this mechanism could be in response to the presence of microbeads and activated as a means to eliminate them from the DRG. Further investigation is necessary to understand the significance of afferent-to-urothelium transport in both normal and pathological situations.

Furthermore, following DRG injections, there were large autofluorescent vesicles present in the urothelium that fluoresced through multiple excitation wavelengths. These were most likely lipofuscin vesicles which have been described in the urothelium of aged animals and humans [486,487]. Lipofuscins are thought to be lysosomal vesicles that act as a repository for oxidatively damaged proteins and organelles that cannot be degraded by proteasomes. This may demonstrate injury or stress to sensory nerves that can in turn induce oxidative damage to the urothe-

lium. Lipofuscins are referred to as the “ageing pigment” and can be identified by the various autofluorescent molecules that accumulate within them [488].

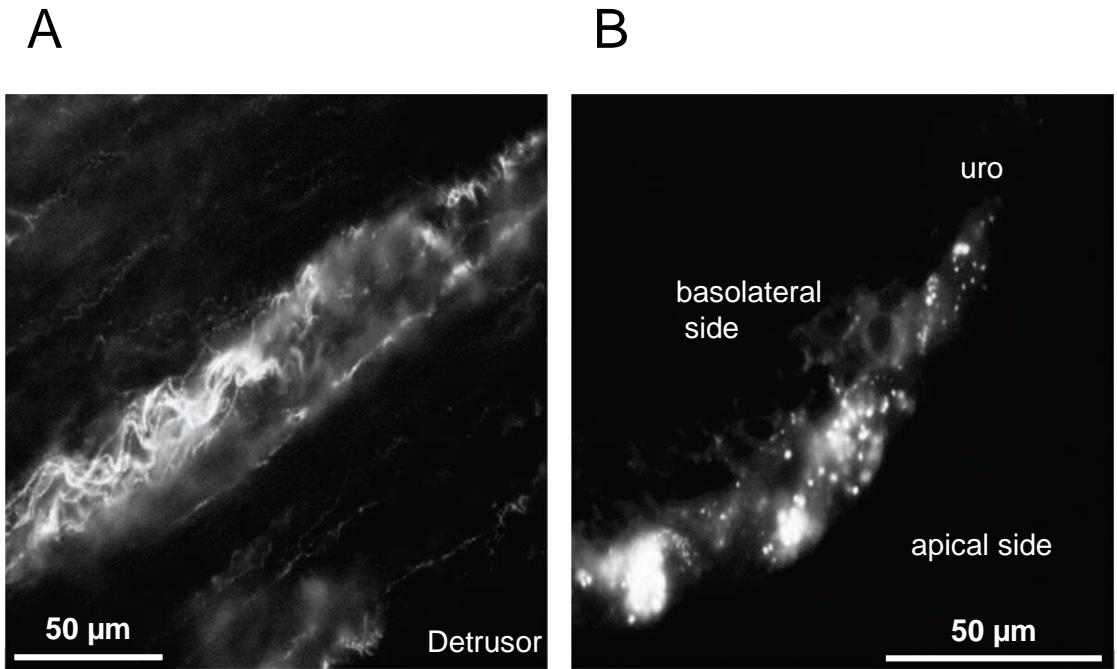

Figure 30. Urothelial uptake of fluorescent microbeads from afferent nerves following L6/S1 dorsal root ganglia (DRG) injection. Demonstration of the release of factors from afferent nerves that make contact with the urothelium. Fluorescent microbeads (0.02-0.04 µm diameter) were injected into the dorsal root ganglia (DRG, L6-S1) and allowed to recover for a minimum of seven days. A: Fluorescence in afferent nerves throughout the bladder wall. B: Fluorescence in vesicle-like structures in the urothelium (uro). (Figure with the courtesy of Youko Ikeda and Anthony Kanai)

It may be proposed that damage to afferent neurons during the microinjection surgery could cause neuropeptide release and oxidative stress in the urothelium resulting in lipofuscin accumulation. Large numbers of lipofuscins do indeed accumulate in the urothelium following the selective exposure of the bladder or descending colon to ionising radiation (data not shown) and thus these structures may be identified with some confidence. Therefore, it is important to distinguish between the fluorescent protein/marker of interest and any intrinsic fluorescence that may be present within the urothelium, especially if the bladder may be subject to a high degree of oxidative stress.

Thus, there is sufficient evidence that the urothelium and afferent nerves regulate each other's activity by release of signaling molecules. The significance of urothelial-to-afferent signaling in normal bladder function has been well established but the role for signaling in the afferent-to-urothelial direction requires further investigation. Afferent nerves do innervate the

urothelium (Figure 31A) and could release an array of molecules that appear to be taken up by apical cells. This could be a mechanism by which afferents can remove unwanted proteins. When afferents are damaged or sensitized there may be increased transport of damaged proteins, which cannot be removed/degraded by the urothelium and accumulate in lipofuscins. For example, following oxidative damage to L6/S1 DRG (by surgery or colon irradiation), there is a significant accumulation of autofluorescent lipofuscin vesicles in the apical urothelium, suggesting that oxidative stress in sensory nerves spreads to urothelial cells. The mechanism for this is unclear but could involve localised release of excitatory neuropeptides or increased uptake of oxidatively damaged proteins transported from the DRG (figure 31B). This could in turn increase urothelial signaling to promote afferent sensitization. Accordingly, dysregulation of afferent-urothelial communication may underlie a number of LUT pathologies.

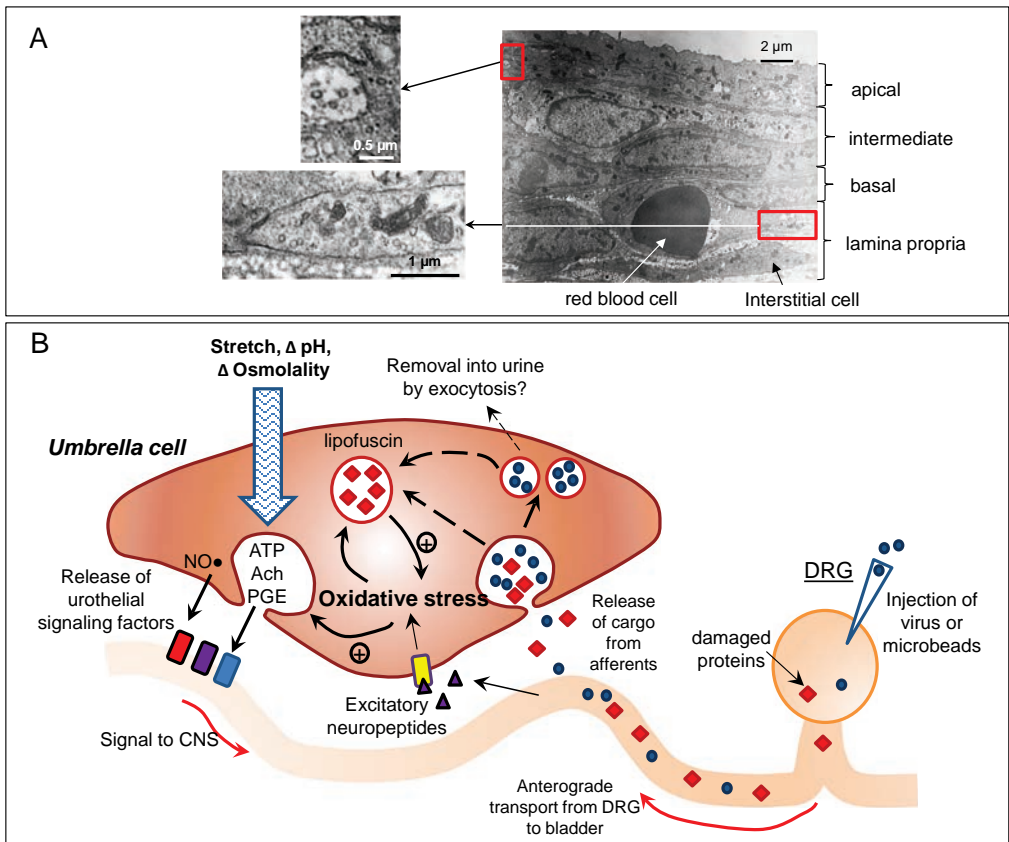

Figure 31. Proposed physiological role of afferent-urothelial communication. A: Transmission electron micrograph of the human bladder urothelial layer. Regions which showed characteristic clustering of dark core and clear vesicular structures near the apical and basal urothelium are highlighted with a red box and expanded. B: A schematic of afferent-urothelial communication. (Figure with the courtesy of Lori Birder, Youko Ikeda and Anthony Kanai)

VIII. MOLECULAR TARGETS FOR MANAGING LOWER URINARY TRACT FUNCTION

1. INTRODUCTION

Recent advances in our understanding of the basic science of lower urinary tract function, make it clear that control of bladder function is far more complex than previously believed. As reviewed above, prominent roles have emerged for the urothelium and the underlying suburothelium of the urinary bladder in mechanosensory control and their relationship with afferent pathways in the pathophysiology of lower urinary tract dysfunction (LUTD) including overactive bladder (OAB) and urinary incontinence (UI) [489-491].

According to the most recent classification [492,493], these signal transduction mechanisms have been

subclassified into seven different categories (G-protein coupled receptors, Ligand-gated ion channels, Ion channels, Nuclear Receptors, Catalytic Receptors, Transporters, and Enzymes). Among these seven categories, we will especially focus on Ion Channels as sources of novel targets for the treatments of overactive bladder and urinary incontinence in this chapter.

OAB could be a disorder of urothelial dysfunction or sensory dysfunction that causes the occurrence of urgency sensation or urgency UI (UUI). Furthermore, the causes and the natural history of OAB and UI have not been clearly defined, nor do we have any objective tools to help us understand the progression or remission of OAB after treatment. Interest has focused on urinary factors (e.g. cytokines, prostaglandin E₂ and nerve growth factor), imaging (video urodynamics, estimation of bladder wall thickness) and genetic (e.g. functional polymorphisms of the cytochrome P450). Here, we focus on novel molecular targets for managing lower urinary tract function and LUTD including OAB and UI.

2. G PROTEIN-COUPLED RECEPTORS (GPCR)S

GPCRs are subclassified into 74 subfamilies including orphan receptors, and acetylcholine-muscarinic receptors are the most important for not only urinary bladder contraction, but also treatment for OAB. In this chapter. The most important nine receptor subfamilies are discussed.

2.1. Orphan GPCRs [494]

The nociceptin/orphanin FQ peptide (N/OFQ) (495,496) is involved in a wide range of physiological responses with effects in the central and peripheral nervous system, the cardiovascular system, the airways, the gastrointestinal tract, the urogenital tract and the immune system [497,498]. The N/OFQ receptor (NOP; also known as ORL1, OP4 or LC132) is a deorphanised member of the G-protein coupled receptor (GPCR) superfamily. NOP is currently classified as a non-opioid member of the opioid receptor family. Although NOP shares considerable structural and localization features with classical opioid receptors, NOP activity is insensitive to the opioid antagonist naloxone.

In the rat, NOP located on capsaicin-sensitive bladder primary afferent fibres inhibit the volume-evoked micturition reflex [499-502]. There are no studies detailing NOP expression in bladder tissue of human origin. However, based on animal data there has been a series of clinical studies using intravesical N/OFQ by Lazzeri. In a pilot study of 14 patients, five normal controls and nine with detrusor overactivity, intravesical instillation of 1 μ M N/OFQ increased bladder capacity and volume required to initiate detrusor overactivity; the effect lasted 24–48 hours. Of interest, the effects of N/OFQ were minimal with one patient who had previously received intravesical capsaicin, indicating a capsaicin-sensitive target [503]. In a follow-up study, N/OFQ was compared with the structurally similar but inactive [desPhe1]N/OFQ (a major metabolite of N/OFQ which does not bind to NOP) in 14 patients with detrusor overactivity due to spinal-cord damage. Intravesical administration of 1 μ M N/OFQ but not [desPhe1]N/OFQ increased bladder capacity and volume required for detrusor hyperreflexia [504]. A further study used 18 patients with incontinence and neurogenic DO, who were capable of self-catheterisation: half were group instilled 1 mg of N/OFQ and the remainder with saline for 10 days at the first catheterisation of the morning. Again bladder capacity increased following N/OFQ treatment and the number of daily urine leakage episodes were reduced only in the N/OFQ group. There were no apparent major practical problems and the effects of this single instillation appeared to last the whole day [505].

Collectively, these patient studies broadly agree with those in rats that NOP is probably expressed on capsaicin-sensitive primary afferents and their activation

inhibits the micturition reflex. However, basic work has only been done in normal rats, and N/OFQ is only effective in spinally injured patients [506,507]. However, N/OFQ and N/OFQ mimetics have a potential role in the treatment of overactive bladder and their use is not limited to specialist centres capable of intravesical administration. At present any potential development will be for patients resistant to conventional use of anticholinergics [508].

2.2. Acetylcholine-Muscarinic Receptors

The urinary bladder is profusely supplied with autonomic nerve fibers, which form a dense plexus among detrusor smooth muscle cells, although some muscle bundles appear to be more richly innervated than others. The majority of nerves contain acetyl cholinesterase and thus are considered to be excitatory cholinergic [509]. Contraction of normal human detrusor is mediated almost exclusively through muscarinic receptor stimulation by acetylcholine (ACh) and can be completely abolished by atropine [510]. Molecular cloning studies have revealed five distinct genes for muscarinic ACh receptors in rats and humans and five receptor subtypes correspond to these gene products [511]. Muscarinic receptors are coupled to G-proteins; M2, M4 are inhibitory (Gi), whilst M1, M3, M5 are facilitatory (Gq). The signal transduction systems of M1, M3, and M5 preferentially couple to phosphoinositide hydrolysis leading to mobilisation of intracellular Ca^{2+} , whereas activation of muscarinic M2 and M4 receptors inhibit adenylyate cyclase activity (but see also section II.3 above). Detrusor expresses both M2 and M3 cholinoreceptors and activation of both can elicit bladder contraction [512,513]. Although M2 receptors predominate in receptor binding studies, it is the M3 receptor that is thought to mediate contraction. Desensitisation of muscarinic acetylcholine receptors is one mechanism that reduces detrusor muscle contractile response to incoming stimuli. It is mediated by phosphorylation of M2 and M3 receptors by guanosine phosphate binding (G) protein coupled receptor kinase (GRK) [514-516]. Protein expression of GRK2 is significantly lower in detrusor from bladders obstructed by BPH compared to that from normal bladders [516].

In addition to ACh released from peripheral nerve ending, non-neuronal ACh can be released from bladder urothelium or suburothelial region, although its function is unknown. The non-neuronal ACh release is increased by stretch itself augmented by age [517].

The principal treatment for overactive bladder (OAB) is with anticholinergic drugs, initially believed to inhibit the effect of ACh on detrusor, released from parasympathetic efferents. However, there is now evidence to suggest that anticholinergic drugs could interact with sensory pathways. Stimulation of muscarinic receptor pathways can depress sensory transduction by a mechanism independent of changes in bladder tone, suggesting that muscarinic receptor pathways and ACh could contribute to normal or pathological

bladder sensation [518]; however, there is no apparent evidence in the clinical setting. Recent studies have described muscarinic receptors on the mucosa as well as the detrusor of the human urinary bladder. The density and binding affinity profile of the muscarinic receptor population in the human bladder mucosa was shown to be similar to that of the detrusor muscle by radioligand binding assay. Moreover, commonly used and clinically effective muscarinic receptor antagonists bind to receptors located on the bladder mucosa as well as detrusor, providing support for the hypothesis that muscarinic receptors in the mucosa may represent an important site of action for these agents in OAB [519].

2.3. Adrenergic β -receptors

During the urine storage phase, sympathetic nerve activity is dominant and there is both indirect relaxation of detrusor muscle by adrenergic β -receptors and contraction of urethral smooth muscle by adrenergic α 1-receptors [520]. There are three β -adrenoceptor (β -AR) subtypes (β 1, β 2, β 3). The β -AR is a G(s)-protein-coupled receptor and its activation elevates smooth muscle cAMP, which is a key trigger to elicit smooth muscle relaxation. Downstream effectors activated via cAMP-dependent mechanism(s) include K^+ channels, including large-conductance, Ca^{2+} -activated K^+ (BK) channels (see section II.1.6). β -AR-mediated relaxant mechanisms also include cAMP-independent pathways, supported by pharmacological and electrophysiological evidence. In airway smooth muscle, stimulation of β 2-ARs relaxes it by direct activation of the BK channels by G(s) α [521].

β 3-receptors were thought to be related only to fat metabolism. However, human detrusor relaxes by a β 3-receptor pathway, and its gene expression in the same tissue makes this a significant pathway [522-525]. Several β 3-agonists KUC-7483, YM-178, FK-175 have been developed in Japan, and YM-178 has been launched in September 2011 in Japan, and then USA and European Countries. Although β 3-ARs are an attractive target for drug discovery, activation of β 1- or β 2-ARs can cause undesirable side-effects such as tachycardia or muscle tremors. Consequently, attention has been directed towards the design of more selective β 3-AR agonists [526]. GW427353, another novel β 3-AR agonist, relaxes the bladder and facilitates storage in dogs [527]. In addition, the β 3-AR agonist CL-316243 increases urine storage in spontaneously hypertensive rats [528].

β 3-AR agonists can mediate reduced detrusor contractions via the urothelium in pig bladder dome [529], which might underly reduced afferent nerve activity and in addition β 3-AR mRNA is present in the urothelium. In chronically ischaemic rat bladders, treatment with mirabegron protects bladder function and morphology, resulting in reduced bladder hyperactivity [530]. These data suggest multiple site of actions for β 3-AR agonists, including the urothelium.

2.4. Cannabinoids, GPR18, GPR55, GPR119

Cannabinoids, the active components of *Cannabis sativa linnaeus* (marijuana) and their derivatives are drawing renewed attention due to their diverse pharmacological activities such as cell growth inhibition, anti-inflammatory effects, and tumour regression [531-536].

The cannabinoid receptor has two subtypes, CB1 and CB2, which are both guanine-nucleotide-binding protein (G-protein)-coupled receptors [537]. Cannabinoid receptors are activated by endogenous ligands that include N-arachidonylethanolamine (anandamide), N-homo-g-linolenylethanolamine, N-docosatetra-7,10,13,16-enylethanolamine and 2-arachidonoylglycerol [493]. CB1 was initially characterized in rat brains [538], and later cloned from rat cerebral cortex [539] and human testis [540]. CB1 distributed mainly throughout the central nervous system, in the cerebellum, hippocampus, and cerebral cortex [541], and is present on peripheral neurons. However, it also found in tissues including pituitary gland, adrenal gland, lung, testis, ovary, uterus, prostate, eye, vascular tissue and peripheral immune system tissues [541-546].

Increased cannabinoid receptor-1 (CB1) expression in human urinary bladder hyper-sensitivity and over-activity disorders is correlated with changes with lower urinary tract symptoms and pain scores [547]. Their findings supported clinical trials of CB1 agonists in bladder disorders. A *Cannabis sativa* extract enriched in cannabidiol (CBD) botanic drug substance (BDS) and pure CBD reduced cholinergic-mediated contractility and this effect was modulated by TRPV1 in rats but not in humans. CBD is the chemical ingredient of CBD BDS responsible for such activity. If confirmed *in vivo*, such results could provide a pharmacologic basis to explain, at least in part, the efficacy of *Cannabis* medicines to reduce incontinence episodes in multiple sclerosis patients [548,549].

GPR18, GPR55 and GPR119 (provisional nomenclature) respond to agents analogous to endogenous cannabinoid ligands, as well as some natural/synthetic cannabinoid receptor ligands, although they show little structural similarity to CB1 and CB2 receptors [493]. The expression of the endocannabinoid-degrading enzyme fatty acid amide hydrolase (FAAH) was measured in human, rat and mouse bladders. The effects of FAAH inhibition during urodynamics were studied in awake rats using a FAAH inhibitor oleoyl ethyl amide (OEtA), as well as, rimonabant (CB1 antagonist) and SR144528 (CB2 antagonist). Bladder mucosa of all species expressed FAAH. Rat and human urothelium coexpressed FAAH and CB2. The FAAH inhibitor OEtA altered urodynamic parameters that reflect sensory functions of micturition in rats, suggesting a role for the endocannabinoid system in bladder mechanoafferent functions of rats [550].

FAAH inhibition in the sacral spinal cord by OEtA resulted in urodynamic effects in normal rats and rats

with bladder overactivity induced by pBOO. The spinal endocannabinoid system may be involved in normal micturition control and altered with bladder overactivity [551]. Inhibiting peripheral FAAH depressed A δ - and C-fibre activity of primary bladder afferents via CB1 and CB2 receptors. CB antagonists alone exerted facilitatory effects on single unit afferent activity during bladder filling in rats. Thus, the endocannabinoid system may be involved in the physiological control of micturition by regulating bladder afferents [552]. CP55,940 is a synthetic analogue of tetrahydrocannabinol, a psychoactive ingredient of the Cannabis plant. CP55,940 decreases normal rat bladder activity and urinary frequency induced by nociceptive stimuli, probably by suppression of bladder afferent activity. The effects of CP55,940 were abolished by both CBR antagonists. These data implicate a role for the endocannabinoid system in bladder mechanosensory function, and CP55,940 be an effective treatment for patients with lower urinary tract symptoms.

However, the role of CBR subtypes in micturition has yet to be evaluated [553]. Parts of the endocannabinoid system may be involved in regulation of bladder function, possibly at several levels of the micturition pathway. However, it is unclear if either CB receptor has a dominant role in modification of sensory signals or if differences exist at peripheral and central nervous sites. Amplification of endocannabinoid activity by FAAH inhibitors may be an attractive drug target in specific pathways involved in LUTS [554]. Overall the endocannabinoid system is a potential drug target for pharmacological management of LUTS, with a more favourable side-effect profile than antimuscarinic agents [555].

2.5. GABA_B Receptors

Functional GABA_B receptors are formed from the heterodimerisation of two similar subunits termed GABA_{B1} ENSG00000168760 and GABA_{B2} ENSG00000136928. Stimulation of spinal GABAergic mechanisms by intrathecal application of GABA_A and GABA_{A/B} receptor agonists have been used to treat detrusor overactivity in spinal cord injured rats [556]. Detrusor overactivity can be controlled by modulating the afferent input from the bladder and the excitability of the sacral reflex centre to suggest a novel method to treat overactive bladder patients with oral gabapentin [557]. Fourteen of 31 patients with refractory (OAB) and nocturia improved with oral gabapentin, and it was well-tolerated. It may be considered in selective patients when conventional modalities have failed. Gabapentin also revealed efficacy in treatment of neurogenic DO. There were significant modifications of urodynamic indexes, whereas symptomatic score evaluation and voiding diary data demonstrated a significant lowering of the irritative symptoms [557].

2.6. Glutamate Metabotropic Receptors.

There are two major classes of glutamate receptors: ionotropic receptors which form ligand-gated cation channels and metabotropic receptors (mGluRs) which are a family of G-protein coupled receptors

[558,559]. The former include *N*-methyl-D-aspartate (NMDA), α -amino-3-hydroxy-5-methyl-isoxazole-4-propionic acid (AMPA), and kainite receptors, which play essential roles in the control of micturition reflexes [560,561]. mGluRs have eight subtypes (mGluR1 to mGluR8) arranged in three groups (I - III) based on sequence homology, transduction mechanism and agonist pharmacology. Less is known about their functional roles in the lower urinary tract. Glutamate is involved in many CNS functions, and thus drugs acting on different glutamate receptors may affect not only micturition.

A selective mGluR5 antagonist, 6-methyl-2-(phenylethynyl)pyridine (MPEP) was used with both wild-type and mGluR1 knock-out mice. The study suggested both mGluR1 and mGluR5 were involved in modulating bladder afferent signalling and bladder capacity. Thus, an antagonist, which blocks both mGluR1 and mGluR5, would exert a more beneficial effect on storage dysfunctions, including overactive bladder and urgency urinary incontinence [562]. Similar data from other groups indicate that glutamic acid has a transmitter function in bladder and somato-bladder reflex mechanisms [563,564].

2.7. Prostanoid Receptors.

Prostanoid receptors are activated by the endogenous ligands prostaglandin (PG) D₂ (D), PGE₂ (E), PGF_{2 α} (F), PGH₂ (H), prostacyclin [PGI₂ (I)] and thromboxane A₂ (T). Prostanoid actions are mediated by specific receptors on cell membranes, including the DP, EP, FP, IP, and TP receptors that preferentially respond to PGD₂, PGE₂, PGF₂, PGI₂, and TXA₂, respectively. Furthermore, EP is subdivided into four subtypes: EP₁, EP₂, EP₃ and EP₄ (Table 1, [565,566]). EP₁ signal via IP₃ generation and increase cell Ca²⁺, activation of EP₂ and EP₄ leads to an increase in cAMP, and EP₃ activation inhibits cAMP generation via a pertussis toxin-sensitive G_i-coupled mechanism and may also signal via the small G-protein Rho. TP signal via the G_s G protein, activating Ca²⁺/diacylglycerol pathways, but other G-proteins may also be involved. Prostanoids affect excitation-contraction coupling in detrusor muscle directly by effects on the smooth muscle itself, and/or indirectly via effects on neurotransmission, but the prostanoid receptor most important for detrusor function has not been established.

Bladder outlet obstruction of EP₁-receptor knockout mice did not prevent the resulting increase in bladder weight but prevented the increase in spontaneous contractile activity (nonvoiding contractions) seen in the wild-type controls [567]. PGE₂ enhances the micturition reflex through C-fibre afferents via EP₁, thereby EP₁-selective antagonists may improve bladder storage function [568]. However, the prostaglandin EP₁ receptor antagonist ONO-8359 failed to distinguish itself from placebo and was inferior to tolterodine [569]. The urodynamic effects of an EP₄ antagonist (AH23848) in cyclophosphamide (CYP)-

induced overactive bladder (OAB) generated favourable results [570] and may also be a new target for treatment of patients with OAB. The change in expression of each EP receptor subtype associated with

bladder outlet obstruction has been examined, as well as the functional role of EP₄ using ONO-AE1-329 (a selective antagonist for EP₄).

Nomenclature	EP ₁	EP ₂	EP ₃	EP ₄
Ensembl ID	ENSG00000160951	ENSG00000125384	ENSG00000050628	ENSG00000171522
Principal transduction	Gq/11	Gs	Gi/o	Gs
Rank order of potency	E > F, I > D, T	E > F, I > D, T	E > F, I > D, T	E > F, I > D
Selective agonists	17-Phenyl-PGE ₂ , ONO-DI-004	Butaprost-free acid, CP533536, ONO-AE1-259	Sulprostone, SC46275, ONO-AE-248	ONO-AE1-329, L902688, CP734432
Selective antagonists	ONO8711 (9.2), GW848687X, SC51322		L798106, ONO-AE3-240	GW627368, ONO-AE3-208, L161982, BGC201531, CJ042794, ER819762, MK2894
Probes	³ H-PGE ₂ (1–25 nM)	³ H-PGE ₂ (5–22 nM)	³ H-PGE ₂ (0.3–7 nM)	³ H-PGE ₂ (0.6–24 nM)

Table 1. Classification of prostanoid receptors:EP₁-EP₄

EP₄ receptor mRNA and protein were clearly detected in detrusor and urothelium from obstructed bladders. ONO-AE1-329 significantly relaxed KCl-induced contractions of bladder strips from rats with bladder outlet obstruction with a significant correlation between the relaxant effect and whole bladder weight [571]. Activation of EP₄ in bladder outlet obstruction (BOO) may suppress detrusor muscle contraction and afferent activity and represent a compensatory mechanism to counteract the deterioration of storage function in BOO. EP₂ and EP₄ mRNA are also over-expressed in urothelium of obstructed human urinary bladder compared to normal bladders, which was significantly correlated with IPSS, especially storage IPSS. Hence, in contrast to previous mouse data, EP₂ and EP₄ also are potential targets for OAB treatment [572].

EP₃ and microsomal PG synthase type-1 decrease collecting duct water permeability, so increasing water excretion, whereas EP₂ and EP₄ bypass vasopressin signaling and increase water reabsorption through different intracellular signaling pathways. PGE₂ has an intricate role in urinary concentration and targeting specific prostanoid receptor signaling pathways could also be exploited for the treatment of disorders such as nocturia or nocturnal polyuria [573].

The role of prostanoids in the pathophysiology of underactive bladder is also under investigation. The roles of nerve growth factor (NGF) and PGE₂ were studied in bladder and urine in STZ-induced diabetic rats. Diabetes mellitus induced hyposensitive underactive bladder which is characterised by an increased

inflammatory reaction, apoptosis and urine NGF levels, as well as upregulation of EP₁ and EP₃ receptors and decreased bladder NGF and urine PGE₂ [574].

Potent agonists for EP₂ and EP₃ have been developed. The cyclic carbamate derivatives, 2-melatonin-2-oxo-1,3-oxazolidin-3-yl)ethyl]sulfanyl)-1,3-thiazole-4-carboxylic acid and 2-2-oxo-1,3-oxazolidin-3-yl)ethyl]sulfanyl)-1,3-thiazole-4-carboxylic acid have been identified as the first potent dual EP₂ and EP₃ agonists, with EC₅₀ values of 10 nM or less and selectivity against the EP₁ and EP₄ subtypes [575].

ONO-8055 is also a highly potent and selective agonist for EP₂ and EP₃ on CHO (Chinese hamster ovary) cells, using an increase of intracellular [Ca²⁺] and intracellular cAMP production as indicators of receptor activation. While this compound contracted bladder strips, it relaxed urethral muscle. Awake cystometry showed that ONO-8055 significantly decreased bladder capacity, post-void residual urine and voiding pressure. Compared with vehicle, tamsulosin and ONO-8055 significantly decreased urethral pressure. *In vivo*, ONO-8055 decreased post-void residual urine, probably by decreasing bladder capacity. A reduction of voiding pressure probably resulted from lowered urethral pressure due to relaxation of the urethra [576].

2.8. Tachykinins

Tachykinin receptors are activated by the endogenous peptides substance-P (SP), neurokinin-A (NKA; previously known as substance-K, neurokinin-A or neuromedin L), neurokinin-B (NKB; previously known as neurokinin-B or neuromedin-K), neuropeptide-K and neuropeptide-G (N-terminally extended forms of

neurokinin A). Neurokinins-A and -B are mammalian members of a tachykinin family, which includes peptides containing the consensus sequence: Phe-x-Gly-Leu-Met. Marked species differences in pharmacology.

Clinical trials showed Aprepitant, a neurokinin-1 receptor antagonist, is efficacious to treat OAB [577]. However, the effect was small but demonstrated a proof of concept. Cizolirtine citrate (cizolirtine) exerts an inhibitory influence on calcitonin gene-related peptide (CGRP) and substance-P release by primary afferent fibres and/or dorsal horn interneurons, mediated through presynaptic serotonin and α_2 -adrenoceptors that are partly related to an increase of the descending noradrenaline pain inhibitory system [576-580]. A dose-finding study was performed as the first step in the clinical development of cizolirtine citrate. The therapeutic potential of cizolirtine citrate 400mg b.i.d. in overactive bladder was demonstrated [581].

2.9. Taste Receptors

The expression of a functional sweet taste receptor has been reported in numerous extragustatory tissues, including the gut, pancreas, bladder, brain and, more recently, bone and adipose tissues [582]. T1R_{2/3} sweet taste receptors are expressed in human and rat bladder urothelium. Their activation by artificial sweeteners has been proposed to augment bladder contractions, resulting in urinary frequency or OAB [583].

The presence of a previously unidentified cholinergic, polymodal chemosensory cell in the mammalian urethra, but not in bladder, ureter or renal pelvis has been reported. It represents a potential portal of entry for bacteria and harmful substances into the urogenital system. Urethral brush cells express bitter and umami taste receptors and downstream components of the taste transduction cascade; respond to stimulation with bitter (denatonium), umami (monosodium glutamate) and uropathogenic *Escherichia coli*. They also release Ach to communicate with other cells and intraurethral application of denatonium reflexively increases activity of the bladder detrusor muscle in anesthetized rats. Urinary bladder may be controlled via a previously unidentified cholinergic chemosensory cell monitoring the chemical composition of the urethral luminal microenvironment for potential hazardous content [584].

The bitter taste receptor (TAS2Rs) family perform non-gustatory functions outside the mouth in addition to taste. mRNA for various TAS2R subtypes is also expressed in both human and mouse detrusor smooth muscle. Chloroquine (CLQ), an agonist for TAS2Rs, concentration-dependently relaxed carbachol- and KCl-induced contractions of human DSM strips. Furthermore, CLQ treatment significantly suppressed OAB symptoms of mice with pBOO [585].

3. ION CHANNELS

3.1. Ligand-gated Ion Channels

Ligand-gated ion channels are integral membrane proteins that contain a pore to allow the regulated flow of selected ions across the plasma membrane. They are relatively voltage-insensitive and are gated by second messengers and other intracellular and/or extracellular mediators. The channels are opened, or gated, by the binding of a neurotransmitter to an orthosteric site(s) that triggers a conformational change that results in the conducting state. Of the eight ligand-gated ion channel families (5-HT₃, nicotinic-acetylcholine, GABA_A, glutamate-ionotropic, glycine, P2X, and zinc-activated channels), only P2X will be discussed here.

Purinergic mechanosensory transduction occurs where ATP, released from urothelial cells during distension of bladder and ureter, acts on P2X₃ and P2X_{2/3} receptors on suburothelial sensory nerves to initiate the voiding reflex via low threshold fibres, as well as nociception via high threshold fibres. In human bladder the purinergic component of parasympathetic excitatory cotransmission is small. However, in pathological conditions, such as interstitial cystitis, obstructed and neuropathic bladder, the purinergic component is increased to as much as 40 %. Other pathological conditions of the bladder have been shown to involve purinoceptor-mediated activities, including multiple sclerosis, ischaemia, diabetes, cancer and bacterial infections. Purinergic therapeutic strategies are being explored that hopefully will be developed and bring benefit and relief to many patients with urinary tract disorders [586].

Functional P2X receptors exist as polymeric transmitter-gated channels. The native receptors may occur as homopolymers (e.g. P2X₁ in smooth muscle) or heteropolymers (e.g. P2X₂:P2X₃ in the nodose ganglion and P2X₁:P2X₅ in mouse cortical astrocytes). P2X₂, P2X₄ and P2X₇ receptors form functional homopolymers which, in turn, activate pores permeable to low molecular weight solutes. The hemi-channel pannexin-1 has been implicated in pore formation induced by P2X₇, but not P2X₂ receptor activation [493].

Afferent signals originating from the bladder are regulated by P2X₃ and P2X_{2/3} receptors in the urothelium and afferent nerves and antagonists to these receptors are promising agents to treat conditions such as OAB and other sensory disorders including chronic pain states. AF-792 [5-(5-ethynyl-2-isopropyl-4-methoxy-phenoxy)-pyrimidine-2,4-diamine] is a selective P2X₃ and P2X_{2/3} antagonist that inhibits the micturition reflex significantly at 300 nM and increases inter-contraction intervals [587]. After BOO, with bladder overactivity, the expression of M2, M3 and P2X₃ receptors is increased in rat urothelium, suggesting that changes in urothelium P2X₃ receptor expression can mediate afferent sensory responses

in the urinary bladder [588]. The P2X₃ and P2X_{2/3} receptor antagonist A-317491 is effective at improving the symptoms of CYP-induced cystitis in the rat, suggesting that these receptors are involved in bladder overactivity observed during CYP-induced cystitis [589].

The precise mechanisms that underline mechanosensory transduction in the bladder remain ambiguous. However, a wide range of ion channels (e.g. TTX-resistant Na⁺ channels, Kv channels and HCN channels) and receptor-channels (e.g. TRPV₁, TRPM₈, TRPA₁, P2X_{2/3}) have been identified at bladder afferent terminals and implicated in the generation and modulation of afferent signals. The expression and/or the function of these ion channels and receptors may be altered in animal models and patients with overactive and painful bladder disorders and may be potential therapeutic targets for bladder diseases [590]. Another report showed also that detrusor from patients with idiopathic detrusor overactivity showed a selective absence of P2X₃ and P2X₅ that may impair control of detrusor contractility [591].

3.2. Acid-sensing (Proton-gated) Ion Channels (ASIC)

Acid-sensing ion channels (ASICs) are members of a Na⁺ channel superfamily that includes the epithelial Na⁺ channel (ENaC), the FMRF-amide activated channel (FaNaC) of invertebrates, the degenerins (DEG) of *Caenorhabditis elegans*, channels in *Drosophila melanogaster* and 'orphan' channels. ASIC subunits contain two transmembrane domains and assemble as homo- or hetero-trimers to form proton-

gated, voltage-insensitive, Na⁺ permeable, channels (Table 2).

ASIC₁ is the dominant ASIC subunit expressed in bladder urothelium, whereas both ASIC₁ and ASIC₂ are expressed in bladder smooth muscle. ASIC₃ expression is much less abundant, but localised in the suburothelial region. In the mucosa, the ASIC₁ gene is more highly expressed in male than in female mice, whereas the expression level of ASIC₂ in the bladder muscle is higher in female than in male mice. Thus, ASICs might be involved in observed sex differences in the bladder response to irritation with acetic acid [592]. Capsaicin, acting at TRPV₁ receptors, and acid, acting at both TRPV₁ and ASIC, induce ATP release from the rat bladder mucosa and highlights the importance of ATP and acid as signalling molecules in modulating bladder function [593]. Urothelial cells express multiple TRP (see also below) and ASIC channels, whose activation elicits ionic currents and Ca²⁺ influx. These "neuron-like" properties might be involved in release of transmitters such as ATP that act on afferent nerves or smooth muscle to modulate their responses to different stimuli [594]. Urinary bladder inflammation induced by cyclophosphamide alters ASIC_{2a} and ASIC₃ expression in the rat bladder, although ASIC₁ expression is unaffected, and again highlight the potential involvement of ASICs in its development [595]. Up-regulation of ASIC_{2a} and ASIC₃ in patients with bladder pain syndrome suggests involvement in increased pain and hyperalgesia. Down-regulation of transient receptor potential vanilloid 1 mRNA might indicate that a different regulatory mechanism controls its expression in the human bladder [596].

Table 2. Classification of ASICs

Nomenclature	ASIC ₁	ASIC ₂	ASIC ₃
Other names	ASIC; BNaC ₂	BNC ₁ ; BNaC ₁ ; MDEG	DRASIC, TNaC ₁
Ensembl ID	ENSG00000110881	ENSG00000108684	ENSG00000213199
Endogenous activators	Extracellular H ⁺ , ASIC _{1a} , pEC ₅₀ ~6.2-6.8 ASIC _{1b} , pEC ₅₀ ~5.1-6.2	Extracellular H ⁺ , pEC ₅₀ ~4.1- 5.0	Extracellular H ⁺ , transient component pEC ₅₀ ~6.2-6.7 sustained component pEC ₅₀ ~3.5-4.3 agmatine (EC ₅₀ ~ 9.8 mM @ pH 7.4, aracaine (EC ₅₀ ~1.2 mM @ pH 7.4, GMQ (largely non-desensitising; pEC ₅₀ 3.0 (pH 7.4) transient component: APETx2 (63 nM), nafamostat ~2.5 mM), amiloride (16-63 mM) sustained component: amiloride (pH 4, 200 mM, A-317567 (~10 mM); aspirin/diclofenac (92 mM), salicylic acid (260 mM), Gd ³⁺ (40 mM), Zn ²⁺ (61 mM).

3.3. Epithelial Sodium Channels (ENaC)

Epithelial Na⁺ channels (ENaCs) are responsible for Na⁺ reabsorption by epithelia lining the distal part of the kidney tubule, and fulfil similar functional roles in some other tissues such as the alveolar epithelium

and the distal colon. This reabsorption of Na⁺ is regulated by aldosterone, vasopressin and glucocorticoids, and is one of the essential mechanisms in the regulation of sodium balance, blood volume and blood pressure. Furthermore, cAMP stimulates the insertion of new ENaC into the apical membrane [597].

The degenerin-epithelial Na⁺ channel (ENaC) family has been proposed as a transducer of sensory stimuli in several species [598-600] and these channels seem to be mechanosensitive. In the rabbit urinary bladder ENaC can change their Na⁺ transporting properties after changes in hydrostatic pressure [598]. ENaCs in the renal pelvic epithelium of rats participate in activation of afferent renal mechanosensitive neurons by increased renal pelvic pressure [601]. ENaCs are expressed in the mammalian urinary bladder and suggests that amiloride-sensitive Na⁺ transport across the apical membrane of the urothelium is mediated significantly by ENaC [602]. Thus, ENaCs could be involved in mechanosensitive transduction in the bladder and their upregulation could contribute to the pathophysiology of changes to sensory nerve function.

ENaC in human urinary bladder: The α -, β -, and γ -ENaC proteins and mRNA are clearly expressed in human bladder epithelium with and without BOO and ENaC mRNA expression correlates significantly with the storage symptom score [603]. A study with samples from bladders of control and neuropathic DO patients showed greater expression of γ -ENaC and ASIC₁ was associated with decreased compliance of the donor bladders [604]. The authors proposed that whilst changes to γ -ENaC might impair the mechanosensory function of the urothelium, the increase of ASIC1 might compensate for the excess in local sensitivity.

ENaC in rat urinary bladder: Intravesical infusion of the ENaC blocker amiloride significantly reduced the frequency of reflex voiding during bladder filling, increased bladder capacity, both without effect on the amplitude of micturition pressure. Stretch-induced significant increase in the ATP release from whole layer bladder strips and this was greatly reduced by amiloride [603,605].

3.4. Potassium Channels

K⁺ channels are fundamental regulators of cell excitability (see also sections II.1.6 and III.4.1). They control the frequency and the shape of action potential waveform, the secretion of hormones and neurotransmitters and cell membrane potential. Their activity may be regulated by voltage, Ca²⁺ and neurotransmitters (and the signalling pathways they stimulate). They consist of a primary pore-forming α subunit often associated with auxiliary regulatory subunits. The three main groups are the 2-TM (two transmembrane domain), 4-TM and 6-TM families – the latter are considered here [493].

The 6TM family of K⁺ channels. These comprise the voltage-gated K_V subfamilies, the KCNQ subfamily the EAG subfamily (which includes hERG channels), the Ca²⁺-activated Slo subfamily (actually with 7TM) and the Ca²⁺-activated SK subfamily. The pore-forming α -subunits form tetramers and heteromeric channels may be formed within subfamilies (e.g. K_V1.1 with K_V1.2; KCNQ2 with KCNQ3).

Large-conductance, voltage- and Ca²⁺-activated K⁺ (BK) channels regulate the resting potential and repolarisation of the action potential, and play a critical role in modulating contractile tone of smooth muscle, and neuronal processes. BK channels play an important role in controlling membrane potential and contractility of urinary bladder smooth muscle [606,607]. In addition, small-conductance (SK) channels, are regulators of excitability in detrusor smooth muscle. The role of SK channels in guinea-pig detrusor was examined using the SK channel blocker apamin. Ca²⁺ entry through voltage-dependent Ca²⁺ channels activates both BK and SK channels, but Ca²⁺ release (Ca²⁺ sparks) through ryanodine receptors activates only BK_{Ca} channels [50,55]. BK channels are activated strongly to counteract enhanced spontaneous mechanical activity with detrusor muscle stretch. The role of different K⁺ channels in regulating spontaneous contractile activity varies between pathologies. K(ATP) and SK channels regulate detrusor spontaneous contractions from NDO patients and BK channels are not involved. By contrast, BK have a role in tissue from normal bladders [608].

The effects of NS-8, a selective antagonist for BK channels on the micturition reflex in rats has been investigated. During bladder filling, NS-8 decreased the discharge rate of the afferent pelvic nerve and could be used to manage symptoms of urinary frequency and incontinence [608]. The importance of the BK_{Ca} channel was shown in that local hSlo cDNA (i.e., the BK_{Ca} channel) injection ameliorated detrusor overactivity in a rat model of partial urinary outlet obstruction [609]. It was suggested that expression of hSlo in the bladder functionally antagonised the increased contractility normally observed in obstructed animals and thereby improved detrusor overactivity. Consistent with increased urinary bladder contractility caused by the absence of BK currents, Slo knock-out mice demonstrated a marked elevation in urination frequency [51]. BK channel activation also has a significant role in reducing both cholinergic- and purinergic-induced contractions [610]. Thus, alterations to BK channel expression or function, along with changes to SK and K(ATP) channels, could contribute to pathologies such as overactive detrusor and, represent pharmacological targets for decreasing phasic OAB contractions of detrusor. A novel BK channel blocker, A-272651, represents one of the first small molecule channel blocker and could serve as a tool to characterise the role of BK channels in physiological and pathological states [611].

However, no K⁺ channel opener has passed the proof of concept stage, and there is at present no convincing evidence showing that K⁺ channel opening is a useful principle for treatment of detrusor overactivity [612]. The safety and tolerability of escalating doses of hMaxi-K, a gene transfer product of human BK ion channel, were confirmed by clinical evaluation and laboratory tests in 11 patients with moderate to severe erectile dysfunction and hMaxi-K gene transfer is a viable approach to treat erectile dysfunction and other smooth muscle diseases with targeted access [613].

The identification of novel BK has been attempted by screening a library of 794 natural compounds using a cell-based fluorescence assay. Kurarinone, a flavanone from *Sophora flavescens*, was identified as a strong potentiator of BK channels and directly potentiates BK channels [614]. Finally an interaction between phosphodiesterases and BK channels has been identified. Phosphodiesterase type 4 (PDE4) is present in the pig and human bladder neck smooth muscle, where the PDE4 inhibitor rolipram exerts a much more potent relaxation than that elicited by PDE5 inhibitors. In pig tissue the rolipram-induced response is produced through a PKA pathway involving BK channel activation and $[Ca^{2+}]_i$ desensitisation-dependent mechanisms [615].

3.5. Transient Receptor Potential (TRP) Cation Channels – Distribution and Function

The TRP family of channels has been considered in terms of their physiological functions above with respect to detrusor muscle (section II.1.5) and also in the following chapter regarding the urothelium and neural sites. Here their significance as drug targets will be considered. The TRP superfamily of cation channels, whose founder member is the *Drosophila* Trp channel. Mammalian TRP channels are activated and regulated by a wide variety of stimuli so TRPs can act as sensors of osmotic pressure, volume, stretch or vibration. Many post-transcriptional mechanisms are also possible, that include phosphorylation, G-protein receptor coupling, ligand-gating and ubiquitination.

Table 3. Potential mechanosensing and thermosensing TRP channels (expression and function in urogenital organs)

Subtype	Activator	Blocker	Function in urino-genitary system	Location
TRPV ₁	Heat (43°C), low pH, voltage, anandamide vanilloids, OEA, eicosanoids, AA	Capsazepin, BCTC	Detection of chemical irritants, intravesical pressure sensor, diuresis, natriuresis	Urothelium, nerve, DRG, prostate, seminiferous tubules, corpus cavernosum
TRPV ₂	Noxious heat (53°C), mechanical, growth factors		Intravesical pressure sensor	Urothelium, nerve endings, myofibroblasts
TRPV ₄	Moderate heat (24°C), cell swelling, mechanical (shear stress), anandamide, 4 α -PDD, 52,62EET, AA		Urethrovesical reflex	Urothelium, DRG, prostate, testicles
TRPA ₁	Mechanical, noxious cold (17°C), cinnamaldehyde, isothiocyanate, garlic, marijuana, bradykinin		Bladder contractions	urothelium, nerve endings, detrusor
TRPM ₈	Cold (8-28°C), icilin		Reflex micturition, normal prostate secretion, sperm motility, testicular temperature homeostasis	Prostate, urothelium, nerve endings, detrusor

Key: AA, arachidonic acid; OEA, oleylethanolamide; 4 α -PDD, 4 α -phorbol 12,13-didecanoate; 52,62EET, 52,62-epoxyeicosatrienoic acid; BCTC, N-(4- tertiary butylphenyl)-4-(3-chloropyridin-2-yl) tetrahydropyrazine-1(2H)-2-carboxamide; DRG, dorsal root ganglion.

In mammals TRPs can be divided into six families; TRPC, TRPM, TRPV, TRPA, TRPP and TRPML based on amino acid homologies. TRP subunits contain six putative transmembrane domains and assemble as homo- or hetero-tetramers to form cation selective channels with varied permeation properties.

The TRPC ('Canonical') and TRPM ('Melastatin') sub-families consist of seven and eight different channels, respectively (*i.e.*, TRPC₁-TRPC₇ and TRPM₁-TRPM₈). The TRPV ('Vanilloid') subfamily comprises six members (TRPV₁-TRPV₆) whereas the TRPA (Ankyrin) subfamily has only one mammalian member (TRPA₁). Established, or potential, physiological

pathological functions of the individual members of the TRP families are discussed in detail in the recommended reviews and are only briefly mentioned here [616,617].

Thus far, expression of TRPV1, TRPV2, TRPV4, TRPA1, and TRPM8 has been reported in different regions of the urogenital tracts and on sensory nerve endings (Table 3, [618-622]). TRP channels have been significantly linked to mechanosensory transduction and the release of ATP from the urothelium to excite sensory afferents [623]. Candidate mechanosensitive molecules in urothelial cells underlying ATP release may be ENaCs or TRPs. In addition to mechano-transduction, many TRP molecules are thermosensitive (Table 3). Specific mention will be made here of four thermosensitive TRP channels – TRPV1, TRPV4, TRPA1 and TRPM8.

3.6. TRPV₁ Channels

TRPV₁ is an ion channel activated by capsaicin, heat, protons and endogenous ligands such as anandamide and largely expressed in the urinary tract of mammals. Receptor expression is firmly established in sensory fibers and urothelial cells, and reported in other cell types. Pain perception was the first role attributed to TRPV₁ in the urinary tract. However, it is clear that TRPV₁ also regulates the frequency of bladder reflex contractions, either through direct excitation of sensory fibers or through urothelial-sensory fibre interaction involving the release of neuromediators from the urothelial cells. Capsaicin and resiniferatoxin are agonists for TRPV₁, and desensitisation of the receptor by them has been investigated for therapeutic purposes to manage bladder pain syndrome and OAB of neurogenic and non-neurogenic origin. However, desensitisation may become obsolete when non-toxic, potent TRPV₁ antagonists become available [624]. TRPV₁ channel blockers are used to ameliorate chronic pain, whereas TRPV₁ agonists that induce desensitisation are used to treat conditions in which channel overexpression occurs [625]. A splice variant of TRPV₁, TRPV_{1b}, in which 60 amino acids are deleted in the intracellular N-terminal region, forms capsaicin-insensitive and stretch-inhibited cation channels [626]. The channel is activated by changes to extracellular tonicity and mediates osmosensitivity changes in the supraoptic nucleus [627]. Such TRPV₁ variants might explain partly why some reports have suggested the mechanosensory function of TRPV₁ in the bladder [627,628], although the expressions of variants in the bladder or DRG have not been studied. With bladder strips excised from mice lacking TRPV₁ hypoosmolality-evoked ATP and NO releases are diminished [628].

TRPV₁ is expressed in the urothelium, interstitial cells and sensory nerve terminals. TRPV₁-deficient mice displayed a higher frequency of low-amplitude non-voiding bladder contractions in comparison with wild-type mice [627], suggesting that TRPV₁ is required for detection of bladder stretch. The release of both ATP and NO upon stretch was reduced in the bladders of

TRPV₁-deficient mice. In a clinical setting, capsaicin or resiniferatoxin reduces bladder overactivity through desensitisation of bladder afferents by acting on TRPV₁ [624]. Patients with neurogenic detrusor overactivity (NDO) have an increased immunoreactivity of PGP 9.5 and TRPV₁ in the suburothelium and an increased TRPV₁ reactivity in the basal layers of the urothelium compared to control patients. In addition, patients with NDO clinically responding to intravesical instillations of resiniferatoxin show a significant decrease of this TRPV₁ immunoreactivity in both the suburothelium and the basal urothelial layers compared to non-responders, suggesting a role for TRPV₁ in the pathophysiology of NDO [491,629]. The effect on urinary urgency of bladder desensitisation by RTX instillation into the bladder of OAB patients with refractory urgency were investigated and RTX showed significantly greater efficacy than placebo. The specific effect of RTX on TRPV₁ receptors suggests that urothelium and sub-urothelial C-fibres play an important role to the generation of urgency sensation [630].

The effects of GRC-6211, an orally active TRPV₁ antagonist, were tested on the function of control and inflamed rat bladders. GRC-6211 counteracted bladder hyperactivity induced by cystitis and at high doses it suppressed normal bladder activity by a TRPV₁ dependent mechanism [631]. XEN-D0501, a TRPV₁ antagonist, is being developed to treat overactive bladder. It is safe and well-tolerated at doses up to 5 mg twice daily for 14 days in healthy subjects and being evaluated for use in management of OAB. Further study is needed for the development of OAB therapy [632].

Botulinum toxin A (BoNT/A) injection into the bladder wall is in widespread use to manage persistent OAB. The effects of BoNT/A on the expression of nerve growth factor (NGF) and TRPV₁ in the urothelium and detrusor of rats with pBOO-induced detrusor overactivity has been studied. Although BoNT/A reduced raised NGF levels found in BOO, TRPV₁ expression, particularly in the urothelium, was unchanged [633].

3.7. TRPV₄ Channels

TRPV₄ was originally postulated to serve as a mechano- or osmosensor [634]. Recent studies using mice lacking TRPV₄ revealed its involvement of TRPV₄ in sensing additionally warmth *in vivo* [635,636]. TRPV₄ is abundantly expressed in rodent urothelium [637] and knockout mice show an incontinence phenotype of spontaneous voiding pattern, but lower frequency of voiding contractions and increased bladder volume in continuous filling cystometry [638]. In cultured rat urothelial cells, a TRPV₄ agonist promoted Ca²⁺ influx and enhanced ATP release [637]. These findings indicate a critical role of TRPV₄ in physiological bladder function. A study investigated their role in a stretch-sensing mechanism, using mouse primary urothelial cell cultures from wild-type and TRPV₄-deficient mice. The results suggested that TRPV₄ senses distension of the bladder urothelium, which is

converted to an ATP release signal during filling [639].

If TRPV₄ channels are candidates as mechanosensors in the bladder, their inhibition could represent a novel therapy for overactive bladder and storage dysfunction [640]. Recent work showed that the development of cystitis-induced bladder dysfunction is strongly impaired in TRPV₄ knock-out mice, and that HC-067047, a previously uncharacterised, potent, and selective TRPV₄ antagonist increased functional bladder capacity and reduced micturition frequency in normal mice and rats with cystitis. HC-067047 did not affect bladder function in TRPV₄ knock-out mice [641].

TRPV₄ and TRPV₁ are present in different bladder afferent populations. The synergistic activity of antagonists for these receptors in very low doses may offer the opportunity to treat lower urinary tract symptoms while minimising the potential side-effects of each drug, in bladder hyperactivity and pain induced by cystitis [642]. A dual analysis of voiding behaviour and reflex micturition was performed to examine lower urinary tract function in TRPV₁ knockout mice and TRPV₄ knockout mice. In reflex micturition, a lack

of either channel was involved in non-voiding contractions during bladder filling [643].

3.8. TRPA₁ Channels

TRPA₁ is the only mammalian member of the Ankyrin TRP (Figure 32) subfamily and is a potential candidate for mechanosensor and/or nociceptor responding to chemicals such as (allyl isothiocyanate (the pungent compound in mustard oil), allicin (garlic) and cinnamaldehyde (in cinnamon) [644,645] as well as cold stimuli <17C [635,646]. TRPA₁ is expressed in rodent and human bladders and sensory C-fibres [637,647] and activation induces bladder contractions, mediated by sensory afferent stimulation and release of tachykinins and prostanoids. In diabetic rats, functional coupling between the tachykinin and prostanoid systems is enhanced, and their impact on DSM contractility in response to TRPA₁ activation is increased [648]. The expression levels of TRPA₁ mRNA is much greater in mucosa compared to detrusor or prostate tissue and further upregulated in obstructed bladders [619].

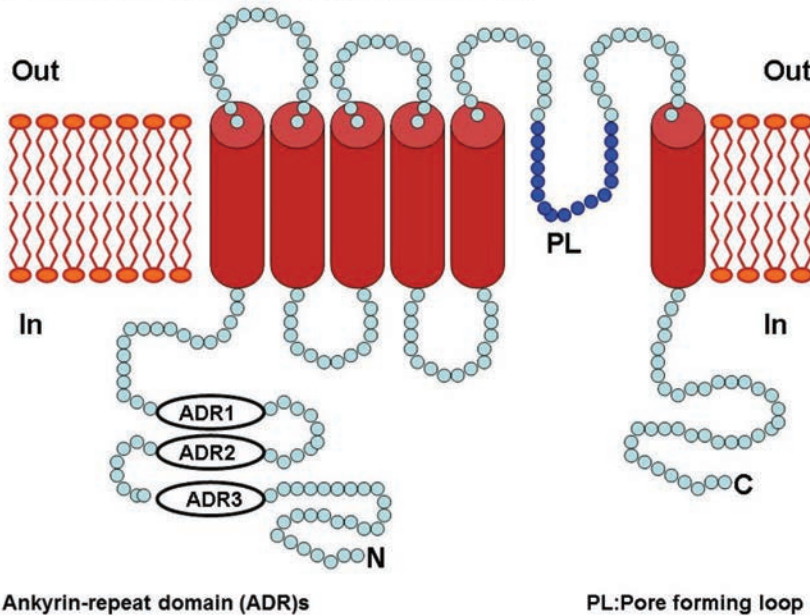

Figure 32. Structure of TRP channels. Most TRP channels are composed of 6 membrane-spanning helices with intracellular N- and C-termini. As part of the C-terminal region, ankyrin-repeat domain (ADR)s are present as a sensor.

The relevance of TRPA₁ in OAB induced by spinal cord injury was evaluated in rats using HC-030031 (a TRPA₁ antagonist) and the TRPA₁ antisense oligodeoxynucleotide (AS-ODN). TRPA₁ activity and upregulation exerts an important role in developing OAB following SCI [649]. TRPA₁ distribution and the effects of hydrogen sulphide, H₂S, as a TRPA₁ activator on micturition in conscious rats were examined. The expression of TRPA₁ on C-fibre bladder afferents and

urothelial cells together with the observation that intravesical H₂S initiated detrusor overactivity showed that TRPA₁ has a role in sensory. H₂S as a TRPA₁ activator is also potentially involved in inflammatory bladder disease [650]. Cyclophosphamide (CPS)-induced bladder hyperalgesia can be induced without robust inflammation or changes to primary afferent TRPV₁. However, significant changes were observed

in TRPA₁ expression, and blockade of TRPA₁ alleviated CPS-induced bladder hyperalgesia [651].

The effects of blocking TRPA₁ by intrathecal administration of antagonists (HC-030031 and A-967079) on the afferent pathways of micturition in rats with CPS-induced cystitis found a pronounced TRPA₁ up-regulation in dorsal root ganglia but less so in the mucosa. Blockade of neuronal activation of TRPA₁ by intrathecal administration of antagonists could decrease afferent nerve activity and attenuate detrusor overactivity induced by inflammation [652].

3.9. TRPM₈ Channels

TRPM₈ are both mechanosensitive and cold-sensitive. A bladder cooling reflex is observed in guinea pigs if pretreated with menthol, a TRPM₈ agonist. This reflex is sensitive to ganglion blockade or capsaicin-sensitive C-fibre deafferentation and might be mediated by through TRPM₈ [622]. TRPM₈ may play a role in the pathophysiology of overactive and painful bladders and provide an additional target for future pharmacotherapy [623].

The TRPM₈ channel blocker, N-(3-aminopropyl)-2-N-(2-thienylmethyl)benzamide hydrochloride (AMTB) acts on the bladder afferent pathway to attenuate the micturition reflex and nociceptive reflex responses in the rat [653]. Intravesical infusion of menthol facilitated the micturition reflex, and capsaicin pretreatment had no effect on this response [654]. Bladder afferents expressing TRPM₈ in rats are mainly A- δ although some C-fibres will be involved in nociceptive sensations [655].

Brief cold stimuli applied to the skin can evoke a sudden desire to urinate, which can be highly bothersome in patients with overactive bladder. There is no adequate explanation for the mechanism of acute cold-induced urinary urgency (ACUU). Cold and menthol stimuli to the skin generate bladder nerve responses conducted through dichotomising axons, and these significantly decreased in the presence of the TRPM₈ blocker BCTC. This suggests TRPM₈-expressing sensory neurons with dichotomizing axons projecting to the skin and bladder may be responsible for the urinary urgency evoked by cold sensation [656]. A novel TRPM₈-selective antagonist (DFL23448[5-(2-ethyl-2H-tetrazol-5-yl)-2-(3-fluorophenyl)-1,3-thiazol-4-ol]) has been tested in cold-induced behavioral tests on overactive bladder function in rats and suggested a role TRPM₈-

mediated signals in cold-induced bladder overactivity [657,658].

3.10. Piezo1 Channels

Piezo1 is a mechanosensitive ion channel protein that in humans is encoded by the gene PIEZO1. Piezo1 and its close homolog piezo2 were cloned in 2010, using an siRNA-based screen for mechanosensitive ion channels [659]. PIEZO1 and PIEZO2 share 47% identity with each other and they have no similarity to any other protein and contain no known protein domains. They are predicted to have 24-36 transmembrane domains, depending on the prediction algorithm used. In the original publication the authors were careful not to call the piezo proteins ion channels, but a more recent study by the same lab convincingly demonstrated that indeed piezo1 is the pore forming subunit of a mechanosensitive channel [660].

Piezo1 is expressed in the lungs, bladder and skin, where mechanosensation has important biological roles. Unlike Piezo2, which is highly expressed in sensory dorsal root ganglia, Piezo1 is not expressed in sensory neurons [660]. Piezo1 channels are pivotal integrators in vascular biology [661] and is also found in red blood cells, and gain of function mutations in the channels are associated with hereditary xerocytosis or stomatocytosis [662-664].

With respect to the urinary tract, mouse urothelial cells label for Piezo1 and TRPV₄ (Figure 33). Moreover these cells exhibit a Piezo1-dependent increase of intracellular [Ca²⁺] in response to mechanical stretch stimuli, leading to ATP release. However, Piezo1 and TRPV₄ respond to different intensities of mechanical stimulus. Moreover, GsMTx4, an inhibitor of such channels, attenuated Ca²⁺ influx into urothelial cells and decreased ATP release upon stretch. The consequence of Piezo1 inhibition by GsMTx4 on urinary tract function is seen in Figure 34. Experiments with a new metabolic cage design show that GsMTx4 did not affect total water intake and urinary loss throughout a dark-light cycle. However, Piezo1 inhibition reduced the number of voids and hence the voided amount per micturition. Hence, Piezo1, possibly acting through sensation of bladder (urothelial) stretch and ATP release, influences initiation of the micturition reflex. Thus, inhibition of Piezo1 might provide a promising means of treating bladder dysfunction [665].

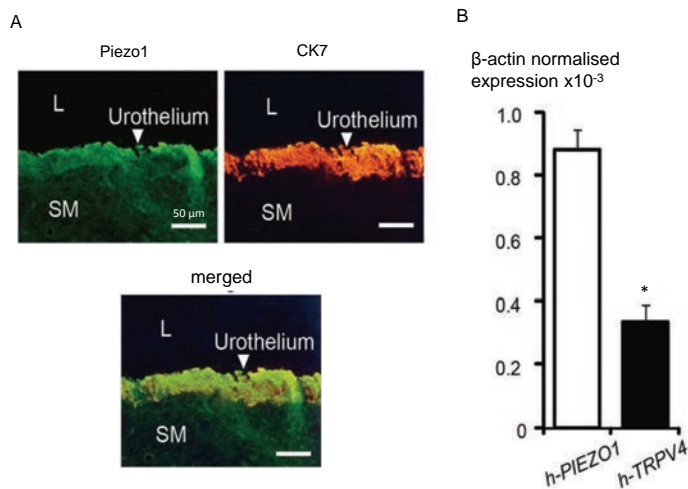

Figure 33 Piezo1 protein and mRNA expression in human bladder urothelium. **A:** immuno-histochemistry of Piezo1 (left) and a urothelial label CK7 (right). The merged image is shown below. **L:** lumen-facing side. **SM:** smooth muscle-facing side. **B:** quantitative RT-PCR of human Piezo1 and TRPV4 transcripts, normalised to β -actin. * $p < 0.05$ vs Piezo1.

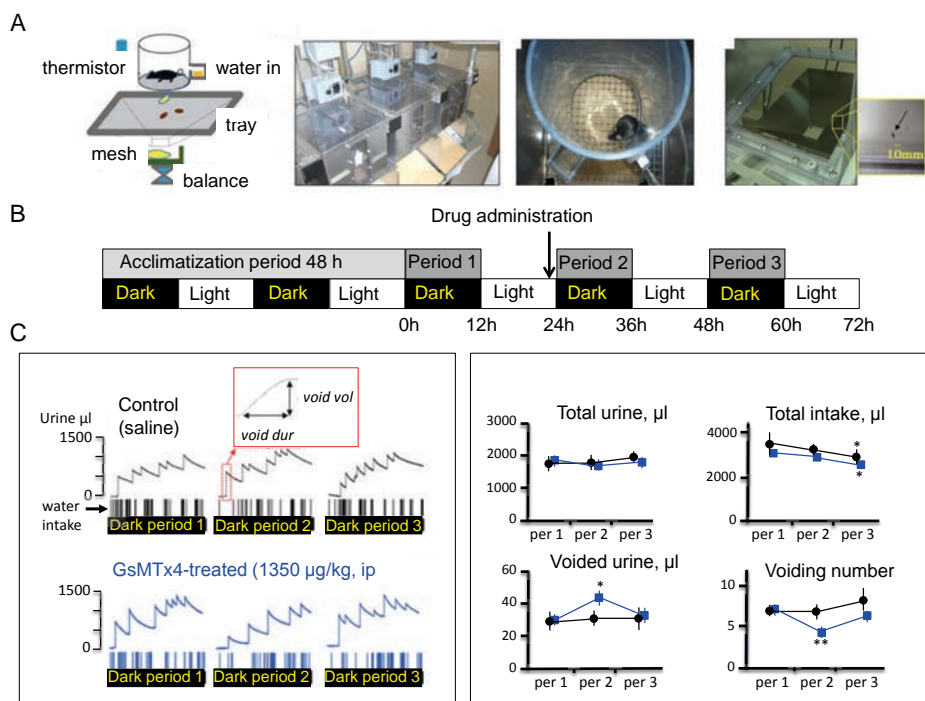

Figure 34 Metabolic cage system to study the effects of test agents on urinary function **A:** Schematic drawing and photographs (ii-iv) of a metabolic cage system for mice. The system is housed in a sound-proof room at 25°C away from air-flow fluctuations (ii). The special mesh (middle photograph, patent licence no. 2009-187420, Mitsubishi Kumamoto, Japan) allows passage of urine but catches faeces and/or food (right photograph). Each mouse is provided with free access to food and water and housed at a 12/12 h dark/light period. Water intake volume is measured by a drink sensor. **B:** Protocol for a study of a drug on urinary function. After an acclimatisation period three dark/light periods are followed: a drug administration period, preceded and followed by control periods. **C:** Effect of the Piezo1 inhibitor GsMTx4 on urinary function. **Left:** Urine production and drinking times in the three dark-periods of the above protocol. **Right:** values of total urine production, water intake, voided volume and voiding episodes in the three periods indicated in the protocol of part B. Mean data \pm SD: * $p < 0.05$, ** $p < 0.01$.

4. TRANSPORTERS

Membrane transporters carry solutes across cell membranes ultimately against energy gradients that require ATP. Transporters can be divided into three major classes: P-type ATPases; F-type or V-type ATPases and ATP-binding cassette transporters. The first of these are multimeric proteins which primarily transport inorganic cations. The F-type or V-type ATPases are proton-coupled transporters or as motors and the ATP-binding cassette transporters are involved in drug disposition and transporting endogenous solutes. This solute carrier (SLC) family therefore transports a great variety of solutes includes 52 separate groups with almost 400 members. The SLC transporters include members which function as antiports, symports or equilibrative transporters – the latter allow solutes to travel across membranes down their concentration gradients. Many transporters also express electrogenic properties [492,494].

The vesicular nucleotide transporter (VNUT), SLC17A9, is the most recent member of the SLC17 family to have an assigned function. Uptake of ATP is independent of pH, but dependent on Cl⁻ and membrane potential. Endogenous substrates are guanosine 5'-diphosphate, guanosine-5'-triphosphate, and ATP. VNUT can be inhibited by DIDS and Evans blue dye [666]. The release of ATP from urothelium when stretched may occur through multiple pathways. VNUT is abundantly expressed in the urothelium, and VNUT-deficient mice show reduced bladder compliance and frequent urination and this transporter has been implicated in this pathology [667]

5. CLOCK GENES

Clock genes exist in most cells and organs, and their products regulate oscillations in the sleep-awake rhythm and gene expression rhythms of various metabolic enzymes, channels, and receptors. Of more than ten types of clock genes that have been identified, period protein (Per), cryptochrome protein (Cry), brain and muscle ARNT-like 1 (Bmal1), and clock locomotor output cycles kaput (Clock) play the most important role in regulating cellular master and peripheral circadian rhythms. Such circadian rhythms are driven by several complex feedback loops some of which are under the control of the master clock in the suprachiasmatic nucleus (SCN, Figure 35) [668].

The pathophysiology of nocturia (NOC) and nocturnal polyuria (NP) appear to be multifactorial and complex and their etiologies remain unclear in a large number of patients. There is currently no ideal animal model for NOC and/or NP which in turn hinder any scientific or clinical approaches for examining and evaluating the efficacy of therapeutic modalities for NOC and NP. Recent studies reported that renal and lower urinary tract functions are regulated by clock genes [669,670]. Moreover, melatonin secretion exhibits a circadian rhythm that is regulated by SCN clock genes. The rhythmicity of melatonin secretion regulates circadian rhythms in peripheral tissues mainly by controlling tissues' hormonal activities. It has also been shown to influence the onset of NOC in patients [671,672]. Based on these findings, a novel hypothesis has been proposed regarding the relationship between abnormalities in clock genes and lower urinary tract functions (Figure 36).

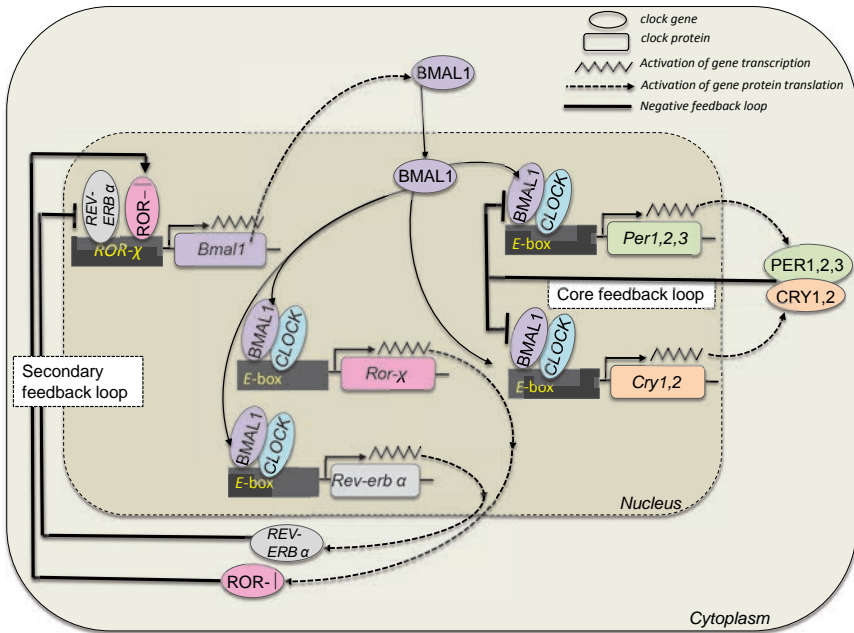

Figure 35. Mechanisms of circadian rhythm formation by oscillation of clock genes. More than ten types of clock genes that have been identified. *Per*, *Cry*, *Bmal* and *Clock* play the most important role in regulation of circadian rhythms. Particular circadian rhythms are driven by the formation of a large number of complex feedback loops under the control of a master clock in the suprachiasmatic nucleus (SCN). In the core loop, transcriptional factors, *Clock* and *Bmal* can activate *Per* and *Cry* genes by attaching to an E-box.

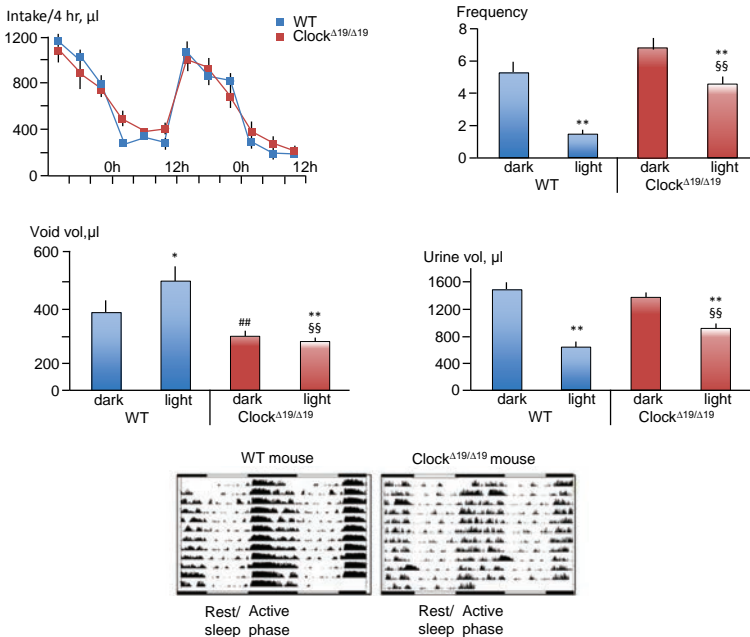

Figure 36 Water intake and voiding patterns in a clock mutant mouse model. Upper and middle panels. Comparison between wild type (WT) and *Clock* mutant ($\Delta 19/\Delta 19$) mice in micturition patterns. Plots and bar charts show: water intake over two 12hr/12hr light-dark cycles and over one light-dark cycle: average voiding episodes; volume per void; and total voided volume. * $p < 0.05$, ** $p < 0.01$ light vs dark for each group: ## $p < 0.01$ WT vs *Clock* $\Delta 19/\Delta 19$ for dark cycles: §§ $p < 0.01$ WT vs *Clock* $\Delta 19/\Delta 19$ for light cycles. Lower panels. Actograms of WT and *Clock* $\Delta 19/\Delta 19$ mice for a two-day period; there is no overall difference.

To investigate the effect of clock genes on lower urinary tract function the voiding behaviour of the ClockD19/D19 mutant mouse, Clock^{Δ19/Δ19}, was recorded for 24hr using metabolic cages and compared with wild-type (WT) mice. No significant differences were observed in behaviour patterns between Clock^{Δ19/Δ19} and WT mice. However, Clock^{Δ19/Δ19} mice showed greater voiding frequencies and urine volumes during the sleep phase when compared to WT mice. Moreover, the diurnal change (between the dark and light periods) in voiding frequency as well as urine volume observed in WT mice was absent in Clock^{Δ19/Δ19} mice. Additionally, functional bladder capacity was significantly lower in Clock^{Δ19/Δ19} mice when compared to WT mice. Overall, the clock gene mutant mice, Clock^{Δ19/Δ19} mice, exhibit several abnormalities that are the main characteristics of the nocturia/nocturnal polyuria phenotype and hence may be used as an animal model for these conditions [673].

IX. PHYSIOLOGY OF THE ANO-RECTUM

1. FUNCTIONS OF THE ANO-RECTUM

The functions of the anorectum are: the storage of stools and their evacuation at convenient times. The rectum acts as a store for stools and as a conduit to the anus, while the sphincters that develop spontaneous contractile tone, are critical for faecal continence but also allow control of defecation. Sphincter defects are associated with faecal incontinence, but the sphincters are not alone responsible for maintaining faecal continence [674].

Defecation: The presence of stools in the rectum causes rectal distension and the activation of stretch receptors that initiate viscerovisceral reflexes and the recto-anal inhibitory reflex (RAIR) [675]. The former inhibits colonic activity, while the latter causes anal sphincter relaxation. Once defecation is initiated, the rectal angle straightens, the pelvic floor descends and the tonic activity of the sphincters is inhibited simultaneously with contraction of the rectum. Together, these responses result in the evacuation of the rectal contents [675,676] and a sensory input from the anus maintains this activity until the rectum is fully evacuated [677].

2. STRUCTURE OF THE ANO-RECTUM

The rectum is a muscular channel that stores stools until convenient to defecate and terminates with the

anus which offers control over the passage of stools [678]. The anal sphincter itself consists of the internal anal sphincter (IAS), the external anal sphincter (EAS), and the anal mucosal folds and vascular cushion, all of which contribute to the tight seal of the anus and maintenance of continence [678]. A number of key features contribute to the maintenance of continence (Figure 37).

2.1. External Anal Sphincter (EAS)

The external anal sphincter (EAS) is a ring of striated muscle that contributes to the maintenance of anal luminal pressure and provides some voluntary control of the anorectum [676]. It is an extension of the levator ani muscle and morphologically separated from the IAS. It is innervated by the pudendal nerve which is a mixed nerve carrying both somatic motor fibres and sensory nerve fibres. During sudden increases of intra-abdominal pressure, spinal reflexes cause the EAS to contract thereby maintaining continence during coughs and sneezes etc [676].

2.2. The Puborectalis Muscle

The puborectalis muscle is also a striated muscle and wraps around the rectum creating the anorectal angle (normally about 90°) which acts to prevent the movement of faeces from the rectum to the anal canal between defecations. Like the EAS, the puborectalis develops tonic contractions and is under voluntary control [679].

2.3. The Internal Anal Sphincter (IAS)

The internal anal sphincter (IAS) is a ring of predominantly slow-twitch, fatigue-resistant smooth muscle that encircles the anus and normally prevents the passage of faecal material, thus maintaining continence [680,681]. The smooth muscle differs from that of the rectum and the rest of the non-sphincter muscle of the gastrointestinal tract by developing spontaneous tone that is not dependent on nervous innervation or hormonal influences [682]. This intrinsic muscle tone accounts for up to 85% of anal luminal resting pressure and is essential for the maintenance of continence [676]. However, IAS muscle tone is influenced by the autonomic innervation and some hormones (eg. angiotensin II). Importantly, a non-cholinergic, non-adrenergic (NANC) innervation relaxes the IAS transiently during defaecation. The loss of IAS intrinsic tone can lead to the development of faecal incontinence, whilst chronically elevated IAS tone may hinder healing of anal fissures by reducing blood flow in the sphincter region [683]. It is thus a tissue of interest when considering drug development for these conditions.

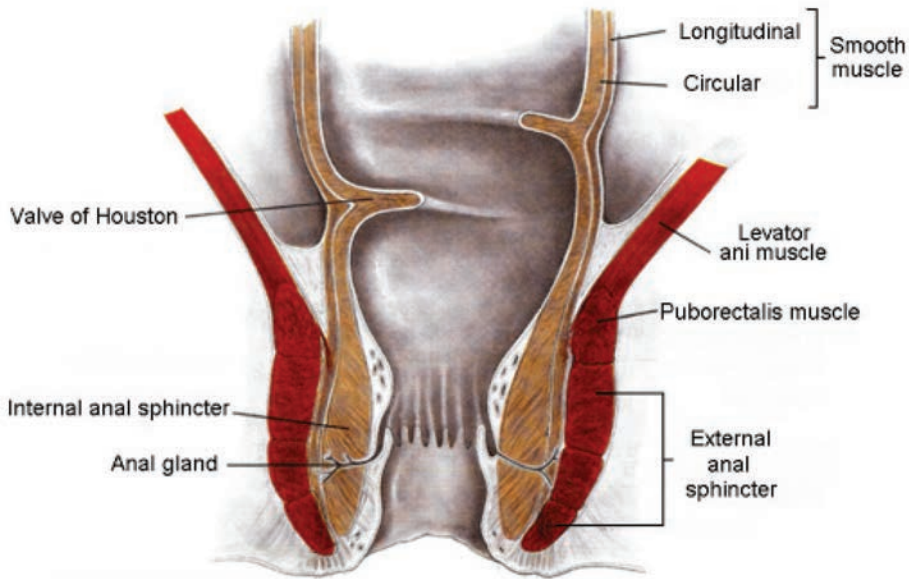

Figure 37 Water intake and voiding patterns in a clock mutant mouse model. Upper and middle panels. Comparison between wild type (WT) and *Clock* mutant ($\Delta 19/\Delta 19$) mice in micturition patterns. Plots and bar charts show: water intake over two 12hr/12hr light-dark cycles and over one light-dark cycle; average voiding episodes; volume per void; and total voided volume. * $p < 0.05$, ** $p < 0.01$ light vs dark for each group: ## $p < 0.01$ WT vs *Clock* $\Delta 19/\Delta 19$ for dark cycles: §§ $p < 0.01$ WT vs *Clock* $\Delta 19/\Delta 19$ for light cycles. Lower panels. Actograms of WT and *Clock* $\Delta 19/\Delta 19$ mice for a two-day period; there is no overall difference.

3. INNERVATION OF THE ANO-RECTUM

The enteric nervous system (ENS) consists of a network of ganglia (myenteric plexus and submucous plexus) that is present throughout the gastrointestinal tract and regulates gastrointestinal secretion, motility and blood flow [684,685]. In the myenteric plexus of the intestine, multifunctional rapidly adapting mechanosensitive enteric neurones (RAMEN) have been identified that can trigger reflexes [686,687].

The anorectum as part of the gastrointestinal tract is innervated by the ENS, but the region also receives parasympathetic, sympathetic and somatic innervation. These modulate peristalsis and are involved in the defecation reflex. The parasympathetic efferent innervation to the distal colon and anorectum arise from spinal segments S_2 – S_4 and increase rectal muscle tone in humans. In contrast, the sympathetic innervation to this region is carried in the hypogastric nerve which originates in spinal segments T_5 – L_2 . These sympathetic fibres contribute to continence by inhibiting rectal tone and by increasing contractile tone of the IAS [688–690]. Some voluntary control of defecation is provided by the pudendal nerve, this arises in the sacral (S_2 – S_4) spinal cord and innervates the pelvic floor and puborectalis muscles as well as the EAS [690].

3.1. Sensory Innervation

The sensory innervation of the anorectum has two main functions: firstly, to sample rectal contents and rectal distention, which can lead to initiation of the RAIR or postponement of defecation with voluntary external sphincter contractions if required; and secondly, to provide anal sensitivity [691]. Both unmyelinated and myelinated sensory nerve fibres are present in the anorectum [688]. The nerves mediate a number of distention-induced reflexes including the RAIR with afferent nerve fibres running in the pudendal nerves [692]. The sensory nerves are also a component of the rectal sampling reflex, which involves short-lasting rectal contraction and relaxation of the upper part of the anal canal that allows a sampling of the content of the rectum. Intra-ganglionic laminar nerve endings that are sensitive to mechanical distension have been identified in the rectal myenteric plexus of the rat [693].

3.2. Innervation of the Internal Anal Sphincter

The IAS receives both an excitatory and an inhibitory innervation: the former necessary for the maintenance of sphincter tone and continence; the latter for sphincter relaxation during defecation. As in other parts of the gastrointestinal tract, contraction and relaxation of the IAS smooth muscle are regulated by enteric and autonomic neurones and by the actions of other cell types, including interstitial cells of Cajal

[694]. The IAS is innervated by both sympathetic and parasympathetic fibres [695,696], but excitatory motor innervation to the IAS is almost exclusively sympathetic and abolished by guanethidine, a drug that inhibits transmitter release from adrenergic nerves [682,697,698]. However, when purinergic neurotransmission is blocked by desensitising muscle purinergic P2X receptors with α,β methylene-ATP (ABMA), this also inhibits (about 30%) contractions of the IAS smooth muscle induced by electrical field stimulation (EFS), suggesting ATP is acting as an excitatory neurotransmitter [698]. Since ATP contributes to the response, but guanethidine abolishes contractions, it appears that both noradrenaline and ATP are co-released from adrenergic nerves in the IAS to mediate excitatory neurotransmission. In contrast to the IAS, motor innervation to the rectum also appears to involve co-transmission, but in this case mainly cholinergic and tachykinergic mechanisms are involved [699].

The predominant influence of the sympathetic system has been confirmed with neurogenic responses being inhibited in the presence of α_1 -adrenoceptor antagonists such as prazosin [697,699-701]. However, intravenous infusions of α - and β -adrenoceptor agonists in cats [702] suggest that inhibitory effects via β -adrenoceptor may also be present but masked by the larger responses mediated via α_1 -adrenoceptors.

4. EXCITATORY NEUROTRANSMISSION

4.1. Sympathetic Innervation

α_1 -adrenoceptors: Sympathetic nerve stimulation causes IAS contraction [703] and the main body of evidence indicates that these responses are mediated via α_1 -adrenoceptors. Thus, autoradiographic studies with ^3H prazosin have identified α_1 -adrenoceptors on the smooth muscle fibres of sheep and human IAS [704]. Furthermore, it has now been shown in many studies with different species, including man, that the sympathetic neurotransmitter noradrenaline and synthetic α_1 -adrenoceptor agonists cause large contractions of IAS smooth muscle that are blocked by α -adrenoceptor antagonists [704,705-707]. Also, it was demonstrated that stimulation of α_1 -adrenoceptors increases resting luminal pressure developed by the sphincter without affecting the anal pressure response to rectal distension [708]. In sheep, mice and human IAS, electrical field stimulation of tissues produces contractions that are blocked by α -adrenoceptor antagonists [697,709-711].

Activation of α_1 -adrenoceptors mediates contraction of IAS smooth muscle of pig [706], sheep [704] and human [707] and the receptor subtype has been identified as the α_{1A} -adrenoceptor subtype. Unlike all the cloned α_1 -adrenoceptor subtypes the IAS receptor has a low affinity for prazosin [706]. This characteristic is found with a number of functional α_{1A} -adrenoceptor receptors in various tissues and the receptors

are thought to represent a pharmacologically distinct form of the α_{1A} -adrenoceptor and termed α_{1L} -adrenoceptors [712]. This conclusion is supported by the finding that deletion of the α_{1A} -adrenoceptor gene in knock-out mice, results in the absence of the α_{1L} -adrenoceptor subtype in tissues [713].

α_2 -adrenoceptors: α_2 -adrenoceptors are present throughout the gastrointestinal tract and in the rectum activation causes relaxation [714,715]. Functionally α_2 -adrenoceptors appear to play a dual role, with small direct contractile effects on muscle and an indirect pre-junctional regulation of transmitter release. Thus, α_2 -agonists have been shown to induce direct contraction of the IAS in sheep and pig [714,716], but inhibit the recto-anal inhibitory reflex (RAIR)-induced relaxation of opossum IAS [708]. Physiologically the latter effect dominates and for the endogenous agonist noradrenaline, the direct contractile effect on the IAS is only observed at high concentrations [706].

β -adrenoceptors: There is little information available in the literature concerning the β -adrenoceptors of the IAS. β -adrenoceptor agonists relax the opossum IAS, but the receptor subtype was not examined [717]. It has been reported that all three β -adrenoceptor subtypes are present in the rat IAS, but that the β_1 - and β_3 -adrenoceptors elicit responses via cGMP, whilst the population of β_2 -adrenoceptors induce IAS relaxation via both cAMP and cGMP second messenger pathways [718]. The human IAS also possesses a population of β_3 -adrenoceptors which induce direct smooth muscle relaxation [719]. However the responses to selective β_3 -agonists were only one third the magnitude of those to non-selective β -agonists and this may reflect the receptor population identified using Western blotting in human IAS ($\beta_2 \geq \beta_1 \geq \beta_3$).

4.2. Parasympathetic Innervation

Cholinergic transmission: Cholinergic neurones mediate the contraction of gastrointestinal smooth muscle [720] with acetylcholine (Ach) activating M_2 and M_3 muscarinic receptors to induce increases in cytosolic Ca^{2+} and contraction [79,721]. The situation is less clear in the IAS where Ach has both excitatory and inhibitory effects on the smooth muscle. Activation of muscarinic receptors of the human IAS induces contraction that is mediated via the M_3 receptor subtype [722,723]. However, several reports have suggested that muscarinic receptor stimulation can cause relaxation of the IAS. These have been reported for IAS from cats, opossum and human [724-726]. This inhibitory response to muscarinic agonists appears to be due to the release of nitric oxide since inhibitors of NO synthase have been shown to block the relaxations [724,725,727]. To complete the picture it should be noted that in the pig IAS, carbachol fails to elicit contraction and atropine has no effect on neurogenic responses to EFS [698]. Thus the role of muscarinic receptors and Ach as a neurotransmitter appears to be species dependent.

Purinergic transmission: The role of ATP and purinergic receptors in the IAS is controversial with some

studies finding excitatory effects and other inhibitory effects. In the porcine IAS desensitisation of smooth muscle P2X receptors with ABMA significantly reduces neurogenic (EFS) contractions. Furthermore, this effect is greater at 5 Hz than at 10 Hz stimulation suggesting that ATP provides a greater contribution to contractions at lower frequencies of stimulation. A similar frequency dependent effect has been observed in visceral and vascular smooth muscle, where the inhibition of ATP breakdown has a greater potentiating effect on neurogenic responses at low frequencies compared to higher frequencies [728].

In contrast, many studies have suggested that ATP is an inhibitory neurotransmitter in the IAS [682,729,730]. ATP has been shown to mediate inhibitory junction potentials and relaxations in guinea-pig and human IAS [726,730], while both ATP and adenosine have been shown to produce concentration-dependent relaxations of the guinea pig [730], rabbit [731], rat [729,732], mouse [733] and sheep [709] IAS smooth muscle. The inhibitory junction potentials induced by ATP were mediated via P2Y₁ re-

ceptors [709,729,733]. Thus, P2X receptors may mediate contractile responses of the IAS, whilst P2Y receptors may mediate the inhibitory junction potentials and relaxations. In other tissues such as the bladder, ATP can induce a number of smooth muscle responses via different mechanisms including (1) direct actions via P2Y receptors (2) indirect actions by inducing NO release from epithelial cells and (3) indirect actions via P1 receptors after being broken down to adenosine [586].

5. INHIBITORY NEUROTRANSMISSION

NANC neurotransmitters such as NO, play a major role in the inhibitory neurotransmission of the IAS and are essential for transient anal relaxation during defecation. However, inhibitory neurotransmission in the IAS involves a number of neurotransmitters or modulators that may be co-released to cause relaxation (Figure 38).

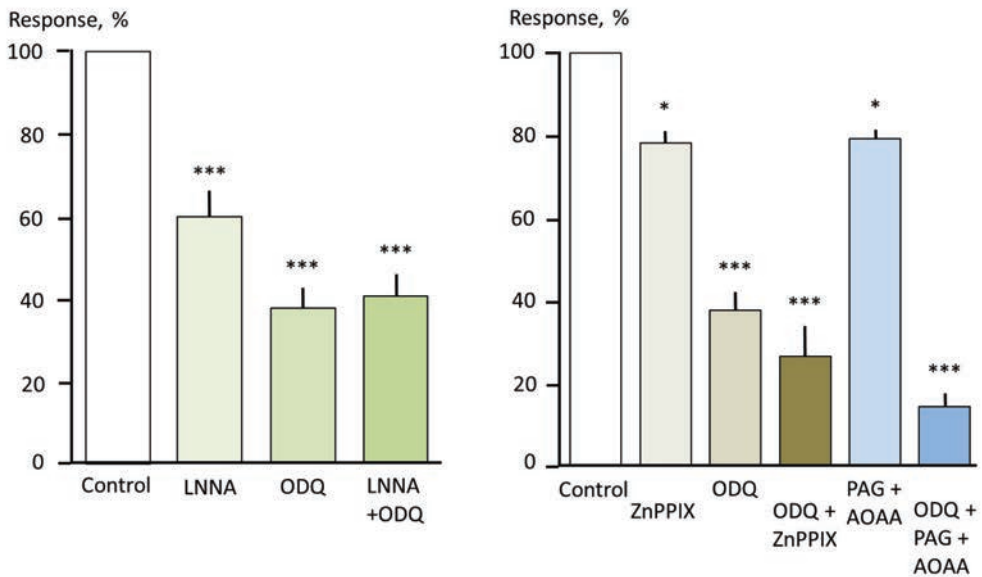

Figure 38: NANC relaxation responses to electric field stimulation. Stimulation at 10Hz was carried out in the presence or absence of inhibitors of the synthesis of: NO (L-NNA), cGMP (ODQ), CO (ZnPPiX) or H2S (PAG+AOAA), either alone or in combination. *p<0.05, **p<0.01, and *p<0.001 compared to control values in the absence of inhibitors.**

5.1. Nitric oxide (NO)

Nitric oxide is predominantly an inhibitory neurotransmitter causing relaxation of the IAS in all species so far examined. Thus inhibitors of NO synthase (NOS) reduce neurogenic relaxations of the IAS in animals and human [698,709,729,734-738]. NO stimulates guanylate cyclase resulting in the activation of cGMP-dependent protein kinase I (cGKI) and the opening of potassium channels to produce inhibitory junctional potentials and relaxation [729,737,738]. The cGMP pathway has been demonstrated in human IAS [739]

(Lies et al., 2014). In cGKI-knockout mice NO induced relaxations can still be observed suggesting that a cGKI-independent pathways may also exist in the IAS [735]. The inhibitory actions of NO are exerted directly on the IAS smooth muscle since relaxation remains in the presence of the neurotoxin tetrodotoxin [738]. In the human IAS, NO donors relax tissues and in the presence of atropine and guanethidine, EFS produces tetrodotoxin-sensitive relaxations, which are inhibited by inhibitors of NO synthase [736].

Both neuronal (nNOS) and endothelial (eNOS) isoforms of NOS have been identified in the anorectum: nNOS in the gastrointestinal neurones of the myenteric plexus [740] and eNOS and nNOS in the IAS circular smooth muscle [694,741,742]. nNOS has also been identified in the human IAS using immunohistochemistry [703] and it has been suggested that inhibition of nNOS by reactive oxygen species (ROS) may contribute to pathological conditions of the IAS [743]. Thus, it is clear that NO is the major NANC neurotransmitter mediating neurogenic relaxation of the IAS in animals and human [730,736,744].

5.2. Carbon Monoxide (CO)

Carbon monoxide is another gaseous neurotransmitter that plays a significant role in the gastrointestinal tract and NANC neurotransmission. Direct relaxation of the mouse and opossum IAS has been reported [745,746], while NANC neurotransmission is markedly reduced in knockout mice incapable of generating CO, and restored with the addition of exogenous CO [747]. The synthesis of CO is catalysed by heme oxygenase (HO), which is the rate-limiting enzyme in the catabolism of heme [748]. There are two isoforms of heme oxygenase; the induced enzyme (HO₁) and the constitutively expressed isoform (HO₂). The mechanism of IAS smooth muscle relaxation for CO is similar to that of NO, with activation of guanylate cyclase, production of cGMP resulting in hyperpolarisation and smooth muscle relaxation [745,746]. However NO is about 80-fold more potent at activating guanylate cyclase than CO [749]. As with NO, relaxation of IAS smooth muscle has been reported that can occur independently of the cGMP pathway, a process by which CO opens potassium channels directly to cause hyperpolarization and smooth muscle relaxation [750].

5.3. Hydrogen Sulphide (H₂S)

H₂S is the third gaseous transmitter found in the NANC nerves of the IAS. It is produced from L-cysteine by two enzymes; cystathionine-β-synthetase and cystathionine-γ-lyase, although, a third enzyme (3-mercaptosulphurtransferase) also has been associated with H₂S synthesis in mammals [751]. Expression of these enzymes is widespread throughout the body, but particularly in nervous tissue [752]. H₂S has been implicated in K⁺ channel opening and hyperpolarisation although H₂S-induced relaxations have been observed that do not involve K⁺ channels [753].

H₂S production has been demonstrated in the gastrointestinal tract, and both cystathionine-β-synthetase and cystathionine-γ-lyase are expressed along the rat and mouse intestine [754,755]. Cystathionine-β-synthetase and cystathionine-γ-lyase have been detected immunohistochemically and at the mRNA level in rat colonic smooth muscle cells [756,757]. H₂S is endogenously produced in the rat colon and it regulates colonic motility [754]. It has been reported that NaHS, a H₂S donor, relaxes a number of gastrointestinal tissues and inhibits smooth muscle contractile

responses to nerve stimulation [758]. There have been few studies of the role of H₂S in the IAS, but it was recently shown that H₂S contributes to inhibitory neurotransmission in the pig IAS [698]. However, NO remains the main mediator of relaxation in this tissue.

5.4. Vasoactive Intestinal Polypeptide (VIP)

Vasoactive intestinal polypeptide originally isolated from pig intestinal extracts [759] (Said & Mutt, 1970), also participates in NANC relaxation throughout the intestine, including the IAS of many species including man [731,733]. In particular in mice, electrical stimulation, particularly with longer stimulation trains of pulses, induces a slowly developing and long lasting NANC relaxation and hyperpolarisation, which is abolished in the presence of a VIP receptor antagonists and is absent in VIP-knockout mice [733]. It was proposed by these authors that the VIP pathway may be activated with greater rectal distensions, leading to a more prolonged period of anal relaxation.

Using genetic knockout of the biosynthetic enzymes for CO and NO, it has been shown at least in the mouse that the effects of exogenous and endogenous VIP in the IAS are mediated by heme oxygenase HO₂-synthesized CO [760]. At the postsynaptic level, many studies support the concept that VIP and NO are parallel co-transmitters, acting via the adenylate cyclase and guanylate cyclase pathways respectively. Based on results from gastrointestinal tract smooth muscle cells, VIP is thought to be the principal neurotransmitter, acting partly via a VPAC receptor, the cAMP pathway and by NO production [761]. In addition, the capacity of VIP to release NO from isolated smooth muscle cells is associated with the induction of iNOS in these cells [761]. Thus, VIP may mediate relaxation of the IAS by a direct effect and also modulation of other neurotransmitters (NO and CO).

In a comprehensive study of inhibitory neurotransmission in the pig IAS, the role of NO, CO and H₂S were examined after removing contractile responses with guanethidine (Figure 38). Inhibiting NO synthase reduced relaxations to EFS by about 50%. However after removing NO effects with a NOS inhibitor, the non-nitric relaxation of the pig IAS to field stimulation were further reduced by ODQ which suggests the involvement of CO in the relaxation of this tissue. This was confirmed using ZnPPiX an inhibitor of heme oxygenase which is responsible for the synthesis of CO. This inhibitor reduced IAS relaxation responses by about 20% and this effect was not additive with ODQ. These data suggest that the ODQ sensitive component of the relaxation is composed of predominantly NO (50%) but with a smaller contribution from CO (20%).

In the presence of ODQ, the remaining small, non-NO, non-CO relaxation must be mediated via a neurotransmitter that is cGMP-independent. It has been shown that the enzymes responsible for the production of H₂S are present in the enteric nerves and the

myenteric interstitial cells of Cajal [762], both of which can be found in the IAS [708,763]. Inhibition of H₂S synthesis with PAG and AOAA depressed relaxation responses to EFS and the depression was additive to that of ODQ and therefore independent of cGMP indicating a small role for H₂S in relaxation of the IAS to EFS. Thus inhibitory neurotransmission in the pig IAS involved all three gaseous neurotransmitters (NO>>CO=H₂S), illustrating the complex mechanisms involved in the transient relaxation of the IAS during defecation.

6. MYOGENIC ACTIVITY IN THE IAS AND RECTUM

6.1. Spontaneous Contractions

The spontaneous development of tone in IAS smooth muscle is an intrinsic property of the sphincter smooth muscle itself and develops independently of neuronal and hormonal influences [682]. Basal tone develops gradually (see Figure 39) and is associated with an elevation of intracellular calcium that involves ryanodine receptors, L-type Ca²⁺ channels and Ca²⁺-activated Cl⁻ channels [764]. The elevated intracellular calcium, via calmodulin, activates myosin light chain kinase (MLCK) and triggers an increase in basal tone.

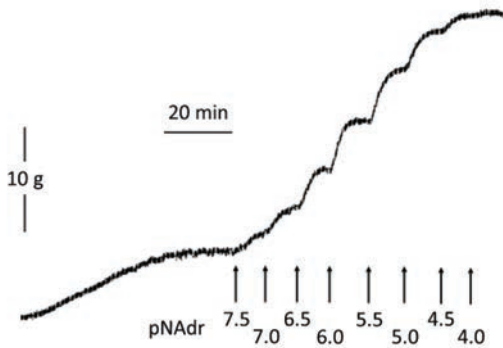

Figure 39. Noradrenaline and basal tension in IAS. Isolated IAS preparation showing a spontaneous rise in basal tension over 60min before the addition of noradrenaline (NAdr: 10^{-7.5} to 10⁻⁴ M) to generate tonic contractions.

Two intracellular mechanisms result in the development of smooth muscle contraction and spontaneous tone. The first is a direct contractile mechanism involving increases in intracellular calcium which activate calmodulin thereby activating myosin light chain (MLC) kinase and phosphorylation of MLC to induce contraction. Stimulation of G-protein linked receptors, eg muscarinic receptors in the rectum or α₁-adrenoceptors in the IAS, increases intracellular calcium and induces contraction via this mechanism. Ca²⁺ release from the sarcoplasmic reticulum of IAS is the initial signal for the generation of IAS smooth

muscle basal tone and maintenance, and this increased Ca²⁺ then activates Ca²⁺-activated Cl⁻ channels which activated the L-type Ca²⁺ channels [764]. Also, extracellular Ca²⁺ influx via L-type Ca²⁺ channels and contribute to the maintenance of IAS basal tone in many species including man [737,765].

The second mechanism for muscle tone development occurs simultaneously to elevation of intracellular Ca²⁺, and is known as Ca²⁺-sensitisation. This mechanism involves an inhibition of the dephosphorylation of MLC by MLC-phosphatase via the Rho/ROCK pathway [766,767]. Rho is a small GTP binding protein which can interact with a serine/threonine kinase known as ROCK (Rho activated, coiled coil containing protein kinase 2). Rho when bound to GTP, activates ROCK which can phosphorylate and inhibit MLC-phosphatase. There are two isoforms of ROCK (I and II) and although both forms are found in smooth muscle it is ROCKII that is expressed in visceral smooth muscle [768]. The inhibition of MLC-phosphatase results in reduced de-phosphorylation of MLC and more contractile force development for a given calcium concentration. Hence the pathway is also known as the Ca²⁺-sensitisation pathway and leads to tonic myogenic force development.

In tissues that have significant myogenic tone such as the IAS, the Rho/ROCK pathway is active even in unstimulated muscle cells and can result in the development of spontaneous basal contraction. Thus Rho/ROCK levels are greater in IAS smooth muscle than rectal smooth muscle [769,770]. Moreover, Rho kinase (ROCK) is also important in the maintenance of IAS smooth muscle basal tone [771-773]. The molecular basis for the basal myogenic tone in the IAS was examined and compared to rectal smooth muscle (a mixture of phasic and tonic), and anococcygeus smooth muscle (phasic muscle) in the rat [769]. The levels of Rho/ROCK were higher at the cell membrane in the IAS compared with those from the rectal and anococcygeus smooth muscle. Also, a RhoA inhibitor (C3 exoenzyme) and a ROCK inhibitor (Y27632) caused relaxations of the IAS illustrating a basal level of pathway activation.

For the rectum, the literature on the characterisation of spontaneous phasic activity is quite limited. However the role of this system has been investigated in the rat rectum where both PKC and Rho/ROCK appear to play a significant role in slow-rate high-amplitude spontaneous phasic activity. However, only the RhoA/ROCK pathway mediated fast-rate low-amplitude phasic activity [774]. Extracellular signals for Rho/ROCK activation system in human IAS and rectum have been sought and the renin-angiotensin and arachidonic acid pathways provide such a link by activating RhoA/ROCK for the maintenance of basal tone [773].

The IAS had higher levels of expression of the biosynthetic machinery for the renin-angiotensin system (RAS) and the cyclooxygenase (COX) system than the rectum. Furthermore, inhibitors of the RAS and

COX pathways depressed IAS basal tone by 80% and 20% respectively, while the end products of these pathways angiotensin II (ANG II), thromboxane A₂ (TxA₂) and prostaglandin F_{2α} (PGF_{2α}) increased IAS tone [773].

Following receptor stimulation, two pathways may result in Rho activation. One involves activation of Rho/ROCK after receptor coupling with G_{12/13} G-proteins [775]. The other involves protein kinase C (PKC) inhibition of MLCP via phosphorylation of PKC-potentiator inhibitor (CPI-17), the endogenous inhibitory protein of MLCP [776]. In human IAS smooth muscle, phorbol esters which activate PKC and the Rho/ROCK pathway cause contraction [777]. Since this pathway controls IAS myogenic tone, drugs that modulate the Rho/ROCK pathway may offer new opportunities for drug development in the treatment of faecal incontinence.

6.2. Smooth Muscle Relaxation

Reduction of intracellular Ca²⁺ ([Ca²⁺]_i) induces smooth muscle relaxation; although Ca²⁺-independent smooth muscle relaxation can occur, a phenomenon known as Ca²⁺ desensitisation [778]. Smooth muscle relaxation ([Ca²⁺]_i dependent or independent of reduced [Ca²⁺]_i) has been associated with activation of cGMP-dependent protein kinase (PKG) and cAMP-dependent protein kinase (PKA). These kinases are induced by gaseous transmitters such as NO, carbon monoxide (CO) and GPCR activation respectively [779-781]. PKG and PKA-induce smooth muscle relaxation even when [Ca²⁺]_i is unchanged (Ca²⁺-desensitisation), because activation of PKG inhibits Rho, thereby reducing the sensitivity of the contraction process to calcium [782,783]. Furthermore, PKG can induce calcium desensitisation by phosphorylating CPI-17 [784].

In the sheep IAS, endogenous angiotensin II (Ang II) is another agent involved in maintaining basal tone and contraction of the IAS smooth muscle [773,785,786]. The biosynthetic machinery for Ang II is present in the IAS of rat, and the agent may be synthesised locally [785]. Early studies in the IAS smooth muscle of rat demonstrated the presence of ANG II and also AT₁ receptors [785]. AT₁ and AT₂ receptors are expressed in the IAS smooth muscle of rat [787]. However, ANG II causes contraction of rat IAS smooth muscle by the activation of AT₁ receptors at the smooth muscle cell and involves multiple intracellular pathways including influx of Ca²⁺, and activation of protein kinase C and ROCK [787]. It is concluded that basal IAS tone is partially under the autocrine control of the cellular renin-angiotensin system and is evident in the expression of angiotensinogen, renin, and angiotensin-converting enzyme in the IAS smooth muscle cells [786]. Also, Ang II causes an increase in the IAS smooth muscle tone via activation of RhoA/ROCK in the human [773]. Thus the renin-angiotensin system may mediate IAS basal tone and contractile responses.

7. INTERSTITIAL CELLS OF CAJAL (ICC) AND SPONTANEOUS CONTRACTILE ACTIVITY

Interstitial cells of Cajal (ICC) are specialised cells distributed throughout the gastrointestinal tract including the rectum and IAS [788]. Various populations of ICC exist which have different functions (pacemaker vs neurotransmission) and also morphology. One population makes synaptic connections with efferent parasympathetic nerves and via gap junctions with smooth muscle fibres. The other population of ICC are located in the myenteric/submucosal plexuses, where they are thought to act as pacemakers of contractile activity. In these cells spontaneous phasic slow wave activity passes between ICC and muscle fibres via gap junction and these can summate and initiate phasic contractile activity [15,789]. The contractile functions of the rectum and anus differ (phasic vs tonic) and these differences in function are reflected in the characteristics of their respective ICC. Rectal ICC more closely resemble the spindle-shaped, intramuscular ICC found throughout the rest of the gastrointestinal tract and their density is greater than that in the IAS [694,790].

The function of the anal sphincter is to develop tone rather than phasic contractile activity and the IAS differs from the rectum in having a predominantly sympathetic excitatory input and also a different distribution of ICC. In this tissue, the sympathetic motor fibres do not appear to be associated with intramuscular ICC. Thus sympathetic nerves are likely to innervate directly the smooth muscle of the IAS and may contribute to myogenic tone [694,791].

As in the rectum the IAS has a nitrergic innervation, but unlike the rectum, this does not seem to innervate the ICCs. The role of ICCs has been investigated in mice deficient in these cells (*W/W^v* mice) and these studies have identified a dense network of ICCs in the IAS of normal but not mutated mice, but relaxation responses to EFS were normal suggesting only a minor role for ICC in the sphincter [792]. It is also unclear whether ICCs are essential for the RAIR, with conflicting reports concerning the effect deletions in mutant mice [793,794]. Thus in the sphincter, ICC may have a role in regulating muscle tone, and basal myogenic tone is lower in ICC deficient mice compared with controls. The intramuscular ICC contribute to the electrical events underlying nitrergic neuromuscular transmission in the mouse IAS [792] and the enzyme heme oxygenase, which produces CO, has been found to be present in the myenteric and submucosal neurones of the IAS as well as in the ICCs found in this tissue [795].

Thus ICC in the rectum and anus differ, reflecting the different functions of these two tissues. There is also growing evidence that ICC play a role in sensory mechanisms in the gastrointestinal tract. Vagal afferent nerve endings are found in close proximity to ICC

and may be involved in stretch perception since in the bladder, they release ATP when stretched, a chemical known to sensitise afferent nerves [796].

8. MUCOSAL INFLUENCES ON THE ANAL SPHINCTER

In the lower urinary tract, the lining of the bladder, the urothelium/lamina propria, releases a number of factors thought to be involved in bladder control (Figure

40). Specifically of interest, the urothelium/lamina propria releases a factor which inhibits contraction of the smooth muscle [797,798]. A similar mechanism was recently shown to inhibit contractility of the smooth muscle of the internal anal sphincter. This inhibition does not involve ATP acting via purinergic P2 receptors and is not NO, CO or H₂S [799]. Whilst the precise mechanism of mucosal inhibition remains to be elucidated, it may provide a novel target for development of drugs to increase tone in the internal anal sphincter and thus treat faecal incontinence.

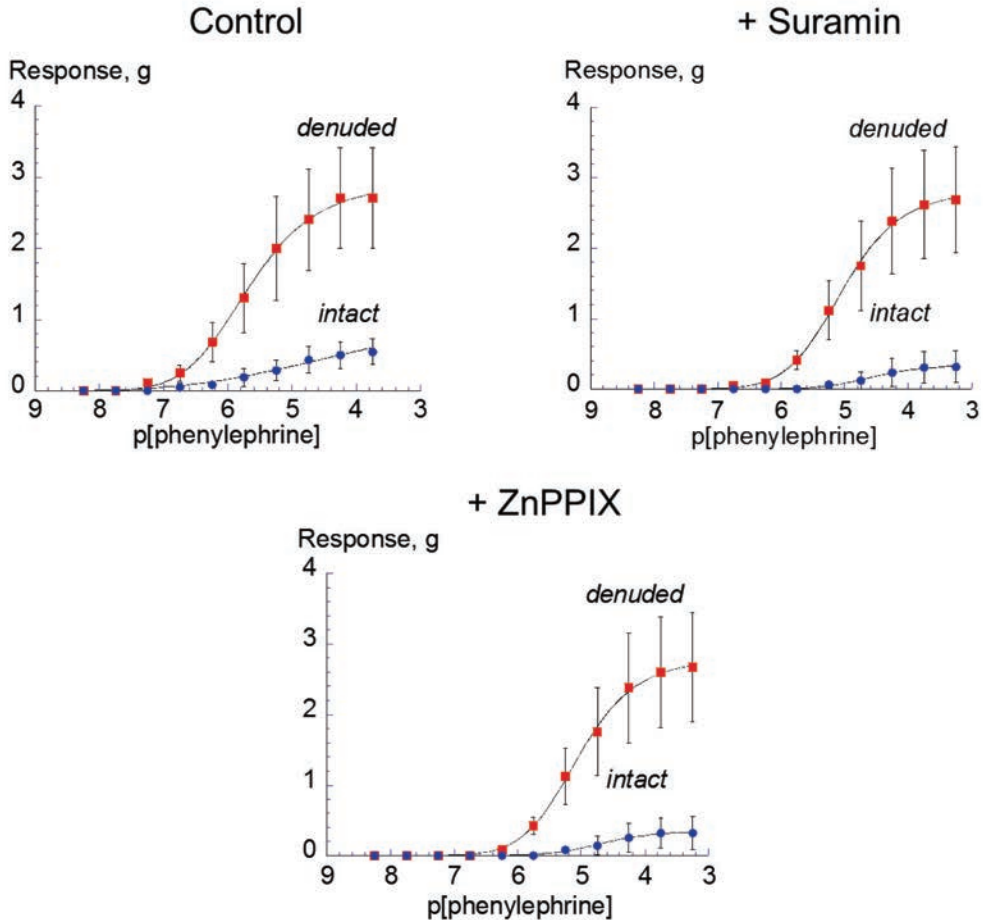

Figure 40. Inhibition of porcine IAS responses to phenylephrine in the presence of an intact mucosa. Denuded tissue strips have mucosa removed. Dose responses to phenylephrine (range 10^{-7.5} to 10⁻⁴ M) in control conditions or in the presence of suramin or ZnPPiX. *p<0.05, ***p<0.001 compared to response of denuded tissues.

X. RECOMMENDATIONS FOR FUTURE RESEARCH

It is not the purpose to list a number of research projects but to highlight those areas that are more novel and/or under-investigated. Implicit is the appreciation that an understanding of changes to LUT and lower gastro-intestinal tract function associated with clinical conditions can only be achieved by a detailed characterisation of normal function. A description of particular pathways and processes in these tissues will not necessarily lead to targeted drug models but will provide avenues for exploration. Therefore, no particular potential targets amenable to treatment by particular drugs or other external drivers will be identified here. However, potential research areas of interest include:

Understand the basis of spontaneous contractile activity in the bladder, especially the role of any inter-relationship between mucosa and detrusor layers.

1. Characterise the basis of contraction in the trigone.
2. Describe the contractile properties of the *muscularis mucosae* and other non-detrusor muscles in the bladder wall.
3. Identify the role of interstitial cells in regulating the functional characteristics of tissue in which they are embedded in normal and pathological conditions.
4. Characterise the control of water and electrolyte transport by the urothelium and its physiological role in salt and water balance.
5. Determine the functional development of the normal lower urinary tract and the lower gastro-intestinal tract during embryonic development and further changes in childhood.
6. Characterise the changes to lower urinary tract function, at cellular, tissue and system levels in children with congenital anomalies of the tract.
7. Investigate electromechanical coupling of the pelvic floor musculature.
8. Characterise the cellular and tissue physiology of external urethral sphincter skeletal muscle as a prelude to pathological changes to sphincter function.
9. Describe the functional inter-relationship between changes to the lower urinary tract and other visceral organs and tissues.
10. Characterise the role of clock genes to determine diurnal variability in lower urinary tract and lower-gastrointestinal tract contractile and transport functions.

11. Investigate the inter-relationship between excitatory and inhibitory control over ano-rectal function.
12. Describe the underlying mechanisms underlying filling sensations in the lower-gastrointestinal tract
13. Determine how ageing *per se* affects lower urinary tract and lower-gastrointestinal tract functions.

REFERENCES

1. Brading AF. Spontaneous activity of lower urinary tract smooth muscles: correlation between ion channels and tissue function. *J Physiol* 2006; 570: 13-22.
2. Robertson AS. Behaviour of the human bladder during natural filling: the Newcastle experience of ambulatory monitoring and conventional artificial filling cystometry. *Scand J Urol Nephrol Suppl* 1999; 201: 19-24.
3. Drake MJ, Harvey IJ, Gillespie JI, Van Duyl WA. Localized contractions in the normal human bladder and in urinary urgency. *BJU Int* 2005; 95: 1002-1005.
4. Streng T, Hedlund P, Talo A, Andersson KE, Gillespie JI. Phasic non-micturition contractions in the bladder of the anaesthetized and awake rat. *BJU Int* 2006; 97: 1094-1101.
5. Biallostowski BT, van Koevinge GA, van Kerbroeck PE, Gillespie JI, de Wachter SG. Non-voiding activity of the guinea pig bladder. *J Urol* 2011; 186: 721-727.
6. Drake MJ, Harvey IJ, Gillespie JI. Autonomous activity in the isolated guinea pig bladder. *Exp Physiol* 2003; 88: 19-30.
7. Parsons BA, Drake MJ, Gammie A, Fry CH, Vahabi B. The validation of a functional, isolated pig bladder model for physiological experimentation. *Front Pharmacol* 2012; 3: 52.
8. Hammad FT, Stephen B, Lubbad L, Morrison JF, Lammers WJ. Macroscopic electrical propagation in the guinea pig urinary bladder. *Am J Physiol Renal Physiol* 2014; 307: F172-182.
9. Sibley GN. A comparison of spontaneous and nerve-mediated activity in bladder muscle from man, pig and rabbit. *J Physiol* 1984; 354: 431-443.
10. Vahabi B, Sellers DJ, Bijos DA, Drake MJ. Phasic contractions in urinary bladder from juvenile versus adult pigs. *PLoS One* 2013; 8: e58611.
11. Hashitani H, Brading AF, Suzuki H. Correlation between spontaneous electrical, calcium and mechanical activity in detrusor smooth muscle of the guinea-pig bladder. *Br J Pharmacol* 2004; 141: 183-193.
12. Vahabi B, Drake MJ. Physiological and pathophysiological implications of micromotion activity in urinary bladder function. *Acta Physiol* 2015; 213: 360-370.
13. Heppner TJ, Tykocki NR, Hill-Eubanks D, Nelson MT. Transient contractions of urinary bladder smooth muscle are drivers of afferent nerve activity during filling. *J Gen Physiol* 2016; 147: 323-335.
14. McCloskey KD, Gurney AM. Kit positive cells in the guinea pig bladder. *J Urol* 2002; 168: 832-836.
15. Sanders KM, Ward SM, Koh SD. Interstitial cells: regulators of smooth muscle function. *Physiol Rev* 2014; 94: 859-907.
16. Kubota Y, Biers SM, Kohri K, Brading AF. Effects of imatinib mesylate (Glivec) as a c-kit tyrosine kinase inhibitor in the guinea-pig urinary bladder. *NeuroUrol Urodyn* 2006; 25: 205-210.
17. Hashitani H, Yanai Y, Suzuki H. Role of interstitial cells and gap junctions in the transmission of spontaneous Ca^{2+} signals in detrusor smooth muscles of the guinea-pig urinary bladder. *J Physiol* 2004; 559: 567-581.
18. Hashitani H, Hayase M, Suzuki H. Effects of imatinib mesylate on spontaneous electrical and mechanical activity in smooth muscle of the guinea-pig stomach. *Br J Pharmacol* 2008; 154: 451-459.
19. Beckett EA, Ro S, Bayguinov Y, Sanders KM, Ward SM. Kit signaling is essential for development and maintenance of interstitial cells of Cajal and electrical rhythmicity in the embryonic gastrointestinal tract. *Dev Dyn* 2007; 236: 60-72.
20. McCloskey KD, Anderson UA, Davidson RA, Bayguinov YR, Sanders KM, Ward SM. Comparison of mechanical and electrical activity and interstitial cells of Cajal in urinary bladders from wild-type and W/W^v mice. *Br J Pharmacol* 2009; 156: 273-283.
21. Koh BH, Roy R, Hollywood MA, Thornbury KD, McHale NG, Sergeant GP, Hatton WJ, Ward SM, Sanders KM, Koh SD. Platelet-derived growth factor receptor- α cells in mouse urinary bladder: a new class of interstitial cells. *J Cell Mol Med*. 2012; 16: 691-700.
22. Montgomery BS, Fry CH. The action potential and net membrane currents in isolated human detrusor smooth muscle cells. *J Urol* 1992; 147: 176-184.
23. Wellner MC, Isenberg G. Stretch effects on whole-cell currents of guinea-pig urinary bladder myocytes. *J Physiol* 1994; 480: 439-448.
24. Hashitani H, Brading AF. Electrical properties of detrusor smooth muscles from the pig and human urinary bladder. *Br J Pharmacol* 2003; 140: 146-158.
25. Hashitani H, Brading AF. Ionic basis for the regulation of spontaneous excitation in detrusor smooth muscle cells of the guinea-pig urinary bladder. *Br J Pharmacol* 2003; 140: 159-169.

26. Fry CH, Jabr RI. T-type Ca^{2+} channels and the urinary and male genital tracts. *Pflugers Arch* 2014; 466: 781-789.
27. Sui GP, Wu C, Fry CH. Inward calcium currents in cultured and freshly isolated detrusor muscle cells: evidence of a T-type calcium current. *J Urol* 2001; 165: 621-626
28. Sui GP, Wu C, Fry CH. A description of Ca^{2+} channels in human detrusor smooth muscle. *BJU Int* 2003; 92: 476-482.
29. Yanai Y, Hashitani H, Kubota Y, Sasaki S, Kohri K, Suzuki H. The role of Ni^{2+} -sensitive T-type Ca^{2+} channels in the regulation of spontaneous excitation in detrusor smooth muscles of the guinea-pig bladder. *BJU Int* 2006; 97: 182-189.
30. Lang RJ, Tonta MA, Takano H, Hashitani H. Voltage-operated Ca^{2+} currents and Ca^{2+} -activated Cl^- currents in single interstitial cells of the guinea-pig prostate. *BJU Int* 2014; 114: 436-446.
31. Sui GP, Wu C, Severs N, Newgreen D, Fry CH. The association between T-type Ca^{2+} current and outward current in isolated human detrusor cells from stable and overactive bladders. *BJU Int* 2007; 99: 436-441.
32. Sui G, Fry CH, Malone-Lee J, Wu C. Aberrant Ca^{2+} oscillations in smooth muscle cells from overactive human bladders. *Cell Calcium* 2009; 45: 456-464.
33. Sergeant GP, Hollywood MA, McCloskey KD, Thornbury KD, McHale NG. Specialised pace-making cells in the rabbit urethra. *J Physiol* 2000; 526: 359-366.
34. Kajioka S, Nakayama S, McCoy R, McMurray G, Abe K, Brading AF. Inward current oscillation underlying tonic contraction caused via ETA receptors in pig detrusor smooth muscle. *Am J Physiol Renal Physiol* 2004; 286: F77-85.
35. Bijos DA, Drake MJ, Vahabi B. Anoctamin-1 in the juvenile rat urinary bladder. *PLoS One* 2014; 9: e106190.
36. Li L, Jiang C, Song B, Yan J, Pan J. Altered expression of calcium-activated K and Cl channels in detrusor overactivity of rats with partial bladder outlet obstruction. *BJU Int* 2008; 101: 1588-1594.
37. Hashitani H, Bramich NJ, Hirst GD. Mechanisms of excitatory neuromuscular transmission in the guinea-pig urinary bladder. *J Physiol* 2000; 524: 565-579.
38. Sergeant GP, Hollywood MA, McHale NG, Thornbury KD. Spontaneous Ca^{2+} activated Cl^- currents in isolated urethral smooth muscle cells. *J Urol* 2001; 166: 1161-1166.
39. Singh RD, Gibbons SJ, Saravanaperumal SA, Du P, Hennig GW, Eisenman ST, Mazzone A, Hayashi Y, Cao C, Stoltz GJ, Ordog T, Rock JR, Harfe BD, Szurszewski JH, Farrugia G. Ano1 , a Ca^{2+} -activated Cl^- channel, coordinates contractility in mouse intestine by Ca^{2+} transient coordination between interstitial cells of Cajal. *J Physiol* 2014; 592: 4051-4068
40. Gevaert T, Vriens J, Segal A, Everaerts W, Roskams T, Talavera K, Owsianik G, Liedtke W, Daelemans D, Dewachter I, Van Leuven F, Voets T, De Ridder D, Nilius B. Deletion of the transient receptor potential cation channel TRPV_4 impairs murine bladder voiding. *J Clin Invest* 2007; 117: 3453-3462.
41. Thorneloe KS, Sulpizio AC, Lin Z, Figueroa DJ, Clouse AK, McCafferty GP, Chendrimada TP, Lashinger ES, Gordon E, Evans L, Misajet BA, Demarini DJ, Nation JH, Casillas LN, Marquis RW, Votta BJ, Sheardown SA, Xu X, Brooks DP, Laping NJ, Westfall TD. N-((1S)-1-((4-((2S)-2-((2,4-dichlorophenyl)sulfonyl)amino)-3-hydroxy propanoyl)-1-piperazinyl)carbonyl)-3-methylbutyl)-1-benzothiophene-2-carboxamide (GSK1016790A), a novel and potent transient receptor potential vanilloid 4 channel agonist induces urinary bladder contraction and hyperactivity: Part I. *J Pharmacol Exp Ther* 2008; 326: 432-442
42. Young JS, Johnston L, Soubrane C, McCloskey KD, McMurray G, Eccles R, Fry CH. The passive and active contractile properties of the neurogenic, underactive bladder. *BJU Int* 2013; 111: 355-361
43. Yoshiyama M, Mochizuki T, Nakagomi H, Miyamoto T, Kira S, Mizumachi R, Sokabe T, Takayama Y, Tominaga M, Takeda M. Functional roles of TRPV_1 and TRPV_4 in control of lower urinary tract activity: dual analysis of behavior and reflex during the micturition cycle. *Am J Physiol Renal Physiol* 2015; 308: F1128-1134
44. Isogai A, Lee K, Mitsui R, Hashitani H. Functional coupling of TRPV_4 channels and BK channels in regulating spontaneous contractions of the guinea-pig urinary bladder. *Pflugers Arch*. 2016
45. Smith AC, Parajuli SP, Hristov KL, Cheng Q, Soder RP, Afeli SA, Earley S, Xin W, Malysz J, Petkov GV. TRPM4 channel: a new player in urinary bladder smooth muscle function in rats. *Am J Physiol Renal Physiol* 2013; 304: F918-929 & 304: C467-477
46. Hristov KL, Smith AC, Parajuli SP, Malysz J, Rovner ES, Petkov GV. Novel regulatory mechanism in human urinary bladder: central role of transient receptor potential melastatin 4 channels in detrusor smooth muscle function. *Am J Physiol Cell Physiol* 2016; 310: C600-611.

47. Petkov GV. Role of potassium ion channels in detrusor smooth muscle function and dysfunction. *Nat Rev Urol* 2011; 9: 30-40.
48. Petkov GV. Central role of the BK channel in urinary bladder smooth muscle physiology and pathophysiology. *Am J Physiol Regul Integr Comp Physiol* 2014; 307: R571-584.
49. Hayase M, Hashitani H, Kohri K, Suzuki H. Role of K⁺ channels in regulating spontaneous activity in detrusor smooth muscle in situ in the mouse bladder. *J Urol* 2009; 181: 2355-2365.
50. Hristov KL, Chen M, Kellett WF, Rovner ES, Petkov GV. Large-conductance voltage- and Ca²⁺-activated K⁺ channels regulate human detrusor smooth muscle function. *Am J Physiol Cell Physiol* 2011; 301: C903-912.
51. Herrera GM, Nelson MT. Differential regulation of SK and BK channels by Ca²⁺ signals from Ca²⁺ channels and ryanodine receptors in guinea-pig urinary bladder myocytes. *J Physiol* 2002; 541: 483-492.
52. Meredith AL, Thorneloe KS, Werner ME, Nelson MT, Aldrich RW. Overactive bladder and incontinence in the absence of the BK large conductance Ca²⁺-activated K⁺ channel. *J Biol Chem* 2004; 279: 36746-36752.
53. Layne JJ, Nausch B, Olesen SP, Nelson MT. BK channel activation by NS11021 decreases excitability and contractility of urinary bladder smooth muscle. *Am J Physiol Regul Integr Comp Physiol* 2010; 298: R378-384.
54. Koh BH, Roy R, Hollywood MA, Thornbury KD, McHale NG, Sergeant GP, Hatton WJ, Ward SM, Sanders KM, Koh SD. Platelet-derived growth factor receptor- α cells in mouse urinary bladder: a new class of interstitial cells. *J Cell Mol Med* 2012; 16: 691-700.
55. Lee H, Koh BH, Peri LE, Sanders KM, Koh SD. Functional expression of SK channels in murine detrusor PDGFR⁺ cells. *J Physiol* 2013; 591: 503-513.
56. Herrera GM, Pozo MJ, Zvara P, Petkov GV, Bond CT, Adelman JP, Nelson MT. Urinary bladder instability induced by selective suppression of the murine small conductance calcium-activated potassium (SK3) channel. *J Physiol* 2003; 551: 893-903.
57. Thorneloe KS, Knorn AM, Doetsch PE, Lashinger ES, Liu AX, Bond CT, Adelman JP, Nelson MT. Small-conductance, Ca²⁺-activated K⁺ channel 2 is the key functional component of SK channels in mouse urinary bladder. *Am J Physiol Regul Integr Comp Physiol* 2008; 294: R1737-1743.
58. Parajuli SP, Hristov KL, Soder RP, Kellett WF, Petkov GV. NS309 decreases rat detrusor smooth muscle membrane potential and phasic contractions by activating SK3 channels. *Br J Pharmacol* 2013; 168: 1611-1625
59. Soder RP, Parajuli SP, Hristov KL, Rovner ES, Petkov GV. SK channel-selective opening by SKA-31 induces hyperpolarization and decreases contractility in human urinary bladder smooth muscle. *Am J Physiol Regul Integr Comp Physiol* 2013; 304: R155-163.
60. Takagi H, Hashitani H. Effects of K⁺ channel openers on spontaneous action potentials in detrusor smooth muscle of the guinea-pig urinary bladder. *Eur J Pharmacol.* 2016; 789:179-186.
61. Afeli SA, Malysz J, Petkov GV. Molecular expression and pharmacological evidence for a functional role of Kv7 channel subtypes in guinea pig urinary bladder smooth muscle. *PLoS One.* 2013; 8: e75875.
62. Anderson UA, Carson C, Johnston L, Joshi S, Gurney AM, McCloskey KD. Functional expression of KCNQ (Kv7) channels in guinea pig bladder smooth muscle and their contribution to spontaneous activity. *Br J Pharmacol* 2013; 169: 1290-304.
63. Provence A, Malysz J, Petkov GV. The novel KV7.2/KV7.3 channel opener ICA-069673 reveals subtype-specific functional roles in guinea pig detrusor smooth muscle excitability and contractility. *J Pharmacol Exp Ther* 2015; 354: 290-301.
64. Thorneloe KS, Nelson MT. Properties and molecular basis of the mouse urinary bladder voltage-gated K⁺ current. *J Physiol* 2003; 549: 65-74.
65. Andersson KE. The pharmacological perspective: role for the sympathetic nervous system in micturition and sexual function. *Prostate Cancer Prostatic Dis* 1999; 2: S5-S8
66. Gosling JA. The distribution of noradrenergic nerves in the human lower urinary tract. *Clin Sci* 1986; 70 Suppl 14: 3s-6s.
67. Gabella G. Nerve control of bladder function. In: Bolis L, Licinio J, Govoni S eds. *Handbook of the Autonomic Nervous System in Health and Disease*, Marcel Dekker, inc., 2002; pp589-633.
68. Persson K, Andersson KE. Nitric oxide and relaxation of pig lower urinary tract. *Br J Pharmacol* 1992; 106: 416-422.
69. Hashitani H, Takano H, Fujita K, Mitsui R, Suzuki H. Functional properties of suburothelial microvessels in the rat bladder. *J Urol* 2011; 185: 2382-2391.

70. Shimizu Y, Mochizuki S, Mitsui R, Hashitani H. Neurohumoral regulation of spontaneous constrictions in suburothelial venules of the rat urinary bladder. *Vascul Pharmacol* 2014; 60: 84-94.
71. Andersson KE, Wein AJ. Pharmacology of the lower urinary tract: basis for current and future treatments of urinary incontinence. *Pharmacol Rev* 2004; 56: 581-631.
72. Hristov KL, Cui X, Brown SM, Liu L, Kellett WF, Petkov GV. Stimulation of β_3 -adrenoceptors relaxes rat urinary bladder smooth muscle via activation of the large-conductance Ca^{2+} -activated K^+ channels. *Am J Physiol Cell Physiol* 2008; 295: C1344-1353
73. Xin W, Li N, Cheng Q, Petkov GV. BK channel-mediated relaxation of urinary bladder smooth muscle: a novel paradigm for phosphodiesterase type 4 regulation of bladder function. *J Pharmacol Exp Ther* 2014; 349: 56-65
74. Cernecka H, Kersten K, Maarsingh H, Elzinga CR, de Jong IJ, Korstanje C, Michel MC, Schmidt M (2015). β_3 -Adrenoceptor-mediated relaxation of rat and human urinary bladder: roles of BKCa channels and Rho kinase. *Naunyn Schmiedebergs Arch Pharmacol* 2015; 388: 749-759
75. Steers WD, Broder SR, Persson K, Bruns DE, Ferguson JE 2nd, Bruns ME, Tuttle JB. Mechanical stretch increases secretion of parathyroid hormone-related protein by cultured bladder smooth muscle cells. *J Urol* 1998; 160: 908-912.
76. Nishikawa N, Kanematsu A, Negoro H, Imamura M, Sugino Y, Okinami T, Yoshimura K, Hashitani H, Ogawa O. PTHrP is endogenous relaxant for spontaneous smooth muscle contraction in urinary bladder of female rat. *Endocrinology* 2013; 154: 2058-2068.
77. Nishikawa N, Yago R, Yamazaki Y, Negoro H, Suzuki M, Imamura M, Toda Y, Tanabe K, Ogawa O, Kanematsu A. Expression of parathyroid hormone/parathyroid hormone-related peptide receptor 1 in normal and diseased bladder detrusor muscles: a clinico-pathological study. *BMC Urol* 2015; 15: 2.
78. Lee K, Mitsui R, Kajioaka S, Naito S, Hashitani H. Role of PTHrP and sensory nerve peptides in regulating the contractility of muscularis mucosae and detrusor smooth muscle in the guinea-pig bladder. *J Urol* 2016
79. Monaghan KP, Johnston L, McCloskey KD. Identification of PDGFR α positive populations of interstitial cells in human and guinea pig bladders. *J Urol* 2012; 188: 639-647
80. Lee H, Koh BH, Peri LE, Sanders KM, Koh SD. Purinergic inhibitory regulation of murine detrusor muscles mediated by PDGFR α interstitial cells. *J Physiol* 2014 15; 592: 1283-1293.
81. Uchiyama T, Chess-Williams R. Muscarinic receptor subtypes of the bladder and gastrointestinal tract. *J Smooth Muscle Res* 2004; 40: 237-247
82. Hegde SS. Muscarinic receptors in the bladder: from basic research to therapeutics. *Br J Pharmacol* 2006; 147 Suppl 2: S80-87
83. Yamanishi T, Kaga K, Fuse M, Shibata C, Kamai T, Uchiyama T. The role of muscarinic receptor subtypes on carbachol-induced contraction of normal human detrusor and overactive detrusor associated with benign prostatic hyperplasia. *J Pharmacol Sci* 2015; 128: 65-70.
84. Schneider T, Fetscher C, Krege S, Michel MC. Signal transduction underlying carbachol-induced contraction of human urinary bladder. *J Pharmacol Exp Ther* 2004; 309: 1148-1153.
85. Nausch B, Heppner TJ, Nelson MT. Nerve-released acetylcholine contracts urinary bladder smooth muscle by inducing action potentials independently of IP₃-mediated calcium release. *Am J Physiol Regul Integr Comp Physiol* 2010; 299: R878-888.
86. Parajuli SP, Hristov KL, Cheng Q, Malysz J, Rovner ES, Petkov GV. Functional link between muscarinic receptors and large-conductance Ca^{2+} -activated K^+ channels in freshly isolated human detrusor smooth muscle cells. *Pflugers Arch* 2015; 467: 665-675.
87. Takahashi R, Nishimura J, Hirano K, Seki N, Naito S, Kanaide H. Ca^{2+} sensitization in contraction of human bladder smooth muscle. *J Urol* 2004; 172: 748-752.
88. Tsai MH, Kamm KE, Stull JT. Signalling to contractile proteins by muscarinic and purinergic pathways in neurally stimulated bladder smooth muscle. *J Physiol* 2012; 590: 5107-5121
89. Bhetwal BP, Sanders KM, An C, Trapanese DM, Moreland RS, Perrino BA. Ca^{2+} sensitization pathways accessed by cholinergic neurotransmission in the murine gastric fundus. *J Physiol* 2013; 591: 2971-2986.
90. Hashitani H, Brading AF, Suzuki H. Correlation between spontaneous electrical, calcium and mechanical activity in detrusor smooth muscle of the guinea-pig bladder. *Br J Pharmacol* 2004; 141: 183-193.
91. Hayase M, Hashitani H, Suzuki H, Kohri K, Brading AF. Evolving mechanisms of action of alverine citrate on phasic smooth muscles. *Br J Pharmacol* 2007; 152: 1228-1238.

92. Wang T, Kendig DM, Trapanese DM, Smollock EM, Moreland RS. Phorbol 12,13-dibutyrate-induced, protein kinase C-mediated contraction of rabbit bladder smooth muscle. *Front Pharmacol* 2012; 2: 83.
93. Takahashi N, Shiomi H, Kushida N, Liu F, Ishibashi K, Yanagida T, Shishido K, Aikawa K, Yamaguchi O. Obstruction alters muscarinic receptor-coupled RhoA/Rho-kinase pathway in the urinary bladder of the rat. *Neurourol Urodyn* 2009; 28: 257-262.
94. Akaihata H, Nomiya M, Hata J, Yabe M, Takahashi N, Haga N, Kushida N, Ishibashi K, Aikawa K, Yamaguchi O, Kojima Y. Pelvic arterial occlusive disease affects the RhoA/Rho-kinase pathway in bladder smooth muscle. *J Urol* 2015; 193: 706-713.
95. Shahab N, Kajioka S, Takahashi-Yanaga F, Onimaru M, Matsuda M, Seki N, Naito S. Obstruction enhances rho-kinase pathway and diminishes protein kinase C pathway in carbachol-induced calcium sensitization in contraction of α -toxin permeabilized guinea pig detrusor smooth muscle. *Neurourol Urodyn* 2012; 31: 593-599.
96. Leiria LO, Sollon C, Calixto MC, Lintomen L, Mónica FZ, Anhê GF, De Nucci G, Zanesco A, Grant AD, Antunes E. Role of PKC and CaV1.2 in detrusor overactivity in a model of obesity associated with insulin resistance in mice. *PLoS One* 2012; 7: e48507.
97. Balkanci ZD, Pehlivanoğlu B, Bayrak S, Karabulut I, Karaismailoğlu S, Erdem A. The effect of hypercholesterolemia on carbachol-induced contractions of the detrusor smooth muscle in rats: increased role of L-type Ca²⁺ channels. *Naunyn Schmiedebergs Arch Pharmacol* 2012; 385: 1141-1148.
98. Nobe K, Fujii A, Saito K, Negoro T, Ogawa Y, Nakano Y, Hashimoto T, Honda K. Adiponectin enhances calcium dependency of mouse bladder contraction mediated by protein kinase C α expression. *J Pharmacol Exp Ther* 2013; 345: 62-68
99. Bayliss M, Wu C, Newgreen D, Mundy AR, Fry CH. A quantitative study of atropine-resistant contractile responses in human detrusor smooth muscle, from stable, unstable and obstructed bladders. *J Urol* 1999; 162: 1833-1839.
100. Johal N, Wood DN, Wagg AS, Cuckow P, Fry CH. Functional properties and connective tissue content of pediatric human detrusor muscle. *Am J Physiol Renal Physiol* 2014; 307: F1072-1079
101. Elliott RA, Tonnu A, Ghaffar N, Taylor AH, Tincello DG, Norman RI. Enhanced purinergic contractile responses and P2X₁ receptor expression in detrusor muscle during cycles of hypoxia-glucopenia and reoxygenation. *Exp Physiol* 2013; 98: 1683-1695.
102. Triguero D, Lafuente-Sanchis A, Garcia-Pascual A. Changes in nerve-mediated contractility of the lower urinary tract in a mouse model of premature ageing. *Br J Pharmacol* 2014; 171: 1687-1705.
103. Ito H, Aizawa N, Fujita Y, Suzuki M, Fukuhara H, Homma Y, Kubota Y, Ito M, Andersson KE, Igawa Y. Long-term caloric restriction in rats may prevent age related impairment of in vitro bladder function. *J Urol* 2015; 193: 2123-2130.
104. Afeli SA, Rovners ES, Petkov GV. BRL37344, a β_3 adrenergic receptor agonist, decreases nerve-evoked contractions in human detrusor smooth muscle isolated strips: role of BK channels. *Urology* 2013; 82: 744,e1-7.
105. Hayashi M, Kajioka S, Itsumi M, Takahashi R, Shahab N, Ishigami T, Takeda M, Masuda N, Yamaguchi A, Naito S. Actions of cAMP on calcium sensitization in human detrusor smooth muscle contraction. *BJU Int* 2016; 117: 179-191.
106. Sadananda P, Chess-Williams R, Burcher E. Contractile properties of the pig bladder mucosa in response to neurokinin A: a role for myofibroblasts? *Br J Pharmacol* 2008; 153: 1465-1473.
107. Moro C, Uchiyama J, Chess-Williams R. Urothelial/lamina propria spontaneous activity and the role of M3 muscarinic receptors in mediating rate responses to stretch and carbachol. *Urology* 2011; 78: 1442.e9-15.
108. Kushida N, Fry CH. On the origin of spontaneous activity in the bladder. *BJU Int* 2016; 117: 982-992.
109. Heppner TJ, Layne JJ, Pearson JM, Sarkissian H, Nelson MT. Unique properties of muscularis mucosae smooth muscle in guinea pig urinary bladder. *Am J Physiol Regul Integr Comp Physiol* 2011; 301: R351-362
110. Andersson KE, Nomiya M, Sawada N, Yamaguchi O. Pharmacological treatment of chronic pelvic ischemia. *Ther Adv Urol* 2014 ;6: 105-114.
111. Kullmann FA, Birder LA, Andersson KE. Translational Research and Functional Changes in Voiding Function in Older Adults. *Clin Geriatr Med* 2015; 31: 535-548.
112. Thurmond P, Yang JH, Azadzo KM. LUTS in pelvic ischemia: a new concept in voiding dysfunction. *Am J Physiol Renal Physiol* 2016 doi: 10.1152/ajprenal.00333.2015.

113. Azadzoï K, Tarcan T, Kozłowski R, Krane R, Si-roky M. Overactivity and structural changes in the chronically ischemic bladder. *J Urol* 1999; 162: 1768–1778.
114. Nomiya M, Yamaguchi O, Andersson KE, Sa-gawa K, Aikawa K, Shishido K, Yanagida T, Ku-shida N, Yazaki J, Takahashi N. The effect of atherosclerosis-induced chronic bladder ische-mia on bladder function in the rat. *NeuroUrol Urodyn* 2012; 31: 195-200.
115. Chiu JJ, Chien S. Effects of disturbed flow on vascular endothelium: pathophysiological basis and clinical perspectives. *Physiol Rev* 2011; 91: 327-387.
116. Steers WD, Clemow DB, Persson K, Sherer TB, Andersson KE, Tuttle JB. The spontane-ously hypertensive rat: insight into the patho-genesis of irritative symptoms in benign pros-tatic hyperplasia and young anxious males. *Exp Physiol* 1999; 84: 137-147.
117. Yoshida M, Masunaga K, Nagata T, Satoji Y, Shiomi M. The effects of chronic hyperlipidemia on bladder function in myocardial infarction-prone Watanabe heritable hyperlipidemic (WHHLMI) rabbits. *NeuroUrol Urodyn* 2010; 29: 1350-1354.
118. Miodoński AJ, Litwin JA. Microvascular archi-tecture of the human urinary bladder wall: a corrosion casting study. *Anat Rec* 1999; 254: 375-381.
119. Hashitani H, Mitsui R, Shimizu Y, Higashi R, Nakamura K. Functional and morphological properties of pericytes in suburothelial venules of the mouse bladder. *Br J Pharmacol* 2012; 167: 1723-1736.
120. Mitsui R, Hashitani H. Immunohistochemical characteristics of suburothelial microvascula-ture in the mouse bladder. *Histochem Cell Biol* 2013; 140: 189-200.
121. Mine S, Yamamoto T, Mizuno H, Endo K, Matsukawa Y, Funahashi Y, Kato M, Hattori R, Gotoh M. Effect of tamsulosin on bladder mi-crocirculation in rat model of bladder outlet ob-struction using pencil lens charge-coupled de-vice microscopy system. *Urology* 2013; 81: 155-159.
122. Mizuno H, Yamamoto T, Okutsu H, Ohtake A, Sasamata M, Matsukawa Y, Funahashi Y, Kato M, Hattori R, Gotoh M. Effect of tamsulosin on bladder microcirculation in a rat ischemia-reperfusion model, evaluated by pencil lens charge-coupled device microscopy system. *Urology* 2010; 76: 1266.e1-5
123. Roosen A, Wu C, Sui G, Chowdhury RA, Patel PM, Fry CH. Characteristics of spontaneous activity in the bladder trigone. *Eur Urol* 2009; 56: 346-353.
124. Callahan SM, Creed KE. Electrical and me-chanical activity of the isolated lower urinary tract of the guinea-pig. *Br J Pharmacol* 1981, 74: 353-358.
125. Akino H, Chapple CR, McKay N, Cross RL, Mu-rakami S, Yokoyama O, Chess-Williams R, Sellers DJ. Spontaneous contractions of the pig urinary bladder: the effect of ATP-sensitive po-tassium channels and the role of the mucosa. *BJU Int* 2008; 102: 1168-74.
126. Shafik A. Role of the trigone in micturition. *J Endourol* 1998; 12: 273-277.
127. Lentle RG, Reynolds GW, Janssen PW, Hulls CM, King QM, Chambers JP. Characterisation of the contractile dynamics of the resting ex vivo urinary bladder of the pig. *BJU Int* 2015; 116: 973-983.
128. Speakman MJ, Walmsley D, Brading AF. An in vitro pharmacological study of the human trigone - a site of non-adrenergic, non-choliner-gic neurotransmission. *Br J Urol* 1988; 61: 304-309.
129. Roosen A, Fry CH, Sui G, Wu C. Adreno-mus-carinic synergy in the bladder trigone: calcium-dependent and -independent mechanisms. *Cell Calcium* 2009; 45: 11-17.
130. Teixeira CE, Jin L, Priviero FB, Ying Z, Webb RC. Comparative pharmacological analysis of Rho-kinase inhibitors and identification of mo-lecular components of Ca²⁺ sensitization in the rat lower urinary tract. *Biochem Pharmacol* 2007; 74: 647-658
131. Pagala MK, Tetsoti L, Nagpal D, Wise GJ. Ag-ing effects on contractility of longitudinal and circular detrusor and trigone of rat bladder. *J Urol* 2001; 166: 721-727.
132. Templeman L, Chapple CR, Chess-Williams R. Urothelium derived inhibitory factor and cross-talk among receptors in the trigone of the bladder of the pig. *J Urol* 2002; 167: 742-745.
133. Persson K, Alm P, Johansson K, Larsson B, Andersson KE. Nitric oxide synthase in pig lower urinary tract: immunohistochemistry, NADPH diaphorase histochemistry and func-tional effects. *Br J Pharmacol* 1993; 110: 521-530.
134. Noda K, Takebe M, Oka M, Hirouchi M, Ukai Y, Toda N. Functional role of inhibitory and exci-tatory nerves in the porcine lower urinary tract. *Eur J Pharmacol* 2002; 456: 81-90.
135. Masuda H, Yano M, Sakai Y, Kihara K, Goto M, Azuma H. Roles of accumulated endogenous nitric oxide synthase inhibitors and decreased nitric oxide synthase activity for impaired trigo-nal relaxation with ischemia. *J Urol* 2003; 170: 1415-1420.

136. Brading AF, McCloskey KD. Mechanisms of disease: specialized interstitial cells of the urinary tract--an assessment of current knowledge. *Nat Clin Pract Urol* 2005; 2: 546-554.
137. Thornbury KD, Hollywood MA, McHale NG, Sergeant GP. Cajal beyond the gut: interstitial cells in the urinary system--towards general regulatory mechanisms of smooth muscle contractility. *Acta Gastroenterol Belg* 2011; 74: 536-542.
138. McCloskey KD. Interstitial cells and bladder pathophysiology - passive bystanders or active participants? *J Urol* 2011;185:1562-1563.
139. Kubota Y, Kojima Y, Shibata Y, Imura M, Sasaki S, Kohri K. Role of KIT-positive interstitial cells of Cajal in the urinary bladder and possible therapeutic target for overactive bladder. *Adv Urol* 2011; 2011: 816342.
140. McCloskey KD. Bladder interstitial cells: an updated review of current knowledge *Acta Physiol (Oxf)* 2013; 207: 7-15.
141. Kuijpers KA, Heesakkers JP, Hafmans TG, Schalken JA. An update of the interstitial cell compartment in the normal human bladder *Biomed Res Int.* 2014; 2014: 464217.
142. Andersson KE, McCloskey KD. Lamina propria: the functional center of the bladder?. *Neurourol Urodyn* 2014; 33: 9-16.
143. Smet PJ, Jonavicius J, Marshall VR, de Vente J. Distribution of nitric oxide synthase-immunoreactive nerves and identification of the cellular targets of nitric oxide in guinea-pig and human urinary bladder by cGMP immunohistochemistry. *Neuroscience* 1996; 71: 337-348.
144. Sui GP, Rothery S, Dupont E, Fry CH, Severs NJ. Gap junctions and connexin expression in human suburothelial interstitial cells. *BJU Int* 2002; 90: 118-129.
145. Davidson RA, McCloskey KD. Morphology and localization of interstitial cells in the guinea pig bladder: structural relationships with smooth muscle and neurons. *J Urol* 2005; 173: 1385-1390.
146. Gevaert T, Hutchings G, Everaerts W, Prenen H, Roskams T, Nilius B, de Ridder D. Administration of imatinib mesylate in rats impairs the neonatal development of intramuscular interstitial cells in bladder and results in altered contractile properties. *Neurourol Urodyn* 2014; 33: 461-468.
147. Johnston L, Woolsey S, Cunningham RM, O'Kane H, Duggan B, Keane P, McCloskey KD. Morphological expression of KIT positive interstitial cells of Cajal in human bladder. *J Urol* 2010; 184: 370-377.
148. Gray SM, McGeown JG, McMurray G, McCloskey KD. Functional innervation of Guinea-pig bladder interstitial cells of cajal subtypes: neurogenic stimulation evokes in situ calcium transients. *PLoS One* 2013, 8; e53423.
149. Hashitani H, Mitsui R, Masaki S, van Helden DF. Pacemaker role of pericytes in generating synchronized spontaneous Ca²⁺ transients in the myenteric microvasculature of the guinea-pig gastric antrum. *Cell Calcium* 2015; 58: 442-456.
150. de Jongh R, van Koeveeringe GA, van Kerrebroeck PE, Markerink-van Ittersum M, de Vente J, Gillespie JI. Alterations to network of NO/cGMP-responsive interstitial cells induced by outlet obstruction in guinea-pig bladder. *Cell Tissue Res* 2007; 330: 147-160.
151. Collins C, Klausner AP, Herrick B, Koo HP, Miner AS, Henderson SC, Ratz PH. Potential for control of detrusor smooth muscle spontaneous rhythmic contraction by cyclooxygenase products released by interstitial cells of Cajal. *J Cell Mol Med* 2009; 13: 3236-3250.
152. Piaseczna-Piotrowska AM, Dzieciecka M, Kulig A, Danilewicz M, Chilarski A. Different distribution of c-kit positive interstitial cells of Cajal-like in children's urinary bladders. *Folia Histochem Cytobiol* 2011; 49: 431-435.
153. Li Y, Xue L, Miao Q, Mao F, Yao L, Yuan J, Qin W, Zhao Y, Sun H, Liu F, Wang H. Expression and electrophysiological characteristics of P2X₃ receptors in interstitial cells of Cajal in rats with partial bladder outlet obstruction. *BJU Int* 2013; 111: 843-851.
154. Vannucchi MG, Traini C, Guasti D, Del Popolo G, Faussone-Pellegrini MS. Telocytes subtypes in human urinary bladder. *J Cell Mol Med* 2014; 18: 2000-2008.
155. Yu W, Zeidel ML, Hill WG. Cellular expression profile for interstitial cells of cajal in bladder - a cell often misidentified as myocyte or myofibroblast. *PLoS One* 2012; 7: e48897
156. Johnston L, Carson C, Lyons AD, Davidson RA, McCloskey KD. Cholinergic-induced Ca²⁺ signaling in interstitial cells of Cajal from the guinea pig bladder. *Am J Physiol Renal Physiol* 2008; 294: F645-655.
157. Kim SO, Jeong HS, Jang S, Wu MJ, Park JK, Jiao HY, Jun JY, Park JS. Spontaneous electrical activity of cultured interstitial cells of cajal from mouse urinary bladder. *Korean J Physiol Pharmacol* 2013; 17: 531-536.
158. Wu C, Sui GP, Fry CH. Purinergic regulation of guinea pig suburothelial myofibroblasts. *J Physiol* 2004; 559: 231-243

159. Wu Y, Shi C, Deng J, Zhang X, Song B, Li L. Expression and function of muscarinic subtype receptors in bladder interstitial cells of cajal in rats. *Urol J* 2014; 11: 1642-1647.
160. Gray SM, McGeown JG, McMurray G, McCloskey KD. Functional innervation of Guinea-pig bladder interstitial cells of cajal subtypes: neurogenic stimulation evokes in situ calcium transients. *PLoS One* 2013; 8: e53423.
161. Cheng S, Scigalla FP, Speroni di Fenizio P, Zhang ZG, Stolzenburg JU, Neuhaus J. ATP enhances spontaneous calcium activity in cultured suburothelial myofibroblasts of the human bladder. *PLoS One* 2011; 6, e25769.
162. Sui GP, Wu C, Roosen A, Ikeda Y, Kanai AJ, Fry CH. Modulation of bladder myofibroblast activity: implications for bladder function. *Am J Physiol Renal Physiol* 2008; 295: F688-697.
163. McCloskey KD. Calcium currents in interstitial cells from the guinea-pig bladder. *BJU Int* 2006; 97: 1338-1343.
164. McCloskey KD. Characterization of outward currents in interstitial cells from the guinea pig bladder. *J Urol* 2005; 173: 296-301.
165. Deng J, He P, Zhong X, Wang Q, Li L, Song B. Identification of T-type calcium channels in the interstitial cells of Cajal in rat bladder. *Urology* 2012; 80: 1389.e1-7.
166. Deng T, Zhang Q, Wang Q, Zhong X, Li L. Changes in hyperpolarization-activated cyclic nucleotide-gated channel expression and activity in bladder interstitial cells of Cajal from rats with detrusor overactivity. *Int Urogynecol J* 2015; 26: 1139-1145.
167. Xue L, Li Y, Han X, Yao L, Yuan J, Qin W, Liu F, Wang H. Investigation of hyperpolarization-activated cyclic nucleotide-gated channels in interstitial cells of Cajal of human bladder. *Urology* 2012; 80: 224.e13-18.
168. Dong X, Song Q, Zhu J, Zhao J, Liu Q, Zhang T, Long Z, Li J, Wu C, Wang Q, Hu X, Damaser M, Li L. Interaction of Caveolin-3 and HCN is involved in the pathogenesis of diabetic cystopathy. *Sci Rep* 2016; 6: 24844.
169. Bijos DA, Drake MJ, Vahabi B. Noctamin-1 in the juvenile rat urinary bladder. *PLoS One* 2014; 9: e106190.
170. McCloskey KD. Interstitial cells of Cajal in the urinary tract. *Handb Exp Pharmacol* 2011; (202): 233-254.
171. Lies B, Groneberg D, Friebe A. Correlation of cellular expression with function of NO-sensitive guanylyl cyclase in the murine lower urinary tract. *J Physiol* 2013; 591:5365-5375.
172. Rahnama'i MS, Hohnen R, Van Kerrebroeck PE, van Koeveringe GA. Phosphodiesterase type 2 distribution in the guinea pig urinary bladder. *World J Urol* 2015; 33: 1623-1633.
173. Rahnama'i MS, van Koeveringe GA, Hohnen R, Ona S, van Kerrebroeck PE, de Wachter SG. Distribution of phosphodiesterase type 5 (PDE5) in the lateral wall of the guinea pig urinary bladder. *BJU Int* 2013; 112: 246-257.
174. Rahnama'i MS, Bialosterski BT, de Wachter SG, Van Kerrebroeck PE, van Koeveringe GA. The distribution of the prostaglandin E receptor type 2 (EP2) in the detrusor of the guinea pig. *Prostaglandins Other Lipid Mediat* 2012; 99: 107-115.
175. Cunningham RM, Larkin P, McCloskey KD. Ultrastructural properties of interstitial cells of Cajal in the Guinea pig bladder. *J Urol* 2011; 185: 1123-1131.
176. Johnston L, Cunningham RM, Young JS, Fry CH, McMurray G, Eccles R, McCloskey KD. Altered distribution of interstitial cells and innervation in the rat urinary bladder following spinal cord injury. *J Cell Mol Med* 2012; 16: 1533-1543.
177. Deng J, Zhang Y, Wang L, Zhao J, Song B, Li L. The effects of Glivec on the urinary bladder excitation of rats with suprasacral or sacral spinal cord transection. *J Surg Res* 2013; 183: 598-605.
178. Canda AE, Dogan H, Kandemir O, Atmaca AF, Akbulut Z, Balbay MD. Does diabetes affect the distribution and number of interstitial cells and neuronal tissue in the ureter, bladder, prostate, and urethra of humans?. *Cent European J Urol* 2014; 67: 366-374.
179. Vahabi B, McKay NG, Lawson K, Sellers DJ. The role of c-kit-positive interstitial cells in mediating phasic contractions of bladder strips from streptozotocin-induced diabetic rats. *BJU Int* 2011; 107: 1480-1487.
180. Kubota Y, Kajioka S, Biers SM, Yokota E, Kohri K, Brading AF. Investigation of the effect of the c-kit inhibitor Glivec on isolated guinea-pig detrusor preparations. *Auton Neurosci* 2004; 115: 64-73.
181. Kubota Y, Hashitani H, Shirasawa N, Kojima Y, Sasaki S, Mabuchi Y, Soji T, Suzuki H, Kohri K. Altered distribution of interstitial cells in the guinea pig bladder following bladder outlet obstruction. *Neurourol Urodyn* 2008; 27: 330-340.
182. Grol S, Nile CJ, Martinez-Martinez P, van Koeveringe G, de Wachter S, de Vente J, Gillespie JI. M3 muscarinic receptor-like immunoreactivity in sham operated and obstructed guinea pig bladders. *J Urol* 2011; 185:1959-1966.

183. Feng QF, Hou YH, Hou WG, Lin ZX, Tang KM, Chen YL. The effects of acupuncture on bladder interstitial cells of cajal excitability in rats with overactive bladder. *Evid Based Complement Alternat Med* 2013; 2013: 261217.
184. Meng M, Zheng J, Yan J, Li Q, Fang Q, Li W.. P2X2 and P2X5 receptors mediate bladder hyperesthesia in ICC in female overactive bladder. *Cell Biochem Biophys* 2015; 72: 375-383.
185. Piaseczna-Piotrowska A, Dzieciecka M, Samolewicz E, Lesniak D, Kulig A. Distribution of interstitial cells of Cajal in the neurogenic urinary bladder of children with myelomeningocele. *Adv Med Sci* 2013; 58: 388-393.
186. Shafik A, El Sibai O, Shafik AA, Ahmed I. Do vesical and voided urine have identical compositions? *Scand J Urol Nephrol* 2004; 38: 243-246.
187. Shafik A, Ahmed I, El Sibai O, Shafik AA. Does the composition of voided urine reflect that of the renal pelvis? *Urol Res* 2006; 34: 261-264.
188. Khandelwal P, Abraham SN, Apodaca G. Cell biology and physiology of the uroepithelium. *Am J Physiol Renal Physiol* 2009; 297: F1477-1501.
189. Petry G, Amon H. Light and electron microscopic studies on the structure and dynamics of transitional epithelium. *Z Zellforsch Mikrosk Anat.* 1969; 69: 587-612.
190. Jost SP, Gosling JA, Dixon JS. The morphology of normal human bladder urothelium. *J Anat* 1989; 167: 103-115.
191. Papafiotou G, Paraskevopoulou V, Vasilaki E, Kanaki Z, Paschalidis N, Klinakis A. KRT14 marks a subpopulation of bladder basal cells with pivotal role in regeneration and tumorigenesis. *Nat Commun* 2016; 7: 11914.
192. Jost SP. Cell cycle of normal bladder urothelium in developing and adult mice. *Virchows Arch B Cell Pathol Incl Mol Pathol* 1989; 57: 27-36.
193. Kreft ME, Sterle M, Veranic P, Jezernik K. Urothelial injuries and the early wound healing response: tight junctions and urothelial cytodifferentiation. *Histochem Cell Biol* 2005; 123: 529-539.
194. Veranic P, Erman A, Kerec-Kos M, Bogataj M, Mrhar A, Jezernik K. Rapid differentiation of superficial urothelial cells after chitosan-induced desquamation. *Histochem Cell Biol* 2009; 131: 129-139.
195. Apodaca G. The uroepithelium: not just a passive barrier. *Traffic* 2004; 5: 117-128.
196. Haefliger JA, Tissieres P, Tawadros T, Formenton A, Beny JL, Nicod P, Frey P, Meda P. Connexins 43 and 26 are differentially increased after rat bladder outlet obstruction. *Exp Cell Res* 2002; 274: 216-225.
197. Wu XR, Kong XP, Pellicer A, Kreibich G, Sun TT. Uroplakins in urothelial biology, function, and disease. *Kidney Int* 2009; 75: 1153-1165.
198. Apodaca G, Kiss S, Ruiz W, Meyers S, Zeidel M, Birder L. Disruption of bladder epithelium barrier function after spinal cord injury. *Am J Physiol Renal Physiol* 2003; 284: F966-976.
199. Lavelle J, Meyers S, Ramage R, Bastacky S, Doty D, Apodaca G, Zeidel M. Bladder permeability barrier: recovery from selective injury of surface epithelial cells. *Am J Physiol Renal Physiol* 2002; 283: F242-253.
200. Hicks RM. The mammalian urinary bladder: an accommodating organ. *Biol Rev Camb Philos Soc* 1975; 50: 215-246.
201. Hicks RM, Ketterer B, Warren RC. The ultrastructure and chemistry of the luminal plasma membrane of the mammalian urinary bladder: a structure with low permeability to water and ions. *Phil Trans R Soc Lond B Biol Sci* 1974; 268: 23-38.
202. Zhou G, Mo WJ, Sebbel P, Min G, Neubert TA, Glockshuber R, Wu XR, Sun TT, Kong XP. Uroplakin Ia is the urothelial receptor for uropathogenic *Escherichia coli*: evidence from in vitro FimH binding. *J Cell Sci* 2001; 114: 4095-1403.
203. Yu J, Manabe M, Sun TT. Identification of an 85-100 kDa glycoprotein as a cell surface marker for an advanced stage of urothelial differentiation: association with the inter-plaque ('hinge') area. *Epithelial Cell Biol* 1992; 1: 4-12.
204. Hicks RM. The function of the golgi complex in transitional epithelium. Synthesis of the thick cell membrane. *J Cell Biol* 1966; 30: 623643.
205. Truschel ST, Wang E, Ruiz WG, Leung SM, Rojas R, Lavelle J, Zeidel M, Stoffer D, Apodaca G. Stretch-regulated exocytosis/endocytosis in bladder umbrella cells. *Mol Biol Cell* 2002; 13: 830-846.
206. Kreft ME, Hudoklin S, Jezernik K, Romih R. Formation and maintenance of blood-urine barrier in urothelium. *Protoplasma* 2010; 246: 3-14.
207. Cahill DJ, Fry CH, Foxall PJ. Variation in urine composition in the human urinary tract: evidence of urothelial function in situ? *J Urol* 2003; 169: 871-874.
208. Lasic E, Visnjar T, Kreft ME. Properties of the Urothelium that Establish the Blood-Urine Barrier and Their Implications for Drug Delivery. *Rev Physiol Biochem Pharmacol* 2015; 168: 1-29.

209. Carattino MD, Prakasam HS, Ruiz WG, Clayton DR, McGuire M, Gallo LI, Apodaca G. Bladder filling and voiding affect umbrella cell tight junction organization and function. *Am J Physiol Renal Physiol* 2013; 305: F1158-1168.
210. Acharya P, Beckel J, Ruiz WG, Wang E, Rojas R, Birder L, Apodaca G. Distribution of the tight junction proteins ZO-1, occludin, and claudin-4, -8, and -12 in bladder epithelium. *Am J Physiol Renal Physiol* 2004; 287: F305-318.
211. Gonzalez-Mariscal L, Betanzos A, Nava P, Jaramillo BE. Tight junction proteins. *Prog Biophys Mol Biol* 2003; 81: 1-44.
212. Anderson JM, van Itallie CM. Physiology and function of the tight junction. *Cold Spring Harb Perspect Biol* 2009; 1(2): a002584.
213. Furuse M, Sasaki H, Tsukita S. Manner of interaction of heterogeneous claudin species within and between tight junction strands. *J Cell Biol* 1999; 147: 891-903.
214. Krug SM, Gunzel D, Conrad MP, Lee IF, Amasheh S, Fromm M, Yu AS. Charge-selective claudin channels. *Ann NY Acad Sci* 2012; 1257: 20-28.
215. Mysorekar IU, Mulvey MA, Hultgren SJ, Gordon JL. Molecular regulation of urothelial renewal and host defenses during infection with uropathogenic *Escherichia coli*. *J Biol Chem* 2002; 277: 7412-7419.
216. Varley CL, Garthwaite MA, Cross W, Hinley J, Trejdosiewicz LK, Southgate J. PPAR γ -regulated tight junction development during human urothelial cytodifferentiation. *J Cell Physiol* 2006; 208: 407-417.
217. Saitou M, Furuse M, Sasaki H, Schulzke JD, Fromm M, Takano H, Noda T, Tsukita S. Complex phenotype of mice lacking occludin, a component of tight junction strands. *Mol Biol Cell* 2000; 11: 4131-4142.
218. Van Itallie CM, Anderson JM. The molecular physiology of tight junction pores. *Physiology (Bethesda)*. 2004; 19: 331-338.
219. Shen L, Weber CR, Turner JR. The tight junction protein complex undergoes rapid and continuous molecular remodeling at steady state. *J Cell Biol* 2008; 181: 683-695.
220. Lewis SA. Everything you wanted to know about the bladder epithelium but were afraid to ask. *Am J Physiol Renal Physiol* 2000; 278: F867-874.
221. Clausen C, Lewis SA, Diamond JM. Impedance analysis of a tight epithelium using a distributed resistance model. *Biophys J* 1979; 26: 291-317.
222. Hu P, Meyers S, Liang FX, Deng FM, Kachar B, Zeidel ML, Sun TT. Role of membrane proteins in permeability barrier function: uroplakin ablation elevates urothelial permeability. *Am J Physiol Renal Physiol* 2002; 283: F1200-1207.
223. Verkman AS. Aquaporins at a glance. *J Cell Sci* 2011; 124: 2107-2112.
224. Rubenwolf PC, Georgopoulos NT, Clements LA, Feather S, Holland P, Thomas DF, Southgate J. Expression and localisation of aquaporin water channels in human urothelium in situ and in vitro. *Eur Urol* 2009; 56: 1013-1023.
225. Spector DA, Wade JB, Dillow R, Steplock DA, Weinman EJ. Expression, localization, and regulation of aquaporin-1 to -3 in rat urothelia. *Am J Physiol Renal Physiol* 2002; 282: F1034-1042.
226. Nelson RA. Winter sleep in the black bear. A physiologic and metabolic marvel. *Mayo Clin Proc* 1973; 48: 733-737.
227. Spector DA, Deng J, Coleman R, Wade JB. The urothelium of a hibernator: the American black bear. *Physiol Rep* 2015; 3(6) pii: e12429.
228. Vlaskovska M, Kasakov L, Rong W, Bodin P, Bardini M, Cockayne DA, Ford AP, Burnstock G. P2X₃ knock-out mice reveal a major sensory role for urothelially released ATP. *J Neurosci* 2001; 21: 5670-5677.
229. Yu Y, de Groat WC. Effects of stimulation of muscarinic receptors on bladder afferent nerves in the in vitro bladder-pelvic afferent nerve preparation of the rat. *Brain Res* 2010; 1361: 43-53.
230. Levinsky NG, Berliner RW. Changes in composition of the urine in ureter and bladder at low urine flow. *Am J Physiol* 1959; 196: 549-553.
231. Walser BL, Yagil Y, Jamison RL. Urea flux in the ureter. *Am J Physiol* 1988; 255: F244-249.
232. Smith CP. Mammalian urea transporters. *Exp Physiol* 2009; 94: 180-185.
233. Spector DA, Yang Q, Liu J, Wade JB. Expression, localization, and regulation of urea transporter B in rat urothelia. *Am J Physiol Renal Physiol* 2004; 287: F102-108.
234. Lewis SA, Eaton DC, Diamond JM. The mechanism of Na⁺ transport by rabbit urinary bladder. *J Memb Biol* 1976; 28: 41-70.
235. Wang EC, Lee JM, Johnson JP, Kleyman TR, Bridges R, Apodaca G. Hydrostatic pressure-regulated ion transport in bladder uroepithelium. *Am J Physiol Renal Physiol* 2003; 285: F651-663.
236. Spector DA, Yang Q, Klopouh L, Deng J, Weinman EJ, Steplock DA, Biswas R, Brazie MF, Liu

- J, Wade JB. The ROMK potassium channel is present in mammalian urinary tract epithelia and muscle. *Am J Physiol Renal Physiol* 2008; 295: F1658-1665.
237. Yu W, Khandelwal P, Apodaca G. Distinct apical and basolateral membrane requirements for stretch-induced membrane traffic at the apical surface of bladder umbrella cells. *Mol Biol Cell* 2009; 20: 282-295.
 238. Araki I, Du S, Kobayashi H, Sawada N, Mochizuki T, Zakoji H, Takeda M. Roles of mechanosensitive ion channels in bladder sensory transduction and overactive bladder. *Int J Urol* 2008; 15: 681-687.
 239. Deruyver Y, Voets T, de Ridder D, Everaerts W. Transient receptor potential channel modulators as pharmacological treatments for lower urinary tract symptoms (LUTS): myth or reality? *BJU Int* 2015; 115: 686-697.
 240. *Developmental Biology*, 6th edition Scott F Gilbert. Sunderland (MA): Sinauer Associates; 2000. ISBN-10: 0-87893-243-7
 241. Woolf AS, Winyard PJ, Hermanns MM, Welham SJ. Maldevelopment of the human kidney and lower urinary tract: an overview. In: Vize PD, Woolf AS; Bard JBL, editors. *The Kidney: From Normal Development to Congenital Disease*. London, UK: Academic Press; 2003. pp 377-393.
 242. Thomas JC, DeMarco RT, Pope JC 4th. Molecular biology of ureteral bud and trigonal development. *Curr Urol Rep* 2005; 6: 146-151.
 243. Tanaka ST, Ishii K, Demarco RT, Pope JCT, Brock JW 3rd, Hayward SW. Endodermal origin of bladder trigone inferred from mesenchymal-epithelial interaction. *J Urol* 2010; 183: 386-391.
 244. Baskin LS, Hayward SW, Young P, Cunha GR. Role of mesenchymal-epithelial interactions in normal bladder development. *J Urol* 1996; 156: 1820-1827.
 245. Cao M, Liu B, Cunha G, Baskin L. Urothelium patterns bladder smooth muscle location. *Pediatric Res* 2008; 64: 352-357.
 246. Shiroyanagi Y, Liu B, Cao M, Agras K, Li J, Hsieh MH, Willingham EJ, Baskin LS. Urothelial sonic hedgehog signaling plays an important role in bladder smooth muscle formation. *Differentiation* 2007; 75: 968-977.
 247. DeSouza KR, Saha M, Carpenter AR, Scott M, McHugh KM. Analysis of the Sonic Hedgehog signaling pathway in normal and abnormal bladder development. *PLoS One* 2013; 8: e53675.
 248. Cuckow PM, Nyirady P. Embryology of the Urogenital Tract. In: Gearhart JP, Rink RC, Mouriquanad PDE, editors. *Pediatric Urology*. Philadelphia: W.B. Saunders, 2001: 3-13.
 249. Rabinowitz R, Peters MT, Vyas S, Campbell S, Nicolaidis KH. Measurement of fetal urine production in normal pregnancy by real-time ultrasonography. *Am J Obstet Gynecol* 1989; 161: 1264-1266.
 250. Lee JG, Coplen D, Macarak E, Wein AJ, Levin RM 1994. Comparative studies on the ontogeny and autonomic responses of the fetal calf bladder at different stages of development: involvement of nitric oxide on field stimulated relaxation. *J Urol* 151: 1096-1101.
 251. Kim KM, Kogan BA, Massad CA, Huang YC. Collagen and elastin in the normal fetal bladder. *J Urol* 1991; 146: 524-527.
 252. Coplen DE, Macarak EJ, Levin RM. Developmental changes in normal fetal bovine whole bladder physiology. *J Urol* 1994; 151: 1391-1395.
 253. Baskin LS, Constantinescu S, Duckett JW, Snyder HM, Macarak E. Type III collagen decreases in normal fetal bovine bladder development. *J Urol* 1994; 152: 688-691.
 254. Dean GE, Cargill RS, III, Macarak E, Snyder HM, Duckett JW, Levin R. Active and passive compliance of the fetal bovine bladder. *J Urol* 1997; 158: 1094-1099.
 255. Koo HP, Howard PS, Chang SL, Snyder HM, Duckett JW, Macarak EJ. Developmental expression of interstitial collagen genes in fetal bladders. *J Urol* 1997; 158: 954-961.
 256. Gosling JA1, Dixon JS, Jen PY. The distribution of noradrenergic nerves in the human lower urinary tract. A review. *Eur Urol* 1999; 36 Suppl 1: 23-30.
 257. Mitolo-Chieppa D, Schönauer S, Grasso G, Ciccinelli E, Carratù MR. Ontogenesis of autonomic receptors in detrusor muscle and bladder sphincter of human fetus. *Urology* 1983; 21: 599-603.
 258. Karam I, Droupy S, Abd-Alsamad I, Korbage A, Uhl JF, Benoît G, Delmas V. The precise location and nature of the nerves to the male human urethra: histological and immunohistochemical studies with three-dimensional reconstruction. *Eur Urol* 2005; 48: 858-864.
 259. Kogan BA, Iwamoto HS. Lower urinary tract function in the sheep fetus: studies of autonomic control and pharmacologic responses of the fetal bladder. *J Urol* 1989; 141: 1019-1024.
 260. Lee JG, Macarak E, Coplen D, Wein AJ, Levin RM. Distribution and function of the adrenergic

and cholinergic receptors in the fetal calf bladder during mid-gestational age. *Neurourol Urodyn* 1993; 12: 599-607.

261. Dixon JS, Jen PY. Development of nerves containing nitric oxide synthase in the human male urogenital organs. *Br J Urol* 1995; 76: 719-725.
262. Wu C, Sui G, Thiruchelvam N, Cuckow P, Fry CH. Ca^{2+} regulation in detrusor smooth muscle from developing fetal sheep bladders. *Cell Calcium* 2006; 39: 367-374.
263. Nyirády P, Thiruchelvam N, Godley ML, David A, Cuckow PM, Fry CH. Contractile properties of the developing fetal sheep bladder. *Neurourol Urodyn* 2005; 24: 276-281.
264. Thiruchelvam N, Wu C, David A, Woolf AS, Cuckow PM, Fry CH. Neurotransmission and viscoelasticity in the ovine fetal bladder after in utero bladder outflow obstruction. *Am J Physiol Regul Integr Comp Physiol* 2003; 284: R1296-1305.
265. Koo HP, Macarak EJ, Zderic SA, Duckett JW, Synder HM 3rd, Levin RM. The ontogeny of bladder function in the fetal calf. *J Urol.* 1995; 154: 283-287.
266. Olsen LH, Dalmose AL, Swindle MM, Jørgensen TM, Djurhuus JC. Male fetal pig lower urinary tract function in mid second and early third trimester of gestation. *J Urol* 2001; 165: 2331-2334.
267. de Tayrac R, Cuckow PM, Devlieger R, Deprest J, Bogaert G, Ville Y. Antenatal urodynamic studies in the fetal lamb: experimental protocol and preliminary results. *Prenat Diagn* 2003; 23: 187-192.
268. Olsen LH, Dalmose AL, Swindle MM, Djurhuus JC, Jørgensen TM. Male fetal pig lower urinary tract function. Part II: free voiding pattern close to term and in the newborn. *J Urol* 2004; 171: 2660-2663.
269. Thiruchelvam N, Godley ML, Farrugia MK, Cuckow PM 2004. A preliminary study of natural fill, radiotelemetered ovine fetal cystometry. *BJU Int* 2004; 93: 382-387.
270. Lee BR, Perlman EJ, Partin AW, Jeffs RD, Gearhart JP. Evaluation of smooth muscle and collagen subtypes in normal newborns and those with bladder exstrophy. *J Urol* 1996; 156: 2034-2036.
271. Johal N, Wood DN, Wagg AS, Cuckow P, Fry CH. Functional properties and connective tissue content of pediatric human detrusor muscle. *Am J Physiol Renal Physiol* 2014; 307: F1072-1079.
272. Wuest M, Eichhorn B, Braeter M, Strugala G, Michel MC, Ravens U. Muscarinic receptor expression and receptor-mediated detrusor contraction: comparison of juvenile and adult porcine tissue. *Pflug Arch* 2008; 456: 349-358.
273. Austin PF, Bauer SB, Bower W, Chase J, Franco I, Hoebcke P, Rittig S, Walle JV, von Gontard A, Wright A, Yang SS, Nevéus T. The standardization of terminology of lower urinary tract function in children and adolescents: Update report from the standardization committee of the International Children's Continence Society. *Neurourol Urodyn* 2016; 35: 471-481.
274. Wahl EF, Lerman SE, Lahdes-Vasama TT, Churchill BM. Measurement of bladder compliance can be standardized by a dimensionless number: clinical perspective. *BJU Int* 2004; 94: 898-900.
275. Harvey RA, Skennerton DE, Newgreen D, Fry CH. The contractile potency of adenosine triphosphate and ecto-adenosine triphosphatase activity in guinea pig detrusor and detrusor from patients with a stable, unstable or obstructed bladder. *J Urol* 2002; 168: 1235-1239.
276. Lovering JS, Tallett SE, McKendry JB. Oxybutynin efficacy in the treatment of primary enuresis. *Pediatrics.* 1988; 82: 104-106.
277. Patidar N, Mittal V, Kumar M, Sureka SK, Arora S, Ansari MS. Transcutaneous posterior tibial nerve stimulation in pediatric overactive bladder: A preliminary report. *J Ped Urol* 2105; 11: 351e1-e6.
278. Kanai A, Roppolo J, Ikeda Y, Zabbarova I, Tai C, Birder L, Griffiths D, de Groat W, Fry CH. Origin of spontaneous activity in neonatal and adult rat bladders and its enhancement by stretch and muscarinic agonists. *Am J Physiol Renal Physiol* 2007; 292: F1065-1072.
279. Sugaya K, de Groat WC. Inhibitory control of the urinary bladder in the neonatal rat in vitro spinal cord-bladder preparation. *Brain Res Dev Brain Res* 2002; 138: 87-95.
280. Ikeda Y, Fry CH, Hayashi F, Stolz D, Griffiths D, Kanai A. Role of gap junctions in spontaneous activity of the rat bladder. *Am J Physiol Renal Physiol* 2007; 293: F1018-1025.
281. von der Mark K. Localization of collagen types in tissues. *Int Rev Connect Tissue Res* 1981; 9: 265 - 324.
282. Gelse K, Pöschl E, Aigner T. Collagens - structure, function, and biosynthesis. *Adv Drug Delivery Rev* 2003; 55: 1531-1546.
283. Orgel JP, Irving TC, Miller A, Wess TJ. Microfibrillar structure of type I collagen in situ. *Proc Natl Acad Sci* 2006; 103: 9001-9005.
284. Chang SW, Buehler MJ. Molecular biomechanics of collagen molecules. *Materials Today* 2014; 17: 70-76

285. A. Liapis, P. Bakas, A. Pafiti, Frangos-Plemenos M, Arnoyannaki N, Creatsas G. Changes of collagen type III in female patients with genuine stress incontinence and pelvic floor prolapse. *Eur J Obstet Gynecol Reprod Biol.* 2001; 97: 76-79.
286. Kerkhof MH, Hendriks L, Brolmann HA. Changes in connective tissue in patients with pelvic organ prolapse - a review of the current literature. *Int Urogynecol J Pelvic Floor Dysfunct* 2009; 20: p. 461-474.
287. Wenger MP, Bozec L, Horton MA, Mesquida P. Mechanical properties of collagen fibrils. *Biophys J* 2007; 93: 1255–1263.
288. Yang L, van der Werf KO, Fitié CF, Bennink ML, Dijkstra PJ, Feijen J. Mechanical properties of native and cross-linked type I collagen fibrils. *Biophys J* 2008 15; 94: 2204-2211.
289. Dutov P, Antipova O, Varma S, Orgel JPRO, Schieber JD. Measurement of elastic modulus of collagen type I single fiber. *PLoS ONE* 2016; 11: e0145711.
290. 290 Weis MA, Hudson DM, Kim L, Scott M, Wu JJ, Eyre DR. Location of 3-hydroxyproline residues in collagen types I, II, III, and V/XI implies a role in fibril supramolecular assembly. *J Biol Chem* 2010; 285; 2580–2590.
291. Chao W, Hao Z, Wen S, Leng H. A quantitative study of the relationship between the distribution of different types of collagen and the mechanical behavior of rabbit Medial collateral ligaments. *PLoS One* 2014; 9: e103363.
292. Williams A. Congenital abnormalities of the lower urinary tract. *Surgery* 2013; 31: 371-377.
293. Malin G, Tonks AM, Morris RK, Gardosi J, Kilby MD. Congenital lower urinary tract obstruction: a population-based epidemiological study. *BJOG* 2012; 119: 1455-1464.
294. Taskinen S, Heikkilä J, Rintala R. Effects of posterior urethral valves on long-term bladder and sexual function. *Nat Rev Urol.* 2012; 9: 699-706.
295. Ludwig M, Ching B, Reutter H, Boyadjiev SA. Bladder exstrophy-epispadias complex. *Birth Defects Res A Clin Mol Teratol* 2009; 85: 509-522.
296. Arlen AM, Smith EA. Disorders of the bladder and cloacal anomaly. *Clin Perinatol* 2014; 41: 695-707.
297. Cervellione RM, Mantovani A, Gearhart J, Bogaert G, Gobet R, Caione P, Dickson AP. Prospective study on the incidence of bladder/cloacal exstrophy and epispadias in Europe. *J Pediatr Urol* 2015; 11: 337.e1-6
298. Tonni G, Ida V, Alessandro V, Bonasoni MP. Prune-belly syndrome: case series and review of the literature regarding early prenatal diagnosis, epidemiology, genetic factors, treatment, and prognosis. *Fetal Pediatr Pathol.* 2013; 31: 13-24.
299. Liao AW, Sebire NJ, Geerts L, Cicero S, Nicolaides KH. Megacystis at 10-14 weeks of gestation: chromosomal defects and outcome according to bladder length. *Ultrasound Obstet Gynecol* 2003; 21: 338-341.
300. Bhat A, Bothra R, Bhat MP, Chaudhary GR, Saran RK, Saxena G. Congenital bladder diverticulum presenting as bladder outlet obstruction in infants and children. *J Pediatr Urol* 2012; 8: 348-353.
301. Carr MC. Neuropathic bladder in the neonate. *Clin Perinatol* 2014; 41: 725-733.
302. Hennis PM, van der Heijden GJ, Bosch JL, de Jong TP, de Kort LM. A systematic review on renal and bladder dysfunction after endoscopic treatment of infravesical obstruction in boys. *PLoS One.* 2012; 7: e44663.
303. Moorthy I, Joshi N, Cook JV, Warren M. Antenatal hydronephrosis: negative predictive value of normal postnatal ultrasound - a 5-year study. *Clin Radiol* 2003; 58: 964-970.
304. Parkhouse HF, Barrat TM, Dillon MJ, Duffy PJ, Fay J, Ransley PG, Woodhouse CR, Williams DI. Long-term outcome of boys with posterior urethral valves. *BJU Int* 1988; 62: 59–62.
305. Kousidis G, Thomas DF, Morgan H, Haider N, Subramanian R, Feather S. Long-term outcome of prenatally detected posterior urethral valves: a 10 to 23-year follow-up study *BJU Int* 2008; 102: 1020–1024.
306. Youssif M, Dawood W, Shabaan S, Mokhless I, Hanno A. Early valve ablation can decrease the incidence of bladder dysfunction in boys with posterior urethral valves. *J Urol* 2009; 182(4 Suppl): 1765-1768.
307. Gonzalez R, Reinberg Y, Burke B, Wells T, Vernier RL. Early bladder outlet obstruction in fetal lambs induces renal dysplasia and the prune-belly syndrome. *J Pediatr Surg* 1990; 25: 342-345.
308. Peters CA, Vasavada S, Dator D, Carr M, Shapiro E, Lepor H, McConnell J, Retik AB, Mandell J. The effect of obstruction on the developing bladder. *J Urol* 1992; 148: 491-496.
309. de Tayrac R, Cuckow PM, Devlieger R, Deprest J, Bogaert G, Ville Y. Antenatal urodynamic studies in the fetal lamb: experimental protocol and preliminary results. *Prenat Diagn* 2003; 23: 187-192.

310. Kitajima K, Aoba T, Pringle KC, Seki Y, Zuccollo J, Koike J, Chikaraishi T, Kitagawa H. Bladder development following bladder outlet obstruction in fetal lambs: optimal timing of fetal therapy. *J Pediatr Surg* 2010; 45: 2423-2430.
311. Pringle KC, Kitagawa H, Seki Y, Koike J, Zuccollo J. 60-day-gestation fetal lambs. In lambs, glomerulogenesis is complete by 90 days gestation. Development of an animal model to study congenital urinary obstruction. *Pediatr Surg Int* 2013; 29: 1083-1089.
312. Peters CA, Carr MC, Lais A, Retik AB, Mandell J. The response of the fetal kidney to obstruction. *J Urol* 1992; 148: 503-509.
313. Cendron M, Horton CE, Karim OM, Takishima H, Haberlik A, Mostwin JL, Gearhart JP. A fetal lamb model of partial urethral obstruction: experimental protocol and results. *J Pediatr Surg* 1994; 29: 77-80.
314. Levin RM, Macarak E, Howard P, Horan P, Kogan BA. The response of fetal sheep bladder tissue to partial outlet obstruction. *J Urol* 2001; 166: 1156-1160.
315. Nyirady P, Thiruchelvam N, Fry CH, Godley ML, Winyard PJ, Peebles DM, Woolf AS, Cuckow PM. Effects of in utero bladder outflow obstruction on fetal sheep detrusor contractility, compliance and innervation. *J Urol* 2002; 168: 1615-1620.
316. Thiruchelvam N, Wu C, David A, Woolf AS, Cuckow PM, Fry CH. Neurotransmission and viscoelasticity in the ovine fetal bladder after in utero bladder outflow obstruction. *Am J Physiol Regul Integr Comp Physiol*. 2003; 284: R1296-1305.
317. Peters CA, Freeman MR, Fernandez CA, Shepard J, Wiederschain DG, Moses MA. Dysregulated proteolytic balance as the basis of excess extracellular matrix in fibrotic disease. *Am J Physiol* 1997; 272: R1960-1965.
318. Thiruchelvam N, Nyirady P, Peebles DM, Fry CH, Cuckow PM, Woolf AS. Urinary outflow obstruction increases apoptosis and deregulates Bcl-2 and Bax expression in the fetal ovine bladder. *Am J Pathol* 2003; 162: 1271-1282.
319. Kim KM, Kogan BA, Massad CA, Huang YC. Collagen and elastin in the obstructed fetal bladder. *J Urol* 1991; 146: 528-531.
320. Freedman AL1, Qureshi F, Shapiro E, Lepor H, Jacques SM, Evans MI, Smith CA, Gonzalez R, Johnson MP. Smooth muscle development in the obstructed fetal bladder. *Urology* 1997; 49: 104-107.
321. Wu C, Thiruchelvam N, Sui G, Woolf AS, Cuckow P, Fry CH. Ca²⁺ regulation in detrusor smooth muscle from ovine fetal bladder after in utero bladder outflow obstruction. *J Urol* 2007; 177: 776-780.
322. Farrugia MK, Long DA, Godley ML, Peebles DM, Fry CH, Cuckow PM, Woolf AS. Experimental short-term fetal bladder outflow obstruction: I. Morphology and cell biology associated with urinary flow impairment. *J Pediatr Urol* 2006; 2: 243-253.
323. Farrugia MK, Godley ML, Woolf AS, Peebles DM, Cuckow PM, Fry CH. Experimental short-term partial fetal bladder outflow obstruction: II. Compliance and contractility associated with urinary flow impairment. *J Pediatr Urol* 2006; 2: 254-260.
324. Edouga D, Huguency B, Gasser B, Bussieres L, Laborde K. Recovery after relief of fetal urinary obstruction: morphological, functional and molecular aspects. *Am J Physiol, Renal Physiol* 2001; 281: F26-37.
325. Sato Y, Kitagawa H, Pringle KC, Koike J, Zuccollo J, Robinson R, Wakisaka M, Seki Y, Nakada K. I. Effects of early vesicostomy in obstructive uropathy on bladder development. *J Pediatr Surg* 2004; 39: 1849-1852.
326. Lee BR, Perlman EJ, Partin AW, Jeffs RD, Gearhart JP. Evaluation of smooth muscle and collagen subtypes in normal newborns and those with bladder exstrophy. *J Urol* 1996; 156: 2034-2036.
327. Slaughenhaupt BL, Chen CJ, Gearhart JP. Creation of a model of bladder exstrophy in the fetal lamb. *J Urol* 1996; 156: 816-818.
328. Slaughenhaupt BL, Mathews RI, Peppas DS, Gearhart JP. A large animal model of bladder exstrophy: observations of bladder smooth muscle and collagen content. *J Urol*. 1999; 162: 2119-2122.
329. Mathews R, Wills M, Perlman E, Gearhart JP. Neural innervation of the newborn exstrophic bladder: an immunohistochemical study. *J Urol* 1999; 162: 506-508.
330. Woolf AS, Stuart HM, Newman WG. Genetics of human congenital urinary bladder disease. *Pediatr Nephrol* 2014; 29: 353-360.
331. Meuli M, Meuli-Simmen C, Yingling CD, Hutchins GM, Hoffman KM, Harrison MR, et al. Creation of myelomeningocele in utero. A model of functional damage from spinal cord: exposure in fetal sheep. *J Pediatr Surg* 1995; 30: 1028-1032.
332. Danzer E, Kidoo D, Redden R, Robinson L, Radu A, Zderic SA, et al. Structural and functional characterization of bladder smooth muscle in fetal rats with retinoic acid-induced myelomeningocele. *Am J Physiol Renal Physiol* 2007; 292: 197-206.

333. Burgos L, Encinas JL, García-Cabezas MÁ, Peiró JL, López-Santamaría M, Jaureguizar E. Bladder changes after several coverage modalities in the surgically induced model of myelomeningocele in lambs. *Actas Urol Esp* 2014; 38: 55-61.
334. Shapiro E, Becich MJ, Perlman E, Lepor H. Bladder wall abnormalities in myelodysplastic bladders: a computer assisted morphometric analysis. *J Urol* 1991; 145: 1024-1029.
335. Podesta M, Ruarte AC, Gargiulo C, Medel R, Castera R, Herrera M, Levitt SB, Weiser A. Bladder function associated with posterior urethral valves after primary valve ablation or proximal urinary diversion in children and adolescents. *J Urol* 2002; 168: 1830-1835.
336. Misseri R, Combs AJ, Horowitz M, Donohoe JM, Glassberg KI. Myogenic failure in posterior urethral valve disease: real or imagined? *J Urol* 2002; 168: 1844-1848.
337. Androulakakis PA, Karamanolakis DK, Tsaouridis G, Stefanidis AA, Palaeodimos I. Myogenic bladder decompensation in boys with a history of posterior urethral valves is caused by secondary bladder neck obstruction? *BJU Int* 2005; 96: 140-143.
338. Mathews R, Gosling JA, Gearhart JP. Ultrastructure of the bladder in classic exstrophy: correlation with development of continence. *J Urol* 2004; 172: 1446-1449.
339. Lais A, Paolucci N, Ferro F, Bosman C, Boldrini R, Caione P. Morphometric analysis of smooth muscle in the exstrophy-epispadias complex. *J Urol* 1996; 156: 819-821.
340. Shapiro E, Jeffs RD, Gearhart JP, Lepor H. Muscarinic cholinergic receptors in bladder exstrophy: insights into surgical management. *J Urol* 1985; 134: 308-310.
341. Birder L, Chai T, Griffiths D, Grundy D, Thor K, Valentino R. Chapter 3, Neural control. In *Incontinence*, ed P Abrams, L Cardozo, S Khoury, A Wein, pp179-259. 2013. ISBN 978-9953-493-21-3.
342. DeLancey JO, Morgan DM, Fenner DE, Kearney R, Guire K, Miller JM, Hussain H, Umek W, Hsu Y, Ashton-Miller JA. Comparison of levator ani muscle defects and function in women with and without pelvic organ prolapse. *Obstet Gynecol* 2007; 109: 295-302.
343. Lawson JO. Pelvic anatomy. I. Pelvic floor muscles. *Ann R Coll Surg Engl* 1974; 54: 244-252.
344. Hinata N, Murakami G. The urethral rhabdosphincter, levator ani muscle, and perineal membrane: a review. *Biomed Res Int* 2014; 2014: 906921.
345. Ritty TM, Ditsios K, Starcher BC. Distribution of the elastic fiber and associated proteins in flexor tendon reflects function. *Anat Rec* 2002; 268: 430-440.
346. Ochala J, Frontera WR, Dorer DJ, van Hoecke J, Krivickas LS. Single skeletal muscle fiber elastic and contractile characteristics in young and older men. *J Gerontol A* 2007; 62, 375-381.
347. Arakawa T, Murakami G, Nakajima F, Matsubara A, Ohtsuka A, Goto T, Teramoto T. Morphologies of the interfaces between the levator ani muscle and pelvic viscera, with special reference to muscle insertion into the anorectum in elderly Japanese. *Anat Sci Int*, 2004; 79: 72-81.
348. Ji G, Barsotti RJ, Feldman ME, Kotlikoff MI. Stretch-induced calcium release in smooth muscle. *J Gen Physiol* 2002; 119: 533-544.
349. Ishihara A, Hori A, Roy RR, Oishi Y, Talmadge RJ, Ohira Y, Kobayashi S, Edgerton VR. Perineal muscles and their innervation: metabolic and functional significance of the motor unit. *Acta Anat* 1997; 159: 156-166.
350. Chen X, Creed KE. Histochemical and contractile properties of striated muscles of urethra and levator ani of dogs and sheep. *Neurourol Urodyn* 2004; 23: 702-708.
351. Helt M, Benson JT, Russell B, Brubaker L. Levator ani muscle in women with genitourinary prolapse: indirect assessment by muscle histopathology. *Neurourol Urodyn*. 1996; 15: 17-29.
352. Sumino Y, Sato F, Kumamoto T, Mimata H. Striated muscle fiber compositions of human male urethral rhabdosphincter and levator ani. *J Urol* 2006; 175: 1417-1421.
353. Pierce LM, Baumann S, Rankin MR, Wasserman RM, Biaggi A, Kuehl TJ, Coates KW. Levator ani muscle and connective tissue changes associated with pelvic organ prolapse, parity, and aging in the squirrel monkey: a histologic study. *Am J Obstet Gynecol* 2007; 197: 60.e1-9.
354. Vyskocil F, Gutmann E. Electrophysiological and contractile properties of the levator ani muscle after castration and testosterone administration. *Pflügers Arch* 1977; 368: 105-109.
355. Kössler F, Lange F, Caffier G, Küchler G. External potassium and action potential propagation in rat fast and slow twitch muscles. *Gen Physiol Biophys* 1991; 10: 485-498.
356. Tuttle LJ, Nguyen OT, Cook MS, Alperin M, Shah SB, Ward SR, Lieber RL. Architectural

- design of the pelvic floor is consistent with muscle functional subspecialization. *Int Urogynecol J* 2014; 25: 205-212.
357. Alperin M, Tuttle LJ, Conner BR, Dixon DM, Mathewson MA, Ward SR, Lieber RL. Comparison of pelvic muscle architecture between humans and commonly used laboratory species. *Int Urogynecol J* 2014; 25: 1507-1515.
 358. Gerling ME, Brown SH. Architectural analysis and predicted functional capability of the human latissimus dorsi muscle. *J Anat* 2013; 223: 112-122.
 359. Baker SJ, Hardy L. Effects of high intensity canoeing training on fibre area and fibre type in the latissimus dorsi muscle. *Br J Sports Med* 1989; 23: 23-26.
 360. Regev GJ, Kim CW, Tomiya A, Lee YP, Ghofrani H, Garfin SR, Lieber RL, Ward SR. Psoas muscle architectural design, in vivo sarcomere length range, and passive tensile properties support its role as a lumbar spine stabilizer. *Spine* 2011; 36: E1666-1674.
 361. Arbanas J, Klasan GS, Nikolic M, Jerkovic R, Miljanovic I, Malnar D. Fibre type composition of the human psoas major muscle with regard to the level of its origin. *J Anat* 2009; 215: 636-641.
 362. Shobeiri SA, Chesson RR, Gasser RF. The internal innervation and morphology of the human female levator ani muscle. *Am J Obstet Gynecol* 2008; 199: 686.e1-6.
 363. Thor KB, de Groat WC. Neural control of the female urethral and anal rhabdosphincters and pelvic floor muscles. *Am J Physiol Regul Integr Comp Physiol* 2010; 299: R416-438.
 364. Loukas M, Joseph S, Etienne D, Linganna S, Hallner B, Tubbs RS. Topography and landmarks for the nerve supply to the levator ani and its relevance to pelvic floor pathologies. *Clin Anat* 2016; 29: 516-523.
 365. Wallner C, Maas CP, Dabhoiwala NF, Lamers WH, DeRuiter MC. Innervation of the pelvic floor muscles: a reappraisal for the levator ani nerve. *Obstet Gynecol* 2006; 108: 529-534.
 366. Kim CM, Jeon MJ, Chung DJ, Kim SK, Kim JW, Bai SW. Risk factors for pelvic organ prolapse. *Int J Gynaecol Obstet* 2007; 98: 248-251.
 367. Berger MB, Morgan DM, DeLancey JO. Levator ani defect scores and pelvic organ prolapse: is there a threshold effect? *Int Urogynecol J* 2014; 25: 1375-1379.
 368. Pierce LM, Coates KW, Kramer LA, Bradford JC, Thor KB, Kuehl TJ. Effects of bilateral levator ani nerve injury on pelvic support in the female squirrel monkey. *Am J Obstet Gynecol* 2008; 198: 585.e1-585.e8.
 369. Pierce LM, Reyes M, Thor KB, Dolber PC, Bremer RE, Kuehl TJ, Coates KW. Innervation of the levator ani muscles in the female squirrel monkey. *Am J Obstet Gynecol* 2003; 188: 1141-1147.
 370. Palmieri G, Panu R, Asole A, Sanna L, Farina V. Coccygeus and levator ani muscles in the rabbit: morphology and proprioceptive innervation. *Biol Struct Morphog* 1988; 1: 142-146.
 371. Corona-Quintanilla DL, Castelan F, Fajardo V, Manzo J, Martinez-Gomez M. Temporal coordination of pelvic and perineal striated muscle activity during micturition in female rabbits. *J Urol* 2009; 181: 1452-1458.
 372. Manzo J, Esquivel A, Hernández ME, Carrillo P, Martínez-Gómez M, Pacheco P. The role of pubococcygeus muscle in urinary continence in the male rat. *J Urol* 1997; 157: 2402-2406.
 373. Manzo J, Vazquez MI, Cruz MR, Hernandez ME, Carrillo P, Pacheco P. Fertility ratio in male rats: effects after denervation of two pelvic floor muscles. *Physiol Behav* 2000; 68: 611-618.
 374. Godinho RO, Souccar C, Lapa AJ. Testosterone control of endplate and non-endplate acetylcholinesterase in the rat levator ani muscle. *Neurochem Res* 1994; 19: 657-663.
 375. Bleisch WV, Harrelson AL, Luine VN. Testosterone increases acetylcholine receptor number in the "levator ani" muscle of the rat. *J Neurobiol* 1982; 13: 153-161.
 376. Nudler SI, Pagani MR, Urbano FJ, McEnery MW, Uchitel OD. Testosterone modulates Cav2.2 calcium channels' functional expression at rat levator ani neuromuscular junction. *Neuroscience* 2005; 134: 817-826.
 377. Souccar C, Lapa AJ, do Valle JR. The influence of testosterone on neuromuscular transmission in hormone sensitive mammalian skeletal muscles. *Muscle Nerve* 1982; 5: 232-237.
 378. Jordan CL, Pawson PA, Arnold AP, Grinnell AD. Hormonal regulation of motor unit size and synaptic strength during synapse elimination in the rat levator ani muscle. *J Neurosci* 1992; 12: 4447-4459.
 379. Jordan CL, Watamura S, Arnold AP. Androgenic, not estrogenic, steroids alter neuromuscular synapse elimination in the rat levator ani. *Brain Res Dev Brain Res* 1995; 84: 215-224.
 380. Fishman RB, Chism L, Firestone GL, Breedlove SM. Evidence for androgen receptors in sexually dimorphic perineal muscles of neonatal male rats. *J Neurobiol* 1990; 21: 694-704.
 381. Smith MR, Hamson DK, Poort JE, Jordan CL, Breedlove SM. Ontogeny of androgen receptor

- expression in spinal nucleus of the bulbocavernosus motoneurons and their target muscles in male mice. *Neurosci Lett* 2012; 513: 119-123.
382. Colleselli K, Stenzl A, Eder R, Strasser H, Poisel S, Bartsch G. The female urethral sphincter: a morphological and topographical study. *J Urol*. 1998; 160: 49-54.
 383. Strasser H, Klima G, Poisel S, Horninger W, Bartsch G. Anatomy and innervation of the rhabdosphincter of the male urethra. *Prostate* 1996; 28: 24-31.
 384. Elbadawi A, Mathews R, Light JK, Wheeler TM. Immunohistochemical and ultrastructural study of rhabdosphincter component of the prostatic capsule. *J Urol* 1997; 158: 1819-1828.
 385. Hirata E, Fujiwara H, Hayashi S, Ohtsuka A, Abe S, Murakami G, Kudo Y. Intergender differences in histological architecture of the fascia pelvis parietalis: a cadaveric study. *Clin Anat* 2011; 24: 469-477.
 386. Bazeed MA, Thüroff JW, Schmidt RA, Tanagho EA. Histochemical study of urethral striated musculature in the dog. *J Urol* 1982; 128: 406-410.
 387. Whitmore I, Gosling JA, Gilpin SA. A comparison between the physiological and histochemical characterisation of urethral striated muscle in the guinea pig. *Pflügers Arch* 1984; 400: 40-43.
 388. Tokunaka S, Murakami U, Ohashi K, Okamura K, Yachiku S. Electrophoretic and ultrastructural analysis of the rabbit's striated external urethral sphincter. *J Urol* 1984; 132: 1040-1043.
 389. Tokunaka S, Murakami U, Okamura K, Miyata M, Yachiku S. The fiber type of the rabbits' striated external urethral sphincter: electrophoretic analysis of myosin. *J Urol* 1986; 135: 427-430.
 390. Gosling JA, Dixon JS, Critchley HO, Thompson SA. A comparative study of the human external sphincter and periurethral levator ani muscles. *Br J Urol* 1981; 53: 35-41.
 391. Elbadawi A, Atta MA. Ultrastructure of vesicourethral innervation. IV. Evidence for somatomotor plus autonomic innervation of the male feline rhabdosphincter *Neurourol Urodyn* 1985; 4: 23
 392. Creed KE, van der Werf BA, Kaye KW. Innervation of the striated muscle of the membranous urethra of the male dog. *J Urol* 1998; 159: 1712-1716.
 393. Martin WD, Fletcher TF, Bradley WE. Innervation of feline perineal musculature. *Anat Rec* 1974; 180: 15-29.
 394. Kavia RB, Datta SN, Dasgupta R, Elneil S, Fowler CJ. Urinary retention in women: its causes and management. *BJU Int* 2006; 97: 281-287.
 395. Bacsu CD, Chan L, Tse V. Diagnosing detrusor sphincter dyssynergia in the neurological patient. *BJU Int* 2012; 109 Suppl 3: 31-34.
 396. Corvin S, Strasser H, Boesch ST, Bartsch G, Klocker H. Human rhabdosphincter cell culture: a model for videomicroscopy of cell contractions. *Prostate* 2001; 47: 189-193.
 397. Fu Q, Song X, Liao G, Deng C, Cui L. Myoblasts differentiated from adipose-derived stem cells to treat stress urinary incontinence. *Urology* 2010; 75: 718-723.
 398. Kim S, Na H, Kwon D, Joo S, Kim H, Ahn Y. Bone-marrow-derived mesenchymal stem cell transplantation enhances closing pressure and leak point pressure in a female urinary incontinence rat model. *Urol Int* 2010; 86: 110-116.
 399. Carr L, Robert M, Kultgen P, Herschorn S, Birch C, Murphy M, Chancellor MB. Autologous muscle derived cell therapy for stress urinary incontinence: a prospective, dose ranging study. *J Urol* 2013; 189: 595-601.
 400. Berjukow S, Margreiter E, Marksteiner R, Strasser H, Bartsch G, Hering S. Membrane properties of single muscle cells of the rhabdosphincter of the male urethra. *Prostate* 2004; 58: 238-274
 401. Bijlenga P, Hiu JH, Espinos E, Haenggeli CA, Fischer-Lougheed J, Bader CR, Bernheim L. T-type alpha 1H Ca²⁺ channels are involved in Ca²⁺ signalling during terminal differentiation (fusion) of human myoblasts. *Proc Natl Acad Sci* 2000; 67: 7627-7632.
 402. Mills KR. The basics of electromyography. *J Neurol Neurosurg Psychiatry* 2005; 76: ii32-ii35.
 403. Selvan VA. Single-fiber EMG: a review. *Ann Indian Acad Neurol* 2011; 14: 64-67.
 404. Buffini M, O'Halloran KD, O'Herlihy C, O'Connell PR, Jones JF. Comparison of the motor discharge to the voluntary sphincters of continence in the rat. *Neurogastroenterol Motil* 2012; 24: e175-184.
 405. Craggs MD, Balasubramaniam AV, Chung EA, Emmanuel AV. Aberrant reflexes and function of the pelvic organs following spinal cord injury in man. *Autonom Neurosci* 2006; 126-127: 355-370.
 406. de Groat WC. Central neural control of the lower urinary tract. *Ciba Found Symp* 1990; 151:27-44.

407. LaPallo BK, Wolpaw JR, Chen XY, Carp JS. Long-term recording of external urethral sphincter EMG activity in unanesthetized, unrestrained rats. *Am J Physiol Renal Physiol* 2014; 307: F485-497.
408. Stoffel JT. Detrusor sphincter dyssynergia: a review of physiology, diagnosis, and treatment strategies. *Trans Androl Urol* 2016; 5: 127-135.
409. Mahfouz W, Corcos J. Management of detrusor external sphincter dyssynergia in neurogenic bladder. *Eur J Phys Rehabil Med* 2011; 47: 639-650.
410. Utomo E, Groen J, Blok BF. Surgical management of functional bladder outlet obstruction in adults with neurogenic bladder dysfunction. *Cochrane Database Syst Rev* 2014 May 24; (5): CD004927.
411. Fowler CJ, Kirby RS. Abnormal electromyographic activity (decelerating bursts and complex repetitive discharges) in the striated muscle of the sphincter in 5 women with persisting urinary retention. *Br J Urol* 1985; 57: 69-70
412. Fowler CJ, Kirby RS, Harrison MJ. Decelerating burst and complex repetitive discharges in the striated muscle of the urethral sphincter, associated with urinary retention in women. *J Neurol Neurosurg Psychiatry* 1985; 48: 1004-1009
413. Tawadros C, Burnett K, Derbyshire LF, Tawadros T, Clarke NW, Betts CD. External urethral sphincter electromyography in asymptomatic women and the influence of the menstrual cycle. *BJU Int* 2015; 116: 423-431.
414. Andrich DE, Rickards D, Landon DN, Fowler CJ, Mundy AR. Structural assessment of the urethral sphincter in women with urinary retention. *J Urol* 2005; 173: 1246-1251.
415. Katz B, Schmitt OH. Electric interaction between two adjacent nerve fibres. *J Physiol* 1940; 97: 471-488.
416. Rasminsky M. Ephaptic transmission between single nerve fibres in the spinal nerve roots of dystrophic mice. *J Physiol* 1980; 305: 151-169.
417. Clark JW, Plonsey R. A mathematical study of nerve fiber interaction. *Biophys J* 1970; 10: 937-957.
418. Sun C, Tranebjaerg L, Torbergsen T, Holmgren G, Van Ghelue M. Spectrum of CLCN1 mutations in patients with myotonia congenita in Northern Scandinavia. *Eur J Hum Genet* 2001; 9: 903-909.
419. Fialho D, Kullmann DM, Hanna MG, Schorge S. Non-genomic effects of sex hormones on CLC-1 may contribute to gender differences in myotonia congenital. *Neuromuscul Disord* 2008; 18: 869-872.
420. Burge JA, Hanna MG, Schorge S. Nongenomic actions of progesterone and 17 β -estradiol on the chloride conductance of skeletal muscle. *Muscle Nerve* 2013; 48: 589-591.
421. Perucchini D, DeLancey JO, Ashton-Miller JA, Peschers U, Kataria T. Age effects on urethral striated muscle. I changes in number and diameter of striated muscle fibers in the ventral urethra. *Am J Obstet Gynecol* 2002; 186: 351-355.
422. Carlile A, Davies I, Rigby A, Brocklehurst JC. Age changes in the human female urethra: a morphometric study. *J Urol* 1988; 139: 532-535.
423. Strasser H, Tiefenthaler M, Steinlechner M, Eder I, Bartsch G, Konwalinka G. Age dependent apoptosis and loss of rhabdosphincter cells. *J Urol* 2000; 164: 1781-1785.
424. Perucchini D, DeLancey JO, Ashton-Miller JA, Galecki A, Schaer GN. Age effects on urethral striated muscle. II. Anatomic location of muscle loss. *Am J Obstet Gynecol* 2002; 186: 356-360.
425. Klauser A, Frauscher F, Strasser H, Helweg G, Kölle D, Strohmeyer D, Stenzl A, zur Nedden D. Age-related rhabdosphincter function in female urinary stress incontinence: assessment of intraurethral sonography. *J Ultrasound Med* 2004; 23: 631-637.
426. Tokunaka S, Fujii H, Hashimoto H, Yachiku S. Proportions of fiber types in the external urethral sphincter of young nulliparous and old multiparous rabbits. *Urol Res* 1993; 21: 121-124.
427. Frauscher F, Helweg G, Strasser H, Enna B, Klauser A, Knapp R, Colleselli K, Bartsch G, zur Nedden D. Intraurethral ultrasound: diagnostic evaluation of the striated urethral sphincter in incontinent females. *Eur Radiol* 1998; 8: 50-53.
428. Morgan DM, Umek W, Guire K, Morgan HK, Garabrant A, DeLancey JO. Urethral sphincter morphology and function with and without stress incontinence. *J Urol* 2009; 182: 203-209.
429. Strasser H, Frauscher F, Helweg G, Colleselli K, Reissigl A, Bartsch G. Transurethral ultrasound: evaluation of anatomy and function of the rhabdosphincter of the male urethra. *J Urol* 1998; 159: 100-104.
430. Dell'Atti L. Ultrasound evaluation of the striated urethral sphincter as a predictive parameter of urinary continence after radical prostatectomy. *Arch Ital Urol Androl* 2016; 87: 317-321.
431. Paparel P, Akin O, Sandhu JS, Otero JR, Serio AM, Scardino PT, Hricak H, Guillonneau B. Recovery of urinary continence after radical prostatectomy: association with urethral length and urethral fibrosis measured by preoperative and

- postoperative endorectal magnetic resonance imaging. *Eur Urol* 2009; 55: 629-637.
432. Bathgate RA, Halls ML, van der Westhuizen ET, Callander GE, Kocan M, Summers RJ. Relaxin family peptides and their receptors. *Physiol Rev* 2013; 93:405-480.
 433. Hisaw FL. Experimental relaxation of the pubic ligament of the guinea pig. *Exp Biol Med (Maywood)* 1926; 23: 661
 434. Lessing JB, Brenner SH, Colon JM, Ginsburg FW, Schoenfeld C, Goldsmith LT, Sarosi P, Amelar RD, Dubin L, Weiss G. Effect of relaxin on human spermatozoa. *J Reprod Med* 1986; 31: 304-309.
 435. Halls ML, Bathgate RA, Sutton SW, Dschietzig TB, Summers RJ. International Union of Basic and Clinical Pharmacology. XCV. Recent advances in the understanding of the pharmacology and biological roles of relaxin family peptide receptors 1-4, the receptors for relaxin family peptides. *Pharmacol Rev* 2015; 67: 389-440.
 436. Bastakoty D, Young PP. Wnt/beta-catenin pathway in tissue injury: roles in pathology and therapeutic opportunities for regeneration. *FASEB J*, 2016 pii: fj.201600502R.
 437. Ahmad N, Wang W, Nair R, Kapila S. Relaxin induces matrix-metalloproteinases-9 and -13 via RXFP1: induction of MMP-9 involves the PI3K, ERK, Akt and PKC-zeta pathways. *Mol Cell Endocrinol* 363; 46: 46-61.
 438. Han, X., Habuchi, Y., Giles, W. R.: Relaxin increases heart rate by modulating calcium current in cardiac pacemaker cells. *Circ Res* 1994; 74: 537; 8118961
 439. Samuel CS. Relaxin: antifibrotic properties and effects in models of disease. *Clin Med Res* 2005; 3: 241-249.
 440. Society AC. Cancer; Facts and Figures 2016: American Cancer Society 2016
 441. Petrovich Z, Jozsef G, Brady LW. Radiotherapy for carcinoma of the bladder: a review. *Am J Clin Oncol* 2001; 24: 1-9.
 442. Smit SG, Heyns CF. Management of radiation cystitis. *Nat Rev Urol* 2013; 10: 713-722.
 443. Crowe R, Vale J, Trott KR, Soediono P, Robson T, Burnstock G. Radiation-induced changes in neuropeptides in the rat urinary bladder. *J Urol* 1996; 156: 2062-2066.
 444. Zabbarova I, Kanai A. Targeted delivery of radioprotective agents to mitochondria. *Mol Interv* 2008; 8: 294-302.
 445. Streng T, Axelsson HE, Hedlund P, Andersson DA, Jordt SE, Bevan S, Andersson KE, Högestätt ED, Zygmunt PM. Distribution and function of the hydrogen sulfide-sensitive TRPA1 ion channel in rat urinary bladder. *Eur Urol*2006; 53: 391-399.
 446. Birder LA1, Nakamura Y, Kiss S, Nealen ML, Barrick S, Kanai AJ, Wang E, Ruiz G, De Groat WC, Apodaca G, Watkins S, Caterina MJ. Altered urinary bladder function in mice lacking the vanilloid receptor TRPV1. *Nat Neurosci* 2002; 5: 856-860.
 447. Uchida K, Kanematsu M, Morimitsu Y, Osawa T, Noguchi N, Niki E. Acrolein is a product of lipid peroxidation reaction. Formation of free acrolein and its conjugate with lysine residues in oxidized low density lipoproteins. *J Biol Chem* 1998;273: 16058-16066.
 448. Bjorling DE, Elkahwaji JE, Bushman W, Janda LM, Boldon K, Hopkins WJ, Wang ZY. Acute acrolein-induced cystitis in mice. *BJU Int* 2007; 99: 1523-1529.
 449. Browne C, Davis NF, Mac Craith E, Lennon GM, Mulvin DW, Quinlan DM, Mc Vey GP, Galvin DJ. A narrative review on the pathophysiology and management for radiation cystitis. *Adv Urol* 2015: 346812.
 450. Osman NI, Chapple CR, Abrams P, Dmochowski R, Haab F, Nitti V, Koelbl H, van Kerrebroeck P, Wein AJ. Detrusor underactivity and the underactive bladder: a new clinical entity? A review of current terminology, definitions, epidemiology, aetiology, and diagnosis. *Eur Urol* 2014; 65: 389-398.
 451. Andersson KE. The many faces of impaired bladder emptying. *Curr Opin Urol* 2014; 24: 363-369.
 452. Tyagi P, Smith PP, Kuchel GA, de Groat WC, Birder LA, Chermansky CJ, Adam RM, Tse V, Chancellor MB, Yoshimura N. Pathophysiology and animal modeling of underactive bladder. *Int Urol Nephrol* 2014; 46 Suppl 1: S11-21.
 453. Toni T, Dua P, van der Graaf PH. Systems pharmacology of the NGF signaling through p75 and TrkA receptors. *CPT Pharmacometrics Syst Pharmacol* 2014; 3: e150.
 454. Meeker RB, Williams KS. The p75 neurotrophin receptor: at the crossroad of neural repair and death. *Neural Regen Res* 2015; 10: 721-725.
 455. Chao MV. Neurotrophins and their receptors: a convergence point for many signalling pathways. *Nat Rev Neurosci* 2003; 4: 299-309.
 456. Hempstead BL. Deciphering proneurotrophin actions. *Handb Exp Pharmacol* 2014; 220: 17-32.
 457. Ochodnický P, Cruz CD, Yoshimura N, Michel MC. Nerve growth factor in bladder dysfunction

- tion: contributing factor, biomarker, and therapeutic target. *Neurourol Urodyn* 2011; 30: 1227-1241.
458. Ochodnický P, Cruz CD, Yoshimura N, Cruz F. Neurotrophins as regulators of urinary bladder function. *Nat Rev Urol* 2012; 9: 628-637.
 459. Cruz C D. Neurotrophins in bladder function: what do we know and where do we go from here? *Neurourol Urodyn* 2014; 33: 39-45.
 460. Frias B, Santos J, Morgado M, Sousa MM, Gray SM, McCloskey KD, Allen S, Cruz F, Cruz CD. The role of brain-derived neurotrophic factor (BDNF) in the development of neurogenic detrusor overactivity (NDO). *J Neurosci* 2015; 35: 2146-2160.
 461. Tong YC, Cheng JT. Changes in bladder nerve-growth factor and p75 genetic expression in streptozotocin-induced diabetic rats. *BJU Int* 2005; 96: 1392-1396.
 462. Vizzard MA. Changes in urinary bladder neurotrophic factor mRNA and NGF protein following urinary bladder dysfunction. *Exp Neurol* 2000; 161: 273-284.
 463. Beattie MS1, Harrington AW, Lee R, Kim JY, Boyce SL, Longo FM, Bresnahan JC, Hempstead BL, Yoon SO. ProNGF induces p75-mediated death of oligodendrocytes following spinal cord injury. *Neuron* 2002; 36: 375-386.
 464. Harrington AW, Leiner B, Blechschmitt C, Arevalo JC, Lee R, Mörl K, Meyer M, Hempstead BL, Yoon SO, Giehl KM. Secreted proNGF is a pathophysiological death-inducing ligand after adult CNS injury. *Proc Natl Acad Sci U S A* 2004; 101: 6226-6230.
 465. Fuhrer W B, Rasetti V, Riniker B. Peptide containing substituted 5-amino-4-hydroxyvalerly moiety. Switzerland: Ciba-Geigy Corporation, patent, 1985
 466. Tep C, Lim TH, Ko PO, Getahun S, Ryu JC, Goettl VM, Massa SM, Basso M, Longo FM, Yoon SO. Oral administration of a small molecule targeted to block proNGF binding to p75 promotes myelin sparing and functional recovery after spinal cord injury. *J Neurosci* 2013; 33: 397-410.
 467. Apodaca G, Kiss S, Ruiz W, Meyers S, Zeidel M, Birder L. Disruption of bladder epithelium barrier function after spinal cord injury. *Am J Physiol Renal Physiol* 2003; 284: F966-976.
 468. Vaidyanathan S, Krishnan KR, Mansour P, Soni BM, McDicken I. p75 nerve growth factor receptor in the vesical urothelium of patients with neuropathic bladder: an immunohistochemical study. *Spinal Cord* 1998; 36: 541-547.
 469. Qiao LY, Shen S, Liu M, Xia C, Kay JC, Zhang QL. Inflammation and activity augment brain-derived neurotrophic factor peripheral release. *Neuroscience* 2016; 318: 114-121.
 470. Birder L, Andersson K E. Urothelial signaling. *Physiol Rev* 2013; 93: 653-680.
 471. Zhong Y, Dunn PM, Bardini M, Ford AP, Cockayne DA, Burnstock G. Changes in P2X receptor responses of sensory neurons from P2X₃-deficient mice. *Eur J Neurosci* 2001; 14: 1784-1792.
 472. Cockayne DA, Dunn PM, Zhong Y, Rong W, Hamilton SG, Knight GE, Ruan HZ, Ma B, Yip P, Nunn P, McMahon SB, Burnstock G, Ford AP. P2X₂ knockout mice and P2X₂/P2X₃ double knockout mice reveal a role for the P2X₂ receptor subunit in mediating multiple sensory effects of ATP. *J Physiol* 2005; 567: 621-639.
 473. Khera M, Somogyi GT, Kiss S, Boone TB, Smith CP. Botulinum toxin A inhibits ATP release from bladder urothelium after chronic spinal cord injury. *Neurochem Int* 2004; 45: 987-993.
 474. Smith CP, Vemulakonda VM, Kiss S, Boone TB, Somogyi GT.: Enhanced ATP release from rat bladder urothelium during chronic bladder inflammation: effect of botulinum toxin A. *Neurochem Int* 2005; 47: 291-297.
 475. Sun Y, Keay S, De Deyne PG, Chai TC. Augmented stretch activated adenosine triphosphate release from bladder uroepithelial cells in patients with interstitial cystitis. *J Urol* 2001; 166: 1951-1956.
 476. Birder LA, Barrick SR, Roppolo JR, Kanai AJ, de Groat WC, Kiss S, Buffington CA. Feline interstitial cystitis results in mechanical hypersensitivity and altered ATP release from bladder urothelium. *Am J Physiol Renal Physiol* 2003; 285: F423-429.
 477. Arms L, Vizzard MA. Neuropeptides in lower urinary tract function. *Handb Exp Pharmacol* 2011; (202): 395-423.
 478. Girard BM, Wolf-Johnston A, Braas KM, Birder LA, May V, Vizzard MA. PACAP-mediated ATP release from rat urothelium and regulation of PACAP/VIP and receptor mRNA in micturition pathways after cyclophosphamide (CYP)-induced cystitis. *J Mol Neurosci* 2008; 36: 310-320.
 479. Chopra B, Barrick SR, Meyers S, Beckel JM, Zeidel ML, Ford AP, de Groat WC, Birder LA. Expression and function of bradykinin B1 and B2 receptors in normal and inflamed rat urinary bladder urothelium. *J Physiol* 2005; 562: 859-871.
 480. Birder LA, Apodaca G, De Groat WC, Kanai AJ. Adrenergic- and capsaicin-evoked nitric oxide release from urothelium and afferent nerves in

- urinary bladder. *Am J Physiol* 1998; 275: F226-229.
481. Zvarova K, Dunleavy JD, Vizzard MA. Changes in pituitary adenylate cyclase activating polypeptide expression in urinary bladder pathways after spinal cord injury. *Exp Neurol* 2005;192: 46-59.
 482. Kramer T, Enquist LW. Directional spread of alpha-herpes viruses in the nervous system. *Viruses* 2013; 5: 678-707.
 483. Eisen DP, Fraser IR, Sung LM, Finlay M, Bowden S, O'Connell H. Decreased viral load and symptoms of polyomavirus-associated chronic interstitial cystitis after intravesical cidofovir treatment. *Clin Infect Dis* 2009; 48: e86-88.
 484. van der Aa F, Beckley I, de Ridder D. Polyomavirus BK - a potential new therapeutic target for painful bladder syndrome/interstitial cystitis? *Med Hypotheses* 2104; 83: 317-320.
 485. Brittle EE, Reynolds AE, Enquist LW. Two modes of pseudorabies virus neuroinvasion and lethality in mice. *J Virol* 2004; 78: 12951-12963.
 486. Jacob J, Ludgate CM, Forde J, Tulloch WS. Recent observations on the ultrastructure of human urothelium. 1. Normal bladder of elderly subjects. *Cell Tissue Res* 1978; 193: 543-560.
 487. Perše M, Injac R, Erman A. Oxidative status and lipofuscin accumulation in urothelial cells of bladder in aging mice. *PLoS One* 2013; 8: e59638.
 488. Nowotny K, Jung T, Grune T, Höhn A. Reprint of "accumulation of modified proteins and aggregate formation in aging". *Exp Gerontol* 59: 3-12.
 489. Abrams P, Kelleher CJ, Kerr LA, Rogers RG. Overactive bladder significantly affects quality of life. *Am J Manag Care* 2000; 6: S580-590.
 490. 490 Temml C, Heidler S, Ponholzer A, Madersbacher S. Prevalence of the overactive bladder syndrome by applying the International Continence Society definition, *Eur Urol* 2005; 48: 622-627.
 491. Apostolidis A, Brady CM, Yiangou Y, Davis J, Fowler CJ, Anand P. Capsaicin receptor TRPV1 in urothelium of neurogenic human bladders and effect of intravesical resiniferatoxin, *Urology* 2005; 65: 400-405.
 492. Alexander SP, Kelly E, Marrion N, Peters JA, Benson HE, Faccenda E, Pawson AJ, Sharman JL, Southern C, Davies JA. *The Concise Guide to Pharmacology* 2015/16: Transporters, *Br J Pharmacol* 2015; 172: 6110-6202.
 493. Alexander SP, Mathie A, Peters JA. *Guide to receptors and channels*, 5th Edition. *Br J Pharmacol* 2011; 164: 1-324.
 494. Lambert DG. The nociceptin/orphanin FQ receptor: a target with broad therapeutic potential. *Nat Rev Drug Discov* 2008; 7: 694-710.
 495. Meunier JC, Mollereau C, Toll L, Suaudeau C, Moisand C, Alvinerie P, Butour JL, Guillemot JC, Ferrara P, Monsarrat B, et al. Isolation and structure of the endogenous agonist of opioid receptor-like ORL1 receptor. *Nature* 1995; 377: 532-535.
 496. Reinscheid RK, Nothacker HP, Boursion A, Ardani A, Henningsen RA, Bunzow JR, Grandy DK, Langen H, Monsma FJ Jr, Civelli O. Orphanin FQ: a neuropeptide that activates an opioidlike G protein-coupled receptor. *Science* 1995; 270: 792-794.
 497. Mogil JS, Pasternak GW. The molecular and behavioral pharmacology of the orphanin FQ/nociceptin peptide and receptor family. *Pharmacol Rev* 2001; 53: 381-415.
 498. Chiou LC, Liao YY, Fan PC, Kuo PH, Wang CH, Riemer C, Prinssen EP. Nociceptin/orphanin FQ peptide receptors: pharmacology and clinical implications. *Cur Drug Targets* 2007; 8: 117-135.
 499. Giuliani S, Lecci A, Tramontana M, Maggi CA. The inhibitory effect of nociceptin on the micturition reflex in anaesthetized rats. *Br J Pharmacol* 1998; 124: 1566-1572.
 500. Giuliani S, Lecci A, Tramontana M, Maggi CA. Nociceptin protects capsaicin-sensitive afferent fibers in the rat urinary bladder from desensitization. *Naunyn Schmiedebergs Arch Pharmacol* 1999; 360: 202-208.
 501. Lecci A, Giuliani S, Tramontana M, Meini S, Santicoli P, Maggi CA. Tachykinin-mediated effect of nociceptin in the rat urinary bladder in vivo. *Eur J Pharmacol* 2000; 389: 99-102.
 502. Lecci A, Giuliani S, Meini S, Maggi CA. Nociceptin and the micturition reflex. *Peptides* 2000; 21: 1007-1021.
 503. Lazzeri M, Calò G, Spinelli M, Guerrini R, Beneforti P, Sandri S, Zanollo A, Regoli D, Turini D. Urodynamic and clinical evidence of acute inhibitory effects of intravesical nociceptin/orphanin FQ on detrusor overactivity in humans: a pilot study. *J Urol* 2001; 166: 2237-2240.
 504. Lazzeri M, Calò G, Spinelli M, Guerrini R, Salvadori S, Beneforti P, Sandri S, Regoli D, Turini D. Urodynamic effects of intravesical nociceptin/orphanin FQ in neurogenic detrusor overactivity: a randomized, placebo-controlled, double-blind study. *Urology* 2003; 61: 946-950.

505. Lazzeri M, Calò G, Spinelli M, Malaguti S, Guerrini R, Salvadori S, Beneforti P, Regoli D, Turini D. Daily intravesical instillation of 1 mg nociceptin/orphanin FQ for the control of neurogenic detrusor overactivity: a multicenter, placebo controlled, randomized exploratory study. *J Urol* 2006; 176: 2098-2102.
506. Fowler CJ, Griffiths D, de Groat WC. The neural control of micturition. *Nat Rev Neurosci* 2008; 9: 453-466.
507. de Groat WC, Kawatani M, Hisamitsu T, Cheng CL, Ma CP, Thor K, Steers W, Roppolo JR. Mechanisms underlying the recovery of urinary bladder function following spinal cord injury. *J Auton Nerv Syst* 1990; 30 Suppl: S71-77.
508. Lazzeri M, Spinelli M. The challenge of overactive bladder therapy: alternative to antimuscarinic agents. *Int Braz J Urol* 2006; 32: 620-630.
509. Dixon JS, Jen PY, Gosling JA. The distribution of vesicular acetylcholine transporter in the human male genitourinary organs and its co-localization with neuropeptide Y and nitric oxide synthase. *Neurourol Urodyn* 2000; 19: 185-194.
510. Sibley GN. A comparison of spontaneous and nerve-mediated activity in bladder muscle from man, pig and rabbit. *J Physiol* 1984; 354: 431-443.
511. Alexander SP, Mathie A, Peters JA. Acetylcholine receptors (muscarinic). *Trends Pharmacol Sci* 2001; 22: 15-18.
512. Eglen RM, Reddy H, Watson N, Challiss RA. Muscarinic acetylcholine receptor subtypes in smooth muscle. *Trends Pharmacol Sci* 1994; 15: 114-119.
513. Kondo S, Morita T, Tashima Y. Muscarinic cholinergic receptor subtypes in human detrusor muscle studied by labeled and nonlabeled pirenzepine, AFDX-116 and 4DAMP. *Urol Int* 1995; 54: 150-153.
514. Pals-Rylaarsdam R, Xu Y, Witt-Enderby P, Benovic JL, Hosey MM. Desensitization and internalization of the M2 muscarinic acetylcholine receptor are directed by independent mechanisms. *J Biol Chem* 1995; 270: 29004-29011.
515. Hosey MM, DebBurman SK, Pals-Rylaarsdam R, Richardson RM, Benovic JL. The role of G-protein coupled receptor kinases in the regulation of muscarinic cholinergic receptors, *Prog Brain Res* 1996; 109: 169-179.
516. Furuya Y, Araki I, Kamiyama M, Zakoji H, Takihana Y, Takeda M. Decreased expression of G protein-coupled receptor kinases in the detrusor smooth muscle of human urinary bladder with outlet obstruction. *Int J Urol* 2006; 13: 1226-1232.
517. Yoshida M, Inadome A, Maeda Y, Satoji Y, Masunaga K, Sugiyama Y, Murakami S. Non-neuronal cholinergic system in human bladder urothelium. *Urology* 2006; 67: 425-430.
518. Daly DM, Chess-Williams R, Chapple C, Grundy D. The inhibitory role of acetylcholine and muscarinic receptors in bladder afferent activity. *Eur Urol* 2010; 58: 22-28.
519. Mansfield KJ, Chandran JJ, Vaux KJ, Millard RJ, Christopoulos A, Mitchelson FJ, Burcher E. Comparison of receptor binding characteristics of commonly used muscarinic antagonists in human bladder detrusor and mucosa. *J Pharmacol Exp Ther* 2009; 328: 893-899.
520. Elbadawi A. Comparative neuromorphology in animals. In *The physiology of the lower urinary tract*. (Torrens, M., and Morrison, J. F. B., Eds. 1987), p 23, Springer-Verlag, Berlin.
521. Tanaka Y, Horinouchi T, Koike K. New insights into beta-adrenoceptors in smooth muscle: distribution of receptor subtypes and molecular mechanisms triggering muscle relaxation. *Clin Exp Pharmacol Physiol* 2005; 32: 503-514.
522. Takeda M, Obara K, Mizusawa T, Tomita Y, Arai K, Tsutsui T, Hatano A, Takahashi K, Nomura S. Evidence for beta3-adrenoceptor subtypes in relaxation of the human urinary bladder detrusor: analysis by molecular biological and pharmacological methods. *J Pharmacol Exp Ther* 1999; 288: 1367-1373.
523. Fujimura T, Tamura K, Tsutsumi T, Yamamoto T, Nakamura K, Koibuchi Y, Kobayashi M, Yamaguchi O. Expression and possible functional role of the beta3-adrenoceptor in human and rat detrusor muscle. *J Urol* 1999; 161: 680-685.
524. Igawa Y, Yamazaki Y, Takeda H, Hayakawa K, Akahane M, Ajisawa Y, Yoneyama T, Nishizawa O, Andersson KE. Functional and molecular biological evidence for a possible beta3-adrenoceptor in the human detrusor muscle. *Br J Pharmacol* 1999; 126: 819-825.
525. Nomiya M, Yamaguchi O. A quantitative analysis of mRNA expression of alpha 1 and beta-adrenoceptor subtypes and their functional roles in human normal and obstructed bladders. *J Urol* 2003; 170: 649-653.
526. Sawa M, Harada H. Recent developments in the design of orally bioavailable beta3-adrenergic receptor agonists. *Curr Med Chem* 2006; 13: 25-37.
527. Hicks A, McCafferty GP, Riedel E, Aiyar N, Pullen M, Evans C, Luce TD, Coatney RW, Rivera GC, Westfall TD, Hieble JP. GW427353 (solabegron), a novel, selective beta3-adrenergic receptor agonist, evokes bladder relaxation and increases micturition reflex threshold in the

- dog. *J Pharmacol Exp Ther* 2007; 323: 202-209.
528. Leon LA, Hoffman BE, Gardner SD, Laping NJ, Evans C, Lashinger ES, Su X. Effects of the beta 3-adrenergic receptor agonist disodium 5-[(2R)-2-[(2R)-2-(3-chlorophenyl)-2-hydroxyethyl]amino]propyl]-1,3-benzodioxole-2,2-dicarboxylate (CL-316243) on bladder micturition reflex in spontaneously hypertensive rats. *J Pharmacol Exp Ther* 2008; 326: 178-185.
529. Masunaga K, Chapple CR, McKay NG, Yoshida M, Sellers DJ. The beta3-adrenoceptor mediates the inhibitory effects of beta-adrenoceptor agonists via the urothelium in pig bladder dome. *Neurourol Urodyn* 2010; 29: 1320-1325.
530. Sawada N, Nomiya M, Hood B, Koslov D, Zarifpour M, Andersson KE. Protective effect of a beta3-adrenoceptor agonist on bladder function in a rat model of chronic bladder ischemia. *Eur Urol* 2013; 64: 664-671.
531. Galve-Roperh I, Sánchez C, Cortés ML, Gómez del Pulgar T, Izquierdo M, Guzmán M. Anti-tumoral action of cannabinoids: involvement of sustained ceramide accumulation and extracellular signal-regulated kinase activation. *Nat Med* 2006; 6: 313-319.
532. Bifulco M, Laezza C, Portella G, Vitale M, Orlando P, De Petrocellis L, Di Marzo V. Control by the endogenous cannabinoid system of ras oncogene-dependent tumor growth. *Faseb J* 2001; 15: 2745-2747.
533. Sánchez C, de Ceballos ML, Gomez del Pulgar T, Rueda D, Corbacho C, Velasco G, Galve-Roperh I, Huffman JW, Ramón y Cajal S, Guzmán M. Inhibition of glioma growth in vivo by selective activation of the CB(2) cannabinoid receptor. *Cancer Res* 2001; 61: 5784-5789.
534. Casanova ML, Blázquez C, Martínez-Palacio J, Villanueva C, Fernández-Aceñero MJ, Huffman JW, Jorcano JL, Guzmán M. Inhibition of skin tumor growth and angiogenesis in vivo by activation of cannabinoid receptors. *J Clin Invest* 2003; 111: 43-50.
535. Guzman M. Cannabinoids: potential anti-cancer agents. *Nat Rev Cancer* 2003; 3: 745-755.
536. Klein TW. Cannabinoid-based drugs as anti-inflammatory therapeutics. *Nat Rev Immunol* 2005; 5: 400-411.
537. Howlett AC, Qualy JM, Khachatrian LL. Involvement of Gi in the inhibition of adenylate cyclase by cannabimimetic drugs. *Mol Pharmacol* 1986; 29: 307-313.
538. Devane WA, Dysarz FA 3rd, Johnson MR, Melvin LS, Howlett AC. Determination and characterization of a cannabinoid receptor in rat brain. *Mol Pharmacol* 1988; 34: 605-613.
539. Matsuda LA, Lolait SJ, Brownstein MJ, Young AC, Bonner TI. Structure of a cannabinoid receptor and functional expression of the cloned cDNA. *Nature* 1990; 346: 561-564.
540. Gérard CM, Mollereau C, Vassart G, Parmentier M. Molecular cloning of a human cannabinoid receptor which is also expressed in testis. *Biochem J* 1991; 279: 129-134.
541. Galiègue S, Mary S, Marchand J, Dussosoy D, Carrière D, Carayon P, Bouaboula M, Shire D, Le Fur G, Casellas P. Expression of central and peripheral cannabinoid receptors in human immune tissues and leukocyte subpopulations. *Eur J Biochem* 1995; 232: 54-61.
542. Straiker AJ, Maguire G, Mackie K, Lindsey J. Localization of cannabinoid CB1 receptors in the human anterior eye and retina. *Invest Ophthalmol Vis Sci* 1999; 40: 2442-2448.
543. Liu J, Gao B, Mirshahi F, Sanyal AJ, Khanolkar AD, Makriyannis A, Kunos G. Functional CB1 cannabinoid receptors in human vascular endothelial cells. *Biochem J* 2000; 346: 835-840.
544. Pagotto U, Marsicano G, Fezza F, Theodoropoulou M, Grübler Y, Stalla J, Arzberger T, Milone A, Lusa M, Di Marzo V, Lutz B, Stalla GK. Normal human pituitary gland and pituitary adenomas express cannabinoid receptor type 1 and synthesize endogenous cannabinoids: first evidence for a direct role of cannabinoids on hormone modulation at the human pituitary level. *J Clin Endocrinol Metab* 2001; 86: 2687-2696.
545. Pertwee RG. (1999) Evidence for the presence of CB1 cannabinoid receptors on peripheral neurones and for the existence of neuronal non-CB1 cannabinoid receptors. *Life Sci* 1999; 65: 597-605.
546. Munro S, Thomas KL, Abu-Shaar M. Molecular characterization of a peripheral receptor for cannabinoids. *Nature* 1993; 365: 61-65.
547. Mukerji G, Yiangou Y, Agarwal SK, Anand P. Increased cannabinoid receptor 1-immunoreactive nerve fibers in overactive and painful bladder disorders and their correlation with symptoms. *Urology* 2010; 75: 1514 e1515-1520.
548. Brady CM, DasGupta R, Dalton C, Wiseman OJ, Berkley KJ, Fowler CJ. An open-label pilot study of cannabis-based extracts for bladder dysfunction in advanced multiple sclerosis. *Mult Scler* 2004; 10: 425-433.

549. Capasso R, Aviello G, Borrelli F, Romano B, Ferro M, Castaldo L, Montanaro V, Altieri V, Izzo AA. Inhibitory effect of standardized cannabis sativa extract and its ingredient cannabidiol on rat and human bladder contractility. *Urology* 2011; 77: 1006 e1009-1006.
550. Strittmatter F, Gandaglia G, Benigni F, Bettiga A, Rigatti P, Montorsi F, Gratzke C, Stief C, Colciago G, Hedlund P. Expression of fatty acid amide hydrolase (FAAH) in human, mouse, and rat urinary bladder and effects of FAAH inhibition on bladder function in awake rats. *Eur Urol* 2012; 61: 98-106.
551. Füllhase C, Russo A, Castiglione F, Benigni F, Campeau L, Montorsi F, Gratzke C, Bettiga A, Stief C, Andersson KE, Hedlund P. Spinal cord FAAH in normal micturition control and bladder overactivity in awake rats. *J Urol* 2013; 189: 2364-2370.
552. Aizawa N, Hedlund P, Füllhase C, Ito H, Homma Y, Igawa Y. Inhibition of peripheral FAAH depresses activities of bladder mechanosensitive nerve fibers of the rat. *J Urol* 2014; 192: 956-963.
553. Bakali E, Mbaki Y, Lambert DG, Elliott RA, Mason R, Tincello DG. Effects of cannabinoid receptor activation by CP55,940 on normal bladder function and irritation-induced bladder overactivity in non-awake anaesthetised rats. *Int Urogynecol J* 2016; 27: 1393-1400.
554. Hedlund P. Cannabinoids and the endocannabinoid system in lower urinary tract function and dysfunction. *Neurourol Urodyn* 2014; 33: 46-53.
555. Hedlund P, Gratzke C. The endocannabinoid system - a target for the treatment of LUTS? *Nat Rev Urol* 2016; 13: 463-470.
556. Miyazato M, Sasatomi K, Hiragata S, Sugaya K, Chancellor MB, de Groat WC, Yoshimura N. GABA receptor activation in the lumbosacral spinal cord decreases detrusor overactivity in spinal cord injured rats. *J Urol* 2008; 179: 1178-1183.
557. Carbone A, Palleschi G, Conte A, Bova G, Iacovelli E, Bettolo CM, Pastore A, Inghilleri M. Gabapentin treatment of neurogenic overactive bladder. *Clin Neuropharmacol* 2006; 29: 206-214.
558. De Blasi A, Conn PJ, Pin J, Nicoletti F. Molecular determinants of metabotropic glutamate receptor signalling. *Trends Pharmacol Sci* 2001; 22: 114-120.
559. Wollmuth LP, Sobolevsky AI. Structure and gating of the glutamate receptor ion channel. *Trends Neurosci* 2004; 27: 321-328.
560. Yoshiyama M, Roppolo JR, de Groat WC. Effects of MK-801 on the micturition reflex in the rat - possible sites of action. *J Pharmacol Exp Ther* 1993; 265: 844-850.
561. Yoshiyama M, Roppolo JR, de Groat WC. Effects of LY215490, a competitive alpha-amino-3-hydroxy-5-methylisoxazole-4-propionic acid (AMPA) receptor antagonist, on the micturition reflex in the rat. *J Pharmacol Exp Ther* 1997; 280: 894-904.
562. Yoshiyama M, Araki I, Zakohji H, Kobayashi H, Du S, Aiba A, Takeda M. Role of metabotropic glutamate receptor subtype 1 in afferent processing of reflex micturition in mice. *J Urol* 2007; 177: 84.
563. Larson JA, Ogagan PD, Chen G, Shen B, Wang J, Roppolo JR, de Groat WC, Tai C. Involvement of metabotropic glutamate receptor 5 in pudendal inhibition of nociceptive bladder activity in cats. *J Physiol* 2011; 589: 5833-5843.
564. Hu Y, Dong L, Sun B, Guillon M., Burbach LR, Nunn PA, Liu X, Vilenski O, Ford AP, Zhong Y, Rong W. The role of metabotropic glutamate receptor mGlu5 in control of micturition and bladder nociception. *Neurosci Lett* 2009; 450: 12-17.
565. Narumiya S, Sugimoto Y, Ushikubi F. Prostanoid receptors: structures, properties, and functions. *Physiol Rev* 1999; 79: 1193-1226.
566. Breyer RM, Bagdassarian CK, Myers SA, Breyer MD. Prostanoid receptors: subtypes and signalling. *Ann Rev Pharmacol Toxicol* 2001; 41: 661-690.
567. Schneider T, Hein P, Michel MC. Signal transduction underlying carbachol-induced contraction of rat urinary bladder. I. Phospholipases and Ca²⁺ sources. *J Pharmacol Exp Ther* 2004; 308: 47-53.
568. Yokoyama O, Yusup A, Oyama N, Aoki Y, Miwa Y, Akino H. Improvement in bladder storage function by tamsulosin depends on suppression of C-fiber urethral afferent activity in rats. *J Urol* 2007; 177: 771-775.
569. Chapple CR, Abrams P, Andersson KE, Radziszewski P, Masuda T, Small M, Kuwayama T, Deacon S. Phase II study on the efficacy and safety of the EP1 receptor antagonist ONO-8539 for non-neurogenic overactive bladder syndrome. *J Urol* 2014; 191: 253-260.
570. Chuang YC, Yoshimura N, Huang CC, Wu M, Tyagi P, Chancellor MB. Expression of E-series prostaglandin (EP) receptors and urodynamic effects of an EP4 receptor antagonist on cyclophosphamide-induced overactive bladder in rats. *BJU Int* 2010; 106: 1782-1787.

571. Beppu M, Araki I, Yoshiyama M, Du S, Kobayashi H, Zakoji H, Takeda M. Bladder outlet obstruction induced expression of prostaglandin E2 receptor subtype EP4 in the rat bladder: a possible counteractive mechanism against detrusor overactivity. *J Urol* 2011; 186: 2463-2469.
572. Yuanjun J, Kobayashi H, Sawada N, Yoshiyama M, Mochizuki T, Zakoji H, Araki I, Takeda M. The expression of prostaglandin E2 receptors (EP1, 2, 3, and 4) in the human urinary bladder epithelium of normal and bladder outlet obstruction. *J Urol* 2008; 179: 452.
573. Olesen ET, Fenton RA. (2013) Is there a role for PGE2 in urinary concentration? *J Am Soc Nephrol*. 2013; 24: 169-178.
574. Nirmal J, Tyagi P, Chuang YC, Lee WC, Yoshimura N, Huang CC, Rajaganapathy B, Chancellor MB. Functional and molecular characterization of hyposensitive underactive bladder tissue and urine in streptozotocin-induced diabetic rat, *PLoS one* 2014; 9: e102644.
575. Kinoshita A, Higashino M, Aratani Y, Kakuuchi A, Matsuya H, Ohmoto K. Discovery of highly potent dual EP2 and EP3 agonists with subtype selectivity. *Bioorg Med Chem Lett* 2016; 26: 1016-1019.
576. Sekido N, Kida J, Mashimo H, Wakamatsu D, Okada H, Matsuya H. Promising effects of a novel EP2 and EP3 receptor dual agonist, ONO-8055, on neurogenic underactive bladder in a rat lumbar canal stenosis model. *J Urol* 2016; 196: 609-616.
577. Green SA, Alon A, Ianus J, McNaughton KS, Tozzi CA, Reiss TF. Efficacy and safety of a neurokinin-1 receptor antagonist in postmenopausal women with overactive bladder with urge urinary incontinence. *J Urol* 2006; 176: 2535-2540.
578. Ballet S, Aubel B, Mauborgne A, Poli  n H, Farr   A, Cesselin F, Hamon M, Bourgoin AS. The novel analgesic, cizolirtine, inhibits the spinal release of substance P and CGRP in rats. *Neuropharmacology* 2001; 40: 578-589.
579. Aubel B, Kayser V, Farr   A, Hamon M, Bourgoin S. Evidence for adenosine- and serotonin-mediated antihyperalgesic effects of cizolirtine in rats suffering from diabetic neuropathy. *Neuropharmacology* 2007; 52: 487-496.
580. Alvarez I, Andreu F, Buxens J, Colombo M, Dordal A, Fort M, Guti  rrez B, Farr   AJ. Pharmacology of cizolirtine: a new analgesic agent. *Methods Find Exp Clin Pharmacol* 2000; 22: 211-221.
581. Mart  nez-Garc  a R, Abad  as M, Ara  o P, Perales L, Ru  z JL, Sust M, Conejero J. Cizolirtine citrate, an effective treatment for symptomatic patients with urinary incontinence secondary to overactive bladder: a pilot dose-finding study. *Eur Urol* 2009; 56: 184-190.
582. Laffitte A, Neiers F, Briand L. Functional roles of the sweet taste receptor in oral and extraoral tissues. *Curr Opin Clin Nutr Metab Car* 2014; 17: 379-385
583. Elliott RA, Kapoor S, Tincello DG. Expression and distribution of the sweet taste receptor isoforms T1R2 and T1R3 in human and rat bladders. *J Urol* 2011; 186: 2455-2462.
584. Deckmann K, Filipski K, Krasteva-Christ G, Fronius M, Althaus M, Rafiq A, Papadakis T, Renno L, Jurastow I, Wessels L, Wolff M, Sch  tz B, Weihe E, Chubanov V, Gudermann T, Klein J, Bschleipfer T, Kummer W. Bitter triggers acetylcholine release from polymodal urethral chemosensory cells and bladder reflexes. *Proc Natl Acad Sci USA* 2014; 111: 8287-8292.
585. Zhai K, Yang Z, Zhu X, Nyirimigabo E, Mi Y, Wang Y, Liu Q, Man L, Wu S, Jin J, Ji G. Activation of bitter taste receptors (tas2rs) relaxes detrusor smooth muscle and suppresses overactive bladder symptoms. *Oncotarget* 2016; 7: 21156-21167.
586. Burnstock G. Purinergic signalling in the urinary tract in health and disease. *Purinergic signalling* 2014; 10: 103-155.
587. Kaan TK, Yip PK, Grist J, Cefalu JS, Nunn PA, Ford AP, Zhong Y, McMahon SB. Endogenous purinergic control of bladder activity via presynaptic P2X₃ and P2X_{2/3} receptors in the spinal cord. *J Neurosci* 2010; 30 4503-4507.
588. Kim JC, Yoo JS, Park EY, Hong SH, Seo SI, Hwang TK. Muscarinic and purinergic receptor expression in the urothelium of rats with detrusor overactivity induced by bladder outlet obstruction. *BJU Int* 2008; 101: 371-375.
589. Ito, K., Iwami, A., Katsura. Therapeutic effects of the putative P2X₃/P2X_{2/3} antagonist A-317491 on cyclophosphamide-induced cystitis in rats. *Naunyn Schmiedeberg's Arch Pharmacol* 2008; 377: 483-490.
590. Sun B, Li Q, Dong L, Rong W. Ion channel and receptor mechanisms of bladder afferent nerve sensitivity. *Auton Neurosci* 2010; 15.: 26-32.
591. Moore KH, Ray FR, Barden JA. Loss of purinergic P2X₃ and P2X₅ receptor innervation in human detrusor from adults with urge incontinence. *J Neurosci* 2001; 21: RC166.
592. Kobayashi H, Yoshiyama M, Zakoji H, Takeda M, Araki I. Sex differences in the expression profile of acid-sensing ion channels in the mouse urinary bladder: a possible involvement in irritative bladder symptoms. *BJU Int* 2009; 104: 1746-1751.

593. Sadananda P, Shang F, Liu L, Mansfield KJ, Burcher E. Release of ATP from rat urinary bladder mucosa: role of acid, vanilloids and stretch. *Br J Pharmacol* 2009; 158: 1655-1662.
594. Kullmann FA1, Shah MA, Birder LA, de Groat WC. Functional TRP and ASIC-like channels in cultured urothelial cells from the rat. *Am J Physiol Renal Physiol* 2009; 296: F892-901.
595. Corrow K, Girard BM, Vizzard MA. Expression and response of acid-sensing ion channels in urinary bladder to cyclophosphamide-induced cystitis. *Am J Physiol Renal Physiol* 2010; 298: F1130-1139.
596. Sánchez-Freire V, Blanchard MG, Burkhard FC, Kessler TM, Kellenberger S, Monastyrskaya K. Acid-sensing channels in human bladder: expression, function and alterations during bladder pain syndrome. *J Urol* 2011; 186: 1509-1516.
597. Burton TJ, Elneil S, Nelson CP, Ferguson DR. Activation of epithelial Na⁺ channel activity in the rabbit urinary bladder by cAMP. *Eur J Pharmacol* 2000; 404: 273-280.
598. Ferguson DR. Urothelial function. *BJU Int* 1999; 84: 235-242.
599. Fricke B, Lints R, Stewart G, Drummond H, Dodt G, Driscoll M, von Düring M. Epithelial Na⁺ channels and stomatin are expressed in rat trigeminal mechanosensory neurons. *Cell Tissue Res* 2000; 299: 327-334.
600. Gillespie PG, Walker RG. Molecular basis of mechanosensory transduction. *Nature* 2001; 413: 194-202.
601. Kopp UC, Matsushita K, Sigmund RD, Smith LA, Watanabe S, Stokes JB. Amiloride-sensitive Na⁺ channels in pelvic uroepithelium involved in renal sensory receptor activation. *Am J Physiol* 1998; 275: R1780-1792.
602. Smith PR, Mackler SA, Weiser PC, Brooker DR, Ahn YJ, Harte BJ, McNulty KA, Kleyman TR. Expression and localization of epithelial sodium channel in mammalian urinary bladder. *Am J Physiol* 1998; 274: F91-96.
603. Araki I, Du S, Kamiyama M, Mikami Y, Matsushita K, Komuro M, Furuya Y, Takeda M. Overexpression of epithelial sodium channels in epithelium of human urinary bladder with outlet obstruction. *Urology* 2004; 64: 1255-1260.
604. Traini C, Del Popolo G, Lazzeri M, Mazzaferro K, Nelli F, Calosi L, Vannucchi MG. gamma-epithelial Na⁺ channel (gammaENaC) and the acid-sensing ion channel 1 (ASIC1) expression in the urothelium of patients with neurogenic detrusor overactivity. *BJU Int* 2015; 116: 797-804.
605. Du S, Araki I, Mikami Y, Zakoji H, Beppu M, Yoshiyama M, Takeda M. Amiloride-sensitive ion channels in urinary bladder epithelium involved in mechanosensory transduction by modulating stretch-evoked adenosine triphosphate release. *Urology* 2007; 69: 590-595.
606. Heppner TJ, Bonev AD, Nelson MT. Ca²⁺-activated K⁺ channels regulate action potential repolarization in urinary bladder smooth muscle. *Am J Physiol* 1997; 273: C110-117.
607. Christ GJ, Day NS, Santizo C, Zhao W, Sclafani T, Karicheti V, Valcic M, Melman A. Bladder instillation of "naked" hSlo/pcDNA3 ameliorates detrusor hyperactivity in obstructed rats in vivo. *Urology* 2011; 57: 111.
608. Tanaka Y, Okamoto T, Imai T, Yamamoto Y, Horinouchi T, Tanaka H, Koike K, Shigenobu K. BKCa channel activity enhances with muscle stretch in guinea-pig urinary bladder smooth muscle. *Res Commun Mol Pathol Pharmacol* 2003; 113-114: 247-252.
609. Christ GJ, Day NS, Day M, Santizo C, Zhao W, Sclafani T, Zinman J, Hsieh K, Venkateswarlu K, Valcic M, Melman A. Bladder injection of "naked" hSlo/pcDNA3 ameliorates detrusor hyperactivity in obstructed rats in vivo. *Am J Physiol Regul Integr Comp Physiol* 2001; 281: R1699-1709.
610. Werner ME, Knorn AM, Meredith AL, Aldrich RW, Nelson MT. Frequency encoding of cholinergic- and purinergic-mediated signaling to mouse urinary bladder smooth muscle: modulation by BK channels. *Am J Physiol Regul Integr Comp Physiol* 2007; 292: R616-624.
611. Shieh CC, Turner SC, Zhang XF, Milicic I, Parihar A, Jinkerson T, Wilkins J, Buckner SA, Gopalakrishnan M. A-272651, a nonpeptidic blocker of large-conductance Ca²⁺-activated K⁺ channels, modulates bladder smooth muscle contractility and neuronal action potentials. *Br J Pharmacol* 2007; 151: 798-806.
612. Andersson KE. Treatment of the overactive bladder: possible central nervous system drug targets. *Urology* 2002; 59: 18-24.
613. Melman A, Bar-Chama N, McCullough A, Davies K, Christ G. Plasmid-based gene transfer for treatment of erectile dysfunction and overactive bladder: results of a phase I trial. *Isr Med Assoc* 2007; 9: 143-146.
614. Lee S, Chae MR, Lee BC, Kim YC, Choi JS, Lee SW, Cheong JH, Park CS. Urinary bladder-relaxant effect of kurarinone depending on potentiation of large-conductance Ca²⁺-activated K⁺ channels. *Mol Pharmacol* 2016; 90: 140-150.
615. Ribeiro AS, Fernandes VS, Martínez-Sáenz A, Martínez P, Barahona MV, Orensanz LM,

- Blahe I, Serrano-Margüello D, Bustamante S, Carballido J, García-Sacristán A, Prieto D, Hernández M. Powerful relaxation of phosphodiesterase type 4 inhibitor rolipram in the pig and human bladder neck. *J Sex Med* 2014; 11: 930-941.
616. Kiselyov K, Soyombo A, Muallem S. TRPpa-thies. *J Physiol* 2007; 578: 641-653.
617. Nilius B. TRP channels in disease *Biochim Biophys Acta* 2007; 1772, 805-812.
618. Everaerts W, Gevaert T, Nilius B, De Ridder D. On the origin of bladder sensing: Tr(i)ps in urology. *Neurourol Urodyn* 2008; 27: 264-273.
619. Du S, Araki I, Kobayashi H, Zakoji H, Sawada N, Takeda M. Differential expression profile of cold (TRPA1) and cool (TRPM8) receptors in human urogenital organs. *Urology* 2008; 72: 450-455.
620. Du S, Araki I, Yoshiyama M, Nomura T, Takeda M. Transient receptor potential channel A1 involved in sensory transduction of rat urinary bladder through C-fiber pathway. *Urology* 2007; 70: 826-831.
621. Andrade EL, Ferreira J, André E, Calixto JB. Contractile mechanisms coupled to TRPA1 receptor activation in rat urinary bladder. *Biochem Pharmacol* 2006; 72: 104-114.
622. Tsukimi Y, Mizuyachi K, Yamasaki T, Niki T, Hayashi F. Cold response of the bladder in guinea pig: involvement of transient receptor potential channel, TRPM8. *Urology* 2005; 65: 406-410.
623. Birder LA. More than just a barrier: urothelium as a drug target for urinary bladder pain. *Am J Physiol Renal Physiol* 2005; 289: F489-495.
624. Avelino A, Cruz F. TRPV₁ (vanilloid receptor) in the urinary tract: expression, function and clinical applications. *Naunyn Schmiedebergs Arch Pharmacol* 2006; 373: 287-299.
625. Nilius B, Owsianik G, Voets T, Peters JA. Transient receptor potential cation channels in disease. *Physiol Rev* 2007; 87: 165-217.
626. Sharif Naeini R, Witty MF, Séguéla P, Bourque CW. An N-terminal variant of TRPV1 channel is required for osmosensory transduction *Nat Neurosci* 2006; 9: 93-98.
627. Ciura S, Bourque CW. Transient receptor potential vanilloid 1 is required for intrinsic osmoreception in organum vasculosum lamina terminalis neurons and for normal thirst responses to systemic hyperosmolality. *J Neurosci* 2006; 26: 9069-9075.
628. Daly D, Rong W, Chess-Williams R, Chapple C, Grundy D. Bladder afferent sensitivity in wild-type and TRPV₁ knockout mice. *J Physiol* 2007; 583: 663-674.
629. Brady CM, Apostolidis AN, Harper M, Yiangou Y, Beckett A, Jacques TS, Freeman A, Scara-villi F, Fowler CJ, Anand P. Parallel changes in bladder suburothelial vanilloid receptor TRPV₁ and pan-neuronal marker PGP9.5 immunoreactivity in patients with neurogenic detrusor overactivity after intravesical resiniferatoxin treatment *BJU Int* 2004; 93: 770-776.
630. Castro Nda S, de Castro KP, Orlandi I, Feitosa Ldos S, Rosa e Silva LK, Vainstein MH, Bão SN, Vai M, Soares CM. Bladder sensory desensitization decreases urinary urgency. *BMC Uro* 2007; 7: 9.
631. Charrua A, Cruz CD, Narayanan S, Gharat L, Gullapalli S, Cruz F, Avelino A. GRC-6211, a new oral specific TRPV₁ antagonist, decreases bladder overactivity and noxious bladder input in cystitis animal models. *J Urol* 2009; 181: 379-386.
632. Round P, Priestley A, Robinson J. An investigation of the safety and pharmacokinetics of the novel TRPV₁ antagonist XEN-D0501 in healthy subjects. *Br J Clin Pharmacol* 2011; 72: 921-931.
633. Ha US, Park EZ, Kim JC. Effect of botulinum toxin on expression of nerve growth factor and transient receptor potential vanilloid 1 in urothelium and detrusor muscle of rats with bladder outlet obstruction-induced detrusor overactivity. *Urology* 2011; 78: e721-726.
634. Voets T, Owsianik G, Janssens A, Talavera K, Nilius B. Sensing with TRP channels. *Nat Chem Biol* 2005; 1: 85-92.
635. Suzuki M, Mizuno A, Kodaira K, Imai M. Impaired pressure sensation in mice lacking TRPV₄. *J Biol Chem* 2003; 278: 22664-22668.
636. Liedtke W, Friedman JM. Abnormal osmotic regulation in TRPV₄^{-/-} mice. *Proc Natl Acad Sci USA* 2003; 100: 13698-13703.
637. Birder L, Kullmann FA, Lee H, Barrick S, de Groat W, Kanai A, Caterina M. Activation of urothelial transient receptor potential vanilloid 4 by 4alpha-phorbol 12,13-didecanoate contributes to altered bladder reflexes in the rat. *J Pharmacol Exp Ther* 2007; 323: 227-235.
638. Gevaert T, Vriens J, Segal A, Everaerts W, Roskams T, Talavera K, Owsianik G, Liedtke W, Daelemans D, Dewachter I, Van Leuven F, Voets T, De Ridder D, Nilius B. Deletion of the transient receptor potential cation channel TRPV₄ impairs murine bladder voiding. *J Clin Invest* 2007; 117 3453-3462.
639. Mochizuki T, Sokabe T, Araki I, Fujishita K, Shibasaki K, Uchida K, Naruse K, Koizumi S,

- Takeda M, Tominaga M. The TRPV₄ cation channel mediates stretch-evoked Ca²⁺ influx and ATP release in primary urothelial cell cultures. *J Biol Chem* 2009; 284: 21257-21264.
640. Angelico P, Testa R. TRPV₄ as a target for bladder overactivity, *F1000 Biol Rep* 2010; 2.pii: 12.
641. Everaerts W, Zhen X, Ghosh D, Vriens J, Gevaert T, Gilbert JP, Hayward NJ, McNamara CR, Xue F, Moran MM, Strassmaier T, Uykai E, Owsianik G, Vennekens R, De Ridder D, Nilius B, Fanger CM, Voets T. Inhibition of the cation channel TRPV₄ improves bladder function in mice and rats with cyclophosphamide-induced cystitis. *Proc Natl Acad Sci USA* 2010; 107: 19084-19089.
642. Charrua A, Cruz CD, Jansen D, Rozenberg B, Heesakkers J, Cruz F. Co-administration of transient receptor potential vanilloid 4 (TRPV₄) and TRPV₁ antagonists potentiate the effect of each drug in a rat model of cystitis. *BJU Int* 2015; 115: 452-460.
643. Yoshiyama M, Mochizuki T, Nakagomi H, Miyamoto T, Kira S, Mizumachi R, Sokabe T, Takayama Y, Tominaga M, Takeda M. Functional roles of TRPV₁ and TRPV₄ in control of lower urinary tract activity: dual analysis of behavior and reflex during the micturition cycle. *Am J Physiol Renal Physiol* 2015; 308: F1128-1134.
644. Macpherson LJ, Dubin AE, Evans MJ, Marr F, Schultz PG, Cravatt BF, Patapoutian A. Noxious compounds activate TRPA1 ion channels through covalent modification of cysteines. *Nature* 2007; 445: 541-545.
645. Hinman A1, Chuang HH, Bautista DM, Julius D. TRP channel activation by reversible covalent modification. *Proc Natl Acad Sci USA* 2006; 103: 19564-19568.
646. Nilius B, Voets T, Peters J. TRP channels in disease. *Sci STKE* 2005; 2005 (295): re8.
647. Nagata K, Duggan A, Kumar G, García-Añoveros J. Nociceptor and hair cell transducer properties of TRPA1, a channel for pain and hearing. *J Neurosci* 2005; 25: 4052-4061.
648. Philippov IB, Paduraru ON, Gulak KL, Skryma R, Prevarskaya N, Shuba YM. TRPA1-dependent regulation of bladder detrusor smooth muscle contractility in normal and type I diabetic rats. *J Smooth Muscle Res* 2016; 52: 1-17.
649. Andrade EL, Forner S, Bento AF, Leite DF, Dias MA, Leal PC, Koeppe J, Calixto JB. TRPA1 receptor modulation attenuates bladder overactivity induced by spinal cord injury. *Am J Physiol Renal Physiol* 2011; 300: F1223-1234.
650. Streng T, Axelsson HE, Hedlund P, Andersson DA, Jordt SE, Bevan S, Andersson KE, Högestätt ED, Zygmunt PM. Distribution and function of the hydrogen sulfide-sensitive TRPA1 ion channel in rat urinary bladder. *Eur Urol* 2008; 53: 391-399.
651. DeBerry JJ, Schwartz ES, Davis BM. TRPA1 mediates bladder hyperalgesia in a mouse model of cystitis. *Pain* 2014; 155: 1280-1287.
652. Chen Z, Du S, Kong C, Zhang Z, Mokhtar AD. Intrathecal administration of TRPA1 antagonists attenuate cyclophosphamide-induced cystitis in rats with hyper-reflexia micturition. *BMC Urol* 2016; 16: 33.
653. Lashinger ES, Steingina MS, Hieble JP, Leon LA, Gardner SD, Nagilla R, Davenport EA, Hoffman BE, Laping NJ, Su X. AMTB, a TRPM8 channel blocker: evidence in rats for activity in overactive bladder and painful bladder syndrome. *Am J Physiol Renal Physiol* 2008; 295: F803-810.
654. Nomoto Y, Yoshida A, Ikeda S, Kamikawa Y, Harada K, Ohwatashi A, Kawahira K. Effect of menthol on detrusor smooth-muscle contraction and the micturition reflex in rats. *Urology* 2008; 72: 701-705.
655. Hayashi T, Kondo T, Ishimatsu M, Takeya M, Igata S, Nakamura K, Matsuoka K. Function and expression pattern of TRPM8 in bladder afferent neurons associated with bladder outlet obstruction in rats. *Auton Neurosci* 2011; 164: 27-33.
656. Shibata Y, Ugawa S, Imura M, Kubota Y, Ueda T, Kojima Y, Ishida Y, Sasaki S, Hayashi Y, Kohri K, Shimada S. TRPM8-expressing dorsal root ganglion neurons project dichotomizing axons to both skin and bladder in rats. *Neuroreport* 2011; 22: 61-67.
657. Uvin P, Franken J, Pinto S, Rietjens R, Grammet L, Deruyver Y, Alpizar YA, Talavera K, Vennekens R, Everaerts W, De Ridder D, Voets T. Essential role of transient receptor potential M8 (TRPM8) in a model of acute cold-induced urinary urgency. *Eur Urol* 2015; 68: 655-661.
658. Mistretta FA, Russo A, Castiglione F, Bettiga A, Colciago G, Montorsi F, Brandolini L, Aramini A, Bianchini G, Allegretti M, Bovolenta S, Russo R, Benigni F, Hedlund P. DFL23448, A novel transient receptor potential melastin 8-selective ion channel antagonist, modifies bladder function and reduces bladder overactivity in awake rats *J Pharmacol Exp Ther* 2016; 356: 200-211.
659. Coste B., Mathur, J., Schmidt, M., Earley, T. J., Ranade, S., Petrus, M. J., Dubin, A. E., and Patapoutian, A. (2010) Piezo1 and Piezo2 are

essential components of distinct mechanically activated cation channels, *Science* (New York, N.Y.) 330, 55-60.

660. Coste B, Mathur J, Schmidt M, Earley TJ, Ranade S, Petrus MJ, Dubin AE, Patapoutian A. Piezo proteins are pore-forming subunits of mechanically activated channels. *Nature* 2012; 483: 176-181.
661. Li J, Hou B, Tumova S, Muraki K, Bruns A, Ludlow MJ, Sedo A, Hyman AJ, McKeown L, Young RS, Yuldasheva NY, Majeed Y, Wilson LA, Rode B, Bailey MA, Kim HR, Fu Z, Carter DA, Bilton J, Imrie H, Ajuh P, Dear TN, Cubbon RM, Kearney MT, Prasad KR, Evans PC, Ainscough JF, Beech DJ. Piezo1 integration of vascular architecture with physiological force. *Nature* 2014; 515: 279-282.
662. Zarychanski R, Schulz VP, Houston BL, Maksimova Y, Houston DS, Smith B, Rinehart J, Gallagher PG. Mutations in the mechanotransduction protein PIEZO1 are associated with hereditary xerocytosis. *Blood* 2012; 120: 1908-1915.
663. Bae C, Gnanasambandam R, Nicolai C, Sachs F, Gottlieb PA. Xerocytosis is caused by mutations that alter the kinetics of the mechanosensitive channel PIEZO1, *Proc Natl Acad Sci USA* 2013; 110: E1162-1168.
664. Albuissou J1, Murthy SE, Bandell M, Coste B, Louis-Dit-Picard H, Mathur J, Fénéant-Thibault M, Tertian G, de Jaureguiberry JP, Syfuss PY, Cahalan S, Garçon L, Toutain F, Simon Rohrlch P, Delaunay J, Picard V, Jeunemaitre X, Patapoutian A. Dehydrated hereditary stomatocytosis linked to gain-of-function mutations in mechanically activated PIEZO1 ion channels. *Nat Comm* 2013; 4: 1884.
665. Miyamoto T, Mochizuki T, Nakagomi H, Kira S, Watanabe M, Takayama Y, Suzuki Y, Koizumi S, Takeda M, Tominaga M. Functional role for Piezo1 in stretch-evoked Ca^{2+} influx and ATP release in urothelial cell cultures. *J Biol Chem* 2014; 289: 16565-16575.
666. Sawada K, Echigo N, Juge N, Miyaji T, Otsuka M, Omote H, Yamamoto A, Moriyama Y. Identification of a vesicular nucleotide transporter. *Proc Natl Acad Sci USA* 2008; 105: 5683-5686.
667. Nakagomi H, Yoshizawa M, Mochizuki T, Miyamoto T, Komatsu R, Imura Y, Morizawa Y, Hisasa M, Miyaji T, Kira S, Araki I, Fujishita K, Shibata K, Shigetomi E, Shinozaki Y, Ichikawa R, Uneyama H, Iwatsuki K, Nomura M, de Groat WC, Moriyama Y, Takeda M, Koizumi S. Urothelial ATP exocytosis: regulation of bladder compliance in the urine storage phase. *Sci Rep* 2016; 6: 29761.
668. Okamura H, Doi M, Fustin JM, Yamaguchi Y, Matsuo M. Mammalian circadian clock system: Molecular mechanisms for pharmaceutical and medical sciences, *Adv Drug Deliv Rev.* 2010; 62: 876-884.
669. Negoro H, Kanematsu A, Doi M, Suadicani SO, Matsuo M, Imamura M, Okinami T, Nishikawa N, Oura T, Matsui S, Seo K, Tainaka M, Urabe S, Kiyokage E, Todo T, Okamura H, Tabata Y, Ogawa O. Involvement of urinary bladder Connexin43 and the circadian clock in coordination of diurnal micturition rhythm. *Nat Comm* 2012; 3: 809.
670. Stow LR, Gumz ML. The circadian clock in the kidney. *J Am Soc Nephrol.* 2011; 22: 598-604.
671. Vriend J, Reiter, RJ. Melatonin feedback on clock genes: a theory involving the proteasome. *J Pin Res* 2015: 58: 1-11.
672. Obayashi K, Saeki K, Kurumatani N. Association between melatonin secretion and nocturia in elderly individuals: a cross-sectional study of the HEIJO-KYO cohort. *J Urol* 2014; 191: 1816-1821.
673. Ihara T, Mitsui T, Nakamura Y, Kira S, Miyamoto T, Nakagomi H, Sawada N, Hirayama Y, Shibata K, Shigetomi E, Shinozaki Y, Yoshizawa M, Andersson KE, Nakao A, Takeda M, Koizumi S. The Clock mutant mouse is a novel experimental model for nocturia and nocturnal polyuria. *NeuroUrol Urodyn.* 2016 Jun 27. doi: 10.1002/nau.23062.
674. Siproudhis L, Bellissant E, Pagenault M, Mandler MH, Allain H, Bretagne JF, Gosselin M. Fecal incontinence with normal anal canal pressures: where is the pitfall? *Am J Gastroenterol* 1999; 94: 1556-1563.
675. Palit S, Lunniss PJ, Scott SM. The physiology of human defecation. *Digest Dis Sci* 2012; 57: 1445-1464.
676. Lazarescu A, Turnbull GK, Vanner S. Investigating and treating fecal incontinence: when and how. *Can J Gastroenterol* 2009; 23: 301-308.
677. McCreia GL, Miaskowski C, Stotts NA, Macera L, Varma MG. Pathophysiology of constipation in the older adult. *World J Gastroenterol* 2008; 7; 14: 2631-2638.
678. Rao SS. Advances in diagnostic assessment of fecal incontinence and dyssynergic defecation. *Clin Gastroenterol Hepatol* 2010; 8: 910-919.
679. Fernández-Fraga X, Azpiroz F, Malagelada JR. Significance of pelvic floor muscles in anal incontinence. *Gastroenterology* 2002; 123: 1441-1450.
680. Bharucha AE, Kulkarni A, et al. First-in-human study demonstrating pharmacological activation of heme oxygenase-1 in humans. *Clin Pharmacol Ther* 2010; 87: 187-190.

681. Rattan S, Singh J. Basal internal anal sphincter tone, inhibitory neurotransmission, and other factors contributing to the maintenance of high pressures in the anal canal. *Neurogastroenterol Motil* 2011; 23: 3-7.
682. Rattan S. The internal anal sphincter: regulation of smooth muscle tone and relaxation. *Neurogastroenterol Motil* 2005; 17: Suppl 50-59: 425
683. Farouk R, Duthie GS, et al. Sustained internal sphincter hypertonia in patients with chronic anal fissure. *Dis Colon Anorectum* 1994; 37: 424-429.
684. Zhang Y, Hu W. Mouse enteric neuronal cell culture. *Methods in Molecular Biology* 2013; 1078: 55-63.
685. Furness JB, Callaghan BP, Rivera LR, Cho HJ. The enteric nervous system and gastrointestinal innervation: integrated local and central control. *Adv Exp Med Biol* 2014; 817: 39-71.
686. Mazzuoli G, Schemann M. Mechanosensitive enteric neurons in the myenteric plexus of the mouse intestine. *Plos One* 2012; 7: e39887.
687. Mazzuoli G, Schemann M. Multifunctional rapidly adapting mechanosensitive enteric neurons (RAMEN) in the myenteric plexus of the guinea pig ileum. *J Physiol* 2009; 587: 4681-4694.
688. Rao SS. Pathophysiology of adult fecal incontinence. *Gastroenterology* 2004; 126, 1 Suppl 1): S14-S22.
689. Barleben A, Mills S. Anorectal Anatomy and Physiology. *Surg Clin North Am* 2010; 90: 1-15.
690. Ranson RN, Saffrey MJ. Neurogenic mechanisms in bladder and bowel ageing. *Biogerontol* 2015; 16: 265-284.
691. Benezech A, Bouvier M, Vitton V. Faecal incontinence: Current knowledges and perspectives. *World J Gastrointest Pathophysiol* 2016; 7: 59-71.
692. Remes-Troche JM, Rao SS. Neurophysiological testing in anorectal disorders. *Exp Rev Gastroenterol Hepatol* 2008; 2: 323-335.
693. Zagorodnyuk VP, Lynn P, Costa M, Brookes SJ. Mechanisms of mechanotransduction by specialized low-threshold mechanoreceptors in the guinea pig rectum. *Am J Physiol Gastrointest Liver Physiol* 2005; 289: G397-G406.
694. Cobine CA, Hennig GW, Kurahashi M, Sanders KM, Ward SM, Keef KD. Relationship between interstitial cells of Cajal, fibroblast-like cells and inhibitory motor nerves in the internal anal sphincter. *Cell Tissues Res* 2011; 344: 17-30.
695. Ishiyama G, Hinata N, Kinugasa Y, Murakami G, Fujimiya M. Nerves supplying the internal anal sphincter: an immunohistochemical study using donated elderly cadavers. *Surg Radiol Anat* 2014; 36: 1033-1042.
696. Kinugasa Y, Arakawa T, Murakami G, Fujimiya M, Sugihara K. Nerve supply to the internal anal sphincter differs from that to the distal rectum: an immunohistochemical study of cadavers. *Int J Colorectal Dis* 2014; 29: 429-436.
697. Cobine CA, Fong M, Hamilton R, Keef KD. Species dependent differences in the actions of sympathetic nerves and noradrenaline in the internal anal sphincter. *Neurogastroenterol motil* 2007; 19: 937-945.
698. Folasire O, Mills KA, Sellers DJ, Chess-Williams R. Three gaseous neurotransmitters, nitric oxide, carbon monoxide and hydrogen sulphide, are involved in the neurogenic relaxation responses of the porcine internal anal sphincter. *J Gastroenterol Motil* 2016; 22, 141-148.
699. Tichenor SD, Buxton IL, Johnson P, O'Driscoll K, Keef KD. Excitatory motor innervation in the canine rectoanal region: role of changing receptor populations. *Br J Pharmacol* 2002; 137: 1321-1329.
700. Cobine CA, Hennig GW, Bayguinov YR, Hatton WJ, Ward SM, Keef KD. Interstitial cells of Cajal in the cynomolgus monkey rectoanal region and their relationship to sympathetic and nitregeric nerves. *Am J Physiol, Gastrointest Liver Physiol* 2010; 298: G643-G656.
701. Glavind EB, Forman A, Madsen G, Tøttrup A. Effects of transmural field stimulation in isolated smooth muscle of human rectum and internal anal sphincter. *Am J Physiol* 1997; 272: G1075-G1082.
702. Penninckx F, Kerremans R, Beckers J. Pharmacological characteristics of the non-striated anorectal musculature in cats. *Gut* 1973; 14: 393-398.
703. Moszkowicz D, Peschard F, Bessede T, Benoit G, Alsaid B. Internal anal sphincter parasympathetic-nitregeric and sympathetic-adrenergic innervation: a 3-dimensional morphological and functional analysis. *Dis Colon Rectum* 2012; 55: 473-481.
704. Rayment SJ, Eames T, Simpson JA, Dashwood MR, Henry Y, Gruss H, Acheson AG, Scholefield JH, Wilson VG. Investigation of the distribution and function of alpha-adrenoceptors in the sheep isolated internal anal sphincter. *Br J Pharmacol* 2010; 160: 1727-1740.
705. Parks AG, Fishlock DJ, Cameron JD, May H. Preliminary investigation of the pharmacology of the human internal anal sphincter. *Gut* 1969; 10(8): 674-677.

706. Mills KA, Hausman N, Chess-Williams R. Characterization of the α 1-adrenoceptor subtype mediating contractions of the pig internal anal sphincter. *Br J Pharmacol* 2008; 155: 110-117.
707. Owaki H, Sadahiro S, Takaki M. Characterizations of the α 1-adrenoceptor subtypes mediating contractions of the human internal anal sphincter. *J Pharmacol Sci* 2015; 127: 424-429.
708. Yamato S, Rattan S. Role of alpha adrenoceptors in opossum internal anal sphincter. *J Clin Invest* 1990; 86: 424-429.
709. Acheson A, Rayment S, Eames T, Munday M, Nisar P, Scholefield J, Wilson VG. Investigation of the role of adrenergic and non-nitric, non-adrenergic neurotransmission in the sheep isolated internal anal sphincter. *Neurogastroenterol Motil* 2009; 21: 335-345.
710. Speakman CT, Hoyle CH, Kamm MA, Henry MM, Nicholls RJ, Burnstock G. Adrenergic control of the internal anal sphincter is abnormal in patients with idiopathic faecal incontinence. *Br J Surg* 1990; 77(12): 1342-1344
711. Speakman CT, Hoyle CH, Kamm MM, Henry MM, Nicholls RJ, Burnstock G. Abnormalities of innervation of internal anal sphincter in fecal incontinence. *Digest Dis Sci* 1993; 38: 1961-1969.
712. Ford AP, Daniels DV, Chang DJ, Gever, JR, Jasper, JR, Lesnick JD, Clarke DE. Pharmacological pleiotropism of the human recombinant α 1A-adrenoceptor: implications for α 1-adrenoceptor classification. *Br J Pharmacol* 1997; 121: 1127-1135.
713. Muramatsu I, Morishima S, Suzuki F, Yoshiki H, Anisuzzaman AS, Tanaka T, Rodrigo MC, Myagmar BE, Simpson PC. Identification of α 1L-adrenoceptor in mice and its abolition by α 1A-adrenoceptor gene knockout. *Br J Pharmacol* 2008; 155: 1224-1234.
714. Viramontes BE, Malcolm A, Camilleri M, Szarka LA, McKinzie S, Burton DD, Zinsmeister AR. Effects of an α 2-adrenergic agonist on gastrointestinal transit, colonic motility, and sensation in humans. *Am J Physiol, Gastrointest Liver Physiol* 2001; 281: G1468-G1476.
715. Camilleri M, Kim DY, McKinzie S, Kim HJ, Thomforde GM, Burton DD, Low PA, Zinsmeister AR. A randomized, controlled exploratory study of clonidine in diarrhea-predominant irritable bowel syndrome. *Clin Gastroenterol Hepatol* 2003; 1: 111-121.
716. Rayment SJ, Simpson JA, Eames T, Acheson AG, Dashwood MR, Henry Y, Gruss H, Scholefield JH, Wilson VG. Dual effects of α 2-adrenoceptors in modulating myogenic tone in sheep isolated internal anal sphincter. *Neurogastroenterol Motil* 2014; 26: 1095-1103.
717. Rathi S, Kazerounian S, Banwait K, Schulz S, Waldman SA, Rattan S. Functional and molecular characterization of β -adrenoceptors in the internal anal sphincter. *J Pharmacol Exp Ther* 2003; 305: 615-624.
718. Li F, De Godoy M, Rattan S. Role of adenylate and guanylate cyclases in β 1, β 2, and β 3-adrenoceptor-mediated relaxation of internal anal sphincter smooth muscle. *J Pharmacol Exp Ther* 2004; 308: 1111-1120.
719. Ballester C, Sarriá B, García-Granero E, Mata M, Milara J, Morcillo EJ, Lledó S, Cortijo J. Relaxation by β 3-adrenoceptor agonists of the isolated human internal anal sphincter. *Life Sci* 2010; 86: 358-364.
720. Inoue R, Isenberg G. Acetylcholine activates nonselective cation channels in guinea pig ileum through a G protein. *Am J Physiol* 1990; 258: C1173-C1178.
721. Zhang LB, Horowitz B, Buxton IL. Muscarinic receptors in canine colonic circular smooth muscle. I. Coexistence of M2 and M3 subtypes. *Mol Pharmacol* 1991; 40: 943-951.
722. Singh J, Mehendiratta V, Del Galdo F, Jimenez SA, Cohen S, DiMarino AJ, Rattan S. Immunoglobulins from scleroderma patients inhibit the muscarinic receptor activation in internal anal sphincter smooth muscle cells. *Am J Physiol, Gastrointest Liver Physiol* 2009; 297: G1206-G1213.
723. Somara S, Gilmont RR, Dennis RG, Bitar KN. Bioengineered internal anal sphincter derived from isolated human internal anal sphincter smooth muscle cells. *Gastroenterology* 2009; 137: 53-61,
724. Buntzen S, Nordgren S, Hultén L, Delbro D. The role of nitric oxide in the acetylcholine-induced relaxation of the feline internal anal sphincter, in vitro. *Scand J Gastroenterol* 1996; 31: 1189-1194.
725. O'Kelly TJ, Brading A, Mortensen NJ. In vitro response of the human anal canal longitudinal muscle layer to cholinergic and adrenergic stimulation: evidence of sphincter specialization. *Br J Surg* 1993; 80: 1337-1341.
726. Burleigh DE, D'Mello A, Parks AG. Responses of isolated human internal anal sphincter to drugs and electrical field stimulation. *Gastroenterology* 1979; 77: 484-490.
727. Ramalingam T, Durlu-Kandilci NT, Brading AF. A comparison of the contractile properties of smooth muscle from pig urethra and internal anal sphincter. *Neurourological Urodyn* 2010; 29: 1326-1331.

728. Khurana S, Chacon I, Xie G, Yamada M, Wess J, Raufman JP, Kennedy RH. Vasodilatory effects of cholinergic agonists are greatly diminished in aorta from M3R^{-/-} mice. *Eur J Pharmacol* 2004; 493: 127-132.
729. Opazo A, Lecea B, Gil V, Jiménez M, Clavé P, Gallego D. Specific and complementary roles for nitric oxide and ATP in the inhibitory motor pathways to rat internal anal sphincter. *Neurogastroenterol Motil* 2011; 23: e11-e25.
730. Rae MG, Muir TC. Neuronal mediators of inhibitory junction potentials and relaxation in the guinea-pig internal anal sphincter. *J Physiol* 1996; 493 : 517-527.
731. Biancani P, Walsh J, Behar J. Vasoactive intestinal peptide: a neurotransmitter for relaxation of the rabbit internal anal sphincter. *Gastroenterology* 1985; 89: 867-874.
732. Nissan S, Vinograd Y, Hadari A, Merguerian P, Zamir O, Lernau O, Hanani M. Physiological and pharmacological studies of the internal anal sphincter in the rat. *J Pediat Surg* 1984; 19: 12-14.
733. Keef KD, Saxton SN, McDowall RA, Kaminski RE, Duffy AM, Cobine CA. Functional role of vasoactive intestinal polypeptide in inhibitory motor innervation in the mouse internal anal sphincter. *J Physiol* 2013; 591: 1489-1506.
734. McDonnell B, Hamilton R, Fong M, Ward SM, Keef KD. Functional evidence for purinergic inhibitory neuromuscular transmission in the mouse internal anal sphincter. *Am J Physiol; Gastrointest Liver Physiol* 2008; 294: G1041-G1051.
735. Cobine CA, Sotherton AG, Peri LE, Sanders KM, Ward SM, Keef KD. Nitrgenic neuromuscular transmission in the mouse internal anal sphincter is accomplished by multiple pathways and postjunctional effector cells. *Am J Physiol, Gastrointest Liver Physiol* 2014; 307: G1057-G1072.
736. O'Kelly TJ, Brading A, Mortensen NJ. Nerve mediated relaxation of the human internal anal sphincter: the role of nitric oxide. *Gut* 1993; 34: 689-693.
737. Munday MK, Jonas M, Worthley T, Scholefield JH, Wilson VG. Pharmacological characterization of neurogenic responses of the sheep isolated internal anal sphincter. *Br J Pharmacol* 2000; 130: 489-494.
738. Rattan S, Chakder S. Role of nitric oxide as a mediator of internal anal sphincter relaxation. *Am J Physiol* 1992; 262: G107-G112.
739. Lies B, Groneberg D, Friebe A. Toward a better understanding of gastrointestinal nitrgenic neuromuscular transmission. *Neurogastroenterol Motil* 2014; 26: 901-912.
740. Ward SM, Xue C, Shuttleworth CW, Bredt DS, Snyder SH, Sanders KM. NADPH diaphorase and nitric oxide synthase colocalization in enteric neurons of canine proximal colon. *Am J Physiol* 1992; 263: G277-G284.
741. Banwait KS, Rattan S. Role of nitric oxide in β 3-adrenoceptor activation on basal tone of internal anal sphincter. *Am J Physiol; Gastrointest Liver Physiol* 2003; 285: G547-G555.
742. Houghton MJ, Gamage PP, Collins HE, Patel BA, Yeoman MS, Ranson RN, Saffrey MJ. Changes in the innervation of the mouse internal anal sphincter during aging. *Neurogastroenterol Motil* 2013; 25: e469-e477.
743. Singh J, Kumar S, Rattan S. Bimodal effect of oxidative stress in internal anal sphincter smooth muscle. *Am J Physiol, Gastrointest Liver Physiol* 2015; 309: G292-G300.
744. Jones OM, Brading AF, Mortensen NJ. The physiology, pharmacology and therapeutic manipulation of the internal anal sphincter. *Can J Gastroenterol* 2002; 16: 249-257.
745. Rattan S, Al Haj R, De Godoy MA. Mechanism of internal anal sphincter relaxation by CORM-1, authentic CO, and NANC nerve stimulation. *Am J Physiol, Gastrointest Liver Physiol* 2004; 287: G605-G611.
746. Rattan S, Regan RF, Patel CA, de Godoy MA. Nitric oxide not carbon monoxide mediates nonadrenergic noncholinergic relaxation in the murine internal anal sphincter. *Gastroenterology* 2005; 129: 1954-1966.
747. Xue L, Farrugia G, Miller SM, Ferris CD, Snyder SH, Szurszewski JH. Carbon monoxide and nitric oxide as coneurotransmitters in the enteric nervous system: evidence from genomic deletion of biosynthetic enzymes. *Proc Natl Acad Sci USA* 2000; 97: 1851-1855.
748. Tenhunen R, Marver HS, Schmid R. Microsomal heme oxygenase. Characterization of the enzyme. *J Biol Chem* 1969; 244: 6388-6394.
749. Denninger JW, Marletta MA. Guanylate cyclase and the NO/cGMP signaling pathway. *Biochimica et Biophysica Acta* 1999; 1411: 334-350.
750. Matsuda NM, Miller SM. Non-adrenergic noncholinergic inhibition of gastrointestinal smooth muscle and its intracellular mechanism(s). *Fund Clin Pharmacol* 2010; 24: 261-268.

751. Chen CQ, Xin, H, Zhu YZ. Hydrogen sulfide: third gaseous transmitter, but with great pharmacological potential. *Acta Pharmacologica Sinica* 2007; 28: 1709-1716.
752. Kabil O, Vitvitsky V, Xie P, Banerjee R. The quantitative significance of the transsulfuration enzymes for H₂S production in murine tissues. *Antiox Redox Signal* 2011; 15: 363-372.
753. Dhaese I, Van Colen I, Lefebvre RA. Mechanisms of action of hydrogen sulfide in relaxation of mouse distal colonic smooth muscle. *Eur J Pharmacol* 2010; 628: 179-186.
754. Gil V, Gallego D, Jiménez M. Effects of inhibitors of hydrogen sulphide synthesis on rat colonic motility. *Br J Pharmacol* 2011; 164: 485-498.
755. Martin GR, McKnight GW, et al. Hydrogen sulphide synthesis in the rat and mouse gastrointestinal tract. *Digest Liver Dis* 2010; 42: 103-109.
756. Hennig B, Diener M. Actions of hydrogen sulphide on ion transport across rat distal colon. *Br J Pharmacol* 2009; 158: 1263-1275.
757. Linden DR, Sha L, Mazzone A, Stoltz GJ, Bernard CE, Furne JK, Levitt MD, Farrugia G, Szurszewski JH. Production of the gaseous signal molecule hydrogen sulfide in mouse tissues. *J Neurochem* 2008; 106: 1577-1585.
758. Teague B, Asiedu S, Moore PK. The smooth muscle relaxant effect of hydrogen sulphide in vitro: evidence for a physiological role to control intestinal contractility. *Br J Pharmacol* 2002; 137: 139-145.
759. Said SI, Mutt V. Polypeptide with broad biological activity: isolation from small intestine. *Science* 1970; 169: 1217-1218.
760. Watkins CC, Boehning D, Kaplin AI, Rao M, Ferris CD, Snyder SH. Carbon monoxide mediates vasoactive intestinal polypeptide-associated nonadrenergic/ noncholinergic neurotransmission. *Proc Nat Acad Sci USA* 2004; 101: 2631-2635.
761. van Geldre LA, Lefebvre RA. Interaction of NO and VIP in gastrointestinal smooth muscle relaxation. *Curr Pharmaceutical Design* 2004; 10: 2483-2497.
762. Schicho R, Krueger D, Zeller F, Von Weyhern CW, Frieling T, Kimura H, Ishii I, De Giorgio R, Campi B, Schemann M. Hydrogen sulphide is a novel prosecretory neuromodulator in the guinea-pig and human colon. *Gastroenterology* 2006; 131:1542-1552
763. Shafik A, El Sibai O, Ahmed I. The identification of specialized pacemaking cells in the anal sphincter. *Int J Colorectal Dis* 2006; 21:453-457.
764. Zhang CH, Wang P, Liu DH, Chen CP, Zhao W, Chen X, Chen C, He WQ, Qiao YN, Tao T, Sun J, Peng YJ, Lu P, Zheng K, Craige SM, Lifshitz LM, Keane JF Jr, Fogarty KE, ZhuGe R, Zhu MS. The molecular basis of the genesis of basal tone in internal anal sphincter. *Nat comm* 2016; 7: 11358.
765. Cook TA, Brading AF, Mortensen NJM. Differences in contractile properties of anorectal smooth muscle and the effects of calcium channel blockade. *Br J Surg* 1999; 86: 70-75.
766. Rattan S. Role of RHO kinase in gastrointestinal motility. *Gastroenterology* 2009; 136: 1109-1112.
767. de Godoy MA, Rattan S. Role of rho kinase in the functional and dysfunctional tonic smooth muscles. *Trends Pharmacol Sci* 2011; 32: 384-393.
768. Gur S, Kadowitz PJ, Hellstrom WJ. RhoA/Rho-kinase as a therapeutic target for the male urogenital tract. *J Sexual Med* 2011; 8: 675-687.
769. Patel CA, Rattan S. Spontaneously tonic smooth muscle has characteristically higher levels of RhoA/ROK compared with the phasic smooth muscle. *Am J Physiol, Gastrointest Liver Physiol* 2006; 291: G830-G837.
770. Patel CA, Rattan S. Cellular regulation of basal tone in internal anal sphincter smooth muscle by RhoA/ROCK. *Am J Physiol, Gastrointest Liver Physiol* 2007; 292: G1747-G1756,
771. Rattan S, De Godoy MA, Patel CA. Rho kinase as a novel molecular therapeutic target for hypertensive internal anal sphincter. *Gastroenterology* 2006; 131: 108-116.
772. Rattan S, Singh J. RhoA/ROCK pathway is the major molecular determinant of basal tone in intact human internal anal sphincter. *Am J Physiol, Gastrointest Liver Physiol* 2012; 302: G664-G675.
773. Rattan S, Singh J, Kumar S, Phillips B. Nature of extracellular signal that triggers RhoA/ROCK activation for the basal internal anal sphincter tone in humans. *Am J Physiol, Gastrointest Liver Physiol* 2015; 308: G924-G933,
774. Singh J, Rattan S. Role of PKC and RhoA/ROCK pathways in the spontaneous phasic activity in the rectal smooth muscle. *Am J Physiol Gastrointest Liver Physiol* 2013; 15; 304: G723-G731.
775. Somlyo AP, Somlyo AV. Signal transduction by G-proteins, rho-kinase and protein phosphatase to smooth muscle and non-muscle myosin II. *J Physiol* 2000; 522: 177-185.
776. Kitazawa T, Eto M, Woodsome TP, Khaleqzaman M. Phosphorylation of the myosin phosphatase targeting subunit and CPI-17 during

- Ca²⁺ sensitization in rabbit smooth muscle. *J Physiol* 2003; 546: 879–889.
777. Singh J, Maxwell PJ 4th, Rattan S. Immunocytochemical evidence for PDBu-induced activation of RhoA/ROCK in human internal anal sphincter smooth muscle cells. *Am J Physiol Gastrointest Liver Physiol* 2011; 301: G317-G325.
778. Schlossmann J, Hofmann F. cGMP-dependent protein kinases in drug discovery. *Drug Discovery Today* 2005; 10: 627-634.
779. Carvajal J A, Germain AM, et al. Molecular mechanism of cGMP-mediated smooth muscle relaxation. *J Cell Physiol* 2000; 184: 409-420.
780. da Silva-Santos JE, Chiao CW, Leite R, Webb RC. The Rho-A/Rho-kinase pathway is upregulated but remains inhibited by cyclic guanosine monophosphate-dependent mechanisms during endotoxemia in small mesenteric arteries. *Critical Care Med* 2009; 37: 1716-1723.
781. Surks HK. cGMP-dependent protein kinase I and smooth muscle relaxation: a tale of two isoforms. *Circ Res* 2007; 101: 1078-1080.
782. Ellerbroek SM, Wennerberg K, Burridge K. Serine phosphorylation negatively regulates RhoA in vivo. *J Biol Chem* 2003; 278: 19023-19031.
783. Wooldridge AA, MacDonald JA, et al. Smooth muscle phosphatase is regulated in vivo by exclusion of phosphorylation of threonine 696 of MYPT1 by phosphorylation of Serine 695 in response to cyclic nucleotides. *J Biol Chem* 2004; 279: 34496-34504.
784. Butler T, Paul J, Europe-Finner N, Smith R, Chan EC. Role of serine-threonine phosphoprotein phosphatases in smooth muscle contractility. *Am J Physiol, Cell Physiol* 2013; 304: C485-C504.
785. de Godoy MAF, Dunn S, Rattan S. Evidence for the role of angiotensin II biosynthesis in the rat internal anal sphincter tone. *Gastroenterology* 2004; 127: 127-138.
786. de Godoy MA, Rattan S. Autocrine regulation of internal anal sphincter tone by renin-angiotensin system: comparison with phasic smooth muscle. *Am J Physiol, Gastrointest Liver Physiol* 2005; 289: G1164-G1175.
787. Fan YP, Puri RN, Rattan S. Animal model for angiotensin II effects in the internal anal sphincter smooth muscle: mechanism of action. *Am J Physiol, Gastrointest Liver Physiol* 2002; 282: G461-G469.
788. Hagger R, Gharai S, Finlayson C, Kumar D. Regional and transmural density of interstitial cells of Cajal in human colon and rectum. *Am J Physiol* 1998; 275: G1309-G1316.
789. Huizinga JD, Zarate N, Farrugia G. Physiology, injury, and recovery of interstitial cells of Cajal: basic and clinical science. *Gastroenterology* 2009; 137:1548-1556.
790. Hagger R, Gharai S, Finlayson C, Kumar D. Regional and transmural density of interstitial cells of Cajal in human colon and rectum. *Am J Physiol* 1998; 275: G1309-G1316.
791. McHale NG, Hollywood MA, Sergeant GP, Shafei M, Thornbury KT, Ward SM. Organization and function of ICC in the urinary tract. *J Physiol* 2006; 576: 689-694.
792. Duffy AM, Cobine CA, Keef KD. Changes in neuromuscular transmission in the W/W(v) mouse internal anal sphincter. *Neurogastroenterol Motil* 2012; 24: e41e55.
793. Terauchi A, Kobayashi, D, Mashimo H. Distinct roles of nitric oxide synthases and interstitial cells of Cajal in rectoanal relaxation. *Am J Physiol, Gastrointest Liver Physiol* 2005; 289: G291-G299.
794. de Lorijn F, de Jonge WJ, Wedel T, Vanderwinden JM, Benninga MA, Boeckstaens GE. Interstitial cells of Cajal are involved in the afferent limb of the rectoanal inhibitory reflex. *Gut* 2005; 54: 1107-1113.
795. Battish R, Cao GY, et al. Heme oxygenase-2 distribution in anorectum: colocalization with neuronal nitric oxide synthase. *Am J Physiol, Gastrointest Liver Physiol* 2000; 278: G148-G155.
796. Cheng CL, de Groat WC. Effect of ovariectomy on external urethral sphincter activity in anesthetized female rats. *J Urol* 2011; 186:334-340.
797. Hawthorn MH, Chapple CR, Cock M, Chess-Williams R. Urothelium-derived inhibitory factor(s) influence detrusor muscle contractility in vitro. *Br J Pharmacol* 2000; 129: 416-419.
798. Templeman L, Chapple CR, Chess-Williams R. Urothelium derived inhibitory factor and crosstalk among receptors in the trigone of the bladder of the pig. *J Urol* 2002; 167: 742-745.
799. Dixelius O, Winder M, Sellers D, Chess-Williams R. Inhibitory effect of the mucosa on contractile responses of the internal anal sphincter. 2016; Available online at <http://www.ics.org/Abstracts/Publish/326/000457.pdf>

NEURAL CONTROL

Chair

L. Birder (USA)

Members

B. Blok (Netherlands)

G. Burnstock (UK)

F. Cruz (Portugal)

D. Griffiths (CAN)

H.C. Kuo (Taiwan)

N. Yoshimura (USA)

Consultants

C. Fry (UK)

K. Thor (USA)

CONTENTS

I. THE UROTHELIUM	262	III. EFFERENT PATHWAYS TO THE BLADDER	287
1. Anatomy and Barrier Function.....	262	1. Preganglionic Neurons	288
2. Repair and Regeneration.....	264	2. Ganglia	289
3. Role of the Urothelium in Immune and Inflammatory Responses.....	266	3. Terminal Nerve Fibers.....	290
4. Epithelial Heterogeneity in the Lower Urinary Tract.....	269	4. Transmitters.....	291
5. Role for Urothelial Cells in Visceral Sensation.....	269	4.1. Glutamate.....	291
5.1. Influence of the Extracellular Matrix....	270	4.2. Glycine/ gamma amine butyric acid	291
5.2. Urothelial-Neuronal Signaling.....	270	4.3. Serotonin.....	292
5.3. Involvement of the Urothelium in “Sensing” Chemical and Mechanical Stimuli.....	270	4.4. Adrenergic	292
5.3.1 Purinergic Receptors.....	271	4.5. Substance P.....	292
5.3.2 TRP Channels.....	272	4.6. Purinergic.....	292
5.3.3 Acetylcholine.....	272	4.7. Parasympathetic Co-transmission.....	293
6. Clinical Significance of the Sensory Web	273	4.8. Sympathetic Co-transmission	294
II. AFFERENT PATHWAYS	273	5. Pelvic Organ Interactions at the Efferent Neural Level	295
1. Overview: Properties of Afferent Pathways	273	5.1. Bladder and Outlet	295
2. Pathways to the Spinal Cord.....	274	5.2. Bladder and Bowel	296
3. Functional Properties of Bladder Afferents	276	5.3. Bladder and Prostate/Uterus	296
3.1. Electrophysiological properties of afferent neurons.....	276	6. Efferent Inhibition.....	298
3.2. Functional properties of afferent nerves	276	7. Peripheral Excitatory Mechanisms	298
4. Modulating Afferent Sensitivity.....	277	7.1. Perinatal development and ageing of efferent nerve signalling in urinary bladder	299
4.1. Nitric oxide	279	7.2. Plasticity of efferent nerve signalling in bladder in pregnancy and disease	299
4.2. Purinergic Signalling	280	IV. NEURAL CONTROL OF PELVIC FLOOR MUSCLES AND RHABDOSPHINCTERS	300
4.3. Cholinergic Mechanisms	283	1. Structural Elements of the Pelvic Floor (Fig. 40).....	300
4.4. Botulinum Toxin.....	284	2. Peripheral Innervation of the Levator Ani (LA) Muscles	301
4.5. Transient Receptor Potential (TRP) Cation Channels.....	284	2.1. LA Motor Neurons	302
4.6. Cannabinoids	285	2.2. LA Afferent Innervation.....	303
4.7. Adrenoreceptors	285	3. Peripheral Innervation of Urethral and Anal Rhabdosphincters	303
5. Cross Talk Between the Bladder and Bowel	286	3.1. Urethral and Anal Rhabdosphincter Motor Neurons	305

3.2. Afferent Innervation of the Urethral and Anal Rhabdosphincters	306	6.1.4 Deep brain stimulation for treatment of Parkinson's disease: effects on bladder function	321
4. Reflex Activation of Urethral and Anal Rhabdosphincters.....	306	6.1.5 Abnormal brain responses following radical prostatectomy	321
5. Inhibition of Urethral Rhabdosphincter (URS) Reflexes during Voiding	308	6.2. Connectivity	321
6. Supraspinal Activation of Rhabdosphincters and Pelvic Floor Muscles.....	309	6.2.1 Psycho- and physio-physiological interaction	321
7. Neurochemical Anatomy of Rhabdosphincter Motor Neurons	309	6.2.2 Resting-state functional connectivity .	322
7.1. Pharmacology of Urethral and Anal Rhabdosphincters (Figure 43).....	309	6.2.3 White-matter integrity and tractography.....	323
8. LA and Rhabdosphincter Neuropathy .	310	7. Conclusion.....	323
9. Summary.....	312	VI. PONTINE-MIDBRAIN CONTROL OF BLADDER FUNCTION	324
V. FOREBRAIN CONTROL OF BLADDER FUNCTION	313	<hr/>	
1. Background	313	1. Afferent Pathways Linking the Bladder and Urethra to the Pons and Midbrain	324
2. Role and Importance of Cerebral Control of Voiding	313	2. Efferent pathways from the Pontine Micturition Center (PMC or Barrington's nucleus).....	326
3. Forebrain centres and connecting pathways involved in bladder control .	314	3. Forebrain Inputs to the pontine micturition center	326
3.1. Centres versus pathways or neural networks	314	4. Coordination of Bladder with Other Pelvic Viscera by the PMC	327
3.2. Frontal Lobes	314	5. The Pontine Continence Centre (PCC)	327
3.3. Anterior cingulate cortex (ACC), supplementary motor cortex (SMA) and insula	315	VII. REFERENCES	328
3.4. Periaqueductal grey (PAG).....	316	<hr/>	
3.5. Hypothalamus	316		
4. Voiding.....	316		
5. Neural circuits	317		
5.1. Normal and Abnormal Function.....	319		
5.1.1 Complete spinal cord injury	319		
5.2. Voiding.....	319		
6. Recent Developments in fMRI and Related Studies	319		
6.1. Treatment of urgency incontinence.....	319		
6.1.1 Behavioural treatment: biofeedback-assisted pelvic floor muscle training (BFB-PFMT)	319		
6.1.2 Pharmacological treatment of urgency incontinence.....	320		
6.1.3 Neuromodulation for treatment of neurogenic incontinence.....	320		

NEURAL CONTROL

L. BIRDER (USA)

B. BLOK (NETHERLANDS), G. BURNSTOCK (UK), F. CRUZ (PORTUGAL), D. GRIFFITHS (CAN),
H.C. KUO (TAIWAN), N. YOSHIMURA (USA)

I. THE UROTHELIUM

The urothelium can be thought of as a first responder to various types of stress that can include physiological, psychological and disease-related factors. The urothelium is an interface between the urinary space and underlying tissues (Figure 1) and as such, forms a high resistance barrier. Beside this necessary function, the urothelium can modulate the volume and composition of urine (1) and actively participates as an integral part of what has been termed a ‘sensory web’ where it receives, integrates, amplifies and transmits information about the external environment to underlying nervous and muscular systems. Alterations of bladder urothelium at the molecular and structural levels have been reported in both patients and animals modeled for various bladder disorders. It is likely that many therapies currently used in the treatment of bladder disease may target urothelial receptors and/or their release mechanisms.

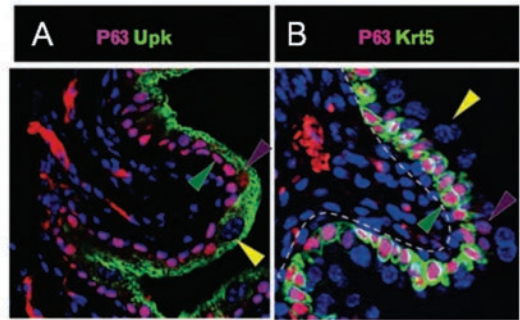

Figure 2: (A, B) Illustration of three cell types of the urothelium distinguished by expression of keratin-5, p63 and uroplakin. Basal cells (green arrow) express keratin-5 and p63, but do not express uroplakin. Intermediate cells (purple arrow) express p63 and uroplakin, but not keratin-5. Superficial cells (yellow arrow) express uroplakin, but not p63 or keratin-5. (from Yamany et al., 2014).

1. ANATOMY AND BARRIER FUNCTION.

The urothelium is the epithelial lining of the lower urinary tract between the renal pelvis and the urinary bladder. Adult urothelium is composed of at least three layers with distinct cell types (the exact number

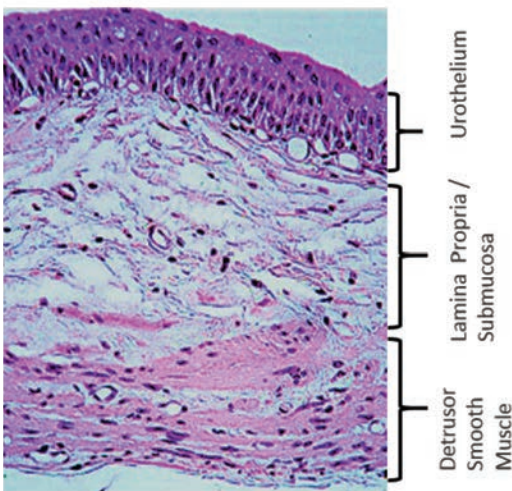

Figure 1: Urinary wall (bladder)

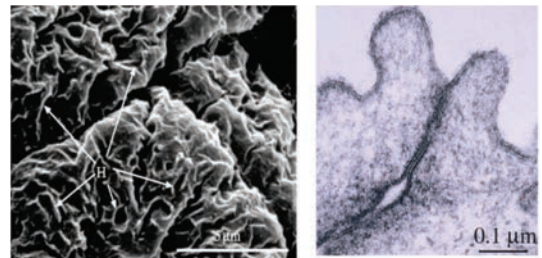

Figure 3: Ultrastructural features of umbrella cell apical membrane. Left: Scanning electron micrograph (high magnification) of apical surface of rabbit umbrella cell layer (hinges “H” marked with arrows). Right, high power view of tight junctions. (from Apodaca, 2004; Truschel et al., 1999).

of layers is species dependent) and can be distinguished by expression of keratin-5, p63 and uroplakin (Figure 2A,B). These consist of a basal cell layer attached to a basement membrane, an intermediate layer, and a superficial or apical layer that is in contact with urine and microorganisms and composed of large hexagonal cells (diameters of 25-250 μm) known as 'umbrella cells'. (2-5) These umbrella cells exhibit a distinctive plasma membrane that contains both 'hinge' and 'plaque' regions (Figure 3). The umbrella cells (which are also termed facet or superficial cells) are interconnected by tight junctions (composed of multiple proteins such as the claudins). Another characteristic of the apical or umbrella cells is the expression of discoidal fusion vesicles or DFVs (Figure 4). In response to bladder filling, these DFVs fuse with the apical membrane releasing crystalline proteins termed uroplakins to the cell surface that assemble into hexagonal plaques. (5-8) The attachment of *Escherichia coli* type I fimbriae to uroplakins also initiates the host-pathogen response, described more fully in later sections. It has been suggested that 'non-plaque' proteins that include receptors and ion channels, may be located to the hinge areas of these cells.

Uroplakins and other urothelial cellular differentiation markers, such as cytokeratin 20, are not expressed in the stratified epithelium of the urethra. There have been suggestions in early studies in some species, that umbrella cells and perhaps also the intermediate cells may have projections to the basement membrane.(4) The ability of the bladder to maintain a highly effective barrier, despite large alterations in urine volume and increases in pressure during blad-

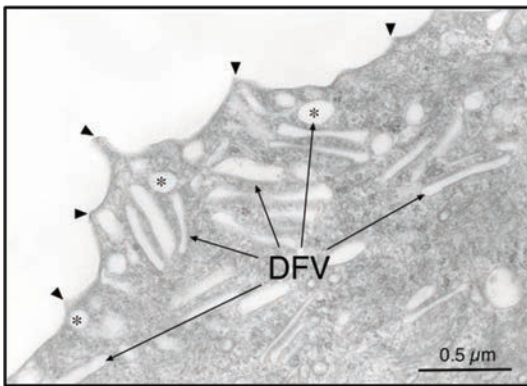

Figure 4: Ultrastructure of the bladder uroepithelium. Transmission electron micrograph of the apical pole of a rat umbrella cell. Examples of discoidal/fusiform-shaped vesicles (DFV) are marked with arrows and hinges with arrowheads. Plaques are located in the intervening membrane between hinges. Apical cytoplasm of rat umbrella cells has disc-shaped (*) and fusiform-shaped vesicles. (from Khandelwal et al., 2009)

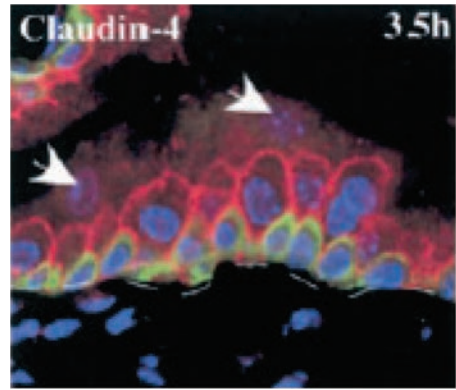

Figure 5: *FimH+* UPEC infection leads to increased expression of the tight junction protein claudin-4 in intermediate cells. Multilabel immunohistochemical study showing that levels of claudin-4 (red) are increased in intermediate cells 3.5 hr after *FimH+* UPEC infection. Cytokeratins 5/6 have been used to mark basal cells (green). Nuclei are stained blue with bis-benzimide. Note claudin-4 is absent in superficial facet cells (arrows). Bars, 50 μm . (from Mysorekar et al., 2002)

der filling and emptying, is dependent on several features of the umbrella cell layer. These features include specialized lipid molecules and tight-junction proteins (such as zona occludens-1, occludins, claudins) that reduce the movement of ions and solutes between cells.(4, 9) These proteins can adapt to mechanical stretching of the urothelium during filling and emptying. For example, the claudins are a family of integral membrane proteins (at least 24 members identified in mice and humans) and can be classified as either pore forming (makes the epithelium leakier) or barrier-forming. The importance of claudin-based tight junctions *in vivo* has been studied in a number of tissues under various conditions. For example, claudins (in particular claudin 4) may play a role in regulation of urothelial proliferation. There is evidence that attachment of uropathogenic *Escherichia coli* (UPEC) to urothelial superficial cells triggers the rapid induction of claudin-4 within the intermediate cells of the urothelium (Figure 5). (10)

This increase in claudin-4 may explain how the urothelium is able to maintain the integrity of the urothelial barrier following infection and exfoliation of the apical urothelium. In another study, overexpression of the pore-forming claudin-2 in rat urothelium resulted in increased urothelial permeability that seemed to trigger inflammation and altered bladder function.(11) It has not been established whether disruption of the urothelial barrier alone is sufficient to trigger inflammation and altered bladder reflexes or whether association with other factors (such as urine) may be needed to facilitate this response.(12)

In addition, there is evidence in many types of epithelium (including uro-epithelium) that adhesion molecules such as members of the cadherin family play

important roles in establishing and maintaining epithelial-cell contacts.(13) Altered urothelial-cadherin expression has been reported in IC/BPS patient bladder urothelium.

The lipid composition of the apical membrane is unusual in composition and is rich in cholesterol, phosphatidylcholine, phosphatidylethanolamine and cerebroside.(4) Recent studies suggest that liposomes, consisting of an aqueous core enclosed in one or more phospholipid bilayers, may help to restore urothelial-barrier function. Liposomes have typically been used to transport drug molecules in a variety of cells. Urothelial cells appear to take up liposomes via an endocytotic process, providing evidence for a possible mechanism by which liposomes act as a drug delivery system(14-16). In addition, empty liposomes have shown promise to repair and enhance the barrier function of a dysfunctional urothelium (Figure 6).(17-19)

The apical surface of the urothelium is also covered with a sulfated polysaccharide glycosaminoglycan (GAG) or mucin layer that is thought to act as a non-specific anti-adherence factor and as a defense mechanism against infection.(20-22) In addition, during bladder filling the umbrella cells become flat and squamous and this shape change is accompanied by vesicular traffic (i.e. exocytosis/endocytosis), adding membrane to the apical surface thereby increasing overall urinary bladder surface area.(5, 23, 24) This process of ongoing replacement of apical membrane by newly fused discoid vesicles also serves to maintain the urothelial barrier.(25) There is evidence that this stretch-induced exocytosis is dependent on activation of epidermal growth factor receptor (EGFR).(26, 27) These processes allow the bladder to accommodate increasing volumes of urine during filling without compromising the barrier function. There is some evidence that superficial urothelial cells exhibit a lower level of endocytotic activity, which may be a protective mechanism against internalization of toxic substances excreted in the urine.(28) Exocytosis/endocytosis (vesicular recycling) may also play an important role in modulating the release of a number of neurotransmitters/mediators as well as regulation of the function of many receptors and ion channels in urothelial cells.(29, 30)

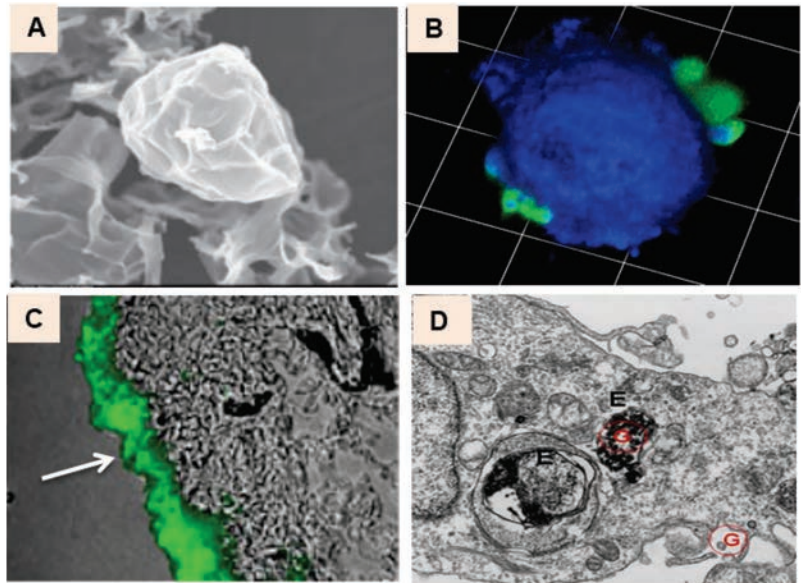

Figure 6: (A) EM picture of liposome, (B), liposomes (in green) attached to primary cultured urothelial cell membrane, In C, liposomes instilled in a rat bladder forming a coating (green) on urothelial surface and D, vesicle-like structures in urothelial cell endosomal compartment (marked as E) containing liposome encapsulated gold marker. (from Hsu et al., 2013, Nirmal et al., 2014 and Rajaganapathy et al., 2015).

2. REPAIR AND REGENERATION

Epithelial integrity is maintained through a complex process of migration and proliferation (to restore cell numbers) and differentiation (to restore function).(31) Basal cells normally exhibit a low (3-6 month) turnover rate, in fact the slowest turnover of any mammalian epithelial cells.(23, 32)

It has been suggested that neither urine-derived factors nor cyclic mechanical changes contribute to urothelial proliferation and differentiation. However differentiation of urothelial cells in culture can be stimulated by prostaglandin (which is abundant in the urine)(1, 33) and accelerated proliferation and regeneration of the urothelium can occur in various bladder pathologies. For example, using agents (protamine sulfate; cyclophosphamide) that damage the umbrella cell layer, it has been shown that the urothelium rapidly undergoes both functional and structural changes in order to restore the barrier in response to injury. (28, 34) Following disruption of the barrier, in the early stages of regeneration the superficial cells may appear smaller in size and often covered with microvilli. (35) In some pathologies, a deficiency or defect in maturation or terminal differentiation of superficial umbrella cells have been reported, though the factors which may be involved are not yet known.(36) Recent evidence has shown that following cyclophosphamide treatment of rodent bladders,

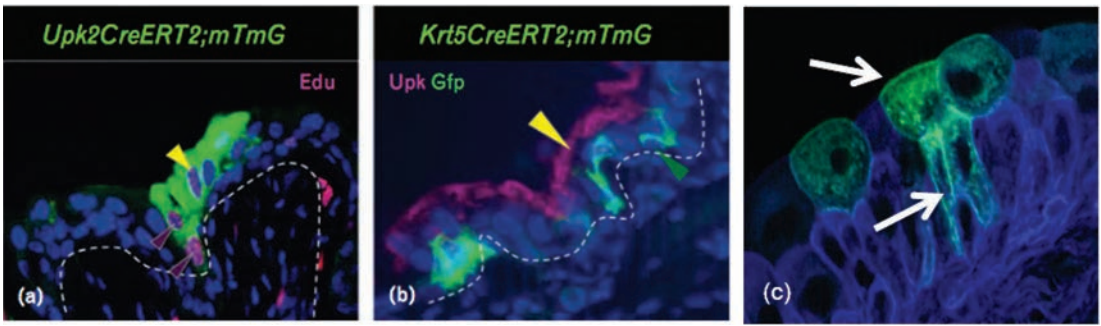

Figure 7: Intermediate cells are the progenitors for superficial cells in adult urothelium. Uroplakin-expressing cells are labeled using Upk2CreERT2;mTmG line (a) and basal cells labeled using Krt5CreERT2;mTmG line (b). Following cyclophosphamide administration, urothelial regeneration occurs. a- shows intermediate cells are progenitors for superficial cells and b- show basal cells proliferate but do not differentiate into intermediate or superficial cells based on lineage-tracing studies. In the adult- following injury, intermediate cells function as progenitors for superficial cells and are self-renewing. (From Yamany et al., 2014). Panel C- long and thin intermediate cells regenerate the outer protective layer- intermediate cells and progeny (white arrows) appear green (C. Mendelsohn).

there is a rapid desquamation, proliferation and regeneration of the urothelium. In this study, the intermediate cells (and not the basal cells) seem to be the adult progenitor cells for superficial cells and they are self-renewing. (Figure 7)(37)

The processes underlying urothelial repair is complex involving several structural elements, signaling pathways, trophic factors and the cellular environment. Furthermore, the interaction between these biochemical signals and mechanical forces in the bladder during the course of urothelial repair is not well understood. For example, the initiation of urothelial proliferation or differentiation of intermediate cells is thought to involve up-regulation of growth factors such as fibroblast growth factor and nerve growth factor (NGF).(38, 39) In addition, members of the PPAR γ and EGFR signaling pathways may contribute to urothelial 're-epithelialization' in wound repair.(33) There is also evidence that Hedgehog/Wnt signaling acting across the basal urothelial cell-stromal cell boundary contributes to increases in urothelial prolifer-

ation in response to injury.(40) Retinoic acid (synthesized from underlying stroma) has been shown to be important for urothelial differentiation.(41)

Though the urothelium maintains a tight barrier to ion and solute flux, a number of factors or stressors such as tissue pH, mechanical or chemical trauma, hormonal changes or bacterial infection and even changes in blood flow can modulate the barrier function of the urothelium.(29, 42) It has been shown that ischemia can augment release of inflammatory mediators such as reactive oxygen species or eicosanoids from urothelial and suburothelial tissues, altering bladder tone and contractility.(43) Stress-mediated activation of the hypothalamic-pituitary-adrenal axis can result in increased production of corticotrophin releasing factor, which can regulate neuroendocrine and autonomic responses to stress. The net effect can include disruption of the epithelial barrier and increased prevalence of infection. In addition, altered levels of circulating estrogens have been associated with changes to the urothelial structure including epithelial

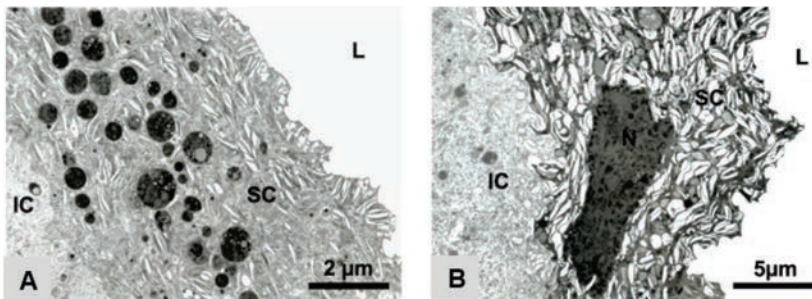

Figure 8: Structure of aging and young mice urothelium. A- ultrathin section of aging urothelium-depicting superficial cell filled with vesicles and numerous osmiophilic lipofuscin granules. B- ultrathin section of young urothelium depicting typical superficial cell with large amounts of fusiform vesicles in cytoplasm but no lipofuscin granules. SC-superficial cells, IC-intermediate cells, BC- basal cells, L-bladder lumen. (from Perse et al., 2013).

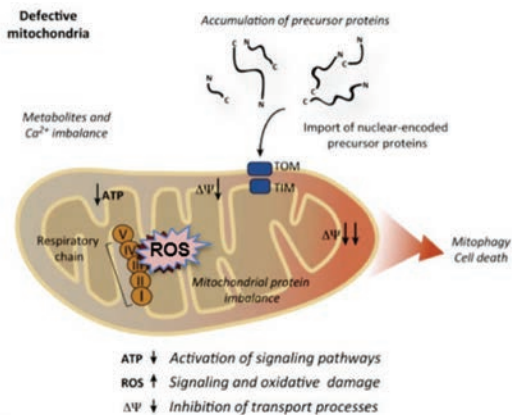

Figure 9: Causes and consequences of mitochondrial dysfunction. Respiratory chain malfunction can lead to elevation in levels of reactive oxygen species (ROS), decrease in ATP and the electrochemical potential of the inner mitochondrial membrane and imbalance in calcium homeostasis. Severe mitochondrial dysfunction targets the organelle for mitophagy or eventual cell death. TOM, translocase of the outer membrane; TIM, translocase of the inner membrane. (from Topf et al., 2016)

shedding or mucosal atrophy.(44, 45) Other conditions such as bladder pain syndrome/interstitial cystitis (BPS/IC), senescence, diabetes or spinal cord injury are also associated with changes in the urothelial barrier.(34, 46) Studies utilizing aged animals have demonstrated significant alterations to the bladder mucosa including areas of mucosal denudation.(47, 48)

A number of bladder disorders can increase susceptibility to injury and apoptosis through pathways including oxidative stress. Oxidative stress, characterized in part by an increase in the level of proinflammatory mediators and reactive oxygen species or ROS, can lead to disruption of various cellular components.(49, 50) Oxidative stress can be produced by bladder pathologies including ischemia or repeated ischemia/reperfusion during a micturition cycle.(51, 52) Indeed, the bladder mucosa exhibits a higher metabolic rate as compared to other regions in the bladder wall and the urothelium is highly vulnerable to any changes in blood flow. Both acute and chronic reduction in blood flow has revealed significant defects in the mucosal barrier with disruption of urothelial tight junctions. Within the urethra and urinary bladder, age-related changes include a thinning of the epithelium and decreased vascularity. Findings from aged animals reveal that urothelial cells show a decreased antioxidant capacity with increased levels of markers for oxidative stress. Further, this is associated with alterations in mitochondria and increased accumulation of an aging pigment termed lipofuscin (Figure 8).(53) The decline in these various epithelial elements may lead to a decrease in both regenerative ability and also immunological defense mechanisms that are critical for maintaining epithelial integrity.

Mitochondria, considered the powerhouse organelles in a cell, play a key role in cellular homeostasis, including generation of ROS, apoptosis, and production of ATP via oxidative phosphorylation.(54) Indeed, the study of bioenergetics and the influence of mitochondrial functions on cell signaling and disease is an emerging and exciting area of research. Mitochondrial dysfunction has been implicated in a number of disorders. These structures are highly sensitive to changes in their cellular environment and can be easily affected by a number of conditions. For example, these is ample evidence that ischemia leads to cellular damage by overproduction of superoxide by the mitochondrial electron chain (Figure 9). Studies have shown that mitochondrial abnormalities (such as increased ROS) can lead to changes in mucosal barrier function in a number of tissues including the urinary bladder. Further, recent studies have shown some evidence demonstrating mitochondrial dysfunction and oxidative stress (elevated ROS) may play a role in urothelial barrier (and sensory) abnormalities observed in the urinary bladder in a number of conditions such as ketamine-induced ulcerative cystitis.(55, 56)

3. ROLE OF THE UROTHELIUM IN IMMUNE AND INFLAMMATORY RESPONSES

There is new evidence that the human urinary tract contains a diverse microbiota that is likely to play an important role in bladder health and disease.(57) Evidence in the GI tract supports a role for gut microbiota on intestinal barrier function that can be altered by psychological and physical stressors.(58) In terms of the urinary tract, the urothelium is truly the first line of defense against pathogens and irritative substances with a number of mechanisms in place to limit inflammatory responses (Figure 10).(59) Some examples include uromodulin (also known as Tamm-Horsfall urinary glycoprotein), which acts to prevent bacteria from interacting with the epithelial cell surface.(60) Other factors such as β -defensin 1 are secreted from epithelial cells into the urine and restrict bacterial growth.(61)

Both physiological and psychological stress can result in a failure of urothelial and suburothelial 'defensive' systems and thereby promote changes in both urothelial barrier and signaling function. For example, alterations in proteins including proteoglycans and bacterial defense molecules may lead to distinctive changes in urothelial structure and play a role in bacteria adherence. (62) In this regard, urinary tract infections produced by uropathogenic *Escherichia coli* (UPEC) are initiated by bacterial adherence to uroplakin proteins on the apical surface of umbrella

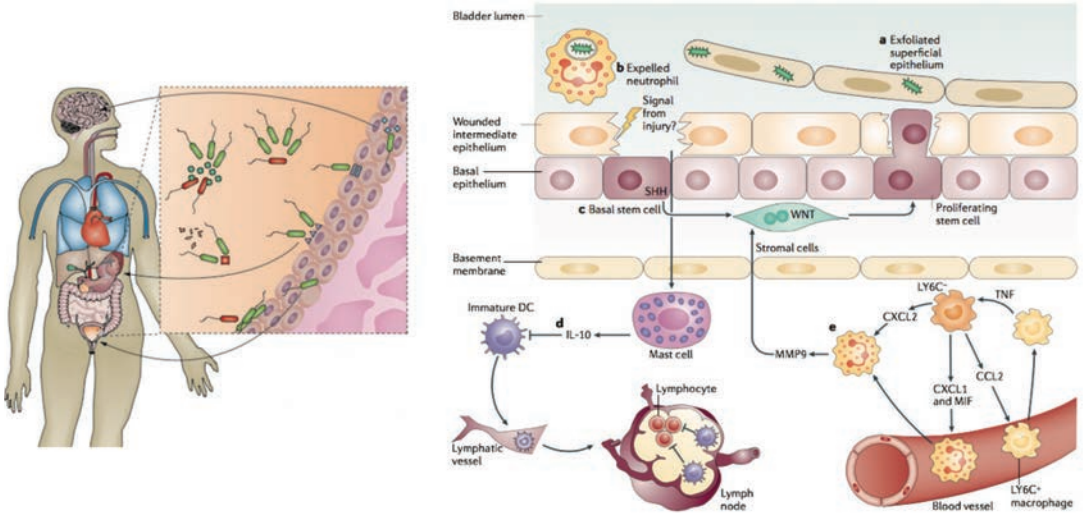

Figure 10: The human urinary tract contains a diverse microbiota. Right- overview of mechanisms that may be employed to curtail inflammatory responses in the bladder following infection. These can include exfoliation of bladder epithelial cells, increased proliferation to regenerate the barrier; mast cell secretion of interleukins (to aid in tissue regeneration); release of chemokines and other factors from macrophages (from Abraham and Miao, 2015).

cells. (42, 63) The UPEC express filamentous adhesive organelles (type 1 pili) that mediate bacterial attachment, invasion and apoptosis of the urothelial cells. It has been suggested that urothelial differentiation (and increased uroplakin III expression) plays a pivotal role in sensitizing urothelial cells to UPEC-induced infection and possible cell death.(64) Even acute contact (within hours) of the mucosal surface

by bacteria may result in altered urothelial barrier function.(65) UPEC can also internalize within umbrella cells forming intracellular colonies (biofilm-like pods) of UPEC that has been implicated in the mechanism of chronic urinary tract infections. UPEC are able to commandeer the endocytic/exocytic machinery of urothelial cells, residing inside fusiform vesicles.(66)This permits the bacteria to escape elimina-

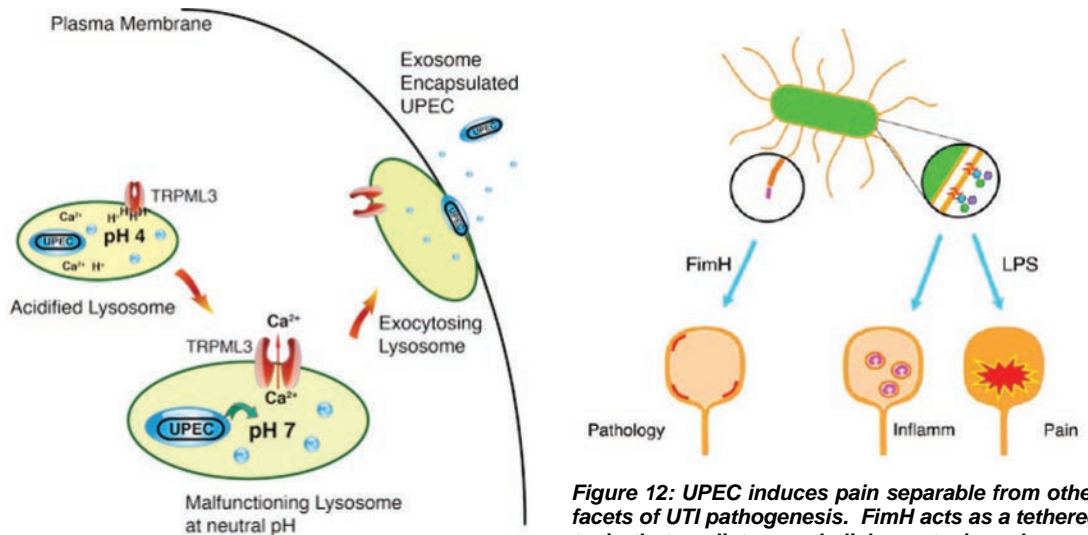

Figure 11: Following UPEC infection of urothelial cells- activation of the mucolipin TRP channel 3 (TRPML3) spontaneously initiates lysosomal exocytosis- leading to an expulsion of exosome-encased bacteria. (from Miao et al., 2015).

Figure 12: UPEC induces pain separable from other facets of UTI pathogenesis. FimH acts as a tethered toxin that mediates urothelial apoptosis and consequent bladder-barrier dysfunction. LPS plays dual roles through its interactions with TLR4. In addition to triggering inflammation, LPS mediates pelvic-pain responses. (from Rosen and Klumpp, 2014 and Klumpp and Birder, 2016).

tion during voiding and re-emerge into the urine during distension. When expelled into the urine during the storage phase, the urine may provide a nutrient-rich environment optimizing bacterial survival. Infected urothelial cells have also been shown to use their export machinery to reduce bacterial loads. For example, UPEC found in epithelial 'lysosomes' are sensed by a transient receptor potential (TRP) mucopolin 3 (TRPML3). This is a cation channel expressed on lysosomes, and this sensing leads to a spontaneous exocytosis of the lysosome expelling the bacteria (Figure 11).(67)

UPEC can trigger an inflammatory response within the urothelium with release of multiple mediators (such as interleukins and cytokines)(68) and the end result of this immune response is structural damage to the urothelial barrier. Recent evidence has shown that hypoxia inducible factor 1-alpha (HIF-1a) can play a role in modulating the innate immune cell function.(69, 70) Human urothelial cells treated with a HIF-1a stabilizing agent exhibited less cell death when exposed to UPEC supporting a role for HIF-1a in defense against UPEC infection.(71) There is also evidence for a role of endotoxin (lipopolysaccharide, LPS) on the bacterial cell wall in mediating the pain associated with UPEC infection.(72) This seems to function independent of urothelial damage, as erosion of the urothelial surface with protamine sulfate in mice failed to elicit bladder pain when instilled with UPEC strain of bacteria. In addition, bacteria can possess a wide range of pain phenotypes, largely dependent upon Toll-like receptors (Figure 12).(73, 74)

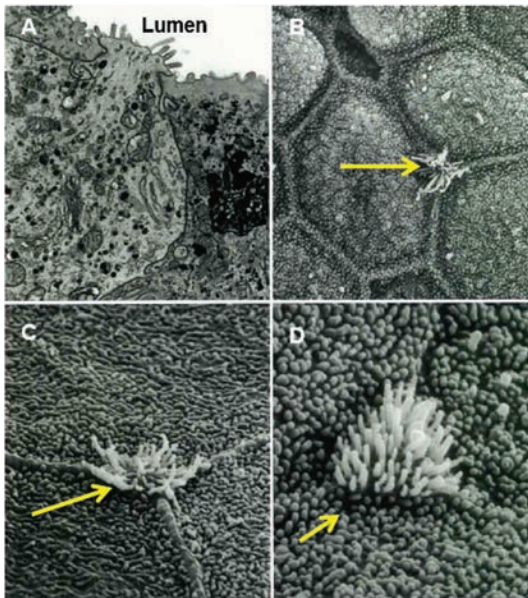

Figure 13: Images depicts 'open type' paraneurons in the dog urethra. A, paraneuron reaching the lumen; B-D, Scanning EM identifies (arrows) microvillous cells among the epithelial cells. A: x14,000; b: x4600, c: x12,000, d: x16,000. (from Hashimoto et al., 1999).

Taken together, these findings support the view that UPEC-induced urothelial dysfunction is the transducer of the UTI pain signal.

Disruption of urothelial function can also be induced by more remote pathological conditions that influence neural or hormonal mechanisms. For example, spinal cord transection in rats leads to a rapid alteration in the urothelial barrier including ultrastructural changes and increased permeability.(75) The changes are blocked by pretreatment with a ganglionic blocking agent, suggesting an involvement of efferent autonomic pathways in the acute effects of spinal cord injury on bladder urothelium. Other types of urothelial-neural interactions are also likely, based on the recent reports that various stimuli induce urothelial cells to release chemical mediators that can in turn modulate the activity of afferent nerves.(4, 29) This has raised the possibility that the urothelium may have a role in sensory mechanisms in the urinary tract.

In summary, modification of the urothelium and/or loss of epithelial integrity in a number of pathological conditions can result in passage of toxic/irritating urinary constituents through the urothelium or release of neuroactive substances from the urothelium. This may lead to changes in the properties of sensory nerves and in turn sensory symptoms such as urinary frequency and urgency. Thus chemical communication between the nervous system and the urothelial cells may play an important role in the generation of urinary bladder dysfunction.

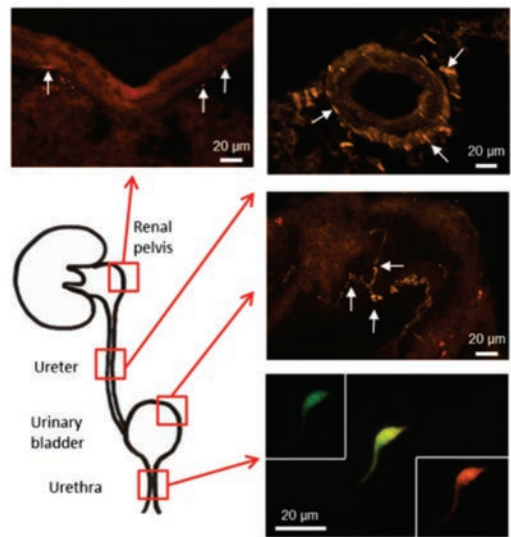

Figure 14: Cholinergic eGFP-expressing epithelial cells are restricted to the urethra in the urinary tract. In all other parts of the urinary system, cholinergic nerve fibers (arrows) were visualized, but not ChAT-eGFP-expressing epithelial cells. (from Deckmann, 2014).

4. EPITHELIAL HETEROGENEITY IN THE LOWER URINARY TRACT

Studies (comparing a number of species) have shown that the major part of the urinary tract is lined with a fully differentiated urothelium.(1) Findings in cultured cells reveal a distinct difference in morphology of ureteral and bladder urothelial cells, supporting a difference in cell lineage. Present evidence suggests at least 3 urothelial lineages: 1) those of the ureter/renal pelvis, 2) detrusor/trigone and 3) bladder neck/proximal urethra.(76)

There seems to be no apparent difference between the urothelium of the trigone compared to the detrusor, in contrast to cells from the proximal urethra. (1, 77) In this region, there is a transition from urothelium to a stratified or columnar epithelium accompanied by a lack of urothelial-specific differentiation markers. In addition, specialized chemosensory neuroendocrine cells are distributed within the urethral epithelia. These cells are often exposed to the lumen and may share similarities to GI enterochromaffin cells or chemosensory cells of the trachea or respiratory tract

(often termed 'brush cells'),(78) including expression of microvilli (Figure 13; 14). These urethral specialized chemosensory cells are able to respond to detect potential noxious stimuli (using the classic taste transduction pathway) by releasing mediators such as acetylcholine.(78, 79) Similar to urothelial cells in the bladder wall, these urethral chemosensory cells are also in close proximity to sensory nerve fibers whereby intraurethral stimulation can lead to activation of underlying cells including bladder smooth muscle. In addition, there are also reports that have identified functional properties of sacral afferents that are able to respond to changes in fluid flow through the urethra.(80) While the functional significance of these findings may not yet be fully appreciated, it is clear that such 'sentinel' type cells are able to recognize potentially harmful stimuli (including bacteria) in the urethral lumen and in turn, alter bladder function.

5. ROLE FOR UROTHELIAL CELLS IN VISCERAL SENSATION

While urothelial cells are often viewed as bystanders in the process of visceral sensation, recent evidence

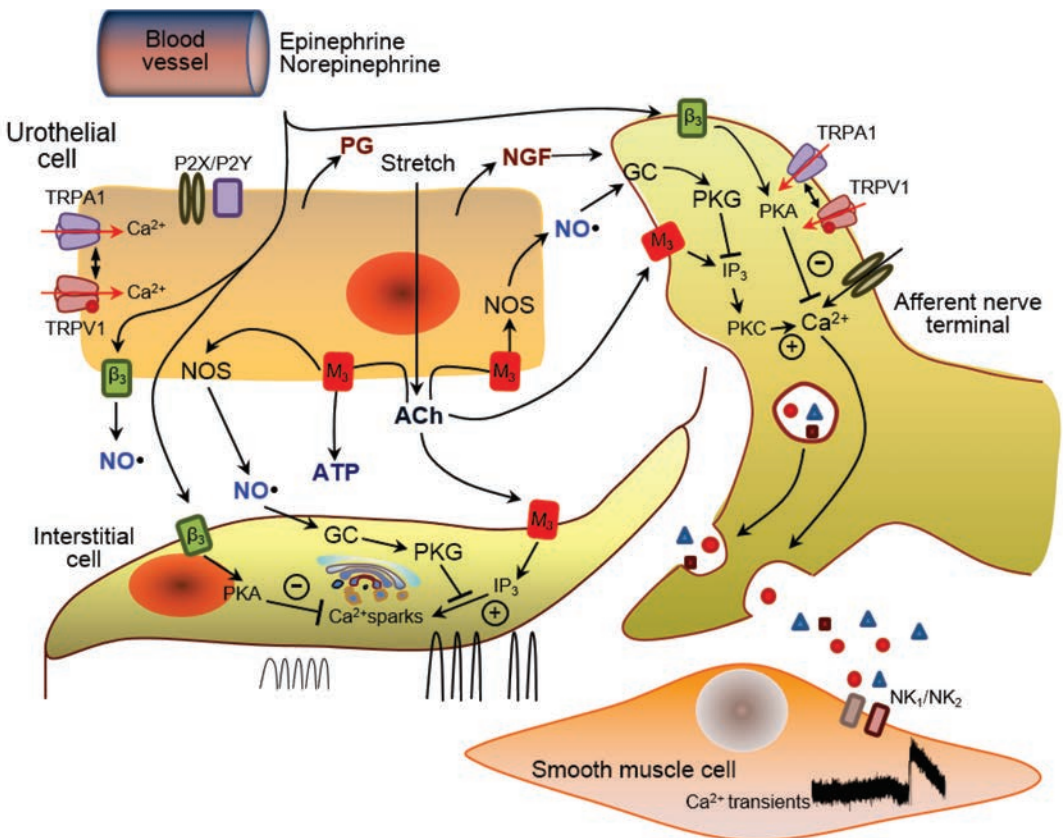

Figure 15: Hypothetical model depicting possible interactions between bladder nerves, urothelial cells, smooth muscle, interstitial cells and blood vessels. Urothelial cells can also be targets for transmitters released from nerves or other cell types. Urothelial cells can be activated by either autocrine (i.e. auto regulation) or paracrine (release from nearby nerves or other cells) mechanisms.

has supported the view that these cells function as primary transducers of some physical and chemical stimuli and are able to communicate with underlying cells including bladder nerves, smooth muscle and inflammatory cells. (Figure 15)

5.1. Influence of the Extracellular Matrix

The urothelium is able to respond to a wide variety of mechanical stresses during bladder filling and emptying by activating a number of possible transducer proteins. Possibilities of mechanical signals include bladder pressure, tension in the urothelium or bladder wall, torsion, geometrical tension, movement of visceral organs and even urine tonicity and pH.(81) Alterations in the composition of urine are a type of stress whose contents can vary in both their rate of delivery as well as the particular constituents. Additionally, dynamic reciprocal interactions of the urothelium with underlying extracellular matrix (ECM) not only aid in maintaining normal bladder structure but also play an important role in generating signaling responses. The urothelium is highly sensitive to the mechanics of the underlying ECM, thus understanding the complexity and relationship between mechanics and biological activities of cells throughout the bladder wall is important. In this regard, studies using multiphoton imaging have revealed differences in collagen fiber structure and recruitment throughout the bladder wall (Figure 16).(82) It is likely that pathology-induced changes in fiber architecture could alter neural-epithelial interactions including the response to mechanical strain that can influence bladder compliance and sensation.

Additional lines of evidence suggest that urothelial cells participate in the detection of both physical and chemical stimuli. Bladder nerves (afferent and efferent) are localized in close proximity, and some within, the urothelium.(83-86) In addition, urothelial cells express numerous receptors/ion channels similar to that found in both nociceptors and mechanoreceptors.

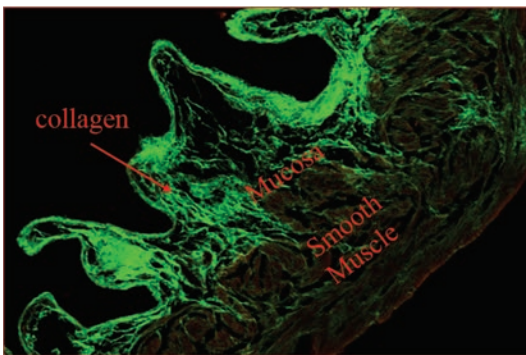

Figure 16: Cross-section of rat bladder depicting collagen fiber (green) orientation throughout the bladder wall using multi-photon microscopy (original image- Hornsby et al., 2016).

And finally, these cells secrete a number of transmitters or mediators capable of modulating, activating or inhibiting sensory neurons.

5.2. Urothelial-Neuronal Signaling

Recent studies have shown that both afferent and autonomic efferent nerves are located in close proximity to the urothelium. Peptidergic, P2X- and TRPV1- immunoreactive nerve fibers presumed to arise from afferent neurons in the lumbosacral dorsal root ganglia are distributed throughout the urinary bladder musculature as well as in a plexus beneath and extending into the urothelium.(29, 85) In humans with neurogenic detrusor overactivity intravesical administration of resiniferatoxin, a C-fiber afferent neurotoxin, reduces the density of TRPV1 and P2X3 immunoreactive suburothelial nerves, indicating that these are sensory nerves.(87, 88) In addition, immunohistochemical studies have also revealed both adrenergic (tyrosine hydroxylase) positive as well as cholinergic (choline acetyltransferase, ChAT) positive nerves in close proximity to the urothelium.(84)

A network of cells with morphologic characteristics similar to those of myofibroblasts or interstitial cells is also detected in the suburothelial space of the bladder in both humans and animals.(89-92) These cells, which are extensively linked by gap junctions and have close contacts with nerves, can respond to neurotransmitters, such as ATP released from nerves or urothelial cells, suggesting that they could act as intermediaries in urothelial-nerve interactions.(89, 91, 93) Thus the anatomic substrates for bidirectional urothelial-neural communication exist within the urinary bladder.

5.3. Involvement of the Urothelium in “Sensing” Chemical and Mechanical Stimuli

The involvement of urothelial function in sensory signaling is suggested by the finding that urothelial cells express various receptors that are linked to mechano- or nociceptive sensations. Examples of neuronal “sensor molecules” (receptors / ion channels) that have been identified in urothelium include receptors for purines (P2X₁₋₇ and P2Y_{1,2,4}) adenosine (A₁, A_{2a}, A_{2b} and A₃), norepinephrine (α and β), acetylcholine (muscarinic and nicotinic), protease-activated receptors (PARs), amiloride- and mechanosensitive epithelial sodium channels (ENaC), bradykinin (B1 and B2), neurotrophins (p75, trkA, EGF family ERB1-3), corticotrophin releasing factor (CRF1 and CRF2), estrogens (ER α and ER β), endothelins and various TRP channels (TRPV1, TRPV2, TRPV4, TRPM8 and TRPA1).(94-105) The expression of these various receptors enable the urothelium to respond to a number of “sensory inputs” from a variety of sources. These inputs include increased stretch during bladder filling, soluble factors (many found in the urine) such as epidermal growth factor (EGF), or chemical mediators/peptides/transmitters such as substance P, calcitonin gene-related peptide

(CGRP), corticotrophin releasing factor (CRF), acetylcholine, adenosine or norepinephrine released from nerves, inflammatory cells and even blood vessels.(29, 30, 106, 107)

Various stimuli can lead to secretion of numerous chemical substances such as neurotrophins, peptides, ATP, acetylcholine, prostaglandins, prostacyclin, nitric oxide (NO) and cytokines that are capable of modulating the activity of underlying smooth muscle(93, 108) as well as nearby sensory neurons.(29, 30) For example, urothelial-specific overexpression of NGF results in increased bladder nerve 'sprouting' and increased voiding frequency.(109, 110) It has been shown that urothelial-derived NO can be released in response to mechanical as well as chemical stimulation and may either facilitate or inhibit the activity of bladder afferent nerves conveying bladder sensation.(111) In this regard, activation of urothelial-receptors and release of inhibitory mediators may explain in part, the mechanism of action for therapies (e.g. β -adrenergic receptor agonists) in treatment of bladder disorders such as OAB.(112-114)

The mechanism underlying release of chemical mediators from the urothelium, including whether all sensory "inputs" stimulate membrane turnover (i.e. vesicular exocytosis) is not well understood. What little is known about the roles and dynamics of membrane-bound cytoplasmic vesicles in urothelial cell physiology is derived from measurements of membrane capacitance and microscopy of fixed tissues and cells. For example, there is evidence that once released, ATP can enhance both stretch induced exocytosis and endocytosis.(115) Alterations in membrane turnover can not only increase apical surface area (as described above) but also regulate the number and function of receptors and channels at the cell surface.

There is evidence that epithelial cells in different organ systems may express similar receptor subtypes.(116-118) Accordingly, epithelial cells could use multiple signaling pathways, whose intracellular mechanisms differ according to location and environmental stimuli. This would permit a greater flexibility for the cell to regulate function and respond to complex changes in their surrounding microenvironment. Whether urothelial-sensor molecules all feed into a diverse array of signaling pathways or share similarities with systems such as olfaction, whereby hundreds of receptors share identical transduction cascades,(119) is yet to be uncovered.

5.3.1 Purinergic Receptors

Since the first report of distension-evoked ATP release from the urothelium there is now abundant evidence supporting a role for urothelially-derived release of ATP in autocrine and paracrine signaling within the lower urinary tract.(120) ATP is abundant in the cell cytoplasm and can be released extracellularly by several mechanisms including vesicular exocytosis, transporters such as a member of the ATP-binding cassette (ABC) transporter superfamily, or anion-selective channels such as the maxi-anion

channel.(99) ATP is released from both the apical and basolateral urothelial surfaces in response to bladder stretch and can act on P2X2 and P2X3 urothelial receptors to stimulate stretch-induced exocytosis.(115) (Figure 17A) There is also evidence that pannexin channels, which are expressed throughout the urothelium (Figure 17B and 18), may be involved in modulating voiding reflexes via urothelial release of ATP.(101, 121)

The expression of both P2X and P2Y receptors in nerve fibers and myofibroblasts in close proximity to the bladder lumen and the sensitivity of these cells to ATP suggests that basolateral ATP release from the urothelium may also influence function of myofibroblasts and bladder nerves.(90, 122) Also, since the P2X3 null mice have a lower frequency of voiding contractions during bladder filling, suggests that P2X antagonists could play a role in treatment of OAB. The amiloride-sensitive apical sodium channel, ENaC, may be involved in mechanotransduction by controlling basolateral release of ATP.(123, 124) In addition, intercellular communication mediated by gap junctions in myofibroblasts could provide a mechanism for long-distance spread of signals from the urothelium to the detrusor muscle.(93) Interestingly, this type of nucleotide-mediated wave of cell-cell communication may also play a role in the response to injury.(124) While evidence supports a role for ATP and purinergic receptors in modulating symptoms in

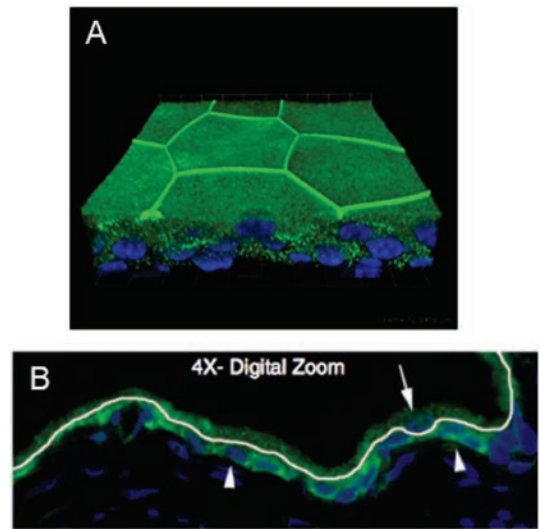

Figure 17: A- Image is a 3-dimensional reconstruction (taken with a confocal microscope) depicting localization of P2X3 (green; nuclei blue) in the urothelium (from Wang et al., 2005).

B- Rat urothelium expresses pannexin 1 channels. Shown is a 4X digital zoom image where the white line denotes boundary of the umbrella cells as determined by cytokeratin staining. Note pannexin 1 is expressed in the umbrella cell layer (white arrow), as well as underlying intermediate and basal cell layers (arrowheads). (from Beckel et al., 2015).

several urologic diseases, the mechanisms underlying activation of the micturition pathway at lower bladder volumes (during urgency) and mediators (amount; type) involved are not understood. In addition, the directionality of transmitter release, the mixture of receptor subtypes in the apical and basolateral domains and interactions between multiple-transmitters is likely to affect the nature of the output in both health and disease.

5.3.2 TRP Channels

The ability of capsaicin to evoke NO release from rat urothelium, reported in 1998, provided the first, albeit indirect, demonstration that TRPV1 channels are expressed in urothelial cells and that urothelial cells and afferent nerves, which also express these channels, share a number of common properties.(125) This ion-channel protein is activated by capsaicin, as well as to moderate heat, protons, nitro-fatty acids and lipid metabolites such as anandamide (an endogenous ligand of both cannabinoid and vanilloids receptors).(126, 127) TRPV1-positive nerves are in close contact with urothelial cells.(128, 129) Activation of urothelial cells with capsaicin or resiniferatoxin can increase intracellular calcium, evoke transmitter (nitric oxide, NO or ATP) release, and elicit transient currents.(85, 130) Similar to that in sensory neurons, urothelial-response to vanilloids are enhanced by low pH, blocked by TRPV1 antagonists and eliminated in TRPV1 null mice.(85) In afferent neurons, TRPV1 is thought to integrate/amplify the response to various stimuli and to play an essential role in the development of inflammation-induced hyperalgesia. It seems likely that urothelial-TRPV1 might participate in a similar manner, in the detection of irritant stimuli following bladder inflammation or infection.

Additional TRP channels

Much less is known about the involvement of other TRPs in bladder function or disease. TRPV4 which is a nonselective cation channel activated by a number of stimuli including heat, shear stress, changes in osmolarity and lipid ligands is expressed mainly within the epithelium of the urinary bladder.(131) While a definitive role for TRPV4 in bladder function has not been established, there is evidence that null mice exhibit impaired voiding responses and, intravesical instillation of a TRPV4 agonist in the rat triggers a novel voiding reflex which could regulate the late phase of micturition.(86, 132) Additional studies suggest activation of urothelial-TRPV4 facilitates bladder reflexes via activation of mechanosensitive, capsaicin- (insensitive) C fibers.(133) In addition, in the awake ewe, TRPV4 may also be involved in a urethra to bladder reflex, proposed to facilitate bladder emptying.(134) Another member of the TRP family, TRPA1 (characterized as a thermoreceptor activated by noxious cold), is expressed in C-fiber afferents as well as urothelium and agonists to this channel induce bladder hyperreflexia.(135) Of interest is the finding that hydrogen sulfide, which may be formed

during infection/inflammation, is an activator of TRPA1.

5.3.3 Acetylcholine

There is evidence that the urothelium expresses the full complement of muscarinic receptors as well as enzymes necessary for the synthesis and release of acetylcholine.(106, 136) Further, the urothelium is able to release acetylcholine following both chemical and mechanical stimulation.(106) The mechanism underlying acetylcholine release from urothelium may be through organic cationic transporters (OCTs) rather than vesicular exocytosis, differing from that of bladder nerves.(137) Once released, urothelial-derived acetylcholine is likely to exert effects via a number of sites including smooth muscle, nerves as well as urothelial associated-muscarinic or nicotinic receptors, the latter that could contribute to feedback mechanisms modifying urothelial function.(138) In addition, stimulation of urothelial-cholinergic receptors elicits release of mediators such as nitric oxide, prostaglandin as well as ATP, which could alter bladder sensation by stimulating nearby sensory afferent nerves. (139-141)

Thus, targeting muscarinic receptors and/or urothelial synthesis or release mechanisms may play an important role in the treatment for a number of bladder disorders. By inhibiting SNARE-dependent exocytotic processes, botulinum toxin A (BTX-A) can prevent the release of transmitters from bladder nerves as well as translocation of various receptors and channels to the plasma membrane.(142) Urothelial-derived acetylcholine may not be sensitive to BTX-A, however studies have shown that other transmitters (such as ATP) released by the urothelium can be blocked by this treatment in addition to normalizing the expression of urothelial-receptors (TRPV1; muscarinic) and trophic factors.(143, 144) These and

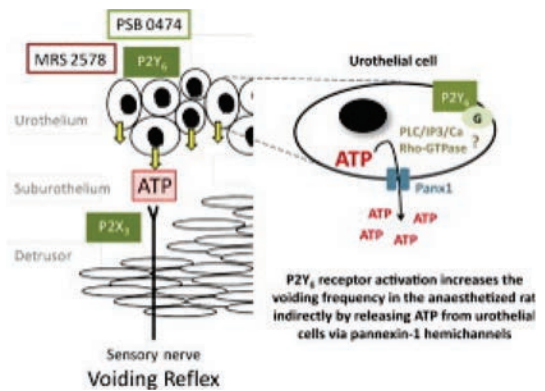

Figure 18: Activation of urothelial P2Y6 receptors can modulate urodynamic responses in the anesthetized rat. The increase in voiding frequency is mediated by increased ATP release from the urothelium via pannexin-1 hemi channels. (from Timoteo et al., 2014).

other studies suggest that the urothelium may be a

target for this treatment and that urothelial-released mediators may contribute to sensory urgency.

6. CLINICAL SIGNIFICANCE OF THE SENSORY WEB

Defects in urothelial sensor molecules and urothelial-cell signaling are likely to contribute to the pathophysiology of bladder diseases. For example, a number of bladder conditions (BPS/IC, spinal cord injury (SCI), chemically-induced cystitis) are associated with augmented release of urothelial-derived ATP, which is likely to result in altered sensations or changes in bladder reflexes induced by excitation of purinergic receptors on nearby sensory fibers.(98, 145) ATP can also act in an autocrine manner that would act to facilitate its own release from urothelial cells. Augmented expression/release of urothelial-derived chemical mediators is likely to reduce the threshold for activation of nearby bladder afferents. Thus, the urothelium has the potential for amplifying signals, both within the urothelium and the bladder wall and contributing to a gain of function in sensory processing. Stressors that can impact on this 'gain of function' include alterations in levels of trophic factors as well as stress and steroid hormones. For example, altered levels of circulating estrogens may play a role

in urinary bladder dysfunction, including urgency and frequency.(44, 146) The resulting structural and functional abnormalities may lead to enhanced signaling between the urothelium and underlying cells.

Changes in epithelial signaling/barrier function would not be unique to the urinary bladder. Activation of keratinocytes alone in mice expressing a light-activated channel can result in nociceptive responses demonstrating signaling between epithelial and neural tissues. (147) (figure 19) In addition, airway epithelia in asthmatic patients as well as keratinocytes in certain types of skin diseases also exhibit a number of similar abnormalities and compromised repair processes.(116, 148, 149) This is particularly relevant given the high incidence of associated diseases that can include both visceral and somatic conditions, many of which exhibit a shared loss of epithelial barrier function. Further, many of these systems do share a number of commonalities that include increased afferent activation of supraspinal centers in order to effectively coordinate efferent outflow as well as dependence on similar types of neurotransmitters (such as ATP) to mediate sensory responses. A recent example is the use of P2X3 antagonists in the treatment of both respiratory and urological disorders.(150) Taken together, epithelial cells can respond to a number of challenges (including environmental pollutants and mediators released from nerves or nearby inflammatory cells) resulting in altered expression and/or sensitivity of various receptor/channels as well as changes in release of mediators, all of which could impact function.

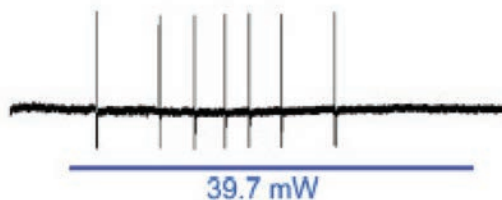
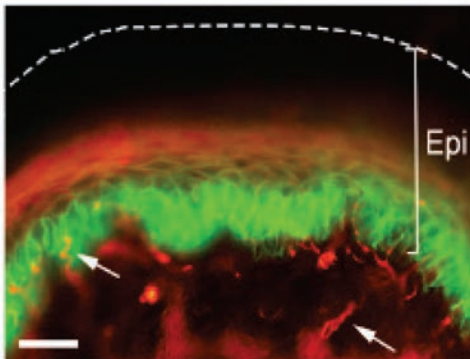

Figure 19: Blue light stimulates multiple types of afferents in KRT-ChR2 transgenic mice. Top- ChR2-YFP expression in glabrous skin of KRT-ChR2 mouse. PGP9.5 positive nerve fibers (red) are in dermis and epidermis (arrows); Bottom- example showing activation of a cutaneous fiber in response to blue laser applied to KRT-ChR2 skin in an ex vivo preparation. (from Baumbauer et al., 2015).

II. AFFERENT PATHWAYS

1. OVERVIEW: PROPERTIES OF AFFERENT PATHWAYS

The bladder and lower urinary tract serves to store and evacuate urine and is controlled by a complex hierarchy of neural mechanisms organized by local, spinal and brain circuits. Most of the time is spent in storage mode during which the bladder accommodates urine and maintains continence via reflexes that prevent contraction of bladder smooth muscle and contract the urethral sphincter. This switches during micturition when the bladder contracts and the sphincter opens to facilitate voiding. This switch relies on sensory signals, which provide the input to the reflex circuits that control bladder filling and emptying and are also the source of both non-painful sensations of fullness and pain. Dysfunction leads to a number of distressing disorders such as overactive bladder syndrome (OAB) and Bladder Pain Syndrome/Interstitial Cystitis (BPS/IC) with symptoms including urgency, pain and urinary incontinence. Currently available therapeutic approaches are aimed primarily at reducing bladder contraction in order to relieve intravesical pressure and maintain continence. Interest in bladder afferent signalling has been fuelled by the

recent realization that symptoms are a feature of dysregulated storage rather than exaggerated contractile responses and therefore targeting afferent mechanisms may be a rational approach to treatment.

Our understanding of bladder afferent signalling has been advanced by studies that are designed to reveal firstly, the morphological features of the afferent terminations in both the periphery and spinal cord; secondly, identify the receptors and ion channels present on these terminations that determine afferent excitability and, thirdly, by recording electrophysiologically the action potentials in afferent fibres it has been possible to characterize the stimulus-response functions of the various populations of afferents conveying sensory information towards the CNS. Such afferent recordings have been performed *in vivo* in anaesthetized animals and *in vitro* using isolated tissue preparations. *In vivo* studies have the advantage that reflex function remains intact although they may be influenced by the use of anaesthetics. Also, by maintaining vascular perfusion, tissue oxygenation will be better maintained, and blood borne factors, including leukocytes, important for neuro-immune functions, can be recruited to the bladder milieu. Similarly, any biochemical factors released into the tissue will be rapidly eliminated into the blood stream. However, an intact vascular supply may also offer a number of disadvantages. Reflex changes in blood flow may lead to secondary alterations in afferent firing, while in the absence of blood flow there is the potential for surgical and pharmacological interventions to probe stimulus-response function. For example, flat-sheet preparations with the urothelium uppermost in a tissue bath allow the pinpoint mapping of receptive fields and the localized application of stimuli directly to the surface of the urothelium. In contrast, surgical removal of the urothelium and sub-urothelial tissue has been used to determine the source of afferent signals from different layers of the bladder wall and the role of urothelial factors in afferent activation. The perfusion medium can incorporate drugs to target specific ion channels and receptors that would be lethal to the whole animal or can be manipulated (calcium-free conditions) to attenuate processes that require calcium entry for downstream signalling. The combination of these different approaches has been essential in understanding the nature of sensory signalling from the lower urinary tract.

2. PATHWAYS TO THE SPINAL CORD

Afferent fibres reach the lower urinary tract via pelvic, hypogastric (lumbar splanchnic) and pudendal nerves. These nerves are mixed nerves that also contain the efferent parasympathetic, sympathetic and motor fibres supplying the bladder, urethra and sphincters. Axonally transported dyes applied to these nerves are taken up and transported to the cell bodies in the lumbosacral dorsal root ganglia and the

terminations in the spinal cord. Mapping the distribution of these dorsal root ganglia (DRG) allows the pattern of innervation to be determined in detail and when used in combination with immunocytochemistry provide information on the neuronal phenotype. Moreover, these neurones can be isolated and maintained in cell culture and the labelling using to identify specific functional properties of bladder projecting sensory neurones.

Only a small proportion of DRG neurones supply the viscera with majority supplying somatic targets in the skin and skeletal muscles. Those supplying the bladder are pseudounipolar with a central projection into the dorsal horn of the spinal cord and a peripheral axon that terminates at different levels in the bladder wall. DRGs supplying pelvic and pudendal afferents originate in the thoracic, lumbar and sacral regions while hypogastric afferents arise mainly from the rostral lumbar dorsal root ganglia. The central projections of these DRG neurones carry the sensory information from the lower urinary tract to second order neurons in the spinal cord. These second order neurons provide the basis for spinal reflexes and ascending pathways to higher brain regions involved in micturition and in mediating sensation.

The cell size of bladder DRGs is consistent with there being 2 populations of afferents with one connecting to small unmyelinated C-fibre afferents and the other to finely myelinated A-delta fibres. These cell bodies can be further classified according to the presence or absence of certain biochemical markers, namely peptidergic and non-peptidergic. Many unmyelinated afferents are peptidergic, containing calcitonin-gene related peptide (CGRP) and many of these also contain substance P as well as various other peptides. However, some small myelinated fibres also express CGRP. Non-peptidergic neurones can be identified by labelling for isolectin IB4, which recognizes terminal sugar residues on the cell membrane. Both small and medium sized DRGs are labelled with IB4. This non-peptidergic subgroup also expresses P2X3 receptors, which is predominantly found in small unmyelinated fibres. TRPV1 and other sensory markers described below have been demonstrated mainly in peptidergic populations.(151)

Staining for these sensory markers have also been used to identify the terminations of sensory afferents in the bladder wall. CGRP-containing afferent fibres are abundant in the bladder wall and distributed within 4 different layers distinct layers: within the urothelium, around the base of the urothelium within the lamina propria, in the muscle and associated with blood vessels in the serosa. These fibres have conspicuous varicosity, which are release sites for stored transmitter indicating a role for these afferents in so called "axon reflexes". Upon activation the afferents convey information towards the CNS but also release mediators onto cells in their vicinity to mediate localized responses. Targets for these mediators include vascular smooth muscle, detrusor muscle, urothe-

lium, fibroblast-like cells, mast cells and other neurons. In the human bladder, CGRP containing fibres occur only infrequently in nerves in the muscle but are moderately frequent in the suburothelial layer. Some of these fibres synapse on intramural ganglia within the bladder forming the basis for local neural reflexes.(152-155) Ultrastructural studies of human bladder have found only unmyelinated nerves in the urothelium and immediate suburothelial layer, small myelinated nerves being closely associated with the

smooth muscle layers.(156) The plexus of afferent nerves in the lamina propria is thickest in the neck of the bladder and in the initial portion of the urethra, and becomes progressively less dense in the adjacent regions such that cranial region of the bladder have no afferent axons. In contrast, the afferent innervation of the musculature is more uniform throughout the bladder.

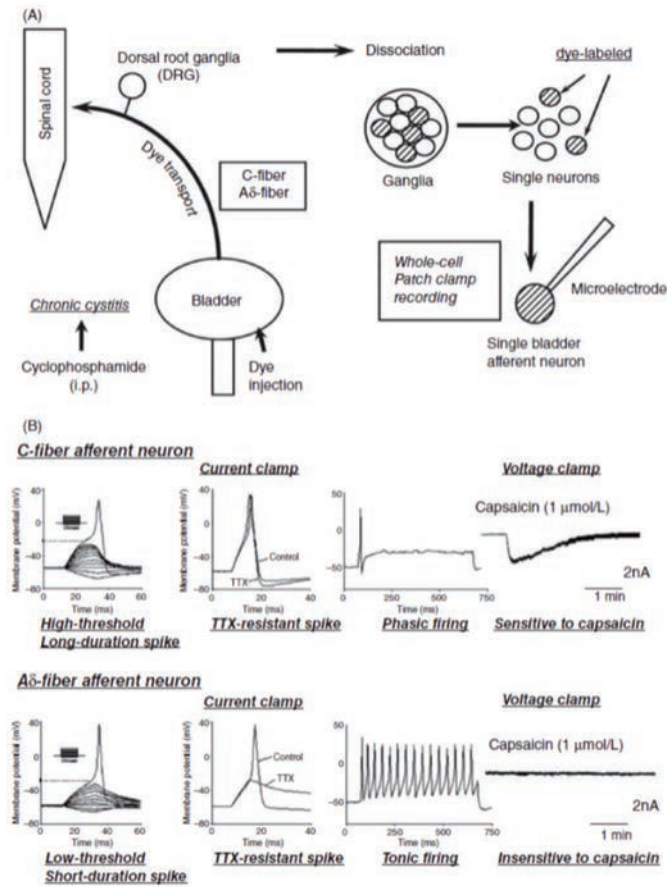

Figure 20: A. Experimental methods for performing patch-clamp recordings on bladder afferent neurons obtained from rats with chronic cystitis. Chronic cystitis was induced by intraperitoneal injection of cyclophosphamide. Fluorescent dye (fast blue) injected into the bladder wall was transported via A δ - and C-fiber bladder afferent axons to neurons in the dorsal root ganglia (DRG). L6 and S1 DRG were dissected and dissociated into single neurons by enzymatic methods. Whole cell patch-clamp recordings were performed on fast blue-labeled bladder afferent neurons identified with a fluorescence microscope. B. Characteristics of a bladder afferent neuron (24- μ m diameter, C-fiber afferent neuron, top record) exhibiting tetrodotoxin (TTX)-resistant action potentials and a bladder afferent neuron (33- μ m diameter, A δ -fiber afferent neuron, bottom record) exhibiting TTX-sensitive action potentials. The left panels are voltage responses and action potentials evoked by 30-ms depolarizing current pulses injected through the patch pipette in current-clamp conditions. Asterisks with dashed lines indicate the thresholds for spike activation. The second panel on the left side show the effects of TTX application (1 μ M) on action potentials. The third panel from the left show firing patterns during membrane depolarization (700-ms duration). The panels on the right show the responses to extracellular application of capsaicin (1 μ M) in voltage-clamp conditions. Note that the C-fiber afferent neuron exhibited TTX-resistant phasic firing (i.e., one to two spikes during prolonged membrane depolarization) and an inward current in response to capsaicin, while A-fiber afferent neuron exhibited TTX-sensitive tonic firing (i.e., repetitive firing during membrane depolarization) and no response to capsaicin.

3. FUNCTIONAL PROPERTIES OF BLADDER AFFERENTS

3.1. Electrophysiological properties of afferent neurons

Functional properties of dissociated bladder and urethral afferent neurons identified by retrograde axonal transport of fluorescent dyes injected into the bladder or urethra have been investigated using patch clamp techniques (157-164).

Based on electrical and chemical properties (Figure 20), bladder afferent neurons are divided into two populations (163) in rats. The most common population of neurons (greater than 70%) are small in size, sensitive to capsaicin and exhibit high-threshold, long-duration action potentials resistant to tetrodotoxin (TTX), a Na⁺ channel blocker. The other population of bladder afferent neurons which are larger in size and insensitive to capsaicin exhibit low-threshold, short-duration action potentials, which are reversibly blocked by TTX. Because the majority of bladder afferent neurons with TTX-resistant spikes are sensitive to capsaicin, these neurons are likely to be the origin of C-fiber afferent axons (165). In rat models of cystitis or spinal cord injury, which exhibit C-fiber-dependent bladder overactivity, it has been shown that capsaicin-sensitive bladder afferent neurons increase their excitability due to decreased density of A-type K⁺ (K_A) currents, associated with the decreased expression of the Kv1.4 α -subunit, which can form the K_A channel(166). Thus, the reduction in K_A current size could be a key mechanism inducing C-fiber afferent hyperexcitability in bladder overactivity conditions in the bladder.

3.2. Functional properties of afferent nerves

Recording from bladder afferents has confirmed the diversity of afferent populations described above based on morphology.(167) Conduction velocity measurements confirm the predominance of fibres conducting action potentials in the A-delta and C-fibre range (Table 1 and Figure 21). The majority of these

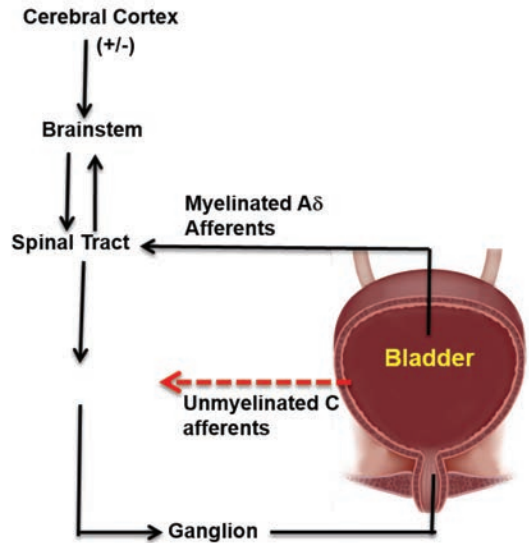

Figure 21: Illustration depicting predominant Ad afferent contribution to normal micturition reflex. C fibers (dotted line) are normally silent unless activated with pathology.

are mechanosensitive, responding to bladder filling with a range of thresholds from volumes that would be encountered under normal bladder filling to extreme levels of distension that would be considered noxious and give rise to pain. Those with lower thresholds have small myelinated axons while unmyelinated fibres have generally higher thresholds for activation. Other afferents do not respond to bladder filling. Some can be activated by intraluminal chemicals such as hypertonic saline, capsaicin or ATP, suggesting they may function as chemoreceptors. Others may be so called "silent afferents" that have been described elsewhere including the gastrointestinal tract. These afferents can be recruited or sensitized in conditions (neuropathic; inflammatory) resulting in urgency, incontinence and even pain. (Figure 22)

A series of studies have used open-sheet preparations of guinea-pig bladder to examine the diversity of

Table 1: Bladder Afferent Properties

Fiber Type	Location	Normal Function	Inflammation Effect
Ad (finely myelinated axons)	Smooth Muscle	Sense bladder fullness (wall tension)	Increase discharge at lower pressure threshold
C fiber (unmyelinated axons)	Mucosa	Respond to stretch (bladder volume sensors)	Increase discharge at lower threshold
C fiber (unmyelinated axons)	Mucosa muscle	Nociception to overdilatation; Silent afferent	Sensitive to irritants; Becomes mechanosensitive and unmasks new afferent pathway during inflammation

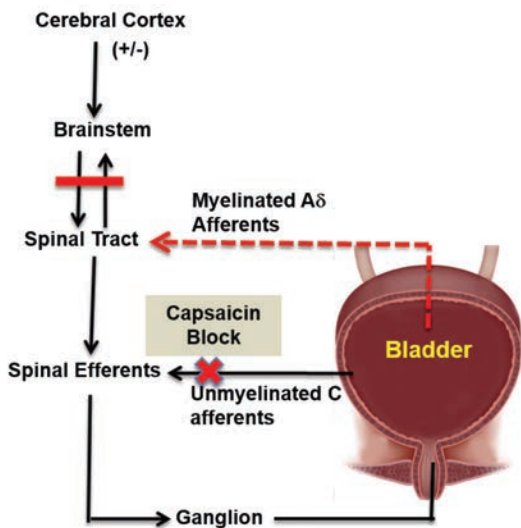

Figure 22: Illustration depicting switch in afferent contribution to the micturition reflex from Ad-fiber predominant to C-fiber predominance with neurologic diseases, aging and possibly inflammatory diseases. Note capsaicin (and other vanilloids) can block the C-fiber contribution under these conditions.

bladder afferents and to attempt to correlate structure with function. Low threshold afferents have terminals in the muscle where they have been described as having “antenna-like endings” and are referred to as stretch sensitive muscular mechanoreceptors.(168, 169) Since these afferents also respond to contraction of the detrusor muscle there are also called tension receptors since they respond to tension generated by both elongation during stretch and shortening during contraction. High threshold afferents are also likely to terminate in the deeper muscle layers or in the serosa. These mechanosensitive endings have receptive fields (located by mechanical probing) associated with blood vessels. These likely respond to high levels of stretch that distort the bladder wall but may also become sensitized in response to inflammation.

Another class of mechanoreceptor can be activated by stretch and by light stroking of the urothelium. These endings are referred to as muscular-mucosal by analogy to similar endings in the bowel wall but muscular-urothelial mechanoreceptor may be a more correct term. Their sensitivity could arise because the afferent terminal branches to supply the muscle and urothelium or a single ending in the lamina propria might detect changes in muscle tension and stimulation of the urothelium.(170) Zagorodnyuk et al suggest that non-peptidergic “grape like” endings in the lamina propria may be the substrate for these endings. Other urothelial endings respond to stroking but not stretch and some of these are stimulated by luminal chemicals such as capsaicin, acid and are temperature-sensitive. Peptidergic afferents identified by

dye filling from the pelvic nerve may be the basis for these epithelial responses.

Mechanosensitivity can arise either directly as a consequence of mechanosensitive ion channels on the sensory nerve ending or secondary to chemicals released in response to stimulation, which in turn activate the ending secondary to stimulation of ligand-gated ion channels. As outlined below there is considerable debate as to the role of the urothelium in sensory signaling. One attempt to resolve this has been to dissect off the urothelium and lamina propria and determine the impact on mechanosensitivity. In the case of muscular and serosal mechanoreceptors removal of the urothelium has little impact on distension response, suggesting these endings may be directly responsive, although the nature of the mechanosensitive ion channels has yet to be elucidated. In contrast the response of muscular-urothelial endings to distension is markedly attenuated following removal of the surface layers of urothelium.(169) The same is true for the mucosal endings. This could imply that the urothelium is involved in transducing stimuli. However, an alternative view might be that dissection causes damage to the underlying nerves that are no longer able to respond to any stimulus. An alternative approach to determining the role of the urothelium may rely on pharmacological manipulations that interfere with urothelial signaling. In this respect the response of low threshold mechanoreceptors was unchanged in calcium-free buffer, which would be expected to prevent urothelial mediator release through exocytosis.

More recent studies in the mouse identified similar populations of afferents and used a systematic classification system to establish the relative proportion of these different types of afferents in the pelvic and lumbar splanchnic nerve supply. The basis for classification and the relative distribution of the terminals and projecting pathway is shown in Figure 23. Another important observation in this study was the finding that both low threshold and high threshold mechanosensitivity became heightened following exposure to inflammatory mediators which has implications for our understanding of how sensory signaling is altered in disease and a basis for altered micturition and sensations such as pain.(171) There are also studies that identified and characterized sacral afferents responding to ‘flow’ through the urethra.(80) These are important observations whereby properties of these flow-responsive afferents seem to parallel that of cutaneous afferents. This could be important in terms of restoration of bladder emptying following spinal cord injury.

4. MODULATING AFFERENT SENSITIVITY

The discussion above has emphasized how stimulus-response function can be used to define the features of the various sub-populations of afferents that supply

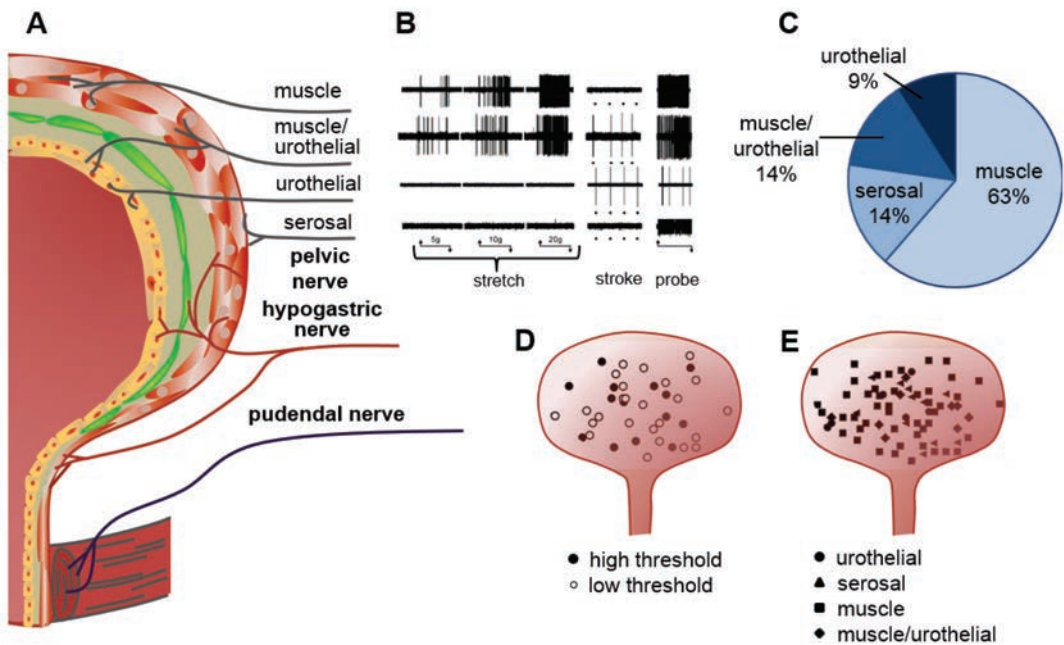

Figure 23: LUT afferent nerve classes and distribution. *A, fiber classes in bladder wall and urethra. B, in pelvic nerve 4 types of mechanosensitive fibers were identified by stretch, stroke and probe. C, proportion of afferent fiber types recorded in pelvic nerve. D, low and high threshold receptive fields of pelvic nerve muscle fibers based on response to stretch. E, receptive fields of 4 pelvic nerve fiber classes (Kanai and Andersson, 2009).*

the lower urinary tract. The relationship between stimulus and response is not fixed but can be changed according to the mechanical and chemical environment of the sensory ending. Contractions can distort the afferent ending while connective tissue elements will transmit or dissipate stimulus energy within the tissue determining for example whether a response is rapidly or slowly adapting to maintained stretch. Similarly, chemicals released from a variety of cells within the bladder wall and particular the urothelium and lamina propria will influence afferent firing.

Many mediators are released during inflammation, injury and ischemia, from platelets, leukocytes, lymphocytes, macrophages, mast cells, glia, fibroblasts, blood vessels, muscle and neurons. Each cell type may release several of these modulating agents. Some mediators act directly on sensory nerve terminals, while others act indirectly, causing release of yet other agents from nearby cells. This “inflammatory soup” acts on sensory nerve terminals to modify signalling (this is often referred to as “plasticity”). The increased sensitivity to both mechanical and chemical stimuli may contribute to chronic pain states – a feature of clinical relevance. Moreover, since these afferents also trigger reflexes that coordinate bladder function, sensitization can also cause detrusor overactivity or dysreflexia. Various experimental models have been employed to examine changes in the bladder innervation in disease. These include spinal cord

injury, bladder outlet obstruction, and various models of hyperactivity based upon chemical injury and autoimmune reactions to name just a few. While these models have generated a wealth of information there is some concern about their translational value and as a consequence their predictive value when testing novel therapeutics.(172)

Local mediators may include neurotrophins, amines, purines, prostanoids, proteases, and cytokines. They produce their effects on visceral afferent nerves by three distinct processes. First, they can act directly, by opening ion channels on the nerve terminals. Secondly, they can sensitize endings, without causing direct stimulation, but causing hyperexcitability to other chemical and mechanical stimuli. This can occur when G-protein coupled receptors (GPCRs) are activated by mediators, which act via second messenger systems, to phosphorylate membrane receptors and ion channels that control excitability. Thirdly, as is the case for neurotrophins, they can change the phenotype of the afferent nerve over long periods. For example, they may alter expression of channels, receptors or mediators in the sensory neuron.(173) (Fig.24) They may also modulate ligand-binding characteristics or coupling efficiency of receptors. The result of sensitization is a leftward shift in the stimulus-response function. This means that for any given level of stimulation a greater afferent barrage is generated. Peripheral sensitization normally develops rapidly and is relatively short-lived. However, in the presence

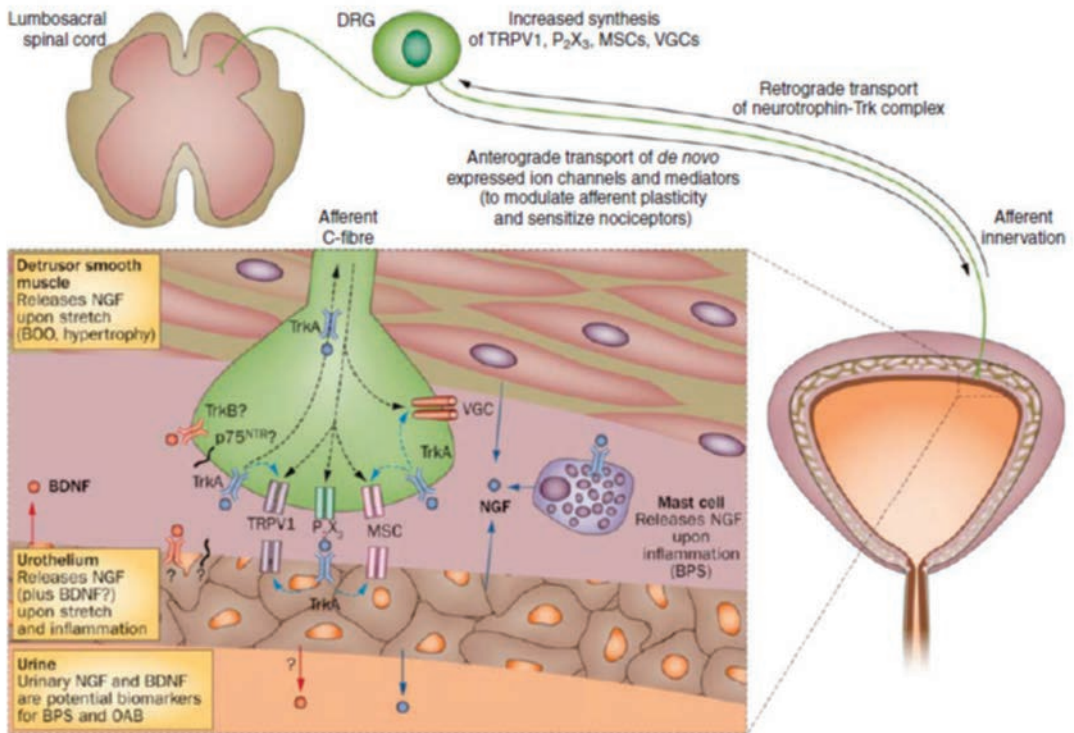

Figure 24: Peripheral mechanisms involved in neurotrophin-mediated development of bladder overactivity. In urinary bladder, NGF (shown in blue) is produced by several cell types—including urothelium, mast cells and detrusor smooth muscle cells—upon stretch or inflammation. The urothelium also produces BDNF (red). NGF binding to urothelial TrkA receptors might directly activate urothelial sensory ion channels, such as TRPV1 (purple), or increase expression of TRPV1 and mechanosensitive channels (MSC, pink). Increased TRPV1 and MSC activity stimulate the release of urothelial mediators, such as ATP, which sensitize the underlying afferents. NGF activates TrkA receptors expressed on suburothelial afferent C-fiber terminals, directly sensitizing neuronal TRPV1, MSCs and voltage-gated ion channels (VGCs, orange). The TrkA-NGF complex is internalized (dashed lines) and retrogradely transported to cell bodies in lumbosacral DRG, where de novo transcription of TRPV1, VGCs, MSCs and additional sensory ion channels (including purinergic P2X3 receptor for ATP; green) is initiated. These newly synthesized ion channels are anterogradely transported back to afferent terminals to contribute to peripheral hypersensitivity. Neurotrophin receptors TrkB (red) and p75NTR (black) are also expressed on both urothelium and afferent terminals, although their role has not yet been defined. Abbreviations: ATP, adenosine triphosphate; BDNF, brain-derived nerve factor; BOO, bladder outlet obstruction; BPS, bladder pain syndrome; DRG, dorsal root ganglia; MSC, mechanosensory channel; NGF, nerve growth factor; OAB, overactive bladder syndrome; P2X3, P2X purinoceptor 3; TrkA, tropomyosin-related kinase A; TrkB, tropomyosin-related kinase B; TRPV1, transient receptor potential cation channel vanilloid subfamily member 1; VGC, voltage-gated ion channel.

of maintained injury or inflammation, the sensitization can be prolonged by changes in gene expression. Genes influenced in this way include those that determine the amount and pattern of neurotransmitters release by central nerve terminals in the brain and spinal cord. This alters the way that sensory signals are processed within the CNS and contributes to “central sensitization”.(174)

Role of the urothelium in sensory signal transduction

The urothelium can no longer be considered a passive barrier protecting against diffusion of urine constituents. Recent evidence suggests instead that the urothelium possesses sensory functions and may

transduce mechanical and chemical stimuli to underlying structures including smooth muscle, fibroblast-like cells, immune cells and bladder nerves including the terminals of afferents which are located in close proximity, or even within, the urothelium. The recent evidence supporting involvement of a number of these urothelially-derived factors in sensory signalling and the therapeutic potential of targeting these signalling pathways is considered below.

4.1. Nitric oxide

Enzymes responsible for the generation of nitric oxide (NO) are expressed in both the urothelium and in the adjacent nerve fibres. Knockout mice in which neuronal NOS has been deleted do not have an obvious

bladder phenotype. The same is true when inducible NOS is knocked out. However, NO may be involved in bladder dysfunction since expression of NOS is elevated in neurogenic bladder and release of NO may be reduced in experimental interstitial cystitis. Munoz *et al* (175) recently found that while electrical stimulation-evoked release of some urothelial mediators (ATP) was attenuated by disruption of the urothelium, release of NO was maintained which may suggest that under these conditions NO is derived from suburothelial structures. Interestingly, NO release triggered by cholinergic stimulation was lost after urothelial disruption, consistent with NO derived from multiple sources including the urothelium.

A previous study by Aizawa *et al* examined the effect of NO on sensory signalling by directly recording afferent activity arising from the bladder *in vivo*. (176) Release of NO can be inhibited using non-metabolizable analogues that compete with L-arginine as substrate for NOS. On such inhibitor, L-NAME, increased the afferent response to bladder filling by about 50%, which was reversed by activation of NO pathways with L-arginine. This data suggests that NO is able to inhibit afferent activity, an observation consistent with earlier cystometric analysis of the effect of activating the NO pathway. (177, 178) In addition to studying NO mechanisms in the normal bladder, Aizawa and colleagues also showed that application of L-arginine significantly inhibited hypersensitivity in-

BPS/IC. (176) The actions of NO are mediated through elevation of the intracellular second messenger cGMP (Figure 25). (179) In contrast, phosphodiesterase (PDE) type 5 terminates the action of NO, and PDE inhibitors can be used therapeutically to prolong the action of NO. Behr-Roussel *et al* found that inhibition of PDE5 attenuated bladder afferent activity in a rat model of spinal cord injury, (180) an indication that this might represent a target for treatment of hypersensitivity disorders of the bladder such as BPS and OAB.

4.2. Purinergic Signalling

ATP acting via purinergic receptors modulates bladder function mediated by both afferent and efferent pathways involved in urine storage and emptying. There is evidence that ATP is co-released with SP and calcitonin gene-related peptide from sensory nerves. (181, 182) Differences in sensitivity to purinergic agonists in lumbo sacral and thoracolumbar DRG sensory neurons that innervate the bladder via hypogastric and pelvic nerves were investigated. (157) The majority of lumbo sacral neurons (93%) were sensitive to α, β -meATP compared to 50% of thoracolumbar neurons. It was concluded that bladder pelvic and hypogastric splanchnic afferents are functionally distinct and are likely to mediate different sensations

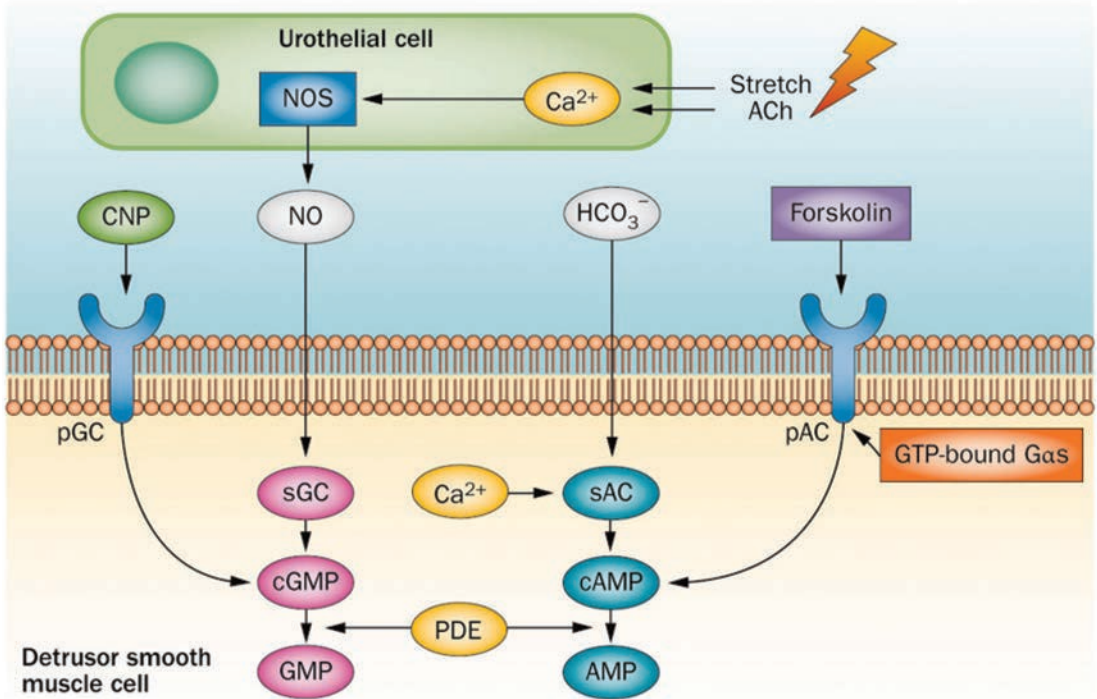

Figure 25: Schematic diagram of the cyclic nucleotide signalling pathways (from Rahnama'i *et al.*, 2013)

duced by the cyclophosphamide metabolite acrolein that is used experimentally as a model for

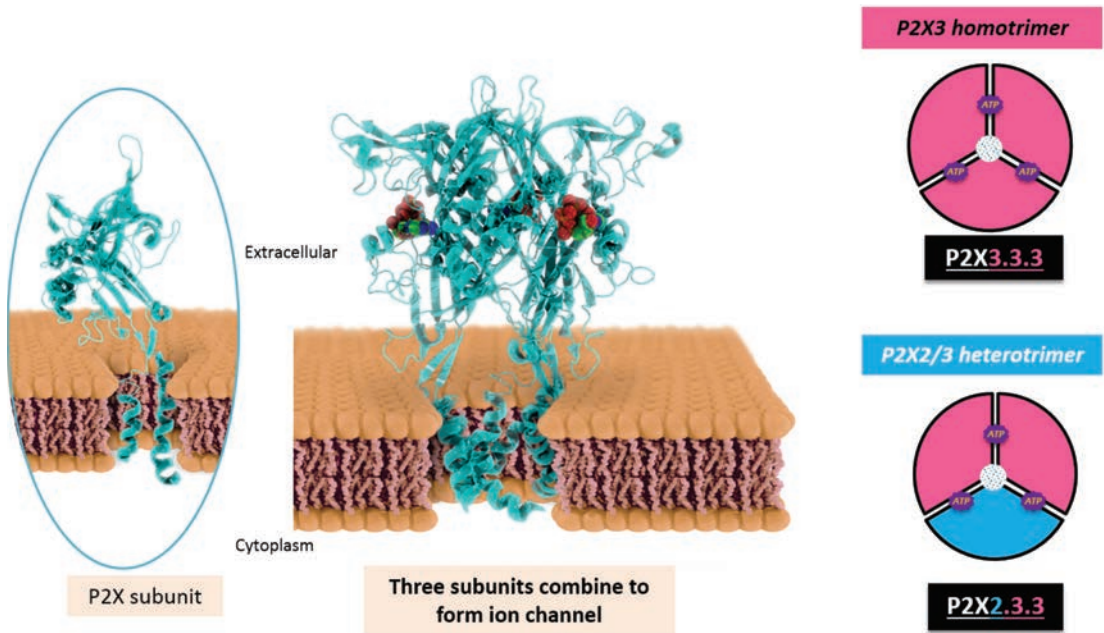

Figure 26: ATP-gated ionotropic channels are formed by certain combinations of the 7 (P2X1-7) subunits (from A. Ford, 2016)

arising from the urinary bladder. The central projections of pelvic and pudendal afferents overlap within the spinal cord facilitating integration of somatic and parasympathetic motor activity. (183)

Intravesical administration of ATP stimulated the micturition reflex in awake freely moving rats, probably by stimulating suburothelial C-fibres, although other mediators might also be involved. (184) The activities of primary afferents by intravesical introduction of ATP are mediated largely through a subset of capsaicin-sensitive C-fibres. (185) Pretreatment of the anaesthetised guinea-pig with both atropine and α, β -meATP or by ganglion blockers led to complete blockade of neurokinin NK₂ receptor-induced contractions. These results suggest that stimulation of NK₂ receptors located on capsaicin-sensitive sensory nerves (where NK₂ receptors have been demonstrated autoradiographically) leads to bladder contractions via both cholinergic and purinergic parasympathetic motor nerves. Taken together, studies have concluded that excitatory and inhibitory purinergic mechanisms are present not only in the peripheral nervous system/smooth muscle of the lower urinary tract but also in reflex pathways in the spinal cord that control micturition.

It is well established that the urothelium releases ATP in response to stretch and that this acts in a paracrine fashion to influence the function of myofibroblasts and bladder afferent nerves. Prolonged exposure to a desensitizing concentration of α, β -meATP reduced the activity of mechanosensitive pelvic nerve afferents in an *in vitro* model of rat urinary bladder. (186) P2X2 and P2X3 receptors (Figure 26; Figure 27A) are

expressed on unmyelinated afferent fibres innervating the bladder, and thus the hypothesis has been put forward that mechanosensitivity, at least in those afferents in proximity to the urothelium, involved ATP release by stretch and activation of P2X2 and P2X2/3 receptors on the afferents. (96, 187) Mice lacking the P2X3 receptor showed reduced inflammatory pain and marked urinary bladder hyporeflexia with reduced voiding frequency and increased voiding volume. (188) This suggested that P2X3 receptors are involved in mechanosensory transduction underlying both inflammatory pain and hyperreflexia indicating a role in physiological voiding reflexes. (188) A later study using P2X2 KO mice and P2X2/P2X3 double KO mice showed a role for the P2X2 subtype too in mediating the sensory effect of ATP. (189) The increase in pelvic sensory nerve activity was mimicked by ATP and α, β -meATP and attenuated by P2X3 antagonists as well as in P2X3 KO mice and P2X3 receptors were shown to be localized on suburothelial sensory nerve fibres (Figure 27b). (187) In the mouse urinary bladder both low and high threshold fibres sensitive to ATP were shown to contribute to both physiological (non-nociceptive) and nociceptive mechanosensory transduction by single unit analysis of sensory fibres. (190) There are several functionally distinct populations of bladder sensory nerves, not all of which respond to ATP. (168) The excitability of afferent fibres to distension is increased by purinergic agonists. (190) Sadananda *et al* (191) investigated whether other stimuli, besides bladder distension,

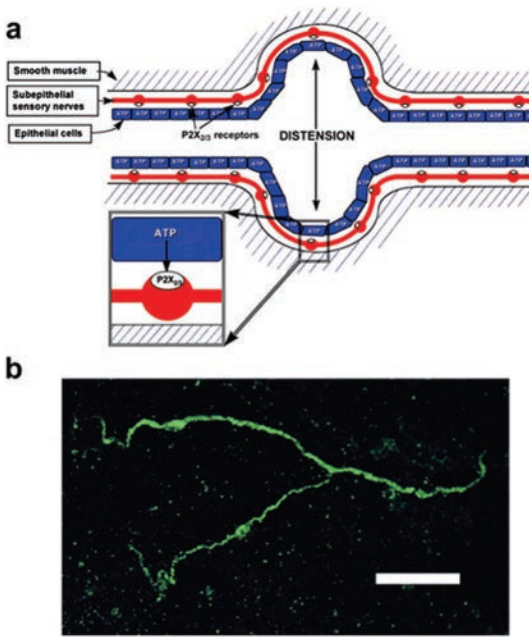

Figure 27: (a) Schematic of hypothesis for purinergic mechanosensory transduction in tubes (e.g. ureter, vagina, salivary and bile duct, gut) and sacs (e.g. urinary and gall bladders, and lung). It is proposed that distension leads to release of ATP from epithelium lining the tube or sac, which then acts on P2X2/3 receptors on subepithelial sensory nerves to convey sensory/nociceptive signals to the CNS. (Reproduced from Burnstock, 1999)

(b) P2X3 receptor immunoreactivity in the mouse bladder. Immunostaining is seen on small suburoepithelial nerve fibres. Calibration bar = 50 μ m. (Cockayne et al., 2000)

could stimulate urothelial ATP release. They compared ATP release levels in rat bladder when subjected to stretch, capsaicin and acid. Interestingly, the amiloride-sensitive apical sodium channel, ENaC, may be involved in mechanotransduction by controlling basolateral release of ATP.(123) Adenosine is also produced and released by the urothelium, and may play important roles in modulating sensory afferent function and smooth muscle contraction.(192)

P2X1 and P2X3 receptors play a pivotal role in the micturition reflex in female urethane-anaesthetized rats.(193) It was also shown that P2X3 receptor blockade by phenol red raised the pressure and volume thresholds for the reflex, while P2X1 receptor blockade diminished motor activity associated with voiding and also that P2Y₁ receptor blockade may remove an accommodating inhibitory drive to rat detrusor muscle. In the normal bladder, it is believed that a balance between the excitatory effects of ATP and inhibitory effects of NO release may determine micturition thresholds and frequency and that this balance may be disturbed in bladder disorders. For example,

muscarinic receptors localized near the luminal surface of the bladder were stimulated and shown to affect voiding functions via mechanisms involving ATP and NO release from the urothelium that in turn altered the firing properties of afferent nerves.(194) This supported the view that urothelial-afferent nerve interactions can influence reflex voiding functions. In addition, elevated ATP levels have been demonstrated in patients with detrusor overactivity and BPS(195), Munoz *et al*, using a rat model of detrusor overactivity (diabetic bladder), found increased levels of ATP but normal levels of NO.(175) Conversely in an underactive bladder model, induced by chronic sugar intake, NO levels were increased while ATP remained normal. This suggests that the balance between ATP and NO is altered in bladder dysfunction. From the translational perspective, a P2X3 antagonist, AF-219, has been tested in a proof-of-concept trial in treating symptoms associated with BPS/IC. In 36 and 38 BPS/IC women treated with AF-219 and placebo, respectively, patients treated with AF-219 had improvement in the key symptoms of IC/BPS: pain scores, urinary urgency and general improvement in patient reported symptoms, suggesting the

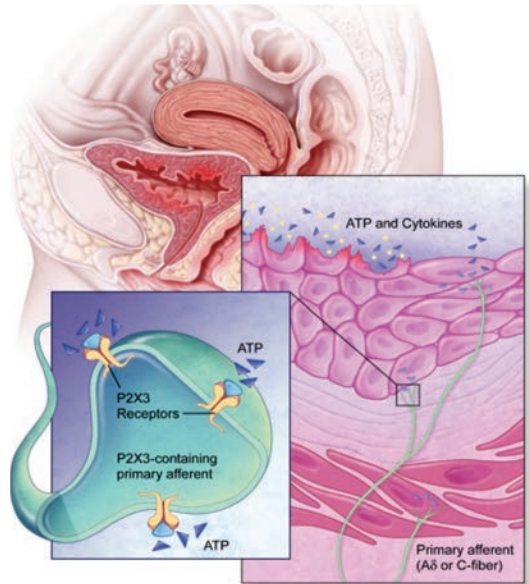

Figure 28: Sensory fibers in visceral organs, especially the urinary bladder, express high levels of P2X3 receptors that are elevated in pathological conditions; unmasking segmental spinal reflexes that sense ATP content during filling and distension. P2X3 antagonists suppress afferent excitation and raise filling volume thresholds, especially in rodent models of cystitis. The distressing and largely unmet painful and irritative symptoms of bladder pain syndrome/interstitial cystitis and chronic prostatitis as well as lower urinary tract symptoms (urgency, frequency, and nocturia) associated with overactive bladder and benign prostatic hyperplasia, represent important visceral indications for novel P2X3 antagonists.(From Ford AP, 2012)

potential efficacy of P2X3 receptor antagonists for the treatment of BPS/IC symptoms.(196) (Fig 28)

4.3. Cholinergic Mechanisms

The discovery that ACh can be released from the human bladder urothelium has led to the concept that cholinergic mechanisms could contribute to sensory signalling.(197) This concept has been reinforced by clinical findings showing that anticholinergic drugs, the current mainstay for the treatment of bladder overactivity, appear to exhibit efficacy during the bladder storage phase when parasympathetic cholinergic activity is minimal.

A number of studies have examined the effect of cholinergic receptors on bladder afferent firing. However, the data are conflicting and a consensus has yet to emerge. *In vivo* studies using clinical anticholinergic agents such as oxybutynin and darifenacin suggest that inhibiting muscarinic receptors, attenuates the afferent response to bladder filling.(198, 199) However, due to the nature of *in vivo* studies it is unclear if these effects are direct, at the level of the sensory terminal, or secondary to altered muscle tone following either peripheral or central effects on parasympathetic transmission. Similarly, Matsumoto *et al* found that stimulating muscarinic receptors induced bladder hyperactivity, and that this was blocked by inhibiting the M2 receptor, suggesting that M2 receptors play a role in cholinergic modulation of bladder afferent excitability. However, it is important to note that in this study, excitability was inferred from cystometry and afferent activity was not measured directly.(200) In contrast,

Masuda *et al* (2009) found that pharmacological activation of muscarinic receptors attenuated micturition reflexes in the rat suggesting that muscarinic receptor activation leads to attenuated afferent signalling.(201) Such inhibition has been observed in afferent recording studies using isolated bladder preparations in which any secondary effects on muscle tone could be controlled.(202) In these studies blocking cholinesterase activity to augment endogenous cholinergic activity lead to attenuated afferent signalling that could be reversed by antimuscarinics. Surprisingly, antimuscarinics alone had no effect on bladder afferent responses to distension suggesting that acetylcholine release during stretch was not part of the sensory transduction pathway but cholinergic influences become manifested only under circumstances in which acetylcholine release is increased.

How ACh and muscarinic receptor pathways could modulate transmission is unclear. It is possible that there is a direct action and in this respect DRG neurones retrogradely labelled from the bladder have been shown to express M2, M3 and M4 receptors.(203) However, stimulation of muscarinic receptors on the urothelium causes the release of other excitatory and inhibitory mediators including ATP and NO.(106, 204) It is possible therefore that muscarinic receptors modulation of afferent activity is indirect via the release of a secondary mediator. Such a view is supported by the observation that bladder hypersensitivity, triggered by cholinergic stimulation was abolished by inhibition of P2X receptors, suggesting that muscarinic receptors and purinergic receptors may

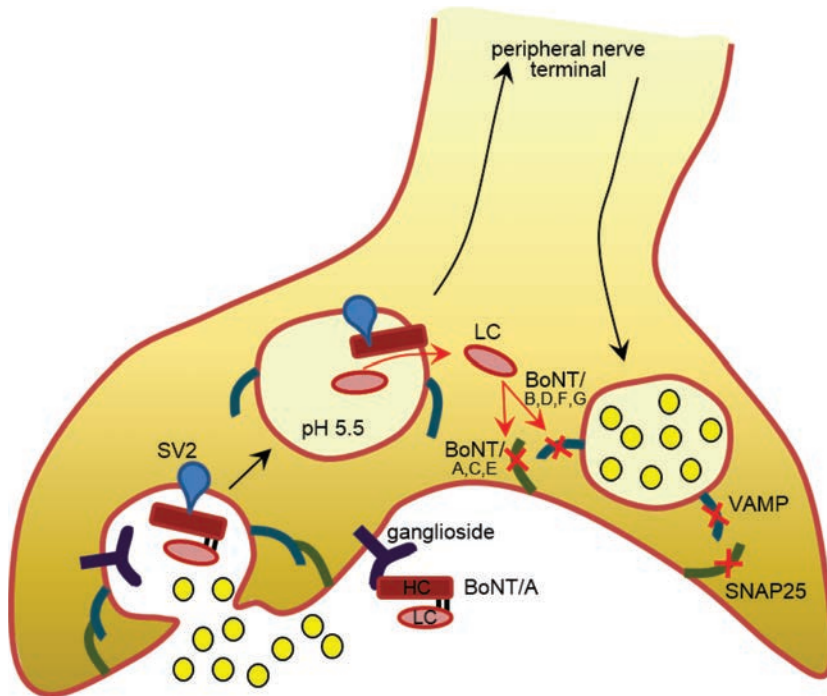

Figure 29: Hypotheses for the pathways mediating the effects of botulinum toxin in afferents

work in tandem to modulate afferent transmission.(205) These studies highlight the complex nature of cholinergic signalling in the bladder, and indicate that more research is necessary to fully understand whether muscarinic receptors on the afferent limb could become a therapeutic target for OAB.

4.4. Botulinum Toxin

Botulinum toxin A (BoNT/A) was shown in an early paper to inhibit the release of ATP as well as acetylcholine from parasympathetic nerves innervating the bladder.(206) The effects of purified botulinum neurotoxin type A on cholinergic, adrenergic and non-adrenergic, atropine-resistant autonomic neuromuscular transmission was subsequently confirmed.(207) Botulinum toxin A (BoNT/A) inhibits the vesicular release of acetylcholine and ATP following uptake into presynaptic nerve terminals (see Figure 29) and proteolytic cleavage of the SNARE protein SNAP-25 that prevents docking and fusion of synaptic vesicles at the neuro-muscular junction. BoNT/A was first clinically used in the bladder to treat neurogenic bladder overactivity caused by spinal cord injury.(208) Since then, intravesical injections of BoNT/A has proved a highly effective treatment for patients with detrusor overactivity, with numerous studies reporting improvements in the sensory symptoms of urgency and urinary frequency.(209) (210, 211) Since acetylcholine can be released from the urothelium it is possible that BoNT/A is acting at this level to modulate sensory signalling. In addition, there is recent evidence that SNAP-25, the intracellular target for proteolysis by BoNT/A, is expressed in the urothelium.(106) This is consistent with experimental data showing that BoNT/A inhibits the release of ATP and augments NO release from the urothelium in animal models of spinal cord injury.(211) Others have shown that application of BoNT/A directly attenuated afferent firing in *ex vivo* mouse models.(212-214) Other potential targets for BoNT/A include the suburothelial sensory nerve endings, and in this respect a decrease in suburothelium immunoreactivity for P2X3 and TRPV1 has been reported in human bladders following treatment with BoNT/A.(215)

4.5. Transient Receptor Potential (TRP) Cation Channels

A number of different members of the transient receptor potential (TRP) channel family are expressed in the bladder mostly in association with sensory nerve fibres involved in mechanotransduction and nociception. TRPV1, TRPV2, TRPV4, TRPM8, and TRPA1 have all been shown to be expressed in the bladder. TRPV1 has been shown to play an integral role in modulating the excitability of bladder afferents and the generation of hypersensitivity, induced by bladder inflammation.(85, 88) It is through desensitization of this receptor that agents like resiniferatoxin act to treat symptoms in OAB.(216) TRPV1 is predominantly expressed on sensory nerves and has been identified within nerve plexuses running in both the

muscle layer and suburothelium. In addition some investigators have also demonstrated that TRPV1 is expressed within the urothelium, however the specificity of commercially available TRPV1 receptor antibodies has been questioned.(132)

TRPA1 is also expressed in the bladder and is particularly associated with C-fibre endings in the suburothelium that co-localize CGRP. Agonists acting at the receptor cause bladder hyper-reflexia and is suggested to play a role in mechanotransduction and in signalling pain. TRPA1 has also been demonstrated in the urothelium at both transcriptional and protein levels. Expression is increased in a spinal cord injury model and both pharmacological blockade and RNA knockdown of TRPA1 were effective in normalizing bladder reflex function.(217) Studies have shown that trophic factors (such as nerve growth factor-NGF or artemin) can regulate the sensitivity of sensory neurons via regulation of TRP (TRPV1; TRPA1) expression and/or sensitivity. Administration of antibodies against these trophic factors can block or reverse bladder hyperalgesia in rodent models for bladder pain.(218, 219)

Interest in TRPV4 has been fuelled by the observation of impaired voiding behaviour in knockout mice.(220) This channel shows mechanosensitivity and is proposed to play a role in the micturition reflex by activating C-fibre afferents.(185) However, the site of action of TRPV4 agonists may in fact be the urothelium which expresses the TRPV4 channel,(86) particularly in association with adherence junctions where they may be preferentially activated by stretch and lead to the release of ATP.(221) Inhibition of TRPV4 has recently been shown to improve symptoms in a model of experimental cystitis.(222) Further, there is evidence that a co-administration of antagonists to both TRPV4 and TRPV1 can potentiate the effect of each drug and reduce bladder hyperactivity in a rodent model for cystitis.(223)

TRPM8 was first described as a cold receptor and interest in its role in the bladder stems from the observation that instillation of cold saline into the bladder elicits a contractile response (at pressures or volumes below the threshold for normal voiding). This response to a cooling stimulus (which has been referred to as the bladder cooling reflex) was originally thought to indicate a supraspinal neurological lesion and the test (termed the 'ice water test')(224) has been used in the diagnosis of bladder disorders such as detrusor overactivity. Expression of TRPM8 has been identified on bladder afferent fibers and on the cell bodies in the DRG where it co-localizes with nociceptive markers such as CGRP and IB4.(225) Previously Lashinger *et al* (2008) showed that application of a TRPM8 channel blocker, decreased voiding frequency and abdominal motor responses in the rat(226) suggesting that in addition to cold sensing TRPM8 may also be involved in the afferent control of micturition and nociception. A recent study by Ito *et al.* also showed that TRPM8 have a role in activation of mechanosensitive C-fiber bladder afferent

pathways during bladder by using single-unit afferent activity recordings in the normal rat.(227)

Until now the contribution of TRP receptors have been typically studied isolated. However it is possible that in real life conditions several of these receptors are activated together, opening the possibility to the advantage of antagonizing more than one at the same time if a therapeutic objective is pursued.(223)

4.6. Cannabinoids

The multi-centre CAMS study (Cannabinoids in Multiple Sclerosis) reported that the use of cannabis based extracts significantly improved symptoms of urge incontinence and detrusor overactivity in patients with multiple sclerosis. This observation has provoked interest in the study of expression and function of cannabinoid receptors in the bladder. Endogenous cannabinoids can potentially interact with TRPV1 but in addition can act on G-protein coupled cannabinoid receptors 1 and 2 (CB1, CB2). In the human bladder, both receptors could be identified in the urothelium and detrusor where CB1 receptors were more abundant than CB2.(228) In patients with bladder pain syndrome and idiopathic detrusor overactivity (IDO), a significant increase in nerve fibres expressing CB1 in the urothelium was observed, strongly suggesting a role for CB1 in overactive bladder.(229) In contrast, Gratzke and colleagues(230) found CB2 receptors predominated in the urothelium, suburothelium and on sensory nerve fibres and found that CB2 agonists inhibited nerve induced contractions of the bladder providing evidence that CB2 receptors are important in micturition.

Expression of CB1 receptors were also identified in the urothelium and on nerve fibres in the detrusor of mouse bladder.(231) These receptors co-localized with P2X3 receptors, suggesting an interaction between cannabinoid and purinergic systems. In addition, a synthetic cannabinoid active at both CB1 and CB2 receptor was shown to inhibit the evoked release of CGRP from afferent nerve terminals.(232) Functional experiments also found a reduction in distension evoked afferent firing in response to application of a CB1 agonist. In particular, high threshold afferents typically associated with noxious stimuli were directly affected. A recent study by Aizawa et al. using a peripherally restricted inhibitor (URB937) of the endocannabinoid-degrading enzyme fatty acid amide hydrolase (FAAH), upregulation of the peripheral endocannabinoid system reduces bladder overactivity and C-fiber hyperexcitability in the rat bladder provoked by PGE2, suggesting an important role of the peripheral endocannabinoid system in bladder overactive conditions induced by afferent hypersensitivity.(233) There is also evidence that the fatty acid amid anandamide, which activates both CB1 as well as TRPV1 receptors on primary afferents, is upregulated in a model for inflammatory pain and induces bladder hyperreflexia.(234) Taken together these studies suggest that CB receptors in the bladder may have a modulatory role in sensory afferent signalling

and a greater understanding of which could lead to new therapeutic strategies for treatment of bladder disorders. Understanding the differential roles of CB1 and CB2 receptors may add a new dimension to our ability to target these pathways.

4.7. Adrenoreceptors

Alpha-1-adrenoreceptor (α 1-AR) antagonists are the current first line for treatment of lower urinary tract symptoms (LUTS) due to benign prostatic hyperplasia (BPH). A systemic review and meta-analysis showed that alpha blockers in general improve BOO as shown by a positive changes of bladder outlet obstruction index.(235) By inhibiting prostatic smooth muscle contraction, these agents reduce bladder outlet obstruction (BOO). In addition, recent data report an improvement in other symptoms, such as frequency suggesting that they may also act via the afferent system to influence storage function. Adrenoreceptors have been detected throughout the urothelium and on the sensory neurones innervating the bladder.(236, 237) Bladder afferent responses to distension *in vivo* are inhibited following intravesical application of the clinical α 1-AR antagonist Tamulosin. Moreover, chronic systemic treatment with two different α 1-AR antagonists inhibited reflex voiding in a rat model of BOO.(238) A previous experimental study by Nagabukuro *et al* investigated changes in afferent firing following treatment with a number of commonly used clinical drugs. The study found that Tamulosin treatment significantly attenuated activation of the early gene *c-fos* in the spinal cord, used as a marker for sensory neuronal activation.(239) A recent study also showed that α 1A- or α 1D- adrenoreceptors in the rat bladder are involved in the activation of the bladder mechanosensory A δ -fibres during bladder filling by directly recording afferent activity arising from the

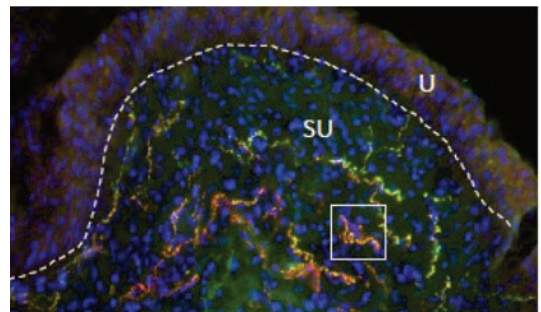

Figure 30: Representative photomicrographs of cholinergic fibers expressing both VAcHT and b3AR-IR through the human bladder. Double labeling using immunocytochemistry revealed that virtually all neuronal profiles expressing the cholinergic marker VAcHT also express b3AR-IR throughout the suburothelial plexus, muscular layer and around blood vessels. VAcHT-IR (red), b3AR-IR (green) and the nuclear marker DAPI (blue); U-urothelium and SU-suburothelium. (from Coelho et al., 2015)

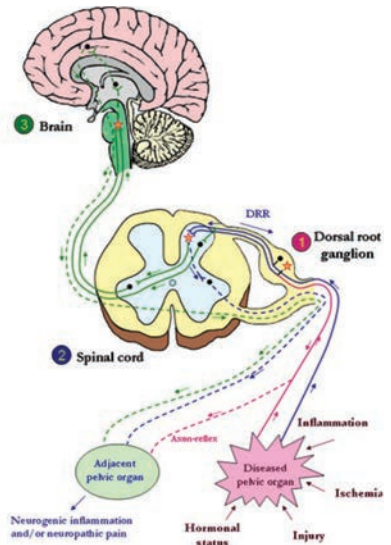
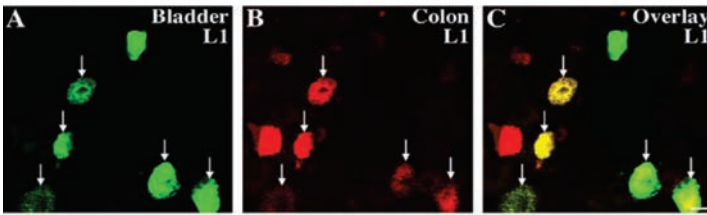

Figure 31: A-C: Dichotomizing afferents. Panels depict retrogradely labeled cell bodies in rat DRG following urinary bladder and colon injections of Alexa Fluor 388 and 64-conjugated cholera toxin B (CTB). A, CTB-positive bladder afferents, B, CTB-positive distal colon afferents and C-dual labeled cells (from Christianson *et al.*, 2007).

D- Schematic representation of convergent afferent pathways: (1) Convergence of sensory neural pathways within a DRG, (2) Convergence of afferent information in the spinal cord, (3) Convergence of afferent inputs from two different pelvic organs in the brain. Anterograde AP propagation from the brain, spinal cord and DRG to the periphery is shown by dotted lines (from Malykhina 2007).

bladder *in vivo*.⁽²⁴⁰⁾ In addition, interactions between sympathetic efferent and primary afferents can occur via a chemical cross-talk that can enhance the sensitization of nociceptive afferents in both somatic and visceral pain conditions. In support is evidence that prolonged activation of peripheral alpha adrenoceptors can augment bladder pain likely through sensitization of TRP (TRPV1) channels on nociceptive afferents and increased release of algogenic substances such as ATP.⁽²⁴¹⁾ The increased bladder pain and hyperactivity was blocked by silodosin, implicating a role for activation of peripheral alpha 1A adrenoceptors in visceral pain.

In contrast to the α -adrenoreceptors, the beta adrenoreceptors (β ARs) mediate relaxation of the bladder smooth muscle in response to sympathetically released noradrenaline. The β 3-AR subtype is the predominant isoform responsible for relaxation of the human detrusor and β 3-AR agonists are now clinically available for the treatment of OAB.⁽²⁴²⁾ A previous study by Kullmann *et al* demonstrated the presence of the β 3-AR in the urothelium and observed inhibition of voiding contractions in response to the β 3-AR agonists TAK-677 and BRL37344. This effect was independent of any changes in smooth muscle tone suggesting that β 3-AR could also participate in bladder afferent function.⁽²⁴³⁾ A more recent study has shown that β 3-AR is expressed in nerve fibers in both suburothelium as well as the detrusor layer in the human bladder (Figure 30).⁽²⁴⁴⁾ In terms of the neurochemical nature, while there was a modest expression of β 3-AR in sensory fibers, the presence of β 3-

AR in cholinergic fibers were the most abundant. While a number of possibilities exist, these findings suggest that β 3-AR may modulate contractility of the smooth muscle and indirectly regulate bladder sensory functions.

5. CROSS TALK BETWEEN THE BLADDER AND BOWEL

Patients with IBS often report bladder symptoms including nocturia, frequent and urgent micturition, and incomplete emptying.⁽²⁴⁵⁾ The counterpart is also true with patients with BPS complaining of gastrointestinal symptoms such as constipation.^(246, 247) These observations are consistent with the concept of cross-organ sensitization which extends to different abdominal and pelvic structures and contributes to a more generalized chronic pelvic pain syndrome reviewed by Brumovski *et al*.⁽²⁴⁸⁾ In experimental models inflammation of the colon has been shown to lead to increased frequency of bladder contractions and altered micturition reflexes.⁽²⁴⁹⁾ In contrast, experimental bladder inflammation has been reported to sensitize the bowel to distension.⁽²⁵⁰⁾ Such cross-organ sensitization has also been demonstrated between the uterus, pelvic urethra and vagina. In men there is the potential for cross-organ sensitization between the prostate and other pelvic organs.

The mechanisms underlying cross-organ sensitization have not been fully elucidated but there are po-

tentially several levels at which the sensory innervation to the different pelvic structures can interact. In terms of periphery mechanisms there is evidence that afferent fibres branch extensively to innervate multiple target structures. Different retrograde tracer injected into the bladder and bowel results in a number of DRG neurones carrying both labels although the numbers are low (Figure 31A-C).(251) Similarly, dichotomizing afferents have been shown to innervate the colon and uterus with DRGs expressing TRPV1 and P2X3 receptors implying a role in nociception.(252) Sensitization of the endings in one organ by local inflammation, steroid hormone or via various neurotrophic factors would likely impact on overall sensitivity following upregulation in excitability in all terminal receptive fields.(253) A recent study also showed in rats that colonic inflammation induces up-regulation of urothelial NGF expression in the bladder and that the reduction of overexpressed NGF in the mucosa is associated with the significant improvement of bladder overactivity and pain behavior, suggesting that the local NGF upregulation plays an important role in cross sensitization in pelvic organs.(17) There is also evidence that visceral organ cross talk may be due to a change in epithelial permeability in one target organ (i.e. urinary bladder) that may in turn, alter epithelial permeability in another structure.(254) Studies have utilized contrast-enhanced magnetic resonance imaging (CE-MRI) to quantitate changes in epithelial permeability in both IC patients and in animal models for cross-sensitization.(Figure 32) (255, 256) Findings from these studies revealed that this method may provide a quantifiable method to assess epithelial permeability and could be used to study underlying mechanisms, stratify patients and monitor therapy.

Central sensitization may also contribute to cross-organ sensitization (Figure 31D). Excitability of spinal neurons receiving afferent input from the bladder has been shown to respond to afferent input from other pelvic structures such as the colon.(257, 258) Second order neurones in the spinal cord therefore receive convergent input from various visceral structures (i.e. viscerovisceral convergence) as well as somatic inputs (visceral-somatic convergence). The later ex-



Figure 32: Quantitative assessment of increased bladder permeability in protamine sulfate (PS) exposed rats. Regions assessed: peripheral bladder area (white arrowhead), medial thigh muscle (1) and adipose body (2). (From Towner et al., 2015).

plains the phenomenon of referred pain where sen-

sations from the viscera are experienced in the associated somatic sensory field, the classic example being angina. Such viscerosomatic convergence has been extensively investigated and only recently has viscerovisceral referral received attention. Nevertheless convergent inputs would explain the poor localization of pelvic pain and the difficulty in diagnosis and treatment. There is also recent evidence that desensitization of TRPV1 receptors in the bladder reduces the excitability of bladder projecting neurons but has no effect on spinal cord neurons receiving convergent bladder/somatic input.(259) Taken together, these studies suggest that targeting additional levels of the pain-processing pathway (both centrally and in the periphery) may be required in order to provide better clinical outcomes for patients for chronic pelvic pain disorders.(260)

Clemens recently coined a term “afferent neurourology” to describe the study of sensory signaling related to the genitourinary tract, which encompasses other organs besides the bladder including the prostate, urethra, vagina, testicles and scrotum.(261) Therefore, disorders in afferent neurology would include other urologic symptoms perceived by the patients outside of the bladder including disorders, for example, such as chronic prostatitis/chronic pelvic pain syndrome (CP/CPPS), pelvic pain syndrome, vaginal pain syndrome, and urethral pain syndrome. Clemens’ review suggests that many of these afferent neurologic symptoms, including BPS/IC, may be due to systemic pathophysiology rather than localized to the organ of suspicion.

III. EFFERENT PATHWAYS TO THE BLADDER

Three main neural pathways regulate lower urinary tract efferent activity: 1) sacral parasympathetic (pelvic) nerves provide excitatory input to the bladder; 2) thoracolumbar sympathetic nerves provide inhibitory input to the bladder and excitatory input to the bladder neck and urethra; and 3) sacral somatic (pudendal) nerves innervate the striated muscles of the sphincters and pelvic floor (262, 263) (Figure 33). This section will describe the spinal and then peripheral pathways controlling efferent drive to the bladder.

Parasympathetic and sympathetic pre-ganglionic neurons release acetylcholine, which acts on nicotinic receptors to activate post-ganglionic fibres. In some species they also release opioid peptide transmitters and express nitric oxide synthase(264); there is also evidence of involvement of pituitary adenylate cyclase activating peptide (PACAP), a peptide present in visceral afferent neurones, and of prostaglandins within the spinal cord.(265)

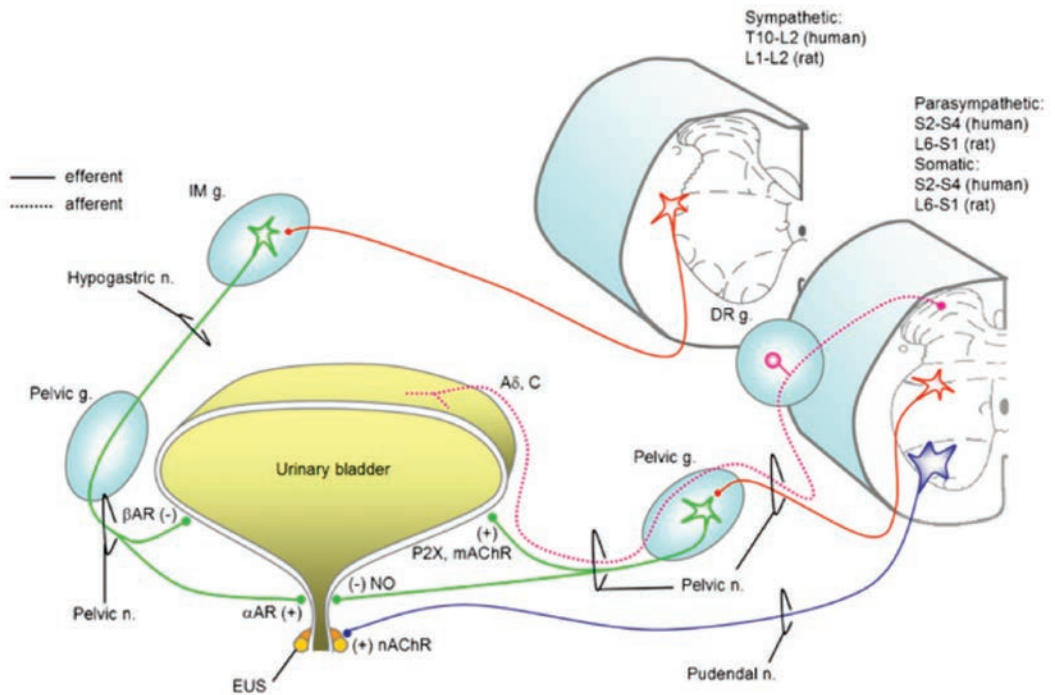

Figure 33: Innervation of the lower urinary tract (LUT). The LUT is comprised of the bladder, urethral sphincter and urethra. The LUT receives the bulk of its innervation from three nerves. The hypogastric nerve carries sympathetic innervation to the LUT; contributing spinal nerves exit the spinal cord (SC) between L1 and L2. Muscle activity for storage is mediated by β -AR expressed in the trigone, bladder neck and urethra (excitatory) and by α -AR expressed in the bladder dome (inhibitory). The pelvic nerve contains parasympathetic input originating in the sacral cord and controls micturition via cholinergic muscarinic receptors (mAChR) expressed throughout the LUT. The human pudendal nerve exits the sacral SC and provides somatic innervation to the striated muscle of the external urethral sphincter. In addition to their efferent function, each of these nerves carries afferent input from the LUT. Abbreviations: AR, adrenergic receptors; DRG, dorsal root ganglion; EUS, external urinary sphincter; g, ganglion; IMG, inferior mesenteric ganglion; L, lumbar spinal cord; mAChR, muscarinic cholinergic receptors n, nerve; nAChR, nicotinic cholinergic receptors; NO, nitric oxide; P2X, purinergic receptor; S, sacral spinal cord; (+) denotes excitatory synapses; (-) denotes inhibitory synapses. (from Inskip et al., 2009)

Parasympathetic post-ganglionic fibres terminate predominately at the detrusor muscle and release acetylcholine, resulting in detrusor contraction during voiding. Studies in animals have shown that sympathetic post-ganglionic fibres predominately terminate at the mucosal and urothelial level, releasing norepinephrine (NA), contributing to bladder relaxation during storage (via stimulation of beta-adrenergic receptors expressed in detrusor).

1. PREGANGLIONIC NEURONS

Parasympathetic preganglionic neurons are located in the lateral part of the sacral intermediolateral gray matter in a region termed the sacral parasympathetic nucleus. The neurons are small, fusiform-shaped cells which send dendrites into lateral lamina I of the dorsal horn, the lateral funiculus and medially into the

dorsal grey commissure (DGC). The bladder pre-ganglionic motor neurons are located in the S1-S3 segments in the cat,(266), dog(267) and monkey.(268) The rat is different, as preganglionic motor neurons are located at L6-S1;(269, 270) unilateral ventral root rhizotomy at the L5 level in the rat decreases peak cystometric pressures.(271) The parasympathetic preganglionic neurones project through the ventral spinal roots to the major pelvic ganglion.(272, 273)

At spinal levels L1–L2, both the intermediolateral horn and the DGC contain sympathetic preganglionic neurones whose axons also project to the major pelvic ganglion. Electrical stimulation of the lumbar sympathetic chain evokes firing in the pelvic nerve and in postganglionic nerves on the surface of the bladder and colon, at latencies of 60-150 ms.(274) With ageing, there is selective attrition of preganglionic sym-

pathetic neurones in L1–L2, which project to the pelvic ganglion, with reductions in the extent of the dendritic arbors of remaining cells. (272, 273, 275)

In spinal cord injured patients, where disruption to pathways at pre-ganglionic levels is observed, several groups have used neural stimulation techniques to restore normal bladder function. Stimulating parasympathetic pre-ganglionic roots at S3 with implanted electrodes elicits two principal responses(276): at low levels of stimulation, the external urethral sphincter, external anal sphincter and pelvic floor muscles are contracted. At high levels of stimulation, parasympathetic activation contracts the detrusor muscle, leading to efficient emptying of the bladder when the sphincter muscle relaxes(277)

The recent increase in the use of sacral neuromodulation for the treatment of detrusor overactivity has resulted in numerous potential theories of its actions, including stimulation of efferents, direct effect on the muscle, stimulation of the afferents, induction of spinal plasticity, and modifications of cortical activation.(278)

The DGC also contains a group of interneurons, which have recently received more attention as main players in the guarding reflex (these are further discussed below in *Bladder and Outlet*.(279)

2. GANGLIA

The peripheral ganglia are the link in the relay of autonomic innervation to the lower urinary tract and reproductive organs, along with a substantial part of the extrinsic motor innervation of the lower bowel. There are species differences in organization and neurochemistry of pelvic ganglion cells and their spinal inputs. Large mammals have a plexus of pelvic and intramural ganglia, containing both sympathetic and parasympathetic neurons. The guinea pig is intermediate in complexity, with separate posterior and anterior plexuses innervating different pelvic organs. In the rat and mouse, the pelvic plexus consists of the major pelvic ganglia (MPG) and a number of small accessory ganglia.

Within the pelvic plexus there is topographical representation of the pelvic organs. In the female dog, neurons supplying different pelvic organs are located in separate ganglia, which possess a distinctive composition of neurone types and different preganglionic supply.(280) Neurons retrogradely labelled from the urinary bladder mainly occur in ganglia located at the vesico-ureteric junction. They comprise catecholaminergic calbindin neurons and noncatecholaminergic neurons containing calbindin or NOS, with relatively sparse pericellular varicose nerve fibres. In male mice,(281) the major pelvic ganglia are close to the dorsal surface of the prostate gland. Their main inputs are the pelvic nerves, and the hypogastric nerve from the inferior mesenteric ganglion. The major outputs are the penile (cavernous) nerve and the supply to the urogenital organs.

Functionally, the preganglionic sympathetic and parasympathetic neurons synapse on post-ganglionic fibres within the specific ganglia, releasing acetylcholine, which acts on nicotinic receptors. Patients with megacystis-microcolon-intestinal-hypoperistalsis syndrome (MMHIS)(282) have reduced or no alpha-3 nicotinic receptor subunit.(283) Selective gene knockout mice lacking the alpha-3 nicotinic receptor subunit alone or the beta-2 and beta-4 subunits in combination,(284) develop severe bladder distension soon after birth, and later overflow incontinence. The detrusor muscle in these animals contracts in response to field stimulation or muscarinic agonists, but not nicotinic agonists,(285) indicating the potential importance of alpha-3, beta-2, and beta-4 nicotinic receptor components in functional control of voiding, but not their location.

About half of the cholinergic ganglion cells contain VIP, distributed throughout most of the ganglion, with a cluster near the origin of the penile nerve. Neurones with NPY are numerous and apparently randomly distributed throughout the ganglion, with marked variation between mouse strains. All noradrenergic neurons contain NPY, but many NPY neurons are not noradrenergic. Many of the cholinergic NPY neurons also contain VIP. Neurons immunostained for choline acetyl transferase (ChAT) have a complementary distribution to noradrenergic neurons. ChAT is seen in varicose axon terminals closely associated with ganglion neurons. Neither NPY nor VIP is present in preganglionic terminals, except for a small number of individual neurones. The latter may arise from viscerofugal neurons in the myenteric plexus of the lower bowel.(286) Tyrosine hydroxylase (TH) is expressed by one-third of neurons, almost all co-expressing dopamine beta hydroxylase (DBH). Numerous TH axons are present in the hypogastric nerve, but very few in the pelvic nerve, supporting a primarily sympathetic origin. Non-neuronal cells containing TH are also present, resembling small, intensely fluorescent cells observed in many other autonomic ganglia.

Intramural Bladder Neurons and Pelvic Ganglia

The bladder wall itself contains intramural ganglia, and small clusters of autonomic ganglion cells are present in the adventitial connective tissue and among the detrusor muscle bundles. Intramural ganglia have been observed in the bladder of mammalian species, including humans.(287-291) There is species variation in the extent of intramural innervation of the bladder; ganglia are present in many species such as the cat and guinea pig, while the rat bladder contains the postsynaptic innervation alone.(292) The ganglia are found throughout the bladder wall and vary considerably in size.(293) Quinacrine, a fluorescent dye that selectively labels high levels of ATP bound to peptides in granular vesicles, positively stained a subpopulation of neurons in ganglia in the guinea-pig bladder (Figure 34 A).(294, 295) Subpopulations of neurons in bladder ganglia also show immunoreactivity to vasoactive intestinal polypeptide (VIP), nitric oxide synthase (NOS), neuropeptide Y

(NPY), ChAT and galanin (Gal) in varying amounts (Figure 34B).(296) Thus, intramural ganglia, perhaps a subpopulation of largely parasympathetic postganglionic neurons probably release ATP. Postganglionic sympathetic nerves, identified with antibodies to TH and NPY, also synapse on these neurones. Nicotinic receptors have been identified on intramural nerve cell bodies within the bladder.(285)

Parasympathetic ganglia on the surface of the cat urinary bladder contain several types of principal ganglion cells (coexpressing various neuropeptides, ACh, NA, ATP and nitric oxide (NO) as well as small intensely fluorescent cells. They are innervated by both parasympathetic and sympathetic preganglionic axons. Parasympathetic preganglionic axons, arising in the sacral segments of the spinal cord, travel in the pelvic nerve and represent the principal excitatory pathway to the cholinergic-purinergic ganglion cells.(297, 298) These in turn provide an excitatory input to the detrusor smooth muscle.

Caffeine and theophylline block the inhibitory effects of purinergic agents on ganglionic transmission and on neurally-evoked bladder contractions. This indicates that the inhibition is mediated by P1 receptors. The P1 receptors are located presynaptically as well as postsynaptically on the ganglion cells. Sympathetic input has a modulatory effect on transmission in bladder ganglia,(274, 299, 300) and since ATP is released as a cotransmitter from sympathetic nerve terminals, sympathetic nerves may be a source of ATP in the bladder ganglion. However, the principal sympathetic modulatory mechanisms in the ganglia are mediated by NA acting on α -adrenoceptors.(301)

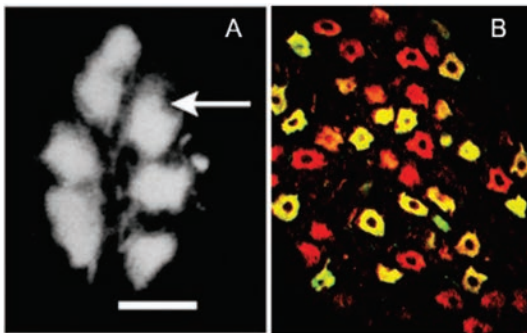

Figure 34: (a) Fluorescent histochemical localization of quinacrine in whole-mount stretch preparation of adult rabbit urinary bladder showing a ganglion cell containing at least 6 fluorescent nerve cells. The nuclei (arrow) are non-fluorescent. Calibration bars = 50 μ m. (Crowe and Burnstock, 1985.)

(b) Double staining to show colocalization (yellow/orange) of P2X3 receptor immunoreactivity (red) with NOS in intramural ganglia of the cat urinary bladder. (from Ruan et al., 2006)

The precise physiological roles of purinergic agents in the control of transmission in bladder ganglia are not clear. Purinergic slow hyperpolarising potentials

following stimulation of preganglionic nerves indicates that purinergic agents are released in ganglia during neural activity. Since ATP is present in bladder postganglionic neurons as well as in cholinergic and adrenergic nerve terminals, there are different possible sources of purinergic transmitter. Although adenosine has been proposed as the inhibitory transmitter,(302) it is possible that the extracellular breakdown of ATP to adenosine could be important in the mediation of the slow hyperpolarising responses. It is also important to note that preganglionic nerves contain both parasympathetic and sympathetic postganglionic axons, so various neural pathways could be involved in eliciting the slow hyperpolarising potential. Adenosine deaminase is present in sacral preganglionic neurons in the rat.(303) Therefore preganglionic pathways may be purinergic as well as cholinergic.

3. TERMINAL NERVE FIBERS

Smooth muscle cells in the bladder are grouped into fascicles, several of which make up a muscle bundle. They receive a dense innervation, which runs in line with the axis of the fascicle and is derived from coarse nerve trunks in the connective tissue around the fascicles and bundles. This innervation mediates the widespread co-ordinated detrusor contraction accompanying voiding. The anatomical relationship between the preterminal innervation and the muscle fascicles has been described in a serial sectioning study in the human bladder.(304) The nerve supply is distributed by a series of dichotomous branchings, illustrated schematically in Figure 35.(305) Adjacent to the muscle bundles, 1 or 2 primary nerve trunks run parallel to the long axis of the bundle. These give rise to circumferential peribundle branches. Both the longitudinal and circumferential trunks give off transverse interfascicular branches, entering the bundle perpendicular to its long axis, approximately at the midpoint of the bundle. Within the bundle they give axial interfascicular branches running along the long axis within and closely adjacent to individual fascicles, ending in the preterminal and terminal varicose intrafascicular axial innervation.

The majority of nerves running in the detrusor stains positively for acetylcholinesterase and for vesicular acetylcholine transferase (VAcHT)(293, 305, 306) and are thought to be parasympathetic. Electrical field stimulation studies have been used to elucidate the neurotransmitter content from muscle strips (with or without mucosa). Acetylcholine and ATP appear to provide the bulk of the excitatory input, since electrical field stimulation responses are blocked by muscarinic receptor antagonists combined with purinergic antagonists. Both transmitters are released in the innervated muscle layer and persist after removal of urothelium. By using high-frequency field stimulation, it is possible to delineate the cholinergic and purinergic component.(207) Apart from acetylcholine and ATP, there are additional substances present in parasympathetic efferents (VIP, NOS, Gal), which allow

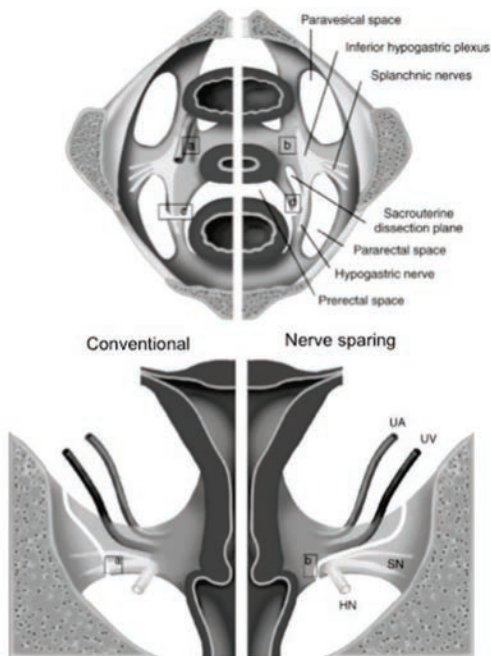

Figure 35: (a) Diagram of the pelvic autonomic nerves in radical hysterectomy. Top panel Transverse section through the pelvis showing the bladder, cervix and rectum. Left side represents the conventional technique, right side represents the nerve sparing technique. Scale bar 250 μ m. a, Vesicouterine ligament, conventional, b, vesicouterine ligament, nerve sparing; c, Sacrouterine ligament, conventional; d, Sacrouterine ligament, nerve sparing. Lower panel: Frontal sections through the uterus and cardinal ligament. UA, uterine artery, UV, uterine vein, SN, splanchnic nerves, HN, hypogastric nerve. Left side represents the conventional technique, right side represents the nerve sparing technique. Scale bar 250 μ m. A, Posterior cardinal ligament, conventional; B, posterior cardinal ligament, nerve sparing. From (Maas, 2005).

immunohistochemical subclassification of nerve fibres, and raise the question as to whether additional transmitters (other than ACh/ATP) have a role in normal micturition function or disease pathophysiology.

Cholinergic nerves are also present in the suburothelium. Although sparse in rodents in human bladder they form a dense plexus in the suburothelium. These cholinergic fibers are not sensory in nature and they do not stain for CGRP.(244) The final target for the ACh presumably released from these nerve endings is not known but in the humans a relatively well organized muscularis mucosae exists and muscarinic receptors M2 and M3 have been identified.(143) In addition, the suburothelium contains terminal nerve fibers that contain NPY and TH and some contain NOS. In the muscle of the trigone, the most common axons contain both VIP and NPY, with noradrenergic

axons forming only a sparse supply. Indeed, noradrenergic neurons are rare in the detrusor and absent in mucosa.(281)

4. TRANSMITTERS

4.1. Glutamate

Glutamate is present in the terminals of primary afferent neurons in the spinal cord along with interneurons and fibres originating in the medulla oblongata. In general, glutamatergic neurons tend to be excitatory, contrasting with generally inhibitory effects of glycinergic neurons; however, excitatory/ inhibitory effects of transmitters can be reversed by the nature of the post-synaptic neuron. Thus, glutamatergic neurons can indirectly have an inhibitory effect if an inhibitory neuron is interposed before the ultimate target.(307) Glutamate acts on spinal neurons through a variety of receptor subtypes. These include NMDA receptors, which are important in controlling polysynaptic reflex pathways at the lumbosacral levels. The NMDAR1 glutamatergic receptor sub-unit is present in the spinal cord of male rats, and is expressed in the SPN. Glutamate is present in the dorsal root ganglion cells supplying the bladder,(308) and the NMDAR1 sub-unit is also present in L6 dorsal root ganglion cells of the rat.(309) In female rats intrathecal injection of an NMDA receptor antagonist decreases bladder contraction pressure.(310) With ageing, there is a decrease in the density of glutamatergic synaptic inputs, which may influence urinary tract function.(311)

4.2. Glycine/ gamma amine butyric acid

Glycinergic and GABAergic interneurons have a major role in neural control processes mediating bladder function.(312) Glycinergic/ GABAergic projections to the lumbosacral cord inhibit the micturition reflex and also inhibit glutamatergic neurons.(313) Rectal distention prolongs the interval, decreases the amplitude and shortens the duration of bladder contractions in rats; this effect is not seen after simultaneous intrathecal injection of low dose strychnine (a selective glycine-receptor antagonist) and bicuculline (GABA-A receptor antagonist), suggesting that the inhibitory rectovesical reflex involves glycinergic and GABAergic mechanisms in the lumbosacral spinal cord, which may be synergistic.(314)

Indeed, in the spinal cord, several transmitters synergistically mediate the effects of modulatory pathways that influence the onward progression of efferent activity. In a rat model of neurogenic bladder dysfunction (autoimmune encephalomyelitis), an exaggerated descending excitatory control arises at the spinal segmental level, which gives rise to detrusor overactivity. Some animals with autoimmune encephalomyelitis develop detrusor areflexia rather than overactivity;(278) in these animals, the excitatory control is probably dominated by segmental inhibition, mediated primarily by glycine receptor activation. A change in the ratio of excitation and inhibition was also observed in humans suffering from spasticity

and pain.(315) This balance of inputs, and the potential plasticity of neuronal circuits, is crucial in understanding pathophysiological processes.

4.3. Serotonin

Spinal reflex circuits involved in voiding function have a dense serotonergic innervation.(316) Immunocytochemical studies in rats, cats and primates show that lumbo-sacral sympathetic and parasympathetic autonomic nuclei receive serotonergic inputs from the raphe nuclei.(317, 318) Activation of the central serotonergic system can suppress voiding by inhibiting the parasympathetic excitatory input to the urinary bladder, and 5-HT elicits a prolonged activation of thoracic sympathetic preganglionic neurons. Stimulation of the raphe nuclei in the cat inhibits reflex bladder activity.(319, 320) 5-HT_{1A} and 5-HT₂ receptors are present in the SPN. However, in different species serotonin (5-hydroxy tryptamine, 5-HT) may have varying functions in the central nervous control of bladder activity. For example, activation of 5-HT_{1A} receptors facilitates reflex bladder activity in rats,(316, 321) and has been used to reverse the effects of diabetes mellitus.(322)

Inhibitory effects on bladder activity are most likely mediated primarily by 5-HT_{1A} receptors. The transmitter released by inhibitory interneurons has not been identified. Activation of 5-HT_{1A} and 5-HT₃ receptors also results in inhibition of afferent input passing from the bladder to the brain. Blockade of 5-HT_{1A} receptors in raphe neurons would increase raphe neuron firing and enhance serotonergic control of spinal reflex mechanisms. This effect would promote urine storage by enhancing sphincter activity and depressing bladder activity.(323)

4.4. Adrenergic

Descending catecholaminergic neurones are primarily located in the upper medulla or pons(324). (In clinical use, non-selective α_1 -adrenergic antagonists influence urine flow and storage phase lower urinary tract symptoms; the two effects probably occur by different mechanisms, and central or peripheral locations may be responsible.(325) Reflex bladder activity is modulated by at least two spinal α_1 -adrenergic mechanisms. Firstly, there is inhibitory control of reflex bladder contractions, probably by modulation of afferent processing. Secondly, there is excitatory modulation of the amplitude of bladder contractions due to regulation of the descending glutamatergic limb of the spinobulbospinal bladder reflex pathway.(326, 327) α_{1A} adrenoceptors comprise 70% and α_{1B} -adrenoceptor 30% of the α -adrenergic receptors in the rat lumbar spinal cord,(328) while α_{1D} adrenoceptors do not appear to have a significant role.

Blood pressure, vascular resistance and tissue blood flow are also regulated by α -adrenergic receptors. Aging is thought to impact pelvic blood flow and thus, bladder function. Pharmacological blockade of the vascular α_{1B} -adrenoceptor may increase pelvic blood

flow and contribute to an improvement in bladder dysfunctions associated with aging and/or hypertension.(329) β_3 -adrenoceptors, although well documented peripherally, are also present in the rat sacral spinal cord. They are upregulated in rat models of partial urethral obstruction.

4.5. Substance P

Substance P-containing terminals are closely apposed to both sympathetic and parasympathetic preganglionic neurons projecting to the major pelvic ganglion.(330) Substance P- containing afferents in the pelvic nerve terminate in the outer laminae of the dorsal horn and in the region of the SPN and DGC.(331) Substance P is also located in intraspinal neurons located in the dorsal horn(332) or DGC.(333) In young adult rats, substance P in the ventral horn is almost exclusively co-localized with serotonin and derived from descending axons of medullary neurons(334) and is also often co-localized with serotonin in axon terminals in the lumbosacral spinal cord.(335) Functionally, substance P affects micturition reflex activity;(336) intrathecal administration of Substance P at spinal levels L5–S1 induces bladder contraction.(337) Studies in the rat show that substance P levels decline with ageing in both the dorsal and ventral regions of the lumbosacral cord.(338) Substance P-immunoreactive innervation of the dorsolateral nucleus (supplying the EUS) is not obviously altered with ageing.(339)

4.6. Purinergic

ATP and Neuromodulation in the bladder

ATP is released as a cotransmitter from sympathetic, parasympathetic, sensory and motor nerve terminals, at synapses in autonomic ganglia and in the central nervous system (CNS). It is broken down by ectonucleotidases to adenosine that then acts on prejunctional P1 receptors to modulate the release of neurotransmitters.(340-349) P1 (A1) receptors are expressed on the nerve terminals on the bladder, while postjunctional smooth muscle receptors are of the A2 subtype.(345, 350) Where the junctional cleft is narrow, ATP itself acts on prejunctional P2 receptors to modulate transmitter release.(351-354)

Identification of purinergic receptor subtypes mediating contraction and relaxation of bladder

Although ATP undisputedly contracts the urinary bladder of most species(355-357) it can also cause relaxation, indicating that there are multiple purinergic receptors present in the bladder. Investigations of the excitatory actions of purine and pyrimidine nucleotides on the guinea-pig bladder revealed the following order of potency: β, γ -meATP > ATP > GTP = CTP > ADP, while adenosine, AMP, GDP, GMP, guanosine, CDP, CMP and cytidine had no contractile activity up to 10^{-3} mol/l.(358) The response to ATP was biphasic in the rabbit urinary bladder, suggesting that more than one type of excitatory receptor to ATP was pre-

sent.(359, 360) Contractile responses of the rat bladder induced by ATP and α,β -meATP, a selective agonist to P2X1 and P2X3 receptors, were fast and transient, reaching a maximum in about 20s; in contrast, contractions in response to adenosine 5'-O-2-thiodiphosphate and uridine 5'-triphosphate (UTP), which activates P2Y receptors, were slower and sustained and were barely affected by α,β -meATP desensitisation.(361)

Immunohistochemical studies showed that P2X1 receptors are the dominant subtype in the membranes of the smooth muscle cells in the rat detrusor and also vascular smooth muscle in blood vessels in the bladder.(362) In another immunohistochemical study of the rat bladder, clusters of P2X1 receptors were described on smooth muscle cells, some, but not all, of which were closely related to nerve varicosities.(363) It has been claimed that there is an interaction of P2X2 and nicotinic ACh receptors in smooth muscle cells from the base, but not the dome, of rat urinary bladder.(364) ATP, as well as adenosine, reduced pelvic nerve-evoked bladder contractions; however, since methylxanthines did not fully antagonise the responses, this suggested that P2Y receptors might also be involved in purine inhibition.(365) These P2Y receptors are located on nerve terminals in the bladder providing prejunctional inhibition of release of excitatory neurotransmitters and both Reactive blue 2 and Coomassie brilliant blue G antagonise the inhibitory actions of ATP on nerve-mediated contractions.(359) Bladder contractions are mediated predominantly via P2X1 receptors, while P2Y₂, P2Y₄, P2Y₆ and A_{2B} receptors mediate relaxation.(366) ATP is released together with noradrenaline and neuropeptide Y from sympathetic nerves. It is also released as a cotransmitter with acetylcholine from parasympathetic nerves supplying the bladder. Cotransmission likely offers subtle, local variations in neurotransmission and neuromodulation mechanisms.(367)

4.7. Parasympathetic Co-transmission

In normal conditions, the human detrusor contraction is totally cholinergic.(368) NANC contractions can be seen in human bladders with IDO.(369) Atropine-resistant responses of the urinary bladder to stimulation of parasympathetic nerves have been recognised for many years.(370-373) They were later shown to be due to non-cholinergic, non-adrenergic transmission.(374-376) In 1972 evidence was presented to support the view that the atropine-resistant component in guinea-pig bladder was purinergic, i.e. due to adenosine 5'-triphosphate (ATP) released as a cotransmitter with acetylcholine (ACh) from the purinergic nerves supplying the bladder.(377) Supporting evidence included: mimicry by ATP of the non-adrenergic, non-cholinergic (NANC) nerve-mediated excitatory responses (Figure 36a); block by quinidine of contractions both to NANC nerve stimulation and to exogenous application of ATP, but not to ACh; and depression during tachyphylaxis of NANC responses produced by high concentrations of ATP. Evidence

for ATP release from NANC nerves came in later papers (Figure 36b).(378) There has been unequivocal support for this hypothesis(373) in guinea-pig bladder,(295, 379-382) but also in mouse,(383, 384) pig,(385) hamster,(386) marmoset and ferret,(387) dog,(388) monkey,(389) cat,(390) shrew,(391) sheep,(389, 392) rat,(393-397) rabbit(210, 398-402) and human.(403-407) Prejunctional inhibition of both cholinergic and purinergic components of the nerve-mediated responses of the rat bladder by adenosine was taken as supporting evidence for cotransmission.(408, 409)

After the early proposal that ATP contributed to the contractile responses of the urinary bladder to parasympathetic nerve stimulation,(377) much debate followed. A paper entitled 'Evidence against purinergic motor transmission in guinea-pig bladder' was published by Ambache (410) based mainly on the relative insensitivity of the bladder to ATP and the inability of ATP to match precisely the atropine-resistant neurogenic responses. Nevertheless, several other laboratories confirmed and extended the evidence in favour of purinergic transmission. Desensitisation with ATP selectively depressed responses to ATP and to field stimulation (particularly at low frequencies), but not those in response to carbachol.(398) Quinacrine, a fluorescent dye known to bind to high levels of ATP in granular vesicles, produced positive staining in neurons and nerve fibres in the bladder.(378) Release of ATP during stimulation of NANC excitatory nerves was demonstrated using the firefly luciferin-luciferase assay method,(295, 378) also 6-hydroxydopamine-induced sympathectomy did not affect the release of ATP in response to intramural nerve stimulation. One hundred-fold lower concentrations of the slowly degradable analogue β,γ -methylene ATP (β,γ -meATP), compared to ATP, were shown to mimic contractions of the atropine-resistant responses of the rat bladder. This suggested that the relative insensitivity of the bladder to ATP may be due to its rapid degradation to adenosine 5'-monophosphate (AMP) and adenosine, which cause relaxation of the bladder.(393)

Evidence for purinergic and cholinergic components of parasympathetic nerve stimulation of the bladder in an *in vivo* preparation of urethane-anaesthetised guinea-pigs was presented.(411) Ganglion stimulants, nicotine and dimethyl-phenylpiperazinium, increased intravesicular pressure in anaesthetised cats by an atropine-resistant mechanism that was mimicked by ATP.(412) *In vivo* responses of the cat bladder to pelvic nerve stimulation suggested that purinergic transmission plays a role in the initiation of bladder contraction and perhaps in the initiation of urine flow, while cholinergic transmission is involved in maintenance of contractile activity and flow.(413) The purinergic component of parasympathetic cotransmission mediated Ca²⁺ signals that provide the initial Ca²⁺/calmodulin activation of myosin light chain kinase in smooth muscle, while the muscarinic receptors provide supporting sustained responses.(384)

The limited information about parasympathetic co-transmission may be due to the fact that it is easier to eliminate surgically or chemically postganglionic sympathetic nerves, where cotransmission in sympathetic nerves by noradrenaline and ATP is well established, than it is to disrupt surgically or chemically postganglionic parasympathetic nerves. The first hint that ATP and ACh might be cotransmitters in parasympathetic nerves supplying the bladder came from an ultrastructural study of vesicles.(414) Indirect evidence for purinergic cotransmission came from studies of botulinum neurotoxin (BTX) type A and neuromuscular transmission in the guinea-pig bladder where both cholinergic and purinergic components of the excita-

The M₃ muscarinic receptor appears to be the subtype responsible for excitatory cholinergic transmission in the bladder, although M₂ receptors are also involved in some species.(415) In M₃ knockout (KO) mice functional impairments were milder than those elicited by active blockade of muscarinic receptors in wild type mice.(416) This suggested that non-cholinergic (purinergic) transmission may compensate for the chronic loss of M₃ receptors.(416) In an *in vitro* preparation of whole rabbit bladder, exogenous ATP and electrical field stimulation in the presence of atropine produced a transient rapid rise in intravesical pressure.(417) Studies of whole rabbit bladders led to the conclusion that neurally released ATP is im-

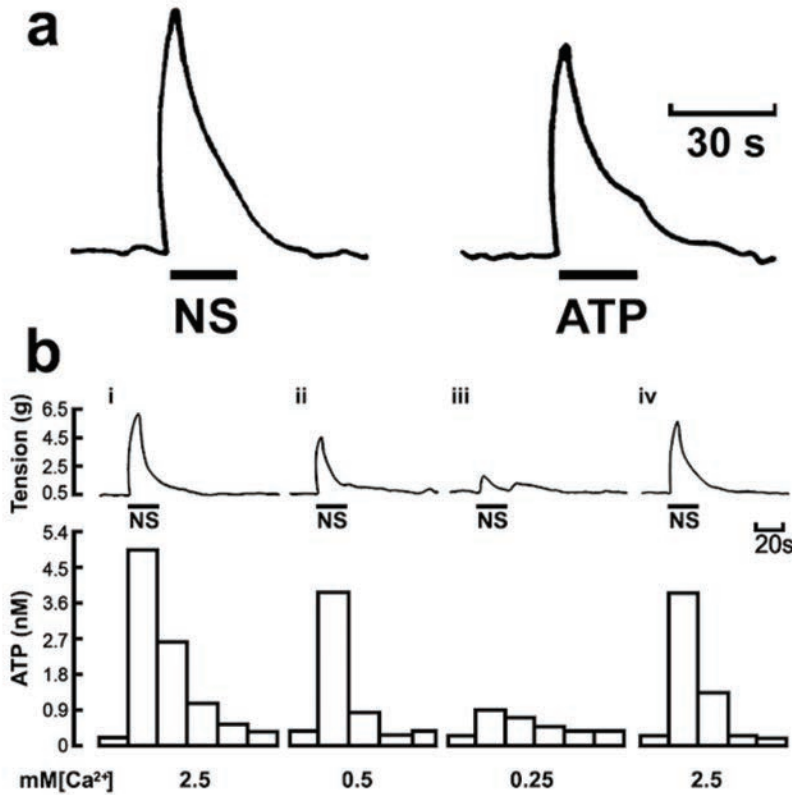

Figure 36: (a) Contractile responses of the guinea-pig bladder strip to intramural nerve stimulation (NS; 2 Hz, 0.2 ms pulse duration, supramaximal voltage for 20 s) and ATP (8.5 μ M). Atropine (1.4 μ M) and guanethidine (3.4 μ M) were present throughout. (b) Effect of changing the Ca²⁺ concentration on the release of ATP from the guinea-pig isolated bladder strip during stimulation of intramural nerves. Upper trace: mechanical recording of changes in tension (g) during intramural nerve stimulation (NS; 2 Hz, 0.2 ms pulse duration, supramaximal voltage for 20 s). Lower trace: concentration of ATP in consecutive 20-s fractions of the superfusate. The Ca²⁺ concentration in the superfusate varied as follows: i = 2.5 mM (normal Krebs); ii = 0.5 mM; iii = 0.25 mM; iv = 2.5 mM. The successive contractions were separated by 60-min intervals as indicated by the breaks in the mechanical trace. Atropine (1.4 μ M) and guanethidine (3.4 μ M) were present throughout. The temperature of the superfusate was between 22°C and 23°C. (from Burnstock et al., 1978).

tory responses to nerve stimulation were significantly reduced by BTX.(206) A spectrum of nerves exists, utilizing different proportions of ATP and ACh, from predominantly ATP in cat and guinea pig through to roughly 50:50 in rat and dog to predominantly ACh in healthy human bladder.

portant in the initiation of micturition, but ACh is necessary for bladder emptying.(400, 418)

4.8. Sympathetic Co-transmission

The sympathetic innervation of the bladder originates in the thoracolumbar spinal cord and reaches the

5. PELVIC ORGAN INTERACTIONS AT THE EFFERENT NEURAL LEVEL

5.1. Bladder and Outlet

Neural coordination of physiological and behavioral functions depends on convergence within the nervous system of information from relevant areas. There is extensive convergence of pelvic organ input (433, 434) at the levels of the spinal cord, dorsal column nuclei, solitary nucleus, medullary reticular formation, and thalamus.(435) The fundamental role of spinal and supraspinal mechanisms in maintaining normal lower urinary tract synergy, between the bladder and sphincter, is well recognized.

In this context, the role of spinal interneurons must be considered. Involuntary bladder emptying during urine storage is considered to involve somatic nerve activity originating from cells in the lateral ventral horn, in a region called Onuf's nucleus. Normally, cholinergic sphincter moto-neurons project to the urethral striated muscle/rhabdosphincter via the pudendal nerve, resulting in its contraction. This contraction can be activated by bladder afferent activity conveyed through pelvic nerves, and is considered to be organized by interneuronal circuitry in the spinal cord. It is thought to come into play in response to sudden increases in bladder pressure – for example, during a cough, sneeze, laugh. With aging, there is a loss of innervation at the terminal muscle level, which is displayed as a loss of striated muscle fibres in the sphincter and thus, a loss of urethral closing pressure.(436)

bladder via the hypogastric nerves and the sympathetic chain. The sympathetic system provides inhibitory control over activity of the detrusor muscle and excitatory input to the trigone and urethra. Sympathetic innervation of the detrusor has been reported to be sparse, although the trigone region is relatively densely innervated by sympathetic nerves.(419, 420) Sympathetic nerve fibres supply the bladder largely in the hypogastric nerve. Stimulation of the hypogastric nerve has been reported to cause an increase or decrease in pressure in the urinary bladder, but always excites the urethra.(297, 421, 422) Inhibitory sympathetic transmission in the detrusor is important during the filling phase of the voiding cycle.(423, 424) The transmitters released from sympathetic nerves act directly on smooth muscle, but they may also act prejunctionally on parasympathetic nerve terminals to inhibit both cholinergic and purinergic excitation, involved in the voiding phase of the micturition cycle.

ATP is well established as a cotransmitter with norepinephrine (NA) in sympathetic nerves.(349, 425) Although purinergic transmission predominantly originates from postganglionic parasympathetic or intramural nerves, in the cat at least, ATP is also released from the hypogastric nerve, which is predominantly sympathetic, although it may also contain parasympathetic elements.(426) When the cat hypogastric nerve is stimulated it causes the bladder to contract. The contraction was reduced by ANAPP₃.(427, 428) implying that ATP is being released. In addition, 6-hydroxydopamine, which destroys sympathetic nerves, prevents this contractile response, indicating that the ATP is released from sympathetic nerves.(427) Guanethidine, in a dose that blocked the bladder relaxation induced by hypogastric nerve stimulation and mediated by NA acting on β -adrenergic receptors,(429) did not affect hypogastric nerve-mediated excitation. However, in guanethidine-treated animals, ANAPP₃ blocked the excitation. These findings suggest that ATP is released from the hypogastric nerve.

One of the basic features of sympathetic neuromuscular cotransmission appears to be that the cotransmitters released act synergistically.(430, 431) However, there do not appear to be any reports of synergistic cotransmission in the urinary bladder involving either parasympathetic or sympathetic nerves. ATP is likely to be a cotransmitter with NA in perivascular sympathetic nerves supplying blood vessels in the bladder.(350) Experiments using a whole rabbit bladder preparation, showed that pre-treatment with isoprenaline, a β -adrenergic agonist, significantly inhibited contractions to ACh or ATP.(432) Thus in pathological conditions such as bladder-urethral dyssynergia, involving simultaneous firing of sympathetic and parasympathetic nerves, both cholinergic and purinergic bladder contractions could be suppressed while the urethra was contracted.

Synergic lower urinary tract function may also be a feature of the peripheral innervation, independent of CNS co-ordination. In the female minipig, pre-ganglionic pelvic nerve stimulation evokes a pressure increase in the bladder and a pressure decrease in the urethra.(437) It remains to be determined whether this observation suggests pre-determined, separate inputs to the bladder (excitatory to the bladder, inhibitory to the outlet), or whether the divergence occurs at postganglionic motorneuron level, which send branches supplying both bladder and urethra. In the latter arrangement, release of different neuromuscular transmitters from branches of the same motorneuron, or interposition of an additional intermediary cell would be required. The former is circumstantially supported by the observed co-localization of acetylcholine- and nitric oxide-related enzymes.(438)

rectal distention inhibits bladder activity via glycinergic and GABAergic mechanisms in rats. Dual labeling studies show that many neurones in Barrington's nucleus supply both colon and bladder, with smaller populations supplying the two organs separately (Figure 37) – with dorsal neurons being bladder-related and ventral neurons being colon-related.(440) At the level of the major pelvic ganglion, double-labeled cells are relatively infrequent, but processes of colonic-retrograde-labeled cells often surround cell bodies of equivalent cells for the bladder. Dual-labeled cells in the spinal cord are rare.

5.3. Bladder and Prostate/Uterus

Voiding dysfunction is commonly associated with symptoms of chronic prostatitis/chronic pelvic pain syndrome, suggesting a prostate-bladder neural re-

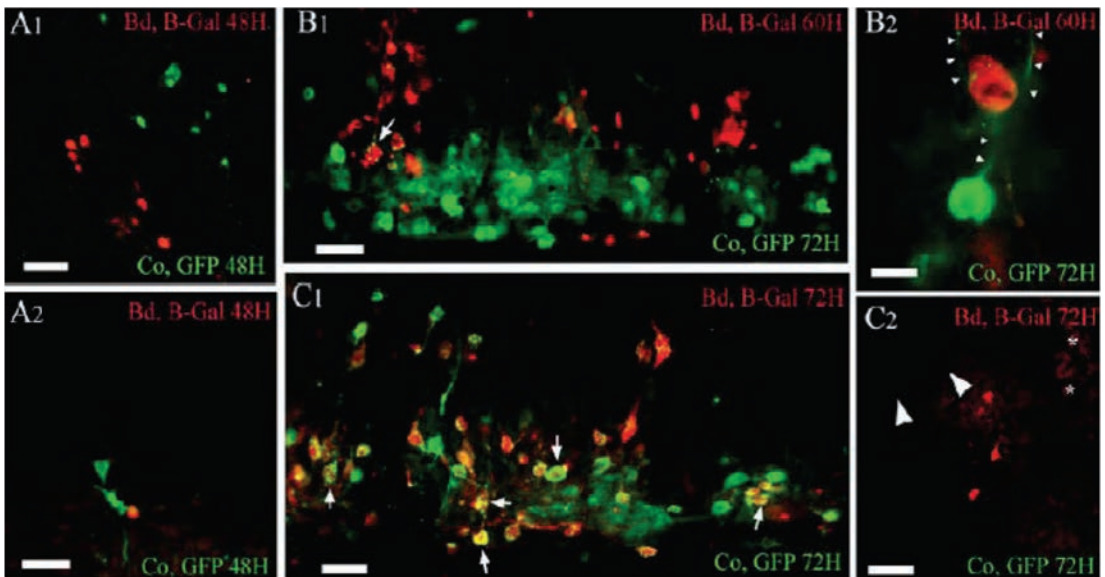

Figure 37: A, Fluorescent micrographs of sections at the level of (A1) the major pelvic ganglion, (A2, B1, B2 and C1) the lumbosacral spinal cord and (C2) Barrington's nucleus of rats injected with PRV-Beta-GAL in the bladder and PRV-GFP in the colon and having different survival times. The viscera, tracer and survival time are indicated in each photomicrograph. BD, bladder. CO, colon. A1. Separate labeling from both viruses is apparent in the MPG at 48 hours. A2. In the same case, only occasional cells are labeled in the spinal cord. B1. Substantial labeling from both organs is visible in the preganglionic parasympathetic column of the spinal cord and most cells are singly labeled from either the colon or the bladder. The arrow points to a rare double-labelled neuron. B2. Bladder- and colon-related neurons in close proximity. Processes from the colon-related neuron (arrow heads) are apposed to the bladder-related neuron. C1. Increasing survival time results in greater number of double-labelled cells (arrows). In most double labeled cells PRV-Beta-GAL label from the bladder is surrounded by PRV-GFP label from the colon. C2. Section from Barrington's nucleus from the same case as C1 indicating that only a few cells are transsynaptically labeled from the bladder and none from the colon at the survival time. Arrow heads point to the surface of the fourth ventricle and stars indicate the location of trigeminal mesencephalic neurons. Calibration bars: 50 μ m A1 and A2, 30 μ m B2 and C1, 50 μ m B2, 50 μ m C2. From Rouzade-Dominquez et al., 2003.

5.2. Bladder and Bowel

Clinicians are familiar with the detrimental effect of bowel disorders on lower urinary tract activity. Physiologically, the efferent limb of the micturition reflex is inhibited by afferent input from the rectum;(439) thus,

flex. Electrical stimulation of the prostate following transection of the prostate nerves or lidocaine injections into the prostate, evokes changes in bladder cystometry parameters.(441) Anatomically, voiding cannot be initiated unless the prostate first rotates around the symphysis.(442) This preceding action of

the prostate is suggestive of a higher centre efferent coordination.

Neurons labeled from the prostate are found mainly in L1-L2 whereas neurons labeled from the bladder are found mainly in L6-S1. Double-labeled neurons are located in L1-L2 mainly in the dorsal gray commissure. However, the number of bladder neurons are much greater than that of prostate, and both neurons increase significantly at longer incubation times.(443) At the brainstem level, double-labeled neurons are more common (Figure 38).

overactivity induced by inflammation is influenced by estradiol, probably mediated through effects on the sympathetic nervous control of the bladder.(446) There are several potential mechanisms by which neural input could contribute to emergence of inflammation in neighboring organs (Figure 39);

1. A dorsal root reflex; hypogastric afferents from the inflamed organ could, via a spinal interneuron, sensitize and antidromically activate other hypogastric afferents from a non-inflamed organ.(447)

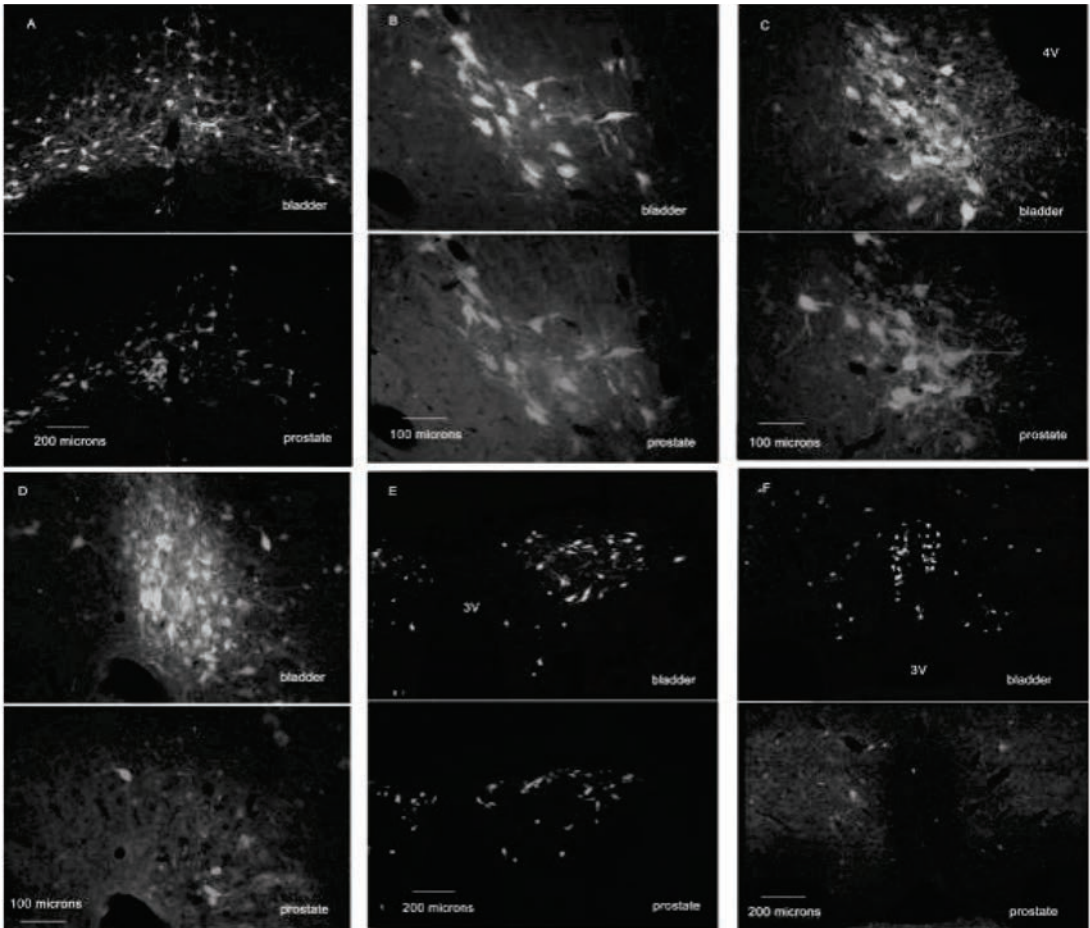

Figure 38: Neurons in selected brain nuclei, arranged in caudal to rostral order labeled by virus from the bladder or from the prostate. A: Raphe and gigantocellular reticular nuclei. Double-labeled neurons are common. B: The A5 adrenergic nucleus. Note that there are numerous double-labeled neurons. C: The locus coeruleus. Several neurons are double-labeled. D: Barrington's nucleus (the pontine micturition center). Bladder virus labels the overwhelming number of neurons. Only a few neurons contain prostate virus. E: The paraventricular nucleus. Approximately equal numbers of bladder and prostate neurons. Some are double-labeled. F: The medial preoptic nucleus. Only bladder neurons are found. From Nadelhaft et al., 2002.

Inflammation of the uterine horn or colon gives rise to inflammation in the bladder, an effect that can be eliminated by sectioning the hypogastric nerve.(444) Similarly, inflammation of the bladder causes heightened sensitivity of uterine cannabinoid receptors, likely inhibiting its adrenergic input.(445) Bladder

2. Axon reflexes occurring in hypogastric sensory nerves that branch to supply more than one pelvic organ. Though such branching has not yet been specifically identified, a small proportion of single afferent fibres may branch to supply the colon and bladder.(447)

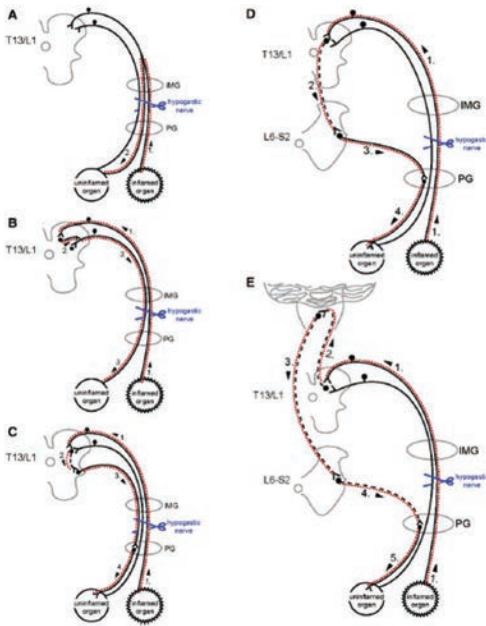

Figure 39: Five compatible mechanisms by which hypogastric nerve fibres can contribute to the process of inflammatory induction between organs. A. Branching sensory afferents. B. Dorsal root reflex. C. Multisynaptic route involving sensory afferents from the inflamed organ to the T-13/L1 segment of the cord followed by output from preganglionic fibres in the T13/L1 segment to postganglionic in the pelvic ganglion that innervate the uninflamed organ. D. Multisynaptic route involving sensory afferents from the inflamed organ to the T13/L1 segment of the cord followed by output from preganglionic fibres in the L6-S2 segments to postganglionic fibres in the pelvic ganglion that innervate the uninflamed organ. E. Multisynaptic route involving sensory afferents from the inflamed organ to the T-13/L1 segment of the cord followed by output from preganglionic fibres in the L6-S2 segments to postganglionic fibres in the pelvic ganglion that innervate the uninflamed organ. In this case the multisynaptic route includes ascending connections from spinal cord to brain and descending connections from brain to L6-S2. From Winnard et al., 2006.

3. Input from the inflamed organ (via the hypogastric nerve) activates neurons in the dorsal horn that activate postganglionic neurons in the pelvic ganglion via thoracolumbar preganglionic neurons.
4. A spinal mechanism could be mediated by intraspinal connections to lumbosacral preganglionic neurons (as seen for gynaecological organs).(448)
5. A suprasacral mechanism could be mediated through the brain stem.(449, 450)

6. EFFERENT INHIBITION

The sympathetic pathway contributes to inhibition of parasympathetic efferent input to the detrusor smooth muscle. In isolated whole bladders, there is a high level of spontaneous contractile activity,(220, 451, 452) suggesting active neural inhibition of the bladder during urine storage. In a novel perfused decerebrate preparation of the whole rat, ganglion blockade using hexamethonium also leads to an increase in spontaneous activity.(453) Rat brainstem/ spinal cord/ bladder preparations or neonatal spinal cord/ bladder preparations show tonic inhibition, arising at L6-S1 and involving a peripheral ganglionic synapse.(453, 454) Clearly, efferent inhibition of the bladder facilitates urine storage.

In the neonatal rat, considerable activity arises in the bladder wall when inputs from the lumbosacral spinal cord are disrupted.(455) Selective spinal cord and root lesions indicate that intrinsic bladder activity of the neonatal rat is tonically inhibited by parasympathetic efferent outflow. This path is additional to the predominant cholinergic preganglionic efferents mediating the main voiding reflexes. The functional difference in the two sets of cholinergic ventral root efferents may result from differing synaptic targets, since both are blocked by the nicotinic antagonist hexamethonium. Thus, inhibitory efferents must synapse with noncholinergic inhibitory neurons in the major pelvic ganglia, in contrast to excitatory efferents synapsing with the cholinergic detrusor innervation.

In addition to efferent input, local reflexes may contribute to the inhibition of detrusor activity, probably driven by interstitial cells,(456) so that peripheral autonomous activity increases as a result of bladder distension.(457) This has been proposed to signify the presence of a regional regulatory influence (458) and a peripheral "pacemaker"(49) and various mechanisms for the propagation of activity within the bladder wall.

7. PERIPHERAL EXCITATORY MECHANISMS

Agonist exposure appears to elicit contraction by two different mechanisms, comprising a component derived from direct stimulation of the muscle cell ('classical' efferent), and a separate component that is more phasic, responsible for the obvious pressure fluctuations. The latter 'intrinsic' mechanism may involve an intermediary cell type.(459) Optical imaging and calcium-/ voltage-sensitive dyes in whole rat bladder preparations have detected electrical activity moving in a coordinated manner from localized regions over the entire bladder.(460) The isolated whole bladder shows regionalized responses when exposed to cholinergic/ muscarinic agonists.(461, 462) Dynamic migrating localities of contraction and

elongation, give rise to a complex mix of micromotion phenomena, including micro contractions, micro stretches and propagating waves.

Several species show differences in contractile activity according to the region of the bladder from which a muscle strip is taken. Different effects are seen according to stage of development- spontaneous activity is high in bladder strips from neonatal rats, but small or almost non-existent in adults and reemerges in older bladders.(463) The likely functional significance of peripheral excitatory mechanisms is exemplified by the rodent neonate voiding reflex, which is induced by parental stimulation of the perineum, prior to establishment of mature control by the higher micturition centres.(464) The physiological role of such activity in the older adult is not known, but could include; 1. Optimization of the bladder wall configuration for volume contained, to ensure efficient voiding regardless of volume.(465) 2. Stimulation of 'in series' receptors for signaling bladder volume,(466) 3. A mechanistic component of accommodation during filling, a counterintuitive suggestion supported by the observation that accommodation in the colon involves synchronous contraction and relaxation,(467) 4. Maintaining the voiding contraction until complete evacuation is achieved.(468)

7.1. Perinatal development and ageing of efferent nerve signalling in urinary bladder

The main pathway in nerve activation of the urinary bladder of newborn mice is cholinergic with a relatively low contribution of the purinergic component, compared to adult bladder, which is equally dependent on cholinergic and purinergic activation.(469) At foetal day 26, large numbers of ganglia (25-38), each containing 30-40 quinacrine-positive neurons, were seen in the detrusor wall, while only 5-12 ganglia contained 3-12 acetylcholinesterase-positive nerve cell bodies at the same foetal age.(470) Neurogenic contractions of bladders from newborn rats were atropine-sensitive. During the first 2 weeks, the atropine-resistant component of these contractions increased progressively to reach adult-like conditions.(471) Responses to adenosine (inhibitory) and ATP (excitatory) mediated by P1 and P2X receptors, respectively, were present as early as postnatal day 2.(472) Adenosine was more potent in the neonate than in the adult, while the potency of ATP initially increased with age, peaking between postnatal days 10 and 25, but then declined. Expression of P2X1 receptor transcripts was much lower in foetal human bladder than in adult bladder, while P2X4 and P2X7 receptors were also present in the foetus.(473) The P2 receptor expression shifted from the dome to the body of the bladder with increasing gestation.

There are few reports describing changes in purinergic signalling in the ageing bladder. A comparison of contractions in detrusor muscle strips from unobstructed bladders of young and aged rats showed that, with age, there is an increased sensitivity to ATP

as well as NA, but with no change in response to ACh and KCl.(474) There is a reduction in acetylcholinesterase-positive nerve fibres in the human bladder with increasing age(291) and decreased fluorescence intensity for catecholamines in neurons in the hypogastric ganglion, which supplies sympathetic fibres to the bladder. Ageing impairs neurogenic contractions mediated by ATP, but less so ACh, in guinea-pig urinary bladder(475). ATP released as a cotransmitter from parasympathetic nerves of rat bladder produces increased contractile responses with age.(476) The purinergic component of nerve-mediated contractions of the human bladder was also increased with age, largely due to increased release of ATP(477) and the sensitivity of the bladder to α,β -meATP increased with age.(478) Purinergic transmission increases with age in the human bladder, but cholinergic transmission decreases. This appears to be due to increased release of ATP and decrease in ACh release.(477) The authors suggest that purinergic receptor antagonists may provide a useful addition to muscarinic receptor antagonists for the treatment of older patients with overactive bladder. Down-regulation of P2X1 mRNA expression with age in the detrusor muscle of male patients has been reported with and without bladder outlet obstruction.(479)

7.2. Plasticity of efferent nerve signalling in bladder in pregnancy and disease

The first symptoms of urinary incontinence in adult women can arise after the first pregnancy and the risk of incontinence increases with multiple deliveries.(480) The sensitivity of the rat detrusor muscle to ATP was not modified by multiple pregnancies, but there was increased sensitivity to adrenergic and cholinergic stimulation,(481) although other studies reported that the responses were reduced.(482, 483) The responses to ATP increased during pregnancy in both rat and rabbit bladders.(482, 483) Detrusor responses to purinergic stimuli are influenced by sex hormones.(484) Chronic treatment with oestrogen induced an increase in the responses to purinergic (as well as muscarinic and α -adrenergic) agonists in the rabbit bladder body and mid-section, but not the bladder base.(485) Oestradiol and tamoxifen, the oestrogen receptor antagonist, inhibited contractions of rabbit detrusor strips produced by α,β -meATP.(486) There was an increase in P2X3 receptor mRNA expression in the bladder after ovariectomy.(487) Since ATP is a cotransmitter in sympathetic nerves, it would appear that less ATP as well as NA is available in pregnant compared to non-pregnant bladders.

Valuable reviews concerning the roles of purinergic signalling in overactive bladder (OAB) syndrome are available.(488-494) Women with OAB have high urinary levels of ATP compared to controls and the nucleotide levels increase with water intake and it was suggested that higher urinary ATP may be a useful prognostic marker for detrusor overactivity.(495, 496) Transient receptor potential vanilloid (TRPV) 1 and P2X3 receptors are both present in the human bladder and they may become upregulated and contribute

to OAB.(497) In OAB there was an increase in expression of P2X3 receptors in subepithelial sensory nerves leading to increased bladder activity.(498) OAB is common among patients with Parkinson's disease and suppression of this overactivity by A_{2A} receptor antagonists has been reported, which are probably acting in the CNS to regulate the micturition reflex.(499) Uridine diphosphate via P2Y₆ receptors regulates abnormal bladder smooth muscle activity in OAB enhancing P2X1-mediated contractions.(500) Neurogenic bladders are hyper-responsive to ATP.(405) A purinergic component of 40% of parasympathetic nerve stimulation was identified in neurogenic bladders.(501)

In a mouse model of bladder overactivity, bradykinin facilitated the release of ATP from nerve terminals via prejunctional receptors.(502) In the P2X3 receptor mouse KO, the bladder is hyperactive.(187, 188) The P2X3 and P2X2/3 antagonist AF-219, which is orally bioavailable and metabolically stable,(493) is being explored as a therapeutic agent for urinary tract dysfunction. Mice treated with ketamine, a recreational drug, for 8 weeks showed side effects in the bladder and enhanced P2X1 receptor expression and non-cholinergic nerve-mediated contractions were observed.(503)

The purinergic atropine-resistant contraction was prominent in human obstructed or unstable bladders but not those with neurogenic instability.(504) P2X receptor expression was increased in patients with idiopathic detrusor instability.(369) A further possible explanation for the increased potency of ATP in contracting detrusor muscle from unstable bladders may be due to reduced extracellular ATP hydrolysis.(505) Reduction of P2X3 and P2X5 receptors in human detrusor from adults with urge incontinence has been reported.(506) The increase in purinergic transmission in unstable bladders may be due to a contribution of increased neural release of ATP, reduction in ecto-ATPase activity or to changes in gap junctions between muscle cells.(507) Preparations obtained from hypertrophic human bladders were more sensitive to ATP than healthy preparations.(508) ATP is released during cystometry in women with detrusor overactivity and may contribute to urgency. (509)

In detrusor strips taken from patients with interstitial cystitis (IC), the atropine-resistant contractile component was increased to about 43% of the total response.(404) The atropine-resistant component in the neurogenic bladder was abolished following desensitisation with α,β -meATP and the detrusor muscle showed increased sensitivity to the agonist actions of α,β -meATP, indicating that it is purinergic transmission via P2X1 receptors. P2X3 receptors were upregulated during stretch of cultured urothelial cells from patients with IC.(510) Detrusor overactivity was induced by intravesical application of ATP. The enhanced penetration of endogenous ATP may be due to urothelial damage contributing to urinary frequency and bladder pain in hypersensitive bladder in

bladder pain syndrome (BPS) and IC.(511) In cyclophosphamide-induced cystitis in rats, there were substantial changes in both sympathetic and parasympathetic efferent nerves, which alter the afferent nervous input from the bladder.(512) Changes in parasympathetic innervation occur prejunctionally, while changes in sympathetic innervation occur postjunctionally.

P2X1 receptor expression in bladder smooth muscle increased considerably in the symptomatically obstructed human bladder.(369, 513) Both cholinergic and purinergic transmission are important for pressure generation and emptying of the bladder.(514) The force of contraction produced by ATP and α,β -meATP on hypertrophied smooth muscle was significantly lower than in controls, and the rate of contraction slower.(515) The sympathetic innervation of the bladder neck was diminished in patients with bladder outlet obstruction,(516) suggesting that there may be a reduced role for sympathetic nerve-released ATP as well as NA.

Multiple sclerosis (MS) patients often have peripheral problems, including bladder dysfunction (517-519) and it has been claimed that peripheral nerve damage occurs in the MS bladder.(153) A selective change in purinergic transmission occurred in mice infected with the Semliki Forest Virus, while cholinergic transmission remained unchanged.(520) There was an increase in the contractile responses to β,γ -meATP and in the purinergic component of nerve-mediated contractions.

IV. NEURAL CONTROL OF PELVIC FLOOR MUSCLES AND RHABDOSPHINCTERS

The urethral rhabdosphincter and pelvic floor muscles are important in maintenance of urinary continence and in preventing descent of pelvic organs (i.e. pelvic organ prolapse, POP). It is estimated that 11 % of US women will undergo a surgical procedure for POP or urinary incontinence during their lifetime.(521) Because of the importance of understanding pelvic floor function, recent clinical and preclinical studies have focused on this topic. Reviews of functional anatomy(522) and neural control(523) of the pelvic floor muscles and the urethral and anal rhabdosphincter have been published.(524)

1. STRUCTURAL ELEMENTS OF THE PELVIC FLOOR (FIG. 40)

The pelvic floor (522) in women is a bowl-shaped structure comprised of bone, muscle, and connective tissue. The rim of the bowl is formed by the bones of the pelvic girdle (sacrum, ilium, ischium, and pubis). The "bottom" of the bowl is lined with striated muscle:

the iliococcygeus and pubococcygeus (which together comprise the levator ani - LA - muscle), the coccygeus, and puborectalis(522, 525, 526) muscles. The muscles are attached to the bone and to each other with various connective tissue supports. These three components, bone, muscle, and connective tissue provide support of the pelvic viscera (i.e. rectum, vagina, and bladder) but also allow for excretory and sexual function.

ter, the striated urethral sphincter, the striated urethralis muscle and other names. The term “external urethral sphincter” is downplayed because the urethral rhabdosphincter is not really external to the lower urinary tract; it surrounds the middle of the urethra. Therefore the term urethral rhabdosphincter is recommended.

A. Levator Ani Nerve

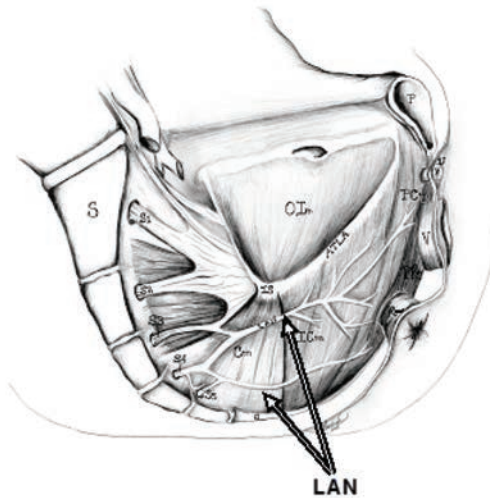

B. Pudendal Nerve

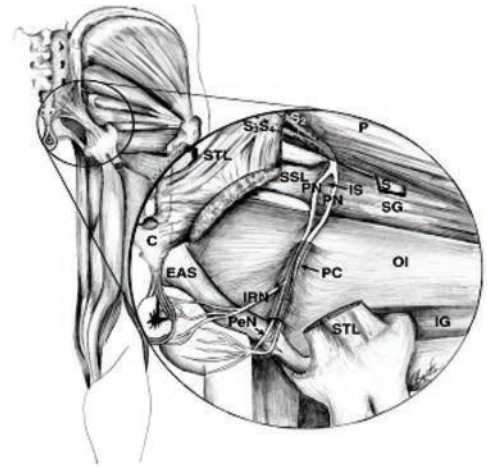

Figure 40: A) Sagittal drawing of medial surface of a woman’s pelvic floor showing the course of the LA nerve (LAN) from the sacral roots (S3-S5) across the internal surface of coccygeus (Cm), iliococcygeus (ICm) puborectalis (PRm) and Pubococcygeus (PCm) muscles. S=sacrum; C=coccyx; IS=ischial spine; OIm=obturator internus muscle; ATLA=arcus tendineus LA; U=urethra; V=vagina; R=rectum. B) Drawing of a posterior view of the hip muscles showing the course of the pudendal nerve (PN) from the S2-S4 roots across the lateral surface of the superior gemellus (SG) and obturator internus (OIm) muscles, through the pudendal canal (PC), and its branching into the inferior rectal nerve (IRN) and perineal nerve (PeN). P=periformis muscle; STL=sacrotuberous ligament; C=coccyx; IS=ischial spine; SSL=sacrospinous ligament; S=sciatic nerve; EAS=external anal sphincter; IG=inferior gemellus muscle. Adapted from Barber et al., 2002.

The viscera, as well as striated muscles that serve as true sphincters - urethral and anal rhabdosphincters, attach to pelvic floor muscles and each other by connective tissue but do not attach directly to bone. The urethrovaginal sphincter, the compressor urethrae muscle, the ischiocavernosus, and bulbospongiosus muscles are additional striated perineal muscles that are intimately associated with the viscera(522, 525, 526) During embryogenesis, the rhabdosphincter and perineal muscles develop from the cloaca with a two-week delay in striated muscular differentiation compared to the LA and other skeletal muscles.(527, 528) Furthermore, rhabdosphincters are completely separated from the LA muscles by connective tissue.(525) Thus, the striated muscles associated with the viscera (i.e. rhabdosphincters) are quite distinct from the striated skeletal muscle of the pelvic floor (e.g. LA). The urethral rhabdosphincter has been referred to by many names, including the external urethral sphinc-

2. PERIPHERAL INNERVATION OF THE LEVATOR ANI (LA) MUSCLES

The LA muscle of the pelvic floor is innervated by the LA nerve in human, (Figure 40A)(529, 530) squirrel monkey(531), dog(532) and rat.(533, 534) The LA nerve primarily arises from sacral spinal roots (e.g. S3-S5 in humans) and travels along the intrapelvic face of the LA muscle with a high degree of variability in branching patterns.(530) In humans, there is some controversy whether or not the pudendal nerve also innervates the LA muscle.(535) In human female fetus samples, a contribution to LA innervation by the pudendal nerve was only seen in about half the samples. A detailed study of women 45-55 years of age, using an elaborate Sihler’s stain to trace branches down to single fibers, did not describe any contribution of the LA muscle from the pudendal nerve.(529)

In animal studies, a number of findings refute an innervation of the LA muscles by the pudendal nerve:

1. a marked decrease in LA muscle mass and myocyte diameter, as well as vacuolization of the muscle following transection of the LA nerve but not after pudendal neurectomy.(531)
2. transection of the LA nerve abolished LA muscle EMG activity in rats,(533) while transection of the pudendal nerve had no effect on LA EMG activity but abolished rhabdosphincter activity.
3. an absence of contractions of LA muscles upon electrical stimulation of pudendal nerve efferent fibers (Thor and Karicheti, unpublished observations in cats and rats).
4. only a single motor endplate zone is found in the LA muscle, located at the point of LA nerve insertion into the muscle.(531)
5. large α motor neuron axons (i.e. 10 μm diameter), which are a hallmark of skeletal muscle innervation, are not found in the pudendal nerve.(534, 536)
6. distinct populations of motor neurons, extremely unique in phenotype, are labeled following application of tracers to the pudendal nerve versus the LA nerve(537-539).

Thus, divergent techniques support the conclusion that only the LA nerve innervates the LA muscles with no significant contribution from the pudendal nerve in non-human species. These direct observations, coupled with the distinct embryological origins of LA muscles versus rhabdosphincter and perineal muscles(527, 528), as well as a respective “compartmentalization” of the rhabdosphincter and perineal muscles by connective tissue(525), are in line with distinct “special somatic” motor innervation of the rhabdosphincter by the pudendal nerve versus typical skeletal motor innervation of the LA muscle by the LA nerve. The work in human female fetal samples(540, 541) suggests that an innervation of the LA muscle by the pudendal nerve should be considered, especially during the perinatal period. Whether these pudendal branches to the LA muscle recede during maturation or aging should also be considered in light of the difficulty identifying them in older women.(529)

The complexity of the perineal region, which consists of various small muscles (puborectalis, compressor urethrae, urethrovaginal sphincter, urethral and anal rhabdosphincter, ischiocavernosus, and bulbocavernosus), blood vessels, connective tissues, and nerves, makes dissection, identification, and nomenclature of specific nerve branches and muscles difficult in cadavers. Indeed, even the nomenclature of the muscles themselves is uncertain.(525) A recent study has suggested more attention to detail and more rigorous adherence to “origin – insertion” nomenclature standards are being adopted.(529)

Detailed anatomical, histological, and physiological studies of the small, intricate muscles of the perineum coupled with studies of their afferent and efferent neurons in humans and larger laboratory species (where they can be readily visualized) is an important area for future research. As a first step, agreements regarding muscle classification should be established in regard to which muscles actually comprise the LA or pelvic floor versus those that are more intimately associated with the viscera. In other words, should “pelvic floor muscles” include only the skeletal striated muscles such as pubococcygeus, iliococcygeus, coccygeus, and puborectalis muscles, while non-skeletal striated muscle such as urethralis, urethrovaginal sphincter, and compressor urethrae be distinguished from the pelvic floor? Are these latter muscles similar to the urethral and anal rhabdosphincter? Presumably, characteristics of their muscular function, their innervation, their pharmacological responses, or physiological integration with visceral function may allow better understanding of their roles in excretion or sexual function.

Clarity regarding pudendal versus LA nerve innervation is also important because attributes ascribed to pudendal nerve involvement may be more correctly ascribed to LA nerve involvement. For example, the intrapelvic positioning of the LA nerve on the surface of the muscles may expose it to damage as the fetal head passes through the birth canal(530) and may contribute to the correlation between parity and POP.(522) This positioning also allows exposure to electrical current applied with a St. Mark’s electrode situated in the rectum with subsequent EMG activation of the LA muscle. The LA nerve positioning, close to the ischial spine, also risks entrapment by sutures used for various POP suspension surgeries or may account for dyspareunia, pelvic pain, and/or recurrent prolapse(542) associated with such surgery. Finally, since the ischial spine is a landmark for transvaginal “pudendal nerve” block,(540) the possibility that this procedure also anesthetizes the LA nerve should be considered.

2.1. LA Motor Neurons

Retrograde tracing studies in cats,(543) dogs,(532) and squirrel monkeys(531) identify LA motor neurons in a longitudinal column in the sacral ventral horn of the spinal cord, while in rats(544, 545) they are in the L6-S1 ventral horn. In contrast to dense packing of sphincter motor neurons in Onuf’s nucleus,(537, 538, 546) the LA motor neurons are distributed more diffusely. Furthermore, LA motor neurons show a bimodal distribution of large neurons (presumably α motor neurons) and small neurons (presumably γ motor neurons) in contrast to the uniform intermediate size of pudendal motor neurons. The two sizes of LA motor neurons are in keeping with the presence of muscle spindles (whose intrafusal muscle fibers are innervated by γ motor neurons) in LA muscle,(547, 548) while muscle spindles are absent from the rhabdosphincter muscles;(547, 549-551) consequently LA may exhibit 1α (muscle spindle) evoked

monosynaptic stretch reflexes, whereas the urethral rhabdosphincter does not.(552)

LA motor neuron processes (dendrites or axon collaterals) project into two important areas in the sacral spinal cord.(553) One area, medial lamina VI, is where primary afferent fibers from muscle spindles and Golgi tendon organs terminate.(554, 555) again suggesting an important role for stretch-activated reflex contractions of LA muscles. The second area is to Onuf's nucleus that contains rhabdosphincter motor neurons. These LA motor neuron processes form close appositions with sphincter motor neurons in both monkey(531) and rat.(544) Presumably, these appositions reflect a neuroanatomical substrate for coordination of the rhabdosphincter and the pelvic floor muscles during micturition and defecation. These projections could be dendrites receiving common afferent input with rhabdosphincter motor neurons or axon collaterals transmitting information to rhabdosphincter motor neurons, which might provide insight into functional coordination.

Ovariectomy in rats reduced LA neuron dendritic arbors, while estradiol and progesterone expanded them, indicating hormonal regulation.(556)

2.2. LA Afferent Innervation

Afferent LA fibers innervate muscle spindles(531, 547) and Golgi tendon organs(557) which are common in skeletal muscles but absent in the rhabdosphincters.(547, 549-551) Cholera toxin B (CTB) injection into the LA muscle(553) of squirrel monkeys labels approximately 4 times as many afferent neurons versus motor neurons. About 25% of these primary afferent neurons are large, myelinated (i.e. RT-97 neurofilament positive) neurons and are negative for the peptide transmitter calcitonin-gene-related peptide (CGRP), binding sites for isolectin-B4 (IB-4), and the growth factor receptor, TrkA. Of the remaining small, RT97 negative neurons, approximately 50% contain CGRP, IB-4 binding sites, and TrkA. It is tempting to speculate that large, myelinated afferent neurons signal proprioceptive information from muscle spindles(531) and Golgi tendon organs and in turn control reflex activity of the LA muscles, while the small peptidergic, IB-4, TrkA positive neurons transmit nociceptive information. In addition, large sensory neurons may regulate bladder reflex pathways during LA motor activity; while the small peptidergic fibers might play a role in bladder hyperreflexia associated with pelvic floor trauma or nerve entrapment.

CTB labeled afferent terminals were only seen in medial lamina VI of the lumbosacral spinal cord,(553) an area for termination of large, myelinated proprioceptive terminals(554, 555). The absence of CTB labeling in the superficial dorsal horn, which should contain the central terminals of small peptidergic, IB-4, and TrkA positive afferent neurons, is likely due to an inability of small afferent neurons to transganglionically transport CTB rather than a true absence of LA nociceptive terminals in the region.

3. PERIPHERAL INNERVATION OF URETHRAL AND ANAL RHABDOSPINCTERS

The urethra and anal canal are surrounded by bands of striated muscle fibers; the urethral and anal rhabdosphincters, respectively as they pass through the pelvic diaphragm. The muscles do not attach to skeletal structures and thus act as true sphincters (i.e. contraction produces virtually no movement except constriction of the lumen). In addition, there are small, thin bands of striated muscle (compressor urethra, urethrovaginal sphincter, bulbocavernosus, and ischiocavernosus) that surround the urethra, vagina, and/or rectum and have connective tissue attachments to the perineal body.(522)

The urethral rhabdosphincter, anal rhabdosphincter, bulbocavernosus, and ischiocavernosus muscles are innervated by the pudendal nerve,(538, 539, 558, 559) which originates from the S2-4 sacral roots and passes along the lateral surface of the internal obturator and coccygeus muscles and through Alcock's canal (Figure 40B). As the nerve passes through the canal, it branches into the inferior rectal nerve (which innervates the anal rhabdosphincter), the perineal nerve (which innervates the urethral rhabdosphincter, the bulbospongiosus muscle, the ischiocavernosus muscle, superficial transverse perineal muscle, and the labial skin), and the dorsal nerve of the clitoris. The branches of the perineal nerve are more superficial than the dorsal nerve of the clitoris and, in most cases, travel on the superior surface of the perineal musculature. The terminal branch of the perineal nerve to the striated urethral sphincter travels on the surface of the bulbocavernosus muscle then penetrates the urethra to innervate the sphincter from the lateral aspects (Figure 40B). The specific innervation of the smaller bands of muscles attached to the perineal body has not been characterized.

Nerve fascicles(560), as well as the motor nerve terminals and end plates(548) of the urethral rhabdosphincter, are preferentially located along the lateral aspects of the urethra in rat. Overlap, or crossing of the midline, between the left and right pudendal nerve terminal fields has been described in monkey anal rhabdosphincter(561). The rhabdosphincter of both men and women contain neuronal nitric oxide synthase (nNOS), which is contained in a subpopulation (43%) of the muscle fibers, as well as nerve fibers, with concentration at the neuromuscular junction in humans and sheep.(562, 563) Additionally, nNOS has been localized to pudendal motor neurons, which innervate the rhabdosphincter in rats, cats, monkeys, and humans.(564, 565) nNOS is responsible for producing the transmitter nitric oxide (NO). While NO is known to increase cGMP levels in many types of smooth muscle; its role in control of striated muscle and in neuromuscular transmission is not well established.(566) An NO donor has been shown to

reduce urethral pressures at the level of the rhabdosphincter,(567) but it is difficult to determine if the effect is on smooth or striated muscle.

The possibility that the urethral rhabdosphincter receives a "triple innervation" from somatic, parasympathetic, and sympathetic nerves(568) as raised in early histological studies. However, this has been disputed by subsequent studies(569) that showed no physiological effects of autonomic nerve stimulation on striated sphincter function and showed that the autonomic fibers are only "passing through" the outer layer of striated muscle to reach the inner layers of smooth muscle.

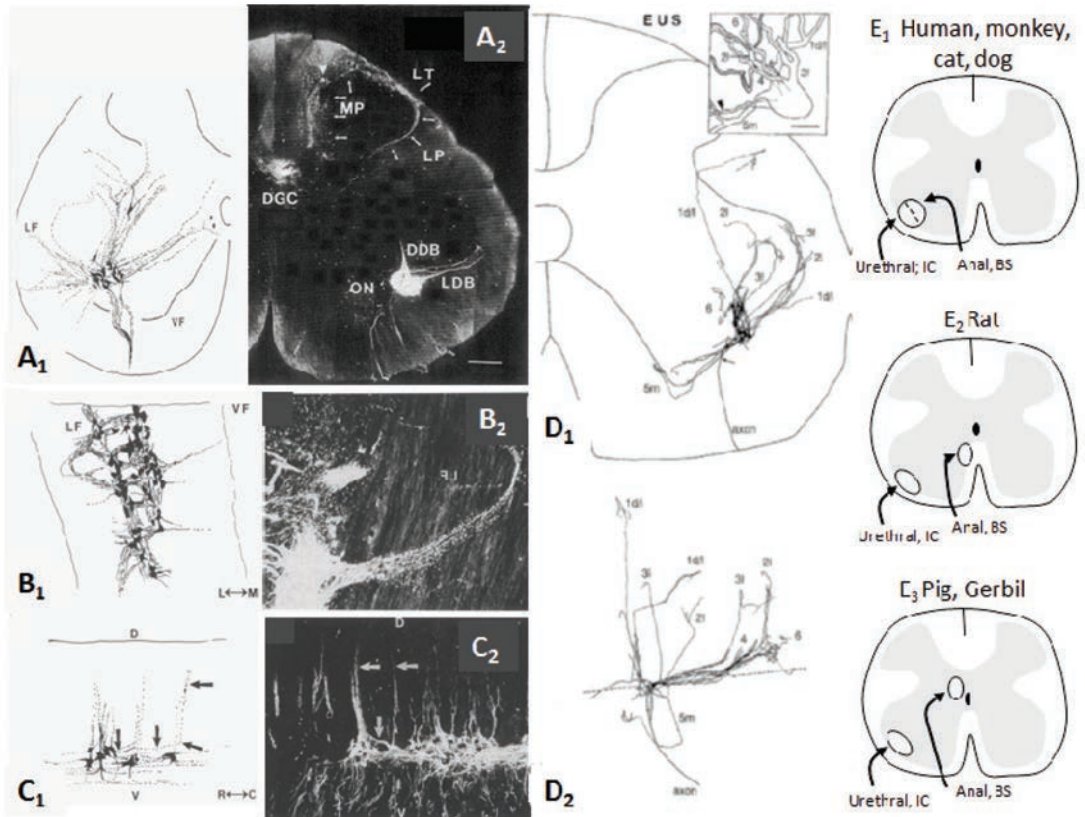

Figure 41: A-C. Composite drawings (A1-C1) and photomicrographs (A2-C2) of pudendal motor neurons in cat labeled by application of horseradish peroxidase (HRP) to the pudendal nerve as seen in transverse (A), horizontal (B), and sagittal (C) sections. The photographs provide raw data from 1 of the single sections used to make the corresponding composite drawing. Note that the dendrites of pudendal motor neurons project into the lateral funiculus (LF). D=dorsal, V=ventral, M=medial, L=lateral, R=rostral, C=caudal. DDB=dorsal dendritic bundle, LDB=lateral dendritic bundle. Primary afferent terminal labeling can also be seen in Lissauer's tract (LT), the lateral pathway (LP), medial pathway (MP), and dorsal gray commissure (DGC) in panel A1. (Primary afferents were not drawn in panel A1, only motor neurons). Adapted from Thor et al., 1989. D. Composite drawing of a single pudendal motor neuron labeled by intracellular injection of HRP showing the transverse (D1) and sagittal (D2) distribution of dendrites (Designations, such as 1d/l, 2l, 3l, 6 etc., indicate individual dendrites that are seen in both panels D1 and D2). The arrow head in the insert of D1 indicates the cell's axon. The dashed line in D2 represents the border between the ventral horn and ventral funiculus. Inset in D1 is a 3D rendition of the neuron. Adapted from Sasaki et al 1994. E. Diagrams comparing locations of urethral rhabdosphincter and ischio-cavernosus (IC) versus anal rhabdosphincter and bulbospongiosus (BS) motor neurons in various species.

3.1. Urethral and Anal Rhabdosphincter Motor Neurons

Pudendal motor neurons that innervate the urethral and anal rhabdosphincters (and bulbocavernosus and ischiocavernosus) muscles are situated along the lateral border of the sacral ventral horn in Onuf's nucleus in human(570) monkey,(571) dog, cat(572,

573) and guinea pig.(574) Studies in cat,(539) monkey,(538) and human(570) show that urethral rhabdosphincter motor neurons occupy a ventrolateral position and anal rhabdosphincter motor neurons occupy a dorsomedial position within the confines of Onuf's nucleus (Figure 41A). However in other species, urethral and anal rhabdosphincter motor neurons are located in separate nuclei (Figure

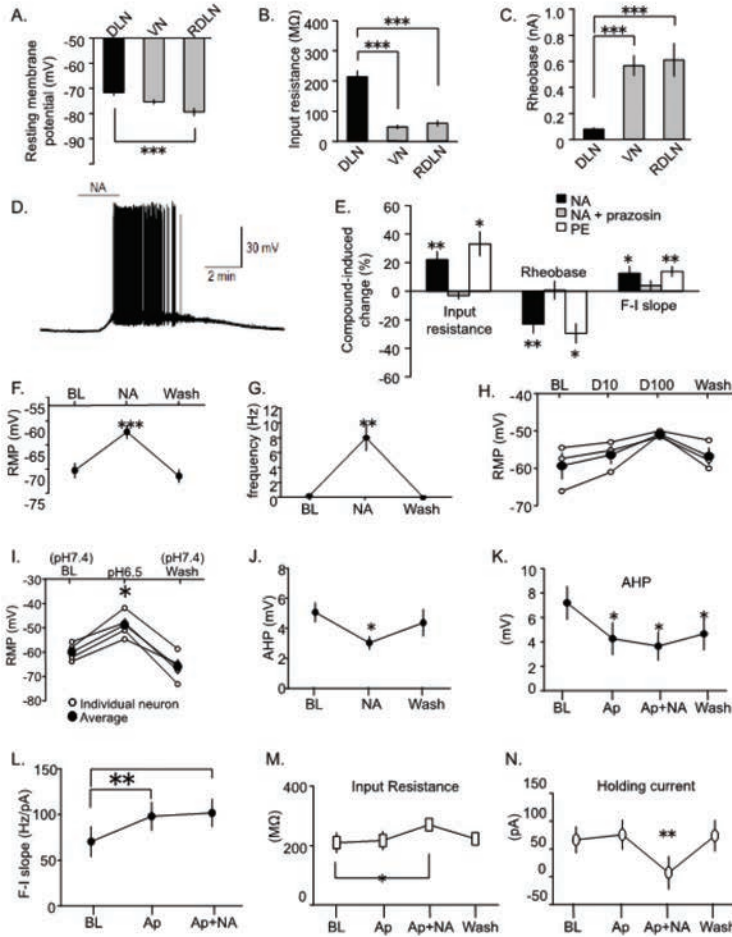

Figure 42: Membrane properties, responses to noradrenaline, and involvement of TASK and SKCa channels in retrogradely-labeled rhabdosphincter motor neurons recorded using patch clamp electrophysiology in L5/6 spinal cord slices from 6-14 day old female rats. Comparison of resting membrane potential (RMP, A), input resistance (B), and rheobase (C) in urethral rhabdosphincter motor neurons (dorsolateral nucleus, DLN), axial motor neurons (Ventral nucleus, VN), and hindlimb motor neurons (retrodorsolateral nucleus, RDLN). D) Noradrenaline (NA, 20 μ M) depolarizes rhabdosphincter motor neurons and induces robust firing. E) NA and phenylephrine (PE), and alpha1 adrenoceptor agonist, increase input resistance, rheobase, and firing rate-current injection (F-I slope) relationship in a prazosin-sensitive (alpha1 adrenoceptor antagonist) manner in rhabdosphincter motor neurons. Significant and reversible, mean increases in RMP (F) and firing frequency (G) in rhabdosphincter motor neurons produced by NA (20 μ M). Doxapram (H), a TASK channel blocker, at 10 μ M (D10) and 100 μ M (D100), mimics NA's ability to depolarize rhabdosphincter motor neurons. Decreasing extracellular pH to 6.5 (I), which closes TASK channels, mimics NA's ability to depolarize these neurons. NA significantly reduces the afterhyperpolarization (AHP) in rhabdosphincter motor neurons (J) in a prazosin-resistant manner. Apamin (A), an SKCa channel blocker, reduces AHP (K), increases the F-I slope (L) and occludes NA's ability to reduce the AP and increase the F-I slope. Apamin does not influence the input resistance (M) or holding current (N), nor occludes NA's ability to do so. From Yashiro et al., 2010.

41E). In rat,(537) anal sphincter (and bulbospongiosus) motor neurons are located medially in the ventral horn, just ventrolateral to the central canal; while the urethral sphincter (and ischiocavernosus) motor neurons are located in the same region as others species, i.e. along the lateral edge of the ventral horn.

Sphincter motor neurons are different from motor neurons that innervate skeletal muscles. They are densely packed within the confines of Onuf's nucleus and exhibit tightly bundled dendrites that run rostrocaudally within the confines of the nucleus. Transverse dendrites are particularly unique in bundling and projecting laterally into the lateral funiculus, dorsally towards the sacral parasympathetic nucleus, and dorsomedially towards the central canal (Figure 41).(539, 573) This is similar to bladder preganglionic neurons,(575) suggesting that rhabdosphincter motor neurons and preganglionic neurons receive inputs from similar spinal regions. The dense packing and dendritic bundling of sphincter motor neurons may be related to their special sphincteric function and facilitate simultaneous activation of sphincter motor units. Recurrent axon collaterals (Figure 41D)(573) in the absence of recurrent inhibition(576) suggests a recurrent facilitation that may also reinforce simultaneous activation. Finally, the arrangement of peripheral motor nerve terminals bilaterally at dorsolateral and ventrolateral positions in the urethra may also provide symmetrical force generation.(548)

Rhabdosphincter motor neurons are also physiologically different from skeletal muscle motor neurons in that they do not exhibit significant monosynaptic inputs,(552) Renshaw cell inhibition(552), nor crossed disynaptic inhibition(576). Patch clamp recordings from urethral rhabdosphincter motor neurons in spinal slices(577) demonstrate higher resting membrane potentials, higher membrane resistance, and a lower rheobase compared to other motor neurons in the slice (Figure 42A-C). These *in vitro* results are similar to *in vivo* results that also showed unique passive membrane properties (e.g. high input resistance, low rheobase, short after-hyperpolarization, membrane bistability, and non-linear responses to depolarizing current injection, which was recently reviewed.(578) This combination of biophysical properties is uniquely conducive to simultaneous, prolonged, tonic activity, in keeping with the anatomical and functional properties described above.

3.2. Afferent Innervation of the Urethral and Anal Rhabdosphincters

Various studies have characterized primary afferent neurons sending axons into the pudendal nerve.(537, 539) However this nerve carries the innervation to many visceral structures (e.g. urethra, genitalia, rectum, vagina) in addition to skin and rhabdosphincters, thus it is difficult to specifically characterize the sensory innervation of the sphincters per se. Nevertheless, the paucity of large sensory neurons in sacral dorsal root ganglia following application of tracers to

the pudendal nerve suggests that the sensory innervation of the rhabdosphincters does not contain large myelinated fibers (i.e. Type Ia and Ib) that innervate these sensory organs(549-551, 579) that typically innervate muscle spindles, Golgi tendon organs, or Pacinian corpuscles. Indeed, multiple investigators using various techniques have not found muscle spindles or Golgi tendon organs in the rhabdosphincters. This is consistent with the finding that the pudendal nerves lack small g motor neuron axons (which innervate muscle spindles)(579) and the absence of rhabdosphincter connections to bone by tendons. On the other hand, Pacinian corpuscle-like structures have been found in the urethra of cat(551) and may play a role in sensing urine flow during micturition to inhibit sphincter activity and/or reinforce detrusor contractions.

The spinal terminals of pudendal primary afferent fibers are distributed throughout laminae I, V, VII, and the dorsal gray commissure (Figure 41A₂), while labeling in laminae III and IV is well-defined and restricted to the medial third of the dorsal horn.(539) This restricted pattern in laminae III and IV is consistent with the somatotopic organization expected for cutaneous mechanoreceptors originating in the perineal skin(580). Local injection of tracers targeted to the urethral and anal rhabdosphincters(539) only produced labeling of the spinal terminals of primary afferent neurons in lateral and medial lamina I, the intermediate gray matter, and the dorsal commissure gray matter, not in laminae III or IV. Since the HRP likely spread into the urethra and rectum, it is possible that this labeling occurred in visceral as well as rhabdosphincter afferent pathways. However, since no labeling was seen in large diameter primary afferent neurons nor in terminals in medial laminae III and IV (cutaneous fields) nor medial lamina VI, an area where large diameter myelinated fibers of muscle spindle and Golgi tendon organs nerves terminate(554, 555) it is reasonable to conclude that the rhabdosphincters are not significantly innervated by large myelinated nerve fibers typically associated with other striated muscle.

4. REFLEX ACTIVATION OF URETHRAL AND ANAL RHABDOSPHINCTERS

Rhabdosphincter motor neurons can be activated via segmental (536, 581, 582) and descending pathways (Figure 43).(523, 583) The segmental inputs can be activated by stretch receptors and nociceptors in the bladder or urethra or genitalia.(584) Electrophysiological studies in cats(539, 581, 582, 585) show that stimulation of either pelvic nerve or pudendal nerve afferent fibers can activate polysynaptic spinal segmental reflexes that can be recorded at central delays of 1.5 msec with intracellular electrodes in sphincter motor neurons(586, 587) and at a latency of about 10

msec from electrodes placed on pudendal nerve efferent fibers or inserted directly into the urethral or anal rhabdosphincter muscles.(585, 588, 589) The segmental reflex is considered polysynaptic based on the latency(586, 587) and retrograde transynaptic labeling of interneurons in laminae I and V of the dorsal

horn and in the dorsal gray commissure by pseudorabies virus (PRV) injected into the urethral rhabdosphincter(590). The dorsal horn interneurons are likely those that participate in the segmental reflex activation of sphincter motor neurons while the dorsal gray commissure interneurons are likely inhibitory (see below). Studies in rats also show that electrical

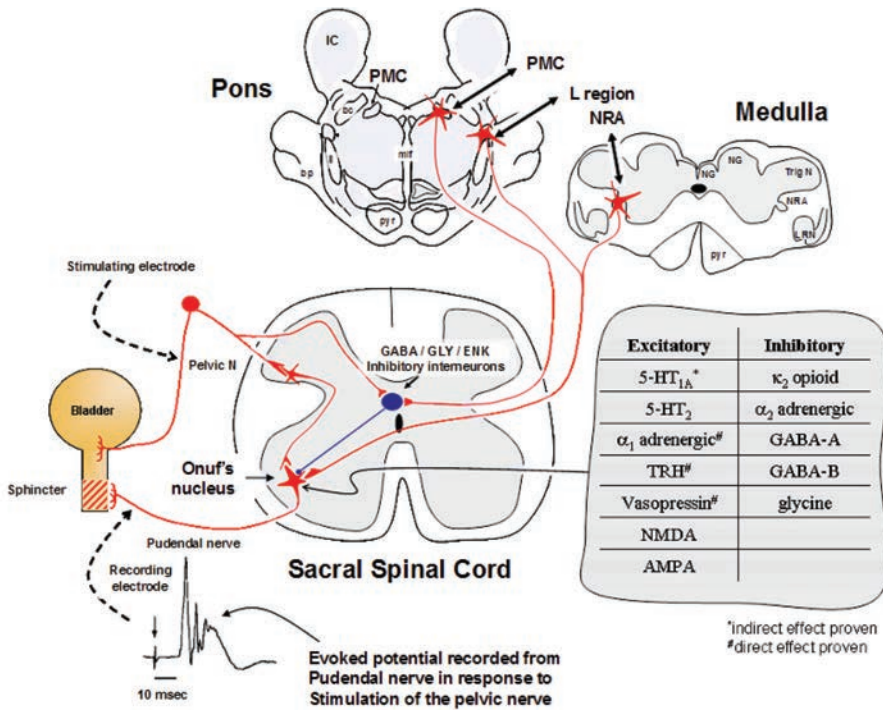

Figure 43: Drawing of proposed model for spinal and supraspinal excitation and inhibition of rhabdosphincter pudendal motor neurons. Example depicts evoked potential recorded by an electrode on the pudendal nerve in response to electrical stimulation of pelvic nerve (0.5 Hz; table showing the predominant effects of various receptor subtypes on evoked potentials recorded from the pudendal nerve or urethral rhabdosphincter). Red stellate shapes and lines represent excitatory neurons and their axonal pathways, respectively; black oval shape and line represent an inhibitory interneuron and its axonal pathway. Stimulation of the pelvic nerve activates a polysynaptic spinal reflex arc that produces an evoked potential recorded from axons of sphincter motor neurons in Onuf's nucleus at a latency of about 10 msec. This stimulation also activates inhibitory interneurons that, after 50 msec delay, produce inhibition of sphincter motor neurons for about 1,000 msec. Presumably this arrangement allows low frequency pelvic afferent activity (1 Hz) to increase sphincter activity during urine storage and to inhibit sphincter activity when the pelvic afferent activity markedly increases (> 5 Hz) as might occur with very large bladder volumes or during a micturition contraction. The model includes GABAergic, glycinergic, or enkephalinergic inhibitory neurons located in the dorsal gray commissure. Supraspinal pathways originating in the medullary nucleus retroambiguus (NRA) and the pontine "L region" can activate sphincter motor neurons during Valsalva maneuvers and during urine storage, respectively. When micturition occurs, neurons in the pontine micturition center (PMC) provide descending activation of the GABAergic, glycinergic, or enkephalinergic neurons in the dorsal gray commissure to inhibit sphincter motor neurons and allow voiding to begin. Various other areas of the brain (e.g. medullary raphe serotonergic pathways, pontine locus coeruleus noradrenergic pathways, etc) provide "modulation" of the reflexes. Those excitatory and inhibitory modulatory pathways that have been explored pharmacologically are also listed in the table.

Abbreviations: IC=inferior colliculus; NG=nucleus gracilis; NC=nucleus cuneatus; TrigN=spinal nucleus of the trigeminal nerve; LRN=lateral reticular nucleus; pyr=pyramidal tract; mlf=medial longitudinal fasciculus; ll=lateral lemniscus; bc=brachium conjunctivum; bp=brachium pontis; GABA=gamma amino butyric acid; GLY=glycine; ENK=enkephalin; TRH=thyrotropin releasing hormone; NMDA=N-methyl D-aspartate; AMPA=a-amino-3-hydroxy-5-methyl-4-isoxazolepropionic acid; 5-HT=5-dihydroxytryptamine (from Thor 2010).

stimulation of afferent axons in the pelvic nerve elicits reflexes in pudendal nerve efferent fibers or the urethral rhabdosphincter(591, 592) similar to the cat. Also similar to the cat, PRV injected into the urethral rhabdosphincter(593) labels interneurons in laminae I and V of the dorsal horn and in the dorsal gray commissure.

Previously, the afferent inputs from the urinary bladder have been emphasized as being of primary importance for activation of the segmental reflex by pelvic nerve stimulation because bladder distension will activate the urethral rhabdosphincter(594). This reflex activation is often referred to as the “guarding reflex” or “continence reflex”. However, recent studies are placing greater emphasis on urethral afferent fibers.(595, 596) It is tempting to speculate that the guarding reflex is actually activated more vigorously by urethral afferent fibers if urine inadvertently begins to pass through the bladder neck and into the proximal urethra, with a requirement for a rapid closure of the more distal urethral sphincter (i.e. guarding against urine loss) compared to simple bladder distension or increases in intravesical pressure.

The greater importance of urethral afferent fibers is also suggested by experiments where bladder afferent fibers are electrically stimulated. For example, in studies by McMahon et al(581), electrical stimulation of pelvic nerve fibers close to the bladder was not able to evoke pudendal nerve firing in a large proportion of cats but placement of electrodes more centrally on the pelvic nerve was able to evoke firing. Karicheti and Thor (unpublished observations) also found that stimulating nerve bundles close to the bladder is often ineffective in producing a spinal reflex to the urethral rhabdosphincter, but in the same animals it evokes reflex activity on the hypogastric nerve (indicating that the electrical stimulation is activating bladder afferent fibers). Furthermore, it was possible to consistently evoke a reflex when the stimulus was applied more centrally on the pelvic nerve, which would include fibers from the urethra. Since the more central electrode placement would also activate colonic and genital afferent fibers, additional experiments are needed to specifically compare urethral versus bladder versus colonic afferent fibers in evoking the “guarding reflex”.

Electrical stimulation of pudendal afferent fibers also evokes a spinal reflex to activate the rhabdosphincter in cat(597, 598) and rat.(592) Since some urethral afferent fibers (as well as rectal, genital, and cutaneous afferent fibers) travel in the pudendal nerve, it is possible that the spinal urethral rhabdosphincter activation by pudendal afferent stimulation is also a manifestation of the “guarding reflex”.

Sphincter reflexes in the cat also exhibit prolonged changes in excitability following short trains (5-10 second) of electrical stimulation of afferent axons in the pudendal nerves.(597) Recordings from sphincter motor neurons in the sacral spinal cord and from rhabdosphincter peripheral motor axons revealed

that stimulation of pudendal afferent axons elicited not only short latency transient responses but also sustained activity persisting for 3-30 seconds after the end of the stimulus train.(597) The persistent activity was associated with a small membrane depolarization and was terminated by small hyperpolarizing currents. Similar persistent activity has been observed in hindlimb motor neurons with slow axonal conduction velocities similar to those of sphincter motor neurons. (599)

5. INHIBITION OF URETHRAL RHBDSPHINCTER (URS) REFLEXES DURING VOIDING

Voiding is induced voluntarily or reflexively by neural circuitry in the brain.(600) For voiding to occur, there must be contraction of the bladder and simultaneous relaxation of the urethral rhabdosphincter. These responses are mediated by descending projections from neurons in the pontine micturition center (PMC) that excite the sacral autonomic outflow to the bladder and inhibit the motor outflow to the sphincter (Figure 43). This coordination is lost following spinal cord injury.(600) Electrical or chemical stimulation in the PMC in cats excites the bladder and inhibits sphincter EMG activity(590, 601, 602) and hyperpolarizes sphincter motor neurons.(597) The descending inhibitory pathway from the PMC to sphincter motor neurons is thought to involve spinal GABAergic inhibitory neurons in the dorsal commissure of the sacral spinal cord (Figure 43).(603, 604) A role for glycinergic and enkephalinergic interneurons in the dorsal commissure has also been proposed(590, 604-606) in mediating inhibition of the sphincter during voiding (Figure 43).

In addition to supraspinal inhibitory mechanisms, a “spinal, urine storage reflex, inhibitory center” (SUSRIC) was found that inhibited both the somatic and the sympathetic urine storage reflexes controlling the urethral rhabdosphincter and smooth muscle, respectively, in the cat. (588) Activation of this inhibitory center by electrical stimulation of the pelvic nerve afferent fibers occurs simultaneously with the activation of the URS reflex itself. The latency of the inhibition was < 50 msec and had a duration of 500-1,000 msec. Activation of this inhibitory center explains the diminished capacity of the URS evoked reflex to follow frequencies of pelvic afferent stimulation greater than 5 Hz. Physiological stimulation of the pelvic nerve afferent fibers, which occurs with distension of the bladder, has also been reported to inhibit rhabdosphincter EMG activity in both spinal intact(582) and spinalized cats in the absence of a bladder contraction and its associated inhibitory mechanisms. Possibly the inhibition of rhabdosphincter activity by distension of the bladder represents a physiological corollary for the inhibition of rhabdosphincter activity by high frequency electrical stimulation of pel-

vic nerve afferent fibers. Although the inhibitory effects are localized to the spinal cord caudal to the T₁₂ level, they are regulated by supraspinal systems that respond to 5-HT_{1A} receptor activation and enhance sphincter activity through disinhibition.(607, 608) A possible clinical correlation of SUSRIC activation may be the elegant demonstration in men that conditioning stimuli applied to the dorsal nerve of the penis (i.e. pudendal nerve afferent fibers) inhibited urethral rhabdosphincter contractions reflexively evoked by magnetic stimulation of the spinal cord applied at intervals of 20 - 100 msec after the conditioning stimuli.(609)

6. SUPRASPINAL ACTIVATION OF RHABDOSPHINCTERS AND PELVIC FLOOR MUSCLES

Supraspinal activation of urethral and anal rhabdosphincter motor neurons can be mediated in response to voluntary (i.e. corticospinal(571)), as well as involuntary reflexic inputs (e.g. during coughing, sneezing, vomiting) presumably from nucleus retroambiguus in the caudal medulla (Figure 43)(610-613). Nucleus retroambiguus also innervates the pelvic floor muscles(614), as well as abdominal muscles, consistent with a role in raising intra-abdominal pressure during Valsalva maneuvers. Generally, the pelvic floor and rhabdosphincter muscles are activated as a functional unit when voluntarily contracted. However, differential activation of the rhabdosphincter and the pelvic floor muscles has been demonstrated,(615) indicating distinct CNS control systems and innervation.

Rhabdosphincter motor neurons are unique among somatic motor neurons in receiving input from the paraventricular hypothalamus,(583) although the function of this input has not been determined. In addition, their input from brainstem serotonergic and noradrenergic neurons is among the densest in the spinal cord.(616, 617)

7. NEUROCHEMICAL ANATOMY OF RHABDOSPHINCTER MOTOR NEURONS

In addition to their unique morphology, neurophysiology, and supraspinal inputs, rhabdosphincter motor neurons in Onuf's nucleus also exhibit a plethora of unique and highly diverse neurotransmitters, receptors, ion channels, and growth factors (Figure 43) and indicate a role in continence and/or sexual function.

7.1. Pharmacology of Urethral and Anal Rhabdosphincters (Figure 43)

The excitatory amino acid neurotransmitter, glutamate, mediates initiation of action potentials in rhabdosphincter motor neurons (and subsequent

rapid contraction of the muscle) by binding to NMDA and AMPA receptors.(618-623) Thus it is useful to think of these transmitters as part of the "hardwired" reflex circuitry that is involved in all or none activation of consistent and reliable storage reflexes, as compared to monoamines and peptide transmitters.

The inhibitory amino acids glycine, acting through strychnine-sensitive ionotropic receptors,(624) and GABA, acting through both GABA-A (ionotropic) and GABA-B (metabotropic) receptors(625-627) are thought to be major inhibitory transmitters regulating rhabdosphincter activity. Clinical studies indicate that systemic(324) or intrathecal(627) administration of the GABA-B agonist, baclofen, may reduce bladder-sphincter dyssynergia in some patients with neurogenic bladder.

In addition to amino acid transmitters, the monoamine transmitters (norepinephrine and serotonin) are also important in modulating rhabdosphincter motor neuron activity. (628) It was the preferential distribution of norepinephrine and serotonin terminals in Onuf's nucleus(616, 617) that led to extensive animal studies of noradrenergic and serotonergic control of rhabdosphincter function and eventual clinical studies of duloxetine, a norepinephrine and serotonin reuptake inhibitor, as a treatment for stress urinary incontinence.(584, 613, 629-631) Elegant studies in humans using magnetic stimulation of brain and sacral nerve roots(632) have indicated that duloxetine increases the excitability of rhabdosphincter motor neurons to both supraspinal and segmental inputs to increase urethral pressures. Importantly, duloxetine's ability to increase urethral rhabdosphincter activity did not interfere with the inhibition of sphincter activity during voiding (i.e. bladder-sphincter synergy was well-maintained).(584) Similar clinical results occurred after administration of S,S-reboxetine, a selective norepinephrine reuptake inhibitor.(633, 634) This approach of increasing synaptic levels of serotonin and/or norepinephrine is logical, since it has been shown that noradrenergic and serotonergic terminals associated with rhabdosphincter motor neurons show an age-dependent decrease in density in rats(324) that might explain the increased incidence of stress incontinence with aging.

Multiple adrenergic receptor subtypes play a role in control of rhabdosphincter motor neurons, and the results with norepinephrine reuptake inhibitors indicate that these receptors can be activated by endogenous norepinephrine.(585) Strong evidence exists that α_1 adrenoceptors excite rhabdosphincter motor neurons.(585, 635) Patch clamp studies(577) have shown that norepinephrine produces a direct depolarizing effect, accompanied by an increase in input resistance and decreased rheobase (Figure 42D-G). These excitatory effects are largely mimicked by the α_1 adrenoceptor agonist, phenylephrine, blocked by the α_1 adrenoceptor antagonist, prazosin, but were resistant to apamin (Figure 42M-N), a small conductance Ca⁺² activated K⁺ (SK_{Ca}) channel blocker. Excitatory effects of α_1 adrenoceptor stimulation on

rhabdosphincter neurons are supported by clinical studies(635) where decreases in rhabdosphincter activity were seen after administration of prazosin to human subjects. On the other hand, strong evidence exists that α_2 adrenoceptor stimulation has the opposite effect, i.e. inhibition, of rhabdosphincter activity.(585, 615, 636) Importantly, reflex activity in the sympathetic pathway to the urethral and anal smooth muscle (i.e. the hypogastric nerve) shows similar adrenergic pharmacology-an enhancement of activity by α_1 adrenoceptors(585) and inhibition of activity by α_2 adrenoceptors.(585, 637)

Multiple subtypes of serotonin (5-hydroxytryptamine, 5-HT) receptors are also involved in modulating rhabdosphincter motor neuron excitability. Strong evidence exists that 5-HT₂ receptors can excite sphincter motor neurons.(598) Indeed duloxetine's facilitatory effects on rhabdosphincter activity in anesthetized cats are mediated in part through activation of 5-HT₂ receptors.(584) Both 5-HT_{2A} and 5-HT_{2C} receptor agonists increase rhabdosphincter EMG activity in dogs, guinea pigs, and rats.(586, 638, 639) Recent *in vitro* rat spinal cord slice patch clamp studies show that part of this effect may be directly on rhabdosphincter motor neurons, as opposed to interneurons,(640) since 5-HT induces a direct depolarization of rhabdosphincter motor neurons. The effect of 5-HT to enhance the bistable behavior, plateau potentials and persistent firing of motor neurons(641) very likely contributes to its facilitatory effect on sphincter reflexes and sphincter motor neuron firing.(597) Interestingly, substance P, a peptide transmitter that is co-localized with 5-HT in raphespinal nerve terminals, also produces direct depolarization of rhabdosphincter motor neurons in rat spinal cord slices,(642) and thyrotropin releasing hormone (TRH), another peptide transmitter co-localized with 5-HT in nerve terminals, induces excitation of rat sphincter activity(643) *in vivo*.

Immunohistochemical and molecular studies in humans and dogs have shown that 5-HT_{2A}, 5-HT_{2B}, and 5-HT_{2C} receptor subtypes are associated with Onuf's nucleus motor neurons. In addition, 5-HT_{2C} receptor mRNA has been localized to anal sphincter motor neurons in the rat.(644) On the other hand, another immunohistochemistry study with retrograde labeling of urethral rhabdosphincter motor neurons and ischiocavernosus motor neurons in male rats indicates that the 5-HT_{5A} receptor is associated with the rhabdosphincter motor neurons, while the 5-HT_{2A} receptor is preferentially associated with the ischiocavernosus motor neurons(171) and thus may be preferentially involved in sexual function.

As described above, supraspinal 5-HT_{1A} receptor stimulation also enhances rhabdosphincter activity in cats.(607, 608) Importantly, the excitatory effects of 5-HT_{1A} receptor agonists on the rhabdosphincter can still be "over ridden" by inhibitory mechanisms during voiding, i.e. bladder-sphincter synergy remains despite 8-OH-DPAT induced enhancement of

rhabdosphincter activity.(607, 608, 645) The enhancement of sphincter activity by 8-OH-DPAT in cats is not seen following acute(645) or chronic(607) spinal cord transection, indicating the 5-HT_{1A} receptors mediating these effects are located supraspinally. 5-HT_{1A} receptor activation may inhibit supraspinal neurons that facilitate SUSRIC-mediated inhibition of sphincter reflexes and thereby facilitate URS activity through disinhibition.

In addition to amino acid and monoamine control of the rhabdosphincter motor neurons, peptides have also been shown to influence their activity. Onuf's nucleus is densely innervated by the opioid peptides enkephalin and dynorphin.(646, 647) In cats, the k opioid receptor agonist, ethylketocyclazocine, selectively inhibits spinal rhabdosphincter reflexes.(589) However, attempts to block sphincter inhibition during voiding with high doses of the opioid receptor antagonist, naloxone, were unsuccessful, indicating the enkephalins are not mediating physiological inhibition. In spinal intact rats, it was found that a k₂ opioid receptor agonist inhibits the rhabdosphincter bursting pattern associated with micturition, leading to decreased voiding efficiency.(607) In these studies, k opioid receptor stimulation had no influence on the asynchronous rhabdosphincter activity that precedes and follows micturition-associated bursting, only on the bursting itself. Onuf's nucleus is abundantly invested with other peptidergic terminals. Excitatory effects of peptides; vasopressin, thyrotropin-releasing hormone (TRH) and substance P (SP), on rhabdosphincter motor neurons have been demonstrated.(642)

8. LA AND RHABDOSPINCTER NEUROPATHY

Childbirth is a risk factor for development of pelvic organ prolapse (POP).(648) Furthermore, various studies have indicated damage to the innervation of the pelvic floor muscles, which might be expected to initiate pelvic descent and prolapse.(649) Early studies using pudendal nerve terminal latency as a measure of nerve damage(650) were met with skepticism for many reasons, however with more sophisticated analyses using EMG interference patterns a more recent series of elegant studies(649, 651) have provided evidence that LA nerve damage accompanies parturition in about 25% of women with approximately 1/3 of those continuing to show evidence of nerve damage at 6 months after parturition.(651, 652) Importantly, women undergoing elective Caesarian section (i.e. without preceding labor) showed no signs of LA nerve damage.(649) Furthermore, changes in function of the urethral rhabdosphincter were also associated with pregnancy (i.e. before labor), and these remained evident at 6 months postpartum.(649, 652) In rabbits,(653) it has also been shown that multiparous females have thinner, longer, and weaker pubococcygeus muscles than nulliparous females, which

A**B**

Figure 44: Relative expression of BDNF and β II-tubulin mRNA in Onuf's nucleus. A: Images of Onuf's nucleus from a laser dissection microscope. Purple coloration is from thioinin staining of neuronal cell bodies. The circled group indicates Onuf's nucleus, which was cut and collected using laser microdissection, and subsequently used for quantitative RT-PCR. Bar = 100 μ m. B: Relative expression of BDNF and β II-tubulin mRNA in Onuf's nucleus after sham or simulated childbirth injury and pudendal nerve stimulation or sham stimulation. Each bar represents mean \pm standard error of the mean of data from 10 animals. The mean RQ in Onuf's nucleus of the pudendal nerve receiving sham stimulation were normalized to 1. * indicates a significant difference compared to sham stimulation ($p < 0.05$) in the same animals. (From Jiang et al., 2013)

may indicate nerve damage also occurs in this species. A recent study comparing continent and incontinent women(654) also demonstrated that incontinent women showed evidence of poor neuromuscular function of the rhabdosphincter, and the authors indicated that there was a correlation with age.

Studies have indicated that neurotrophins such as brain derived neurotrophic factor or BDNF plays an important role in neural control of bladder storage and emptying. In addition, BDNF also is involved in neural regeneration after an injury. Recent evidence using a childbirth simulated injury model in rodents has revealed that electrical stimulation of the pudendal nerve significantly augments BDNF expression in injured motoneurons (Figure 44). This increase in trophic factors such as BDNF at the spinal cord level can accelerate axonal regeneration and improves continence.(655) While underlying mechanism has not been established, electrical stimulation of a cut or damaged peripheral nerve is likely independent of

production of trophic factors by surrounding cells though is dependent upon stimulation of factors in the regenerating axons themselves (Figure 45).(656) Other studies have used administration of insulin like growth factor-1 to activate satellite cells in the rhabdosphincter, which, in turn induces regeneration and improves continence.(657) Thus, future research might focus on the changes in administration of trophic factors or extracellular matrix that occur with pregnancy, childbirth, and aging.

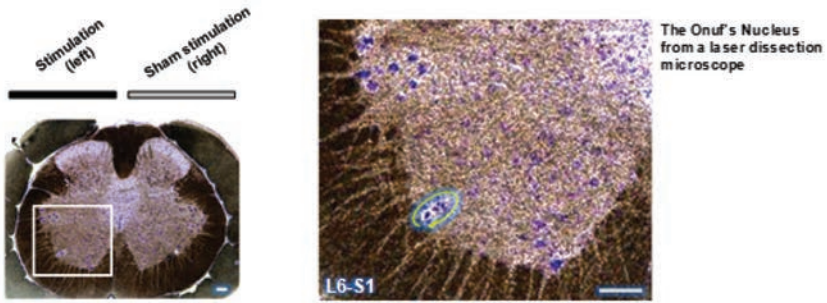
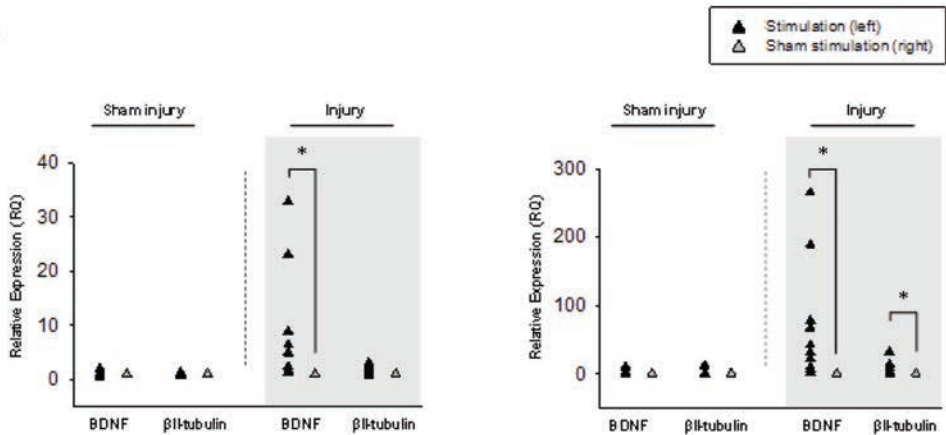
LA and pudendal nerves contribute to continence mechanisms during sneezing in rats and cats

Analysis of the urethral closure mechanisms during sneeze-induced stress conditions in anesthetized female rats and cats has revealed that pressure increases in the middle portion of the urethra are mediated by reflex contractions of the rhabdosphincter as well as the pelvic floor muscles.(594, 658) Transection of the pudendal nerves reduced sneeze-induced urethral reflex responses by 67% and transecting the

nerve to the iliococcygeus and pubococcygeus muscles reduced urethral reflex responses by an additional 25%. Transecting the hypogastric nerves and visceral branches of the pelvic nerves did not affect the urethral reflexes indicating that sneeze-evoked

urethral reflexes in normal rats were not mediated by these autonomic pathways. However, hypogastric nerve transection in conscious, chronic spinal cord injured, female rats reduced urethral baseline pressure, reduced post-void residual urine volumes, reduced maximal voiding pressure, and increased voiding efficiency. This indicates that sympathetic pathways to the bladder neck and proximal urethra contribute to urethral pressure and functional outlet obstruction and voiding dysfunction after spinal cord injury in un-anesthetized animals, but not during sneezing.(659)

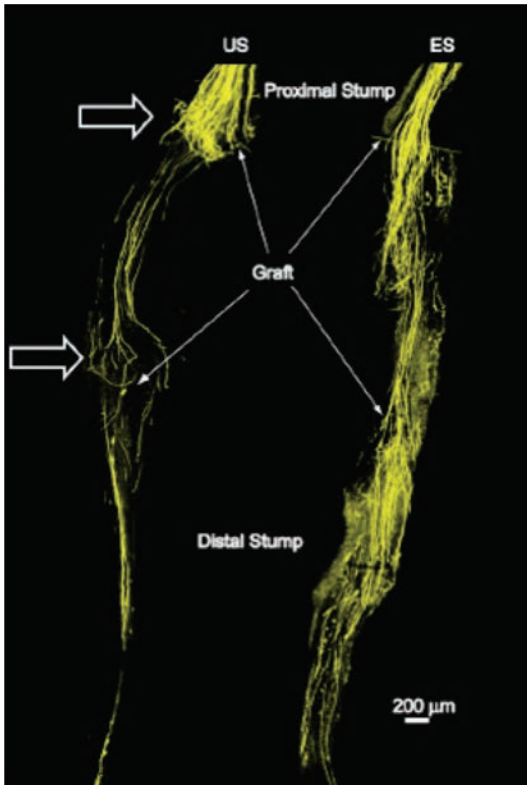

Figure 45: Low magnification images of two common fibular nerves are used to show the effects of electrical stimulation on regeneration of cut axons. Each nerve had been cut and surgically repaired 2 weeks earlier using a ca. 2 mm long graft from a wild type donor mouse. The boundaries of each graft are indicated by arrows. The overall image of each nerve is a montage, constructed from images from several microscope fields, each taken at the same confocal plane through whole mounts of the nerve. They represent a single optical section through the nerve from proximal to the lesion site to its muscle entry point. By 2 weeks after nerve repair, any residual fluorescence in the original distal stump (distal to the graft) due to degeneration of the host axons has disappeared. Fluorescence found in this region represents profiles of regenerating axons that have grown entirely through the grafts. The nerve on right (ES) was stimulated for 1 hr at the time of the nerve repair. The nerve on the left (US) was from a mouse that was unstimulated. Note that in US nerve, build-up and recurrent loopings of regenerating axons are found near the proximal and distal attachments of the host nerve to the graft (open arrows). No such effects were noted in electrically stimulated nerve and larger numbers of regenerating axon profiles are present. (From English et al., 2007)

9. SUMMARY

Neural control of the pelvic floor (LA and coccygeus) is provided by the LA nerve, while the urethral and anal rhabdosphincters are controlled by the pudendal nerve. LA motor neurons are similar in morphology to other skeletal motor neurons, showing large α and small γ neuronal populations diffusely distributed in the sacral ventral horn. One distinguishing feature, however, is projections from LA motor neurons into Onuf's nucleus, the location of rhabdosphincter motor neurons. Presumably these projections coordinate pelvic floor and rhabdosphincter function. This proposed coordination of visceral and rhabdosphincter activity with pelvic floor muscle activity is one important area for future research. Rhabdosphincter muscles and their innervation are remarkably different from skeletal muscles. The rhabdosphincter striated muscles do not have Golgi tendon organs and muscle spindles, which are common in skeletal muscles. In addition, the rhabdosphincters are intimately associated with the urethra and anal canal and participate extensively in voiding and sexual function. Thus it should not be surprising that rhabdosphincter motor neurons are quite distinctive from skeletal muscle motor neurons. In contrast to the diffuse distribution of LA motor neurons in the sacral ventral horn, the rhabdosphincter motor neurons are densely packed within Onuf's nucleus (and homologous nuclei in other species). Finally, rhabdosphincter neurons exhibit a number of unique membrane properties that may contribute to simultaneous activation and which are distinctive from skeletal muscle motor neurons. Important species differences exist in the spinal localization of anal sphincter neurons. Other distinguishing characteristics of rhabdosphincter motor neurons are their unique morphology, their association with abundant neurotransmitters and receptors, a diverse physiology, and a rich pharmacology. These differences presumably reflect their integral role in coordinating somatic and visceral function during micturition, defecation, and copulation. Denervation of both the pelvic floor and the rhabdosphincters has been associated with childbirth and aging.

V. FOREBRAIN CONTROL OF BLADDER FUNCTION

1. BACKGROUND

This contribution to the International Consultation on Incontinence should be read in conjunction with the companion section on *midbrain* control of bladder function. Its aim is to present the clinical and experimental evidence for the role of the forebrain in bladder control, and to summarize our understanding, not just of the individual brain regions mediating specific aspects of bladder behaviour, but of how they work together to evoke bladder sensations and appropriate motor activity. An important goal will be to understand how lack of control (urgency incontinence) can arise and be treated.

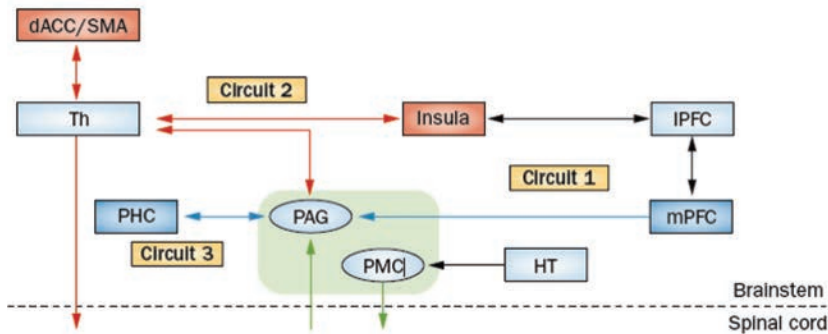

Figure 46: Working model showing forebrain part of bladder control network. Note that PAG and PMC form the link with the voiding reflex, of which they are the upper terminus. The PAG receives ascending afferents via spinal cord from bladder; passes signals on to circuits 1, 2 and 3; and receives input back from these circuits, which control the state of the PMC (storage or voiding). This model is not intended to be definitive but to serve as a stepping stone to more detailed understanding of bladder control.

The importance of the frontal cortex and brainstem in the control of voiding has long been recognized, but only in the past 2 or 3 decades has functional brain imaging come to dominate bladder control research. Most studies have been carried out using either positron emission tomography (PET) or functional magnetic resonance imaging (fMRI). A few have utilized single-photon emission computed tomography (SPECT) or near-infrared spectroscopy (NIRS). All these methods provide indirect measures of regional blood flow and assumed to be related to local neuronal activity. Each has advantages and disadvantages: PET is good for measuring long-lasting states of a system; fMRI is better for following relatively fast events, although resting-state fMRI measures long-lasting states; SPECT has rather poor temporal and spatial resolution; NIRS(660) requires no scanner but has limited penetration through the skull (10 mm) and modest spatial resolution: it has not become popular.

2. ROLE AND IMPORTANCE OF CEREBRAL CONTROL OF VOIDING

Normal human micturition is organized in 2 phases, storage and voiding, governed by reflexes involving the midbrain, brainstem and spinal cord. During storage (99.8% of the time in health) the urethral sphincter mechanism contracts tonically, preventing urine leakage, while the detrusor remains relaxed, so as to avoid developing a pressure that would expel urine.

During voluntary voiding, the urethral sphincter relaxes, facilitating urine flow, and the detrusor contracts so as to expel urine. This coordinated relaxation and contraction is driven by a long-loop, spinobulbospinal, voiding reflex.(600) As the bladder fills, increasingly strong bladder afferents travel via the sacral cord to the brainstem and midbrain. If a certain

trigger level is exceeded in the midbrain periaqueductal grey (PAG), a pontine nucleus (the pontine micturition centre, PMC) is excited, the voiding reflex is triggered and voiding occurs. Thus this spinobulbospinal voiding-reflex pathway functions like a switch, either “off” (for storage) or “on” (for voiding). (661)

In the absence of higher control, such switching behaviour would lead to involuntary bladder emptying (i.e. incontinence) whenever the bladder volume reached the critical level sufficient to trigger the brainstem switch. However underlying this apparently simple mode of behaviour are complex networks of cerebral neurons (Figure 46). During storage of urine the ascending afferent signals received by the midbrain periaqueductal grey (PAG) are relayed to higher regions of the brain, generating unconscious changes (for example, changes in connectivity)(662-664) as well as conscious bladder sensations which are factored into the assessment of whether voiding is appropriate. Crucially, motor output from these higher centres is able to suppress or promote voiding by manipulating the switch at brainstem level.

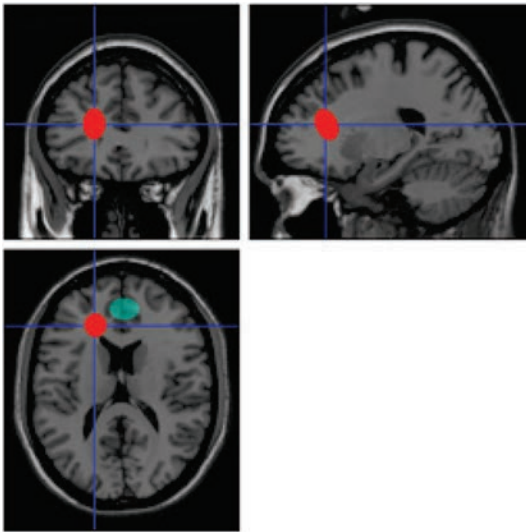

Figure 47: In Andrew and Nathan's series, regions where cortical lesions led to temporary incontinence (turquoise, in grey matter) or permanent incontinence (red, in white matter). Modified from Maurice-Williams 1974 and from a sketch made by Dr Nathan, kindly provided by Dr Clare Fowler (private communication).

This arrangement forms the substrate for the bladder behaviour characteristic of our species. Embarrassment caused by inappropriate voiding and feelings of shame about incontinence are deeply embedded in human behaviour. Voiding at a socially acceptable time and place is achieved by maintaining strict voluntary control of the voiding reflex. Knowledge of the extent to which one's bladder content is 'safe' is central in this process. Thus, voluntary control of the bladder and urethra has 2 important aspects: registration of bladder filling sensations and manipulation of the voiding reflex switch. The PAG seems to play a pivotal role in both: as shown in Figure 46, on the one hand it receives bladder afferents(665) and transmits them to higher brain centres and into the realm of conscious sensation; on the other hand it receives projections from those higher centres which thus provide critical input to the voiding reflex.(666) This input to the PAG, together with some direct input from the hypothalamus (Figure 46), normally suppresses excitation of the PMC during bladder filling, so preventing voiding or incontinence. Thus the net effect of higher control during the storage phase is tonic suppression of the voiding reflex. If voiding becomes *necessary* (bladder volume is large), and is judged (perhaps unconsciously) to be *safe*, and is consciously assessed to be *socially acceptable*, suppression can be voluntarily interrupted, allowing the brainstem switch to be turned on and voiding to occur. These social and emotional aspects of continence and voiding rely on the neural pathways discussed below.

3. FOREBRAIN CENTRES AND CONNECTING PATHWAYS INVOLVED IN BLADDER CONTROL

3.1. Centres versus pathways or neural networks

There is a long tradition of describing brain control of the bladder in terms of the activation of 'reflexes', 'neural circuits' or 'loops'. (667, 668) Nevertheless, most early functional imaging studies were interpreted in terms of activation or deactivation of compact regions or centres. More recently, in a second wave of imaging studies, results have again been interpreted in terms of neural circuits or connecting pathways governing various aspects of bladder control.

Sections 3 and 4 describe the older evidence for the involvement of some of the regions of the brain that have proved to be the most important for bladder control or lack of control (urgency incontinence). The results are systematized with the help of the working model that comprises a number of neural circuits working together. Finally, in sections 5 and 6, the more recent imaging results, including studies of connectivity, white-matter pathways, and the cerebral effects of treatment of urgency incontinence, are described and placed in the same provisional framework.

3.2. Frontal Lobes

Although Andrew and Nathan(669) were not the first to describe disturbances of micturition resulting from a variety of causes of frontal lobe pathology, their celebrated 1964 paper reporting the syndrome of frequency, urgency and urinary incontinence (and in some patients faecal incontinence), is regarded as seminal in the field. Their description of these patients cannot be improved upon:

"[They] were not demented, indifferent or lacking in social awareness; they were much upset and embarrassed ... The acts of micturition and defaecation occur in a normal manner; what is disturbed ... is the higher control of these acts. The lesion causes frequency and extreme urgency of micturition when the patient is awake, incontinence when asleep. The sensation of gradual awareness of increasing fullness of the bladder and the sensation that micturition is imminent, are impaired. When the syndrome is less pronounced, the sensation underlying the desire to micturate is absent, whereas the sensation that micturition is imminent still occurs. Then the patient is waylaid by a sudden awareness that he is about to pass urine; when neither sensation is experienced, the patient is amazed to find that he has passed urine. The threshold of the micturition reflex is much lowered. In the most complete form of the syndrome, the patient cannot inhibit the detrusor contraction of the micturition reflex; he is thus forced to empty his bladder as

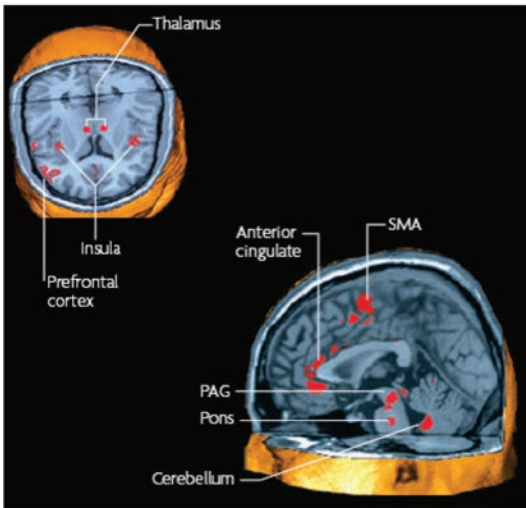

Figure 48: Brain areas involved in the regulation of urine storage. A meta-analysis of positron-emission tomography and functional MRI studies that investigated which brain areas are involved in the regulation of micturition reveals that the thalamus, the insula, the prefrontal cortex, the anterior cingulate, the periaqueductal grey (PAG), the pons, the medulla and the supplementary motor area (SMA) are activated during the urinary storage. Reproduced with permission from (DasGupta et al., 2007)

soon as the reflex occurs. When the syndrome is less pronounced, the patient can make a conscious effort to stop the act of micturition, and he may or he may not succeed ...”

The cases of leucotomy in Andrew and Nathan’s series were regarded as the most useful for localizing the lesion causing the syndrome. The significant plane of the lesion lay immediately anterior to the tips of the ventricles and the genu of the corpus callosum. Such lesions involved grey matter, in particular the superomedial part of the frontal lobe (the turquoise blob in Figure 47); but they caused a permanent disorder of the control of micturition and of defaecation only when they involved some of the white matter lateral to the anterior horns of the lateral ventricle (red blobs in Figure 47).

Subsequently the same features were observed in 7 patients out of a series of 50 consecutive frontal tumours.(670) In an analysis of patients with acute hemispheric strokes the occurrence of disturbance of micturition was found to be more common in frontal than occipital lobe lesions and there was an association with hemiparesis.(671) In 3 cases, Andrew and Nathan observed that lesions in similar areas to those discussed above led to urinary retention rather than incontinence. Three further cases of frontal lesions with urinary retention have been reported. Successful treatment brought recovery of bladder function.(672, 673)

Early studies using PET(674-677) or fMRI (678, 679) were in agreement that, during bladder filling, storage or withholding of urine, there was activity in the right inferior frontal or dorsolateral prefrontal cortex, perhaps extending into the lateral part of the superior frontal cortex. There was some right-sided predominance. In contrast there was little evidence for *activation* of the medial parts of the frontal cortex during storage. An fMRI study showed abnormally weak activation in medial prefrontal cortex in subjects with urgency incontinence,(679) and further analysis suggested that, in these subjects, bladder filling tends to provoke *deactivation* in this region. Disappointingly, there is little overlap of this medial prefrontal cortex with the superomedial frontal region described by Andrew and Nathan.(669)

3.3. Anterior cingulate cortex (ACC), supplementary motor cortex (SMA) and insula

The *anterior cingulate* is an extensive area with parts serving varied functions. The cases of aneurysm in Andrew and Nathan’s series of frontal lobe pathologies were thought to have involved the anterior end of the cingulate gyrus.(669) Incontinence was observed as part of a complex behavioural disorder following bilateral infarction of the anterior cingulate gyri. (680) A more recent report of a patient in whom

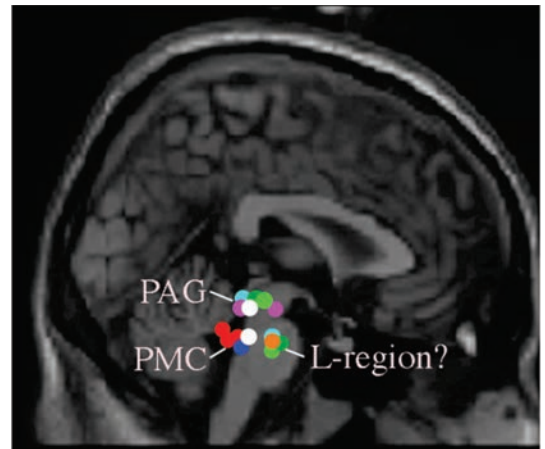

Figure 49: Summary of early PET, fMRI and SPECT studies of brainstem activation during storage and voiding phases of healthy subjects. PAG, periaqueductal grey; PMC pontine micturition centre; L-region, putative pontine incontinence centre. (Adapted from Seseke et al., 2006)

a glioma in the right posterior ACC and supplementary motor area was resected described how she experienced urgency incontinence and loss of bladder sensation following surgery.(681)

Many functional imaging studies have observed responses (mostly activations) in ACC to bladder filling, storage or withholding. (674, 677);(679, 682) The re-

ported locations trail from dorsal to ventral ACC. Figure 48, adapted from a review(683) of five PET studies, (675, 677, 684); indicates some of those locations. Response to bladder filling in the dorsal part of the anterior cingulate (dACC) is weak in Figure 48, but this cingulate region and the adjacent supplementary motor area (SMA) are often abnormally activated in patients with urgency incontinence.(679) (See Figure 50 upper left panel, for an example.) These patients, with full bladder but without any actual bladder contraction, experience the abnormal sensation of urgency (a compelling desire to void that is difficult to inhibit,(685) also associated with fear of leakage,(686) i.e. embarrassment). Thus urgency is a powerful homeostatic and social emotion that provides strong motivation to void, perhaps with motor output aimed at suppressing or delaying incontinence until a socially acceptable location can be reached. fMRI observations in rats confirm activation in the cingulate cortex during bladder filling, (687) although whether the region is homologous with the human dACC, and whether rats ever experience urgency or void voluntarily, are not known.

Co-activation of the insula with the ACC is frequently seen in functional brain imaging studies of other organ systems(688) and has been reported in almost all bladder experiments. The insula, an island of cortex deep beneath the operculum of the temporal and fronto-parietal lobes, is regarded as the seat of “interoception”, the sense of the physiological condition of the entire body, (689) including visceral sensation.(690, 691) A key feature of such sensations is an association with an affective, motivational aspect: hence their value in homeostasis. Consistent with this role, there is a correlation between the degree of bladder filling and insula activation in healthy controls with an exaggerated increase in activation at high volumes in women with poor bladder control. (679) The homolog of the insula in the rat responds to bladder filling,(687) although it is also activated during voiding.

Given these observations it is remarkable that there have not been more reported cases of bladder dysfunction from insular lesions. One patient in whom a glioma affecting the inferior frontal gyrus and the insula was excised experienced incontinence without loss of bladder sensation.(681)

Imaging studies during storage or withholding of urine show that regions reported as insula form a cluster near the expected location (see Figure 48)(674, 675, 679, 692, 693). There is slight right-sided predominance, barely visible in Figure 48. In healthy subjects, insular activation becomes stronger with increasing filling of the bladder, consistent with its postulated role in bladder sensation.(694) In normal elderly, the insular response to bladder filling decreases with age, consistent with age-associated loss of sensation. However, insula activity cannot by itself be responsible for conscious desire to void or urgency, because these sensations are lost following extensive frontal lesions,(669) suggesting that integrity of connecting

pathways between insula and frontal cortex is essential for conscious sensation.

Voiding, as opposed to storage, is considered in section 4.

3.4. Periaqueductal grey (PAG)

The PAG must be mentioned here because of its presumed pivotal role in bladder control, even though it is part of the midbrain circuitry that is the topic of the companion chapter. A single case history describes a young man presenting with urinary retention in whom the only abnormality found was a small, presumed inflammatory lesion in the PAG.(695) Presumably in other cases the clinical picture was dominated by other symptoms and deficits that were more striking to a neurologist.

The brainstem/midbrain activations reported during the storage and voiding phases seem to cluster in 3 distinct regions (Figure 49), one of them being the PAG. PAG response to bladder filling is reported in 3 studies.(677, 679) This response may reflect increased afferent signals arriving at the PAG or increased inhibitory activity from the medial PFC, needed to prevent triggering of the voiding reflex (see pathway in Figure 46).

The PAG responded to imagined voiding in one fMRI study,(696) but not to real voiding.

3.5. Hypothalamus

Imaging studies have suggested hypothalamic involvement only sporadically. Correspondingly, lesions in the hypothalamus as a cause of bladder symptoms are rare but 3 cases of pituitary tumours, extending upwards into the hypothalamus, have been described with urgency incontinence or retention, weight loss, psychiatric disturbance and bitemporal field restriction.(697) Other instances include gliomas involving the hypothalamus(698) or vascular disturbances of the anterior hypothalamus. Andrew and Nathan also reported five patients with bladder symptoms appearing after a ruptured cerebral aneurysm and speculated that the site of lesion responsible was the anterior hypothalamus. (699)

Animal observations suggest that the anterior and caudal hypothalamus have monosynaptic projections to the PAG and PMC.(666) Correspondingly, two human brain imaging reports suggest response to bladder filling in a region near the caudal hypothalamus,(677, 694) and one near the preoptic area.(679) These connections may allow the hypothalamus to inhibit voiding until the situation is judged to be safe.

4. VOIDING

The preceding sections have been largely devoted to storage or withholding of urine (the filling phase), and

this is partly a reflection of the fact that, in brain imaging, voiding has been much less intensively studied than storage (due to logistical limitations of fMRI). It is also true that urinary incontinence, one of the most troublesome manifestations of a breakdown in bladder control, is a disorder of storage, not voiding.

A signature of voiding is the behaviour of the pontine micturition centre (PMC) which will be discussed in greater detail within this chapter.

fMRI findings regarding voiding. The insula was activated in only one(684) of four imaging studies of real(674, 675) or imagined(696) voiding, suggesting that it is not closely involved in this phase of micturition. All 4 studies revealed ACC involvement, particularly of the perigenual part of the ACC adjacent to the ventromedial prefrontal complex. One fMRI study of voiding in the anesthetized rat(687) showed several regional activations, but human homologs are difficult to establish.

Imagined voiding. In a group of 11 healthy women, relaxation of the pelvic floor, as if intending to void but without actually voiding, evoked activations in many of the same regions as contraction of the pelvic floor muscles.(696) Thus this does not seem to be a good model of real voiding, although another group(662) using a similar protocol found a different result. Indeed, a pontine region that was found to be activated (696) may be the L-region or pontine storage centre activated when subjects tried but were unable to void in the PET scanner (see Figure 49).(700)

Purinergic signaling is involved in the voiding reflex, both at the peripheral and central nerve levels.(349) P2X1 and P2X3 receptors play an important role in the micturition reflex with altered purinergic receptor expression in patients with detrusor overactivity.(87, 193) Intravesical ATP has been shown (in awake rats) to stimulate overactivity and in patients with idiopathic detrusor instability there is an abnormal purinergic transmission.(184, 491)

Involuntary voiding. A preliminary fMRI study of involuntary voiding (detrusor overactivity, DO)(701) showed marked deactivation of the frontal cortex during DO, a finding that still awaits confirmation.

PET studies of voiding. Blok and Holstege used PET to show that a pontine region probably homologous with the PMC was activated during voluntary voiding in humans, suggesting that the voiding reflex had indeed been triggered.(674, 684) They showed also that the right inferior frontal gyrus (or lateral prefrontal cortex) was activated during voiding. The perigenual cingulate, close to the ventromedial prefrontal cortex, which during storage, is typically *deactivated*, was *activated* during voiding. This change may indicate that tonic inhibition of the voiding reflex exerted by the medial frontal cortex (Fig. 50) has been switched off, allowing voiding to take place. During voiding the PAG was activated, as were a number of other regions including the hypothalamus and right inferior frontal gyrus.

Nour et al,(684) using PET, demonstrated many regional activations during voiding, including the PAG and a pontine region close to the PMC. However, the perigenual region was not activated, while the SMA, dACC, and left insula, were unexpectedly active.

Some subjects who were unable to void in the scanner failed to show activation either in the perigenual region or in the PMC. They did however show activation of a different region in the pons, believed to be the L-region(702) or pontine continence centre (see Figure 49). This may suggest involuntary tightening of the urethral sphincter.

5. NEURAL CIRCUITS

We have seen that many brain regions respond with altered neuronal activity to bladder filling or voiding, and thus presumably form part of the brain-bladder control network. Such brain regions are believed to be organized in neural circuits that perform tasks related to homeostasis – i.e. maintenance of continence and appropriate timing of voiding – answering questions regarding the adequacy of bladder filling, and the safety and social appropriateness of voiding, as well as the mechanical aspects dealt with by the brainstem switch. In the simple model shown in Figure 46, the regions described above are provisionally organized in 3 neural circuits that govern bladder and urethral behaviour.

Circuit 2 is the most firmly established of these circuits. It comprises the dACC or midcingulate and the insula bilaterally (perhaps with slight right-sided predominance). Together these regions form a network known elsewhere as the salience network, responsible for salience or motivation as well as corresponding motor output.(703) This circuit is activated by bladder filling, markedly in some women with urgency incontinence but barely in normal controls. It seems to correspond therefore to the sensation of urgency, as defined by the International Continence Society.(685, 686) The working model suggests (by analogy with heart rate control)(704, 705) that the output from dACC bypasses the PAG and descends via pathways that are involved in sympathetic regulation of bladder and urethral smooth muscle, thus helping to control incontinence and possibly to modulate voiding. The dACC and adjacent sensorimotor areas, especially the supplementary motor area (SMA), seem to form a functional complex that is often co-activated. The SMA is also activated during purely voluntary contraction of the striated muscles of the pelvic floor and urethral sphincter.(696, 700, 706, 707) Thus SMA co-activation during urgency may reflect tightening of the striated urethral sphincter.

The lateral part of the prefrontal cortex, sometimes called the inferior frontal gyrus, is activated by bladder filling if the dACC, SMA and insula are strongly activated. It therefore fits naturally in circuit 2.

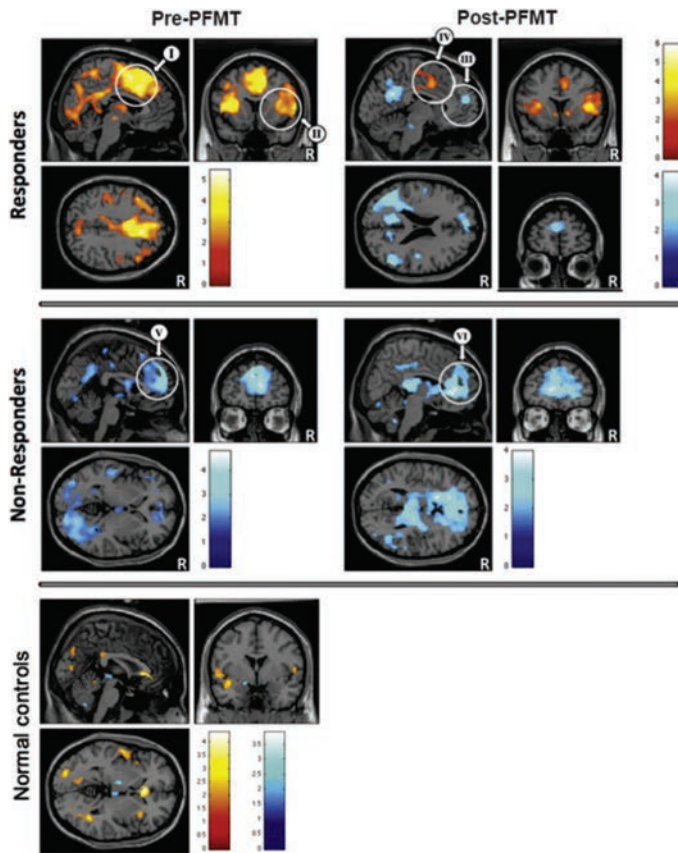

Figure 50: Responses to bladder filling in 62 older women with urgency incontinence and age-matched normal controls, examined with full bladder and urgency or strong desire to void. Prior to behavioural treatment with BFB-PFMT, those who will later respond to treatment show activation (orange/yellow blobs) in dACC/SMA (I), and insula (II), circuit 2. Those who will later fail to respond show deactivation (blue blobs, circuit 1) in mPFC (V). Normal controls show little activation or deactivation. Post-treatment, responders show evidence of de novo mPFC deactivation (III) and reduced dACC and SMA activation (IV). Non-responders show almost unchanged mPFC deactivation (VI). Adapted from Griffiths et al, 2015.

Circuit 1 has as key region the medial prefrontal cortex (mPFC), which in some women with urgency incontinence, is deactivated when the bladder is filled to the point of leakage. The concept of deactivation has caused some perplexity, and mPFC deactivation was initially but incorrectly classified as a deficit in activation.(679) However, circuit 1 is part of the widely recognized default mode network (DMN) that is active at rest and deactivated if conscious attention to a task or event such as rapid bladder filling is required. mPFC deactivation may contribute to suppression of voiding at the PAG, presumably by directing conscious attention to the behaviour of the bladder and sphincter. The posterior cingulate and the occipital cortex are other parts of the DMN that are frequently observed to be deactivated, although this has been little remarked upon.

Circuit 3, often co-deactivated with circuit 1, includes the parahippocampal complex (the hippocampus and surrounding temporal area). These subcortical regions are sometimes classified as a sub-branch of the

DMN (circuit 1). Regardless, deactivation on attention to the bladder presumably contributes to voiding suppression in a similar way to circuit 1.

The hypothalamus is sometimes activated by bladder filling in healthy individuals or urgency-incontinent women. It is believed to provide a 'safe' signal to the PMC or PAG, to allow or prevent voiding. Tentatively, this subcortical region may belong to circuit 3.

Other regions observed in some studies but not assigned to one of the 3 circuits are the thalamus, shown as a relay station to/from the cortex, with an array of connections based on what is known about a better-studied control system.(704, 705) The basal ganglia, specifically the putamen, are seen in some studies of connectivity. Parts of the cerebellum are often activated but its role in bladder control has been little studied.

5.1. Normal and Abnormal Function

In healthy individuals, as the bladder fills during urine storage it generates afferent signals that ascend to the brainstem switch but do not trigger it. If bladder volume is small then sensation of bladder filling carried by these afferents is weak or absent. Correspondingly, cerebral response to bladder filling is quite difficult to reveal when bladder volume is small, but there appears to be weak activation of circuit 3 (the parahippocampal region) that may reflect subconscious monitoring of the bladder and may help to maintain continence.(708) It should be remembered however that under these circumstances continence may be maintained principally at the spinal cord level, by spinal reflexes that are discussed in another section.

If the normal bladder is filled to capacity so as to evoke a strong desire to void, parts of circuit 2 – insula and dACC/SMA – are slightly activated, consistent with the salience of the sensation (Figure 50, lower left panel).(709) Such normal subjects never show incontinence, detrusor overactivity, or the urgency experienced by subjects with urgency incontinence; but if there is a strong desire to void, propagation of activity to the lateral and ultimately the medial prefrontal cortex probably enables a conscious decision about voiding and an assessment of social propriety and possible embarrassment. If voiding is desired, activation of the return pathway from mPFC to midbrain PAG may trigger the voiding reflex. If no voiding is planned, mPFC presumably remains deactivated, so helping to suppress voiding via this return pathway, part of the normal continence mechanism. During normal daily life however there is usually no conscious awareness of the bladder at all. The mechanism that monitors bladder behaviour in this situation may include the subcortical circuitry of circuit 3, involving the parahippocampal complex and hypothalamus.

In those suffering from urgency incontinence – and to a lesser extent in healthy people – the dACC and SMA in circuit 2 (the salience network) are frequently activated when the bladder is well filled, generating the sensation of urgency and presumably sending a descending signal that delays bladder contraction and tightens the urethral sphincter. It is suggested that this signal makes use of sympathetic pathways, so bypassing the PAG and the voiding reflex in its action on the lower urinary tract. This appears to be a normal mechanism that helps maintain homeostasis by generating sensation and motor output so as to address the threat of incontinence. It is exaggerated in those with urgency incontinence. One would expect that a lesion affecting this pathway would interfere with both sensation of bladder filling and continence.

5.1.1 Complete spinal cord injury

A spinal cord injury will interfere with the propagation of afferent signals from the bladder to the brainstem; a complete injury would be expected to abolish all

such bladder signals, making bladder sensation and control impossible. Krhut et al.(710) showed however, in 14 patients with complete lesions at C7 to T5 sustained about 17 months previously, that bladder filling evoked activity in several regions, including the nucleus of the solitary tract and the parabrachial nucleus, nuclei which probably carry afferents via the vagal nerve, bypassing the normal afferent pathway. These afferents were able to excite several regions belonging to the circuits shown in Figure 46 (hypothalamus, thalamus, amygdala, insula, anterior cingulate, and prefrontal cortex), suggesting that the vagal nerve may play a role in the re-innervation of the bladder after spinal cord injury, so perhaps allowing a measure of bladder sensation to be regained.

5.2. Voiding

Referring to Figure 46, if voiding is voluntarily decided upon (in the prefrontal cortex) a series of stereotypical actions follows (finding a toilet, adjusting clothing, adopting the correct posture) and ultimately the deactivating pathway from mPFC to brainstem PAG is silenced or reversed, removing inhibition of the voiding reflex and allowing activation of the PMC – provided that input from the hypothalamus permits it.

6. RECENT DEVELOPMENTS IN FMRI AND RELATED STUDIES

Since the previous ICI, a number of imaging studies have been reported which add to our knowledge of the effect of treatment and the connectivity of the neural circuits outlined above, so further testing the working model and its interpretation.

6.1. Treatment of urgency incontinence

6.1.1 Behavioural treatment: biofeedback-assisted pelvic floor muscle training (BFB-PFMT)

BFB-PFMT is not just 'Kegel exercises'. As well as EMG or pressure feedback from the pelvic floor to help identify the correct muscles to exercise, it includes practice in the techniques of urge suppression, and this is the part of the treatment most valued by patients.(711) Urge suppression is the conscious attempt to control the bladder, overriding any automatic or reflex responses by using voluntary effort and attention to keep the sphincter shut.

In a group of neurologically normal older women with moderate to severe urgency incontinence, a 12-week course of biofeedback-assisted pelvic floor muscle training (BFB-PFMT) reduced the frequency of incontinence episodes from 3.5 to 1.9 per 24 hours ($p < 0.0001$). (709) Not all patients responded to treatment (arbitrarily defined as 50% or greater reduction in incontinence frequency): 46% of all subjects were responders by this criterion. Functional brain imaging showed that, prior to treatment, not all patients responded in the same way to bladder filling (Figure 50): some activated circuit 2, including dACC/SMA;

others deactivated circuit 1, including the mPFC. Intriguingly, the mPFC deactivators tended to fail to respond to BFB therapy, while the dACC/SMA activators did respond. Moreover, those who responded tended to do so by deactivating the mPFC (Figure 50), suggesting that BFB-PFMT works by increasing conscious attention to the bladder (exactly as taught by urge suppression,(711) and consistent with Andrew and Nathan's original description(669) of the importance of conscious attention). Furthermore, among responders, dACC/SMA activation decreased after treatment, consistent with reduced salience (less urgency), thereby showing that dACC/SMA activation is not the cause but the consequence of UUI improvement. It appears therefore that those who already, at baseline, exercise conscious control of the bladder cannot reduce incontinence by increasing that conscious control, while others who experience great urgency without much attempt at conscious control are able to improve the situation by increasing their conscious control, a skill that can be taught by urge suppression techniques.

These observations fit nicely into the circuits identified in the working model of bladder control. They show also that a trial of therapy, monitored with brain imaging, can yield a good deal of information about how the therapy works, although without a formal control arm it provides little information about the actual cause of the urgency incontinence.

The urge suppression used in this study was based on the use of quick pelvic floor muscle squeezes to control the bladder whenever urgency was experienced. BFB-aided instruction in pelvic floor exercises, particularly quick squeezes, was a helpful preliminary. Note that urge suppression is aimed at exerting voluntary control of the bladder. It is different from "the knack", which is a technique for stress incontinence aimed at the pelvic floor muscles.

6.1.2 Pharmacological treatment of urgency incontinence

Antimuscarinics are widely used to treat urgency incontinence. They are believed to act peripherally, by reducing the activity of bladder afferents (and in turn, excitability of the bladder muscle) and thus the amplitude of the afferents ascending to the PAG and thence to the forebrain and circuits 1, 2, and 3. Manufacturers have attempted to reduce any direct central effect of their drugs by limiting penetration of the blood-brain barrier or by other means.

A pilot study(712) of the effect of a commonly used antimuscarinic agent, fesoterodine, showed that, in 8 older women with UUI, cortical activation was reduced after treatment, in regions that included dACC/SMA. This is consistent with the expected reduction of urgency after improvement of urgency incontinence, and tends to support the interpretation of circuit 2 in the working model. A similar study of the effect of a β_3 adrenergic agonist, a non-antimuscarinic pharmacological treatment for overactive bladder, has not yet been reported.

6.1.3 Neuromodulation for treatment of neurogenic incontinence

Blok et al.(713) used PET to measure brain activity in 20 patients with urgency incontinence. 12 had had chronic sacral neuromodulation (SN) via an implanted unilateral S3 nerve neuro-stimulator for > 6 months. 8 underwent SN acutely for the first time in the scanner.

In the chronically implanted patients, switching on the stimulation caused significant *decreases* in brain activity in the middle part of the cingulate gyrus (circuit 2) and the ventromedial orbitofrontal cortex (circuit 1), suggesting deactivation of circuit 1 that leads to suppression of voiding at the PAG, with a consequent reduction in urgency (circuit 2). Other stimulation-dependent changes seen in midbrain, thalamus, and dorsolateral prefrontal cortex are more difficult to interpret. Nonetheless these observations imply that long-term neuromodulation does indeed alter the bladder control system.

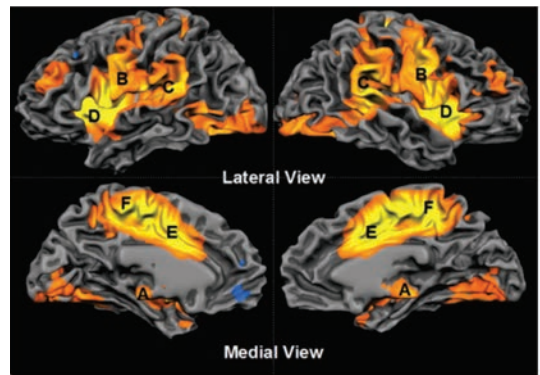

Figure 51: Activation patterns (orange/yellow blobs) revealed by mimicking micturition in 22 patients. (A) Periaqueductal gray, (B) inferior frontal cortex, (C) inferior parietal cortex, (D) insula, (E) anterior cingulate cortex and (F) supplementary motor area. Blue blobs show a trend to deactivation near mPFC. (From Seseke et al., 2013)

In newly implanted patients, in contrast, acute sacral neuromodulation (SN) caused significant decrease in the activity of the medial cerebellum, and increase in the right postcentral gyrus cortex, the right insular cortex and the ventromedial orbitofrontal cortex. Some of these regions are similar to those in the chronic stimulation group, but the effects of chronic and acute SN showed significant differences in parts of the brain believed to be concerned with learning: the associative sensory cortex, the premotor cortex and the cerebellum.

These findings suggest that, acutely, SN predominantly modulates areas involved in sensorimotor learning. These areas become less active as SN is continued, revealing ultimately that chronic SN influences, via the spinal cord, brain areas of the working

model implicated in detrusor hyperactivity, awareness of bladder filling, the urge to void and the timing of micturition. Furthermore, SN affects areas involved in alertness and awareness.

6.1.4 Deep brain stimulation for treatment of Parkinson's disease: effects on bladder function

Deep brain stimulation of the subthalamic nucleus (STN-DBS), part of the basal ganglia, has proved to be an effective therapy for off-period motor symptoms and dyskinesias in advanced Parkinson's disease. Clinical studies have shown that STN-DBS also ameliorates urinary bladder function in Parkinson's disease by delaying the first desire to void and increasing bladder capacity.(714, 715) Herzog et al performed a PET imaging study aimed at investigating the effect of STN-DBS on the neural mechanisms underlying cerebral bladder control.(714) In 11 patients with bilateral STN-DBS they observed a significant interaction between bladder state (full/empty) and STN-DBS in ACC and lateral frontal cortex.(714) During urodynamic bladder filling, with or without stimulation, a filled bladder led to a significant increase of activity in the anterior cingulate cortex, which was further enhanced with stimulation off. These authors suggested that STN-DBS ameliorates bladder dysfunction and that the mechanism may include facilitated processing of afferent bladder information.

In a second PET study of 9 such patients,(716) urinary bladder filling led to increased activity in the periaqueductal grey (PAG), the posterior thalamus, and the insular cortex, as well as in the right frontal cortex and the cerebellum bilaterally. A significant interaction between bladder filling and STN-DBS was observed in the posterior thalamus and the insular cortex, with enhanced modulation of these areas when stimulation was on. Furthermore, modulation of the neural activity in the thalamus and the insular cortex by PAG activity was observed only with stimulation on. These data suggest that STN-DBS facilitates the discrimination of different bodily states by supporting sensory perception and underlying neural mechanisms. Furthermore, the brain regions identified by DBS (except for the stimulation site itself) belong to the working model (Figure 46).

More recently it has been shown,(717) in humans and rodents, that deep brain stimulation in the PAG can rapidly and reversibly manipulate the voiding switch, so as to defer voiding and maintain urinary continence, even when the bladder is full. It appears therefore that manipulation of neural continence pathways by deep brain stimulation may offer new avenues for the treatment of urinary incontinence but, given the invasive nature of DBS, only those whose incontinence is of central origin as in Parkinson's disease are likely to be considered for treatment.

6.1.5 Abnormal brain responses following radical prostatectomy

Seseke et al.(718) demonstrated brain responses to urethral sphincter contraction that involved expected regions (Figure 51); among other observations it revealed a trend to mPFC deactivation that supports the results shown in Figure 50 and elsewhere. These responses were similar to those found previously in a different group of males without urological abnormality,(719) except that they were smaller overall in the post-operative group. This was taken to imply a degree of iatrogenic sphincter damage caused by surgery.

6.2. Connectivity

Increased interest in neural circuits, as opposed to isolated centres of brain activity, has led to a proliferation of methods intended to quantify the connectivity that supports the integrity of the circuits. Many studies depend on correlation between the fMRI signals in different regions, known as "functional connectivity" and defined as statistical dependency among remote neurophysiological events. (718, 720) Functional connectivity conveys no information about the direction of the connection. Various methods have been devised to get around this limitation and thus measure "effective connectivity" – the influence that one neural system exerts over another.

6.2.1 Psycho- and physio-physiological interaction

Psycho- and physio-physiological interaction are methods intended – at least partially – to demonstrate effective connectivity. Tadic et al.(721) used physio-physiological interaction to study effective connectivity in women aged 26-85 years, 11 with urgency incontinence and 10 with normal bladder function. Regions of interest representing the right insula (RI) and anterior cingulate gyrus (ACG) were used as seed regions. Other regions effectively connected to them were identified by significant correlation between the local fMRI signal and the interaction RIxACG. Among normal subjects, many regions involved in bladder control were effectively connected with RI/ACG, including frontotemporal and sensorimotor cortex, fore-brain, midbrain and pontine regions. Among urgency-incontinent subjects, the effective connectivity was shifted posteriorly to a parieto-temporal complex. Thus, the connectivity of the bladder control network appeared to differ in normal and UI subjects. A subsequent paper using the same method in 10 continent, healthy women aged 30-79 years revealed connectivity with RI and dACC in regions that included bilateral putamen (basal ganglia) and right pontine micturition center. Connectivity tended to become stronger with age in regions that included L insula, L paracentral lobule and PAG. Consistent with its putative role in maintaining continence (see Figure 46), medial prefrontal cortex (mPFC) showed a trend to deactivation on bladder infusion that became more prominent in old age, and connectivity that weakened significantly with age. Thus, with increasing age,

weaker signals in the bladder control network as a whole as well as changes in mPFC function or connecting pathways may contribute to the development of urgency incontinence.

seed region. High correlation implies strong functional connectivity, and experience in non-bladder fields has shown that it usually indicates an actual neural interconnection (not necessarily monosynap-

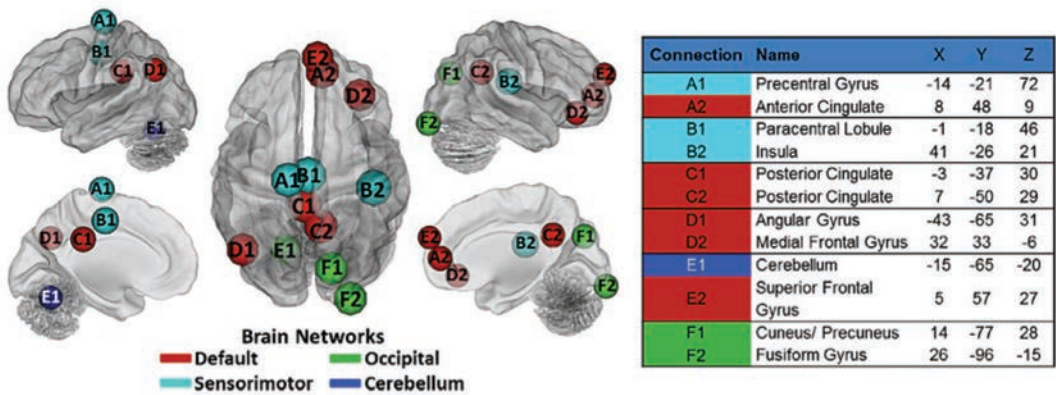

Figure 52: Resting state connectivity data: functional connections that are predictive of whether or not an individual had urgency incontinence. Each connection is a correlation between two regions of interest (ROIs, represented as spheres) that are functionally connected, indicated by having the same letter. The names of the ROIs and coordinates in Talairach Atlas space are indicated on the right.

Kuhtz-Buschbeck et al.(662) pointed out that, when the bladder is moderately full, the desire to void can be suppressed, but it can also be called forth deliberately. They studied brain activity during such intentional modulations of bladder sensation in healthy volunteers (17 women, 16 men). The supplementary motor area, midcingulate cortex, insula, frontal operculum, and right prefrontal cortex (regions of circuit 2; see Figure 46) were consistently more active when the desire to void was enhanced without allowing urine to pass ("attempted micturition") than when bladder sensations were suppressed. Consistent with the above, the psychophysiological interaction method showed that the midcingulate cortex had stronger connectivity with the PAG and medial motor areas during attempted micturition than during suppression. The left and right insula however showed *weaker* connectivity with many other brain regions during "attempted micturition". Therefore intentional modulations of the desire to void can change the effective connectivity of the brain regions involved in circuit 2, the salience network. Some but not all of the observations are in the direction of greater salience and stronger connectivity when desire to void is enhanced, as one would expect from the interpretation of the working model.

6.2.2 Resting-state functional connectivity

Study of resting-state functional connectivity has recently become popular because it provides information about connectivity in a given "resting" state without requiring use of an artificial protocol such as infusion/withdrawal or attempted micturition. Typically, a seed region is chosen *a priori* and parts of the brain are sought where, over a long period in a resting state, neural activity is correlated with activity in the

tic). The direction of the interconnection remains uncertain.

Nardos et al. have published a pair of papers based on resting-state data. They first showed in *continent* women (663) that bladder filling was associated with activation of a large number of brain regions, and with these as seed regions used resting-state fMRI to identify significant change in connectivity between full versus empty bladder in numerous brain regions, including medial frontal gyrus, posterior cingulate (PCC), inferiolateral temporal and post-central gyrus, amygdala and caudate. Tellingly, many of these regions form parts of the working model. They then used multivariate pattern analysis in women with urgency incontinence to demonstrate abnormal patterns of functional connectivity in a resting state. Their findings were able to classify individual patients as having urgency incontinence or not with good sensitivity (89%) and specificity (83%).(722) (See Figure 52) Furthermore, they pointed out that a large well-distributed brain system reacted to bladder filling, but very few regions showed different levels of activation when the bladder was full versus when it was empty. Therefore it appeared that something other than the level of brain activity must account for a significant portion of the bladder control involved when the bladder was filled to capacity. The large and significant changes in the brain's functional connectivity when the bladder was full, versus when it was empty, suggested that the central process responsible for increased control in the full bladder state relied largely on how distributed brain systems were functionally integrated. Thus there are likely two mechanistic targets for understanding atypical bladder function – one target that focuses on the level of activity in critical

brain regions, and another on how these brain regions are functionally connected. This may be an important insight.

Jarrahi et al, (723) using a network variant of functional connectivity, found that bladder filling (to strong desire to void) changed the connectivity between insula and parahippocampal complex; insula and ventromedial prefrontal cortex; and ventromedial prefrontal cortex and temporal-parietal junction. These regions are again as expected from the working model.

Although not strictly a measure of connectivity, the parameter “regional homogeneity” (ReHo) is a measure of brain activity that evaluates the similarity between the fMRI signal for a given voxel and its nearest neighbors. Usually resting-state data is employed. ReHo is based on the hypothesis that intrinsic brain activity is manifested by clusters of voxels (high ReHo) rather than isolated single voxels (low ReHo). Recently, Gao et al (664) used this method to determine brain activity of healthy men and women with empty and full bladder, and the difference between these two bladder states. In contrast to the Nardos group,(722) they found that brain activity became stronger with full bladder, perhaps suggesting that this method is more sensitive than the functional connectivity method. Increased activity was observed in the prefrontal cortex, anterior cingulate, hypothalamus, temporal lobes and left caudate, broadly consistent with the working model.

6.2.3 White-matter integrity and tractography

Proper connectivity between regions of the brain requires intact white-matter pathways. Damage to critical pathways may cause permanent incontinence (see section 3.2). For example, disruption of the pathway from medial frontal cortex to brainstem may interfere with the signal that maintains continence by tonically inhibiting the voiding reflex (see Figure 46). Indeed, studies have identified white-matter disease as the pathology underlying a triad of symptoms commonly seen in the elderly – incontinence, impairment of gait and cognitive disability.(724-726) The Kuchel group(724) used structural MRI to demonstrate that the burden of white-matter disease (white-matter hyperintensities, WMH) in right inferior frontal regions and selected white-matter tracts predicted incontinence, incontinence severity, and degree of bother. (724) The Pittsburgh group(725) used functional and structural MRI to show that, in elderly incontinent women, regional brain activations and deactivations became more prominent with globally increased WMH: increased activity in medial/superior frontal gyrus (adjacent to dACC) seemed to suggest augmented urgency with increasing WMH; more prominent deactivation in perigenual ACG (adjacent to mPFC) might suggest augmented conscious attention to the bladder with increasing WMH. Damage affecting the anterior thalamic radiation seemed to be particularly associated with urinary incontinence: this tract may include part of the pathway from medial pre-

frontal cortex to brainstem mentioned above (see Figure 46). Regardless, this behaviour is consistent with a general principle governing functional impairment in the elderly, that increased effort is required to maintain homeostasis.(724)

Diffusion Tensor Imaging is a quite different method of assessing the integrity of white-matter pathways. Because white matter tracts have a fibrous structure, water molecules diffuse more rapidly in the direction aligned with the internal structure, and more slowly in the perpendicular direction. This difference can be detected by MRI. Expressed as a fraction of the mean (the “fractional anisotropy”) it measures the integrity of the structure, while the direction of fastest diffusion in each voxel can be used to track the white-matter pathways and hence visualize the connectivity of various brain regions (“tractography”). Detrusor-tensor imaging has not been used to its full potential in brain-bladder studies but initial results in women with urgency incontinence appear promising, since they suggest reduced white-matter integrity in pathways such as the fornix, that might not otherwise be revealed.

7. CONCLUSION

The fact that voiding and continence are under fore-brain control is now well established by multiple lines of evidence. Brain-imaging protocols designed to excite bladder afferent signals lead to striking changes – activation or deactivation – in many brain regions. An obvious question is: what do these changes represent? Are they simply a side-effect of bladder manipulation or do they reveal the actual working of the bladder control system? This chapter takes the latter view. Some of the brain regions involved are known with reasonable certainty, although further investigations, particularly of normal behaviour, voiding, and different age groups of both genders, will be helpful. The specific functions of these regions and the pathways connecting them are less well known but speculatively they can be organized in a working model comprising a few neural circuits that perform tasks related to homeostasis and maintenance of continence. These tasks include reception of bladder afferents; generation of bladder sensation aimed at ensuring regular (but voluntary) voiding; and provision of motor output that acts on the voiding reflex, via the brainstem switch, to delay or advance the moment of voiding; a second output pathway bypasses the brainstem switch and so is not concerned with the timing of voiding.

Looked at in this way, it is clear that bladder function disorders such as urgency incontinence might in principle be facilitated by abnormalities in the voiding reflex itself (peripheral or spinal); or by abnormalities of cerebral control, the topic of this chapter; or by both. And indeed there is evidence that structural damage to critical connecting pathways can contribute causally to urgency incontinence. Treatment of such disorders leads to changes in brain activity that may be

simply a consequence of successful treatment, but can sometimes indicate a mechanism of therapy, thus helping to design improved therapies and guide new research.

Bladder dysfunction is encountered in both neurologically compromised and neurologically apparently intact people. It is a characteristic feature of some diseases, such as Parkinson's disease, which have a cerebral origin. In such diseases one would expect to find changes in brain function that could be a target for therapy or a marker of therapeutic success. Patients with such serious disease may be candidates for invasive therapies that interfere directly with brain function. For example deep brain stimulation of subcortical nuclei may improve bladder function as well as motor function in general. Other patients, for example women with overactive bladder, have no obvious neurological abnormality. In them one might expect to find a number of factors, cerebral, spinal or peripheral, that contribute to the dysfunction; any of them might be a target for therapy.

Deeper understanding of bladder control, by elucidating causal and therapeutic mechanisms, is expected to show the way to a new generation of treatments for otherwise intractable bladder dysfunction.

VI. PONTINE-MIDBRAIN CONTROL OF BLADDER FUNCTION

The coordinating role of the caudal brainstem in the urinary bladder control was demonstrated by the observation that micturition was abolished by precise lesions at the level of the inferior colliculus whereas lesions rostral to the colliculus facilitated micturition, presumably by removing inhibitory influences.(727, 728) (Anatomical and physiological studies in both rat and cat have delineated midbrain-pontine-spinal cord circuits in reflexes controlling filling and emptying of the bladder. The role of the so-called pontine micturition center (PMC) revealed by animal models translates well to humans as indicated by brain imaging during micturition and urine withholding(674, 729) and clinical cases showing that specific pontine lesions can result in either urinary retention or urinary incontinence.(671, 730, 731) This section will review the anatomical and physiological evidence for the caudal brainstem circuitry that regulates the autonomic and somatic motor innervation of the lower urinary tract.

1. AFFERENT PATHWAYS LINKING THE BLADDER AND URETHRA TO THE PONS AND MIDBRAIN

Sensations of bladder fullness are conveyed to the spinal cord by the pelvic and hypogastric nerves,

while input from the bladder neck and urethra is carried in the pudendal and hypogastric nerves. Afferents arising from the bladder and urethra are mechanoreceptive (myelinated A δ fibres) and nociceptive (unmyelinated C fibres). The main afferents for the

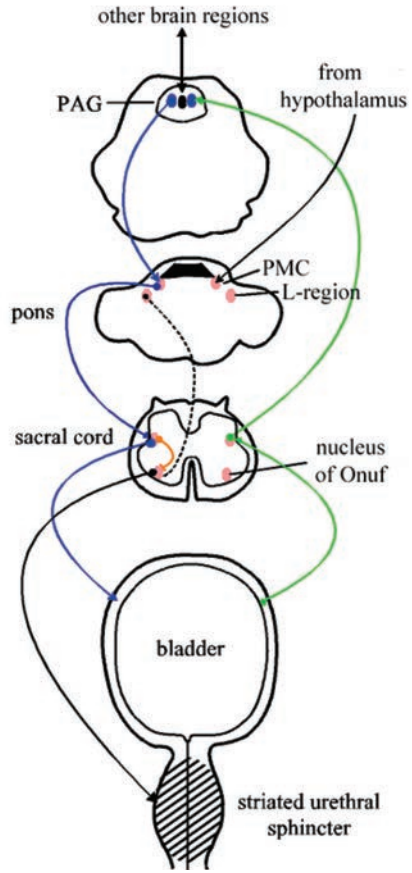

Figure 53: Schematic depicting information flow between the bladder, spinal cord and brain. In the cat spinal cord interneurons relay information about the bladder to the PAG. The pontine micturition center (or PMC) gets input from the PAG, lateral hypothalamus and medial preoptic nucleus. The PMC also gets input from the PAG, lateral hypothalamus and medial preoptic nucleus. PMC neurons project to the locus coeruleus (LC) and preganglionic parasympathetic neurons of the lumbosacral spinal cord that innervate the detrusor. There are also projections to premotor neurons in the dorsal gray commissure that innervate and inhibit Onuf's nucleus which projects to the urethral sphincter. A pontine continence center (PCC) has been proposed in the cat and is localized to the L-region of the pons. Neurons here project to Onuf's nucleus.

control of the bladder during continence and micturition are those passing through the pelvic nerves, whose fibers terminate on neurons in the lateral aspect of the dorsal horn and the intermediate zone of the lumbar and sacral spinal cord.(600, 732) Many of

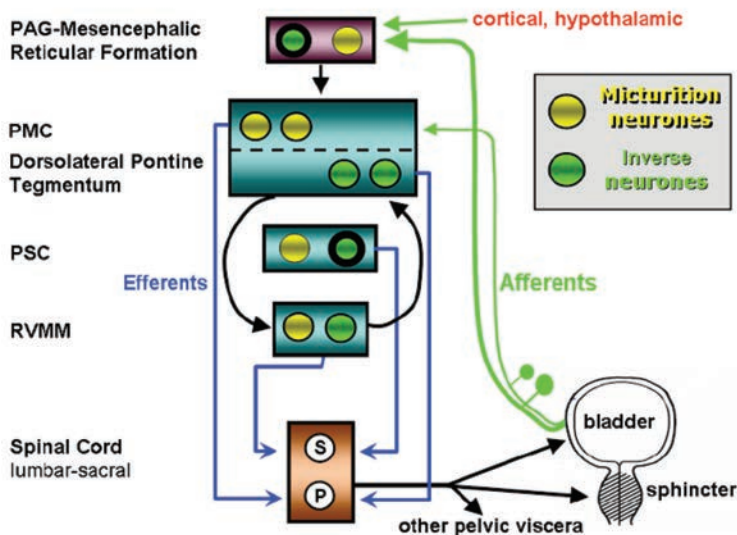

Figure 54: Schematic depicting neuronal types (micturition or bladdercontraction) versus inverse or bladder filling within the major midbrainand ponto-medullary regions involved in central neural regulation of bladder function. A major future aim must be to understand both the intra- and inter-nuclear connectivity of neurons involved in bladder contraction and filling. Who drives who and what terminates firing of neurones during bladder filling and contraction. Additionally, how are the volitional drives integrated with the automatic control circuitry of the lower brain. Abbreviations: P, parasympathetic neuron; PAG, periaqueductal grey; PMC, pontine micturition centre; PSC, pontine storage (continence) centre; RVMM, rostral ventromedial medulla; S, sympathetic neuron.

these interneurons make spinal connections that mediate segmentally organized reflex responses. However, a proportion of these spinal interneurons send ascending projections supraspinally to specific areas in the pons and midbrain that are involved in the micturition reflex (Figure 53) Other interneurons relay information to forebrain structures, including the thalamus and the hypothalamus,(733) but these are though not to play a role in the basic micturition reflex. The circuitry through which information from the urinary bladder is conveyed to the brain varies somewhat depending on the species in which the anatomy was characterized. The main area in the caudal brainstem in the cat and presumably also in humans which receives this information is the periaqueductal gray (PAG), a region of the midbrain.(625) The PAG is a midbrain area mainly known for its role in pain modulation.(734) In recent years it has become clear that this nucleus around the aqueduct of Sylvius is essential for many vital functions, like respiration, aggression, mating, defecation and micturition. The forebrain controls the PAG like a switch and complex behavior like micturition can be turned on or off instantly depending of the state of the individual.(735, 736)

In the cat anterogradely labeled fibers from the lumbar-sacral spinal cord form a dense terminal field particularly in the lateral PAG.(625) Furthermore, bladder and pelvic nerve stimulation evokes activation of the PAG.(737) The importance of the PAG in the cat

is exemplified by the observation that electrical stimulation of the lateral PAG results in the cat in micturition that includes an initial relaxation of the external urethral sphincter (EUS) followed by a bladder contraction.(738, 739) Furthermore, the lateral and, to a lesser extent, the dorsal PAG projects specifically to the PMC.(739) It has been proposed that the basic micturition reflex contains an ascending pathway from the lumbar-sacral cord to the PAG and PMC and a descending pathway from the PMC to the sacral cord. Lesioning between the PAG-PMC and the sacral spinal cord will result in a disruption of the normal micturition reflex. Lesions of rostral from the mesencephalic PAG will result in the loss of control of the timing of micturition, but the micturition reflex, with relaxation of the EUS followed by a contraction of the bladder muscle, remains intact.

Studies in the rat using retrograde tracing from the PMC and anterograde tracing from the spinal cord provided evidence for direct projections from spinal neurons to the PAG, but also to the PMC, which do not exist in the cat. This suggests that the role of the PAG in the micturition reflex of the rat is more modulatory than primary part of the reflex loop.(740, 741) (Given the role of the PAG in nociception and defensive behavior it is likely that in rats the PAG exerts an influence on micturition through the PMC under specific conditions but that it is not necessary for micturition to occur with bladder filling. Although these putative circuits are based on animal models, a pivotal role for both the PAG and PMC has been confirmed

in man using positron emission tomography and functional magnetic imaging with and without a full bladder (see Figure 48).(674, 675, 679, 683, 692)

2. EFFERENT PATHWAYS FROM THE PONTINE MICTURITION CENTER (PMC OR BARRINGTON'S NUCLEUS)

In 1925 Barrington was the first to describe a pontine control center for micturition in the cat on the basis of bilateral lesion studies.(727, 728) This region was localized in the dorsal pons and is now termed pontine micturition center (PMC) or Barrington's nucleus. Later studies used more discrete lesions that abolished micturition and caused urinary retention in cats and rats.(742, 743) Lesions in humans as a result of stroke or multiple sclerosis in an analogous region similarly result in urinary retention in man.(731, 744)(Figure 54)

The PMC is located in the dorsal pons ventromedial to the rostral pole of the locus coeruleus (LC) in the rat, but intermingled with neurons the LC in the cat.(745) Notably the LC in rats and cats differ substantially in that the LC is homogeneous in the rat with all neurons containing norepinephrine, whereas it is more heterogeneous in the cat, with norepinephrine neurons being interdigitated with non-norepinephrine neurons.(746) In humans, comparable regions in the pons have been described recently in the dorsal part of the pontine tegmentum, including the possible PMC.(747) Long descending axons from the PMC have been described to project to the intermediolateral cell column.(748) These axons have excitatory terminal boutons on parasympathetic preganglionic motoneurons innervating the bladder in the lumbosacral preganglionic cell column.(603) PMC neurons are antidromically activated from the dorsolateral funiculus of the first sacral segment, providing physiological confirmation of its spinal projections.(597, 749)

Physiological studies have confirmed the role of the PMC in micturition. Both electrical and chemical activation of the PMC in rats and cats initiates bladder contractions and relaxes the urethral sphincter mimicking normal micturition.(602, 702, 750) Single unit recordings in rat pons revealed 3 types of responses to bladder contraction, an excitation that occurred only prior to contraction (E1), an excitation that occurred prior to and was maintained during contraction (E2) and an inhibition during contraction.(751) Neurons that were activated just prior to contraction and that maintained activation during contraction were found in the PMC while the other two types of neurons were scattered throughout the pontine tegmentum. Similar results were reported in cats during cystometry.(752)

There are basically three micturition phases: 1. pre-micturition phase during realization of a safe environ-

ment; 2. relaxation phase during relaxation of the external urethral sphincter; and 2. contraction phase during contraction of the detrusor muscle. Without the onset of one of these phases normal micturition at the right time and place does not take place. These three micturition phases are controlled by three separated specific central pathways. The pre-micturition phase is controlled via a forebrain pathway to the PAG and PMC,(583) the relaxation phase is controlled via an excitatory PMC pathway to inhibitory sacral interneurons,(605) and the contraction phase via the already mentioned excitatory PMC pathway to sacral preganglionic bladder motoneurons.(603)

The forebrain pathway is important for the executive signal to initiate micturition. The inhibitory PMC pathway to the sacral spinal cord does not terminate directly on the motoneurons of the external urethral sphincter in the Onuf's nucleus. The PMC sends long descending fibers to the intermediomedial cell column, also called dorsal gray commissure or lamina X, which make contact with inhibitory interneurons containing GABA and glycine.(605, 606) These inhibitory interneurons, in turn, project specifically to the motoneurons of the striated external urethral sphincter.(753) Stimulation of the sacral intermediomedial cell column of the cat results in a strong relaxation of the external urethral sphincter, mimicking the relaxation of the sphincter during micturition.(604)

Together, the anatomical and physiological findings described above point to the PMC as being the command center during micturition for both the relaxation phase involving the external urethral sphincter and the contraction phase involving the smooth detrusor muscle of the urinary bladder.

3. FOREBRAIN INPUTS TO THE PONTINE MICTURITION CENTER

As mentioned previously, the PAG and the PMC are both part of the basic micturition reflex. Afferents to the PAG and PMC are important to initiate or withhold micturition (pre-micturition phase) and could be targets for modulating bladder function. The most prominent afferents in the cat and rat are the lateral hypothalamus and medial preoptic area.(754-756)

The lateral hypothalamus, particularly, the perifornical region is a major source of afferents to the PMC.(755, 756) The lateral hypothalamus is involved in defensive responses and modulation of the PAG and PMC by the hypothalamic afferents likely plays a role in urination as a component of the defense response (757, 758). A second major afferent arises from the medial preoptic area. This pathway terminates directly on spinal-projecting PMC neurons.(759) Many of these neurons express estrogen receptor alpha, suggesting that this is an estrogen sensitive pathway.(760) The medial preoptic region has been suggested to provide an inhibitory influence during sleep and/or sexual activity to suppress micturition.(761)

4. COORDINATION OF BLADDER WITH OTHER PELVIC VISCERA BY THE PMC

Transneuronal tracing studies with pseudorabies virus injection into different pelvic viscera suggests that the PMC neurons are also positioned to regulate activity of multiple pelvic viscera, including bladder, distal colon and sex organs, and perhaps coordinate activity between viscera. Dual PRV labeling from colon and bladder results in a large population of Barrington's nucleus neurons that are double labeled from both viscera, suggesting that their axons diverge to innervate both bladder and colonic parasympathetic efferent.(440) PRV labeling from the penis, prostate and perineal muscles also suggests an overlap of central neurons and time course of labeling with bladder.(762) Chemical stimulation of Barrington's nucleus neurons increases distal colonic intraluminal pressure, which is abolished by muscarinic antagonists.(763) Notably, most Barrington's nucleus neurons are activated by increases in bladder pressure and many of these are also activated by increases in colonic intraluminal pressure indicating that these neurons receive convergent information from both viscera.(449) Although these findings suggest a role for the PMC in coordinating bladder and colonic activity, currently there is no evidence that PMC impacts on ongoing distal colon activity. Furthermore, the activity of the distal colon is highly dependent on other factors such as pressure gradients and the enteric nervous system. Recently, PET scanning suggested that the PMC is also involved in the control of orgasm in both men and women.(764)

5. THE PONTINE CONTINENCE CENTRE (PCC)

The bladder's function of urine storage requires detrusor relaxation accompanied by urethral sphincter contraction. Studies in the cat identified a pontine continence center (PCC) also termed the L-region that is distinct from and lying ventrolateral to the micturition center (Holstege et al, 1986). Neurons in this region project selectively to Onuf's nucleus in the sacral cord, which contains the external urethral sphincter motoneurons. The majority of neurons in the PCC fire during the relaxation phase of bladder contractions and the onset of their firing can be prior to the initiation of bladder relaxation.(765) Indeed, this would make sense if their prime function were to close the urethral sphincter. Another potential role for these neurons is in off-switching micturition. Supporting this, stimulation of this region stops micturition, excites the pelvic floor musculature and contracts the urethral sphincter. Conversely, bilateral lesions of the PCC cause incontinence, excessive detrusor activity, an inability to store urine and relaxation of the urethral

sphincter.(702) However, there is no anatomical evidence for connections between the PMC and the PCC and it has been suggested that the PMC and PCC function independently.(766) Notably, the PCC has also been characterized by PET scanning in humans who try to start micturition(675, 700) or orgasm,(764) but fail to do so.

Future challenges

Although advances have been made in our understanding of central control of lower urinary tract during the decades, many challenges remain. Especially, the patients with functional bladder problems did not benefit much from the better understanding of the central control of the urinary tract. The therapies, such as antimuscarinics and artificial urethral sphincter, which are used by clinicians are usually quite old fashioned and full of side effects. Remarkably, there has been an astounding technical and medical progress for the treatment of patients with cancer because of the focus of the scientists involved aimed at direct treatment. In contrast, the science involved in the dysfunctional control of the pelvic organs were mainly focused on mechanisms of action and not so much on improvement of the future of patients involved. Perhaps the necessary change will come in the near future due to the advance of new imaging techniques, like diffusion tractography and high field magnetic resonance imaging. Also new noninvasive electrophysiological recording technology and optogenetic methods of neuronal stimulation could lead to improvement of the quality of life in chronic patients with functional bladder problems.

VII. REFERENCES

1. Sun TT. Altered phenotype of cultured urothelial and other stratified epithelial cells: implications for wound healing. *Am J Physiol*. 2006;291:F9-21.
2. Apodaca G. The uroepithelium: Not just a passive barrier. *Traffic*. 2004;5:117-28.
3. Lewis SA. Everything you wanted to know about the bladder epithelium but were afraid to ask. *Am J Physiol Renal Physiol*. 2000;278:F867-F74.
4. Khanderwal P, Abraham,S.N., Apodaca,G. Cell biology and physiology of the uroepithelium. *Am J Physiol*. 2009;297:F1477-501.
5. Truschel ST, Wang E, Ruiz WG, Leung SM, Rojas R, Lavelle J, et al. Stretch-regulated exocytosis/endocytosis in bladder umbrella cells. *Molecular Biology of the Cell*. 2002;13:830-43.
6. Khandelwal P, Prakasam,H.S., Clayton,D.R. A Rab11a-Rab8a-Myo5B network promotes stretch-regulated exocytosis in bladder umbrella cells. *Mol Biol Cell*. 2013;24:1007-19.
7. Min G, Wang,H., Sun,T.T., Kong,X.P. Structural basis for tetraspanin functions as revealed by the cryo-EM structure of uroplakin complexes at 6Å resolution. *J Cell Biol*. 2008;173:975-83.
8. Zhou G, Liang,F.X., Romih,R. MAL facilitates the incorporation of exocytic uroplakin-delivering vesicles into the apical membrane of urothelial umbrella cells. *Mol Biol Cell*. 2012;23:1354-66.
9. Acharya P, Beckel JM, Ruiz WG, Wang E, Rojas R, Birder LA, et al. Distribution of the tight junction proteins ZPO-1, occludin, and claudin-4, -8, and -12 in bladder epithelium. *Am J Physiol Renal Physiol*. 2004;287(2):F305-F18.
10. Mysorekar IU, Mulvey,M.A., Hultgren,S.J., Gordon,J.I. Molecular regulation of urothelial renewal and host defenses during infection with uropathogenic *Escherichia coli*. *J Biol Chem*. 2002;277:7412-9.
11. Montalbetti N, Rued,A.C., Clayton,D.R., Ruiz,W.G., Bastacky,S.I., Prakasam,H.S., Eaton,A.F., Kullmann,F.A., Apodaca,G., Caratino,M.D. Increased urothelial paracellular transport promotes cystitis. *Am J Physiol Renal Physiol*. 2015;309:F1070-81.
12. Soler R, Bruschini,H., Freire,M.P., Alves,M.T., Srougi,M., Ortiz,V. Urine is necessary to provoke bladder inflammation in protamine sulfate induced urothelial injury. *J Urol*. 2008;180:1527-31.
13. Nawijn MC, Hackett,T.L., Postma,D.S., van Oosterhout,A.J.M., Heijink,I.H. E-cadherin: gatekeeper of airway mucosa and allergic sensitization. *Trends Immuno*. 2011;32:248-44.
14. Hsu CC, Chuang,Y.C., Chancellor,M.B. Intravesical drug delivery for dysfunctional bladder. *Int J Urol*. 2013;20:552-62.
15. Nirmal J, Wolf-Johnston,A.S., Chancellor,M.B., Tyagi,P., Anthony,M., Kaufman,J., Birder,L.A. Liposomal inhibition of acrolein-induced injury in rat cultured urothelial cells. *Int Urol Nephrol*. 2014;46:1947-52.
16. Nirmal J, Tyagi,P., Dang,L., Hanna-Mitchell,A., Wolf-Johnston,A., Kaufman,J., Birder,L., Chancellor,M. Endocytosis uptake of liposomes in urothelium cells detected by transmission electron microscopy. *American Urological Association*. 2012;1202359.
17. Kawamorita N, Yoshikawa,S., Kashyap,M., Tyagi,P., Arai,Y., Chancellor,M.B., Yoshimura,N. Liposome based intravesical therapy targeting nerve growth factor ameliorates bladder hypersensitivity in rats with experimental colitis. *J Urol*. 2016;195:1920-6.
18. Peters KM, Hasenau,D., Kilinger,K.A., Chancellor,M.B., Anthony,M., Kaufman,J. Liposomal bladder instillations for IC/BPS: an open-label clinical evaluation. *Int Urol Nephrol*. 2014;46:2291-5.
19. Tyagi P, Chuang,Y-C., Yoshimura,N., Kaurman,J., Chancellor,M.B. Bladder instillation of liposomes for bladder coating and drug delivery platform. *LUTS*. 2009;1:S90-3.
20. Parson CL, Boychuk,D., Jones,S., Hurst,R., Callahan,H. Bladder surface glycosaminoglycans: an epithelial permeability barrier. *J Urol*. 1990;143:139-42.
21. Parsons CL, Greenspan,C., Moore,SW., Mulholland,S.G. Role of surface mucin in primary antibacterial defense of bladder. *Urology*. 1977;9:48-52.
22. Parsons CL, Lilly JD, Stein P. Epithelial dysfunction in nonbacterial cystitis (interstitial cystitis). *J Urology*. 1991;145(4):732-5.
23. Hicks M, Ketterer,B., Warren,R. The ultrastructure and chemistry of the luminal plasma membrane of the mammalian urinary bladder: a structure with low permeability to water and ions. *Phil trans R Soc Lond*. 1974;268:23-38.
24. Hicks M. The mammalian urinary bladder: an accommodating organ. *Biol Rev* 1975;50:215-46.
25. Born M, Pahner,I., Ahnert-hilger,G., Jons,T. The maintenance of the permeability barrier of bladder facet cells requires a continuous fusion of discoid vesicles with the apical plasma membrane. *Eur J Cell Biol*. 2003;82:343-50.

26. Cheng J, Huang,H., Zhang,Z.T. Overexpression of epidermal growth factor receptor in urothelium elicits urothelial hyperplasia and promotes bladder tumore growth. *Cancer Res.* 2002;62:4157-63.
27. Balestreire EM, Apodaca,G. Apical EGF receptor signaling: regulation of stretch-dependent exocytosis in bladder umbrella cells. *Mol Biol Cell.* 2007;13:830-43.
28. Kreft ME, Romih,R., Kreft,M., Jezernik,K. Endocytotic activity of bladder superficial urothelial cells is inversely related to their differentiation stage. *Differentiation.* 2009;77:48-59.
29. Birder LA, DeGroat WC. Mechanisms of disease: involvement of the urothelium in bladder dysfunction. *Nature Clinical Practice.* 2007;4(1):46-54.
30. Apodaca G, Balestreire,E., Birder,L.A. The uroepithelial-associated sensory web. *Kidney Int.* 2007;72:1057-64.
31. Romih R, Korosec,P., de Mello,W., Jezernik,K. Differentiation of epithelial cells in the urinary tract. *Cell Tissue Res.* 2005;320:259-68.
32. Martin BF. Cell replacement and differentiation in transional epithelium: a histological and autographical study of the guinea-pig bladder and urethra. *J Anat.* 1972;112:433-55.
33. Varley CL, Stahlschmidt,J., Lee,W.C., Holder,J., Diggle,C., Selby,P.J., Trejdosiewicz,L.K., Southgate,J. Role of PPAR gamma and EGFR signaling in the urothelial terminal differentiation process. *J Cell Sci.* 2004;117:2029-36.
34. Lavelle J, Meyers,S., Ramage,R., Bastacky,S., Doty,D., Apodaca,G., Zeidel,M.L. Bladder permeability barrier: recovery from selective injury of surface epithelial cells. *Am J Physiol.* 2002;283:F242-53.
35. Kreft ME, Jezernik,K., Kreft,M., Romih,R. Apical plasma membrane traffic in superficial cells of bladder urothelium. *Ann NY Acad Sci.* 2009;1152:18-29.
36. Hurst RE, Moldwin RM, Mulholland SG. Bladder defense molecules, urothelial differentiation, urinary biomarkers, and interstitial cystitis. *Urology.* 2007;69(Suppl 4A):17-23.
37. Yamany T, Van Batavia,J., Mendelsohn,C. Formation and regeneration of the urothelium. *Curr Opin Organ Transplant.* 2014;19:323-30.
38. Bassuk JA, Cockrane,K., Mitchell,M.E. Induction of urothelial cell proliferation by fibroblast growth factor-7 in RAG1-deficient mice. *Adv Exp Med Biol.* 2003;539:623-33.
39. de Boer WI, Vermeij,M., Diez de Medina,S.G., Bindels,E., Radvanyi,F., van der Kwast,T., Chopin,D. Functions of fibroblast and transforming growth factors in primary organoid-like cultures of normal human urothelium. *Lab Invest.* 1996;75:147-56.
40. Shin K, Lee,J., Guo,N., Kim,J., Lim,A., Qu,L., Mysorekar,I.U., Beachy,P.A. Hedgehog/Wnt feedback supports regenerative proliferation of epithelial stem cells in bladder. *Nature.* 2011;472:110-16.
41. Gandhi D, Molotkov,A., Batourina,E. Retinoid signaling in progentiros controls specification and regeneration of the urothelium. *Dev Cell.* 2013;26:469-82.
42. Anderson G, Palermo,J., Schilling,J., Roth,R., Heuser,J., Hultgren,S. Intracellular bacterial biofilm-like pods in urinary tract infections. *Science.* 2003;301:105-7.
43. Azadzo KM, Keim,V.K., Tarcan,T., Siroky,M.B. Alteration of urothelial-mediated tone in the ischemic bladder: role of eicosanoids. *Neurourol Urodyn.* 2004;23:258-64.
44. Robinson D, Cardozo,L. Estrogens and the lower urinary tract. *Neurourol Urodyn.* 2011;30:754-7.
45. Erikson BC, Hunskar,S. Urogenital estrogen deficiency syndrome; investigation and treatment with special reference to hormone stimulation. *Tidsskr Nor Laegeforen.* 1991;111:2249-51.
46. Lavelle JP, Meyers SA, Ruiz WG, Buffington CAT, Zeidel M, Apodaca G. Urothelial pathophysiological changes in feline interstitial cystitis: A human model. *Am J Physiol Renal Physiol.* 2000;278:F540-F53.
47. Al-Motabagani MA. Age-related changes in the urinary bladder of the female albino rats. *Int J Morphol.* 2005;23:309-16.
48. Canon E, Timmermans,L.G., Reznik,M., timmermans,L.M. Ultrastructural modifications of the bladder wall in senescence. *Acta Urol Belg.* 1990;58:29-40.
49. de Jongh R, van Koevinge GA, van Kerrebroeck PE, Markerink-van Ittersum M, de Vente J, Gillespie JI. Damage to the bladder neck alters autonomous activity and its sensitivity to cholinergic agonists. *BJU Int.* 2007;100(4):919-29.
50. Andersson KE, Nomiya,M., Yamaguchi,O. Chronic pelvic ischemia: contribution to the pathogenesis of lower urinary tract symptoms (LUTS): a new target for pharmacological treatment. *LUTS.* 2015;7:1-8.
51. Michel MC, Chess-Williams,R., Hegde,S.S. Are blood vessels a target to treat lower urinary tract dysfunction? *Naunyn-Schmiedeberg's Arch Pharmacol.* 2015;388:687-94.

52. Nomiya M, Yamaguchi,O., Andersson,K.E., Sugawa,K., Aikawa,K., Shishido,K., Yanagida,T., Kushida,N., Yazaki,J., Takahashi,N. The effect of atherosclerosis-induced chronic bladder ischemia on bladder function in the rat. *Neurourol Urodyn.* 2012;31:195-200.
53. Perse M, Injac,R., Erman,A. Oxidative status and lipofuscin accumulation in urothelial cells of bladder in aging mice. *PLoS One.* 2013;8:e59638.
54. Topf T, Wrobel,L., Chacinska,A. Chatty mitochondria: keeping balance in cellular protein homeostasis. *Trends in Cell Biol.* 2016;26:577-86.
55. Baker SC, Stahlschmidt,J., Oxley,J. Nerve hyperplasia: a unique feature of ketamine cystitis. *Acta Neuropathol Commun.* 2013;1:64.
56. Juan YS, Lee,Y.L., Long,C.Y., Wong,J.H., Jang,M.Y., Lu,J.H., Wu,W.J., Huang,Y.S., Chang,W.C., Chuang,S.M. Translocation of NF- κ B and expression of cyclooxygenase-2 are enhanced by ketamine induced ulcerative cystitis in rat bladder. *The American journal of pathology.* 2015;185:2269-85.
57. Hilt Ee, McKinley,K., Pearce, M.M., Rosenfeld,A.B., Zilliox,M.J., Mueller,E.R., Brubaker,L, Gai,X., Wolfe,A.J., Schreckenberger,P.C. Urine is not sterile: use of enhanced urine culture techniques to detect resident bacterial flora in the adult female bladder. *J Clin Microbiol.* 2014;52:871-6.
58. Mayer EA, Tillisch,K., Gupta,A. Gut/brain axis and the microbiota. *J Clin Invest.* 2015;125:926-38.
59. Abraham SN, Miao,Y. The nature of immune responses to urinary tract infections. *Nature Reviews Immunology.* 2015;15:655-63.
60. Mo L. Ablation of the Tamm-Horsfall protein gene increases susceptibility of mice to bladder colonization by type 1 fimbriated *Escherichia coli*. *Am J Physiol Renal Physiol.* 2004;286:F795-802.
61. Valore EV, Park,C.H., Quayle,A.J., Wiles,K.R., McCray,P.B., Ganz,T. Human beta-defensin-1: an antimicrobial peptide of urogenital tissues. *J Clin Invest.* 1998;101:1633-42.
62. Rostand KS, Esko,J.D. Microbial adherence to and invasion through proteoglycans. *Infect Immun.* 1997;65:1-8.
63. Schilling J, Hultgren S. Recent advances into the pathogenesis of recurrent urinary tract infections: the bladder as a reservoir for uropathogenic *Escherichia coli*. *Int J Antimicrob Agents.* 2002;19:457-560.
64. Thumbikat P, Berry,R.E., Zhou,G., Billips,B.K., Yaggie,R.E., Zaichuk,T., Sun,T.T., Schaeffer,A.J., Klumpp,D.J. Bacteria-induced uroplakin signaling mediates bladder response to infection. *PLOS pathogens.* 2009;5:1-17.
65. Wood MW, Breitschwerdt,E.B., Nordone,S.K., Linder,K.E., Gookin,J.L. uropathogenic *E. coli* promote a paracellular urothelial barrier defect characterized by altered tight junction integrity, epithelial cell sloughing and cytokine release. *J Comp Path.* 2011;5:1-9.
66. Bishop BL, Duncan,M.J., Song,J., Li,G., Zaas,D., Abraham,S.N. Cyclic AMP-regulated exocytosis of *Escherichia coli* from infected bladder epithelial cells. *Nat Med.* 2007;13:625-30.
67. Miao Y, Li,G., Zhang,X., Xu,H., Abraham,S.N. A TRP channel senses lysome neutralization by pathogens to trigger their expulsion. *Cell.* 2015;161:1306-19.
68. Schilling JD, Mulvey,M.A., Vincent,C.D., Lorenz,R.G., Hultgren,S.J. Bacterial invasion augments epithelial cytokine responses to *Escherichia coli* through a lipopolysaccharide-dependent mechanism. *J Immunol.* 2001;166:1148-55.
69. Zinkernagel AS, Johnson,R.S., Nizet,V. Hypoxia inducible factor (HIF) function in innate immunity and infection. *J Mol Med.* 2007;85:1339-46.
70. Nizet V, Johnson,R.S. Interdependence of hypoxic and innate immune responses. *Nat Rev Immunol.* 2009;9:609-17.
71. Lin AE, Beasley,F.C., Olson,J., Keller,N., Shalwitz,R.A., Hannan,T.J., Hultgren,S.J., Nizet,V. Role of hypoxia inducible factor-1a (HIF-1a) in innate defense against uropathogenic *Escherichia coli* infection *PLOS Pathogens.* 2015;11:e1004818.
72. Taylor A, Schaeffer,A., Klumpp,D., Rudick,C. Rapid attenuation of acute urinary tract infection pain and colonization using an asymptomatic bacteriuria strain. *J Urol.* 2011;185:e545-6.
73. Rosen JM, Klumpp,D.J. Mechanisms of pain from urinary tract infection. *Int J Urol.* 2014;21:26-32.
74. Birder LA, Klumpp,D.J. Host responses to urinary tract infections and emerging therapeutics: sensation and pain within the urinary tract. In: Mulvey MA, Stapleton,A.E., Klumpp,D.J., editor. *Microbiol Spectrum.* 4. Chicago, IL: Northwestern University; 2016.
75. Apodaca G, Kiss S, Ruiz WG, Meyers S, Zeidel M, Birder LA. Disruption of bladder epithelium barrier function after spinal cord injury. *Am J Physiol Renal Physiol.* 2003;284(5):F966-F76.

76. Liang FX, Bosland, M.C., Huang, H., Romih, R., Baptiste, S., Deng, F.M., Wu, X.R., Shapiro, E., Sun, T.T. Cellular basis of urothelial squamous metaplasia: roles of lineage heterogeneity and cell replacement. *J Cell Biol.* 2005;171:835-44.
77. Thomas JC, DeMarco, R.T., Pope, J.C. Molecular biology of ureteral bud and trigonal development. *Curr Urol Rep.* 2005;6:146-51.
78. Deckmann K, Filipski, K., Krasteva-Christ, G., Fronius, M., Althaus, M., Rafiq, A., Papadakis, T., Renno, L., Jurastow, I., Wessels, L., Wolff, M., Schultz, B., Weihe, E., Chubanov, V., Gudemann, T., Klein, J., Bschiepfer, T., Kummer, W. Bitter triggers acetylcholine release from polymodal urethral chemosensory cells and bladder reflexes. *PNAS.* 2014;111:8287-92.
79. Hashimoto Y, Ushiki, T., Uchida, T., Yamada, J., Iwanaga, T. Scanning electron microscopic observation of apical sites of open-type paraneurons in the stomach, intestine and urethra. *Arch Histol Cytol.* 1999;62:181-9.
80. Snellings AE, Grill, W.M., Yoo, P.B. Urethral flow-responsive afferents in the cat sacral dorsal root ganglia. *SFN.* 2011;716.05.
81. Charrua A, Reguenga, C., Cordeiro, J.M., Correiade-Sa, P., Paule, C., Nagy, I., Cruz, F., Avelino, A. Functional transient receptor potential vanilloid 1 is expressed in human urothelial cells. *J Urol.* 2009;182:2944-50.
82. Hornsby J, Cheng, F., Kullmann, A., Afaq, H., Duffy, M., Robertson, A., Birder, L., Thompson, M., Watton, P. Developing a mechaobiological model of the murine bladder: in vivo, in vitro and in silico modeling. *ECCOMAS.* 2016.
83. Kunze A, Neuhaus, J., Stolzenburg, J.U. Quantitative immunohistochemical study of the innervation of the guinea-pig lower urinary tract. *BJU Int.* 2006;98:424-9.
84. Jen PY, Dixon, J.S., Gosling, J.A. Immunohistochemical localization of neuromarkers and neuropeptides in human fetal and neonatal urinary bladder. *Br J Urol.* 1995;75:230-5.
85. Birder LA, Nakamura Y, Kiss S, Nealen ML, Barrick SR, Kanai AJ, et al. Altered urinary bladder function in mice lacking the vanilloid receptor TRPV1. *Nat Neurosci.* 2002;5(9):856-60.
86. Birder LA, Kullmann, F.A., Lee, H., Barrick, S., de Groat, W.C., Kanai, A., Caterina, M. Activation of urothelial transient receptor potential vanilloid 4 by 4 α phorbol 12,13-didecanoate contributes to altered bladder reflexes in the rat. *J Pharm Exp Ther.* 2007;323:227-35.
87. Brady CM, Apostolidis, A., Yiangou, Y., Baecker, P.A., Ford, A.P., Freeman, A., Jacques, T.S. Fowler, C.J., Anand, P. P2X3-immunoreactive nerve fibres in neurogenic detrusor overactivity and the effect of intravesical resiniferatoxin. *Eur Urol.* 2004;46:247-53.
88. Apostolidis A, Brady, C.M., Yoangou, Y., Davis, J., Fowler, C.J., Anand, P. Capsaicin receptor TRPV1 in urothelium of neurogenic human bladders and effect of intravesical resiniferatoxin. *Urology.* 2005;65:400-5.
89. Brading AF, McCloskey, K.D. Mechanisms of disease: specialized interstitial cells of the urothelium: an assessment of current knowledge. *Nature Clinical Practice Urology.* 2005;2:546-54.
90. Sui GP, Wu C, Fry CH. Characterization of the purinergic receptor subtype on guinea-pig suburothelial myofibroblasts. *BJU Int.* 2006;97(6):1327-31.
91. McCloskey KD. Interstitial cells of Cajal in the urinary tract. *Handb Exp Pharmacol.* 2011(202):233-54.
92. Griffiths DJ, Apostolidis, A. Neurological control of the bladder in health and disease. In: Clare J. Fowler, editor. *Pelvic organ dysfunction in neurological disease: clinical management and rehabilitation.* Cambridge: Cambridge University Press; 2010. p. 1-10.
93. Ikeda Y, Fry C, Hayashi F, Stolz D, Griffiths D, Kanai AJ. Role of gap junctions in spontaneous activity of the rat bladder. *Am J Physiol Renal Physiol.* 2007;293(4):F1018-F25.
94. Carattino MD, Sheng, S., Kleyman, T.R. Mutations in the pore region modify epithelial sodium channel gating by shear stress. *J Biol Chem.* 2005;280:4393-401.
95. Ossovskaia VS, Bunnett, N.W. Protease-activated receptors: contribution to physiology and disease. *Physiol Rev.* 2004;84:579-621.
96. Ferguson DR, Kennedy I, Burton TJ. ATP is released from rabbit urinary bladder epithelial cells by hydrostatic pressure changes--a possible sensory mechanism? *J Physiol.* 1997;505 (Pt 2):503-11.
97. Chess-Williams R. Muscarinic receptors of the urinary bladder: detrusor, urothelial and prejunctional. *Auton Autocoid Pharmacol.* 2002;22:133-45.
98. Birder LA, Barrick SR, Roppolo JR, Kanai AJ, DeGroat WC, Kiss S, et al. Feline interstitial cystitis results in mechanical hypersensitivity and altered ATP release from bladder urothelium. *Am J Physiol Renal Physiol.* 2003;285:F423-F9.
99. Burnstock G. Purine-mediated signalling in pain and visceral perception. *Trends in Pharmacol Sci.* 2001;22:182-8.

100. Beckel JM, Kanai AJ, Lee SJ, DeGroat WC, Birder LA. Expression of functional nicotinic acetylcholine receptors in rat urinary bladder epithelial cells. *Am J Physiol Renal Physiol*. 2006;290(1):F103-F10.
101. Beckel JM, Daugherty,S.L., Tyagi,P., Wolf-Johnston,A.S., Birder,L.A., Mitchell,C.H., de Groat,W.C. Pannexin 1 channels mediate the release of ATP into the lumen of the rat urinary bladder. *J Physiol*. 2015;593.8:1857-71.
102. Beckel JM, Birder,L.A. Differential expression and function of nicotinic acetylcholine receptors in the urinary bladder epithelium of the rat. *J Physiol*. 2012;PMID:22250215.
103. Birder LA, Nealen,M.L., Kiss,S., de Groat,W.C., Caterina,M.J., Wang,E., Apodaca,G., Kanai,A.J. Beta-adrenoceptor agonists stimulate endothelial nitric oxide synthase in rat urinary bladder urothelial cells. *J Neurosci*. 2002;22:8063-70.
104. Chopra B, Barrick SR, Meyers S, Beckel JM, Zeidel ML, Ford AP, et al. Expression and function of bradykinin B1 and B2 receptors in normal and inflamed rat urinary bladder urothelium. *J Physiol*. 2005;562(Pt 3):859-71.
105. Chopra B, Gever J, Barrick SR, Hanna-Mitchell AT, Beckel JM, Ford AP, et al. Expression and function of rat urothelial P2Y receptors. *Am J Physiol Renal Physiol*. 2008;294(4):F821-F9.
106. Hanna-Mitchell AT, Beckel JM, Barbadora S, Kanai AJ, DeGroat WC, Birder LA. Non-neuronal acetylcholine and urinary bladder urothelium. *Life Sci*. 2007;80(24-25):2298-302.
107. LeBerge J, Malley SE, Zvarova K, Vizzard MA. Expression of corticotropin-releasing factor and CRF receptors in micturition pathways after cyclophosphamide-induced cystitis. *Am J Physiol Regul Integr Comp Physiol*. 2006;291(3):R692-R703.
108. Templeman L, Chapple CR, Chess-Williams R. Urothelium derived inhibitory factor and cross-talk among receptors in the trigone of the bladder of the pig. *J Urology*. 2002;167:742-5.
109. Schnegelsberg B, Sun,T.T., Cain,G., Bhattacharya,A., Nunn,P.A., Ford,A.P., Vizzard,M.A., Cockayne,D.A. Overexpression of NGF in mouse urothelium leads to neuronal hyperinnervation, pelvic sensitivity, and changes in urinary bladder function. *Am J Physiol*. 2010;298:R534-47.
110. Girard BM, Malley,S.E., Vizzard,M.A. Neurotrophin/receptor expression in urinary bladder of mice with overexpression of NGF in urothelium. *Am J Physiol*. 2011;300:F345-55.
111. Andersson KE, Persson,K. Nitric oxide synthase and the lower urinary tract: possible implications for physiology and pathophysiology. *Scand J Urol Nephrol*. 1995;175:43-53.
112. Yamaguchi O, Chapple,C.R. beta3-adrenoceptors in urinary bladder. *NeuroUrol Urodyn*. 2007;26:752-56.
113. Igawa Y, Aizawa,N., Homma,Y. Beta3-adrenoceptor agonists: possible role in the treatment of overactive bladder. *Korean J Urol*. 2010;51:811-8.
114. Tyagi P, Tyagi,V., Yoshimura,N., Chancellor,M., Yamaguchi,O. beta3-adrenoceptor agonists for the treatment of overactive bladder. *Drugs of the future*. 2009;34:635-40.
115. Wang EC, Lee JM, Ruiz WG, Balestreire EM, von Bodungen M, Barrick S, et al. ATP and purinergic receptor-dependent membrane traffic in bladder umbrella cells. *J Clin Invest*. 2005;115(9):2412-22.
116. Lumpkin EA, Caterina,M.J. Mechanisms of sensory transduction in the skin. *Nat Rev*. 2007;445:858-65.
117. Kummer W, Lips,K.S., Pfell,U. The epithelial cholinergic system of the airways. *Histochem Cell Biol*. 2008;130:219-34.
118. Folkers G, Nijkamp,F.P. Airway epithelium: more than just a barrier! *Trends Pharma Sci*. 1998;19:334-41.
119. Brunet LJ, Gold,G.H., Ngai,J. General anosmia caused by a targeted disruption of the mouse olfactory cyclic nucleotide-gated cation channel. *Neuron*. 1996;17:681-83.
120. Burnstock G. Release of vasoactive substances from endothelial cells by shear stress and purinergic mechanosensory transduction. *J Anat*. 1999;194:335-42.
121. Timoteo MA, Carneiro,I., Silva,I., Noronha-Matos,J.B., Ferreirinha,F., Silva-Ramos,M., Correia-de-Sa,P. ATP released by pannexin-1 hemichannels mediates bladder overactivity triggered by urothelial P2Y6 receptors. *Biochem Pharmacol*. 2014;87:371-9.
122. Fry CH, Sui GP, Kanai AJ, Wu C. The function of suburothelial myofibroblasts in the bladder. *NeuroUrol Urodyn*. 2007;26(6 Suppl):914-9.
123. Du S, Araki I, Mikami Y, Zakoji H, Beppu M, Yoshiyama M, et al. Amiloride-sensitive ion channels in urinary bladder epithelium involved in mechanosensory transduction by modulating stretch-evoked adenosine triphosphate release. *Urology*. 2007;69(3):590-5.
124. Boucher I, Rich,C., Lee,A., Marcincin,M., Trinkaus-Randall,V. The P2Y2 receptor mediates

- the epithelial injury response and cell migration. *Am J Physiol.* 2010;299:C411-21.
125. Birder LA, Apodaca,G., de Groat,W.C., Kanai,A.J. Adrenergic and capsaicin-evoked nitric oxide release from urothelium and afferent nerves in urinary bladder. *Am J Physiol.* 1998;275:F226-9.
 126. Artim DE, Bazely,F., Daugherty,S.L., Sculp-toreanu,A., Koronowski,K.B., Schopfer,F.J., Woodcock,S.R., Freeman,B.A., de Groat,W.C. Nitro-oleic acid targets transient receptor potential (TRP) channels in capsaicin sensitive afferent nerves of rat urinary bladder. *Exp Neurol.* 2011;232:90-9.
 127. Caterina MJ, Schumacher MA, Tominaga M, Rosen TA, Levine JD, Julius D. The capsaicin receptor: a heat-activated ion channel in the pain pathway. *Nature.* 1997;389(6653):816-24.
 128. Chancellor MB, de Groat,W.C. Intravesical capsaicin and resiniferatoxin therapy: spicing up the ways to treat the overactive bladder. *J Urol.* 1999;162:3-11.
 129. Szallasi A, Blumber,P.M. Vanilloid (capsaicin) receptors and mechanisms. *Pharmacol Rev.* 1999;51:150-221.
 130. Kullmann FA, Shah,M.A., Birder,L.A., de Groat,W.C. Functional TRP and ASIC-like channels in cultured urothelial cells from the rat. *Am J Physiol.* 2009;296:F892-901.
 131. Liedtke W. TRPV4 plays an evolutionary conserved role in the transduction of osmotic and mechanical stimuli in live animals. *Pflugers Arch.* 2005;451:176-80.
 132. Gevaert T, Vriens,J., Segal,A., Evaraerts,W., Roskams,T., Talavera,K., Owsianik,G., Liedtke,W., Daelemans,D., dewachter,I., Van Leuven,F., Voets,T., De Ridder,D., Nilius,B. Deletion of the transient receptor potential cation channel TRPV4 impairs murine bladder voiding. *J Clin Invest.* 2007;117:3453-62.
 133. Aizawa N, Wyndaele,J.J., Homma,Y., Igawa,Y. Effects of TRPV4 cation channel activation on the primary bladder afferent activities of the rat. *Neurourol Urodyn.* 2011;PMID: 22038643.
 134. Combrisson H, Allix,S., Robain,G. Influence of temperature on urethra to bladder micturition reflex in the awake ewe. *Neurourol Urodyn.* 2007;26:290-5.
 135. Du S, Araki,I., Yoshiyama,M., Nomura,T., Takeda,M. Transient receptor potential channel A1 involved in sensory transduction of rat urinary bladder through C-fiber pathway. *Urology.* 2007;70:826-31.
 136. Zarghooni S, Wunsch,J., Bodenbenner,M., Bruggmann,D., Grando,S.A., Schwantes,Y., Wess,J., Kummer,W., Lips,K.S. Expression of muscarinic and nictotinic acetylcholine receptors in the mouse urothelium. *Life Sci.* 2007;80:2308-13.
 137. Kawashima K, Fujii,T. Basic and clinical aspects of non-neuronal acetylcholine: overview of non-neuronal cholinergic systems and their biological significance. *J Pharmacol Sci.* 2008;106:167-73.
 138. Arrighi N, Bodei,S., Lucente,A., Michel,M.C., Zani,D., Simeone,C., Cunico,S.C., Spano,P., Sigala,S. Muscarinic receptors stimulate cell proliferation in the human urothelium-derived cell line UROtsa. *Pharmacol Res.* 2011;64:420-5.
 139. Kullmann FA, Artim DE, Birder LA, de Groat WC. Activation of muscarinic receptors in rat bladder sensory pathways alters reflex bladder activity. *J Neurosci.* 2008;28(8):1977-87.
 140. Kullmann FA, Artim,D.E., Beckel,J.M., BarrickS.R., de Groat,W.C., Birder,L.A. heterogeneity of muscarinic receptor-mediated Ca²⁺ responses in cultured urothelial cells from rat. *Am J Physiol.* 2008;294:F971-81.
 141. Nile CJ, Gillespie,J.I. Interactions between cholinergic and prostaglandin signaling elements in the urothelium. *Urology.* 2012;79:240.e17-e23.
 142. Chancellor MB, Fowler,C.J., Apostolidis,a., de Groat,W.C., Smith,C.P., Somogyi,G.T., Aoki,R. Drug insight: biological effects of botulinum toxin A in the lower urinary tract. *Nat Clin Prac Urol.* 2008;5:319-28.
 143. Datta SN, Roosen,A., Pullen,A., Popat,R., Rosenbaum,T.P., Elneil,S., Dasgupta,P., Fowler,C.J., Apostolidis,A. Immunohistochemical expression of muscarinic receptors in the urothelium and suburothelium of neurogenic and idiopathic overactive human bladders, and changes with botulinum neurotoxin administration. *J Urol.* 2010;184:2578-85.
 144. Liu HT, Kuo HC. Intravesical botulinum toxin A injections plus hydrodistension can reduce nerve growth factor production and control bladder pain in interstitial cystitis. *Urology.* 2007;70(3):463-8.
 145. Sun Y, Keay S, De Deyne PG, Chai TC. Augmented stretch activated adenosine triphosphate release from bladder uroepithelial cells in patients with interstitial cystitis. *J Urol.* 2001;166(5):1951-6.
 146. Hillard T. The postmenopausal bladder. *Menopause Int.* 2010;16:74-80.
 147. Baumbauer KM, DeBerry,J.J., Adelman,P.C., Miller,R.H., Hachisuka,J., Lee, K.H., Ross,S.E., Koerber,H.R., Davis,B.M., Albers,K.M. Keratinocytes can modulate and directly initiate

- nociceptive responses. *eLIFE Sci.* 2015;309674:1-14.
148. Hendrix S. Neuroimmune communication in skin: Far from peripheral. *J Invest Derm.* 2008;128:260-1.
 149. Bosse Y, Pare, P.D., Seow, C.Y. Airway wall remodeling in asthma: from the epithelial layer to the adventitia. *Curr Allergy Asthma Rep.* 2008;8:357-66.
 150. Ford AP, Udem, B.J. The therapeutic promise of ATP antagonism at P2X3 receptors in respiratory and urological disorders. *Front in Cellular Neurosci.* 2013;7:1-10.
 151. Avelino A, Cruz, C., Nagy, I., Cruz, F. Vanilloid receptor 1 expression in the rat urinary tract. *Neuroscience.* 2002;109:787-98.
 152. Drake MJ, Hedlund P, Mills IW, McCoy R, McMurray G, Gardner BP, et al. Structural and functional denervation of human detrusor after spinal cord injury. *Lab Invest.* 2000;80(10):1491-9.
 153. Gu J, Polak, J.M., Deane, A., Cocchia, D., Michei, F. Increase of S-100 immunoreactivity in the urinary bladder from patients with multiple sclerosis, an indication of peripheral neuronal lesion. *Am J Clin Pathol.* 1984;82:649-54.
 154. Smet PJ, Edyvane KA, Jonavicius J, Marshall VR. Neuropeptides and neurotransmitter-synthesizing enzymes in intrinsic neurons of the human urinary bladder. *J Neurocytol.* 1996;25(2):112-24.
 155. Smet PJ, Moore KH, Jonavicius J. Distribution and colocalization of calcitonin gene-related peptide, tachykinins, and vasoactive intestinal peptide in normal and idiopathic unstable human urinary bladder. *Lab Invest.* 1997;77(1):37-49.
 156. Wiseman OJ, Brady CM, Hussain IF, Dasgupta P, Watt H, Fowler CJ, et al. The ultrastructure of bladder lamina propria nerves in healthy subjects and patients with detrusor hyperreflexia. *J Urol.* 2002;168(5):2040-5.
 157. Dang K, Bielefeldt, K., Gebhart, G.F. Differential responses of bladder lumbosacral and thoracolumbar dorsal root ganglion neurons to purinergic agonists, protons, and capsaicin. *J Neurosci.* 2005;25:3973-84.
 158. Dang K, Lamb, K., Cohen, M., Bielefeldt, K., Gebhart, G.F. Cyclophosphamide-induced bladder inflammation sensitizes and enhances P2X receptor function in rat bladder sensory neurons. *J Neurophysiol.* 2008;99:49-59.
 159. Sculptoreanu A, de Groat, W.C., Buffington, C.A., Birder, L.A. Abnormal excitability in capsaicin-responsive DRG neurons from cats with feline interstitial cystitis. *Exp Neurol.* 2005;193:437-43.
 160. Yoshimura N. Bladder afferent pathway and spinal cord injury: possible mechanisms inducing hyperreflexia of the urinary bladder. *Prog Neurobiol.* 1999;57(6):583-606.
 161. Yoshimura N, de Groat WC. Plasticity of Na⁺ channels in afferent neurones innervating rat urinary bladder following spinal cord injury. *J Physiol.* 1997;503 (Pt 2):269-76.
 162. Yoshimura N, Seki, S., de Groat, W.C. Nitric oxide modulates calcium channels in dorsal root ganglion neurons innervating rat urinary bladder. *J Neurophysiol.* 2001;86:304-11.
 163. Yoshimura N, White, G., Weight, F.F., de Groat, W.C. Different types of Na⁺ and A-type K⁺ currents in dorsal root ganglion neurones innervating the rat urinary bladder. *J Physiol.* 1996;393:1-16.
 164. Zhong Y, Banning AS, Cockayne DA, Ford AP, Burnstock G, McMahon SB. Bladder and cutaneous sensory neurons of the rat express different functional P2X receptors. *Neuroscience.* 2003;120(3):667-75.
 165. Yoshimura N, de Groat WC. Increased excitability of afferent neurons innervating rat urinary bladder after chronic bladder inflammation. *J Neurosci.* 1999;19(11):4644-53.
 166. Takahashi R, Yoshizawa, T., Yunoki, T., Tyagi, P., Naito, S., de Groat, W.C., Yoshimura, N. Hyperexcitability of bladder afferent neurons associated with reduction of Kv1.4 alpha subunit in rats with spinal cord injury. *J Urol.* 2013;190:2296-304.
 167. Kanai A, Andersson, K.E. Bladder afferent signaling: recent findings. *J Urol.* 2010;183:1288-95.
 168. Zagorodnyuk VP, Costa M, Brookes SJ. Major classes of sensory neurons to the urinary bladder. *Auton Neurosci.* 2006;126-127:390-7.
 169. Zagorodnyuk VP, Gibbins IL, Costa M, Brookes SJ, Gregory SJ. Properties of the major classes of mechanoreceptors in the guinea pig bladder. *J Physiol.* 2007;585(Pt 1):147-63.
 170. Zagorodnyuk VP, Brookes SJ, Spencer NJ, Gregory S. Mechanotransduction and chemosensitivity of two major classes of bladder afferents with endings in the vicinity to the urothelium. *J Physiol.* 2009;587(Pt 14):3523-38.
 171. Xu L, Gebhart GF. Characterization of mouse lumbar splanchnic and pelvic nerve urinary bladder mechanosensory afferents. *J Neurophysiol.* 2008;99(1):244-53.

172. Andersson KE, Soler R, Fullhase C. Rodent models for urodynamic investigation. *Neurourol Urodyn.*30(5):636-46.
173. Vergnolle N. Postinflammatory visceral sensitivity and pain mechanisms. *Neurogastroenterology & Motility.* 2008;20 Suppl 1:73-80.
174. Woolf CJ. Central sensitization: implications for the diagnosis and treatment of pain. *Pain.* 2011;152(3 Suppl):S2-15.
175. Munoz A, Gangitano DA, Smith CP, Boone TB, Somogyi GT. Removal of urothelium affects bladder contractility and release of ATP but not release of NO in rat urinary bladder. *BMC Urol.*10:10.
176. Aizawa N, Igawa Y, Nishizawa O, Wyndaele JJ. Effects of Nitric Oxide on the Primary Bladder Afferent Activities of the Rat With and Without Intravesical Acrolein Treatment. *Eur Urol.* 2011; 59:264-71.
177. Ozawa H, Chancellor MB, Jung SY, Yokoyama T, Fraser MO, Yu Y, et al. Effect of intravesical nitric oxide therapy on cyclophosphamide-induced cystitis. *J Urol.* 1999;162(6):2211-6.
178. Caremel R, Oger-Roussel S, Behr-Roussel D, Grise P, Giuliano FA. Nitric oxide/cyclic guanosine monophosphate signalling mediates an inhibitory action on sensory pathways of the micturition reflex in the rat. *Eur Urol.*58(4):616-25.
179. Rahnama'I MS, Uckert,S., Hohnen,R., van Koeveringe,G.A. the role of phosphodiesterases in bladder pathophysiology. *Nat Rev Urology.* 2013;10:414-24.
180. Behr-Roussel D, Oger S, Caisey S, Sandner P, Bernabe J, Alexandre L, et al. Vardenafil Decreases Bladder Afferent Nerve Activity in Unanesthetized, Decerebrate, Spinal Cord-Injured Rats. *Eur Urol.* 2011; 59:272-9.
181. Holton P. The liberation of adenosine triphosphate on antidromic stimulation of sensory nerves. *J Physiol.* 1959;145(3):494-504.
182. Burnstock G. Purines and sensory nerves. *Handbk of Exp Pharmacol.* 2009;194:333-92.
183. de Groat WC, Booth,A.M., Yoshimura,N. Neurophysiology of micturition and its modification in animal models of human disease. In: Maggi CA, editor. *The autonomic nervous system Nervous Control of the Urogenital System.* 3. Switzerland: Harwood Academic Publishers; 1993. p. 227-90.
184. Pandita RK, Andersson KE. Intravesical adenosine triphosphate stimulates the micturition reflex in awake, freely moving rats. *J Urol.* 2002;168(3):1230-4.
185. Aizawa N, Igawa,Y., Andersson,K.E., Iijima,K., Nishizawa,O., Wyndaele,J.J. Effects of intravesical instillation of ATP on rat bladder primary afferent activity and its relationship with capsaicin-sensitivity. *Neurourol Urodyn.* 2011;30:163-68.
186. Namasivayam S, Eardley I, Morrison JF. Purinergic sensory neurotransmission in the urinary bladder: an in vitro study in the rat. *BJU Int.* 1999;84(7):854-60.
187. Vlaskovska M, Kasakov L, Rong W, Bodin P, Bardini M, Cockayne DA, et al. P2X3 knock-out mice reveal a major sensory role for urothelially released ATP. *J Neurosci.* 2001;21(15):5670-7.
188. Cockayne DA, Hamilton SG, Zhu QM, Dunn PM, Zhong Y, Novakovic S, et al. Urinary bladder hyporeflexia and reduced pain-related behaviour in P2X3-deficient mice. *Nature.* 2000;407(6807):1011-5.
189. Cockayne DA, Dunn,P.P.M., Zhong,Y., Hamilton,S.G., Cain,G.R., Knight,G., Ruan,H.Z., Ping,Y., Nunn,P., Bei,M., McMahon,S.B., Burnstock,G., Ford,A.P.D.W. P2X2 knockout mice and P2X2/P2X3 double knockout mice reveal a role for the P2X2 receptor subunit in mediating multiple sensory effects of ATP. *J Physiol.* 2005;567:621-39.
190. Rong W, Spyer KM, Burnstock G. Activation and sensitisation of low and high threshold afferent fibres mediated by P2X receptors in the mouse urinary bladder. *J Physiol.* 2002;541(Pt 2):591-600.
191. Sadananda P, Shang F, Liu L, Mansfield KJ, Burcher E. Release of ATP from rat urinary bladder mucosa: role of acid, vanilloids and stretch. *British Journal of Pharmacology.* 2009;158(7):1655-62.
192. Yu W, Zacharia LC, Jackson EK, Apodaca G. Adenosine receptor expression and function in bladder uroepithelium. *American journal of physiology Cell physiology.* 2006;291(2):C254-65.
193. King BF, Knowles ID, Burnstock G, Ramage AG. Investigation of the effects of P2 purinoceptor ligands on the micturition reflex in female urethane-anaesthetized rats. *Br J Pharmacol.* 2004;142(3):519-30.
194. Kullmann FA, Artim,D.E., Birder,L.A., de Groat,W.C. Activation of muscarinic receptors in rat bladder sensory pathways alters reflex bladder activity. *J Neuroscience.* 2008;28:1977-87.
195. Kumar V, Chapple CR, Surprenant AM, Chess-Williams R. Enhanced adenosine triphosphate release from the urothelium of patients with

painful bladder syndrome: a possible pathophysiological explanation. *J Urol.* 2007;178(4 Pt 1):1533-6.

196. Moldwin R, Kitt M, Mangel J, Beyer R, Hanno P, Butera P, et al. a phase 2 study in women with interstitial cystitis/bladder pain syndrome (IC/BPS) of the novel p2x3 antagonist AF219. *International Continence Society* 2015.
197. Yoshida M, Inadome A, Maeda Y, Satoji Y, Masunaga K, Sugiyama Y, et al. Non-neuronal cholinergic system in human bladder urothelium. *Urology.* 2006;67(2):425-30.
198. Iijima K, De Wachter S, Wyndaele JJ. Effects of the M3 receptor selective muscarinic antagonist darifenacin on bladder afferent activity of the rat pelvic nerve. *Eur Urol.* 2007;52(3):842-7.
199. De Wachter S, Wyndaele JJ. Intravesical oxybutynin: a local anesthetic effect on bladder C afferents. *J Urol.* 2003;169(5):1892-5.
200. Matsumoto Y, Miyazato M, Furuta A, Torimoto K, Hirao Y, Chancellor MB, et al. Differential roles of M2 and M3 muscarinic receptor subtypes in modulation of bladder afferent activity in rats. *Urology.* 75(4):862-7.
201. Masuda H, Ichiyanagi N, Yokoyama M, Sakai Y, Kihara K, Chancellor MB, et al. Muscarinic receptor activation in the lumbosacral spinal cord ameliorates bladder irritation in rat cystitis models. *BJU Int.* 2009;104(10):1531-7.
202. Daly D, Rong, W., Chess-Williams, R., Chapple, C., Grundy, D. Bladder afferent sensitivity in wild-type and TRPV1 knockout mice. *J Physiol.* 2007;583:663-74.
203. Nandigama R, Bonitz M, Papadakis T, Schwantes U, Bschiepfer T, Kummer W. Muscarinic acetylcholine receptor subtypes expressed by mouse bladder afferent neurons. *Neuroscience.* 168(3):842-50.
204. Hawthorn MH, Chapple CR, Cock M, Chess-Williams R. Urothelium-derived inhibitory factor(s) influences on detrusor muscle contractility in vitro. *Br J Pharmacol.* 2000;129(3):416-9.
205. Yu Y, de Groat WC. Effects of stimulation of muscarinic receptors on bladder afferent nerves in the in vitro bladder-pelvic afferent nerve preparation of the rat. *Brain Res.* 1361:43-53.
206. MacKenzie I, Burnstock G, Dolly JO. The effects of purified botulinum neurotoxin type A on cholinergic, adrenergic and non-adrenergic, atropine-resistant autonomic neuromuscular transmission. *Neuroscience.* 1982;7(4):997-1006.
207. Lawrence GW, Aoki KR, Dolly JO. Excitatory cholinergic and purinergic signaling in bladder are equally susceptible to botulinum neurotoxin a consistent with co-release of transmitters from efferent fibers. *J Pharmacol Exp Ther.* 2010;334(3):1080-6.
208. Schurch B, Hauri D, Rodic B, Curt A, Meyer M, Alain BR. Botulinum-A Toxin as a Treatment of Detrusor-Sphincter Dyssynergia: A Prospective Study in 24 Spinal Cord Injury Patients. *The Journal of Urology.* 1996;155(3):1023-9.
209. Khan S, Kessler TM, Apostolidis A, Kalsi V, Panicker J, Roosen A, et al. What a Patient With Refractory Idiopathic Detrusor Overactivity Should Know About Botulinum Neurotoxin Type A Injection. *The Journal of Urology.* 2009;181(4):1773-8.
210. Chancellor MB, Kaplan, S.A., Blaivas, J.G. The cholinergic and purinergic components of detrusor contractility in a whole rabbit bladder model. *J Urol.* 1992;148:906-9.
211. Khera M, Somogyi GT, Salas NA, Kiss S, Boone TB, Smith CP. In vivo effects of botulinum toxin A on visceral sensory function in chronic spinal cord-injured rats. *Urology.* 2005;66(1):208-12.
212. Collins VM, Chapple CR, McKay NG, Sellers DJ, Grundy D. Botulinum toxin attenuates sensory afferent nerve firing in an ex vivo mouse bladder model *The Journal of Urology.* 2009;181(4):82-3.
213. Kanai A, Zabbarova I, Oefelein M, Radziszewski P, Ikeda Y, Andersson KE. Mechanisms of action of botulinum neurotoxins, beta(3)-adrenergic receptor agonists, and PDE5 inhibitors in modulating detrusor function in overactive bladders. *NeuroUrol Urodyn.*
214. Ikeda Y, Zabbarova I, Birder, L., de Groat, W., McCarthy, C., Hanna-Mitchell, A., Kanai, A. Botulinum neurotoxin serotype A suppresses neurotransmitter release from afferent as well as efferent nerves in the urinary bladder. *European Urology.* 2012;62L1157-64.
215. Apostolidis A, Popat R, Yiangou Y, Cockayne D, Ford APDW, Davis JB, et al. decreased sensory receptors p2x3 and trpv1 in suburothelial nerve fibers following intradetrusor injections of botulinum toxin for human detrusor overactivity. *J Urol.* 2005;174(3):977-83.
216. Kissin I, Szallasi A. Therapeutic targeting of TRPV1 by resiniferatoxin, from preclinical studies to clinical trials. *Curr Top Med Chem.* 11(17):2159-70.
217. Andrade EL, Forner S, Bento AF, Leite DF, Dias MA, Leal PC, et al. TRPA1 receptor modulation attenuates bladder overactivity induced by spinal cord injury. *Am J Physiol Renal Physiol.* 300(5):F1223-34.

218. Ochodnický P, Cruz, C.D., Yoshimura, N., Cruz, F. Neurotrophins as regulators of urinary bladder function. *Nat Rev Urology*. 2012;9:628-37.
219. DeBerry JJ, Saloman, J.L., Dragoo, B.K., Albers, K.M., Davis, B.M. Artemin immunotherapy is effective in preventing and reversing cystitis-induced bladder hyperalgesia via TRPA1 regulation. *J Pain*. 2015;16:626-36.
220. Gevaert T, Vandepitte J, Ost D, Nilius B, De Ridder D. Autonomous contractile activity in the isolated rat bladder is modulated by a TRPV1 dependent mechanism. *NeuroUrol Urodyn*. 2007;26(3):424-32; discussion 51-3.
221. Yamada T, Ugawa S, Ueda T, Ishida Y, Kajita K, Shimada S. Differential localizations of the transient receptor potential channels TRPV4 and TRPV1 in the mouse urinary bladder. *J Histochem Cytochem*. 2009;57(3):277-87.
222. Everaerts W, Zhen, X., Ghosh, D., Vriens, J., Gevaert, T., Gilbert, J.P., Hayward, N.J., McNamara, C.R., Xue, F., Moran, M.M., Strassmaier, T., Uykai, E., Owslanik, G., Vennekens, R., de Ridder, D., Nilius, B., Fanger, C.M., Voets, T. Inhibition of the cation channel TRPV4 improves bladder function in mice and rats with cyclophosphamide-induced cystitis. *Proc Natl Acad Sci* 2010;107:19084-9.
223. Charrua A, Cruz, C.D., Jansen, D., Rozenberg, B., Heesakkers, J., Cruz, F. Co-administration of transient receptor potential vanilloid 4 (TRPV4) and TRPV1 antagonists potentiate the effect of each drug in a rat model of cystitis. *BJU Int*. 2015;115:452-60.
224. Mukerji G, Waters, J., Chessell, I.P., Bountra, C., Agarwal, S.K., Anand, P. Pain during ice water test distinguishes clinical bladder hypersensitivity from overactivity disorders. *BMC Urol*. 2006;6:31.
225. Hayashi T, Kondo T, Ishimatsu M, Yamada S, Nakamura K, Matsuoka K, et al. Expression of the TRPM8-immunoreactivity in dorsal root ganglion neurons innervating the rat urinary bladder. *Neurosci Res*. 2009;65(3):245-51.
226. Lashinger ES, Steingina MS, Hieble JP, Leon LA, Gardner SD, Nagilla R, et al. AMTB, a TRPM8 channel blocker: evidence in rats for activity in overactive bladder and painful bladder syndrome. *Am J Physiol Renal Physiol*. 2008;295(3):F803-10.
227. Ito H, Aizawa, N., Sugiyama, R., Watanabe, S., Takahashi, N., Tajimi, M., Fukuhara, H., Homma, Y., Kubota, Y., Andersson, K.E., Igawa, Y. Functional role of the transient receptor potential melastatin 8 (TRPM8) ion channel in the urinary bladder assessed by conscious cystometry and ex vivo measurements of single-unit mechanosensitive bladder afferent activities in the rat. *BJU Int*. 2016;117:484-94.
228. Tyagi V, Philips BJ, Su R, Smaldone MC, Erickson VL, Chancellor MB, et al. Differential Expression of Functional Cannabinoid Receptors in Human Bladder Detrusor and Urothelium. *J Urol*. 2009;181(4):1932-8.
229. Mukerji G, Yiangou Y, Agarwal SK, Anand P. Increased Cannabinoid Receptor 1-Immunoreactive Nerve Fibers in Overactive and Painful Bladder Disorders and Their Correlation With Symptoms. *Urology*. 75(6):1514.e15-e20.
230. Gratzke C, Streng T, Park A, Christ G, Stief CG, Hedlund P, et al. Distribution and Function of Cannabinoid Receptors 1 and 2 in the Rat, Monkey and Human Bladder. *J Urol*. 2009;181(4):1939-48.
231. Walczak JS, Price TJ, Cervero F. Cannabinoid CB1 receptors are expressed in the mouse urinary bladder and their activation modulates afferent bladder activity. *Neuroscience*. 2009;159(3):1154-63.
232. Hayn MH, Ballesteros I, de Miguel F, Coyle CH, Tyagi S, Yoshimura N, et al. Functional and Immunohistochemical Characterization of CB1 and CB2 Receptors in Rat Bladder. *Urology*. 2008;72(5):1174-8.
233. Aizawa N, Hedlund, P., Fullhase, C., Ito, H., Homma, Y., Igawa, Y. Inhibition of peripheral FAAH depresses activities of bladder mechanosensitive nerve fibers of the rat. *J Urol*. 2014;192:956-63.
234. Dinis P, Charrua, A., Avelino, A., Yaqoob, M., Bevan, S., Nagy, I., Cruz, F. Anandamide-evoked activation of vanilloid receptor 1 contributes to the development of bladder hyperreflexia and nociceptive transmission to spinal dorsal horn neurons in cystitis. *J Neurosci*. 2004;24:11253-63.
235. Fusco F, Palmieri, A., Ficarra, V., Giannarini, G., Novara, G., Longo, N., Verze, P., Creta, M., Mirone, V. alpha1 blockers improve benign prostatic obstruction in men with lower urinary tract symptoms: a systematic review and meta-analysis of urodynamic studies. *European Urology* 2016;69:1091-101.
236. Trevisani M, Campi B, Gatti R, Andre E, Materazzi S, Nicoletti P, et al. The influence of alpha1-adrenoreceptors on neuropeptide release from primary sensory neurons of the lower urinary tract. *Eur Urol*. 2007;52(3):901-8.
237. Yanase H, Wang X, Momota Y, Nimura T, Kawatani M. The involvement of urothelial alpha1A adrenergic receptor in controlling the micturition reflex. *Biomed Res*. 2008;29(5):239-44.

238. Yazaki J, Aikawa K, Shishido K, Yanagida T, Nomiya M, Ishibashi K, et al. Alpha1-Adrenoceptor Antagonists Improve Bladder Storage Function Through Reduction of Afferent Activity in Rats With Bladder Outlet Obstruction. *Neurourol Urodyn*. 2011; 30:461-7.
239. Nagabukuro H, Degenhardt A, Villa KL, Mistry SL, Gichuru L, Jochnowitz N, et al. Correlation between pharmacologically-induced changes in cystometric parameters and spinal c-Fos expression in rats. *Auton Neurosci*.156(1-2):19-26.
240. Aizawa N, Sugiyama,R., Ichbara,K., Fujimura,T., Fukuhara,H., Homma,Y., Igawa,Y. Functional roles of bladder alpha1 adrenoceptors in the activation of single-unit primary bladder afferent activity in rats. *BJU Int*. 2016;117:993-1001.
241. Matos R, Cordeiro,J.M., Coelho,A., Ferreira,S., Silva,C., Igawa,Y., Cruz,F., Charrua,A. Bladder pain induced by prolonged peripheral alpha 1A adrenoceptor stimulation involves the enhancement of transient receptor potential vanilloid 1 (TRPV1) activity and an increase of urothelial adenosine triphosphate (ATP)- release. 2016;Acta Physiol.
242. Michel MC, Korstanje,C. Beta-adrenoceptor agonists for overactive bladder syndrome: role of translational pharmacology in a repositioning clinical drug development project. *Pharmacol Ther*. 2016;159:66-82.
243. Kullmann FA, Downs TR, Artim DE, Limberg BJ, Shah M, Contract D, et al. Urothelial beta-3 adrenergic receptors in the rat bladder. *Neurourol Urodyn*.30(1):144-50.
244. Coelho A, Gillespie,J., Cruz,F. Identification of the human urinary bladder structures expressing the beta-3 adrenoceptor. *American Urological Association*2015.
245. Whorwell PJ, McCallum M, Creed FH, Roberts CT. Non-colonic features of irritable bowel syndrome. *Gut*. 1986;27(1):37-40.
246. Kaplan SA, Dmochowski,R., Cash,B.D., Kopp,Z.S., Berriman,S.J., Khullar,V. Systematic review of the relationship between bladder and bowel function: implications for patient management. *Int J Clin Prac*. 2013;67:205-16.
247. Alagiri M, Chottiner S, Ratner V, Slade D, Hanno PM. Interstitial cystitis: unexplained associations with other chronic disease and pain syndromes. *Urology*. 1997;49(5A Suppl):52-7.
248. Brumovsky PR, Gebhart GF. Visceral organ cross-sensitization - an integrated perspective. *Auton Neurosci*.153(1-2):106-15.
249. Pezzone MA, Liang R, Fraser MO. A model of neural cross-talk and irritation in the pelvis: implications for the overlap of chronic pelvic pain disorders. *Gastroenterology*. 2005;128(7):1953-64.
250. Bielefeldt K, Lamb K, Gebhart GF. Convergence of sensory pathways in the development of somatic and visceral hypersensitivity. *Am J Physiol Gastrointest Liver Physiol*. 2006;291(4):G658-65.
251. Christianson JA, Liang,R., Ustinova,E.E., Davis,B.M., Fraser,M.O., Pezzone,M.A. Convergence of bladder and colon sensory innervation occurs at the primary afferent level. *Pain*. 2007;128:235-43.
252. Chaban VV. Visceral sensory neurons that innervate both uterus and colon express nociceptive TRPV1 and P2X3 receptors in rats. *Ethn Dis*. 2008;18:S2-20.
253. Chaban V. Estrogen modulation of visceral nociceptors. *Curr Trends Neurol*. 2013;7:51-5.
254. Greenwood-Van Meerveld B, Mohammadi E, Tyler K, Van Gordon S, Parker A, Towner R, et al. Mechanisms of Visceral Organ Crosstalk: Importance of Alterations in Permeability in Rodent Models. *J Urol*. 2015;194(3):804-11.
255. Towner RA, Wisiewski,A.B., Wu,D.H., Van Gordon,S.B., Smith,N., North,J.C., McElhancy,R., Aston,C.E., Shobeiri,S.A., Kropp,B.P., Greenwood-Van Meerveld,B., Hurst,R.E. A feasibility study to determine whether clinical contrast enhanced magnetic resonance imaging can detect increased bladder permeability in patients with interstitial cystitis. *J Urol*. 2016;195:631-8.
256. Towner RA, Smith N, Saunders D, Van Gordon SB, Tyler KR, Wisniewski AB, et al. Assessment of colon and bladder crosstalk in an experimental colitis model using contrast-enhanced magnetic resonance imaging. *Neurogastroenterology and motility*. 2015;27(11):1571-9.
257. Clemens JQ, Meenan RT, O'Keeffe Rosetti MC, Kimes TA, Calhoun EA. Case-control study of medical comorbidities in women with interstitial cystitis. *J Urol*. 2008;179(6):2222-5.
258. Malykhina AP. Neural mechanisms of pelvic organ cross-sensitization. *Neuroscience*. 2007;149(3):660-72.
259. Lei Q, Pan,X., Villamor,A.N., Asfaw,T.S., Chang,S., Zderic,S.A., Malykhina,A.P. Lack of transient receptor potential vanilloid 1 channel modulates the development of neurogenic bladder dysfunction induced by cross-sensitization in afferent pathways. *J Neuroinflamm*. 2013;10.1187/1742-2094-10-3.

260. Klumpp DJ, Rudick CN. Summation model of pelvic pain in interstitial cystitis. *Nature clinical practice Urology*. 2008;5(9):494-500.
261. Clemens JQ. Afferent neurourology: an epidemiological perspective. *The Journal of urology*. 2010;184(2):432-9.
262. Kluck P. The autonomic innervation of the human urinary bladder, bladder neck and urethra: a histochemical study. *Anat Rec*. 1980;198(3):439-47.
263. Inskip JA, Ramer, L.M., Ramer, M.S., Krassloulkov, A.V. Autonomic assessment of animals with spinal cord injury- tools, techniques and translation. *Spinal Cord*. 2009;47:2-35.
264. Vizzard MA, Erdman SL, Forstermann U, de Groat WC. Differential distribution of nitric oxide synthase in neural pathways to the urogenital organs (urethra, penis, urinary bladder) of the rat. *Brain Res*. 1994;646(2):279-91.
265. Ishizuka O, Alm P, Larsson B, Mattiasson A, Andersson KE. Facilitatory effect of pituitary adenylate cyclase activating polypeptide on micturition in normal, conscious rats. *Neuroscience*. 1995;66(4):1009-14.
266. Morgan C, Nadelhaft I, de Groat WC. Location of bladder preganglionic neurons within the sacral parasympathetic nucleus of the cat. *Neurosci Lett*. 1979;14(2-3):189-94.
267. Petras JM, Cummings JF. Sympathetic and parasympathetic innervation of the urinary bladder and urethra. *Brain Res*. 1978;153(2):363-9.
268. Nadelhaft I, Roppolo J, Morgan C, de Groat WC. Parasympathetic preganglionic neurons and visceral primary afferents in monkey sacral spinal cord revealed following application of horseradish peroxidase to pelvic nerve. *J Comp Neurol*. 1983;216(1):36-52.
269. Nadelhaft I, Booth AM. The location and morphology of preganglionic neurons and the distribution of visceral afferents from the rat pelvic nerve: a horseradish peroxidase study. *J Comp Neurol*. 1984;226(2):238-45.
270. Banrezes B, Andrey P, Maschino E, Schirar A, Peytevin J, Rampin O, et al. Spatial segregation within the sacral parasympathetic nucleus of neurons innervating the bladder or the penis of the rat as revealed by three-dimensional reconstruction. *Neuroscience*. 2002;115(1):97-109.
271. Liao JM, Cheng CL, Lee SD, Chen GD, Chen KJ, Yang CH, et al. Impaired micturition reflex caused by acute selective dorsal or ventral root(s) rhizotomy in anesthetized rats. *NeuroUrol Urodyn*. 2006;25(3):283-9.
272. Dering MA, Santer RM, Watson AH. Age-related changes in the morphology of preganglionic neurons projecting to the rat hypogastric ganglion. *J Neurocytol*. 1996;25(10):555-63.
273. Dering MA, Santer RM, Watson AH. Age-related changes in the morphology of preganglionic neurons projecting to the paracervical ganglion of nulliparous and multiparous rats. *Brain Res*. 1998;780(2):245-52.
274. Kuo DC, Hisamitsu T, de Groat WC. A sympathetic projection from sacral paravertebral ganglia to the pelvic nerve and to postganglionic nerves on the surface of the urinary bladder and large intestine of the cat. *J Comp Neurol*. 1984;226(1):76-86.
275. Warburton AL, Santer RM. Sympathetic and sensory innervation of the urinary tract in young adult and aged rats: a semi-quantitative histochemical and immunohistochemical study. *Histochem J*. 1994;26(2):127-33.
276. Brindley GS. An implant to empty the bladder or close the urethra. *J Neurol Neurosurg Psychiatry*. 1977;40(4):358-69.
277. Brindley GS. The first 500 patients with sacral anterior root stimulator implants: general description. *Paraplegia*. 1994;32(12):795-805.
278. Vignes JR, Deloire M, Petry K. Animal models of sacral neuromodulation for detrusor overactivity. *NeuroUrol Urodyn*. 2009;28(1):8-12.
279. Vizzard MA. Spinal interneurons and micturition reflexes: focus on "Characterization of a spinal, urine storage reflex, inhibitory center and its regulation by 5-HT1A receptors in female cats". *Am J Physiol Regul Integr Comp Physiol*. 2010;298(5):R1195-7.
280. Li MZ, Masuko S. Target specific organization and neuron types of the dog pelvic ganglia: a retrograde-tracing and immunohistochemical study. *Arch Histol Cytol*. 2001;64(3):267-80.
281. Wanigasekara Y, Kepper ME, Keast JR. Immunohistochemical characterisation of pelvic autonomic ganglia in male mice. *Cell Tissue Res*. 2003;311(2):175-85.
282. Anneren G, Meurling S, Olsen L. Megacystis-microcolon-intestinal hypoperistalsis syndrome (MMIHS), an autosomal recessive disorder: clinical reports and review of the literature. *Am J Med Genet*. 1991;41(2):251-4.
283. Richardson CE, Morgan JM, Jasani B, Green JT, Rhodes J, Williams GT, et al. Megacystis-microcolon-intestinal hypoperistalsis syndrome and the absence of the alpha3 nicotinic acetylcholine receptor subunit. *Gastroenterology*. 2001;121(2):350-7.

284. Xu W, Orr-Urtreger A, Nigro F, Gelber S, Sutcliffe CB, Armstrong D, et al. Multiorgan autonomic dysfunction in mice lacking the beta2 and the beta4 subunits of neuronal nicotinic acetylcholine receptors. *J Neurosci.* 1999;19(21):9298-305.
285. De Biasi M, Nigro F, Xu W. Nicotinic acetylcholine receptors in the autonomic control of bladder function. *Eur J Pharmacol.* 2000;393(1-3):137-40.
286. Gabella G. Intramural neurons in the urinary bladder of the guinea-pig. *Cell Tissue Res.* 1990;261(2):231-7.
287. Alm P. cholinergic innervation of the human urethra and urinary bladder: A histochemical study and review of methodology. *Acta Pharmacol Toxicol.* 1978;43:56-62.
288. Burnstock G, Allen,T.G.J., Hassall,C.J.S., Pitam,B.S. Properties of intramural neurones cultured from the heart and bladder. In: Heym C, editor. *Histochemistry and cell biology of autonomic neurons and paraganglia.* 16. heidelberg: Springer Verlag; 1987. p. 323-28.
289. Crowe R, Haven,A.J., Burnstock,G. Intramural neurons of the guinea-pig urinary bladder: histochemical localization of putative neurotransmitters in cultures and newborn animals. *J Auton Nerv Sys.* 1986;15:319-39.
290. Crowe R, Burnstock,G. A histochemical and immunohistochemical study of the autonomic innervation of the lower urinary tract of the female pig. *J Urol.* 1989;141:414-22.
291. Gilpin CJ, Dixon,J.S., Gilpin,S.A., Gosling,J.A. The fine structure of autonomic neurons in the wall of the human urinary bladder. *J Anat.* 1983;137:705-13.
292. Gabella G, Berggren T, Uvelius B. Hypertrophy and reversal of hypertrophy in rat pelvic ganglion neurons. *J Neurocytol.* 1992;21(9):649-62.
293. Dixon JS, Gilpin SA, Gilpin CJ, Gosling JA. Intramural ganglia of the human urinary bladder. *Br J Urol.* 1983;55(2):195-8.
294. Crowe R, Light,J.K., Chilton,C.P., Burnstock,G. Vasoactive intestinal polypeptide (VIP_ immunoreactive nerve fibres associated with the striated muscle of the human external urethral sphincter. *Lancet.* 1985;325:47-8.
295. Burnstock G, Cocks,T., Crowe,R., Kasakov,L. Purinergic innervation of the guinea-pig urinary bladder. *Br J Pharmacol.* 1978;63:125-38.
296. Ruan HZ, Birder,L.A., Xiang,Z., Chopra,B., Buffington,T., Tai,C., Roppolo,J.R., de Groat,W.C., Burnstock,G. Expression of P2X and P2Y receptors in the intramural parasympathetic ganglia of the cat urinary bladder. *Am J Physiol Renal Physiol.* 2006;290:F1143-52.
297. de Groat WC, Theobald,R.J. Reflex activation of sympathetic pathways to vesical smooth muscle and parasympathetic and parasympathetic ganglia by electrical stimulation of vesical afferents. *J Physiol.* 1976;259:223-37.
298. de Groat WC, Booth,A.M., Krier,J., Milne,R.J., Morgan,C., Nadelhaft,I. Neural control of the urinary bladder and large intestine. In: Brooks CM, Koizumi,K., Sato,A., editor. *Integrative functions of the autonomic nervous system.* Amsterdam: Elsevier/North Holland Biomedical Press; 1979. p. 50-67.
299. de Groat WC, Saum,W.R. Sympathetic inhibition of the urinary bladder and of pelvic ganglionic transmission in the cat. *J Physiol.* 1972;220:297-314.
300. Kuo DC, Hisamitsu T, de Groat WC. The function of efferent projections from the lumbosacral sympathetic chain to the urinary bladder in the cat. *Society for Neuroscience Abstracts* 9:6101983.
301. Keast JR, Kawatani M, De Groat WC. Sympathetic modulation of cholinergic transmission in cat vesical ganglia is mediated by alpha 1- and alpha 2-adrenoceptors. *Am J Physiol.* 1990;258(1 Pt 2):R44-50.
302. Akasu T, Shinnick-Gallagher,P., Gallagher,J.P. Adenosine mediates a slow hyperpolarizing synaptic potential in autonomic neurones. *Nature.* 1984;311:62-5.
303. Senba E, Daddona PE, Nagy JI. Development of adenosine deaminase-immunoreactive neurons in the rat brain. *Brain Res.* 1987;428(1):59-71.
304. Drake MJ, Hedlund P, Harvey IJ, Pandita RK, Andersson KE, Gillespie JI. Partial outlet obstruction enhances modular autonomous activity in the isolated rat bladder. *J Urol.* 2003;170(1):276-9.
305. Maas CP, Kenter GG, Trimboos JB, Deruiter MC. Anatomical basis for nerve-sparing radical hysterectomy: immunohistochemical study of the pelvic autonomic nerves. *Acta Obstet Gynecol Scand.* 2005;84(9):868-74.
306. Ek A, Alm P, Andersson KE, Persson CG. Adrenergic and Cholinergic Nerves of the Human Urethra and Urinary Bladder. A histochemical study. *Acta Physiol Scand.* 1977;99(3):345-52.
307. de Groat WC, Yoshimura N. Pharmacology of the lower urinary tract. *Annu Rev Pharmacol Toxicol.* 2001;41:691-721.
308. Keast JR, Stephensen TM. Glutamate and aspartate immunoreactivity in dorsal root ganglion

- cells supplying visceral and somatic targets and evidence for peripheral axonal transport. *J Comp Neurol.* 2000;424(4):577-87.
309. Gougis S, Prud'homme MJ, Rampin O. Presence of the N-methyl-D-aspartic acid R1 glutamatergic receptor subunit in the lumbosacral spinal cord of male rats. *Neurosci Lett.* 2002;323(3):224-8.
 310. Nishizawa O, Igawa Y, Satoh T, Yamashiro S, Sugaya K. Effects of glutamate receptor antagonists on lower urinary tract function in conscious unanesthetized rats. *Adv Exp Med Biol.* 1999;462:275-81.
 311. Santer RM, Dering MA, Ranson RN, Waboso HN, Watson AH. Differential susceptibility to ageing of rat preganglionic neurones projecting to the major pelvic ganglion and of their afferent inputs. *Auton Neurosci.* 2002;96(1):73-81.
 312. Shefchyk SJ. Spinal cord neural organization controlling the urinary bladder and striated sphincter. *Prog Brain Res.* 2002;137:71-82.
 313. Miyazato M, Sugaya K, Nishijima S, Ashitomi K, Hatano T, Ogawa Y. Inhibitory effect of intrathecal glycine on the micturition reflex in normal and spinal cord injury rats. *Exp Neurol.* 2003;183(1):232-40.
 314. Miyazato M, Sugaya K, Nishijima S, Ashitomi K, Ohyama C, Ogawa Y. Rectal distention inhibits bladder activity via glycinergic and GABAergic mechanisms in rats. *J Urol.* 2004;171(3):1353-6.
 315. Mertens P, Ghaemmaghami C, Bert L, Perret-Liaudet A, Sindou M, Renaud B. Amino acids in spinal dorsal horn of patients during surgery for neuropathic pain or spasticity. *Neuroreport.* 2000;11(8):1795-8.
 316. de Groat WC. Influence of central serotonergic mechanisms on lower urinary tract function. *Urology.* 2002;59(5 Suppl 1):30-6.
 317. Skagerberg G, Bjorklund A. Topographic principles in the spinal projections of serotonergic and non-serotonergic brainstem neurons in the rat. *Neuroscience.* 1985;15(2):445-80.
 318. Mizukawa K. The segmental detailed topographical distribution of monoaminergic terminals and their pathways in the spinal cord of the cat. *Anat Anz.* 1980;147(2):125-44.
 319. Chen SY, Wang SD, Cheng CL, Kuo JS, De Groat WC, Chai CY. Glutamate activation of neurons in CV-reactive areas of cat brain stem affects urinary bladder motility. *Am J Physiol.* 1993;265(4 Pt 2):F520-9.
 320. McMahon SB, Spillane K. Brain stem influences on the parasympathetic supply to the urinary bladder of the cat. *Brain Res.* 1982;234(2):237-49.
 321. Lecci A, Giuliani S, Santicoli P, Maggi CA. Involvement of 5-hydroxytryptamine_{1A} receptors in the modulation of micturition reflexes in the anesthetized rat. *J Pharmacol Exp Ther.* 1992;262(1):181-9.
 322. Gu B, Wu G, Si J, Xu Y, Andersson KE. Improving voiding efficiency in the diabetic rat by a 5-HT_{1A} serotonin receptor agonist. *NeuroUrol Urodyn.* 2012; 31:168-73.
 323. Thor KB, Hisamitsu T, de Groat WC. Unmasking of a neonatal somatovesical reflex in adult cats by the serotonin autoreceptor agonist 5-methoxy-N,N-dimethyltryptamine. *Brain Res Dev Brain Res.* 1990;54(1):35-42.
 324. Ranson RN, Dodds AL, Smith MJ, Santer RM, Watson AH. Age-associated changes in the monoaminergic innervation of rat lumbosacral spinal cord. *Brain Res.* 2003;972(1-2):149-58.
 325. Somogyi GT, Tanowitz M, de Groat WC. Prejunctional facilitatory alpha 1-adrenoceptors in the rat urinary bladder. *Br J Pharmacol.* 1995;114(8):1710-6.
 326. Yoshiyama M, Yamamoto T, de Groat WC. Role of spinal alpha(1)-adrenergic mechanisms in the control of lower urinary tract in the rat. *Brain Res.* 2000;882(1-2):36-44.
 327. de Groat WC, Yoshiyama M, Ramage AG, Yamamoto T, Somogyi GT. Modulation of voiding and storage reflexes by activation of alpha1-adrenoceptors. *Eur Urol.* 1999;36 Suppl 1:68-73.
 328. Wada T, Otsu T, Hasegawa Y, Mizuchi A, Ono H. Characterization of alpha 1-adrenoceptor subtypes in rat spinal cord. *Eur J Pharmacol.* 1996;312(2):263-6.
 329. Yono M, Tanaka T, Tsuji S, Irie S, Sakata Y, Otani M, et al. Effects of age and hypertension on alpha1-adrenoceptors in the major source arteries of the rat bladder and penis. *Eur J Pharmacol.* 2011;670(1):260-5.
 330. Wu W, Elde R, Wessendorf MW. Organization of the serotonergic innervation of spinal neurons in rats--III. Differential serotonergic innervation of somatic and parasympathetic preganglionic motoneurons as determined by patterns of co-existing peptides. *Neuroscience.* 1993;55(1):223-33.
 331. Pascual JI, Insausti R, Gonzalo LM. Urinary bladder innervation in male rat: termination of primary afferents in the spinal cord as determined by transganglionic transport of WGA-HRP. *J Urol.* 1993;150(2 Pt 1):500-4.
 332. Ljungdahl A, Hokfelt T, Nilsson G. Distribution of substance P-like immunoreactivity in the central nervous system of the rat--I. Cell bodies

- and nerve terminals. *Neuroscience*. 1978;3(10):861-943.
333. Sasek CA, Seybold VS, Elde RP. The immunohistochemical localization of nine peptides in the sacral parasympathetic nucleus and the dorsal gray commissure in rat spinal cord. *Neuroscience*. 1984;12(3):855-73.
334. Micevych PE, Coquelin A, Arnold AP. Immunohistochemical distribution of substance P, serotonin, and methionine enkephalin in sexually dimorphic nuclei of the rat lumbar spinal cord. *J Comp Neurol*. 1986;248(2):235-44.
335. Maxwell L, Maxwell DJ, Neilson M, Kerr R. A confocal microscopic survey of serotonergic axons in the lumbar spinal cord of the rat: colocalization with glutamate decarboxylase and neuropeptides. *Neuroscience*. 1996;75(2):471-80.
336. Lecci A, Maggi CA. Tachykinins as modulators of the micturition reflex in the central and peripheral nervous system. *Regul Pept*. 2001;101(1-3):1-18.
337. Mersdorf A, Schmidt RA, Kaula N, Tanagho EA. Intrathecal administration of substance P in the rat: the effect on bladder and urethral sphincteric activity. *Urology*. 1992;40(1):87-96.
338. Goettl VM, Tejwani GA, Neff NH, Hadjiconstantinou M. Decreased neuropeptide content in the spinal cord of aged rats: the effect of GM1 ganglioside. *Neuroreport*. 1999;10(3):513-6.
339. Ranson RN, Priestley DJ, Santer RM, Watson AH. Changes in the substance P-containing innervation of the lumbosacral spinal cord in male Wistar rats as a consequence of ageing. *Brain Res*. 2005;1036(1-2):139-44.
340. De Mey J, Burnstock G, VanHoutte P.M. Modulation of the evoked release of noradrenaline in canine saphenous vein via presynaptic receptors for adenosine but not ATP. *Eur J Pharmacol*. 1979;55:401-5.
341. Ribeiro JA. Purinergic modulation of transmitter release. *J Theor Biol*. 1979;80(2):259-70.
342. Snyder SH. Adenosine as a neuromodulator. *Annu Rev Neurosci*. 1985;8:103-24.
343. Katsuragi T, Kuratomi L, Furukawa T. Clonidine-evoked selective P1-purinoceptor antagonism of contraction of guinea-pig urinary bladder. *Eur J Pharmacol*. 1986;121(1):119-22.
344. Sperlagh B, Vizi ES. Effect of presynaptic P2 receptor stimulation on transmitter release. *J Neurochem*. 1991;56(5):1466-70.
345. Acevedo CG, Contreras E., Lewin J., Huidobro-Toro J.P. Pharmacological characterization of adenosine A1 and A2 receptors in the bladder: evidence for a modulatory adenosine tone regulating non-adrenergic non-cholinergic neurotransmission. *Br J Pharmacol*. 1992;107:120-26.
346. Funder H, Muscholl E. Heteroreceptor-mediated modulation of noradrenaline and acetylcholine release from peripheral nerves. *Rev Physiol Biochem Pharmacol*. 1995;126:265-412.
347. MacDermott AB, Role LW, Siegelbaum SA. Presynaptic ionotropic receptors and the control of transmitter release. *Annu Rev Neurosci*. 1999;22:443-85.
348. Burnstock G. Puriner and pyrimidine receptors. *Cellular and molecular life sci*. 2007;64:1471-83.
349. Burnstock G. Purinergic signalling in the urinary tract in health and disease. *Purinergic Signal*. 2014;10(1):103-55.
350. Burnstock G. Co-transmission. The fifth Heymans memorial lecture. *Arch Int Pharmacodyn Ther*. 1990;304:7-33.
351. Fuder H, Muth U. ATP and endogenous agonists inhibit evoked [3H] noradrenaline release in rat iris via A1 and P2Y like purinoceptors. *Naunyn-Schmiedeberg's Arch Pharmacol*. 1993;348:352-57.
352. King JA, Huddart H, Staff WG. Purinergic modulation of rat urinary bladder detrusor smooth muscle. *Gen Pharmacol*. 1997;29(4):597-604.
353. Shinozuka K, Bjur RA, Westfall DP. Effects of alpha,beta-methylene ATP on the prejunctional purinoceptors of the sympathetic nerves of the rat caudal artery. *J Pharmacol Exp Ther*. 1990;254(3):900-4.
354. Wiklund NP, Gustafsson LE. Neuromodulation by adenine nucleotides, as indicated by experiments with inhibitors of nucleotide inactivation. *Acta Physiol Scand*. 1986;126(2):217-23.
355. Hoyle CH, Burnstock G. Atropine-resistant excitatory junction potentials in rabbit bladder are blocked by alpha,beta-methylene ATP. *Eur J Pharmacol*. 1985;114(2):239-40.
356. Buchthal F, Kahlson G. The motor effect of adenosine triphosphate and allied phosphorus compounds on smooth mammalian muscle. *Acta Physiol Scand*. 1944;8:325-34.
357. Andersson KE. Pharmacology of lower urinary tract smooth muscles and penile erectile tissues. *Pharmacol Rev*. 1993;45:253-308.
358. Lukacszo P, Krell RD. Response of the guinea-pig urinary bladder to purine and pyrimidine nucleotides. *Eur J Pharmacol*. 1982;80(4):401-6.

359. Theobald RJ, Jr. Subclasses of purinoceptors in feline bladder. *Eur J Pharmacol.* 1992;229(2-3):125-30.
360. Chen HI, Brading A.F. The mechanism of action of putative non-adrenergic, non cholinergic transmitters on the rabbit urinary bladder. *J Auton Nerv Sys.* 1991;33:178-79.
361. Bolego C, Abbracchio M.P., Cattabeni F., Ruzza R., Puglisi L. Effects of ADPbeta S and UTP on the rat urinary bladder smooth muscle. *Res Comm in Molecular Pathol Pharmacol.* 1995;87:75-6.
362. Lee HY, Bardini M, Burnstock G. Distribution of P2X receptors in the urinary bladder and the ureter of the rat. *J Urol.* 2000;163(6):2002-7.
363. Hansen MA, Balcar V.J., Barden J.A., Bennett M.R. The distribution of single P2X1 receptor clusters on smooth muscle cells in relation to nerve varicosities in the rat urinary bladder. *J Neurocytol.* 1998;27:529-39.
364. Jenes A, Ruzsnavszky F, Telek A, Szigeti GP, Csernoch L. A possible role of the cholinergic and purinergic receptor interaction in the regulation of the rat urinary bladder function. *J Muscle Res Cell Motil.* 2012;32(6):421-31.
365. Theobald RJ, Jr., de Groat WD. The effects of purine nucleotides on transmission in vesical parasympathetic ganglia of the cat. *J Auton Pharmacol.* 1989;9(3):167-81.
366. Aronsson P, Andersson M., Ericsson T., Gigglio D. Assessment and characterization of purinergic contractions and relaxations in the rat urinary bladder. *Basic Clin Pharmacol Toxicol.* 2010;107:603-13.
367. Burnstock G. Purinergic signalling: past, present and future. *Braz J Med Biol Res.* 2009;42(1):3-8.
368. Rouget C, Rekik M., Camparo P., Botto H., Rischmann P., Lluet P., Palea S., Westfall T.D. Modulation of nerve-evoked contractions by beta3-adrenoceptor agonism in human and rat isolated urinary bladder. *Pharmacol Res.* 2014;80:14-20.
369. O'Reilly BA, Kosaka AH, Knight GF, Chang TK, Ford AP, Rymer JM, et al. P2X receptors and their role in female idiopathic detrusor instability. *J Urol.* 2002;167(1):157-64.
370. Langley JN, Anderson HK. The Innervation of the Pelvic and adjoining Viscera: Part II. The Bladder. Part III. The External Generative Organs. Part IV. The Internal Generative Organs. Part V. Position of the Nerve Cells on the Course of the Efferent Nerve Fibres. *J Physiol.* 1895;19(1-2):71-139.
371. Henderson VE. The action of atropine on intestine and urinary bladder. *Arch Int Pharmacodyn Ther.* 1923;27:205-11.
372. Chesher GB, Thorp R.H. The atropine resistance of the response to intrinsic nerve stimulation of the guinea pig bladder. *Br J Pharmacol.* 1965;25:288-94.
373. Burnstock G. Purinergic signalling in lower urinary tract. In: Abbracchio MP, Williams M., editor. *Handbook of experimental pharmacology Purinergic and pyrimidinergic signaling molecular, nervous and urinogenitary system function.* 15 I/I. Berlin: Springer-Verlag; 2001. p. 423-515.
374. Ambache N, Zar M.A. Non-cholinergic transmission by post-ganglionic motor neurones in the mammalian bladder. *J Physiol.* 1970;210:761-3.
375. Krell RD, McCoy JL, Ridley PT. Pharmacological characterization of the excitatory innervation to the guinea-pig urinary bladder in vitro: evidence for both cholinergic and non-adrenergic-non-cholinergic neurotransmission. *Br J Pharmacol.* 1981;74(1):15-22.
376. Maggi CA, Santicoli P, Meli A. Pharmacological evidence for the existence of two components in the twitch response to field stimulation of detrusor strips from the rat urinary bladder. *J Auton Pharmacol.* 1985;5(3):221-9.
377. Burnstock G, Dumsday B., Smythe A. Atropine resistant excitation of the urinary bladder: the possibility of transmission via nerves releasing a purine nucleotide. *Br J Pharmacol.* 1972;44:451-61.
378. Burnstock G, Cocks T., Kasakov L., Wong H.K. Direct evidence for ATP release from non-adrenergic, non cholinergic (purinergic) nerves in the guinea-pig taenia coli and bladder. *Eur J Pharmacol.* 1978;49:145-9.
379. Kasakov L, Burnstock G. The use of the slowly degradable analog, alpha, beta-methylene ATP, to produce desensitisation of the P2-purinoceptor: effect on non-adrenergic, non-cholinergic responses of the guinea-pig urinary bladder. *Eur J Pharmacol.* 1982;86(2):291-4.
380. Brading AF, Williams J.H. Contractile responses of smooth muscle strips from rat and guinea pig urinary bladder to transmural stimulation: effects of atropine and alpha beta methylene ATP. *Br J Pharmacol.* 1990;99:493-98.
381. Meldrum LA, Burnstock G. Evidence against VIP or substance P being the transmitter in non-cholinergic excitatory nerves supplying the guinea-pig bladder. *J Pharm Pharmacol.* 1985;37(6):432-4.

382. Iacovou JW, Hill SJ, Birmingham AT. Agonist-induced contraction and accumulation of inositol phosphates in the guinea-pig detrusor: evidence that muscarinic and purinergic receptors raise intracellular calcium by different mechanisms. *J Urol.* 1990;144(3):775-9.
383. Acevedo CG, Contreras E. Possible involvement of adenine nucleotides in the neurotransmission of the mouse urinary bladder. *Comp Biochem Physiol.* 1985;82:357-61.
384. Tsai MH, Kamm KE, Stull JT. Signalling to contractile proteins by muscarinic and purinergic pathways in neurally stimulated bladder smooth muscle. *J Physiol.* 2012;590(20):5107-21.
385. Fujii K. Electrophysiological evidence that adenosine triphosphate (ATP) is a cotransmitter with acetylcholine (ACh) in isolated guinea-pig, rabbit and pig urinary bladder. *Proc Physiol Soc.* 1987;394:26P.
386. Pinna C, Puglisi L, Burnstock G. ATP and vasoactive intestinal polypeptide relaxant responses in hamster isolated proximal urethra. *Br J Pharmacol.* 1998;124(6):1069-74.
387. Moss HE, Burnstock G. A comparative study of electrical field stimulation of the guinea-pig, ferret and marmoset urinary bladder. *Eur J Pharmacol.* 1985;114(3):311-6.
388. Taira N. The autonomic pharmacology of the bladder. *Annu Rev Pharmacol.* 1972;12:197-208.
389. Creed KE, Callahan S.M., Ito Y. Excitatory neurotransmission in the mammalian bladder and the effects of suramin. *Br J Urol.* 1994;74:736-43.
390. Levin RM, Longhurst PA, Kato K, McGuire EJ, Elbadawi A, Wein AJ. Comparative physiology and pharmacology of the cat and rabbit urinary bladder. *J Urol.* 1990;143(4):848-52.
391. Hoyle CH, Chakrabarti G, Pendleton NP, Andrews PL. Neuromuscular transmission and innervation in the urinary bladder of the insectivore *Suncus murinus*. *J Auton Nerv Syst.* 1998;69(1):31-8.
392. Cotton KD, Hollywood M.A., Thornbury K.D., McHale N.G. Effect of purinergic blockers on outward current in isolated smooth muscle cells of the sheep bladder. *Am J Physiol Renal Physiol.* 1996;270:C969-73.
393. Brown C, Burnstock G., Cocks T. Effects of adenosine 5 triphosphate (ATP) and beta gamma methylene ATP on the rat urinary bladder. *Br J Pharmacol.* 1979;65:97-102.
394. Bhat MB, Mishra S.K., Raviprakash V. Sources of calcium for ATP-induced contractions in rat urinary bladder smooth muscle. *Eur J Pharmacol.* 1989;164:163-66.
395. Boselli C, Bianchi L., Grana E. Effect of cromakalim on the purinergic and cholinergic transmission in the rat detrusor muscle. *Eur J Pharmacol.* 1997;335:23-30.
396. Hegde SS, Mandel D.A., Wilford M.R., Briaud S., Ford A.P.D.W., Eglén R.M. Evidence for purinergic neurotransmission in the urinary bladder of pithed rats. *Eur J Pharmacol.* 1998;349:75-82.
397. Igawa Y, Mattiasson A, Andersson KE. Functional importance of cholinergic and purinergic neurotransmission for micturition contraction in the normal, unanaesthetized rat. *Br J Pharmacol.* 1993;109(2):473-9.
398. Dean DM, Downie J.W. Contribution of adrenergic and purinergic neurotransmission to contraction in rabbit detrusor. *J Pharmacol Exp Ther.* 1978;207:431-45.
399. Husted S, Sjogren C, Andersson KE. Mechanisms of the responses to non-cholinergic, non-adrenergic nerve stimulation and to ATP in isolated rabbit urinary bladder: evidence for ADP evoked prostaglandin release. *Acta Pharmacol Toxicol (Copenh).* 1980;47(2):84-92.
400. Levin RM, Ruggieri MR, Wein AJ. Functional effects of the purinergic innervation of the rabbit urinary bladder. *J Pharmacol Exp Ther.* 1986;236(2):452-7.
401. Longhurst PA, Belis JA, O'Donnell JP, Galie JR, Westfall DP. A study of the atropine-resistant component of the neurogenic response of the rabbit urinary bladder. *Eur J Pharmacol.* 1984;99(4):295-302.
402. Ziganshin AU, Hoyle CH, Bo X, Lambrecht G, Mutschler E, Baumert HG, et al. PPADS selectively antagonizes P2X-purinoceptor-mediated responses in the rabbit urinary bladder. *Br J Pharmacol.* 1993;110(4):1491-5.
403. Inoue R, Brading AF. Human, pig and guinea-pig bladder smooth muscle cells generate similar inward currents in response to purinoceptor activation. *Br J Pharmacol.* 1991;103(4):1840-1.
404. Palea S, Artibani W, Ostardo E, Trist DG, Pietra C. Evidence for purinergic neurotransmission in human urinary bladder affected by interstitial cystitis. *J Urol.* 1993;150(6):2007-12.
405. Saito M, Kondo A, Kato T, Hasegawa S, Miyake K. Response of the human neurogenic bladder to KCl, carbachol, ATP and CaCl₂. *Br J Urol.* 1993;72(3):298-302.
406. Bo X, Burnstock G. Characterization and autoradiographic localization of [³H] alpha beta methylene adenosine 5 triphosphate binding

- sites in human urinary bladder. *Br J Urol.* 1995;76:297-302.
407. Wu C, Bayliss M, Newgreen D, Mundy AR, Fry CH. A comparison of the mode of action of ATP and carbachol on isolated human detrusor smooth muscle. *J Urol.* 1999;162(5):1840-7.
 408. Parija SC, Raviprakash V, Mishra SK. Adenosine- and alpha,beta-methylene ATP-induced differential inhibition of cholinergic and non-cholinergic neurogenic responses in rat urinary bladder. *Br J Pharmacol.* 1991;102(2):396-400.
 409. Morris JL, Gibbins IL. Co-transmission and neuromodulation. In: Burnstock G, Hoyle CHV, editors. *Autonomic Neuroeffector Mechanisms.* Chur: Harwood Academic Publishers; 1992. p. 33-119.
 410. Ambache N, Killick, S.W., Woodley, J.P. Evidence against purinergic motor transmission in guinea-pig urinary bladder. *Br J Pharmacol.* 1977;61:464P.
 411. Peterson JS, Noronha-Blob L. Effects of selective cholinergic antagonists and alpha,beta-methylene ATP on guinea-pig urinary bladder contractions in vivo following pelvic nerve stimulation. *J Auton Pharmacol.* 1989;9(5):303-13.
 412. Koley B, Koley J, Saha JK. The effects of nicotine on spontaneous contractions of cat urinary bladder in situ. *Br J Pharmacol.* 1984;83(2):347-55.
 413. Theobald RJ, Jr. Purinergic and cholinergic components of bladder contractility and flow. *Life Sci.* 1995;56(6):445-54.
 414. Hoyes AD, Barber P, Martin BG. Comparative ultrastructure of the nerves innervating the muscle of the body of the bladder. *Cell Tissue Res.* 1975;164(1):133-44.
 415. Ehlert FJ, Ahn, S., Pak, K.J., Park, G.J., Sangnil, M.S., Tran, J.A., Matsui, M. Neuronally released acetylcholine acts on the M2 muscarinic receptor to oppose the relaxant effect of isoproterenol on cholinergic contractions in mouse urinary bladder. *J Pharmacol Exp Ther.* 2007;322:631-37.
 416. Igawa Y, Zhang X, Nishizawa O, Umeda M, Iwata A, Taketo MM, et al. Cystometric findings in mice lacking muscarinic M2 or M3 receptors. *J Urol.* 2004;172(6 Pt 1):2460-4.
 417. Levin RM, Wein AJ. Response of the in vitro whole bladder (rabbit) preparation to autonomic agonists. *J Urol.* 1982;128(5):1087-90.
 418. Levin RM, Brendler K, Wein AJ. Comparative pharmacological response of an in vitro whole bladder preparation (rabbit) with response of isolated smooth muscle strips. *J Urol.* 1983;130(2):377-81.
 419. Hoyle CHV, Burnstock G. Postganglionic efferent transmission to the bladder and urethra. In: Maggi CA, editor. *The Autonomic Nervous System, Vol 3 Nervous Control of the Urogenital System 3.* Switzerland: Harwood Academic Publishers; 1993. p. 349-83.
 420. Alm P, Elmer, M. Adrenergic and cholinergic innervation of the rat urinary bladder. *Acta Physiol.* 1975;94:36-45.
 421. Creed KE. The role of the hypogastric nerve in bladder and urethral activity of the dog. *Br J Pharmacol.* 1979;65:367-75.
 422. Imagawa J, Akima M, Sakai K. Functional evaluation of sympathetically mediated responses in in vivo lower urinary tract of dogs. *J Pharmacol Methods.* 1989;22(2):103-11.
 423. Labadia A, Rivera L, Costa G, Garcia-Sacristan A. Influence of the autonomic nervous system in the horse urinary bladder. *Res Vet Sci.* 1988;44(3):282-5.
 424. Maggi CA, Conte B, Furio M, Santicoli P, Giuliani S, Meli A. Further studies on mechanisms regulating the voiding cycle of the rat urinary bladder. *Gen Pharmacol.* 1989;20(6):833-8.
 425. Burnstock G. The Erasmus Lecture 2012, Academia Europaea. The concept of cotransmission: focus on ATP as a cotransmitter and its significance in health and disease. *Eur Rev.* 2014;22:1-17.
 426. Lincoln J, Burnstock G. Autonomic innervation of the urinary bladder and urethra. . In: Maggi CA, editor. *The Autonomic Nervous System, Vol 3 Nervous Control of the Urogenital System.* Chur, Switzerland: Harwood Academic Publishers; 1993. p. 33-68.
 427. Theobald RJ, Jr. Evidence against purinergic nerve fibres in the hypogastric nerves of the cat. *J Auton Pharmacol.* 1983;3(4):235-9.
 428. Theobald RJ, Jr., Hoffman V. Long-lasting blockade of P2-receptors of the urinary bladder in vivo following photolysis of arylazido aminopropionyl ATP, a photoaffinity label. *Life Sci.* 1986;38(17):1591-5.
 429. de Groat WC, Saum, W.R. Synaptic transmission in parasympathetic ganglia in the urinary bladder of the cat. *J Physiol.* 1976;256:137-58.
 430. Burnstock G. Noradrenaline and ATP as cotransmitters in sympathetic nerves. *Neurochem Int.* 1990;17:357-68.
 431. Holck MI, Marks BH. Purine nucleoside and nucleotide interactions on normal and subsensitive alpha adrenoreceptor responsiveness in guinea-pig vas deferens. *J Pharmacol Exp Ther.* 1978;205(1):104-17.

432. Lin MJ, Liu SH, Lin-Shiau SY. Phorbol ester-induced contractions of mouse detrusor muscle are inhibited by nifedipine. *Naunyn Schmiedebergs Arch Pharmacol.* 1998;357(5):553-7.
433. Foreman RD. Integration of viscerosomatic sensory input at the spinal level. *Prog Brain Res.* 2000;122:209-21.
434. Kaddumi EG, Hubscher CH. Convergence of multiple pelvic organ inputs in the rat rostral medulla. *J Physiol.* 2006;572(Pt 2):393-405.
435. Bruggemann J, Shi T, Apkarian AV. Squirrel monkey lateral thalamus. II. Viscerosomatic convergent representation of urinary bladder, colon, and esophagus. *J Neurosci.* 1994;14(11 Pt 2):6796-814.
436. Strasser H, Tiefenthaler M, Steinlechner M, Eder I, Bartsch G, Konwalinka G. Age dependent apoptosis and loss of rhabdosphincter cells. *J Urol.* 2000;164(5):1781-5.
437. Dalmose AL, Rijkhoff NJ, Andersen IS, Stefania D, Jorgensen TM, Djurhuus JC. Bladder and urethral responses to pelvic nerve stimulation in the pig. *Scand J Urol Nephrol Suppl.* 2002(210):34-45.
438. Persson K, Pandita RK, Spitsbergen JM, Steers WD, Tuttle JB, Andersson KE. Spinal and peripheral mechanisms contributing to hyperactive voiding in spontaneously hypertensive rats. *Am J Physiol.* 1998;275(4 Pt 2):R1366-73.
439. Kruse MN, Mallory BS, Noto H, Roppolo JR, de Groat WC. Modulation of the spinobulbosacral micturition reflex pathway in cats. *Am J Physiol.* 1992;262(3 Pt 2):R478-84.
440. Rouzade-Dominguez ML, Miselis R, Valentino RJ. Central representation of bladder and colon revealed by dual transsynaptic tracing in the rat: substrates for pelvic visceral coordination. *Eur J Neurosci.* 2003;18(12):3311-24.
441. Song B, Jiang C, Wang Y, Lu Y, Li L. Newly found prostate-bladder neural reflex in rats--possible mechanism for voiding dysfunction associated with prostatitis/pelvic pain. *Urology.* 2009;74(6):1365-9.
442. Hocaoglu Y, Roosen A, Herrmann K, Tritschler S, Stief C, Bauer RM. Real-time magnetic resonance imaging (MRI): anatomical changes during physiological voiding in men. *BJU Int.* 2011;109(2):234-9.
443. Nadelhaft I, Miranda-Sousa AJ, Vera PL. Separate urinary bladder and prostate neurons in the central nervous system of the rat: simultaneous labeling with two immunohistochemically distinguishable pseudorabies viruses. *BMC Neurosci.* 2002;3:8.
444. Winnard KP, Dmitrieva N, Berkley KJ. Cross-organ interactions between reproductive, gastrointestinal, and urinary tracts: modulation by estrous stage and involvement of the hypogastric nerve. *Am J Physiol Regul Integr Comp Physiol.* 2006;291(6):R1592-601.
445. Dmitrieva N, Berkley KJ. Contrasting effects of WIN 55212-2 on motility of the rat bladder and uterus. *J Neurosci.* 2002;22(16):7147-53.
446. Dmitrieva N, Berkley KJ. Influence of estradiol on micturition thresholds in the rat: involvement of the hypogastric nerve. *Am J Physiol Regul Integr Comp Physiol.* 2005;289(6):R1724-8.
447. Qin C, Malykhina AP, Akbarali HI, Foreman RD. Cross-organ sensitization of lumbosacral spinal neurons receiving urinary bladder input in rats with inflamed colon. *Gastroenterology.* 2005;129(6):1967-78.
448. Wall PD, Hubscher CH, Berkley KJ. Intrasacral modulation of neuronal responses to uterine and cervix stimulation in rat L1 and L6 dorsal horn. *Brain Res.* 1993;622(1-2):71-8.
449. Rouzade-Dominguez M-L, Pernar L, Beck S, Valentino RJ. Convergent responses of Barrington's nucleus neurons to pelvic visceral stimuli: a juxtacellular labeling study. *Eur J Neurosci.* 2003;18:3325-34.
450. Hubscher CH, Kaddumi EG, Johnson RD. Brain stem convergence of pelvic viscerosomatic inputs via spinal and vagal afferents. *Neuroreport.* 2004;15(8):1299-302.
451. Gevaert T, Ost D, De Ridder D. Comparison study of autonomous activity in bladders from normal and paraplegic rats. *NeuroUrol Urodyn.* 2006;25(4):368-78; discussion 79-80.
452. Finney SM, Stewart LH, Gillespie JI. Cholinergic activation of phasic activity in the isolated bladder: possible evidence for M3- and M2-dependent components of a motor/sensory system. *BJU Int.* 2007;100(3):668-78.
453. Sadananda P, Drake MJ, Paton JF, Pickering AE. An exploration of the control of micturition using a novel in situ arterially perfused rat preparation. *Front Neurosci.* 2011;5:62.
454. Sugaya K, de Groat WC. Effects of MK-801 and CNQX, glutamate receptor antagonists, on bladder activity in neonatal rats. *Brain Res.* 1994;640(1-2):1-10.
455. Sugaya K, de Groat WC. Inhibitory control of the urinary bladder in the neonatal rat in vitro spinal cord-bladder preparation. *Brain Res Dev Brain Res.* 2002;138(1):87-95.
456. Lagou M, Gillespie JI, Andersson KE, Kirkwood T, Drake MJ. Bladder volume alters cholinergic responses of the isolated whole mouse bladder. *J Urol.* 2006;175(2):771-6.

457. Lagou M, Gillespie J, Kirkwood T, Harvey I, Drake MJ. Muscarinic stimulation of the mouse isolated whole bladder: physiological responses in young and ageing mice. *Auton Autacoid Pharmacol.* 2006;26(3):253-60.
458. Grol S, van Koeveringe GA, de Vente J, van Kerrebroeck PE, Gillespie JI. Regional differences in sensory innervation and suburothelial interstitial cells in the bladder neck and urethra. *BJU Int.* 2008;102(7):870-7.
459. Gillespie JI, Harvey IJ, Drake MJ. Agonist- and nerve-induced phasic activity in the isolated whole bladder of the guinea pig: evidence for two types of bladder activity. *Exp Physiol.* 2003;88(3):343-57.
460. Kanai A, Roppolo J, Ikeda Y, Zabbarova I, Tai C, Birder L, et al. Origin of spontaneous activity in neonatal and adult rat bladders and its enhancement by stretch and muscarinic agonists. *Am J Physiol Renal Physiol.* 2007;292(3):F1065-72.
461. Finney SM, Stewart LH, Gillespie JI. Volume-induced responses in the isolated bladder: evidence for excitatory and inhibitory elements. *BJU Int.* 2008;102(9):1154-61.
462. Drake MJ, Harvey IJ, Gillespie JI. Autonomous activity in the isolated guinea pig bladder. *Exp Physiol.* 2003;88(1):19-30.
463. Szigeti GP, Somogyi GT, Csernoch L, Szell EA. Age-dependence of the spontaneous activity of the rat urinary bladder. *J Muscle Res Cell Motil.* 2005;26(1):23-9.
464. Szell EA, Yamamoto T, de Groat WC, Somogyi GT. Smooth muscle and parasympathetic nerve terminals in the rat urinary bladder have different subtypes of alpha(1) adrenoceptors. *Br J Pharmacol.* 2000;130(7):1685-91.
465. Drake MJ, Mills IW, Gillespie JI. Model of peripheral autonomous modules and a myovesical plexus in normal and overactive bladder function. *Lancet.* 2001;358(9279):401-3.
466. Coolsaet BL, Van Duyl WA, Van Os-Bossagh P, De Bakker HV. New concepts in relation to urge and detrusor activity. *Neurourol Urodyn.* 1993;12(5):463-71.
467. Smith TK, Robertson WJ. Synchronous movements of the longitudinal and circular muscle during peristalsis in the isolated guinea-pig distal colon. *J Physiol.* 1998;506 (Pt 2):563-77.
468. Drake MJ. The integrative physiology of the bladder. *Ann R Coll Surg Engl.* 2007;89(6):580-5.
469. Ekman M, Andersson, K.E., Arner, A. Developmental regulation of nerve and receptor mediated contractions of mammalian urinary bladder smooth muscle. *Eur J Pharmacol.* 2006;532:99-106.
470. Crowe R, Burnstock, G. Perinatal development of adrenergic, cholinergic and non-adrenergic, non cholinergic nerves and sif cells in the rabbit urinary bladder. *Int J Dev Neurosci.* 1985;3:89-101.
471. Maggi CA, Santicioli P, Meli A. Postnatal development of myogenic contractile activity and excitatory innervation of rat urinary bladder. *Am J Physiol.* 1984;247(6 Pt 2):R972-8.
472. Nicholls J, Hourani SM, Kitchen I. The ontogeny of purinoceptors in rat urinary bladder and duodenum. *Br J Pharmacol.* 1990;100(4):874-8.
473. O'Reilly BA, Kosaka AH, Chang TK, Ford AP, Popert R, Rymer JM, et al. A quantitative analysis of purinoceptor expression in human fetal and adult bladders. *J Urol.* 2001;165(5):1730-4.
474. Ferguson D, Christopher, N. Urinary bladder function and drug development. *Trends Pharmacol Sci.* 1996;17:161-65.
475. Gomez-Pinilla PJ, Pozo, M.J., Camello, P.J. Aging impairs neurogenic contraction in guinea pig urinary bladder: role of oxidative stress and melatonin. *Am J Physiol Regul Integ Comp Physiol.* 2007;293:R793-803.
476. Kageyama S, Fujita K, Suzuki K, Shinbo H, Masuda N, Uchida W. Effect of age on the responses of rat bladder detrusor strips to adenosine triphosphate. *BJU Int.* 2000;85(7):899-904.
477. Yoshida M, Miyamae K, Iwashita H, Otani M, Inadome A. Management of detrusor dysfunction in the elderly: changes in acetylcholine and adenosine triphosphate release during aging. *Urology.* 2004;63(3 Suppl 1):17-23.
478. Wuest M, Morgenstern K, Graf EM, Braeter M, Hakenberg OW, Wirth MP, et al. Cholinergic and purinergic responses in isolated human detrusor in relation to age. *J Urol.* 2005;173(6):2182-9.
479. Chua WC, Liu, L., Mansfield, K.J., Vaux, K.J., Moore, K.H., Millard, R.J., Burcher, E. Age-related changes of P2X1 receptor mRNA in the bladder detrusor from men with and without bladder outlet obstruction. *Exp Gerontol.* 2007;42:686-92.
480. Ryhammer AM, Bek KM, Laurberg S. Multiple vaginal deliveries increase the risk of permanent incontinence of flatus urine in normal premenopausal women. *Dis Colon Rectum.* 1995;38(11):1206-9.

481. Grandadam F, Lluel,P., Palea,S., Martin,D.J. Pharmacological and urodynamic changes in rat urinary bladder function after multiple pregnancies. *BJU Int.* 1999;84:861-66.
482. Levin RM, Tong Y-C, Wein AJ. Effect of pregnancy on the autonomic response of the rabbit urinary bladder. *Neurourology and Urodynamics.* 1991; 10:313.
483. Tong YC, Hung YC, Lin JS, Hsu CT, Cheng JT. Effects of pregnancy and progesterone on autonomic function in the rat urinary bladder. *Pharmacology.* 1995;50(3):192-200.
484. Theobald RJ, Zepp EA, Westhoff R. Endocrine influences on the detrusor of male and female cats. *Neurourology and Urodynamics.* 1988;7(5):493-500.
485. Levin RM, Shofer FS, Wein AJ. Estrogen-induced alterations in the autonomic responses of the rabbit urinary bladder. *J Pharmacol Exp Ther.* 1980;215(3):614-8.
486. Ratz PH, McCammon KA, Altstatt D, Blackmore PF, Shenfeld OZ, Schlossberg SM. Differential effects of sex hormones and phytoestrogens on peak and steady state contractions in isolated rabbit detrusor. *J Urol.* 1999;162(5):1821-8.
487. Carley ME, Cliby,W.A., Spelsberg,T.C. P2X3 receptor subunit messenger RNA expression in the female mouse bladder after oophorectomy with or without estrogen replacement. *Am J Obstet Gynecol.* 2002;187:103-6.
488. Ouslander JG. Management of overactive bladder. *N Engl J Med.* 2004;350(8):786-99.
489. Kumar V, Cross RL, Chess-Williams R, Chapple CR. Recent advances in basic science for overactive bladder. *Curr Opin Urol.* 2005;15(4):222-6.
490. Athanasopoulos A, Cruz,F. The medical treatment of overactive bladder, including current and future treatments. *Expert Opin Pharmacother.* 2011;12:1041-55.
491. Burnstock G. Therapeutic potential of purinergic signalling for diseases of the urinary tract. *BJU Int.* 2011;107:192-204.
492. Burnstock G. Purinergic signalling in the lower urinary tract. *Acta Physiol.* 2013;207:40-52.
493. Ford AP, Cockayne,D.A. ATP and P2X purinoceptors in urinary tract disorders. *Handbk of Exp Pharmacol.* 2011;202:485-526.
494. Meng E, Lin WY, Lee WC, Chuang YC. Pathophysiology of Overactive Bladder. *Low Urin Tract Symptoms.* 2012;4 Suppl 1:48-55.
495. Cheng Y, Mansfield,K.J., Allen,W., Millard,R.J., Burcher,E., Moore,K.H. Correlation between cystometric voluments, ATP release and pH in women with overactive bladder versus controls. *Neurourol Urodyn.* 2013;32:969-73.
496. Silva-Ramos M, Silva I, Oliveira O, Ferreira S, Reis MJ, Oliveira JC, et al. Urinary ATP may be a dynamic biomarker of detrusor overactivity in women with overactive bladder syndrome. *PLoS One.* 2013;8(5):e64696.
497. Yiangou Y, Facer P, Ford A, Brady C, Wiseman O, Fowler CJ, et al. Capsaicin receptor VR1 and ATP-gated ion channel P2X3 in human urinary bladder. *BJU Int.* 2001;87(9):774-9.
498. Chung SD, Chien,C.T., Yu,H.J. Alterations in peripher al purinergic and muscarinic signaling of rat bladder after long-term fructose-induced metabolic syndrome. *Eur J Nutr.* 2013;52:347-59.
499. Kitta T, Chancellor MB, de Groat WC, Kuno S, Nonomura K, Yoshimura N. Suppression of bladder overactivity by adenosine A2A receptor antagonist in a rat model of Parkinson disease. *J Urol.* 2012;187(5):1890-7.
500. Yu Y, de Groat WC. Nitric oxide modulates bladder afferent nerve activity in the in vitro urinary bladder-pelvic nerve preparation from rats with cyclophosphamide induced cystitis. *Brain Res.* 2013;1490:83-94.
501. Wammack R, Weihe E, Dienes HP, Hohenfeller R. Die neurogene blase in vitro. *Akt Urol.* 1995;26:16-1.
502. Fabiyi AC, Brading AF. The use of the isolated mouse whole bladder for investigating bladder overactivity. *J Pharmacol Exp Ther.* 2006;319(3):1386-94.
503. Meng E, Cheng,H.Y., Chang,S.Y. Involvement of purinergic neurotransmission in ketamine induced bladder dysfunction. *J Urol.* 2011;186:1134-41.
504. Bayliss M, Wu C, Newgreen D, Mundy AR, Fry CH. A quantitative study of atropine-resistant contractile responses in human detrusor smooth muscle, from stable, unstable and obstructed bladders. *J Urol.* 1999;162(5):1833-9.
505. Harvey RA, Skennerton DE, Newgreen D, Fry CH. The contractile potency of adenosine triphosphate and ecto-adenosine triphosphatase activity in guinea pig detrusor and detrusor from patients with a stable, unstable or obstructed bladder. *J Urol.* 2002;168(3):1235-9.
506. Moore KH, Ray FR, Barden JA. Loss of purinergic P2X(3) and P2X(5) receptor innervation in human detrusor from adults with urge incontinence. *J Neurosci.* 2001;21(18):RC166.
507. Fry CH, Wu,C. Determinants of mechanical activity in detrusor smooth muscle. *J Physiol.* 2000;523:61P.

508. Husted S, Sjogren C, Andersson KE. Direct effects of adenosine and adenine nucleotides on isolated human urinary bladder and their influence on electrically induced contractions. *J Urol.* 1983;130(2):392-8.
509. Cheng Y, Allen, W., Walsh, C., Mansfield, K.J., Burcher, E., Moore, K.H. ATP release during cystometry in women with detrusor overactivity and painful bladder syndrome: contribution to 'urgency'. *Neurourol Urodyn.* 2009;28:838-39.
510. Sun Y, Chai TC. Up-regulation of P2X3 receptor during stretch of bladder urothelial cells from patients with interstitial cystitis. *J Urol.* 2004;171(1):448-52.
511. Nishiguchi J, Hayashi Y, Chancellor MB, de Miguel F, de Groat WC, Kumon H, et al. Detrusor overactivity induced by intravesical application of adenosine 5'-triphosphate under different delivery conditions in rats. *Urology.* 2005;66(6):1332-7.
512. Giglio D, Aronsson, P., Eriksson, L., Tobin, G. In vitro characterization of parasympathetic and sympathetic responses in cyclophosphamide-induced cystitis in the rat. *Basic Clin Pharmacol Toxicol.* 2007;100:96-108.
513. Boselli C, Govoni, S., Condino, A.M., D'Agostino, G. Bladder instability: a reappraisal of classical experimental approaches and development of new therapeutic strategies. *J Auton Pharmacol.* 2001;21:219-29.
514. Igawa Y, Mattiasson A, Andersson KE. Micturition and premicturition contractions in unanesthetized rats with bladder outlet obstruction. *J Urol.* 1994;151(1):244-9.
515. Sjuve R, Ingvarson T, Arner A, Uvelius B. Effects of purinoceptor agonists on smooth muscle from hypertrophied rat urinary bladder. *Eur J Pharmacol.* 1995;276(1-2):137-44.
516. Park Y-C, Sugiyama T, Kaneko S, Kurita T. Sympathetic contribution to bladder outlet obstructions: Quantitative analysis of tissue catecholamine content. *Neuroulogy and Urodynamics.* 1986;5(6):573-7.
517. Blaivas JF, Holland, N.J., Giesser, B., LaRocca, N., Madonna, M., Scheinberg, L. Multiple sclerosis bladder. *Studies and care.* *Ann NY Acad Sci.* 1984;436:328-46.
518. Blaivas JG, Bhimani, G., Labib, K.B. Vesicourethral dysfunction in multiple sclerosis. *J Urol.* 1979;122:342-47.
519. Miller H, Simpson CA, Yeates WK. Bladder Dysfunction in Multiple Sclerosis. *Br Med J.* 1965;1(5445):1265-9.
520. Moss HE, Tansey EM, Burnstock G. Abnormalities of responses to autonomic stimulation in the mouse urinary bladder associated with Semliki Forest virus-induced demyelination. *J Urol.* 1989;142(3):850-4.
521. Olsen AL, Smith VJ, Bergstrom JO, Colling JC, Clark AL. Epidemiology of surgically managed pelvic organ prolapse and urinary incontinence. *Obstet Gynecol.* 1997;89(4):501-6.
522. Ashton-Miller JA, DeLancey JO. Functional anatomy of the female pelvic floor. *Ann N Y Acad Sci.* 2007;1101:266-96.
523. Thor KB, de Groat WC. Neural control of the female urethral and anal rhabdosphincters and pelvic floor muscles. *Am J Physiol Regul Integr Comp Physiol.* 2010;299(2):R416-38.
524. Hinata N, Murakami, G. The urethral rhabdosphincter, levator ani muscle, and perineal membrane: a review. *BioMed Res Int.* 2014:906921.
525. Dorschner W, Biesold M, Schmidt F, Stolzenburg JU. The dispute about the external sphincter and the urogenital diaphragm. *J Urol.* 1999;162(6):1942-5.
526. Mirilas P, Skandalakis JE. Urogenital diaphragm: an erroneous concept casting its shadow over the sphincter urethrae and deep perineal space. *J Am Coll Surg.* 2004;198(2):279-90.
527. Sebe P, Fritsch H, Oswald J, Schwentner C, Lunacek A, Bartsch G, et al. Fetal development of the female external urinary sphincter complex: an anatomical and histological study. *J Urol.* 2005;173(5):1738-42.
528. Sebe P, Schwentner C, Oswald J, Radmayr C, Bartsch G, Fritsch H. Fetal development of striated and smooth muscle sphincters of the male urethra from a common primordium and modifications due to the development of the prostate: an anatomic and histologic study. *Prostate.* 2005;62(4):388-93.
529. Shobeiri SA, Chesson RR, Gasser RF. The internal innervation and morphology of the human female levator ani muscle. *Am J Obstet Gynecol.* 2008;199(6):686 e1-6.
530. Barber MD, Bremer RE, Thor KB, Dolber PC, Kuehl TJ, Coates KW. Innervation of the female levator ani muscles. *Am J Obstet Gynecol.* 2002;187(1):64-71.
531. Pierce LM, Reyes M, Thor KB, Dolber PC, Bremer RE, Kuehl TJ, et al. Innervation of the levator ani muscles in the female squirrel monkey. *Am J Obstet Gynecol.* 2003;188(5):1141-7.
532. Thuroff JW, Bazeed MA, Schmidt RA, Luu DH, Tanagho EA. Regional topography of spinal cord neurons innervating pelvic floor muscles and bladder neck in the dog: a study by combined horseradish peroxidase histochemistry

- and autoradiography. *Urol Int.* 1982;37(2):110-20.
533. Jiang HH, Salcedo LB, Song B, Damaser MS. Pelvic floor muscles and the external urethral sphincter have different responses to applied bladder pressure during continence. *Urology.* 2010;75(6):1515 e1-7.
 534. Bremer RE, Barber MD, Coates KW, Dolber PC, Thor KB. Innervation of the levator ani and coccygeus muscles of the female rat. *Anat Rec A Discov Mol Cell Evol Biol.* 2003;275(1):1031-41.
 535. Grigorescu BA, Lazarou G, Olson TR, Downie SA, Powers K, Greston WM, et al. Innervation of the levator ani muscles: description of the nerve branches to the pubococcygeus, iliococcygeus, and puborectalis muscles. *Int Urogynecol J Pelvic Floor Dysfunct.* 2008;19(1):107-16.
 536. Bradley WE, Teague CT. Electrophysiology of pelvic and pudendal nerves in the cat. *Exp Neurol.* 1972;35(2):378-93.
 537. McKenna KE, Nadelhaft I. The organization of the pudendal nerve in the male and female rat. *J Comp Neurol.* 1986;248(4):532-49.
 538. Roppolo JR, Nadelhaft I, de Groat WC. The organization of pudendal motoneurons and primary afferent projections in the spinal cord of the rhesus monkey revealed by horseradish peroxidase. *J Comp Neurol.* 1985;234(4):475-88.
 539. Thor KB, Morgan C, Nadelhaft I, Houston M, de Groat WC. Organization of afferent and efferent pathways in the pudendal nerve of the female cat. *J Comp Neurol.* 1989;288(2):263-79.
 540. Wallner C, Maas CP, Dabhoiwala NF, Lamers WH, DeRuiter MC. Innervation of the pelvic floor muscles: a reappraisal for the levator ani nerve. *Obstet Gynecol.* 2006;108(3 Pt 1):529-34.
 541. Wallner C, van Wissen J, Maas CP, Dabhoiwala NF, Deruiter MC, Lamers WH. The contribution of the levator ani nerve and the pudendal nerve to the innervation of the levator ani muscles; a study in human fetuses. *Eur Urol.* 2007;54(5):1143-4.
 542. Wieslander CK, Roshanravan SM, Wai CY, Schaffer JI, Corton MM. Uterosacral ligament suspension sutures: Anatomic relationships in unembalmed female cadavers. *Am J Obstet Gynecol.* 2007;197(6):672 e1-6.
 543. Vanderhorst VG, Holstege G. Organization of lumbosacral motoneuronal cell groups innervating hindlimb, pelvic floor, and axial muscles in the cat. *J Comp Neurol.* 1997;382(1):46-76.
 544. Yang Z, Bremer RB, Jin H, Dolber PC, Thor KB. Characterization of neurons innervating the pubocaudalis muscle of the rat. *Society for Neuroscience Abstracts.* 2002:70.6.
 545. Schroder HD. Organization of the motoneurons innervating the pelvic muscles of the male rat. *J Comp Neurol.* 1980;192(3):567-87.
 546. Ueyama T, Arakawa H, Mizuno N. Central distribution of efferent and afferent components of the pudendal nerve in rat. *Anat Embryol (Berl).* 1987;177(1):37-49.
 547. Gosling JA, Dixon JS, Critchley HO, Thompson SA. A comparative study of the human external sphincter and periurethral levator ani muscles. *Br J Urol.* 1981;53(1):35-41.
 548. Praud C, Sebe P, Mondet F, Sebillé A. The striated urethral sphincter in female rats. *Anat Embryol (Berl).* 2003;207(2):169-75.
 549. Borghi F, Di Molfetta L, Garavoglia M, Levi AC. Questions about the uncertain presence of muscle spindles in the human external anal sphincter. *Panminerva Med.* 1991;33(3):170-2.
 550. Martin WD, Fletcher TF, Bradley WE. Innervation of feline perineal musculature. *Anat Rec.* 1974;180(1):15-29.
 551. Todd JK. Afferent Impulses in the Pudendal Nerves of the Cat. *Q J Exp Physiol Cogn Med Sci.* 1964;49:258-67.
 552. Mackel R. Segmental and descending control of the external urethral and anal sphincters in the cat. *J Physiol.* 1979;294:105-22.
 553. Pierce LM, Rankin MR, Foster RT, Dolber PC, Coates KW, Kuehl TJ, et al. Distribution and immunohistochemical characterization of primary afferent neurons innervating the levator ani muscle of the female squirrel monkey. *Am J Obstet Gynecol.* 2006;195(4):987-96.
 554. Brown A, Fyffe R. The morphology of group Ia afferent fibre collaterals in the spinal cord of the cat. *J Physiol.* 1978;274:111-27.
 555. Brown AG, Fyffe RE. The morphology of group Ib afferent fibre collaterals in the spinal cord of the cat. *J Physiol.* 1979;296:215-26.
 556. Cuevas E, Camacho M, Alvarado M, Hudson R, Pacheco P. Participation of estradiol and progesterone in the retrograde labeling of pubococcygeus motoneurons of the female rat. *Neuroscience.* 2006;140(4):1435-42.
 557. Palmieri G, Panu R, Asole A, Sanna L, Farina V. Coccygeus and levator ani muscles in the rabbit: morphology and proprioceptive innervation. *Biol Struct Morphog.* 1988;1(4):142-6.

558. Pacheco P, Camacho MA, Garcia LI, Hernandez ME, Carrillo P, Manzo J. Electrophysiological evidence for the nomenclature of the pudendal nerve and sacral plexus in the male rat. *Brain Research*. 1997;763:202-8.
559. Pacheco P, Martinez-Gomez M, Whipple B, Beyer C, Komisaruk BR. Somato-motor components of the pelvic and pudendal nerves of the female rat. *Brain Research*. 1989;490:85-94.
560. Kenton K, Brubaker L. Relationship between levator ani contraction and motor unit activation in the urethral sphincter. *Am J Obstet Gynecol*. 2002;187(2):403-6.
561. Wunderlich M, Swash M. The overlapping innervation of the two sides of the external anal sphincter by the pudendal nerves. *J Neurol Sci*. 1983;59(1):97-109.
562. Ho KM, Borja MC, Persson K, Brading AF, Andersson KE. Expression of nitric oxide synthase immunoreactivity in the human female intramural striated urethral sphincter. *J Urol*. 2003;169(6):2407-11.
563. Ho KM, McMurray G, Brading AF, Noble JG, Ny L, Andersson KE. Nitric oxide synthase in the heterogeneous population of intramural striated muscle fibres of the human membranous urethral sphincter. *J Urol*. 1998;159(3):1091-6.
564. Pullen AH, Humphreys P. Protracted elevation of neuronal nitric oxide synthase immunoreactivity in axotomised adult pudendal motor neurons. *J Anat*. 1999;194 (Pt 4):547-65.
565. Pullen AH, Humphreys P, Baxter RG. Comparative analysis of nitric oxide synthase immunoreactivity in the sacral spinal cord of the cat, macaque and human. *J Anat*. 1997;191 (Pt 2):161-75.
566. Stamler JS, Meissner G. Physiology of nitric oxide in skeletal muscle. *Physiological Reviews*. 2001;81(1):209-37.
567. Reitz A, Bretscher S, Knapp P, Müntener M, Wefer B, Schurch B. The effect of nitric oxide on the resting tone and the contractile behaviour of the external urethral sphincter: a functional urodynamic study in healthy humans. *Eur Urol*. 2004;45(3):367-73.
568. Elbadawi A, Schenk EA. A new theory of the innervation of bladder musculature. 2. Innervation of the vesicourethral junction and external urethral sphincter. *J Urol*. 1974;111(5):613-5.
569. Creed KE, Van Der Werf BA, Kaye KW. Innervation of the striated muscle of the membranous urethra of the male dog. *J Urol*. 1998;159(5):1712-6.
570. Onufrowicz B. On the arrangement and function of the cell groups of the sacral region of the spinal cord in man. *Arch Neurol Psychopathol*. 1900;3:387-411.
571. Nakagawa S. Onuf's nucleus of the sacral cord in a South American monkey (*Saimiri*): its location and bilateral cortical input from area 4. *Brain Res*. 1980;191(2):337-44.
572. Ueyama T, Mizuno N, Nomura S, Konishi A, Itoh K, Arakawa H. Central distribution of afferent and efferent components of the pudendal nerve in cat. *J Comp Neurol*. 1984;222(1):38-46.
573. Sasaki M. Morphological analysis of external urethral and external anal sphincter motoneurons of cat. *J Comp Neurol*. 1994;349(2):269-87.
574. Kuipers R, Izhar Z, Gerrits PO, Miner W, Holstege G. Location of bladder and urethral sphincter motoneurons in the male guinea pig (*Cavia porcellus*). *Neurosci Lett*. 2004;362(1):57-60.
575. Nadelhaft I, deGroat WC, Morgan C. Location and morphology of parasympathetic preganglionic neurons in the sacral spinal cord of the cat revealed by retrograde axonal transport of horseradish peroxidase. *J Comp Neurol*. 1980;193(1):265-81.
576. Jankowska E, Padel Y, Zarzecki P. Crossed disynaptic inhibition of sacral motoneurons. *J Physiol*. 1978;285:425-44.
577. Yashiro K, Thor KB, Burgard EC. Properties of urethral rhabdosphincter motoneurons and their regulation by noradrenaline. *J Physiol*. 2010;588(Pt 24):4951-67.
578. Shefchyk SJ. Spinal mechanisms contributing to urethral striated sphincter control during continence and micturition: "how good things might go bad". *Prog Brain Res*. 2006;152:85-95.
579. Rockswold GL, Bradley WE, Chou SN. Innervation of the external urethral and external anal sphincters in higher primates. *J Comp Neurol*. 1980;193(2):521-8.
580. Koerber HR, Brown PB. Somatotopic organization of hindlimb cutaneous nerve projections to cat dorsal horn. *J Neurophysiol*. 1982;48(2):481-9.
581. McMahon SB, Morrison JF, Spillane K. An electrophysiological study of somatic and visceral convergence in the reflex control of the external sphincters. *J Physiol*. 1982;328:379-87.
582. Rampal G, Mignard P. Organization of the nervous control of urethral sphincter. A study in the anaesthetized cat with intact central nervous system. *Pflugers Arch*. 1975;353(1):21-31.
583. Holstege G, Tan J. Supraspinal control of motoneurons innervating the striated muscles of

the pelvic floor including urethral and anal sphincters in the cat. *Brain*. 1987;110 (Pt 5):1323-44.

584. Thor KB, Katofiasc MA. Effects of duloxetine, a combined serotonin and norepinephrine reuptake inhibitor, on central neural control of lower urinary tract function in the chloralose-anesthetized female cat. *J Pharmacol Exp Ther*. 1995;274(2):1014-24.
585. Danuser H, Bemis K, Thor KB. Pharmacological analysis of the noradrenergic control of central sympathetic and somatic reflexes controlling the lower urinary tract in the anesthetized cat. *J Pharmacol Exp Ther*. 1995;274(2):820-5.
586. Fedirchuk B, Hochman S, Shefchyk SJ. An intracellular study of perineal and hindlimb afferent inputs onto sphincter motoneurons in the decerebrate cat. *Experimental brain research*. 1992;89(3):511-6.
587. Fedirchuk B, Song L, Downie JW, Shefchyk SJ. Spinal distribution of extracellular field potentials generated by electrical stimulation of pudendal and perineal afferents in the cat. *Experimental brain research*. 1992;89(3):517-20.
588. Karicheti V, Langdale CL, Ukai M, Thor KB. Characterization of a spinal, urine storage reflex, inhibitory center and its regulation by 5-HT_{1A} receptors in female cats. *Am J Physiol Regul Integr Comp Physiol*. 2010;298(5):R1198-208.
589. Thor KB, Hisamitsu T, Roppolo JR, Tuttle P, Nagel J, deGroat WC. Selective inhibitory effects of ethylketocyclazocine on reflex pathways to the external urethral sphincter of the cat. *J Pharmacol Exp Ther*. 1989;248(3):1018-25.
590. de Groat WC, Fraser MO, Yoshiyama M, Smerin S, Tai C, Chancellor MB, et al. Neural control of the urethra. *Scand J Urol Nephrol Suppl*. 2001(207):35-43; discussion 106-25.
591. Chang HY, Cheng CL, Chen JJ, Peng CW, de Groat WC. Reflexes evoked by electrical stimulation of afferent axons in the pudendal nerve under empty and distended bladder conditions in urethane-anesthetized rats. *J Neurosci Methods*. 2006;150(1):80-9.
592. McKenna K, Nadelhaft I. The pudendo-pudendal reflex in male and female rats. *J Auton Nerv Syst*. 1989;27(1):67-77.
593. Nadelhaft I, Vera PL. Neurons in the rat brain and spinal cord labeled after pseudorabies virus injected into the external urethral sphincter. *J Comp Neurol*. 1996;375(3):502-17.
594. Kamo I, Torimoto K, Chancellor MB, de Groat WC, Yoshimura N. Urethral closure mechanisms under sneeze-induced stress condition in rats: a new animal model for evaluation of stress urinary incontinence. *Am J Physiol Regul Integr Comp Physiol*. 2003;285(2):R356-65.
595. Hurtado EA, Smith PP, Smith CP, Boone TB, Somogyi GT. Urethral afferent signaling leads to activation of the external urethral sphincter and abdominal wall muscles. *Neurourology and Urodynamics*. 2008;27(2):105.
596. Thor KB, Muhlhauser MA. Vesicoanal, urethroanal, and urethrovesical reflexes initiated by lower urinary tract irritation in the rat. *Am J Physiol*. 1999;277:R1002-R12.
597. Paroschy KL, Shefchyk SJ. Non-linear membrane properties of sacral sphincter motoneurons in the decerebrate cat. *J Physiol*. 2000;523 Pt 3:741-53.
598. Danuser H, Thor KB. Spinal 5-HT₂ receptor-mediated facilitation of pudendal nerve reflexes in the anaesthetized cat. *Br J Pharmacol*. 1996;118(1):150-4.
599. Lee RH, Heckman CJ. Bistability in spinal motoneurons in vivo: systematic variations in rhythmic firing patterns. *J Neurophysiol*. 1998;80(2):572-82.
600. Fowler CJ, Griffiths D, de Groat WC. The neural control of micturition. *Nat Rev Neurosci*. 2008;9(6):453-66.
601. Mallory B, Steers WD, deGroat WC. Electrophysiological study of micturition reflexes in rats. *Am J Physiol*. 1989;R410-21.
602. Mallory BS, Roppolo JR, de Groat WC. Pharmacological modulation of the pontine micturition center. *Brain Res*. 1991;546(2):310-20.
603. Blok BFM, Holstege G. Ultrastructural evidence for a direct pathway from the pontine micturition center to parasympathetic preganglionic motoneurons of the bladder of the cat. *Neurosci Lett*. 1997;222:195-8.
604. Blok BF, van Maarseveen JT, Holstege G. Electrical stimulation of the sacral dorsal gray commissure evokes relaxation of the external urethral sphincter in the cat. *Neurosci Lett*. 1998;249(1):68-70.
605. Blok BF, de Weerd H, Holstege G. The pontine micturition center projects to sacral cord GABA immunoreactive neurons in the cat. *Neurosci Lett*. 1997;233(2-3):109-12.
606. Sie JA, Blok BF, de Weerd H, Holstege G. Ultrastructural evidence for direct projections from the pontine micturition center to glycine-immunoreactive neurons in the sacral dorsal gray commissure in the cat. *J Comp Neurol*. 2001;429(4):631-7.

607. Gu B, Thor KB, Reiter JP, Dolber PC. Effect of 5-hydroxytryptamine₁ serotonin receptor agonists on noxiously stimulated micturition in cats with chronic spinal cord injury. *J Urol.* 2007;177(6):2381-5.
608. Gu B, Fraser MO, Thor KB, Dolber PC. Induction of bladder sphincter dyssynergia by kappa-2 opioid receptor agonists in the female rat. *J Urol.* 2004;171(1):472-7.
609. Wefer B, Reitz A, Knapp PA, Bannowsky A, Juenemann KP, Schurch B. Conditioning stimulus can influence an external urethral sphincter contraction evoked by a magnetic stimulation. *Neurourol Urodyn.* 2005;24(4):311-7; discussion 8.
610. Miller AD, Nonaka S, Siniatia MS, Jakus J. Multifunctional ventral respiratory group: bulbospinal expiratory neurons play a role in pudendal discharge during vomiting. *J Auton Nerv Syst.* 1995;54(3):253-60.
611. Boers J, Ford TW, Holstege G, Kirkwood PA. Functional heterogeneity among neurons in the nucleus retroambiguus with lumbosacral projections in female cats. *J Neurophysiol.* 2005;94(4):2617-29.
612. Miyazato M, Kaiho Y, Kamo I, Chancellor MB, Sugaya K, de Groat WC, et al. Effect of duloxetine, a norepinephrine and serotonin reuptake inhibitor, on sneeze-induced urethral continence reflex in rats. *Am J Physiol Renal Physiol.* 2008;295(1):F264-71.
613. Miyazato M, Kaiho Y, Kamo I, Kitta T, Chancellor MB, Sugaya K, et al. Role of spinal serotonergic pathways in sneeze-induced urethral continence reflex in rats. *Am J Physiol Renal Physiol.* 2009;297(4):F1024-31.
614. Vanderhorst VG, Holstege G. Caudal medullary pathways to lumbosacral motoneuronal cell groups in the cat: evidence for direct projections possibly representing the final common pathway for lordosis. *J Comp Neurol.* 1995;359(3):457-75.
615. Downie JW, Bialik GJ. Evidence for a spinal site of action of clonidine on somatic and viscerosomatic reflex activity evoked on the pudendal nerve in cats. *J Pharmacol Exp Ther.* 1988;246(1):352-8.
616. Kojima M, Matsuura T, Kimura H, Nojyo Y, Sano Y. Fluorescence histochemical study on the noradrenergic control to the anterior column of the spinal lumbosacral segments of the rat and dog, with special reference to motoneurons innervating the perineal striated muscles (Onuf's nucleus). *Histochemistry.* 1984;81(3):237-41.
617. Rajaofetra N, Passagia JG, Marlier L, Poulat P, Pellas F, Sandillon F, et al. Serotonergic, noradrenergic, and peptidergic innervation of Onuf's nucleus of normal and transected spinal cords of baboons (*Papio papio*). *J Comp Neurol.* 1992;318(1):1-17.
618. Furuta A, Asano K, Egawa S, de Groat WC, Chancellor MB, Yoshimura N. Role of alpha₂-adrenoceptors and glutamate mechanisms in the external urethral sphincter continence reflex in rats. *J Urol.* 2009;181(3):1467-73.
619. Yoshiyama M, Roppolo JR, de Groat WC. Effects of GYKI 52466 and CNQX, AMPA/kainate receptor antagonists, on the micturition reflex in the rat. *Brain Res.* 1995;691(1-2):185-94.
620. Yoshiyama M, Roppolo JR, de Groat WC. Interactions between NMDA and AMPA/kainate receptors in the control of micturition in the rat. *Eur J Pharmacol.* 1995;287(1):73-8.
621. Yoshiyama M, Roppolo JR, de Groat WC. Effects of LY215490, a competitive alpha-amino-3-hydroxy-5-methylisoxazole-4-propionic acid (AMPA) receptor antagonist, on the micturition reflex in the rat. *J Pharmacol Exp Ther.* 1997;280(2):894-904.
622. Yoshiyama M, Roppolo JR, de Groat WC. Alteration by urethane of glutamatergic control of micturition. *Eur J Pharmacol.* 1994;264(3):417-25.
623. Yoshiyama M, Roppolo JR, de Groat WC. Interactions between glutamatergic and monoaminergic systems controlling the micturition reflex in the urethane-anesthetized rat. *Brain Res.* 1994;639(2):300-8.
624. Shefchyk SJ, Espey MJ, Carr P, Nance D, Sawchuk M, Buss R. Evidence for a strychnine-sensitive mechanism and glycine receptors involved in the control of urethral sphincter activity during micturition in the cat. *Experimental brain research.* 1998;119(3):297-306.
625. Blok BFM, De Weerd H, Holstege G. Ultrastructural evidence for a paucity of projections from the lumbosacral cord to the pontine micturition center or M-region in the cat: a new concept for the organization of the micturition reflex with the periaqueductal gray as a central relay. *J Comp Neurol.* 1995;359:300-9.
626. Miyazato M, Sasatomi K, Hiragata S, Sugaya K, Chancellor MB, de Groat WC, et al. GABA receptor activation in the lumbosacral spinal cord decreases detrusor overactivity in spinal cord injured rats. *J Urol.* 2008;179(3):1178-83.
627. Teague CT, Merrill DC. Effect of baclofen and dantrolene on bladder stimulator-induced detrusor-sphincter dyssynergia in dogs. *Urology.* 1978;11(5):531-5.

628. Thor KB. Targeting serotonin and norepinephrine receptors in stress urinary incontinence. *Int J Gynaecol Obstet.* 2004;86 Suppl 1:S38-52.
629. Dmochowski RR, Miklos JR, Norton PA, Zinner NR, Yalcin I, Bump RC. Duloxetine versus placebo for the treatment of North American women with stress urinary incontinence. *J Urol.* 2003;170(4 Pt 1):1259-63.
630. Millard RJ, Moore K, Rencken R, Yalcin I, Bump RC. Duloxetine vs placebo in the treatment of stress urinary incontinence: a four-continent randomized clinical trial. *BJU Int.* 2004;93(3):311-8.
631. van Kerrebroeck P, Abrams P, Lange R, Slack M, Wyndaele JJ, Yalcin I, et al. Duloxetine versus placebo in the treatment of European and Canadian women with stress urinary incontinence. *BJOG.* 2004;111(3):249-57.
632. Boy S, Reitz A, Wirth B, Knapp PA, Braun PM, Haferkamp A, et al. Facilitatory neuromodulatory effect of duloxetine on pudendal motor neurons controlling the urethral pressure: a functional urodynamic study in healthy women. *Eur Urol.* 2006;50(1):119-25.
633. Klarskov N, Scholfield D, Soma K, Darekar A, Mills I, Lose G. Evaluation of the sensitivity of urethral pressure reflectometry and urethral pressure profilometry to detect pharmacological augmentation of urethral pressure using [S,S]-reboxetine. *J Urol.* 2008;179(4, Suppl.):521-2.
634. Zimmern P, Litman HJ, Nager CW, Lemack GE, Richter HE, Sirls L, et al. Effect of aging on storage and voiding function in women with stress predominant urinary incontinence. *J Urol.* 2014;192(2):464-8.
635. Gajewski J, Downie JW, Awad SA. Experimental evidence for a central nervous system site of action in the effect of alpha-adrenergic blockers on the external urinary sphincter. *J Urol.* 1984;132(2):403-9.
636. Downie JW, Espey MJ, Gajewski JB. Alpha 2-adrenoceptors not imidazole receptors mediate depression of a sacral spinal reflex in the cat. *Eur J Pharmacol.* 1991;195(2):301-4.
637. Krier J, Thor KB, de Groat WC. Effects of clonidine on the lumbar sympathetic pathways to the large intestine and urinary bladder of the cat. *Eur J Pharmacol.* 1979;59(1-2):47-53.
638. Mbaki Y, Ramage AG. Investigation of the role of 5-HT(2) receptor subtypes in the control of the bladder and the urethra in the anaesthetized female rat. *Br J Pharmacol.* 2008.
639. Conlon K, Miner W, Christy C, McCleary S, Brinkman H, Rees H, et al. Identification of 5-HT2C-mediated mechanisms involved in urethral sphincter reflexes. *Abstract Society for Neuroscience.* 2005;Program No. 48.14.
640. Burgard EC, Fraser MO, Thor KB. Serotonergic modulation of bladder afferent pathways. *Urology.* 2003;62(4 Suppl 1):10-5.
641. Hounsgaard J, Hultborn H, Jespersen B, Kiehn O. Bistability of alpha-motoneurons in the decerebrate cat and in the acute spinal cat after intravenous 5-hydroxytryptophan. *J Physiol.* 1988;405:345-67.
642. Ogier R, Tribollet E, Suarez P, Raggenbass M. Identified motoneurons involved in sexual and eliminative functions in the rat are powerfully excited by vasopressin and tachykinins. *J Neurosci.* 2006;26(42):10717-26.
643. Kimura Y, Hamada K, Taniguchi N, Ukai Y, Yoshikuni Y, Kimura K. CNS-mediated influence of TRH and its analog, NS-3, on the function of the rabbit lower urinary tract. *J Auton Nerv Syst.* 1996;60(1-2):1-11.
644. Holmes GM. 5-Hydroxytryptamine2C receptors on pudendal motoneurons innervating the external anal sphincter. *Brain Res.* 2005;1057(1-2):65-71.
645. Thor KB, Katofiasc MA, Danuser H, Springer J, Schaus JM. The role of 5-HT(1A) receptors in control of lower urinary tract function in cats. *Brain Res.* 2002;946(2):290-7.
646. Tashiro T, Satoda T, Matsushima R, Mizuno N. Convergence of serotonin-, enkephalin- and substance P-like immunoreactive afferent fibers on single pudendal motoneurons in Onuf's nucleus of the cat: a light microscope study combining the triple immunocytochemical staining technique with the retrograde HRP-tracing method. *Brain Res.* 1989;481(2):392-8.
647. Glazer EJ, Basbaum AI. Leucine enkephalin: localization in and axoplasmic transport by sacral parasympathetic preganglionic neurons. *Science.* 1980;208(4451):1479-81.
648. Dietz HP, Wilson PD. Childbirth and pelvic floor trauma. *Best Pract Res Clin Obstet Gynaecol.* 2005;19(6):913-24.
649. Weidner AC, Jamison MG, Branham V, South MM, Borawski KM, Romero AA. Neuropathic injury to the levator ani occurs in 1 in 4 primiparous women. *Am J Obstet Gynecol.* 2006;195(6):1851-6.
650. Snooks SJ, Swash M, Henry MM, Setchell M. Risk factors in childbirth causing damage to the pelvic floor innervation. *Int J Colorectal Dis.* 1986;1(1):20-4.
651. Weidner AC, South MM, Sanders DB, Stinnett SS. Change in urethral sphincter neuromuscu-

lar function during pregnancy persists after delivery. *Am J Obstet Gynecol.* 2009;201(5):529 e1-6.

652. South MM, Stinnett SS, Sanders DB, Weidner AC. Levator ani denervation and reinnervation 6 months after childbirth. *Am J Obstet Gynecol.* 2009;200(5):519 e1-7.
653. Fajardo V, Pacheco P, Hudson R, Jimenez I, Martinez-Gomez M. Differences in morphology and contractility of the bulbospongiosus and pubococcygeus muscles in nulliparous and multiparous rabbits. *Int Urogynecol J Pelvic Floor Dysfunct.* 2008;19(6):843-9.
654. Kenton K, Mueller E, Brubaker L. Continent women have better urethral neuromuscular function than those with stress incontinence. *Int Urogynecol J.* 2011;22(12):1479-84.
655. Jiang HH, Gill,B.C., Dissaranan,C., Zutshi,M., Balog,B.M., Lin,D., Damaser,M.S. Effects of acute selective pudendal nerve electrical stimulation after simulated childbirth injury. *Am J Physiol.* 2013;304:F239-47.
656. English AW, Schwartz,G., Meador,W., Sabatier,M.J., Mulligan,A. Electrical stimulation promotes peripheral axon regeneration by enhanced neuronal neurotrophin signaling. *Dev Neurobiol.* 2007;67:158-72.
657. Wei W, Howard,P.S., Macarak,E.J. REcombinant insulin-like growth factor-1 activates satellite cells in the mouse urethral rhabdosphincter. *BMC Urol.* 2013;13:62.
658. Bernabe J, Julia-Guilloteau V, Denys P, Chartier-Kastler E, Alexandre L, Peeters M, et al. Peripheral neural lesion-induced stress urinary incontinence in anaesthetized female cats. *BJU Int.* 2008.
659. Yoshiyama M, de Groat WC. Effect of bilateral hypogastric nerve transection on voiding dysfunction in rats with spinal cord injury. *Exp Neurol.* 2002;175(1):191-7.
660. Matsumoto S, Ishikawa A, Kume H, Takeuchi T, Homma Y. Near infrared spectroscopy study of the central nervous activity during artificial changes in bladder sensation in men. *Int J Urol.* 2009;16(9):760-4.
661. Griffiths DJ, Fowler,C.J. The micturition switch and its forebrain influences. *Acta Physiol.* 2013;207:93-109.
662. Kuhtz-Buschbeck JP, Gilster,R., van der Horst,C., Hamann,M., Wolff,S., Jansen,O. Control of bladder sensations: an fMRI study of brain activity and effective connectivity. *Neuroimage.* 2009;47:18-27.
663. Nardos R, Gregory,W.T., Krisky,C. Examining mechanisms of brain control of bladder function with resting state functional connectivity MRI. *NeuroUrol Urodyn.* 2014; 33:493-501.
664. Gao Y, Liao,L., Blok,B.F. A resting-state functional MRI study on central control of storage: brain response provoked by strong desire to void. *Int Urol Nephrol.* 2015;47:927-35.
665. Blok BF, Holstege G. The central nervous system control of micturition in cats and humans. *Behavioural brain research.* 1998;92(2):119-25.
666. Holstege G. Micturition and the soul. *J Comp Neurol.* 2005;493(1):15-20.
667. Barrington SJF. Nervous control of micturition. *Q J Exp Physiol.* 1915;33:3-71.
668. Bradley WE, Timm,G.W., Scott,F.B. Cystometry- Central nervous system organization of detrusor reflex. *Urology.* 1975;5:578-80.
669. Andrew J, Nathan, P.W. Lesions of the anterior frontal lobes and disturbances of micturition and defaecation. *Brain.* 1964;87:233-62.
670. Maurice-Williams RS. Micturition symptoms in frontal tumours. *Journal of neurology, neurosurgery, and psychiatry.* 1974;37(4):431-6.
671. Sakakibara R, Hattori T, Yasuda K, Yamanishi T. Micturitional disturbance and the pontine tegmental lesion: urodynamic and MRI analyses of vascular cases. *J Neurol Sci.* 1996;141:105-10.
672. Yamamoto S, Soma,T., Hatayama,T., Mori,H., Yoshimura,N. Neurogenic bladder induced by brain abscess. *Br J Urol.* 1995;76:272.
673. Lang EW, Chesnut RM, Hennerici M. Urinary retention and space-occupying lesions of the frontal cortex. *European neurology.* 1996;36(1):43-7.
674. Blok BF, Willemsen AT, Holstege G. A PET study on brain control of micturition in humans. *Brain.* 1997;120 (Pt 1):111-21.
675. Blok BF, Sturms LM, Holstege G. Brain activation during micturition in women. *Brain.* 1998;121 (Pt 11):2033-42.
676. Matsuura S, Kakizaki H, Mitsui T, Shiga T, Tamaki N, Koyanagi T. Human brain region response to distention or cold stimulation of the bladder: a positron emission tomography study. *The Journal of urology.* 2002;168(5):2035-9.
677. Athwal BS, Berkley KJ, Hussain I, Brennan A, Craggs M, Sakakibara R, et al. Brain responses to changes in bladder volume and urge to void in healthy men. *Brain.* 2001;124(Pt 2):369-77.
678. Kuhtz-Buschbeck JP, van der Horst C, Wolff S, Filippow N, Nabavi A, Jansen O, et al. Activation of the supplementary motor area (SMA)

- during voluntary pelvic floor muscle contractions--an fMRI study. *NeuroImage*. 2007;35(2):449-57.
679. Griffiths D, Derbyshire S, Stenger A, Resnick N. Brain control of normal and overactive bladder. *J Urol*. 2005;174(5):1862-7.
680. Laplane D, Degos JD, Baulac M, Gray F. Bilateral infarction of the anterior cingulate gyri and of the fornices. Report of a case. *Journal of the neurological sciences*. 1981;51(2):289-300.
681. Duffau H, Capelle L. Incontinence after brain glioma surgery: new insights into the cortical control of micturition and continence. *J neurosurg*. 2005;102:148-51.
682. Komesu YM, Ketai LH, Mayer AR, Teshiba TM, Rogers RG. Functional MRI of the Brain in Women with Overactive Bladder: Brain Activation During Urinary Urgency. *Female pelvic medicine & reconstructive surgery*. 2011;17(1):50-4.
683. Kavia RB, Dasgupta R, Fowler CJ. Functional imaging and the central control of the bladder. *J Comp Neurol*. 2005;493(1):27-32.
684. Nour S, Svarer C, Kristensen JK, Paulson OB, Law I. Cerebral activation during micturition in normal men. *Brain : a journal of neurology*. 2000;123 (Pt 4):781-9.
685. Abrams P, Cardozo L, Fall M, Griffiths D, Rosier P, Ulmsten U, et al. The standardisation of terminology of lower urinary tract function: report from the Standardisation Sub-committee of the International Continence Society. *American journal of obstetrics and gynecology*. 2002;187(1):116-26.
686. Abrams P, Blaivas JG, Stanton SL, Andersen JT. The standardisation of terminology of lower urinary tract function. The International Continence Society Committee on Standardisation of Terminology. *Scandinavian journal of urology and nephrology Supplementum*. 1988;114:5-19.
687. Tai C, Wang J, Jin T, Wang P, Kim SG, Ropolo JR, et al. Brain switch for reflex micturition control detected by FMRI in rats. *J Neurophysiol*. 2009;102(5):2719-30.
688. Critchley HD, Mathias CJ, Josephs O, O'Doherty J, Zanini S, Dewar BK, et al. Human cingulate cortex and autonomic control: converging neuroimaging and clinical evidence. *Brain : a journal of neurology*. 2003;126(Pt 10):2139-52.
689. Craig AD. How do you feel? Interoception: the sense of the physiological condition of the body. *Nature reviews Neuroscience*. 2002;3(8):655-66.
690. Craig AD. Interoception: the sense of the physiological condition of the body. *Current opinion in neurobiology*. 2003;13(4):500-5.
691. Mayer EA, Naliboff BD, Craig AD. Neuroimaging of the brain-gut axis: from basic understanding to treatment of functional GI disorders. *Gastroenterology*. 2006;131(6):1925-42.
692. Dasgupta R, Kavia R.B., Fowler C.J. Cerebral mechanisms and voiding dysfunction. *BJU Int*. 2007;99:731-4.
693. Kuhtz-Buschbeck JP, van der Horst C, Pott C, Wolff S, Nabavi A, Jansen O, et al. Cortical representation of the urge to void: a functional magnetic resonance imaging study. *The J Urol*. 2005;174(4 Pt 1):1477-81.
694. Griffiths D, Tadic S.D., Schaefer W., Resnick N.M. Cerebral control of the bladder in normal and urge-incontinent women. *NeuroImage*. 2007;37:1-7.
695. Yaguchi H, Soma H, Miyazaki Y, Tashiro J, Yabe I, Kikuchi S, et al. A case of acute urinary retention caused by periaqueductal grey lesion. *Journal of neurology, neurosurgery, and psychiatry*. 2004;75(8):1202-3.
696. Seseke S, Baudewig J, Kallenberg K, Ringert RH, Seseke F, Dechent P. Voluntary pelvic floor muscle control--an fMRI study. *NeuroImage*. 2006;31(4):1399-407.
697. Yamamoto T, Sakakibara R, Uchiyama T, Liu Z, Ito T, Yamanishi T, et al. Lower urinary tract function in patients with pituitary adenoma compressing hypothalamus. *Journal of neurology, neurosurgery, and psychiatry*. 2005;76(3):390-4.
698. Andrew J, Nathan P.W. The cerebral control of micturition. *Proc RSM*. 1965;58:553.
699. Andrew J, Nathan PW, Spanos NC. Disturbances of micturition and defaecation due to aneurysms of anterior communicating or anterior cerebral arteries. *Journal of neurosurgery*. 1966;24(1):1-10.
700. Blok BF, Sturms LM, Holstege G. A PET study on cortical and subcortical control of pelvic floor musculature in women. *J Comp Neurol*. 1997;389(3):535-44.
701. Griffiths D, Tadic SD. Bladder control, urgency, and urge incontinence: evidence from functional brain imaging. *Neurourology and urodynamics*. 2008;27(6):466-74.
702. Holstege G, Griffiths D, de Wall H, Dalm E. Anatomical and physiological observations on supraspinal control of bladder and urethral sphincter muscles in the cat. *J Comp Neurol*. 1986;250(4):449-61.

703. Devinsky O, Morrell MJ, Vogt BA. Contributions of anterior cingulate cortex to behaviour. *Brain : a journal of neurology*. 1995;118 (Pt 1):279-306.
704. Wager TD, Waugh,C.E., Lindquist,M., Noll,D.C., Fredrickson,B.L., Taylor,S.F. Brain mediators of cardiovascular responses to social threat: part I: Reciprocal dorsal and ventral subregions of the medial prefrontal cortex and heart-rate reactivity. *Neuroimage*. 2009;47:821-35.
705. Wager TD, van Ast,V.A., Hughes,B.L., Davidson,M.L., Lindquist,M.A., Ochsner,K.N. Brain mediators of cardiovascular responses to social threat, part II: Prefrontal-subcortical pathways and relationship with anxiety. *Neuroimage*. 2009;47:836-51.
706. Schrum A, Wolff S, van der Horst C, Kuhtz-Buschbeck JP. Motor cortical representation of the pelvic floor muscles. *The Journal of urology*. 2011;186(1):185-90.
707. Zhang H, Reitz A, Kollias S, Summers P, Curt A, Schurch B. An fMRI study of the role of suprapontine brain structures in the voluntary voiding control induced by pelvic floor contraction. *NeuroImage*. 2005;24(1):174-80.
708. Tadic SD, Tannenbaum,C., Resnick,N.M., Griffiths,D. Brain responses to bladder filling in older women without urgency incontinence. *Neurourol Urodyn*. 2013;32:435-40.
709. Griffiths D, Clarkson B, Tadic SD, Resnick NM. Brain Mechanisms Underlying Urge Incontinence and its Response to Pelvic Floor Muscle Training. *J Urol*. 2015;194(3):708-15.
710. Krhut J, Tintera,J., Bilkova,K. Brain activity on fMRI associated with urinary bladder filling in patients with a complete spinal cord injury. *Neurourol Urodyn*. 2015.
711. Riley MA, Oganist,L. Streamlining biofeedback for urge incontinence. *Urol Nurs*. 2014;34:19-26.
712. Gary B, Murrin,A., Tadic,S. Changes in brain activity during reported urgency after 8 week trial of fesoterodine in older women with refractory urinary incontinence. *Neurourol Urodyn*. 2013;32:799-800.
713. Blok BF, Groen J, Bosch JL, Veltman DJ, Lamertsmas AA. Different brain effects during chronic and acute sacral neuromodulation in urge incontinent patients with implanted neurostimulators. *BJU international*. 2006;98(6):1238-43.
714. Herzog J, Weiss PH, Assmus A, Wefer B, Seif C, Braun PM, et al. Subthalamic stimulation modulates cortical control of urinary bladder in Parkinson's disease. *Brain : a journal of neurology*. 2006;129(Pt 12):3366-75.
715. Finazzi-Agro E, Peppe A, D'Amico A, Petta F, Mazzone P, Stanzione P, et al. Effects of subthalamic nucleus stimulation on urodynamic findings in patients with Parkinson's disease. *J Urol*. 2003;169(4):1388-91.
716. Herzog J, Weiss,PhH., Assmus,A. Improved sensory gating of urinary bladder afferents in Parkinson's disease following subthalamic stimulation. *Brain* 2008;131:132-45.
717. Green AL, Stone,E., Sitsapesan,H. Switching off micturition using deep brain stimulation at midbrain sites. *Ann Neurol*. 2012;72:144-7.
718. Seseke S, Baudewig,J., Ringert,R.H., Rebmann,U., Dechent,P. Monitoring brain activation changes in the early postoperative period after radical prostatectomy using fMRI. *Neuroimage*. 2013;78:1-6.
719. Seseke S, Baudewig J, Kallenberg K, Ringert RH, Seseke F, Dechent P. Gender differences in voluntary micturition control: an fMRI study. *Neuroimage*. 2008;43(2):183-91.
720. Friston KJ. Functional and effective connectivity: a review. *Brain connectivity*. 2011;1:13-36.
721. Tadic SD, Griffiths D, Schaefer W, Resnick NM. Abnormal connections in the supraspinal bladder control network in women with urge urinary incontinence. *NeuroImage*. 2008;39(4):1647-53.
722. Nardos R, Karstens L, Carpenter S, Aykes K, Krisky C, Stevens C, et al. Abnormal functional connectivity in women with urgency urinary incontinence: Can we predict disease presence and severity in individual women using Rs-fcMRI. *Neurourol Urodyn*. 2016;35(5):564-73.
723. Jarrahi B, Mantini,D., Balsters,J.H. Differential functional brain network connectivity during visceral interoception as revealed by independent component analysis of fMRI time-series. *Hum Brain Mapp*. 2015.
724. Kuchel GA, Moscufo N, Guttmann CR, Zeevi N, Wakefield D, Schmidt J, et al. Localization of brain white matter hyperintensities and urinary incontinence in community-dwelling older adults. *The journals of gerontology Series A, Biological sciences and medical sciences*. 2009;64(8):902-9.
725. Tadic SD, Griffiths D, Murrin A, Schaefer W, Aizenstein HJ, Resnick NM. Brain activity during bladder filling is related to white matter structural changes in older women with urinary incontinence. *NeuroImage*. 2010;51(4):1294-302.
726. Sakakibara R, Hattori T, Uchiyama T, Yamanishi T. Urinary function in elderly people

- with and without leukoaraiosis: relation to cognitive and gait function. *Journal of neurology, neurosurgery, and psychiatry*. 1999;67(5):658-60.
727. Barrington FJF. The relation of the hind-brain to micturition. *Brain*. 1921;44:23-53.
728. Barrington FJT. The effect of lesion of the hind-brain mid-brain on micturition in the cat. *Quart J Exp Physiol*. 1925;15:81-102.
729. Fukuyama H, Matsuzaki S, Ouchi Y, Yamauchi H, Nagahama Y, Kimura J, et al. Neural control of micturition in man examined with single photon emission computed tomography using ^{99m}Tc-HMPAO. *Neuroreport*. 1996;7(18):3009-12.
730. Charil A, Zijdenbos AP, Taylor J, Boelman C, Worsley KJ, Evans AC, et al. Statistical mapping analysis of lesion location and neurological disability in multiple sclerosis: application to 452 patient data sets. *Neuroimage*. 2003;19:532-44.
731. Cho H, Kang T., Chang J. Neuroanatomical correlation of urinary retention in lateral medullary infarction. *Ann Neurol*. 2015;77:726-33.
732. de Groat WC. Integrative control of the lower urinary tract: preclinical perspective. *Br J Pharmacol*. 2006;147:S25-40.
733. Klop EM, Kuipers R., Mouton L.J. Direct projections from the sacral spinal cord to the medial preoptic area in the cat and guinea pig. *Neuroscience*. 2009;164:1732-43.
734. Basbaum AI, Fields H.L. Endogenous pain control systems: brainstem spinal pathways and endorphin circuitry. *Annu Rev Neurosci*. 1984;7:309-38.
735. Bandler R, Keay K.A., Floyd N., Price J. Central circuits mediating patterned autonomic activity during active vs. passive emotional coping. *Brain Res Bull*. 2000;53:95-104.
736. Holstege G. The periaqueductal gray controls brainstem emotional motor systems including respiration. *Prog Brain Res*. 2014;209:379-405.
737. Noto H, Roppolo J.R., Steers W.C., de Groat W.C. Electrophysiological analysis of the ascending and descending components of the micturition reflex pathway in the rat. *Brain Res*. 1991;549:95-105.
738. Taniguchi N, Miyata M, Yachiku S, Kaneko S, Yamaguchi S, Numata A. A study of micturition inducing sites in the periaqueductal gray of the mesencephalon. *J Urol*. 2002;168(4 Pt 1):1626-31.
739. Blok BFM, Holstege G. Direct projections from the periaqueductal gray to the pontine micturition center (M-region). An anterograde and retrograde tracing study in the cat. *Neurosci Lett*. 1994;166:93-6.
740. Ding Y-Q, Zheng H-X, Gong L-W, Lu Y, Zhao H, Qin B-Z. Direct projections from lumbosacral spinal cord to Barrington's nucleus in the rat: a special reference to micturition reflex. *J Comp Neurol*. 1997;389:149-60.
741. Blok BFM, Holstege G. The pontine micturition center in the rat receives direct lumbosacral input. An ultrastructural study. *Neurosci Lett*. 2000;282:29-32.
742. Tang PC. Levels of brain stem and diencephalon controlling micturition reflex. *J Neurophysiol*. 1955;18(6):583-95.
743. Satoh K, Shimizu N, Tohyama M, Maeda T. Localization of the micturition reflex center at dorsolateral pontine tegmentum of the rat. *Neurosci Lett*. 1978;8(1):27-33.
744. Komiyama A, Kubota A, Hidai H. Urinary retention associated with a unilateral lesion in the dorsolateral tegmentum of the rostral pons. *J Neurol Neurosurg Psychiatry*. 1998;65(6):953-4.
745. Valentino RJ, Pavcovich LA, Hirata H. Evidence for corticotropin-releasing hormone projections from Barrington's nucleus to the periaqueductal gray region and dorsal motor nucleus of the vagus in the rat. *J Comp Neurol*. 1995;363:402-22.
746. Wiklund L, Leger L, Persson M. Monoamine cell distribution in the cat brain stem. A fluorescence histochemical study with quantification of indolaminergic and locus coeruleus cell groups. *J Comp Neurol*. 1981;203(4):613-47.
747. Blanco L, Yuste J., Carillo-de Sauvage M. Critical evaluation of the anatomical location of the Barrington nucleus: relevance for deep brain stimulation surgery of pedunculo-pontine tegmental nucleus. *Neuroscience*. 2013;247:351-63.
748. Loewy AD, Saper C.B., Baker R.P. Descending projections from the pontine micturition center. *Brain Res*. 1979;172:533-38.
749. Kruse MN, Mallory BS, Noto H, Roppolo JR, de Groat W. Properties of the descending limb of the spinobulbospinal micturition reflex pathway in the cat. *Brain Res*. 1991;556(1):6-12.
750. Noto H, Roppolo JR, Steers WD, de Groat WC. Excitatory and inhibitory influences on bladder activity elicited by electrical stimulation in the pontine micturition center in the rat. *Brain Res*. 1989;492(1-2):99-115.

751. Tanaka Y, Koyama Y, Kayama Y, Kawauchi A, Ukimura O, T. M. Firing of micturition center neurons in the rat mesopontine tegmentum during bladder contraction. *Brain Res.* 2003;965:146-54.
752. Sugaya K, Ogawa Y, Hatano T, Nishijima S, Matsuyama K, Mori S. Ascending and descending brainstem neuronal activity during cystometry in decerebrate cats. *Neurourol Urodyn.* 2003;22(4):343-50.
753. Konishi A, Itoh K, Sugimoto T, Yasui Y, Kaneko T, Takada M, et al. Leucine-enkephalin-like immunoreactive afferent fibers to pudendal motoneurons in the cat. *Neurosci Lett.* 1985;61(1-2):109-13.
754. Holstege G. Some anatomical observations on the projections from the hypothalamus to brainstem and spinal cord: an HRP and autoradiographic tracing study in the cat. *J Comp Neurol.* 1987;260:98-126.
755. Kuipers R, Mouton LJ, Holstege G. Afferent projections to the pontine micturition center in the cat. *J Comp Neurol.* 2006;494(1):36-53.
756. Valentino RJ, Page ME, Luppi PH, Zhu Y, Van Bockstaele E, Aston-Jones G. Evidence for widespread afferents to Barrington's nucleus, a brainstem region rich in corticotropin-releasing hormone neurons. *Neuroscience.* 1994;62(1):125-43.
757. Fuchs SA, Edinger HM, Siegel A. The organization of the hypothalamic pathways mediating affective defense behavior in the cat. *Brain Res.* 1985;330(1):77-92.
758. Yardley CP, Hilton SM. The hypothalamic and brainstem areas from which the cardiovascular and behavioural components of the defence reaction are elicited in the rat. *J Auton Nerv Syst.* 1986;15(3):227-44.
759. Ding YQ, Wang D, Xu JQ, Ju G. Direct projections from the medial preoptic area to spinally-projecting neurons in Barrington's nucleus: an electron microscope study in the rat. *Neurosci Lett.* 1999;271(3):175-8.
760. Rickey LM, Sarkey S, DonCarlos LL. Estrogen-sensitive projections from the medial preoptic area to the dorsal pontine tegmentum, including Barrington's nucleus, in the rat. *Neurourol Urodyn.* 2008;27(5):440-5.
761. Rizvi TA, Ennis M, Luppi P, Aston-Jones G, Jiang M, Shipley MT. Preoptic projections to Barrington's nucleus and the pericoerulear region: architecture and terminal organization. *J Comp Neurol.* 1994;347:1-24.
762. Marson L, Carson 3rd CC. Central Nervous System Innervation of the Penis, Prostate, and Perineal Muscles: A Transneuronal Tracing Study. *Mol Urol.* 1999;3(2):43-50.
763. Pavcovich LA, Yang M, Miselis RR, Valentino RJ. Novel role for the pontine micturition center, Barrington's nucleus: evidence for coordination of colonic and forebrain activity. *Brain Res.* 1998;784:355-61.
764. Huynh HK, Willemsen, A.T.M., Lovick, T.A., Holstege, G. Pontine control of ejaculation and female orgasm. *J Sex Med.* 2013;10:3038-48.
765. Sakakibara R, Nakazawa K, Shiba K, Nakajima Y, Uchiyama T, Yoshiyama M, et al. Firing patterns of micturition-related neurons in the pontine storage centre in cats. *Auton Neurosci.* 2002;99(1):24-30.
766. Blok BF, Holstege G. Two pontine micturition centers in the cat are not interconnected directly: implications for the central organization of micturition. *J Comp Neurol.* 1999;403(2):209-18.

PATHOPHYSIOLOGY OF URINARY INCONTINENCE, FAECAL INCONTINENCE AND PELVIC ORGAN PROLAPSE

Chair

S. Salvatore (Italy)

Members

K. Rademakers (Netherlands)

J. DeLancey (USA)

Y. Igawa (Japan)

H. Koelbl (Germany)

R.M. Laterza (Germany)

M. Serati (Italy)

A. Sultan (UK)

K.D. Sievert (Germany)

A. Lowry (USA)

CONTENTS

LIST OF ABBREVIATIONS	364	5. Hypermobility vs. ISD: From Dichotomy to Continuum	389
PREFACE	365	6. The Last Pathophysiological Models ..	393
I. THE OVERACTIVE BLADDER	365	7. Conclusions	393
1. Introduction	365	V. PELVIC ORGAN PROLAPSE	394
2. Mechanisms Underlying Increased Afferent Activity	365	1. Pathophysiology of Pelvic Organ Prolapse	394
3. Mechanism Involved in Abnormal Handling of the Afferent Signals in the Brain.....	368	2. Conclusions and Recommendations ..	409
II. THE ROLE OF URINARY MICROBIOTA IN INCONTINENCE AND PELVIC FLOOR DYSFUNCTIONS	370	VI. PATHOPHYSIOLOGY OF FAECAL INCONTINENCE	409
1. Introduction	370	1. Structure and Function of the Anorectum	410
2. Microbiota and Urinary Tract Homeostasis.....	371	2. Continence Mechanism.....	412
3. The Pathophysiological Role of Microbiota in the Urinary Tract	371	3. Development of Incontinence.....	413
III. PREGNANCY, CHILDBIRTH AND THE PELVIC FLOOR	375	4. Risk Factors for Faecal Incontinence .	413
1. Damage to Functions Sustained by the Pelvic Floor.....	375	5. Summary and Research Recommendations	419
2. Effects of Pregnancy on Pelvic Floor Function.....	378	VII. CHILDBIRTH AND FAECAL INCONTINENCE	419
3. Pathophysiologic Mechanism of Birth Injury to the Pelvic Floor	379	1. Neurogenic Trauma	420
4. Perineal Trauma	382	2. Mechanical Trauma	420
5. Conclusions and Recommendations ..	385	3. Instrumental Vaginal Delivery.....	428
IV. PATHOPHYSIOLOGY OF STRESS INCONTINENCE IN WOMEN: URETHRAL STRUCTURE, SUPPORT AND FUNCTION	385	4. Episiotomy	429
1. The Female Urogenital Diaphragm: Urethral Sphincter Location	385	5. Delivery Techniques.....	429
2. Effect of Childbirth, Vaginal Prolapse and Urethral Position on Urinary Continence	387	6. Training	430
3. Role of Connective Tissue	388	7. Irritable Bowel Syndrome (IBS)	430
4. Emerging Concepts of Urethra Weakness and ISD.....	388	8. Conclusions and Recommendations ..	430
		VIII. PATHOPHYSIOLOGY OF INCONTINENCE IN MEN	431
		1. Continence Mechanism in the Male	431
		2. Incontinence Associated with BPH and Its Treatment	433
		3. Incontinence Associated with Radical Prostatectomy.....	434
		4. Incontinence Related to Radiation Therapy for Prostate Cancer.....	439
		5. Conclusions	439

IX. CAUSES OF REVERSIBLE INCONTINENCE IN OLDER ADULTS	440
<hr/>	
1. Urinary Incontinence	440
2. Faecal Incontinence	443
3. Summary.....	445
4. Recommendations	445
5. Research Priorities	445
REFERENCES	446

PATHOPHYSIOLOGY OF URINARY INCONTINENCE, FAECAL INCONTINENCE AND PELVIC ORGAN PROLAPSE

S. SALVATORE

J. DELANCEY, Y. IGAWA, H. KOELBL, R.M. LATERZA, M. SERATI, A. SULTAN, K.D. SIEVERT, A. LOWRY

LIST OF ABBREVIATIONS

ACS	American College of Surgeons	ICI	International Consultation on Incontinence
AI	Anal Incontinence	IPSS	International Prostate Symptom Score
ANS	Autonomic Nervous System	ISD	Intrinsic Sphincter Deficiency
Ach	Acetylcholine	LAM	Levator Ani Muscle
AChE	Acetylcholinesterase	LUTS	Lower Urinary Tract Symptoms
ASR	Anal Sphincter Rupture	MRI	Magnetic Resonance Imaging
ATP	Adenosine Triphosphate	MS	Multiple Sclerosis
BPH	Benign Prostatic Hyperplasia	NO	Nitric Oxide
BOO	Bladder Outlet Obstruction	NOS	Nitric Oxide Synthase
BPO	Benign Prostatic Obstruction	NGF	Nerve Growth Factor
CNS	Central Nervous System	OAB	Overactive Bladder
CI	Confidence Interval	OR	Odds Ratio
cAMP	Cyclic Adenosine Monophosphate	PBS/IC	Painful Bladder Syndrome/Interstitial Cysti-tis
CPPS	Chronic Pelvic Pain Syndrome	PMC	Pontine Micturition Center
DO	Detrusor Overactivity	PFM	Pelvic Floor Muscle
DUA	Detrusor Underactivity	PFD	Pelvic Floor Dysfunction
DM	Diabetes Mellitus	POP	Pelvic Organ Prolapse
DSD	Detrusor Sphincter Dyssynergia	POP-Q	Pelvic Organ Prolapse Quantification
EMG	Electromyography	PNTML	Pudendal Nerve Motor Terminal Motor Latency
EAS	External Anal Sphincter	RRP	Radical Retropubic Prostatectomy
FI	Faecal Incontinence	RCOG	Royal College of Obstetricians and Gynaecologists
IBD	Inflammatory Bowel Disease	RR	Relative Risk
IBS	Irritable Bowel Syndrome	SSRI	Selective Serotonin Re-uptake Inhibitor
IAS	Internal Anal Sphincter		

SUI	Stress Urinary Incontinence
TURP	Transurethral Prostatectomy
TUIP	Transurethral Incision of the Prostate
TTX	Tetrodotoxin
UI	Urinary incontinence
USI	Urodynamic stress incontinence
UUI	Urgency urinary incontinence
VLPP	Valsalva Leak Point Pressure

PREFACE

For this 6th International Consultation on Incontinence, the Committee on Pathophysiology has updated the previous chapter with the most recent knowledge on the causes of pelvic organ prolapse, urinary and faecal incontinence.

Gender differences in the pathophysiological mechanisms of pelvic floor dysfunction have driven the structure of this chapter. The importance of pregnancy and childbirth for pelvic organ prolapse and urinary incontinence in women is considered and a complete section is dedicated to this.

In the area of male incontinence, the greatest concern remains the problem of sphincter injury following radical pelvic surgery and brachytherapy. In contrast to this kind of sphincter injury, the causes of incontinence associated with bladder outlet obstruction and prostatic enlargement have been well characterised, and little new knowledge has appeared in recent years.

Common neurological mechanisms determining urinary and/or faecal incontinence have been treated as well as the role of ageing and comorbidities in both genders.

I. THE OVERACTIVE BLADDER

1. INTRODUCTION

The International Continence Society defines urgency as “the complaint of a sudden compelling desire to pass urine, which is difficult to defer” [1]. The “overactive bladder” (OAB) is a symptom syndrome which is defined by the presence of urgency, with or without urge incontinence, but usually with frequency and nocturia in the absence of infection or other obvious etiology [1]. Therefore, urgency is the pivotal symptom of the OAB syndrome. A better understanding of the genesis of urgency and its relationship to other aspects of bladder function is required to unravel the pathophysiology of OAB and to develop more effective treatments [2].

OAB symptoms are suggestive of urodynamically demonstrable detrusor overactivity (DO; involuntary detrusor contractions) during the filling phase which may be spontaneous or provoked [1]. However, OAB is not interchangeable with DO regardless of whether they are associated with reported urgency. Only about half of all patients with DO experience urgency [3], whereas among patients with urgency 44–69% exhibit DO during cystometric studies [4-7].

The definition of urgency as a complaint implies that it can only be measured in cognitively intact patients [2, 8]. Quantifiable and objective demonstration of urgency is difficult, and thus surrogate measures are often used as outcome measures in OAB, leading to inconsistency between clinical trials. Urgency is a pathological sensation and does not necessarily involve the same mechanisms as those underlying the physiological urge to void upon bladder filling. Therefore, comparisons between urge in healthy people and urgency in patients may help our understanding of the mechanisms involved in the latter but, in fact, may be misleading [8].

The emphasis on urgency, rather than DO, as the defining element of OAB gives the condition a subjective foundation which renders derivation of basic science insights challenging. The subjective nature of urgency makes development of animal models impossible. Despite of these limitations, most studies on mechanisms related to urgency/OAB have employed the use of isolated tissues and experimental animals. Non-voiding contractions remains the most frequently used surrogate parameter in such experimental animal studies [8]. The pathophysiology of the OAB syndrome and DO is still incompletely known, but most probably multifactorial. Against the background mentioned above, this section focuses on pathophysiology of the OAB and reviews studies that have provided insight into the mechanisms underlying OAB symptoms and DO.

DO may be further characterized as neurogenic when there is a relevant neurological condition. The dependence of lower urinary tract (LUT) functions on complex central neural networks makes these functions susceptible to a variety of neurologic disorders. Non-neurogenic etiologies may be related to outflow obstruction, aging and female anatomical incontinence, but most cases are idiopathic. There may be two possible origins of OAB symptoms: 1) decreased capacity to handle the afferent signals in the brain, and 2) abnormally increased afferent signals from the bladder and /or urethra (Figure 1).

2. MECHANISMS UNDERLYING INCREASED AFFERENT ACTIVITY

Two theories probably contribute in varying proportion to the complex mechanisms underlying the genesis of DO and the associated storage symptoms composing OAB, have been put forward (Figure 2):

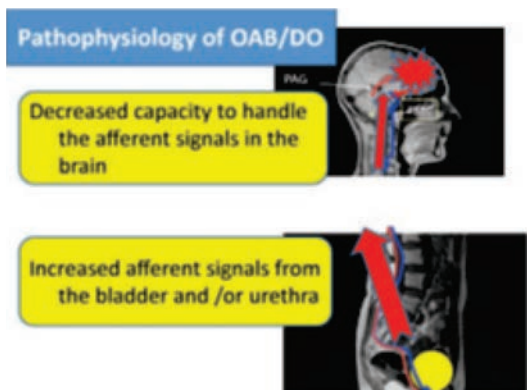

Figure 1: Two possible origins of OAB symptoms: 1) decreased capacity to handle the afferent signals in the brain and, 2) abnormally increased afferent signals from the bladder and/or urethra.

- The urothelium-based hypothesis: changes in urothelial receptor function and neurotransmitter release as well as in the sensitivity and coupling of the suburothelial interstitial cell network lead to enhancement of involuntary contractions [9, 10].
- The myogenic hypothesis: changes to the excitability and coupling of smooth muscle cells with other myocytes or interstitial cells lead to the generation of uninhibited contractions [11, 12].

2.1. The Urothelium-based Hypothesis

There is increasing evidence that urothelial cells play an important role in modulation of bladder activity by responding to local chemical and mechanical stimuli and then sending chemical signals to bladder afferent nerves. It has been shown that urothelial cells express various “sensor molecules” such as receptors of bradykinin, neurotrophins, purines (P2X and P2Y), norepinephrine (NE) (α and β), ACh (nicotinic and muscarinic), epithelial Na⁺ channels (ENaC), and a number of transient receptor potential (TRP) channels. These sensor molecules respond to mechanical as well as chemical stimuli and in turn release chemicals such as ATP, prostaglandins (PG), nerve growth factor (NGF), ACh, and NO. These transmitters are known to have excitatory or inhibitory actions on afferent nerves, which are located close to or in the urothelium [10].

The urothelium interacts closely with the underlying suburothelial layer, in particular the interstitial cell network contained within it, so that the whole structure can be regarded as a functional unit [9]. The suburothelium is an area composed of nerves, blood vessels, and connective tissue in intimate contact with the urothelium. The roles of the urothelium and suburothelial myofibroblasts in afferent activation have been emphasised with intense interest. The C-fibre afferents generally have endings in the suburothelial layer of the bladder wall, but in some cases, they also penetrate the urothelium [13].

ATP was the first neurotransmitter demonstrated to be released directly from the urothelium [14]. Non-vesicular ATP release is evoked by chemical stimuli or by stretch proportional to the extent of bladder distension [15-19]. Both P2X and P2Y purinergic receptor subtypes have been identified in the bladder urothelium. It is now thought that these purinergic receptors may respond to urothelial-derived ATP release in autocrine and paracrine signalling [15, 16, 20-23]. By acting on structures such as nerves [24] and interstitial cells in the suburothelial space, urothelial-derived ATP may trigger the underlying afferent signalling of bladder fullness and pain and possibly even the micturition reflex [25].

After successful treatment with botulinum toxin injection, a reduced P2X3-immunoactive suburothelial nerve fibres correlated with a reduction in urgency [26]. Pathologically increased amounts of urothelially released ATP in rats with spinal cord injury can be reduced on treatment with botulinum toxin [27]. Sugaya et al reported that improvement of OAB symptoms with antimuscarinic treatment was significantly correlated with a decrease in urinary ATP level in female patients with OAB [28].

The presence and localisation of muscarinic receptor protein and mRNA in the human [29-34] and mouse [35] urothelium have been studied. All five muscarinic subtypes are expressed throughout the urothelial layers with a specific localisation of the M2 subtype to the umbrella cells and M1 to the basal layer, with M3 receptors more generally distributed. Release of ACh from human urothelial and suburothelial sites increases with age, as well as during bladder stretch, and represents a functional, non-neuronal, alternative cholinergic system [31]. At therapeutic doses, anti-muscarinics act mainly during the filling phase and exert little effect on detrusor contraction during emptying [36-38]. This lends support to the suggestion that urothelial muscarinic receptors might be involved in the generation of afferent impulses.

Urothelial cells express also both α and β adrenoceptor subtypes, stimulation of which has been shown to trigger the release of ATP and nitric oxide (NO), respectively [39, 40]. Stimulation of urothelial β adrenoceptors triggers also a urothelially-derived inhibitory factor [41]. Catecholamines could be released from nerves adjacent to the urothelium; however, neither a role of catecholamines nor an altered adrenoceptor profile has yet been shown in pathologic conditions.

In addition to the changes in ACh-release mentioned above, several specific alterations in urothelial function and ultrastructure have been demonstrated in OAB. Expression of the mechanosensitive ENaC is increased significantly in human obstructed bladders in comparison with unobstructed controls and correlates significantly with storage symptom scores [42]. It is possible that increased expression of mechanosensitive channels such as ENaC in the urothelium enhances substance release upon bladder stretch. Levels of PG, which are locally synthesized in bladder

muscle and mucosa, and levels of NGF are increased in subjects with OAB in comparison with controls; and in symptomatic patients, levels of PGE2 are positively correlated with OAB symptoms and maximum cystometric capacity [43, 44]. Bladder biopsies from patients with both idiopathic detrusor overactivity (IDO) [45] and neurogenic detrusor overactivity (NDO) [46] showed increased urothelial TRPV1 expression. This may be in accordance with the fact that intravesical vanilloids (resiniferatoxin) have been shown to improve OAB symptoms in patients with (IDO) as well as with hypersensitivity disorders [47, 48].

This sensory process is more complex than originally thought. Suburothelial myofibroblasts (interstitial cells) in the bladder wall form a functional syncytium through connexin 43 gap junction [49, 50]. These myofibroblasts make close appositions to unmyelinated nerves (afferent C-fibre nerves) [51]. Studies investigating human myofibroblasts show that these cells can respond to ATP by generating an intracellular Ca²⁺ transient, which is mediated by a P2Y receptor, most likely including a P2Y6 [52]. On the basis of these observations, it has been hypothesized that the close relation between nerves and myofibroblasts allows an amplification of the afferent system in its response to stimulatory mediators such as ATP.

Overall, up-regulation of urothelial function and increased release of various chemical mediators and known neurotransmitters may influence afferent nerve activity to generate OAB symptoms, although the precise mechanism by which these processes in-

Thus, local contraction (activity) that occurs somewhere in the detrusor will spread throughout the bladder wall, resulting in coordinated myogenic contraction of the whole bladder. In addition, this local contraction in the bladder wall has been shown to generate afferent discharge [54, 55]. Localized bladder activity was assessed by the micromotion detection method, demonstrating that women with increased bladder sensation on filling cystometry had a significantly higher prevalence of localized activity than the control group [56]. This observation suggests that localized distortion of the bladder wall simulates afferent activity, which would precipitate a feeling of urgency and (DO) [57, 58] (Figure 3).

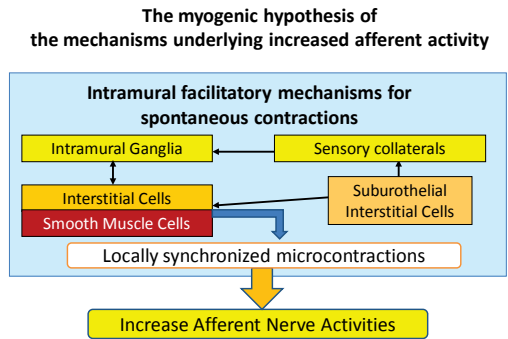

Figure 3: The myogenic hypothesis of the mechanisms involved in increased afferent input from the bladder.

Mechanisms involved in increased afferent input from the bladder



Figure 2: Mechanisms involved in increased afferent input from the bladder: the urothelium-based and myogenic theories.

teract with neural tissue to achieve signal transduction remains to be clarified.

2.2. Myogenic Hypothesis

Brading and Turner [11, 12] have emphasised that myogenic changes (regardless of aetiology) may contribute to the pathophysiology of (IDO). On the basis of observation that denervation is consistently found in detrusor biopsy specimen from patients with various forms of non- (NDO), it has been proposed that partial denervation of the detrusor may alter the properties of smooth muscle, leading to increased excitability and increased coupling between cells [53].

Although the relationships between intercellular communication and spontaneous mechanical activity and the degree of involvement of different types of connexins (Cxs) need further study, Cx45 and Cx43 appear to be the most prominent Cxs expressed in human detrusor smooth muscle tissue and cultured cells. Observations in tissue biopsies from patients with NDO and urgency symptoms clearly demonstrated an increase in the presence of Cx43-derived gap junction channels in detrusor muscle [59].

In addition, another population of cells in the bladder known as interstitial cells has been proposed for a pacemaking role in spontaneous activity of the bladder [60, 61]. Because it has been reported that the number of interstitial cells is increased in a guinea-pig model of bladder outlet obstruction (BOO) [62] and that c-kit tyrosine kinase inhibitors, which inhibit interstitial cell activity, decreased the amplitude of spontaneous contractions in the guinea-pig and human bladder [63, 64], interstitial cells may also be involved in the emergence of (DO) because of enhanced autonomous detrusor muscle activity.

2.3. Other Factors

Aside from the two main hypothesis in the genesis of DO, several other processes may factor in development of DO/OAB. This includes the process of ageing, BOO, bladder ischaemia and mucosal injury. Ageing and BOO may have a common pathway in contribution to DO/OAB development. Remodelling of the micturition circuits caused by ageing and BOO both involve a) ischemia/reperfusion, and subject to oxidative stress, and b) chronic inflammation (Figure 4). In addition, there is an increasing amount of evidence for the potential role of the urinary microbiome in correlation to DO/OAB (See section: B. THE ROLE OF URINARY MICROBIOTA IN INCONTINENCE AND PELVIC FLOOR DYSFUNCTIONS).

2.3.1 Process of ischaemia and reperfusion

Ischaemia/reperfusion has been proposed as a pathophysiological factor of DO/OAB. Recent studies suggest that arterial obstructive disease, such as atherosclerosis, may cause OAB in both men and women via ischemia, hypoxia and oxidative stress in the bladder [65-68]. DO associated mitochondrial stress may have a central role in epithelial damage, smooth muscle cell injury and neurodegeneration. Superoxide dismutase and aldose reductase up-regulation in the OAB imply intrinsic defensive reaction against free radicals that apparently fails to prevent oxidative damage and neurodegeneration [67]. Up-regulation of HIF, TGF- β , VEGF and NGF in the ischemic bladder was accompanied by the loss of mitochondrial structural integrity, fibrosis, and the degeneration of microvasculature and nerve fibres [69]. These observations may suggest the role of ischaemia in OAB with impaired contraction, as reported in elderly pa-

70]. Increases in cytokines, chemokines, and growth factors have been reported in the urine of OAB patients [71]. Consistent association of increasing serum CRP levels and OAB has been demonstrated in the literature [72-74]. Moreover, a recent study demonstrated increased levels of serum adipokines (adipose tissue secreted cytochines), including IL-1 β , IL-6, IL-8, and TNF- α , in patients with OAB refractory to antimuscarinic therapy compared to the control subjects [74]. In this study, no significant difference was found in adipokine levels between OAB-dry and OAB-wet, while serum CRP and NGF levels were significantly higher in OAB-wet, compared to controls. The prevalence of OAB increased with increasing CRP levels in both men and women, supporting the hypothesis for the role of inflammation in the development of OAB. These findings suggest that some OAB patients might have pathophysiology linked to urinary or systemic inflammatory conditions.

Serum MCP-1 levels have shown to be significantly higher only in OAB-dry compared to controls [74]. This may imply that more systemic inflammatory disorders exist among OAB-dry patients, as MCP-1 provokes mast cell activation and has chemotactic activity for monocytes that mature into macrophages at the site of inflammation. Age-associated biochemical changes may accentuate the inflammation associated with OAB. A study on urinary chemokines in OAB patients showed an age-associated elevation of NGF, suggesting a homeostatic response to counter the senescence of bladder nerves and arrest the progression of OAB into detrusor hyperactivity with impaired contractility [75]. All together, these findings support the hypothesis for the role of chronic inflammation at the local and systemic levels in the development of OAB.

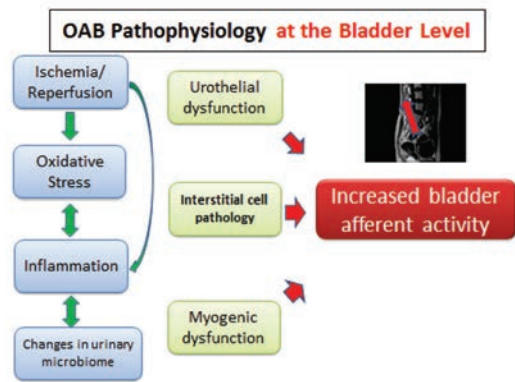

Figure 3: Potential factors involved in OAB pathophysiology at bladder level

tients without obstruction. Ischaemia may be a key factor in aging associated LUTS.

2.3.2 Inflammation

Recent studies have noted signs of inflammation in bladder biopsy specimens from OAB patients [69,

3. MECHANISM INVOLVED IN ABNORMAL HANDLING OF THE AFFERENT SIGNALS IN THE BRAIN

3.1. Functional Brain Imaging in Patients with Idiopathic Urgency Urinary Incontinence

Recent advances in functional brain imaging have made it possible to study directly the supraspinal control system operating during bladder filling. Comparisons between brain response in subjects with normal bladder function and those with urgency urinary incontinence (UUI) may give insight neural circuit involvement and the relation to symptomatology [79-81].

The 'neurogenic hypothesis' suggests that abnormal handling of the afferent signals in the brain leads to urgency/Urgency Urinary Incontinence (UUI). Recent functional Magnetic Resonance Imaging (fMRI) data suggested that the PAG is not relatively overactivated

in UUI patients. On the contrary, the elderly show reduced sensory feedback from the LUT, suggesting alterations at the brain level are involved in DO/OAB [82]. Women with UUI showed weaker activity in the prefrontal cortex (PFC) and exaggerated activity in the anterior cingulate cortex (ACC) and supplementary motor area (SMA) compared with normal controls [83-86]. Responders to pelvic floor muscle training (PFMT) showed exaggerated activity in the ACC and SMA before PFMT, which diminished after successful PFMT. The medial PFC was deactivated in non-responders and only showed minor change in activity after PFMT [86].

Reductions in ACC activity after PFMT with biofeedback in women with SUI were also reported [87]. The anterior cingulate cortex initially was considered to be responsible for monitoring bladder volume. However, the ACC additionally appears to play a role in integrating afferent information and internal motivational states, and management and evaluation of bladder filling information [88].

3.2. Neurogenic Detrusor Overactivity

Damage to the central inhibitory pathways, or sensitisation of afferent nerves, may lead to the unmasking of primitive voiding reflexes, which may trigger involuntary detrusor contractions [89,90]. In addition, increased release of nerve growth factor in DO has been reported, which may alter the neural regulation of detrusor muscle [91-93]. Plasticity in peripheral innervation and within the central nervous system (CNS) may both play a pathophysiological role in DO [94]. Peripherally, neurological diseases might cause a sensitisation of C-fibers that are silent under normal circumstances, thereby leading to the emergence of a C-fibre-mediated reflex.

While many neurologic diseases predispose patients to NDO, the only populations that have been systematically studied are adults with multiple sclerosis, adults with spinal cord injury (SCI) and children and young adults with myelodysplasia [90].

3.2.1 Suprapontine lesions

It is generally accepted that suprapontine lesions such as cerebrovascular disease and Parkinson's disease produce DO. The patient with a suprapontine lesion loses voluntary inhibition of micturition, which corresponds to uninhibited overactive bladder according to a classification by Fall et al [95, 96].

Higher brain centres provide an additional level of urinary control, which is responsible for conscious sensation, volition and emotional response. Key higher centres include the prefrontal cortex, insular cortex and anterior cingulate gyrus, and functional brain imaging has shown changes in higher CNS activity in OAB [79, 80, 90]. Although such observations have been made infrequently, they do point to some key areas for consideration. For example, the participation of several brain areas in urinary control may explain why brain diseases and senile cerebral atrophy

are risk factors for lower urinary tract dysfunction [90]. Variation in observations between individuals implicates a diversity of processes in the mechanisms that underlie OAB, although these are expressed clinically in the common manifestation of OAB. The increased activity observed in certain regions of the brain in patients with OAB may actually be compensatory, to counteract urgency, rather than being responsible for the symptom [90]. This confounds interpretation of function, and there are many questions that still need to be answered.

Brain transection studies in animals with an intact neuroaxis showed that suprapontine areas generally exert a tonic inhibitory influence on the pontine micturition center (PMC) [97,98]. In humans, the cerebral cortex (medial frontal lobes) and the basal ganglia are thought to suppress the micturition reflex. Thus, damage to the brain induces DO by reducing suprapontine inhibition.

3.2.1.1 Stroke Cerebral Infarction

The mechanism of DO induced by cerebral infarction or Parkinson's disease has been further studied using animal models [99, 100]. In the central nervous system, a glutamatergic pathway is known to play a role in both excitatory and inhibitory regulation of micturition [100-102]. It has been demonstrated that in the rat cerebral infarction model, bladder overactivity is mediated by NMDA glutamatergic and D2 dopaminergic excitatory mechanisms [100], suggesting that cerebral infarction may alter a balance between the facilitatory and inhibitory mechanism that results in up-regulation of an excitatory pathway and down-regulation of a tonic inhibitory pathway.

3.2.1.2 Parkinson's Disease

Parkinson's disease (PD) is characterised by the degeneration of dopamine-producing cells in the substantia nigra of the midbrain and Lowy body formation. PD is the most common cause of parkinsonism which is the neurological syndrome bearing the hallmarks, hypokinesia and postural instability. Urgency occurs in 33-54% of patients with PD. Neurogenic DO was seen in 45-93% of PD patients [103]. The most widely accepted theory of pathophysiology of DO in PD is that basal ganglia inhibits the micturition reflex in the normal situation via D1 receptors, and that cell depletion in the substantia nigra in PD results in loss of D1-mediated inhibition and consequently DO [103, 104]. The absence of dopaminergic tone via D1 receptors may cause a dysfunction in GABA regulation in the periaqueductal grey (PAG) and DO [105]. Kitta et al [106] demonstrated an increased activation in the PAG, supplementary motor area, cerebellar vermis, insula, putamen and thalamus during DO in male patients with PD. Compared with previous results in healthy volunteers the periaqueductal grey, insula, putamen and thalamus were common activation sites responding to bladder filling, while the pons was not activated during DO, suggesting alteration in brain activation sites in response to bladder filling

may be related to the pathophysiology of DO in patients with PD.

3.2.2 Spinal cord lesions

A spinal cord lesion above the lumbosacral level eliminates voluntary and supraspinal control of micturition, leading to DO mediated by spinal reflex pathways [107]. Disruption below the level of the pons leads to unsustainable and uncoordinated detrusor contractions often associated with uncoordinated sphincter overactivity (detrusor-sphincter dyssynergia, DSD). Impairment or loss of bladder sensation is a typical feature.

Electrophysiological studies of the effect of capsaicin on voiding reflexes have shown that the afferent limb of the micturition reflex in chronic spinal cats, consists of unmyelinated C-fibre afferents, whereas in normal cats it consists of myelinated A-delta afferents [97, 107, 108]. Since C-fiber bladder afferents in the cat do not usually respond to bladder distension [109], a considerable reorganisation of reflex connections takes place in the spinal cord following the interruption of descending pathways from the brain. In humans with spinal cord lesions, NDO is likely to be mediated by capsaicin-sensitive C-fibre afferents. Clinical experience with capsaicin supports the role of these C-fibre afferents in the pathophysiology of NDO. Capsaicin has been used for the treatment of NDO in patients with spinal cord injury or multiple sclerosis. When administered intravesically, capsaicin increases bladder capacity, reduces micturition contraction pressure, decreases autonomic dysreflexia and reduces the frequency of incontinence [110-112]. More recently, resiniferatoxin, an ultra-potent analogue of capsaicin, has been also used [113-115].

Increased TRPV1, P2X3 and pan-neuronal marker (PGP9.5) staining in suburothelial nerves and increased TRPV1 staining in the basal layer of the urothelium have been observed in patients with neurogenic bladder due to SCI and multiple sclerosis [26]. Treatment of NDO patients with intravesical capsaicin or resiniferatoxin reduces the density of TRPV1, P2X3 and PGP9.5 immunoreactive nerve fibres and urothelial TRPV1 immunoreactivity in those patients exhibiting symptomatic improvement [116]. Injections into the bladder wall of botulinum neurotoxin type A (BoNTA), an agent that blocks the release of neurotransmitters from afferent and efferent nerves, and from urothelial cells, also reduces NDO and the density of TRPV1- and P2X3-immunoreactive nerves [117]. These results indicate that an abnormality of the C-fibre afferent innervation contributes to NDO.

Upregulation of TRPA1 protein and mRNA levels, in bladder and in dorsal root ganglion (DRG; L6-S1) has been reported in rats with SCI. Moreover, HC-030031 (TRPA1 antagonist) treatment decreased the number and the amplitude of DO, suggesting that the TRPA1

activation and upregulation seem to exert an important role in DO following SCI [118].

Following SCI changes in the electrophysiological properties of bladder afferent neurons have also been observed consisting in multiple action potentials (tonic firing) in response to long depolarizing current pulses [119]. In addition, A-type K⁺ channels are suppressed in parallel with an increased expression of TTX-sensitive Na⁺ currents, thereby increasing excitability of C-fibre bladder afferent neurons [120]. These electrophysiological changes contribute to the emergence of the C-fibre-mediated spinal micturition reflex following SCI.

II. THE ROLE OF URINARY MICROBIOTA IN INCONTINENCE AND PELVIC FLOOR DYSFUNCTIONS

1. INTRODUCTION

Historically urine was considered to be sterile and it has only recently been appreciated that the bladder contains its own microbiome. With that understanding a whole novel field of research within urology has been opened up with regard to the physiological role of the lower urinary tract microbiome and the pathophysiology of microbiota in lower urinary tract dysfunctions and urinary tract infections (UTIs). Over 50% of women will experience at least one UTI during their life, with a yearly prevalence of 11% [121]. In addition, UTIs are responsible for substantial morbidity in the group of frail elderly patients. Amongst community dwelling elderly women, UTIs compromise the second most common cause of infection. In long-term care facilities and hospitalised subjects, UTIs represent the most common cause of infection [122]. Aside from the patient's burden this results in a significant increase in health care expenses. UTIs are estimated to be responsible for more than 100.000 hospital visits and costs of 3.5 billion dollar annually In the United States of America [123]. A sample analysis on UTI prevalence of 456.586 German patients with type 2 DM showed a prevalence of 48.337 UTI episodes over a mean observation period of 665 days. Additional multivariable cost analysis in this group showed a UTI cost-increasing effect of 3.916 euro per patient year [124]. These UTI related additional costs might be even higher in a group of frail elderly UTIs in this group lead more often to hospitalisation [125]. During a 90-day follow-up period Turner et al. showed that in-hospital treatment leads to significantly more costs during treatment but also at 90 days post-treatment follow-up [125].

1.1. Terminology

Microbiome: The microbiome represents the genes and genomes of the microbiota. In addition, it represents the products of microbiota and the host environment. The microbiome incorporates biotic and abiotic factors (including archaea, viruses and fungi and products of microbiota) [144].

Metagenome: The metagenome refers to the genes and genomes of the microbiota and highlight the genetic potential of a population.

Microbiota: Identification of the microorganisms in an environment by the use of molecular techniques (such as 16S ribosomal RNA sequencing). The term microbiota refers to the microbial taxa associated with an environment [144, 145].

2. MICROBIOTA AND URINARY TRACT HOMEOSTASIS

The significance of microbiome in maintenance of health and development has been extensively explored in organ systems other than the urinary tract and it has only been recently accepted that most of the human body is colonised with bacteria. The Human Microbiome Project (HMP) is a large mapping study of the human microbiome sampling 300 individuals at five body sites (gastrointestinal tract, mouth, vagina, skin and nasal cavity) using culture independent methods [146]. In addition, specific microbial sites have been linked to diseases. For example, gastrointestinal imbalance in microbiota has been related to brain abnormalities [147], problems in the musculoskeletal system [148] and linked to metabolic processes [149].

In addition to the Human Microbiome Project multiple studies have suggested that the lower urinary tract contains a unique set of microbiota that is vastly different from gastrointestinal and vaginal colonisation (Table 1) [132, 135, 150]. In contrast to traditional bacterial culturing of urine which only allow identification of fast-growing pathogens, recent progress has been made possible by advanced culture and molecular techniques (PCR and 16S ribosomal RNA sequencing). The initial disadvantage of the molecular techniques was that they were not able to distinguish life from death bacteria. However, by combining RNA sequencing with expanded cultures Hilt et al. were able to show that indeed most bacteria in the bladder were alive [135].

Is there a 'core set' of bladder microbiota? In 2013 Lewis et al presented a catalogue of bacterial DNA from a small cross-sectional sample of healthy adults. In addition, they proposed the concept of a set of bacteria that exist across different age groups but may fluctuate in abundance with age [133]. However, with regard to the variations in detected microbiota amongst the different studies presented in Table 1, larger longitudinal studies will be needed to confirm

the existence of core set of microbiota in the bladder. Moreover, evolution of the bladder's microbiome over time and factors influencing these specific microbiota need further investigation.

The specific role of microbiota and the microbiome in the urinary tract still needs to be sorted out. In contrast to other organ systems the homeostatic role of bacteria in the lower urinary tract has only received minimal research attention. However, specific key roles of the urinary tract's microbiome have been suggested based on research in other organ systems: 1) Regulation and maintenance of barrier function of the bladder wall and functioning as prime urothelial defence mechanism. For example through competition of commensal microbiota with pathogens for common resources. This is true for other sites of the body such as the gut and vagina [151, 152]. 2) Products of microbiota may kill pathogens and degrade certain harmful compounds. 3) Involvement of microbiota in the development of the urinary tract, including the connected peripheral nervous system. There is only little known about the link between microbiota and development of the nervous system. Through production of neurotransmitters microbiota might be needed for the correct development of bladder's signalling system. Incorrect development of these signalling systems might be related to lower urinary tract dysfunctions such as OAB or detrusor underactivity (DUA). Gastrointestinal studies on germ-free mice show that absence of microbes correlated with behavioural and neurological disorders [147]. However, the exact role of microbiota in the bladder and its relation to signalling systems in the bladder-brain axis is still unknown due to the lack of studies in this specific area of research.

3. THE PATHOPHYSIOLOGICAL ROLE OF MICROBIOTA IN THE URINARY TRACT

Acknowledgement of the suggested physiological role of the urinary tract microbiome does raise questions about the pathophysiological role of microbiota in different urological entities. For example, microbiota have suggested to be involved in development of urolithiasis and as treatment for recurrent superficial bladder cancer. However, both of these topics go beyond the scope of this chapter. In this section the link between microbiota and functional lower urinary tract disorders will be further elaborated.

3.1. Stress Urinary Incontinence

To date there is only one study available on the relationship between urinary microbiota and the characteristics of women with stress urinary incontinence. This cross-sectional study in 197 women showed no associations between stress urinary incontinence symptoms and the bacterial diversity. Based only on these results, the involvement of the urinary microbiome in SUI seems of less importance compared to

other lower urinary tract dysfunctions. However, more research is needed to conform these initial conclusions.

3.2. Urgency Urinary Incontinence

Urgency Urinary Incontinence is a widespread disorder affecting many adult women. It is only recently that the potential role of the microbiome has been explored. In 2014 Pearce et al compared microbiota of women with and without UUI using molecular sequencing. Results showed that women with UUI had decreased *Lactobacillus* taxa and higher *Gardnerella* presence. In addition, *Actinobaculum*, *Actinomyces*, *Aerococcus*, *Arthrobacter*, *Corynebacterium*, *Oligella*, *Staphylococcus* and *Streptococcus* were found more frequently in the UUI group [136]. However, no difference was found in microbial diversity. One of studies describing the variability in female microbiota in patients with UUI, an association between certain microbial characteristics (i.e. taxa and variety of microbes) and symptom severity was found. An increase in UUI symptom severity may be associated with a loss of microbial diversity in women with UUI [141]. In a follow-up study Pearce et al compared sequencing positive and negative UUI groups before oral drug treatment for UUI. They found that positive sequencing was associated with more severe UUI and better response to treatment.

In 2016 Thomas-White et al reported a 12 week anticholinergic follow-up study in women with UUI suggesting that less diversity tended to be associated with fewer UUI symptoms and with better treatment response to an anticholinergic drug [142]. Non-responders had a more diverse microbial population that was different from the population found in responders. An additional study in women with stress urinary incontinence, gave consistent results. Increased microbial diversity was associated with a higher urge index score [143]. In addition to the finding of differences between women with UUI and healthy controls several studies have shown a relationship between urinary microbiota and response to oral drug treatment. The variations in outcome between the studies might be related to the sampling method. However, in general the results highlight the potential clinical importance of the urinary microbiome in UUI [138].

Hence, recent research gives clues regarding the potential role of urinary microbiota diversity in the aetiology and treatment of women with UUI. However, a major flaw still is the variability in sampling methods between the different studies. This makes replication and clinical utility difficult, at least for now [153].

3.3. Urological Pain Syndromes

The role of microbiota in different urological pain syndromes has been explored, for example in PBS/IC and CPPS. Saddiqui et al collected urine samples from women with interstitial cystitis and compared this with healthy volunteers. They were able to show

that IC patients had lower bacterial diversity and an increase in *Lactobacillus* compared to healthy volunteers (92 vs 57%) [131]. Reduction of bacterial diversity in general is seen in chronic inflammatory states such as in inflammatory bowel disease [154]. The relative abundance of Lactobacilli however is yet to be confirmed in other studies and the question is whether or not this is truly associated with IC in women.

The Multidisciplinary Approach to the Study of Chronic Pelvic Pain (MAPP) research network compared female patients with Urological Chronic Pelvic Pain Syndrome (UCPPS) who reported symptom flare vs those who did not report a flare, to examine differences in microbiota. The results revealed no difference in bacterial prevalence in the urine samples. However, the group with flare had a significantly greater prevalence of fungi (*Candida* and *Saccharomyces* sp.) [140]. This is in concordance with an earlier study from the same group in which they performed a two year follow-up of IC/PBS patients to identify bacterial culture status using only standard culture techniques [155]. The same MAPP research network studied male UCPPS (PBS/IC/chronic prostatitis) patients and compared the microbiota with aged-matched controls. The study group showed higher presence of *Burkholderia Cenocepacia* in the UCPPS group of patients in the initial urinary stream urine [139]. However, these differences were not reproducible for the midstream urine samples or after prostate massage.

A recent study examining stool samples of women UCPPS patients identified potential stool-based microbial and metabolome markers for UCPPS, with specific interest for *Colinsella aerofaciens* and metabolite glyceraldehyde. These biomarkers were, amongst several others, altered in the gut compared to healthy controls in this pilot study consisting of a total of 34 women (16 healthy controls vs. 18 women with UCPPS) [156]. Shoskes et al analysed gut microbiota in men with UCPPS and showed a decreased microbial diversity in the gut in men with UCPPS compared to controls [157].

In theory the urinary microbiome might be involved in aetiology or development of IC/PBS/UCPPS, however different studies show largely varying results. Up until now there is no compelling evidence to support the specific role of the microbiome in patients with urological pain syndromes and more research is needed in this specific area.

Table 1: Registration of Urinary tract microbiota in different studies.

	Patientgroups	n	Predominant strains	Urine Sample collection
Nelson et al. 2010 [126]	Men with STI Men without STI	10 9	Lactobacillus, Sneathia, Gemella, Aerococcus, Corynebacterium, Streptococcus, Veillonella, Prevotella, Anaerococcus, Propionibacterium, Atopobium, Staphylococcus	First-void
Dong et al. 2011 [127]	Men with STI Men without STI	10 22	Lactobacillus, Sneathia, Gemella, Aerococcus, Corynebacterium, Streptococcus, Veillonella, Anaerococcus, Propionibacterium, Atopobium, Staphylococcus, Ureaplasma, Mycoplasma, Enterococcus, Finegoldia, Neisseria, Ralstonia	First-void
Siddiqui et al. 2011 [128]	Healthy women	8	Lactobacillus, Prevotella, Gardnerella, Peptoniphilus, Dialister, Finegoldia, Anaerococcus, Allisonella, Streptococcus, Staphylococcus	Clean-catch midstream
Fouts et al. 2012 [129]	Healthy controls Patients with NBD	26 (58% women) 27 (48% women)	Lactobacillus, Enterobacteriales, Actinomycetales, Bacillales, Anaerococcus, Allisonella, Clostridiales, Bacteroidales, Burkholderiales, Pseudomonadales, Bifidobacteriales, Coriobacteriales	Midstream, catheterisation
Nelson et al. 2012 [130]	Healthy adolescent men	18	Lactobacillus, Streptococcus, Sneathia, Mycoplasma, Ureaplasma	First-void
Siddiqui et al 2012 [131]	Women with IC	8	Lactobacillus, Gardnerella, Corynebacterium, Prevotella, Ureaplasma, Eterococcus, Atopobium, Proteus, Cronobacter	Clean-catch midstream
Wolfe et al. 2012 [132]	Healthy women Women with POP/UI	23 11	Lactobacillus, Actinobaculum, Aerococcus, Anaerococcus, Atopobium, Burkholderia, Corynebacterium, Gardnerella, Prevotella, Ralstonia, Sneathia, Staphylococcus, Streptococcus, Veillonella	Clean-catch midstream, Suprapubic
Lewis et al. 2013 [133]	Healthy men Healthy women	6 10	Jonquetella, Parvimonas, Proteiniphilum, Saccharofermentans Phyla: Actinobacteria, Bacteroidetes	Clean-catch midstream
Fricke et al. 2014 [134]	Patients receiving 1 st renal transplant	60 (37% women)	Lactobacillus, Enterococcus, Pseudomonas, Streptococcus Families: Bifidobacteriaceae, Corynebacterineae	Not described
Hilt et al. 2014 [135]	Healthy women Women with OAB	24 41	Lactobacillus, Corynebacterium, Streptococcus, Actinomyces, Staphylococcus, Aerococcus, Gardnerella, Bifidobacterium, Actinobaculum	Transurethral catheterisation
Pearce et al. 2014 [136]	Healthy women Women with urgency UUI	58 60	Gardnerella, Lactobacillus, Actinobaculum, Actinomyces, Aerococcus, Arthrobacter, Corynebacterium, Oligella, Staphylococcus, Streptococcus	Transurethral catheterisation
Willner et al. 2014 [137]	Patients with uncomplicated UTI	50 (76% women)	Anaerococcus, Peptoniphilus, Streptococcus, Lactobacillus, Staphylococcus, Escherichia, Pseudomonas	Midstream

Pearce et al. 2015 [138]	Women UUI	182	Lactobacillus, Aerococcus, Bifidobacterium, Enterobacterium, Prevotella, Staphylococcus	Transurethral catheter
Nickel et al 2015 [139]	Men UCPPS Aged-matched controls	110 115	Lactobacillus, Listeria, Staphylococcus, Streptococcus, Propionibacterium, Finegoldia, Burkholderia, Bifidobacterium	Initial stream urine, midstream, after prostate massage
Nickel et al 2016 [140]	Women UCPPS and flare Women UCPPS without flare	127 86	Lactobacillus, Staphylococcus, Streptococcus, Finegoldia, Bifidobacterium, Corynebacterium, Escherichia	Initial stream urine, midstream
Karstens et al 2016 [141]	Women UUI Healthy controls	10 10	Lactobacillus, Lachnospiria, Enterobacterium, Comamonadacium, Micrococcus, Bifidobacterium, Prevotella, Flavobacterium	Transurethral catheter
Thomas-White et al 2016 [142]	Women UUI Healthy controls	74 60	Lactobacillus, Streptococcus, Enterobacterium, Staphylococcus, Actinobaculum, Bifidobacterium, Alloscardovia, Atopobium, Micrococcus	Transurethral catheter
Thomas-White et al 2016 [143]	Women with SUI	197	Lactobacillus, Streptococcus, Bifidobacterium, Corynebacterium, Atopobium, Prevotella,	Transurethral catheter, midstream

The presented strains are highlighted by the authors of the original studies as predominant or more prevalent than other populations. The microbiota are listed as genera unless otherwise specified. STI: sexually transmitted infection, NBD: neurogenic bladder dysfunction, IC: interstitial cystitis, POP: pelvic organ prolapse, OAB: overactive bladder, UUI: urgency urinary incontinence, UTI: urinary tract infection, UCPPS: urological chronic pelvic pain syndrome, SUI: Stress Urinary Incontinence.

III. PREGNANCY, CHILDBIRTH AND THE PELVIC FLOOR

Despite the great achievements made in modern obstetric practice in developed countries during the last 100 years, delivery remains the most stressful and dangerous event the female pelvic diaphragm is submitted to during a woman's lifespan.

Reduction in both perinatal and maternal mortality rates in recent decades has allowed us to focus increasingly on maternal morbidity and the long-term sequelae of childbirth. Due to improved investigative techniques available over the past decade, the incidence and mechanisms of obstetric injury to the pelvic floor have come under scrutiny.

However, the controversial debate on whether and how pregnancy and vaginal delivery are responsible for pelvic floor morbidity is still wide open.

During pregnancy, muscular, connective and nervous pelvic structures are subjected to anatomical, morphological, functional and hormonal changes. During vaginal delivery, the pelvic floor undergoes an enormous amount of stretching to allow the passage of the newborn through it.

Through pregnancy and just after delivery, the functions sustained by the pelvic floor (urinary and faecal continence, pelvic organ containment and sexual function) often begin to fail. Evident or hidden injuries to the pelvic floor may manifest themselves through urinary and faecal incontinence, prolapse symptoms or sexual dysfunction, with a considerable impact on quality of life.

Several mechanisms of birth trauma have already been investigated, but a lot needs to be understood regarding the role of pregnancy on the pelvic floor.

The growing knowledge of the consequences of childbirth and pregnancy on the pelvic floor offers the chance to develop prevention and treatment strategies. It is important that contributing obstetric factors are identified and their occurrence minimised, in order to focus efforts on preventable risk factors.

1. DAMAGE TO FUNCTIONS SUSTAINED BY THE PELVIC FLOOR

1.1. Postpartum Urinary Incontinence

A systematic review of 33 studies reported a 33% prevalence of any type of postpartum urinary incontinence (UI) in the first 3 months postpartum, with a prevalence of weekly and daily incontinence of 12% and 3% respectively. The prevalence in the vaginal delivery group (31%) was double that of the caesarean section group (15%). Long-term studies in the first year postpartum showed small changes in prevalence over time [158]. Caesarean section seems to

decrease the risk of postpartum UI [159, 160], but its protective effect seems to diminish over time and disappears after multiple deliveries [160, 161].

In a recent cohort study extracted by the national Swedish Medical Birth Registry between 1973 and 1982, two groups were identified: 30,880 women who had their first and all subsequent deliveries by caesarean vs. an age-matched sample of 60,122 women who delivered vaginally only. Stress urinary incontinence (SUI) surgery was observed in 0.4% of the caesarean group and 1.2% of the vaginal group (follow-up time 26.9 years), and the risk of SUI is estimated to be 2.9 times higher after vaginal delivery compared with women after caesarean section. Among women with vaginal deliveries, rates of SUI surgery increased with the number of births, whereas in the caesarean delivery cohort it slightly decreased with a higher number of births. Compared with caesarean delivery, the risk of SUI was more than doubled for vaginal delivery with vacuum extraction and tripled for a vaginal non-instrumental delivery, but this lower risk for a vacuum extraction delivery has been in part explained by an overall lower birth rate in this subset of patients. After vaginal delivery, the incidence rates for SUI surgery steadily increased, reaching a peak close to three decades after the first delivery. For caesarean delivery, the incidence of SUI

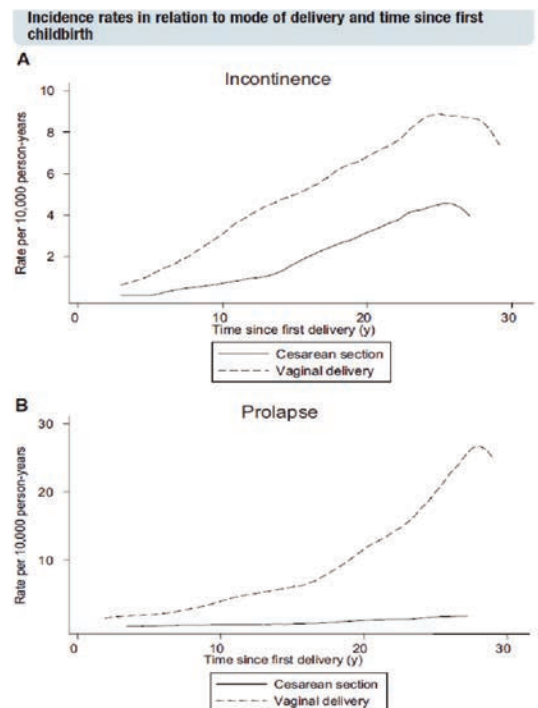

A. Incidence rates of stress urinary incontinence surgery in relation to mode of delivery and time since first childbirth; B. Incidence rates of pelvic organ prolapse surgery in relation to mode of delivery and time since first childbirth.

Figure 5: Incidence rates in relation to mode of delivery and time since first childbirth. From: Leijonhufvud et al. Incontinence and prolapse surgery after childbirth. Am J Obstet Gynecol 2011. [162]

increased more slowly and started to diverge from the curve for vaginal delivery very early during follow-up (Figure 5) [162].

After the first delivery, women who delivered vaginally seem to have at least a two-fold greater risk of UI than those delivered by caesarean. However, data for the rates of incontinence after elective and emergency caesarean section are mixed; we therefore lack the information as to whether caesarean carried out before labour confers greater protection than caesarean done after labour is established.

To understand the true impact of caesarean delivery on UI, future studies must compare incontinence by planned mode of delivery, consider a woman's entire reproductive career, focus on leakage severe enough to be problematic, consider other bladder symptoms as well as incontinence, and take into account other risk factors, particularly antepartum UI [163].

1.2. Postpartum Anal Incontinence

De-novo anal incontinence (AI) symptoms after childbirth are described as up to 26-38% between 6 weeks-6 months postpartum [164-169].

In a population-based survey estimating the postpartum incidence of faecal incontinence (FI), Guise et al. [165] reported that 29% of 8,774 women reported FI (defined as recurring episodes of involuntary loss of stool or flatus since delivery) within 3-6 months postpartum: almost half (46%) of them reported incontinence of stool, and 38% reported incontinence of flatus only. Approximately 46% reported the onset of incontinence after the delivery of their first child. Higher body mass index, longer pushing, forceps-assisted delivery, third or fourth-degree laceration and smoking were associated with severe FI. The authors conclude that in this population-based study, more than one in four women reported FI within 6 months of childbirth, with almost half reporting the onset of symptoms after delivery of their first child. Four in ten women reported loss of flatus or stool during intercourse. Given the burden of this condition, both in number and social impact, coupled with the hesitancy of women in initiating this conversation, providers should ask women about symptoms of FI during postpartum examinations. Additionally, these data suggest that there may be a benefit to extending postpartum follow-up visits beyond the typical 6-8 weeks to provide surveillance for potential incontinence. LEVEL OF EVIDENCE: II.

In comparison with caesarean section, vaginal delivery seems to be associated with an increased risk of AI. In a population-based study, Guise et al. [164], reported that vaginal delivery has a greater risk of FI compared to caesarean (OR 1.45; 95%CI: 1.29-1.64) 3-6 months postpartum. However, a vaginal delivery without laceration or instrument assistance did not create a higher risk of FI than the risk with caesarean delivery. Being overweight (body mass index ≥ 30

kg/m²), pushing for greater than two hours, and constipation were independently associated with postpartum FI ($p < 0.05$) regardless of route of delivery.

A self-administered survey of FI symptoms and delivery events administered to 50 women at six weeks postpartum, showed that vaginal delivery was associated with an increased risk of any FI symptom in comparison with caesarean section (43% vs. 20%) [166].

1.3. Pelvic Organ Prolapse

The occurrence rate of pelvic organ prolapse (POP) stage ≥ 2 in the first 3-6 months postpartum has been described in literature between 18.1-56% [170-172].

In a cross-sectional study of 382 primigravid women, pelvic organ support was explored 6 months postpartum: POP-Q stage $\geq II$ was present in 7.7%, 18.1% and 29% of women who delivered by caesarean section, spontaneous and instrumental vaginal delivery, respectively. Spontaneous vaginal delivery increased the risk by more than three times (OR 3.19) while instrumental vaginal delivery increased it more than five-fold (OR 5.52) in comparison with caesarean section. Instrument-assisted delivery did not increase the risk of prolapse in women who delivered vaginally. The authors concluded that caesarean section is associated with a lower prevalence of POP after delivery and instrument assisted delivery is not associated with an increased risk of postpartum prolapse among women who delivered vaginally [170].

In the cohort study extracted by the nationwide Swedish Medical Birth Registry [162], POP surgery was observed in 2.2% of vaginal deliveries and 0.2% of caesarean sections (follow-up time 25.9 years). Among women only having had vaginal deliveries, rates of POP surgery increased with number of childbirths. In the caesarean delivery cohort, rates of POP surgery slightly decreased with increasing parity number. Compared with a caesarean delivery, the risk of POP surgery was increased nine-fold both after non-instrumental vaginal delivery and after vacuum extraction, whereas among women with forceps delivery a twenty-fold increase in risk was observed. The incidence rate of POP in women with caesarean deliveries showed very little variation over time, but started to diverge more notably from the vaginal delivery cohort 10 years after the first birth (Figure 5B).

The association between caesarean section and POP was investigated by Larsson et al. [173]: the Swedish Hospital Discharge Registry was used to identify women with an inpatient diagnosis of POP, and the data were linked to the Swedish Medical Birth Registry. A total of 1.4 million women were investigated. A strong and statistically significant association between caesarean section and POP was found (Adjusted OR 0.18 [95% CI: 0.16-0.20] and overall hazard ratio=0.20 [95% CI: 0.18-0.22]). The authors concluded that caesarean section is associated with a lower risk of POP than vaginal delivery.

A registry-based national cohort study carried out by Gyhagen et al [174], demonstrated that the prevalence of symptomatic POP (sPOP) was doubled after vaginal delivery compared with caesarean section, two decades after one birth. Infant birthweight and current BMI were risk factors for sPOP after vaginal delivery. The same authors demonstrated that the prevalence of SUI, UUI and mixed UI was higher and moderate to severe UI and bothersome UI were reported more often after vaginal delivery than caesarean section 20 years after one delivery [175]. Moreover, the late prevalence of UI, sPOP, and FI were almost identical between vacuum extraction (VE) and spontaneous vaginal delivery (SVD). VE almost tripled the rate of obstetric anal sphincter injury (OASI) compared with SVD (6.3 vs. 2.4 %, $p < 0.001$). FI rate after an OASI was similar for both VE and SVD [30.2 vs. 27.8 %, adjusted odds ratio (aOR) 1.12; 95 % confidence interval (CI) 0.49-2.56]. Comparing VE without laceration, VE complicated by OASI increased the rate of FI (from 15.4 to 30.2 %, aOR 2.55; 95 % CI 1.26-5.15) and UI (from 39.0 to 61.4 %, aOR 2.28; 95 % CI 1.19-4.34), but the rate of sPOP was almost unaltered (from 15.0 to 15.9 %).

The incidence rate of UI and AI during pregnancy in previously continent women has been reported as 39.1% and 10.3% respectively. Age, baseline body mass index, and family history of UI were significantly associated with the occurrence of UI during pregnancy, while age and excess weight gain during pregnancy were associated with the occurrence of AI during pregnancy. The identified risk factors for both incontinences postpartum were incontinence during pregnancy and vaginal delivery. LEVEL OF EVIDENCE II [176].

About half of all women develop transient UI during pregnancy [163]; SUI in pregnancy was a significant predictor for postpartum incontinence. The weight of the women and duration of their labor were also significantly associated with the development of SUI postpartum [177]. Women with incontinence before pregnancy were nearly three times more likely to have postpartum incontinence [178].

Among 272 eligible women attending a follow-up visit at two years postpartum, 26 (9.5%) women reported persistent SUI since pregnancy. A higher BMI in pregnant women at term was recognized as an independent risk factor for the persistence of SUI from pregnancy to two years post-partum [179].

Fear of birth is a frequent indication for caesareans demanded by the patient [180, 181]. A cross-sectional study based on the Norwegian Mother and Child Cohort Study ($n=58,881$), reported that 6% of the sample preferred caesarean over vaginal delivery in week 30 of pregnancy; 16% reported "fear of giving birth" as the reason for caesarean preference [182]. A general fear of pelvic floor trauma was cited as the most common reason for this choice [183]. Despite being based on incomplete prognostic data, this feel-

ing may be echoed increasingly among obstetric patients and may lead to an unselected, and even misguided, increase in caesarean delivery rates.

However, so far, there is no evidence from randomised controlled trials, upon which to base any practice recommendations regarding planned caesarean section for non-medical reasons at term in order to avoid pelvic floor symptoms in a woman without previous disorders. This has been demonstrated by Lavender et al. [184]: their aim was to find out, from randomized trials, the effects on perinatal and maternal morbidity and mortality, and on maternal psychological morbidity, of planned caesarean delivery versus planned vaginal birth in women with no clear clinical indication for caesarean section. A search of the Cochrane Pregnancy and Childbirth Group's Trials Register (December 2005), MEDLINE (1974 to April 2005), EMBASE (1974 to April 2005), CINAHL (1982 to April 2005) and PsycINFO (1887 to April 2005) was carried out. The selection criteria were the following: comparisons of intention to perform caesarean section and intention for women to give birth vaginally; random allocation to treatment and control groups; adequate allocation concealment; women at term with single foetuses with cephalic presentations and no clear medical indication for caesarean section. No studies were identified that met the inclusion criteria [184].

To our knowledge, scientific data are insufficient to justify an elective caesarean section in order to avoid pelvic floor symptoms in a woman without previous disorders [185], considering that pregnancy itself may be involved in the development of such dysfunctions.

A systematic review of Cochrane assessed the ability of caesarean delivery (CD), in comparison to vaginal delivery (VD), to preserve anal continence: 21 reports have been found eligible for inclusion, encompassing 31,698 women having had 6,028 CDs and 25,170 VDs, as the index event prior to anal continence assessment. Only one report randomised women (with breech presentation) to CD or VD, but because of extensive cross-over, 52.1% after randomization, it was analysed along with the other 20 studies as treated, i.e. as a non-randomised trial. Only one of these reports demonstrated a significant benefit of CD in the preservation of anal continence, a report in which incontinence incidence was extremely high, 39% in CD and 48% in VD, questioning, relative to other reports, the timing and nature of continence assessment. The authors did not find any difference in continence in women who had an emergency versus elective CD. They concluded that, without demonstrable benefit, preservation of anal continence should not be used as a criterion for choosing elective primary CD [186].

2. EFFECTS OF PREGNANCY ON PELVIC FLOOR FUNCTION

2.1. Effect on Collagen

Despite the great advances that have been made in many areas of obstetric care, the effect of pregnancy on the morphology and function of the pelvic floor is still mostly unknown. Prospective data assessing the severity of urinary and anal incontinence during pregnancy are scarce.

During pregnancy, hormones affect the biochemical composition of the solid matrix and hydration phases constituting each pelvic floor tissue. Remodelling mechanisms lead to changes in the organisation, orientation, and diameter of the collagen fibres as well as the crimp structure of the collagen fibrils reinforcing each tissue. Such effects can significantly affect the short and long-term viscoelastic properties of the vaginal wall, the pubovisceral muscles, and the perineal body, for example. They will largely determine (a) the extent and rate at which these structures can be stretched by an expulsive force acting cyclically on the foetal head, and (b) the resistance to stretch provided by those structures. The more a tissue exhibits creep behaviour, the further it will stretch under a constant load. And the more it exhibits relaxation behaviour, the more the stress in a tissue will decrease over time when held at a constant length, thereby helping to lower the risk of rupture in the next loading cycle. Were a tissue to exhibit viscoplasticity, it would behave as a solid below a critical level of stress, but above that level, it would flow like a viscous liquid. There is evidence that tensile failure in some soft tissues can be predicted by the product of the stress times the strain extent in the tissue, so mechanisms that lower one or both these variables will reduce the risk of rupture. Pregnancy is known to significantly affect the instantaneous stiffness and relaxation behaviour of vaginal tissues in rats. However, accurate data are lacking for pregnant human pelvic floor tissues, and the effects of pregnancy on injury at any tissue level, and on structural failure, are as yet largely unknown [187].

Changes in collagen may result in greater mobility of the bladder neck resulting in stress incontinence. In a study of 116 primigravidae, perineal ultrasound was used to assess bladder neck mobility. Women with antenatal bladder neck mobility of more than 5mm on linear movement (equivalent to $>108^\circ$ rotation) were found to be at higher risk of developing postpartum stress incontinence. Approximately 50% of this group reported stress incontinence at 3 months postpartum [188].

There may be a group of women at an inherent increased risk of developing incontinence due to abnormalities in collagen [189], as the collagenous component of the connective tissue contributes to structural support of the bladder neck. In pregnancy, the tensile

properties of the connective tissue are reduced, with a reduction in total collagen content and increase in glycosaminoglycans [190].

2.2. Natural History

Distinguishing the time of onset, severity, and persistence of urinary and anal incontinences during and after pregnancy may provide an insight into the natural history of incontinence, and hence in the differences between transient incontinence due to the hormonal and mechanical effects of pregnancy and the damage that may occur as a result of delivery [176].

Solans-Domenech et al. [176] have brought to light the high incidence of UI and AI over the three trimesters of pregnancy, and particularly in the second trimester. In this cohort study, an incidence rate of UI during pregnancy of 39.1% and 10.3% of AI was found.

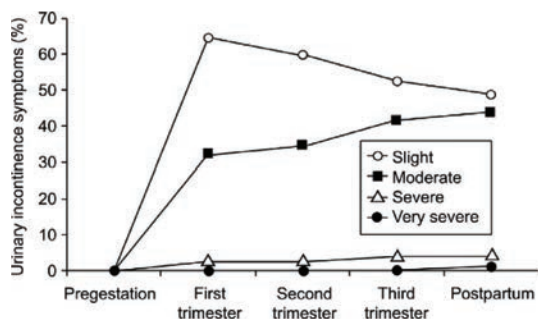

Figure 6: Evolution of the severity of urinary incontinence symptoms by time of data collection. From: Solans-Domenech. Incontinence During Pregnancy and Postpartum. *Obstet Gynecol* 2010 [176].

Figure 6 shows the evolution of severity of UI by data collection time, as well as the changes in trends between slight and moderate UI, with a tendency for slight to become moderate UI. The correlation between the severity of UI and level of interference in daily living was moderate but statistically significant in all periods of data collection with correlation coefficients of 0.35, 0.13, 0.46, and 0.47 for the first, second, and third trimesters and postpartum, respectively.

The same authors [191] showed in a cohort study of healthy, nulliparous, continent pregnant women, that symptoms of double incontinence are prevalent during first pregnancy; age and other intrinsic factors may favour the occurrence of double incontinence throughout gestation, while instrumental delivery and episiotomy increase the risk of double incontinence in the postpartum period.

Huebner et al [192] confirmed that pregnancy itself may influence pelvic floor function in a different way compared with vaginal delivery: in 411 pregnant women, the prevalence of UI increased significantly in the second half of pregnancy (26.3%, $P<0.001$).

Although the overall number of women who reported UI within 6 weeks after delivery was almost the same as the number reporting UI in the second half of pregnancy, approximately every second woman changed from being continent to incontinent and vice versa.

Ten percent of women presented with AI at some point during pregnancy: the prevalence of AI in this study cohort is 2.3%, 6.8% and 7.4% in the first, second and third trimesters. The presence of AI was characterised by loss of flatus in more than 90% of cases and common to all periods. LEVEL OF EVIDENCE: II [176].

In a prospective population-based cohort study, Johannessen et al [193], involving 1571 pregnant women, one in four primiparae experienced AI in late pregnancy; one year later, one in five still suffered from incontinence. Sphincter injury predicted incontinence of stool and flatus, whereas greater age and operative delivery predicted urgency. The authors suggest that identification and adequate follow-up of pregnant women with AI may reduce postpartum AI.

The prevalence of urinary and anal incontinence in a subgroup of pregnant women, constituted of African American adolescents (age: 14-19 years) in the third trimester, resulted in: 44% of patients complaining of UUI and 43% of SUI; 12% complained of faecal and 41% of flatal incontinence [194].

Incontinence during pregnancy has been linked to age [195], body mass index [196], strenuous physical exercise [197] and smoking history [196].

The risk of UI increases in pregnant women aged more than 35 years, in women who are overweight or obese at baseline, and in those with a family history of UI, while the risk of AI rises with age and excessive weight gain during pregnancy [176]. Weight gain greater than the 50th percentile during weeks 0–15 of pregnancy was weakly associated with higher incidence of UI at week 30 compared with weight gain less than or equal to the 50th percentile [198].

The data regarding the relationship between UI during pregnancy and its persistence or worsening condition postpartum are controversial: the results of Solans-Domenech et al. [176] showed that the occurrence of UI and AI during pregnancy is related to the presence of incontinence in the postpartum period, and vaginal delivery increases the risk of persistent incontinence. On the other hand Wesnes et al [199] concluded that the association between incontinence postpartum and mode of delivery is not substantially influenced by incontinence status in pregnancy and the prediction of a group with high risk of incontinence according to mode of delivery cannot be based on continence status in pregnancy.

2.3. Familial Predisposition

A familial predisposition in the aetiology of UI has also been considered, but the results are still controversial. Buchsbaum et al. [200] investigated the role of

vaginal delivery and familial factors in the development of UI by comparing the prevalence of this condition in nulliparous women and their parous sisters. Among this sample of biological sisters, UI was reported by 47.6% of nulliparous women and by 49.7% of parous women ($P = 0.782$). Considering the high concordance in continence status between sister pairs, and considering that the majority of parous women are continent, an underlying familial predisposition toward the development of UI may be present. LEVEL OF EVIDENCE II-2.

Nguyen et al. [201] analysed a large population comprising 1530 identical and 234 non-identical female twins (mean age 41.3 years), who answered a specific questionnaire focusing on symptoms of SUI. The two groups were comparable in terms of age, race, parity, BMI, menopausal status, tobacco use, mode of delivery and prior pelvic surgery. The authors demonstrated that environmental factors contributed significantly to the occurrence of SUI (shared environmental factors contribute 77.6% of the variance, unique environmental factors contribute to 20.9% of the variance; $p < 0.001$). The heritability of SUI was not statistically significant for the contribution of the phenotypic variance (1.49%; $p = 0.46$). Additional analyses were performed on the subgroup of women without prior incontinence or prolapse surgery (638 twin pairs) and in the subgroup of twins with “pure stress urinary incontinence” (458 twin pairs): the results in this cohort of patients showed no genetic influence. The authors point out that environmental factors (in particular obstetrical events) play a dominant role in middle-aged women; genetics contributed more toward the development of SUI in elderly women, as reported by Rohr et al. [202]: “nurture” before menopause and “nature” during aging. LEVEL OF EVIDENCE II.

3. PATHOPHYSIOLOGIC MECHANISM OF BIRTH INJURY TO THE PELVIC FLOOR

Strong epidemiological evidence links vaginal childbirth and the development of postpartum incontinence and prolapse.

There would seem to exist four major mechanisms by which vaginal delivery might contribute to the pelvic floor trauma: a) muscle trauma, b) connective tissue damage, c) nerve injury, d) vascular damage.

3.1. Muscle Trauma

The effect of delivery on muscular structure has been widely investigated, either with computer models, MRI and ultrasound. In a three-dimensional computer model Lien et al. [203] predicted levator ani muscle (LAM) stretch during vaginal birth. Serial magnetic resonance images from a healthy nulliparous 34-year-old woman, and engineering graphics software,

were used to construct a structural model of the levator ani muscles along with related passive tissues. The model was used to quantify pelvic floor muscle stretch induced during the second stage of labor as a model in which the foetal head progressively engaged and then stretched the iliococcygeus, pubococcygeus and puborectalis muscles. The largest tissue strain reached a stretch ratio (tissue length under stretch/original tissue length) of 3.26 in the medial pubococcygeus muscle, the shortest, most medial and ventral LAM. Regions of the ileococcygeus, pubococcygeus, and puborectalis muscles reached a maximal stretch ratio of 2.73, 2.50, and 2.28, respectively. Tissue stretch ratios were proportional to foetal head size: for example, increasing foetal head diameter by 9% increased medial pubococcygeus stretch by the same amount. The authors demonstrated that

the medial pubococcygeus muscles undergo the largest stretch of any levator ani muscles during vaginal birth and it is therefore at the greatest risk of stretch-related injury [203] (Figure 7).

Svabik et al. [204] showed that the area of the levator hiatus needs a distension of between 25% and 245% to allow the passage of the foetal head, considering as average a cross-sectional foetal head area of 68 cm², based on Caucasian biometric data.

The occurrence rate of postpartum levator avulsion in primiparae, diagnosed with 3D-4D ultrasound between 24 hours and 9 months after vaginal delivery, is reported between 15-39.5% [205-211]. The incidence of levator trauma evaluated with MRI is reported between 17.7%-19.1% 6-12 months postpartum [212-215].

A study published by Novellas et al. [212], reported an occurrence of 19.1% levator abnormalities diagnosed with MRI in primiparae submitted to caesarean section and they found that patients who underwent emergency caesarean sections had 2.7 times more abnormalities than patients who underwent elective caesarean. Only one study in literature reported 4 cases of levator defect diagnosed with 3D ultrasound following emergency caesarean section [210].

Avulsion of the pubovisceral muscle seems to occur more frequently after forceps delivery than after spontaneous vaginal delivery: 1-12 months postpartum the occurrence rate of levator avulsion after forceps reaches the incidence rate of 59-72% [205, 216].

Kearney et al. [217] compared LAM injury rates in primiparous women who had a forceps delivery owing to foetal distress, with women delivered by forceps for second stage arrest; they compared these injury rates with a historical control group of women who delivered spontaneously. The major defect rates were 42% for women who delivered by forceps with a short second stage; 63% for women who delivered by forceps and had a prolonged second stage; and 6% for spontaneous delivery. The odds ratios for major injury were: 11.0 for forceps and short second stage compared with spontaneous delivery; 25.9 for forceps and second stage arrest compared with spontaneous delivery; and 2.3 for forceps and second stage arrest compared with short second stage (p=0.07). These authors also confirmed that women delivered by forceps have a higher rate of levator ani injury compared with spontaneous delivery controls, but the length of the second stage of labor does not influence the effect of the forceps on the LAM.

Several obstetric factors associated with the occurrence of levator avulsion have been investigated: Valsky et al. [207] reported that a foetal head circumference ≥ 35.5 cm and a second stage of labour ≥ 110 min, increased odds of LAM trauma by a factor of 5.32. DeLancey's group [215] demonstrated that injuries to the levator ani muscles in women after their first vaginal delivery are associated with forceps use

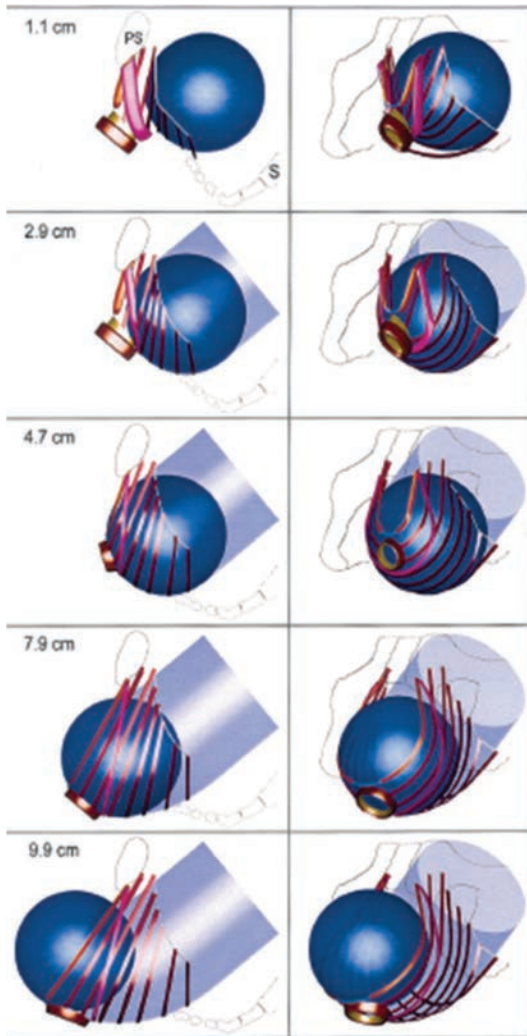

Figure 7: Simulated effect of fetal head descent on the levator ani muscles in the second stage of labor. From Lien et al, *Obstet Gynecol* 2004 [203].

(OR 14.7 [95% CI: 4.9-44.3]), anal sphincter rupture (OR 8.1 [95% CI: 3.3-19.5]) and episiotomy (OR 3.1 [95% CI: 1.4-7.2]); vacuum delivery (OR 0.9 [95% CI: 0.19-4.3]), epidural use (OR 0.9 [95% CI: 0.4-2.0]) and oxytocin use (OR 0.8 [95% CI: 0.3-1.8]) seem instead to have a protective effect against the occurrence of pubovisceral avulsion after delivery avulsion. LEVEL OF EVIDENCE II-3.

The LAM plays an independent role in pelvic organ support. The levator hiatus is the "hernial portal" through which female POP develops and damage to the levator 'plate' leads to a weakening of muscular supports to the pelvic organs and an increase in load carried by connective tissue and fascia.

It has been demonstrated that increasing POP is associated with increasing urogenital hiatus size [218].

The results published by Dietz and Simpson [219] in a retrospective study of a urogynecological population, showed that prolapse was seen in 150/181 (83%) women with avulsion and in 265/600 (44%) women without avulsion, giving a RR of 1.9 (95% CI: 1.7-2.1). The association was strongest for cystocele (RR 2.3, 95% CI: 2.0-2.7) and uterine prolapse (RR 4.0, 95% CI: 2.5-6.5). The authors conclude that women with levator avulsion defects were about twice as likely to show POP of stage II or higher than those without.

Chen et al. [220] used a biomechanical model to explore how the impairment of the pubovisceral portion of the LAM, of the apical vaginal suspension complex, or both might interact to affect anterior vaginal wall prolapse severity. The authors stated that once a certain degree of pubovisceral impairment was reached, the genital hiatus opened and a prolapse developed; the larger the pubovisceral impairment, the larger the anterior wall prolapse became. A 90% impairment of apical support led to an increase in anterior wall prolapse from 0.3 cm to 1.9 cm (a 530% increase) at 60% pubovisceral muscle impairment, and from 0.7 cm to 2.4 cm (a 240% increase) at 80% pubovisceral muscle impairment.

Rostaminia et al [221] shown that levator ani deficiency severity is associated with clinically significant prolapse: no patients with stage 3 prolapse had less than mild levator ani deficiency, and no patients with stage 4 prolapse had less than moderate levator ani deficiency. In patients with prolapse, those with moderate levator ani deficiency had 3.2 times the odds of POP compared with patients with a minimal defect; those with severe levator ani deficiency had 6.4 times the odds of prolapse than those with minimal deficiency. (LEVEL OF EVIDENCE: II)

The aetiological role of LAM integrity in bladder dysfunction is still not completely clear. A weakly significant association between levator avulsion and worsening or de novo UI has been reported 3 months postpartum, through the use of ultrasound [209]. Recent evidence questions this link, reporting that women with major levator defect diagnosed by MRI are less

likely to experience SUI [222], and that puborectalis trauma evaluated by ultrasound is not associated with an increased risk of SUI or urodynamic stress incontinence [223].

The involvement of urethral function in the presence of levator avulsion has been approached recently, considering that it is often assumed that SUI may be due to abnormal pelvic floor muscle function or anatomy. Brincat et al [224], found no significant association between maximal urethral closure pressure (MUCP) and urethral closure pressure with a pelvic floor contraction or Kegel (KUCP) in women with or without LAM defects ($p = 0.94$, $p = 0.95$). Additionally, there was no correlation between MUCP and vaginal closure force ($r = 0.06$, $p = 0.41$), and there was a weak correlation between KUCP and vaginal closure force ($r = 0.20$, $p = 0.01$). They conclude that urethral pressure profiles are unrelated to LAM defect status after vaginal birth, indicating that the mechanism responsible for LAM damage spares the urethra. Shek et al. [211], demonstrated that except at the bladder neck, there was no significant association between urethral mobility and avulsion.

In regard to anorectal function, Heilbrun et al. [213] showed a weak trend towards more FI in women with LAM avulsion and anal sphincter tears, but the interpretation of these results must take into account that this is a rather select group, with a special set of risk factors.

One might speculate as to how 85–90% of first time mothers can undergo vaginal birth without the foetal head overstretching and rupturing the U-shaped loop of pubovisceral muscle tissue. One possibility is that the structure that lies in series with this muscle could protect it by stretching more than the muscle itself, just as a fusible link protects the wiring harness of an automobile against an electrical short. That structure, the perineal body, located between the vagina and rectum and comprised of relatively soft connective tissue, has material properties that do appear to change in late pregnancy, but these remain to be quantified [187].

3.2. Nerve Injury

A geometric model has been used to predict the stretch ratios in the nerves innervating the levator ani, urethra, and anal sphincter during the second stage of vaginal labour [225]. The results showed that the inferior rectal branch exhibited the maximum strain, 35%, and this strain varied by 15% from the scenario with the least perineal descent to that with the most perineal descent. The strain in the perineal nerve branch innervating the anal sphincter reached 33%, whereas the branches innervating the posterior labia and urethral sphincter reached values of 15% and 13%, respectively. It was concluded that during the second stage (a) nerves innervating the anal sphincter are stretched beyond the 15% strain threshold known to cause permanent damage in the non-preg-

nant appendicular nerve, and (b) the degree of perineal descent is shown to influence pudendal nerve strain.

Pudendal nerve lesions usually result in demyelination of the fibres; axonal breaks may occur in severe cases where there is no recovery of the tissues [226]. c-Fos expression (an early reactive nerve injury marker) in the L6 to S1 spinal cord segments was observed in rats after simulated birth trauma, indicating acute nerve injury or irritation in spinal neurons. Also, histological studies have revealed a marked decrease of ganglion cells in the neural plexuses posterolateral to the vagina in rats after simulated birth [227].

Neuromuscular abnormal pelvic floor activation patterns may also contribute to the development of postpartum pelvic floor disorders [228-230]. Electroneuromyography studies have shown that 80% of primigravidae developed evidence of partial denervation with signs of reinnervation and increase in the density of nerve fibres in the postpartum period after vaginal delivery [231, 232]. The latency time of pudendal nerve motor fibres increased after two to threedays following vaginal delivery, but values normalised after six months in 66% [232]. Most nerve lesions spontaneously recover within a year by regenerative processes [226]. However, pudendal nerve damage, even with partial reinnervation of the external anal sphincter muscle, may persist and become more marked in the long term [233]. Neurophysiological tests revealed nerve damage in 36% of women with persistent SUI at 3 months postpartum. Compared with nulliparous control subjects, patients with SUI and POP had changes in the levator ani and external anal sphincter consistent with either motor unit loss or failure of central activation, or both [234].

4. PERINEAL TRAUMA

4.1. Epidural Analgesia During Labour

Regional anaesthesia for the relief of labour pain has become more popular during the past 20 years. Despite interest in its possible obstetric consequences, little attention has been paid to its potential effects on the pelvic floor and perineal injury.

The available published data describe controversial results. Some studies suggest that epidural analgesia, by enabling relaxation of the pelvic floor, leads to greater control of crowning of the foetal head and consequently fewer perineal lacerations [235], but prolongation of the second stage may also increase the incidence of pudendal nerve damage [236, 237].

Robinson et al. [238] examined whether epidural analgesia is associated with differences in rates of severe perineal trauma during vaginal deliveries. Among women who had epidurals, 16.1% (221/1376) had severe perineal lacerations compared with 9.7% (55/ 566) women who did not have epidurals (P <

.001; OR 1.8, 95% CI: 1.3-2.4). When controlling for birth weight, use of oxytocin, and maternal age in logistic regression analysis, epidural remained a significant predictor of severe perineal injury (OR 1.4, 95% CI: 1.0-2.0). Epidural use is consistently associated with increased operative vaginal deliveries and consequent episiotomies, so the authors constructed a logistic regression model to evaluate whether the higher rates of those procedures were responsible for the effect of epidurals on severe perineal trauma. With operative vaginal delivery and episiotomy in the model, epidural was no longer an independent predictor of perineal injury (OR 0.9, 95% CI: 0.6-1.3). They concluded that epidural analgesia is associated with an increase in the rate of severe perineal trauma because of the more frequent use of operative vaginal delivery and episiotomy.

Carroll et al. [239], evaluated whether epidural analgesia was an independent risk factor for severe perineal laceration. Among women who had epidural analgesia, 10.25% (65 of 634) had severe perineal lacerations compared with 5.22% (111 of 2,125) of the women who did not have epidural analgesia. After controlling for major variables in a logistic regression analysis, epidural analgesia remained a significant predictor of severe perineal injury (OR 1.5, 95% CI = 1.0-2.1). A logistic regression model examining predictors of instrument use found that epidural analgesia does significantly predict instrument use (OR 3.01, 95% CI: 2.2-4.0). The author concluded that epidural analgesia is associated with an increase in severe perineal trauma as a result of an associated three-fold increased risk of instrument use. Instrument use in vaginal delivery more than triples the risk of severe perineal laceration.

No significant association between anal sphincter injury and the use of epidural anaesthesia was observed in 91 women in the retrospective study published by Christianson et al. [240]. On the other hand, Fitzgerald et al. [241] demonstrated that epidural was significantly associated with anal sphincter tear when the analysis was adjusted for maternal age, race, and gestational age .

In a study of 82 women, Meyer et al. [242] assessed the effects of epidural analgesia on pelvic floor function. Eighty-two primiparous women (consisting of 41 given an epidural and 41 not given an epidural) were investigated during pregnancy and at 2 and 10 months after delivery by a questionnaire, clinical examination, and assessment of bladder neck behaviour, urethral sphincter function and intravaginal/intra-anal pressures. Ten months after spontaneous delivery, there were no significant differences in the prevalence of SUI and decreased sexual vaginal response, or in bladder neck behaviour, urethral sphincter function and pelvic floor muscle strength between women who had or had not had epidural analgesia.

Sartore et al. [243] concluded that the use of epidural analgesia is not associated with symptoms related to

perineal trauma and pelvic floor muscle weakness 3 months after vaginal delivery.

In a prospective observational study of 488 primiparae, Shek et al. [244], demonstrated with 3D ultrasound that intrapartum epidural appeared to have a protective effect ($P=0.03$; OR 0.42; 95% CI: 0.19-0.93) against levator trauma at the time of first delivery. Also Kearney et al. [215], using MRI, confirmed that epidural reduce the risk of developing a levator defect during vaginal delivery.

4.2. Role of Episiotomy

The episiotomy, a surgical incision in the perineum made to enlarge the vaginal opening and facilitate delivery, was originally introduced as a method assumed to improve maternal and neonatal outcomes and rapidly became a part of standard obstetric care. However, since the 1980s, routine use of episiotomy has been challenged, based on the lack of evidence of benefits of the procedure [245] and the publication of multiple studies reporting increased blood loss at delivery, perineal scar breakdown and infection, postpartum pelvic pain, and dyspareunia [246-249].

Nowadays routine episiotomy is not recommended any more. Various types of episiotomy have been described in the past (median, modified median, J-shaped episiotomy, mediolateral, lateral, radical lateral and anterior) in papers and textbooks (Figure 8). The description of mediolateral episiotomy (the most

frequently used in Europe) in standard obstetrics textbooks differs widely: some publications provide only descriptive terms, the angle of incision varies between 31° and 63° , suggesting the wide potential variation in the practice of episiotomy worldwide.

Some studies deal with the different use of various episiotomies in different countries (e.g. UK, Finland and Greece) [251-254]. However randomised trials comparing alternative methods or position of episiotomy are lacking, resulting in Level 2b or Level 3 of evidence, only. To ensure Level 1 evidence from randomised trials, it needs a standardisation of the practice and reporting of the episiotomy incision. However, a standardized classification system has not been introduced yet, making it difficult to compare the various techniques. Even in the last Cochrane review of episiotomy, an exact classification or definition of episiotomies is lacking [255].

Some studies have demonstrated increased incidence of third and fourth-degree lacerations associated with the use of midline episiotomy [256, 257]. The resulting damage to the internal and external anal sphincters can lead to devastating long-term sequelae, including FI and rectovaginal fistulae [258].

To support the benefits of episiotomy, some clinicians have claimed that meticulous repair of a surgical episiotomy yields improved wound healing when compared with an unpredictable spontaneous laceration [246]. This assertion, however, has not been substantiated by evidence [259].

Kalis et al. [260] evaluated the results of mediolateral episiotomy with incision angle of 60° : the study group comprised 60 consecutively recruited primiparous women who required episiotomy during delivery. The results showed that the angles differed significantly among the incision (60°), repair (45°), and 6-month (48°) measurements ($P < 0.001$). There was a poor correlation between the suture angle and the angle measured at 6 months postpartum. No severe perineal tear was diagnosed in the cohort. At 6 months postpartum, only one woman reported mild symptoms of de novo AI, whereas 7 women reported perineal pain related to episiotomy.

Many institutions and individual obstetric practitioners have decreased their performance of episiotomy over the past 20 years, most likely as a result of practicing evidence-based medicine.

An electronic audit of the medical procedures database at Thomas Jefferson University Hospital from 1983 to 2000 was completed to determine if practice patterns have been altered by the large body of literature strongly advocating the selective use of episiotomy. Overall episiotomy rates in 34,048 vaginal births showed a significant reduction from 69.6% in 1983 to 19.4% in 2000. Significantly decreased risk of episiotomy was seen based upon year of childbirth (OR 0.87, 95% CI: 0.86-0.87), black race (OR 0.29, 95% CI: 0.28-0.31), and spontaneous vaginal delivery (OR 0.40, 95% CI: 0.36-0.45). Increased association with



Figure 8: Types of episiotomy. 1: median episiotomy, 2: modified median episiotomy, 3: 'J'-shaped episiotomy, 4: mediolateral episiotomy, 5: lateral episiotomy, 6: radical lateral (Schardt incision), 7: anterior episiotomy (white arrow). From Kalis et al. Classification of episiotomy: towards a standardization of terminology. BJOG 2012 [250].

episiotomy was seen in forceps deliveries (OR 4.04, 95% CI: 3.46-4.72), and with third or fourth-degree lacerations (OR 4.87, 95% CI: 4.38-5.41). This study demonstrates a statistically significant reduction in the overall episiotomy rate between 1983 and 2000. White women consistently underwent episiotomy more frequently than black women, even when controlling for age, parity, insurance status, and operative vaginal delivery [249].

A population-based register of 514,741 women with singleton vaginal deliveries recorded in the Finnish Medical Birth Register was reviewed. Primiparous and multiparous women who had undergone episiotomy were compared to women who had not undergone episiotomy, for possible risk factors. The occurrence of episiotomy decreased from 71.5% in 1997-1999 to 54.9% in 2006-2007 among primiparous women, and from 21.5% in 1997-2001 to 9.2% in 2006-2007 among multiparous women. The use of episiotomy decreased in not only low-risk but also high-risk women who had operative vaginal or breech deliveries, macrosomic newborns, and oxytocin augmentation. The ratio of episiotomy use remained relatively unchanged in different subgroups even though episiotomy policy became increasingly restrictive over time. The authors concluded that the spectrum of episiotomy indications has not changed over time, and use of episiotomy has declined arbitrarily to a similar extent among high and low-risk women [261].

To identify the risk factors for obstetric anal sphincter rupture (OASR), a retrospective population-based register study was carried out. A total of 514,741 women with singleton pregnancy and vaginal delivery between 1997 and 2007 in Finland were recruited. Episiotomy decreased the likelihood of OASR for the primiparous [OR 0.83, 95% CI: 0.75-0.92], but not the multiparous women (OR 2.01, 95% CI: 1.67-2.44). Episiotomy was associated with decreased risks for obstetric anal sphincter rupture in vacuum assisted deliveries (OR 0.70, 95% CI: 0.57-0.85). These results support the restrictive use of episiotomy, since 909 episiotomies appear to be needed to prevent one OASR among primiparous women. The equivalent estimate in vacuum assisted deliveries among primiparous women was 66, favoring routine use of episiotomy in such cases [253].

Robinson et al. [262], carried out a study to identify factors associated with the use of episiotomy at spontaneous vaginal delivery. They studied 1576 consecutive term, singleton, spontaneous vaginal deliveries; the association of demographic variables and obstetric factors with the rate of episiotomy use were examined. The overall rate of episiotomy was 40.6% (640 of 1576). Midwives performed episiotomies at a lower rate (21.4%) than faculty (33.3%) and private providers (55.6%) ($P=0.001$). After controlling for confounding factors with logistic regression, private practice provider was the strongest predictor of episiotomy use (OR 4.1, 95% CI: 3.1-5.4) followed by faculty provider (OR 1.7; 95% CI: 1.1-2.5), prolonged second

stage of labour (OR 1.8; 95% CI: 1.2-2.7), foetal macrosomia (OR 1.6; 95% CI: 1.1-2.5), and epidural analgesia (OR 1.4 95% CI: 1.1-1.8). The authors conclude that the strongest factor associated with episiotomy at delivery was the category of obstetric provider. Obstetric and demographic factors evaluated did not readily explain this association.

A study was carried out to lower the episiotomy rate through physician education and to document the indication when episiotomy was performed. The intervention consisted of an evidence-based lecture recommending limited usage of episiotomy and requesting documentation of any indication for episiotomy. Data 3 months prior to the intervention were compared to those of the following year. For all vaginal deliveries, there was a 17% decrease in the rate of episiotomy, from 46.9% to 38.8%. For spontaneous vaginal deliveries, there was a 25% decrease in the episiotomy rate, from 40.8% to 30.8%. The most common indications for episiotomy reported were routine/elective, 41.0%; vacuum, 18.6%; forceps, 16.4%; and non-reassuring foetal heart tracing, 10.9% [263].

A review was conducted of women with consecutive vaginal deliveries at Magee-Women's Hospital between 1995 and 2005 to evaluate the episiotomy exposure at first vaginal delivery. A total of 6,052 patients were included, of whom 47.8% had episiotomy at first delivery. Spontaneous second-degree lacerations at the time of second delivery occurred in 51.3% of women with history of episiotomy at first delivery, compared with 26.7% without history of episiotomy ($P<0.001$). Severe lacerations (third or fourth-degree) occurred in 4.8% of women with history of episiotomy at first delivery compared with 1.7% without history of episiotomy ($P<0.001$). Prior episiotomy remained a significant risk factor for second-degree (OR 4.47, 95% CI: 3.78-5.30) and severe obstetric lacerations (OR 5.25, 95% CI: 2.96-9.32) in the second vaginal delivery after controlling for confounders. Based on these findings, for every four episiotomies not performed, one second-degree laceration would be prevented. To prevent one severe laceration, performing 32 fewer episiotomies is required. Episiotomy at first vaginal delivery increases the risk of spontaneous obstetric laceration in the subsequent delivery. This finding should encourage obstetric providers to further restrict the use of episiotomy. LEVEL OF EVIDENCE II [264].

In a recent study of Bø et al [265], aiming to compare vaginal resting pressure, pelvic floor muscle strength and endurance and prevalence of UI at 6 weeks postpartum in women with and without episiotomy, the authors conclude that pelvic floor muscle function and prevalence of postpartum UI were not affected by a lateral or mediolateral episiotomy.

In a biomechanical analysis on the impact of episiotomy during childbirth, Oliveira et al. [266] demonstrated that a mediolateral episiotomy has a protective effect, reducing the stress on the muscles, and the force required to delivery successfully up to

52.2%. The intervention also has benefits on muscle injury, reducing the damage to a small zone.

5. CONCLUSIONS AND RECOMMENDATIONS

- a) Prevalence of UI after vaginal delivery is double than after caesarean section [158]. Caesarean section seems to decrease the risk of postpartum UI [159, 160], but its protective effect seems to diminish over time and disappears after multiple deliveries [160, 161]. Risk of SUI is estimated to be 2.9 times higher after vaginal delivery compared with women after caesarean section [162]. Information as to whether caesarean done before labour confers greater protection than caesarean done after labour is lacking. To understand the true impact of caesarean delivery on UI, future studies must compare incontinence by planned delivery modes.
- b) De-novo AI symptoms after child-birth are described as up to 26-38% between 6 weeks-6 months postpartum [164-169]. Vaginal delivery has a greater risk of FI compared to caesarean 3-6 months postpartum [164] [166]. It is recommended extending postpartum follow-up visits beyond the typical 6-8 weeks to provide surveillance for potential incontinence. LEVEL OF EVIDENCE: II.
- c) POP rate in the first 3-6 months postpartum is reported between 18.1-56% [170-172]. Spontaneous vaginal delivery increased the risk by more than three times while instrumental vaginal delivery increased it more than five-fold in comparison with caesarean section [170]. Caesarean section has a protective effect on occurrence of POP [173].
- d) The occurrence of UI and AI during the postpartum period is related to the presence of incontinence in pregnancy, and vaginal delivery increases the risk of persistent incontinence. LEVEL OF EVIDENCE II [176].
- e) So far, there is no evidence from randomized controlled trials, upon which to base any practice recommendations regarding planned caesarean section for non-medical reasons at term or to avoid pelvic floor symptoms in a woman without previous disorders, considering that pregnancy itself may be involved in the development of such dysfunctions [184-186].
- f) Obstetrics factors associated with the occurrence of LAM trauma postpartum: forceps use, foetal head circumference ≥ 35.5 cm, second stage of labour ≥ 110 min, anal sphincter rupture, episiotomy. LEVEL OF EVIDENCE II-3. Levator ani avulsion is associated with the occurrence of pelvic organ prolapse later in life, but the role of LAM

integrity in bladder and anorectal dysfunctions are still not completely clear.

- g) Epidural analgesia during labour: controversial results regarding its potential effect on the pelvic floor and perineal injury. There is a lack of prospective, randomised trials, requiring further research and development in order to draw recommendations.
- h) Randomized trials comparing alternative methods or position of episiotomy are lacking, resulting in Level IIb or Level III of evidence, only. To ensure Level 1 evidence from randomized trials, it needs a standardisation of the practice and reporting of the episiotomy incision. The actual evidence shows that episiotomy is associated with 3rd-4th degree of perineal laceration and with an increased risk of spontaneous obstetrics laceration in the subsequent delivery. These findings encourage restriction of routine use of episiotomy. LEVEL OF EVIDENCE II.

IV. PATHOPHYSIOLOGY OF STRESS INCONTINENCE IN WOMEN: URETHRAL STRUCTURE, SUPPORT AND FUNCTION

The factors necessary for the urethra to remain closed at rest and during increased abdominal pressure have been well characterised, but their functional inter-relationships are still not fully understood. These factors include: 1) healthy, functioning striated sphincter controlled by pudendal innervation, 2) well vascularised urethral urothelium and sub-mucosa, 3) properly aligned and functioning intrinsic urethral smooth muscle, and 4) intact vaginal wall support.

1. THE FEMALE UROGENITAL DIAPHRAGM: URETHRAL SPHINCTER LOCATION

Detailed descriptions of the striated urogenital sphincter muscle have been made by Max Brodel working with Howard Kelly [267], Oelrich [268] and further expanded by DeLancey [269]. These reports have provided clear descriptions of the urethral rhabdosphincter. The location of the sphincter elements can be understood by dividing the urethral lumen into 5 equal segments. The first 20% is surrounded by the bladder muscle and detrusor loop, the next 40% is surrounded by a sleeve of striated muscle that forms the sphincteric portion of the striated sphincter. Next, from 60 to 80% two arch shaped bands of muscle diverge from the wall of the urethra to surround the vagina (urethrovaginal sphincter) and

perineal membrane (compressor urethrae). Manometric and electrophysiological recordings from the mid-urethra have shown that it generates the highest level of resting pressure and electromyographic activity.

This portion of the urethra is an intra-pelvic structure located immediately posterior to the pubic bone. In the past, much has been made of the loss of this intra-pelvic position in stress incontinence. It had been suggested that when the urethra descended away from its intra-abdominal position, intra-abdominal forces no longer constricted it during straining. This concept has survived and been modified into the "hammock hypothesis" [270] which suggests that the anterior vaginal wall provides a backboard against which increasing intra-abdominal forces compress the urethra. The anterior vaginal wall is stabilized by its lateral attachments to the arcus tendineus fascia pelvis and levator ani muscle. Data supporting this hypothesis are drawn from urethral pressure transmission studies showing that continent patients experience an increase in intra-urethral pressures during coughing. This pressure increase is lost in stress incontinence and may be restored following successful operations designed to stabilize or elevate the sub-urethral vaginal wall [271-280].

The urethra is supported by the anterior vaginal wall. The superior vaginal sulcus, most clearly found in nullipara, exists at this junction of the lower and middle third of the vaginal wall. This point represents the two lateral insertion points of the vaginal "hammock". Portions of the pubococcygeus muscle attach to these sulci within the pelvis and can produce elevation during voluntary contraction.

Immediately anterior to the proximal urethra are found the reflections of the endopelvic fascia. The most prominent of these, the attachments of the arcus tendineus fascia pelvis (sometimes referred to clinically as "pubo-urethral ligaments"), are sufficiently condensed to form distinct and recognisable ligaments on either side of the pubis where they attach to the pubic bone about 1 cm from the midline and 1 cm above the bottom of the pubis. These structures are continuous with a complex of tissues including the perineal membrane and levator ani. The arcus tendineus fascia pelvis, which can be seen at the time of retropubic surgery, is the more familiar of these.

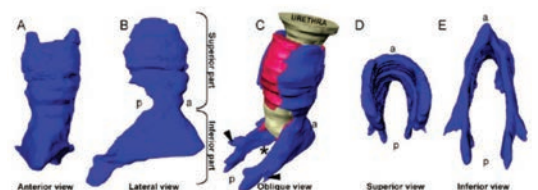

Figure 9: EUS in 18 weeks female foetus: A anterior view, B lateral view, C oblique view, D superior view, E inferior view - From Wallner et al., Eur Urol 2009 [284].

This is a strong fascial condensation which most likely maintain their characteristics throughout life. Previous investigators have suggested that elongation of this structure may be responsible for the loss of urethral support seen in stress incontinence, yet objective evidence for this is lacking.

Different authors have described the striated urogenital sphincter (SUS) that has also been called the external urethral sphincter (EUS) by some authors, both in foetuses [281, 282] and adults [283] as a superior horseshoe structure covering the urethra and an inferior one surrounding the anterolateral aspect of the urethra and the lateral part of the vagina.

The LAM is involved in urethral support. Wallner et al. [284] investigated the topographical relationship between the EUS and the LAM (Figure 9, 10), showing that in female foetuses, but not in male, the inferior part of the EUS is firmly attached to the LAM by a tendinous connection. This determines an anterior bending of the midurethral zone when a simultaneous contraction of the LAM and EUS occurs, closing the

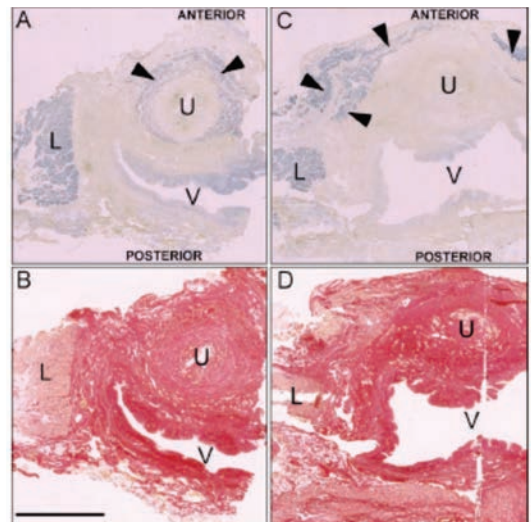

Figure 10: The anatomical relationship of the EUS to the LAM in adults. Panels (A) through (D) show transverse sections through the EUS and the LAM of an adult female (54 yr): (A) superior part of the EUS (arrowheads), section stained immunohistochemically for striated muscle; (B) sequential section stained with sirius red for connective tissue; (C) inferior part of the EUS (arrowheads), section stained immunohistochemically for striated muscle; (D) sequential section stained with sirius red for connective tissue. Note in (C) that in the adult, the anatomical relationship between the inferior part of the EUS and the LAM is still maintained. The contrast of images (A) and (C) was increased digitally. L = levator ani muscle; U = urethra; V = vagina. From Wallner et al Eur Urol 2009 [284].

urethral lumen and maintaining continence. The functional integrity of this connection between the EUS and the LAM is therefore crucial to avoid UI.

The striated EUS, both in foetuses and adults, has a superior horseshoe structure covering the urethra and an inferior one surrounding the anterolateral aspect of the urethra and the lateral part of the vagina.

Moreover, while the lower one-third of the vagina is oriented more vertically in the nullipara, the upper two-thirds of the vagina deviate horizontally [285]. This orientation is due: 1) to the posterior attachments of the cervix by the cardinal and utero-sacral ligaments and 2) to the anterior position of the levator hiatus. Barium vaginograms have demonstrated this horizontal angulation of the upper two-thirds of the vagina, and show that during coughing and stressful manoeuvres, the levator hiatus is shortened in an anterior direction by the contraction of the pubococcygeus muscles. Thus, the pelvic organs receive support from the shape and active contraction of the levator muscles.

Modifications of the genital hiatus determining an increase in the genitohiatal distance can be associated with urodynamic stress incontinence (USI). In a retrospective study of 396 women with USI [286], pelvic floor ultrasound revealed a small but statistically significant negative association of the genitohiatal distance to urodynamic functional urethral parameters such as the functional profile length, the maximum urethral closure pressure and a low Valsalva leak-point pressure ($r = -0.148$, $P = 0.018$ and $r = -0.227$, $P = 0.009$, $r = -0.199$, $P = 0.02$ respectively), that would explain about 5% of the observed variation.

2. EFFECT OF CHILDBIRTH, VAGINAL PROLAPSE AND URETHRAL POSITION ON URINARY CONTINENCE

Labour and delivery alter vaginal and pelvic anatomy and innervation in several ways as has been discussed in other sections of this chapter. Each of these may contribute to the eventual development of UI:

Direct crushing or traction on the pudendal nerve has been discussed above and has previously been suggested as a primary cause of sphincter incompetence in stress incontinence. The pudendal nerve, which projects from Onuf's nucleus and traverses Alcock's canal before entering the ischiorectal fossa and innervating the EUS, can be injured during vaginal delivery, particularly in the area between the sacrospinous and sacrotuberous ligaments. Two different mechanisms of pudendal nerve damage during delivery have been described: 1) nerve compression and stretching which may cause an elongation of the 13% of its motor branch innervating the EUS [287]; 2) a reduced at 8% stretch and complete ischemia at 15%

stretch of the nerve as shown in a tibial nerve rat model [288]. Thus, pudendal nerve ischemia likely occurs during vaginal delivery as a result of both stretch and compression [289].

The vagina itself may be torn away from its intrapelvic attachments; some believe there is also subsequent loss of the superior vaginal sulcus. There may be direct attenuation of the vaginal wall itself, manifested by loss of vaginal rugae and a thin appearance. Cullen Richardson has suggested four distinct kinds of vaginal injuries: paravaginal, central, distal, and cervical, the first two being the most commonly seen in women with stress incontinence. These defects have been identified by sonographic examination [290].

Finally, detachment of the pubococcygeal (sometimes called pubovisceral) portion of the LAM [291], often described as stretching, tearing and avulsion of the levator muscles, result in a longer and wider levator hiatus. This is not due to nerve injury or muscle compression as sometimes suggested. Studies that are designed to evaluate differences between possible injury mechanisms to include muscle detachment from their origin, neuropathic atrophy and compression injury show evidence of direct injury but not compression or nerve damage as a cause for this injury [292]. Consequently, the perineum is displaced caudally and posteriorly under stress and temporarily fails to support the pelvic organs. These changes in the levator hiatus with or without associated relaxation of cervical support result in chronic anterior displacement of pelvic organs with a loss of both active and passive organ support during rest and especially during straining.

In the patient with SUI these changes typically give rise to a rotational descent of the proximal urethra away from its retropubic position. Radiographic images of SUI in women have noted this and generated our earliest concepts of this condition. Jeffcoate and Roberts [293], using lateral cystourethrograms, concluded: "...the most common characteristic anatomical change, present in four out of five cases of incontinence, is loss of the posterior urethro-vesical angle so that the urethra and trigone tend to come into line."

In 2002, fifty years later, perineal sonographic studies of urethrovesical angle differences in incontinent and normal patients have found excellent correlation identified between angle and degree of incontinence, supporting these original observations [294].

The history of urethrovesical support involves many studies focusing on the use of barium paste placed in the bladder and in the urethra [295, 296], but they are outdated and covered in prior editions of this book.

These kinds of radiographic studies, however, cannot distinguish between lateral or central defects in vaginal wall support. Therefore, while urethral movement can be identified as an important finding in stress incontinence, one cannot determine the exact location of the vaginal defect. Because the proximal urethra

rotates out of the focal plane of ultrasonographic probes or MRI, coronal images of vaginal relaxation have not yet shown anatomical detail at the moment of incontinence. They cannot distinguish central from paravaginal defects. For this, an examination of the patient is required. 3D stress MRI, however, has made this possible and reveals that the dominant factor in loss of anterior vaginal wall support comes from paravaginal separation and apical descent that are highly correlated with one another [297].

Although we have considerable knowledge about anatomical defects in the majority of patients USI, less is understood about the exact effect of these defects, and indeed, vaginal position itself, on urethral closure. Early experience with operations for stress incontinence showed that not all women with SUI had vaginal prolapse, that correction of vaginal relaxation did not always correct stress incontinence, and that women who redeveloped stress incontinence symptoms after apparently successful surgery did not necessarily show a recurrence of their prolapse [298].

The effect on the urethral mechanism of anatomical defects induced by vaginal delivery has been recently investigated. In a rat model birth trauma has been simulated by inducing vaginal distension by balloon catheter inflation [299]. Sneeze induced SUI was caused by decreased active closure mechanisms at the mid-urethra without affecting the passive transmission of abdominal pressure in the proximal urethra.

The greater involvement of the urethral mechanism in the occurrence of post-partum stress incontinence was confirmed in a case control study evaluating urethral closure pressure and bladder neck movement assessed with ultrasound [300]. Eighty primiparous women complaining of de-novo stress incontinence 9-12 months after delivery were compared with 80 primiparous continent and 80 nulliparous continent women. Lower maximal urethral closure pressure was the closest association with de novo stress incontinence after first vaginal birth followed by vesical neck mobility and was as strong a predictor of incontinence as were changes in urethral support.

3. ROLE OF CONNECTIVE TISSUE

Collagen and smooth muscle are the main constituents of endopelvic fascia and abnormalities in the quantity, type and quality of collagen have been observed in women with stress incontinence. Several studies have reported a decrease in the total collagen content in women with SUI [301-303]; moreover, in SUI a defect in endopelvic fascia is also likely to be of functional significance given that the urethra is indirectly attached to the levators by endopelvic fascia and an intact arrangement assists in urethral positioning [304]. Stress incontinence may be acquired through conditions causing changes in connective tissue:

The incidence of SUI is more common with increasing age. In postmenopausal women, connective tissue to muscle ratio is reduced, and although the formation of collagen cross-links stabilizes the molecule it prevents remodelling and flexibility [305].

It is well known that stress incontinence is more common in multiparous women. There is evidence to suggest that trauma during childbirth may cause neuromuscular injury. However, changes in connective tissue also occur during pregnancy. Fascia becomes more elastic and vulnerable and women who have antenatal stress incontinence might have a greater degree of fascial weakness compared with those who remain continent [306]. Women, who develop antenatal stress incontinence, even when it resolves in the postnatal period, are twice as likely to develop it again in the future compared with those without antenatal stress incontinence [307]. Whether this is due to pregnancy unmasking women with congenitally weak sphincter mechanisms or changes due to the pregnancy remains to be determined. The hormonal changes during pregnancy or abnormal remodelling of collagen may be important in the development of these conditions so this is plausible thought not proven.

4. EMERGING CONCEPTS OF URETHRA WEAKNESS AND ISD

The idea that primary urethral weakness could cause SUI was first proposed by Howard Kelly in 1914 [308] and its relationship to problems with urethral support emphasized in a proposed classification by Blaivas et al. [309]. In their classification, they named this Type III incontinence to distinguish it from Types I and II, each of which showed movement, while Type III did not. This term still remains in the contemporary literature, although it has now been largely replaced by the term intrinsic sphincter deficiency (ISD), focusing attention on urethral elements which appear to be independent of vaginal position and mobility. These elements include pudendal innervation, striated sphincter mass and function, and urethral smooth muscle, mucosa and submucosal cushions.

When ISD was first introduced as a concept to explain surgical failures and the presence of stress incontinence in the absence of vaginal mobility, the diagnostic tendency was to consider the cause of stress incontinence as a dichotomy, due either to hypermobility (displacement, or prolapse of the vaginal wall) or ISD. The typical patient with ISD was described as having low urethral closure pressures, a "stovepipe" appearance on cystoscopy, and opening or funneling of the urethra under resting or minimal increases in intra-abdominal pressures on radiographic images. The common causes were thought to be surgical injury, ischemia following previous pelvic or vaginal surgery or radiation damage.

It appears now, that these examples of ISD may represent the most advanced or extreme forms.

5. HYPERMOBILITY VS. ISD: FROM DICHOTOMY TO CONTINUUM

Currently, it appears to be a shift away from this simple categorisation of stress incontinence as being due either to hypermobility or ISD. This has arisen in part because of the development of the concept of Valsalva Leak Point Pressure (VLPP) [310, 311] and more recent analyses of long term results of stress incontinence surgery [312].

VLPP emerged as an alternative method to study urethral closure during stress for studies of urethral bulking with collagen. Investigators recognised that improvements in continence following urethral bulking did not correlate with urethral closure pressures, but did correlate with the amount of pressure required to produce leakage in the absence of intrinsic detrusor contraction. Although VLPP still lacks specific anatomic or theoretical grounding and many uncertainties related to standardisation of recording methods and associated prolapse remain, low VLPP (without specified or established values) has been widely embraced as an indicator of ISD.

Just as the concept of VLPP blurred the previous distinction between simple ISD and simple hypermobility, long term outcome studies of correction of hypermobility have suggested that there may be more urethral weakness among patients with hypermobility than had been previously considered.

Long term outcome studies of stress incontinence surgery have shown that there is a much greater failure rate of many of the commonly performed stress incontinence operations than had been generally appreciated, and that slings providing direct sub-urethral support seemed to give the greatest long term protection against recurrence of incontinence [312]. Since slings had traditionally been the procedure of choice for recurrent incontinence or “Type III” (now ISD) incontinence, the possibility that ISD was more common than previously thought was more widely considered. Recently, Horbach and Ostergaard have found that age is a significant, independent predictor of ISD in the setting of USI [313], suggesting that age-related reduction in muscle mass, slowed reflexes or repeated episodes of prolapse may all contribute to the condition.

In two interesting studies Perucchini et al. [314, 315] showed that aging can cause a decrease in the number and density of urethral striated muscle fibres at the bladder neck and along the ventral wall of the urethra [315]. These changes were also associated with a loss of nerves within the urethra [316]. Whether the muscle loss leads to reduced numbers and size of nerves or vice versa is difficult to say.

These two developments have led to a growing clinical impression that some degree of ISD may exist in many patients who, until recently, were thought to have only hypermobility as the cause of their incontinence. Atypical expression of this approach can be found in the conclusion of Kayigil et al. [317] following examination of 50 patients; “The high rate of intrinsic sphincter deficiency in patients with urethral hypermobility indicates that the incidence with stress incontinence may be greater than previously believed, and may influence the apparently higher failure rates after bladder neck suspension.” In contemporary clinical practice, this impression has given rise to a growing tendency to recommend suburethral sling surgery as a form of primary surgical treatment for all women with stress incontinence, whereas formerly this approach was reserved almost exclusively for patients with recurrent stress incontinence or significant ISD [318, 319].

5.1. Direct Studies of Urethral Function

As recognition of the importance of urethral function has increased, so too have the number of investigations of urethral position, urethral closure and transmission pressure profiles, Valsalva leak point pressure measurements and electromyographic examinations of the pudendal nerve and the striated sphincter.

5.1.1 Studies of urethral position

Stress incontinence is frequently associated with loss of urethral position. This has been the primary pathophysiological paradigm since the observations of Hodgkinson and Jeffcoate and Roberts. Similar observations are still reported today [320, 321]. Even when some displacement is seen in continent nulliparous females, incontinent women show a greater degree of mobility [260].

This pathophysiological mechanism has been supported by different authors [227, 323, 324] using a rat model. Induced trauma on structures supporting the urethra (such as the pubourethral ligaments) and urethrolisis resulted in SUI in short and long term because of increased urethral mobility.

Successful suspensory operations, whether by sling or paraurethral suspension stabilise urethral position [298] and, when studied, increase pressure transmission during stress. It is not clear if the active contraction of urethral support seen in the female is restored after surgery, nor is it known if it is necessary for continence. It has been suggested that passive support alone is what restores continence after suspension.

Direct comparison of urethral sphincter function and urethral support in women with clinical SUI and asymptomatic volunteers who were of similar age and parity allows the relative contributions of both factors to be compared. In such a study [325], the difference between incontinent and continent women was far greater for maximal urethral closure pressure (effect size 1.6) than for any of several parameters of urethral support (largest effect size 0.6). Because of

concern that the measures of urethral support might not be adequately capturing the some aspect of urethral support, the authors had individuals with published expertise in assessing urethral support on ultrasound review recordings of the women blinded to their status to see if they could discern continence status [326]. The raters were only 7% better than random chance supporting the idea that urethral support is not as important as previously thought.

5.1.2 Studies of urethral pressure and resistance

Stress incontinence is generally thought to be characterised by a decrease in urethral transmission profiles and resting closure pressure. The correlation between low resting pressures and low leak point pressures is still controversial. With a bladder filled up to 200ml Almeida et al. [327] reported a significant correlation between MUCP and LPP. Patients with a LPP of 60 cm H₂O or less also had shorter urethral functional length and lower sphincter activity. Moreover Sinha et al [328] showed that women with USI were more likely to leak at cough leak point pressure than the Valsalva manoeuvre, with the opposite happening for women with DO. On the contrary Martan et al. [329] could not find any significant correlation between MUCP and VLPP.

Different urodynamic parameters have also been considered to assess urethral function and to correlate with women with stress incontinence. Digesu et al. [330] showed that urethral resistance pressure (URP) and pressure flow parameters were reduced in women with stress incontinence. Salvatore et al. [331] found that the opening vesical pressure is significantly correlated with ISD.

Sonographic studies have recently shown a relationship between low urethral resistance and decreased urethral smooth and skeletal muscle layers [332].

Improvement in transmission pressures is associated with successful outcomes after suspensory operations for SUI [271, 275, 278, 279, 333, 334]. The exact mechanism for this increase in transmission is not clear. Increased exposure to intra-abdominal forces has been suggested [280, 335, 336]. Compression against the pubis by the pelvic viscera has also been suggested [337]. The final position of the urethra, however, may not be the key variable [271].

5.1.3 Electrophysiological studies of urethral function

Snooks and Swash [338, 339] first brought attention to the importance of urethral denervation after its possible contribution to urinary and faecal incontinence. Stress incontinence is frequently associated with a decline in the electrophysiological function of the pudendal nerve [340], the striated urethral sphincter [341], and the pelvic floor muscles [229, 234]. Most recent studies continue to support the finding of prolonged pudendal nerve terminal motor latency in SUI [342].

With the use of animal models simulating intrinsic urethra deficit through periurethral cauterisation, urethral sphincterectomy or pudendal nerve transection, different authors reported a decrease of LPP lasting for weeks [343-345]. Injury of the pudendal nerve determined a dramatic decrease of urethral resistance causing urinary loss during an intrabdominal pressure increase.

Electromyographic studies of normal sphincter function show that in continent women, pressures begin to rise in the urethra before rising in the bladder, suggesting an active muscular component [346].

Women with stress incontinence have an altered pattern of pelvic floor muscle response during successive coughing efforts [347] with a sharp decrease in MUCP after repeated coughs [348]. EMG studies have also shown that women with persistent stress incontinence after previous surgery have poorer urethral neuromuscular function than naïve stress incontinent women [349]. Experimental studies of urethral function and the role of Onuf's nucleus in the sacral spinal cord have led to recent practical innovations in the development of serotonin uptake inhibitor agents in the treatment of stress incontinence [350]. Most electrophysiological studies have concentrated on motor rather than sensory innervation, however, and the role of urethral sensation in USI is unknown.

Needle electromyographic studies to assess urethral sphincter function have been performed by Takahashi et al. [351] to determine the electromyographic features of the striated urethral sphincter due to intrinsic sphincter deficiency. Myogenic dominant damages of the striated sphincter were suggested to contribute to the etiology of ISD [352]. Heesakkers et al. proposed circumferential sphincter surface electromyography (CSS-EMG), a less invasive and, therefore more patient friendly procedure, of the urethral sphincter and to identify CSS-EMG parameters for diagnosing ISD [353]. The authors found that the Average Rectified Value of the Motor Unit Action Potential, a measure of strength of the urethral rhabdosphincter, at 12 o'clock at 100% squeeze of the urethral sphincter, could discriminate between ISD and non ISD.

5.1.4 Genetic factors

Recent research is now focusing on the identification of factors related to stress incontinence which might be genetically determined. Chen et al. [354] reported that genes involved in elastin metabolism were differentially expressed in vaginal tissue from women with stress incontinence, suggesting that elastin remodelling may be important in the molecular aetiology of stress incontinence. Wen et al. [355] recently reported a decreased expression of alpha2-M mRNA and protein and protease inhibitor activity in the vaginal wall tissues of women with stress incontinence.

There is a need for a hypothesis which would integrate these various observations regarding hypermobility, ISD and pudendal nerve function, place them within the context of an abnormal pelvic floor and provide a model to guide research and studies of the natural history of the condition.

5.2. Role of Advanced Imaging in Understanding Pathophysiology

Many imaging modalities have been used to improve our knowledge on pelvic floor dysfunction, such as: radiographic imaging, ultrasound, computed tomography and magnetic resonance imaging (MRI).

Radiographic imaging has provided considerable insight into the pathophysiology of stress incontinence, ever since the advent of bead chain cystograms and simple static and straining lateral cystograms.

MRI and real time ultrasonography, in addition to showing the events of stress incontinence on both a global pelvic and local urethral scale, have suggested a relationship between the proximal urethra to vaginal wall movement.

5.2.1 Magnetic resonance imaging

Dynamic fastscan MRI can visualise all compartments of the female pelvis during increased intraabdominal straining [356]. MRI is comparable to standard cystography in demonstrating cystocele defects [357].

Using the pubococcygeal line as a reference marker, the normal displacement of bladder base, cervix or cervical cuff, and the rectum can be identified and compared to women with prolapse. The urethra is shown in the context of global pelvic relaxation [358]. Although most MRI studies have been descriptive rather than quantitative, they still show far more soft tissue detail than earlier radiographic studies and continue to offer promising research opportunities. Recent studies have utilised an endovaginal coil to obtain higher resolution images of the urethra [359].

Dynamic MRI with cine-loop reconstruction produces vivid, intuitively appealing images which can show movement of all compartments of the relaxed pelvis during straining [358]. Static MRI shows details of urethral and peri-urethral anatomy and the striated sphincter can be clearly seen [360]. Pending further improvements in resolution, MRI remains a most promising tool for studying details of urethral movement [361].

Functional MRI has recently been evaluated to assess the efficacy of pelvic floor muscle training with EMG-biofeedback in women with stress incontinence. After a 12-week training period a more focused activation in the primary motor and somatosensory cortical representation sites of the lower urogenital tract was found [362].

Madill et al. have recently proposed another clinically promising application of MRI. They hypothesized that

the Pelvic Floor Muscle (PFM) rehabilitation program would also exercise the striated urethral sphincter and that this would be demonstrated by hypertrophy of the sphincter on MRI [363]. Their results appears to demonstrate that MRI is able to show that PFM training for SUI also trains the striated urethral sphincter and that improvement in incontinence signs and symptoms is associated with sphincter hypertrophy in older women with SUI. These findings support previous ultrasound (US) data showing an increase in urethral cross-sectional area following PFM training and extend the previous findings by more specifically assessing the area of hypertrophy and by demonstrating that older women present the same changes as younger women when assessed using MRI data. Similar data on the role of hypertrophy of the urethral sphincters after an effective PFM training, and therefore in the pathophysiology of SUI, were observed also by McLean et al, using a two- and three-dimensional ultrasound imaging of the pelvic structures [364].

Very recently, Macura et al., combining in women with SUI, the urodynamic findings with eight different MRI parameters, stated that MRI might play an important role in assessing the contribution of hypermobility and sphincter dysfunction to the SUI in women when considering treatment options. However the authors included a small study population [365].

Ultrasonography is simpler and less expensive in comparison with MRI, and, for now, provides better visualisation of moving structures.

5.2.2 Real time ultrasonography

Several sonographic approaches have been used for the study of stress incontinence: suprapubic, translabial, transvaginal and transperineal.

As resolution of sonographic probes has improved, the detail previously best seen with the transrectal approach may now be seen by a transperineal approach. Earlier studies with a transrectal approach have shown that funnelling of the proximal urethra was the sonographic sign most-frequently associated with loss of urine [366].

In about half the patients with stress incontinence in the study of Schaer et al. [367], funnelling was seen only with straining. In the other half, some degree of funnelling was already present at rest, increasing with straining and present with actual leakage. Enhanced views of the urethra are possible with sonographic contrast material.

Most recently, 3-D reconstruction from translabial views of the urethra has been used to compare findings in normal volunteers and those with ISD [368].

The most recent sonographic study of women with SUI found funnelling at rest in 109 of 330 patients, and found that the degree of vaginal relaxation as well as the parameters of intrinsic urethral function, including VLPP and urethral closure pressures, were worse

in patients with funnelling than without. The authors of this study concluded that: "In primary genuine stress incontinence, bladder neck funnelling on ultrasound cystourethrography implies the potential coexistence of poor anatomic support and an intrinsic sphincter defect [369]." Ghoniem et al. [370] also found that urethral funnelling was more likely to be associated with low closure pressures, low VLPPs, and a higher incidence of ISD in patients with SUI. However, recently, Tunn et al. [371] could not find an association between the ultrasound findings of urethral funnelling with stress incontinence using an intra-areolar approach, demonstrating it only in 59% of the patients with SUI.

Ultrasound has been used to identify paravaginal defects prior to Burch colposuspension to guide surgical modification, and then repeated after surgery to show correction of the defects [372].

Urethral movement and funnelling seen by ultrasound resemble the rotational descent previously described by Nichols and Randall [373]. It is also consistent with the previously cited descriptions of Jeffcoate and Roberts, and that of Hodgkinson. Improved soft tissue detail seen with ultrasound has permitted an extension of these original observations. The anterior and posterior walls of the proximal urethra appear to move differently during increases in intra-abdominal pressure. At first, they appear to move together: the urethra begins its descent as a single unit. At some point, however, the anterior urethra becomes arrested in its rotational movement and appears to move more slowly. The posterior portion of the urethra continues to descend along with the vaginal wall [366, 374].

This difference in movement suggests a shearing apart of the two walls, leading to the appearance of funnelling, which can be seen as urine leaks out of the urethra.

On Valsalva, the proximal urethra rotates in a postero-inferior direction approximating to the symphysis pubis. This movement can be measured by comparing the angle of inclination between the proximal urethra and any other fixed axis. No normal values of bladder neck descent have been defined but cutoffs of 20, 25 and 30 mm have been reported to classify urethral hypermobility [375, 376]. The anatomical and functional integrity of PFM have been suggested as having an important role in the urethral support system and, therefore, in the continence mechanism. It has been shown that women with UI, compared to continent subjects, have less effective PFM in terms of: strength, reduced endurance, reduced thickness, coordination of PFM and lower abdominal muscles, and altered electromyographic activity [377-379]. This does not, however, appear to be due to visible damage to the levator ani muscle because direct comparison of women with stress incontinence to those who were stress continent do not show a difference in visible levator damage [325]. With transperineal ultrasound it is possible to evaluate the urethral

displacement towards the pubic bone caused by PFM contractions [380]. This mechanism is involved in maintaining urinary continence by determining good efficacy in intraurethral pressure transmission [381].

Anatomic correlation suggests that what clinicians have called pubourethral ligaments, that in standardized anatomical terms are called the arcus tendineus fascia pelvis, may restrict the movement of the anterior urethral wall, facilitating downward traction by the prolapsing vagina during stress, contributing to the shear. At the level of the pubis, a body of connective tissue (the posterior portion of the pubourethral ligament) travels beneath the pubis to form an anterior portion, which supports the clitoris in women, and the corpora cavernosa in men. Both Milley and Nichols [382], and Zacharin [383, 384] and Mostwin [385] have previously suggested that the posterior pubourethral ligaments might support the urethra, and their laxity might contribute to the descent of the urethra in stress incontinence. These studies, however, suggest a different interpretation. Longitudinal and cross-sectional views of the proximal urethra show that the ligaments travel along only the anterior portion of the urethra as they pass beneath the pubis to emerge as the anterior pubourethral ligaments. The vagina and its bilateral attachments forming the lateral sulcus support the posterior part of the urethra. It is more likely that the vaginal wall and its attachments become weaker than the strong condensations of endopelvic fascia forming these ligaments. Therefore, the pubourethral complex, even if attenuated, probably remains stronger than the underlying vaginal wall. Sonographic examination of the prolapsing urethra therefore suggests arrest of anterior urethral wall movement by the pubourethral complex, while the vaginal wall continues to rotate, pulling the posterior wall of the urethra along with it.

These anatomical considerations, combined with current knowledge about pudendal nerve activity in normal, prolapse or stress incontinence, suggest an inter-relationship regarding urethral closure and vaginal movement. As intra-abdominal pressure increases, the proximal urethra experiences two kinds of forces, which may lead to opening. The first of these is a shearing force produced by the unequal separation of the anterior and posterior urethral walls from the pubis during straining. This is the effect of vaginal mobility on urethral closure. The second is an expulsive force, produced by the transmission of intra-abdominal forces to the bladder, which must be resisted by the urethra if opening is to be prevented.

The urethra resists this primarily by intrinsic closure of the pudendally innervated striated sphincter, aided by vaginal support.

3D ultrasound has recently introduced new insights into the image of urethral sphincters. Athanasiou et al. [386], using a transvaginal approach, reported a close correlation between the urethral sphincter volume and the degree of incontinence assessed on videocystourethrography ($r = -.65$; $P < 0.001$).

With the use of three-dimensional ultrasound Athanasios et al. [324] quantitatively evaluated the urethra and the urethral sphincter in women with stress incontinence. These authors reported that this group of women have urethral sphincters that are shorter, thinner, and smaller in volume compared to controls.

Urethral vasculature has also been postulated to play a role in the continence mechanism and different Doppler parameters have been studied to evaluate correlation with SUI and experimental studies suggest that vascular factors contribute about 1/3 of MUCP [387].

However, Tsai et al. [388] reported that urethral vasculature, and in particular the anterior branch of the middle urethral vessels is less likely to be seen after the menopause (89.1% vs. 79.2% pre- and postmenopause, $P = 0.030$). In the postmenopausal women hormone replacement therapy did not affect the appearance of the urethral vessels.

However, results are controversial since some authors [360] reported less periurethral vessels and flow in women suffering from SUI whereas others [389] could not find any difference in the appearance of the urethral vasculature in subjects with or without SUI.

It is likely that these shearing and expulsive forces are generated simultaneously as intra-abdominal pressure rises. One can easily imagine that the urethra can be brought to a continence threshold beyond which urethral closure cannot be maintained. One can further imagine that repeated episodes of prolapse may eventually stretch, tear or attenuate sphincter mass and contribute to a chronically weakened urethra manifested by low VLPP or low urethral closure pressures, characteristic of ISD. After severe or prolonged untreated prolapse and stress incontinence, vaginal support alone may not be sufficient to correct the deficiencies of an exhausted sphincter. Although theoretical rather than evidence-based, such considerations may direct future research efforts towards a more integrated hypothesis regarding stress incontinence in women. The relative contributions of abnormal vaginal mobility and intrinsic urethral function should be considered as part of a continuum rather than a dichotomy. Current research and interest has concentrated mostly on ISD as the primary cause of SUI in women, but the relationship of the many factors affecting urethral support and function should remain a perspective in interpreting emerging findings.

6. THE LAST PATHOPHYSIOLOGICAL MODELS

Reviewing all the available evidences on the pathogenesis of SUI, DeLancey proposed a new conceptual model to describe the interaction between the different possible mechanisms. Considerable progress has been made to date, yet the author concluded that

our understanding is far from complete. The urethra is a dynamic structure with variations in closure from second to second, minute-to-minute, day to day and year to year. The role of the submucosal vascular plexus is still poorly understood; also, the complex neural control mechanisms that allow for temporary and total relaxation during voiding, that somehow know when to re-establish normal muscle function are still not entirely understood. In addition, although it is clear that urethral support is not as important as previously thought, it is one of the major contributing factors for stress incontinence. Understanding what it is about urethral support that lessens continence is vital. However, the finding that maximal urethral closure pressure, and not urethral support, is the factor most strongly associated with stress incontinence implies that improving urethral function may have therapeutic promise. Racial disparities exist in incontinence, and the biological basis for these differences should help our understanding [390, 325].

7. CONCLUSIONS

We are approaching a new classification of stress incontinence which will integrate hypermobility and urethral dysfunction as inter-related elements on a spectrum of change. Certain concepts have stood the test of time, and they are included below, along with conclusions:

Sphincter insufficiency is related to a decline in striated sphincter muscle mass and function as measured by electrophysiological studies of pudendal nerve and sphincter function, and MRI and sonographic estimates of muscle mass (Level 1). If repeated episodes of vaginal traction can be shown to enhance sphincter damage, then the effect of early treatment of stress incontinence and prolapse on future development of ISD should be investigated, since advanced ISD remains difficult to treat.

Many patients with urodynamic stress incontinence show urethral mobility (Level 2), though it is not yet known what is about that mobility which permits urethral opening during stress.

Some patients who present with minimal mobility or who have recurred after successful surgery have primary or residual sphincter insufficiency.

Successful operations can restore urethral position but probably do not restore urethral function. A good surgical outcome probably requires a certain reserve of urethral function. It is in the area of functional understanding of urethral anatomy that the greatest progress is likely to be made.

V. PELVIC ORGAN PROLAPSE

1. PATHOPHYSIOLOGY OF PELVIC ORGAN PROLAPSE

Anatomical support of pelvic viscera is mainly provided by the levator ani muscle complex and connective tissue attachments of the pelvic organs: vaginal support arises from the connective tissue attachments between the vagina and the pelvic sidewall, the vaginal wall, and the levator ani muscles [391, 392].

Two mechanical principles explain how the uterus and vagina are normally held in place. First, the uterus and vagina are attached to the walls of the pelvis by the endopelvic fascia that suspends the organs from the pelvic sidewalls. Second, the levator ani muscles constrict the lumen of these organs closed, forming an occlusive layer on which the pelvic organs may rest [393].

The levator ani complex consists of the pubococcygeus, the puborectalis, and the iliococcygeus muscles [394]. These muscles are tonically contracted at rest and act to close the genital hiatus, providing a stable platform for the pelvic viscera. Decline of normal levator ani tone by denervation or direct muscle trauma, results in an open urogenital hiatus, weakening of the horizontal orientation of the levator plate, and a bowl-like configuration [395, 396].

The supportive connective tissues are a continuous, highly interdependent sheet in which all members interact to achieve support of the vagina and, therefore, of the pelvic organs. DeLancey has introduced the concept of dividing the connective tissue support of the pelvis into three levels, with level I, II and III representing apical, midvaginal and distal support respectively. The upper portion of the paracolpium (Level I) consists of a relatively long sheet of tissue that suspends the vagina by attaching it to the pelvic wall, and it is responsible for suspending the apex of the vagina after hysterectomy. In the middle third of the vagina, the paracolpium attaches the vagina laterally, to the arcus tendineus and fascia of the levator ani muscles (Level II). This attachment stretches the vagina transversely between the bladder and the rectum. The structural layer that supports the bladder (pubocervical fascia) is composed of the anterior vaginal wall and its attachment through the endopelvic fascia to the pelvic wall. Similarly, the posterior vaginal wall and endopelvic fascia (rectovaginal fascia) form the restraining layer that prevents the rectum from protruding forward. The vagina's lower third (Level III) fuses with the perineal membrane, levator ani muscles and perineal body, without any intervening paracolpium (Figure 11) [393, 397]. Damage to the upper suspensory fibres of the paracolpium causes a different type of prolapse from damage to

the mid-level supports of the vagina. Defects in the support provided by the mid-level vaginal supports (pubocervical and rectovaginal fascia) result in cystocele and rectocele, while loss of the upper suspensory fibers of the paracolpium and parametrium is responsible for the development of vaginal and uterine prolapse. These defects usually occur in varying combinations and this is responsible for the diversity of clinical problems encountered within the overall spectrum of pelvic organ prolapse [393].

For conceptual purposes the supportive connective tissue has been related with structural elements of

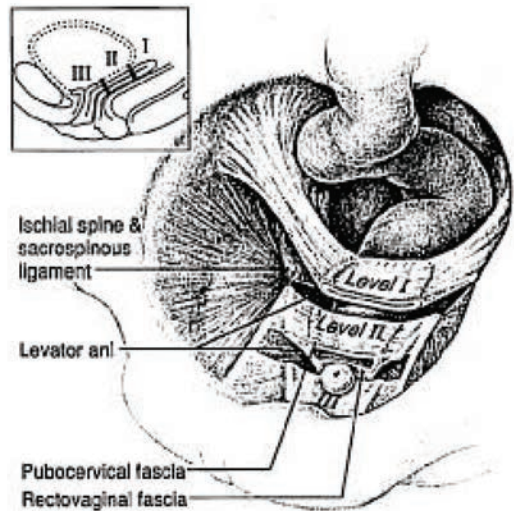

Figure 11: Level I (suspension) and level II (attachment). In level I the paracolpium suspends the vagina from the lateral pelvic walls. Fibers of level I extend both vertically and also posteriorly towards sacrum. In level II vagina is attached to arcus tendineus fasciae pelvis and superior fascia of levator ani. From DeLancey et al, Clin Obstet Gynecol, 1993 [398].

pelvic floor: the uterosacral ligaments (level I); the paravaginal attachments (endopelvic fascia) that connect the lateral vaginal walls to the arcus tendineous fascia pelvis (ATFP) and the fascia of the levator ani muscles (level II); the perineal membrane and the perineal body (level III) [397]. Table 2 lists the structural elements of pelvic organ support, their possible damage and subsequent site of pelvic organ prolapse.

Table 2: Structural elements of pelvic organ support, their possible damage and subsequent site of pelvic organ prolapse. The levels of support and anatomical defects are derived from the anatomical studies of DeLancey [393, 397].

	Structure	Failure/Defects	Anatomical results
Level 1	Uterosacral ligaments	- Disruption - Overdistension - Elongation	- Uterine prolapse - Vault prolapse
Level 2	- Anterior endopelvic fascia (pubocervical fascia) - Posterior endopelvic fascia (rectovaginal fascia)	- Central impairment of fascia - Lateral detachment of fascia from ATPF - Impairment of fascia	- Midline cystocele - Paravaginal defect-cystocele - Rectocele
Level 3	Perineum	- Disruption from endopelvic fascia - Disruption of bulbocavernosus muscles	- Excessive perineal descent - Rectocele

Table 3: Determinants of normal pelvic organ support. Possible sites of failure and possible causes, established and theoretical risk factors. LE = LEVEL OF EVIDENCE

Normal support	Failure	Possible cause/risk factors
Normal connective tissue including normal tone (smooth muscle cells)	<ul style="list-style-type: none"> • Reduced tone • Pathological type and cross linking (LOE 2) • Disruption (LOE 2) 	<ul style="list-style-type: none"> • Genetic (LOE 2) • Pregnancy (connective tissue remodelling) (LOE 3) • Vaginal birth (mechanical) (LOE2) • Chronic pelvic floor stress (straining, constipation, asthma) • Obesity
Normal attachment of connective tissue and pelvic floor musculature	<ul style="list-style-type: none"> • Disruption, detachment (LOE2) 	<ul style="list-style-type: none"> • Vaginal birth (LOE 1) • Hysterectomy, pelvic operations (LOE3) • Chronic pelvic floor stress (LOE3) • Pelvic trauma (accidents, falls) (LOE3)
Normal tone of the pelvic floor muscle	<ul style="list-style-type: none"> • Hypotonic pelvic floor muscle (LOE4) 	<ul style="list-style-type: none"> • Pregnancy, childbirth (ischemic, mechanical, hormonal) (LOE2) • Reduced connective tissue tone • Chronic pelvic floor stress
Normal, nearly horizontal, axis of the vagina	<ul style="list-style-type: none"> • Vertical course of the vagina (LOE3) 	<ul style="list-style-type: none"> • Hysterectomy, pelvic operations including Burch colposuspension (LOE3) • Chronic pelvic floor stress • Vaginal birth (LOE2)
Normal innervations and pre-programming of abdominal capsule and pelvic floor muscle	<ul style="list-style-type: none"> • Denervation/re-innervation (LOE1) • Loss of pre-programming (LOE4) 	<ul style="list-style-type: none"> • Vaginal birth (LOE1) • Pelvic trauma/pain • Delayed or lack of pelvic floor contraction during increased abdominal pressure (LOE3)

The integrity of muscular, connective and nerve structures is essential to guarantee a normal pelvic organ support. If one of these factors fails, the other might be able to compensate to a certain degree.

In an American gynaecology clinic population (18-83 years), approximately 3-6% of women had pelvic organ prolapse descending beyond the vaginal opening on routine pelvic examination [399]; an estimated 11% of women will undergo surgery for pelvic organ descent and urinary incontinence sometime in their lifespan [400].

The aetiology of pelvic organ prolapse (POP) is thought to be multifactorial with contributions from both environmental and genetic risk factors. Environmental factors that contribute to POP include vaginal delivery, chronic increases in intra-abdominal pressure, obesity, advanced age and oestrogen deficiency [401, 402]. Evidence for a genetic contribution to pelvic organ prolapse has been found in family-based studies, candidate gene association studies, expression studies and linkage studies [403].

Table 3 lists anatomical and functional determinants of normal pelvic organ support. It also summarises the possible nature of failure and its potential causes as well as the established and theoretical risk factors.

Vaginal delivery has been considered the main causal factor in the development of pelvic organ prolapse for some years [161, 400, 404-407]. However, if it is true that all women undergo pelvic floor stretching during vaginal delivery, not all of them develop a further prolapse; moreover, pelvic floor dysfunctions have also been described in women who gave birth by caesarean section only [161, 402] and in nulliparous women [408]. Therefore, vaginal delivery does not totally explain the origin and progression of pelvic floor descent in all women. This supports the hypothesis that other causes, besides obstetrics, are involved in the aetiology of pelvic organ prolapse: connective tissue deficiencies, genetic predisposition, sexual hormones, pregnancy, ageing, menopause, obesity, neuropathies, ethnicity and family history.

Miedel et al [409] showed that age and parity are the dominating risk factors for symptomatic pelvic organ prolapse, but significant independent associations with markers suggestive of congenital susceptibility (family history and conditions signaling weak connective tissue) and nonobstetric strain on the pelvic floor (overweight/obesity, heavy lifting, and constipation) imply that individual predisposition and lifestyle/environment also may play an important role. (LEVEL OF EVIDENCE: II)

In the last decade, attention has increasingly focused on understanding of the molecular basis of POP and the recognition of the potential molecular markers and their modulators in pelvic floor supportive tissues in order to identify the women predisposed to develop POP.

1.1. Inheritance, Genetic and Ethnic Predisposition

Several studies have recently focused their attention on the inheritable predisposition for pelvic organ prolapse.

In the large case-control study carried out by Chiapparino et al. [410], a higher risk of prolapse was reported in women whose mother (OR: 3.2; 95% CI: 1.1-7.6) or sister (OR: 2.4; 95% CI: 1.0-5.6) were affected by the same condition; their data support that first-degree family history of prolapse is a risk factor for POP.

Jack et al. [411] demonstrated that the risk of POP among siblings of young women (average age: 37 years) with stage III and IV POP was five times higher than in the general population. Genetic analysis of the inheritance pattern within these families showed that pelvic organ prolapse segregated in a dominant fashion with incomplete penetrance.

Positive family history has been recently identified as independent risk factor (OR 8.016) for prolapse [412].

The findings of high concordance in the POP stage between nulliparous women and their parous sisters strongly support the hypothesis of a familial basis for POP. Buchsbaum et al. [413] investigated the role of familial factors in the development of pelvic organ prolapse by comparing the prevalence of this condition in nulliparous postmenopausal women and their parous sisters. By compartment, there was a 74.3% to 91.1% concordance in prolapse stage within sister pairs. In discordant sister pairs, the parous sister was found to have the more advanced prolapse 88% of the time. Based on these results, the authors conclude that a high concordance of pelvic organ prolapse in nulliparous and parous sister pairs suggests a familial predisposition toward developing this condition. However, vaginal delivery appeared to confer a risk for more advanced pelvic organ prolapse. LEVEL OF EVIDENCE: II-2.

Some studies have drawn attention to the incidence of pelvic organ prolapse amongst identical twins.

In the large Swedish twin registry of 3,376 monozygotic and 5,067 dizygotic female twin pairs, a greater twin similarity among the monozygotic twins was found, indicating the influence of a genetic component to the aetiology of pelvic organ prolapse. Genetic and non-shared environmental factors seemed to contribute equally to the development of pelvic floor disorders in these women, about 40% for each factor [414].

Buchsbaum et al. [415] even reported that vaginal delivery was not associated with clinically relevant differences in relaxation of the pelvic support system within four sets of postmenopausal identical twins with different parity status.

Genetic variants that run in families with an increased incidence of pelvic organ prolapse have been documented.

A recent trial provides strong scientific evidence for a genetic contribution to pelvic organ prolapse: using a genome-wide association study, Allen-Brady et al. [416], demonstrated that 6 single-nucleotide polymorphisms (SNPs) are significantly associated with POP in high-risk familial case group participants. LEVEL OF EVIDENCE: II. Their results showed that two of the six SNPs are located within the genes ZFAT and COL18A1, both with Mendelian inheritance in man. The ZFAT has been found to play a transcriptional regulator role for immune regulation and apoptosis and, hence, may affect development of the muscle and connective tissue of the pelvic floor. The COL18A1 gene (precursor of the collagen XVIII) may play a role in the structural organization of basement membranes. The other four SNPs identified are intergenic, but one of them is close to the ANTXR2 gene, which binds intravenously to collagen and laminin, suggesting that it may be involved in extracellular matrix adhesion. The authors identified at least three strong candidate genes for POP that warrant follow-up.

A recent genomewide linkage analysis to identify pelvic organ prolapse predisposition genes using a resource of high-risk POP pedigrees, provided evidence that loci on the chromosomes 10q and 17q may contribute to POP aetiology [417].

Further data suggest a role of genetic influence in early onset of POP. In a family in which three generations of female relatives suffered from prolapse at a very young age, a polymorphism in the promoter of *LAMC1* gene has been found that seems to increase the susceptibility to early onset pelvic organ prolapse, as an autosomal dominant transmission [418].

A metaanalysis of genetic association studies provided moderate epidemiological credibility for association of variation of *COL1A1* gene with prolapse [419]. However the authors suggested that clinical testing for these polymorphisms cannot be recommended based on current evidence.

One study examined gene expression of structural proteins that are related to actin and myosin in five women with, and five women without, pelvic organ prolapse in the pubococcygeal muscle. Several genetic differences between subjects and controls with gene under- and overexpression were found [420].

In mice, *HOXA11* has been identified as an essential gene for the development of the uterosacral ligaments [421]. In *HOXA11*-null mice, the uterosacral ligaments were absent. Women with POP might have weakened connective tissue due to changes in a signalling pathway involving *HOXA11* [421].

Increasing evidence supports a genetic aetiology of POP, also with respect to abnormal extracellular matrix remodelling [422]. A genetic predisposition to POP specific to elastin metabolism was noted in the

rodent model, in which genetic mutation of the *LOXL1* or the fibulin-5 gene in mice are involved in the altered elastic fibre assembly and then in the pathogenesis of the pelvic prolapse [423]. Altered gene expression of elastin has also been described in women with POP [424].

The study carried out by Wang et al [425] supported the view that the polymorphism of the matrix metalloproteinase-10 (*MMP-10*) gene may be associated with an increased risk of POP.

A genetic screening may be a future tool for identifying the woman at risk for POP and for refining the counseling of women deemed to be at elevated risk; the following consequences will be the prevention of this condition and a targeted treatment. The primary prevention tool could be the adaptation of the delivery mode in at-risk groups. These patients could also benefit from changing the management treatment, such as whether surgery should be considered early or late in the woman's lifespan.

Race is another demographic factor that seems to be associated with the development of POP. Some studies reported that Hispanic and European women appear to be at higher risk for POP than those of African, Asian or other descent [399, 402, 406, 426, 427]. This is also supported by evidence suggesting that women of Asian descent have reduced inherent pelvic organ mobility. In a cadaveric study, Zacharin [428] reported that Chinese women have stronger and thicker pubourethral ligaments, endopelvic fascia and endopelvic attachment to the obturator fascia compared to Caucasian women. More recently, Dietz et al. [427] confirmed these results using pelvic floor ultrasound, showing that Asian women have significantly less pelvic organ mobility than Caucasian women both antepartum and postpartum.

In cohort analysis of 27,342 women, Hendrix et al. [406], confirmed previously reported differences between white and African-American women. Hispanic women had the highest rate of uterine prolapse (OR: 1.24, 95% CI: 1.01-1.54) and an increased risk for cystocele (OR: 1.20, 95% CI: 1.05-1.36) but not rectocele (OR: 0.95, 95% CI: 0.82-1.11).

The reasons for these ethnic differences are unclear; however, some evidence indicates that African-American women have smaller pelvic outlets than those of European descent [429].

Other connective tissue deficiencies such as hernias may share common pathophysiological mechanisms with POP. In a group of 60 women with advanced prolapse, the total prevalence of hiatal and inguinal hernias was significantly higher than in a control group of 60 women with mild or no prolapse (31.6% vs. 5%, $p < 0.001$) [430].

A population-based, cross-sectional study of 5,489 Stockholm women found an OR of 1.8 for a positive association with symptomatic prolapse in women with

a history of conditions suggestive of deficient connective tissue (varicose veins/hernia/haemorrhoids) [409].

McLennan et al. [431] demonstrated that the risk of prolapse was 1.4 (95% CI 1.2-1.8) times higher in women with a family history of prolapse and/or hernia, after adjusting for vaginal deliveries, hysterectomy and incontinence. The authors confirm that heredity is a risk factor for prolapse and suggest that history taking should include both male and female family members.

Taken together, this evidence suggests that exists a familial or genetic basis for POP in some women, and that heritable or genetic factor plays a role in its development.

1.2. Alteration of Collagen, Elastin and Smooth Muscle of Vaginal and Supportive Tissue

It has been demonstrated that young women with POP are more likely to have connective or neurological tissue diseases and congenital abnormalities [432].

Women with Marfan or Ehlers-Danlos syndrome have high rates of POP. Intrinsic joint hypermobility is another well recognised connective tissue disease that is associated with pelvic descent [433-436]. This finding supports the hypothesised aetiological role of connective tissue disorders as a factor in the pathogenesis of this conditions [437].

The vaginal wall is comprised of four layers: a superficial layer of non-keratinised stratified squamous epithelium; a subepithelial dense connective tissue layer composed primarily of collagen and elastin; a layer of smooth muscle referred to as the muscularis; and a layer of adventitia, composed of loose connective tissue. The subepithelium and muscularis together are thought to confer the greatest tensile strength to the vaginal wall. In the normally supported vagina, the supportive connective tissues pull the vagina up and back away from the vaginal introitus over the levator ani muscles. A normally supported vagina, in turn, provides support to the bladder, urethra, uterus and rectum. Disruptions of - or damage to - these connective tissue structures and injury to the vaginal wall are thought to be two important mechanisms causing prolapse.

The connective tissue of the vagina and supportive tissues contains a fibrillar component (collagen and elastin) and a non-fibrillar component (non-collagenous glycoproteins, hyaluronan, and proteoglycans). In addition, and with the exception of the arcus tendineus, these tissues contain a significant amount of smooth muscle. The fibrillar component is thought to contribute the most to the biomechanical behaviour of these tissues. The quantity and quality of collagen and elastin are maintained through a precise balance between synthesis, post-translational modification, and degradation.

Therefore, the integrity of the vagina and its supportive connective tissues are essential for keeping the pelvic organs in their normal anatomic position. Evaluation of these tissues from a biochemical perspective enables us to better discern the complex interplay between structural composition and supportive capacity.

Collagen types I, III and V are the main structural components of vaginal epithelium and endopelvic fascia and they are thought to be the principal determinants of tissue strength. Type I collagen confers strength to tissues while type III contributes to elasticity. Type III collagen is the primary collagen subtype in the vagina and its supportive structures. The ratio of collagen I to III is an indicator of tensile strength: the higher the amount of collagen type III, the lower is the mechanical strength. To our knowledge the role of type V collagen, which is found in small quantities in the vagina, is still unknown.

The turnover of connective tissues throughout the body is maintained by a family of highly conserved, zinc-dependent endopeptidases referred to as matrix metalloproteinases (MMPs). The MMPs are involved in both normal physiological and pathological proteolytic processes, which are an integral part of tissue remodeling in both women with and without prolapse. An excessive tendency toward connective tissue degradation may underlie the predisposition of some women to prolapse.

Interstitial collagens (types I, II and III) are cleaved by MMP-1, 8 and 13. The cleaved collagen fragments are susceptible to rapid gelatinase (MMP-2 and 9) degradation into amino acids. These gelatinases (MMP-2 and 9) also degrade elastin.

Reports of decreased total collagen in pelvic tissue from women with POP suggest that collagen degradation may contribute to POP. Collagen degradation depends on the activity of MMPs produced by connective tissue cells. MMP proteolytic activity is specifically regulated by their inhibitors, TIMPs, which bind stoichiometrically to MMPs to inhibit their activity. The balance between MMPs and TIMPs defines the collagenolysis.

In women with prolapse, MMP-2 mRNA expression is increased with a concurrent decrease in the inhibitor TIMP-2 [438]. Recent data also indicate increased MMP-1 expression and decreased collagen I in the uterosacral ligaments of women with POP [439]. In contrast, collagen I and III mRNA expression was increased in vaginal tissue from women with POP [440]. Discrepancies in the literature can be due to the different methodological issues (different tissues targeted or a different method of protein quantification) used. Mismatches between mRNA and protein data are often found when examining proteins in the extracellular matrix. Thus, gene expression should always be confirmed with protein expression. These issues contribute to significant variations in the reported data and underscore the importance of careful

research methodology. These discrepancies also suggest the possibility that different pathways in the extracellular matrix may be activated depending on injury type and severity, mechanical load and environmental factors [422].

Despite discrepancies in the precise MMP/TIMP or collagen type, the mentioned data and numerous other publications indicate that women with POP show an abnormal pelvic extracellular matrix metabolism with increased collagen remodelling.

Recent data suggested that oxidative stress (a well-recognised mechanism involved in fibre metabolic disorders) may be involved in the pathophysiology of POP by contributing to collagen metabolic disorders in a severity-dependent manner in human uterosacral ligaments fibroblasts, possibly through the regulation of metalloproteinase (MMPs), tissue inhibitor of metalloproteinase (TIMPs) and transforming growth factor (TGF)- β 1 indirectly [441]

Takano et al. [442] demonstrated that the general amount of collagen in the parametria is reduced in pre- and postmenopausal women with pelvic organ prolapse compared with women without prolapse. Moalli et al. [443] showed that collagen III is increased in vaginal subepithelium and muscularis in patients with prolapse relative to patients without prolapse, independent of age and parity. LEVEL OF EVIDENCE II-2. Increase in collagen III has been reported also in the uterosacral and cardinal ligaments of women with prolapse [444, 445]. The Moalli's group [446] demonstrated that collagen III is the primary subtype in the arcus tendineus fascia pelvis; a decrease in the ratio of collagen I/(III+V) is associated with menopause in the absence of hormone therapy and a restoration of this ratio to premenopausal levels with hormone therapy. From these data the authors suggested that sex steroid hormones may improve the biomechanical properties of the supportive tissues of the vagina.

As all studies involving the procurement of human tissue are by necessity cross-sectional, it is impossible to determine whether the increase in collagen III reflects the causes or effects of prolapse. In either case, the increased flexibility and distensibility plus the decreased tensile strength associated with an increase in collagen III very likely contribute to the progression of POP.

Elastin is primarily laid down during fetal development and rarely synthesised in adult tissues. In contrast to the other tissues in which elastin fibres do not experience a turnover in a lifespan, there is cyclical remodeling of elastin fibres in the reproductive tract. A massive degradation of elastin occurs at the time of parturition, followed by postpartum resynthesis, allowing recovery of reproductive tissues to their pre-pregnancy state [447]. Mice deficient in LOX (lysyl oxidase) fail to replenish mature elastin fibres in the reproductive tract following parturition and develop spontaneous prolapse [448]. Yamamoto et al. [424] found a marked decrease in elastin mRNA and tropoelastin protein in the cardinal ligaments of

women with pelvic organ prolapse relative to women without prolapse. Chen et al. [449] demonstrated a significant decrease in the endogenous inhibitors of elastases with increase in elastolytic activity in vaginal tissue from women with stress urinary incontinence and pelvic organ prolapse compared with control subjects. Therefore, these data suggest that the proper degradation, synthesis, and regeneration of elastic fibres are essential for maintaining pelvic organ support.

If damaged or destroyed, metabolically repaired elastin frequently results in malformed and dysfunctional repair products. Proteolytic enzymes capable of degrading elastin include the serine proteases, such as neutrophil elastase, the cysteine proteases, and MMP-2, 9 and 12. Marked decreases in elastin gene transcripts and elastin synthesis in pelvic fibroblasts were noted in women with POP [424], suggesting that altered elastin metabolism may contribute to prolapse. In rodent models with genetic disruption to LOXL1 or fibulin-5 gene, prolapse develops due to failure to synthesize and assemble functional elastic fibres [448]. Elastin content was decreased in the uterosacral ligaments of women with POP, as were LOX, and LOXL1 and LOXL2 gene expression [450].

A recent study by Moon et al. [451], evaluated the alteration of elastin metabolism in women with pelvic organ prolapse in a prospective case-control study: their results showed that expression of neutrophil elastase and matrix metalloproteinase-2 mRNA was higher in women with than in those without POP. Compared to before menopause, neutrophil elastase and matrix metalloproteinase-2 showed a significant decrease in postmenopausal women without POP, although they remained increased in postmenopausal women with POP. Alpha-1-antitrypsin was significantly lower in postmenopausal women with pelvic organ prolapse than in postmenopausal women without. The activities of neutrophil elastase, matrix metalloproteinase-2 and matrix metalloproteinase-9 were increased in women with POP, and these trends were similar to neutrophil elastase and matrix metalloproteinase-2 expression even after adjusting for age, parity and menopausal status. This study demonstrates that after menopause increased elastolytic protease has a significant role in the development of POP.

In a recent clinical trial of de Landsheere et al [452], the authors shown that biomechanical testing highlights the hyperelastic behaviour of the vaginal wall: at low strains, vaginal tissue appeared stiffer when elastin density was low, with a significant inverse relationship between low strains and the elastin/collagen ratio in the lamina propria. They suggested that elastin density deserve consideration as a relevant factor of vaginal stiffness in women with POP.

The strongly heritable connective tissue diseases, in which pelvic organ prolapse predominates as a result of an elastinopathy, highlight the importance of elastic

fibres for maintaining vaginal support. Marfan's syndrome, characterized by mutations in the fibrillin-1 gene, and cutis laxa with mutations in the elastin and fibulin-5 genes, are notable for an increased incidence of POP in affected women [453-456].

Childbirth is an important risk factor for POP, not only for the mechanical trauma that the pelvic floor is submitted to: also inflammatory pathways are activated during the complex process of tissue healing after birth trauma. During healing proteinases, growth factors such as TGF- β , cytokines and chemokines are secreted into the extracellular matrix by surrounding cells. TGF- β is one of a family of 25 kDa polypeptide growth factors that is currently viewed as the most important fibrosis promoting cytokine. It is responsible for extracellular matrix synthesis in fibroblasts, the differentiation of fibroblasts to myofibroblasts and the inhibition of matrix degradation by inhibiting MMP expression and up-regulating TIMP expression. Thus, it is important in extracellular matrix metabolism and affects tissues or organs in various ways. There is sparse but growing evidence of TGF- β modulation in pelvic connective tissue. Large quantities of TGF- β 1 are stored in readily available form in the extracellular matrix. Release and activation of stored latent TGF- β 1 by proteases can generate rapid, highly localised signals. Therefore, the modulation of TGF- β 1 activity by extracellular proteases provides faster signal transduction than alterations in gene expression. This is important for tissue remodelling during pregnancy and repair after birth trauma [422].

1.3. Neurological Factors

Integrity of the pelvic innervation is essential to the normal pelvic functions. The changes in neurophysiological parameters seen after childbirth were interpreted to reflect neuromuscular injury caused by forces exerted on the sacral plexus, pudendal nerves, and pelvic floor muscles.

Abnormal tests have also been found in women with prolapse or stress incontinence. Histologically, there were smaller and fewer nerve bundles in women with posterior vaginal wall prolapse compared with women without prolapse [457]. It has been demonstrated that the density of peptide-containing nerves in the periurethral tissue and in the levator ani muscle in women with prolapse is reduced [458, 459].

Between 1985 and 1987, Allen et al. [232] found that 80% of primigravidae developed evidence of partial denervation of the pelvic floor following delivery. However, evidence of reinnervation and increased fibre density 2 months after vaginal delivery has been detected [232, 460]. Snooks et al. investigated 14 multiparous women from their previous studies [231, 460] 5 years after first vaginal delivery and demonstrated that pelvic floor striated sphincter musculature denervation progressed, indicating that age is a contributory factor [233]. Similarly, progressive denervation with time up to 15 years postpartum was found in

another prospective study, corroborating the ageing factor [461].

The pudendal nerve innervates the voluntary urethral and anal sphincters, but it does not innervate the levator ani muscles, which receive their own nerve supply from the sacral plexus. Therefore, there is currently no clear evidence whether the neurological damage is responsible, together with the mechanical damage of stretching, of the visible levator defects.

Information from electrodiagnostic studies has demonstrated that birth causes changes in mean motor unit duration after vaginal birth and changes in pudendal nerve conduction patterns [232, 233, 462-464]. Prolongation of the pudendal nerve terminal motor latency (PNTML) is thought to be a result of pudendal nerve damage during vaginal delivery. Significantly prolonged mean PNTML's have been found in women two to three days after vaginal delivery, compared to a multiparous [231] and a nulliparous control group [389]. At follow-up five years later, prolongation of PNTML persisted [233]. Two prospective analyses demonstrated a prolongation of PNTML antenatally to six to eight weeks after vaginal delivery, particularly after the first delivery [465, 466]. But, again, many of these changes seem to be temporary, as two-thirds of the women with an abnormally prolonged PNTML after delivery had normal measurement six months later [465].

There has been recent electrophysiological work to add to the literature, probably due to the technical difficulty of the nerve function tests in clinical practice.

Although it has not been proved in studies, it is reasonable to assume that periods of pain and discomfort after childbirth (e.g., due to perineal tears and episiotomy) and especially the pain related to attempted PFM contraction, could lead to a temporary nonactivation of the PFM. This could be the origin of disturbances in behavioural patterns, which would need to be readjusted. In combination with a particularly vulnerable pelvic floor neural control, whose complexity only evolved phylogenetically after the attainment of the upright stance, such a temporary disturbance of neural control after childbirth may persist, although the lesion(s) would have fully recovered.

Therefore, the effects of vaginal delivery on pelvic floor nerves are still controversial to date. While it seems logical that vaginal delivery causes some neuromuscular injury and this would be at risk for development of pelvic organ dysfunctions, many details are far from being resolved.

1.4. Pregnancy and Pelvic Floor Muscle Remodeling

Several of the changes occurring prior to delivery are in all likelihood normal physiological changes and may be secondary to hormone-induced collagen alterations. Hormonal alterations are essential to prepare the body and to adjust the musculature and connective tissue for vaginal birth.

The high progesterone levels during pregnancy influence the pelvic floor structures: progesterone has smooth muscle-relaxing and oestrogen-antagonising effects, reducing the tonus in ureters, bladder and urethra [467].

Relaxin, increases markedly during pregnancy and it modifies the connective tissue: its collagenolytic effect, that allows appropriate stretching during vaginal birth, has been demonstrated in guinea pigs [468]. As a likely result of connective tissue remodelling in preparation for birth, Landon and colleagues found that the connective tissue of the rectus sheath fascia and the obturator fascia could be stretched to greater length during pregnancy, but it is also much weaker. In some women, these changes may be irreversible and further stretching beyond physiological limits may result in permanent dysfunction [469].

Recently, several researchers have focused on the effect of pregnancy on the pelvic floor and on the development of prolapse.

Rahn et al. [470] identified pregnancy-induced changes in biomechanical properties of the vaginal wall and compare these with fibulin-5 knockout mice (*Fbln5*^{-/-}) with and without prolapse. Compared with nonpregnant mice, vaginas of pregnant and *Fbln5*^{-/-} (with prolapse) mice exhibited decreased maximal stress, increased distensibility and strain, plus decreased stiffness. Tissues from *Fbln5*^{-/-} mice without prolapse were similar to non-pregnant wild-type animals. The authors conclude that pregnancy confers remarkable changes in the vaginal wall that include increased distensibility, decreased stiffness and maximal stress. Elastinopathy alone is insufficient to cause significant changes in these properties, but prolapse confers additional alterations in distensibility and stiffness that are similar to those changes that have been observed in pregnancy. These changes may contribute to the poor durability of many restorative surgical procedures for prolapse.

The effect of pregnancy on the development of pelvic organ prolapse was evaluated by O'Boyle et al. [471]: in a series of 135 nulliparous pregnant women, POPQ stage appears to increase during pregnancy and does not change significantly following delivery. POPQ stage assignments and POPQ component measurements were compared for first-, second- and third-trimester examinations. Overall, POPQ stage was significantly higher in the third trimester than in the first. These findings probably represent normal physiologic changes of the pelvic floor during pregnancy, but suggest that significant changes may be objectively demonstrated prior to delivery. In nulliparous women, pregnancy is associated with increased POPQ stage compared with non-pregnant control subjects [472].

Sze et al. reported that 46% of 94 nulliparous women had pelvic organ prolapse at their 36-week antepartum visit. Of them, 26% had a stage II prolapse [473].

A recent prospective cohort study assessing 300 nulliparous pregnant women [474], showed that vaginal POP-Q points made a cranial shift from mid to late pregnancy, a caudal shift following delivery, and again a cranial shift after 6 weeks postpartum. Postpartum change was present following both vaginal and caesarean deliveries, but was more pronounced following vaginal delivery. The perineal body and genital hiatus became longer from mid to late pregnancy, and shortened after 6 weeks postpartum. At 12 months postpartum all POP-Q points, except cervix, had recovered to baseline in the vaginal delivery group. The authors concluded that short-term ability to recover was good after the first pregnancy and delivery.

In a recent review, Gachon et al [475] conclude that pelvic organ mobility, ligamentous laxity, levator hiatus and urethral mobility change in a similar way during pregnancy (increase of mobility or distension) and postpartum (recovery). LEVEL OF EVIDENCE:3

1.5. Childbirth

Undoubtedly, vaginal delivery constitutes a traumatic event for the pelvic floor: it may affect the pelvic nerves, the pubococcygeus-puborectalis muscle complex, the pelvic fascial structures or the anal sphincter. However, all women sustain the trauma of their pelvic floor during vaginal birth, but only some of them experience injury.

Several attempts have been made to define fascial trauma after vaginal delivery. In the anterior compartment, childbirth may result in disruption of the 'endopelvic fascia', in particular of the paraurethral and paravaginal structures. Analogous to increased bladder descent after childbirth, there is a highly significant increase in caudal displacement of the rectal ampulla after childbirth [476]. The rectovaginal septum and the Denonviller's fascia are the connective structures involved in the posterior compartment damage that appears as a rectocele. It has recently been shown that vaginal childbirth also results in an increased prevalence of true rectocele, i.e. presumptive defects of the rectovaginal septum [477]. Such defects are strongly associated with symptoms of pelvic organ prolapse and obstructed defecation [478].

Specific features of injury during vaginal birth influence whether a woman develops prolapse later in life. Several factors, that can be grouped together as descriptors of difficult vaginal delivery, are associated with increased occurrence of prolapse: forceps delivery, a prolonged second stage of labour, and large infant birth weight. Unfortunately, because of the overlapping nature of these different factors, it is difficult to determine which of them is causal and which of them is associated (e.g., forceps delivery is used when there has been a prolonged second stage of labour, and both of these factors increase in large-sized infants).

A recent mechanical model study has shown that even an apparently uneventful vaginal delivery inflicts

injuries to the pelvic floor muscles, particularly during the extension of the fetal head, having been obtained more than 10% of damaged fibres; the puborectalis component of the levator ani muscle (LAM) is the most prone to damage [479]

The role of childbirth in causing damage to the LAM, which is associated with both vaginal delivery and with pelvic organ prolapse, is probably the mediating mechanism in these injuries. Recent investigations using techniques such as magnetic resonance imaging (MRI) and three-four dimensional ultrasound have focused on the morphology of the levator ani complex and its integrity after delivery.

The occurrence of levator trauma after vaginal delivery is reported to be between 15-39.5% when investigated with ultrasound [205-211, 480] (Figure 12) and between 17.7%-19.1% when assessed with MRI [213-215]. This difference in occurrence rate is probably due to the different postpartum assessment of levator ani muscle (which varies in these studies between 24-72 hours to 12 months postpartum). In fact, it has been demonstrated by Staer-Jensen et al [481] that the levator ani muscle has the ability to recover after pregnancy and delivery and most of the recovery occurs during the first 6 months postpartum (LEVEL OF EVIDENCE: II). These results are consistent with other research evaluating levator morphology using either MRI or ultrasonography: 26 primiparous women demonstrated major levator ani defects at 6 weeks, but at 12 months postpartum, 10 of these 26 women no longer had a major defect (6 were categorized as partial defects and 4 as normal). Others similarly have found that avulsion injuries of the levator ani after childbirth resolve in 10-20% of women [214, 482, 483]. On the other hand, recent results from Valsky et al [484] showed that a sonographic finding of LAM defect identified in the period immediately postpartum persists months or year after delivery; therefore this test may be performed following the delivery, or may be delayed without impact the result. Also the DeLancey group demonstrated that the magnitude of LAM tear did not substantially change by 8 months postpartum, but LAM oedema and bone injuries showed total or near total resolution [485].

The following risk factors for levator trauma after vaginal delivery have been described in literature: obstetric anal sphincter injuries (OR: 4.4-8.1); prolonged active second stage of labour per hour (OR: 2.2); forceps delivery (OR: 14.7); fetal head circumference (OR: 3.3); episiotomy (OR: 3.1); increased maternal age [205, 207, 215, 216, 244, 480, 483, 486].

Memon et al [487] showed that ten years after delivery, the prevalence of levator avulsion is almost tripled after forceps compared with vacuum-assisted vaginal delivery (LEVEL OF EVIDENCE II).

An observational study done in women 2-4 weeks before and 2-6 months after vaginal childbirth provided a direct proof for the hypothesis that childbirth

is responsible for certain morphological abnormalities of LAM observed in parous women and suggests that older age at first delivery is a risk factor for such trauma. LEVEL OF EVIDENCE II-3 [209].

Vaginal sidewall and third-fourth-degree perineal tears were found to be independent clinical indicators of an increased risk of levator trauma. Such clinical markers may become useful in the identification of women at high risk of levator trauma and future pelvic floor disorders [488].

A recent study carried out by Kamisan Atan et al [489] investigated if the antepartum use of a birth trainer (Epi-No®) may prevent such injuries by altering the biomechanical properties of the pelvic floor. 504 women were assessed with 4D translabial ultrasound in the late third trimester, and again 3-6 months postpartum, after randomisation to control or intervention (use the Epi-No® device from 37 weeks of gestation until delivery) groups. The results of this trial showed no significant difference in the incidence of levator avulsion, irreversible hiatal overdistension, clinical anal sphincter trauma and perineal tears. A marginally higher rate of significant defects of the external anal sphincter on ultrasound was observed in the intervention group. The authors concluded that the antenatal use of Epi-No® device is unlikely to be clinically beneficial in the prevention of intrapartum levator ani damage, or anal sphincter and perineal trauma.

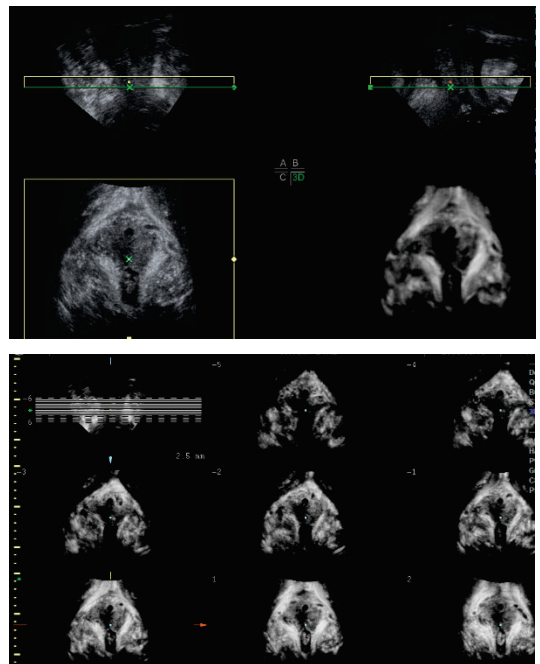

Figure 12: Levator ani defect early postpartum in a patient had spontaneous vaginal delivery (acquisition screen GE Voluson-e ® System).

From Albrich et al, BJOG 2011 [210] with permission.

*In the multiplanar mode, the axial plane (lower left) and the rendered image (lower right) show an unilateral levator discontinuity (**) on the right side of pubococcygeal-puborectalis muscle.*

*Eight slices obtained with TUI in coronal-C plane in the same patients: the discontinuity (arrow) is demonstrated in at least three consecutive slices at and above the plane of minimal hiatal dimension (frames *, -1, -2, -3).*

To estimate the risk of prolapse associated with levator avulsion injury among a urogynaecological clinic population, Dietz et al. [219] retrospectively considered 781 women, with a mean age 53 years (range 15-89 years), and a median parity of 2 (range 0-12). Significant prolapse (stage II or higher) was diagnosed in 415 (53%) women, and 181 (23%) women were found to have levator avulsion defects. Prolapse was seen in 150/181 (83%) women with avulsion and in 265/600 (44%) women without avulsion, giving a RR of 1.9 (95% CI: 1.7-2.1). The association was strongest for cystocele (RR 2.3, 95% CI: 2.0-2.7) and uterine prolapse (RR 4.0, 95% CI: 2.5-6.5). The authors concluded that women with levator avulsion defects were about twice as likely to show pelvic organ prolapse of stage II or higher than those without, with an increased risk of cystocele and uterine prolapse.

A cystocele with an intact retrovesical angle is more likely to be associated with avulsion injury of the LAM and thus more likely to be caused by birth-related trauma [490].

Puborectalis avulsion injury and levator hiatal ballooning are independent risk factors for symptoms and sign of prolapse. The role of avulsion in the pathogenesis of prolapse is not fully explained by its effect on hiatal dimensions. It likely that avulsion implies not only muscular trauma but also damage to structures impossible to assess clinically or by imaging, i.e. myofascial and connective tissue [491].

Pelvic organ prolapse seems considerably lower after caesarean section [161, 429] but it has been described in a prospective study in 35% of 26 women after caesarean section during active labour compared to 32% of 41 women who had spontaneous vaginal deliveries [473]. On the other hand, one epidemiological study using validated questionnaires ruled out the influence of labour versus no-labour caesarean delivery on pelvic organ prolapse [492] (LEVEL OF EVIDENCE: II-2). Recent studies [210, 212] reported cases of early levator abnormalities after emergency caesarean section, and hypothesised a possible role of the active labour in the occurrence of lesions of the pelvic muscular floor.

A recent study of Leijonhufvud et al. [162] considered a cohort study of all women having their first and all subsequent caesarean deliveries (n = 33,167), and an age-matched sample of women having only vaginal deliveries (n = 63,229). Women who had only vaginal deliveries had an overall increased risk of prolapse surgery (HR, 9.2; 95% CI: 7.0-12.1) compared

with women who had only having caesarean deliveries. They conclude that having only vaginal deliveries was associated with a significantly increased risk of pelvic organ prolapse surgery later in life compared with only having caesarean deliveries.

There seems to be sufficient proof for the hypothesis that pelvic organ support can be impaired by vaginal childbirth. It is unclear whether this effect is due to stretching or avulsion of structures and whether the observed changes are primary (i.e. directly due to childbirth) or the medium-term or long-term consequence of levator impairment. Several mechanisms may well coexist in one individual [493].

Furthermore, it has been shown that any delivery-related changes occur against the background of marked variations in pelvic organ support in young nulliparous women [494]. As the most significant changes are observed in those with the least organ mobility antenatally [495], the effect of childbirth may be a partial equalisation of those inter-individual differences.

1.6. Obstetric and Maternal Factors

A clear link between vaginal delivery and symptoms and signs of pelvic organ prolapse in urogynaecological patients was recently demonstrated by Trutnovsky et al [496]: nulliparae showed the lowest prevalence of most measures of POP, followed by women exclusively delivered by caesarean section. Highest prevalences were consistently found in women delivered at least once by forceps, although the differences between this group and women delivered by normal vaginal delivery and/or vacuum extraction were significant in three out of eight measures only. Compared with women in the caesarean section group, the adjusted odds ratios for reporting symptoms of prolapse were 2.4 (95% CI 1.30-4.59) and 3.2 (95% CI 1.65-6.12) in the normal vaginal delivery/vacuum extraction group and forceps group, respectively.

Increasing vaginal parity was the strongest risk factor for pelvic organ prolapse in women younger than 60 years in the Oxford Family Planning Study [405]. Compared with nulliparous individuals, the relative risk of developing prolapse was 8.4 for a woman who had delivered two children and 10.9 (95% CI: 4.7-33.8) for someone with four or more children [405]. The Women's Health Initiative reported that single childbirth was associated with raised odds of uterine prolapse (OR 2.1; 95% CI: 1.7-2.7), cystocele (OR 2.2; 95% CI: 1.8-2.7), and rectocele (OR 1.9; 95% CI: 1.7-2.2) [406]. Every additional delivery up to five births increased the risk of worsening prolapse by 10-20% [406]. Similarly, the Progetto Menopausa Italia study showed that risk of pelvic organ prolapse increases with the number of vaginal births [497].

To ascertain the effect of a second delivery on pelvic floor anatomy, Horak et al [498] showed that a second pregnancy and delivery do not seem to have a major effect on bladder support and/or levator function. However, the authors documented a case of major

levator trauma after vaginal birth after caesarean section.

Caesarean section seems to protect against prolapse development whereas forceps delivery increases the risk [492, 499]. Findings of a cross-sectional study of 3050 women randomly selected from a large southern California Health Maintenance Organisation showed that women who had undergone one or more vaginal deliveries had a significantly greater risk of developing symptomatic pelvic organ prolapse than did those who had only caesarean sections (OR 3.21; 95% CI: 1.96–5.26), after adjusting for age, parity, and obesity [492]. The attributable risk of vaginal delivery for development of symptomatic prolapse, or the proportion that could have been prevented with a policy of routine elective caesarean section, was 46% in this population. LEVEL OF EVIDENCE: II-2 [492].

Other obstetric factors that have been associated with an increased risk of pelvic organ prolapse, albeit less consistently, are high infant birth weight (>4500 g), delivery of a macrosomic infant, prolonged second stage of labour, and age <25 years at first delivery [499, 500]. Somewhat more controversial is whether pregnancy itself, distinct from mode of delivery, alters the risk of pelvic organ prolapse. In a small case-control study, pregnancy was associated with worsening prolapse compared with non-pregnant controls matched for age and ethnic origin [472]. A substantial proportion of pregnant nulliparous women show progression from stage 0 or I support in the first trimester to stage I or II in the third trimester [471]. This loss of vaginal support does not seem to return to baseline in the postpartum period.

To date, the studies are controversial considering younger age (25 versus 28 years of age) [499] as well as older age (more than 30 years) [501] at first delivery as risk factors for the development of pelvic organ prolapse. Another large study did not reveal any association at all [402].

Despite the strong relation between obstetric factors and pelvic organ prolapse, most symptomatic cases arise a long time after vaginal childbirth, and most women who bear children do not have symptomatic prolapse [502].

1.7. Age

Both incidence and prevalence of pelvic organ prolapse increase with advancing age. In a cross-sectional study of 1004 women (age 18–83 years) who came for their yearly examination, the relative prevalence of this disorder rose by about 40% with every decade of life [399]. In the Women's Health Initiative, American women aged 60–69 years (OR 1.2; 95% CI: 1.0–1.3) and 70–79 years (OR 1.4; 95%CI: 1.2–1.6) had a higher risk of prolapse than did those aged 50–59 [406]. Similarly, findings of a cross-sectional study of 21449 menopausal Italian women showed an augmented risk of pelvic organ prolapse in women aged

52–55 years (OR 1.3; 95% CI:1.1–1.5) and those 56 years or older (OR 1.7; 95% CI: 1.5–2.0) compared with those younger than 51 years [497]. Surgery for prolapse is uncommon in people younger than 30 and older than 80 years; for women between these ages, incidence rises steadily [400].

1.8. Hormones

As age has been clearly shown to affect the prevalence and progression of POP, it is intuitive to believe that declining sex hormone levels observed with ageing may contribute to biochemical changes observed within tissue. However, several researchers studying hormonal status and prolapse have failed to find an association between oestrogen status and the disorder [405, 410, 429, 497].

The female lower urinary tract is a target organ for the action of the two sex steroid hormones, oestrogen and progesterone.

Steroidal hormones exert their effect on tissue through an interaction with specific intracellular receptors. Hormone receptor affinity may be at the root of the differences between women with pelvic floor diseases and normal controls. Progesterone receptors have been found to be expressed more frequently in women with POP than in women without POP [503]. Several polymorphisms are present in the progesterone receptor gene that can alter its expression. A specific genotype (PGR rs484389) was significantly associated with the risk of having POP [504]. Similarly, the oestrogen receptor β gene also contains multiple single nucleotide polymorphisms that affect its expression. A case-control study of 69 women with POP and 141 control subjects found that a specific haplotype for the oestrogen receptor β gene was associated with an increased risk of POP [505].

Studies have shown lower serum oestradiol (E2) levels in premenopausal women with SUI, with [506] and without concurrent POP [507], compared with control subjects. The impact of oestrogen on tissue may be related to its systemic or local levels, or altered sensitivity from a decreased amount of receptors noted in genitourinary tissues [506, 508].

Skala et al. [509], evaluated the expression of oestrogen receptor (ER) alpha (α) and beta (β) and progesterone receptor (PR) in vaginal and periurethral tissue in women with genital prolapse. The expression of PR and ER varied with the extent of prolapse. For patients with prolapse >stage 1 (n=32), there was a significantly greater amount of PR in periurethral tissue (p=0.007) and a significantly lower expression of ER β in vaginal tissue (p=0.008) compared to patients with a low stage prolapse (n=15). Patients with stage II and III prolapse did not differ in their receptor expression. The authors concluded that the expression of PR in periurethral and ER in vaginal tissue varied with the extent of the prolapse.

In a cross-sectional study aiming to determine whether there is a change in the number of vessels in the lamina propria of the vagina after menopause in parallel to ER- α expression on the vaginal wall, Lara et al [510] showed that postmenopausal women with genital prolapse have a smaller number of vessels and a lower ER- α expression on the vaginal wall compared to normo-oestrogenic premenopausal controls.

The current status of the literature is controversial: some results suggest a hormonal impact on pelvic floor disease, recent findings suggest that hormone deficiency following menopause is unlikely to play a major role in pelvic organ prolapse support and levator ani function [511]. The weak level of evidence emphasises the necessity for future research endeavours in this field to elucidate these complex relationships.

1.9. Obesity

Increasing body-mass index also seems to have a role in development of pelvic organ prolapse. An high BMI increases the risk for prolapse [399, 405, 499, 512, 513] and specifically for progressive rectocele [514]. Increased waist circumference was associated with more pelvic organ prolapse in some studies [429, 514]. Handa et al. [514] demonstrated this for cystoceles. Women who are overweight (body mass index 25–30 kg/m²) and obese (>30 kg/m²) are at high risk for developing pelvic organ prolapse [406, 500]. Similarly, women with a body mass index of more than 26 kg/m² are more likely (OR 3.0; 95%CI: 1.6–5.7) to undergo surgery for prolapse than are those with a lower value [499].

1.10. Constipation

Repetitive straining, such as that seen in patients with chronic constipation or workers whose jobs entail heavy lifting, has also been associated with pelvic organ prolapse. Spence-Jones et al. [515] reported that straining at stool as a young adult was more common in women with prolapse than in those without (61% vs 4%; $p < 0.001$). Individuals with stage II or greater pelvic organ prolapse had an increased risk of constipation (OR 3.9; 95% CI: 1.4–11.9) compared with women with stage 0 or 1 prolapse [516]. However, findings of larger studies have disputed this association, and several groups have shown that neither overall stage of prolapse nor stage of the posterior vaginal wall correlate with bowel function [517–519]. Additionally, women with only urinary incontinence and no prolapse seem to meet Rome II criteria for constipation with the same frequency as those with advanced pelvic organ prolapse [519].

1.11. Chronic Pelvic Floor Stress

Low socioeconomic status [520] and a labour-intensive occupation [410, 520, 521] are two demographic factors identified as risk factors for the development of POP.

Housewives, who perform more physically demanding work, seem more likely to have prolapse (OR: 3.1;

95% CI: 1.6–8.8) than do professional managerial women [410]. Similarly, people with occupations involving heavy lifting might have a higher chance of undergoing surgery for pelvic organ prolapse [521].

1.12. Previous Operations

Although hysterectomy might heighten the risk of subsequent POP, prolapse symptoms typically develop many years after this procedure [400, 405, 499, 522, 523]. In the Oxford Family Planning Study, surgery for prolapse in women who had undergone a previous hysterectomy was 29 per 1000 women-years versus 16 per 1000 women-years for the entire cohort [405]. The cumulative risk of surgery for pelvic organ prolapse rose from 1% at 3 years after hysterectomy to 5% at 15 years. Risk was highest in women who had undergone a previous hysterectomy for prolapse (158 per 1000 women-years). In a retrospective cohort study of 149,554 women aged 20 and older, the mean interval between hysterectomy and surgery for pelvic organ prolapse in those who developed the disorder was 19.3 years [400, 524]. Contrary to findings of many other studies, the prevalence of prolapse in women with a uterus in the Women's Health Initiative was slightly higher than for those who had undergone hysterectomy, suggesting that previous prolapse of pelvic organs might have been repaired at the time of the procedure in this study population [406]. The surgical technique performed during hysterectomy, including performance of prophylactic culdoplasty, can lessen the development of a subsequent prolapse [525].

1.13. The Bony Pelvis

There is evidence from several case control studies that variations in axial and pelvic skeletal structure can be associated with increased POP risks. These include increasing severity of thoracic kyphosis, a decrease in lumbar lordosis and in vertical orientation of the pelvic inlet, and an increase in the transverse diameter of the pelvic inlet [526–528]. In a case control study, Handa [529] compared 59 women with pelvic floor disorders with controls using standardised pelvimetry techniques during MRI. After controlling for age, race and parity and using a multiple logistic regression analysis, pelvic floor disorders were significantly associated with a wider transverse inlet (OR 3.4) and a shorter obstetrical conjugate (OR 0.23). The association between early age, advanced stage POP and severe disruption of pubic bone and pelvic muscle structure in women with bladder exstrophy is well recognised [530].

1.14. Associated Pelvic Floor Conditions

During a woman's lifespan, the pelvic floor is responsible for the urinary and the faecal continence as well as for sexual function. If the anatomy of the pelvic floor is altered, each one of these functions may be compromised. Pelvic organ prolapse is a common condition that often leads to lower urinary tract symptoms (LUTS) and may require surgical intervention to alleviate those symptoms. Therefore, the clinical

evaluation of women with POP symptoms also requires the assessment of urinary and faecal incontinence symptoms as well as sexual disorders. Physicians, who examine women seeking care for one condition, should enquire about the symptoms of other disorders.

The relationship between LUTS and pelvic organ descent however, is not completely understood, so far.

In a recent study, Costantini et al. [531] evaluated the correlation between LUTS and POP. They retrospectively reviewed 256 patients who presented with POP and LUTS and underwent POP surgery. Almost 50% of patients reported two or more symptoms and only 4.2% were asymptomatic for LUTS. 73.8% patients had voiding symptoms, 15% urodynamic detrusor overactivity, 5% suffered from hydronephrosis. 57.8% had SUI. The authors concluded that urologists and gynaecologists should be aware of the high frequency of the association of POP and LUTS. POP repair may restore normal anatomy but LUTS may persist after the surgery or develop "de novo."

1.14.1 Bladder function

In a large community-based questionnaire survey, 44% (104/239) of women who had prolapse symptoms (239/3799) also complained of SUI and 37% of overactive bladder [532]. SUI can be masked by POP. SUI may develop after POP surgery and clinically continent women are at risk for developing symptomatic postoperative SUI.

The role of urodynamic studies (UDS) before prolapse surgery is contentious and a hotly debated topic in urogynaecology. Previous studies in women with prolapse and women with uncomplicated SUI have focused on women without preoperative incontinence. Currently, it has not been possible to reach a universal consensus on the role of UDS before prolapse surgery in women with concomitant symptomatic or occult SUI. It is clear that UDS can add some information in women undergoing pelvic organ prolapse surgery and could facilitate counselling of patients. However, there is no evidence that the outcome of surgery is altered by prior UDS [533]. In fact, Weber et al. [534] showed that urodynamic testing before surgery in women with prolapse and stress urinary incontinence symptoms is not cost-effective relative to basic office evaluation. It is possible that UDS could help to identify some urinary dysfunctions, such as a preoperative detrusor overactivity or a occult SUI, but this information rarely leads to a change in the management plan or the type of surgical procedure. Moreover, at present, we have no data to show that UDS can improve subjective or objective outcomes of surgery for prolapse. New well-designed randomised studies are necessary to improve our understanding of this topic.

Evidence of reduced peptide-containing innervation of perineal and periurethral muscles in women with

SUI and POP has emerged [449], suggesting a neural abnormality in their pathogenesis. Connective tissue alterations such as decreased α -1 antitrypsin expression and altered elastin metabolism [449], decreased collagen concentration [535], and decreased estrogen receptors [508, 536] have been described in women with urinary incontinence and/or POP.

Failure of bladder, bladder neck, and urethral support is often part of a more extensive defective pelvic organ support. Poor pelvic organ support can lead to pathological pelvic relaxation in one or more compartment(s). Marinkovic and Stanton [537] published a review of 97 articles regarding incontinence and voiding difficulties associated with POP: they describe the incidence, pathophysiology, anatomical changes and resultant consequences, evaluation and imaging of cystocele, rectocele, enterocele, and uterine and vaginal vault prolapse in combination with urinary incontinence. The authors concluded that POP appears to have significant clinical effects on urethral and voiding function that should be quantified preoperatively to allow appropriate surgical intervention, with the aim of restoring vaginal function and correcting concurrent incontinence, whether overt or occult. Not uncommonly, POP can lead to bladder outlet obstruction, detrusor overactivity, and latent SUI that is unmasked only with reduction of the POP (potential, latent, or unmasked SUI) [538]. It is recognised that POP surgery can improve voiding dysfunction and unmask occult SUI by alleviating the urethral kinking causing outlet obstruction [539].

Burrows et al. [540] described symptoms of bladder, bowel, and sexual function in 330 women with POP, comparing different degrees of prolapse staged by POP-Q system. Women with SUI symptoms had less advanced prolapse (median 5 cm less prolapse in the apical compartment) than those without SUI. Women who needed to manually assist micturition had more advanced prolapse (median 3.5 cm more prolapse in the most severe compartment) than those who did not. Women with urgency and urgency incontinence had less advanced prolapse (median 3 cm or less) but the differences were smaller than those for SUI. Severity of prolapse was not associated with bowel or sexual symptoms in this study. The most important finding is that there are few strong associations between specific symptoms and severity of prolapse. LEVEL OF EVIDENCE: II-2.

Women without anterior prolapse on POP-Q exam rarely (<10%) report urinary splinting but ranged between 23 and 36% for stage III and IV. Urinary splinting is 97% specific for anterior prolapse. Seventy-seven percent of women with stage II POP report a symptomatic bulge, and report of a bulge has an 81% positive predictive value and a 76% negative predictive value [541]. It seems therefore that if women present with symptoms of vaginal/perineal bulge, then careful assessment for POP is warranted. If a woman with SUI, however, presents with no symptoms of

POP, then surgical treatment of asymptomatic and incidental anterior POP does not seem to be indicated.

The surgical management of women with POP and with latent SUI remains controversial and challenging. Maher et al. [542] aimed to determine the effects of surgery in the management of POP by searching the Cochrane Incontinence Group trials register (as on June 2004) for randomized or quasi-randomized controlled trials that included surgical procedures for POP. The meta-analysis on the impact of POP surgery on continence was 'limited and inconclusive', but they report that 10% of women developed new incontinence symptoms postoperatively.

Levin et al. [543] prospectively evaluated 313 women who underwent TVT procedure for overt (228 women) or occult (85 women) SUI. About 50% women also underwent POP surgery concurrently. Overall, for 241 women with a follow-up of at least 12 months, 6.6% had persistent mild SUI, an additional 7% had urodynamic evidence of asymptomatic sphincter incontinence, whereas 8% developed de-novo urgency incontinence.

Among 130 women who underwent surgical treatment for an enterocele (75% the vaginal wall protruded through the introitus), 77% presented with SUI or detrusor overactivity. Sixty-seven percent patients underwent Burch colposuspension with enterocele repair. Postoperative SUI requiring further treatment occurred in 10% after a mean period of follow up of 10 months, and cystocele developed in 1.5% [544].

Urologists and urogynecologists are faced with the challenge of determining which women with POP associated with SUI will benefit from concurrent surgical intervention for the POP. A comprehensive and anatomic approach to pelvic floor reconstruction is recommended, but no high-level evidence-based studies exist in the contemporary literature.

The intended goal of surgical correction of SUI and POP is durable restoration of normal anatomy and function, with symptomatic relief and avoidance of morbidity. At present, few evidence-based conclusions can be drawn regarding when to surgically intervene for SUI in women who present with POP. The available contemporary studies are few with a small number of patients; however, it seems prudent to recommend repairing symptomatic POP in women who present with SUI. So far, routine performance of anti-incontinence procedures at the same time as reconstruction of anterior compartment does not seem to be justified by the current evidence. In women with symptomatic SUI and incidental, asymptomatic POP, one must balance any potential treatment associated morbidity with the intended clinical/surgical outcome.

Recently, Ramanah et al [545] compared changes in urinary symptoms before and after POP surgery, using either laparoscopic sacrocolpopexy (LSC) or transvaginal porcine dermis hammock placement with sacrospinous ligament suspension (VS). Out of the 151 patients included, 87 patients underwent

LSC, and 64 VS. Overall, after a median follow-up of 32.4 months, POP surgery improved urinary frequency ($P=0.006$), voiding difficulty ($P=0.001$), stress urinary incontinence ($P=0.001$), but not urgency ($P=0.29$). VS was more effective in treating SUI ($P<0.001$ vs. 0.52) while LSC more effective on voiding difficulty ($P=0.01$ vs. 0.08). Postoperative de novo symptoms were observed in 35.8% of patients with no difference between the groups ($P=0.06$). UDI ($P=0.04$) and UIQ ($P=0.01$) scores were significantly lower after surgery. However, LSC significantly improved UDI ($P=0.03$) with no effect on UIQ ($P=0.29$) scores while VS significantly improved both scores ($P=0.02$ and 0.001, respectively). Upon multivariate analysis, only the improvement in the impact of urinary symptoms on daily living was independently associated to VS (OR 5.45, $P=0.01$). The authors concluded that most preoperative urinary symptoms decreased after POP surgery with equivalent proportion of de novo symptoms after vaginal and laparoscopic approaches.

The prevalence of OAB symptoms in relation to sign and symptoms of POP is reported to be between 22.5-36.8% in community based studies [532, 546-548] and between 16-88% in hospital based studies [538, 549-551]. By and large, the prevalence of OAB with POP is greater in the hospital-based studies than in the community-based studies, which is not surprising, given the selected nature of the hospital samples. Only three studies, one community-based and two hospital-based, were identified that presented data specified by compartment and showed conflicting results: in the study by Miedel et al. [548], there is a clear relationship between anterior and posterior compartment prolapse and OAB symptoms in contrast to central compartment prolapse. In the studies by Bradley and Nygaard [552] and Sobhgol and Charandabee [553] such a relation could not be identified. In a study by Ellerkmann et al. [554] no correlation between worsening of the anterior compartment and urgency incontinence could be found. Data regarding the relationship between the stage of prolapse and OAB are very sparse. Burrows et al. [540] found that urgency and urge incontinence occurred more often in women with a less advanced prolapse. Another study using ultrasound reached the same conclusion; women with a higher grade of bladder descent were less likely to suffer from urgency incontinence [555].

The pathophysiology of OAB in women with POP is unclear. Several theories exist: bladder outlet obstruction; release of various chemical factors (ATP, Ach, and P2X3) by bladder distension stimulating the detrusor receptors; traction on the urethra due to prominent cystocele resulting in an open urethra with urine entering the urethra that causes detrusor contractions. Bladder outlet obstruction is likely to be the most important mechanism by which POP induces OAB symptoms and DO signs. However, several other mechanisms might also play a role but indicators show a causal relationship between OAB and POP [556].

1.14.2 Anorectal function

Prolapse of the posterior vaginal wall, alone or in combination with other compartment defects, can be challenging for the pelvic surgeon. Pelvic pressure, vaginal/ perineal splinting to defecate, difficult defecation, faecal incontinence (FI) and impaired sexual relations are some of the symptoms associated with posterior POP. Whether the prolapse is the cause of the symptoms or is a result of straining and stretching of supporting structures in women with defecation disorders, remains unclear.

Bowel symptom like incontinence of flatus and obstructed defecation are common in women with POP. In several surveys, the incidence of anal incontinence (AI) ranges from 15-50% [517, 532, 557-564]. FI was reported in 5-22% of women with prolapse [414, 557, 563] which was significantly more than bowel symptoms in a control group [563]. There were no associations found between prolapse stages and symptoms after adjusting for age and BMI [517, 562].

Meschia et al. [559] reported that among 881 women with symptoms of urinary incontinence and pelvic organ prolapse, the prevalence of AI was 20%. Urinary incontinence and severe rectocele were found to be associated with AI.

Disparities have been shown between the degree of POP, pelvic floor symptoms and defaecography results [414, 565]. Two series of defaecographies in consecutive patients with prolapse and/or evacuation disorders described defaecographic findings that changed the patients diagnosis (though not always the management) in 46 of 62 of cases and noted enteroceles that were not found on physical exam in approximately 50% of cases [566-568]. Sigmoidoceles are present in 4-11% of reported series, and are nearly always missed on physical examination [568, 569]. Their clinical impact and management remain unclear. Defaecography is not a routine investigation in women with POP and interpretation may be difficult in some cases since normal asymptomatic women may have focal defaecographic abnormalities [565]. The prevalence of abnormal colonic transit time is approximately 20% in patients presenting with evacuation disorders [570]. An abnormal preoperative colonic transit study is the most consistently cited risk factor for failure of rectocele repair to relieve evacuatory symptoms, regardless of the surgical technique [571-573]. Goh et al. [574] reviewed the management of rectocele and clearly describe the complexity of clinical conditions resulting from the possible combination of various gynaecological and colorectal symptoms with anatomical abnormalities and the different surgical approaches.

Recently, Ramanah et al. [575] evaluated changes in anorectal symptoms before and after POP surgery, using laparoscopic sacrocolpoperineopexy. Preoperative and postoperative anorectal symptoms, colorectal-anal distress inventory (CRADI) and colorectal-

anal impact questionnaire (CRAIQ) scores were prospectively compared from 90 consecutive women undergoing laparoscopic sacrocolpoperineopexy. After a median follow-up of 30.7 months, laparoscopic surgery significantly worsened CRADI ($p=0.02$) with no effect on CRAIQ ($p=0.37$) scores. Post-operative and de novo straining (27%) and the need for digital assistance (17%) were the most frequent anorectal symptoms. No correlation was found between laparoscopic surgery and anorectal symptoms after multivariate analysis (OR 2.45, $p=0.05$). The authors conclude that anorectal symptoms are not improved after POP surgery by laparoscopic sacrocolpoperineopexy.

1.14.3 Sexual function

Patients who present with POP symptoms should be questioned about their sexual function. Surgical treatment in these patients may be curative of their sexual disorders (e.g., by solving incontinence in patient with coital incontinence) but may also have undesired effects on sensation, blood flow, and the anatomy. These effects can affect sexual arousal and orgasm or cause dyspareunia.

Dyspareunia, coital incontinence and vaginal dryness are common complaints in women with pelvic floor disorders [576, 577]. Although sexual dysfunction appears to be more frequently observed in these women, pelvic organ prolapse seems not to negatively impact on sexual satisfaction when controlled for confounders like age [577-579].

Clinical populations are likely to have more severe pelvic floor symptoms and more advanced pelvic organ prolapse, with a greater potential for impact on sexual function, whereas community populations may have mild symptoms and prolapse, with minimal impact. These conflicting results may also be the result of population differences in other related factors, such as age, menopause, or the status of the woman's intimate relationship. Other challenges in studying the factors associated with sexual function in women with POP include a limited characterisation of female sexual function in some studies and difficulties assessing sexual function among women who do not have intercourse.

Handa et al. [580] reported that, with respect to anatomic prolapse, women with stage III-IV prolapse were more likely to report decreased libido and infrequent orgasm than women with stage 0 support. Adjustment for other characteristics attenuated the strength of these associations, although the association between prolapse and infrequent orgasm remained statistically significant. In the final adjusted model, the odds of infrequent orgasm were increased more than three times for women with stage III-IV prolapse ($P=0.02$). The authors conclude that women the anatomic prolapse (stage III-IV) were more likely to report infrequent orgasm but they were not at increased risk of other sexual problems. An important observation is that women with stage II support were

not more likely to report any sexual complaint than women with stage 0 support. This suggests that the physical presence of stage II prolapse alone is not associated with sexual dysfunction. In contrast, women with prolapse symptoms (as reflected by a high score on the prolapse scale of the Pelvic Floor Distress Inventory) were much more likely to report sexual complaints. Thus, one can conclude that sexual function is worse in women with symptomatic prolapse. LEVEL OF EVIDENCE II.

In 305 women over 40 years seeking outpatient gynecological care association between sexual complaints and perceived sexual distress has been investigated. Women with sexual distress were also more likely to report sexual difficulty related to pelvic floor symptoms, sexual avoidance due to vaginal prolapse (13.9% vs. 1%, $P=0.001$) [581].

A better understanding of the anatomy of this area and of sexual function will guide us in a more targeted approach to management of these conditions.

2. CONCLUSIONS AND RECOMMENDATIONS

The aetiology of POP is thought to be multifactorial with contributions from both environmental and genetic risk factors. Vaginal delivery is the most traumatic event for the pelvic floor during the woman lifespan, recent growing evidence underlines the possible genetic influence in aetiology of POP. High concordance in the POP stage between nulliparous and parous sister suggest a familial predisposition toward developing this condition [413]. LEVEL OF EVIDENCE II-2. Recent studies provided strong scientific evidence of genetic contribution to pelvic organ prolapse: 6 single-nucleotide polymorphisms are significantly associated with POP in high-risk familial case group participants [416]. LEVEL OF EVIDENCE II.

Also with respect to abnormal extracellular matrix (difference in collagen type and metabolism, elastin turnover), increasing evidence supports the genetic aetiology of POP. LEVEL OF EVIDENCE II. This has been confirmed by severe heritable connective tissue disease, in which POP predominates [453-456].

Hormonal and mechanical physiological alteration during pregnancy affect the pelvic floor support, but it has still to be demonstrated if it is a reversible factor.

Even if it has been demonstrated that vaginal delivery is the major traumatic event for the pelvic floor during the woman lifespan, caesarean section does not seem to be completely protective (LEVEL OF EVIDENCE II). Forceps, vaginal parity, prolonged second stage of labour, infant birthweight >4500 g are obstetrics risk factors for development of POP. The neurological sequelae of the vaginal delivery on the pelvic floor are still controversial.

Declining sex hormone level, ageing, age, obesity, constipation, chronic pelvic floor stress are associated with pelvic organ prolapse.

Although it has been documented that most of the patients with POP experience, beside prolapse symptoms, urinary, faecal and sexual symptoms, their anatomical-functional relationship remains unclear. Moreover, last findings demonstrated that there are few strong associations between specific symptoms and severity of prolapse. LEVEL OF EVIDENCE: II-2.

It is becoming imperative to better understand the pathophysiology underlying the SUI concomitant with POP, in order to adapt the surgical management of these patients.

Also the complexity of anorectal function in patient with POP need to be clarified, as well as sexual function, which seems to worse in women with symptomatic prolapse but not with the physical presence of stage II prolapse alone.

New research focuses on the identification of at-risk populations to develop pelvic organ descent. Establishing the familiarity of POP may identify populations that can be targeted for primary and secondary prevention studies, such as elective caesarean delivery. If specific genes can be identified, we may understand why some patients do not respond to certain therapies. Moreover, biomarkers or novel proteins, are expected to be related to various POP phenotypes.

The research priorities in pelvic organ prolapse are:

- to understand the mechanical and functional aspects of the vaginal birth
- to clarify the effects of the labour on the pelvic floor and consequently of emergency caesarean section
- to quantify the importance of genetic heritability for POP
- to increase the number of genetic resources (racial and ethnic background investigated with genetic studies)
- to determine possible explanations for related conditions (e.g. hernia, bowel dysfunction)

VI. PATHOPHYSIOLOGY OF FAECAL INCONTINENCE

Faecal continence is maintained by a complex, poorly elucidated process involving the structural and functional integrity of the anorectal unit, the central and peripheral nervous system and pelvic structures. Continence requires a closed anal canal at rest, sensory function to detect the presence of flatus or stool in the rectum, intact reflex response of the appropriate muscles, cognitive recognition of the sensory signal, adequate storage capacity in the rectum and adequate function of the puborectalis and sphincter

muscles. In addition, other factors such as stool consistency and physical mobility play a role. Disruption in the normal anatomy or physiology in any of these areas may lead to incontinence. Often, multiple factors are contributing in patients with significant faecal incontinence [582-586].

1. STRUCTURE AND FUNCTION OF THE ANOECTUM

The anus is a muscular tube 2 cm to 4 cm long consisting of the internal anal sphincter, conjoined longitudinal muscle, external anal sphincter and puborectalis muscle.

1.1. Muscles

1.1.1 Internal anal sphincter (IAS)

The internal anal sphincter (IAS), an involuntary smooth muscle, is a 0.3 cm to 0.5 cm thick expansion of the circular smooth muscle layer of the rectum. The IAS ends about 10 mm proximal to the distal end of the external sphincter. It is primarily responsible for closure of the anal canal at rest through both myogenic and sympathetic excitatory activity. Studies disagree about the relative contribution of myogenic and nerve induced activity to the resting tone [587, 588]. The IAS generates slow waves occurring 6-20 times per minute; about 10 % of asymptomatic people also have ultra-slow waves with pressures fluctuating between 20 mmHg and 50 mm Hg. [589-591]. The significance of variations in recordings between controls and incontinent patients is not well understood [592]. The internal anal sphincter contains non-adrenergic, non-cholinergic (NANC) fibres which contribute to contraction of the muscle mediated by nitric oxide [593-595]. The possible roles of other neurotransmitters and of the interstitial cells of Cajal are being actively studied in animal models [596-600]. Other animal studies have focused on the cellular regulation of basal tone in the IAS. Up regulation of RhoA/Rho kinase in the smooth muscle cells of the IAS plays a significant role in the maintenance of the basal tone [601]. The RhoA/Rho kinase components are responsible for the inhibition of myosin light-chain phosphatase of resulting in high level of myosin regulatory light chain [602].

1.1.2 External anal sphincter (EAS)

The external anal sphincter, a 0.6 cm to 1.0 cm thick cylinder of striated muscle covers the whole length of the internal sphincter and extends more distally into the subcutaneous tissue. The external sphincter contributes to the resting tone. Its primary function, however, is to contract to preserve continence when stool or flatus is present in the rectum or intra-abdominal pressure increases. The contraction may be voluntary or reflexive with increased abdominal pressure from coughing or distension [603]. The muscle also relaxes to facilitate evacuation. The separation of the

external sphincter into sections is controversial [604]. Many authors describe three sections termed superficial, subcutaneous and deep but they have also been described as subcutaneous, main body and deep winged portion based upon MRI imaging [605, 606]. On MRI images, the subcutaneous portion is visibly distinct from the other portions with less clear separation between the middle and deeper portions [605]. Others argue the EAS functions as a single muscle unit. The EAS is a predominantly slow-twitch, fatigue resistant muscle with a majority of Type I fibres although there are also Type II rapidly contracting fibres as well [607, 608].

1.1.3 Conjoined longitudinal muscle

The outer longitudinal muscle layer of the rectal wall joins with fibres of the levator ani muscle to become the conjoined longitudinal muscle. The muscle extends distally between the internal and external anal sphincter and then splits into extensions that traverse the superficial portion of the external sphincter to attach to the perianal skin and medially through the internal anal sphincter to join the submucosa smooth muscle [609]. Suggested roles for this muscle include provision of supporting meshwork for the anal sphincters and assistance in maintaining anal closure. A more functional role is suggested by the differential response of the longitudinal muscle to neurotransmitters when compared to the internal anal sphincter [595]. One suggested role is that contraction of the muscle flattens the anal cushions and shortens the anal canal [610].

1.1.4 Puborectalis muscle (PR)

The puborectalis muscle, the most medial portion of the levator ani muscle, is a U-shaped loop of striated muscle that encircles the anorectal junction and attaches to the posterior aspect of the pubis. The puborectalis muscle is a mixture of Type I and Type II fibres but has fewer Type II fibres than the EAS [611]. It functions to close the upper anal canal [612, 613]. It is situated immediately cephalad to the external sphincter. The configuration of the puborectalis muscle results in the anorectal angle between the distal rectum and anal canal. At rest, the anal canal forms an angle with the axis of the rectum of approximately 90°; during voluntary squeeze the angle becomes more acute, approximately 70°; during defecation, the angle becomes more obtuse, about 110° to 130°. Some data support the concept that the puborectalis muscle is part of the levator ani muscle (embryology, in vitro stimulation studies, innervation) [614-620], while other research suggests that it is part of the external anal sphincter (anatomic dissection, function during cough and straining [621-623]. The puborectalis muscle responds to increased abdominal pressure (coughing or straining) and rectal distension by contraction.

1.1.5 Levator ani

The levator ani muscles are a pair of broad sheets of striated muscle lying below the pelvic organs. There are three major components with different attachments. The ileococcygeus muscle arises from the ischial spine and attaches to the lateral aspect of the lower sacrum and coccyx. The pubococcygeus muscle runs from the posterior aspect of the pubis, mixes with fibres from the contralateral muscle at the anococcygeal raphe and inserts at the distal sacrum and coccyx. The third component is the puborectalis muscle which is described above. The urethra, vagina and rectum pass through an opening between the levator ani muscles called the levator hiatus.

1.2. Nerve Structure and Sensation

The somatic nerve supply arises from the second, third and fourth sacral spinal segments. The lower motor neuronal cell bodies for those nerves are located in Onuf's nucleus of those sacral spinal segments. The primary nerve is the pudendal nerve which has both motor and sensory functions [624]. The pudendal nerve divides into three main branches. One branch, the inferior rectal nerve, supplies the external sphincter. The levator muscles including the puborectalis receive innervation directly from those spinal segments [617, 618, 620, 625]. However, the puborectalis muscle frequently receives an auxiliary supply from the inferior rectal and perineal branches of the pudendal nerve on its inferior aspect [626]. Both the EAS and levator ani muscles may be controlled voluntarily through corticospinal descending motor pathways [611]. They are also under reflex control through sacral reflex pathways. Pudendal nerve block creates a loss of sensation in the perianal and genital skin and weakness of the anal sphincter muscle, but it does not affect rectal sensation [627]. It also abolishes the rectoanal contractile reflexes, suggesting that pudendal neuropathy may affect the rectoanal contractile reflex response.

The anorectum also has a rich nervous supply thought to be the enteric, sympathetic, parasympathetic and extrinsic spinal sensory neurons. Enteric motor neurons control most aspects of rectal motility; parasympathetic and sympathetic influence is mediated largely through modulation of the enteric neuronal circuits [628]. Within the myenteric plexuses there are motor, sensory and interneurons. The sympathetic supply of the rectum arises from the first three lumbar spinal segments. The innervation is carried through the preaortic plexus to the upper rectum and through the presacral nerves to the hypogastric plexus and then through the hypogastric nerves to the pelvic plexus. The parasympathetic fibres originate in the sacral parasympathetic nucleus in the sacral spinal cord and emerge through the sacral foramen as the nervi erigentes. They join the sympathetic fibres at the pelvic plexus and pass through rectal nerves to the rectal wall. The parasympathetic pathways have a role in propulsive activity of the colon and defaecation.

Extrinsic sensory innervation of the rectum seems to be responsible for sensory perception of rectal distension. Sacral afferents have cell bodies in the dorsal root ganglia of the sacral segments. Specialised sacral afferents have mechano-sensitive transduction sites within the myenteric ganglia of the rectum [629, 630]. These sites are sensitive to distension and contraction of surrounding muscle layers. Both thinly myelinated A-fibres and unmyelinated C-fibres are present in the rectal mucosa, and the myenteric plexus [7631-634]. The C-fibres are mostly present in the wall of the rectum, while the A-fibres predominate in the rectal mucosa [634]. These nerves most likely mediate the distension or stretch-induced sensory responses as well as the viscerovisceral, the rectoanal inhibitory, and the rectoanal contractile reflexes [633-635]. The sensation of rectal distension is most likely transmitted along the S2, S3, and S4 parasympathetic nerves [633]. Clinical studies confirm that balloon distension is perceived in the rectum and that such perception plays a role in maintaining continence [636, 637]. Furthermore, sensory conditioning can improve hyposensitivity of the rectum [638, 639].

Anal sensation is carried in the inferior rectal branch of the pudendal nerve. The upper anal canal particularly has a rich mixture of free and organised nerve endings such as the Krause end-bulbs, (cold) Golgi-Mazzoni bodies (pressure), genital corpuscles (friction), and the sparse Meissner's corpuscles (touch) [633, 640, 641]. Specialised afferent nerves may exist that transmit the sensations of touch, temperature, tension, and friction, but are incompletely understood [633]. The role of anorectal temperature sensation is subject to debate [642-646]. The likely role of anal sensation is to facilitate discrimination between flatus and faeces and the fine-tuning of the continence barrier, but its precise role needs to be characterised.

1.3. Cerebral Cortex

Rectal distension produces activations bilaterally in the secondary somatosensory cortex, sensory association cortex, the anterior cingulate cortex and insular cortex, as well as bilateral activation in the prefrontal cortex and extending from the peri-orbital cortex to the anterior temporal lobe [647-650]. Studies have identified activation in multiple areas of the cortex including those involved in spatial discrimination (secondary somatosensory cortex, sensory association cortex) and those that process affective and cognitive aspects of sensation (the anterior cingulate cortex, insula and prefrontal cortex). While rectal and anorectal stimulation activated similar regions of the brain the locations within the regions varied [651]. Anal musculature is represented bilaterally on the superior motor cortex (Brodmann area 4); the degree of symmetry varies [652].

1.4. Reflexes

Distension of the rectum results in contraction of the rectum, relaxation of the internal anal sphincter and contraction of the external anal sphincter.

1.4.1 Rectoanal inhibitory reflex (RAIR)

Rectal distension is associated with a fall in anal resting pressure known as the rectoanal inhibitory reflex. The amplitude and duration of this relaxation increases with the volume of rectal distension [653]. It has been suggested that bowel contents are periodically sensed by anorectal "sampling," the process by which transient relaxation of the IAS allows the rectal contents from the rectum to come into contact with specialised sensory organs [654-656]. This process allows discrimination between flatus and stool.

1.4.2 Cough reflex

Abrupt increases in intra-abdominal pressure, such as those caused by coughing or laughing, are associated with increases in anal sphincter pressure [603, 657-660]. The increased pressure may be achieved through multiple mechanisms, including reflex contraction of the puborectalis [661]. The response is relative to the intensity of the cough [657]. It is unclear whether the response is a polysynaptic spinal reflex [603, 658] since it is preserved after spinal cord transection [662] or also requires central integrative centers [659].

1.4.3 Rectoanal contractile reflex (sensorimotor response)

The rectoanal contractile reflex (or rectal anal excitatory reflex or inflation reflex) is the contraction of the EAS in response to rectal distension [663-665]. The amplitude and duration of the rectoanal contractile reflex increases with rectal distension up to a maximum volume of 30 ml [653].

1.5. Rectum

The rectum is a hollow muscular tube, 12 cm to 15 cm long, composed of a continuous layer of longitudinal muscle that interlaces with the underlying circular muscle. These muscles are a mixture of smooth muscle cells and several types of interstitial cell of Cajal [628]. A network of interstitial cells of Cajal joined by gap junction connections coupled to smooth muscle cells trigger mechanisms that give rise to large, slow repetitive depolarisation of the smooth muscle, the slow waves [666]. The proximal end is defined either as the sacral promontory, the third sacral vertebrae or the area where the colonic taeniae splay out and end. The distal end is the dentate line or anorectal ring. The rectum serves as a reservoir for storage and a "pump" for evacuation of stool facilitated by several characteristics. The rectal walls are compliant maintaining a relatively low pressure with increasing volumes. Its innervation allows the sensation of increasing volume [582, 628].

1.6. Anal Endovascular Cushions

The submucosa of the anal lining contains blood vessels, connective tissue, smooth muscle and elastic tissue. They typically form three separate complexes of smooth muscle fibres and vascular channels called

the anal cushions [667, 668]. A recent study of women demonstrated the normal variation in size; the size did vary with posture and parity but not age, history of obstetrical trauma or mild haemorrhoid symptoms [669]. Their contribution to continence is poorly studied and controversial.

1.7. Stool Consistency

Considerable evidence exists that evacuation of formed stool is more easily deferred than loose stool (discussed in detail under diarrhoea).

1.8. Physical Mobility

The ability to defer evacuation until a socially acceptable time and place requires the physical mobility to reach a bathroom in the required time frame. The contribution of physical mobility to continence is largely inferred from studies identifying lack of physical mobility as a risk factor for incontinence [670-672]. There is limited information about the relative role for mobility in continent patients.

2. CONTINENCE MECHANISM

Complete continence is most likely with normal transit of formed stool, anal closure at rest, sufficient reservoir capacity and sensation in the rectum, functional reflexes for sampling and sphincter contraction, adequate cognitive function to recognise the urge to defaecate and physical mobility to reach the bathroom in time.

The anus is normally closed by the tonic activity of the IAS with contribution from the EAS and PR at different levels of the anal canal [613, 673]. Studies of the relative contribution of the IAS to the resting tone yield results varying from 55-85% [588, 627]. Some of that variation is likely related to the measurement technique utilised but it has also been found that resting pressure varies during the day and with posture, increasing with the upright position [674, 675]. The IAS contribution is also influenced by rectal distension [588, 676]. Some postulate that the anal cushions provide a tight seal based upon studies showing that the sphincter muscles in their circular configuration cannot contract sufficiently to provide complete closure [677, 678]. An *in vitro* study showed that even during maximal involuntary contraction, the internal sphincter ring was unable to close the anal orifice completely and a gap of approximately 7 mm was left open. This gap was filled by the anal cushions [679]. Anal cushions may exert pressures of up to 9 mmHg and thereby may contribute 10% to 20% of resting anal pressure [680]. These barriers are further augmented by the puborectalis muscle, which pulls the anal canal forward forming the anorectal angle. The extent to which the anorectal angle contributes to continence is controversial [673, 681-685]. One study suggests that it is important to the control of semi-solid material more than the control of liquid [686].

With rectal distension or increased intra-abdominal pressure, this barrier is reinforced by reflex or voluntary contraction of the EAS and PR. The contraction requires functional peripheral, spinal and cerebral function to sense and recognise the distension, activate the reflex and voluntary responses. In addition, adequate muscular contraction to increase the anal pressure is required. The rectal wall must distend to allow accommodation to the increased pressure. Finally, the mobility to reach an appropriate setting before the muscle fatigues is required.

3. DEVELOPMENT OF INCONTINENCE

Clearly there are a number of potential areas of injury or dysfunction in the complex mechanisms required for continence that might result in incontinence. Faecal incontinence (FI) occurs when one or more mechanisms that maintain continence is disrupted to an extent that other mechanisms are unable to compensate. Hence, FI is often multi-factorial [582-586]. In a prospective study, 80% of patients with FI had more than one pathogenic abnormality [583]. The interaction of those factors and when they result in clinical incontinence is poorly understood.

3.1. Passive Incontinence

Compromise of anal closure and loss of sensation may result in soiling or incontinence without awareness. Prolapsing tissue (either mucosal or full thickness rectal prolapse, rectal lesions) prevents closure of the anus. Some believe that the anal cushions are a necessary component of anal closure [678]. Injury secondary to trauma, surgery or childbirth and weakness of the IAS are other causes. IAS atrophy occurs in systemic sclerosis and likely contributes to FI [687, 688] although neuropathy appears to be a contributing factor as well [689]. Loss of sensation occurs from peripheral neuropathy, spinal cord and cerebral cortex events or after transection of the nerve supply by surgical or other trauma. Increasing evidence suggests that rectal hyposensitivity significantly contributes to passive incontinence [690-694]. Interestingly faecal seepage in men occurs despite normal anorectal physiology testing [690, 695, 696].

3.2. Urgency Incontinence

Incontinence occurs when the ability to hold stool or flatus is overwhelmed. If the rectum cannot distend to hold stool or the muscles do not contract adequately incontinence results. Changes in the reservoir function of the rectum from disease processes, radiation therapy or surgical resection. Pelvic floor muscle dysfunction may result from direct injury causing a defect or weakness. Iatrogenic or obstetrical trauma to the IAS is the most common cause of injury to that muscle. Direct injury to the EAS occurs most frequently from obstetrical injuries which are comprehensively presented elsewhere but may also occur from surgery or other trauma. The puborectalis and levator ani

muscles may also be injured and the presence of defects appears to correlate with poor contractility and symptoms in several studies [697-701]. Major levator ani muscle injuries are more frequent in women with EAS obstetrical injuries and those with combined injuries are more likely to be symptomatic [699]. However, other investigators found no relationship between the presence of levator ani injuries and FI [702, 703].

Rectal hypersensitivity, a lower threshold for the urge to defaecate, also contributes to urgency incontinence [584, 585, 704-708]. Complex, poorly understood mechanisms mediate rectal hypersensitivity. Variables include decreased compliance, increased sensitivity of extrinsic peripheral pathways or central afferent mechanisms [706].

4. RISK FACTORS FOR FAECAL INCONTINENCE

Many events and conditions impact the mechanisms of continence often in multiple ways. The next section covers the conditions that most frequently contribute to incontinence.

4.1. Ageing

Multiple studies document the increasing incidence of FI with aging in both men and women [586, 709-715]. One study of women in a community found that 70% of incontinence developed after the age of 40 [716]. Another study of women in the United States documented an initial 15% prevalence of incontinence in women over 50 years old and onset rate of 7% over the next 10 years [717].

While the rising incidence is well documented, understanding of the physiologic impact of aging is less clear. Conflicting evidence exists about the effect of ageing on anal resting pressure. While a number of studies report decreased anal resting pressures in older continent and incontinent persons [707, 718-721], some found lower pressures in patients with incontinence but not asymptomatic older persons [722, 723]. Increased thickness of the internal anal sphincter is associated with aging [707, 724-727]; the finding is thought to represent increased fibrosis although that hypothesis is not proven. Animal studies of smooth muscle contraction demonstrate decreased contractility with aging [728]. Studies of the internal sphincters of ageing animals found changes in translocation of signalling molecules as well association and phosphorylation of contractile proteins [728].

Most studies of the effect of ageing on anal squeeze pressures found decreasing pressures with advanced age [719-723, 729, 730] but not all [707, 731, 732]. One report found decreasing anal squeeze pressures with age in women but not men [730]. The decrease in anal squeeze pressures does not correlate with easier fatigability of the external sphincter. Indeed, studies show no change with age [733] or that the

external sphincter becomes more resistant to fatigue with age [734]. These findings are consistent with studies of skeletal muscle in general which show that reduction of muscle fibers with increasing age with a greater loss of Type-II fibers which are less fatigue resistant [735]. The result is a weaker but more fatigue resistant muscle. Very little specific data about the external anal sphincter exists, however.

The decreased anal squeeze pressures might also be related to external sphincter atrophy. Thinning, presumed to be secondary to atrophy, of the external sphincter has been documented in both endoanal ultrasound and MRI studies [724-726, 736-738]. One study found excellent correlation of atrophy on imaging with the pathologic changes of atrophy [739]. Some studies found that atrophy is related to aging [726, 737], but not all [707]. FI did correlate with external sphincter atrophy [707]. Data from studies of nerve injury in animals reveals that sphincter atrophy and decreased function develops after nerve injury [740-742]. It is known that muscle atrophy secondary to age related loss of anterior horn cell occurs [743]. Human studies demonstrate increased muscle fiber density suggesting re-innervation in the external sphincter with age [723, 744].

Finally several studies found a decrease in rectal sensitivity with increasing age [718, 729]. One study found that decrease only in women [721]. The relationship of this finding to FI is not clear.

There is early and sometimes inconsistent evidence from primarily animal research of age related changes in spinal neurons, dorsal root ganglion cells and interstitial cells that govern bowel reflexes and continence.

4.2. Gender

Prevalence studies suggest that FI occurs more frequently in young women but as people age, many studies report essentially equal incidence in men and women [711, 713-715, 730, 745, 746]. In a large epidemiologic study, risk factors for men and women with incontinence differed [747]. Advanced age, depression, heart disease, urinary incontinence and polypharmacy were significant risk factors in women while malnutrition was a significant risk factor in men. Increased dependence for basic activities of daily life were significant risk factors for both genders. The mechanisms of FI in men appear to differ from women [586, 690, 695, 696, 748-750]. In general external sphincter defects, low resting and squeeze pressures and POP are more common in women with rectal hyposensitivity and evacuation disorders being more common in men. Normal anorectal physiology testing is notably more common in men.

Oestrogen and progesterone receptors are found in the IAS and EAS. Because of this finding, some proposed that menopause is a risk factor for incontinence in women. However, since ageing and meno-

pause are closely related, an independent relationship is difficult to prove. Symptomatic improvement from oral oestrogen replacement supports the proposed relationship; however study of topical oestrogen compared to placebo showed no difference. In addition one study found a 30% increased risk of incontinence in patients currently taking oral oestrogens [751]. At the present, the role of the hormone receptors and relationship of menopause to the onset of incontinence is uncertain.

4.3. Diabetes

Diabetes is reported as a risk factor for FI in several prevalence studies [714, 715, 751, 752]. One study reported a 40% increase in the risk of FI [751]. Another population based study found that both occasional and frequent episodes of incontinence were more common in diabetic patients (OR 2.7) [753]. In a study of elderly Korean patients, diabetes was associated with FI in women but not men [754]. A review of incontinence in community dwelling men did identify diabetes as a risk factor, however [749]. A case control investigation found that diabetic patients had more frequent and severe episodes of FI [755]. Several reports found that incontinence was more frequent in patients with other diabetic complications particularly neuropathy and retinopathy [755-757]. It is uncertain whether longer duration of disease increases the likelihood of incontinence as one study found an association [756] but two did not [755, 757]. FI was associated with poor glycaemic control in one report [755], however not confirmed by another study [757]. As in other conditions, multiple risk factors appears to increase the chance of incontinence. In a study of the subset of diabetic women from the National Health and Nutrition Examination Survey (NHANES) increasing age, depression, poorer health status, urinary incontinence and greater bowel frequency were associated with fecal incontinence in a multivariate regression model adjusted for race, BMI, medical co-morbidities and stool consistency [758]. The underlying mechanism for FI in diabetic patients is not clear. One likely contributor is oral medication taken for diabetic control. Metformin has been found to be independently related to faecal incontinence in diabetic patients [759]. In addition, withdrawal of metformin was reported to eliminate the incontinence [760]. One confounding factor is that diarrhoea, a known risk factor for FI, occurs in 5-35% of patients with diabetes [753, 756, 761, 762].

There is evidence that acute hyperglycaemia in patients with either Type 1 or 2 diabetes results in decreased squeeze pressures and rectal compliance. When studied when blood glucose was normal, the results in the diabetic patients were the same as the normal controls [763]. An animal study showed that those changes could be reversed by administration of a nitric oxide synthase antagonist suggesting that change in anal pressure is related to oxidative stress [764].

One hypothesis on the underlying mechanism is that microvascular changes associated with diabetes result in damage to pelvic floor innervations and muscles [763]. A comparative study of anorectal physiology of controls, incontinent patients with diabetes and continent and incontinent patients with multiple sclerosis found that the incontinent, diabetic patients had higher sensory thresholds and lower resting and squeeze pressures [765]. An anal physiology study compared findings of patients with the diagnosis of diabetes for less than 10 years to those with the diagnosis for longer than 10 years [766]. Both groups of patients had lower resting and squeeze anal pressures ($P < 0.01$), impaired rectoanal inhibitory and anocutaneous reflexes, and reduced sensitivity in rectal distention. Although both groups had statistically significant differences from the control group, the patients with the longer duration of disease had lower sphincter pressures and more blunted sensation in addition to more frequent episodes of incontinence. The latter group also had more evidence of microvascular disease and neuropathy. Blunted rectal sensation and internal sphincter dysfunction were identified in diabetic patients in two separate studies [639, 767]. Another group performed anorectal physiology tests on diabetic patients with FI and normal sphincters on ultrasounds. The findings were compared to controls [768]. While the patients had decreased resting and squeeze pressures, multivariate analysis found that the rectoanal inhibitory reflex recovery time was the only test result that correlated with severity of symptoms. They postulate that those changes are related to decreased sympathetic innervation. These findings would be consistent with underlying neurologic and/or microvascular changes. It is unclear how to reconcile that hypothesis, however, with the lack of association of incontinence with neuropathy in some epidemiology studies [761, 769].

4.4. Gastrointestinal Disorders

4.4.1 Diarrhoea

Diarrhoea is consistently reported as a risk factor for FI. For many patients symptoms of diarrhoea include loose consistency of the stool and rectal urgency. Loose stool is an independent risk factor for incontinence and is additive to other risk factors such as obstetrical sphincter injury [586, 709, 711, 712, 717, 745, 749, 751, 770, 771]. Diarrhoea has a significant impact on the development of incontinence with OR 53 in one study [709]. Loose stool is also reported to result in incontinence after treatment with pelvic radiation [772].

4.4.2 Rectal urgency

Rectal urgency is reported as an independent risk factor for FI [711, 773, 774] as well as a factor in worsening symptoms in patients with incontinence [706]. It is unclear whether the aetiology is rapid transit into the rectum overwhelming the reservoir function or hypersensitivity or some combination of factors [711, 745]. Several investigators found that rectal hypersensitivity to be a common finding but incontinence

developed only in patients with associated sphincter weakness [584, 706]. Rectal hypersensitivity has also been found to be associated with an abnormal colonic motility pattern in the sigmoid colon in incontinent patients [775]. The relationship of this finding to irritable bowel syndrome remains to be clarified. Data from other investigators documents increased rectal stiffness, rectal wall tension and stress in patients with FI [776]. Although the underlying cause of these changes is unknown, the authors postulate these findings explain the rectal urgency. Similar findings are noted in asymptomatic older women as well [719].

4.4.3 Constipation/impaction

Constipation and incomplete evacuation of the rectum are associated with FI in several studies [710, 717]. A study of hospitalized elderly patients found that faecal impaction and diarrhoea were strongly associated with FI [777]. Uncertainty exists regarding whether these two factors result in incontinence in patients with otherwise normal anorectal function. Overflow incontinence occurs in some patients with faecal impactions. The use of laxatives may exacerbate the problem [778]. One study of elderly patients with impaction compared to controls found that they had blunted rectal sensation and less frequent external sphincter contractions in response to rectal distension [779]. In addition the internal sphincter relaxed at lower levels of rectal distension. Studies of impacted patients without incontinence have not been reported.

4.4.4 Irritable bowel syndrome

A number of studies found irritable bowel syndrome to be a risk factor for FI [709-711, 751, 780-782]. Proposed mechanisms include loose stool consistency, rapid colonic motility and rectal hypersensitivity [775, 783]. Incontinence may be more likely in patients with multiple risk factors. In a study of 164 women, the combination of an obstetric sphincter injury, urgency and diarrhoea significantly increased the risk of incontinence [784].

4.5. Neurologic/Psychiatric Conditions

4.5.1 Dementia

The prevalence of FI is higher in patients with dementia compared to others of similar age. One study reported a prevalence of 32% in older patients with dementia [785]. Another study reported a rate of 34% in patients with dementia compared to 6.7% in those without dementia [786]. Although diarrhoea was the greatest risk factor for incontinence in a study of nursing home residents, dementia also contributed to the development of incontinence [787]. In the study of community-living older adults in the United States, the prevalence odds ratio of FI decreased by 51% with each unit improvement in cognitive score [788]. A Japanese study of community dwelling older adults found dementia to be a risk factor for double incontinence [789]. There is limited information available about the relationship of intellectual disability and FI

[790]. Proposed mechanisms for the specific contribution of dementia include lack of recognition or understanding of the urge to defecate and lack of ability to articulate the need for the bathroom.

4.5.2 Depression

Several studies identified depression as a risk factor for FI [712, 714, 745, 747, 749, 758, 791]. Many assume that the association occurs because of the psychological burden of the symptoms while it is also possible that side effects of anti-depressant medication contribute to the symptoms. An editorial challenged investigators to “clarify the link between the cerebral impact of neurotransmitters and anorectal physiology” given the role of serotonin in depression and gastrointestinal function [792]. Depression and FI are both associated with poor nutritional status in the elderly [793]; that association confounds understanding of any true causal relationship between any two of the conditions.

4.5.3 Spinal cord injury

Patients with spinal cord injuries frequently report difficulty with both constipation and incontinence [794, 795]. The level of the injury determines the effect on continence. Supraconal lesions lead to delayed colonic transit and exaggerated rectal contractions and anal relaxation in response to rectal distension. Cauda equina lesions interrupt the efferent limb of the reflex arc which results in loss of rectal sensation and tone as well as impaired sphincter function [796]. Paraplegics or persons with sacral neuronal lesions may retain some degree of sensory function, but virtually no sensation is felt if lesions reach the higher spine [637, 662].

4.5.4 Stroke

In several large surveys, stroke is identified as a risk factor for incontinence [714, 745, 749, 789]. Studies of stroke patients demonstrate fairly consistent rates of FI from 30-40% on admission [785, 797-800]. The rates decreased to 20% by the time of discharge [797, 799] and 7-11% at 6-12 months [785, 798, 800]. The Copenhagen Stroke Study found that the events in patients with incontinence were more likely to haemorrhagic, larger in size and involve the cerebral cortex than stroke patients without incontinence [800]. Research identified that FI may develop early after a stroke or months later [801]. Early onset seems to be related to age, stroke severities, diabetes and other medical co-morbidities while late onset is associated with anticholinergic drugs and requirement for assistance with toileting [798, 801].

4.6. Nutrition

4.6.1 Obesity

Population based studies of FI identify obesity as a significant risk factor [709, 710, 751]. In addition studies of pelvic floor symptoms in obese patients find a higher incidence of FI than generally found in the non-

obese population with rates ranging from 16-68% [802-809]. A non-significant trend towards worsening incontinence was found in another study [810]. Four studies investigated the relationship between the rate of incontinence to the BMI; three found increasing rates of incontinence with increasing BMI [751, 807, 811]. One did not [809]. The relationship is further supported by data that weight loss after bariatric surgery decreases the incidence of FI [803, 807, 812-814]. But again, not all studies showed that result [815, 816]. While the findings of these studies are generally consistent a recent systematic review of obesity and pelvic floor disorders found the number of studies to be limited, primarily focused upon women, and usually lacking control groups and physiology testing [817]. Two confounding factors were noted in studies of this relationship. One is that diarrhoea, an independent risk factor for incontinence, is also frequently associated with obesity [817]. The second is the association of FI with low fibre intake in obese women raising the question of dietary contribution to the increased incidence of FI with obesity [805]. Chronically elevated intra-abdominal pressure, known to be associated with obesity [818, 819], is typically proposed as the reason for pelvic floor dysfunction in obesity. Other factors including diabetes, neurological changes and intervertebral disc herniation which are common in the obese population may very well contribute.

4.6.2 Vitamin D

Vitamin D is a key micronutrient of muscle function. Vitamin D deficiency is associated with urinary incontinence in men and women [820, 821]. One small study of ten patients with FI found that all had either vitamin D deficiency or relative vitamin D insufficiency [822]. These rates are much higher than the 36-57% rate of deficiency or relative insufficiency from historical data of the general population. In a large study of 1881 women in the US, there was a non-significant trend towards an association between lower vitamin D levels and FI [820]. A case control study compared vitamin D levels in women with FI symptoms to controls [823]. The incontinent women had significantly lower vitamin D levels and higher odds of vitamin D deficiency. It is known that vitamin D absorption and synthesis in the skin declines with age [824, 825]. Any association between lower levels of vitamin D and FI may represent only that both are common in the elderly. Another potential mechanism is that the antioxidant effect of Vitamin D reduces the apoptosis of sphincter muscles associated with aging. That mechanism is postulated based upon the protective effect of Vitamin D on castration induced generation of reactive oxidative species and apoptosis in rats [826].

4.7. Obstetrical Injury

The impact of pregnancy and vaginal delivery on continence is described in the section on obstetrical injury. While those injuries occur with reasonable frequency, quite often the patient does not develop clinical incontinence until later in life. The reasons for the

onset of symptoms and the required combination of factors are poorly understood. However the contribution of EAS defects to incontinence is supported by data demonstrating that clinical improvement after sphincteroplasty is more likely in patients with successful anatomic repair seen on ultrasound [736, 827-829]. The frequency of puborectalis or levator ani muscle injury as well as the degree to which it contributes to FI is unclear but is being more actively investigated [698, 700, 702, 830].

4.8. Physical Mobility

Intuitively, adequate physical mobility to reach the toilet in a timely manner in response to the urge to defecate is necessary for continence. Limited mobility was found to be a risk factor for incontinence in two population based studies [745, 747] and an investigation of nursing home residents [671]. In a study of urban dwelling older persons, the odds of prevalent incontinence increased by 20% for each unit decrease in the physical performance measure [788]. In a study of long-term care patients, immobility was one of the strongest predictors of incontinence [831]. In another study, the use of physical restraints (maximal limitation of mobility) was found to be the most significant cause of incontinence when the data was adjusted for other risk factors [832].

4.9. Radiation

FI occurs after pelvic radiation for prostate, gynecological, anal and rectal cancer [833-837] with an incidence as high as 43%. Radiation therapy adds to the risk of incontinence associated with rectal resection [838-842]. It appears that short course radiotherapy carries a higher risk than long term radiation [843]. Direct comparison trials powered to answer the question are currently in progress [844, 845]. Recently a 14 year follow up study of patients without stomas from the Dutch rectal cancer trial revealed significantly more incontinence in the group treated with short course radiation and surgery versus those treated with surgery alone [846]. In a study of the relationship of radiation dosage to symptoms after prostate radiotherapy, FI was associated primarily to radiation to the EAS and PR [847]. Another study of gynecological cancer survivors treated with pelvic radiation found that mean doses greater than 50 GY to the anal sphincter, sigmoid and small intestines were associated with FI [848]. The exact mechanism(s) that radiation therapy causes incontinence is uncertain. A systemic review published in 2014 review 21 studies rated low to moderate quality. Most studies found that decreased anal resting pressures, impaired rectal distensibility with less consistent changes in squeeze pressures [849].

The rectum may be stiffer and less compliant [850] and the anal pressures reduced either from muscle or nerve injury by the radiation [839, 851, 852]. A study of incontinent men compared those with a history of radiation for prostate cancer to those no history of radiation; the authors reported a markedly increased in-

cidence of pudendal nerve injury in the radiated patients but similar anal pressures and sensitivity measures [853]. Genetics may also play a role. A study of rectal cancer patients treated with pelvic radiation identified specific genotypes with an increased risk of acute post-treatment incontinence [854].

4.10. Rectal Prolapse

Mucosal, external and full thickness rectal prolapse – a significant portion (48-63%) of patients with prolapsing haemorrhoids or mucosal prolapse report soiling [855, 856]. Symptoms resolve with successful treatment [855-858].

External rectal prolapse is associated with FI in up to 66% of patients [859-862]. Diminished anal resting tone commonly accompanies rectal prolapse [662, 860, 863]; that finding suggests that internal sphincter dysfunction perhaps from repeated stretching is one mechanism for incontinence. Other considerations include the presence of neuropathy; it is unclear if the prolapse results in prolonged pudendal nerve latencies [864, 865] or if both share a common aetiology. The exact mechanism or combination of causes is uncertain. Other investigators, however, found that patients with rectal prolapse and persistent incontinence had evidence of sphincter defects either from surgical or obstetrical injury [866, 867].

Internal rectal prolapse is also associated with FI [868, 869] and decreased anal pressures [863]. In one study, an increase in the grade of intussusception is associated with an increase in severity of FI; the relationship remained significant in a multivariate analysis controlling for age [870] but not in another [871]. Surgical intervention was controversial in the past but there is increasing evidence that incontinence improves after ventral rectopexy [872-876]. Finally there is evidence that the presence of an internal intussusception reduces the benefit of sacral nerve stimulation and biofeedback [877-879]. One group raised the question of how often internal rectal prolapse is the explanation for idiopathic incontinence. In a group of patients without sphincter defects or constipation who underwent pelvic floor testing, high grade intussusception was found in 49% of the 174 patients [871]. It was largely associated with urgency incontinence.

4.11. Surgery

4.11.1 Anorectal surgery

Lateral internal sphincterotomy, is the recommended surgical procedure for refractory anal fissures. The surgery involves the division of the internal sphincter and may result in incontinence of flatus and stool [880-885]. Quite variable rates of post-operative incontinence from none to 36 % are reported. The definition of incontinence, type of follow-up and length of sphincterotomy contribute to the variability. A number of studies sought to identify risk factors for incontinence after LIS. Age [880, 882], female gender [886],

history of vaginal delivery [887-890] and combination with another anorectal procedure [889] were found to increase the risk. Some authors suggest that pre-existing sphincter injury might predispose to incontinence [889, 890]. Another author found evidence for increased sphincter asymmetry in the patients with incontinence after sphincterotomy compared to continent post-operative patients but no differences in pre-existing sphincter defects [891]. Patients with anterior fissures developed incontinence after partial lateral internal sphincterotomy at a much higher rate than ones with posterior fissures (39% versus 6% $p < 0.003$) [892]. A recent report suggests that the development of symptoms of incontinence may be delayed similar to women with obstetrical sphincter injuries [893].

Incontinence is reported in 0-14% of patients after haemorrhoidectomy [894-897]. In the limited studies available, increased risk of incontinence has been related to previous vaginal deliveries [895], number of haemorrhoids excised [896] and post-operative internal sphincter defects [895, 898]. Within a cohort of 418 patients following Milligan-Morgan hemorrhoidectomy, 40 patients reported new onset FI [899]. Nineteen of those patients underwent evaluation and were compared to 15 asymptomatic hemorrhoidectomy patients and 19 people from a matched population based control group. The study group had higher incontinence scores, more complaints of incomplete evacuation, lower resting pressures and lower threshold volumes during saline infusion test. Four of the nine patients had sphincter defects on anal ultrasound; all defects were in the external sphincter. This study suggests a multifactorial explanation for the new symptoms.

Some have argued that excision of the anal cushions is the reason for incontinence [678]. Li and colleagues investigated whether removal of the anal cushions alone caused incontinence [900]. Seventy six patients underwent saline infusion testing prior to Milligan-Morgan hemorrhoidectomy. They were categorized into three groups based upon their pre-operative saline threshold volume. Only the group with lowest threshold volume experienced a significant difference in pre and post-operative threshold volumes and Cleveland Clinic incontinence scores; none of the patients reported clinical incontinence. The authors contend that since the anal cushions were excised in all of the patients another mechanism is the explanation for the changes.

Surgery for anal fistulas may result in FI. The frequency depends upon the anatomy of the fistula, baseline sphincter function and the surgical procedure performed. The reported rates of post-operative incontinence range from 0-50% [901-913]. The definition and measurement of incontinence varies among the studies. Treatment of high fistulas involving more sphincter muscle is more likely to be followed by incontinence [881, 901, 908, 913]. Injections of fibrin glue and endorectal advancement flaps have

lower post-operative incontinence rates than other fistula procedures in a Cochrane review [904]. However, most studies did not include pre and post-operative evaluation or standardized instruments. Roig and colleagues prospectively analysed 143 patients with pre and post-operative surveys, manometry, pudendal nerve testing and anal ultrasounds after fistula surgery [914]. Pre-operative incontinence was noted in 14.2% of patients and in 49.2% of patients post-operatively. Incontinence scores worsened in patients after fistulotomy and endorectal advancement flap but improved slightly in patients after fistulotomy and immediate sphincter reconstruction. All surgical approaches produced new defects in the internal sphincter on ultrasound; new defects in external sphincter developed only after fistulotomy. The presence of defects correlated significantly with post-operative incontinence and lower manometry results. Age over 45 years old [901] and gender [903, 912] were found to increase the risk in some studies. The mechanism appears to be iatrogenic (and at times intentional) sphincter injury.

4.11.2 Rectal resection

In a recent meta-analysis of functional outcomes after resection for rectal cancer inclusive of studies reported between 1978 and 2004, FI of any kind occurred in 3-79% of patients [836]. Rates of incontinence of solid stool ranged from 0-40%, liquids 0-60% and flatus 9-76%. The pooled proportion of incontinence of solid stool was 14% and liquid stool 29%. The risk of incontinence appears to depend upon the tumour location and level of the anastomosis [915, 916]. Theoretically loss of the rectal reservoir contributes to incontinence. The goal of replacing the reservoir function led to the development various types of reconstruction following resection (coloplasty, colonic J pouch, ileoanal reservoir). While long-term data are sparse, in the first 18 months post-operatively colonic J pouches result in lower rates of incontinence than straight anastomoses or coloplasty according to a recent Cochrane review [917]. Damage to the internal sphincter occurs during this type of resection presumably from transanal introduction of stapling devices and may contribute to incontinence as well [918, 919]. However a recent study comparing patients undergoing handsewn anastomoses to double stapled ones found no difference in FI post-operatively or anorectal manometry results [920]. Diminished rectal sensation and changes in motility seen post-operatively indicate that nerve damage may also contribute [920-922]. Rectal sensation and the ability to defecate can be abolished completely by resection of the *nervi erigentes* [923]. If parasympathetic innervation is absent, rectal filling is only perceived as a vague sensation of discomfort. Cadaver studies after total mesorectal excision reveal the close proximity of the levator ani nerve and pelvic splanchnic nerves to the plane of dissection particularly for low rectal resections [924]. Damage to those nerves would impact function of the puborectalis muscle. It is likely that

multiple factors contribute to incontinence after rectal resection and difficult to assign relative importance.

4.11.3 Hysterectomy

Several reports identified hysterectomy as a risk factor for FI [709, 745]. However, another study found a decreased risk of incontinence [751] and two found no association [710, 925]. In addition to conflicting results, the mechanism is not understood. Nerve injury during surgery is thought to be one factor. A series of 56 women who underwent either a standard or nerve-sparing radical hysterectomy were evaluated prospectively [926]. Although more women reported FI after a standard procedure in the first year, there was no statistical difference in the last two years of follow up. The study may have been underpowered to resolve the issue.

4.11.4 Cholecystectomy

Cholecystectomy results in diarrhoea in some patients. It is often assumed that incontinence occurring after cholecystectomy is related to the onset of diarrhoea. However, two studies identified cholecystectomy as a significant independent risk factor for incontinence [709, 927]. The underlying mechanism, if not associated loose stool, is uncertain but perhaps could be related to rectal urgency secondary to bile salt irritation.

4.12. Smoking

A study from the Mayo Clinic reported an association of incontinence in older adults with current smoking with an odds ratio of 4.7 [709]. An earlier study reported the same finding in post-partum patients with FI. This finding has been confirmed by others [712, 928]. The reason is unclear [929]. Chronic obstructive pulmonary disease has been associated with FI [751] but in Mayo Clinic study pulmonary disease was not found to be a factor. Other proposed mechanisms include the anti-oestrogen effect of nicotine [930] or accelerate colonic transit secondary to nicotine induced high amplitude contractions in the colon [931]. In addition, heavy smoking (20+ pack years) is associated with external sphincter atrophy on MRI [932].

4.13. Urinary Incontinence

Many studies report an association of urinary and FI. It is likely that it is not a causative relationship but rather that the two conditions result from common aetiology [709, 712, 715, 745, 751, 771, 933-935].

5. SUMMARY AND RESEARCH RECOMMENDATIONS

Since the last report, it is even clearer that FI is most often multifactorial. The role of obstetrical injury is somewhat better understood. The importance of rectal urgency and internal rectal prolapse has been identified but both require further research to understand their role in FI and the underlying mechanisms. Basic science research continues about the impact of

aging on the anal sphincter, other pelvic floor muscles and neurologic structures. Recent work has also focused on remediable risk factors such as nutritional factors and lifestyle choices.

However the complex interaction of the pelvic floor structures, gastrointestinal function including stool consistency and perhaps the microbiome is not fully understood and requires more investigation. More information about the aging process including the potential for reversible changes is of interest. The ability to identify specific phenotypes and perhaps genotypes should facilitate targeted therapy and perhaps prevention for patients with FI. Testing of alternative methods of evaluation of neurologic function that are more tolerable for patients would be very beneficial. Understanding the mechanism for sphincter weakness in patients without sphincter injury should be part of that effort. The reservoir function of the rectum and underlying causes of rectal urgency warrant more investigation. Increased focus is required on the pathophysiology of incontinence in men. In addition, little data exists to demonstrate whether changes in theoretically remediable risk factors will decrease incontinence.

VII. CHILDBIRTH AND FAECAL INCONTINENCE

Pregnancy and childbirth have a significant impact on the emotional and physical wellbeing of a woman. It is reported that as many as 91% of women report at least one new symptom eight weeks post-partum [936]. A fall in maternal mortality accompanied by an increase in female life expectancy (86 years in the Japan) has now shifted the focus of attention towards identification of factors that may minimise morbidity. Although pre-existing bowel symptoms may be aggravated during pregnancy and childbirth, the development of symptoms *de novo* is a more frequent occurrence. Obstetric trauma is the most common cause of FI. However, the onset of symptoms may occur many years after delivery with a peak incidence in the perimenopausal years. This may reflect the effect of contributory factors such as the process of aging, the effect of the menopause or progression of neuropathy. This section focuses on the association between obstetric trauma and FI. The term 'anal incontinence' is used to include incontinence to flatus, liquid and solids.

Anal incontinence (AI) has been reported to occur between 5 [937, 938] to 26 [939] percent of women during the first year following vaginal delivery. In a Canadian study [940] involving 949 consecutive women who delivered vaginally, 26% reported AI while 3% reported FI. They identified forceps delivery and third/fourth degree tears as independent risk factors. In a population based study of 8774 women in Oregon, USA, more than 25% reported FI within 6 months of childbirth [941].

1. NEUROGENIC TRAUMA

The mechanism that maintains continence is complex and affected by various factors such as mental function, lack of a compliant rectal reservoir, rectal hypersensitivity, enhanced colonic transit and changes in stool consistency and volume. However, the ultimate barrier is the anal sphincter. AI may ensue if there is mechanical disruption to the anal sphincter muscles, disturbance in neurological function or a combination of both factors. In about 80% of women with presumed "idiopathic" anorectal incontinence there is histological evidence of denervation of the striated pelvic floor muscles, particularly the puborectalis and external anal sphincter (EAS) [942]. This feature has also been demonstrated electro-physiologically by means of an increased fibre density in patients with idiopathic FI indicating re-innervation following denervation [943]. Another finding in these patients is a conduction delay in pudendal nerves as measured by pudendal nerve terminal motor latency (PNTML) [944].

Although Hertz in 1909 suggested that pelvic floor damage may result from a normal vaginal delivery, objective scientific evidence for this was only produced in 1984 [945] and a follow-up of 14 patients 5 years later [946]. These authors studied 122 women, 71 after delivery with manometry, perineometry, PNTML and EMG, and 51 before and after delivery with EMG. This study demonstrated an increase in anal sphincter striated muscle fibre density in the vaginal delivery group at 2 months post-partum indicating evidence of re-innervation following denervation. The fibre density was not altered following elective caesarean section. Thirty three percent of primiparae and 50% of multiparae had prolonged PNTML within 48 hours of delivery. However, by 2 months, the PNTML had returned to normal in 60% of these women, indicating that damage to pudendal nerve conduction is reversible. Multiparity, forceps delivery, increased duration of the second stage of labour, third degree perineal tears and high birth weight were important factors leading to pudendal nerve damage. In the five year follow-up study of 14 women, only multiparae who did not have a forceps delivery were selected; the denervating process was found to be progressive in the majority of women and 5 women suffered from stress incontinence of urine, 3 of whom were also incontinent to flatus.

In another prospective neurophysiological study, Allen et al [947] studied 96 nulliparous women with EMG, PNTML and vaginal pressure measurements during pelvic floor contraction. They found evidence of re-innervation in the pelvic floor muscles of 80% of primiparae 2 months after vaginal delivery. The only obstetric factors associated with re-innervation were a high birth weight and a longer active stage of labour. Forty five of the original 96 women were studied again

6 years later and they concluded that changes in pelvic floor neurophysiology occur with time and do not appear to be related to further childbearing [948].

A third prospective study [949] measured anal pressures, anal sensation and the perineal plane in 72 antenatal women and repeated 72 hours post-partum and in 41 women 2 months postpartum. Anal sensation was unchanged. Cornes et al. [950] measured anal sensation in 96 primiparae within 10 days after delivery and measurements were repeated in 74 women 6 months after delivery. They found that at 6 months anal sensation had returned to normal. Anal sensation remained unchanged after caesarean section. In women who had a torn EAS, only impairment of sensation in the upper anal canal persisted at 6 months. More than half the women who admitted to persistent anal incontinence had normal anal sensation. Chaliha et al. [951] measured anal electro-sensitivity before and after childbirth and found it unchanged. Anal sensation in isolation therefore probably plays a minor role in the development of obstetric related faecal incontinence.

2. MECHANICAL TRAUMA

Until the advent of anal endosonography, mechanical trauma to the anal sphincters was only suspected when there was a history of third or fourth degree tears collectively known as obstetric anal sphincter injuries (OASIs). Consequently, when anal endosonography was performed in patients believed to be suffering from "neurogenic" FI unsuspected internal anal sphincter (IAS) and EAS defects were identified [952]. The sonographic appearance of EAS defects has been verified histologically to represent fibrosis [953] while the appearance of IAS defects have been validated prospectively in patients undergoing lateral internal anal sphincterotomy [954]. Trauma as identified by ultrasound may represent unrecognised OASIs (previously referred to as occult) or the consequence of recognised and repaired OASIs.

2.1. Unrecognised ("Occult") Anal Sphincter Trauma

Sultan et al [937] performed the first prospective study (before and after childbirth) to demonstrate both "occult" anal sphincter trauma (Figure 13) and pudendal nerve damage during childbirth in both primiparous and multiparous women (n=150). In 35% of primiparous and 44% of multiparous women anal sphincter defects were identified at 6 weeks postpartum by anal endosonography that were not present before vaginal delivery. Thirteen percent and 23% respectively developed defecatory symptoms (fecal urgency and/or AI) after delivery. Only two of the 150 women (both primiparous) had recognised tears of the anal sphincter at the time of delivery. A strong association was demonstrated between the presence of any defect and the development of symptoms. Only 4% of multiparous women sustained new sphincter

damage following a subsequent delivery. The single independent factor associated with anal sphincter damage was forceps delivery. The 23 women delivered by cesarean section remained asymptomatic and none developed sphincter defects. No relationship was demonstrated between PNTML measurements and defecatory or urinary symptoms.

Donnelly et al [955] interviewed 219 nulliparae in the third trimester regarding bowel habits and performed anal vector manometry. At 6 weeks postpartum 184 women returned and the same bowel symptom questionnaire was completed and anal vector manometry plus PNTML measurements were performed. Anal endosonography was performed in 81 women with al-

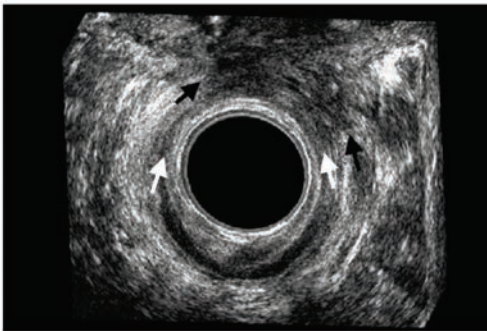

Figure 13: Anal ultrasound image of the mid anal canal. EAS = external anal sphincter. IAS = internal anal sphincter. The area between the black arrows at 11 and 2 o'clock represents an external anal sphincter defect while the area between the white arrows between 9 and 3 represent an internal sphincter defect.

tered faecal continence or abnormal physiology. Instrumental vaginal delivery and a passive second stage of labour prolonged by epidural analgesia were significantly associated with the greatest risk of anal sphincter trauma and impaired faecal continence. As instrumental delivery is a known risk factor (8 fold increased risk of sphincter trauma), early use of oxytocin was recommended to shorten the second stage. A continuation of the same study [956] reported that PNTML was prolonged and the squeeze pressure increment was reduced in women who had a caesarean section in the late first stage (>8cm cervical dilatation) or second stage.

Chalilha et al [951] measured anal sensation and manometry in 286 nulliparae during the third trimester and repeated in 161 women postpartum when anal endosonography was also performed. Anal endosonography revealed sphincter defects in 38% of women and this was associated with the presence a lowering of anal squeeze and resting pressures. Threshold anal electrosensitivity remained unchanged and bore no relationship to symptoms. Postpartum sphincter defects were associated with perineal laceration and vaginal delivery.

Abramowitz et al [957] performed a prospective study of 233 women who had anal endosonography performed before and 6 to 8 weeks after childbirth. Of the 233 women (118 primiparae), 202 had a vaginal delivery. Postpartum AI in the 233 women was reported by 13% of primiparae and 8.5% of multiparae and anal sphincter defects in 21% and 12% respectively. However, the prevalence of anal sphincter defects amongst those who had a vaginal delivery (n=202) was 26% and 13% respectively. Previous studies [958, 959] including others mentioned in Table 4 and 5 have shown that the first delivery is at greatest risk for anal sphincter trauma but this study is at variance as it claimed that secundiparous females have the same risk as primiparous women. However, this finding remains unsubstantiated and is further disputed by a subsequent prospective study [959].

Fynes et al [960] undertook a prospective study of 59 previously nulliparous women through 2 successive pregnancies and found that 34% had anal sphincter injury after their first delivery but only 2 new injuries occurred after the second delivery confirming the findings in Sultan's study [937]. An important finding in this study was that 42% of women (5 of 12) who had a severe 'occult' sphincter injury during their first delivery (squeeze pressure increment < 20mmHg or anal sphincter defect > one quadrant) developed AI after the second delivery.

Willis et al [961] performed anal vector manometry, endosonography, PNTML and rectal sensibility at the 32 weeks and 6 weeks postpartum. Using the Kelly-Holschneider score they reported AI in 5% and identified occult injuries in 19%. PNTML and rectal sensibility was unaffected by vaginal delivery.

Nazir et al [962] performed vector manometry and endoanal ultrasound in 73 nulliparous woman at 25 weeks and 5 months postpartum (Table 4). There was no correlation between vector manometry and anal endosonography or clinical variables.

Belmonte-Montes [963] performed anal endosonography in 98 nulliparous women 6 weeks before and 6 weeks after delivery and after excluding 20 third degree tears found occult sphincter injuries in 13%. Seventy five percent of women with defects were symptomatic and there was a good correlation between defects and symptoms. However, it is not clear as to how many with 'occult' defects were symptomatic (Table 4).

In 3 further studies [964, 967, 968] anal ultrasound was performed only after delivery and defects were identified in 11.5 to 34% (Table 5). Varma et al [964] studied 159 postnatal women (105 primiparous and 54 secundiparous) and found occult anal sphincter defects in 11.5% of primiparous and 19% of secundiparous vaginal deliveries but 80% of forceps deliveries. None of their patients suffered FI but only 72% of questionnaires were returned. However, their cohort was recruited before 1998 and had a high caesarean section rate (25%) and a low forceps rate (4%).

Williams et al [969] performed a prospective study in 45 nulliparous women before and after vaginal delivery using 3 dimensional endosonography. There was evidence of perineal trauma in 29% (external sphincter 11%, puboanalis 20%, transverse perineal muscle 7%). Sudol-Szopinńska et al [970] performed 3 dimensional endoanal ultrasound in 112 primiparous women and found only 2.6% sonographic injuries. However, their obstetric practice was different in that they had a 77% episiotomy rate and a 59% epidural rate.

Oberwalder et al [971] performed a meta-analysis of 717 vaginal deliveries and found a 26.9% incidence of anal sphincter defects in primiparous women and an 8.5% incidence of new sphincter defects in multiparous women. Although two thirds of these women with “occult” defects were asymptomatic in the postpartum period, the probability of FI associated with a sphincter defect was 76.8 to 82.8%.

Some 15 years after having first coined the term “occult” OASIs based on anal endosonography, Sultan [937] began questioning whether the 28% sonographic anal sphincter defects (Table 6) identified some weeks after delivery were really genuine occult defects that were not identifiable clinically at delivery. They therefore conducted a prospective study [976] in which 241 women having their first vaginal delivery had their perineum re-examined by an experienced research fellow and endoanal ultrasound was performed immediately after delivery and repeated 7

weeks postpartum. When OASIs were identified by the research fellow, the injuries were confirmed and repaired by the duty registrar or consultant. The prevalence of clinically diagnosed OASIs increased from 11% to 25% (n=59). Every clinically diagnosed injury was identified by postpartum endoanal ultrasound. However, there were three women with sonographic defects in whom the injury was not identified clinically. Two of these had only small IAS defects that were not considered clinically significant. The other was a combined defect of both the IAS and EAS and while this could be classified as an occult tear, it is most probably a tear that was not recognised by the research fellow. At 7 weeks postpartum, no *de novo* defects were identified by ultrasound. This study concluded that virtually all sphincter defects that have previously been designated as “occult” injuries (Table 6) were in fact OASIs that could have been identified by a trained clinician [977] and that less than one percent are genuine occult OASIs (if indeed they exist). Interestingly, 87% of midwives and 27% of junior doctors failed to recognise OASIs clinically. Although it is likely that some of these injuries would have been detected at the time of suturing the tear, it is concerning that clinical recognition of OASIs is suboptimal [977]. However, this finding is not unique as Groom and Patterson [978] also found that the rate of third degree tears rose to 15% when all “2nd degree tears” were re-examined by a second experienced person.

Table 4: Prospective studies before and after vaginal delivery of “occult” anal sphincter injury (using 2d ultrasound) and anal incontinence but excluding fecal urgency.

Study	Parity	Vaginal delivery (n)	FU in weeks postpartum	Sphincter Defects	Anal Incontinence
Sultan et al 93 ⁹³⁷	Primi	79	6	33%	5%
	Multi	48	6	44%	19%
*Donnelly et al 98 ⁹⁵⁵	Primi	168	6	35%	25%
Rieger et al 98 ⁹⁶⁵	Primi	37	6	41%	8%
Zetterstrom et al 99 ⁹⁶⁶	Primi	38	9	20%	18%
*Fynes et al 99 ⁹⁶⁰	Multi	59	6-12	37%	17%
Abramowitz et al 00 ⁹⁵⁷	Primi	202 including multi	8	26%	15%
	Multi			13%	10%
Chaliha et al 01 ⁹⁵¹	Primi	130	12	19%	13%
Belmonte-Montes et al 01 ⁹⁶³	Primi	78	6	13%	?
Nazir et al 02 ⁹⁶²	Primi	73	20	19%	25%
Willis et al 02 ⁹⁶¹	Primi +Multi	42	12	10%	5%
MEAN (excluding Willis et al)	Primi Multi			28% 31%	16% 15%

*modified continence score questionnaire used and may include urgency

Table 5: Postnatal studies of “occult” anal sphincter injury (using 2d ultrasound) sustained during vaginal delivery and anal incontinence excluding fecal urgency.

Study	Vaginal delivery	Parity	FU	Study	Vaginal delivery
*Varma et al 99 ⁹⁶⁴	78 31	Primi Multi	4 weeks 4weeks	11.5% 19%	0% 0%
Damon 00 ⁹⁶⁷	197	Primi	3 months	34%	6%
**Faltin 00 ⁹⁶⁸	150	Primi	3 months	28%	15%

*Ultrasound performed < 1 week after delivery

** anal ultrasound performed immediately after delivery before perineal repair

Table 6: Prevalence of anal incontinence and fecal incontinence following primary repair of obstetric anal sphincter rupture. (predominantly end-to-end repair of external sphincter)

Authors (n=42)	Year	Country	N	Follow-up Months	Anal(Fecal) incontinence
Bagade & MacKenzie ⁹⁷² Sangali et al ⁹⁸⁷ Wood J et al ⁹⁹⁷	2010 2000 1998	UK Switzerland Australia	79 177 84	>6 13 years 31	10% (111%) 15% (10%) 17%* (7%)
Walsh et al ⁹⁹⁸	1996	UK	81	3	20% (7%)
Sander et al ⁹⁹⁹ Pretlove et al ¹⁰⁰⁰	1999 2004	Denmark UK	48 41	1 ?	21% (4%) 22% (22%)
Crawford et al ¹⁰⁰¹	1993	USA	35	12	23% (6%)
Sorensen et al ⁹⁹⁵	1993	Denmark	38	3	24% (?)
Mackenzie et al ¹⁰⁰²	2003	UK	53	3	25% (7%)
Nichols et al ¹⁰⁰³ Shek et al ⁹⁷³	2005 2014	USA Australia	56 140	3 2	25% (11%) 25% (3%)
Nielsen et al ¹⁰⁰⁴	1992	Denmark	24	12	29% (?)
*Go & Dunselman ¹⁰⁰⁵	1988	Netherland	20	6	30% (15%)
Fenner et al ¹⁰⁰⁶	2003	USA	165	6	30% (?)
DeLeeuw et al ¹⁰⁰⁷	2001	Netherland	125	14 years	31% (?)
Wagenius et al ¹⁰⁰⁸ Vaccaro & Clemons ¹⁰²²	2003 2008	Sweden USA	186 60	4 years 3	33% (25%) 33% (12%)
Kumar ⁹⁷⁴ Huebner et al ⁹⁷⁵ Uustal Fornell et al ¹⁰⁰⁹	2012 2013 1996	UK Germany Sweden	41 99 51	52 28 years 6	37 (25%) 39% (13%) 40% (16%)
Poen et al ⁹⁹²	1998	Netherland	117	56	40% (?)
Sultan et al ⁹⁸⁵	1994	UK	34	2	41% (9%)
Zetterstrom et al ⁹⁹⁰	1999	Sweden	46	9	41% (2%)
Sorensen et al ¹⁰¹⁰	1988	Denmark	25	78	42% (?)
Tetzschner et al ¹⁰¹¹	1996	Denmark	72	24-48	42% (17%)
Williams et al ¹⁰¹²	2003	UK	124	?	42% (?)

Authors (n=42)	Year	Country	N	Follow-up Months	Anal(Fecal) incontinence
Norderval et al ¹⁰¹³	2004	Norway	156	25	42% (17%)
Garcia et al ¹⁰¹⁴	2005	USA	26	3	42% (15%)
Kammerer-Doak et al ⁹⁹⁴	1999	USA	15	4	43% (13%)
Haadem et al ⁹⁹⁶	1988	Sweden	62	3	44% (?)
Rieger et al ¹⁰¹⁵	2004	Australia	51	3	45% (25%)
Bek & Laurberg ¹⁰¹⁶	1992	Denmark	121	?	50% (?)
Davis et al ¹⁰¹⁷	2003	UK	52	3.6	50% (?)
Fitzpatrick et al ⁹⁸⁸	2000	Ireland	154	3	53% (6%)
Samarasekera et al ¹⁰²⁴	2007	UK	53	15	53% (32%)
Nazir et al ¹⁰¹⁸	2003	Norway	100	18	54% (17%)
Gjessing H et al ⁹⁹¹	1998	Norway	35	12-60	57% (23%)
Savoye-Collet et al ¹⁰¹⁹	2003	France	21	4	57% (29%)
Goffeng et al ⁹⁹³	1998	Sweden	27	12	59% (11%)
Nygaard et al ¹⁰²⁰	1997	USA	29	30 years	59% (28%)
Pinta et al ¹⁰²¹	2004	Finland	52	15	61% (10%)
†Sakse et al ¹⁰²³	2009	Denmark	33	5	67% (42%)
Mean					37% (12%)

*Includes 2 with secondary sphincter repair † includes only 4th degree tears

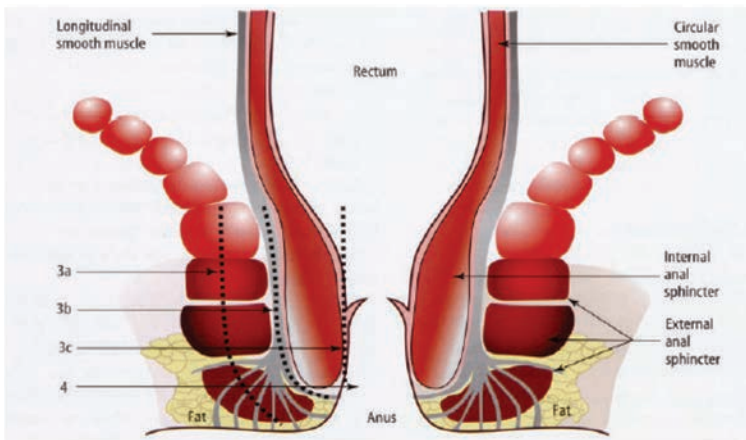

Figure 14: Schematic representation of the classification of 3rd and 4th degree tears (with permission from Springer) [982]

These studies [976, 978] confirm the lack of adequate training as previously highlighted by Sultan et al [979] who reported that 91% of doctors who had done at least 6 months of training in obstetrics and 60% of

midwives indicated inadequate training in perineal anatomy and 84% and 61% respectively reported inadequate training in identifying 3rd degree tears. Another possible reason for under-diagnosis is that

tears of the anal sphincter have been wrongly classified and therefore anal sphincter tears have been under-reported. Any involvement of the anal sphincter should be classified as a third degree tear. However 41% of doctors and 16% of midwives classified a torn anal sphincter as a 2nd degree tear [979]. Sultan and Thakar [980] reviewed every relevant text book (n=65) in the library of the Royal College of Obstetricians and Gynaecologists (RCOG) and found that there was a lack of consistency in classification and in about 40% the classification was omitted or wrong. Furthermore, previous classifications were incomplete because they did not incorporate depth of EAS rupture or involvement of the IAS. This therefore has epidemiological, clinical and medicolegal implications. If a third degree tear is incorrectly classified as second degree, then inappropriate repair could result in sub-optimal outcome (see below). Sultan [981] therefore proposed the following classification (Figure 14) that has been incorporated into the 29th RCOG green top guidelines [982], adopted by The American College of Obstetricians and Gynecologists (ACOG) [983] and included in this ICI textbook since its first edition in 2002.:

First degree: laceration of the vaginal epithelium or perineal skin only.

Second degree: involvement of the perineal muscles but not the anal sphincter.

Third degree: disruption of the anal sphincter muscles and this should be further subdivided into:

3a: <50% thickness of external sphincter torn.

3b: >50% thickness of external sphincter torn.

3c: internal sphincter torn also.

Fourth degree: a third degree tear with disruption of the anal epithelium.

An isolated rectal tear without involvement of the anal sphincter is rare and should not be included in the above classification.

2.2. Recognised Obstetric Anal Sphincter Injuries

The rate of OASIs is increasing and in England alone there has been a 3 fold increase between 2000 and 2012 from 1.8 to 5.9% in primiparous vaginal deliveries. This has been attributed to improvements in understanding anal sphincter anatomy and clinical diagnosis [977]. Primary repair of OASIs are usually performed by obstetricians using the end-to-end repair technique [985]. However, as shown in Table 6, AI occurs in 37% (range 10 to 67%) and in addition, urgency can affect a further 28% [985] to 28% [986, 988]. Frank FI affected 12% (range 2 to 42%). The reasons for persistent symptoms are unclear but there are at least six studies [985, 986, 988, 991-993] demonstrating anal sphincter defects following repair in 40 to 91% of women. Although the extent of the sphincter injury appears to be related to outcome of repair,

in some studies (Table 6) the data was not interpretable [994], incomplete [993] or inclusive of symptoms other than anal incontinence [996]. Nulliparity, instrumental delivery especially forceps without episiotomy, large baby >4 kg, shoulder dystocia and a persistent occipito-posterior position and prolonged second stage of labour have been identified as the main risk factors for the development of OASIs [957, 958, 982, 985, 992].

Traditionally, the technique described to repair the torn anal mucosa (4th degree tear) was to insert interrupted sutures with the knot tied within the anal canal [985, 989]. However, this was recommended when catgut was in use to minimise tissue reaction and infection. With the availability of polyglactin suture material this is no longer necessary as it dissolves by hydrolysis. Figure of eight sutures should be avoided during repair of the anal mucosa as they can cause ischaemia and therefore a continuous non-locking suture is adequate [982, 989, 1025].

The most popular method of EAS repair is the end-to-end technique but colorectal surgeons prefer the overlap technique for secondary repair because of better outcome [1025]. It is now known that similar to other operations for incontinence, the outcome can deteriorate with time and one study has reported continence in 50% of women at 5-year follow-up [1026]. However, at least one third of women in this study had more than one attempt at sphincter repair and therefore these findings cannot be extrapolated to that following primary repair of acute injury [1026]. In 1999, Sultan et al [1025] were the first to explore the feasibility of the overlap technique of repair for acute EAS rupture but more importantly advocated the identification and separate repair of the torn IAS [982]. Until then, very little importance was given to the torn IAS during primary repair. However, subsequently in a study involving 500 consecutive women with OASIs it has been shown that sonographic evidence of IAS injury was predictive of FI [1027]. Roos et al [1028] studied 531 consecutive women with OASIs and found that women who sustained an IAS tear were significantly more likely to suffer incontinence, have lower anal pressures, persistent IAS defects and a reduced quality of life. Increasing IAS defect size has also been shown to be related to symptoms of AI [1022]. Reid et al [1029] performed a prospective study using validated outcome measures at 9 weeks and 3.2 years after primary repair involving 539 women with OASIs. All those who had an internal sphincter injury were classified as major tears (including 4th degree tears). There was no significant difference in outcome between minor and major tears in relation to urgency (10%), flatus (7%) or FI (0.9%). In fact there was a significant improvement in symptoms over time confirming that good outcomes can be achieved when the internal sphincter is repaired as a primary procedure. Oude Lohuis et al [986] have shown that only 10% (26 of the 29) of women who sustained internal anal sphincter injuries (3c and 4th degree tears) had no persistent internal sphincter de-

fects at 3 months follow up indicating adequate repair. Dickinson et al [1030] followed up 136 women who sustained OASIs (25 women sustained 3c/4th degree tears) and found internal sphincter defects in 32% of women but this could have included undiagnosed internal sphincter injuries.

When a patient presents with FI months or years after delivery, it is almost impossible to perform a successful IAS repair highlighting the importance of identification and repair immediately after delivery [989, 1025]. Compared to matched historical controls [985] who had an end-to-end repair, Sultan et al [1025] found that the rate of AI was reduced from 41% to 8% when the overlap technique was used for EAS repair with separate repair of the torn IAS [1025] and therefore recommended the performance of a randomized controlled trial.

The first published randomised trial by Fitzpatrick et al [988] reported no significant difference between end-to-end and overlap repair although there appeared to be trend towards more symptoms in the end-to-end group. However, there were methodological differences in that the torn IAS was not identified and repaired separately and they used a constipating agent for 3 days after the repair. Unfortunately, they included partial EAS tears in their randomised study. A true overlap [989, 1025] is not possible if the sphincter ends are not completely divided and it would be expected that if an overlap is attempted, the residual intact sphincter muscle would have to curl up and hence there would be undue tension on the remaining torn ends of muscle that would be overlapped. This technique would therefore go against the general principles of surgery of deliberately placing tissue under avoidable tension [982, 989].

Garcia et al [1014] also performed a randomized trial of the two techniques and took great care to include only complete ruptures of the EAS (full thickness 3b,3c and 4th degree tears). There were 23 women in the end-to-end group and 18 in the overlap group. Unfortunately, only 15 and 11 women respectively returned for follow-up which was only at 3 months. No significant difference was found between the groups in terms of symptoms of FI or transperineal ultrasound findings. However, the authors have acknowledged that the major limitations of their study were that the randomization process was flawed and that their study was underpowered.

Williams et al [1031] performed a factorial randomized controlled trial (n=112) in which women were randomized into 4 groups: overlap with polyglactin (Vicryl; Ethicon, Edinburgh, UK); end-to-end repair with Vicryl; overlap repair with polydioxanone (PDS; Ethicon, Edinburgh, UK); end-to-end repair with PDS. This trial was specifically designed to test the hypothesis regarding suture related morbidity (need for suture removal due to pain, suture migration or dyspareunia) using the two techniques. At six weeks, there were no differences in suture related morbidity. The authors claimed that there were no differences in

outcome based on repair technique. Unfortunately, the majority of patients included in this trial were partial tears of the EAS (70% were 3a tears) and as mentioned above, a true overlap [989, 1025] cannot be performed if the EAS is only partially torn. Furthermore, their follow up rate at 12 months was only 54%. This data therefore needs to be interpreted by caution.

Fernando et al [1032] performed a randomised controlled trial of end-to-end vs overlap technique. The study had adequate power (n=64) and the primary outcome was FI at one year. All repairs were performed by two trained operators and Grade 3a EAS were excluded. At 12 months (81% follow-up rate), 24% in the end-to-end and none in the overlap group reported FI (p=0.009). Faecal urgency at 12 months was reported by 32% in the end-to-end and 3.7% in the overlap group (p=0.02). There were no significant differences in dyspareunia and quality of life between the groups. At 12 months 20% reported perineal pain in the end-to-end and none in the overlap group (p=0.04). During the 12 months period 16% in end-to-end and none in the overlap group reported deterioration of defecatory symptoms (p=0.01). Further calculation revealed that four women need to be treated with the overlap technique to prevent one woman with OASIs developing FI. On the basis of this randomized trial it would appear that the overlap technique of EAS repair accompanied by separate repair of the torn internal sphincter, performed by trained clinicians is associated with a good outcome. In 2006, the Cochrane review [98] concluded that as the surgeon's experience was not addressed in two of the three randomised studies, it would be inappropriate to recommend one type of repair over the other.

Farrell et al [1034] performed a randomised controlled trial with a 6 month follow-up of end-to-end (n=62) vs overlap (n=63) EAS repair in primiparous women. They reported significantly higher rates of flatal but not FI in the overlap group. However, there were more 4th degree tears in the overlap group and therefore more IAS injury that could explain the increased flatal incontinence in this group [1035]. At 3 year follow up there was no significant difference in AI between the groups [1036]. This supports the findings of Fernando et al [1032, 1033] who demonstrated a significantly higher risk of deterioration in AI over time in the end-to-end group and highlights the importance of longer term follow-up.

Rygh and Korner [1037] performed another randomized controlled trial (n=101) with the primary outcome measure 'of at least weekly solid stool incontinence'.

Table: 4.2

Author	Year	N	Follow up	3a	3b	3c	4°	P value
Poen ⁹⁹²	1998	117	56 months		38%		58%	NS
Sangali ⁹⁸⁷	2000	177	13 years		11.5%		25%	0.049
de Leeuw ¹⁰⁰⁷	2001	125	14 years	21%	31%		64%	0.001
Ramalingam ^{xx}	2013	175	6 months	1%	7%	14%	44%	
Mean					27%		48%	

They concluded that the overlap technique was not superior to the end-to-end repair. However, there were more women with symptoms of AI with the end-to-end repair (34% vs 20%).

The Cochrane Review concluded, "The data available show that at one-year follow-up, immediate primary overlap repair of the external anal sphincter compared with immediate primary end-to-end repair appears to be associated with lower risks of developing faecal urgency and anal incontinence symptoms. At the end of 36 months there appears to be no difference in flatus or faecal incontinence between the

two techniques. However, since this evidence is based on only two small trials, more research evidence is needed in order to confirm or refute these findings" [1033]. Although there are indications from two studies [1022, 1036] that compared to the end-to-end technique, the overlap technique appears to be more robust over time, longer term follow up of a larger cohort is required.

More recently, 3 and 4 dimensional transperineal ultrasound techniques have been used to image the

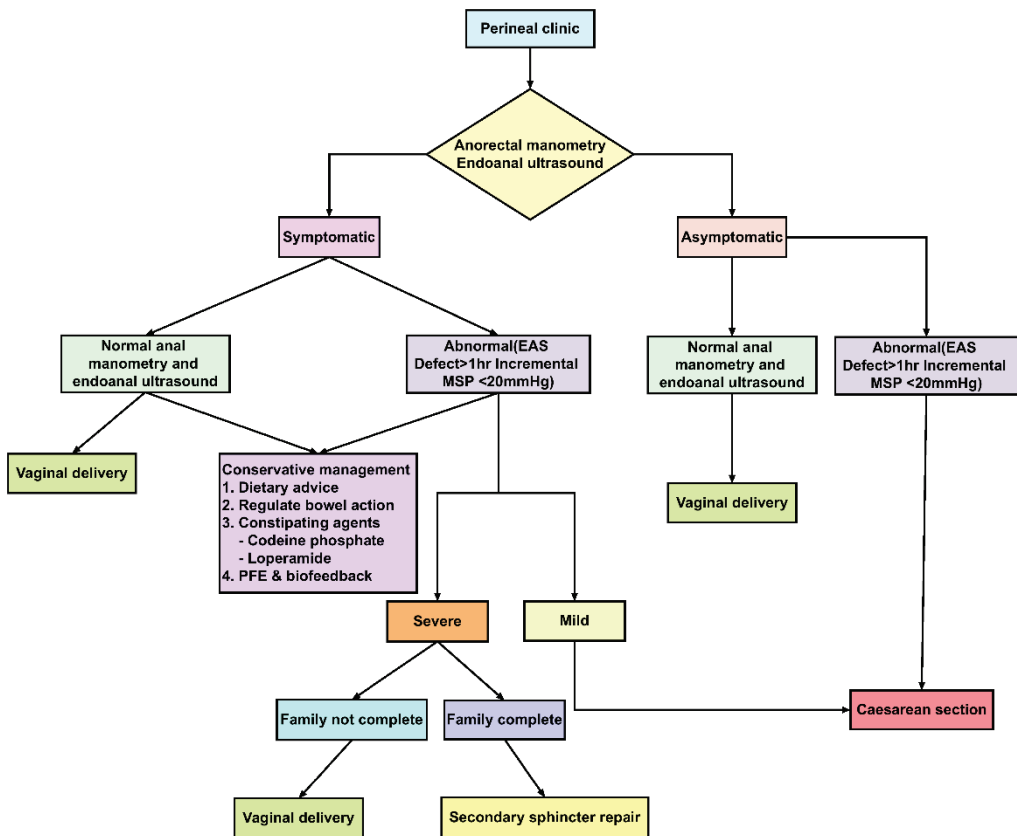

Figure 15: Flow chart demonstrating the Croydon pathway of the management of a subsequent pregnancy following OASIs (EAS = External Anal Pressure; MSP= maximum squeeze pressure)

anal sphincter and 40% residual defects were identified following OASIs repair and levator avulsion in 17% [973].

In terms of long term outcome following primary repair when the Sultan classification [981] was adopted and follow up was greater than 6 months the rates of AI (including flatus) are as follows (modified from Table 4.2 [989]):

2.3. Management of subsequent pregnancy after OASIs

All women who sustained OASIs should be assessed in hospital by a senior obstetrician 6 to 12 weeks after delivery. Some centres have established dedicated multidisciplinary perineal clinics. In a survey conducted in 2010 [1039], 30% of hospitals in the UK had such a dedicated clinic. It is important that a comprehensive history is taken regarding bowel, bladder and sexual function. As these symptoms are embarrassing, a structured questionnaire may be useful. A proper vaginal and rectal examination should be performed to check for complete healing, scar tenderness and sphincter tone [976, 989, 1040]. Mild incontinence (faecal urgency, flatus incontinence, infrequent soiling) may be controlled with dietary advice, constipating agents (Loperamide or Codeine Phosphate), physiotherapy or biofeedback. However, women who have severe incontinence should, in addition, be offered secondary sphincter repair by a colorectal surgeon. Asymptomatic women must be advised to return if symptoms develop [989].

Women with OASIs are at a five-fold increased risk of recurrence in subsequent pregnancy function [1041]. There are no randomized studies to determine the most appropriate mode of delivery. Women who have had a successful secondary sphincter repair for FI should be delivered by caesarean section [1042]. Some women with FI may choose to complete their family prior to embarking on anal sphincter surgery. It would appear that these women could be allowed a vaginal delivery as the damage to the sphincter has already occurred and risk of further damage is minimal and probably insignificant in terms of outcome of surgery. The risk of worsening or *de novo* neuropathy has not been quantified and in practice, does not appear to be clinically significant.

The management of a subsequent pregnancy after OASIs has not been largely based on obstetrician opinion. It has been suggested that a caesarean section should be performed even after transient anal incontinence but this has been questioned [1043].

In order to counsel women with previous OASIs appropriately, Sultan et al [989] find it useful to have a symptom questionnaire, anal ultrasound (Figure 13) and manometry results (Figure 15). It has been shown that clinical assessment alone has a poor sensitivity for detecting anal sphincter defects [1044]. If vaginal delivery is contemplated then these tests should be performed during the current pregnancy

unless performed previously and found to be normal. In a prospective study over a 5 year period, Scheer et al [1045] followed the protocol shown in Figure 15 and found that when women who had no evidence of significant anal sphincter compromise based on anal endosonography and manometry were allowed a vaginal delivery (the others were offered caesarean section) there was no deterioration in symptoms, anorectal function or quality of life. Other units have also reported favourable outcomes when vaginal delivery and caesarean section were offered on selected criteria [1046, 1047]. Although 11% of textbooks recommend a prophylactic episiotomy [980] there is limited evidence that an elective episiotomy prevents subsequent anal sphincter disruption [1007] while other studies have indicated that episiotomy may increase the prevalence of anal sphincter disruption. However, there is no study that has been done evaluating outcome in subsequent pregnancies in which the angle of episiotomy has been controlled for [1048].

3. INSTRUMENTAL VAGINAL DELIVERY

Although only 4% of women delivered by forceps sustain a 3rd/4th degree tear, up to 50% of those that do tear have an instrumental delivery [985]. Vacuum extraction is associated with fewer OASIs than forceps and this view is supported by two large randomized studies [1049, 1050]. A UK study [1049] where mediolateral episiotomy is practised reported severe vaginal lacerations in 17% of forceps compared to 11% of vacuum deliveries and a Canadian study [1050] where midline episiotomy is practised reported OASIs in 29% of forceps compared to 12% of vacuum deliveries. In a Cochrane review [1051], forceps were less likely than the vacuum extractor to fail to achieve a vaginal birth (risk ratio 0.65, 95% confidence interval (CI) 0.45 to 0.94). However, with forceps there was a trend to more caesarean sections, and significantly more third- or fourth-degree tears (with or without episiotomy), vaginal trauma, use of general anaesthesia, and flatus incontinence or altered continence. Facial injury was more likely with forceps (RR 5.10, 95% CI 1.12 to 23.25). Serious neonatal injury was uncommon with either instrument.

A 5 year follow-up of infants who participated in a randomized trial of forceps and vacuum delivery has confirmed that there is no difference in terms of neurological development and visual acuity with use of either instrument [1052]. Compared to vacuum delivery, 'occul't trauma to the anal sphincter has been identified more frequently in forceps delivery occurring in up to 80 percent of women [937, 964, 1053]. A small randomized study (n=44) confirmed this by identifying occult anal sphincter defects in 79% of forceps compared to 40% of vacuum deliveries [1053]. Trauma occurs more frequently when a second instrument is used to attempt vaginal delivery [1053] and therefore

if no descent of the head occurs following appropriate cup selection and application technique of vacuum extraction, one should resort to a caesarean section. Metal cups appear to be more suitable for 'occipito-posterior', transverse and difficult 'occipito-anterior' position deliveries [1054]. The soft cups seem to be appropriate for straight forward deliveries as they are significantly more likely to fail to achieve vaginal delivery. Although, they were associated with less scalp injury, there was no difference between the two groups in terms of maternal injury. Farrell et al [1055] performed a prospective study of 690 primigravid women and found that forceps delivery was associated with a higher incidence of flatal incontinence (RR 2.6) compared to spontaneous vaginal delivery and a higher incidence of both flatal (RR 2.6) and faecal (RR 3.6) incontinence compared to caesarean delivery. Vacuum delivery did not increase the risk of flatus incontinence. MacArthur et al [938] performed the largest questionnaire based multicentre study to establish the prevalence of FI at 3 months post-partum. They reported a prevalence of 9.2%, with 4.2% reporting it more often than rarely. Compared to vacuum extraction, forceps delivery was associated with almost twice the risk of developing FI. Thakar and Eason [1056] performed a meta-analysis and demonstrated that one anal sphincter injury is avoided for every 18 women delivered by vacuum extraction instead of forceps. De Leeuw et al [1057] have shown that when a mediolateral episiotomy is performed during a forceps delivery, the risk of anal sphincter injury is reduced by almost 80%.

The occipito-posterior position at delivery is a known risk factor for the development of a third degree tear and the risk of anal sphincter injury doubles with a vacuum delivery but trebles with the forceps [1058]. It is strongly recommended that a liberal episiotomy should be performed in the presence of an occipito posterior position. When the baby's head is in the occipito-posterior position the diameter presenting at the outlet is larger than that of an occipito-anterior position. Therefore it is more likely to cause a delay in progress and also more likely to result in a more extensive perineal tear particularly with an instrumental delivery.

4. EPISIOTOMY

There are observational data to indicate that a reduction in episiotomy rate is not associated with an increase in OASIs. The Cochrane database [1059] shows that restricting the use of episiotomy is associated with less posterior trauma. Although there was an increase in anterior perineal trauma it had no effect on the development of urinary incontinence. Henriksen et al [1060, 1061] performed an observational study in which they noted that when midwives who previously had a high episiotomy rate reduced their rate, the prevalence of OASIs also reduced. However, this beneficial effect was abolished when midwives with a low rate of episiotomy attempted to reduce it even further. Based on this evidence, it was

suggested that the ideal episiotomy rate should lie between 20 to 30% and no more. Midline episiotomies are more popular in North America as it is believed that they are more comfortable and recovery is less complicated. However Coats et al [1062] performed a quasi-randomised study of 407 primiparae and found 24% of midline episiotomies extended into the anal sphincter (partial or complete tears) compared to 9% of mediolateral episiotomies. Although the perineum was significantly less bruised in the midline group and sexual intercourse commenced earlier, pain and wound breakdown was similar in both groups. Kudish et al (2008) performed an observational study in the USA of 46 239 singleton vertex vaginal deliveries and identified two modifiable risk factors for severe perineal trauma, namely, midline episiotomies and forceps delivery. They recommended the use of vacuum extraction and mediolateral episiotomy [1063]. However, care needs to be taken to ensure that mediolateral episiotomies are performed correctly as Andrews et al [1064] has shown that only 22% of doctors and no midwife made the incision commencing from the posterior fourchette with a 40 to 60 degree angle from the midline. Another study demonstrated that for every six degrees away from the midline there was a 50% reduction in OASIs [1065]. It has also been shown that the angle of incision when the head is crowning is underestimated such that a 60 degree angle measures 45 degrees after delivery [1066].

However, Naidu et al have shown that doctors and midwives were poor at cutting at the prompted episiotomy angle of 60° [1067]. This highlights the need to develop structured training programmes to improve the visual accuracy of estimating angles or the use of fixed angle devices to help improve the ability to estimate the desired angle. There is evidence that Episissors 60 does cut at a 60 degree angle and its introduction in obstetric units is associated with a reduction in OASIs in nulliparous women undergoing spontaneous vaginal deliveries [1048].

5. DELIVERY TECHNIQUES

Pirhonen et al [1068] compared the frequency of OASIs in low risk deliveries between two Scandinavian countries (26 541 vaginal deliveries) and found the risk to be 13 times higher in Sweden (Malmo) vs Finland (Turku). They speculated that the only explanation for this was a difference in manual support given to the baby's head during crowning and pushing the perineum under the chin. Jonsson et al [1069] performed a randomised trial between the Ritgen's maneuver and standard delivery but found no significant difference in OASIS rates. However, only 50% of the eligible women were assigned and almost 20% of the women randomized to the Ritgen's maneuver did not have this method of delivery. Hals et al [1070] provided the best available evidence to show how an interventional program in four Norwegian hospitals can reduce the frequency of OASIs. The program involved a 2-3 day course at the delivery suite of each

hospital that included training on delivery with perineal support and delivery of the neonates. In addition, restrictive mediolateral/ lateral episiotomy was recommended. OASIs rates reduced from 4.16-5.25% before intervention to 1.73% during the last year of intervention

The following interventions with randomized controlled trials evidence regarding effectiveness demonstrated no effect on OASIs: antenatal perineal massage, pelvic floor exercises in pregnancy, water births, positions during labour and birth, epidural analgesia, early vs delayed pushing with epidural and second stage pushing advice [1056]. Although one small randomized trial showed otherwise [940] other large observational studies, have shown that duration of the second stage of labour is an independent risk factor for the occurrence of OASIS [955, 958, 982, 1070, 1071].

6. TRAINING

McLennan et al [1072] who surveyed 1177 fourth year residents and found that the majority of residents had received no formal training in pelvic floor anatomy, episiotomy or perineal repair and supervision during perineal repair was limited. Stepp et al [1073] found that textbooks used in American practice offered little in terms of prevention and repair of perineal trauma. There is evidence from one study [975] that perineal anatomy is poorly understood by midwives and trainee doctors, who perform the bulk of deliveries in the UK. In this study 41% of trainees and 16% of midwives incorrectly classified a partial or complete tear of the EAS as 'second degree'. Inconsistency in classification of tears would allow many injuries to pass, unrecognised. In another study conducted in the USA, the majority of residents demonstrated sub-standard skill in repairing OASIs [1074]. It has been shown that hands-on workshops on perineal repair (www.perineum.net) can change practice [1075-1078] and intensive and focused training in perineal anatomy and repair should therefore become an essential module in the programme for trainees and midwives.

7. IRRITABLE BOWEL SYNDROME (IBS)

IBS affects 3-17% in selected populations and the cause remains unknown. Donnelly et al [1079] recruited 312 primiparous women and reported that 11% of young primiparous women (n= 34 of 208) suffered from pre-existing IBS prior to their first pregnancy. Twenty four percent reported symptoms of impaired faecal continence in the puerperium but symptoms were found significantly more frequently in those with IBS compared to those with normal bowel habit (71% vs 18%). However, women suffering from

IBS are no more likely to incur mechanical or neurologic injury to the anal sphincter. Women with IBS delivered by caesarean section did not have altered continence postpartum. However, 6 months postpartum there were no symptomatic differences between those with IBS and those without but only 90 of the 107 women who had either impaired faecal continence or abnormal anal manometry were studied. Treatment is directed towards the predominant symptom and although antispasmodics such as hyoscine, mebeverine and dicyclomine are used widely to relax intestinal smooth muscle, they should be avoided during pregnancy. Robinson et al used validated questionnaires and bowel symptom diaries and found that the symptoms of urgency and diarrhoea in women with irritable bowel syndrome amplify the risk of anal FI in women who have sustained OASIs [1080].

8. CONCLUSIONS AND RECOMMENDATIONS

- i) Compared to forceps, the vacuum extractor is associated with less perineal and anal sphincter trauma. (Level 1)
- j) Compared to midline episiotomy, mediolateral episiotomy is associated with a significantly lower risk of 3rd/4th degree tears (Level 1)
- k) Liberal use of episiotomy is not beneficial (Level 1) and restricting the rate of episiotomy to about 30% may reduce the risk of trauma to the anal sphincter (Level 4)
- l) A prolonged active second stage of labour is associated with denervation of the pelvic floor and one study has suggested that this also occurs with a prolonged passive second stage of labour with epidural analgesia. In these circumstances, early use of oxytocics in the second stage of labour may be useful. (Level 4)
- m) Selective use of caesarean section may be beneficial particularly in those who have evidence of compromised anal sphincter function and those who have had previous successful continence or prolapse surgery. (Level 4)
- n) Modification in techniques of delivery of the baby particularly appropriate perineal support may reduce anal sphincter injury and further? Compared to midline episiotomy her research is needed (Level 3)
- o) A more focused training program for doctors and midwives needs to be implemented. There is a poor understanding of perineal and anal sphincter anatomy and hence identification of anal sphincter trauma, incorrect classification and poor outcome of repair (Level 4)
- p) There is increasing evidence supporting the identification and repair of the internal anal sphincter.

Repair techniques of the external sphincter (overlap versus the end-to-end) for full thickness tears are inconclusive and more long term research is needed (Level 1)

VIII. PATHOPHYSIOLOGY OF INCONTINENCE IN MEN

Urinary incontinence (UI) in men as in women, which is subdivided into three major groups as there are urgency, stress and mixed UI, may be caused by either an abnormality of the bladder (UUI), an abnormality of the bladder outlet (SUI) (bladder outlet which includes the internal (IUS) and distal of the prostate the external urethral sphincter (EUS)), or a combination of both (MUI) [1081-1083]. Changes in bladder ultrastructure and function that can occur as a result of neurological disease or ageing (that can cause detrusor overactivity or underactivity) are in men [1084].

Many of these foci are around benign and/or malignant diseases of the prostate and their treatment. For example in men the prevalence of detrusor overactivity and impaired compliance causing incontinence are not associated with the bladder outlet obstruction caused by benign prostatic obstruction [1084, 1085].

Key outlet functions are; maintained closure for urine storage, increased closure (guarding) during exertion, sustained opening for voiding, transient opening for territorial marking in animals and orthograde male ejaculation. These are coordinated by several spinal and higher CNS centers, with overlap of the somatic, sympathetic and parasympathetic nervous systems [1086]. Also sphincter insufficiency resulting in stress urinary incontinence (SUI) does not generally occur as the result of ageing, but rather as the attribute of surgery (for benign or malignant conditions) or radiation of the prostate followed by transurethral resection or neurological injury [1087]. The ectopic ureter in the male does not cause incontinence as its insertion into the lower urinary tract is always proximal to the external urethral sphincter. Extra-urethral incontinence in men is only known as a result of a fistula, where as it can occur in the female because of embryological considerations. Fistulae in men are most often iatrogenic (surgery, radiotherapy, cryotherapy, HIFU (High-intensity focused ultrasound)) or inflammatory (diverticulitis).

This section will focus on the Pathophysiology of incontinence as it relates to prostatic obstruction and its treatment and the treatment of prostate cancer.

1. CONTINENCE MECHANISM IN THE MALE

The internal urethral sphincter (IUS) has its source at the urinary bladder's inferior neck (smooth muscle) continues through the prostatic urethra above the

verumontanum and remains under autonomic control. The external urethral sphincter (EUS) located distal to the prostate at the level of the membranous urethra as the secondary sphincter to control the flow of urine. It contains mainly striated muscle and is therefore under voluntary control by the somatic nervous system. Opposite to the female sphincter, the male closing mechanism of the bladder is separated by the prostate.

At the boundary between the IUS and EUS, the striated and smooth muscle fibres intertwine to some extent. The external urethral sphincter (EUS) extends from the prostatic urethra below the verumontanum through the membranous urethra. EUS includes the rhabdosphincter (intrinsic skeletal and smooth muscle) and extrinsic paraurethral skeletal muscle. At the prostate level, the superior part of the striated EUS is largely confined to the anterior side of the urethra and prostate. Inferior to the prostate, the EUS is horse-shoe-shaped (although named as the rhabdosphincter, omega shaped) with the opening on the dorsal side. The dorsal muscle fibers of the left and right sides approach the midline and sometimes cross the prostate [1088-1090].

For simplicity, the normal male urinary sphincter mechanism may be divided into two functionally separate units, the internal urethral sphincter (IUS) and the external urethral sphincter (EUS) [1091]. The IUS consists of the bladder neck, prostate and prostatic urethra to the level of the verumontanum. The IUS is innervated by autonomic parasympathetic and sympathetic fibres from the inferior hypogastric plexus. The EUS extends from the verumontanum to the proximal bulb and is comprised of a number of structures that help to maintain continence. The male EUS urethral sphincter complex is composed of the prostatic-membranous urethra, cylindrical rhabdosphincter (external sphincter muscle) surrounding the prostatic-membranous urethra, and extrinsic paraurethral musculature and connective tissue structures of the pelvis. The rhabdosphincter is a muscular structure consisting of longitudinal smooth muscle and slow-twitch (type I) skeletal muscle fibers, which can maintain resting tone and preserve continence [1088, 1092, 1093]. The striated muscle of the rhabdosphincter is considerably thicker ventrally and thins dorsally. Striated muscle fibres of the rhabdosphincter have been shown to intermingle with smooth muscle fibres of the proximal urethra, suggesting a dynamic and coordinated interaction. The rhabdosphincter is invested in a facial framework, and supported below by a musculofascial plate that fuses with the midline raphe, which is also a point of origin for the rectourethralis muscle [1094]. Superiorly, the fascial investments of the rhabdosphincter fuse with the puboprostatic ligaments [1095]. This dorsal and ventral support probably contributes to the competence of the sphincter. The striated fibers of the extrinsic paraurethral muscle (levator ani complex), on the other hand, are of the fast-twitch (type II) variety [1092]. During sudden increases in abdominal

pressure, these fibers can contract rapidly and forcefully to provide continence. Continence is maintained even after inducing paralysis of the striated sphincter indicating that this structure is not solely responsible for continence [1096]. In addition, unlike in the female where urethral support can be compromised as a result of childbirth and aging [1097], in the majority of the cases the male rhabdosphincter is functioning improperly related to prostate surgery [1098]. The striated muscle fibres of the rhabdosphincter intermingle with smooth muscle fibres of the proximal urethra and in fact have been shown to be inseparable from each other [1089]. In the past related to the approach of radical prostatectomy the smooth muscle fibres concordant into the bladderneck (IUS) were resected, which interrupted innervation. It is worth noting that impaired detrusor contractility seems to be frequently associated with intrinsic sphincter deficiency. With the increasing knowledge of the periprostatic nerves and the improvement of the preservation of the bladder neck (IUS) the functional outcome improved even further [1099].

The EUS is innervated by the autonomic (via the pelvic nerve) and somatic (by the pudendal nerve) nervous systems. Nerve fibres are seen proximally in a dorsolateral position (5 to 7 o'clock), while more distally, they are located primarily laterally [1094, 1100]. The intrinsic smooth muscle of the proximal urethra receives parasympathetic innervation from pelvic nerve branches of the inferior hypogastric plexus [1100, 1101]. The rhabdosphincter may also receive somatic innervation. Hollabaugh et al. described the so-called "putative continence nerves" as branches of the pelvic nerve travelling under the endopelvic fascia picking up intrapelvic branches of the pudendal nerve, given off before it enters the pudendal canal, which was further verified by Castello et al. [1100, 1102]. It has also been proposed that somatic innervation from the pudendal nerve after it exits the pudendal canal is primarily sensory in origin, facilitating reflex contraction of the sphincter complex to maintain continence [1103, 1104].

An elegant histological and immuno-histochemical study with 3-D reconstruction in the male fetus has confirmed mixed autonomic and somatic innervation (Figure 16) [1088]. Unmyelinated (autonomic) nerve fibres destined for smooth muscle fibers run alongside of the myelinated (somatic) fibers. The majority of the unmyelinated fibers approach the smooth muscle layers at 5 and 7 o'clock while the majority of myelinated fibres penetrate the striated sphincter at 3 and 9 o'clock.

Structure and innervation are important components of sphincter function. In addition, Tuygun et al have found a much higher incidence of periurethral (or perisphincter) fibrosis in incontinent vs. continent men after prostatectomy [1105]. Using MRI at least 6 months after prostatectomy they discovered that all 22 incontinent men had periurethral fibrosis while only 4/14 (29%) continent men did [1106, 1107]. This might

lead to the importance of the corpus spongiosum, which surrounds the bulbar urethra and supports with its blood filling in addition to the sphincteric function.

In summary, sphincter continence in male is dependent on the integrity of the IUS and/or EUS, its support structures and neural innervation and probably the prostate, as long it is not enlarged to cause obstruction. Following the removal of the IUS during radical prostatectomy, continence seems to be mainly maintained by the EUS mechanism, consisting of soft tissue supportive structures, smooth muscle, and striated muscle. This outcome even improved even further related to the surgical techniques by the additional preservation of the IUS. The smooth muscle and slow twitch striated muscle of the rhabdosphincter (EUS) are probably majorly responsible for the sphincter continence; however, striated muscle contractions of the periurethral and paraurethral muscles

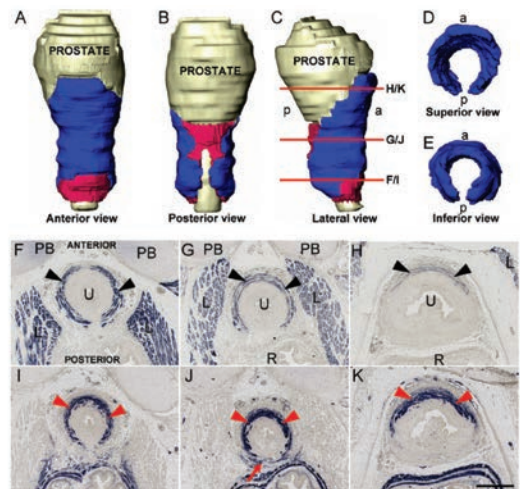

Figure 16: The external urethral sphincter (EUS) and internal urethral sphincter (IUS) in a male fetus (12 wk of gestation). Three-dimensional reconstruction in (A) anterior view, (B) posterior view, (C) right-lateral view, (D) superior view, and (E) inferior view. The EUS is shown in blue, and the IUS is shown in pink. The urethra and prostate are shown in light grey. Anterior and posterior directions are represented by the letters "a" and "p." Immunohistochemically stained sections from inferior (F) to superior (H) stained immunohistochemically for striated muscle, showing the EUS (black arrowheads). Panels (I) through (K) are from same level as sections (F) through (H), stained immunohistochemically for smooth muscle, showing the IUS (red arrowheads). Note the smooth muscle tissue at the dorsal side of the urethra, where the striated muscle of the external sphincter is lacking; see red arrow in (J). Red lines in (C) illustrate the level of the sections as seen in (F) through (H). L = levator ani muscle; PB = pubic bone; R = rectum; U = urethra; bar = 0.5 mm. From Wallner et al, *Eur Urol* 55(4):932-944, 2009 [1088]

are likely assist. Damage to the innervation (parasympathetic and somatic) of the smooth and striated muscle may indirectly contribute to post-prostatectomy incontinence. In addition compromise of the sphincter support mechanism or post-operative changes such as fibrosis can compromise sphincter function (Figure 16, 17).

2. INCONTINENCE ASSOCIATED WITH BPH AND ITS TREATMENT

Benign prostatic hyperplasia (BPH) and benign prostatic obstruction (BPO) and their treatments have long been associated with incontinence in men. De-

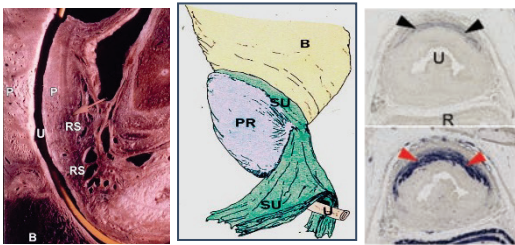

Figure 17: From Colliselli et al., *World J Urol*, 2000, 18:324-9

trusor Overactivity (DO), impaired compliance and urgency incontinence are prevalent in men with BPO. The prevalence of OAB ranges in adult males from 10% to 26% and in adult females from 8% to 42%. It increases with age and often is associated with other LUTS [1108]. In men undergoing urodynamic testing detrusor overactivity is present in 40-80% of patients with obstruction [1109-1111]. In addition, impaired compliance, another potential cause of incontinence, has been shown to have a high correlation with outlet obstruction in men [1112, 1113]. Thus even before treatment of BPH and BPO there is a notable incidence of bladder dysfunction and incontinence.

Incontinence after the treatment of BPH may be related to persistent bladder dysfunction, new onset bladder dysfunction or sphincter dysfunction (injury). However, one European survey of 840 men reported lower prevalence of UI after transvesical prostatectomy for BPH compared to other studies [1114]. Turner-Warwick et al first directed attention to the relationship of bladder outlet obstruction, the symptoms of frequency, urgency and urge incontinence (now commonly known as LUTS: Lower Urinary Tract Symptoms) and the correlation of these symptoms with detrusor overactivity seen on cystometry [1115]. They noted that in 75% of men, symptoms were relieved by de-obstruction. Leng and McGuire showed improvement in compliance after de-obstruction in 7/9 men with severely impaired compliance (<5 ml/cmH₂O), but only one man regained "normal" bladder compliance [1116]. Several contemporary explanations for the cause of persistent overactivity after obstruction endure. These include denervation

supersensitivity of the bladder muscle [1117, 1118], alterations in collagen composition of the obstructed bladder [1119], emergence of altered and increased sensory reflexes mediating the micturition reflex [1120, 1121] and physical changes in detrusor myocytes affecting electrical transmission [1122] or even the remaining influence of CRP as investigated by Kupelian et al [1123]. In addition, the bladder itself and particularly the trigone may be inadvertently resected during surgery, causing bladder dysfunction or even without prior surgical treatment. Causes of sphincter damage related to transurethral or open prostatectomy include direct damage because of surgical performance and electrocautery or thermal injury to the sphincter [1124].

Recently, Han et al conducted a retrospective data analysis using a managed care data set (Integrated Healthcare Information Services National Benchmark Database) from 1997 through 2003 [1125]. They identified a cohort of men with BPH using International Classification of Diseases, Ninth Revision (ICD-9) codes. From a total of over 12 million men, 411,658 men with BPH (3.3%) were identified. The group then determined the nature of incontinence in these men with BPH focusing on its incidence, prevalence, and management. Furthermore they stratified patients by therapeutic subgroups of watchful waiting, alpha blockers, 5-alpha-reductase inhibitors and surgery. Of the total cohort, 2.7% had a diagnosis of incontinence. Most of these men (87.5%) did not have prior BPH surgery, but those who did have surgery 12.5% were diagnosed with incontinence. The rates were almost identical whether the procedure was transurethral resection or incision, laser, transurethral needle ablation, transurethral microwave therapy [1126]. Newer data suggests that the open prostatectomy might be more effective and safer than the transurethral approaches, which probably depends to the size of the prostate and the experience of the surgeon [1127, 1128]. The rate of incontinence after the surgical treatment was 1.4% for both stress and mixed incontinence, 4.5% for urge incontinence and 6.5% for unspecified incontinence whereas the incontinence rates for men on watchful-waiting, alpha-blockers, 5-alpha-reductase inhibitors and combination therapy were 6.4%, 5.7%, 5.1%, and 6, 5% respectively [1125]. This study provides some interesting data but must be interpreted with caution. The diagnosis of incontinence was limited by what the patient and provider considered incontinence and was not often confirmed by objective testing.

Nevertheless, the relationship of BPH and incontinence can clearly be inferred. Until the last decade, transurethral resection of the prostate and open prostatectomy accounted for the majority of surgical procedures to treat BPO. In 1989, the American Urological Association published two major series on TURP and its complications. The AUA cooperative study included 3,885 patients from 13 teaching centres and private practices [1129], while the second consisted of a survey of all practicing urologists in the United States of whom 2,716 urologists responded [1129].

Rates of post-TURP incontinence requiring a pad or collection device were 0.4% in the first and 3.3% in the second study. The AUA Cooperative study also reported mild stress incontinence in 1.2% [1130]. In 1994, the Agency for Health Care Policy and Research published clinical guidelines for the diagnosis and treatment of benign prostatic hyperplasia. The guidelines panel reviewed 27 articles about transurethral prostatectomy and 30 articles reporting open prostatectomy to analyse treatment outcomes. The panel reported that the risk of total incontinence, defined as complete loss of voluntary control over micturition was of great concern to patients facing a treatment decision for BPH. In an overall ranking of 15 different outcomes, the panel's proxy judges ranked total incontinence of urine as the fourth most important outcome influencing a treatment decision. After TURP, 2.1% of patients experienced stress incontinence, 1.9 % had urge incontinence, and 1.0% reported total incontinence. The panel attempted to abstract data on urge incontinence, but found very few studies reporting this particular outcome, therefore a statistical analysis was not performed. For open prostatectomy stress incontinence occurred in 1.9%, urgency incontinence in 0.5% and total incontinence in 0.5% of patients.

Most studies evaluating post TURP and open prostatectomy incontinence have found a significant incidence of sphincter and bladder dysfunction. The incidence of sphincter dysfunction ranges from 20-92% and bladder dysfunction from 56-97% [1131-1136]. The relatively high incidence of sphincter dysfunction may seem somewhat surprising as the incidence of DO before treatment is so high and it persists in 18-59% after surgery to relieve obstruction [1110, 1115]. Therefore one might expect that a large number of patients would have persistent detrusor overactivity and urge incontinence. However, in large series, sphincter dysfunction appears to be the main cause of incontinence. The high incidence of sphincter dysfunction is likely to represent a selection bias, e.g. large numbers of patients referred to tertiary centres for treatment of stress incontinence. Nitti et al evaluated patients with voiding dysfunction after TURP and found that of those who had incontinence 75% had bladder dysfunction, while only 20% had sphincter dysfunction (the cause of incontinence could not be identified in 5%) [1137]. Twenty-seven percent of incontinent patients with bladder dysfunction also had obstruction. In the past decade, alternatives to TURP for the treatment of BPH have emerged. Most notably are thermal therapies and laser resection/enucleation of the prostate. Thermal therapies are considered "less invasive" and outcomes in most series are not comparable to traditional TURP with respect to efficacy. However some laser treatments provide similar efficacy in well-selected patients, at least in the short term. Studies that have evaluated that holmium laser resection (HoLRP) and potassium titanyl phosphate (KTP) laser vaporisation of the prostate have shown a similar incidence of incontinence. Two randomised

controlled trials of holmium laser versus TURP have shown rates of stress incontinence to be very similar. Westenberg et al showed the incidence of stress incontinence with or without urge incontinence to be 7% for HoLRP versus 6.7% for TURP at a minimum of 4 years follow-up [1138]. Kuntz and colleagues found just 1% stress incontinence in each group at 12 months [1139]. They also showed a similar rate of resolution of preoperative urge incontinence for both groups (81% versus 85%). Two other prospective non-randomised trials of HoLEP found 0.6%-2.5% incidence of stress [1140]. Two randomised controlled trials of KTP (green light) laser versus TURP reported 0% and 1% stress incontinence in each group respectively [1141, 1142] while a third randomised trial did not mention incontinence [1143]. A recent study comparing green light with TURP showed a comparable 24-month outcome and safety profile [1144]. Retrospective studies on Greenlight showed a 2-3.3% incidence of stress incontinence [1145, 1146]. Te, et al. [1147] reported 1 year results of Green Light in the first US multicentre prospective trial. At 12 months 2 of 139 men had persistent new onset UI. They reported no stress incontinence. Others report no superiority outcome to standard approaches except the hospitalisation time [1148].

In addition to the surgical treatment, it needs to be kept in mind that males with urinary tract infections (UTIs) had higher adjusted rates of UI with a pooled odds ratio of 3.5 (95% CI: 2.3; 5.2) [1149-1153]. Acute genitourinary toxicity, enuresis, incomplete urination (residual), and other urological conditions were associated with higher adjusted odds of UI in all studies that examined the relationship [1149, 1154-1156].

Recently new minimally invasive treatment options entered the market. Beside one prostatic urethral lift (UroLift®) none has been compared to the standard of surgical benign treatment the TURP. Although the rate of postoperative incontinence did not differ significantly after one year (UroLift 85% vs. TURP 75%, p=0.4 patients recovered significantly faster from the minimally invasive procedure [1157]. In a similar way the results in a cross-over study was reported (LIFT®) and during the American Urology Association meeting in San Diego 2016 with a two year follow-up [1158]. Roehrborn reported that the adverse event of UI after UroLift were moderate to mild in the initial published data [1159].

Other treatment options have not yet been adequately evaluated but will influence the patients choice [1160].

3. INCONTINENCE ASSOCIATED WITH RADICAL PROSTATECTOMY

3.1. Incidence

The incidence of incontinence after radical prostatectomy has been a source of controversy over the past

several decades as reported rates have varied greatly depending on the definition and methodology of data collection. The incidence has probably declined over the past two decades, owing to advances in surgical technique and to earlier recognition of lower stage disease in younger patients, however the prevalence of post-prostatectomy incontinence has risen; paralleling the increase in surgical procedures performed annually [1161]. In 1991, Foote et al tabulated data from series published between 1977 and 1990, and reported a range of incontinence rates from 2.5 to 87% after radical prostatectomy [1162]. In general, older single-institution studies utilizing physician assessments to determine incontinence rates report relatively low rates (5-8%) [1163-1167]. Another study with a follow-up of up to 5 years reported a frequent leakage in 14% or no urinary control men 60 months after diagnosis [1168]. A variety of definitions of incontinence were used, making comparison of data difficult. Since then, validated patient questionnaires have been developed, which help to standardize definitions of incontinence, allow easier comparison between institutions, and assess of the impact of incontinence on quality of life. This eliminates physician bias perhaps improving accuracy [1169-1171], although it introduces the caveat that questionnaire-based data may reflect subjective urine leakage but does not correlate with bother or actual urine, especially for mild degrees of incontinence [1172-1173]. As expected these studies show the incidence of incontinence to be significantly higher, 13-65%, depending upon the definition.

In recent years robotic radical prostatectomy has gained popularity and nowadays, probably the majority of radical prostatectomies are performed with the support of robot surgical assistance. This surgical approach (trans- vs. extraperitoneal) has been further developed so that the outcome related to the approach needs to be evaluated periodically following further developments [1174]. Similar to what has been observed with open radical prostatectomy, the continence rates tend to increase with longer follow-up and may continue to improve even beyond 12 months [1175]. The continence rates from several large recently published series ranged from 68 to 97% at 12 months post-surgery [1175-1180], reaching to the laparoscopic date with the longer time of experience this doesn't make sense (continence range 12 months post op: 84.9 – 94 (mean 72%) [1181]. In their prospective study Jacobson et al reported that there were no differences in urinary functional outcomes one year after open radical retropubic prostatectomy or laparoscopic radical prostatectomy [1182] with 20 - 27% reported to have achieved immediate continence following catheter removal [1176, 1178, 1179]. Anterior vesicourethral reconstruction [1183], posterior vesicourethral reconstruction [1184] and total reconstruction [1185] have been described to increase the continence rate and hasten time to recovery of continence. As in earlier open prostatectomy series, robotic series tend to be

single institution studies with physician reported outcomes and continence status based on no or 0-1 pads. In the meantime the data, which compared open vs. robotic radical prostatectomy became more robust demonstrating that continence post-operatively is in favour for the robot assistant radical prostatectomy [1186, 1187]. Others report this for the early post-operative phase and equal after one year.[1188]

In 1993, The American College of Surgeons Commission on Cancer reviewed the reported results of 2,122 patients treated by radical prostatectomy performed at 484 institutions in 1990 [1189]. Only 58% reported complete continence, 23% reported occasional incontinence not requiring pads, 11.2% wore 2 or fewer pads per day, 4% wore more than 2 pads per day, and 3.6% were completely incontinent. Fowler et al [1190] published the results of an outcomes study on a series of Medicare patients with less encouraging results. In this series patients age >65 surveyed by mail, telephone, and personal interview, over 30% reported currently wearing pads or clamps to deal with wetness; over 40% said they dripped urine during cough or when the bladder was full; 23% reported daily wetting of more than a few drops. Six percent had surgery after the radical prostatectomy to treat incontinence.

There appear to be differences in physician vs. patient reported outcomes and centres of excellence versus community surgeons' outcomes [1191]. When trying to interpret all of the data, it is clear that the varying definitions of incontinence make comparisons impossible. Even using the definition of pad free totally continent has its limitations. Rodriguez et al [1180] found that 70% of men who attained "pad-free continence" after radical prostatectomy have occasional incontinence. Conversely, Lepor et al [1192] asked the single question "Do you consider yourself continent?" at 3-24 months after surgery where 97.1% of men answered yes. They found that the best correlation of objective measures with a positive were 0 or 1 pad, total control or occasional dribbling, and no or slight problem from incontinence on the UCLA/RAND questionnaire [1192]. There is a wealth of good quality prospective studies evaluating incontinence after prostatectomy in an objective manner. One such study compared continence in patients undergoing open versus laparoscopic radical prostatectomy at one year, using a 24-hour pad test, symptom scores and quality of life measures [1193]. Incontinence was defined as a pad weight of > 8 grams/24 hours. There were no differences in objective and subjective measures between the two groups. Urinary incontinence was present in 13% of open and 17% of laparoscopic cases. In practical terms incidence of incontinence that produces bother, no matter what its degree, is the true parameter of interest. However, because of the individual variability of bother and the way data have been collected, we must be aware of the limitations of the historical data in the literature. Tables 7 and 8 highlight the reported rates of post-prostatectomy incontinence in large

contemporary series using physician-gathered and self-reported data respectively. Most large series are on radical retropubic prostatectomy as opposed to radical perineal prostatectomy.

Table 7: Incidence rates of incontinence following radical retropubic prostatectomy based on physician assessment in single institution studies.

Reference	N	F/U (mo)	Mean age (range)	Subjective leakage	Pad use
Patel, et al (2007) [678]	500	12	63.2	N/A	3% (not all patients had 12 month data)
Catalona, et al (1999) [666]	1328	50	63 (38-79) 40-49; 53 50-59; 358 60-69; 632 70+; 282	N/A	8%
Eastham, et al (1996) [667]	581	24	63 med	Stress: 5% Severe: 4%	N/A
Geary, et al (1995) [668]	458	>18	64.1 ± 0.3	N/A	1-2 pads/day – 8.1% 3-5 pads/day – 6.6% Total Incont – 5.2%
Zincke, et al (1994) [671]	3170	12	65.3 (31-81)	N/A	3 or more pads/day: Pre 1988 – 7.9% Post 1988 – 5%
Leandri, et al (1992) [669]	398	12	68 (46-84)	STRESS URINARY INCONTINENCE – 5% Total – 0	5%
Steiner, et al (1991) [670]	593	12	? (34-76)	STRESS URINARY INCONTINENCE – 8% Total - 0	<1 pad/day – 2.2% 1 pad/day – 3.5% 2 pads/day – 1.5% >2 pads/day – 0.5%

Table 8: Incidence rates of incontinence following radical retropubic prostatectomy based on data gathered from validated patient questionnaires.

Reference	N	F/U (mo)	Age (range)	Subjective leakage	Pad use
Lepor, et al (2004) [688]	621	24	58.7 (37-75)	Patients considered "continent" on self assessment	0-1 pad/24 hours
Stanford, et al (2000) [690]	1291	18	<65 – 56% >65 – 44%	Occasional – 40% >Occasional – 8.4%	1-2 pads/day – 18.3% >3 pads/day – 3.3%
Kao, et al (2000) [691]	1069	N/A	63.6 (30-77)	65.6%	33%
Wei, et al (2000) [672]	217	12	62.3 (40-80)	Any leakage – 47% >1 episode/day – 65%	13% (> 1 PPD)
Fontaine, et al (2000) [692]	116	51.6	65.2 (48-76)	14.4%	19.8% 1 pad/day – 74% 2 pads/day – 13% >3 pads/day – 13%
Walsh, et al (2000) [693]	59	18	57 (36-67)	N/A	7%
McCammon, et al (1999) [673]	203	40.3 (12-144)	63.7 (43-73)	61.8%	23.7%

Reference	N	F/U (mo)	Age (range)	Subjective leakage	Pad use
Bates, et al (1998) [694]	87	22 (7-87)	65 (49-73)	69%	24% 1 pad/day – 60% 2 pads/day – 15% >3 pads/day – 25%
Talcott, et al (1997) [695]	94	12	61.5	13%	39%
Donnellan, et al (1997) [675]	51	12	?	Mild – 14% Moderate – 4% Severe – 2%	Pad test Mild – 6% Moderate – 6% Severe – 4%
Jonler, et al (1996) [696]	86	22.5 (12-48)	64 (49-75)	Some – 59% >Few drops – 30%	47%
Goluboff, et al (1995) [650]	480	36.4 (12-106)	62.6	Occasional, no pads – 56.6% Daily incontinence – 8.2%	Regular use – 8.2%
Fowler, et al (1993) [686]	757	>24	65-69 – 51% 70-74 – 39% >74 – 10%	Some – 47% >Few drops and every day – 23%	31%

3.2. Recovery of Continence after Radical Prostatectomy

While the majority of patients experience incontinence immediately following RRP, in most this is transient with a gradual improvement over time. It needs to be kept in mind that there is even a group of about 4% who might be incontinent prior to surgery ($\geq 8g$) although they might not consider themselves as incontinent [1194]. Most studies report progressive return of continence up to one year after surgery and in general intervention for incontinence is usually delayed until one year after surgery unless absolutely no progressive improvement is seen. Thus, most prostatectomy series report continence rates at 1 year. Lepor and Kaci [1192] showed that continence may continue to improve up to 24 months based on objective and subjective measures. They showed modest improvements in both (UCLA RAND questionnaire) pad usage and total control rates between 12 and 24 months. Pad weights were not determined so it is possible that some "improvements" could have been related to patient tolerance and expectations over time. Smither et al objectively assessed the natural history of post radical prostatectomy incontinence using a standardised 1 hour pad test [1195]. They showed a rapid improvement in urinary control during the first 18 weeks post-RRP with a flattening of the recovery curve beyond that point. Minimal incontinence defined as $< 1 g$ on a 1 hour pad test was as demonstrated in 3, 37, 66, 85, 87 and 91% of patients at 2, 6, 18, 30, 42, and 54 weeks. They concluded that the 18-week marker appears to be the time point after which the majority of patients have achieved urinary control, although a small percentage will have continued objective improvement. This estimation is chaired by Socco et al reporting the progressive improvement of continence until two years

after RRP but some patients may become? continent incontinent even later [116] whereas others reported that the maximum continence was already reached after three months [1194].

3.3. Risk Factors

An increased risk of post-prostatectomy incontinence in older men is supported in theory by anatomical observations. With advancing age, there is evidence of atrophy of the rhabdosphincter [1094] and neural degeneration [1197]. Several studies have shown advancing age to be a risk factor for postoperative incontinence [–1163, 1164, 1167, 1198-1200]. Steiner et al [1166] found no correlation between age and continence status, but only 21 of the 593 patients were 70 years or older. Catalona et al [1163] reported that "Recovery of urinary continence occurred in 92% (1,223 of 1,325 men) and was associated with younger age ($p < 0.0001$) which might be related to surgical approach (nerve sparing), which might be performed more often in the younger than in the older patient, although they ultimately reach a similar outcome [1201]. It was recently stated by Khoder et al that nervesparing makes sense for the elderly ($>70y$ of age). It needs to be kept in mind that this patient group increased significantly over the recent years [1202]. Most large series have found no correlation between the stage of disease and incontinence rates, whereas Loeb reported the benefit to the younger patient in the high risk group to aim to maintain continence [1203]. However, in certain cases, the stage of disease may affect the surgical technique (i.e. nerve sparing), but this appears to be a reflection on surgical technique and not disease stage [1164].

Authors of several single-institution studies have argued that surgeon experience and surgical technique

are important determinants of post-operative incontinence rates [1100, 1183, 1204, 1205] and many have found that changes in their own technique have led to reduced rates of incontinence or a reduced time to recover continence [1100, 1183, 1206-1208].

This includes procedural modifications such as, nerve sparing (probably secondary to a more careful dissection) [1209, 1210] bladder neck preservation [1211], preservation of anterior urethral ligamentous attachments and urethrovaginal junction reconstruction (Figure 18) [1212].

Patients who have undergone prior radiation for pros-

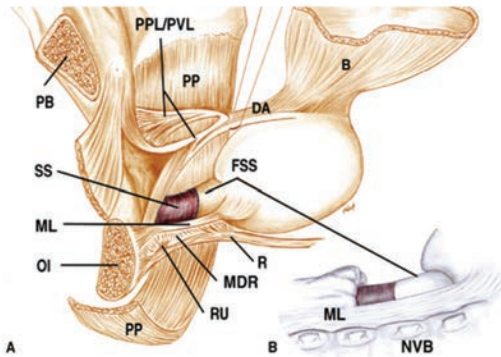

Figure 18: Surgical anatomy of the urethral sphincter complex. (A) Fixation of the urethral sphincter (modified from Luschka [16]). (B) Lateral aspect of the urethral sphincter after nerve sparing. PPL = pubovesical ligament; PVL = pubovesical ligament; PP = puboperinealis muscle; DA = detrusor apron; B = bladder; FSS = fascia of the striated sphincter; ML = Mueller's ligaments (ischio-prostatic ligaments); NVB = neurovascular bundle; R = rectum; MDR = medial dorsal raphe; RU = rectourethralis muscle; OI = Os ischiadicum; SS = striated sphincter (rhabdosphincter); PB = pubis bone.

From Schlomm et al, *Eur Urol* 2011

tate cancer are at high risk of developing incontinence after radical prostatectomy with the possible need of postoperative radiation therapy [1203]. Rates of significant incontinence after salvage prostatectomy range from 57-64% [1213, 1214]. Sanderson and colleagues [1215] reported that 45% of men underwent artificial urinary sphincter placement after salvage prostatectomy and another 31% without an artificial sphincter had incontinence greater than occasional dribbling. This has prompted some to recommend urinary diversion at the time of salvage radical prostatectomy [1216].

3.4. Aetiology and Pathophysiology of Post Radical Prostatectomy Incontinence: Sphincter vs. Bladder Dysfunction

There is fairly extensive literature on urodynamic investigation of post prostatectomy incontinence. While

it is well established that both bladder and sphincter dysfunction may be present after radical prostatectomy, most studies agree that sphincter dysfunction (stress incontinence) is the main cause. Ficazzola and Nitti found that although 46% of patients had bladder dysfunction, incontinence on urodynamic study was demonstrated in only 27%. Even in those patients, sphincter dysfunction was the main cause of incontinence in the overwhelming majority [1207]. Groutz and colleagues found a 33% incidence of bladder dysfunction, but found that it was the main cause of incontinence in only 7.25% [1218]. Two earlier series reported a higher incidence of bladder dysfunction [1132, 1133]. Some authors feel that in some patients with severe intrinsic sphincter deficiency, bladder dysfunction may occur as a result of filling the bladder to volumes that it is not accustomed to holding [1217]. The study of Giannantoni et al. reported that after RRP a high proportion of patients (70.3%) were affected by DO and about half of these patients complained of overactive bladder symptoms of which DO was also observed in 61.2% of patients before surgery, which indicates that the abnormality can be attributed to the surgical damage in a small percentage of patients [1219]. At the 36-month follow-up, the dysfunction persisted in 56.3% of 32 men, and about 40% of these presented with overactive bladder symptoms. At the three year follow-up, the dysfunction persisted in 25% of cases [1219]. Filling to capacity may produce detrusor overactivity or decreased compliance. Thus, bladder dysfunction is in a sense an artefact, but one possibility is partial decentralisation of the bladder as a result of its mobilisation during prostatectomy [1218], combined with somatic denervation, because the branches of the pudendal nerves innervating the pelvic floor muscles and the striated urethral sphincter split before reaching the urogenital diaphragm [86]. This may explain why the outcomes for artificial urinary sphincters for the treatment of stress incontinence are not adversely affected by the presence of detrusor overactivity [1220, 1221]. In addition, bladder dysfunction may be chronic and stem from obstructive uropathy present before prostatectomy. It is also important to note that most of these studies are performed in men seeking treatment for their incontinence. However, it appears that sphincter dysfunction is the primary cause of post-radical prostatectomy incontinence, but bladder dysfunction may be present in a significant number of men (though rarely alone) and must not be completely excluded when planning treatment [1222].

The majority of evidence in the literature supports the conclusion that sphincter damage is the primary cause of incontinence after total prostatectomy. Direct exposure and manipulation of the sphincter during radical prostatectomy would suggest that sphincter damage is the most likely cause of incontinence. Successful treatment with the artificial urinary sphincter and male sling procedures also indirectly suggests that primary sphincter injury is the major cause of incontinence, since outcome is not usually complicated

by bladder dysfunction. It might be helpful to include urodynamics and especially urethral pressure profilometry as suggested by Bentzon et al [1223]. They suggested that postoperative urodynamics after 6 months may be predictive for persistent incontinence due to the bladder, sphincter, and both, that immediate intervention is more appropriate than watchful waiting. They found that sphincter insufficiency was diagnosed by stress incontinence with maximal urethral closure pressure below 30 cmH₂O, decreased functional length and a distinctive profile. For the placement of the artificial sphincter the 2015 consensus conference suggested waiting at least 6 months prior to a AUS-placement [1224]. Bladder dysfunction after prostatectomy may have been present pre-operatively, for example due to pre-existing outflow obstruction, may be caused by the operation itself, or may be due to age related changes in bladder function.

Many patients who have prostate surgery have pre-existing bladder dysfunction, which may or may not be symptomatic. While it is more obvious how an overzealous TURP (with resection into the trigone) can cause detrusor overactivity, it is less apparent how radical prostatectomy affects detrusor function. Some have suggested that denervation of the urethra or the bladder may occur during radical prostatectomy. John et al [1225] studied trigonal innervation by biochemical markers and found that "urinary incontinence was associated with decreased trigonal innervation, a high sensory threshold and low maximal urethral closure pressure" which was evaluated differently by the same author in different reports [1085, 1226].

4. INCONTINENCE RELATED TO RADIATION THERAPY FOR PROSTATE CANCER

Radiation therapy, whether external beam or brachytherapy, can be a cause of voiding dysfunction and incontinence [1222, 1227]. Sometimes this is a direct effect of the radiation or it can be related to the treatment of other sequelae such as urinary retention. The initial response to it is primarily oedema and then gradually degeneration, fibrosis and disorganisation of the bladder musculature. While radiation is primarily delivered to the prostate, portions of the bladder may also be affected. Perivascular fibrosis of blood vessels may then cause vascular occlusion followed by ischemia of the bladder wall, which can then progress to fibrosis within 6 to 12 months [1228]. Choo et al [1229], found that urodynamic bladder capacity decreased by an average of 54 ml, 18 months after radiation therapy. Blaivas et al [1230] evaluated 47 men with symptomatic LUTS after brachytherapy and found that 71% were incontinent and 85% had detrusor overactivity. Similarly, radiation can cause damage to the distal urinary sphincter, which can result in

incontinence. In addition there is a dose-effect relationship for individual pelvic floor muscles and anorectal complaints after prostate radiotherapy, which is related to incontinence-related complaints showing specific dose-effects to individual pelvic floor muscles [1231].

Urinary retention and increased obstructive LUTS are other common problems that radiation therapy and particularly brachytherapy is urinary retention this doesn't make sense. The incidence of retention has been reported to range from 2% to 30% after brachytherapy [1232-1235]. Most patients with retention will have resolution of their obstruction within weeks while others may require surgical procedures. A retrospective review of over 2,100 Medicare patients who underwent brachytherapy for prostate cancer found that 8.3% required a surgical procedure to relieve bladder outlet obstruction post-brachytherapy [1236]. Flam et al reported that 19 of 600 (3.1%) patients receiving brachytherapy required TURP [1237]. Kollmeier and colleagues reported a similar rate of 2% in 2050 men [1238]. Most authors have found significant rates of post TURP incontinence after radiation. Incontinence following TURP after brachytherapy has been reported in 0-70% and is often severe [1237-1239]. External beam radiation is also a risk factor as Green et al reported a 33% incidence of incontinence following TURP in patients post-irradiation for prostate cancer [1240]. Some authors have emphasised that incontinence can be minimised by performing a limited resection [1241] or by performing TURP within 2 years of brachytherapy [1238]. In the latter study, two of 24 patients (8%) that underwent TURP within 2 years of treatment were incontinent and 5 of 14 patients (36%) that underwent TURP 2 years or more after brachytherapy were incontinent ($p=0.04$), which is supported by the findings of Pinkawa et al [1242]. However, others suggest that delaying TURP until 5 years after radiation can actually reduce the risk of incontinence [1243-1245].

5. CONCLUSIONS

Incontinence in the male as in the female can be broadly divided into causes related to bladder and/or sphincter dysfunction. The pathophysiology of incontinence as it relates specifically to the male is fairly well described; however advances in science and anatomy will undoubtedly provide better understanding in the future. For example, the causes of sphincter insufficiency are known (i.e. damage to muscle, nerve and/or supporting structures) but clinicians are not able to accurately assess the exact cause of sphincter insufficiency in any given patient. Therefore much of our understanding of post treatment incontinence "pathophysiology" is derived from reports of incontinence (incidence/prevalence) after surgery or radiation. In addition investigators have not done an adequate job in defining the incidence of incontinence related to interventions for prostatic disease, whether benign or malignant. Some work has been provided to understand and discriminate the issue of pre- and

post-operative incontinence, but as an issue of the shortened hospitalisation those prospective investigations, which are mandatory for the understanding of the physiological functioning and the pathophysiology, which might become clinically significant after the intervention this doesn't make sense. Problems have been two-fold: first in defining incontinence and what is bothersome/significant and second in accurately reporting data. New technologies for the treatment of BPH have provided us with Level 1 evidence regarding the incidence of incontinence in trials comparing new technology to TURP and Level 2 evidence through meta-analysis and prospective series. Data regarding the incidence of post-radical prostatectomy and postradiation incontinence has been less robust and of a lower quality - level 2-4. Even the level 2 evidence lacks consistency.

IX. CAUSES OF REVERSIBLE INCONTINENCE IN OLDER ADULTS

1. URINARY INCONTINENCE

Transient causes of incontinence probably accounts for one-third of cases among community-dwelling older people (>65 years old), up to one-half of cases among acutely-hospitalised older people, and a significant proportion of cases among nursing home residents [1246-1250]. Transient urinary incontinence arises suddenly, lasts less than six months, and results from reversible causes [1251]. Most causes of transient incontinence in the older population lie outside the lower urinary tract but two points are worth emphasising. First, the risk of transient incontinence is increased if, in addition to physiological changes of the lower urinary tract, the older person also suffers from pathological changes [1252, 1253]. Overflow incontinence is more likely to result from an anticholinergic agent in a person with a weak or obstructed bladder, just as urge incontinence is more likely to result from a loop diuretic in someone with detrusor overactivity and/or impaired mobility [1254, 1255].

This fact may explain why some controversy persists regarding some causes of transient incontinence. It also emphasizes that continence depends on the integrity of multiple domains-mental state, mobility, manual dexterity, medical factors, and motivation, as well as lower urinary tract function. Although in younger individuals incontinence usually results from lower urinary tract dysfunction alone, incontinence in older patients often results from deficits in multiple domains that together result in incontinence [1250, 1256]. Attention to any one or more of these risk factors can restore continence or at least improve it. Second, although termed "transient," these causes of incontinence may persist if left untreated, and so they

cannot be dismissed merely because the incontinence is of short duration.

1.1. Quality of Data

In older people, continence status may not be absolute, especially in those who are frail. Infrequent leakage of small amounts may appear and disappear, and reporting accuracy varies as well [1257]. Sometimes the changing status of incontinence is the initial symptom of LUTS, neurological disorder (Parkinson's disease, MS etc.), cardiogenic changes or diabetes. Furthermore, ethical constraints and methodological issues preclude robust investigations of the conditions commonly impugned as causes of transient incontinence. Thus, it is not surprising that evidence supporting the association between these conditions and transient incontinence consists predominantly of case reports and case series.

1.2. Results of Literature Review

Transient causes of incontinence in older people are shown in Table 9 and can be recalled using the mnemonic DIAPPERS (Delirium, Infection, Atrophic vaginitis, Pharmaceuticals, Psychological condition, Excess urine output, Reduced mobility, Stool impaction) [1251, 1258-1260].

Table 9. Transient Incontinence in Older Adult

- Delirium
- Infection
- Atrophic vaginitis
- Pharmaceuticals
- Psychological condition
- Excess urine output
- Reduced mobility
- Stool impaction

1.2.1 Delirium

"D" is for delirium, a confusional state characterised by fluctuating inattentiveness and disorientation. Its onset occurs over hours to days, as contrasted with dementia, which develops over years. Delirium can result from almost any medication and from virtually any acute illness, including congestive heart failure, deep vein thrombosis, or infection. Many of these conditions may present atypically in older patients, and if the patient becomes confused because of them, incontinence may be the first abnormality detected [1261]. Delirium leads the list because, if unrecognised, it is associated with significant mortality [1262]. Thus, in this case, meticulous medical evaluation - not cystometry - is crucial [1263].

1.2.2 Urinary tract infection

Symptomatic urinary tract infection is another cause of incontinence, although it is supposing uncommon

one [1249]. However, asymptomatic urinary infection, is much more common in older people [1264-1266]. Women with recurrent urinary tract infection had the highest increase in UI by 230% for weekly UI [1267] and for monthly UI [1268], 220% for UI in the past year [1269], and by 470% for ever having UI [1270]. In addition Arya et al reported that women with recurrent UTIs have greater urinary frequency and increased perceived bladder sensation in the absence of an active infection than control women [1271].

1.2.3 Atrophic vaginitis

Atrophic vaginitis in older women is frequently associated with lower urinary tract symptoms, which occasionally include incontinence [1272]. As many as 80% of such women attending an incontinence clinic are reported to have physical evidence of atrophic vaginitis, characterised by vaginal mucosal atrophy, friability, erosions, and punctuate haemorrhages. While the evidence supporting the use of oestrogens in lower urinary tract dysfunction remains controversial there are considerable data to support their use in urogenital atrophy and the vaginal route of administration correlates with better symptom relief by improving vaginal dryness, pruritis and dyspareunia, greater improvement in cytological findings, and lower serum oestradiol levels [1273]. Atrophic vaginitis has been associated with urgency and occasionally a sense of "scalding" dysuria, but both symptoms may be relatively unimpressive. More recent epidemiologic and clinical studies have called these beliefs into question since they have demonstrated an association with oestrogen treatment and the onset of incontinence [1274]. Unfortunately, limitations in their design allow for the possibility of both bias and confounding factors. Further research is warranted.

1.2.4 Medications

Pharmaceuticals are one of the most common causes of incontinence in older people, with several categories of drugs commonly implicated [1275, 1276] (Table 10). Of note, many of these agents also are used in the treatment of incontinence, underscoring the fact that most medications used by older people are "double-edged swords." The first category of relevant drugs is the long-acting sedative/hypnotics, such as diazepam and flurazepam, which can cloud an older patient's brain "Loop" diuretics, such as furosemide or bumetanide, by inducing a brisk diuresis, can also provoke leakage. Drugs with anticholinergic side effects are a particular problem and include major tranquilizers, antidepressants, anti-Parkinsonian agents (e.g., benzotropine mesylate or trihexyphenidyl), first generation (sedating) antihistamines, anti-arrhythmics (disopyramide), antispasmodics, and opiates. By decreasing detrusor contractility, they can cause urinary retention and overflow incontinence. They can also cause confusion. Anticholinergic agents are particularly important to enquire about for two reasons. First, older patients may often take more than one of them at a time. Second, they are contained in many non-prescription preparations that

older people frequently take without consulting a physician.

Adrenergically-active agents have also been associated with incontinence. Many alpha-adrenoreceptor antagonists (used mainly for treatment of hypertension) block receptors at the bladder neck and may induce stress incontinence in women [1277]. Older women are particularly at risk because their urethral length and closure pressure normally decline with age. Thus, prior to considering other interventions for stress incontinence in a woman taking such a drug, substitution of an alternative agent should be tried and the incontinence re-evaluated. Calcium channel blockers can cause incontinence. As smooth muscle relaxants, they can increase residual volume, especially in older adults with impaired detrusor contractility. Increased residual urine may occasionally lead to stress incontinence in women with a weak urethral sphincter, or to overflow incontinence in men with concurrent urethral obstruction. Finally, angiotensin converting enzyme inhibitors, by inducing cough (the risk of which is age-related), may precipitate stress incontinence in older women whose urethra has shortened and sphincter weakened with age [1278].

Table 10: Common medications affecting continence

Type of Medication	Examples	Potential Effect on Continence
Sedatives/Hypnotics	Long-acting benzodiazepines (e.g. diazepam, flurazepam)	Sedation, delirium, immobility
Alcohol		Polyuria, frequency, urgency, sedation, delirium, immobility
Anticholinergics	Dicyclomine, disopyramide, antihistamines (sedating ones only, e.g. Benadryl®)	Urinary retention, overflow incontinence, delirium, impaction
Antipsychotics	Thioridazine, haloperidol	Anticholinergic actions, sedation, rigidity, immobility
Antidepressants (tricyclics)	Amitriptyline, desipramine; not SSRI's	Anticholinergic actions, sedation
Anti-Parkinsonians	Trihexyphenidyl, benzotropine mesylate, (not L-dopa or selegiline)	Anticholinergic actions, sedation
Narcotic analgesics	Opiates	Retention, impaction, sedation, delirium
Adrenergic antagonists	Prazosin, terazosin, doxazosin	Urethral relaxation may precipitate stress incontinence in women
Adrenergic agonists	Nasal decongestants	Urinary retention in men
Calcium channel blockers	All dihydropyridines	Urinary retention; nocturnal diuresis due to fluid retention
Potent diuretics	Furosemide, bumetanide (not thiazides)	Polyuria, frequency, urgency
NSAIDs Thiazolidinediones	Indomethacin, COX-2 inhibitors, rosiglitazone, pioglitazone	Nocturnal diuresis from fluid retention
Angiotensin Converting Enzyme (ACE) inhibitors	Captopril, enalapril, lisinopril	Drug-induced cough precipitates stress incontinence in women and some men after prostatectomy
Vincristine		Urinary retention from neuropathy

1.2.5 Diuresis

Excess urinary output can also cause incontinence, especially in individuals with impaired mobility, mental state, or motivation, particularly if they also have detrusor overactivity. Causes of excess output include excess intake, diuretics (including theophylline-containing fluids and alcohol), and metabolic abnormalities (e.g., hyperglycemia and hypocalcaemia). Nocturnal incontinence can be caused or exacerbated by disorders associated with excess nocturnal excretion, such as congestive heart failure, peripheral venous insufficiency, hypoalbuminemia (especially in malnourished older people), and drug induced peripheral oedema associated with NSAIDs, thiazolidinediones, and some calcium channel blockers (e.g., dihydropyridines such as nifedipine, isradipine,

and nocardipine). In addition, certain foods are natural diuretic like asparagus, parsley, beets, grapes, green beans, leafy greens, pineapple, pumpkin, onion, leeks, and garlic, as well as juices such as orange juice. The role of caffeine and timing of drinking fluids (e.g. in the evening or before bedtime) is still not clear, but should nonetheless be considered a possible contributing cause for nocturia and nocturnal incontinence, whereas it is known to increase the bowel motility [1279-1281].

1.2.6 Restricted mobility

Restricted mobility is an easily understood but frequently overlooked cause of incontinence [1282]. In addition to obvious causes, restricted mobility may be associated with orthostatic or postprandial hypotension, poorly-fitting shoes, poor physical state, or fear

of falling, all of which are common geriatric conditions. All of the prior mentioned reasons and because of the restricted mobility might be the cause of incontinence because of nocturia.

1.2.7 Nocturia

For frail/older people with bothersome nocturia, assessment should focus on identifying the potential underlying cause(s), including (GR: C):

- Nocturnal polyuria;
- Primary sleep problem (including sleep apnea);
- Conditions resulting in a low voided volumes (e.g. elevated post-voiding residual) co-morbidity.

1.2.8 Post-void residual (PVR) volume

A post-void residual volume (PVR) is impractical to obtain in many care settings. However, there is compelling clinical experience for measuring PVR in selected frail/ older persons with:

- Diabetes mellitus (especially if longstanding);
- Prior episodes of urinary retention or history of high PVR;
- Recurrent UTIs;
- Medications that impair bladder emptying (e.g. anticholinergics);
- Chronic constipation;
- Persistent or worsening UI despite treatment with antimuscarinics;
- Prior urodynamic study demonstrating detrusor underactivity and/or bladder outlet obstruction (GR: C).

2. FAECAL INCONTINENCE

2.1. Background

The prevalence of FI in older adults ranges from 3.7-27% in community dwelling elderly persons to over 50% in nursing home residents. In addition FI is a common reason for referral of elderly persons to a nursing home [1284, 1285]. Underreporting is an issue with both urinary and faecal incontinence [1286-1289]; memory-loss and dementia exacerbate that problem in the elderly. While the prevalence is fairly well documented, the percentage of those people who have transient as opposed to long-term incontinence is not well known. There is significant financial and social cost associated with management of FI in the community and nursing homes [1286, 1290-1295]. Identifying transient and remediable causes would benefit patients, caregivers and the health care system. One confounding aspect in the discussion of transient incontinence is the largely unknown natural history of FI. It is clear that the symptom is intermittent

in some patients and spontaneously resolves in others. As noted earlier in this chapter, continence for stool is a complex mechanism involving the consistency and transit time of stool, rectal capacity and pelvic floor function. Rectal capacity and pelvic floor function are less likely to undergo transient changes but stool consistency, transit time of the intestinal tract and other medical conditions may change. It is well established that the prevalence of FI increases with age, even if the mechanism is not completely understood; the increase in prevalence suggests progressive deterioration of some aspect of anorectal function [1286, 1290, 1296-1301]. Theoretically, alternations in stool consistency, transit time and medical conditions would be more likely to result in incontinence in the elderly although that there is minimal confirmatory data.

The literature on transient FI is limited with a dominance of case series and retrospective reports. Some information is inferred from data from large studies of prevalence and risk factors. Treatment recommendations are frequently based upon an empirical rather than evidence-based approach.

2.2. Causes

FI occurs when the propulsive forces in the colon and rectum overwhelm the resistant forces of the pelvic floor. Continence for stool requires the receipt and recognition of the urge to defecate, mobility to reach the toilet in time, and the ability to postpone defaecation until reaching the bathroom. Delaying defaecation requires sufficient rectal capacity and compliance and adequate neurologic and anal sphincter function.

2.2.1 Altered mental status

Acute medical illness, hospitalisation, surgery and medications such as opiates and sedatives may result in delirium or disorientation in the elderly. The reported rates of mental status changes to as high as 74% after surgery and from 11 to 42% during medical hospitalisation [1302, 1303]. In a systematic review of delirium associated with medication, opioids, benzodiazepines, and dihydropyridines were found to clearly increase the risk of delirium. There was uncertainty regarding antihistamines, tricyclic antidepressants, anti-Parkinson medications, steroids and non-steroidal anti-inflammatory medication [1304]. Delirium, confusion and other transient changes in cognitive function may impair a patient's ability to recognise the urge to defaecate and/or their motivation to remain continent. The limited investigations of the relationship of delirium and incontinence studied patients with chronically altered mental status; any relationship of acute delirium and/or confusion with faecal incontinence is inferred from those data. Studies of the impact of delirium on continence show that delirium plays an important role in the development of incontinence [1305, 1306]. The impact of altered mental status on continence has also been inferred from studies showing improvement in continence with scheduled toileting programs [1307, 1308]. Ignoring the urge to defaecate combined with the effect of medications

may result in faecal impaction followed by incontinence. Delirium may require the use of restraints. Need for a restraint has been reported as an independent factor in incontinence [1309].

2.2.2 Impaired mobility

Lack of adequate mobility may prevent a patient from reaching the bathroom in time to avoid incontinence. In addition to the causes described in the urinary incontinence section, musculoskeletal ailments, such as arthritis and bone fractures, occur more commonly in the elderly and limit mobility. During the recovery phase from joint replacements ambulation may be slow and unsteady. Acute neurological conditions such as stroke may affect a patient's gait as well as debilitated states from other illness. FI is fairly common (up to 30% in first week) immediately after a stroke; with rehabilitation, the rate decreases [1310, 1311]. The use of anticholinergic medication and requiring assistance to reach the toilet were significant independent factors [1310]. For patients temporarily requiring assistance to reach the bathroom, the timeliness of the assistance may impact on their continence.

2.2.3 Stool consistency

Change in stool consistency affects continence; both constipation and diarrhoea may result in FI.

2.2.4 Diarrhoea

Loose stool is clearly a risk factor for incontinence [1299, 1311-1315]; one study identified loose stool as the most important independent risk factor [1290]. Any condition or medication resulting in loose stools may also lead to incontinence including acute infection, intestinal inflammatory processes, medication and supplements (Table 11). Medications with the side effects of diarrhoea and/or steatorrhea may result in faecal incontinence. Table 12 lists the medications, which cause diarrhoea or steatorrhea with reasonable frequency [1316, 1317]. Laxatives and the medications used for bowel preparation for colonoscopy and surgery frequently result in temporary incontinence in older patients.

Although rarely described in the literature, intuitively cessation of the causative medication should decrease the incontinence. In a case report, withdrawal of the offending medication, metformin, resolved the incontinence [1318].

Table 11: Causes of Loose Stool

Infection	<ul style="list-style-type: none"> • Acute viral or bacterial gastroenteritis • Clostridium difficile colitis
Inflammation	<ul style="list-style-type: none"> • Ischaemic colitis • Inflammatory bowel disease flare (ulcerative colitis, Crohn's colitis) • Microscopic colitis
Medications	<ul style="list-style-type: none"> • Supplements/dietary elements • Caffeine • Fructose • High dose probiotics • Magnesium • Omega-3 fatty acids • Orlistat
Tube feedings	

Table 12: Medications causing diarrhoea

Alpha-glucosidase inhibitors
Antibiotics
Antiretroviral therapy
Biguanides (e.g. Metformin)
Bile acids
Chemotherapy agents
Cholinergic drugs
Colchicine
Diacerein
Digoxin
Immunosuppressive agents
Mesalamine
Metocopramide
Non-steroidal anti-inflammatory agents
Orlistat
Osmotic laxatives
Prostaglandins
Selective serotonin reuptake inhibitors
Ticlopidine
Tyrosine kinase inhibitors

2.2.5 Constipation

Paradoxical FI may occur in patients with faecal impaction [1319-1323]. Immobility, inadequate dietary and fluid intake, depression, metabolic disorders neurological conditions, connective tissue disorders and medications contribute to constipation [1319, 1320]. Impaction may result in overflow incontinence with

loose stool leaking around the faecal bolus [1324]. Evaluation of impacted patients compared to elderly controls revealed similar resting and squeeze pressures although both groups had lower pressures than younger healthy controls. However, perianal and rectal sensation was impaired in 74% of the impacted patients [1325]. The theory is the patients with impaired sensation do not experience the urge to defaecate with the typical volume of stool. The stool bolus causes the usual reflex relaxation of the internal anal sphincter but the lack of perception prevents the normal contraction of the external sphincter muscle. Incontinence is often aggravated by the use of laxatives to relieve constipation.

3. SUMMARY

Apart from re-challenged data for alpha-adrenergic agents (Level of Evidence = 2), the level of evidence for most of these causes is Level 3-4. Nonetheless, because many are easily addressed and contribute to morbidity beyond the lower urinary tract and perianal area, they are worth identifying even if the evidence is not strong.

4. RECOMMENDATIONS

Despite the lack of robust data regarding the incidence and causes, transient urinary and faecal incontinence is a clinically common problem. Since in most cases treatment is relatively straightforward, it is important to consider the causes discussed in this section when elderly patients present with new onset incontinence. Moreover, addressing them may further improve the incontinence even if it does not eliminate it completely, and it may make the incontinence more amenable to subsequent therapy. (Grade of recommendation C).

5. RESEARCH PRIORITIES

Further research should be performed on the mechanisms, prevalence, incidence, and remission rates of each of the known causes of transient incontinence, and possible additional causes should be identified as well. Since the clinical circumstances of older people are heterogeneous, studies should be conducted among several subgroups, including independent and homebound and community-dwelling older people, bedbound and mobile institutionalised older people and acutely hospitalised older people.

X. REFERENCES

1. Abrams, P., et al., The standardisation of terminology of lower urinary tract function: report from the Standardisation Sub-committee of the International Continence Society. *Neurourol Urodyn*, 2002. 21(2): p. 167-78.
2. Michel, M.C. and C.R. Chapple, Basic mechanisms of urgency: roles and benefits of pharmacotherapy. *World J Urol*, 2009. 27(6): p. 705-9.
3. Wyndaele, J.J., T.D. Van Meel, and S. De Wachter, Detrusor overactivity. Does it represent a difference if patients feel the involuntary contractions? *J Urol*, 2004. 172(5 Pt 1): p. 1915-8.
4. Malone-Lee, J., D.J. Henshaw, and K. Cummings, Urodynamic verification of an overactive bladder is not a prerequisite for antimuscarinic treatment response. *BJU Int*, 2003. 92(4): p. 415-7.
5. Rovner E, P.C., Yalla S Response to fesoterodine in overactive bladder (OAB) patients is independent of the urodynamics finding of detrusor overactivity. .
6. Matharu, G., et al., Relationship between urinary symptoms reported in a postal questionnaire and urodynamic diagnosis. *Neurourol Urodyn*, 2005. 24(2): p. 100-5.
7. Hashim, H. and P. Abrams, Is the bladder a reliable witness for predicting detrusor overactivity? *J Urol*, 2006. 175(1): p. 191-4; discussion 194-5.
8. Michel, M.C. and C.R. Chapple, Basic mechanisms of urgency: preclinical and clinical evidence. *Eur Urol*, 2009. 56(2): p. 298-307.
9. Andersson, K.E., Bladder activation: afferent mechanisms. *Urology*, 2002. 59(5 Suppl 1): p. 43-50.
10. Yoshida, M., et al., The forefront for novel therapeutic agents based on the pathophysiology of lower urinary tract dysfunction: pathophysiology and pharmacotherapy of overactive bladder. *J Pharmacol Sci*, 2010. 112(2): p. 128-34.
11. Brading, A.F., A myogenic basis for the overactive bladder. *Urology*, 1997. 50(6A Suppl): p. 57-67; discussion 68-73.
12. Brading, A.F. and W.H. Turner, The unstable bladder: towards a common mechanism. *Br J Urol*, 1994. 73(1): p. 3-8.
13. Maggi, C.A., Tachykinins and calcitonin gene-related peptide (CGRP) as co-transmitters released from peripheral endings of sensory nerves. *Prog Neurobiol*, 1995. 45(1): p. 1-98.
14. Ferguson, D.R., I. Kennedy, and T.J. Burton, ATP is released from rabbit urinary bladder epithelial cells by hydrostatic pressure changes--a possible sensory mechanism? *J Physiol*, 1997. 505 (Pt 2): p. 503-11.
15. Chopra, B., et al., Expression and function of rat urothelial P2Y receptors. *Am J Physiol Renal Physiol*, 2008. 294(4): p. F821-9.
16. Wang, E.C., et al., ATP and purinergic receptor-dependent membrane traffic in bladder umbrella cells. *J Clin Invest*, 2005. 115(9): p. 2412-22.
17. Kumar, V., C.C. Chapple, and R. Chess-Williams, Characteristics of adenosine triphosphate [corrected] release from porcine and human normal bladder. *J Urol*, 2004. 172(2): p. 744-7.
18. Lewis, S.A. and J.R. Lewis, Kinetics of urothelial ATP release. *Am J Physiol Renal Physiol*, 2006. 291(2): p. F332-40.
19. Rong, W., K.M. Spyer, and G. Burnstock, Activation and sensitisation of low and high threshold afferent fibres mediated by P2X receptors in the mouse urinary bladder. *J Physiol*, 2002. 541(Pt 2): p. 591-600.
20. Vial, C. and R.J. Evans, P2X receptor expression in mouse urinary bladder and the requirement of P2X(1) receptors for functional P2X receptor responses in the mouse urinary bladder smooth muscle. *Br J Pharmacol*, 2000. 131(7): p. 1489-95.
21. Elneil, S., et al., Distribution of P2X(1) and P2X(3) receptors in the rat and human urinary bladder. *Pharmacology*, 2001. 63(2): p. 120-8.
22. Lee, H.Y., M. Bardini, and G. Burnstock, Distribution of P2X receptors in the urinary bladder and the ureter of the rat. *J Urol*, 2000. 163(6): p. 2002-7.
23. Yu, W., et al., Adenosine receptor expression and function in bladder uroepithelium. *Am J Physiol Cell Physiol*, 2006. 291(2): p. C254-65.
24. Vlaskovska, M., et al., P2X3 knock-out mice reveal a major sensory role for urothelially released ATP. *J Neurosci*, 2001. 21(15): p. 5670-7.
25. Andersson, K.E., LUTS treatment: future treatment options. *Neurourol Urodyn*, 2007. 26(6 Suppl): p. 934-47.
26. Apostolidis, A., et al., Decreased sensory receptors P2X3 and TRPV1 in suburothelial nerve fibers following intradetrusor injections of botulinum toxin for human detrusor overactivity.

- J Urol, 2005. 174(3): p. 977-82; discussion 982-3.
27. Khera, M., et al., Botulinum toxin A inhibits ATP release from bladder urothelium after chronic spinal cord injury. *Neurochem Int*, 2004. 45(7): p. 987-93.
 28. Sugaya, K., et al., Relationship between lower urinary tract symptoms and urinary ATP in patients with benign prostatic hyperplasia or overactive bladder. *Biomed Res*, 2009. 30(5): p. 287-94.
 29. Bschiepfer, T., et al., Expression and distribution of cholinergic receptors in the human urothelium. *Life Sci*, 2007. 80(24-25): p. 2303-7.
 30. Chess-Williams, R., Muscarinic receptors of the urinary bladder: detrusor, urothelial and prejunctional. *Auton Autacoid Pharmacol*, 2002. 22(3): p. 133-45.
 31. Yoshida, M., et al., Non-neuronal cholinergic system in human bladder urothelium. *Urology*, 2006. 67(2): p. 425-30.
 32. Mukerji, G., et al., Localization of M2 and M3 muscarinic receptors in human bladder disorders and their clinical correlations. *J Urol*, 2006. 176(1): p. 367-73.
 33. Mansfield, K.J., et al., Muscarinic receptor subtypes in human bladder detrusor and mucosa, studied by radioligand binding and quantitative competitive RT-PCR: changes in ageing. *Br J Pharmacol*, 2005. 144(8): p. 1089-99.
 34. Tyagi, S., et al., Qualitative and quantitative expression profile of muscarinic receptors in human urothelium and detrusor. *J Urol*, 2006. 176(4 Pt 1): p. 1673-8.
 35. Zarghooni, S., et al., Expression of muscarinic and nicotinic acetylcholine receptors in the mouse urothelium. *Life Sci*, 2007. 80(24-25): p. 2308-13.
 36. Andersson, K.E. and M. Yoshida, Antimuscarinics and the overactive detrusor--which is the main mechanism of action? *Eur Urol*, 2003. 43(1): p. 1-5.
 37. Finney, S.M., et al., Antimuscarinic drugs in detrusor overactivity and the overactive bladder syndrome: motor or sensory actions? *BJU Int*, 2006. 98(3): p. 503-7.
 38. Andersson, K.E., Antimuscarinics for treatment of overactive bladder. *Lancet Neurol*, 2004. 3(1): p. 46-53.
 39. Ishihama, H., et al., Activation of alpha1D adrenergic receptors in the rat urothelium facilitates the micturition reflex. *J Urol*, 2006. 175(1): p. 358-64.
 40. Birder, L.A., et al., Beta-adrenoceptor agonists stimulate endothelial nitric oxide synthase in rat urinary bladder urothelial cells. *J Neurosci*, 2002. 22(18): p. 8063-70.
 41. Masunaga, K., et al., The beta3-adrenoceptor mediates the inhibitory effects of beta-adrenoceptor agonists via the urothelium in pig bladder dome. *NeuroUrol Urodyn*, 2010. 29(7): p. 1320-5.
 42. Araki, I., et al., Overexpression of epithelial sodium channels in epithelium of human urinary bladder with outlet obstruction. *Urology*, 2004. 64(6): p. 1255-60.
 43. Kim, J.C., et al., Nerve growth factor and prostaglandins in the urine of female patients with overactive bladder. *J Urol*, 2006. 175(5): p. 1773-6; discussion 1776.
 44. Kim, D.K., et al., The case for bladder botulinum toxin application. *Urol Clin North Am*, 2006. 33(4): p. 503-10, ix.
 45. Liu, H.T. and H.C. Kuo, Increased expression of transient receptor potential vanilloid subfamily 1 in the bladder predicts the response to intravesical instillations of resiniferatoxin in patients with refractory idiopathic detrusor overactivity. *BJU Int*, 2007. 100(5): p. 1086-90.
 46. Apostolidis, A., et al., Capsaicin receptor TRPV1 in urothelium of neurogenic human bladders and effect of intravesical resiniferatoxin. *Urology*, 2005. 65(2): p. 400-5.
 47. Silva, C., M.J. Ribeiro, and F. Cruz, The effect of intravesical resiniferatoxin in patients with idiopathic detrusor instability suggests that involuntary detrusor contractions are triggered by C-fiber input. *J Urol*, 2002. 168(2): p. 575-9.
 48. Apostolidis, A., G.E. Gonzales, and C.J. Fowler, Effect of intravesical Resiniferatoxin (RTX) on lower urinary tract symptoms, urodynamic parameters, and quality of life of patients with urodynamic increased bladder sensation. *Eur Urol*, 2006. 50(6): p. 1299-305.
 49. Wiseman, O.J., C.J. Fowler, and D.N. Landon, The role of the human bladder lamina propria myofibroblast. *BJU Int*, 2003. 91(1): p. 89-93.
 50. Sui, G.P., et al., Gap junctions and connexin expression in human suburothelial interstitial cells. *BJU Int*, 2002. 90(1): p. 118-29.
 51. Sui, G.P., C. Wu, and C.H. Fry, Characterization of the purinergic receptor subtype on guinea-pig suburothelial myofibroblasts. *BJU Int*, 2006. 97(6): p. 1327-31.
 52. Fry, C.H., et al., The function of suburothelial myofibroblasts in the bladder. *NeuroUrol Urodyn*, 2007. 26(6 Suppl): p. 914-9.

53. Mills, I.W., et al., Studies of the pathophysiology of idiopathic detrusor instability: the physiological properties of the detrusor smooth muscle and its pattern of innervation. *J Urol*, 2000. 163(2): p. 646-51.
54. Coolsaet, B.L., et al., New concepts in relation to urge and detrusor activity. *Neurourol Urodyn*, 1993. 12(5): p. 463-71.
55. Downie, J.W. and J.A. Armour, Mechanoreceptor afferent activity compared with receptor field dimensions and pressure changes in feline urinary bladder. *Can J Physiol Pharmacol*, 1992. 70(11): p. 1457-67.
56. Drake, M.J., et al., Localized contractions in the normal human bladder and in urinary urgency. *BJU Int*, 2005. 95(7): p. 1002-5.
57. Gillespie, J.I., A developing view of the origins of urgency: the importance of animal models. *BJU Int*, 2005. 96 Suppl 1: p. 22-8.
58. Gillespie, J.I., et al., On the origins of the sensory output from the bladder: the concept of afferent noise. *BJU Int*, 2009. 103(10): p. 1324-33.
59. Andersson, K.E., Detrusor myocyte activity and afferent signaling. *Neurourol Urodyn*, 2010. 29(1): p. 97-106.
60. Andersson, K.E. and A. Arner, Urinary bladder contraction and relaxation: physiology and pathophysiology. *Physiol Rev*, 2004. 84(3): p. 935-86.
61. Yoshimura N, C.M., Physiology and pharmacology of the bladder and urethra. *Campbell-Walsh urology*, ed. e. Wein AJ. Vol. 3. 2007, Philadelphia: PA: Saunders. p. 1922-1972.
62. Kubota Y, K.Y., Hayase M, Hirose M, Okada O, Sasaki S, et al, Association between bladder overactivity and increased numbers of interstitial cells in the guinea pigs with partial bladder outlet obstruction. *J Urol*, 2007. 177(4 Suppl: 85).
63. Biers, S.M., et al., The functional effects of a c-kit tyrosine inhibitor on guinea-pig and human detrusor. *BJU Int*, 2006. 97(3): p. 612-6.
64. Kubota, Y., et al., Effects of imatinib mesylate (Glivec) as a c-kit tyrosine kinase inhibitor in the guinea-pig urinary bladder. *Neurourol Urodyn*, 2006. 25(3): p. 205-10.
65. Yamaguchi, O., et al., Place of overactive bladder in male lower urinary tract symptoms. *World J Urol*, 2009. 27(6): p. 723-8.
66. Yoshida, M., et al., The effects of chronic hyperlipidemia on bladder function in myocardial infarction-prone Watanabe heritable hyperlipidemic (WHHLMI) rabbits. *Neurourol Urodyn*, 2010. 29(7): p. 1350-4.
67. Azadzi, K.M., et al., Oxidative modification of mitochondrial integrity and nerve fiber density in the ischemic overactive bladder. *J Urol*, 2010. 183(1): p. 362-9.
68. Azadzi, K.M., et al., Molecular reactions and ultrastructural damage in the chronically ischemic bladder. *J Urol*, 2011. 186(5): p. 2115-22.
69. Comperat, E., et al., Histologic features in the urinary bladder wall affected from neurogenic overactivity--a comparison of inflammation, oedema and fibrosis with and without injection of botulinum toxin type A. *Eur Urol*, 2006. 50(5): p. 1058-64.
70. Apostolidis, A., et al., Histological changes in the urothelium and suburothelium of human overactive bladder following intradetrusor injections of botulinum neurotoxin type A for the treatment of neurogenic or idiopathic detrusor overactivity. *Eur Urol*, 2008. 53(6): p. 1245-53.
71. Tyagi, P., et al., Urine cytokines suggest an inflammatory response in the overactive bladder: a pilot study. *Int Urol Nephrol*, 2010. 42(3): p. 629-35.
72. Chung, S.D., et al., Elevation of serum c-reactive protein in patients with OAB and IC/BPS implies chronic inflammation in the urinary bladder. *Neurourol Urodyn*, 2011. 30(3): p. 417-20.
73. Kupelian, V., et al., Association of overactive bladder and C-reactive protein levels. Results from the Boston Area Community Health (BACH) Survey. *BJU Int*, 2011, 110(3): 401-7.
74. Liu HT, Jiang YH, Kuo HC. Increased serum adipokines implicate chronic inflammation in the pathogenesis of overactive bladder syndrome refractory to antimuscarinic therapy. *PLoS One*. 2013 Oct 1;8(10):e76706. doi:10.1371
75. Tyagi P, Tyagi V, Qu X, Lin HT, Kuo HC, Chuang YC, Chancellor M. Association of inflammation (inflammation + aging) with higher prevalence of OAB in elderly population. *Int Urol Nephrol*. 2014 ;46(5):871-7.
76. Karstens L, Asquith M, Davin S, Stauffer P, Fair D, Gregory WT, Rosenbaum JT, McWeeney SK, Nardos R. Does the Urinary Microbiome Play a Role in Urgency Urinary Incontinence and Its Severity? *Front Cell Infect Microbiol*. 2016 Jul 27;6:78. doi: 10.3389/fcimb.2016.00078. eCollection 2016.
77. Thomas-White, K.J., et al., Incontinence medication response relates to the female

- urinary microbiota. *Int Urogynecol J*, 2016. 27(5): p. 723-733.
78. Brubaker, L. and A.J. Wolfe, The new world of the urinary microbiota in women. *American Journal of Obstetrics and Gynecology*, 2015. 213(5): p. 644-649.
 79. Griffiths, D. and S.D. Tadic, Bladder control, urgency, and urge incontinence: evidence from functional brain imaging. *Neurourol Urodyn*, 2008. 27(6): p. 466-74.
 80. Drake, M.J., C. Tannenbaum, and A.J. Kanai, Potential insights into lower urinary function derived from CNS imaging. *Neurourol Urodyn*, 2010. 29(4): p. 629-33.
 81. Fowler, C.J. and D.J. Griffiths, A decade of functional brain imaging applied to bladder control. *Neurourol Urodyn*, 2010. 29(1): p. 49-55.
 82. Kitta T, Mitsui T, Kanno Y, Chiba H, Moriya K, Shinohara N. Brain-bladder control network: the unsolved 21st century urological mystery. *Int J Urol*. 2015;22(4):342-8.
 83. Griffiths D, Tadic SD, Schaefer W, Resnick NM. Cerebral control of the bladder in normal and urge-incontinent women. *Neuroimage*. 2007;37(1):1-7.
 84. Tadic SD, Griffiths D, Schaefer W, Resnick NM. Abnormal connections in the supraspinal bladder control network in women with urge urinary incontinence. *Neuroimage*. 2008 Feb 15;39(4):1647-53.
 85. Tadic SD, Griffiths D, Schaefer W, Cheng CI, Resnick NM. Brain activity measured by functional magnetic resonance imaging is related to patient reported urgency urinary incontinence severity. *J Urol*. 2010;183(1):221-8.
 86. Tadic SD, Tannenbaum C, Resnick NM, Griffiths D. Brain responses to bladder filling in older women without urgency incontinence. *Neurourol Urodyn*. 2013;32(5):435-40.
 87. Griffiths D, Clarkson B, Tadic SD, Resnick NM. Brain Mechanisms Underlying Urge Incontinence and its Response to Pelvic Floor Muscle Training. *J Urol*. 2015;194(3):708-15.
 88. Tadic SD, Griffiths D, Schaefer W, Murrin A, Clarkson B, Resnick NM. Brain activity underlying impaired continence control in older women with overactive bladder. *Neurourol Urodyn*. 2012; 31: 652–8.
 89. de Groat, W.C., A neurologic basis for the overactive bladder. *Urology*, 1997. 50(6A Suppl): p. 36-52; discussion 53-6.
 90. Gulur, D.M. and M.J. Drake, Management of overactive bladder. *Nat Rev Urol*, 2010. 7(10): p. 572-82.
 91. Liu, H.T., M.B. Chancellor, and H.C. Kuo, Urinary nerve growth factor level could be a biomarker in the differential diagnosis of mixed urinary incontinence in women. *BJU Int*, 2008. 102(10): p. 1440-4.
 92. Kuo, H.C., H.T. Liu, and M.B. Chancellor, Can urinary nerve growth factor be a biomarker for overactive bladder? *Rev Urol*, 2010. 12(2-3): p. e69-77.
 93. Kuo, H.C., H.T. Liu, and M.B. Chancellor, Urinary nerve growth factor is a better biomarker than detrusor wall thickness for the assessment of overactive bladder with incontinence. *Neurourol Urodyn*, 2010. 29(3): p. 482-7.
 94. Steers, W.D. and J.B. Tuttle, Mechanisms of Disease: the role of nerve growth factor in the pathophysiology of bladder disorders. *Nat Clin Pract Urol*, 2006. 3(2): p. 101-10.
 95. Fall, M., G. Geirsson, and S. Lindstrom, Toward a new classification of overactive bladders. *Neurourol Urodyn*, 1995. 14(6): p. 635-46.
 96. Fall, M., B.L. Ohlsson, and C.A. Carlsson, The neurogenic overactive bladder. Classification based on urodynamics. *Br J Urol*, 1989. 64(4): p. 368-73.
 97. de Groat, W.C., Booth AM, Yoshimura N, Neurophysiology of micturition and its modification in animal models of human disease, in *The Autonomic Nervous System: Nervous Control of the Urogenital System*, ed. E. C.A. Maggi. 1993: Harwood Academic Publishers: London.
 98. Ruch, T.C. and P.C. Tang, Localization of brain stem and diencephalic areas controlling the micturition reflex. *J Comp Neurol*, 1956. 106(1): p. 213-45.
 99. Yoshimura, N., et al., The dopamine D1 receptor agonist SKF 38393 suppresses detrusor hyperreflexia in the monkey with parkinsonism induced by 1-methyl-4-phenyl-1,2,3,6-tetrahydropyridine (MPTP). *Neuropharmacology*, 1993. 32(4): p. 315-21.
 100. Yokoyama, O., et al., Glutamatergic and dopaminergic contributions to rat bladder hyperactivity after cerebral artery occlusion. *Am J Physiol*, 1999. 276(4 Pt 2): p. R935-42.
 101. Chen, S.Y., et al., Glutamate activation of neurons in CV-reactive areas of cat brain stem affects urinary bladder motility. *Am J Physiol*, 1993. 265(4 Pt 2): p. F520-9.
 102. Yoshiyama, M., J.R. Roppolo, and W.C. de Groat, Effects of MK-801 on the micturition reflex in the rat--possible sites of action. *J Pharmacol Exp Ther*, 1993. 265(2): p. 844-50.

103. Campeau, L., R. Soler, and K.E. Andersson, Bladder dysfunction and parkinsonism: current pathophysiological understanding and management strategies. *Curr Urol Rep*, 2011. 12(6): p. 396-403.
104. Sakakibara, R., et al., Pathophysiology of bladder dysfunction in Parkinson's disease. *Neurobiol Dis*, 2011.
105. Kitta, T., et al., GABAergic mechanism mediated via D receptors in the rat periaqueductal gray participates in the micturition reflex: an in vivo microdialysis study. *Eur J Neurosci*, 2008. 27(12): p. 3216-25.
106. Kitta, T., et al., Brain activation during detrusor overactivity in patients with Parkinson's disease: a positron emission tomography study. *J Urol*, 2006. 175(3 Pt 1): p. 994-8.
107. de Groat, W.C., et al., Mechanisms underlying the recovery of urinary bladder function following spinal cord injury. *J Auton Nerv Syst*, 1990. 30 Suppl: p. S71-7.
108. de Groat, W.C., et al., Organization of the sacral parasympathetic reflex pathways to the urinary bladder and large intestine. *J Auton Nerv Syst*, 1981. 3(2-4): p. 135-60.
109. Habler, H.J., W. Janig, and M. Koltzenburg, Activation of unmyelinated afferent fibres by mechanical stimuli and inflammation of the urinary bladder in the cat. *J Physiol*, 1990. 425: p. 545-62.
110. Fowler, C.J., et al., Intravesical capsaicin for neurogenic bladder dysfunction. *Lancet*, 1992. 339(8803): p. 1239.
111. Fowler, C.J., et al., Intravesical capsaicin for treatment of detrusor hyperreflexia. *J Neurol Neurosurg Psychiatry*, 1994. 57(2): p. 169-73.
112. Geirsson, G., M. Fall, and L. Sullivan, Clinical and urodynamic effects of intravesical capsaicin treatment in patients with chronic traumatic spinal detrusor hyperreflexia. *J Urol*, 1995. 154(5): p. 1825-9.
113. Cruz, F., et al., Suppression of bladder hyperreflexia by intravesical resiniferatoxin. *Lancet*, 1997. 350(9078): p. 640-1.
114. Silva, C., M.E. Rio, and F. Cruz, Desensitization of bladder sensory fibers by intravesical resiniferatoxin, a capsaicin analog: long-term results for the treatment of detrusor hyperreflexia. *Eur Urol*, 2000. 38(4): p. 444-52.
115. Silva, C., et al., Urodynamic effect of intravesical resiniferatoxin in patients with neurogenic detrusor overactivity of spinal origin: results of a double-blind randomized placebo-controlled trial. *Eur Urol*, 2005. 48(4): p. 650-5.
116. Brady, C.M., et al., P2X3-immunoreactive nerve fibres in neurogenic detrusor overactivity and the effect of intravesical resiniferatoxin. *Eur Urol*, 2004. 46(2): p. 247-53.
117. Apostolidis, A. and C.J. Fowler, The use of botulinum neurotoxin type A (BoNTA) in urology. *J Neural Transm*, 2008. 115(4): p. 593-605.
118. Andrade, E.L., et al., TRPA1 receptor modulation attenuates bladder overactivity induced by spinal cord injury. *Am J Physiol Renal Physiol*, 2011. 300(5): p. F1223-34.
119. Steers, W.D., Pathophysiology of overactive bladder and urge urinary incontinence. *Rev Urol*, 2002. 4 Suppl 4: p. S7-S18.
120. Yoshimura, N. and W.C. de Groat, Plasticity of Na⁺ channels in afferent neurones innervating rat urinary bladder following spinal cord injury. *J Physiol*, 1997. 503 (Pt 2): p. 269-76.
121. Foxman, B., et al., Urinary tract infection: self-reported incidence and associated costs. *Annals of Epidemiology*, 2000. 10(8): p. 509-515.
122. Matthews, S.J. and J.W. Lancaster, Urinary tract infections in the elderly population. *The American journal of geriatric pharmacotherapy*, 2011. 9(5): p. 286-309.
123. Foxman, B., Epidemiology of urinary tract infections: incidence, morbidity, and economic costs. *The American journal of medicine*, 2002. 113(1): p. 5-13.
124. Wilke, T., et al., Disease Burden And Costs Associated With Urinary Tract Infections In Type 2 Diabetes Mellitus Patients: An Analysis Based On A Large Sample Of 456,586 German Patients. *Value in Health*, 2015. 18(7): p. A513.
125. Turner, R.M., et al., Assessment of Outpatient and Inpatient Antibiotic Treatment Patterns and Health Care Costs of Patients with Complicated Urinary Tract Infections. *Clinical therapeutics*, 2015. 37(9): p. 2037-2047.
126. Nelson, D.E., et al., Characteristic male urine microbiomes associate with asymptomatic sexually transmitted infection. *PLoS One*, 2010. 5(11): p. e14116.
127. Dong, Q., et al., The microbial communities in male first catch urine are highly similar to those in paired urethral swab specimens. *PLoS One*, 2011. 6(5): p. e19709.
128. Siddiqui, H., et al., Assessing diversity of the female urine microbiota by high throughput sequencing of 16S rDNA amplicons. *BMC Microbiology*, 2011. 11(1): p. 1.
129. Fouts, D.E., et al., Integrated next-generation sequencing of 16S rDNA and metaproteomics

- differentiate the healthy urine microbiome from asymptomatic bacteriuria in neuropathic bladder associated with spinal cord injury. *Journal of Translational Medicine*, 2012. 10(1): p. 1.
130. Nelson, D.E., et al., Bacterial communities of the coronal sulcus and distal urethra of adolescent males. *PloS One*, 2012. 7(5): p. e36298.
 131. Siddiqui, H., et al., Alterations of microbiota in urine from women with interstitial cystitis. *BMC Microbiology*, 2012. 12(1): p. 1.
 132. Wolfe, A.J., et al., Evidence of uncultivated bacteria in the adult female bladder. *Journal of Clinical Microbiology*, 2012. 50(4): p. 1376-1383.
 133. Lewis, D.A., et al., The human urinary microbiome; bacterial DNA in voided urine of asymptomatic adults. *Frontiers in cellular and infection microbiology*, 2013. 3: p. 41.
 134. Fricke, W., et al., Human microbiota characterization in the course of renal transplantation. *American Journal of Transplantation*, 2014. 14(2): p. 416-427.
 135. Hilt, E.E., et al., Urine is not sterile: use of enhanced urine culture techniques to detect resident bacterial flora in the adult female bladder. *Journal of Clinical Microbiology*, 2014. 52(3): p. 871-876.
 136. Pearce, M.M., et al., The female urinary microbiome: a comparison of women with and without urgency urinary incontinence. *MBio*, 2014. 5(4): p. e01283-14.
 137. Willner, D., et al., Single clinical isolates from acute uncomplicated urinary tract infections are representative of dominant in situ populations. *MBio*, 2014. 5(2): p. e01064-13.
 138. Pearce, M.M., et al., The female urinary microbiome in urgency urinary incontinence. *American Journal of Obstetrics and Gynecology*, 2015. 213(3): p. 347. e1-347. e11.
 139. Nickel, J.C., et al., Search for microorganisms in men with urologic chronic pelvic pain syndrome: a culture-independent analysis in the MAPP Research Network. *The Journal of Urology*, 2015. 194(1): p. 127-135.
 140. Nickel, J.C., et al., Assessment of the Lower Urinary Tract Microbiota during Symptom Flare in Women with Urologic Chronic Pelvic Pain Syndrome: A MAPP Network Study. *The Journal of Urology*, 2016. 195(2): p. 356-362.
 141. Karstens, L., et al., Does the urinary microbiome play a role in urgency urinary incontinence and its severity? *Frontiers in Cellular and Infection Microbiology*, 2016. 6.
 142. Thomas-White, K.J., et al., Incontinence medication response relates to the female urinary microbiota. *Int Urogynecol J*, 2016. 27(5): p. 723-733.
 143. Thomas-White, K.J., et al., Evaluation of the urinary microbiota of women with uncomplicated stress urinary incontinence. *American Journal of Obstetrics and Gynecology*, 2016.
 144. Cho, I. and M.J. Blaser, The human microbiome: at the interface of health and disease. *Nature Reviews Genetics*, 2012. 13(4): p. 260-270.
 145. Ursell, L.K., et al., Defining the human microbiome. *Nutrition Reviews*, 2012. 70(suppl 1): p. S38-S44.
 146. Peterson, J., et al., The NIH human microbiome project. *Genome Research*, 2009. 19(12): p. 2317-2323.
 147. Cryan, J.F. and T.G. Dinan, Mind-altering microorganisms: the impact of the gut microbiota on brain and behaviour. *Nature reviews neuroscience*, 2012. 13(10): p. 701-712.
 148. Scher, J.U., et al., Expansion of intestinal *Prevotella copri* correlates with enhanced susceptibility to arthritis. *Elife*, 2013. 2: p. e01202.
 149. Larsen, N., et al., Gut microbiota in human adults with type 2 diabetes differs from non-diabetic adults. *PloS One*, 2010. 5(2): p. e9085.
 150. Xu, W., et al., Mini-review: perspective of the microbiome in the pathogenesis of urothelial carcinoma. *American journal of clinical and experimental urology*, 2014. 2(1): p. 57.
 151. Hooper, L.V. and J.I. Gordon, Commensal host-bacterial relationships in the gut. *Science*, 2001. 292(5519): p. 1115-1118.
 152. Ghartey, J.P., et al., *Lactobacillus crispatus* dominant vaginal microbiome is associated with inhibitory activity of female genital tract secretions against *Escherichia coli*. *PloS One*, 2014. 9(5): p. e96659.
 153. Brubaker, L. and A.J. Wolfe, The new world of the urinary microbiota in women. *American Journal of Obstetrics and Gynecology*, 2015. 213(5): p. 644-649.
 154. Ott, S., et al., Reduction in diversity of the colonic mucosa associated bacterial microflora in patients with active inflammatory bowel disease. *Gut*, 2004. 53(5): p. 685-693.
 155. Nickel, J.C., D.A. Shoskes, and K. Irvine-Bird, Prevalence and impact of bacteriuria and/or urinary tract infection in interstitial

- cystitis/painful bladder syndrome. *Urology*, 2010. 76(4): p. 799-803.
156. Braundmeier-Fleming, A., et al., Stool-based biomarkers of interstitial cystitis/bladder pain syndrome. *Scientific Reports*, 2016. 6.
 157. Shoskes, D.A., et al., Analysis of gut microbiome reveals significant differences between men with chronic prostatitis/chronic pelvic pain syndrome and controls. *The Journal of Urology*, 2016.
 158. Thom, D.H. and G. Rortveit, Prevalence of postpartum urinary incontinence: a systematic review. *Acta Obstet Gynecol Scand*, 2010. 89(12): p. 1511-22.
 159. Persson, J., P. Wolner-Hanssen, and H. Rydhstroem, Obstetric risk factors for stress urinary incontinence: a population-based study. *Obstet Gynecol*, 2000. 96(3): p. 440-5.
 160. Rortveit, G., et al., Urinary incontinence after vaginal delivery or cesarean section. *N Engl J Med*, 2003. 348(10): p. 900-7.
 161. MacLennan, A.H., et al., The prevalence of pelvic floor disorders and their relationship to gender, age, parity and mode of delivery. *BJOG*, 2000. 107(12): p. 1460-70.
 162. Leijonhufvud, A., et al., Risks of stress urinary incontinence and pelvic organ prolapse surgery in relation to mode of childbirth. *Am J Obstet Gynecol*, 2011. 204(1): p. 70 e1-7.
 163. Nygaard, I., Urinary incontinence: is cesarean delivery protective? *Semin Perinatol*, 2006. 30(5): p. 267-71. 231
 164. Guise, J.M., et al., Does cesarean protect against fecal incontinence in primiparous women? *Int Urogynecol J Pelvic Floor Dysfunct*, 2009. 20(1): p. 61-7.
 165. Guise, J.M., et al., Incidence of fecal incontinence after childbirth. *Obstet Gynecol*, 2007. 109(2 Pt 1): p. 281-8.
 166. Hall, W., et al., Frequency and predictors for postpartum fecal incontinence. *Am J Obstet Gynecol*, 2003. 188(5): p. 1205-7.
 167. Borello-France, D., et al., Fecal and urinary incontinence in primiparous women. *Obstet Gynecol*, 2006. 108(4): p. 863-72.
 168. Zetterstrom, J.P., et al., Anal incontinence after vaginal delivery: a prospective study in primiparous women. *Br J Obstet Gynaecol*, 1999. 106(4): p. 324-30.
 169. Brown, S.J., et al., Effects of prolonged second stage, method of birth, timing of caesarean section and other obstetric risk factors on postnatal urinary incontinence: an Australian nulliparous cohort study. *BJOG*, 2011. 118(8): p. 991-1000.
 170. Diez-Iltza, I., et al., Influence of mode of delivery on pelvic organ support 6 months postpartum. *Gynecol Obstet Invest*, 2011. 72(2): p. 123-9.
 171. Diez-Iltza, I., et al., Postpartum impairment of pelvic floor muscle function: factors involved and association with prolapse. *Int Urogynecol J*, 2011.
 172. Wai, C.Y., et al., Urodynamic indices and pelvic organ prolapse quantification 3 months after vaginal delivery in primiparous women. *Int Urogynecol J*, 2011. 22(10): p. 1293-8.
 173. Larsson, C., K. Kallen, and E. Andolf, Cesarean section and risk of pelvic organ prolapse: a nested case-control study. *Am J Obstet Gynecol*, 2009. 200(3): p. 243 e1-4. 232
 174. Gyhagen M et al., Prevalence and risk factors for pelvic organ prolapse 20 years after childbirth: a national cohort study in singleton primiparae after vaginal or caesarean delivery. *BJOG*. 2013 Jan;120(2):152-60.
 175. Gyhagen M. et al., A comparison of the long-term consequences of vaginal delivery versus caesarean section on the prevalence, severity and bothersomeness of urinary incontinence subtypes: a national cohort study in primiparous women. *BJOG*. 2013 Nov;120(12):1548-55.
 176. Solans-Domenech, M., E. Sanchez, and M. Espuna-Pons, Urinary and anal incontinence during pregnancy and postpartum: incidence, severity, and risk factors. *Obstet Gynecol*, 2010. 115(3): p. 618-28.
 177. Groutz, A., et al., Cesarean section: does it really prevent the development of postpartum stress urinary incontinence? A prospective study of 363 women one year after their first delivery. *Neurourol Urodyn*, 2004. 23(1): p. 2-6.
 178. Farrell, S.A., V.M. Allen, and T.F. Baskett, Parturition and urinary incontinence in primiparas. *Obstet Gynecol*, 2001. 97(3): p. 350-6.
 179. Arrue, M., et al., Factors involved in the persistence of stress urinary incontinence from pregnancy to 2years post partum. *Int J Gynaecol Obstet*, 2011.
 180. Wiklund, I., et al., Expectation and experiences of childbirth in primiparae with caesarean section. *BJOG*, 2008. 115(3): p. 324-31.
 181. Waldenstrom, U., I. Hildingsson, and E.L. Ryding, Antenatal fear of childbirth and its association with subsequent caesarean section and experience of childbirth. *BJOG*, 2006. 113(6): p. 638-46.

182. Fuglenes, D., et al., Why do some pregnant women prefer cesarean? The influence of parity, delivery experiences, and fear. *Am J Obstet Gynecol*, 2011.
183. Sjogren, B., Reasons for anxiety about childbirth in 100 pregnant women. *J Psychosom Obstet Gynaecol*, 1997. 18(4): p. 266-72.
184. Lavender, T., et al., Caesarean section for non-medical reasons at term. *Cochrane Database Syst Rev*, 2006. 3: p. CD004660.
185. Fritel, X., [Pelvic floor and pregnancy]. *Gynecol Obstet Fertil*, 2010. 38(5): p. 332-46. 233
186. Nelson, R.L., et al., Cesarean delivery for the prevention of anal incontinence. *Cochrane Database Syst Rev*, 2010(2): p. CD006756.
187. Ashton-Miller, J.A. and J.O. Delancey, On the biomechanics of vaginal birth and common sequelae. *Annu Rev Biomed Eng*, 2009. 11: p. 163-76.
188. King, J.K. and R.M. Freeman, Is antenatal bladder neck mobility a risk factor for postpartum stress incontinence? *Br J Obstet Gynaecol*, 1998. 105(12): p. 1300-7.
189. Keane, D.P., et al., Analysis of collagen status in premenopausal nulliparous women with genuine stress incontinence. *Br J Obstet Gynaecol*, 1997. 104(9): p. 994-8.
190. Lavin JM, S.A., Anderson J., The effect of pregnancy on the connective tissue rectus sheath. *Neurourol Urodyn* 1997. 16: p. 381-382.
191. Espuna-Pons M. et al., Double incontinence in a cohort of nulliparous pregnant women. *Neurol Urodyn*. 2012, Nov; 31(8): 1236-41
192. Heubner M. et al., The impact of pregnancy and vaginal delivery on urinary incontinence. *Int J Gynaecol Obstet*. 2010 Sep; 110 (3): 249-51
193. Johannessen HH, Wibe A, Stordahl A, Sandvik L, Backe, B, Mørkved S. Prevalence and predictors of anal incontinence during pregnancy and 1 year after delivery: a prospective cohort study. *BJOG* 2014;121:269–280.
194. Lewicky-Gaupp, C., et al., Urinary and anal incontinence in African-American teenaged gravidas during pregnancy and the puerperium. *J Pediatr Adolesc Gynecol*, 2008. 21(1): p. 21-6.
195. Rortveit, G. and S. Hunskar, Urinary incontinence and age at the first and last delivery: the Norwegian HUNT/EPINCONT study. *Am J Obstet Gynecol*, 2006. 195(2): p. 433-8.
196. Hannestad, Y.S., et al., Are smoking and other lifestyle factors associated with female urinary incontinence? The Norwegian EPINCONT Study. *BJOG*, 2003. 110(3): p. 247-54.
197. Eliasson, K., et al., Influence of physical activity on urinary leakage in primiparous women. *Scand J Med Sci Sports*, 2005. 15(2): p. 87-94.
198. Wesnes, S.L., et al., Urinary incontinence and weight change during pregnancy and postpartum: a cohort study. *Am J Epidemiol*, 2010. 172(9): p. 1034-44. 234
199. Wesnes, S.L., et al., The effect of urinary incontinence status during pregnancy and delivery mode on incontinence postpartum. A cohort study. *BJOG*, 2009. 116(5): p. 700-7.
200. Buchsbaum, G.M., et al., Urinary incontinence in nulliparous women and their parous sisters. *Obstet Gynecol*, 2005. 106(6): p. 1253-8.
201. Nguyen, A., et al., Nongenetic factors associated with stress urinary incontinence. *Obstet Gynecol*, 2011. 117(2 Pt 1): p. 251-5.
202. Rohr, G., et al., Genetic and environmental influences on urinary incontinence: a Danish population-based twin study of middle-aged and elderly women. *Acta Obstet Gynecol Scand*, 2004. 83(10): p. 978-82.
203. Lien, K.C., et al., Levator ani muscle stretch induced by simulated vaginal birth. *Obstet Gynecol*, 2004. 103(1): p. 31-40.
204. Svabik, K., K.L. Shek, and H.P. Dietz, How much does the levator hiatus have to stretch during childbirth? *BJOG*, 2009. 116(12): p. 1657-62.
205. Cassado Garriga, J., et al., Tridimensional sonographic anatomical changes on pelvic floor muscle according to the type of delivery. *Int Urogynecol J*, 2011. 22(8): p. 1011-8.
206. Shek, K.L. and H.P. Dietz, The effect of childbirth on hiatal dimensions. *Obstet Gynecol*, 2009. 113(6): p. 1272-8. 1
207. Valsky, D.V., et al., Fetal head circumference and length of second stage of labor are risk factors for levator ani muscle injury, diagnosed by 3-dimensional transperineal ultrasound in primiparous women. *Am J Obstet Gynecol*, 2009. 201(1): p. 91 e1-7. 235 1
208. Dietz, H.P. and K.L. Shek, Tomographic ultrasound imaging of the pelvic floor: which levels matter most? *Ultrasound Obstet Gynecol*, 2009. 33(6): p. 698-703.
209. H.P. and V. Lanzarone, Levator trauma after vaginal delivery. *Obstet Gynecol*, 2005. 106(4): p. 707-12.
210. Albrich, S., et al., Impact of mode of delivery on levator morphology: a prospective observational study with three-dimensional ultrasound early in the postpartum period. *BJOG*, 2011.

211. Shek, K.L., A. Pirpiris, and H.P. Dietz, Does levator avulsion increase urethral mobility? *Eur J Obstet Gynecol Reprod Biol*, 2010. 153(2): p. 215-9.
212. Novellas, S., et al., MR features of the levator ani muscle in the immediate postpartum following cesarean delivery. *Int Urogynecol J*, 2010. 21(5): p. 563-8.
213. Heilbrun, M.E., et al., Correlation between levator ani muscle injuries on magnetic resonance imaging and fecal incontinence, pelvic organ prolapse, and urinary incontinence in primiparous women. *Am J Obstet Gynecol*, 2010. 202(5): p. 488 e1-6.
214. Branham, V., et al., Levator ani abnormality 6 weeks after delivery persists at 6 months. *Am J Obstet Gynecol*, 2007. 197(1): p. 65 e1-6.
215. Kearney, R., et al., Obstetric factors associated with levator ani muscle injury after vaginal birth. *Obstet Gynecol*, 2006. 107(1): p. 144-9.
216. Krofta, L., et al., Pubococcygeus-puborectalis trauma after forceps delivery: evaluation of the levator ani muscle with 3D/4D ultrasound. *Int Urogynecol J Pelvic Floor Dysfunct*, 2009. 20(10): p. 1175-81. 236
217. Kearney, R., et al., Levator ani injury in primiparous women with forceps delivery for fetal distress, forceps for second stage arrest, and spontaneous delivery. *Int J Gynaecol Obstet*, 2010. 111(1): p. 19-22.
218. Delancey, J.O. and W.W. Hurd, Size of the urogenital hiatus in the levator ani muscles in normal women and women with pelvic organ prolapse. *Obstet Gynecol*, 1998. 91(3): p. 364-8.
219. Dietz, H.P. and J.M. Simpson, Levator trauma is associated with pelvic organ prolapse. *BJOG*, 2008. 115(8): p. 979-84.
220. Chen, L., et al., Interaction among apical support, levator ani impairment, and anterior vaginal wall prolapse. *Obstet Gynecol*, 2006. 108(2): p. 324-32.
221. Rostaminia G. et al., Levator ani deficiency and pelvic prolapse severity. *Obstet Gynecol*. 2013 May; 121 (5) 1017-24
222. Morgan, D.M., et al., Levator ani defect status and lower urinary tract symptoms in women with pelvic organ prolapse. *Int Urogynecol J*, 2010. 21(1): p. 47-52.
223. Dietz, H.P., et al., Does avulsion of the puborectalis muscle affect bladder function? *Int Urogynecol J Pelvic Floor Dysfunct*, 2009. 20(8): p. 967-72.
224. Brincat, C.A., J.O. Delancey, and J.M. Miller, Urethral closure pressures among primiparous women with and without levator ani muscle defects. *Int Urogynecol J*, 2011.
225. Martins, J.A., et al., Finite element studies of the deformation of the pelvic floor. *Ann N Y Acad Sci*, 2007. 1101: p. 316-34.
226. Fitzpatrick, M. and C. O'Herlihy, The effects of labour and delivery on the pelvic floor. *Best Pract Res Clin Obstet Gynaecol*, 2001. 15(1): p. 63-79.
227. Lin, A.S., et al., Effect of simulated birth trauma on the urinary continence mechanism in the rat. *Urology*, 1998. 52(1): p. 143-51. 237
228. Deindl, F.M., et al., Pelvic floor activity patterns: comparison of nulliparous continent and parous urinary stress incontinent women. A kinesiological EMG study. *Br J Urol*, 1994. 73(4): p. 413-7.
229. Gunnarsson, M. and A. Mattiasson, Female stress, urge, and mixed urinary incontinence are associated with a chronic and progressive pelvic floor/vaginal neuromuscular disorder: An investigation of 317 healthy and incontinent women using vaginal surface electromyography. *Neurourol Urodyn*, 1999. 18(6): p. 613-21.
230. Vodusek, D.B., The role of electrophysiology in the evaluation of incontinence and prolapse. *Curr Opin Obstet Gynecol*, 2002. 14(5): p. 509-14.
231. Snooks, S.J., et al., Injury to innervation of pelvic floor sphincter musculature in childbirth. *Lancet*, 1984. 2(8402): p. 546-50.
232. Allen, R.E., et al., Pelvic floor damage and childbirth: a neurophysiological study. *Br J Obstet Gynaecol*, 1990. 97(9): p. 770-9.
233. Snooks, S.J., et al., Effect of vaginal delivery on the pelvic floor: a 5-year follow-up. *Br J Surg*, 1990. 77(12): p. 1358-60.
234. Weidner, A.C., et al., Pelvic muscle electromyography of levator ani and external anal sphincter in nulliparous women and women with pelvic floor dysfunction. *Am J Obstet Gynecol*, 2000. 183(6): p. 1390-9; discussion 1399-401.
235. Abitbol, M.M., Birth and human evolution: anatomical and obstetrical mechanics in primates. , ed. C.B.G. Westport. 1996, London.
236. Rortveit, G., et al., Vaginal delivery parameters and urinary incontinence: the Norwegian EPINCONT study. *Am J Obstet Gynecol*, 2003. 189(5): p. 1268-74. 238
237. Moerman, M.L., Growth of the birth canal in adolescent girls. *Am J Obstet Gynecol*, 1982. 143(5): p. 528-32.
238. Robinson, J.N., et al., Episiotomy, operative vaginal delivery, and significant perinatal

- trauma in nulliparous women. *Am J Obstet Gynecol*, 1999. (5 Pt 1): p. 1180-4.
239. Carroll, T.G., et al., Epidural analgesia and severe perineal laceration in a community-based obstetric practice. *J Am Board Fam Pract*, 2003. 16(1): p. 1-6.
 240. Christianson, L.M., et al., Risk factors for perineal injury during delivery. *Am J Obstet Gynecol*, 2003. 189(1): p. 255-60.
 241. Fitzgerald, M.P., et al., Risk factors for anal sphincter tear during vaginal delivery. *Obstet Gynecol*, 2007. 109(1): p. 29-34.
 242. Meyer, S., et al., Effects of epidural analgesia on pelvic floor function after spontaneous delivery: a longitudinal retrospective study. *Int Urogynecol J Pelvic Floor Dysfunct*, 2002. 13(6): p. 359-64; discussion 364-5.
 243. Sartore, A., et al., Effects of epidural analgesia during labor on pelvic floor function after vaginal delivery. *Acta Obstet Gynecol Scand*, 2003. 82(2): p. 143-6.
 244. Shek, K.L. and H.P. Dietz, Intrapartum risk factors for levator trauma. *BJOG*, 2010. 117(12): p. 1485-92.
 245. Thacker, S.B. and H.D. Banta, Benefits and risks of episiotomy: an interpretative review of the English language literature, 1860-1980. *Obstet Gynecol Surv*, 1983. 38(6): p. 322-38.
 246. Carroli, G. and J. Belizan, Episiotomy for vaginal birth. *Cochrane Database Syst Rev*, 2000(2): p. CD000081. 239
 247. Woolley, R.J., Benefits and risks of episiotomy: a review of the English-language literature since 1980. Part I. *Obstet Gynecol Surv*, 1995. 50(11): p. 806-20.
 248. Woolley, R.J., Benefits and risks of episiotomy: a review of the English-language literature since 1980. Part II. *Obstet Gynecol Surv*, 1995. 50(11): p. 821-35.
 249. Goldberg, J., et al., Has the use of routine episiotomy decreased? Examination of episiotomy rates from 1983 to 2000. *Obstet Gynecol*, 2002. 99(3): p. 395-400.
 250. Kalis, V., et al., Classification of episiotomy: towards a standardisation of terminology. *BJOG*, 2012.
 251. Tincello, D.G., et al., Differences in episiotomy technique between midwives and doctors. *BJOG*, 2003. 110(12): p. 1041-4.
 252. Laine, K., M. Gissler, and J. Pirhonen, Changing incidence of anal sphincter tears in four Nordic countries through the last decades. *Eur J Obstet Gynecol Reprod Biol*, 2009. 146(1): p. 71-5.
 253. Raisanen, S.H., et al., Lateral episiotomy protects primiparous but not multiparous women from obstetric anal sphincter rupture. *Acta Obstet Gynecol Scand*, 2009. 88(12): p. 1365-72.
 254. Raisanen, S., et al., High episiotomy rate protects from obstetric anal sphincter ruptures: a birth register-study on delivery intervention policies in Finland. *Scand J Public Health*, 2011. 39(5): p. 457-63.
 255. Carroli, G. and L. Mignini, Episiotomy for vaginal birth. *Cochrane Database Syst Rev*, 2009(1): p. CD000081.
 256. Klein, M.C., et al., Relationship of episiotomy to perineal trauma and morbidity, sexual dysfunction, and pelvic floor relaxation. *Am J Obstet Gynecol*, 1994. 171(3): p. 591-8. 240
 257. Sultan, A.H., et al., Anal-sphincter disruption during vaginal delivery. *N Engl J Med*, 1993. 329(26): p. 1905-11.
 258. Haadem, K., et al., Anal sphincter function after delivery rupture. *Obstet Gynecol*, 1987. 70(1): p. 53-6.
 259. Eason, E., et al., Preventing perineal trauma during childbirth: a systematic review. *Obstet Gynecol*, 2000. 95(3): p. 464-71.
 260. Kalis, V., et al., Evaluation of the incision angle of mediolateral episiotomy at 60 degrees. *Int J Gynaecol Obstet*, 2011. 112(3): p. 220-4.
 261. Raisanen, S., et al., A population-based register study to determine indications for episiotomy in Finland. *Int J Gynaecol Obstet*, 2011. 115(1): p. 26-30.
 262. Robinson, J.N., et al., Predictors of episiotomy use at first spontaneous vaginal delivery. *Obstet Gynecol*, 2000. 96(2): p. 214-8.
 263. Goldberg, J., et al., The Philadelphia Episiotomy Intervention Study. *J Reprod Med*, 2006. 51(8): p. 603-9.
 264. Alperin, M., M.A. Krohn, and K. Parviainen, Episiotomy and increase in the risk of obstetric laceration in a subsequent vaginal delivery. *Obstet Gynecol*, 2008. 111(6): p. 1274-8.
 265. Bo et al., Does episiotomy influence vaginal resting pressure, pelvic floor muscle strength and endurance, and prevalence of urinary incontinence 6 weeks postpartum? *Neurourolog Urodyn*. 2016 Apr 5
 266. Oliveira et al. A biomechanical analysis on the impact of episiotomy during childbirth. *Biomech Model Mechanobiol*. 2016 Dec; 15(6): 1523-1534.
 267. Kelly, H.A.a.C.F.B., *Diseases of kidneys, ureters and bladder*. Vol. 2v. 1922, New York and London: D. Appleton and company.

268. Oelrich, T.M., The striated urogenital sphincter muscle in the female. *Anat Rec*, 1983. 205(2): p. 223-32.
269. DeLancey, J.O., Functional anatomy of the female lower urinary tract and pelvic floor. *Ciba Found Symp*, 1990. 151: p. 57-69; discussion 69-76.
270. DeLancey, J.O., Structural support of the urethra as it relates to stress urinary incontinence: the hammock hypothesis. *Am J Obstet Gynecol*, 1994. 170(6): p. 1713-20; discussion 1720-3.
271. Athanassopoulos, A., et al., Stamey endoscopic vesical neck suspension in female urinary stress incontinence: results and changes in various urodynamic parameters. *Int Urol Nephrol*, 1994. 26(3): p. 293-9.
272. Bump, R.C., J.A. Fantl, and W.G. Hurt, Dynamic urethral pressure profilometry pressure transmission ratio determinations after continence surgery: understanding the mechanism of success, failure, and complications. *Obstet Gynecol*, 1988. 72(6): p. 870-4.
273. Bunne, G. and A. Obrink, Influence of pubococcygeal repair on urethral closure pressure at stress. *Acta Obstet Gynecol Scand*, 1978. 57(4): p. 355-9.
274. Hilton, P. and S.L. Stanton, Urethral pressure measurement by microtransducer: the results in symptom-free women and in those with genuine stress incontinence. *Br J Obstet Gynaecol*, 1983. 90(10): p. 919-33.
275. Masuda, H., et al., [Analysis of continence mechanisms by stress urethral pressure profiles]. *Nihon Hinyokika Gakkai Zasshi*, 1994. 85(3): p. 434-9.
276. Obrink, A., G. Bunne, and A. Ingelman-Sundberg, Pressure transmission to the pre-urethral space in stress incontinence. *Urol Res*, 1978. 6(3): p. 135-40.
277. Penttinen, J., et al., Successful colposuspension in stress urinary incontinence reduces bladder neck mobility and increases pressure transmission to the urethra. *Arch Gynecol Obstet*, 1989. 244(4): p. 233-8.
278. Penttinen, J., K. Kaar, and A. Kauppila, Effect of suprapubic operation on urethral closure. Evaluation by single cough urethrocytometry. *Br J Urol*, 1989. 63(4): p. 389-91.
279. Rottenberg, R.D., et al., Urodynamic and clinical assessment of the Lyodura sling operation for urinary stress incontinence. *Br J Obstet Gynaecol*, 1985. 92(8): p. 829-34.
280. van Geelen, J.M., et al., The clinical and urodynamic effects of anterior vaginal repair and Burch colposuspension. *Am J Obstet Gynecol*, 1988. 159(1): p. 137-44.
281. Sebe, P., et al., Fetal development of the female external urinary sphincter complex: an anatomical and histological study. *J Urol*, 2005. 173(5): p. 1738-42; discussion 1742.
282. Yucel, S. and L.S. Baskin, An anatomical description of the male and female urethral sphincter complex. *J Urol*, 2004. 171(5): p. 1890-7.
283. Ludwikowski, B., et al., The development of the external urethral sphincter in humans. *BJU Int*, 2001. 87(6): p. 565-8.
284. Wallner, C., et al., The anatomical components of urinary continence. *Eur Urol*, 2009. 55(4): p. 932-43.
285. Luo J, Betschart C, Ashton-Miller JA, DeLancey JO. Quantitative analyses of variability in normal vaginal shape and dimension on MR images. *Int Urogynecol J*. 2016 Jan 25. [Epub ahead of print]
286. Huang, W.C., S.H. Yang, and J.M. Yang, Anatomical and functional significance of urogenital hiatus in primary urodynamic stress incontinence. *Ultrasound Obstet Gynecol*, 2006. 27(1): p. 71-7.
287. Lien, K.C., et al., Pudendal nerve stretch during vaginal birth: a 3D computer simulation. *Am J Obstet Gynecol*, 2005. 192(5): p. 1669-76.
288. Diao E, A.A., Diao J, Animal models of peripheral nerve injury. *Oper Tech Orthop*, 2004. 14: p. 153-162.
289. Sajadi, K.P., B.C. Gill, and M.S. Damaser, Neurogenic aspects of stress urinary incontinence. *Curr Opin Obstet Gynecol*, 2010. 22(5): p. 425-9.
290. Martan, A., et al., [Ultrasonic evaluation of paravaginal defects before and after surgical treatment in women with urinary stress incontinence]. *Ceska Gynecol*, 2000. 65(3): p. 152-6.
291. Margulies RU, Huebner M, DeLancey JO. Origin and insertion points involved in levator ani muscle defects. *Am J Obstet Gynecol*, 2007. 196(3):251.e1-5.
292. Miller, J.M., et al., MRI findings in patients considered high risk for pelvic floor injury studied serially after vaginal childbirth. *AJR Am J Roentgenol*, 2010. 195(3): p. 786-91.
293. Jeffcoate, T.N. and H. Roberts, Observations on stress incontinence of urine. *Am J Obstet Gynecol*, 1952. 64(4): p. 721-38.
294. Pregazzi, R., et al., Perineal ultrasound evaluation of urethral angle and bladder neck

- mobility in women with stress urinary incontinence. *BJOG*, 2002. 109(7): p. 821-7.
295. Hodgkinson, C.P., Relationships of the female urethra and bladder in urinary stress incontinence. *Am J Obstet Gynecol*, 1953. 65(3): p. 560-73.
 296. Hodgkinson, C.P., Stress urinary incontinence-1970. *Am J Obstet Gynecol*, 1970. 108(7): p. 1141-68.
 297. Larson KA et al., 3D analysis of cystoceles using magnetic resonance imaging assessing midline, paravaginal, and apical defects. *Int Urogynecol J*. 2012;23(3):285-93.
 298. Wall, L.L., et al., Bladder neck mobility and the outcome of surgery for genuine stress urinary incontinence. A logistic regression analysis of lateral bead-chain cystourethrograms. *J Reprod Med*, 1994. 39(6): p. 429-35.
 299. Kamo, I., et al., Functional analysis of active urethral closure mechanisms under sneeze induced stress condition in a rat model of birth trauma. *J Urol*, 2006. 176(6 Pt 1): p. 2711-5.
 300. DeLancey, J.O., et al., Vaginal birth and de novo stress incontinence: relative contributions of urethral dysfunction and mobility. *Obstet Gynecol*, 2007. 110(2 Pt 1): p. 354-62.
 301. Ulmsten U et al., Different biochemical composition of connective tissue in continent and stress incontinent women. *Acta Obstet Gynecol Scand* 1987;66:455-457 – 235
 302. Falconer C et al., Decreased collagen synthesis in stress-incontinent women. *Obstet Gynecol* 1994;84:583–586 – 236
 303. Keane DP et al., Analysis of collagen status in premenopausal nulliparous women with genuine stress incontinence. *Br J Obstet Gynaecol* 1997;104:994–998 – 237
 304. DeLancey JOL. Structural aspects of the extrinsic continence mechanism. *Obstet &Gynecol* 1988;72:296-301 – 238.
 305. Hilton P, Dolan LM. Pathophysiology of urinary incontinence and pelvic organ prolapse. *BJOG*. 2004;111 Suppl 1:5-9 – 239.
 306. Landon CR et al., Mechanical properties of fascia during pregnancy: a possible factor in the development of stress incontinence of urine. *Contemp Rev Obstet Gynaecol* 1990;2:40-46 - 240.
 307. Dolan LM et al., Stress incontinence and pelvic floor neurophysiology 15 years after the first delivery. *Br J Obstet Gynaecol* 2003;110:1107-1114 - 241.
 308. Kelly HA, Dumm WM. Urinary incontinence in women, without manifest injury to the bladder: A report of cases. *Surg Gynecol Obstet* 1914;18:444-50 – 242.
 309. Blaivas, J.G. and C.A. Olsson, Stress incontinence: classification and surgical approach. *J Urol*, 1988. 139(4): p. 727-31.
 310. McGuire, E.J., R.D. Cespedes, and H.E. O'Connell, Leak-point pressures. *Urol Clin North Am*, 1996. 23(2): p. 253-62.
 311. McGuire, E.J., Diagnosis and treatment of intrinsic sphincter deficiency. *Int J Urol*, 1995. 2 Suppl 1: p. 7-10; discussion 16-8.
 312. Leach, G.E., et al., Female Stress Urinary Incontinence Clinical Guidelines Panel summary report on surgical management of female stress urinary incontinence. The American Urological Association. *J Urol*, 1997. 158(3 Pt 1): p. 875-80.
 313. Horbach, N.S. and D.R. Ostergard, Predicting intrinsic urethral sphincter dysfunction in women with stress urinary incontinence. *Obstet Gynecol*, 1994. 84(2): p. 188-92.
 314. Perucchini, D., et al., Age effects on urethral striated muscle. I. Changes in number and diameter of striated muscle fibers in the ventral urethra. *Am J Obstet Gynecol*, 2002. 186(3): p. 351-5.
 315. Perucchini, D., et al., Age effects on urethral striated muscle. II. Anatomic location of muscle loss. *Am J Obstet Gynecol*, 2002. 186(3): p. 356-60.
 316. Pandit M et al., Quantification of intramuscular nerves within the female striated urogenital sphinc-ter muscle. *Obstet Gynecol*. 2000;95(6 Pt 1):797-800 - 242.
 317. Kayigil, O., S. Iftexhar Ahmed, and A. Metin, The coexistence of intrinsic sphincter deficiency with type II stress incontinence. *J Urol*, 1999. 162(4): p. 1365-6.
 318. Chaikin, D.C., J. Rosenthal, and J.G. Blaivas, Pubovaginal fascial sling for all types of stress urinary incontinence: long-term analysis. *J Urol*, 1998. 160(4): p. 1312-6.
 319. Bemelmans, B.L. and C.R. Chapple, Are slings now the gold standard treatment for the management of female urinary stress incontinence and if so which technique? *Curr Opin Urol*, 2003. 13(4): p. 301-7.
 320. Kiilholma, P.J., et al., Perineal ultrasound: an alternative for radiography for evaluating stress urinary incontinence in females. *Ann Chir Gynaecol Suppl*, 1994. 208: p. 43-5.
 321. Karan, A., et al., Hypermobility syndrome in 105 women with pure urinary stress incontinence and in 105 controls. *Arch Gynecol Obstet*, 2004. 269(2): p. 89-90.

322. Meyer, S., et al., The assessment of bladder neck position and mobility in continent nullipara, multipara, forceps-delivered and incontinent women using perineal ultrasound: a future office procedure? *Int Urogynecol J Pelvic Floor Dysfunct*, 1996. 7(3): p. 138-46.
323. Pauwels, E., S. De Wachter, and J.J. Wyndaele, Evaluation of different techniques to create chronic urinary incontinence in the rat. *BJU Int*, 2009. 103(6): p. 782-5; discussion 785-6.
324. Kefer, J.C., G. Liu, and F. Daneshgari, Pubo-urethral ligament injury causes long-term stress urinary incontinence in female rats: an animal model of the integral theory. *J Urol*, 2009. 181(1): p. 397-400.
325. DeLancey JO et al., Stress urinary incontinence: relative importance of urethral support and urethral closure pressure. *J Urol*. 2008;179(6):2286-90 – 250.
326. Lewicky-Gaupp C et al. "The cough game": are there characteristic urethrovesical movement pat-terns associated with stress incontinence? *Int Uro-gynecol J Pelvic Floor Dysfunct*. 2009;20(2):171-5 – 251
327. Almeida, F.G., H. Bruschini, and M. Srougi, Correlation between urethral sphincter activity and Valsalva leak point pressure at different bladder distentions: revisiting the urethral pressure profile. *J Urol*, 2005. 174(4 Pt 1): p. 1312-5; discussion 1315-6.
328. Sinha, D., V. Nallaswamy, and A.S. Arunkalaivanan, Value of leak point pressure study in women with incontinence. *J Urol*, 2006. 176(1): p. 186-8; discussion 188.
329. Martan, A., et al., Weak VLPP and MUCP correlation and their relationship with objective and subjective measures of severity of urinary incontinence. *Int Urogynecol J Pelvic Floor Dysfunct*, 2007. 18(3): p. 267-71.
330. Digesu, G.A., et al., The relationship of urethral resistance pressure and pressure flow parameters in women with lower urinary tract symptoms. *Int Urogynecol J Pelvic Floor Dysfunct*, 2007. 18(5): p. 493-7.
331. Salvatore, S., et al., Opening vesical pressure: a new test to discriminate urethral sphincter deficiency? *Int Urogynecol J Pelvic Floor Dysfunct*, 2007. 18(12): p. 1435-8.
332. Heit, M., Intraurethral ultrasonography: correlation of urethral anatomy with functional urodynamic parameters in stress incontinent women. *Int Urogynecol J Pelvic Floor Dysfunct*, 2000. 11(4): p. 204-11.
333. Kauppila, A., J. Penttinen, and V.M. Haggman, Six-microtransducer catheter connected to computer in evaluation of urethral closure function of women. *Urology*, 1989. 33(2): p. 159-64.
334. Behr, J., M. Winkler, and U. Schwiersch, [Urodynamic observations on the Marshall-Marchetti-Krantz operation]. *Geburtshilfe Frauenheilkd*, 1986. 46(9): p. 649-53.
335. Vanderschot, E.L., M.L. Chafik, and F.M. Debruyne, Has the suprapubic suspension operation any influence on the urethral pressure profile? *Br J Urol*, 1979. 51(2): p. 140-3.
336. Langer, R., et al., Continence mechanism after colpo-needle suspension for stress urinary incontinence. *J Reprod Med*, 1995. 40(10): p. 699-702.
337. Hertogs, K. and S.L. Stanton, Lateral bead-chain urethrocytography after successful and unsuccessful colposuspension. *Br J Obstet Gynaecol*, 1985. 92(11): p. 1179-83.
338. Snooks, S.J., P.R. Barnes, and M. Swash, Damage to the innervation of the voluntary anal and periurethral sphincter musculature in incontinence: an electrophysiological study. *J Neurol Neurosurg Psychiatry*, 1984. 47(12): p. 1269-73.
339. Swash, M., S.J. Snooks, and M.M. Henry, Unifying concept of pelvic floor disorders and incontinence. *J R Soc Med*, 1985. 78(11): p. 906-11.
340. Ismael, S.S., et al., Postpartum lumbosacral plexopathy limited to autonomic and perineal manifestations: clinical and electrophysiological study of 19 patients. *J Neurol Neurosurg Psychiatry*, 2000. 68(6): p. 771-3.
341. Takahashi, S., et al., Electromyographic study of the striated urethral sphincter in type 3 stress incontinence: evidence of myogenic-dominant damages. *Urology*, 2000. 56(6): p. 946-50.
342. Bakas, P., et al., Pudendal nerve terminal motor latency in women with genuine stress incontinence and prolapse. *Gynecol Obstet Invest*, 2001. 51(3): p. 187-90.
343. Chermansky, C.J., et al., A model of intrinsic sphincteric deficiency in the rat: electrocauterization. *Neurourol Urodyn*, 2004. 23(2): p. 166-71.
344. Eberli, D., et al., A canine model of irreversible urethral sphincter insufficiency. *BJU Int*, 2009. 103(2): p. 248-53.
345. Jiang, H.H., et al., Dual simulated childbirth injuries result in slowed recovery of pudendal nerve and urethral function. *Neurourol Urodyn*, 2009. 28(3): p. 229-35.

346. Pieber, D., F. Zivkovic, and K. Tamussino, Timing of urethral pressure pulses before and after continence surgery. *Neurourol Urodyn*, 1998. 17(1): p. 19-23.
347. Deffieux, X., et al., Pelvic floor muscle activity during coughing: altered pattern in women with stress urinary incontinence. *Urology*, 2007. 70(3): p. 443-7; discussion 447-8.
348. Deffieux, X., et al., Decrease in urethral pressure following repeated cough efforts: a new concept for pathophysiology of stress urinary incontinence. *Int J Urol*, 2007. 14(11): p. 1019-24.
349. Kenton, K., et al., Recurrent stress incontinence is associated with decreased neuromuscular function in the striated urethral sphincter. *Am J Obstet Gynecol*, 2006. 194(5): p. 1434-7.
350. Thor, K.B., Serotonin and norepinephrine involvement in efferent pathways to the urethral rhabdosphincter: implications for treating stress urinary incontinence. *Urology*, 2003. 62(4 Suppl 1): p. 3-9.
351. Takahashi S et al., Electromyographic study of the striated urethral sphincter in type 3 stress incontinence: Evidence of myogenic-dominant damages. *Urology* 2000;56:946-50.
352. Kokoua A et al., Maturation of the external urinary sphincter: A comparative histotopographic study in humans. *J Urol* 1993;150:617-22.
353. Heesakkers J et al. Circumferential urinary sphincter surface electromyography: A novel diagnostic method for intrinsic sphincter deficiency. *Neurourol Urodyn*. 2014 Dec 18. doi: 10.1002/nau.22711. [Epub ahead of print].
354. Chen, B., et al., Microarray analysis of differentially expressed genes in vaginal tissues from women with stress urinary incontinence compared with asymptomatic women. *Hum Reprod*, 2006. 21(1): p. 22-9.
355. Wen, Y., et al., Is alpha2-macroglobulin important in female stress urinary incontinence? *Hum Reprod*, 2008. 23(2): p. 387-93.
356. Yang, A., et al., Pelvic floor descent in women: dynamic evaluation with fast MR imaging and cinematic display. *Radiology*, 1991. 179(1): p. 25-33.
357. Gufler, H., et al., Comparison of cystourethrography and dynamic MRI in bladder neck descent. *J Comput Assist Tomogr*, 2000. 24(3): p. 382-8.
358. Yang, A., et al, Patterns of Prolapse Demonstrated With Dynamic Fastscan MRI; Reassessment of Conventional Concepts of Pelvic Floor Weaknesses. *Neurourol Urodyn*, 1993. 12(4): p. 4.
359. Kim, J.K., et al., The urethra and its supporting structures in women with stress urinary incontinence: MR imaging using an endovaginal coil. *AJR Am J Roentgenol*, 2003. 180(4): p. 1037-44.
360. Yang, A.e.a., High Resolution Magnetic Resonance Imaging of Urethra and Periurethral Structures Using Intravaginal Surface Coil and Quadrature Phased Array Surface Coil. *Neurourol Urodyn*, 1993. 12(4): p. 15.
361. Perez, N., et al., Dynamic magnetic resonance imaging of the female pelvis: radio-anatomy and pathologic applications. Preliminary results. *Surg Radiol Anat*, 1999. 21(2): p. 133-8.
362. Madill SJ et al., Effects of PFM rehabilitation on PFM function and morphology in older women. *Neurourol Urodyn*. 2013;32(8):1086-95.
363. Madill SJ et al., Changes in urethral sphincter size following rehabilitation in older women with stress urinary incontinence. *Int Urogynecol J*. 2015;26(2):277-83.
364. McLean L et al., Pelvic floor muscle training in women with stress urinary incontinence causes hypertrophy of the urethral sphincters and reduces bladder neck mobility during coughing. *Neurourol Urodyn*. 2013;32(8):1096-102.
365. Macura KJ et al., Magnetic resonance imaging in assessment of stress urinary incontinence in wom-en: Parameters differentiating urethral hypermobility and intrinsic sphincter deficiency. *World J Radiol*. 2015;7(11):394-404.
366. Masata, J., et al., [Ultrasonography of the funneling of the urethra]. *Ceska Gynekol*, 2000. 65(2): p. 87-90.
367. Schaer, G.N., et al., Improvement of perineal sonographic bladder neck imaging with ultrasound contrast medium. *Obstet Gynecol*, 1995. 86(6): p. 950-4.
368. Siracusano, S., et al., The feasibility of urethral color ultrasound imaging in the diagnosis of female intrinsic sphincter deficiency: preliminary results. *Spinal Cord*, 2002. 40(4): p. 192-5.
369. Huang, W.C. and J.M. Yang, Bladder neck funneling on ultrasound cystourethrography in primary stress urinary incontinence: a sign associated with urethral hypermobility and intrinsic sphincter deficiency. *Urology*, 2003. 61(5): p. 936-41.
370. Ghoniem, G.M., et al., Grades of intrinsic sphincteric deficiency (ISD) associated with female stress urinary incontinence. *Int*

- Urogynecol J Pelvic Floor Dysfunct, 2002. 13(2): p. 99-105; discussion 105.
371. Tunn, R., et al., Pathogenesis of urethral funneling in women with stress urinary incontinence assessed by introital ultrasound. *Ultrasound Obstet Gynecol*, 2005. 26(3): p. 287-92.
 372. Martan, A., et al., Ultrasound imaging of paravaginal defects in women with stress incontinence before and after paravaginal defect repair. *Ultrasound Obstet Gynecol*, 2002. 19(5): p. 496-500.
 373. Nichols, D.H., Randall C.L., *Vaginal surgery*. 3rd ed. 1989, Baltimore: Williams & Wilkins.
 374. Mostwin, J.L., et al., Radiography, sonography, and magnetic resonance imaging for stress incontinence. Contributions, uses, and limitations. *Urol Clin North Am*, 1995. 22(3): p. 539-49.
 375. Martan, A., et al., Ultrasound imaging of the lower urinary system in women after Burch colposuspension. *Ultrasound Obstet Gynecol*, 2001. 17(1): p. 58-64.
 376. Orno, A.K. and H.P. Dietz, Levator co-activation is a significant confounder of pelvic organ descent on Valsalva maneuver. *Ultrasound Obstet Gynecol*, 2007. 30(3): p. 346-50.
 377. Oliveira, E., et al., Ultrasonographic and Doppler velocimetric evaluation of the levator ani muscle in premenopausal women with and without urinary stress incontinence. *Eur J Obstet Gynecol Reprod Biol*, 2007. 133(2): p. 213-7.
 378. Devreese, A., et al., Clinical evaluation of pelvic floor muscle function in continent and incontinent women. *Neurourol Urodyn*, 2004. 23(3): p. 190-7.
 379. Morin, M., et al., Pelvic floor muscle function in continent and stress urinary incontinent women using dynamometric measurements. *Neurourol Urodyn*, 2004. 23(7): p. 668-74.
 380. Dietz, H.P., S.K. Jarvis, and T.G. Vancaillie, The assessment of levator muscle strength: a validation of three ultrasound techniques. *Int Urogynecol J Pelvic Floor Dysfunct*, 2002. 13(3): p. 156-9; discussion 159.
 381. Constantinou, C.E., Dynamics of female pelvic floor function using urodynamics, ultrasound and Magnetic Resonance Imaging (MRI). *Eur J Obstet Gynecol Reprod Biol*, 2009. 144 Suppl 1: p. S159-65.
 382. Milley, P.S. and D.H. Nichols, The relationship between the pubo-urethral ligaments and the urogenital diaphragm in the human female. *Anat Rec*, 1971. 170(3): p. 281-3.
 383. Zacharin, R.F., The anatomic supports of the female urethra. *Obstet Gynecol*, 1968. 32(6): p. 754-9.
 384. Zacharin, R.F., The Suspensory Mechanism of the Female Urethra. *J Anat*, 1963. 97: p. 423-7.
 385. Mostwin, J.L., et al., Stress incontinence observed with real time sonography and dynamic fastscan magnetic resonance imaging--insights into pathophysiology. *Scand J Urol Nephrol Suppl*, 2001(207): p. 94-9; discussion 106-25.
 386. Athanasiou, S., et al., Imaging the urethral sphincter with three-dimensional ultrasound. *Obstet Gynecol*, 1999. 94(2): p. 295-301.
 387. Rud T et al., Factors maintaining the intraurethral pressure in women. *Invest Urol* 1980;17:343-47.
 388. Tsai, E., et al., Bladder neck circulation by Doppler ultrasonography in postmenopausal women with urinary stress incontinence. *Obstet Gynecol*, 2001. 98(1): p. 52-6.
 389. Yang, J.M., S.H. Yang, and W.C. Huang, Functional correlates of Doppler flow study of the female urethral vasculature. *Ultrasound Obstet Gynecol*, 2006. 28(1): p. 96-102.
 390. Delancey JO. Why do women have stress urinary incontinence? *Neurourol Urodyn*. 2010;29 Suppl 1:S13-7.
 391. Norton, P.A., Pelvic floor disorders: the role of fascia and ligaments. *Clin Obstet Gynecol*, 1993. 36(4): p. 926-38.
 392. Goh, J.T., Biomechanical and biochemical assessments for pelvic organ prolapse. *Curr Opin Obstet Gynecol*, 2003. 15(5): p. 391-4.
 393. DeLancey, J.O., The anatomy of the pelvic floor. *Curr Opin Obstet Gynecol*, 1994. 6(4): p. 313-6.
 394. Kearney, R., R. Sawhney, and J.O. DeLancey, Levator ani muscle anatomy evaluated by origin-insertion pairs. *Obstet Gynecol*, 2004. 104(1): p. 168-73.
 395. Singh, K., et al., Three-dimensional magnetic resonance imaging assessment of levator ani morphologic features in different grades of prolapse. *Am J Obstet Gynecol*, 2003. 188(4): p. 910-5.
 396. DeLancey, J.O., et al., The appearance of levator ani muscle abnormalities in magnetic resonance images after vaginal delivery. *Obstet Gynecol*, 2003. 101(1): p. 46-53.

397. DeLancey, J.O., Anatomic aspects of vaginal eversion after hysterectomy. *Am J Obstet Gynecol*, 1992. 166(6 Pt 1): p. 1717-24; discussion 1724-8.
398. DeLancey, J.O., Anatomy and biomechanics of genital prolapse. *Clin Obstet Gynecol*, 1993. 36(4): p. 897-909.
399. Swift, S., et al., Pelvic Organ Support Study (POSST): the distribution, clinical definition, and epidemiologic condition of pelvic organ support defects. *Am J Obstet Gynecol*, 2005. 192(3): p. 795-806.
400. Olsen, A.L., et al., Epidemiology of surgically managed pelvic organ prolapse and urinary incontinence. *Obstet Gynecol*, 1997. 89(4): p. 501-6.
401. Brown, J.S., et al., Pelvic organ prolapse surgery in the United States, 1997. *Am J Obstet Gynecol*, 2002. 186(4): p. 712-6.
402. Rortveit, G., et al., Symptomatic pelvic organ prolapse: prevalence and risk factors in a population-based, racially diverse cohort. *Obstet Gynecol*, 2007. 109(6): p. 1396-403.
403. Norton, P. and I. Milsom, Genetics and the lower urinary tract. *Neurourol Urodyn*, 2010. 29(4): p. 609-11.
404. Samuelsson, E.C., et al., Signs of genital prolapse in a Swedish population of women 20 to 59 years of age and possible related factors. *Am J Obstet Gynecol*, 1999. 180(2 Pt 1): p. 299-305.
405. Mant, J., R. Painter, and M. Vessey, Epidemiology of genital prolapse: observations from the Oxford Family Planning Association Study. *Br J Obstet Gynaecol*, 1997. 104(5): p. 579-85.
406. Hendrix, S.L., et al., Pelvic organ prolapse in the Women's Health Initiative: gravity and gravidity. *Am J Obstet Gynecol*, 2002. 186(6): p. 1160-6.
407. Scherf, C., et al., Epidemiology of pelvic organ prolapse in rural Gambia, West Africa. *BJOG*, 2002. 109(4): p. 431-6.
408. Harris, R.L., et al., Urinary incontinence and pelvic organ prolapse in nulliparous women. *Obstet Gynecol*, 1998. 92(6): p. 951-4.
409. Miedel, A., et al., Nonobstetric risk factors for symptomatic pelvic organ prolapse. *Obstet Gynecol*, 2009. 113(5): p. 1089-97.
410. Chiapparino, F., et al., Reproductive factors, family history, occupation and risk of urogenital prolapse. *Eur J Obstet Gynecol Reprod Biol*, 1999. 82(1): p. 63-7.
411. Jack, G.S., et al., Familial transmission of genitovaginal prolapse. *Int Urogynecol J Pelvic Floor Dysfunct*, 2006. 17(5): p. 498-501.
412. Mothes, A.R., et al., Risk index for pelvic organ prolapse based on established individual risk factors. *Arch Gynecol Obstet*, 2016. 293(3): p. 617-24.
413. Buchsbaum, G.M., et al., Pelvic organ prolapse in nulliparous women and their parous sisters. *Obstet Gynecol*, 2006. 108(6): p. 1388-93.
414. Altman, D., et al., Genetic influence on stress urinary incontinence and pelvic organ prolapse. *Eur Urol*, 2008. 54(4): p. 918-22.
415. Buchsbaum, G.M. and E.E. Duecy, Incontinence and pelvic organ prolapse in parous/nulliparous pairs of identical twins. *Neurourol Urodyn*, 2008. 27(6): p. 496-8.
416. Allen-Brady, K., et al., Identification of six loci associated with pelvic organ prolapse using genome-wide association analysis. *Obstet Gynecol*, 2011. 118(6): p. 1345-53.
417. Allen-Brady, K., et al., Evidence for pelvic organ prolapse predisposition genes on chromosomes 10 and 17. *Am J Obstet Gynecol*, 2015. 212(6): p. 771 e1-7.
418. Nikolova, G., et al., Sequence variant in the laminin gamma1 (LAMC1) gene associated with familial pelvic organ prolapse. *Hum Genet*, 2007. 120(6): p. 847-56.
419. Cartwright, R., et al., Systematic review and metaanalysis of genetic association studies of urinary symptoms and prolapse in women. *Am J Obstet Gynecol*, 2015. 212(2): p. 199 e1-24.
420. Visco, A.G. and L. Yuan, Differential gene expression in pubococcygeus muscle from patients with pelvic organ prolapse. *Am J Obstet Gynecol*, 2003. 189(1): p. 102-12.
421. Connell, K.A., et al., HOXA11 is critical for development and maintenance of uterosacral ligaments and deficient in pelvic prolapse. *J Clin Invest*, 2008. 118(3): p. 1050-5.
422. Chen, B. and J. Yeh, Alterations in connective tissue metabolism in stress incontinence and prolapse. *J Urol*, 2011. 186(5): p. 1768-72.
423. Drewes, P.G., et al., Pelvic organ prolapse in fibulin-5 knockout mice: pregnancy-induced changes in elastic fiber homeostasis in mouse vagina. *Am J Pathol*, 2007. 170(2): p. 578-89.
424. Yamamoto, K., et al., Decrease in elastin gene expression and protein synthesis in fibroblasts derived from cardinal ligaments of patients with prolapsus uteri. *Cell Biol Int*, 1997. 21(9): p. 605-11.

425. Wang, H., et al., Association of matrix metalloproteinase-10 polymorphisms with susceptibility to pelvic organ prolapse. *J Obstet Gynaecol Res*, 2015. 41(12): p. 1972-81.
426. Kim, S., M.A. Harvey, and S. Johnston, A review of the epidemiology and pathophysiology of pelvic floor dysfunction: do racial differences matter? *J Obstet Gynaecol Can*, 2005. 27(3): p. 251-9.
427. Dietz, H.P., Do Asian women have less pelvic organ mobility than Caucasians? *Int Urogynecol J Pelvic Floor Dysfunct*, 2003. 14(4): p. 250-3; discussion 253.
428. Zacharin, R.F., Abdominoperineal urethral suspension: a ten-year experience in the management of recurrent stress incontinence of urine. *Obstet Gynecol*, 1977. 50(1): p. 1-8.
429. Nygaard, I., C. Bradley, and D. Brandt, Pelvic organ prolapse in older women: prevalence and risk factors. *Obstet Gynecol*, 2004. 104(3): p. 489-97.
430. Segev, Y., et al., Are women with pelvic organ prolapse at a higher risk of developing hernias? *Int Urogynecol J Pelvic Floor Dysfunct*, 2009. 20(12): p. 1451-3.
431. McLennan, M.T., et al., Family history as a risk factor for pelvic organ prolapse. *Int Urogynecol J Pelvic Floor Dysfunct*, 2008. 19(8): p. 1063-9.
432. Strohbehm, K., J.A. Jakary, and J.O. Delancey, Pelvic organ prolapse in young women. *Obstet Gynecol*, 1997. 90(1): p. 33-6.
433. ZS, A.L.-R. and Z.T. Al-Rawi, Joint hypermobility in women with genital prolapse. *Lancet*, 1982. 1(8287): p. 1439-41.
434. Bai, S.W., et al., Pelvic organ prolapse and connective tissue abnormalities in Korean women. *J Reprod Med*, 2002. 47(3): p. 231-4.
435. Marshman, D., et al., Rectal prolapse: relationship with joint mobility. *Aust N Z J Surg*, 1987. 57(11): p. 827-9.
436. Norton, P.A., et al., Genitourinary prolapse and joint hypermobility in women. *Obstet Gynecol*, 1995. 85(2): p. 225-8.
437. Carley, M.E. and J. Schaffer, Urinary incontinence and pelvic organ prolapse in women with Marfan or Ehlers Danlos syndrome. *Am J Obstet Gynecol*, 2000. 182(5): p. 1021-3.
438. Liang, C.C., et al., Expression of matrix metalloproteinase-2 and tissue inhibitors of metalloproteinase-1 (TIMP-1, TIMP-2 and TIMP-3) in women with uterine prolapse but without urinary incontinence. *Eur J Obstet Gynecol Reprod Biol*, 2010. 153(1): p. 94-8.
439. Vulic, M., et al., Difference in expression of collagen type I and matrix metalloproteinase-1 in uterosacral ligaments of women with and without pelvic organ prolapse. *Eur J Obstet Gynecol Reprod Biol*, 2011. 155(2): p. 225-8.
440. Mosier, E., V.K. Lin, and P. Zimmern, Extracellular matrix expression of human prolapsed vaginal wall. *Neurourol Urodyn*, 2010. 29(4): p. 582-6.
441. Liu, C., et al., Collagen metabolic disorder induced by oxidative stress in human uterosacral ligament-derived fibroblasts: A possible pathophysiological mechanism in pelvic organ prolapse. *Mol Med Rep*, 2016. 13(4): p. 2999-3008.
442. Takano, C.C., et al., Analysis of collagen in parametrium and vaginal apex of women with and without uterine prolapse. *Int Urogynecol J Pelvic Floor Dysfunct*, 2002. 13(6): p. 342-5; discussion 345.
443. Moalli, P.A., et al., Remodeling of vaginal connective tissue in patients with prolapse. *Obstet Gynecol*, 2005. 106(5 Pt 1): p. 953-63.
444. Gabriel, B., et al., Uterosacral ligament in postmenopausal women with or without pelvic organ prolapse. *Int Urogynecol J Pelvic Floor Dysfunct*, 2005. 16(6): p. 475-9.
445. Ewies, A.A., F. Al-Azzawi, and J. Thompson, Changes in extracellular matrix proteins in the cardinal ligaments of post-menopausal women with or without prolapse: a computerized immunohistomorphometric analysis. *Hum Reprod*, 2003. 18(10): p. 2189-95.
446. Moalli, P.A., et al., Regulation of matrix metalloproteinase expression by estrogen in fibroblasts that are derived from the pelvic floor. *Am J Obstet Gynecol*, 2002. 187(1): p. 72-9.
447. Liu, X., et al., Failure of elastic fiber homeostasis leads to pelvic floor disorders. *Am J Pathol*, 2006. 168(2): p. 519-28.
448. Liu, X., et al., Elastic fiber homeostasis requires lysyl oxidase-like 1 protein. *Nat Genet*, 2004. 36(2): p. 178-82.
449. Chen, B., Y. Wen, and M.L. Polan, Elastolytic activity in women with stress urinary incontinence and pelvic organ prolapse. *Neurourol Urodyn*, 2004. 23(2): p. 119-26.
450. Klutke, J., et al., Decreased endopelvic fascia elastin content in uterine prolapse. *Acta Obstet Gynecol Scand*, 2008. 87(1): p. 111-5.
451. Moon, Y.J., et al., Alteration of elastin metabolism in women with pelvic organ prolapse. *J Urol*, 2011. 185(5): p. 1786-92.
452. de Landsheere L, Brieu M, Blacher S, Munaut C, Nusgens B, Rubod C, Noel A, Foidart JM,

- Nisolle M, Cosson M., Elastin density: Link between histological and biomechanical properties of vaginal tissue in women with pelvic organ prolapse? *Int Urogynecol J*, 2016. Apr(27(4)): p. 629-35.
453. Judge, D.P. and H.C. Dietz, Marfan's syndrome. *Lancet*, 2005. 366(9501): p. 1965-76.
 454. Gupta, P.A., et al., Ten novel FBN2 mutations in congenital contractural arachnodactyly: delineation of the molecular pathogenesis and clinical phenotype. *Hum Mutat*, 2002. 19(1): p. 39-48.
 455. Milewicz, D.M., Z. Urban, and C. Boyd, Genetic disorders of the elastic fiber system. *Matrix Biol*, 2000. 19(6): p. 471-80.
 456. Lewis, K.G., et al., Acquired disorders of elastic tissue: Part II. decreased elastic tissue. *J Am Acad Dermatol*, 2004. 51(2): p. 165-85; quiz 186-8.
 457. Boreham, M.K., et al., Morphometric properties of the posterior vaginal wall in women with pelvic organ prolapse. *Am J Obstet Gynecol*, 2002. 187(6): p. 1501-8; discussion 1508-9.
 458. Busacchi, P., et al., Abnormalities of somatic peptide-containing nerves supplying the pelvic floor of women with genitourinary prolapse and stress urinary incontinence. *Urology*, 2004. 63(3): p. 591-5.
 459. Busacchi, P., et al., A histological and immunohistochemical study of neuropeptide containing somatic nerves in the levator ani muscle of women with genitourinary prolapse. *Acta Obstet Gynecol Scand*, 1999. 78(1): p. 2-5.
 460. Snooks, S.J., et al., Risk factors in childbirth causing damage to the pelvic floor innervation. *Int J Colorectal Dis*, 1986. 1(1): p. 20-4.
 461. Dolan, L.M., et al., Stress incontinence and pelvic floor neurophysiology 15 years after the first delivery. *BJOG*, 2003. 110(12): p. 1107-14.
 462. Shafik, A. and O. El-Sibai, Study of the levator ani muscle in the multipara: role of levator dysfunction in defecation disorders. *J Obstet Gynaecol*, 2002. 22(2): p. 187-92.
 463. Marshall, K., D.M. Walsh, and G.D. Baxter, The effect of a first vaginal delivery on the integrity of the pelvic floor musculature. *Clin Rehabil*, 2002. 16(7): p. 795-9.
 464. Gregory, W.T., et al., Quantitative electromyography of the anal sphincter after uncomplicated vaginal delivery. *Obstet Gynecol*, 2004. 104(2): p. 327-35.
 465. Sultan, A.H., M.A. Kamm, and C.N. Hudson, Pudendal nerve damage during labour: prospective study before and after childbirth. *Br J Obstet Gynaecol*, 1994. 101(1): p. 22-8.
 466. Tetzschner, T., et al., Pudendal nerve damage increases the risk of fecal incontinence in women with anal sphincter rupture after childbirth. *Acta Obstet Gynecol Scand*, 1995. 74(6): p. 434-40.
 467. Miodrag, A., C.M. Castleden, and T.R. Vallance, Sex hormones and the female urinary tract. *Drugs*, 1988. 36(4): p. 491-504.
 468. Wahl, L.M., R.J. Blandau, and R.C. Page, Effect of hormones on collagen metabolism and collagenase activity in the pubic symphysis ligament of the guinea pig. *Endocrinology*, 1977. 100(2): p. 571-9.
 469. Landon, Mechanical properties of fascia during pregnancy: a possible factor in the development of stress incontinence of urine. *Contemp Rev Obstet Gynaecol*, 1990. 2: p. 40-46.
 470. Rahn, D.D., et al., Biomechanical properties of the vaginal wall: effect of pregnancy, elastic fiber deficiency, and pelvic organ prolapse. *Am J Obstet Gynecol*, 2008. 198(5): p. 590 e1-6.
 471. O'Boyle, A.L., et al., The natural history of pelvic organ support in pregnancy. *Int Urogynecol J Pelvic Floor Dysfunct*, 2003. 14(1): p. 46-9; discussion 49.
 472. O'Boyle, A.L., et al., Pelvic organ support in nulliparous pregnant and nonpregnant women: a case control study. *Am J Obstet Gynecol*, 2002. 187(1): p. 99-102.
 473. Sze, E.H., G.B. Sherard, 3rd, and J.M. Dolezal, Pregnancy, labor, delivery, and pelvic organ prolapse. *Obstet Gynecol*, 2002. 100(5 Pt 1): p. 981-6.
 474. Reimers, C., et al., Change in pelvic organ support during pregnancy and the first year postpartum: a longitudinal study. *BJOG*, 2016. 123(5): p. 821-9.
 475. Gachon, B., et al., [Changes in pelvic organ mobility and ligamentous laxity during pregnancy and postpartum. Review of literature and prospects]. *Prog Urol*, 2016.
 476. Dietz, H.P. and M.J. Bennett, The effect of childbirth on pelvic organ mobility. *Obstet Gynecol*, 2003. 102(2): p. 223-8.
 477. Dietz, H.P. and A.B. Steensma, The role of childbirth in the aetiology of rectocele. *BJOG*, 2006. 113(3): p. 264-7.
 478. Dietz, H.P. and A. Korda, Which bowel symptoms are most strongly associated with a true rectocele? *Aust N Z J Obstet Gynaecol*, 2005. 45(6): p. 505-8.
 479. Oliveira, D.A., et al., Numerical simulation of the damage evolution in the pelvic floor muscles during childbirth. *J Biomech*, 2016. 49(4): p. 594-601.

480. van Delft, K., et al., Levator ani muscle avulsion during childbirth: a risk prediction model. *BJOG*, 2014. 121(9): p. 1155-63; discussion 1163.
481. Staer-Jensen, J., et al., Postpartum recovery of levator hiatus and bladder neck mobility in relation to pregnancy. *Obstet Gynecol*, 2015. 125(3): p. 531-9.
482. Shek, K.L., et al., Does levator trauma 'heal'? *Ultrasound Obstet Gynecol*, 2012. 40(5): p. 570-5.
483. Chan, S.S., et al., Prevalence of levator ani muscle injury in Chinese women after first delivery. *Ultrasound Obstet Gynecol*, 2012. 39(6): p. 704-9.
484. Valsky, D.V., et al., Persistence of levator ani sonographic defect detected by three-dimensional transperineal sonography in primiparous women. *Ultrasound Obstet Gynecol*, 2015. 46(6): p. 724-9.
485. Miller, J.M., et al., Evaluating maternal recovery from labor and delivery: bone and levator ani injuries. *Am J Obstet Gynecol*, 2015. 213(2): p. 188 e1-188 e11.
486. Rahmanou, P., et al., The association between maternal age at first delivery and risk of obstetric trauma. *Am J Obstet Gynecol*, 2016.
487. Memon, H.U., et al., Comparison of levator ani muscle avulsion injury after forceps-assisted and vacuum-assisted vaginal childbirth. *Obstet Gynecol*, 2015. 125(5): p. 1080-7.
488. Shek, K.L., et al., Perineal and vaginal tears are clinical markers for occult levator ani trauma: a retrospective observational study. *Ultrasound Obstet Gynecol*, 2016. 47(2): p. 224-7.
489. Kamisan Atan, I., et al., Does the Epi-No((R)) birth trainer prevent vaginal birth-related pelvic floor trauma? A multicentre prospective randomised controlled trial. *BJOG*, 2016. 123(6): p. 995-1003.
490. Eisenberg, V.H., et al., Does levator ani injury affect cystocele type? *Ultrasound Obstet Gynecol*, 2010. 36(5): p. 618-23.
491. Dietz, H.P., et al., Avulsion injury and levator hiatal ballooning: two independent risk factors for prolapse? An observational study. *Acta Obstet Gynecol Scand*, 2012. 91(2): p. 211-4.
492. Lukacz, E.S., et al., Parity, mode of delivery, and pelvic floor disorders. *Obstet Gynecol*, 2006. 107(6): p. 1253-60.
493. Dietz, H.P., Pelvic floor trauma following vaginal delivery. *Curr Opin Obstet Gynecol*, 2006. 18(5): p. 528-37.
494. Dietz, H.P., et al., Pelvic organ descent in young nulligravid women. *Am J Obstet Gynecol*, 2004. 191(1): p. 95-9.
495. Dietz, H.P. and A.B. Steensma, Which women are most affected by delivery-related changes in pelvic organ mobility? *Eur J Obstet Gynecol Reprod Biol*, 2003. 111(1): p. 15-8.
496. Trutnovsky, G., et al., Delivery mode and pelvic organ prolapse: a retrospective observational study. *BJOG*, 2015.
497. Risk factors for genital prolapse in non-hysterectomized women around menopause. Results from a large cross-sectional study in menopausal clinics in Italy. Progetto Menopausa Italia Study Group. *Eur J Obstet Gynecol Reprod Biol*, 2000. 93(2): p. 135-40.
498. Horak, T.A., et al., Pelvic floor trauma: does the second baby matter? *Ultrasound Obstet Gynecol*, 2014. 44(1): p. 90-4.
499. Moalli, P.A., et al., Risk factors associated with pelvic floor disorders in women undergoing surgical repair. *Obstet Gynecol*, 2003. 101(5 Pt 1): p. 869-74.
500. Swift, S.E., S.B. Tate, and J. Nicholas, Correlation of symptoms with degree of pelvic organ support in a general population of women: what is pelvic organ prolapse? *Am J Obstet Gynecol*, 2003. 189(2): p. 372-7; discussion 377-9.
501. Dietz, H.P. and J.M. Simpson, Does delayed child-bearing increase the risk of levator injury in labour? *Aust N Z J Obstet Gynaecol*, 2007. 47(6): p. 491-5.
502. Bump, R.C. and P.A. Norton, Epidemiology and natural history of pelvic floor dysfunction. *Obstet Gynecol Clin North Am*, 1998. 25(4): p. 723-46.
503. Ewies, A.A., J. Thompson, and F. Al-Azzawi, Changes in gonadal steroid receptors in the cardinal ligaments of prolapsed uteri: immunohistomorphometric data. *Hum Reprod*, 2004. 19(7): p. 1622-8.
504. Chen, H.Y., et al., Progesterone receptor polymorphism is associated with pelvic organ prolapse risk. *Acta Obstet Gynecol Scand*, 2009. 88(7): p. 835-8.
505. Chen, H.Y., et al., Estrogen receptor beta gene haplotype is associated with pelvic organ prolapse. *Eur J Obstet Gynecol Reprod Biol*, 2008. 138(1): p. 105-9.
506. Xie, Z., et al., Alterations of estrogen receptor-alpha and -beta in the anterior vaginal wall of women with urinary incontinence. *Eur J Obstet Gynecol Reprod Biol*, 2007. 134(2): p. 254-8.

507. Lang, J.H., et al., Estrogen levels and estrogen receptors in patients with stress urinary incontinence and pelvic organ prolapse. *Int J Gynaecol Obstet*, 2003. 80(1): p. 35-9.
508. Bai, S.W., et al., The role of estrogen receptor, progesterone receptor and p53 in development of stress urinary incontinence. *Yonsei Med J*, 2004. 45(5): p. 885-90.
509. Skala, C.E., et al., The effect of genital and lower urinary tract symptoms on steroid receptor expression in women with genital prolapse. *Int Urogynecol J*, 2011. 22(6): p. 705-12.
510. Lara, L.A., et al., Estrogen receptor expression and vessel density in the vagina wall in postmenopausal women with prolapse. *Tissue Cell*, 2014. 46(2): p. 159-64.
511. Trutnovsky, G., et al., Pelvic floor dysfunction--does menopause duration matter? *Maturitas*, 2013. 76(2): p. 134-8.
512. Dietz, H.P. and B. Clarke, Prevalence of rectocele in young nulliparous women. *Aust N Z J Obstet Gynaecol*, 2005. 45(5): p. 391-4.
513. Bradley, C.S., et al., Natural history of pelvic organ prolapse in postmenopausal women. *Obstet Gynecol*, 2007. 109(4): p. 848-54.
514. Handa, V.L., et al., Progression and remission of pelvic organ prolapse: a longitudinal study of menopausal women. *Am J Obstet Gynecol*, 2004. 190(1): p. 27-32.
515. Spence-Jones, C., et al., Bowel dysfunction: a pathogenic factor in uterovaginal prolapse and urinary stress incontinence. *Br J Obstet Gynaecol*, 1994. 101(2): p. 147-52.
516. Arya, L.A., et al., Pelvic organ prolapse, constipation, and dietary fiber intake in women: a case-control study. *Am J Obstet Gynecol*, 2005. 192(5): p. 1687-91.
517. Weber, A.M., et al., Posterior vaginal prolapse and bowel function. *Am J Obstet Gynecol*, 1998. 179(6 Pt 1): p. 1446-9; discussion 1449-50.
518. Kahn, M.A., et al., Pelvic Organ Support Study (POSST) and bowel symptoms: straining at stool is associated with perineal and anterior vaginal descent in a general gynecologic population. *Am J Obstet Gynecol*, 2005. 192(5): p. 1516-22.
519. Jelovsek, J.E., et al., Functional bowel and anorectal disorders in patients with pelvic organ prolapse and incontinence. *Am J Obstet Gynecol*, 2005. 193(6): p. 2105-11.
520. Woodman, P.J., et al., Prevalence of severe pelvic organ prolapse in relation to job description and socioeconomic status: a multicenter cross-sectional study. *Int Urogynecol J Pelvic Floor Dysfunct*, 2006. 17(4): p. 340-5.
521. Jorgensen, S., H.O. Hein, and F. Gyntelberg, Heavy lifting at work and risk of genital prolapse and herniated lumbar disc in assistant nurses. *Occup Med (Lond)*, 1994. 44(1): p. 47-9.
522. Karasick, S. and C.M. Spettell, The role of parity and hysterectomy on the development of pelvic floor abnormalities revealed by defecography. *AJR Am J Roentgenol*, 1997. 169(6): p. 1555-8.
523. Swift, S.E., T. Pound, and J.K. Dias, Case-control study of etiologic factors in the development of severe pelvic organ prolapse. *Int Urogynecol J Pelvic Floor Dysfunct*, 2001. 12(3): p. 187-92.
524. Clark, A.L., et al., Epidemiologic evaluation of reoperation for surgically treated pelvic organ prolapse and urinary incontinence. *Am J Obstet Gynecol*, 2003. 189(5): p. 1261-7.
525. Cruikshank, S.H. and S.R. Kovac, Randomized comparison of three surgical methods used at the time of vaginal hysterectomy to prevent posterior enterocele. *Am J Obstet Gynecol*, 1999. 180(4): p. 859-65.
526. Lind, L.R., V. Lucente, and N. Kohn, Thoracic kyphosis and the prevalence of advanced uterine prolapse. *Obstet Gynecol*, 1996. 87(4): p. 605-9.
527. Nguyen, J.K., et al., Lumbosacral spine and pelvic inlet changes associated with pelvic organ prolapse. *Obstet Gynecol*, 2000. 95(3): p. 332-6.
528. Sze, E.H., et al., A retrospective comparison of abdominal sacrocolpopexy with Burch colposuspension versus sacrospinous fixation with transvaginal needle suspension for the management of vaginal vault prolapse and coexisting stress incontinence. *Int Urogynecol J Pelvic Floor Dysfunct*, 1999. 10(6): p. 390-3.
529. Handa, V.L., et al., Architectural differences in the bony pelvis of women with and without pelvic floor disorders. *Obstet Gynecol*, 2003. 102(6): p. 1283-90.
530. Blakeley, C.R. and W.G. Mills, The obstetric and gynaecological complications of bladder exstrophy and epispadias. *Br J Obstet Gynaecol*, 1981. 88(2): p. 167-73.
531. Costantini, E., M. Lazzeri, and M. Porena, [Pelvic organ prolapse and lower urinary tract symptoms: experience from a high-volume urogynecologic center.]. *Urologia*, 2012: p. 0.
532. Lawrence, J.M., et al., Prevalence and co-occurrence of pelvic floor disorders in community-dwelling women. *Obstet Gynecol*, 2008. 111(3): p. 678-85.

533. Serati, M., et al., Role of urodynamics before prolapse surgery. *Int Urogynecol J*, 2015. 26(2): p. 165-8.
534. Weber, A.M. and M.D. Walters, Cost-effectiveness of urodynamic testing before surgery for women with pelvic organ prolapse and stress urinary incontinence. *Am J Obstet Gynecol*, 2000. 183(6): p. 1338-46; discussion 1346-7.
535. Soderberg, M.W., et al., Young women with genital prolapse have a low collagen concentration. *Acta Obstet Gynecol Scand*, 2004. 83(12): p. 1193-8.
536. Zhu, L., et al., Estrogen receptor in pelvic floor tissues in patients with stress urinary incontinence. *Int Urogynecol J Pelvic Floor Dysfunct*, 2004. 15(5): p. 340-3.
537. Marinkovic, S.P. and S.L. Stanton, Incontinence and voiding difficulties associated with prolapse. *J Urol*, 2004. 171(3): p. 1021-8.
538. Romanzi, L.J., D.C. Chaikin, and J.G. Blaivas, The effect of genital prolapse on voiding. *J Urol*, 1999. 161(2): p. 581-6.
539. Romanzi, L.J., Management of the urethral outlet in patients with severe prolapse. *Curr Opin Urol*, 2002. 12(4): p. 339-44.
540. Burrows, L.J., et al., Pelvic symptoms in women with pelvic organ prolapse. *Obstet Gynecol*, 2004. 104(5 Pt 1): p. 982-8.
541. Tan, J.S., et al., Predictive value of prolapse symptoms: a large database study. *Int Urogynecol J Pelvic Floor Dysfunct*, 2005. 16(3): p. 203-9; discussion 209.
542. Maher, C., et al., Surgical management of pelvic organ prolapse in women. *Cochrane Database Syst Rev*, 2004(4): p. CD004014.
543. Levin, I., et al., Surgical complications and medium-term outcome results of tension-free vaginal tape: a prospective study of 313 consecutive patients. *Neurourol Urodyn*, 2004. 23(1): p. 7-9.
544. Cronje, H.S., J.A. De Beer, and R. Bam, The pathophysiology of an enterocele and its management. *J Obstet Gynaecol*, 2004. 24(4): p. 408-13.
545. Ramanah, R., et al., Effects of pelvic organ prolapse repair on urinary symptoms: A comparative study between the laparoscopic and vaginal approach. *Neurourol Urodyn*, 2012. 31(1): p. 126-31.
546. Tegerstedt, G., et al., Prevalence of symptomatic pelvic organ prolapse in a Swedish population. *Int Urogynecol J Pelvic Floor Dysfunct*, 2005. 16(6): p. 497-503.
547. Fritel, X., et al., Symptomatic pelvic organ prolapse at midlife, quality of life, and risk factors. *Obstet Gynecol*, 2009. 113(3): p. 609-16.
548. Miedel, A., et al., Symptoms and pelvic support defects in specific compartments. *Obstet Gynecol*, 2008. 112(4): p. 851-8.
549. Long, C.Y., et al., Abnormal clinical and urodynamic findings in women with severe genitourinary prolapse. *Kaohsiung J Med Sci*, 2002. 18(12): p. 593-7.
550. Digesu, G.A., et al., The relationship of vaginal prolapse severity to symptoms and quality of life. *BJOG*, 2005. 112(7): p. 971-6.
551. Schimpf, M.O., et al., Anterior vaginal wall prolapse and voiding dysfunction in urogynecology patients. *Int Urogynecol J Pelvic Floor Dysfunct*, 2007. 18(7): p. 721-5.
552. Bradley, C.S. and I.E. Nygaard, Vaginal wall descensus and pelvic floor symptoms in older women. *Obstet Gynecol*, 2005. 106(4): p. 759-66.
553. Sobhghol, S.S. and S.M. Charandabee, Related factors of urge, stress, mixed urinary incontinence and overactive bladder in reproductive age women in Tabriz, Iran: a cross-sectional study. *Int Urogynecol J Pelvic Floor Dysfunct*, 2008. 19(3): p. 367-73.
554. Ellerkmann, R.M., et al., Correlation of symptoms with location and severity of pelvic organ prolapse. *Am J Obstet Gynecol*, 2001. 185(6): p. 1332-7; discussion 1337-8.
555. Dietz, H.P. and B. Clarke, Is the irritable bladder associated with anterior compartment relaxation? A critical look at the 'integral theory of pelvic floor dysfunction'. *Aust N Z J Obstet Gynaecol*, 2001. 41(3): p. 317-9.
556. de Boer, T.A., et al., Pelvic organ prolapse and overactive bladder. *Neurourol Urodyn*, 2010. 29(1): p. 30-9.
557. Jackson, S.L., et al., Fecal incontinence in women with urinary incontinence and pelvic organ prolapse. *Obstet Gynecol*, 1997. 89(3): p. 423-7.
558. Khullar, V., et al., Prevalence of faecal incontinence among women with urinary incontinence. *Br J Obstet Gynaecol*, 1998. 105(11): p. 1211-3.
559. Meschia, M., et al., Prevalence of anal incontinence in women with symptoms of urinary incontinence and genital prolapse. *Obstet Gynecol*, 2002. 100(4): p. 719-23.
560. Soligo, M., et al. Double incontinence in urogynecologic practice: a new insight. *Am J Obstet Gynecol*, 2003. 189(2): p. 438-43.

561. Gordon, D., et al., Anal incontinence: prevalence among female patients attending a urogynecologic clinic. *Neurourol Urodyn*, 1999. 18(3): p. 199-204.
562. Bradley, C.S., et al., Bowel symptoms in women planning surgery for pelvic organ prolapse. *Am J Obstet Gynecol*, 2006. 195(6): p. 1814-9.
563. Morgan, D.M., et al., Symptoms of anal incontinence and difficult defecation among women with prolapse and a matched control cohort. *Am J Obstet Gynecol*, 2007. 197(5): p. 509 e1-6.
564. de Mello Portella, P., et al., Prevalence of and quality of life related to anal incontinence in women with urinary incontinence and pelvic organ prolapse. *Eur J Obstet Gynecol Reprod Biol*, 2012. 160(2): p. 228-31.
565. Goei, R., Anorectal function in patients with defecation disorders and asymptomatic subjects: evaluation with defecography. *Radiology*, 1990. 174(1): p. 121-3.
566. Altringer, W.E., et al., Four-contrast defecography: pelvic "floor-oscropy". *Dis Colon Rectum*, 1995. 38(7): p. 695-9.
567. Kelvin, F.M., et al., Female pelvic organ prolapse: diagnostic contribution of dynamic cystoproctography and comparison with physical examination. *AJR Am J Roentgenol*, 1999. 173(1): p. 31-7.
568. Agachan, F., J. Pfeifer, and S.D. Wexner, Defecography and proctography. Results of 744 patients. *Dis Colon Rectum*, 1996. 39(8): p. 899-905.
569. Lopez, A., et al., Cystodefecoperitoneography in patients with genital prolapse. *Int Urogynecol J Pelvic Floor Dysfunct*, 2002. 13(1): p. 22-9.
570. Karasick, S. and S.M. Ehrlich, Is constipation a disorder of defecation or impaired motility?: distinction based on defecography and colonic transit studies. *AJR Am J Roentgenol*, 1996. 166(1): p. 63-6.
571. van Dam, J.H., W.C. Hop, and W.R. Schouten, Analysis of patients with poor outcome of rectocele repair. *Dis Colon Rectum*, 2000. 43(11): p. 1556-60.
572. Karlbom, U., et al., Does surgical repair of a rectocele improve rectal emptying? *Dis Colon Rectum*, 1996. 39(11): p. 1296-302.
573. Mellgren, A., et al., Results of rectocele repair. A prospective study. *Dis Colon Rectum*, 1995. 38(1): p. 7-13.
574. Goh, J.T., J.J. Tjandra, and M.P. Carey, How could management of rectoceles be optimized? *ANZ J Surg*, 2002. 72(12): p. 896-901.
575. Ramanah, R., et al., Anorectal symptoms before and after laparoscopic sacrocolpoperineopexy for pelvic organ prolapse. *Int Urogynecol J*, 2012.
576. Handa, V.L., et al., Sexual function among women with urinary incontinence and pelvic organ prolapse. *Am J Obstet Gynecol*, 2004. 191(3): p. 751-6.
577. Rogers, G.R., et al., Sexual function in women with and without urinary incontinence and/or pelvic organ prolapse. *Int Urogynecol J Pelvic Floor Dysfunct*, 2001. 12(6): p. 361-5.
578. Barber, M.D., et al., Sexual function in women with urinary incontinence and pelvic organ prolapse. *Obstet Gynecol*, 2002. 99(2): p. 281-9.
579. Weber, A.M., et al., Sexual function in women with uterovaginal prolapse and urinary incontinence. *Obstet Gynecol*, 1995. 85(4): p. 483-7.
580. Handa, V.L., et al., Female sexual function and pelvic floor disorders. *Obstet Gynecol*, 2008. 111(5): p. 1045-52.
581. Knoop, L.R., et al., Sexual complaints, pelvic floor symptoms, and sexual distress in women over forty. *J Sex Med*, 2010. 7(11): p. 3675-82.
582. Rao, S.S., Diagnosis and management of fecal incontinence. American College of Gastroenterology Practice Parameters Committee. *Am J Gastroenterol*, 2004. 99(8): p. 1585-604.
583. Rao, S.S. and R.S. Patel, How useful are manometric tests of anorectal function in the management of defecation disorders? *Am J Gastroenterol*, 1997. 92(3): p. 469-75.
584. Sun, W.M., T.C. Donnelly, and N.W. Read, Utility of a combined test of anorectal manometry, electromyography, and sensation in determining the mechanism of 'idiopathic' faecal incontinence. *Gut*, 1992. 33(6): p. 807-13.
585. Bharucha, A.E., et al., Relationship between symptoms and disordered continence mechanisms in women with idiopathic faecal incontinence. *Gut*, 2005. 54(4): p. 546-55.
586. Lam, T.J., D.J. Kuik, and R.J. Felt-Bersma, Anorectal function evaluation and predictive factors for faecal incontinence in 600 patients. *Colorectal Dis*, 2012. 14(2): p. 214-23.
587. Frenckner, B. and T. Ihre, Influence of autonomic nerves on the internal and sphincter in man. *Gut*, 1976. 17(4): p. 306-12.
588. Penninckx, F., B. Lestar, and R. Kerremans, The internal anal sphincter: mechanisms of control and its role in maintaining anal continence. *Baillieres Clin Gastroenterol*, 1992. 6(1): p. 193-214.

589. Mularczyk, A., P.A. Bianchi, and G. Basilisco, Effect of continuous rectal distention on anal resting pressure. *Dis Colon Rectum*, 2001. 44(5): p. 672-6.
590. Rao, S.S., et al., Anorectal contractility under basal conditions and during rectal infusion of saline in ulcerative colitis. *Gut*, 1988. 29(6): p. 769-77.
591. Schouten, W.R. and J.D. Blankensteijn, Ultra slow wave pressure variations in the anal canal before and after lateral internal sphincterotomy. *Int J Colorectal Dis*, 1992. 7(3): p. 115-8.
592. Zbar, A.P. and M. Khaikin, Should we care about the internal anal sphincter? *Dis Colon Rectum*, 2012. 55(1): p. 105-8.
593. Burleigh, D.E., Non-cholinergic, non-adrenergic inhibitory neurons in human internal anal sphincter muscle. *J Pharm Pharmacol*, 1983. 35(4): p. 258-60.
594. Cook, T.A., A.F. Brading, and N.J. Mortensen, Differences in contractile properties of anorectal smooth muscle and the effects of calcium channel blockade. *Br J Surg*, 1999. 86(1): p. 70-5.
595. O'Kelly, T.J., A. Brading, and N.J. Mortensen, In vitro response of the human anal canal longitudinal muscle layer to cholinergic and adrenergic stimulation: evidence of sphincter specialization. *Br J Surg*, 1993. 80(10): p. 1337-41.
596. Goyal, R.K. and A. Chaudhury, Mounting evidence against the role of ICC in neurotransmission to smooth muscle in the gut. *Am J Physiol Gastrointest Liver Physiol*, 2010. 298(1): p. G10-3.
597. McDonnell, B., et al., Functional evidence for purinergic inhibitory neuromuscular transmission in the mouse internal anal sphincter. *Am J Physiol Gastrointest Liver Physiol*, 2008. 294(4): p. G1041-51.
598. Mills, K. and R. Chess-Williams, Pharmacology of the internal anal sphincter and its relevance to faecal incontinence. *Auton Autacoid Pharmacol*, 2009. 29(3): p. 85-95.
599. Opazo, A., et al., Specific and complementary roles for nitric oxide and ATP in the inhibitory motor pathways to rat internal anal sphincter. *Neurogastroenterol Motil*, 2011. 23(1): p. e11-25.
600. Rattan, S. and J. Singh, Basal internal anal sphincter tone, inhibitory neurotransmission, and other factors contributing to the maintenance of high pressures in the anal canal. *Neurogastroenterol Motil*, 2011. 23(1): p. 3-7.
601. Patel, C.A. and S. Rattan, Spontaneously tonic smooth muscle has characteristically higher levels of RhoA/ROCK compared with the phasic smooth muscle. *Am J Physiol Gastrointest Liver Physiol*, 2006. 291(5): p. G830-7.
602. Patel, C.A. and S. Rattan, Cellular regulation of basal tone in internal anal sphincter smooth muscle by RhoA/ROCK. *Am J Physiol Gastrointest Liver Physiol*, 2007. 292(6): p. G1747-56.
603. Meagher, A.P., D.Z. Lubowski, and D.W. King, The cough response of the anal sphincter. *Int J Colorectal Dis*, 1993. 8(4): p. 217-9.
604. Dalley, A.F., 2nd, The riddle of the sphincters. The morphophysiology of the anorectal mechanism reviewed. *Am Surg*, 1987. 53(5): p. 298-306.
605. Hsu, Y., et al., Magnetic resonance imaging and 3-dimensional analysis of external anal sphincter anatomy. *Obstet Gynecol*, 2005. 106(6): p. 1259-65.
606. Guo, M., et al., MRI anatomy of the anal region. *Dis Colon Rectum*, 2010. 53(11): p. 1542-8.
607. Johnson, M.A., et al., Data on the distribution of fibre types in thirty-six human muscles. An autopsy study. *J Neurol Sci*, 1973. 18(1): p. 111-29.
608. Salmons, S. and G. Vrbova, The influence of activity on some contractile characteristics of mammalian fast and slow muscles. *J Physiol*, 1969. 201(3): p. 535-49.
609. Lunniss, P.J. and R.K. Phillips, Anatomy and function of the anal longitudinal muscle. *Br J Surg*, 1992. 79(9): p. 882-4.
610. Shafik, A., A new concept of the anatomy of the anal sphincter mechanism and the physiology of defecation. III. The longitudinal anal muscle: anatomy and role in anal sphincter mechanism. *Invest Urol*, 1976. 13(4): p. 271-7.
611. Azpiroz, F., et al., The puborectalis muscle. *Neurogastroenterol Motil*, 2005. 17 Suppl 1: p. 68-72.
612. Liu, J., et al., Functional correlates of anal canal anatomy: puborectalis muscle and anal canal pressure. *Am J Gastroenterol*, 2006. 101(5): p. 1092-7.
613. Raizada, V., et al., Functional morphology of anal sphincter complex unveiled by high definition anal manometry and three dimensional ultrasound imaging. *Neurogastroenterol Motil*, 2011. 23(11): p. 1013-9, e460.
614. Levi, A.C., F. Borghi, and M. Garavoglia, Development of the anal canal muscles. *Dis Colon Rectum*, 1991. 34(3): p. 262-6.
615. Percy, J.P., et al., Electrophysiological study of motor nerve supply of pelvic floor. *Lancet*, 1981. 1(8210): p. 16-7.

616. Wallner, C., Is the puborectalis muscle part of the levator ani muscle? *Dis Colon Rectum*, 2008. 51(7): p. 1165-6; author reply 1167.
617. Wallner, C., et al., Evidence for the innervation of the puborectalis muscle by the levator ani nerve. *Neurogastroenterol Motil*, 2006. 18(12): p. 1121-2.
618. Wallner, C., et al., Innervation of the pelvic floor muscles: a reappraisal for the levator ani nerve. *Obstet Gynecol*, 2006. 108(3 Pt 1): p. 529-34.
619. Wallner, C., et al., The contribution of the levator ani nerve and the pudendal nerve to the innervation of the levator ani muscles; a study in human fetuses. *Eur Urol*, 2008. 54(5): p. 1136-42.
620. Matzel, K.E., R.A. Schmidt, and E.A. Tanagho, Neuroanatomy of the striated muscular anal continence mechanism. Implications for the use of neurostimulation. *Dis Colon Rectum*, 1990. 33(8): p. 666-73.
621. Lawson, J.O., Pelvic anatomy. II. Anal canal and associated sphincters. *Ann R Coll Surg Engl*, 1974. 54(6): p. 288-300.
622. Oh, C. and A.E. Kark, Anatomy of the external anal sphincter. *Br J Surg*, 1972. 59(9): p. 717-23.
623. Shafik, A., A new concept of the anatomy of the anal sphincter mechanism and the physiology of defecation. The external anal sphincter: a triple-loop system. *Invest Urol*, 1975. 12(5): p. 412-9.
624. Gunterberg, B., et al., Anorectal function after major resections of the sacrum with bilateral or unilateral sacrifice of sacral nerves. *Br J Surg*, 1976. 63(7): p. 546-54.
625. Percy, J.P. and A.G. Parks, The nerve supply of the pelvic floor. *Schweiz Rundsch Med Prax*, 1981. 70(15): p. 640-2.
626. Roberts WH, H.C., Mitchell, Jr. DA, Fischer HF, The Levator Ani Muscle and the Nerve Supply of Its Puborectalis Component. *Clinical Anatomy*, 1988. 1: p. 267-273.
627. Frenckner, B. and C.V. Euler, Influence of pudendal block on the function of the anal sphincters. *Gut*, 1975. 16(6): p. 482-9.
628. Brookes, S.J., P.G. Dinning, and M.A. Gladman, Neuroanatomy and physiology of colorectal function and defaecation: from basic science to human clinical studies. *Neurogastroenterol Motil*, 2009. 21 Suppl 2: p. 9-19.
629. Lynn, P.A., et al., Rectal intraganglionic lamina endings are transduction sites of extrinsic mechanoreceptors in the guinea pig rectum. *Gastroenterology*, 2003. 125(3): p. 786-94.
630. Zagorodnyuk, V.P., et al., Mechanisms of mechanotransduction by specialized low-threshold mechanoreceptors in the guinea pig rectum. *Am J Physiol Gastrointest Liver Physiol*, 2005. 289(3): p. G397-406.
631. Goligher, J.C. and E.S. Hughes, Sensibility of the rectum and colon. Its role in the mechanism of anal continence. *Lancet*, 1951. 1(6654): p. 543-7.
632. Ness, T.J. and G.F. Gebhart, Visceral pain: a review of experimental studies. *Pain*, 1990. 41(2): p. 167-234.
633. Rogers, J., Testing for and the role of anal and rectal sensation. *Baillieres Clin Gastroenterol*, 1992. 6(1): p. 179-91.
634. Sengupta, J.N. and G.F. Gebhart, Characterization of mechanosensitive pelvic nerve afferent fibers innervating the colon of the rat. *J Neurophysiol*, 1994. 71(6): p. 2046-60.
635. Bharucha, A.E., et al., Viscoelastic properties of the human colon. *Am J Physiol Gastrointest Liver Physiol*, 2001. 281(2): p. G459-66.
636. Read, M.G. and N.W. Read, Role of anorectal sensation in preserving continence. *Gut*, 1982. 23(4): p. 345-7.
637. Sun, W.M., N.W. Read, and T.C. Donnelly, Anorectal function in incontinent patients with cerebrospinal disease. *Gastroenterology*, 1990. 99(5): p. 1372-9.
638. Rao, S.S., K.D. Welcher, and J. Happel, Can biofeedback therapy improve anorectal function in fecal incontinence? *Am J Gastroenterol*, 1996. 91(11): p. 2360-6.
639. Wald, A. and A.K. Tunuguntla, Anorectal sensorimotor dysfunction in fecal incontinence and diabetes mellitus. Modification with biofeedback therapy. *N Engl J Med*, 1984. 310(20): p. 1282-7.
640. Duthie, H.L. and F.W. Gairns, Sensory nerve-endings and sensation in the anal region of man. *Br J Surg*, 1960. 47: p. 585-95.
641. Goligher, J.C., The functional results after sphincter-saving resections of the rectum. *Ann R Coll Surg Engl*, 1951. 8(6): p. 421-38.
642. Chan, C.L., et al., Contribution of the pudendal nerve to sensation of the distal rectum. *Br J Surg*, 2005. 92(7): p. 859-65.
643. Miller, R., et al., Anorectal temperature sensation: a comparison of normal and incontinent patients. *Br J Surg*, 1987. 74(6): p. 511-5.
644. Miller, R., et al., Sensory discrimination and dynamic activity in the anorectum: evidence using a new ambulatory technique. *Br J Surg*, 1988. 75(10): p. 1003-7.

645. Rogers, J., et al., Temperature gradient between the rectum and the anal canal: evidence against the role of temperature sensation as a sensory modality in the anal canal of normal subjects. *Br J Surg*, 1988. 75(11): p. 1083-5.
646. Salvioi, B., et al., Rectal compliance, capacity, and rectoanal sensation in fecal incontinence. *Am J Gastroenterol*, 2001. 96(7): p. 2158-68.
647. Mayer, E.A., et al., Brain imaging approaches to the study of functional GI disorders: a Rome working team report. *Neurogastroenterol Motil*, 2009. 21(6): p. 579-96.
648. Mayer, E.A., B.D. Naliboff, and A.D. Craig, Neuroimaging of the brain-gut axis: from basic understanding to treatment of functional GI disorders. *Gastroenterology*, 2006. 131(6): p. 1925-42.
649. Moisset, X., et al., Anatomical connections between brain areas activated during rectal distension in healthy volunteers: a visceral pain network. *Eur J Pain*, 2010. 14(2): p. 142-8.
650. Tillisch, K., E.A. Mayer, and J.S. Labus, Quantitative meta-analysis identifies brain regions activated during rectal distension in irritable bowel syndrome. *Gastroenterology*, 2011. 140(1): p. 91-100.
651. Hobday, D.I., et al., A study of the cortical processing of ano-rectal sensation using functional MRI. *Brain*, 2001. 124(Pt 2): p. 361-8.
652. Turnbull, G.K., et al., The cortical topography of human anorectal musculature. *Gastroenterology*, 1999. 117(1): p. 32-9.
653. Martelli, H., et al., Some parameters of large bowel motility in normal man. *Gastroenterology*, 1978. 75(4): p. 612-8.
654. Bajwa, A. and A. Emmanuel, The physiology of continence and evacuation. *Best Pract Res Clin Gastroenterol*, 2009. 23(4): p. 477-85.
655. Duthie, H.L. and R.C. Bennett, The relation of sensation in the anal canal to the functional anal sphincter: a possible factor in anal continence. *Gut*, 1963. 4(2): p. 179-82.
656. Miller, R., et al., Anorectal sampling: a comparison of normal and incontinent patients. *Br J Surg*, 1988. 75(1): p. 44-7.
657. Amarenco, G., et al., Cough anal reflex: strict relationship between intravesical pressure and pelvic floor muscle electromyographic activity during cough. *Urodynamic and electrophysiological study. J Urol*, 2005. 173(1): p. 149-52.
658. Chan, C.L., S. Ponsford, and M. Swash, The anal reflex elicited by cough and sniff: validation of a neglected clinical sign. *J Neurol Neurosurg Psychiatry*, 2004. 75(10): p. 1449-51.
659. Deffieux, X., et al., External anal sphincter contraction during cough: not a simple spinal reflex. *Neurourol Urodyn*, 2006. 25(7): p. 782-7.
660. Duthie, H.L. and J.M. Watts, Contribution of the External Anal Sphincter to the Pressure Zone in the Anal Canal. *Gut*, 1965. 6: p. 64-8.
661. Dubrovsky, B., Effects of rectal distension on the sphincter ani externus and levator ani muscles in cats. *Am J Physiol*, 1988. 254(1 Pt 1): p. G100-6.
662. Frenckner, B., Function of the anal sphincters in spinal man. *Gut*, 1975. 16(8): p. 638-44.
663. F.C., G., The response to stimulation of the caudal end of the large bowel in the cat. *J. Physiol*, 1933. 78(2): p. 208-24.
664. Gaston, E.A., The physiology of fecal continence. *Surg Gynecol Obstet*, 1948. 87(3): p. 280-90.
665. Kumar, D., et al., Prolonged anorectal manometry and external anal sphincter electromyography in ambulant human subjects. *Dig Dis Sci*, 1990. 35(5): p. 641-8.
666. Smith, T.K., J.B. Reed, and K.M. Sanders, Origin and propagation of electrical slow waves in circular muscle of canine proximal colon. *Am J Physiol*, 1987. 252(2 Pt 1): p. C215-24.
667. Thomson, W.H., The nature of haemorrhoids. *Br J Surg*, 1975. 62(7): p. 542-52.
668. Thomson, H., The anal cushions--a fresh concept in diagnosis. *Postgrad Med J*, 1979. 55(644): p. 403-5.
669. Thekkinkattil, D.K., et al., Measurement of anal cushions in continent women. *Colorectal Dis*, 2011. 13(9): p. 1040-3.
670. AlAmeel, T., M.K. Andrew, and C. MacKnight, The association of fecal incontinence with institutionalization and mortality in older adults. *Am J Gastroenterol*, 2010. 105(8): p. 1830-4.
671. Aslan, E., et al., The prevalence of and the related factors for urinary and fecal incontinence among older residing in nursing homes. *J Clin Nurs*, 2009. 18(23): p. 3290-8.
672. Burge, E., A. Berchtold, and A. von Gunten, Gender-related ADL performance of old people recently admitted to a Swiss nursing home. A cross-sectional study. *Swiss Med Wkly*, 2011. 141: p. w13183.
673. Jung, S.A., et al., Closure mechanism of the anal canal in women: assessed by three-dimensional ultrasound imaging. *Dis Colon Rectum*, 2008. 51(6): p. 932-9.
674. Enck, P., et al., Spontaneous variation of anal "resting" pressure in healthy humans. *Am J Physiol*, 1991. 261(5 Pt 1): p. G823-6.

675. Thekkinkattil, D.K., et al., Contribution of posture to anorectal manometric measurements: are the measurements in left-lateral position physiologic? *Dis Colon Rectum*, 2007. 50(12): p. 2112-9.
676. Bouchoucha, M., et al., Anal sphincter response to distension. *Int J Colorectal Dis*, 2001. 16(2): p. 119-25.
677. Gibbons, C.P., et al., An analysis of anal sphincter pressure and anal compliance in normal subjects. *Int J Colorectal Dis*, 1986. 1(4): p. 231-7.
678. Gibbons, C.P., et al., Role of anal cushions in maintaining continence. *Lancet*, 1986. 1(8486): p. 886-8.
679. Lestar, B., et al., The internal anal sphincter can not close the anal canal completely. *Int J Colorectal Dis*, 1992. 7(3): p. 159-61.
680. Lestar, B., F. Penninckx, and R. Kerremans, The composition of anal basal pressure. An in vivo and in vitro study in man. *Int J Colorectal Dis*, 1989. 4(2): p. 118-22.
681. Bannister, J.J., C. Gibbons, and N.W. Read, Preservation of faecal continence during rises in intra-abdominal pressure: is there a role for the flap valve? *Gut*, 1987. 28(10): p. 1242-5.
682. Bartolo, D.C., et al., Flap-valve theory of anorectal continence. *Br J Surg*, 1986. 73(12): p. 1012-4.
683. Kerremans, R.P., A new method of objective examination in proctology. *Gut*, 1968. 9(2): p. 243-5.
684. Padda, B.S., et al., Effects of pelvic floor muscle contraction on anal canal pressure. *Am J Physiol Gastrointest Liver Physiol*, 2007. 292(2): p. G565-71.
685. Parks, A.G., N.H. Porter, and J. Hardcastle, The syndrome of the descending perineum. *Proc R Soc Med*, 1966. 59(6): p. 477-82.
686. Hajivassiliou, C.A., K.B. Carter, and I.G. Finlay, Anorectal angle enhances faecal continence. *Br J Surg*, 1996. 83(1): p. 53-6.
687. Engel, A.F., M.A. Kamm, and I.C. Talbot, Progressive systemic sclerosis of the internal anal sphincter leading to passive faecal incontinence. *Gut*, 1994. 35(6): p. 857-9.
688. Thoua, N.M., et al., Internal anal sphincter atrophy in patients with systemic sclerosis. *Rheumatology (Oxford)*, 2011. 50(9): p. 1596-602.
689. Thoua, N.M., et al., Fecal Incontinence in Systemic Sclerosis Is Secondary to Neuropathy. *Am J Gastroenterol*, 2011.
690. Burgell, R.E., et al., Fecal incontinence in men: coexistent constipation and impact of rectal hyposensitivity. *Dis Colon Rectum*, 2012. 55(1): p. 18-25.
691. Gladman, M.A., et al., Rectal hyposensitivity: prevalence and clinical impact in patients with intractable constipation and fecal incontinence. *Dis Colon Rectum*, 2003. 46(2): p. 238-46.
692. Hoffmann, B.A., et al., Fecal seepage and soiling: a problem of rectal sensation. *Dis Colon Rectum*, 1995. 38(7): p. 746-8.
693. Rao, S.S., R. Ozturk, and M. Stessman, Investigation of the pathophysiology of fecal seepage. *Am J Gastroenterol*, 2004. 99(11): p. 2204-9.
694. Siproudhis, L., et al., Fecal incontinence with normal anal canal pressures: where is the pit-fall? *Am J Gastroenterol*, 1999. 94(6): p. 1556-63.
695. Qureshi, M.S., et al., Male faecal incontinence presents as two separate entities with implications for management. *Int J Colorectal Dis*, 2011. 26(12): p. 1589-94.
696. Sentovich, S.M., et al., Patterns of male fecal incontinence. *Dis Colon Rectum*, 1995. 38(3): p. 281-5.
697. Dietz, H.P., M. Erdmann, and K.L. Shek, Reflex contraction of the levator ani in women symptomatic for pelvic floor disorders. *Ultrasound Obstet Gynecol*, 2012.
698. Fernandez-Fraga, X., F. Azpiroz, and J.R. Malagelada, Significance of pelvic floor muscles in anal incontinence. *Gastroenterology*, 2002. 123(5): p. 1441-50.
699. Heilbrun, M.E., et al., Correlation between levator ani muscle injuries on magnetic resonance imaging and fecal incontinence, pelvic organ prolapse, and urinary incontinence in primiparous women. *Am J Obstet Gynecol*, 2010. 202(5): p. 488 e1-6.
700. Lewicky-Gaup, C., et al., Fecal incontinence in older women: are levator ani defects a factor? *Am J Obstet Gynecol*, 2010. 202(5): p. 491 e1-6.
701. Steensma, A.B., et al., Prevalence of major levator abnormalities in symptomatic patients with an underactive pelvic floor contraction. *Int Urogynecol J*, 2010. 21(7): p. 861-7.
702. Chantarasorn, V., K.L. Shek, and H.P. Dietz, Sonographic detection of puborectalis muscle avulsion is not associated with anal incontinence. *Aust N Z J Obstet Gynaecol*, 2011. 51(2): p. 130-5.
703. Morgan, D.M., et al., Symptoms of anal incontinence and difficult defecation among women

- with prolapse and a matched control cohort. *Am J Obstet Gynecol*, 2007. 197(5): p. 509 e1-6.
704. Andrews, C., et al., Rectal sensorimotor dysfunction in women with fecal incontinence. *Am J Physiol Gastrointest Liver Physiol*, 2007. 292(1): p. G282-9.
705. Chan, C.L., et al., Rectal sensorimotor dysfunction in patients with urge faecal incontinence: evidence from prolonged manometric studies. *Gut*, 2005. 54(9): p. 1263-72.
706. Chan, C.L., et al., Rectal hypersensitivity worsens stool frequency, urgency, and lifestyle in patients with urge fecal incontinence. *Dis Colon Rectum*, 2005. 48(1): p. 134-40.
707. Lewicky-Gaupp, C., et al., Anal sphincter structure and function relationships in aging and fecal incontinence. *Am J Obstet Gynecol*, 2009. 200(5): p. 559 e1-5.
708. Siproudhis, L., et al., Low rectal volumes in patients suffering from fecal incontinence: what does it mean? *Aliment Pharmacol Ther*, 2005. 22(10): p. 989-96.
709. Bharucha, A.E., et al., Bowel disturbances are the most important risk factors for late onset fecal incontinence: a population-based case-control study in women. *Gastroenterology*, 2010. 139(5): p. 1559-66.
710. Boreham, M.K., et al., Anal incontinence in women presenting for gynecologic care: prevalence, risk factors, and impact upon quality of life. *Am J Obstet Gynecol*, 2005. 192(5): p. 1637-42.
711. Kalantar, J.S., S. Howell, and N.J. Talley, Prevalence of faecal incontinence and associated risk factors; an underdiagnosed problem in the Australian community? *Med J Aust*, 2002. 176(2): p. 54-7.
712. Melville, J.L., et al., Fecal incontinence in US women: a population-based study. *Am J Obstet Gynecol*, 2005. 193(6): p. 2071-6.
713. Pretlove, S.J., et al., Prevalence of anal incontinence according to age and gender: a systematic review and meta-regression analysis. *Int Urogynecol J Pelvic Floor Dysfunct*, 2006. 17(4): p. 407-17.
714. Quander, C.R., et al., Prevalence of and factors associated with fecal incontinence in a large community study of older individuals. *Am J Gastroenterol*, 2005. 100(4): p. 905-9.
715. Whitehead, W.E., et al., Fecal incontinence in US adults: epidemiology and risk factors. *Gastroenterology*, 2009. 137(2): p. 512-7, 517 e1-2.
716. Bharucha, A.E., et al., Prevalence and burden of fecal incontinence: a population-based study in women. *Gastroenterology*, 2005. 129(1): p. 42-9.
717. Rey, E., et al., Onset and risk factors for fecal incontinence in a US community. *Am J Gastroenterol*, 2010. 105(2): p. 412-9.
718. Bannister, J.J., L. Abouzekry, and N.W. Read, Effect of aging on anorectal function. *Gut*, 1987. 28(3): p. 353-7.
719. Fox, J.C., et al., Effect of aging on anorectal and pelvic floor functions in females. *Dis Colon Rectum*, 2006. 49(11): p. 1726-35.
720. Ryhammer, A.M., S. Laurberg, and F.H. Sorensen, Effects of age on anal function in normal women. *Int J Colorectal Dis*, 1997. 12(4): p. 225-9.
721. Gundling, F., et al., Influence of gender and age on anorectal function: normal values from anorectal manometry in a large caucasian population. *Digestion*, 2010. 81(4): p. 207-13.
722. Barrett, J.A., et al., Anal function in geriatric patients with faecal incontinence. *Gut*, 1989. 30(9): p. 1244-51.
723. Laurberg, S. and M. Swash, Effects of aging on the anorectal sphincters and their innervation. *Dis Colon Rectum*, 1989. 32(9): p. 737-42.
724. Beets-Tan, R.G., et al., Measurement of anal sphincter muscles: endoanal US, endoanal MR imaging, or phased-array MR imaging? A study with healthy volunteers. *Radiology*, 2001. 220(1): p. 81-9.
725. Burnett, S.J. and C.I. Bartram, Endosonographic variations in the normal internal anal sphincter. *Int J Colorectal Dis*, 1991. 6(1): p. 2-4.
726. Frudinger, A., et al., Female anal sphincter: age-related differences in asymptomatic volunteers with high-frequency endoanal US. *Radiology*, 2002. 224(2): p. 417-23.
727. Huebner, M., et al., Age effects on internal anal sphincter thickness and diameter in nulliparous females. *Dis Colon Rectum*, 2007. 50(9): p. 1405-11.
728. Bitar, K.N., Aging and Gi smooth muscle fecal incontinence: Is bioengineering an option. *Exp Gerontol*, 2005. 40(8-9): p. 643-9.
729. Akervall, S., et al., The effects of age, gender, and parity on rectoanal functions in adults. *Scand J Gastroenterol*, 1990. 25(12): p. 1247-56.
730. McHugh, S.M. and N.E. Diamant, Effect of age, gender, and parity on anal canal pressures. Contribution of impaired anal sphincter function

- to fecal incontinence. *Dig Dis Sci*, 1987. 32(7): p. 726-36.
731. Jameson, J.S., et al., Effect of age, sex and parity on anorectal function. *Br J Surg*, 1994. 81(11): p. 1689-92.
732. Rao, S.S., et al., Manometric tests of anorectal function in healthy adults. *Am J Gastroenterol*, 1999. 94(3): p. 773-83.
733. Bilali, S. and J. Pfeifer, Anorectal manometry: are fatigue rate and fatigue rate index of any clinical importance? *Tech Coloproctol*, 2005. 9(3): p. 225-8.
734. Nockolds, C.L., G.L. Hosker, and E.S. Kiff, Fatigue rate of the external anal sphincter. *Colorectal Dis*, 2011.
735. Chan, K.M., et al., Age-related changes in muscle fatigue resistance in humans. *Can J Neurol Sci*, 2000. 27(3): p. 220-8.
736. Nielsen, M.B., et al., Endosonography of the anal sphincter: findings in healthy volunteers. *AJR Am J Roentgenol*, 1991. 157(6): p. 1199-202.
737. Rociu, E., et al., Normal anal sphincter anatomy and age- and sex-related variations at high-spatial-resolution endoanal MR imaging. *Radiology*, 2000. 217(2): p. 395-401.
738. Cazemier, M., et al., Atrophy and defects detection of the external anal sphincter: comparison between three-dimensional anal endosonography and endoanal magnetic resonance imaging. *Dis Colon Rectum*, 2006. 49(1): p. 20-7.
739. Briel, J.W., et al., Relationship between sphincter morphology on endoanal MRI and histopathological aspects of the external anal sphincter. *Int J Colorectal Dis*, 2000. 15(2): p. 87-90.
740. Healy, C.F., et al., Experimental models of neuropathic fecal incontinence: an animal model of childbirth injury to the pudendal nerve and external anal sphincter. *Dis Colon Rectum*, 2008. 51(11): p. 1619-26; discussion 1626.
741. Salcedo, L., et al., Long-term effects on pressure and electromyography in a rat model of anal sphincter injury. *Dis Colon Rectum*, 2010. 53(8): p. 1209-17.
742. Voyvodic, F., et al., Delayed pudendal nerve conduction and endosonographic appearance of the anal sphincter complex. *Dis Colon Rectum*, 2000. 43(12): p. 1689-94.
743. Tomlinson, B.E., J.N. Walton, and J.J. Rebeiz, The effects of ageing and of cachexia upon skeletal muscle. A histopathological study. *J Neurol Sci*, 1969. 9(2): p. 321-46.
744. Percy, J.P., et al., A neurogenic factor in faecal incontinence in the elderly. *Age Ageing*, 1982. 11(3): p. 175-9.
745. Goode, P.S., et al., Prevalence and correlates of fecal incontinence in community-dwelling older adults. *J Am Geriatr Soc*, 2005. 53(4): p. 629-35.
746. Perry, S., et al., Prevalence of faecal incontinence in adults aged 40 years or more living in the community. *Gut*, 2002. 50(4): p. 480-4.
747. Tamanini, J.T., et al., The prevalence of fecal incontinence and associated risk factors in older adults participating in the SABE study. *Neurourol Urodyn*, 2015.
748. Christoforidis, D., et al., Faecal incontinence in men. *Colorectal Dis*, 2011. 13(8): p. 906-13.
749. Shamlivan, T.A., et al., Prevalence and risk factors of fecal incontinence in community-dwelling men. *Rev Gastroenterol Disord*, 2009. 9(4): p. E97-110.
750. Townsend, D.C., et al., Pathophysiology of fecal incontinence differs between men and women: a case-matched study in 200 patients. *Neurogastroenterol Motil*, 2016.
751. Varma, M.G., et al., Fecal incontinence in females older than aged 40 years: who is at risk? *Dis Colon Rectum*, 2006. 49(6): p. 841-51.
752. Nelson, R.L., Epidemiology of fecal incontinence. *Gastroenterology*, 2004. 126(1 Suppl 1): p. S3-7.
753. Bytzer, P., et al., Prevalence of gastrointestinal symptoms associated with diabetes mellitus: a population-based survey of 15,000 adults. *Arch Intern Med*, 2001. 161(16): p. 1989-96.
754. Joh, H.K., M.K. Seong, and S.W. Oh, Fecal incontinence in elderly Koreans. *J Am Geriatr Soc*, 2010. 58(1): p. 116-21.
755. Abid, S., et al., Poor glycaemic control is the major factor associated with increased frequency of gastrointestinal symptoms in patients with diabetes mellitus. *J Pak Med Assoc*, 2007. 57(7): p. 345-9.
756. Oh, J.H., et al., The prevalence of gastrointestinal symptoms in patients with non-insulin dependent diabetes mellitus. *Korean J Intern Med*, 2009. 24(4): p. 309-17.
757. Talley, N.J., et al., Predictors of turnover of lower gastrointestinal symptoms in diabetes mellitus. *Am J Gastroenterol*, 2002. 97(12): p. 3087-94.
758. De La Luz Nieto, M., et al., Factors associated with fecal incontinence in a nationally representative sample of diabetic women. *Int Urogynecol J*, 2015. 26(10): p. 1483-8.

759. Bytzer, P., et al., Oral hypoglycaemic drugs and gastrointestinal symptoms in diabetes mellitus. *Aliment Pharmacol Ther*, 2001. 15(1): p. 137-42.
760. Gerstel, C., M. Zarate Lagunes, and U.M. Vischer, Fecal incontinence resolved using metformin withdrawal. *J Am Geriatr Soc*, 2011. 59(4): p. 756-7.
761. Enck, P., et al., Prevalence of gastrointestinal symptoms in diabetic patients and non-diabetic subjects. *Z Gastroenterol*, 1994. 32(11): p. 637-41.
762. Janatuinen, E., et al., Gastrointestinal symptoms in middle-aged diabetic patients. *Scand J Gastroenterol*, 1993. 28(5): p. 427-32.
763. Russo, A., et al., Effects of acute hyperglycaemia on anorectal motor and sensory function in diabetes mellitus. *Diabet Med*, 2004. 21(2): p. 176-82.
764. Fillmann, H.S., et al., Diabetes mellitus and anal sphincter pressures: an experimental model in rats. *Dis Colon Rectum*, 2007. 50(4): p. 517-22.
765. Caruana, B.J., et al., Anorectal sensory and motor function in neurogenic fecal incontinence. Comparison between multiple sclerosis and diabetes mellitus. *Gastroenterology*, 1991. 100(2): p. 465-70.
766. Epanomeritakis, E., et al., Impairment of anorectal function in diabetes mellitus parallels duration of disease. *Dis Colon Rectum*, 1999. 42(11): p. 1394-400.
767. Schiller, L.R., et al., Pathogenesis of fecal incontinence in diabetes mellitus: evidence for internal-anal-sphincter dysfunction. *N Engl J Med*, 1982. 307(27): p. 1666-71.
768. Thiruppathy, K., et al., Gut symptoms in diabetics correlate with components of the rectoanal inhibitory reflex, but not with pudendal nerve motor latencies or systemic autonomic neuropathy. *J Dig Dis*, 2015. 16(6): p. 342-9.
769. Clouse, R.E. and P.J. Lustman, Gastrointestinal symptoms in diabetic patients: lack of association with neuropathy. *Am J Gastroenterol*, 1989. 84(8): p. 868-72.
770. Dunivan, G.C., et al., Fecal incontinence in primary care: prevalence, diagnosis, and health care utilization. *Am J Obstet Gynecol*, 2010. 202(5): p. 493 e1-6.
771. Markland, A.D., et al., Correlates of urinary, fecal, and dual incontinence in older African-American and white men and women. *J Am Geriatr Soc*, 2008. 56(2): p. 285-90.
772. Dunberger, G., et al., Loose stools lead to fecal incontinence among gynecological cancer survivors. *Acta Oncol*, 2011. 50(2): p. 233-42.
773. Bharucha, A.E., et al., Functional anorectal disorders. *Gastroenterology*, 2006. 130(5): p. 1510-8.
774. Bharucha, A.E., et al., Risk factors for fecal incontinence: a population-based study in women. *Am J Gastroenterol*, 2006. 101(6): p. 1305-12.
775. Rodger, C.J., et al., Abnormal colonic motility: a possible association with urge fecal incontinence. *Dis Colon Rectum*, 2010. 53(4): p. 409-13.
776. Bharucha AE, H.D., Haider C, Amador Carrascal C, Edge J, Manduca A, Zinsmeister AR, Increased Rectal Stiffness in Women with Urge-Predominant Fecal Incontinence. *Gastroenterology*, 2013. 144(5, Supplement 1): p. S-82.
777. Kinnunen, O., et al., Diarrhea and fecal impaction in elderly long-stay patients. *Z Gerontol*, 1989. 22(6): p. 321-3.
778. Madoff, R.D., et al., Faecal incontinence in adults. *Lancet*, 2004. 364(9434): p. 621-32.
779. Read, N.W. and L. Abouzekry, Why do patients with faecal impaction have faecal incontinence. *Gut*, 1986. 27(3): p. 283-7.
780. Drossman, D.A., et al., Urgency and fecal soiling in people with bowel dysfunction. *Dig Dis Sci*, 1986. 31(11): p. 1221-5.
781. O'Keefe, E.A., et al., Bowel disorders impair functional status and quality of life in the elderly: a population-based study. *J Gerontol A Biol Sci Med Sci*, 1995. 50(4): p. M184-9.
782. Talley, N.J., et al., Epidemiology of colonic symptoms and the irritable bowel syndrome. *Gastroenterology*, 1991. 101(4): p. 927-34.
783. Kanazawa, M., M. Hongo, and S. Fukudo, Visceral hypersensitivity in irritable bowel syndrome. *J Gastroenterol Hepatol*, 2011. 26 Suppl 3: p. 119-21.
784. Robinson, B.L., et al., Obstetric sphincter injury interacts with diarrhea and urgency to increase the risk of fecal incontinence in women with irritable bowel syndrome. *Female Pelvic Med Reconstr Surg*, 2013. 19(1): p. 40-5.
785. Brocklehurst, J., E. Dickinson, and J. Windsor, Laxatives and faecal incontinence in long-term care. *Elder Care*, 1998. 10(4): p. 22-5.
786. Hellstrom, L., et al., The influence of dementia on the prevalence of urinary and faecal incontinence in 85-year-old men and women. *Arch Gerontol Geriatr*, 1994. 19(1): p. 11-20.

787. Johanson, J.F., F. Irizarry, and A. Doughty, Risk factors for fecal incontinence in a nursing home population. *J Clin Gastroenterol*, 1997. 24(3): p. 156-60.
788. Quander, C.R., et al., Association of fecal incontinence with physical disability and impaired cognitive function. *Am J Gastroenterol*, 2006. 101(11): p. 2588-93.
789. Nakanishi, N., et al., Urinary and fecal incontinence in a community-residing older population in Japan. *J Am Geriatr Soc*, 1997. 45(2): p. 215-9.
790. de Winter CF, J.A., Evenhuis HM, Physical conditions and challenging behaviour in people with intellectual disability: a systematic review. *J Intellect Disabil Res.*, 2011. 55(7): p. 6750698.
791. Markland, A.D., et al., Incidence and risk factors for fecal incontinence in black and white older adults: a population-based study. *J Am Geriatr Soc*, 2010. 58(7): p. 1341-6.
792. Bailey, N. and D. Pares, Faecal incontinence and depression: cause or effect? *Colorectal Dis*, 2010. 12(5): p. 397-8.
793. Saka, B., et al., Malnutrition in the elderly and its relationship with other geriatric syndromes. *Clin Nutr*, 2010. 29(6): p. 745-8.
794. Glickman, S. and M.A. Kamm, Bowel dysfunction in spinal-cord-injury patients. *Lancet*, 1996. 347(9016): p. 1651-3.
795. Krogh, K., et al., Colorectal function in patients with spinal cord lesions. *Dis Colon Rectum*, 1997. 40(10): p. 1233-9.
796. Preziosi, G. and A. Emmanuel, Neurogenic bowel dysfunction: pathophysiology, clinical manifestations and treatment. *Expert Rev Gastroenterol Hepatol*, 2009. 3(4): p. 417-23.
797. Brittain, K.R., S.M. Peet, and C.M. Castleden, Stroke and incontinence. *Stroke*, 1998. 29(2): p. 524-8.
798. Harari, D., et al., New-onset fecal incontinence after stroke: prevalence, natural history, risk factors, and impact. *Stroke*, 2003. 34(1): p. 144-50.
799. Kovindha, A., et al., Prevalence of incontinence in patients after stroke during rehabilitation: a multi-centre study. *J Rehabil Med*, 2009. 41(6): p. 489-91.
800. Nakayama, H., et al., Prevalence and risk factors of incontinence after stroke. The Copenhagen Stroke Study. *Stroke*, 1997. 28(1): p. 58-62.
801. Brocklehurst, J.C., et al., Incidence and correlates of incontinence in stroke patients. *J Am Geriatr Soc*, 1985. 33(8): p. 540-2.
802. Chen, C.C., et al., Obesity is associated with increased prevalence and severity of pelvic floor disorders in women considering bariatric surgery. *Surg Obes Relat Dis*, 2009. 5(4): p. 411-5.
803. Cuicchi, D., et al., Clinical and instrumental evaluation of pelvic floor disorders before and after bariatric surgery in obese women. *Surg Obes Relat Dis*, 2011.
804. Fysekidis, M., et al., Prevalence and Co-occurrence of Upper and Lower Functional Gastrointestinal Symptoms in Patients Eligible for Bariatric Surgery. *Obes Surg*, 2011.
805. Markland, A.D., et al., Fecal incontinence in obese women with urinary incontinence: prevalence and role of dietary fiber intake. *Am J Obstet Gynecol*, 2009. 200(5): p. 566 e1-6.
806. Richter, H.E., et al., Urinary and anal incontinence in morbidly obese women considering weight loss surgery. *Obstet Gynecol*, 2005. 106(6): p. 1272-7.
807. Sileri, P., et al., Prevalence of defaecatory disorders in morbidly obese patients before and after bariatric surgery. *J Gastrointest Surg*, 2012. 16(1): p. 62-7.
808. Uustal Fornell, E., G. Wingren, and P. Kjolhede, Factors associated with pelvic floor dysfunction with emphasis on urinary and fecal incontinence and genital prolapse: an epidemiological study. *Acta Obstet Gynecol Scand*, 2004. 83(4): p. 383-9.
809. Wasserberg, N., et al., Morbid obesity adversely impacts pelvic floor function in females seeking attention for weight loss surgery. *Dis Colon Rectum*, 2007. 50(12): p. 2096-103.
810. Altman, D., et al., The risk of anal incontinence in obese women. *Int Urogynecol J Pelvic Floor Dysfunct*, 2007. 18(11): p. 1283-9.
811. Erekson, E.A., V.W. Sung, and D.L. Myers, Effect of body mass index on the risk of anal incontinence and defecatory dysfunction in women. *Am J Obstet Gynecol*, 2008. 198(5): p. 596 e1-4.
812. Foster, A., et al., Gastrointestinal symptomatic outcome after laparoscopic Roux-en-Y gastric bypass. *J Gastrointest Surg*, 2003. 7(6): p. 750-3.
813. Potoczna, N., et al., Bowel habits after bariatric surgery. *Obes Surg*, 2008. 18(10): p. 1287-96.
814. Burgio, K.L., et al., Changes in urinary and fecal incontinence symptoms with weight loss

- surgery in morbidly obese women. *Obstet Gynecol*, 2007. 110(5): p. 1034-40.
815. Romero-Talamas, H., et al., Comprehensive evaluation of the effect of bariatric surgery on pelvic floor disorders. *Surg Obes Relat Dis*, 2016. 12(1): p. 138-43.
 816. Scozzari, G., et al., Bariatric surgery improves urinary incontinence but not anorectal function in obese women. *Obes Surg*, 2013. 23(7): p. 931-8.
 817. Poylin, V., et al., Obesity and bariatric surgery: a systematic review of associations with defecatory dysfunction. *Colorectal Dis*, 2011. 13(6): p. e92-103.
 818. Lambert, D.M., S. Marceau, and R.A. Forse, Intra-abdominal pressure in the morbidly obese. *Obes Surg*, 2005. 15(9): p. 1225-32.
 819. Noblett, K.L., J.K. Jensen, and D.R. Ostergard, The relationship of body mass index to intra-abdominal pressure as measured by multi-channel cystometry. *Int Urogynecol J Pelvic Floor Dysfunct*, 1997. 8(6): p. 323-6.
 820. Badalian, S.S. and P.F. Rosenbaum, Vitamin D and pelvic floor disorders in women: results from the National Health and Nutrition Examination Survey. *Obstet Gynecol*, 2010. 115(4): p. 795-803.
 821. Vaughan, C.P., et al., Vitamin D and lower urinary tract symptoms among US men: results from the 2005-2006 National Health and Nutrition Examination Survey. *Urology*, 2011. 78(6): p. 1292-7.
 822. Alkhatib, A.A. and A.K. Tuteja, High prevalence of vitamin D deficiency among patients with fecal incontinence. *Dig Dis Sci*, 2010. 55(12): p. 3632-3.
 823. Parker-Autry, C.Y., et al., Vitamin D deficiency is associated with increased fecal incontinence symptoms. *Int Urogynecol J*, 2014. 25(11): p. 1483-9.
 824. Lanske, B. and M.S. Razzaque, Vitamin D and aging: old concepts and new insights. *J Nutr Biochem*, 2007. 18(12): p. 771-7.
 825. Perry, H.M., 3rd, et al., Longitudinal changes in serum 25-hydroxyvitamin D in older people. *Metabolism*, 1999. 48(8): p. 1028-32.
 826. da Silva, R.C., et al., alpha-Tocopherol supplementation avoids apoptosis in the anal sphincter. *Aging Male*, 2012. 15(1): p. 48-53.
 827. Engel, A.F., et al., Anterior anal sphincter repair in patients with obstetric trauma. *Br J Surg*, 1994. 81(8): p. 1231-4.
 828. Karoui, S., et al., Results of sphincteroplasty in 86 patients with anal incontinence. *Dis Colon Rectum*, 2000. 43(6): p. 813-20.
 829. Sitzler, P.J. and J.P. Thomson, Overlap repair of damaged anal sphincter. A single surgeon's series. *Dis Colon Rectum*, 1996. 39(12): p. 1356-60.
 830. Thomas, C., I. Etienney, and P. Atienza, Evaluation of the role of the puborectal part of the levator ani muscle in anal incontinence: a prospective study of 78 female patients with anal incontinence. *Dis Colon Rectum*, 2011. 54(9): p. 1129-33.
 831. Borrie, M.J. and H.A. Davidson, Incontinence in institutions: costs and contributing factors. *CMAJ*, 1992. 147(3): p. 322-8.
 832. Nelson, R.L. and S.E. Furner, Risk factors for the development of fecal and urinary incontinence in Wisconsin nursing home residents. *Maturitas*, 2005. 52(1): p. 26-31.
 833. Hazewinkel, M.H., et al., Long-term cervical cancer survivors suffer from pelvic floor symptoms: a cross-sectional matched cohort study. *Gynecol Oncol*, 2010. 117(2): p. 281-6.
 834. Putta, S. and H.J. Andreyev, Faecal incontinence: A late side-effect of pelvic radiotherapy. *Clin Oncol (R Coll Radiol)*, 2005. 17(6): p. 469-77.
 835. Maeda, Y., et al., Faecal incontinence following radiotherapy for prostate cancer: a systematic review. *Radiother Oncol*, 2011. 98(2): p. 145-53.
 836. Scheer, A.S., et al., The long-term gastrointestinal functional outcomes following curative anterior resection in adults with rectal cancer: a systematic review and meta-analysis. *Dis Colon Rectum*, 2011. 54(12): p. 1589-97.
 837. Bentzen, A.G., et al., Faecal incontinence after chemoradiotherapy in anal cancer survivors: long-term results of a national cohort. *Radiother Oncol*, 2013. 108(1): p. 55-60.
 838. Bosset, J.F., et al., Chemotherapy with preoperative radiotherapy in rectal cancer. *N Engl J Med*, 2006. 355(11): p. 1114-23.
 839. Pollack, J., et al., Long-term effect of preoperative radiation therapy on anorectal function. *Dis Colon Rectum*, 2006. 49(3): p. 345-52.
 840. Peeters, K.C., et al., Late side effects of short-course preoperative radiotherapy combined with total mesorectal excision for rectal cancer: increased bowel dysfunction in irradiated patients--a Dutch colorectal cancer group study. *J Clin Oncol*, 2005. 23(25): p. 6199-206.
 841. Dahlberg, M., et al., Preoperative irradiation affects functional results after surgery for rectal

- cancer: results from a randomized study. *Dis Colon Rectum*, 1998. 41(5): p. 543-9; discussion 549-51.
842. Saito, N., et al., Long-term outcomes after intersphincteric resection for low-lying rectal cancer. *Ann Surg Oncol*, 2014. 21(11): p. 3608-15.
 843. Bujko, K., et al., Long-term results of a randomized trial comparing preoperative short-course radiotherapy with preoperative conventionally fractionated chemoradiation for rectal cancer. *Br J Surg*, 2006. 93(10): p. 1215-23.
 844. Protocol, S. The Stockholm III Trial on Different Preoperative Radiotherapy Regimens in Rectal Cancer. [cited 2012 February 4]; Preoperative radiotherapy (RT) is recommended to many patients with localised rectal cancer, not previously treated with pelvic RT. However, the optimum fractionation, the timing of surgery and the best use of concomitant chemotherapy remains controversial. Short-course, preoperative RT may induce both acute and late morbidity and has been claimed to cause more morbidity than long-course preoperative RT. There are theoretical reasons to believe that RT given in larger fractions during a shorter period of time might result in more late side effects than giving a conventional, more protracted RT. In addition, the optimum timing of surgery after RT, with respect to postoperative morbidity, mortality and potential downsizing of the tumour is not known.]. Available from: <http://clinicaltrials.gov/ct2/show/NCT00904813?term=radiation+therapy+and+rectal+cancer&cond=rectal+cancer&intr=radiation+therapy&cntry1=EU%3ASE&rank=1>.
 845. Siegel, R., et al., Preoperative short-course radiotherapy versus combined radiochemotherapy in locally advanced rectal cancer: a multicentre prospectively randomised study of the Berlin Cancer Society. *BMC Cancer*, 2009. 9: p. 50.
 846. Chen, T.Y., et al., Bowel function 14 years after preoperative short-course radiotherapy and total mesorectal excision for rectal cancer: report of a multicenter randomized trial. *Clin Colorectal Cancer*, 2015. 14(2): p. 106-14.
 847. Smeenk, R.J., et al., Dose-Effect Relationships for Individual Pelvic Floor Muscles and Anorectal Complaints After Prostate Radiotherapy. *Int J Radiat Oncol Biol Phys*, 2011.
 848. Lind, H., et al., Defecation into clothing without forewarning and mean radiation dose to bowel and anal-sphincter among gynecological cancer survivors. *Acta Oncol*, 2016: p. 1-9.
 849. Krol, R., et al., Systematic review: anal and rectal changes after radiotherapy for prostate cancer. *Int J Colorectal Dis*, 2014. 29(3): p. 273-83.
 850. Varma, J.S., A.N. Smith, and A. Busuttill, Correlation of clinical and manometric abnormalities of rectal function following chronic irradiation injury. *Br J Surg*, 1985. 72(11): p. 875-8.
 851. Da Silva, G.M., et al., Histologic analysis of the irradiated anal sphincter. *Dis Colon Rectum*, 2003. 46(11): p. 1492-7.
 852. Petersen, S., et al., Radiation-induced sequelae affecting the continence organ: incidence, pathogenesis, and treatment. *Dis Colon Rectum*, 2007. 50(9): p. 1466-74.
 853. Loganathan, A., et al., Pudendal nerve injury in men with fecal incontinence after radiotherapy for prostate cancer. *Acta Oncol*, 2015. 54(6): p. 882-8.
 854. Zhang, H., et al., Genetic polymorphisms of PAI-1 and PAR-1 are associated with acute normal tissue toxicity in Chinese rectal cancer patients treated with pelvic radiotherapy. *Oncotargets Ther*, 2015. 8: p. 2291-301.
 855. Johannsson, H.O., L. Pahlman, and W. Graf, Randomized clinical trial of the effects on anal function of Milligan-Morgan versus Ferguson haemorrhoidectomy. *Br J Surg*, 2006. 93(10): p. 1208-14.
 856. Murie, J.A., A.J. Sim, and I. Mackenzie, The importance of pain, pruritus and soiling as symptoms of haemorrhoids and their response to haemorrhoidectomy or rubber band ligation. *Br J Surg*, 1981. 68(4): p. 247-9.
 857. Rasmussen, O.O., Anorectal function. *Dis Colon Rectum*, 1994. 37(4): p. 386-403.
 858. Read, M.G., et al., A prospective study of the effect of haemorrhoidectomy on sphincter function and faecal continence. *Br J Surg*, 1982. 69(7): p. 396-8.
 859. Broden, G., A. Dolk, and B. Holmstrom, Recovery of the internal anal sphincter following rectopexy: a possible explanation for continence improvement. *Int J Colorectal Dis*, 1988. 3(1): p. 23-8.
 860. Farouk, R. and G.S. Duthie, Rectal prolapse and rectal invagination. *Eur J Surg*, 1998. 164(5): p. 323-32.
 861. Kairaluoma, M.V. and I.H. Kellokumpu, Epidemiologic aspects of complete rectal prolapse. *Scand J Surg*, 2005. 94(3): p. 207-10.
 862. Williams, J.G., et al., Incontinence and rectal prolapse: a prospective manometric study. *Dis Colon Rectum*, 1991. 34(3): p. 209-16.
 863. Harmston, C., et al., The relationship between internal rectal prolapse and internal anal sphincter function. *Colorectal Dis*, 2011. 13(7): p. 791-5.

864. Neill, M.E., A.G. Parks, and M. Swash, Physiological studies of the anal sphincter musculature in faecal incontinence and rectal prolapse. *Br J Surg*, 1981. 68(8): p. 531-6.
865. Roig, J.V., et al., Anorectal function in patients with complete rectal prolapse. Differences between continent and incontinent individuals. *Rev Esp Enferm Dig*, 1998. 90(11): p. 794-805.
866. Siproudhis, L., et al., Overt rectal prolapse and fecal incontinence. *Dis Colon Rectum*, 2008. 51(9): p. 1356-60.
867. Woods, R., et al., Anal sphincter tears in patients with rectal prolapse and faecal incontinence. *Colorectal Dis*, 2003. 5(6): p. 544-8.
868. Felt-Bersma, R.J. and M.A. Cuesta, Rectal prolapse, rectal intussusception, rectocele, and solitary rectal ulcer syndrome. *Gastroenterol Clin North Am*, 2001. 30(1): p. 199-222.
869. Ihre, T. and U. Seligson, Intussusception of the rectum-internal procidentia: treatment and results in 90 patients. *Dis Colon Rectum*, 1975. 18(5): p. 391-6.
870. Hawkins AT, O.A., Savitt LR, Gingipally S, Wakamatsu MM, Pulliam S, Weinstein MM, Bordeianou L., Impact of Rising Grades of Internal Rectal Intussusception on Fecal Continence and Symptoms of Constipation. *Dis Colon Rectum*, 2016. 59(1): p. 54-61.
871. Bloemendaal, A.L., et al., High-grade internal rectal prolapse: Does it explain so-called "idiopathic" faecal incontinence? *Int J Surg*, 2016. 25: p. 118-22.
872. Collinson, R., et al., Laparoscopic ventral rectopexy for internal rectal prolapse: short-term functional results. *Colorectal Dis*, 2010. 12(2): p. 97-104.
873. Gosselink, M.P., et al., Laparoscopic ventral rectopexy for fecal incontinence associated with high-grade internal rectal prolapse. *Dis Colon Rectum*, 2013. 56(12): p. 1409-14.
874. Portier, G., et al., The effect of abdominal ventral rectopexy on faecal incontinence and constipation in patients with internal intra-anal rectal intussusception. *Colorectal Dis*, 2011. 13(8): p. 914-7.
875. Franceschilli, L., et al., Laparoscopic ventral rectopexy using biologic mesh for the treatment of obstructed defaecation syndrome and/or faecal incontinence in patients with internal rectal prolapse: a critical appraisal of the first 100 cases. *Tech Coloproctol*, 2015. 19(4): p. 209-19.
876. Owais, A.E., et al., Laparoscopic ventral mesh rectopexy in male patients with internal or external rectal prolapse. *Colorectal Dis*, 2014. 16(12): p. 995-1000.
877. Adusumilli, S., et al., Does the presence of a high grade internal rectal prolapse affect the outcome of pelvic floor retraining in patients with faecal incontinence or obstructed defaecation? *Colorectal Dis*, 2013. 15(11): p. e680-5.
878. Prapasivorakul, S., et al., Erratum to: Sacral neuromodulation for faecal incontinence: is the outcome compromised in patients with high-grade internal rectal prolapse? *Int J Colorectal Dis*, 2015. 30(2): p. 235.
879. Prapasivorakul, S., et al., Sacral neuromodulation for faecal incontinence: is the outcome compromised in patients with high-grade internal rectal prolapse? *Int J Colorectal Dis*, 2015. 30(2): p. 229-34.
880. Arroyo, A., et al., Surgical versus chemical (botulinum toxin) sphincterotomy for chronic anal fissure: long-term results of a prospective randomized clinical and manometric study. *Am J Surg*, 2005. 189(4): p. 429-34.
881. Garcia-Aguilar, J., et al., Open vs. closed sphincterotomy for chronic anal fissure: long-term results. *Dis Colon Rectum*, 1996. 39(4): p. 440-3.
882. Khubchandani, I.T. and J.F. Reed, Sequelae of internal sphincterotomy for chronic fissure in ano. *Br J Surg*, 1989. 76(5): p. 431-4.
883. Kiyak, G., et al., Results of lateral internal sphincterotomy with open technique for chronic anal fissure: evaluation of complications, symptom relief, and incontinence with long-term follow-up. *Dig Dis Sci*, 2009. 54(10): p. 2220-4.
884. Nyam, D.C. and J.H. Pemberton, Long-term results of lateral internal sphincterotomy for chronic anal fissure with particular reference to incidence of fecal incontinence. *Dis Colon Rectum*, 1999. 42(10): p. 1306-10.
885. Sileri, P., et al., Conservative and surgical treatment of chronic anal fissure: prospective longer term results. *J Gastrointest Surg*, 2010. 14(5): p. 773-80.
886. Hasse C, B.M., Bachmann S, Lorenz W, Rothmund M, Sitter H., Lateral, partial sphincter myotomy as therapy of chronic anal fissure. Long-term outcome of an epidemiological cohort study. *Chirurg*, 2004. 75(2): p. 160-167.
887. Casillas, S., et al., Incontinence after a lateral internal sphincterotomy: are we underestimating it? *Dis Colon Rectum*, 2005. 48(6): p. 1193-9.
888. Elsebae, M.M., A study of fecal incontinence in patients with chronic anal fissure: prospective, randomized, controlled trial of the extent of internal anal sphincter division during lateral sphincterotomy. *World J Surg*, 2007. 31(10): p. 2052-7.

889. Kement, M., et al., Mild and severe anal incontinence after lateral internal sphincterotomy: risk factors, postoperative anatomical findings and quality of life. *Eur Surg Res*, 2011. 47(1): p. 26-31.
890. Sultan, A.H., et al., Prospective study of the extent of internal anal sphincter division during lateral sphincterotomy. *Dis Colon Rectum*, 1994. 37(10): p. 1031-3.
891. Zbar, A.P., et al., Fecal incontinence after minor anorectal surgery. *Dis Colon Rectum*, 2001. 44(11): p. 1610-9; discussion 1619-23.
892. Gandomkar, H., et al., Partial lateral internal sphincterotomy versus combined botulinum toxin A injection and topical diltiazem in the treatment of chronic anal fissure: a randomized clinical trial. *Dis Colon Rectum*, 2015. 58(2): p. 228-34.
893. Levin, A., et al., Delayed fecal incontinence following surgery for anal fissure. *Int J Colorectal Dis*, 2011. 26(12): p. 1595-9.
894. Ganchrow, M.I., et al., Hemorrhoidectomy revisited--a computer analysis of 2,038 cases. *Dis Colon Rectum*, 1971. 14(2): p. 128-33.
895. Lindsey, I., et al., Patterns of fecal incontinence after anal surgery. *Dis Colon Rectum*, 2004. 47(10): p. 1643-9.
896. Liu, B., Y. Zhang, and X.D. Zeng, [Factors associated with incontinence following anorectal procedures]. *Zhonghua Wei Chang Wai Ke Za Zhi*, 2011. 14(6): p. 452-4.
897. McConnell, J.C. and I.T. Khubchandani, Long-term follow-up of closed hemorrhoidectomy. *Dis Colon Rectum*, 1983. 26(12): p. 797-9.
898. Abbasakoor, F., et al., Anal endosonography in patients with anorectal symptoms after haemorrhoidectomy. *Br J Surg*, 1998. 85(11): p. 1522-4.
899. Johannsson, H.O., L. Pahlman, and W. Graf, Functional and structural abnormalities after milligan hemorrhoidectomy: a comparison with healthy subjects. *Dis Colon Rectum*, 2013. 56(7): p. 903-8.
900. Li, Y.D., et al., Excisional hemorrhoidal surgery and its effect on anal continence. *World J Gastroenterol*, 2012. 18(30): p. 4059-63.
901. Abbas, M.A., C.H. Jackson, and P.I. Haigh, Predictors of outcome for anal fistula surgery. *Arch Surg*, 2011. 146(9): p. 1011-6.
902. Athanasiadis, S., A. Kohler, and M. Nafe, Treatment of high anal fistulae by primary occlusion of the internal ostium, drainage of the intersphincteric space, and mucosal advancement flap. *Int J Colorectal Dis*, 1994. 9(3): p. 153-7.
903. Garcia-Aguilar, J., et al., Anal fistula surgery. Factors associated with recurrence and incontinence. *Dis Colon Rectum*, 1996. 39(7): p. 723-9.
904. Jacob, T.J., B. Perakath, and M.R. Keighley, Surgical intervention for anorectal fistula. *Cochrane Database Syst Rev*, 2010(5): p. CD006319.
905. Joy, H.A. and J.G. Williams, The outcome of surgery for complex anal fistula. *Colorectal Dis*, 2002. 4(4): p. 254-261.
906. Miller, G.V. and P.J. Finan, Flap advancement and core fistulectomy for complex rectal fistula. *Br J Surg*, 1998. 85(1): p. 108-10.
907. Ortiz, H. and J. Marzo, Endorectal flap advancement repair and fistulectomy for high trans-sphincteric and suprasphincteric fistulas. *Br J Surg*, 2000. 87(12): p. 1680-3.
908. Ritchie, R.D., J.M. Sackier, and J.P. Hodde, Incontinence rates after cutting seton treatment for anal fistula. *Colorectal Dis*, 2009. 11(6): p. 564-71.
909. Sangwan, Y.P., et al., Is simple fistula-in-ano simple? *Dis Colon Rectum*, 1994. 37(9): p. 885-9.
910. Schouten, W.R., D.D. Zimmerman, and J.W. Briel, Transanal advancement flap repair of transsphincteric fistulas. *Dis Colon Rectum*, 1999. 42(11): p. 1419-22; discussion 1422-3.
911. Sileri, P., et al., Surgery for fistula-in-ano in a specialist colorectal unit: a critical appraisal. *BMC Gastroenterol*, 2011. 11: p. 120.
912. Vasilevsky, C.A. and P.H. Gordon, Results of treatment of fistula-in-ano. *Dis Colon Rectum*, 1985. 28(4): p. 225-31.
913. Westerterp, M., et al., Anal fistulotomy between Skylla and Charybdis. *Colorectal Dis*, 2003. 5(6): p. 549-51.
914. Roig, J.V., et al., Changes in anorectal morphologic and functional parameters after fistula-in-ano surgery. *Dis Colon Rectum*, 2009. 52(8): p. 1462-9.
915. Denost, Q., et al., Risk factors for fecal incontinence after intersphincteric resection for rectal cancer. *Dis Colon Rectum*, 2011. 54(8): p. 963-8.
916. Battersby, N.J., et al., Predicting the Risk of Bowel-Related Quality-of-Life Impairment After Restorative Resection for Rectal Cancer: A Multicenter Cross-Sectional Study. *Dis Colon Rectum*, 2016. 59(4): p. 270-80.

917. Brown, C.J., D.S. Fenech, and R.S. McLeod, Reconstructive techniques after rectal resection for rectal cancer. *Cochrane Database Syst Rev*, 2008(2): p. CD006040.
918. Farouk, R., et al., Endosonographic evidence of injury to the internal anal sphincter after low anterior resection: long-term follow-up. *Dis Colon Rectum*, 1998. 41(7): p. 888-91.
919. Ho, Y.H., et al., Anal sphincter injuries from stapling instruments introduced transanally: randomized, controlled study with endoanal ultrasound and anorectal manometry. *Dis Colon Rectum*, 2000. 43(2): p. 169-73.
920. Matsuoka, H., et al., Neurophysiologic investigation of anal function following double stapling anastomosis. *Dig Surg*, 2010. 27(4): p. 320-3.
921. Batignani, G., et al., What affects continence after anterior resection of the rectum? *Dis Colon Rectum*, 1991. 34(4): p. 329-35.
922. Matzel, K.E., B. Bittorf, and U. Stadelmaier, Anorectal function after low anterior resection. *Acta Chir Iugosl*, 2004. 51(2): p. 95-7.
923. Devroede, G. and J. Lamarche, Functional importance of extrinsic parasympathetic innervation to the distal colon and rectum in man. *Gastroenterology*, 1974. 66(2): p. 273-80.
924. Wallner, C., et al., Causes of fecal and urinary incontinence after total mesorectal excision for rectal cancer based on cadaveric surgery: a study from the Cooperative Clinical Investigators of the Dutch total mesorectal excision trial. *J Clin Oncol*, 2008. 26(27): p. 4466-72.
925. Humalajarvi, N., et al., Quality of life and pelvic floor dysfunction symptoms after hysterectomy with or without pelvic organ prolapse. *Eur J Obstet Gynecol Reprod Biol*, 2014. 182: p. 16-21.
926. Ceccaroni, M., et al., Pelvic dysfunctions and quality of life after nerve-sparing radical hysterectomy: a multicenter comparative study. *Anticancer Res*, 2012. 32(2): p. 581-8.
927. Markland, A.D., et al., Factors impacting quality of life in women with fecal incontinence. *Dis Colon Rectum*, 2010. 53(8): p. 1148-54.
928. Matthews, C.A., et al., Risk factors for urinary, fecal, or dual incontinence in the Nurses' Health Study. *Obstet Gynecol*, 2013. 122(3): p. 539-45.
929. Guise, J.M., et al., Incidence of fecal incontinence after childbirth. *Obstet Gynecol*, 2007. 109(2 Pt 1): p. 281-8.
930. Baron, J.A., C. La Vecchia, and F. Levi, The antiestrogenic effect of cigarette smoking in women. *Am J Obstet Gynecol*, 1990. 162(2): p. 502-14.
931. Coulie, B., et al., Colonic motility in chronic ulcerative proctosigmoiditis and the effects of nicotine on colonic motility in patients and healthy subjects. *Aliment Pharmacol Ther*, 2001. 15(5): p. 653-63.
932. Bharucha, A.E., et al., Obstetric trauma, pelvic floor injury and fecal incontinence: a population-based case-control study. *Am J Gastroenterol*, 2012. 107(6): p. 902-11.
933. Jelovsek, J.E., et al., Functional bowel and anorectal disorders in patients with pelvic organ prolapse and incontinence. *Am J Obstet Gynecol*, 2005. 193(6): p. 2105-11.
934. Manning, J., et al., Is there an association between fecal incontinence and lower urinary dysfunction? *Dis Colon Rectum*, 2001. 44(6): p. 790-8.
935. Roberts, R.O., et al., Prevalence of combined fecal and urinary incontinence: a community-based study. *J Am Geriatr Soc*, 1999. 47(7): p. 837-41.
936. Glazener CMA, Abdalla M, Stroud P, Naji S, Templeton A, Russell IT. Postnatal maternal morbidity: extent, causes, prevention and treatment. *Br J Obstet Gynaecol* 1995;102:282-87.
937. Sultan AH, Kamm MA, Hudson CN, Thomas JM, Bartram CI. Anal sphincter disruption during vaginal delivery. *N Engl J Med* 1993;329:1905-11.
938. MacArthur C, Glazener CMA, Wilson PD, Herbison GP, Gee H, Lang GD, Lancashire R. Obstetric practice and faecal incontinence three months after delivery. *Br J Obstet Gynaecol* 2001;108:678-83
939. Zetterstrom J, Lopez A, Anzen B, Norman M, Holmstrom B, Mellgren A. Anal sphincter tears at vaginal delivery: risk factors and clinical outcome of primary repair. *Obstet Gynecol* 1999 ;94(1):21-8.
940. Eason E, Labrecque M, Marcoux S, Mondor M. Anal incontinence after childbirth. *CMAJ*. 2002;166(3):326-30.
941. Guise JM, Morris C, Osterweil P, Li H, Rosenberg D, Greenlick M. Incidence of fecal incontinence after childbirth. *Obstet Gynecol*. 2007;109:281-8.
942. Beersiek F, Parks AG Swash M. Pathogenesis of anorectal incontinence: a histometric study of the anorectal musculature. *J Neurol Sci* 1979;42:111-127.
943. Neill ME, Swash M. Increased motor unit fibre density in the external anal sphincter in anorectal incontinence: a single fibre EMG study. *J Neurol Neurosurg Psychiatry* 1980;43:343-347

944. Kiff ES and Swash M. Slowed conduction in the pudendal nerves in idiopathic (neurogenic) faecal incontinence. *B J Surg* 1984; 71:614-616.
945. Snooks SJ, Swash M, Setchell M, Henry MM. Injury to innervation of pelvic floor sphincter musculature in childbirth. *Lancet* 1984; 2:546-50
946. Snooks SJ, Swash M, Mathers SE and Henry MM. Effect of vaginal delivery on the pelvic floor: a 5-year follow-up. *Br J Surg* 1990;77:1358-60.
947. Allen RE, Hosker GL, Smith ARB, Warrell DW. Pelvic floor damage and childbirth: a neurophysiological study. *Br J Obstet Gynaecol* 1990;97:770-779.
948. Mallett V, Hosker G, Smith ARB, Warrell D. Pelvic floor damage and childbirth: a neurophysiologic follow up study. *Neurourol Urodyn* 1994;13:357-8.
949. Small KA, Wynne JM. Evaluating the pelvic floor in obstetric patients. *Aust NZ J Obstet Gynaecol* 1990;30:41-5.
950. Cornes H, Bartolo DCC, Stirrat GM. Changes in anal canal sensation after childbirth. *Br J Surg* 1991;78:74-7.
951. Chaliha C, Sultan AH, Kalia V, Monga AK, Stanton SL. Anal incontinence during pregnancy and following childbirth *Am J Obstet Gynecol* 2001;185:427-32
952. Law PJ, Kamm MA and Bartram CI. Anal endosonography in the investigation of faecal incontinence. *Brit J Surg* 1991;78:312-4.
953. Sultan AH, Kamm MA, Talbot IC, Nicholls RJ, Bartram CI. Anal endosonography: Precision of identifying sphincter defects confirmed histologically. *Br J Surg* 1994;81:466-9.
954. Sultan AH, Kamm MA, Nicholls RJ, Bartram CI. Internal anal sphincter division during lateral sphincterotomy. Prospective ultrasound study. *Dis Colon Rectum* 1994;37:1031-33.
955. Donnelly V, Fynes M, Campbell D, Johnson H, O'Connell R, O'Herlihy C. Obstetric events leading to anal sphincter damage. *Obstet Gynecol* 1998;92:955-61.
956. Fynes M, Donnelly VS, O'Connell PR, O'Herlihy C. Cesarean delivery and anal sphincter injury. *Obstet Gynecol* 1988;92:496-500
957. Abramowitz L, Sobhani I, Ganasia R, Vuagnat A, Benifla JL, Darai E, Madelenat P, Mignon M. Are sphincter defects the cause of anal incontinence after vaginal delivery? Results of a prospective study. *Dis Colon Rectum* 2000;43:590-8.
958. DeLeeuw JW, Struijk PC, Vierhout ME, Wallenburg HCS. Risk factors for third degree perineal ruptures during delivery. *Br J Obstet Gynaecol* 2001;108:383-7.
959. Buchhave P, Flatow L, Rydhystroem H, Thorbert G. Risk factors for rupture of the anal sphincter. *Eur J Obstet Gynecol Reproduct Biol* 1999;87:129-32
960. Fynes M, Donnelly V, Behan M, O'Connell PR, O'Herlihy C. Effect of second vaginal delivery on anorectal physiology and faecal incontinence: a prospective study. *Lancet* 1999;354:983-6.
961. Willis S, Faridi A, Schelzig S, Hoelzl F, Kasperk R, Rath W, Schumpelick V. Childbirth and incontinence: a prospective study on anal sphincter morphology and function before and early after delivery. *Langenbeck's Arch Surg* 2002;387:101-107.
962. Nazir M, Carlsen E, Nesheim B. Do occult anal sphincter injuries, vector volume manometry and delivery variables have any predictive value for bowel symptoms after first time vaginal delivery without third and fourth degree rupture? A prospective study. *Acta Obstet Gynecol Scand* 2002;81:720-726.
963. Belmonte-Montes C, Hagerman G, Vega-Yepey PA, Hernandez-de-Anda E, Fonseca-Morales V. Anal sphincter injury after vaginal delivery in primiparous females. *Dis Colon Rectum* 2001;44:1244-1248.
964. Varma A, Gunn J, Gardiner A, Lindow SW, Duthie GS. Obstetric anal sphincter injury. Prospective evaluation of incidence. *Dis Colon Rectum* 1999;42:1537-43.
965. Rieger N, Schloithe A, Saccone G, Wattchow D. A prospective study of anal sphincter injury due to childbirth. *Scand J Gastroenterol* 1998;33:950-5.
966. Zetterstrom J, Mellgren A, Jensen LJ, Wong WD, Kim DG, Lowry AC, Madoff RD, Congilosi SM. Effect of delivery on anal sphincter morphology and function. *Dis Colon Rectum* 1999;42:1253-60.
967. Damon H, Henry L, Bretones S, Mellier G, Minaire Y, Mion F. Postdelivery anal function in primiparous females. Ultrasound and manometric study. *Dis Colon Rectum* 2000;43:472-7.
968. Faltin DL, Boulvain M, Irion O, Bretones S, Stan C, Weil A. Diagnosis of anal sphincter tears by postpartum endosonography to predict fecal incontinence. *Obstet Gynecol* 2000;95:643-7.
969. Williams AB, Bartram CI, Halligan S, Spencer JA, Nicholls RJ, Kmiot WA. Anal sphincter

- damage after vaginal delivery using three-dimensional endosonography. *Obstet Gynecol* 2001;97:770-5
970. Sudol-Szopinńska I, Radkiewicz J, Szopiński T, Panorska AK, Jakubowski W, Kawka J. Postpartum endoanal ultrasound findings in primiparous women after vaginal delivery. *Acta Radiol.* 2010 Sep;51(7):819-24.
 971. Oberwalder M, Connor J, Wexner SD. Meta-analysis to determine the incidence of obstetric anal sphincter damage. *Br J Surg.* 2003;90(11):1333-7.
 972. Bagade P, Mackenzie S. Outcomes from medium term follow-up of patients with third and fourth degree perineal tears. *J Obstet Gynaecol.* 2010;30(6):609-12
 973. Shek KL, Guzman-Rojas R, Dietz HP. Residual defects of the external anal sphincter following primary repair: an observational study using transperineal ultrasound. *Ultrasound Obstet Gynecol.* 2014 Dec;44(6):704-9
 974. Kumar R, Ooi C, Nicoll A. Anal incontinence and quality of life following obstetric anal sphincter injury. *Arch Gynecol Obstet.* 2012 Mar;285(3):591-7
 975. Huebner M, Gramlich NK, Rothmund R, Nappi L, Abele H, Becker S. Fecal incontinence after obstetric anal sphincter injuries. *Int J Gynaecol Obstet.* 2013 Apr;121(1):74-7
 976. Andrews V, Thakar R, Sultan AH, Jones PW. Occult anal sphincter injuries -- myth or reality? *BJOG* 2006;113:195-200.
 977. Sultan AH, Kettle C. Diagnosis of perineal trauma. In: Sultan AH, Thakar R, Fenner D. *Perineal and anal sphincter trauma.* London:Springer 2007:13-19
 978. Groom KM, Paterson-Brown S. Third degree tears: are they clinically underdiagnosed? *Gastroenterology International* 2000; 13(2):76-7.
 979. Sultan AH, Kamm MA, Hudson CN. Obstetric perineal tears: an audit of training. *Journal of Obstetrics and Gynaecology* 1995;15:19-23.
 980. Sultan AH, Thakar R. Lower genital tract and anal sphincter trauma. In: Baskett and Arulkumar: *Operative and Intrapartum Surgery.* Bailliere's Best Practice & Research – Clinical Obstetrics and Gynaecology, 2002;16:99-115
 981. Sultan AH. Editorial: Obstetric perineal injury and anal incontinence. *Clinical Risk* 1999;5 (5):193-6.
 982. Royal College of Obstetricians and Gynaecologists. *Management of Third and Fourth Degree Perineal Tears Following Vaginal Delivery.* London: RCOG Press: 2015. RCOG Guideline No. 29.
 983. Limitations of perineal lacerations as an obstetric quality measure. Committee Opinion No. 647. American College of Obstetricians and Gynecologists. *Obstet Gynecol* 2015;126:e108–11
 984. Gurol-Urganci I, Cromwell D, Edozien L, Mahmood T, Adams E, Richmond D, Templeton A, Meulen J Third- and fourth-degree perineal tears among primiparous women in England between 2000 and 2012: time trends and risk factors. *BJOG* 2013; 120 (12):1516-25
 985. Sultan AH, Kamm MA, Hudson CN, Bartram CI. Third degree obstetric anal sphincter tears: risk factors and outcome of primary repair. *BMJ* 1994;308:887-91.
 986. Oude Lohuis EJ, Everhardt E. Outcome of obstetric anal sphincter injuries in terms of persisting endoanal ultrasonographic defects and defecatory symptoms. *Int J Gynaecol Obstet.* 2014 Jul;126(1):70-3
 987. Sangalli MR, Floris L, Weil A. Anal incontinence in women with third or fourth degree perineal tears and subsequent vaginal deliveries. *Aust N Z J Obstet Gynaecol* 2000;40:244-8.
 988. Fitzpatrick M, Behan M, O'Connell R, O'Herlihy C. A randomized clinical trial comparing primary overlap with approximation repair of third degree obstetric tears. *Am J Obstet Gynecol* 2000;183:1220-4
 989. Sultan AH, Thakar R. Third and Fourth degree tears. In: Sultan AH, Thakar R, Fenner D. *Perineal and anal sphincter trauma.* London: Springer 2007: 33-51
 990. Zetterstrom J, Lopez A, Anzen B, Norman M, Holmstrom B, Mellgren A. Anal sphincter tears at vaginal delivery: Risk factors and clinical outcome of primary repair. *Obstet Gynecol* 1999;24:21-8.
 991. Gjessing H, Backe B, Sahlin Y. Third degree obstetric tears; outcome after primary repair. *Acta Obstet Gynecol Scand* 1998;77:736-40.
 992. Poen AC, Felt-Bersma RJF, Strijers RLM, Dekkers GA, Cuesta MA, Meuwissen SGM. Third-degree obstetric perineal tear: long-term clinical and functional results after primary repair. *Br J Surg* 1998;85:1433-8.
 993. Goffeng AR, Andersch B, Berndtsson I, Hulten L, Oresland T. Objective methods cannot predict anal incontinence after primary repair of extensive anal tears. *Acta Obstet Gynecol Scand* 1988;77: 439- 43.
 994. Kammerer-Doak DN, Wesol AB, RogersRG, Dominguez, Dorin MH. A prospective cohort study of women after primary repair of obstetric anal sphincter laceration. *Am J Obstet Gynecol.* 1999;181(6):1317-23.

995. Sorensen M, Tetzschner T, Rasmussen OO, Bjarnessen J, Christiansen J. Sphincter rupture in childbirth. *Br J Surg* 1993;80:392-94.
996. Haadem K, Ohrlander S, Lingman G. Long-term ailments due to anal sphincter rupture caused by delivery - a hidden problem. *Eur J Obstet Gynecol Reprod Biol* 1988; 27: 27-32.
997. Wood J, Amos L, Rieger N. Third degree anal sphincter tears: risk factors and outcome. *Aust N Z J Obstet Gynaecol* 1998;38:414-7.
998. Walsh CJ, Mooney EF, Upton GJ, Motson RW. Incidence of third-degree perineal tears in labour and outcome after primary repair. *Br J Surg* 1996;83:218-21.
999. Sander P, Bjarnesen L, Mouritsen A, Fuglsang-Frederiksen A. Anal incontinence after third-/fourth degree laceration. One-year follow-up after pelvic floor exercises. *Int J Urogynecol*. 1999;10:177-81.
1000. Pretlove SJ, Thompson PJ, Guest P, Toozs-Hobson P, Radley S. Detecting anal sphincter injury: acceptability and feasibility of endoanal ultrasound immediately postpartum. *Ultrasound Obstet Gynecol* 2003;22(2):215-7.
1001. Crawford LA, Quint EH, Pearl ML, DeLancey JOL. Incontinence following rupture of the anal sphincter during delivery. *Obstet Gynecol* 1993;82:527-31
1002. Mackenzie N, Parry L, Tasker M, Gowland MR, Michie HR, Hobbiss JH. Anal function following third degree tears. *Colorectal Dis* 2004;6(2):92-6.
1003. Nichols CM, Lamb EH, Ramakrishnan V. Differences in outcomes after third- versus fourth-degree perineal laceration repair: a prospective study. *Am J Obstet Gynecol* 2005;193(2):530-4.
1004. Nielsen MB, Hauge C, Rasmussen OO, Pedersen JF, Christiansen J. Anal endosonographic findings in the follow-up of primarily sutured sphincteric ruptures. *Br J Surg* 1992;79: 104-6.
1005. Go PMNYH, Dunselman GAJ. Anatomic and functional results of surgical repair after total perineal rupture at delivery. *Surg Gynecol Obstet* 1988;166:121-4.
1006. Fenner DE, Becky-Genberg MPH, Brahma P, Marek L, DeLancey JOL. Fecal and urinary incontinence after vaginal delivery with anal sphincter disruption in an obstetrics unit in the United States. *Am J Obstet Gynecol* 2003;189:1543-50.
1007. DeLeeuw JW, Vierhout ME, Struuk PC, Hop WCJ, Wallenberg HCS. Anal sphincter damage after vaginal delivery: functional outcome and risk factors for fecal incontinence. *Acta Obstet Gynecol Scand* 2001;80:830-834
1008. Wagenius J, Laurin J. Clinical symptoms after anal sphincter rupture: a retrospective study. *Acta Obstet Gynecol Scand* 2003;82:246-250.
1009. Uustal Fornell EK, Berg G, Hallbook O, Mathiesen LS, Sjødahl R. Clinical consequences of anal sphincter rupture during vaginal delivery. *J AM Coll Surg* 1996;183:553-8.
1010. Sorensen SM, Bondesen H, Istre O, Vilmann P. Perineal rupture following vaginal delivery. *Acta Obstet Gynecol Scand* 1988;67:315-8.
1011. Tetzschner T, Sorensen M, Lose G, Christiansen J. Anal and urinary incontinence in women with obstetric anal sphincter rupture. *Br J Obstet Gynaecol* 1996;103:1034-40.
1012. Williams A, Adams EJ, Bolderson J, Tincello DG, Richmond D. Effect of new guideline on outcome following third degree perineal tears: results of a three-year audit. *Int Urogynecol J* 2003;14:385-389.
1013. Norderval S, Nsubuga D, Bjelke C, Frasurek J, Myklebust I, Vonon B. Anal incontinence after obstetric sphincter tears: incidence in a Norwegian county. *Acta Obstet Gynecol Scand* 2004;83(10):989-94.
1014. Garcia V, Rogers RG, Kim SS, Hall RJ, Kammerer-Doak DN. Primary repair of obstetric anal sphincter laceration: a randomized trial of two surgical techniques. *Am J Obstet Gynecol* 2005;192(5):1697-701.
1015. Rieger N, Perera S, Stephens J, Coates D, Po D. Anal sphincter function and integrity after primary repair of third-degree tear: uncontrolled prospective analysis. *ANZ J Surg* 2004;74(3):122-4.
1016. Bek KM, Laurberg S. Risks of anal incontinence from subsequent vaginal delivery after a complete obstetric anal sphincter tear. *Br J Obstet Gynaecol* 1992;99:724-7.
1017. Davis I, Kumar D, Stanton SL, Thakar R, Fynes M, Bland J. Symptoms and anal sphincter morphology following primary repair of third degree tears. *Br J Surg* 2003;90:1573-1579.
1018. Nazir M, Stien R, Carlsen E, Jacobsen AF, Nesheim BI. Early evaluation of bowel symptoms after primary repair of obstetric perineal rupture is misleading: an observational cohort study. *Dis Colon Rectum* 2003;46(9):1245-50.
1019. Savoye-Collet C, Savoye G, Koning E, Sassi A, Leroi AM, Dacher JN. Endosonography in the evaluation of anal function after primary repair of a third-degree obstetric tear. *Scand J Gastroenterol* 2003;38(11):1149-53.
1020. Nygaard IE, Rao SS, Dawson JD. Anal incontinence after anal sphincter disruption: a 30-year retrospective cohort study. *Obstet Gynecol* 1997;89(6):896-901.

1021. Pinta TM, Kylanpaa ML, Salmi TK, Teramo KA, Luukkonen PS. Primary sphincter repair: are the results of the operation good enough? *Dis Colon Rectum* 2004;47(1):18-23.
1022. Vaccaro C, Clemons JL. Anal sphincter defects and anal incontinence symptoms after repair of obstetric anal sphincter lacerations in primiparous women. *Int Urogynecol J* 2008;19:1503-8.
1023. Sakse A, Secher NJ, Ottesen M, Starck M. Defects on endoanal ultrasound and anal incontinence after primary repair of fourth-degree anal sphincter rupture: a study of the anal sphincter complex and puborectal muscle. *Ultrasound Obstet Gynecol.* 2009;34(6):693-8.
1024. Samarasekera DN, Bekhit MT, Wright Y, Lowndes RH, Stanley KP, Preston JP, Preston P, Speakman CT. Long-term anal continence and quality of life following postpartum anal sphincter injury. *Colorectal Dis.* 2008 Oct;10(8):793-9
1025. Sultan AH, Monga AK, Kumar D, Stanton SL. Primary repair of obstetric anal sphincter rupture using the overlap technique. *Br J Obstet Gynaecol* 1999;106:318-323.
1026. Malouf AJ, Norton CS, Engel AF, Nicholls RJ, Kamm MA. Long term results of overlapping anterior anal-sphincter repair for obstetric trauma. *Lancet* 2000;355: 260-5
1027. Mahony R, Behan M, Daly L, Kirwan C, O'Herlihy C, O'Connell PR. Internal anal sphincter defect influences continence outcome following obstetric anal sphincter injury. *Am J Obstet Gynecol.* 2007 196(3):217.e1-5
1028. Roos A.-M., Thakar R, Sultan AH. Outcome of primary repair of obstetric anal sphincter injuries (OASIS): does the grade of tear matter? *Ultrasound Obstet Gynecol* 2010;36(3):368–374.
1029. Reid AR, Beggs AD, Sultan AH, Roos A-M, Thakar R. Outcome of repair of Obstetric Anal Sphincter Injuries (OASIS) at three years. *International Journal of Gynecology and Obstetrics* 2014;127:47-50.
1030. Dickinson KJ, Pickersgill P, Anwar S. Functional and physiological outcomes following repair of obstetrics anal sphincter injury. A case. *Int J Surg.* 2013;11(10):1137-40.
1031. Williams A, Adams EJ, Tincello DG, Alfirevic Z, Walkinshaw SA, Richmond DH. How to repair an anal sphincter injury after vaginal delivery: results of a randomised controlled trial. *BJOG* 2006;113(2):201-7.
1032. Fernando RJ, Sultan AH, Kettle C, Radley S, Jones P, O'Brien PMS. Repair techniques for obstetric anal sphincter injuries. A randomized controlled trial. *Obstet Gynecol* 2006;107:1261-8.
1033. Fernando RJ, Sultan AH, Kettle C, Thakar R. Methods of repair for obstetric anal sphincter injury. *Cochrane Database of Systematic Reviews* 2013, Issue 12. Art. No.: CD002866. DOI: 10.1002/14651858.CD002866.pub3. Accessed 2 May 2016.
1034. Farrell SA, Gilmour D, Turnbull GK, Schmidt MH, Baskett TF, Flowerdew G, Fanning CA. Overlapping compared with end-to-end repair of third- and fourth-degree obstetric anal sphincter tears: a randomized controlled trial. *Obstet Gynecol.* 2010;116(1):16-24.
1035. Sultan AH, Fernando R. Overlapping compared with end-to-end repair of third and fourth-degree obstetric anal sphincter tears: A randomized controlled trial. *Obstet Gynecol* 2011;117(2):408-9.
1036. Farrell SA, Flowerdew G, Gilmour D, Turnbull GK, Schmidt MH, Baskett TF, Fanning CA. Overlapping compared with end-to-end repair of complete third-degree or fourth-degree obstetric tears: three-year follow-up of a randomized controlled trial. *Obstet Gynecol.* 2012 Oct;120(4):803-8. Erratum in: *Obstet Gynecol.* 2012 Dec;120(6):1482.
1037. Rygh AB, Korner H. The overlap technique versus end-to-end approximation technique for primary repair of obstetric anal sphincter rupture: a randomized controlled study. *Acta Obstetrica et Gynecologica* 2010;89:1256-62.
1038. Ramalingam K, Monga AK. Outcomes and follow-up after obstetric anal sphincter injuries. *Int Urogynecol J.* 2013; 24:1495–1500
1039. Thiagamoorthy G, Johnson A, Thakar R, Sultan AH. National survey of perineal trauma and its subsequent management in the United Kingdom. *Int Urogynecol J.* 2014 Dec;25(12):1621-7
1040. Sultan AH, Abulafi MA. Anal incontinence – the role of the obstetrician and gynaecologist. In: Sturdee D, Olah K, Keane D (eds) *The yearbook of obstetrics and gynaecology.* Vol 9. London: RCOG press. 2001:170-187.
1041. Edozien LC, Gurol-Urganci I, Cromwell DA, Adams EJ, Richmond DH, Mahmood TA, van der Meulen JH. Impact of third- and fourth-degree perineal tears at first birth on subsequent pregnancy outcomes: a cohort study. *BJOG* 2014;121 (13):1695-1703
1042. Sultan AH, Stanton SL. Preserving the pelvic floor and perineum during childbirth - elective caesarean section? *Br J Obstet Gynaecol* 1996;103:731-4.

1043. Sultan AH, Monga AK. Anal and urinary incontinence in women with obstetric anal sphincter rupture. *Br J Obstet Gynaecol* 1997;104: 753-4
1044. Roos AM, Abdool Z, Sultan AH, Thakar R. Predicting anal sphincter defects: the value of clinical examination and manometry. *International Urogynecology Journal*, Nov 2011 (Epub).
1045. Scheer I, Thakar R, Sultan AH. Mode of delivery after previous obstetric anal sphincter injuries (OASIS) – a reappraisal. *Int Urogynecol J* 2009; 20:1095-1101.
1046. Karmarkar R, Bhide A, Digesu A, Khullar V, Fernando R. Mode of delivery after obstetric anal sphincter injury. *Eur J Obstet Gynecol Reprod Biol*. 2015;Nov;194:7-10.
1047. Fitzpatrick M, Cassidy M, Barassaud ML, Hehir MP, Hanly AM, O'Connell PR, O'Herlihy C. Does anal sphincter injury preclude subsequent vaginal delivery? *Eur J Obstet Gynecol Reprod Biol* 2016 Mar;198:30-4.
1048. van Roon Y, Kirwin C, Rahman N, Vinayakarao L, Melson L, Kester N, Pathak S, Pradhan A. Comparison of obstetric anal sphincter injuries in nulliparous women before and after introduction of the EPISCISSORS-60(®) at two hospitals in the United Kingdom. *Int J Womens Health*. 2015 Dec 9;7:949-55.
1049. Johanson RB, Rice C, Doyle M et al. A randomised prospective study comparing the new vacuum extractor policy with forceps delivery. *Br J Obstet Gynaecol* 1993;100: 524- 30.
1050. Bofill JA, Rust OA, Schorr SJ et al. A randomized prospective trial of the obstetric forceps versus the M-cup vacuum extractor. *Am J Obstet Gynecol* 1996;175:1325-30.
1051. O'Mahony F, Hofmeyr GJ, Menon V. Choice of instruments for assisted vaginal delivery. *Cochrane Database of Systematic Reviews* 2010, Issue 11. Art. No.: CD005455. DOI: 10.1002/14651858.CD005455.pub2.
1052. Johanson RB, Heycock E, Carter J, Sultan AH, Walklate K, Jones PW. Maternal and child health after assisted vaginal delivery: five-year follow up of a randomised controlled study comparing forceps and ventouse. *BJOG* 1999;106:544-9.
1053. Sultan AH, Johanson RB, Carter JE. Occult anal sphincter trauma following randomized forceps and vacuum delivery. *Int J Gynecol Obstet* 1998;61:113-9.
1054. Royal College of Obstetricians and Gynaecologists. *Operative Vaginal Delivery*. London: RCOG Press: 2011. RCOG Guideline No. 26.
1055. Farrell SA, Allen VM, Baskett TF. Anal incontinence in primiparas. *J Soc Obstet Gynaecol Can* 2001;23(4):321-6.
1056. Thakar R, Eason E. Prevention of perineal trauma. In: Sultan AH, Thakar R, Fenner D. *Perineal and anal sphincter trauma*. London: Springer 2007: 52-64
1057. de Leeuw J, de Wit C, Bruinse H, Kuijken J. Mediolateral episiotomy reduces the risk for anal sphincter injury during operative vaginal delivery. *BJOG* 2008;115:104–108
1058. Fitzpatrick M, McQuillan K, O'Herlihy C. Influence of persistent occiput posterior position on delivery outcome. *Obstet Gynecol*. 2001 Dec;98(6):1027-31
1059. Carroli G, Mignini L. Episiotomy for vaginal birth. *Cochrane Database Syst Rev*. 2009 Jan 21;(1):CD000081.
1060. Henriksen TB, Bek KM, Hedegaard M, Secher NJ. Methods and consequences of changes in use of episiotomy. *BMJ* 1994;309:1255-8.
1061. Henriksen TB, Bek KM, Hedegaard M, Secher NJ. Episiotomy and perineal lesions in spontaneous vaginal deliveries. *Br J Obstet Gynaecol* 1992;99:950-4.
1062. Coats PM, Chan KK, Wilkins M, Beard RJ. A comparison between midline and mediolateral episiotomies. *Br J Obstet Gynaecol* 1980; 87: 408-12.
1063. Kudish B, Sokol RJ, Kruger M. Trends in major modifiable risk factors for severe perineal trauma, 1996-2006. *Int J Gynaecol Obstet*. 2008;102(2):165-70.
1064. Andrews V, Thakar R, Sultan AH, Jones PW. Are mediolateral episiotomies actually mediolateral? *BJOG* 2005;112:1156-58.
1065. Eogan M, Daly L, O'Connell PR, O'Herlihy C. Does the angle of episiotomy affect the incidence of anal sphincter injury? *BJOG*. 2006;113(2):190-4.
1066. Kalis V, Landsmanova J, Bednarova B, Karbanova J, Laine K, Rokyta Z. Evaluation of the incision angle of mediolateral episiotomy at 60 degrees. *Int J Gynaecol Obstet*. 2011;112:220-4.
1067. Naidu M, Kapoor DS, Evans S, Vinayakarao L, Thakar R, Sultan AH. Cutting an episiotomy at 60 degrees: how good are we? *Int Urogynecol J*. 2015; 26(6):813-6.
1068. Pirhonen JP, Grenman SE, Haadem K, Gudmundsson S, Lindqvist P, Sihola S, Erkkola RU, Marsal K. Frequency of anal sphincter rupture at delivery in Sweden and Finland – result of difference in manual help to the baby's head. *Acta Obstet Gynecol Scand* 1998;77:974-7.
1069. Jönsson ER, Elfaghi I, Rydhström H, Herbst A. Modified Ritgen's maneuver for anal sphincter

- injury at delivery *Obstet Gynecol* 2008;112: 212-17.
1070. Hals E, Oian P, Pirhonen T, Gissler M, Hjelle S, Nilsen EB, Severinsen AM, Solsletten C, Hartgill T, Pirhonen J. A multicenter interventional program to reduce the incidence of anal sphincter tears. *Obstet Gynecol.* 2010;116(4):901-8.
1071. Handa VL, Danielsen BH, Gilbert WM. Obstetric Anal Sphincter Lacerations. *Obstet Gynecol* 2001;98:225-30.
1072. Landy HJ, Laughon SK, Bailit JL, Kominiarek MA, Gonzalez-Quintero VH, Ramirez M et al. Characteristics associated with severe perineal and cervical lacerations during vaginal delivery. *Obstet Gynecol.* 2011;117:627-35.
1073. McLennan MT, Melick CF, Clancy SL, Artal R. Episiotomy and perineal repair. An evaluation of resident education and experience. *J Reprod Med* 2002;47(12):1025-30.
1074. Stepp KJ, Siddiqui NY, Emery SP, Barber MD. Textbook recommendations for preventing and treating perineal injury at vaginal delivery. *Obstet Gynecol* 2006;107(2):361-6.
1075. Uppal S, Harmanli O, Rowland J, Hernandez E, Dandolu V. Resident competency in obstetric anal sphincter laceration repair. *Obstet Gynecol* 2010;115:305-9.
1076. Andrews V, Thakar R, Sultan AH. Structured hands-on training in repair of obstetric anal sphincter injuries (OASIS): an audit of clinical practice. *Int Urogynecol J* 2009; 20(2):193-9.
1077. Andrews V, Thakar R, Sultan AH. Outcome of an obstetric anal sphincter injury can be optimised by structured training and using an evidence based protocol. *Int Urogynecol J* 2009; 20(2): 973-8.
1078. Andrews V, Thakar R, Sultan AH, Kettle C. Can hands-on perineal repair courses affect clinical practice. *Br J Midwifery* 2005;13(9):562-5.
1079. Donnelly VS, O'Herlihy C, Campbell DM, O'Connell PR. Postpartum fecal incontinence is more common in women with irritable bowel syndrome. *Dis Colon Rectum* 1998;41:586-9.
1080. Robinson BL, Matthews CA, Palsson OS, Geller E, Turner M, Parnell B, Crane A, Jannelli M, Wells E, Connolly A, Lin FC, Whitehead WE. Obstetric sphincter injury interacts with diarrhea and urgency to increase the risk of fecal incontinence in women with irritable bowel syndrome. *Female Pelvic Med Reconstr Surg.* 2013;Jan-Feb;19(1):40-5.
1081. Wein, A.J., Classification of neurogenic voiding dysfunction. *J Urol*, 1981. 125(5): p. 605-9.
1082. Blaivas, J.G., pathophysiology of lower urinary tract dysfunction. *Urol Clin North Am*, 1985. 12(2): p. 215-24.
1083. Blaivas, J.G., et al., Definition and classification of urinary incontinence: recommendations of the Urodynamic Society. *Neurourol Urodyn*, 1997. 16(3): p. 149-51.
1084. Oelke, M., et al., age and bladder outlet obstruction are independently associated with detrusor overactivity in patients with benign prostatic hyperplasia. *Eur Urol*, 2008. 54(2): p. 419-26.
1085. John, H., et al., Ultrastructure of the trigone and its functional implications. *Urol Int*, 2001. 67(4): p. 264-71.
1086. Sadananda, P., B. Vahabi, and M.J. Drake, bladder outlet physiology in the context of lower urinary tract dysfunction. *Neurourol Urodyn*, 2011. 30(5): p. 708-13.
1087. A review of detrusor overactivity and the overactive bladder after radical prostate cancer treatment. Thiruchelvam N, Cruz F, Kirby M, Tubaro A, Chapple CR, Sievert KD. *BJU Int.* 2015 Dec;116(6):853-61. doi: 10.1111/bju.13078. Epub 2015 Jul 3. Review.
1088. Wallner, C., et al., The anatomical components of urinary continence. *Eur Urol*, 2009. 55(4): p. 932-43.
1089. Karam, I., et al., The structure and innervation of the male urethra: histological and immunohistochemical studies with three-dimensional reconstruction. *J Anat*, 2005. 206(4): p. 395-403.
1090. Sebe, P., et al., Fetal development of striated and smooth muscle sphincters of the male urethra from a common primordium and modifications due to the development of the prostate: an anatomic and histologic study. *Prostate*, 2005. 62(4): p. 388-93.
1091. Hadley, H.R., P.E. Zimmermann, and S. Raz, The treatment of male urinary incontinence, in *Campbell's Urology*, M.F. Campbell and P.C. Walsh, Editors. 1986, Saunders: London. p. 2297-3039.
1092. Gosling, J.A., et al., a comparative study of the human external sphincter and periurethral levator ani muscles. *Br J Urol*, 1981. 53(1): p. 35-41.
1093. Turner-Warwick, R.T., The sphincter mechanisms: Their relation to prostatic enlargement and its treatment, in *benign prostatic hyperthrophy*, F. Hinman and S. Boyarsky, Editors. 1983, Springer: New York. p. 809.
1094. Burnett, A.L. and J.L. Mostwin, In situ anatomical study of the male urethral

- sphincteric complex: relevance to continence preservation following major pelvic surgery. *J Urol*, 1998. 160(4): p. 1301-6.
1095. Steiner, M.S., anatomic basis for the continence-preserving radical retropubic prostatectomy. *Semin Urol Oncol*, 2000. 18(1): p. 9-18.
1096. Krahn, H.P. and P.A. Morales, The effect of pudendal nerve anesthesia on urinary continence after prostatectomy. *J Urol*, 1965. 94(3): p. 282-5.
1097. Sievert, K.D., et al., Can we prevent incontinence? ICI-RS 2011. *Neurourol Urodyn*, 2012. 31(3): p. 390-9.
1098. Goldman, H.B., K.D. Sievert, and M.S. Damaser, will we ever use stem cells for the treatment of SUI? ICI-RS 2011. *Neurourol Urodyn*, 2012. 31(3): p. 386-9.
1099. Amend, B., et al., prostatic peripheral nerve distribution may impact the functional outcome of nerve-sparing prostatectomy. *World J Urol*, 2011.
1100. Hollabaugh, R.S., Jr., et al., preservation of putative continence nerves during radical retropubic prostatectomy leads to more rapid return of urinary continence. *Urology*, 1998. 51(6): p. 960-7.
1101. Gosling, J.A. and J.S. Dixon, The structure and innervation of smooth muscle in the wall of the bladder neck and proximal urethra. *Br J Urol*, 1975. 47(5): p. 549-58.
1102. Costello, A.J., M. Brooks, and O.J. Cole, anatomical studies of the neurovascular bundle and cavernosal nerves. *BJU Int*, 2004. 94(7): p. 1071-6.
1103. Narayan, P., et al., neuroanatomy of the external urethral sphincter: implications for urinary continence preservation during radical prostate surgery. *J Urol*, 1995. 153(2): p. 337-41.
1104. Neural supply of the male urethral sphincter: comprehensive anatomical review and implications for continence recovery after radical prostatectomy. Bessedé T, Sooriakumaran P, Takenaka A, Tewari A. *World J Urol*. 2016 Aug 2. [Epub ahead of print] Review.
1105. Tuygun, C., et al., Significance of fibrosis around and/or at external urinary sphincter on pelvic magnetic resonance imaging in patients with postprostatectomy incontinence. *Urology*, 2006. 68(6): p. 1308-12.
1106. El-Sakka, A.I., alleviation of post-radical prostatectomy cavernosal fibrosis: future directions and potential utility for PDE5 inhibitors. *Expert Opin Investig Drugs*, 2011. 20(10): p. 1305-9.
1107. Sirad, F., et al., Sildenafil promotes smooth muscle preservation and ameliorates fibrosis through modulation of extracellular matrix and tissue growth factor gene expression after bilateral cavernosal nerve resection in the rat. *J Sex Med*, 2011. 8(4): p. 1048-60.
1108. Irwin, D.E., et al., overactive bladder is associated with erectile dysfunction and reduced sexual quality of life in men. *J Sex Med*, 2008. 5(12): p. 2904-10.
1109. Abrams, P.H., Investigation of postprostatectomy problems. *Urology*, 1980. 15(2): p. 209-12.
1110. Abrams, P.H., et al., The results of prostatectomy: a symptomatic and urodynamic analysis of 152 patients. *J Urol*, 1979. 121(5): p. 640-2.
1111. Comiter, C.V., et al., Urodynamic risk factors for renal dysfunction in men with obstructive and nonobstructive voiding dysfunction. *J Urol*, 1997. 158(1): p. 181-5.
1112. Madersbacher, S., et al., Interrelationships of bladder compliance with age, detrusor instability, and obstruction in elderly men with lower urinary tract symptoms. *Neurourol Urodyn*, 1999. 18(1): p. 3-15.
1113. Smoger, S.H., T.L. Felice, and G.H. Kloecker, Urinary incontinence among male veterans receiving care in primary care clinics. *Ann Intern Med*, 2000. 132(7): p. 547-51.
1114. Van Kampen, M., et al., Urinary incontinence following transurethral, transvesical and radical prostatectomy. retrospective study of 489 patients. *Acta Urol Belg*, 1997. 65(4): p. 1-7.
1115. Warwick, R.T., et al., a urodynamic view of prostatic obstruction and the results of prostatectomy. *Br J Urol*, 1973. 45(6): p. 631-45.
1116. Leng, W.W. and E.J. McGuire, obstructive uropathy induced bladder dysfunction can be reversible: bladder compliance measures before and after treatment. *J Urol*, 2003. 169(2): p. 563-6.
1117. Speakman, M.J., et al., Bladder outflow obstruction--a cause of denervation supersensitivity. *J Urol*, 1987. 138(6): p. 1461-6.
1118. Brading, A.F., et al., The role of smooth muscle and its possible involvement in diseases of the lower urinary tract. *Clin Sci (Lond)*, 1986. 70 Suppl 14: p. 7s-13s.
1119. Murakumo, M., et al., Three-dimensional arrangement of collagen and elastin fibers in

- the human urinary bladder: a scanning electron microscopic study. *J Urol*, 1995. 154(1): p. 251-6.
1120. Steers, W.D., et al., alterations in afferent pathways from the urinary bladder of the rat in response to partial urethral obstruction. *J Comp Neurol*, 1991. 310(3): p. 401-10.
1121. Steers, W.D. and W.C. De Groat, effect of bladder outlet obstruction on micturition reflex pathways in the rat. *J Urol*, 1988. 140(4): p. 864-71.
1122. Seki, N., O.M. Karim, and J.L. Mostwin, The effect of experimental urethral obstruction and its reversal on changes in passive electrical properties of detrusor muscle. *J Urol*, 1992. 148(6): p. 1957-61.
1123. Kupelian, V., et al., association of overactive bladder and C-reactive protein levels. results from the boston area Community Health (baCH) Survey. *BJU Int*, 2011.
1124. Seaman, E.K., et al., persistence or recurrence of symptoms after transurethral resection of the prostate: a urodynamic assessment. *J Urol*, 1994. 152(3): p. 935-7.
1125. Han, E., L.K. Black, and J.P. Lavelle, Incontinence related to management of benign prostatic hypertrophy. *Am J Geriatr Pharmacother*, 2007. 5(4): p. 324-34.
1126. Thiruchelvam N. Surgical therapy for benign prostatic hypertrophy/bladder outflow obstruction. *Indian J Urol*. 2014 Apr;30(2):202-7.
1127. Ou, R., et al., a randomized trial of transvesical prostatectomy versus transurethral resection of the prostate for prostate greater than 80 ml. *Urology*, 2010. 76(4): p. 95861.
1128. Simforoosh, N., et al., open prostatectomy versus transurethral resection of the prostate, where are we standing in the new era? a randomized controlled trial. *Urol J*, 2010. 7(4): p. 262-9.
1129. Mebust, W.K., et al., Transurethral prostatectomy: immediate and postoperative complications. a cooperative study of 13 participating institutions evaluating 3,885 patients. *J Urol*, 1989. 141(2): p. 243-7.
1130. Mebust, W., et al., Scope of the problem. Indications for treatment and assessment of benign prostatic hyperplasia and its relationship to cancer. *Cancer*, 1992. 70(1 Suppl): p. 369-70.
1131. Winters, J.C., R.A. Appell, and R.R. Rackley, Urodynamic findings in postprostatectomy incontinence. *Neurourol Urodyn*, 1998. 17(5): p. 493-8.
1132. Leach, G.E., et al., post-prostatectomy incontinence: urodynamic findings and treatment outcomes. *J Urol*, 1996. 155(4): p. 1256-9.
1133. Goluboff, E.T., et al., Urodynamics and the etiology of postprostatectomy urinary incontinence: the initial Columbia experience. *J Urol*, 1995. 153(3 Pt 2): p. 1034-7.
1134. Yalla, S.V., L. Karah, and G. Kearney, post-prostatectomy incontinence: urodynamic assessment. *Neurourol Urodyn*, 1982. 1: p. 77-78.
1135. Fitzpatrick, J.M., R.A. Gardiner, and P.H. Worth, The evaluation of 68 patients with post-prostatectomy incontinence. *Br J Urol*, 1979. 51(6): p. 552-5.
1136. Andersen, J.T. and J. Nordling, Urinary-Incontinence after Transvesical prostatectomy. *Urol Int*, 1978. 33(1-3): p. 191-198.
1137. Nitti, V.W., Y. Kim, and A.J. Combs, voiding dysfunction following transurethral resection of the prostate: symptoms and urodynamic findings. *J Urol*, 1997. 157(2): p. 600-3.
1138. Westenberg, A., et al., Holmium laser resection of the prostate versus transurethral resection of the prostate: results of a randomized trial with 4-year minimum long-term followup. *J Urol*, 2004. 172(2): p. 616-9.
1139. Kuntz, R.M., et al., Transurethral holmium laser enucleation of the prostate versus transurethral electrocautery resection of the prostate: a randomized prospective trial in 200 patients. *J Urol*, 2004. 172(3): p. 1012-6.
1140. Vavassori, I., et al., Three-year outcome following holmium laser enucleation of the prostate combined with mechanical morcellation in 330 consecutive patients. *Eur Urol*, 2008. 53(3): p. 599-604.
1141. Horasanli, K., et al., photoselective potassium titanyl phosphate (KTP) laser vaporization versus transurethral resection of the prostate for prostates larger than 70 ml: a shortterm prospective randomized trial. *Urology*, 2008. 71(2): p. 247-51.
1142. Montorsi, F., et al., Holmium laser enucleation versus transurethral resection of the prostate: results from a 2-center, prospective, randomized trial in patients with obstructive benign prostatic hyperplasia. *J Urol*, 2004. 172(5 Pt 1): p. 1926-9.
1143. Bouchier-Hayes, D.M., et al., KTP laser versus transurethral resection: early results of a randomized trial. *J Endourol*, 2006. 20(8): p. 580-5.
1144. Thomas JA, Tubaro A, Barber N. A Multicenter Randomized Noninferiority Trial Comparing

GreenLight-XPS Laser Vaporization of the Prostate and Transurethral Resection of the Prostate for the Treatment of Benign Prostatic Obstruction: Two-yr Outcomes of the GOLIATH Study. *Eur Urol*. 2016 Jan;69(1):94-102.

1145. Seki, N., K. Tatsugami, and S. Naito, Holmium laser enucleation of the prostate: comparison of outcomes according to prostate size in 97 Japanese patients. *J Endourol*, 2007. 21(2): p. 192-6.
1146. Sarica, K., et al., photoselective vaporization of the enlarged prostate with KTP laser: long-term results in 240 patients. *J Endourol*, 2005. 19(10): p. 1199-202.
1147. Te, A.E., et al., photoselective vaporization of the prostate for the treatment of benign prostatic hyperplasia: 12-month results from the first United States multicenter prospective trial. *J Urol*, 2004. 172(4 Pt 1): p. 1404-8.
1148. Biester, K., et al., Systematic review of surgical treatments for benign prostatic hyperplasia and presentation of an approach to investigate therapeutic equivalence (non-inferiority). *BJU Int*, 2011.
1149. Bortolotti, A., et al., prevalence and risk factors for urinary incontinence in Italy. *Eur Urol*, 2000. 37(1): p. 30-5.
1150. Landi, F., et al., potentially reversible risk factors and urinary incontinence in frail older people living in community. *Age Ageing*, 2003. 32(2): p. 194-9.
1151. Nuotio, M., et al., Urinary incontinence in a Finnish population aged 70 and over. prevalence of types, associated factors and self-reported treatments. *Scand J Prim Health Care*, 2003. 21(3): p. 182-7.
1152. Ueda, T., et al., Urinary incontinence among communitydwelling people aged 40 years or older in Japan: prevalence, risk factors, knowledge and self-perception. *Int J Urol*, 2000. 7(3): p. 95-103.
1153. Van Oyen, H. and P. Van Oyen, Urinary incontinence in belgium; prevalence, correlates and psychosocial consequences. *Acta Clin Belg*, 2002. 57(4): p. 207-18.
1154. Liu, M., et al., Urinary incontinence in prostate cancer patients treated with external beam radiotherapy. *Radiother Oncol*, 2005. 74(2): p. 197-201.
1155. Roberts, R.O., et al., natural history of prostatism: high american Urological association Symptom scores among community-dwelling men and women with urinary incontinence. *Urology*, 1998. 51(2): p. 213-9.
1156. Sandhu, A.S., et al., long-term urinary toxicity after 3-dimensional conformal radiotherapy for prostate cancer in patients with prior history of transurethral resection. *Int J Radiat Oncol Biol Phys*, 2000. 48(3): p. 643-7.
1157. Sønksen J, Barber NJ, Speakman MJ et al. Prospective, randomized, multinational study of prostatic urethral lift versus transurethral resection of the prostate: 12-month results from the BPH6 study. *Eur Urol*. 2015 Oct;68(4):643-52.
1158. Rukstalis D, Rashid P, Bogache W et al. Two Year Durability after Crossover to the Prostatic Urethral Lift from Randomized, Blinded Sham. J, Chin P, Woo H, Cantwell A, Cowan B, Bolton D. *BJU Int*. 2016 Sep 29.
1159. Roehrborn CG, Rukstalis DB, Barkin J et al. Three year results of the prostatic urethral L.I.F.T. study. *The Canadian journal of urology*. 2015; 22: 7772-82.
1160. Nair SM, Pimentel MA, Gilling PJ. *Can J Urol*. 2015 Oct;22 Suppl 1:82-7.
1161. Lu-Yao, G.L., et al., an assessment of radical prostatectomy. Time trends, geographic variation, and outcomes. The prostate patient outcomes research Team. *JAMA*, 1993. 269(20): p. 2633-6.
1162. Foote, J., S. Yun, and G.E. Leach, postprostatectomy incontinence. pathophysiology, evaluation, and management. *Urol Clin North Am*, 1991. 18(2): p. 229-41.
1163. Catalona, W.J., et al., potency, continence and complication rates in 1,870 consecutive radical retropubic prostatectomies. *J Urol*, 1999. 162(2): p. 433-8.
1164. Eastham, J.A., et al., risk factors for urinary incontinence after radical prostatectomy. *J Urol*, 1996. 156(5): p. 1707-13.
1165. Geary, E.S., et al., Incontinence and vesical neck strictures following radical retropubic prostatectomy. *Urology*, 1995. 45(6): p. 1000-6.
1166. Steiner, M.S., R.A. Morton, and P.C. Walsh, Impact of anatomical radical prostatectomy on urinary continence. *J Urol*, 1991. 145(3): p. 512-4; discussion 514-5.
1167. Zincke, H., et al., Long-term (15 years) results after radical prostatectomy for clinically localized (stage T2c or lower) prostate cancer. *J Urol*, 1994. 152(5 Pt 2): p. 1850-7.
1168. Penson, D.F., et al., 5-year urinary and sexual outcomes after radical prostatectomy: results from the prostate Cancer outcomes Study. *J Urol*, 2008. 179(5 Suppl): p. S40-4.

1169. Wei, J.T. and J.E. Montie, Comparison of patients' and physicians' rating of urinary incontinence following radical prostatectomy. *Semin Urol Oncol*, 2000. 18(1): p. 76-80.
1170. McCammon, K.A., et al., Comparative quality-of-life analysis after radical prostatectomy or external beam radiation for localized prostate cancer. *Urology*, 1999. 54(3): p. 509-16.
1171. McHorney, C.A., et al., The moS 36-item Short-Form Health Survey (SF-36): III. Tests of data quality, scaling assumptions, and reliability across diverse patient groups. *Med Care*, 1994. 32(1): p. 40-66.
1172. Donnellan, S.M., et al., prospective assessment of incontinence after radical retropubic prostatectomy: objective and subjective analysis. *Urology*, 1997. 49(2): p. 225-30.
1173. Jonler, M., et al., A prospective study of quantification of urinary incontinence and quality of life in patients undergoing radical retropubic prostatectomy. *Urology*, 1996. 48(3): p. 433-40.
1174. Horstmann, M., et al., Single-centre evaluation of the extraperitoneal and transperitoneal approach in robotic-assisted radical prostatectomy. *Scand J Urol Nephrol*, 2011.
1175. Zorn, K.C., et al., robotic-assisted laparoscopic prostatectomy: functional and pathologic outcomes with interfascial nerve preservation. *Eur Urol*, 2007. 51(3): p. 755-62; discussion 763.
1176. Patel, V.R., R. Thaly, and K. Shah, robotic radical prostatectomy: outcomes of 500 cases. *BJU Int*, 2007. 99(5): p. 1109-12.
1177. Borin, J.F., et al., Impact of urethral stump length on continence and positive surgical margins in robot-assisted laparoscopic prostatectomy. *Urology*, 2007. 70(1): p. 173-7.
1178. Menon, M., et al., vattikuti Institute prostatectomy: contemporary technique and analysis of results. *Eur Urol*, 2007. 51(3): p. 648-57; discussion 657-8.
1179. Joseph, J.V., et al., robotic extraperitoneal radical prostatectomy: an alternative approach. *J Urol*, 2006. 175(3 Pt 1): p. 945-50; discussion 951.
1180. Rodriguez, E., Jr., D.W. Skarecky, and T.E. Ahlering, postrobotic prostatectomy urinary continence: characterization of perfect continence versus occasional dribbling in padfree men. *Urology*, 2006. 67(4): p. 785-8.
1181. Rassweiler, J., et al., laparoscopic radical prostatectomy-the experience of the German laparoscopic working Group. *Eur Urol*, 2006. 49(1): p. 113-9.
1182. Jacobsen, N.E., et al., open versus laparoscopic radical prostatectomy: a prospective comparison of postoperative urinary incontinence rates. *J Urol*, 2007. 177(2): p. 615-9.
1183. Tewari, A.K., et al., anatomic restoration technique of continence mechanism and preservation of puboprostatic collar: a novel modification to achieve early urinary continence in men undergoing robotic prostatectomy. *Urology*, 2007. 69(4): p. 726-31.
1184. Rocco, B., et al., posterior reconstruction of the rhabdosphincter allows a rapid recovery of continence after transperitoneal videolaparoscopic radical prostatectomy. *Eur Urol*, 2007. 51(4): p. 996-1003.
1185. Tewari, A., et al., Total reconstruction of the vesico-urethral junction. *BJU Int*, 2008. 101(7): p. 871-7.
1186. Seo HJ, Lee NR, Son SK et al. Comparison of Robot-Assisted Radical Prostatectomy and Open Radical Prostatectomy Outcomes: A Systematic Review and Meta-Analysis. *Yonsei Med J*. 2016 Sep;57(5):1165-77
1187. Ficarra V, Novara G, Rosen RC et al. Systematic review and meta-analysis of studies reporting urinary continence recovery after robot-assisted radical prostatectomy. *Eur Urol*. 2012 Sep;62(3):405-17.
1188. Gagnon LO, Goldenberg SL, Lynch K et al. Comparison of open and robotic-assisted prostatectomy: The University of British Columbia experience. *Can Urol Assoc J*. 2014 Mar;8(3-4):92-7.
1189. Murphy, G.P., et al., national patterns of prostate cancer treatment by radical prostatectomy: results of a survey by the american College of Surgeons Commission on Cancer. *J Urol*, 1994. 152(5 Pt 2): p. 1817-9.
1190. Fowler, F.J., Jr., et al., patient-reported complications and follow-up treatment after radical prostatectomy. The national medicare experience: 1988-1990 (updated June 1993). *Urology*, 1993. 42(6): p. 622-9.
1191. Peterson, A.C. and Y. Chen, patient reported incontinence after radical prostatectomy is more common than expected and not associated with the nerve sparing technique: results from the center for prostate disease research (CpDr) database. *Neurourology Urodyn*, 2011.
1192. Lepor, H., L. Kaci, and X. Xue, Continence following radical retropubic prostatectomy using self-reporting instruments. *J Urol*, 2004. 171(3): p. 1212-5.

1193. Sileri, P., et al., prevalence of defaecatory disorders in morbidly obese patients before and after bariatric surgery. *J Gastrointest Surg*, 2012. 16(1): p. 62-7.
1194. Moore, K.N., et al., Urinary incontinence after radical prostatectomy: can men at risk be identified preoperatively? *J Wound Ostomy Continence Nurs*, 2007. 34(3): p. 270-9; quiz 280-1.
1195. Smither, A.R., et al., Quantifying the natural history of postradical prostatectomy incontinence using objective pad test data. *BMC Urol*, 2007. 7: p. 2.
1196. Sacco, E., et al., Urinary incontinence after radical prostatectomy: incidence by definition, risk factors and temporal trend in a large series with a long-term follow-up. *BJU Int*, 2006. 97(6): p. 1234-41.
1197. Chao, R. and M.E. Mayo, Incontinence after radical prostatectomy: detrusor or sphincter causes. *J Urol*, 1995. 154(1): p. 16-8.
1198. Leandri, P., et al., radical retropubic prostatectomy: morbidity and quality of life. experience with 620 consecutive cases. *J Urol*, 1992. 147(3 Pt 2): p. 883-7.
1199. Stanford, J.L., et al., Urinary and sexual function after radical prostatectomy for clinically localized prostate cancer: the prostate Cancer outcomes Study. *JAMA*, 2000. 283(3): p. 354-60.
1200. Horie, S., et al., Urinary incontinence after non-nerve-sparing radical prostatectomy with neoadjuvant androgen deprivation. *Urology*, 1999. 53(3): p. 561-7.
1201. Rogers, C.G., et al., Age stratified functional outcomes after laparoscopic radical prostatectomy. *J Urol*, 2006. 176(6 Pt 1): p. 2448-52.
1202. Khoder WY, Waidelich R, Seitz M. Do we need the nerve sparing radical prostatectomy techniques (intrafascial vs. interfascial) in men with erectile dysfunction? Results of a single-centre study. *World J Urol*. 2015 Mar;33(3):301-7
1203. Loeb, S., et al., Intermediate-term potency, continence, and survival outcomes of radical prostatectomy for clinically high-risk or locally advanced prostate cancer. *Urology*, 2007. 69(6): p. 1170-5.
1204. Walsh, P., Trends in Treatment of localized prostateCancer by radical prostatectomy - observations from the Commission-on-Cancer national-Cancer-Database. *Urology*, 1994. 43(4): p. 492.
1205. O'Donnell, P.D. and B.F. Finan, Continence following nerve-sparing radical prostatectomy. *J Urol*, 1989. 142(5): p. 1227-8; discussion 1229.
1206. Lowe, B.A., preservation of the anterior urethral ligamentous attachments in maintaining post-prostatectomy urinary continence: a comparative study. *J Urol*, 1997. 158(6): p. 2137-41.
1207. Lowe, B.A., Comparison of bladder neck preservation to bladder neck resection in maintaining postradical prostatectomy urinary continence. *Urology*, 1996. 48(6): p. 889-93.
1208. Kaye, K.W., et al., Urinary continence after radical retropubic prostatectomy. analysis and synthesis of contributing factors: a unified concept. *Br J Urol*, 1997. 80(3): p. 444-501.
1209. Nandipati, K.C., et al., Nerve-sparing surgery significantly affects long-term continence after radical prostatectomy. *Urology*, 2007. 70(6): p. 1127-30.
1210. Burkhard, F.C., et al., nerve sparing open radical retropubic prostatectomy--does it have an impact on urinary continence? *J Urol*, 2006. 176(1): p. 189-95.
1211. Ma X, Tang K, Yang C, Wu G. Bladder neck preservation improves time to continence after radical prostatectomy: a systematic review and meta-analysis. *Oncotarget*. 2016 Sep 13.
1212. Canvasser NE, Lay AH, Koseoglu E, Morgan MS, Cadeddu JA. Posterior Urethral Suspension During Robot-Assisted Radical Prostatectomy Improves Early Urinary Control: A Prospective Cohort Study. *J Endourol*. 2016 Sep 8.
1213. Tefilli, M.V., et al., Salvage surgery or salvage radiotherapy for locally recurrent prostate cancer. *Urology*, 1998. 52(2): p. 224-9.
1214. Stein, M., et al., biofeedback for the treatment of stress and urge incontinence. *J Urol*, 1995. 153(3 Pt 1): p. 641-3.
1215. Sanderson, K.M., et al., Salvage radical prostatectomy: quality of life outcomes and long-term oncological control of radiorecurrent prostate cancer. *J Urol*, 2006. 176(5): p. 2025-31; discussion 2031-2.
1216. Borrie, M.J. and H.A. Davidson, Incontinence in institutions: costs and contributing factors. *CMAJ*, 1992. 147(3): p. 322-8.
1217. Ficazzola, M.A. and V.W. Nitti, The etiology of post-radical prostatectomy incontinence and correlation of symptoms with urodynamic findings. *J Urol*, 1998. 160(4): p. 1317-20.
1218. Groutz, A., et al., The pathophysiology of post-radical prostatectomy incontinence: a clinical and video urodynamic study. *J Urol*, 2000. 163(6): p. 1767-70.

1219. Giannantoni, A., et al., bladder and urethral sphincter function after radical retropubic prostatectomy: a prospective long-term study. *Eur Urol*, 2008. 54(3): p. 657-64.
1220. Perez, L.M. and G.D. Webster, Successful outcome of artificial urinary sphincters in men with post-prostatectomy urinary incontinence despite adverse implantation features. *J Urol*, 1992. 148(4): p. 1166-70.
1221. Thiel, D.D., et al., Do clinical or urodynamic parameters predict artificial urinary sphincter outcome in post-radical prostatectomy incontinence? *Urology*, 2007. 69(2): p. 315-9.
1222. Thiruchelvam N, Cruz F, Kirby M, Tubaro A, Chapple CR, Sievert KD. A review of detrusor overactivity and the overactive bladder after radical prostate cancer treatment. *BJU Int*. 2015 Dec;116(6):853-61.
1223. Bentzon, D.N., C. Graugaard-Jensen, and M. Borre, Urethral pressure profile 6 months after radical prostatectomy may be diagnostic of sphincteric incontinence: preliminary data after 12 months' follow-up. *Scand J Urol Nephrol*, 2009. 43(2): p. 114-8.
1224. Biardeau X, Aharony S, Campeau L, Corcos J. AUS Consensus Group. Artificial Urinary Sphincter: Report of the 2015 Consensus Conference. *Neurourol Urodyn*. 2016 Apr;35 Suppl 2:S8-24
1225. John, H., et al., evidence of trigonal denervation and reinnervation after radical retropubic prostatectomy. *J Urol*, 2001. 165(1): p. 111-3.
1226. Antunes-Lopes T, Cruz CD, Cruz F, Sievert KD. Biomarkers in lower urinary tract symptoms/overactive bladder: a critical overview. *Curr Opin Urol*. 2014 Jul;24(4):352-7.
1227. Peinemann, F., et al., low-dose rate brachytherapy for men with localized prostate cancer. *Cochrane Database Syst Rev*, 2011(7): p. CD008871.
1228. Marks, L.B., et al., The response of the urinary bladder, urethra, and ureter to radiation and chemotherapy. *Int J Radiat Oncol Biol Phys*, 1995. 31(5): p. 1257-80.
1229. Choo, R., et al., Urodynamic changes at 18 months posttherapy in patients treated with external beam radiotherapy for prostate carcinoma. *Int J Radiat Oncol Biol Phys*, 2002. 53(2): p. 290-6.
1230. Blaivas, J.G., J.P. Weiss, and M. Jones, The pathophysiology of lower urinary tract symptoms after brachytherapy for prostate cancer. *BJU Int*, 2006. 98(6): p. 1233-7; discussion 1237.
1231. Smeenk, R.J., et al., Dose-effect relationships for Individual pelvic Floor muscles and anorectal Complaints after prostate radiotherapy. *Int J Radiat Oncol Biol Phys*, 2011.
1232. Landis, D., anemia management of chronic renal insufficiency patients in a managed care setting. *Journal of the American Society of Nephrology*, 2002. 13: p. 639a.
1233. Merrick, G.S., et al., prophylactic versus therapeutic alpha-blockers after permanent prostate brachytherapy. *Urology*, 2002. 60(4): p. 650-5.
1234. Sacco, D.E., et al., Corticosteroid use after prostate brachytherapy reduces the risk of acute urinary retention. *BJU Int*, 2003. 91(4): p. 345-9.
1235. Thomas, M.D., et al., Identifying the predictors of acute urinary retention following magnetic-resonance-guided prostate brachytherapy. *Int J Radiat Oncol Biol Phys*, 2000. 47(4): p. 905-8.
1236. Benoit, R.M., M.J. Naslund, and J.K. Cohen, Complications after prostate brachytherapy in the medicare population. *Urology*, 2000. 55(1): p. 91-6.
1237. Flam, T.A., et al., post-brachytherapy transurethral resection of the prostate in patients with localized prostate cancer. *J Urol*, 2004. 172(1): p. 108-11.
1238. Kollmeier, M.A., et al., Urinary morbidity and incontinence following transurethral resection of the prostate after brachytherapy. *J Urol*, 2005. 173(3): p. 808-12.
1239. Hu, K. and K. Wallner, Urinary incontinence in patients who have a TURp/TUlp following prostate brachytherapy. *Int J Radiat Oncol Biol Phys*, 1998. 40(4): p. 783-6.
1240. Green, N., D. Treible, and H. Wallack, prostate cancer: post-irradiation incontinence. *J Urol*, 1990. 144(2 Pt 1): p. 307-9.
1241. Patel, H., et al., risk of incontinence with transurethral resection of the prostate after radiation therapy for prostate cancer. *J Surg Oncol*, 1997. 64(2): p. 127-9.
1242. Pinkawa M1, Klotz J, Djukic V, Petz D, Holy R, Eble MJ. Transurethral resection of the prostate after radiotherapy for prostate cancer: impact on quality of life. *Int J Urol*. 2014 Sep;21(9):899-903. doi: 10.1111/iju.12460. Epub 2014 Apr 13.
1243. Hirshberg, E.D. and L.H. Klotz, post transurethral resection of prostate incontinence in previously radiated prostate cancer patients. *Can J Urol*, 1998. 5(2): p. 560-563.

1244. Merrick, G.S., K.E. Wallner, and W.M. Butler, minimizing prostate brachytherapy-related morbidity. *Urology*, 2003. 62(5): p. 786-92.
1245. Budaus, L., et al., Functional outcomes and complications following radiation therapy for prostate cancer: a critical analysis of the literature. *Eur Urol*, 2012. 61(1): p. 112-27. *Metab*, 2005. 15(3): p. 252-65.
1246. Baztan, J.J., et al., New-onset urinary incontinence and rehabilitation outcomes in frail older patients. *Age Ageing*, 2005. 34(2): p. 172-5.
1247. Brandeis, G.H., et al., The prevalence of potentially remediable urinary incontinence in frail older people: a study using the minimum Data Set. *J Am Geriatr Soc*, 1997. 45(2): p. 179-84.
1248. Ouslander, J.G., et al., Urinary incontinence in nursing homes: incidence, remission and associated factors. *J Am Geriatr Soc*, 1993. 41(10): p. 1083-9.
1249. Resnick, N.M., voiding dysfunction in the elderly, in *neurourology and Urodynamics. principle and practice.*, V. Yalla, et al., Editors. 1988, Macmillian Publishing Co.: New York. p. 303-330.
1250. DuBeau, C.E., et al., Incontinence in the frail elderly: report from the 4th International Consultation on Incontinence. *Neurourol Urodyn*, 2010. 29(1): p. 165-78.
1251. Dowling-Castronovo, A. and J.K. Specht, How to try this: assessment of transient urinary incontinence in older adults. *Am J Nurs*, 2009. 109(2): p. 62-71; quiz 72.
1252. Anger, J.T., et al., True prevalence of urinary incontinence among female nursing home residents. *Urology*, 2006. 67(2): p. 281-7.
1253. Herzog, A.R., et al., Two-year incidence, remission, and change patterns of urinary incontinence in noninstitutionalized older adults. *J Gerontol*, 1990. 45(2): p. M67-74.
1254. Diokno, A.C., M.B. Brown, and A.R. Herzog, relationship between use of diuretics and continence status in the elderly. *Urology*, 1991. 38(1): p. 39-42.
1255. Fantl, J.A., et al., Urinary incontinence in communitydwelling women: clinical, urodynamic, and severity characteristics. *Am J Obstet Gynecol*, 1990. 162(4): p. 946-51; discussion 951-2.
1256. Resnick, N.M., M. Baumann, and M. Scott, risk factors for incontinence in the nursing home: a multivariate study.. *Neurourol Urodyn*, 1988. 7: p. 274-6.
1257. Resnick, N.M., et al., Short-term variability of self report of incontinence in older persons. *J Am Geriatr Soc*, 1994. 42(2): p. 202-7.
1258. Resnick, N.M., *Urinary incontinence in the elderly Medical Ground Rounds*, 1984. 3: p. 281-290.
1259. Doughty, D.B., *Urinary & fecal incontinence: Current management concepts*. 2006, St. Louis: Mosby.
1260. Dowling-Castronovo, A. and C. Bradway, *Urinary incontinence*, in *Geriatric nursing protocols for best practice*, E. Capezuti, et al., Editors. 2008, Springer Publishing Company, Inc.: New York.
1261. Paillard, M. and N.M. Resnick, natural-History of nosocomial Urinary-Incontinence *Gerontologist*, 1984. 24(212).
1262. Griffiths, D., et al., brain control of normal and overactive bladder. *J Urol*, 2005. 174(5): p. 1862-7.
1263. Tadic, S.D., et al., abnormal connections in the supraspinal bladder control network in women with urge urinary incontinence. *Neuroimage*, 2008. 39(4): p. 1647-53.
1264. Boscia, J.A., et al., lack of association between bacteriuria and symptoms in the elderly. *Am J Med*, 1986. 81(6): p. 979-82.
1265. Ouslander, J.G. and J.F. Schnelle, Incontinence in the nursing home. *Ann Intern Med*, 1995. 122(6): p. 438-49.
1266. Mody L1, Juthani-Mehta M2. Urinary tract infections in older women: a clinical review. *JAMA*. 2014 Feb 26;311(8):844-54
1267. Kocak, I., et al., Female urinary incontinence in the west of Turkey: prevalence, risk factors and impact on quality of life. *Eur Urol*, 2005. 48(4): p. 634-41.
1268. Parazzini, F., et al., risk factors for stress, urge or mixed urinary incontinence in Italy. *BJOG*, 2003. 110(10): p. 927-33.
1269. Bortolotti, A., et al., prevalence and risk factors for urinary incontinence in Italy. *Eur Urol*, 2000. 37(1): p. 30-5.
1270. Ozerdogan, N., N.K. Beji, and O. Yalcin, Urinary incontinence: its prevalence, risk factors and effects on the quality of life of women living in a region of Turkey. *Gynecol Obstet Invest*, 2004. 58(3): p. 145-50.
1271. Arya, L.A., et al., evidence of bladder oversensitivity in the absence of an infection in premenopausal women with a history of recurrent urinary tract infections. *BJU Int*, 2011.
1272. Suckling, J., A. Lethaby, and R. Kennedy, local oestrogen for vaginal atrophy in postmenopausal women. *Cochrane Database Syst Rev*, 2006(4): p. CD001500.

1273. Cardozo, L., et al., meta-analysis of estrogen therapy in the management of urogenital atrophy in postmenopausal women: second report of the Hormones and Urogenital Therapy Committee. *Obstet Gynecol*, 1998. 92(4 Pt 2): p. 722-7.
1274. Sievert KD, Amend B, Toomey PA et al. Can we prevent incontinence? ICI-RS 2011. *Neurourol Urodyn*. 2012 Mar;31(3):390-9.
1275. Holroyd-Leduc, J.M. and S.E. Straus, management of urinary incontinence in women: scientific review. *JAMA*, 2004. 291(8): p. 986-95.
1276. Longo, D.L., et al., Harrison's principles of Internal medicine. 18th ed. 2011, New York: McGraw-Hill Professional.
1277. Marshall, H.J. and D.G. Beevers, alpha-adrenoceptor blocking drugs and female urinary incontinence: prevalence and reversibility. *Br J Clin Pharmacol*, 1996. 42(4): p. 507-9.
1278. Clobes, A., J.O. DeLancey, and D.M. Morgan, Urethral circular smooth muscle in young and old women. *Am J Obstet Gynecol*, 2008. 198(5): p. 587 e1-5.
1279. Grandjean, A.C., et al., The effect of caffeinated, noncaffeinated, caloric and non-caloric beverages on hydration. *J Am Coll Nutr*, 2000. 19(5): p. 591-600.
1280. Armstrong, L.E., et al., Fluid, electrolyte, and renal indices of hydration during 11 days of controlled caffeine consumption. *Int J Sport Nutr Exerc Metab*, 2005. 15(3): p. 252-65.
1281. Rao, S.S., et al., Is coffee a colonic stimulant? *Eur J Gastroenterol Hepatol*, 1998. 10(2): p. 113-8.
1282. Johnson, M.F., et al., outcomes of older persons receiving rehabilitation for medical and surgical conditions compared with hip fracture and stroke. *J Am Geriatr Soc*, 2000. 48(11): p. 1389-97.
1283. Boreham, M.K., et al., anal incontinence in women presenting for gynecologic care: prevalence, risk factors, and impact upon quality of life. *Am J Obstet Gynecol*, 2005. 192(5): p. 1637-42.
1284. Grover, M., et al., Survey of geriatricians on the effect of fecal incontinence on nursing home referral. *J Am Geriatr Soc*, 2010. 58(6): p. 1058-62.
1285. Burge, E., A. Berchtold, and A. von Gunten, Gender-related aDI performance of old people recently admitted to a Swiss nursing home. a cross-sectional study. *Swiss Med Wkly*, 2011. 141: p. w13183.
1286. Dunivan, G.C., et al., Fecal incontinence in primary care: prevalence, diagnosis, and health care utilization. *Am J Obstet Gynecol*, 2010. 202(5): p. 493 e1-6.
1287. Alsheik, E.H., et al., Fecal incontinence: prevalence, severity, and quality of life data from an outpatient gastroenterology practice. *Gastroenterol Res Pract*, 2012. 2012: p. 947694.
1288. Kuehn, B.M., Silence masks prevalence of fecal incontinence. *JAMA*, 2006. 295(12): p. 1362-3.
1289. Johanson, J.F. and J. Lafferty, Epidemiology of fecal incontinence: the silent affliction. *Am J Gastroenterol*, 1996. 91(1): p. 33-6.
1290. Bharucha, A.E., et al., Prevalence and burden of fecal incontinence: a population-based study in women. *Gastroenterology*, 2005. 129(1): p. 42-9.
1291. Sung, V.W., et al., National trends and costs of surgical treatment for female fecal incontinence. *Am J Obstet Gynecol*, 2007. 197(6): p. 652 e1-5.
1292. Deutekom, M., et al., Costs of outpatients with fecal incontinence. *Scand J Gastroenterol*, 2005. 40(5): p. 552-8.
1293. Morris, A.R., et al., Costs of managing urinary and faecal incontinence in a sub-acute care facility: a "bottom-up" approach. *Neurourol Urodyn*, 2005. 24(1): p. 56-62.
1294. Farage, M.A., et al., psychosocial and societal burden of incontinence in the aged population: a review. *Arch Gynecol Obstet*, 2008. 277(4): p. 285-90.
1295. Mellgren, A., et al., Long-term cost of fecal incontinence secondary to obstetric injuries. *Dis Colon Rectum*, 1999. 42(7): p. 857-65; discussion 865-7.
1296. Kalantar, J.S., S. Howell, and N.J. Talley, prevalence of faecal incontinence and associated risk factors; an underdiagnosed problem in the australian community? *Med J Aust*, 2002. 176(2): p. 54-7.
1297. Melville, J.L., et al., Fecal incontinence in US women: a population-based study. *Am J Obstet Gynecol*, 2005. 193(6): p. 2071-6.
1298. Pretlove, S.J., et al., Prevalence of anal incontinence according to age and gender: a systematic review and meta-regression analysis. *Int Urogynecol J Pelvic Floor Dysfunct*, 2006. 17(4): p. 407-17.
1299. Whitehead, W.E., et al., Fecal incontinence in US adults: epidemiology and risk factors. *Gastroenterology*, 2009. 137(2): p. 512-7, 517 e1-2.
1300. Goode, P.S., et al., Prevalence and correlates of fecal incontinence in community-dwelling

- older adults. *J Am Geriatr Soc*, 2005. 53(4): p. 629-35.
1301. Varma, M.G., et al., Fecal incontinence in females older than aged 40 years: who is at risk? *Dis Colon Rectum*, 2006. 49(6): p. 841-51.
1302. Dyer, C.B., C.M. Ashton, and T.A. Teasdale, Postoperative delirium. a review of 80 primary data-collection studies. *Arch Intern Med*, 1995. 155(5): p. 461-5.
1303. Siddiqi, N., A.O. House, and J.D. Holmes, Occurrence and outcome of delirium in medical inpatients: a systematic literature review. *Age Ageing*, 2006. 35(4): p. 350-64.
1304. Clegg, A. and J.B. Young, Which medications to avoid in people at risk of delirium: a systematic review. *Age Ageing*, 2011. 40(1): p. 23-9.
1305. Johanson, J.F., F. Irizarry, and A. Doughty, Risk factors for fecal incontinence in a nursing home population. *J Clin Gastroenterol*, 1997. 24(3): p. 156-60.
1306. Borrie, M.J. and H.A. Davidson, Incontinence in institutions: costs and contributing factors. *CMAJ*, 1992. 147(3): p. 322-8.
1307. Schnelle, J.F., et al., Does an exercise and incontinence intervention save healthcare costs in a nursing home population? *J Am Geriatr Soc*, 2003. 51(2): p. 161-8.
1308. Ouslander, J.G., et al., effects of prompted voiding on fecal continence among nursing home residents. *J Am Geriatr Soc*, 1996. 44(4): p. 424-8.
1309. Nelson, R.L. and S.E. Furner, risk factors for the development of fecal and urinary incontinence in wisconsin nursing home residents. *Maturitas*, 2005. 52(1): p. 26-31.
1310. Harari, D., et al., new-onset fecal incontinence after stroke: prevalence, natural history, risk factors, and impact. *Stroke*, 2003. 34(1): p. 144-50.
1311. Shamlivan, T., et al., prevention of urinary and fecal incontinence in adults. *Evid Rep Technol Assess (Full Rep)*, 2007(161): p. 1-379.
1312. Rey, E., et al., onset and risk factors for fecal incontinence in a US community. *Am J Gastroenterol*, 2010. 105(2): p. 412-9.
1313. Goode, P.S., et al., prevalence and correlates of fecal incontinence in community-dwelling older adults. *J Am Geriatr Soc*, 2005. 53(4): p. 629-35.
1314. Roberson, E.N., J.C. Gould, and A. Wald, Urinary and fecal incontinence after bariatric surgery. *Dig Dis Sci*, 2010. 55(9): p. 2606-13.
1315. Halland, M. and N.J. Talley, Fecal incontinence: mechanisms and management. *Curr Opin Gastroenterol*, 2012. 28(1): p. 57-62.
1316. Abraham, B. and J.H. Sellin, Drug-induced diarrhea. *Curr Gastroenterol Rep*, 2007. 9(5): p. 365-72.
1317. Lisi, D.M., Fecal incontinence: possible role for drug-induced etiology. *J Am Geriatr Soc*, 2011. 59(1): p. 161-2; author reply 162-3.
1318. Gerstel, C., M. Zarate Lagunes, and U.M. Vischer, Fecal incontinence resolved using metformin withdrawal. *J Am Geriatr Soc*, 2011. 59(4): p. 756-7.
1319. Nelson, R.L., epidemiology of fecal incontinence. *Gastroenterology*, 2004. 126(1 Suppl 1): p. S3-7.
1320. Madoff, R.D., et al., Faecal incontinence in adults. *Lancet*, 2004. 364(9434): p. 621-32.
1321. Gallagher, P. and D. O'Mahony, Constipation in old age. *Best Pract Res Clin Gastroenterol*, 2009. 23(6): p. 875-87.
1322. Leung, F.W. and S.S. Rao, Fecal incontinence in the elderly. *Gastroenterol Clin North Am*, 2009. 38(3): p. 503-11.
1323. Tariq, S.H., Geriatric fecal incontinence. *Clin Geriatr Med*, 2004. 20(3): p. 571-87, ix.
1324. Read, N.W. and L. Abouzekry, why do patients with faecal impaction have faecal incontinence. *Gut*, 1986. 27(3): p. 283-7.
1325. Read, N.W., et al., anorectal function in elderly patients with fecal impaction. *Gastroenterology*, 1985. 89(5): p. 959-66.

INITIAL ASSESSMENT OF URINARY INCONTINENCE IN ADULT MALE AND FEMALE PATIENTS

Chairs

David Castro Diaz (Spain)
Dudley Robinson (UK)

Members

Ruud Bosch (Netherlands)
Elisabetta Costantini (Italy)
Nikki Cotterill (UK)
Montse España-Pons (Spain)
Ervin Kocjancic (USA)
Nucelio Lemos (Brazil)
Tufan Tarcan (Turkey)
Masaki Yoshida (Japan)

CONTENTS

ABBREVIATIONS	499	V. SPECIFIC POPULATIONS: EVALUATION OF THE FEMALE PATIENT	512
I. INTRODUCTION	500	1. Establishing the type of urinary incontinence in women	512
II. GENERAL INFORMATION	500	2. General Medical History	513
1. Terminology	500	3. Symptom Assessment	513
1.1. Types of urinary incontinence	500	4. Physical Examination (Female)	514
1.2. Bladder storage symptoms	501	5. Pelvic Assessment: Pelvic Floor Strength and Pelvic Organ Prolapse	516
1.3. Bladder sensation	501	5.1. Assessment of Pelvic Floor Muscle Strength	516
1.4. Voiding and postmicturition symptoms	501	5.2. Assessment of Pelvic Organ Prolapse	517
2. Assessment of Sub-Populations Reviewed by Other Committees	502	VI. SPECIFIC POPULATION: EVALUATION OF THE MALE PATIENT	521
3. Evidence Based Recommendations	502	1. Characteristics of Male LUTS	521
III. INITIAL ASSESEMENT	502	2. Male Incontinence	522
1. Purpose of Intial Assessment (Expert Opinion of the Committee)	502	3. Symptom Assessment	522
2. Initial Assessment – General Recommendations	503	4. Physical Examination	524
3. Intial Assesement – General Research Recommendations	504	4.1. Urinalysis and Urine Cytology	524
IV. GENERAL POPULATIONS	504	4.2. Measurement of the Serum Creatinine	525
1. Initial Assessment of Urinary Incontinence	504	4.3. Measurement of the Serum Prostatespecific Antigen (PSA)	525
1.1. History	504	Recommendations	526
1.2. Bladder Diaries	505	Future Research	526
1.2.1 Bladder Diary Recommendations	507	REFERENCES	527
1.2.2 Future Research	507		
1.3. Urgency Scale	507		
1.4. Urinalysis	510		
1.4.1 Urinalysis - Recommendation	510		
1.4.2 Future Research	510		
1.5. Post voiding residual in the female and male patient	511		
1.5.1 Recommendations	512		
1.5.2 Future Research	512		

INITIAL ASSESSMENT OF URINARY INCONTINENCE IN ADULT MALE AND FEMALE PATIENTS

DAVID CASTRO DIAZ (SPAIN), DUDLEY ROBINSON (UK)
RUUD BOSCH (NETHERLANDS), ELISABETTA COSTANTINI (ITALY), NIKKI COTTERILL (UK),
MONTSE ESPUÑA-PONS (SPAIN), ERVIN KOCJANCIC (USA), NUCELIO LEMOS (BRAZIL),
TUFAN TARCAN (TURKEY), MASAKI YOSHIDA (JAPAN)

ABBREVIATIONS

AHCPR Agency for Health Care Policy and Research's

AUA American Urological Association

BD Bladder Diary

BMI Body Mass Index

BOO Bladder Outlet Obstruction

BPE Benign Prostatic Enlargement

BPH Benign Prostate Hyperplasia

BPO Benign Prostatic Obstruction

CLSS Core LUTS Score

DAN-PSS Danish Prostatic Symptom Score

DO Detrusor Overactivity

DRE Digital Rectal Examination

EBM Evidence Based Medicine

FIGO International Federation of Gynecology And Obstetrics

FVC Frequency-Volume Chart

GFR Glomerular Filtration Rate

GH Genital Hiatus

ICI International Consultation on Incontinence

ICIQ International Consultation on Incontinence Modular Questionnaire

ICIQ-MLUTS International Consultation on Incontinence Modular Questionnaire-Male LUTS

ICIQ-SF International Consultation on Incontinence Questionnaire-Short Form

ICS International Continence Society

ICUD International Consultation on Urologic Diseases

IHCIS Health Care Information Solutions Database

IPSS International Prostate System Score

IUGA International Urogynecological Association

LR Likelihood Ratio

LUT Lower Urinary Tract

LUTD Lower Urinary Tract Disease

LUTS Lower Urinary Tract Symptoms

MOS Modified Oxford Scale

MSAM-7 Multinational Survey of the Aging Male

MUCP Maximum Urethral Closure Pressure

OAB Overactive Bladder Syndrome

OABSS OAB Symptom Score

PB Perineal Body

PFDI Pelvic Floor Distress Inventory

PFM Pelvic Floor Muscles

PGI-I Patient Global Impression of Improvement

PISQ12	Pelvic Organ Prolapse/Urinary Incontinence Sexual Questionnaire
PISQ-IR	Pelvic Organ Prolapse/Incontinence, IUGA-Revised
POP	Pelvic Organ Prolapse
POP-Q	Pelvic Organ Prolapse Quantification
PPI	Post-Prostatectomy Incontinence
P-QOL	Prolapse Quality Of Life
PRO	Patient Reported Outcomes
PSA	Prostatic Specific Antigen
PVR	Post-Void Residual
QOL	Quality of Life
RALP	Robot Assisted Laparoscopic Prostatectomy
RP	Radical Prostatectomy
RRP	Retropubic Radical Prostatectomy
RUTI	Recurrent Urinary Tract Infection
SSC	Standardisation Steering Committee
SUI	Stress Urinary Incontinence
TOT	Transobturator Tape
TVL	Total Vaginal Length
UI	Urinary Incontinence
UTI	Urinary Tract Infection
UUI	Urgency Urinary Incontinence
UWIN	Urgency and Nocturia Scoring Tool
VLPP	Valsalva Leak Point Pressure
VVA	Vulvar and Vaginal Atrophy

I. INTRODUCTION

The aim of this report is to provide an update of the evidence-based recommendations from the 6th ICI regarding the initial assessment of urinary incontinence (Committee 5A) and outcome measurements (Committee 5B) of incontinence for adult men and women.

II. GENERAL INFORMATION

1. TERMINOLOGY

A critical step in the evaluation of urinary incontinence (UI) is the use of up-to-date terminology to describe different types of UI and their associated lower urinary tract symptoms (LUTS). LUTS includes both storage and emptying symptoms in contrast to overactive

bladder syndrome (OAB) which describes a subset of storage symptoms (e.g., urgency, frequency, nocturia), with or without the symptom of UI. The use of standardised terminology during the taking of the history of UI ensures an accurate characterisation of the type of UI experienced by each patient.

The ICS 2002 report (1) and the ICS /IUGA Joint Report (2) are recommended for reference, as well as an update of the terminology for nocturia (3). It should be noted however that a bibliometric and questionnaire analysis of the use of standardised terminology documents the low rate of acceptance of new terminology in both the literature and practice, and the slow abandonment of previously accepted common terms. (4)

The Standardisation Steering Committee (SSC) of the International Continence Society (ICS) “establishes terminology and methodology in the ICS’s areas of activity, to underpin professional standards of clinical management and research”. The value of the SSC is in promoting best standards when clinicians and allied professionals communicate with patients and colleagues, undertake diagnostic tests, proceed to therapeutic interventions and undertake research. Precise use of agreed terminology ensures clear understanding for collaborating centres and readers of publications. Adherence to the diagnostic testing standards gives patients and clinical colleagues confidence that conclusions on which important therapeutic decisions are based are reliable. Development of future insights into mechanisms and treatments of the disease areas relevant to the ICS is enhanced where research studies employ internationally standardised approaches.

The term “urinary incontinence” refers to the complaint of any involuntary loss of urine. The symptom of urinary incontinence can be volunteered by, or elicited from, the individual or may be described by the individual’s caregiver. Urinary incontinence can be categorised into several distinct sub-types based on associated characteristics and circumstances surrounding episodes of urine leakage. Although defining the type of incontinence will not establish a definitive underlying diagnosis, it will ultimately guide investigation and treatment. The following are the accepted ICS definitions of these conditions unless referenced (1).

1.1. Types of urinary incontinence

- a) Stress (urinary) incontinence: Complaint of involuntary loss of urine on effort or physical exertion (e.g., sporting activities), or on sneezing or coughing. (Sporting activities)
- b) Urgency (urinary) incontinence: Complaint of involuntary loss of urine associated with urgency.
- c) Postural (urinary) incontinence: Complaint of involuntary loss of urine associated with change of body position, for example, rising from a seated or lying position.

- d) Mixed (urinary) incontinence: Complaint of involuntary loss of urine associated with urgency and also with effort or physical exertion or on sneezing or coughing.
 - e) Incontinence associated with chronic retention of urine: Complaint of involuntary loss of urine which occurs in conditions where the bladder does not empty completely as indicated by a significantly high residual urine volume and/or a non-painful bladder which remains palpable after the individual has passed urine. (Note: The ICS no longer recommends the term overflow incontinence. A significant residual urine volume denotes a minimum volume of 300 ml, although this figure has not been well established.)
 - f) Nocturnal enuresis: Complaint of involuntary loss of urine which occurs during sleep.
 - g) Continuous (urinary) incontinence: Complaint of continuous involuntary loss of urine.
 - h) Insensible (urinary) incontinence: Complaint of urinary incontinence where the individual is unaware of how it occurred
 - i) Coital incontinence (for women only): Complaint of involuntary loss of urine with coitus. This symptom can be further divided into that occurring with penetration and that occurring at orgasm.
 - j) Functional incontinence: Complaint of involuntary loss of urine that results from an inability to reach the toilet due to cognitive, functional or mobility impairments in the presence of an intact lower urinary tract system.
 - k) Multifactorial incontinence: Complaint of involuntary loss of urine related to multiple interacting risk factors, including factors both within and outside the lower urinary tract such as comorbidity, medication, age-related physiological changes and environmental factors.
- b) Nocturia: Complaint of interruption of sleep one or more times because of the need to void. Each void is preceded and followed by sleep. The number of nocturia episodes and the degree of bother based on number has been questioned and the threshold of 2-3 per night has been suggested(5) (6-10).
 - c) Urgency: Complaint of a sudden, compelling desire to pass urine which is difficult to defer. (Note: The 'all or none' nature of 'urgency' has been questioned)(8).
 - d) Overactive bladder syndrome (OAB): Urinary urgency, usually accompanied by increased urinary frequency and nocturia, with or without urgency urinary incontinence, in the absence of urinary tract infection or other obvious pathology.

1.3. Bladder sensation

Asking patients about bladder sensory symptoms during bladder filling may be helpful in characterising certain types of incontinence.

- a) Increased bladder sensation: Complaint that the desire to void during bladder filling occurs earlier or is more persistent to that previously experienced. This differs from urgency by the fact that micturition can be postponed despite the desire to void.
- b) Reduced bladder sensation: Complaint that the definite desire to void occurs later than that previously experienced despite an awareness that the bladder is filling.
- c) Absent bladder sensation: Complaint of both the absence of the sensation of bladder filling and a definite desire to void.

1.4. Voiding and postmicturition symptoms

Voiding symptoms are experienced during the voiding phase and post-micturition symptoms are experienced immediately after micturition.

- a) Hesitancy: Complaint of a delay in initiating micturition.
- b) Slow stream: The individual's perception of reduced urine flow, usually compared to previous performance or in comparison to others.
- c) Intermittent stream (intermittency): Complaint of urine flow which stops and starts, on one or more occasions, during micturition.
- d) Straining to void: Describes the muscular effort used to initiate, maintain or improve the urinary stream.
- e) Spraying (splitting) of urinary stream: Complaint that the urine sprays or splits rather than coming out as a single, discrete stream.

Urinary incontinence can exist in isolation or may be associated with other lower urinary tract symptoms. The ICS classifies lower urinary tract symptoms (LUTS) into bladder storage, voiding and post-micturition, and pelvic organ prolapse symptoms. The following section summarises the definitions of LUTS described by the ICS-SSC.

1.2. Bladder storage symptoms

Bladder storage symptoms are experienced during the bladder filling phase:

- a) Increased daytime urinary frequency: Complaint that micturition occurs more frequently during waking hours than previously deemed normal. Traditionally seven episodes of micturition during waking hours was considered as the upper limit of normal, although it may be higher in some populations.

- f) Terminal dribble: is the term used when an individual describes a prolonged final part of micturition, when the flow has slowed to a trickle/dribble.
- g) Feeling of incomplete bladder emptying: Complaint that the bladder does not feel empty after passing urine.
- h) Need to immediately re-void: Complaint that further micturition is necessary soon after passing urine.
- i) Postmicturition leakage: Complaint of a further involuntary passage of urine following the completion of micturition.
- j) Position-dependent micturition: Complaint of having to take specific positions to be able to micturate spontaneously or to improve bladder emptying, for example, leaning forwards or backwards on the toilet seat or voiding in the semi-standing position.
- k) Dysuria: Complaint of burning or other discomfort during micturition. Discomfort may be intrinsic to the lower urinary tract or external (vulvar dysuria in women).
- l) (Urinary) retention: Complaint of the inability to pass urine despite persistent effort.

2. ASSESSMENT OF SUB-POPULATIONS REVIEWED BY OTHER COMMITTEES

The targeted assessments and specific outcome measures for conditions of UI in Children (Cmte 9), Neurogenic Patients (Cmte.10), Frail Elderly (Cmte.11), Painful Bladder Syndrome (Cmte.19) and Faecal Incontinence (Cmte.16) are presented separately in the respective reports. The requirements of specific sub-populations negate the ability to recommend a 'universal' initial evaluation. Within the initial assessment of UI, these sub-populations / subgroups are recognised because of the differences within patient groups or the interrelationship between the conditions. Congenital and developmental issues are critical considerations in children. Specific risks for combined storage and emptying abnormalities and upper urinary tract deterioration in the neurogenic population demand a more involved initial and complex evaluation. The effects of ageing on the lower urinary tract, altered toileting functions, and medical co-morbidities in the frail elderly group present unique challenges. These subgroups also include patients with LUTS with and without incontinence and with the presence of pelvic pain or faecal incontinence.

The sub-sections in this report should be utilised in conjunction with other population or condition specific Committee Reports of the Consultation and with the final recommendations of the Consultation which are

presented in simplified form in Appendix (1. Definitions). Recommendations for initial evaluation have been developed by the International Scientific Committee and are also published in Appendix (2. Evaluation). In addition, History and Symptom Assessment recommendations are further detailed as the initial steps in the evaluation of the index adult male (3. Initial Management, II. Male), and adult female (3. Initial Management, III. Female). The reader is encouraged to refer to these recommendations and algorithms in combination with this report.

3. EVIDENCE BASED RECOMMENDATIONS

The recommendations presented in this report are evidence-based and utilise the ICUD-EBM grades. A search of the available literature in English obtained from Medline and Pubmed up to June 2016 by the individual committee members employed multiple search terms related to the initial assessment of the patient with urinary incontinence and patient reported outcome assessment.

III. INITIAL ASSESSMENT

1. PURPOSE OF INITIAL ASSESSMENT (EXPERT OPINION OF THE COMMITTEE)

As will be noted, especially in this committee report (5A), the amount and sophistication of the literature that is applicable for the development of evidence-based guidelines is limited. For this reason, the grade of recommendation in the area of "initial assessment" will often rely on 'expert opinion of the panel'. For the purpose of subsection 5A, the 'initial assessment' represents the components of the history, physical examination, laboratory tests, and basic office testing to:

1. Establish a presumptive or condition specific diagnosis, and exclude underlying organ-specific related or unrelated conditions that would require intervention.
2. Assess the level of bother and desire for intervention from information obtained from the patient or caregivers, utilising objective measures or patient reported outcomes
3. Prepare for the institution of empirical or disease specific primary therapy based on the risk and benefit of the untreated condition, the nature of the intervention and the alternative therapies – including Conservative (Cmte. 12) or Pharmacological (Cmte. 8) therapies.

4. Prompt the recommendation of additional more complex testing or specialist referral (when indicated).
5. Assess the level of improvement after intervention from information obtained from the patient or caregivers, utilising objective measures or patient reported outcomes (Cmte. 5B).

Once the type of Urinary Incontinence (UI) with associated lower urinary tract symptoms (LUTS) has been established, elaboration of a differential diagnosis can occur, and further investigations may be elected and an eventual treatment plan can be formulated to address or modify the effects of the underlying cause(s). The success of the treatment plan can be measured by patient-reported outcomes (from a simple “yes” or “no” to more complex questionnaires), and/or other objective measures of urinary leakage events (including bladder diaries, pad tests, or urodynamics studies).

The initial assessment must consider the degree of bother, and the costs of further evaluation, balanced against the consequences of a failure to diagnose an underlying condition, the risks and benefits of empirical conservative management or pharmacological therapy, and the need for an accurate diagnosis before more complex intervention or empirical therapy. The burden of these conditions and the availability of resources for individual patients, caregivers, physicians, and health care systems requires that primary intervention strategies be formulated, when available, from evidence based findings and decisions emanating from the initial evaluation.

Of note, LUTS cannot be utilised with confidence to make a definitive diagnosis of a specific lower urinary tract condition or lower urinary tract disease (LUTD), as these symptoms may suggest and indicate pathologies such as urinary tract infection (UTI) or more serious underlying conditions. Basic laboratory tests, such as testing for urinary tract infection (UTI) or blood (haematuria), and appropriate screening for malignancy should be considered before the decision is made to choose therapy for incontinence. Urinary retention with overflow may present as urinary urgency, frequency, and nocturia with urinary loss mimicking OAB.

Concomitant pathology may affect urine production as a co-morbid contributory factor, by affecting fluid balance or renal function (fluid intake and output regulation) and may need to be addressed prior to or in combination with bladder or bladder outlet therapy. A thorough review of medications which alter fluid production or lower balance and urinary tract function should be addressed. The physician should also seek a history of pelvic pathology or surgery and neurological symptoms and signs that may indicate alterations in the control of the lower urinary tract function or be responsible for the cognitive, motivational, or physical factors that determine the ability to perform toileting functions effectively. The physical examina-

tion and the appropriate laboratory tests are necessary to refine the differential diagnosis and therapeutic course.

2. INITIAL ASSESSMENT – GENERAL RECOMMENDATIONS

1. Lower Urinary Tract Symptoms (LUTS) cannot be used to make a definitive diagnosis; they may also indicate pathologies other than Lower Urinary Tract Disease (LUTD). Specific to this report, **LUTS includes Overactive Bladder (OAB)** a syndrome which may be associated with urgency incontinence (OAB-wet) or without incontinence (OAB-dry). (Level 4 - Grade D)
2. Urinary incontinence should be described by specifying relevant factors such as type, frequency, severity, precipitating factors, social impact, effect on hygiene and quality of life, the measures used to contain the leakage and whether or not the individual seeks or desires help. (Level 4 - Grade D)
3. Urinary incontinence should be categorized by symptoms into urgency incontinence, stress incontinence or mixed incontinence and conservative (non-invasive) therapies may then be started based on this classification to treat the most troublesome component, or either component of the incontinence (Level - Grade D). More sophisticated testing (e.g., urodynamic studies) is not required prior to the institution of conservative therapy (see indications for urodynamics in the Committee Report on Dynamic Testing Committee 6). (Level 3 - Grade C)
4. Both objective (bladder diary) and subjective (patient reported outcomes – PROs) are recommended for assessment and measurement of the degree of symptoms and bother of UI at baseline, and for the assessment of the impact of therapy. (Level 3 – Grade D).
5. Normal lower urinary tract function requires the ability of the bladder to adequately store urine at low pressure while the bladder outlet remains competent, and the bladder to contract until completely empty while the bladder outlet remains open. In addition to an evaluation of LUT function, a thorough evaluation for co-morbid conditions which affect fluid intake and output should be undertaken. Diseases of the nervous system and pelvic disorders, as well as medications which may affect the LUT should be addressed. (Level 4 - Grade D).
6. Referral to a specialist is recommended for hematuria (visible or microscopic), urinary tract infection (persistent or recurrent), prolapse (symptomatic or below the introitus), obstruction or re-

tention (symptoms or findings of palpable bladder, hydronephrosis or obstructive renal insufficiency), suspected neurological disease, mass (urethral, bladder or pelvic - benign or malignant), fistula (urinary or bowel), faecal incontinence, a history of prior pelvic surgery or radiation (incontinence, oncologic) (Level 4 - Grade D).

3. INITIAL ASSESSMENT – GENERAL RESEARCH RECOMMENDATIONS

1. Standardisation of the 'definition of symptoms' and the 'measurements of symptom frequency, severity and bother' are essential for patient care and research. Continued research into the appropriate scales and metrics should be accompanied by a significant attempt to establish best practice guidelines for their use and a consensus on the adoption of universal standards.
2. Recognition and resolution of the differences in common language usage and scientific utilisation of terms should continue. Resolution of the differences in definitions and metrics between recognised societies and agencies is essential for communicating data with respect to patient care, research, and treatment outcomes.
3. Research into the development of accurate measures to objectify subjective symptoms such as "urgency" and other bladder sensory symptoms.
4. Development, standardisation, and universal adoption of symptom assessment tools (questionnaires) to improve the diagnostic accuracy of lower urinary tract symptoms. (Refer to section 5B of this committee's report)
5. Validation of the accuracy of specific components of the history and physical findings to establish an accurate diagnosis and to initiate non-invasive conservative or pharmacological therapy. In addition, to further identify components that would indicate the need for more invasive testing, complex therapeutic interventions, and indications prior to / or as a result of referral.
6. Creation and institution of evidence based guidelines for the referral of patients to a specialist are needed to improve the efficiency of the healthcare system in treating the large burden of disease. (See Epidemiology, Committee 1). The institution of conservative measures and pharmacology are in the domain of the primary caregiver. Further improvement in the ability to define the index patient, but more importantly the subgroups of patients who will require more complex specialist therapy, will aid in counselling and referral at the primary level. In addition, refining the true risks for significant underlying disease

noted while obtaining the history, or during the examination or laboratory findings will improve resource utilization.

IV. GENERAL POPULATIONS

1. INITIAL ASSESSMENT OF URINARY INCONTINENCE

Individuals with UI can be identified through routine screening, or the patient may initiate discussion about incontinence problems. The initial assessment of UI should help the health care provider to understand the type of incontinence, while identifying potentially modifiable contributing factors. Most primary treatment options, such as lifestyle modifications and behavioral treatments, do not vary by type of UI. However, it is important to determine the type of UI since some treatment options do vary according to incontinence. Equally important, establishing the type of UI will lead the health care provider to a list of possible underlying causes, or differential diagnosis of the urinary symptoms. Most causes of UI are non-life threatening, however symptoms of incontinence may also herald life-threatening or more severe disease such as bladder cancer when associated with haematuria; when more specialized testing will be required immediately. Finally, assessing the level of bother and desire for intervention from information obtained from the patient or caregiver is essential for guiding the nature of the treatment plan.

1.1. History

Taking a careful clinical history is fundamental to the clinical process. Some studies have indicated that patient history alone is not completely accurate as the sole determinant of incontinence type (11, 12). However, Martin et al. (13) in a systematic review and meta-analyses on the methods for diagnostic assessment of urinary incontinence, suggested that women with urodynamic stress incontinence (USI) can be correctly identified in primary care from clinical history alone with a sensitivity of 0.92 (95% C.I.: 0.91- 0.93) and specificity of 0.56 (0.53- 0.60); symptoms of urge incontinence were found to be 0.61 (0.57- 0.65) sensitive and 0.87 (0.85-0.89) specific for the diagnosis of detrusor overactivity.

Despite the lack of formal evidence, there is universal agreement that taking a history should be the first step in the assessment of anyone with UI(1, 14).

The general history should include questions relevant to establish the type of UI and to precipitating and aggravating factors of urinary loss, time of onset and duration of symptoms, severity, degree of bother and finally the association with voiding, storage and other urinary symptoms.

The incontinence first should be characterized subjectively. Does the leakage occur: With physical activity? With a sense of urgency? Without sensory awareness? If the nature of the incontinence is mixed, does one component cause more bother or occur more frequently than the other? Secondly, the leakage should be quantified if possible. Appraisal of the degree of leakage before therapy can be helpful during postoperative assessment of treatment impact. For the purposes of routine outpatient assessment, this quantification can be achieved based on the number of pads used per day or the frequency of clothing changes because of urinary leakage.

Acute symptoms can be defined by documenting patterns of fluid intake and output, acute infection, recent surgery or trauma. Chronic symptoms should prompt queries about a history of congenital abnormalities, neurological disease, relevant surgery or general health issues. History should also identify patients who need rapid referral to an appropriate specialist. These include patients with associated pain, haematuria, a history of recurrent urinary tract infection (UTI), pelvic surgery (particularly prostate surgery) or radiotherapy, constant leakage suggesting a fistula, voiding difficulty or suspected neurological disease (Red Flag Symptoms).

The voiding pattern should also be defined. What is the frequency of urination during the day and during the night? Are there any voiding symptoms and/or storage symptoms? Previous surgery such as pelvic or back surgery and, in males, prostate or urethral surgery for benign or malignant disease should be investigated.

Information should be obtained concerning medications with known or possible effects on the lower urinary tract. The general history in women should also include assessment of menstrual, obstetric, sexual, gynaecological and bowel function. It is also helpful to determine the impact that the leakage has on the patient's daily life and activities if incontinence limits the individual's activity and if the patient made lifestyle changes because of the threat of leakage. Finally, it is important to emphasize the importance of establishing patient expectation of treatment and an understanding of the balance between the benefits and risks/burden of available treatment options (see Committee Report (5B)).

The reader is referred to the report on Epidemiology (Cmte. 1) for specific risk factors to be considered during the medical history, and to the report on Frail Elderly (Cmte. 11) for a list of co-morbidities and medications that can cause or contribute to UI.

A later section of this Committee Report (5B) presents a complete review and evaluation of questionnaires that are applicable for clinical and research use in evaluating patient symptoms. Structured condition specific questionnaires may be utilised, and may be either clinician or self-administered. Use of questionnaires may facilitate disclosure of embarrassing

symptoms, ensure that symptoms are not omitted, and standardise information for audit and research.

In the absence of questionnaire use, Table 1 summarises key questions for the initial assessment of urinary incontinence based on the expert opinion of this committee. Note that the committee strongly encourages the use of standardised questions.

1.2. Bladder Diaries

The micturition time chart records the timing of voids in 24 hours. The term frequency-volume chart is used to describe a chart that records the time of each micturition and the volume voided for at least 24 hours. The bladder diary may include fluid intake, incontinence episodes, pad usage, the degree of incontinence as well as a record of episodes of urgency and sensation and activities performed during or immediately preceding the involuntary loss of urine. Therefore, bladder diaries are most suited for the purpose of comprehensive evaluation of urinary incontinence. However, documentation of the frequency of an individual's lower urinary tract symptoms and the voided volume for at least 24 hours can already be extremely helpful in the initial assessment of urinary incontinence, although 2-3 days of recording generally provide more useful clinical data. Moreover, a diary may be therapeutic as it provides insight into bladder behavior and it can be utilised to monitor the effectiveness of treatment during follow-up.

A frequency-volume chart (FVC) or bladder diary (BD), if properly completed, can confirm all of the following information.

- a) Daytime urinary frequency: Number of voids by day (wakeful hours including last void before sleep and first void after waking and rising).
- b) Nocturnal frequency/nocturia: Number of times sleep is interrupted by the need to micturate. Each void is preceded and followed by sleep.
- c) Twenty-four-hour frequency: Total number of daytime voids and episodes of nocturia during a specified 24-hr period.
- d) Twenty-four-hour urine production: Summation of all urine volumes voided in 24 hr.
- e) Maximum voided volume: Highest voided volume recorded.
- f) Average voided volume: Summation of volumes voided divided by the number of voids.
- g) Median functional bladder capacity: Median maximum voided volume in everyday activities.
- h) Polyuria: Excessive excretion of urine resulting in profuse and frequent micturitions, defined as

Table 1: Key Questions in the Initial Assessment of Urinary Incontinence

Stress urinary incontinence: Do you sometimes leak urine when you cough or sneeze or when you exert yourself, such as when lifting a heavy object?
Urgency urinary incontinence: Do you sometimes feel an urge to void that is so sudden and strong that you sometimes don't make it to the bathroom on time?
How long have the symptoms been present?
How often do you leak urine and how much do you leak? (Do you need protections and how many during day and night?
Circumstances surrounding urine leakage e.g. sexual activity, change in position, provocation by running water or 'key in the latch'?
Nocturnal symptoms or enuresis?
Association with other lower urinary tract or pelvic organ prolapse symptoms?
Impact on personal and social life?
Amount and type of fluid intake e.g. coffee, tea, alcohol?
Episodes of urinary tract infection or haematuria?
Previous treatment attempts (successful and unsuccessful)?
Mobility problems?
Cognitive deficits?
Neurological deficits?
Problems with constipation or faecal incontinence?
Number of pregnancies and the type of delivery, with complications?
Previous prostate, pelvic or abdominal surgeries or radiation treatment?
Coexisting diseases (diabetes, heart disease, neurological impairment)?
Types of medications consumed?

greater than 2.8 L of urine during 24 hours for an individual weighing 70 kg.

- i) Nocturnal urine volume: Cumulative urine volume from voids after going to bed with the intention of sleeping to include the first void at the time of waking with the intention of rising (excludes last void before sleep).
- j) Nocturnal polyuria: Excess (over 20–30% age dependent) proportion of urine excretion (nocturnal voided volume/total 24 hr voided volume x 100%) occurring at night (or when the patient is sleeping)(15)

However, it should be noted that there are some limitations to the use of a frequency-volume chart or bladder diary. There is no evidence that the results of these charts provide a valid prediction of the type of urinary incontinence experienced by each patient (16, 17). Some patients may have difficulty completing the diary in a reliable, meaningful or timely fashion, especially when increasing the complexity or the amount of time (days) required to complete the diary (18). The

bladder diary may not yield information about the evolution of incontinence episodes that occurs less frequently than once per day(18, 19).

Several studies have compared patients' preference for, and the accuracy of, electronic and paper voiding diaries in voiding dysfunction(20-24) , but the utility of electronic diaries has not been fully clarified yet.

Due to intraindividual variation, FVC recordings differ on different days. The more days recorded, the more likely it will be that the recordings will capture the whole spectrum of variation. Few data have been reported on the intraindividual variation of FVC parameters(25) (26, 27) . However, these variations have been used in statistical analysis leading to statements on the optimal duration of FVCs. Recommendations for diary duration vary considerably including 24 hours, 3 days or 7 days; this inconsistency is partially explained by differences among study populations, based on diagnosis, age, sex, and geography, and by differences in methods of analysis and in interpretation of the results. In a mini-review on the reliability of FVCs, Yap et al argued that using FVCs of 3 days or

longer might be the most defensible policy, but they found no evidence that compliance rates had been accounted for in the studies reviewed (28). They concluded that in some reports reliability was overestimated. Another review by Bright et al focusing on the validation of FVCs summarised that excessive duration reduces patient compliance, but too short a duration may produce unreliable measurements [(17)

The choice of diary duration may not only be based upon better validity or reliability but also on the possible behavioural therapeutic effect of keeping a diary (29-31). Recently, Bright et al have described the development of the first validated bladder diary for the assessment of LUTS in both male and female adults, using a psychometric validation methodology. The resulting bladder diary is recommended for use over a 3-d period and has been accepted as the ICIQ bladder diary. Urinary incontinence is assessed by the recording of pad use. The ICIQ bladder diary has been validated using a British English-speaking population and as with all such tools, will require cultural adaptation and linguistic validation for other languages using the formal ICIQ protocol (30, 31). The sample validated ICIQ bladder diary is illustrated with the instructions for use in Chapter 24.

In conclusion, voiding diaries generally give reliable data on lower urinary tract function. However, there remains a lack of consensus on diary duration and how well diary data correlate with some symptoms.

1.2.1 Bladder Diary Recommendations

1. Ask patients with urinary incontinence to complete a bladder diary to evaluate co-existing storage and voiding dysfunction. A bladder diary is recommended in order to document and communicate both objective information and to objectify observations by the patient during the diary period. Although never completely diagnostic, diary patterns may characterise normal and abnormal states. (Grade A)
2. A 1-day frequency volume chart (FVC) which includes the first morning void the following day is a reasonable tool to gain insight into voiding habits during normal daily routine. A 3-day FVC or diary is recommended for accurate assessment of LUTS and for confirming a consistent clinical pattern in day-to-day practice. For atypical clinical patterns or clinical research, a 7-day diary may be recommended (most pharmacological studies now employ a 3-day diary as a standard to improve patient compliance). (Grade C)
3. The validated ICIQ bladder diary is recommended for use over a 3-d period. The inclusion of the diary in research studies is recommended and will provide ongoing evidence of validation, as well as the external validity of the diary. (Grade A)

1.2.2 Future Research

- a) The ideal duration of a bladder diary based on accuracy, compliance, and the utility of the diary for diagnosis, the selection of therapy, and improving the outcomes of therapy requires further investigation.
- b) The utility of paper versus electronic methods of recording voiding patterns requires further research.
- c) The ICIQ bladder diary should be culturally and linguistically validated for other languages than British English and be included in research studies for further validation as well as determining external validity.

1.3. Urgency Scale

According to the IUGA/ICS definition urgency is : “Complaint of a sudden, compelling desire to pass urine which is difficult to defer” (2). However, in clinical practice, urgency is often accompanied by other symptoms. Urgency, with or without urgency incontinence, usually with frequency and nocturia, is the cornerstone symptom of overactive bladder syndrome (OAB) (32); while with bladder pain, and frequency urgency are typical symptoms of interstitial cystitis or bladder pain syndrome (33). However sometimes patients with lower urinary tract symptoms may not be able to differentiate between normal urge (desire) to void and urgency (difficult to postpone)(4), furthermore, with history only it may be difficult to define the severity, duration and frequency of urgency(34, 35). Thus, it is important to have appropriate tools that allow accurate diagnosis, to establish tailored therapy and to assess the effectiveness of treatment. Severity questionnaires and scales have been developed specifically to assess urinary urgency, to help the patient to define the symptoms and severity and the physician to establish the therapy and its effects. Table 2 and table 3 show the validated questionnaires and scales respectively, used to assess the urinary urgency.

Table 2: Questionnaires To Assess Urgency (35-38)

Questionnaire	Aim of tool	Items	Population sample	Reliability	Content Validity	Construct Validity	Concurrent Validity	Discriminant Validity	Responsiveness	GR
UPS (Urgency Perception Score) [35]	Grading the urgency to void and assessing the reason why individuals usually void	5	<i>Men</i> <i>Women</i> OAB + LUTS LUTS (without urgency) Healthy	Yes	Yes	Yes		Yes		B
UQ (Urgency Questionnaire) [36]	Severity of urgency and urge incontinence Impact of urgency and urge incontinence on the quality of life Discomfort of urgency with VAS scale	15 + 10 VAS	<i>Women</i> OAB	Yes	yes	Yes	Yes	Yes	Yes	A
USIQ-QoL (Urgency Severity and Life Impact Questionnaire-Quality of life) [37]	Impact of urgency on the quality of life	8	<i>Women</i> <i>Men</i> OAB	Yes	Yes	Yes .		Yes		B
USIQ-S (Urgency Severity and Life Impact Questionnaire: Severity Symptoms) [37]	Severity of urgency	5	<i>Women</i> <i>Men</i> OAB	Yes	Yes	Yes		Yes		B
UU Scale [38]	Monitoring efficacy treatment	10	<i>Women</i> <i>Man</i> • OAB	Yes		Yes			Yes	A

Table 3: Scales to assess the urinary urgency (39-43)

Scale	Aim of tool	Degrees of urgency	Population sample	Reliability Test-re test	Content validity	Construct Validity	Concurrent Validity	Discriminant Validity	Responsiveness	GR
UPS (Urgency Perception scale) [39]	Severity of urgency	3	<i>Men</i> <i>Women</i> OAB		Yes	Yes	Yes		Yes	B
IUSS (Indevus urgency Severity Scale) [40]	Severity of urgency per void The ability to complete actives	4	<i>Men</i> <i>Women</i> OAB with urge Incontinence	Yes	Yes	Yes	Yes	Yes	Yes	A
PPIUS (Patients' perception of intensity of urgency scale) [41]	Severity of urgency Urgency incontinence	4	<i>Men</i> <i>Women</i> Urgency Urge incontinence	Yes	Yes			Yes	Yes	A
USS (Urinary Sensation Scale) [42]	Severity of urgency	5	<i>Men</i> OAB+LUTS <i>Women</i> OAB		Yes	Yes	Yes	Yes	Yes	A
URS(Urgency Rating Scale) [43]	Severity of urgency	5	<i>Men</i>	Na	Na	Na	Na	Na		C

1.4. Urinalysis

"Urinalysis is a fundamental test that should be performed in all urological patients. Although in many instances a dipstick urinalysis provides the necessary information, a complete urinalysis includes both chemical and microscopic analysis." (44). Urine dipstick testing, as opposed to microscopy, is satisfactory for urinalysis in the diagnosis of acute uncomplicated cystitis (45, 46). In relation to urinary incontinence, dipstick urinalysis is not a diagnostic test, but a screening test, utilised to detect haematuria, proteinuria, glycosuria, pyuria and bacteriuria.

Haematuria can indicate important pathology such as urothelial carcinoma in situ, leading to lower urinary tract storage symptoms including incontinence (47). Glycosuria is relevant, as a potential indicator of diabetes mellitus. This can cause symptoms via several mechanisms including polyuria secondary to osmotic diuresis. Diabetic peripheral autonomic neuropathy affecting bladder innervation may be associated with impaired bladder emptying. The clinician should note that a patient does not generally demonstrate glucose into the urine until the blood glycaemia is >180 mg/dl. Consequently, a dipstick urinalysis may fail to reveal intermittently high sugars or mild diabetics. If diabetes is suspected, then a random or fasting blood sugar is preferred (48-50).

Pyuria and bacteriuria, detected from urinary dipstick leukocyte esterase and nitrite tests respectively, are important signs of urinary tract infection. The specificity and sensitivity of these latter tests for UTI is increased when used together compared to either individual test (50, 51). Even in the absence of controlled studies, there is general consensus that the benefits of urinalysis clearly outweigh the costs involved, although the use of urinalysis should always be associated with prognostic significance (52). A positive dipstick urinalysis will prompt formal urine microscopy and culture to detect UTI prior to antibiotic treatment and/or the use of additional tests such as endoscopy and urinary tract imaging.

Urinalysis negative for nitrite and leucocyte esterase reliably excludes UTI in people with UI (53) and should be included, with urine culture when necessary, in the evaluation of all patients with UI (Le1:GR A based on expert opinion). Urinary incontinence may occur during symptomatic UTI (level 3) (54) and existing UI may worsen during UTI (level 3) (55).

The importance of urinalysis in the basic assessment of patients with urinary incontinence and lower urinary tract symptoms is not dependent on gender, age or aetiology. Indeed, it has been recommended in the evaluation of geriatric patients including nursing home residents who are incontinent (56), in peri- and postmenopausal women (57), and in older women reporting urinary incontinence (58). In the latter context, it has even been observed that clinically significant urine samples can even be obtained from disposable diapers in elderly incontinent women (59). The clinical

relevance of asymptomatic bacteriuria (without pyuria) and pyuria (without bacteriuria) in the elderly is controversial as the rate and severity of UI was unchanged after eradication of asymptomatic bacteriuria in nursing home residents (level 2; Grade B) (56, 60, 61).

Recently, bacterial communities (microbiota) have been discovered in the female bladder and consequently, the sterile urine paradigm is no longer valid. Emerging evidence suggests that the female urinary microbiota may contribute to symptoms of urinary incontinence in women (62). Several bacterial species are more common in women with urgency urinary incontinence than in asymptomatic controls (63, 64). For these reasons new approaches are being developed: the 16s rRNA sequence analysis and the expanded quantitative urine culture protocol (64).

1.4.1 Urinalysis - Recommendation

1. It is considered standard to perform a urinalysis by either using a dipstick test or examining

the spun sediment in incontinent patients. (Level 4-Grade D)

2. If a dipstick test is used, it is recommended that a "multi-property" strip that includes

fields for haematuria, glucose, leukocyte esterase and nitrite tests be chosen. (Level

4 - Grade D) Dipstick is not as accurate as urine culture, being specific for infection but

not sensitive. (Level 2 - Grade C)

3. Additional tests available on urine dipstick strips, such as protein, bilirubin, ketones and

pH, may be helpful in the broader medical management of patients. However, they are

not essential in the context of evaluation of the patient with urinary incontinence or lower

urinary tract symptoms. (Level 4 - Grade D)

4. Do not routinely treat asymptomatic bacteriuria in elderly patients to improve urinary incontinence. (Level 2; Grade B)

1.4.2 Future Research

Emerging evidence challenges the long-held paradigm that the healthy bladder is sterile and evidence indicate that the human urinary tract contains microbial communities; however, the role of these communities in urinary health remains to be elucidated. Interesting findings suggest that previously undetected bacteria in the bladder of women may have a role in UI that will provide new opportunities for prevention and improvement in the treatment approaches for UI (65).

On this basis, traditional tools for urinary bacterial assessment (Urinary dipsticks and standard urine cultures) seem to have significant limitations because they are not able to detect slow-growing bacteria. New diagnostic tools are developing: expanded quantitative urine culture and 16S ribosomal RNA gene sequencing and could give allow a greater insight into many lower urinary tract disease including incontinence (66).

1.5. Post voiding residual in the female and male patient

Post-void residual (PVR) volume (also known as residual urine, bladder residual) is the amount of urine that remains in the bladder after representative voiding. It indicates poor voiding efficiency, which may result from a number of contributing factors. It is important because it may worsen symptoms and, more rarely, may be associated with upper urinary tract dilatation and renal insufficiency. Both bladder outlet obstruction and low bladder contractility contribute to the development of PVR. PVR measurement can be accomplished within a few minutes of voiding either by catheterisation or by calculation of bladder volume using a portable ultrasound scanner.

It is difficult to determine the normal value of post-void residual determination in the initial assessment of urinary incontinence since most studies with data on PVR have not been performed in patients with UI. However, the populations studied have included some women with UI, and incontinent patients with neurogenic bladder disease.

Several studies have compared volumes measured with portable ultrasound scanners versus catheterisation and found portable scanners to be 85-94% accurate (67, 68). A study has imaged the bladder volume after catheterisation and found that the volume of urine remaining in the bladder after catheterisation accounted for most of the difference between the two measurements (67). Bimanual palpation cannot reliably estimate the post-void residual urine volume (69). Since PVR may vary, one measurement of PVR may not be sufficient (70). PVR should probably be measured several times to increase its reliability. In geriatric patients, Griffiths et al found a significant variability in PVR measurement depending on the time of the day, with the greatest volume occurring in the morning (71). A non-representative PVR is particularly common if the patient's bladder is not full enough to yield an urge to void. Special consideration is required in male patients with incontinence and bladder outlet obstruction, in incontinent neurogenic patients who may demonstrate combined disorders of storage and emptying (72), and preoperatively in female patients being considered for incontinence surgery.

An increased PVR alone is not necessarily a problem, but if combined with high pressures it can lead to upper tract problems. If related to UTI's, PVR needs to be treated since UTI's cannot be eradicated in the presence of an infected residual. A significant PVR also decreases the functional bladder capacity

and thus contributes to urgency/frequency, urgency incontinence and nocturia. However, a Scandinavian study in nursing home residents found that an elevated PVR was not associated with bacteriuria and incontinence (73). Since recurrent UTI's [due to elevated PVR] can be associated with urinary incontinence it remains necessary to measure PVR in incontinent patients with UTI.

Review of the literature fails to show an evidence-based specific maximum PVR that is considered normal, nor is there a minimal PVR that is considered abnormal. The amount of residual urine that precludes treatment by various therapies has also not been determined. The AHCPR guidelines state that, in general, a PVR less than 50 ml is considered adequate bladder emptying and over 200 ml is considered inadequate emptying (expert opinion of the panel members) (74).

"Normal values" of PVR have been determined in several groups of non-incontinent and incontinent women. Gehrich et al studied 96 women (mean age 60 ± 11 yrs) that were seen in a well-women clinic. These women had no history of incontinence, retention, symptomatic prolapse or neurologic disorders. Most (97%) had a minor (asymptomatic) degree of prolapse, 80% were post-menopausal and 30% had had a hysterectomy. The median PVR was 19 ml (range 0-145 ml; mean 24 ± 29 ml); only 5% had PVR > 100 ml. Only, age > 65 yrs was associated with higher PVR. This study gives some indication on what might be considered normal or relatively normal (75). Tseng et al studied 107 women with urodynamic stress incontinence. They found a mean PVR of 62.5 ml by bladder scan and 38.5 ml by catheterization. Only 15.9% had a PVR greater than 100 ml. The PVR determined by bladder scan offered a sensitivity of 64.7% and a specificity of 94.3% in detecting PVR greater than 100 ml (76). Haylen et al studying women with lower urinary tract dysfunction found that 81% had a PVR of less than 30 ml (77). Fitzgerald et al studied women with urgency, frequency and urge incontinence: 10% had an elevated PVR of > 100ml. In these women with OAB, the following independent risk factors of increased PVR were found: vaginal prolapse, symptoms of voiding difficulty and absence of stress-incontinence (78). Lukacz et al found that only 11% of women with pelvic floor disorders had an elevated PVR (79). Wu and Baguley studied 319 consecutive patients (196 women, 123 men) in a sub-acute general, but predominantly geriatric, rehabilitation unit. 22 had been admitted with catheter and were excluded. Of the 297 "asymptomatic" patients, 21.5% had PVR volumes of 150 mL or more. Patients with elevated PVR (> 150 ml) were significantly more likely to have a urinary tract infection at admission and have urinary incontinence on discharge (80). Millemann et al retrospectively reviewed 201 women (mean age 55; range 20-90) who presented with complaints of urinary frequency, urgency and /or urge incontinence. 19% had an elevated PVR of more than 100 ml (mean 211 ml; range 100-997 ml). On multivariate analysis the following independent predictors

of raised PVR were identified: age > 55 yrs [OR 3.71], prior incontinence surgery [OR 4.32], a history of multiple sclerosis [OR 15.32] and pelvic organ prolapse grade 2 or greater [OR 3.61] (81). In summary, an elevated PVR > 100 ml was found in 5% of women visiting a well-women clinic, in 10-19% of women with OAB, in 11% of women with pelvic floor disorders and in 15.9% of women with urodynamic SUI. Overall, incontinent women have a slightly higher risk of elevated PVR compared to asymptomatic subjects. Does a significant PVR have an impact on the outcome of treatment in patients with incontinence? Nager et al studied the predictive value of urodynamic measures on stress continence outcomes after surgery for stress urinary incontinence. They found that urodynamic measures do not predict outcomes. However, since women with PVR > 150 ml were excluded in this study, one can only conclude that PVR volumes < 150 ml did not have an adverse impact on stress continence outcomes (82).

A PVR measurement is recommended in men with symptoms suggestive of bladder outlet obstruction. It is a well known clinical principle that chronic urinary retention can be associated with overflow incontinence [ischuria paradoxa]. Apart from this there are unfortunately insufficient data on the role of PVR and its significance in male urinary incontinence. Consequently, there are insufficient data to draw conclusions about the association of PVR and urinary incontinence in men as well as the association of PVR and the outcome of incontinence treatment in men.

In the geriatric patient, a PVR should always be measured since it decreases functional bladder capacity and contributes to urgency/frequency, urge incontinence and nocturia.

PVR should probably be measured several times to increase its reliability. In elderly patients, Griffiths et al found a significant variability in PVR measurement depending on the time of the day; the greatest volume occurred in the morning (71). Counter-intuitively, a Scandinavian study in nursing home residents was unable to show an association between an elevated PVR and bacteriuria and incontinence (73).

1.5.1 Recommendations

1. Varying degrees of decreased bladder emptying or urinary retention may be a cause of LUTS that are associated with symptoms of decreased urinary storage. The decision to perform a PVR in disease specific sub-groups of incontinent patients should be based on an association of the condition with poor bladder emptying (Grade D), whereas in individual patients this decision may be based on symptoms or physical findings. (Grade C)

2. Female patients who present with storage specific symptoms, with normal sensation and no complaints of decreased bladder emptying, and no anatomical, neurological, organ-specific, or co-morbid risk factors for retention may be assessed for bladder emptying by history and physical examination alone, depending

on the potential morbidity of the failure to diagnose and the nature of the intended therapy. (Grade B). Due to the increased possibility of bladder outlet obstruction due to prostatic obstruction being increased in the male patient, the threshold for investigating residual urine in the male is significantly lower (Grade D).

3. A PVR should be performed in incontinent patients when decreased bladder emptying is suspected, especially if treatments that decrease bladder contractility or increase outlet resistance are being considered. (Grade D)

4. Non-invasive ultrasound measurement of PVR is as accurate as measurement by catheterization and is therefore the preferred method. (Grade A)

5. A palpable bladder on physical examination is an indication for referral to a specialist (Grade D)

1.5.2 Future Research

1. Development of more specific indications for PVR testing for diagnosis and prior to instituting therapy based on history, physical examination, and disease specific findings.

2. Further development of low cost, minimally invasive, and accurate means of measurement of PVR that do not require catheterisation.

V. SPECIFIC POPULATIONS: EVALUATION OF THE FEMALE PATIENT

1. ESTABLISHING THE TYPE OF URINARY INCONTINENCE IN WOMEN

The aims of the assessment of women with urinary incontinence are the documentation and characterisation of type of incontinence, its timing and its severity, the differential diagnosis, prognosis evaluation and planning of treatment (83). The classification of subjective diagnosis of urinary incontinence into stress, urgency and mixed incontinence is basically clinical. Assessment should include history, symptom assessment, and physical examination. A careful urological history may be helpful to make a first subjective differentiation between the types of incontinence. In fact as shown in Holroyd-Leduc's meta-analysis (16) simple questions to diagnose stress or urgency urinary incontinence have high reliability in women, with the percent agreement between repeated questioning estimated at 90% for stress, urgency and mixed urinary incontinence sub-types (16). Further questioning on the frequency, severity of leakage and degree of bother, is essential for planning treatment and counseling of the women. The leakage should also be quantified if possible by using voiding diaries (84, 85), pad tests (the 1-hour pad test the most used)

(86), and evaluation of the number of pads used per day. Finally, a general history and medication review are helpful to classify the different types of incontinence into uncomplicated and complicated. The definition of complicated or uncomplicated SUI is not widely agreed. According to FIGO's consensus uncomplicated stress urinary incontinence (SUI) is UI without further storage symptoms, absence of voiding symptoms and without history of recurrent urinary tract infections (RUTI), no prior extensive pelvic surgery or prior surgery for stress incontinence and no medical conditions that can affect the lower urinary tract (87). Complicated SUI doesn't fulfil the uncomplicated SUI criteria (87). In a multicentre single nation database (88) SUI has been defined as uncomplicated when the presenting history of SUI has been present for at least 3 months, the post-void residual urine volume is < 150 ml, urinalysis or urine culture is negative and clinical assessment of urethral mobility, with an expressed desire for surgery for SUI, and a positive provocative stress test. Conversely complicated SUI has been defined as incontinence in women with previous surgery for incontinence, history of pelvic irradiation, pelvic surgery within the previous 3 months, and anterior or apical pelvic-organ prolapse of 1 cm or more distal to the hymen (88). Nevertheless several studies (11, 88) have shown that patient history alone is not completely accurate in determining the type of incontinence. Symptom assessment by validated questionnaires can provide a very helpful complement to the patient history, to assess the impact of urinary incontinence on quality of life, and the symptoms (89-93). In the literature there are no studies that prove the usefulness of physical examination to typify the urinary incontinence. However, it is recommended to identify risk factors as well as significant associated or underlying pathology, such as significant prolapse, obstruction, neurological disease and malignancy(16).

2. GENERAL MEDICAL HISTORY

The main goal of the general medical history in women with urinary incontinence is trying to identify all comorbidities that could initiate or worsen UI as well as those which could negatively impact treatment success. The main factors associated with urinary incontinence are: obesity(94) (95, 96), diabetes and other metabolic conditions (96), neuropsychiatric disorders (97-100) , heavy occupational work, smoking, previous pelvic surgery and constipation (100, 101)

Neurologic diseases, pelvic neoplasms (malignant or benign) and radiotherapy can also lead to incontinence. Therefore, a careful surgical history should be taken and specific attention should be given to pain and other neurological symptoms, especially over the sacral nerve dermatomes, which could suggest neurologic disease or an intrapelvic nerve entrapment.

Pelvic pain can also be associated with apical support defects, endometriosis or pelvic congestion syn-

dromes. The latter two can be associated with neurogenic urgency, depending on localization of lesions and varicosities, and require specific approaches.

Anorectal dysfunction, such as anal incontinence and obstructed defecation must also be carefully assessed and treated simultaneously, as these symptoms are strongly associated with urinary incontinence and may share a common aetiology and be associated with a pelvic support defect.

A careful surgical history should be taken, especially for pelvic surgery and other continence procedures, as the former can disrupt the endopelvic fascia (102) or result in intrapelvic nerve entrapment, thus generating secondary UUI (103) (104, 105). For recurrent SUI, there seems to be a trend for better results with retropubic and/or adjustable slings; however, there is still not enough data to recommend or refute any of the different management strategies for recurrent or persistent stress incontinence after failed suburethral tape surgery (105).

3. SYMPTOM ASSESSMENT

As classification of Urinary incontinence is clinical, a careful symptom assessment is mandatory and it is particularly important to plan the appropriate treatment. Furthermore, it is important to quantify the degree of leakage before and after therapy to evaluate the impact of the disease on quality of life, and to identify patients with complicated incontinence that need to be referred for specialised management (87). To achieve these objectives there are several tools including history and clinical assessment together with validated questionnaires, voiding diaries and pad tests. Many validated questionnaires have been developed to assist in the evaluation of urinary symptoms and to help in diagnosing the type of urinary incontinence (89-93). They may be used in combination with history and clinical examination. The International Consultation on Incontinence (ICI) has developed an ICI questionnaire (ICIQ) to assess pelvic floor function in both clinical practice and research settings (106, 107). It includes many modules about both female and male urinary symptoms or pelvic dysfunctions in particular urinary incontinence (ICIQ-UI). Franco et al (108) and Karantanis et al(109) showed that the short form (ICIQ-SF) correlates well with the 1-hour and 24-hour pad test for evaluation of the severity of SUI. The severity of SUI seems to be correlated to Intrinsic sphincter deficiency, although the diagnosis is possible only by urodynamic study (Urodynamic valsalva leak point pressure (VLPP) < 60 cm water believed to be diagnostic) (110).

The Modified Gaudenz-Incontinence questionnaire increases the likelihood of accurately diagnosing both stress and urge incontinence, however this questionnaire is validated only in the Japanese language (16) , while the Bladder Instability Discrimination Index (91) and Versi's questionnaire (111), although useful to diagnose urgency and stress incontinence, are

complex and sometimes not easily used in the practical clinical setting. The patient-completed Questionnaire for Urinary Incontinence Diagnosis(112) contains 6 questions, of which 3 are intended to predict stress incontinence and 3 are intended to predict urgency incontinence. It appears to increase the likelihood of correctly diagnosing urgency incontinence (positive LR, 3.7; 95% CI, 1.6-9.0; negative LR, 0.27; 95% CI, 0.17-0.42), but is not as helpful in the diagnosis of stress incontinence (positive LR, 2.8; 95% CI, 1.6-4.9; negative LR, 0.21; 95% CI, 0.12-0.37)(16). The Urogenital Distress Inventory (113), that is a widely used symptom tool, is a questionnaire helpful to assess LUTS bother, including incontinence, in women. The Questionnaire for Urinary Incontinence Diagnosis is a reliable 6-item questionnaire able to diagnose stress urinary incontinence and urgency urinary incontinence in a referral urogynecology patient population with accuracy (93). Overactive bladder symptom scores are also very useful for women with storage symptoms including urgency incontinence (32) (34-42) (114) (115).

4. PHYSICAL EXAMINATION (FEMALE)

The main objective of physical examination is to detect signs, defined as any abnormality indicative of disease or a health problem, detectable on examination of the patient; an objective indication of disease; or a health problem. No studies were found to support evidence that clinical examination improves care for diagnosing the type of urinary incontinence (UI) in women. Nonetheless, there is a wide consensus recommending clinical examination as an important part of assessing women with UI, including: abdominal, neurological, gynaecological and pelvic examination, with the purpose of detecting associated or underlying pathology that may explain lower urinary tract symptoms (LUTS). Height and weight should be recorded so that the body mass index can be calculated (Kg/M²) as obesity is an important risk factor for UI (112, 115, 116).

a) Abdominal examination. Observation of the abdomen may yield evidence of scars from previous surgery or abdominal striae. Increased abdominal striae may be found in association with other markers of abnormal collagen metabolism, and are more likely in patients with prolapse and stress incontinence (117, 118).

Bladder fullness or retention may be identified by abdominal palpation or by suprapubic percussion. In one study designed to look at the clinical utility of basic assessment in elderly women, palpable enlargement indicated a post-void residual volume of at least 300ml (119). Other abdominal masses or abdominal distension (e.g. ascites) can also be detected by abdominal examination. Tenderness or a mass in the renal area must be excluded by examination.

b) Neurological examination. Neurological signs related to S2-4 can suggest a possible neurogenic lower urinary tract or pelvic floor dysfunction. Saddle anesthesia will occur with lesions affecting S2-S4. Assessment of gait, abduction and dorsiflexion of the toes (S3) and sensory innervation to the labia minora (L1-L2), sole and lateral aspect of the foot (S1), posterior aspects of the thigh (S2), and cutaneous sacral reflexes bulbocavernosus and anal reflexes) are additional features of the neurological exam that may be assessed. A rectal examination will provide a subjective assessment of resting and voluntary anal tone (S2-S4). For patients with possible neurogenic lower urinary tract dysfunction, a more extensive neurological examination is indicated. In the elderly, full cognitive and mobility assessments are also recommended. An evaluation of hand dexterity should be performed when self-catheterisation is being considered as a treatment option for incontinence associated with chronic urinary retention.

c) Gynaecological examination (vulva and vagina). There are few scientific data documenting the parameters of a normal pelvic examination in women of various ages and with various obstetrical histories. The components of the examination have not been universally agreed upon. Gynaecological examination should include: inspection of the vulva, perineum and vagina, as well as vaginal palpation, with the evaluation of pelvic floor muscle tone, muscle mass and defects. The location of any vaginal pain should be noted and any tenderness over the course of the pudendal nerve. Bimanual pelvic examination is also part of the gynaecological examination, with the assessment of the size, location, and mobility of the uterus and the adnexal structures. Palpation of any pelvic mass or unusual tenderness is possible by vaginal examination together with suprapubic palpation.

Vulval inspection allows a description of the skin and the presence of any abnormal anatomical features (atrophic changes, scars, erythema of the vulva, lichen sclerosis, cysts, other tumors). With inspection of the external genitalia a urethral caruncle may be noted (a small, soft, smooth friable red outgrowth along the edge of the urethra) or urethral mucosa prolapse (smaller eversion of the urethral urothelium, generally involving the posterior lip).

Another important aspect of the examination is the observation of the perineal movement when the patient is asked to cough or Valsalva. This is a way to evaluate the pelvic floor muscles function. We can observe a perineal elevation as the inward (cephalad) movement of the vulva, perineum, and anus and a perineal descent as an outward (caudal) movement of the vulva, perineum, and anus. During cough or Valsalva maneuver the perineum should show a ventral movement due of the contraction of the pelvic floor muscles; a downward movement might indicate a weak pelvic floor.

With vaginal examination we obtain information of the vaginal length and mobility, presence of scarring

and/or pain, and level of oestrogenisation. Vulvar and vaginal atrophy (VVA) is a common condition and is a consequence of reduced oestrogenisation of urogenital tract that results in a loss of vaginal elasticity, dryness, decreased lubrication, with associated irritation, dyspareunia, and urinary symptoms (120). Vaginal atrophy can be treated with vaginal estrogen application and this should be considered as an adjunctive treatment in the management of common pelvic floor disorders in postmenopausal women (121, 122). A urethral diverticulum presenting as a palpable suburethral mass, can also be detected on vaginal examination. The most common finding is a tender anterior vaginal wall mass and if the sacculation communicates with the urethra, it may be possible to express a purulent exudate from the urethra. Occasionally, a stone may develop within the diverticulum. Many patients with urethral diverticula are asymptomatic and need no treatment although symptomatic patients report swelling of the urethra, recurrent cystitis, dyspareunia, urinary incontinence, urinary dribbling after passing urine and voiding difficulties (123-125).

d) Rectal examination. Anal sphincter tone and strength can be classified as good or poor, in the absence of any quantitative assessment. Ano-rectal abnormalities can be found by inspection and digital examination: hemorrhoids, fissure, intussusception; rectovaginal or anocutaneous fistula or tumor. Anal sphincter tear may be recognized as a clear "gap" in the anal sphincter. The presence or absence of fecal impaction may also be assessed.

e) Specialised tests for diagnosis UI in Women

Three special manoeuvres can be performed during the initial assessment of women with urinary incontinence: the stress test, the Q-tip test, and the pad test.

Stress Test. The stress test involves observation for urine loss when women, with a full bladder, are coughing forcefully or during a Valsalva manoeuvre. If the patient leaks with the onset of the cough and terminates with its cessation, the test is positive and confirms stress incontinence. It is an easy test to perform in a single visit and the results are immediately available. The stress test performed with coughing appears to be reliable. Reliability data are not available for tests performed using the Valsalva manoeuvre. This procedure can be performed while the patient is in the lithotomy position, if no leakage is observed, the test should be repeated in standing position [2]. A negative supine cough test does not exclude incontinence. Rimstad et al found that in the supine position only 49% of the women leaked during the stress test (126). Earlier studies have also found that the supine cough test has low sensitivity (127). A positive stress test is helpful in diagnosing the type of urinary incontinence. When stress incontinence is suspected by the symptoms, the cough stress test is the most reliable clinical assessment for confirming the diagnosis (128). When compared with multichan-

nel urodynamic studies, the cough stress test demonstrates good sensitivity and specificity for stress incontinence (129-131). A detrusor contraction may occasionally cause leakage during a stress test and thus the possibility of a detrusor overactivity. Kulseng-Hanssen et al have demonstrated that only 5 of 100 stress and mixed incontinent women had a detrusor contraction simultaneously with stress leakage, and in none was detrusor over-activity the sole cause of leakage (132). Lagro-Janssen et al noted that the presence of urgency incontinence in the absence of stress incontinence excluded the possibility of SUI and had a high specificity for the diagnosis of detrusor overactivity (DO) (133). Holroyd-Leduc et al. reviewed existing evidence on the diagnostic accuracy of the stress test for stress urinary incontinence (16). Results from the meta-analysis revealed that a positive stress test increases the likelihood of a diagnosis of stress urinary incontinence (summary LR, 3.1; 95% CI, 1.7-5.5), while a negative test result decreases the likelihood (summary LR, 0.36; 95% CI, 0.21-0.60).

The main limitations of this test is the variability in the intensity of cough and bladder volume. However, in women complaining of stress urinary incontinence, cough stress test is important as an objective measure to confirm the diagnosis, particularly when surgical treatment is planned.

Pad test. A pad test it is a non-invasive diagnostic tool, involving the continuous wearing of a continence pad for a set period of time. The objective of pad testing is to quantify the volume of urine lost by weighing a perineal pad before and after some type of leakage provocation. It is as an optional test for the evaluation of urinary incontinence, to distinguish continent, from incontinent women, but is not diagnostic of the type of urinary incontinence (134, 135). Holroyd-Leduc et al. reported that a positive pad test increases the likelihood of an incontinence problem (LR, 3.3; 95% CI, 2.0-5.4), while a negative pad test makes an incontinence problem much less likely (LR, 0.11; 95% CI, 0.05-0.27) (16). Price and Noblet have demonstrated that in women with symptoms of predominant stress urinary incontinence, the cough stress test is more reliable than the pad test (131). Pad tests can be divided into short term tests, usually performed under standardized office conditions, and long-term tests, usually performed at home for 24–48 hours. Pad tests are generally performed with a full bladder or with a fixed known volume of saline instilled into the bladder before beginning the series of exercises. Only the "1 hour pad test" has been standardized by the International Continence Society (ICS-pad test) (136). This short test is appropriate in routine evaluation of patients during initial evaluation, however it can be affected by many factors, if either the patient or physician have doubts about the accuracy of the initial test, evaluation should be extended by an additional hour or repeated. The 24-hr test is more reproducible than a 1-hr test, but longer testing requires more preparation and a greater commitment on the part of the patient. A pad weight gain >1 g is considered positive

for a 1-hour test, and a pad weight gain >4 g is positive for a 24-hour test. These values may need to be modified in situations of increased perspiration (137). There is wide variation in the pad weight gain in incontinent women participating in clinical trials. Although some studies have found high test-retest correlations in pad tests (136, 138), some other studies have reported low inter-subject and intra-subject reliability (139, 140). The correlation coefficient between total leakage during two long-term tests appears to exceed that of a standard 1-hour test (141, 142)

A pad test is a good instrument for evaluating severity of urinary incontinence, however, it is not a perfect "gold standard" for UI severity. A pad test should always be interpreted in conjunction with standard self-assessment questionnaires including the bother index. In the analysis of 1-hr pad test, an increase of 1–10 g is classified as representing mild incontinence, 11–50 g moderate and >50 g severe incontinence. Good correlation has been reported by Abdel-Fattah et al. between the self-assessment questionnaires and the 1-hr pad test (141). The King's Health Questionnaire showed a 96% sensitivity and 93% specificity of a 1-hr pad test in identifying incontinent patients(141). The good correlation between self-assessment questionnaires and 1-hr pad test, but not the 24-hr pad test supports the value in standardization. In addition there is also good correlation between the 24-hr pad test and the International Consultation on Incontinence Questionnaire—Short Form (ICIQ-SF) (109). The values for 24-hr pad test are classified as follows: Mild (4–20 g/24 hr), moderate (21–74 g/24 hr), and severe (>75 g/24 hr) incontinence (143). However these values have to be considered with caution and they may change depending on the sample characteristics (eg, proportion of women with more severe incontinence, etc). In another study comparing pad-weighting test with the Incontinence Severity Index (ISI), the mean pad-weights (grams per 24 hours, 95% confidence intervals), were : 7 for slight, 39 (26-51) for moderate, 102 (75-128) for severe, and 200 (131-268) for very severe UI. Spearman's correlation coefficient for pad weighing results and severity index was 0.58 ($p < 0.01$), and bother increased significantly with increasing severity (144).

The main limitation of the pad test as a diagnostic tool for UI is the value for the cutoff of a positive test and the inability to distinguish between types of incontinence. This limitation is especially important when this test is used as an outcome measure, when surgical treatment of stress urinary incontinence is evaluated, as these women can suffer "de novo" urgency urinary incontinence.

Q-tip test. Stress urinary incontinence (SUI) may be classified based on urethral mobility. Urethral hypermobility is associated with greater surgical success after suburethral sling placement. Assessment of urethral mobility is an essential part of pelvic examination in women with symptoms of SUI, especially when surgery is planned. The Q-tip test has traditionally been

used to assess the mobility of the urethro-vesical junction. The test involves placement of a lubricated cotton swab or Q-tip in the urethra to the level of the bladder neck while the woman is in the lithotomy position. The degree of rotation of the free end of the swab is then measured while the woman performs a Valsalva manoeuvre. The free end should remain horizontal if no anatomical defect is present. If the free end moves above the horizontal, urethral hypermobility is suspected, this can occur in patients with stress urinary incontinence. A straining angle of 30° or greater relative to the horizontal during Valsalva or cough has been considered clinically relevant and defined as hypermobility (145, 146). In a meta-analysis by Holroyd-Leduc et al. that examined the accuracy of the Q-tip test for diagnosing stress urinary incontinence, only two relevant studies met the inclusion criteria(16). Results of the analysis suggested that a positive Q-tip test does not accurately predict the diagnosis of stress urinary incontinence in women.

Although the Q-tip test is a useful tool, it may be uncomfortable for many women due to the insertion of a rigid cotton tipped swab into the urethra. The identification of visual examination tool to determine urethral hypermobility would help to eliminate this uncomfortable test. A study has compared the diagnostic accuracy of the Q-tip test with visual urethral mobility examination (VUME) and concluded that VUME is a diagnostic alternative to Q-tip test for the initial assessment of urethral hypermobility when performed by an experienced operator and is preferred by women(147). A recent publication comparing a vaginal swab test with the urethral Q-tip test has demonstrated that the vaginal swab test, with a cotton-tipped swab placed in the vagina 3 cm proximal to the external meatus in the midline at rest, is equivalent to the standard Q-tip test in measuring urethral mobility with less discomfort for patients (148).

Another noninvasive method to identify women with urethral hypermobility is translabial ultrasound (149, 150). This more specialised testing with pelvic floor ultrasound and other imaging techniques appears to be gradually replacing the Q-tip test for a more advanced assessment of bladder neck hypermobility, however they are limited to their cost, availability and special training required.

5. PELVIC ASSESSMENT: PELVIC FLOOR STRENGTH AND PELVIC ORGAN PROLAPSE

5.1. Assessment of Pelvic Floor Muscle Strength

Pelvic floor muscles (PFM) play an important role in continence and support of the pelvic organs. Voluntary pelvic floor muscle contraction and relaxation should be evaluated during the initial assessment. Pelvic floor muscle function can be clinically as-

essed by several different methods, including inspection, visual palpation, ultrasound, electromyography (EMG), dynamometry and manometry (151-154).

Due to the location of the PFM inside the pelvis, the evaluation of the PFM function is difficult only by observation. Vaginal palpation is an accepted method to evaluate muscle tone and strength and is perhaps the most accessible and valid measure of PFM function (155, 156). PFM contractility measured by digital vaginal palpation can be scored according to the Modified Oxford Scale (MOS)(157). According to the joint guidelines published by IUGA/ICS in 2010, pelvic floor muscle strength is qualitatively defined by the tone at rest and the strength of a voluntary or reflex contraction as strong, normal, weak or absent, or by a validated grading symptom (2). Any or all of the following factors can be assessed including muscle strength (static and dynamic), voluntary muscle relaxation (absent, partial, complete), muscular endurance (ability to sustain maximal or near maximal force), repeatability (the number of times a contraction to maximal or near maximal force can be performed), duration, coordination, and displacement. If possible, it is desirable to document findings for each side of the pelvic floor separately to allow for any unilateral defects and asymmetry. The ICS report into the standardization of terminology of pelvic floor muscle function and dysfunction (158) classifies the pelvic floor muscles according with the ability to contract in:

- a) Normal pelvic floor muscles: Pelvic floor muscles which can voluntarily and involuntarily contract and relax.
- b) Overactive pelvic floor muscles: Pelvic floor muscles which do not relax, or may even contract when relaxation is functionally needed, for example, during micturition or defaecation.
- c) Underactive pelvic floor muscles: Pelvic floor muscles which cannot voluntarily contract when this is appropriate (155) .
- d) Non-functioning pelvic floor muscles: Pelvic floor muscles where there is no action palpable.

The morphology and integrity of the pelvic floor muscles, including the puborectalis muscle, may be also assessed by palpating its insertion on the inferior aspect of the os pubis. If the muscle is absent 2–3 cm lateral to the urethra, i.e., if the bony surface of the os pubis can be palpated as devoid of muscle, an “avulsion injury” of the puborectalis muscle is likely (159). This finding is significantly associated with a reduction in MOS, as disconnection of a muscle from its insertion results in functional impairment. Studies in symptomatic women have showed an association between avulsion and reduced contractile strength (160, 161). All these studies demonstrated that MOS grading is strongly associated with subjective and objective measures of pelvic floor dysfunction, both clinically and sonographically, however it appears that MOS obtained by simple digital palpation might be a more valid measure of PFM contractile function than

ultrasound measures of tissue displacement (154, 162).

5.2. Assessment of Pelvic Organ Prolapse

Assessment of pelvic organ prolapse described in this section is in accordance with the joint guidelines produced by IUGA/ICS in 2016 (163, 164). Pelvic organ prolapse (POP) as a sign is defined as the descent of one or more of the anterior vaginal wall, posterior vaginal wall, the uterus (cervix) or the apex of the vagina (vaginal vault or cuff scar after hysterectomy). Urinary incontinence and pelvic organ prolapse are separate clinical entities that often coexist. It is important to assess pelvic organ prolapse in a woman with incontinence, because repair of one pelvic support defect without repair of concurrent symptomatic pelvic support defects can predispose to accentuation of unrepaired effects and new symptoms. Significant pelvic organ prolapse can obstruct voiding and defaecation. The term stress incontinence on prolapse reduction (occult or latent stress incontinence) describes the development of stress urinary incontinence after the reduction of co-existent prolapse by surgical repair or pessary insertion (163, 164).

The presence of any sign of POP should be correlated with relevant POP symptoms, commonly this correlation would occur when the prolapsed organ reaches the level of the hymen or beyond (165, 166). All examinations for pelvic organ prolapse should be performed with an empty bladder (and if possible an empty rectum). An increasing bladder volume has been shown to restrict the degree of descent of the prolapse (167). The choice of the woman's position during examination, e.g. left lateral (Sims), supine, standing or lithotomy is that which can best demonstrate POP in that patient and which the woman can confirm as the maximal extent she has perceived e.g. by use of a mirror or digital palpation (168). The degree of prolapse may be worse after a lengthy time in the upright position.

Pelvic organ prolapse staging. Each aspect of POP, uterine (cervical) prolapse, anterior vaginal wall (compartment), posterior vaginal wall (compartment), vaginal vault (cuff scar) prolapse can and should be subject to a clinical staging. The hymen always remains the fixed point of reference for prolapse description. According with the IUGA/ICS guidelines for POP in 2016 (163, 164) , the following stages are considered:

Stage 0: No prolapse is demonstrated.

Stage I: Most distal portion of the prolapse is more than 1 cm above the level of the hymen.

Stage II: Most distal portion of the prolapse is situated between 1 cm above the hymen and 1cm. below the hymen.

Stage III: The most distal portion of the prolapse is more than 1 cm below the plane of the hymen but everted at least 2cm less than the total length.

Stage IV: Complete eversion or eversion at least within 2 cm of the total length of the lower genital tract is demonstrate

Uterine/ cervical prolapse: Observation of descent of the uterus or uterine cervix.

Anterior vaginal wall (compartment) prolapse: Observation of descent of the anterior vaginal wall (compartment). Most commonly this might represent a bladder prolapse (cystocele). Higher stage anterior vaginal wall prolapse will generally involve descent of uterus or vaginal vault (if uterus is absent). Occasionally, there might be an anterior enterocele (hernia of peritoneum and possibly abdominal contents), most commonly after prior hysterectomy or reconstructive surgery.

Posterior vaginal wall (compartment) prolapse: Observation of descent of the posterior vaginal wall. Commonly, this would represent rectal protrusion into the vagina (rectocele). Higher stage posterior vaginal wall prolapse after prior hysterectomy will generally involve some vaginal vault (cuff scar) descent and possible enterocele formation. Enterocele formation can also occur in the presence of an intact uterus.

Vaginal vault (cuff scar) prolapse: Observation of descent of the vaginal vault (cuff scar after hysterectomy

Pelvic organ prolapse quantification (POP-Q). The need for an objective, site-specific method of quantifying and staging POP led to the design and validation of the POP-Q system. The original description of the POP-Q was by Bump et al in 1996 and is shown in figures 1, 2 and 3 (169) . This standardised system, which represents a reliable and internationally accepted tool for describing the anatomic position of the pelvic organs, has been validated in the dorsal lithotomy, standing, upright and lateral position(170-172).

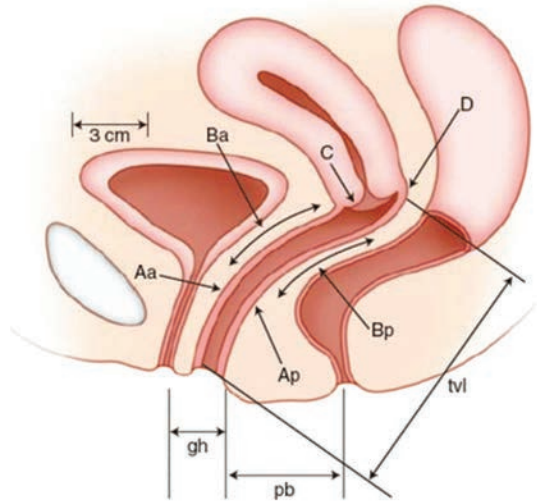

Figure 1: The six sites (Aa, Ba, C, D, Bp and Bp), the genital hiatus (gh), perineal body (pb) and total vaginal length (TVL) used cm above or proximal to the hymen (negative number) or cm below or distal to the hymen (positive number) with the plane of the hymen being defined as zero (0). Alternatively, a three by three grid can be used to organize concisely the measurements as noted in Figure 2.

Anterior wall	Anterior wall	Cervix or Cuff
Aa	Ba	C
Genital hiatus	Perineal Body	Total Vaginal Length
gh	pb	TVL
Posterior wall	Posterior wall	Posterior Fornix
Ap	Bp	D

Figure 2: Grid presentation of POP-Q measurements

The POP-Q records defects relative to the hymeneal remnants in centimetre gradients. These measurements are further staged according to the most distal defect. The POP-Q system for POP considers the anatomic position of six defined points (two on the anterior vaginal wall, two in the superior vagina, and two on the posterior vaginal wall) measurement are in centimetres (cm) above or proximal to the hymen (negative number) or cm below or distal to the hymen (positive number), with the plane of the hymen being defined as zero (0). For example, a cervix that protruded 3 cm distal to the hymen would be + 3 cm. All

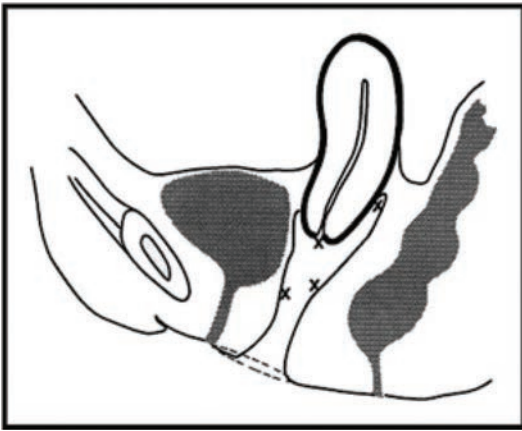

Figure 3: Simplified POP-Q

points are measured on maximal straining (except total vaginal length). The POP-Q as a system for quantitative prolapse description defines also other landmarks and measurements: The genital hiatus (GH) is measured from the middle of the external urethral meatus to the posterior margin of the hymen. The total vaginal length (TVL) is the length of the vagina (cm) from posterior fornix to hymen when Point C or D is reduced to its full normal position. The perineal body (PB) is measured from the posterior margin of the hymen to the mid-anal opening.

Anterior vaginal wall prolapse is defined as descent of the anterior vagina so that the urethra-vesical junction (a point 3cm proximal to the external urinary meatus) or any anterior point proximal to this is less than 3cm above the plane of the hymen. On vaginal examination, there is a loss of the transverse crease between the lower and middle thirds of the anterior vaginal wall and descent of the anterior vaginal wall. Anterolateral protrusion into the vaginal canal may represent unilateral or bilateral detachment of the pubocervical fascia along the anterolateral vaginal sulcus from its attachment to the arcus tendineus fascia pelvis (white line). Central protrusions of the anterior vaginal wall may represent defects in the pubocervical fascia below the trigone and base of the bladder. Advanced prolapse of the upper anterior vaginal wall may obstruct a well-supported bladder neck. The two anterior vaginal wall points are as follows:

Point Aa located in the midline of the anterior vaginal wall three (3) cm proximal to the external urethral meatus. By definition, the range of position of Point Aa relative to the hymen is -3 to +3 cm.

Point Ba that represents the most distal (i.e., most dependent) position of any part of the upper anterior vaginal wall from the vaginal cuff or anterior vaginal fornix to Point Aa. By definition, Point Ba is at -3 cm in the absence of prolapse and would have a positive value equal to the position of the cuff (Point C) in women with total uterine prolapse or post-hysterectomy vaginal eversion.

Prolapse of the apical segment of the vagina is defined as any descent of the vaginal cuff scar (after hysterectomy) or cervix, below a point that is 2cm less than the total vaginal length above the plane of the hymen. In some women, the intravaginal portion of the cervix may become elongated and cause the cervix to extend into the lower vaginal canal, simulating prolapse; however, the uterine fundus may have good support. In other women, the uterus may prolapse fully outside the hymen as uterine procidentia. Following hysterectomy, the vaginal cuff may be well supported or may prolapse fully outside the hymen, along with other vaginal segments. The two superior vaginal points are as follows:

Point C that represents either the most distal (i.e., most dependent) edge of the cervix or the leading edge of the vaginal cuff (hysterectomy scar) after total hysterectomy.

Point D that represents the location of the posterior fornix in a woman who still has a cervix. It is included as a point of measurement to differentiate suspensory failure of the uterosacral-cardinal ligament "complex" from cervical elongation. When the location of Point C is significantly more positive than the location of Point D, this is indicative of cervical elongation which may be symmetrical or eccentric. Point D is omitted in the absence of the cervix.

Posterior vaginal wall prolapse is defined as any descent of the posterior vaginal wall so that a midline point on the posterior vaginal wall 3cm above the level of the hymen or any posterior point proximal to this, less than 3cm above the plane of the hymen. Posterior protrusions into the vaginal canal are most commonly caused by defects in the recto-vaginal fascia allowing protrusions of the small bowel (enterocele) and/or rectum (rectocele). Normally, the anterior vaginal wall lies upon the posterior vaginal wall. Therefore, protrusions of the posterior vaginal wall can affect the function of the urethra and bladder that lie upon the anterior vaginal wall. For example, distal loss of support in the posterior segment may result in a bulge that compresses the urethra and affects voiding. The two posterior vaginal wall points are as follows:

Point Ap is located in the midline of the posterior vaginal wall three (3) cm proximal to the hymen. By definition, the range of position of Point Ap relative to the hymen is -3 to +3 cm.

Point Bp represents the most distal (i.e., most dependent) position of any part of the upper posterior vaginal wall from the vaginal cuff or posterior vaginal fornix to Point Ap. By definition, Point Bp is at -3 cm in the absence of prolapse and would have a positive value equal to the position of the cuff in women with total post-hysterectomy vaginal eversion.

The POP-Q system has not been widely adopted in clinical practice particularly by non-urogynaecologists; owing somewhat to difficulty in learning the assessment (173, 174). A simplified version of the POP-

Q was published by Swift in 2002, whereby the ordinal staging system of the original scale was retained (175). This is based on the POP-Q with similar ordinal staging but with only four points measured instead of nine. There is no Stage 0; it is combined with Stage 1. It is undertaken in the dorsal lithotomy position with patient forcefully bearing down, performing Valsalva or coughing. Four points used: Point Ba in the anterior vaginal segment (estimated around 3 cm proximal to hymenal remnants). Point Bp in the posterior vaginal segment (estimated around 3 cm proximal to hymenal remnants). Point C (cervix). The apex / posterior fornix is Point D in non-hysterectomized women and point C in hysterectomized. (Fig.3). The inter-observer correlation of the simplified POP-Q was investigated in a secondary analysis of data from a large multicenter study. Weighted kappa statistics for the four POP-Q sites ranged from 0.53 (indicating poor agreement) to 1.0 (denoting excellent agreement) (176, 177).

Despite the difficulties highlighted with the adoption of the POP-Q, reproducibility and reliability of the assessment system have been demonstrated (178, 179). Hall et al demonstrated that the examination could be completed within four minutes by new learners and two minutes by clinicians experienced with the assessment (70). With experienced practitioners, POP-Q staging performed using the measurement technique and estimation based on clinical examination are not significantly different (180). Parnell et al have described a POP-Q model in order to teach the POP-Q examination(181).

The relationship between anatomical defects measured by the POP-Q and lower urinary tract symptoms or other pelvic floor symptoms in women with pelvic floor disorders has been investigated and the symptom feeling of a bulge in the vagina is the only symptom that correlated with POP-Q in all vaginal compartments (182-185). A recent published study demonstrates that the sensitivity and specificity of this symptom were 60% and 83% when point Ba was 1 cm below the hymen. Whereas they were 55% and 83% when point C was 3 cm above the hymen (186).

The correlation between posterior compartment prolapse measured by POP-Q and obstructed defecation symptoms has been also investigated; the best-designed studies utilizing validated measures show a significant association between presence of posterior compartment prolapse and specific obstructed defecation symptoms, most significantly splinting, straining, and incomplete emptying (187, 188). A retrospective study by Collins et al showed that a point Bp value of >-5 on the POP-Q, was found to be strongly correlated with defaecatory dysfunction with symptoms of stool trapping and incomplete evacuation according with the CRADI-8 score(189).

The POP-Q has been used for the linguistic validation of condition specific health related quality of life questionnaires such as the Prolapse Quality of life (P-QOL) (190, 191), Pelvic Floor Distress Inventory

(PFDI)(192-194), Pelvic Organ Prolapse/Urinary Incontinence Sexual Questionnaire (PISQ12) (195), Pelvic Organ Prolapse/Incontinence Sexual Questionnaire, IUGA-Revised(PISQ-IR) (196-202), and validation of the Patient Global Impression of Improvement (PGI-I) for urogenital prolapse(202).

An advantage of the widespread adoption of the POP-Q system is the capability to compare results and surgical outcomes of different studies. The POP-Q has been used to define improvement in POP after surgical interventions in a number of studies; including vaginal mesh or abdominal mesh(203-236), laparoscopic techniques(237-240), colpocleisis(241-244), sacrospinous fixation(244-246), and collagen coated mesh repairs(247-249).

The quantification of POP using the POP-Q was compared with dynamic MRI; the results showed that correlations of the anterior compartment were good to moderate, compared with central and posterior compartment that were poor to moderate. Correlations were independent of the POP-Q staging measurements (250-253). The agreement of MRI-based POP staging with the POP-Q is excellent, but the added clinical value is questionable due to poor association with clinical findings and pelvic floor symptoms (251). The relationship between clinical assessment of female pelvic organ prolapse using the POP-Q and dynamic 2D transperineal ultrasound (TPUS) has been also investigated. It was observed that the accuracy of pelvic floor US staging was limited and that clinical assessment remains the gold standard(252). An observational study using POP-Q and pelvic ultrasound for the assessment of the type of cystocele, analysed the agreement between physical POP-Q and the Green radiological classification of cystocele. Kappa co-efficients ranged between 0.56-0.54 and 0.32-0.79 for clinical and ultrasound diagnosis respectively. The clinical utility of these findings has not been established(253, 254). A recent study compared clinical examination and imaging findings, especially regarding cut-offs for the distinction between normal pelvic organ support and prolapse. The conclusion was that the proposed cut-offs for 'significant prolapse' on ultrasound and POP-Q (Ba ≥ -0.5 and cystocele ≥ 10 mm below the symphysis pubis, C ≥ -5 and uterine position of 15 mm above the symphysis pubis, are plausible and mutually consistent (254, 255).

General recommendations in the female patient

A global evaluation for women is essential for an effective treatment and prevention of recurrence of UI, especially in patients with other comorbidities. Identifying and treating those symptoms are directly related of treatment success and resolution of symptoms, as well as their recurrence.

Pain and urgency must be carefully assessed, as they may indicate that incontinence can be secondary to a neurologic or other functional conditions.

Urethral mobility can be assessed using the Q-Tip test and predict success/failure of TOT.

A ring pessary test, VLPP and MUCP have been advocated to elucidate pelvic support-related incontinence/symptoms and predict the outcome of a surgical procedure, but their predictive values still need to be assessed.

VI. SPECIFIC POPULATION: EVALUATION OF THE MALE PATIENT

1. CHARACTERISTICS OF MALE LUTS

In the male population, Lower Urinary Tract symptoms (LUTS) may present with dysfunction of the storage and emptying phase as well as with post micturition signs or symptoms. These symptoms can be non-specific in presentation and are multifactorial in origin. LUTS are a progressive and age related but not sex or organ-specific. They cause significant bother and impair quality of life (256, 257). Traditionally LUTS were thought to be secondary to bladder outlet obstruction due to prostatic enlargement; however, recent scientific evidence failed to show this relationship(257). Often, LUTS are unrelated to changes in prostatic size. Current research is aimed at understanding the impact of the bladder itself in LUTS. Bladder dysfunctions, such as Detrusor Underactivity, Detrusor Overactivity and other functional abnormalities can contribute significantly to LUTS(258).

In vitro as well as in vivo animal studies show a correlation between oxidative stress and ischemia with changes in bladder contractility in animals(259, 260).

LUTS are strongly associated with ageing and represent a major health burden for the patient and the society. Several epidemiological reports have demonstrated that storage symptoms (including urinary urgency and urinary urgency incontinence) defined as overactive bladder syndrome also increases with age in men. LUTS are often under-diagnosed and undertreated and still unfortunately often accepted as part of ageing. In regards to urinary incontinence, epidemiological studies have shown that obesity is an independent risk factor for incontinence. Several studies indicated that each 5-unit increase in body mass index (BMI) above normal weight is associated with a 40% to 70% increased odds of urinary incontinence in a 5 to 10 yearstime period [296]. There is a gender disparity as the correlation between obesity and urinary incontinence is higher in women, with 60 to 70% of incidence of urinary incontinence among severely obese women. Although the incidence appears lower in men, is still quite relevant, as 24% of severely obese men have urinary incontinence(261). Obesity

is a potentially modifiable condition. A recent meta-analysis confirmed that weight loss is associated with a reduction on incidence and severity of urinary incontinence among women and men. Specifically, in male population, obesity appears to be more frequently associated with urgency incontinence(261).

Chronic prostatic pain syndromes (e.g. non-bacterial chronic prostatitis) and other pelvic floor dysfunctions can also present with a component of symptoms compatible with storage symptoms. In younger men, primary bladder neck dysfunction is a common cause of LUTS, with or without pelvic pain. Functional abnormalities of striated sphincter relaxation may also occur in young men. The complexity of the presenting symptoms and the various differential diagnoses mandate a thorough basic assessment of the lower urinary tract in men to plan optimal therapeutic intervention.

Recent epidemiologic studies and meta-analyses confirm a high prevalence of LUTS in the community. There is an increased prevalence of LUTS with ageing(262). The incidence appears to be of 3.5% in men in the fourth decade of life, while in men over age of 85 the incidence is higher than 30%. These epidemiologic data are confirmed by the finding that in the time period from 1992 to 2001 there was an increase of medical treatment for male LUTS from less than 2% to more than 10%. In the same time frame, there was also an increase in the time between the first diagnosis of LUTS and the time to surgery. The Multi-national Survey of the Aging Male (MSAM-7) surveyed over 12 000 men age 50 to 80 in mayor countries of Western Europe and USA [297]. Across all countries, prevalence increased from 22% in men aged 50–59 years to 45% in men aged 70–80 years . 31% of men reported moderate-to-severe LUTS (34% in the USA and 29% in Europe). Interestingly, despite the fact that 19% of men with LUTS present with complaints, only 10% received and appropriate medical treatment (263).

Based on the Integrated Health Care Information Solutions (IHCIS) database, LUTS are among the most frequent reasons for medical consultation among the male population over 50. The fourth most common diagnosis in this population is BPH, after coronary artery disease, hyperlipidemia, hypertension and diabetes mellitus(264).

LUTS have a significant impact on quality of life but also on potentially life-treating conditions such as falls in elderly population. As reported by Parsons et al. moderate and severe LUTS independently increase the 1-year risk of falls, particularly recurrent falls, in community-dwelling older men(265). In their study of 5,872 participants in the Osteoporotic Fractures in Men study were assessed for LUTS, using the AUA symptom score. Patients with moderate LUTS were found to have 11% higher risk of at least one fall, while the risk of fall increased to 33% in subjects with severe LUTS(265) . Falls in the elderly population

might have serious consequences and screening elderly patients for LUTS by primary care providers should be assessed routinely.

2. MALE INCONTINENCE

Improvement in early detection of prostate cancer has led to an increase of men treated for this condition. The rate of post-prostatectomy incontinence (PPI) is difficult to determine because of the varying definitions of incontinence, but approximately one in five men require the use of pads in the long term after radical prostatectomy (RP)(266). Incontinence has a significant negative impact on quality of life. This potential complication is also patients' greatest fear, especially in the youngest subset of patients (65 years or younger), requiring RP(267). Robot-assisted laparoscopic prostatectomy (RALP) was introduced with the aim of improving surgical outcomes, but controlled or randomized studies on the long-term effects are few and present knowledge of effectiveness is based mainly on case series or registry data(268).

The Swedish LAP PRO trial brings some very useful insights into answering the question of true incidence of PPI and whether there are any differences across techniques. In summary, this trial focused on the primary end point of urinary incontinence 12 months after RALP, as reported by the patients (to reduce the potential bias of Surgeon-Patient relationship)(269). Notably, this study recruited only patients for high volume surgeons, those with more than 100 procedures done, to avoid the bias of the single surgeons learning curve. The study recruited 4000 patients and the final analysis included 2625 patients. 778 patients underwent an open retropubic radical prostatectomy (RRP) and 1847 underwent RALP. The study showed that patients classified as having urinary incontinence ranged from 20% to 56% after RRP and from 21% to 57% after RALP. The percentage of incontinence was even higher if a definition of dryness was combined with no use of pads and zero leaks(269).

Catalona et al. showed that incontinence after prostate surgery was primarily dependent on the age of patients(270). The older the patient, the more likely he is to be incontinent and to never regain urinary control. For 40-49 year olds only 3% (12/358) had long term incontinence but that increased to 8% (48/632) in 50-69 year olds 8% (48/632) and 13% (38/282) in men over age 70; for an overall prevalence of 7.7%(270).

Special consideration is needed for irradiated patients as the success rate and incidence of post incontinence surgery differ significantly from non-irradiated patients. The revision rate of Artificial Urinary Sphincter (AUS) surgery, a procedure done for PPI, was significantly higher in irradiated versus non irradiated men (mean 37.3 versus 19.8%; $p < 0.007$) after a mean follow-up of 38.4 months(271). Revision is typically performed for infection, erosion or urethral atrophy. Persistent urinary incontinence was also

more than twice as likely in irradiated versus non-irradiated men (29.5 versus 12.1%; $P = 0.003$) with an odds ratio of 2.08(271). Radiation induced changes involving the bladder neck and urethral tissue, such as fibrosis, are considered to be the primary etiology for the development of incontinence. Surprisingly, the timing of radiation therapy does not seem to have any influence on the incidence of urinary incontinence. Similar rates of incontinence are reported in early and late radiation therapy after radical prostatectomy. Sowerby and colleagues reported the incidence of urinary incontinence to be 24.5% in men who underwent radiation less than 6 months from surgery and 23.3% in men with radiation greater than 6 months after prostatectomy(271).

Urgency incontinence is a failure of bladder storage usually due to the underlying pathology of detrusor overactivity (DO). Urgency incontinence commonly presents as part of the overactive bladder (OAB) syndrome. OAB is described as urinary urgency, with or without urgency incontinence, usually with frequency and nocturia, in the absence of infection or other obvious pathology [1]. In men, OAB symptoms often co-exist with emptying phase LUTS. Men with emptying phase LUTS such as poor flow and hesitancy are often assumed to have benign prostatic obstruction, though research has shown they may not.

3. SYMPTOM ASSESSMENT

Symptom assessment in men with incontinence should identify and exclude patients with complicated incontinence, who need to be referred for specialised management. Complicated incontinence comprises patients with recurrent incontinence after failed previous surgery, with total urinary incontinence, and/or with associated symptoms such as pain, haematuria, recurrent urinary tract infection, voiding symptoms, and/or a history of previous pelvic radiotherapy or radical pelvic surgery(272).

Because the occurrence of LUTS in men does not necessarily indicate concomitant prostate enlargement and/or obstruction, specific modalities should be used to ascertain the potential for the aetiological role of these entities. A variety of symptom scores have been described to assess male patients with LUTS. It is important that symptom scores have a wide applicability across a number of different cultures and languages. Ideally, symptom scores should also help to determine the underlying etiology of LUTS (for example, BOO, DO, impaired detrusor contractility); however, this is made difficult by the fact that different conditions can produce similar or even identical symptoms. Each symptom score has advantages and disadvantages, but it is clear that the worldwide use of such scores has helped in evaluating symptoms, treating patients, and communicating findings globally. Symptom scores have been used in male LUTS for a variety of the purpose. 1) to assess

symptom severity, 2) to examine the relationships between clinical measure/ test results and scores from symptom and quality of life (QOL) questionnaires, 3) to predict to treatment, 4) to assess the outcome of treatment.

The following symptom scores for male LUTS have been evaluated.

Table 4 Symptom Questionnaires for Male-LUTS

The IPSS: symptoms and QOL impact of LUTS
The International Consultation on Incontinence Modular Questionnaire-Male-LUTS (ICIQ-MLUTS): symptoms of LUTS and urinary incontinence
The Danish Prostatic Symptom Score (DAN-PSS): symptoms of LUTS and urinary incontinence
The OAB Symptom Score (OABSS)
The core LUTS Score (CLSS): symptoms of LUTS
The Urgency and Nocturia Scoring TOOL (UWIN): symptoms of LUTS

Three questionnaires with a high level of psychometric validity and reliability are the IPSS, the ICS's ICS-male questionnaire (now known as the ICIQ-MLUTS), and DAN-PSS. Although each was designed with the same purpose, only six symptoms are common to all three, including incomplete emptying, urgency, decreased stream, frequency and nocturia.

In men, the American Urological Association symptom score for BPH (AUA-7) is most commonly used in North America for assessment of subjective symptoms. However, equally reproducible data can be obtained from the International Prostate Symptom Score (IPSS)(273), the ICSmale questionnaire (now renamed the ICIQMLUTS, long and short forms, as part of the ICIQ modular questionnaire: www.iciq.net).

The IPSS has been the most widely used (in many countries and languages), but one of the major criticism of the IPSS is the fact that it is not disease or condition specific. In addition, it neglects the symptom of urgency incontinence, a symptom that produces significant bother. Urgency incontinence is an important symptom, particular in regard to therapeutic outcome in BPO patients. The prevalence of this symptom was also reported as common by the ICS-“BPH” study group and was higher in men with BOO than in those without (274).

ICIQMLUTS (ICSmale-SF) is slightly longer (14 questions), but takes into account the symptom of urgency incontinence, and in fact may be divided into voiding (ICS-male-VS) and incontinence (ICS-male-IS) subscores (275). Thus, it is particularly a questionnaire for assessment of the occurrence and bothersomeness of a wide range of LUTS in man. However, to date, it has not been as widely used as the IPSS, but may be more widespread use as part of the ICIQ Modular Questionnaire.

As the concept of OAB has become widespread, a simple symptom questionnaire to quantitatively assess OAB symptoms, the OABSS, was developed and psychometrically validated. Overactive bladder symptom scores are also very useful for male patients with storage symptoms including urgency incontinence(276, 277). Other new symptom questionnaires to assess male-LUTS include UWIN and the CLSS.

Ten LUTS (increased daytime frequency, nocturia, urgency, urgency incontinence, stress incontinence, slow urinary stream, straining, a feeling of incomplete emptying, bladder pain, and urethral pain) were selected as core symptoms from 25 LUTS defined by the ICS committee, and symptom questionnaire to assess the core symptoms we developed as the CLSS (277). Symptoms were scored according to their frequency and severity. The CLSS questionnaire was confirmed to show good test-retest reliability. The CLSS was compared with IPSS in men with LUTS, and it was suggested that the CLSS is more comprehensive than IPSS for symptom assessment of men various diseases and conditions (278). The CLSS provides overall assessment of relevant symptoms without omission, and may be useful for new patients, patients with multiple diseases, and patients without a definite diagnosis, as well as before and after intervention that may cause other symptoms.

Among LUTS, urgency, nocturia, and hesitancy are most bothersome, whereas weak stream, urgency, and frequency are the most prevalent in pooled populations being evaluated for BPH(279). Postmicturition dribbling is often provoked by an obstructing disease such as BPH or urethral stricture but can also be a symptom of a urethral diverticulum. As yet there is no validated symptom questionnaire that assessed post-micturition symptoms (post-micturition dribble and post-micturition incontinence).

To determine the cause of post-prostatectomy incontinence, many studies have stressed the lack of reliability of symptoms and emphasized the important role of urodynamic testing(280, 281). Nevertheless, valuable information can be gained from a careful history with regard to incontinence, especially when related to sphincter dysfunction. The symptom of stress incontinence is highly predictive of the presence of sphincter dysfunction. Chao and Mayo found that 67 of 71 men with post-prostatectomy incontinence secondary to sphincteric dysfunction complained of the symptom of stress incontinence(282). Similarly, Ficazzola and Nitti found 95% positive predictive value and a 100 % negative predictive value for symptom of stress incontinence(283). Urgency incontinence as a predictor of bladder dysfunction doesn't seem to be as valuable, and the presence of bladder dysfunction cannot be determined accurately without urodynamic testing(282, 283).

An important aspect of the assessment of male incontinence should be a description of the type and severity of incontinence and precipitating events, Severity

may be determined by the number of episodes per day, the need for protection (e.g., pads, penile clamp, external catheter), and the impact of incontinence on activities of daily living. Bladder diaries and pad tests can quantify severity.

A bladder diary (or frequency volume chart) kept for 3 to 5 days may be useful in almost all male patients, especially in those with OAB. The time and voided volume are recorded for each micturition during several 24-hour periods. Bladder diary completion by the patient provides useful evidence about the normal urinary habits of the patient, including giving some estimate of bladder capacity and diurnal and nocturnal frequency, urgency and stress incontinence. It also helps to identify patients with nocturnal polyuria or excessive fluid intake which are common in the aging male. The data obtained from frequency-volume chart provide a strong correlation to cystometric capacities and are reasonably immune to the effect of detrusor overactivity in men with LUTS(284).

The 24 hour pad test is an excellent test to quantitate the amount of urine leakage in men. Since most patients use different size and type of pads, it is difficult to compare number of pad/day per patient. Furthermore, some patients are very disturbed by any leakage at all and change the pad very frequently, before they are saturated. The other distinction to be made is between a safety pad and true urinary incontinence. In general, the each 1g weight equals 1 ml urine loss. It is proposed to use a cut-off value of 250 g of urine to categorize minor from more troublesome or severe leakage(285). Recently, Machold et al. suggested that the technical feasibility of the 20-min pad test to evaluate post-prostatectomy incontinence was excellent. The results correlated significantly with both the self-assessment via questionnaire ($r = 0.63$; $p < 0.001$) and the 1-hour pad test (ICS; $r = 0.66$; $p < 0.001$). Moreover, it was highly reliable ($r = 0.74$; $p < 0.0005$) with excellent patient acceptance (286).

4. PHYSICAL EXAMINATION

The assessments focus on general physical examination, digital rectal examination (DRE) and neurological testing of the perineum and lower extremities.

In a general physical examination, specific attention should be placed on the evaluation of surgical scars, the presence or absence of a distended bladder and excoriation of the genitals secondary to urinary incontinence. Abdominal palpation should be performed to evaluate bladder distension, especially in elderly incontinent men, who may have overflow leakage due to obstruction. In patients suspected of urinary retention, post-void residual volume should be measured. The examination should also include external genitalia, location of the urethral meatus, retractability of the foreskin and evidence of congenital malformation. The evidence of urethral discharge after abdominal straining (a Valsalva manoeuvre) or coughing in ei-

ther the supine or upright position should be evaluated so that the presence of stress incontinence can be ascertained.

A focused neurological examination is also highly recommended. In a patient suspected of neurogenic bladder, evaluation of perineal sensation and lower extremity neuromuscular function, and anal sphincter tone, which is often decreased in neurogenic patients is important (287). A focused neurogenic examination should also assess the patient's general mental status and ambulatory status.

DRE should include palpation of the prostate to assess size, symmetry and consistency of the gland and its relation to the pelvic sidewall and the rectum. Enlarged, indurated and painful prostate may imply BPH, prostate cancer and prostatitis, respectively. The locally advanced prostatic cancer can also produce OAB-like symptoms including incontinence. DRE may exclude prostatic cancer, although its specificity and sensitivity is low(288). The DRE is 53% sensitive and 85% specific for identifying underlying prostate cancer when abnormalities (i.e. induration or nodule) are present(289). Furthermore, abnormal rectal tone can raise suspicion of an occult neurogenic disorder that may be contributing a patient's symptoms. DRE tends to underestimate the true prostatic size: if the prostate feels large by DRE, it usually also is found to be enlarged by ultrasound or other measurement technique(290, 291). Prostate volume has been associated with the risk of BPH progression (292) and response to treatment (293). It has been reported that men with BPH with idiopathic detrusor overactivity showed a significantly higher incidence (54%) of intravesical protrusion of the prostate(294). This finding suggests that intravesical protrusion may in some way increase afferent impulses from the prostate and alter the stability status of the bladder. Occasionally tumors of the anal canal can be diagnosed while performing DRE of the prostate.

4.1. Urinalysis and Urine Cytology

All patients undergoing an evaluation for LUTS due to BPH should have a urinalysis performed to evaluate for UTIs or other uropathology. The most significant findings would include evidence for pyuria, bacteriuria, and/or hematuria. Bladder cancer, carcinoma in situ of the bladder, urinary tract infections, urethral strictures, and bladder stones can cause OAB-like symptoms including incontinence in aged men. Although haematuria or pyuria is not universally present in those conditions, urinalysis is important to rule out these conditions. Urinalysis is not a single test; complete urinalysis includes physical, chemical, and microscopic examinations. Dipstick urinalysis is certainly convenient but false-positive and false negative results may occur. It is considered an inexpensive diagnostic test able to identify patients with urinary tract infection as indicated by the presence of leucocyte esterase and nitrites. A substantial proportion of older patients with chronic OAB-like symptoms have significant bacteriuria, sometimes accompanied by

pyuria. In men, recent urinary tract infections were associated with OAB without urgency incontinence (prevalence ratio=2.9; 95% CI: 1.6-5.0) (295). However, infection may exist in the absence of pyuria and, in the elderly population, pyuria may develop in the absence of urinary tract infection.

Microscopic haematuria can be easily identified by dipsticking because of the presence of haemoglobin. The detection of haematuria is important because the condition is associated with a 4-5% risk of diagnosing urological disorder or malignancy within 3 years.

A systemic review and economic evaluation of diagnostic tests and algorithms used to investigate hematuria concluded that the evidence based on which to determine the ideal means of investigating hematuria was insufficient(296). However, because of the high prevalence of urinary tract infection and the increase of LUTS in the presence of urinary tract infection, various guidelines on the management of patients with LUTS suggestive of BPO, and urinary incontinence, endorse the use of urinalysis in primary care management (297, 298).

Urine cytology is also recommended in male patients with haematuria and a predominance of storage symptoms, especially with a history of smoking or other factors, to aid in the diagnosis of bladder carcinoma in situ and bladder cancer

4.2. Measurement of the Serum Creatinine

Epidemiological studies in community dwelling men have shown the absence of any association between BPO/BPE and chronic kidney disease(297, 299) suggesting that screening for renal function is not justified in male patients. Diabetes and arterial hypertension appear to be the most important causes of elevated serum creatinine in men with BPH and renal failure(297). Data from the MTOPS study showed that the risk of developing de novo renal failure in men with LUTS is low (less than 1 %) suggesting that is not necessary to monitor renal function in patients with LUTS / BPO(292). However, a study examining the association between(299) LUTS and glomerular filtration rate (GFR) in men concluded that in older men without obvious enlargement of the prostate, as LUTS became more severe, GFR fell (300).

4.3. Measurement of the Serum Prostatespecific Antigen (PSA)

In most patients, a normal DRE may be sufficient to exclude locally advanced cancer as a cause of LUTS or OAB. There is no consensus as to the measurement of prostate specific antigen (PSA) in patients with LUTS. The rationale for measuring PSA is twofold: to screen for prostate cancer [337] and to measure a parameter with prognostic value for the progression of BPH and the response to treatment [328,329]. Because prostatic cancer is one of the potential causes of LUTS or OAB in men, PSA (together with DRE) is a relatively sensitive way to exclude prostatic cancer as a diagnosis(301, 302). PSA measurement

is recommended in men with LUTS and a life expectancy of over 10 years in whom the diagnosis of prostate cancer would change the management of patient's symptoms. Given the uncertainties surrounding prostate cancer detection physicians must use clinical judgment in determining which patients should or should not undergo transrectal ultrasonography and prostate biopsy in response to a particular PSA (303).

However, it is important to understand that about 25% of men with BPH have a serum PSA greater than 4 ng/ml. Because of the overlap between serum PSA values in men with BPH and those with clinically localised prostate cancer, other parameters (PSA velocity, free/total PSA ratio, complexed PSA and PSA density) will assist diagnostic specificity (304, 305). It has been suggested that a relationship between initial PSA level and subsequent prostate cancer detection with a stepwise increase in cancer detection rate (from <1% to 58%) in patients with <1.0 ng/ml, 1.1-2.5, 2.6-4.0, 4-1-10.0 and >10 ng/ml PSA value in over 26,000 patients enrolled in a screening program(306, 307). In addition, Thompson reported data on prostate cancer prevalence from the prostate cancer prevention trial (307) confirming a stepwise increase in the risk of having a prostate cancer in patients with serum PSA from 0.5 to 4.0 ng/ml but showing the limitation of the current threshold of 4.0 ng/ml. Change of PSA threshold from 4.0 to 2.0 ng/ml has been proposed but currently no consensus exists (308).

In addition, serum PSA is a reasonable predictor of prostate volume in men with LUTS and can be used in this capacity in clinical decision making(303). It has been reported that the role of IPSS score in the assessment of BOO is questionable, and that the grade of obstruction is more related to prostate volume, PVR, and Qmax(309). It has been demonstrated that moderate-to-severe LUTS in men can result in urinary retention. The incidence of retention in men with untreated LUTS in community-based trials is 6.8 per 1000 during longitudinal follow-up of 4 years(310). If only patients with moderate-to-severe symptoms are considered, the rate of retention increases to 25 per 1000(311). In a meta-analysis of predictors of retention in pooled groups of placebo patients from clinical trials of men with LUTS undergoing active interventions (4300 patients), Roehrborn et al. found PSA and prostate volume to be strong independent predictors of urinary retention and the need for surgery in men with LUTS followed up longitudinally in clinical trials (291, 312).

Laniado et al have also tested the hypothesis that PSA level could be used to predict the presence or absence of BOO, evaluated by pressure flow studies (313). In patients with LUTS, those with a PSA more than 4 ng/ml are significantly more likely to have some degree of BOO. Conversely patients with PSA less than 2 ng/ml have a 33% risk of BOO.

Recommendations

A variety of symptom scores have been described to assess patients with Male-LUTS. The IPSS, ICIQ-MLUTS, and DAN-PPS have been the most tested and were found to be reproducible, valid, and sensitive for initial assessment. (Level 2). However, the IPSS neglects the symptom of incontinence.

Urinalysis is recommended in patients with male-LUTS. There are currently insufficient evidences to recommend routine measurement of serum creatinine and post-void residual urine in male patients with incontinence.

In addition to DRE, PSA measurement is recommended in selected male patients with OAB.

Future Research

1. Improve the understanding of the underlying pathophysiology and contributory clinical factors involved in the development and treatment of detrusor overactivity in the male patient, especially in differentiating the condition from female patients.
2. Development of simple, non-invasive, cost-effective methods to determine the contribution of bladder storage and bladder emptying abnormalities in male patients.

REFERENCES

1. Abrams P, Cardozo L, Fall M, Griffiths D, Rosier P, Ulmsten U, et al. The standardisation of terminology of lower urinary tract function: report from the Standardisation Sub-committee of the Inter-national Continence Society. *Neurourol Urodyn.* 2002;21(2):167-78.
2. Haylen BT, de Ridder D, Freeman RM, Swift SE, Berghmans B, Lee J, et al. An International Urogynecological Association (IUGA)/International Continence Society (ICS) joint report on the terminology for female pelvic floor dysfunction. *Neurourol Urodyn.* 2010;29(1):4-20.
3. Weiss JP, Wein AJ, van Kerrebroeck P, Dmochowski R, Fitzgerald M, Tikkinen KA, et al. Nocturia: new directions. *Neurourol Urodyn.* 2011;30(5):700-3.
4. Cartwright R, Cardozo L. Usage of International Continence Society standardized terminology: A bibliometric and questionnaire study. *Neurourol Urodyn.* 2010;29(8):1373-9.
5. Tikkinen KA, Johnson TM, 2nd, Tammela TL, Sintonen H, Haukka J, Huhtala H, et al. Nocturia frequency, bother, and quality of life: how often is too often? A population-based study in Finland. *Eur Urol.* 2010;57(3):488-96.
6. Kim SO, Choi HS, Kim YJ, Kim HS, Hwang IS, Hwang EC, et al. Impact of nocturia on health-related quality of life and medical outcomes study sleep score in men. *Int Neurourol J.* 2011;15(2):82-6.
7. Vaughan CP, Eisenstein R, Bliwise DL, Endeshaw YK, Nagamia ZJ, Wolf RA, et al. Self-rated sleep characteristics and bother from nocturia. *Int J Clin Pract.* 2012;66(4):369-73.
8. De Wachter S, Hanno P. Urgency: all or none phenomenon? *Neurourol Urodyn.* 2010;29(4):616-7.
9. Bower WF, Whishaw DM, Khan F. Nocturia as a marker of poor health: Causal associations to inform care. *Neurourol Urodyn.* 2016;[Epub ahead of print].
10. Bosch JL, Everaert K, Weiss JP, Hashim H, Rahnama'i MS, Goessaert AS, et al. Would a new definition and classification of nocturia and nocturnal polyuria improve our management of patients? ICI-RS 2014. *Neurourol Urodyn.* 2016;35(2):283-7.
11. Summitt RL, Jr, Stovall TG, Bent AE, Ostergard DR. Urinary incontinence: correlation of history and brief office evaluation with multichannel urodynamic testing. *Am J Obstet Gynecol.* 1992;166(6 Pt 1):1835-40; discussion 40-4.
12. Jensen JK, Nielsen FR, Jr, Ostergard DR. The role of patient history in the diagnosis of urinary incontinence. *Obstet Gynecol.* 1994;83(5 Pt 2):904-10.
13. Martin JL, Williams KS, Sutton AJ, Abrams KR, Assassa RP. Systematic review and meta-analysis of methods of diagnostic assessment for urinary incontinence. *Neurourol Urodyn.* 2006;25(7):674-83; discussion 84.
14. Lucas MG, Bosch RJ, Burkhard FC, Cruz F, Madden TB, Nambiar AK, et al. EAU guidelines on assessment and nonsurgical management of urinary incontinence. *Eur Urol.* 2012;62(6):1130-42. Erratum in: *Eur Urol.* 2013 Jul;64(1):e20.
15. Van Kerrebroeck P, Abrams P, Chaikin D, Donovan J, Fonda D, Jackson S, et al. The standardization of terminology in nocturia: report from the standardization subcommittee of the International Continence Society. *BJU Int.* 2002;90 Suppl 3:11-5.
16. Holroyd-Leduc JM, Tannenbaum C, Thorpe KE, Straus SE. What type of urinary incontinence does this woman have? *JAMA.* 2008;299(12):1446-56.
17. Bright E, Drake MJ, Abrams P. Urinary diaries: evidence for the development and validation of diary content, format, and duration. *Neurourol Urodyn.* 2011;30(3):348-52.
18. Tannenbaum C, Corcos J. Outcomes in urinary incontinence: reconciling clinical relevance with scientific rigour. *Eur Urol.* 2008;53(6):1151-61.
19. Homma Y, Ando T, Yoshida M, Kageyama S, Takei M, Kimoto K, et al. Voiding and incontinence frequencies: variability of diary data and required diary length. *Neurourol Urodyn.* 2002;21(3):204-9.
20. Quinn P, Goka J, Richardson H. Assessment of an electronic daily diary in patients with overactive bladder. *BJU Int.* 2003;91(7):647-52.
21. Rabin JM, McNett J, Badlani GH. Computerized voiding diary. *Neurourol Urodyn.* 1993;12(6):541-53; discussion 53-4.
22. Rabin JM, McNett J, Badlani GH. A computerized voiding diary. *J Reprod Med.* 1996;41(11):801-6.
23. Rabin JM, McNett J, Badlani GH. "Compu-Void II": the computerized voiding diary. *J Med Syst.* 1996;20(1):19-34.
24. Brown JS, McNaughton KS, Wyman JF, Burgio KL, Harkaway R, Bergner D, et al. Measurement characteristics of a voiding diary for use by men and women with overactive bladder. *Urology.* 2003;61(4):802-9.

25. Palmaes Hansen C, Klarskov P. The accuracy of the frequency-volume chart: comparison of self-reported and measured volumes. *Br J Urol.* 1998;81(5):709-11.
26. Bryan NP, Chapple CR. Frequency volume charts in the assessment and evaluation of treatment: how should we use them? *Eur Urol.* 2004;46(5):636-40.
27. Gisolf KW, van Venrooij GE, Eckhardt MD, Boon TA. Analysis and reliability of data from 24-hour frequency-volume charts in men with lower urinary tract symptoms due to benign prostatic hyperplasia. *Eur Urol.* 2000;38(1):45-52.
28. Yap TL, Cromwell DC, Emberton M. A systematic review of the reliability of frequency-volume charts in urological research and its implications for the optimum chart duration. *BJU Int.* 2007;99(1):9-16.
29. Burgio KL, Locher JL, Goode PS, Hardin JM, McDowell BJ, Dombrowski M, et al. Behavioral vs drug treatment for urge urinary incontinence in older women: a randomized controlled trial. *JAMA.* 1998;280(23):1995-2000.
30. Bright E, Cotterill N, Drake M, Abrams P. Developing a validated urinary diary: phase 1. *Neu-rourol Urodyn.* 2012;31(5):625-33.
31. Bright E, Cotterill N, Drake M, Abrams P. Developing and validating the International Consultation on Incontinence Questionnaire bladder diary. *Eur Urol.* 2014;66(2):294-300.
32. Brubaker L. Urgency: the cornerstone symptom of overactive bladder. *Urology.* 2004;64(6 Suppl 1):12-6.
33. De Wachter S, Wyndaele JJ. How sudden is a compelling desire to void? An observational cystometric study on the suddenness of this sensation. *BJU Int.* 2008;101(8):1000-3.
34. Nilsson M, Lalos A, Lalos O. The impact of female urinary incontinence and urgency on quality of life and partner relationship. *Neurourol Urodyn.* 2009;28(8):976-81.
35. Blaivas JG, Panagopoulos G, Weiss JP, Somaroo C, Chaikin DC. The urgency perception score: validation and test-retest. *J Urol.* 2007;177(1):199-202.
36. Matza LS, Thompson CL, Krasnow J, Brewster-Jordan J, Zyczynski T, Coyne KS. Test-retest reliability of four questionnaires for patients with overactive bladder: the overactive bladder questionnaire (OAB-q), patient perception of bladder condition (PPBC), urgency questionnaire (UQ), and the primary OAB symptom questionnaire (POSQ). *Neu-rourol Urodyn.* 2005;24(3):215-25.
37. Lowenstein L, Rickey L, Kenton K, Fitzgerald MP, Brubaker L, Tulke M, et al. Reliability and responsiveness of the Urgency Severity and Life Impact Questionnaire (USIQ). *Int Urogynecol J.* 2012;23(2):193-6.
38. Al-Buheissi S, Khasriya R, Maraj BH, Malone-Lee J. A simple validated scale to measure urgency. *J Urol.* 2008;179(3):1000-5; discussion 5.
39. Cardozo L, Coyne KS, Versi E. Validation of the urgency perception scale. *BJU Int.* 2005;95(4):591-6.
40. Nixon A, Colman S, Sabounjian L, Sandage B, Schwiderski UE, Staskin DR, et al. A validated patient reported measure of urinary urgency severity in overactive bladder for use in clinical trials. *J Urol.* 2005;174(2):604-7.
41. Cartwright R, Srikrishna S, Cardozo L, Robinson D. Validity and reliability of the patient's perception of intensity of urgency scale in overactive bladder. *BJU Int.* 2011;107(10):1612-7.
42. Coyne KS, Margolis MK, Hsieh R, Vats V, Chapple CR. Validation of the urinary sensation scale (USS). *Neurourol Urodyn.* 2011;30(3):360-5.
43. European Agency for the evaluation of medicinal products and committee for proprietary medicinal products: note for guidance on the clinical investigation of medicinal products for the treatment of urinary incontinence. London. 2002.
44. Gerber GS, Brendler CB. Evaluation of the urologic patient: history, physical examination, and urinalysis. In: Walsh PC, editor. *Campbell's Urology.* 8 ed ed. Philadelphia: Saunders; 2002. p. 83-110.
45. Bradbury SM. Collection of urine specimens in general practice: to clean or not to clean? *J R Coll Gen Pract.* 1988;38(313):363-5.
46. Lifshitz E, Kramer L. Outpatient urine culture: does collection technique matter? *Arch Intern Med.* 2000;160(16):2537-40.
47. Khadra MH, Pickard RS, Charlton M, Powell PH, Neal DE. A prospective analysis of 1,930 patients with hematuria to evaluate current diagnostic practice. *J Urol.* 2000;163(2):524-7.
48. Roehrborn CG, McConnell JD, Barry MJ. Guidelines on the Management of Benign Prostatic Hyperplasia. Linthicum, MD: American Urological Association, Education and Research, Inc.; 2003.

49. Rosenberg MT, Staskin DR, Kaplan SA, MacDiarmid SA, Newman DK, Ohl DA. A practical guide to the evaluation and treatment of male lower urinary tract symptoms in the primary care setting. *Int J Clin Pract.* 2007;61(9):1535-46.
50. Al-Daghistani HI, Abdel-Dayem M. Diag-nostic value of various urine tests in the Jordanian population with urinary tract infection. *Clin Chem Lab Med.* 2002;40(10):1048-51.
51. Semeniuk H, Church D. Evaluation of the leukocyte esterase and nitrite urine dipstick screen-ing tests for detection of bacteriuria in women with suspected uncomplicated urinary tract infections. *J Clin Microbiol.* 1999;37(9):3051-2.
52. Aspevall O HH, Gant V, Kouri T. European guidelines for urinalysis: a collaborative document produced by European clinical microbiologists and clinical chemists under ECLM in collaboration with ESCMID. *CMI Clin Microbiology and Infection.* 2001;7:173-8.
53. Buchsbaum GM, Albushies DT, Guzick DS. Utility of urine reagent strip in screening women with incontinence for urinary tract infection. *Int Uro-gynecol J Pelvic Floor Dysfunct.* 2004;15(6):391-3; discussion 3.
54. Arinzon Z, Shabat S, Peisakh A, Berner Y. Clinical presentation of urinary tract infection (UTI) differs with aging in women. *Arch Gerontol Geriatr.* 2012;55(1):145-7.
55. Moore EE, Jackson SL, Boyko EJ, Scholes D, Fihn SD. Urinary incontinence and urinary tract infection: temporal relationships in postmenopausal women. *Obstet Gynecol.* 2008;111(2 Pt 1):317-23.
56. Ouslander JG, Schnelle JF. Incontinence in the nursing home. *Ann Intern Med.* 1995;122(6):439-49.
57. Young SB, Pingeton DM. A practical ap-proach to perimenopausal and postmenopausal urinary incontinence. *Obstet Gynecol Clin North Am.* 1994;21(2):357-79.
58. McIntosh LJ, Richardson DA. 30-minute evaluation of incontinence in the older woman. *Geriatrics.* 1994;49(2):35-8, 43-4.
59. Belmin J, Hervias Y, Avellano E, Oudart O, Durand I. Reliability of sampling urine from disposable diapers in elderly incontinent women. *J Am Geriatr Soc.* 1993;41(11):1182-6.
60. DuBeau CE, Resnick NM. Evaluation of the causes and severity of geriatric incontinence. A critical appraisal. *Urol Clin North Am.* 1991;18(2):243-56.
61. Ouslander JG, Schapira M, Schnelle JF, Fingold S. Pyuria among chronically incontinent but otherwise asymptomatic nursing home residents. *J Am Geriatr Soc.* 1996;44(4):420-3.
62. Wolfe AJ, Brubaker L. "Sterile Urine" and the Presence of Bacteria. *Eur Urol.* 2015;68(2):173-4.
63. Siddiqui H, Nederbragt AJ, Lagesen K, Jeanson SL, Jakobsen KS. Assessing diversity of the female urine microbiota by high throughput se-quencing of 16S rDNA amplicons. *BMC Microbiol.* 2011;11:244.
64. Pearce MM, Zilliox MJ, Rosenfeld AB, Thomas-White KJ, Richter HE, Nager CW, et al. The female urinary microbiome in urgency urinary incontinence. *Am J Obstet Gynecol.* 2015;213(3):347.e1-11.
65. Brubaker L, Nager CW, Richter HE, Visco A, Nygaard I, Barber MD, et al. Urinary bacteria in adult women with urgency urinary incontinence. *Int Urogynecol J.* 2014;25(9):1179-84.
66. Hilt EE, McKinley K, Pearce MM, Rosenfeld AB, Zilliox MJ, Mueller ER, et al. Urine is not sterile: use of enhanced urine culture techniques to detect resident bacterial flora in the adult female bladder. *J Clin Microbiol.* 2014;52(3):871-6.
67. Goode PS, Locher JL, Bryant RL, Roth DL, Burgio KL. Measurement of postvoid residual urine with portable transabdominal bladder ultrasound scanner and urethral catheterization. *Int Urogynecol J Pelvic Floor Dysfunct.* 2000;11(5):296-300.
68. Ouslander JG, Simmons S, Tuico E, Ni-gam JG, Fingold S, Bates-Jensen B, et al. Use of a portable ultrasound device to measure postvoid residual volume among incontinent nursing home residents. *J Am Geriatr Soc.* 1994;42(11):1189-92.
69. Nygaard IE. Postvoid residual volume can-not be accurately estimated by bimanual examination. *Int Urogynecol J Pelvic Floor Dysfunct.* 1996;7(2):74-6.
70. Hall AF, Theofrastous JP, Cundiff GW, Harris RL, Hamilton LF, Swift SE, et al. Interobserver and intraobserver reliability of the proposed International Continence Society, Society of Gynecologic Surgeons, and American Urogynecologic Society pelvic organ prolapse classification system. *Am J Obstet Gynecol.* 1996;175(6):1467-70; discussion 70-1.
71. Griffiths DJ, Harrison G, Moore K, McCracken P. Variability of post-void residual urine volume in the elderly. *Urol Res.* 1996;24(1):23-6.

72. Fowler CJ, Panicker JN, Drake M, Harris C, Harrison SC, Kirby M, et al. A UK consensus on the management of the bladder in multiple sclerosis. *J Neurol Neurosurg Psychiatry*. 2009;80(5):470-7.
73. Barabas G, Mölstad S. No association between elevated post-void residual volume and bacteriuria in residents of nursing homes. *Scand J Prim Health Care*. 2005;23(1):52-6.
74. Fantl JA, Newman DK, Colling J. *Urinary Incontinence in Adults: Acute and Chronic Management: 1996 Update*. Rockville (MD): Agency for Health Care Policy and Research (AHCPR); 1996. Contract No.: 96-0682.
75. Gehrich A, Stany MP, Fischer JR, Buller J, Zahn CM. Establishing a mean postvoid residual volume in asymptomatic perimenopausal and post-menopausal women. *Obstet Gynecol*. 2007;110(4):827-32.
76. Tseng LH, Liang CC, Chang YL, Lee SJ, Lloyd LK, Chen CK. Postvoid residual urine in women with stress incontinence. *Neurourol Urodyn*. 2008;27(1):48-51.
77. Haylen BT, Law MG, Frazer M, Schulz S. Urine flow rates and residual urine volumes in urogynecology patients. *Int Urogynecol J Pelvic Floor Dysfunct*. 1999;10(6):378-83.
78. Fitzgerald MP, Jaffar J, Brubaker L. Risk factors for an elevated postvoid residual urine volume in women with symptoms of urinary urgency, frequency and urge incontinence. *Int Urogynecol J Pelvic Floor Dysfunct*. 2001;12(4):237-9; discussion 9-40.
79. Lukacz ES, DuHamel E, Menefee SA, Lubner KM. Elevated postvoid residual in women with pelvic floor disorders: prevalence and associated risk factors. *Int Urogynecol J Pelvic Floor Dysfunct*. 2007;18(4):397-400.
80. Wu J, Baguley IJ. Urinary retention in a general rehabilitation unit: prevalence, clinical outcome, and the role of screening. *Arch Phys Med Rehabil*. 2005;86(9):1772-7.
81. Milleman M, Langenstroer P, Guralnick ML. Post-void residual urine volume in women with overactive bladder symptoms. *J Urol*. 2004;172(5 Pt 1):1911-4.
82. Nager CW, FitzGerald M, Kraus SR, Chai TC, Zyczynski H, Sirls L, et al. Urodynamic measures do not predict stress continence outcomes after surgery for stress urinary incontinence in selected women. *J Urol*. 2008;179(4):1470-4.
83. Dmochowski RR, Blaivas JM, Gormley EA, Juma S, Karram MM, Lightner DJ, et al. Update of AUA guideline on the surgical management of fe-male stress urinary incontinence. *J Urol*. 2010;183(5):1906-14.
84. Gordon D, Groutz A. Evaluation of female lower urinary tract symptoms: overview and update. *Curr Opin Obstet Gynecol*. 2001;13(5):521-7.
85. Ku JH, Jeong IG, Lim DJ, Byun SS, Paick JS, Oh SJ. Voiding diary for the evaluation of urinary incontinence and lower urinary tract symptoms: pro-spective assessment of patient compliance and bur-den. *Neurourol Urodyn*. 2004;23(4):331-5.
86. Costantini E, Lazzeri M, Bini V, Giannantoni A, Mearini L, Porena M. Sensitivity and specificity of one-hour pad test as a predictive value for female urinary incontinence. *Urol Int*. 2008;81(2):153-9.
87. Medina CA, Costantini E, Petri E, Mourad S, Singla A, Rodríguez-Colorado S, et al. Evaluation and surgery for stress urinary incontinence: A FIGO working group report. *Neurourol Urodyn*. 2016:[Epub ahead of print].
88. Serati M, Topazio L, Bogani G, Costantini E, Pietropaolo A, Palleschi G, et al. Urodynamics useless before surgery for female stress urinary incontinence: Are you sure? Results from a multi-center single nation database. *Neurourol Urodyn*. 2016;35(7):809-12.
89. Cantor TJ, Bates CP. A comparative study of symptoms and objective urodynamic findings in 214 incontinent women. *Br J Obstet Gynaecol*. 1980;87(10):889-92.
90. Digesu GA, Khullar V, Cardozo L, Salvatore S. Overactive bladder symptoms: do we need urodynamics? *Neurourol Urodyn*. 2003;22(2):105-8.
91. Ishiko O, Hirai K, Sumi T, Nishimura S, Ogita S. The urinary incontinence score in the diagnosis of female urinary incontinence. *Int J Gynaecol Obstet*. 2000;68(2):131-7.
92. Contreras Ortiz O, Lombardo RJ, Pellicari A. Non-invasive diagnosis of bladder instability using the Bladder Instability Discriminant Index (BIDI). *Zentralbl Gynakol*. 1993;115(10):446-9.
93. Bradley CS, Rovner ES, Morgan MA, Berlin M, Novi JM, Shea JA, et al. A new questionnaire for urinary incontinence diagnosis in women: development and testing. *Am J Obstet Gynecol*. 2005;192(1):66-73.
94. Dursun M, Otunctemur A, Ozbek E, Sahin S, Besiroglu H, Koklu I. Stress urinary incontinence and visceral adipose index: a new risk parameter. *Int Urol Nephrol*. 2014;46(12):2297-300.

95. Vissers D, Neels H, Vermandel A, De Wachter S, Tjalma WA, Wyndaele JJ, et al. The effect of non-surgical weight loss interventions on urinary incontinence in overweight women: a systematic review and meta-analysis. *Obes Rev.* 2014;15(7):610-7.
96. Lenherr SM, Clemens JQ, Braffett BH, Dunn RL, Cleary PA, Kim C, et al. Glycaemic control and risk of incident urinary incontinence in women with Type 1 diabetes: results from the Diabetes Control and Complications Trial and Epidemiology of Diabetes Interventions and Complications study (DCCT/EDIC). *Diabet Med.* 2016;[Epub ahead of print].
97. Ahn KS, Hong HP, Kweon HJ, Ahn AL, Oh EJ, Choi JK, et al. Correlation between Overactive Bladder Syndrome and Obsessive Compulsive Disorder in Women. *Korean J Fam Med.* 2016;37(1):25-30.
98. Hung KJ, Awtrey CS, Tsai AC. Urinary incontinence, depression, and economic outcomes in a cohort of women between the ages of 54 and 65 years. *Obstet Gynecol.* 2014;123(4):822-7.
99. Walid MS. Prevalence of urinary incontinence in female residents of american nursing homes and association with neuropsychiatric disorders. *J Clin Med Res.* 2009;1(1):37-9.
100. Nygaard IE, Shaw JM, Bardsley T, Egger MJ. Lifetime physical activity and female stress urinary incontinence. *Am J Obstet Gynecol.* 2015;213(1):40.e1-10.
101. Sheyn D, James RL, Taylor AK, Sam-marco AG, Benchek P, Mahajan ST. Tobacco use as a risk factor for reoperation in patients with stress urinary incontinence: a multi-institutional electronic medical record database analysis. *Int Urogynecol J.* 2015;26(9):1379-84.
102. Selcuk S, Cam C, Asoglu MR, Kucukbas M, Arinkan A, Cikman MS, et al. Effect of simple and radical hysterectomy on quality of life - analysis of all aspects of pelvic floor dysfunction. *Eur J Obstet Gynecol Reprod Biol.* 2016;198:84-8.
103. Possover M, Lemos N. Risks, symptoms, and management of pelvic nerve damage secondary to surgery for pelvic organ prolapse: a report of 95 cases. *Int Urogynecol J.* 2011;22(12):1485-90.
104. Possover M. Laparoscopic management of neural pelvic pain in women secondary to pelvic surgery. *Fertil Steril.* 2009;91(6):2720-5.
105. Bakali E, Buckley BS, Hilton P, Tincello DG. Treatment of recurrent stress urinary incontinence after failed minimally invasive synthetic suburethral tape surgery in women. *Cochrane Database Syst Rev.* 2013;28(2):CD009407.
106. Abrams P, Avery K, Gardener N, Donovan J, ICIQ Advisory Board. The International Consultation on Incontinence Modular Questionnaire: <http://www.iciq.net/>. *J Urol.* 2006;175(3 Pt 1):1063-6; discussion 6.
107. Abrams P, Cardozo L, S K. Incontinence. Proceedings from the 3rd International Consultation on Incontinence. Paris: Health Publications; 2005.
108. Franco AV, Lee F, Fynes MM. Is there an alternative to pad tests? Correlation of subjective variables of severity of urinary loss to the 1-h pad test in women with stress urinary incontinence. *BJU Int.* 2008;102(5):586-90.
109. Karantanis E, Fynes M, Moore KH, Stanton SL. Comparison of the ICIQ-SF and 24-hour pad test with other measures for evaluating the severity of urodynamic stress incontinence. *Int Urogynecol J Pelvic Floor Dysfunct.* 2004;15(2):111-6; discussion 6.
110. Blaivas JG, Olsson CA. Stress incontinence: classification and surgical approach. *J Urol.* 1988;139(4):727-31.
111. Versi E, Cardozo L, Anand D, Cooper D. Symptoms analysis for the diagnosis of genuine stress incontinence. *Br J Obstet Gynaecol.* 1991;98(8):815-9.
112. Khullar V, Sexton CC, Thompson CL, Mil-som I, Bitoun CE, Coyne KS. The relationship between BMI and urinary incontinence subgroups: results from EpiLUTS. *Neurourol Urodyn.* 2014;33(4):392-9.
113. Uebersax JS, Wyman JF, Shumaker SA, McClish DK, Fantl JA. Short forms to assess life quality and symptom distress for urinary incontinence in women: the Incontinence Impact Questionnaire and the Urogenital Distress Inventory. Continence Program for Women Research Group. *Neurourol Urodyn.* 1995;14(2):131-9.
114. Hanno PM. Re-imagining Interstitial Cystitis. *Urol Clin North Am.* 2008;35(1):91-9.
115. Hunskaar S. A systematic review of overweight and obesity as risk factors and targets for clinical intervention for urinary incontinence in women. *Neurourol Urodyn.* 2008;27(8):749-57.
116. Devore EE, Minassian VA, Grodstein F. Factors associated with persistent urinary incontinence. *Am J Obstet Gynecol.* 2013;209(2):15.e1-6.
117. Norton PA. Pelvic floor disorders: the role of fascia and ligaments. *Clin Obstet Gynecol.* 1993;36(4):926-38.

118. Veit-Rubin N, Cartwright R, Singh AU, Digesu GA, Fernando R, Khullar V. Association between joint hypermobility and pelvic organ prolapse in women: a systematic review and meta-analysis. *Int Urogynecol J*. 2016;27(10):1469-78.
119. Hilton P, Stanton SL. Algorithmic method for assessing urinary incontinence in elderly women. *Br Med J (Clin Res Ed)*. 1981;282(6268):940-2.
120. Nappi RE, Palacios S, Panay N, Particco M, Krychman ML. Vulvar and vaginal atrophy in four European countries: evidence from the European REVIVE Survey. *Climacteric*. 2016;19(2):188-97.
121. Rahn DD, Ward RM, Sanses TV, Carberry C, Mamik MM, Meriwether KV, et al. Vaginal estrogen use in postmenopausal women with pelvic floor disorders: systematic review and practice guide-lines. *Int Urogynecol J*. 2015;26(1):3-13.
122. Robinson D, Toozs-Hobson P, Cardozo L. The effect of hormones on the lower urinary tract. *Menopause Int*. 2013.
123. Reeves FA, Inman RD, Chapple CR. Management of symptomatic urethral diverticula in women: a single-centre experience. *Eur Urol*. 2014;66(1):164-72.
124. Baradaran N, Chiles LR, Freilich DA, Rames RA, Cox L, Rovner ES. Female Urethral Diverticula in the Contemporary Era: Is the Classic Triad of the "3Ds" Still Relevant? *Urology*. 2016;94:53-6.
125. Cameron AP. Urethral diverticulum in the female: a meta-analysis of modern series. *Mi-nerva Ginecol*. 2016;68(2):186-210.
126. Rimstad L, Larsen ES, Schiøtz HA, Kulseng-Hanssen S. Pad stress tests with increasing load for the diagnosis of stress urinary incontinence. *Neurourol Urodyn*. 2014;33(7):1135-9.
127. Swift SE, Yoon EA. Test-retest reliability of the cough stress test in the evaluation of urinary incontinence. *Obstet Gynecol*. 1999;94(1):99-102.
128. Espuña-Pons M, Dilla T, Castro D, Carbonell C, Casariego J, Puig-Clota M. Analysis of the value of the ICIQ-UI SF questionnaire and stress test in the differential diagnosis of the type of urinary incontinence. *Neurourol Urodyn*. 2007;26(6):836-41.
129. Scotti RJ, Myers DL. A comparison of the cough stress test and single-channel cystometry with multichannel urodynamic evaluation in genuine stress incontinence. *Obstet Gynecol*. 1993;81(3):430-3.
130. Swift SE, Ostergard DR. Evaluation of current urodynamic testing methods in the diagnosis of genuine stress incontinence. *Obstet Gynecol*. 1995;86(1):85-91.
131. Price DM, Noblett K. Comparison of the cough stress test and 24-h pad test in the assessment of stress urinary incontinence. *Int Urogynecol J*. 2012;23(4):429-33.
132. Kulseng-Hanssen S, Moe K, Schiøtz HA. How often does detrusor overactivity cause urinary leakage during a stress test in women with mixed urinary incontinence. *Int Urogynecol J*. 2013;24(9):1537-41.
133. Lagro-Janssen AL, Debruyne FM, van Weel C. Value of the patient's case history in diagnosing urinary incontinence in general practice. *Br J Urol*. 1991;67(6):569-72.
134. Groutz A, Blaivas JG, Chaikin DC, Resnick NM, Engleman K, Anzalone D, et al. Noninvasive outcome measures of urinary incontinence and lower urinary tract symptoms: a multicenter study of mic-turition diary and pad tests. *J Urol*. 2000;164(3 Pt 1):698-701.
135. Krhut J, Zachoval R, Smith PP, Rosier PF, Valanský L, Martan A, et al. Pad weight testing in the evaluation of urinary incontinence. *Neurourol Urodyn*. 2014;33(5):507-10.
136. Sutherst J, Brown M, Shower M. Assessing the severity of urinary incontinence in women by weighing perineal pads. *Lancet*. 1981;1(8230):1128-30.
137. Figueiredo EM, Gontijo R, Vaz CT, Bara-cho E, da Fonseca AM, Monteiro MV, et al. The results of a 24-h pad test in Brazilian women. *Int Urogynecol J*. 2012;23(6):785-9.
138. Fantl JA, Harkins SW, Wyman JF, Choi SC, Taylor JR. Fluid loss quantitation test in women with urinary incontinence: a test-retest analysis. *Obstet Gynecol*. 1987;70(5):739-43.
139. Klarskov P, Hald T. Reproducibility and reliability of urinary incontinence assessment with a 60 min test. *Scand J Urol Nephrol*. 1984;18(4):293-8.
140. Victor A, Larsson G, Asbrink AS. A simple patient-administered test for objective quantitation of the symptom of urinary incontinence. *Scand J Urol Nephrol*. 1987;21(4):277-9.
141. Lose G, Jørgensen L, Thunedborg P. 24-hour home pad weighing test versus 1-hour ward test in the assessment of mild stress incontinence. *Acta Obstet Gynecol Scand*. 1989;68(3):211-5.
142. Abdel-fattah M, Barrington JW, Youssef M. The standard 1-hour pad test: does it have any value in clinical practice? *Eur Urol*. 2004;46(3):377-80.

143. O'Sullivan R, Karantanis E, Stevermuer TL, Allen W, Moore KH. Definition of mild, moderate and severe incontinence on the 24-hour pad test. *BJOG*. 2004;111(8):859-62.
144. Sandvik H EM, Hunskaar S. . . . Validity of the incontinence severity index: comparison with pad-weighing tests. *Int Urogynecol J Pelvic Floor Dysfunct*. 2006;17(5):520-4.
145. Crystle CD, Charme LS, Copeland WE. Q-tip test in stress urinary incontinence. *Obstet Gyne-col*. 1971;38(2):313-5.
146. Caputo RM, Benson JT. The Q-tip test and urethrovaginal junction mobility. *Obstet Gynecol*. 1993;82(6):892-6.
147. Robinson BL, Geller EJ, Parnell BA, Crane AK, Jannelli ML, Wells EC, et al. Diagnostic accuracy of visual urethral mobility exam versus Q-Tip test: a randomized crossover trial. *Am J Obstet Gynecol*. 2012;206(6):528.e1-6.
148. Meyer I, Szychowski JM, Illston JD, Parden AM, Richter HE. Vaginal Swab Test Compared With the Urethral Q-tip Test for Urethral Mobility Measurement: A Randomized Controlled Trial. *Obstet Gynecol*. 2016;127(2):348-52.
149. Shek KL, Dietz HP. The urethral motion profile: a novel method to evaluate urethral support and mobility. *Aust N Z J Obstet Gynaecol*. 2008;48(3):337-42.
150. Pirpiris A, Shek KL, Dietz HP. Urethral mobility and urinary incontinence. *Ultrasound Obstet Gynecol*. 2010;36(4):507-11.
151. Frawley HC, Galea MP, Phillips BA, Sherburn M, Bø K. Reliability of pelvic floor muscle strength assessment using different test positions and tools. *Neurourol Urodyn*. 2006;25(3):236-42.
152. van Delft K, Thakar R, Sultan AH. Pelvic floor muscle contractility: digital assessment vs transperineal ultrasound. *Ultrasound Obstet Gyne-col*. 2015;45(2):217-22.
153. Ferreira CH, Barbosa PB, de Oliveira Souza F, Antônio FI, Franco MM, Bø K. Inter-rater reliability study of the modified Oxford Grading Scale and the Peritron manometer. *Physiotherapy*. 2011;97(2):132-8.
154. Oversand SH, Atan IK, Shek KL, Dietz HP. The association between different measures of pelvic floor muscle function and female pelvic organ prolapse. *Int Urogynecol J*. 2015;26(12):1777-81.
155. Bø K, Sherburn M. Evaluation of female pelvic-floor muscle function and strength. *Phys Ther*. 2005;85(3):269-82.
156. Bø K, Finckenhagen HB. Vaginal palpation of pelvic floor muscle strength: inter-test reproducibility and comparison between palpation and vaginal squeeze pressure. *Acta Obstet Gynecol Scand*. 2001;80(10):883-7.
157. Laycock J. Clinical evaluation of pelvic floor. In: Schussler B, Laycock J, Norton P, Stanton S, editors. *Pelvic floor re-education Principles and practice*. London: Springer-Verlag; 1994. p. 42-8.
158. Messelink B, Benson T, Berghmans B, Bø K, Corcos J, Fowler C, et al. Standardization of terminology of pelvic floor muscle function and dysfunction: report from the pelvic floor clinical assessment group of the International Continence Society. *Neurourol Urodyn*. 2005;24(4):374-80.
159. Kearney R, Miller JM, Delancey JO. Inter-rater reliability and physical examination of the pubovisceral portion of the levator ani muscle, validity comparisons using MR imaging. *Neurourol Urodyn*. 2006;25(1):50-4.
160. Dietz HP, Shek C. Validity and reproducibility of the digital detection of levator trauma. *Int Urogynecol J Pelvic Floor Dysfunct*. 2008;19(8):1097-101.
161. Dietz HP, Shek C. Levator avulsion and grading of pelvic floor muscle strength. *Int Urogynecol J Pelvic Floor Dysfunct*. 2008;19(5):633-6.
162. Guzmán Rojas R, Wong V, Shek KL, Dietz HP. Impact of levator trauma on pelvic floor muscle function. *Int Urogynecol J*. 2014;25(3):375-80.
163. Haylen BT, Maher CF, Barber MD, Caramo S, Dandolu V, Digesu A, et al. An International Urogynecological Association (IUGA) / International Continence Society (ICS) Joint Report on the Terminology for Female Pelvic Organ Prolapse (POP). *Neurourol Urodyn*. 2016;35(2):137-68.
164. Haylen BT, Maher CF, Barber MD, Caramo S, Dandolu V, Digesu A, et al. An International Urogynecological Association (IUGA)/International Continence Society (ICS) joint report on the terminology for female pelvic organ prolapse (POP). *Int Urogynecol J*. 2016;27(4):655-84.
165. Swift S, Woodman P, O'Boyle A, Kahn M, Valley M, Bland D, et al. Pelvic Organ Support Study (POSST): the distribution, clinical definition, and epidemiologic condition of pelvic organ support defects. *Am J Obstet Gynecol*. 2005;192(3):795-806.

166. Swift SE, Tate SB, Nicholas J. Correlation of symptoms with degree of pelvic organ support in a general population of women: what is pelvic organ prolapse? *Am J Obstet Gynecol.* 2003;189(2):372-7; discussion 7-9.
167. Reich A, Kohorst F, Kreienberg R, Flock F. Influence of bladder volume on pelvic organ prolapse quantification results. *Gynecol Obstet Invest.* 2010;70(2):82-6.
168. Silva WA, Kleeman S, Segal J, Pauls R, Woods SE, Karram MM. Effects of a full bladder and patient positioning on pelvic organ prolapse assessment. *Obstet Gynecol.* 2004;104(1):37-41.
169. Bump RC, Mattiasson A, Bø K, Brubaker LP, DeLancey JO, Klarskov P, et al. The standardization of terminology of female pelvic organ prolapse and pelvic floor dysfunction. *Am J Obstet Gynecol.* 1996;175(1):10-7.
170. Swift SE, Herring M. Comparison of pelvic organ prolapse in the dorsal lithotomy compared with the standing position. *Obstet Gynecol.* 1998;91(6):961-4.
171. Barber MD, Lambers A, Visco AG, Bump RC. Effect of patient position on clinical evaluation of pelvic organ prolapse. *Obstet Gynecol.* 2000;96(1):18-22.
172. Digesu GA, Athanasios S, Cardozo L, Hill S, Khullar V. Validation of the pelvic organ prolapse quantification (POP-Q) system in left lateral position. *Int Urogynecol J Pelvic Floor Dysfunct.* 2009;20(8):979-83.
173. Auwad W, Freeman RM, Swift S. Is the pelvic organ prolapse quantification system (POPQ) being used? A survey of members of the International Continence Society (ICS) and the American Urogynecologic Society (AUGS). *Int Urogynecol J Pelvic Floor Dysfunct.* 2004;15(5):324-7.
174. Treszezamsky AD, Rascoff L, Shahryarnejad A, Vardy MD. Use of pelvic organ prolapse staging systems in published articles of selected specialized journals. *Int Urogynecol J.* 2010;21(3):359-63.
175. Swift S. Current opinion on the classification and definition of genital tract prolapse. *Curr Opin Obstet Gynecol.* 2002;14(5):50-7.
176. Lemos N, Korte JE, Iskander M, Freeman R, Arunkalaivanan A, Rizk D, et al. Center-by-center results of a multicenter prospective trial to determine the inter-observer correlation of the simplified POP-Q in describing pelvic organ prolapse. *Int Urogynecol J.* 2012;23(5):579-84.
177. Manonai J, Mouritsen L, Palma P, Contre-ras-Ortiz O, Korte JE, Swift S. The inter-system association between the simplified pelvic organ prolapse quantification system (S-POP) and the standard pelvic organ prolapse quantification system (POPQ) in describing pelvic organ prolapse. *Int Urogynecol J.* 2011;22(3):347-52.
178. Barber MD, Cundiff GW, Weidner AC, Coates KW, Bump RC, Addison WA. Accuracy of clinical assessment of paravaginal defects in women with anterior vaginal wall prolapse. *Am J Obstet Gynecol.* 1999;181(1):87-90.
179. Stark D, Dall P, Abdel-Fattah M, Hagen S. Feasibility, inter- and intra-rater reliability of physiotherapists measuring prolapse using the pelvic organ prolapse quantification system^o. *Int Urogynecol J.* 2010;21(6):651-6.
180. Karp DR, Peterson TV, Jean-Michel M, Lefevre R, Davila GW, Aguilar VC. "Eyeball" POP-Q examination: shortcut or valid assessment tool? *Int Urogynecol J.* 2010;21(8):1005-9.
181. Parnell BA, Dunivan GC, Geller EJ, Con-nolly A. A novel approach to teaching the pelvic organ prolapse quantification (POP-Q) exam. 22. 2011;3(367-70).
182. Ellerkmann RM, Cundiff GW, Melick CF, Nihira MA, Leffler K, Bent AE. Correlation of symptoms with location and severity of pelvic organ prolapse. *Am J Obstet Gynecol.* 2001;185(6):1332-7; discussion 7-8.
183. Bradley CS, Zimmerman MB, Wang Q, Nygaard IE, Women's Health Initiative. Vaginal descent and pelvic floor symptoms in postmenopausal women: a longitudinal study. *Obstet Gynecol.* 2008;111(5):1148-53.
184. Salvatore S SM, Siesto G, Cattoni E, Zani-rato M, Torella m. Correlation between anatomical findings and symptoms in women with pelvic organ prolapse using and artificialneural network analysys. *Int Urogynecol J.* 2011;22(4):453-9.
185. Espuña-Pons M, Fillol M, Pascual MA, Rebollo P, Mora AM, Female Pelvic Floor Dysfunction Research Group (Grupo de Investigación en Disfunciones del Suelo Pélvico en la Mujer-GISPEM). Pelvic floor symptoms and severity of pelvic organ prolapse in women seeking care for pelvic floor problems. *Eur J Obstet Gynecol Reprod Biol.* 2014;177:141-5.
186. Manonai J, Wattanayingcharoenchai R. Relationship between pelvic floor symptoms and POP-Q measurements. *Neurourol Urodyn.* 2016;35(6):724-7.

187. Fialkow MF, Gardella C, Melville J, Lentz GM, Fenner DE. Posterior vaginal wall defects and their relation to measures of pelvic floor neuromuscular function and posterior compartment symptoms. *Am J Obstet Gynecol*. 2002;187(6):1443-8; discussion 8-9.
188. Morgan DM, DeLancey JO, Guire KE, Fenner DE. Symptoms of anal incontinence and difficult defecation among women with prolapse and a matched control cohort. *Am J Obstet Gynecol*. 2007;197(5):509.e1-6.
189. Collins SA, O'Sullivan DM, Lasala CA. Correlation of POP-Q posterior compartment measures with defecatory dysfunction. *Int Urogynecol J*. 2012;23(6):743-7.
190. Morovatdar N, Hghighi L, Najmi Z, Hashe-mi A, Nojomi M. Response validity of Persian version of P-QOL questionnaire in patients with pro-lapse. *Eur J Obstet Gynecol Reprod Biol*. 2015;193:88-91.
191. Veit-Rubin N, Digesu A, Swift S, Khullar V, Kaelin Gambirasio I, Dällenbach P, et al. Validation of the French version of the P-QoL questionnaire. *Eur J Obstet Gynecol Reprod Biol*. 2015;192:10-6.
192. Chan SS, Cheung RY, Yiu AK, Li JC, Lai BP, Choy KW, et al. Chinese validation of Pelvic Floor Distress Inventory and Pelvic Floor Impact Questionnaire. *Int Urogynecol J*. 2011;22(10):1305-12.
193. Due U, Brostrøm S, Lose G. Validation of the Pelvic Floor Distress Inventory-20 and the Pelvic Floor Impact Questionnaire-7 in Danish women with pelvic organ prolapse. *Acta Obstet Gynecol Scand*. 2013;92(9):1041-8.
194. Kaplan PB, Sut N, Sut HK. Validation, cultural adaptation and responsiveness of two pelvic-floor-specific quality-of-life questionnaires, PFDI-20 and PFIQ-7, in a Turkish population. *Eur J Obstet Gynecol Reprod Biol*. 2012;162(2):229-33.
195. Cam C, Sancak P, Karahan N, Sancak A, Celik C, Karateke A. Validation of the short form of the Pelvic Organ Prolapse/Urinary Incontinence Sexual Questionnaire (PISQ-12) in a Turkish population. *Eur J Obstet Gynecol Reprod Biol*. 2009;146(1):104-7.
196. Trutnovsky G, Nagele E, Ulrich D, Aigmüller T, Dörfler D, Geiss I, et al. German translation and validation of the Pelvic Organ Prolapse/Incontinence Sexual Questionnaire-IUGA revised (PISQ-IR). *Int Urogynecol J*. 2016;27(8):1235-44.
197. Farkas B, Tiringier I, Farkas N, Kenyeres B, Nemeth Z. Hungarian language validation of the Pelvic Organ Prolapse/Incontinence Sexual Questionnaire, IUGA-Revised (PISQ-IR). *Int Urogynecol J*. 2016;[Epub ahead of print].
198. Wang H, Lau HH, Hung MJ, Huang WC, Zheng YW, Su TH. Validation of a Mandarin Chinese version of the pelvic organ prolapse/urinary incontinence sexual questionnaire IUGA-revised (PISQ-IR). *Int Urogynecol J*. 2015;26(11):1695-700.
199. El-Azab AS, Ghoniem GM, Leu SY, Ngu-yen DV. Arabic validation of the Pelvic Organ Prolapse/Incontinence Sexual Questionnaire, IUGA-Revised (PISQ-IR). *Int Urogynecol J*. 2015;26(8):1229-37.
200. Fattouh B, Hermieu JF, Cour F, Wagner L, Jacquetin B, de Tayrac R. [French language validation of the Pelvic Organ Prolapse/Urinary Incontinence Sexual Questionnaire - IUGA revised (PISQ-IR)]. *Prog Urol*. 2013;23(17):1464-73.
201. Rogers RG, Rockwood TH, Constantine ML, Thakar R, Kammerer-Doak DN, Pauls RN, et al. A new measure of sexual function in women with pelvic floor disorders (PFD): the Pelvic Organ Prolapse/Incontinence Sexual Questionnaire, IUGA-Revised (PISQ-IR). *Int Urogynecol J*. 2013;24(7):1091-103.
202. Srikrishna S, Robinson D, Cardozo L. Validation of the Patient Global Impression of Improvement (PGI-I) for urogenital prolapse. *Int Urogynecol J*. 2010;21(5):523-8.
203. Yang X, Li H. A modified anterior compartment reconstruction and Prolift-a for the treatment of anterior pelvic organ prolapse: a non-inferiority study. *Arch Gynecol Obstet*. 2012;285(6):1593-7.
204. Sayer T LJ, Gauld JM, Hinoul P, Jones P, Franco N, Van Drie D, Slack M; Prosima Study Investigators. Medium-term clinical outcomes following surgical repair for vaginal prolapse with tension-free mesh and vaginal support device. *Int Urogynecol J*. 2012;23(4):487-93.
205. Grgic O, Oreskovic S, Grsic HL, Kalafatic D, Zupic T, Maurac I. Outcome and efficacy of a transobturator polypropylene mesh kit in the treatment of anterior pelvic organ prolapse. *Int J Gynaecol Obstet*. 2012;116(1):72-5.
206. Antosh DD, Iglesia CB, Vora S, Sokol AI. Outcome assessment with blinded versus unblinded POP-Q exams. *Am J Obstet Gynecol*. 2011;205(5):489.e1-4.

207. Chu LC, Chuang FC, Kung FT, Huang KH. Comparison of short-term outcomes following pelvic reconstruction with Perigee and Apogee systems: hysterectomy or not? *Int Urogynecol J.* 2012;23(1):79-84.
208. Nair R, Nnochiri A, Barnick C, Roberts C. Transvaginal mesh (Prolift™) repair: 2-year anatomical outcomes. *Eur J Obstet Gynecol Reprod Biol.* 2011;158(2):358-60.
209. Palma P, Riccetto C, Prudente A, Dalp-horno F, Delroy C, Castro R, et al. Monoprosthesis for anterior vaginal prolapse and stress urinary incontinence: mid-term results of an international multi-centre prospective study. *Int Urogynecol J.* 2011;22(12):1535-41.
210. Khandwala S, Jayachandran C. Transvaginal mesh surgery for pelvic organ prolapse--Prolift+M: a prospective clinical trial. *Int Urogynecol J.* 2011;22(11):1405-11.
211. Simon M, Debodinance P. Vaginal prolapse repair using the Prolift kit: a registry of 100 successive cases. *Eur J Obstet Gynecol Reprod Biol.* 2011;158(1):104-9.
212. Brocker KA, Alt CD, Corteville C, Hall-scheidt P, Lenz F, Sohn C. Short-range clinical, dynamic magnetic resonance imaging and P-QOL questionnaire results after mesh repair in female pelvic organ prolapse. *Eur J Obstet Gynecol Reprod Biol.* 2011;157(1):107-12.
213. Sergent F, Resch B, Al-Khattabi M, Ricbourg A, Schaal JP, Marpeau L. Transvaginal mesh repair of pelvic organ prolapse by the transobturator-infracoccygeal hammock technique: long-term anatomical and functional outcomes. *Neurourol Urodyn.* 2011;30(3):384-9.
214. McDermott CD, Terry CL, Woodman PJ, Hale DS. Surgical outcomes following total Prolift: colpopexy versus hysterectomy. *Aust N Z J Obstet Gynaecol.* 2011;51(1):61-6.
215. Alcalay M, Cosson M, Livneh M, Lucot JP, Von Theobald P. Trocarless system for mesh attachment in pelvic organ prolapse repair--1-year evaluation. *Int Urogynecol J.* 2011;22(5):551-6.
216. Lee YS, Han DH, Lim SH, Kim TH, Choo MS, Seo JT, et al. Efficacy and Safety of "Tension-free" Placement of Gynemesh PS for the Treatment of Anterior Vaginal Wall Prolapse. *Int Neurourol J.* 2010;14(1):34-42.
217. Lo TS, Ashok K. Combined anterior trans-obturator mesh and sacrospinous ligament fixation in women with severe prolapse--a case series of 30 months follow-up. *Int Urogynecol J.* 2011;22(3):299-306.
218. Zhu L, Lang J, Sun Z, Ren C, Liu X, Li B. Pelvic reconstruction with mesh for advanced pelvic organ prolapse: a new economic surgical method. *Menopause.* 2011;18(3):328-32.
219. Stanford EJ, Mattox TF, Pugh CJ. Outcomes and complications of transvaginal and abdominal custom-shaped light-weight polypropylene mesh used in repair of pelvic organ prolapse. *J Minim Invasive Gynecol.* 2011;18(1):64-7.
220. Fayyad AM, North C, Reid FM, Smith AR. Prospective study of anterior transobturator mesh kit (Prolift™) for the management of recurrent anterior vaginal wall prolapse. *Int Urogynecol J.* 2011;22(2):157-63.
221. Huang WC, Lin TY, Lau HH, Chen SS, Hsieh CH, Su TH. Outcome of transvaginal pelvic reconstructive surgery with Prolift after a median of 2 years' follow-up. *Int Urogynecol J.* 2011;22(2):197-203.
222. Jacquetin B, Fatton B, Rosenthal C, Clavé H, Debodinance P, Hinoul P, et al. Total transvaginal mesh (TVM) technique for treatment of pelvic organ prolapse: a 3-year prospective follow-up study. *Int Urogynecol J.* 2010;21(12):1455-62.
223. Withagen MI, Vierhout ME, Mannaerts GH, van der Weiden RM. Laparoscopic sacrocolpopexy with bone anchor fixation: short-term anatomical and functional results. *Int Urogynecol J.* 2012;23(4):481-6.
224. Shveiky D, Sokol AI, Gutman RE, Kudish BI, Iglesias CB. Vaginal mesh colpopexy for the treatment of concomitant full thickness rectal and pelvic organ prolapse: a case series. *Eur J Obstet Gynecol Reprod Biol.* 2011;157(1):113-5.
225. Sergent F, Resch B, Loisel C, Bisson V, Schaal JP, Marpeau L. Mid-term outcome of laparoscopic sacrocolpopexy with anterior and posterior polyester mesh for treatment of genitourinary prolapse. *Eur J Obstet Gynecol Reprod Biol.* 2011;156(2):217-22.
226. Onol FF, Kaya E, Köse O, Onol SY. A novel technique for the management of advanced uterine/vault prolapse: extraperitoneal sacrocolpopexy. *Int Urogynecol J.* 2011;22(7):855-61.
227. Tate SB, Blackwell L, Lorenz DJ, Steptoe MM, Culligan PJ. Randomized trial of fascia lata and polypropylene mesh for abdominal sacrocolpopexy: 5-year follow-up. *Int Urogynecol J.* 2011;22(2):137-43.
228. Price N, Slack A, Jackson SR. Laparoscopic sacrocolpopexy: an observational study of functional and anatomical outcomes. *Int Urogynecol J.* 2011;22(1):77-82.

229. Chen G, Ling B, Li J, Xu P, Hu W, Zhao W, et al. Laparoscopic extraperitoneal uterine suspension to anterior abdominal wall bilaterally using synthetic mesh to treat uterovaginal prolapse. *J Minim Invasive Gynecol.* 2010;17(5):631-6.
230. Meyer I, McGwin G, Swain TA, Alvarez MD, Ellington DR, Richter HE. Synthetic Graft Augmentation in Vaginal Prolapse Surgery: Long-Term Objective and Subjective Outcomes. *J Minim Invasive Gynecol.* 2016;23(4):614-21.
231. Rudnicki M, Laurikainen E, Pogosean R, Kinne I, Jakobsson U, Teleman P. A 3-year follow-up after anterior colporrhaphy compared with collagen-coated transvaginal mesh for anterior vaginal wall prolapse: a randomised controlled trial. *BJOG.* 2016;123(1):136-42.
232. Teleman P, Laurikainen E, Kinne I, Pogosean R, Jakobsson U, Rudnicki M. Relationship between the Pelvic Organ Prolapse Quantification system (POP-Q), the Pelvic Floor Impact Questionnaire (PFIQ-7), and the Pelvic Floor Distress Inventory (PFDI-20) before and after anterior vaginal wall prolapse surgery. *Int Urogynecol J.* 2015;26(2):195-200.
233. Larouche M, Merovitz L, Correa JA, Walter JE. Outcomes of trocar-guided Gynemesh PS™ versus single-incision trocarless Polyform™ trans-vaginal mesh procedures. *Int Urogynecol J.* 2015;26(1):71-7.
234. Lo TS, Pue LB, Tan YL, Wu PY. Long-term outcomes of synthetic transobturator nonabsorbable anterior mesh versus anterior colporrhaphy in symptomatic, advanced pelvic organ prolapse surgery. *Int Urogynecol J.* 2014;25(2):257-64.
235. Gutman RE, Nosti PA, Sokol AI, Sokol ER, Peterson JL, Wang H, et al. Three-year outcomes of vaginal mesh for prolapse: a randomized controlled trial. *Obstet Gynecol.* 2013;122(4):770-7.
236. Heinonen P, Aaltonen R, Joronen K, Ala-Nissilä S. Long-term outcome after transvaginal mesh repair of pelvic organ prolapse. *Int Urogynecol J.* 2016;27(7):1069-74.
237. Chen G, Wu D, Zhao W, Hu W, Li J, Ling B. Modified laparoscopic extraperitoneal uterine suspension to anterior abdominal wall: the easier way to treat uterine prolapse. *Int Urogynecol J.* 2012;23(7):887-91.
238. Culligan PJ, Gurshumov E, Lewis C, Priestley JL, Komar J, Shah N, et al. Subjective and objective results 1 year after robotic sacrocolpopexy using a lightweight Y-mesh. *Int Urogynecol J.* 2014;25(6):731-5.
239. Rahmanou P, White B, Price N, Jackson S. Laparoscopic hysteropexy: 1- to 4-year follow-up of women postoperatively. *Int Urogynecol J.* 2014;25(1):131-8.
240. Schmid C1 ORP, Maher C. Laparoscopic sacrocolpopexy for recurrent pelvic organ prolapse after failed transvaginal polypropylene mesh surgery. *Int Urogynecol J.* 2013;24(5):763-7.
241. Marrero C, Aponte A, Torres R, Santos F, Rivera J. A preliminary report on pelvic floor reconstruction through colpoceleisis from 2001 to 2007 at the University Hospital of the Puerto Rico Medical Center. *P R Health Sci J.* 2010;29(4):394-6.
242. Zebede S, Smith AL, Plowright LN, Hegde A, Aguilar VC, Davila GW. Obliterative LeFort colpoceleisis in a large group of elderly women. *Obstet Gynecol.* 2013;121(2 Pt 1):279-84.
243. Koski ME, Chow D, Bedestani A, Togami JM, Chesson RR, Winters JC. Colpoceleisis for advanced pelvic organ prolapse. *Urology.* 2012;80(3):542-6.
244. Peng P, Zhu L, Lang JH, Wang WY, Shi HH. Unilateral sacrospinous ligament fixation for treatment of genital prolapse. *Chin Med J (Engl).* 2010;123(15):1995-8.
245. de Tayrac R, Boileau L, Fara JF, Monneins F, Raini C, Costa P. Bilateral anterior sacrospinous ligament suspension associated with a paravaginal repair with mesh: short-term clinical results of a pilot study. *Int Urogynecol J.* 2010;21(3):293-8.
246. Mothes AR, Wanzke L, Radosa MP, Runnebaum IB. Bilateral minimal tension sacrospinous fixation in pelvic organ prolapse: an observational study. *Eur J Obstet Gynecol Reprod Biol.* 2015;188:1-5.
247. Cervigni M, Natale F, La Penna C, Saltari M, Padoa A, Agostini M. Collagen-coated polypropylene mesh in vaginal prolapse surgery: an observational study. *Eur J Obstet Gynecol Reprod Biol.* 2011;156(2):223-7.
248. Lo TS, Tan YL, Khanuengkitkong S, Dass AK, Cortes EF, Wu PY. Assessment of collagen-coated anterior mesh through morphology and clinical outcomes in pelvic reconstructive surgery for pelvic organ prolapse. *J Minim Invasive Gynecol.* 2014;21(5):753-61.
249. Rudnicki M, Laurikainen E, Pogosean R, Kinne I, Jakobsson U, Teleman P. Anterior colporrhaphy compared with collagen-coated transvaginal mesh for anterior vaginal wall prolapse: a randomised controlled trial. *BJOG.* 2014;121(1):102-10.

250. Broekhuis SR, Kluivers KB, Hendriks JC, Fütterer JJ, Barentsz JO, Vierhout ME. POP-Q, dynamic MR imaging, and perineal ultrasonography: do they agree in the quantification of female pelvic organ prolapse? *Int Urogynecol J*. 2009;20(5):541-9.
251. Lakeman MM, Zijta FM, Peringa J, Nederveen AJ, Stoker J, Roovers JP. Dynamic magnetic resonance imaging to quantify pelvic organ prolapse: reliability of assessment and correlation with clinical findings and pelvic floor symptoms. *Int Urogynecol J*. 2012;23(11):1547-54.
252. Lone FW, Thakar R, Sultan AH, Stankiewicz A. Accuracy of assessing Pelvic Organ Prolapse Quantification points using dynamic 2D trans-perineal ultrasound in women with pelvic organ prolapse. *Int Urogynecol J*. 2012;23(11):1555-60.
253. Chantarasorn V, Dietz HP. Diagnosis of cystocele type by clinical examination and pelvic floor ultrasound. *Ultrasound Obstet Gynecol*. 2012;39(6):710-4.
254. Dietz HP, Mann KP. What is clinically relevant prolapse? An attempt at defining cutoffs for the clinical assessment of pelvic organ descent. *Int Urogynecol J*. 2014;25(4):451-5.
255. Dietz HP, Kamisan Atan I, Salita A. Association between ICS POP-Q coordinates and transabdominal ultrasound findings: implications for definition of 'normal pelvic organ support'. *Ultrasound Obstet Gynecol*. 2016;47(3):363-8.
256. Agarwal A, Eryuzlu LN, Cartwright R, Thorlund K, Tammela TL, Guyatt GH, et al. What is the most bothersome lower urinary tract symptom? Individual- and population-level perspectives for both men and women. *Eur Urol*. 2014;65(6):1211-7.
257. Martin SA, Haren MT, Marshall VR, Lange K, Wittert GA, Members of the Florey Adelaide Male Ageing S. Prevalence and factors associated with uncomplicated storage and voiding lower urinary tract symptoms in community-dwelling Australian men. *World J Urol*. 2011;29(2):179-84.
258. van Koeveeringe GA, Rademakers KL, Birdler LA, Korstanje C, Daneshgari F, Ruggieri MR, et al. Detrusor underactivity: Pathophysiological considerations, models and proposals for future research. ICI-RS 2013. *Neurourol Urodyn*. 2014;33(5):591-6.
259. Liu C, Xu H, Fu S, Chen Y, Chen Q, Cai Z, et al. Sulforaphane Ameliorates Bladder Dysfunction through Activation of the Nrf2-ARE Pathway in a Rat Model of Partial Bladder Outlet Obstruction. *Oxid Med Cell Longev*. 2016;2016:7598294.
260. Alexandre EC, Calmasini FB, de Oliveira MG, Silva FH, da Silva CP, Andre DM, et al. Chronic treatment with resveratrol improves overactive bladder in obese mice via antioxidant activity. *Eur J Pharmacol*. 2016;788:29-36.
261. Subak LL, King WC, Belle SH, Chen JY, Courcoulas AP, Ebel FE, et al. Urinary Incontinence Before and After Bariatric Surgery. *JAMA Intern Med*. 2015;175(8):1378-87.
262. Rosen R, Altwein J, Boyle P, Kirby RS, Lukacs B, Meuleman E, et al. Lower urinary tract symptoms and male sexual dysfunction: the multinational survey of the aging male (MSAM-7). *Eur Urol*. 2003;44(6):637-49.
263. Speakman M, Kirby R, Doyle S, Ioannou C. Burden of male lower urinary tract symptoms (LUTS) suggestive of benign prostatic hyperplasia (BPH) - focus on the UK. *BJU Int*. 2015;115(4):508-19.
264. Issa MM, Fenter TC, Black L, Grogg AL, Kruep EJ. An assessment of the diagnosed prevalence of diseases in men 50 years of age or older. *Am J Manag Care*. 2006;12(4 Suppl):S83-9.
265. Parsons JK, Mougey J, Lambert L, Wilt TJ, Fink HA, Garzotto M, et al. Lower urinary tract symptoms increase the risk of falls in older men. *BJU Int*. 2009;104(1):63-8.
266. Prabhu V, Lee T, McClintock TR, Lepor H. Short-, Intermediate-, and Long-term Quality of Life Outcomes Following Radical Prostatectomy for Clinically Localized Prostate Cancer. *Rev Urol*. 2013;15(4):161-77.
267. Boyd BG, McCallum SW, Lewis RW, Terris MK. Assessment of patient concern and adequacy of informed consent regarding infertility resulting from prostate cancer treatment. *Urology*. 2006;68(4):840-4.
268. Tewari A, Sooriakumaran P, Bloch DA, Seshadri-Kreaden U, Hebert AE, Wiklund P. Positive surgical margin and perioperative complication rates of primary surgical treatments for prostate cancer: a systematic review and meta-analysis comparing retropubic, laparoscopic, and robotic prostatectomy. *Eur Urol*. 2012;62(1):1-15.
269. Haglind E, Carlsson S, Stranne J, Wallerstedt A, Wilderang U, Thorsteinsdottir T, et al. Urinary Incontinence and Erectile Dysfunction After Robotic Versus Open Radical Prostatectomy: A Prospective, Controlled, Nonrandomised Trial. *Eur Urol*. 2015;68(2):216-25.
270. Catalona WJ, Bigg SW. Nerve-sparing radical prostatectomy: evaluation of results after 250 patients. *J Urol*. 1990;143(3):538-43; discussion 44.

271. Sowerby RJ, Gani J, Yim H, Radomski SB, Catton C. Long-term complications in men who have early or late radiotherapy after radical prostatectomy. *Can Urol Assoc J.* 2014;8(7-8):253-8.
272. Thüroff JW, Abrams P, Andersson KE, Artibani W, Chapple CR, Drake MJ, et al. EAU guidelines on urinary incontinence. *Eur Urol.* 2011;59(3):387-400.
273. Mebust W, Roizo R, Schroder F. Correlation between pathology, clinical symptoms and the course of the disease. In: AT C, editor. *Proceeding of the international consultation on benign prostatic hyperplasia.* Channel Island: SCI1992. p. 53-62.
274. de la Rosette JJ WW, Shafer W et al. . Relationship between lower urinary tract symptoms and bladder outlet obstruction: Results from ICS-BPH study. *Neurourol Urodyn.* 1988;17(2):99-108.
275. Donovan JL, Peters TJ, Abrams P, Brookes ST, de la Rosette JJ, Schäfer W. Scoring the short form ICSmaleSF questionnaire. *International Continence Society. J Urol.* 2000;164(6):1948-55.
276. Blaivas JG, Panagopoulos G, Weiss JP, Somaroo C. Validation of the overactive bladder symptom score. *J Urol.* 2007;178(2):543-7; discussion 7.
277. Homma Y, Yoshida M, Seki N, Yokoyama O, Kakizaki H, Gotoh M, et al. Symptom assessment tool for overactive bladder syndrome--overactive bladder symptom score. *Urology.* 2006;68(2):318-23.
278. Fujimura T, Kume H, Nishimatsu H, Sugi-hara T, Nomiya A, Tsurumaki Y, et al. Assessment of lower urinary tract symptoms in men by international prostate symptom score and core lower urinary tract symptom score. *BJU Int.* 2012;109(10):1512-6.
279. Eckhardt MD, van Venrooij GE, van Melick HH, Boon TA. Prevalence and bothersomeness of lower urinary tract symptoms in benign prostatic hyperplasia and their impact on well-being. *J Urol.* 2001;166(2):563-8.
280. Hammerer P, Huland H. Urodynamic evaluation of changes in urinary control after radical retropubic prostatectomy. *J Urol.* 1997;157(1):233-6.
281. Winters JC, Appell RA, Rackley RR. Urodynamic findings in postprostatectomy incontinence. *Neurourol Urodyn.* 1998;17(5):493-8.
282. Chao R, Mayo ME. Incontinence after radical prostatectomy: detrusor or sphincter causes. *J Urol.* 1995;154(1):16-8.
283. Ficazzola MA, Nitti VW. The etiology of post-radical prostatectomy incontinence and correlation of symptoms with urodynamic findings. *J Urol.* 1998;160(4):1317-20.
284. van Venrooij GE, Eckhardt MD, Gisolf KW, Boon TA. Data from frequency-volume charts versus filling cystometric estimated capacities and prevalence of instability in men with lower urinary tract symptoms suggestive of benign prostatic hyperplasia. *Neurourol Urodyn.* 2002;21(2):106-11.
285. Brandes SB, Bullock AD. Update on male urinary stress incontinence. *Mo Med.* 2007;104(5):425-9.
286. Machold S, Olbert PJ, Hegele A, Kleinhans G, Hofmann R, Schrader AJ. Comparison of a 20-min pad test with the 1-hour pad test of the international continence society to evaluate post-prostatectomy incontinence. *Urol Int.* 2009;83(1):27-32.
287. Agarwal P, Rosenberg ML. Neurological evaluation of urinary incontinence in the female patient. *Neurologist.* 2003;9(2):110-7.
288. Chodak GW, Keller P, Schoenberg H. Routine screening for prostate cancer using the digital rectal examination. *Prog Clin Biol Res.* 1988;269:87-98.
289. Mistry K, Cable G. Meta-analysis of prostate-specific antigen and digital rectal examination as screening tests for prostate carcinoma. *J Am Board Fam Pract.* 2003;16(2):95-101.
290. Roehrborn CG, Girman CJ, Rhodes T, Hanson KA, Collins GN, Sech SM, et al. Correlation between prostate size estimated by digital rectal examination and measured by transrectal ultrasound. *Urology.* 1997;49(4):548-57.
291. Roehrborn CG, Sech S, Montoya J, Rhodes T, J GC. Interexaminer reliability and validity of a three-dimensional model to assess prostate volume by digital rectal examination. *Urology.* 2001;57(6):1087-92.
292. McConnell JD, Roehrborn CG, Bautista OM, Andriole GL, Jr, Dixon CM, Kusek JW, et al. The long-term effect of doxazosin, finasteride, and combination therapy on the clinical progression of benign prostatic hyperplasia. *N Engl J Med.* 2003;349(25):2387-98.
293. Boyle P, Gould AL, Roehrborn CG. Prostate volume predicts outcome of treatment of benign prostatic hyperplasia with finasteride: meta-analysis of randomized clinical trials. *Urology.* 1996;48(3):398-405.

294. Tong YC, Lin YM, Yang WH, Tzai TS, Lin JS. Correlation of transrectal ultrasonographic findings of the prostate with the occurrence of detrusor instability in patients with benign prostatic hyperplasia. *Urol Int.* 1995;55(3):154-7.
295. Stewart WF, Van Rooyen JB, Cundiff GW, Abrams P, Herzog AR, Corey R, et al. Prevalence and burden of overactive bladder in the United States. *World J Urol.* 2003;20(6):327-36.
296. Rodgers M, Nixon J, Hempel S, Aho T, Kelly J, Neal D, et al. Diagnostic tests and algorithms used in the investigation of haematuria: systematic reviews and economic evaluation. *Health Technol Assess.* 2006;10(18):iii-iv, xi-259.
297. Gerber GS, Goldfischer ER, Karrison TG, Bales GT. Serum creatinine measurements in men with lower urinary tract symptoms secondary to benign prostatic hyperplasia. *Urology.* 1998;49(5):697-702.
298. Roehrborn CG, Bartsch G, Kirby R, Andriole G, Boyle P, de la Rosette J, et al. Guidelines for the diagnosis and treatment of benign prostatic hyperplasia: a comparative, international overview. *Urology.* 2001;58(5):642-50.
299. Rule AD, Roberts RO, Girman CJ, McGree ME, Lieber MM, Jacobsen SJ. The association between benign prostatic hyperplasia and chronic kidney disease in community-dwelling men. *Kidney Int.* 2005 Jun;67(6):2376-82.
300. Kwon YM, Cho B, Son KY, Choi HC, Park SG, Park JH. Lower urinary tract symptoms have negative associations with glomerular filtration rate irrespective of prostate volume in Korean men. *Urology.* 2012;79(1):182-7.
301. Catalona WJ, Richie JP, Ahmann FR, Hudson MA, Scardino PT, Flanigan RC, et al. Comparison of digital rectal examination and serum prostate specific antigen in the early detection of prostate cancer: results of a multicenter clinical trial of 6,630 men. *J Urol.* 1994;151(5):1283-90.
302. Carvalhal GF, Smith DS, Mager DE, Ramos C, Catalona WJ. Digital rectal examination for detecting prostate cancer at prostate specific antigen levels of 4 ng/ml. or less. *J Urol.* 1999;161(1):835-9.
303. McVary KT, Roehrborn CG, Avins AL, Barry MJ, Bruskewitz RC, Donnell RF, et al. Update on AUA guideline on the management of benign prostatic hyperplasia. *J Urol.* 2011;185(5):1793-803.
304. Mikolajczyk SD, Marks LS, Partin AW, Rittenhouse HG. Free prostate-specific antigen in serum is becoming more complex. *Urology.* 2002;59(6):797-802.
305. Polascik TJ, Oesterling JE, Partin AW. Prostate specific antigen: a decade of discovery--what we have learned and where we are going. *J Urol.* 1999;162(2):293-306.
306. Antenor JA, Han M, Roehl KA, Nadler RB, Catalona WJ. Relationship between initial prostate specific antigen level and subsequent prostate cancer detection in a longitudinal screening study. *J Urol.* 2004;172(1):90-3.
307. Thompson IM, Pauler DK, Goodman PJ, Tangen CM, Lucia MS, Parnes HL, et al. Prevalence of prostate cancer among men with a prostate-specific antigen level < or =4.0 ng per milliliter. *N Engl J Med.* 2004;350(22):2239-46.
308. Wilson SS, Crawford ED. Screening for prostate cancer: current recommendations. *Urol Clin North Am.* 2004;31(2):219-26.
309. Vesely S, Knutson T, Fall M, Damber JE, Dahlstrand C. Clinical diagnosis of bladder outlet obstruction in men with lower urinary tract symptoms: reliability of commonly measured parameters and the role of idiopathic detrusor overactivity. *Neurourol Urodyn.* 2003;22(4):301-5.
310. Jacobsen SJ, Girman CJ, Guess HA, Oesterling JE, Lieber MM. New diagnostic and treatment guidelines for benign prostatic hyperplasia. Potential impact in the United States. *Arch Intern Med.* 1995;155(5):477-81.
311. Barry MJ, Fowler FJ, Jr, Bin L, Pitts JC, 3rd, Harris CJ, Mulley AG, Jr. The natural history of patients with benign prostatic hyperplasia as diagnosed by North American urologists. *J Urol.* 1997;157(1):10-4; discussion 4-5.
312. Roehrborn CG, Boyle P, Bergner D, Gray T, Gittelman M, Shown T, et al. Serum prostate-specific antigen and prostate volume predict long-term changes in symptoms and flow rate: results of a four-year, randomized trial comparing finasteride versus placebo. PLESS Study Group. *Urology.* 1999;54(4):662-9.
313. Laniado ME, Ockrim JL, Marronaro A, Tubaro A, Carter SS. Serum prostate-specific antigen to predict the presence of bladder outlet obstruction in men with urinary symptoms. *BJU Int.* 2004;94(9):1283-6.

PATIENT-REPORTED OUTCOME ASSESSMENT

Chairs

David Castro Diaz (Spain)

Dudley Robinson (UK)

Members

Ruud Bosch (Netherlands)

Elisabetta Costantini (Italy)

Nikki Cotterill (UK)

Montse España-Pons (Spain)

Ervin Kocjancic (USA)

Nucelio Lemos (Brazil)

Tufan Tarcan (Turkey)

Masaki Yoshida (Japan)

CONTENTS

<p>ABBREVIATIONS 544</p> <hr/> <p>I. INTRODUCTION 545</p> <hr/> <p>1. Selecting Pro Measures for Clinical Trials and Clinical Practice.....545</p> <p>2. Selecting Pro Measures for Research Studies.....545</p> <p>2.1. Study Design.....545</p> <p>2.2. Study Population546</p> <p>2.3. Intervention546</p> <p>3. Types of Pro Measures546</p> <p>3.1. Quality-adjusted Life Year (QALY).....547</p> <p>4. Literature Search Strategy547</p> <p>II. THE MEASUREMENT OF PATIENT-REPORTED OUTCOMES (PROS) OF INCONTINENCE, OTHER LOWER URINARY TRACT SYMPTOMS, AND BOWEL PROBLEMS 547</p> <hr/> <p>1. Basic Definitions and Terminology547</p> <p>2. Pro Questionnaire Development and Validation.....548</p> <p>2.1. Determining Questionnaire Intent and Purpose.....549</p> <p>2.2. Developing the Items549</p> <p>2.3. Determining the Mode of Administration of a Questionnaire.....549</p> <p>2.4. Questionnaires' Psychometric Properties549</p> <p>2.5. Linguistic and Cultural Validation551</p> <p>2.6. Regulatory Oversight.....551</p> <p>2.7. Questionnaire Development - Conclusion551</p> <p>III. RECOMMENDED PRO QUESTIONNAIRES 552</p> <hr/> <p>Grades of Recommendation for Questionnaires 2016.....552</p> <p>IV. INTERNATIONAL CONSULTATION ON INCONTINENCE MODULAR</p>	<p>QUESTIONNAIRE (ICIQ): WHAT IS THE ICIQ? 555</p> <hr/> <p>1. Aims and Objectives 555</p> <p>2. ICIQ Modules..... 557</p> <p>2.1. Core Modules..... 557</p> <p>2.2. Specific Patient Group Modules..... 557</p> <p>2.3. Optional Modules 557</p> <p>2.4. Post-treatment Module..... 557</p> <p>3. Guidance for Use of the ICIQ..... 557</p> <p>4. ICIQ Questionnaire Implementation 560</p> <p>5. Conclusion..... 560</p> <p>V. PATIENT-REPORTED OUTCOME (PRO) QUESTIONNAIRES TO ASSESS THE IMPACT OF URINARY INCONTINENCE, OAB AND LOWER 560</p> <hr/> <p>1. Urinary Tract Symptoms 560</p> <p>2. Health-Related Quality of Life Measures..... 561</p> <p>3. Patient Satisfaction and Goal Attainment Scaling..... 561</p> <p>4. Screening Tools..... 561</p> <p>5. Assessing Symptom Bother and Overall Bother..... 561</p> <p>6. Assessing the Impact of Urgency 561</p> <p>VI. QUESTIONNAIRES FOR SPECIFIC PATIENT GROUPS 562</p> <hr/> <p>1. Older People 562</p> <p>1.1. The Urge Impact Scale (URIS) [Grade B] 562</p> <p>1.2. Caregivers..... 562</p> <p>2. Children..... 563</p> <p>3. Spinal Cord Injured / Neurological Impairment..... 563</p> <p>3.1. QUALAS-A: Quality of Life Assessment in Spina Bifida for Adults..... 563</p> <p>3.2. IUI: Incontinence Utility Index..... 563</p> <p>3.3. Qualiveen: Quality of Life Related to Urinary Problems in Spinal Cord Injury [Grade A]..... 563</p> <p>4. Prostate / Bladder Cancer 563</p>
--	--

5.	Lower Urinary Tract Symptoms/Benign Prostate Disease	563
VII.	QUESTIONNAIRES TO ASSESS SYMPTOMS AND HRQL IMPACT OF PELVIC ORGAN PROLAPSE	584
VIII.	QUESTIONNAIRES TO ASSESS SYMPTOMS AND HRQL IMPACT OF FAECAL INCONTINENCE	585
IX.	QUESTIONNAIRES TO ASSESS SEXUAL FUNCTION/SEXUAL HEALTH AND URINARY SYMPTOMS	586
X.	RECOMMENDATIONS FOR RESEARCH	587
	REFERENCES	588

PATIENT-REPORTED OUTCOME ASSESSMENT

DAVID CASTRO DIAZ (SPAIN), DUDLEY ROBINSON (UK)
 RUUD BOSCH (NETHERLANDS), ELISABETTA COSTANTINI (ITALY), NIKKI COTTERILL (UK),
 MONTSE ESPUÑA-PONS (SPAIN), ERVIN KOCJANCIC (USA), NUCELIO LEMOS (BRAZIL),
 TUFAN TARCAN (TURKEY), MASAKI YOSHIDA (JAPAN)

ABBREVIATIONS

AI	Anal Incontinence	IUI	Incontinence Utility Index
BISF-W	Index of Sexual Functioning for Women	KHQ	King's Health Questionnaire
CABG	Comparing Artery Bypass Graft	MSHQ	Male Sexual Health Questionnaire
CARES-SF	Cancer Rehabilitation Evaluation System - Short Form	MSIQ	Menopausal Sexual Interest Questionnaire
CSFQ	Change in Sexual Functioning Questionnaire	OAB-FIM	Overactive Bladder Family Impact
DISFI	Derogatis Sexual Functioning Inventory	PCTO-Q	Prostate Cancer Treatment Outcome Questionnaire
DLSA	Daily Log of Sexual Activities	PFDI-20	Pelvic Floor Distress Inventory
EMA's	European Medicines Agency's	PFIQ-7	Pelvic Floor Impact Questionnaire
FACT-B	Functional Assessment of Cancer Therapy - Bladder Form	PPBC	Patient Perception of Bladder Condition
FACT-G	Functional Assessment of Cancer Therapy	PROMs	Patient Reported Outcome Measures
FACT-P	Functional Assessment of Cancer Therapy - Prostate Form	PROSQOLI	Prostate Cancer Specific Quality of Life Instrument
FACT-VCI	Functional Assessment of Cancer Therapy - Vanderviet Cystectomy Index	QALY	Quality-Adjusted Life Year
FI	Faecal Incontinence	QUALAS-A	Quality of Life Assessment in Spina Bifida for Adults
FSDS	Female Sexual Distress Scale	Qualiveen	Quality of Life Related to Urinary Problems in Spinal Cord Injury
FSDSr	Female Sexual Distress Scale - Revised	SAGA	Self Assessment Goal Attainment
FSFI	Female Sexual Function Index	SFQ	Sexual Function Questionnaire
GAS	Goal Attainment Scaling	SHOW-Q	Sexual Health Outcomes in Women Questionnaire
IBD	Irritable Bowel Disease	SIDI-F	Sexual Interest and Desire Inventory Female
IBS	Irritable Bowel Syndrome	SQoL-F	Sexual Quality of Life—Female
ICIQ-VS	International Consultation on Incontinence Questionnaire - Vaginal Symptoms	SSS-W	Sexual Satisfaction Scale for Women
IIEF	International Index of Erectile Function	SWOG	Modified South-West Oncology Group
		URIS	Urge Impact Scale
		WSID-SF	Women's Sexual Interest Diagnostic Interview - Short Form

I. INTRODUCTION

The last update of the International Consultation on Incontinence report broadened the scope of this review to include all patient-reported outcomes, not just health-related quality of life. This chapter updates the previous literature reviews of Patient Reported Outcome Assessments (PROs), for lower urinary tract symptoms (LUTS) and bowel incontinence outcome measures, in addition to providing recommendations for questionnaire selection for use in clinical practice and research. In addition, this summary will review the purpose and content of the ICI questionnaire (ICIQ) modules. The expansion of this review to include all types of patient reported outcomes (PRO) is an important step in recognising the conceptual differences of various PROs each with different assessment goals. A PRO is defined as “any report of the status of a patient’s health condition that comes directly from the patient, without interpretation of the patient’s response by a clinician or anyone else”([1]¹). PROs measure different aspects of disease and therapeutic impact such as: symptom frequency or symptom bother, health-related quality of life (HRQL), treatment satisfaction, or work productivity measures (Figure 1). An essential component of selecting a PRO for use is to ensure that the selected PRO is consistent with the objective of the study or clinical purpose. For example, if the goal is to assess treatment satisfaction, then a treatment satisfaction measure should be incorporated into the study design or as a clinical outcome. The matching of appropriate PRO selection with desired outcomes is critical to success when assessing PRO’s and will be reviewed further in this chapter.

Ultimately, the last decade has been one of tremendous growth in the area of PROs with influences from scientific and regulatory communities. As such, the ICI will endeavour to continually update the recommendations it offers on the basis of emerging data and published evidence based on the recommendations of the prior reviews.

1. SELECTING PRO MEASURES FOR CLINICAL TRIALS AND CLINICAL PRACTICE

How does a researcher choose which instruments are most appropriate for a particular research study and/or clinical assessment? The following section provides general guidelines for use in conducting PRO assessments in clinical trials or other research investigations related to urinary or faecal incontinence.

As there are many available PROs, it is of utmost importance to select the PRO measure that is relevant and applicable to one’s desired outcome. If an intervention is designed to reduce symptom bother, then a relevant PRO would be a symptom bother measure. Multiple PROs can be included in clinical practice or

in a research study; however the designation of the PRO as a primary, co-primary, secondary, tertiary or exploratory endpoint must be noted. In addition, issues of staff and participant burden, time constraints, and resources should be considered in the selection of a PRO measure. Once it has been decided which outcomes are to be assessed it is important to choose a questionnaire that has been scientifically developed and validated. Principles of validation and questionnaires that have been validated are presented in this chapter.

“Outcomes” Claims Classification

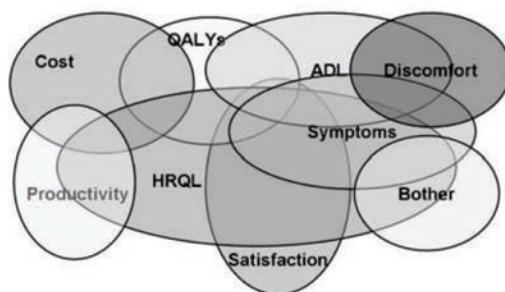

Figure 1: Patient-Reported Outcomes Assessment Areas. Burke L, Evidence Review Branch DDMAC, FDA; DIA Workshop on Pharmacoeconomic and Quality of Life Labelling and Marketing Claims New Orleans October 3, 2000

2. SELECTING PRO MEASURES FOR RESEARCH STUDIES

2.1. Study Design

There are several protocol concerns that must be taken into account when using PRO measures in research studies, including the length of the study, the frequency of contact with the study participants, the timing of clinical assessments, the complexity of the study design, the number of participants enrolled, and participant and staff burden. The goal of the PRO assessment is to “fit” the PRO measures to the protocol without compromising either the study objective or design. For example, if the study design is complex with frequent participant contacts and multiple clinical measures, it may be necessary to keep the PRO measures at a minimum or to reduce the number of times the PRO is assessed (e.g. baseline and end of study rather than during all participant contacts) to minimise participant and staff burden. At the same time, however, PROs must be viewed as an important variable in the overall trial design and should not be devalued in the data collection process. Consequently, PRO measures cannot be altered or reduced to accommodate study design as such alterations may yield less reliable measures or may seriously diminish the integrity of the overall study design and yield less information. Having well developed research

goals and questions regarding PROs will help to guide clinicians in the selection of measures for a study. The aim is to develop a conceptually adequate, yet practical PRO battery given the study population, the specific intervention, and the study design.

The frequency with which a PRO will need to be assessed in a research study will depend upon the nature of the condition or intervention being investigated and the expected effects (both positive and negative) of the treatment. At a minimum, as with all measurements collected in a research study, a baseline and end of study assessment should be completed. In addition, PRO assessments should be timed to match expected changes in functioning due to either the intervention, the condition or the disease itself. Timing follow-up assessments to coincide with typical patient follow-up visits, if appropriate, may also reduce the costs involved in the follow-up PRO assessments.

2.2. Study Population

It is critical to specify key population demographics that could influence the choice of instruments, the relevant dimensions of the PRO to be assessed, and the mode of administration. Thus, age, gender, educational level, language spoken, and cultural diversity should be carefully considered prior to selecting PRO measures. For example, a cohort of patients over the age of 70 may have more visual problems than middle-aged persons, making self-administered questionnaires potentially inadvisable. Ethnically diverse groups also require measures that have been validated across different cultures and/or languages.

In clinical trials, it is also important to consider how the disease or condition will progress and affect the outcomes of patients in the control group as it is to understand the effects of the study treatment. For example, in patients with incontinence assigned to a placebo-control arm of a study, one might expect a symptom to worsen and thus have an effect on daily functioning. The point is to select PRO measures that are sufficiently sensitive to detect changes in both the treatment and the control group patients. Use of the same measures for both groups will ensure an unbiased and comparable assessment.

2.3. Intervention

There are three major factors related to the intervention that are relevant to PRO assessment, and therefore require careful consideration: 1) the positive and adverse effects of treatment; 2) the time course of the effects; and 3) the possible synergism of the treatment with existing medications and conditions. It is crucial to understand how a proposed treatment can affect patient outcomes in both positive and negative ways. For example, some drug therapies may relieve LUTS but produce side effects like dry mouth or sexual dysfunction.

In addition, the time course of an intervention's effects on PROs is also critical both in terms of the selection of measures and the timing of when PRO measures

are administered to study participants. For example, in a trial comparing coronary artery bypass graft (CABG) surgery to angioplasty, an assessment of PRO one week post-intervention might lead to an interpretation that the surgical arm had worse outcomes than angioplasty for PRO since the individuals in this arm of the trial would still be suffering the effects of the surgical procedure (for instance, sore muscles and surgical site discomfort) which could overwhelm any benefits associated with CABG. However, at six months post-intervention, the benefits of CABG surgery such as, relief from angina might be more profound than the benefits received from angioplasty. Thus the timing of when PROs are assessed could influence how one interprets the benefits (or negative effects) of the interventions.

Finally, it is important to have a clear understanding of the current medications the patient population is likely to be taking prior to randomisation to the study treatment, and how these medications might interact with the trial intervention, (either a pharmacological or behavioural intervention), to influence patient outcomes.

3. TYPES OF PRO MEASURES

There are two types of PRO measures: generic and condition-specific. Generic measures are designed to assess outcomes in a broad range of populations (e.g., both healthy as well as ill individuals). These instruments are generally multidimensional, and assess at least the physical, social and emotional dimensions of life. An example of this type of instrument is the Medical Outcomes Study SF-36 Health Status Profile [2]². A second type of measure is condition-specific (e.g., instruments designed to assess the impact of specific diseases, conditions, age groups, or ethnic groups). Condition-specific measures can be similar to generic instruments in that they assess multiple outcome dimensions, but condition-specific measures also include items more specific to the particular condition or population being studied. Examples of condition specific instruments in urology and urogynaecology include the Incontinence Impact Questionnaire [3]³, the King's Health Questionnaire [4]⁴, and the OAB-q [5]⁵.

In general, it is now common to include condition specific outcome measures in clinical trials due to their enhanced sensitivity to change and the need to minimise participant burden. Importantly, the type of instruments selected for inclusion in a research study will depend on the goals of the intervention and the specific research questions to be addressed. In practice, clinical trials that include PROs usually incorporate a combination of PRO measures most relevant to the study population and intervention, if applicable, being mindful of resource constraints and staff and participant burden.

SYMPTOMS, AND BOWEL PROBLEMS

3.1. Quality-adjusted Life Year (QALY)

Increasingly HRQL outcome measures are being used in the development of quality-adjusted life year (QALY) measures. A QALY is a universal health outcome measure applicable to all individuals and all diseases, which combines gains or losses in both life quantity (mortality) and life quality (morbidity) and enables comparisons across diseases and programs. QALYs are widely used for cost-utility analysis [6]⁶. In the past decades, economic evaluation has been increasingly important for the decision maker to decide which treatment or intervention is more cost effective, in order to allocate limited healthcare resources soundly. Economic evaluation aims to compare interventions in terms of their costs and benefits, including their patient outcome impact. Health benefits can be quantified as QALYs which have become a standard measure and are now recommended in most of health economics guidelines as the method of choice [7]⁷. The economic chapter contains additional information regarding QALYs, as do the following references: [8⁸, 9⁹].

4. LITERATURE SEARCH STRATEGY

For the current version of this chapter the previous literature search was updated. A number of databases were accessed, electronically, with specific search criteria, such as validation work from the period January 2006 through August, 2016. Age and gender limits were not specified. Databases used included Pub-Med/MEDLINE, and websites accessed included oab.com, proqolid.com, ncbi.nlm.nih.gov and mapi-institute.com.

The following key words were used separately and/or in combination: "urinary incontinence", "urinary symptoms", "urgency", "overactive bladder", "stress incontinence," "incontinence," "questionnaire," "epidemiology," "prostate," "prolapse," "faecal," "bowel," "anal," "quality of life," "sexual," "geriatric," "paediatric," "satisfaction," "symptom bother," "goal attainment", "screeener," and "generic." Questionnaires evaluated in this chapter were updated with any new information if new validation work was found. New questionnaires not in the previously updated resource tool were added to appropriate sections if they were validated and relevant with regard to the search terms specified above. Grades were evaluated for correctness, based on previous and new validation work, and modified if and when necessary to demonstrate any changes with respect to instrument validation.

II. THE MEASUREMENT OF PATIENT- REPORTED OUTCOMES (PROS) OF INCONTINENCE, OTHER LOWER URINARY TRACT

The symptom impact of urinary incontinence and other lower urinary tract symptoms (LUTS) as well as bowel problems and the treatment benefit of any modality in this field can be assessed in several ways. While taking a detailed clinical history is the most traditional method, patient-completed tools have gained more importance and proved their reliability in the symptom and outcome assessment such as voiding diaries and validated questionnaires.

Patient self-completed questionnaires or patient reported outcomes (PROs) build the basis of the patient-centered healthcare system and represent the most important clinical review of symptom impact and treatment benefit from a patient perspective [10¹⁰, 11¹¹]. PROs or the synonymously used new term patient reported outcome measures' (PROMs) provide a method for the standardised collection of data, or an objective assessment of subjective phenomena, from patients relating to incontinence, other LUTS, and bowel problems. Clinicians' assessments of patients' outcomes have often been shown to underestimate the degree of bother perceived by patients, and to focus on issues of lesser importance to patients [12¹²].

1. BASIC DEFINITIONS AND TERMINOLOGY

It is important to understand the advances in terminology of outcome measures that are categorized in 3 groups: clinical, humanistic and economical [13¹³]. The humanistic outcome measures may focus on role performance and emotional status, whereas economical outcomes on expenses and saving. The clinical outcomes measure cure or survival and they can be further sub-classified as clinician reported, caregiver reported, physiological (e.g. urodynamic improvement) or patient reported. If the patient is observed for the outcomes by a clinician, researcher or caregiver then the outcomes are termed observer reported outcomes (OROs) [14¹⁴]. Proxy reported outcome is a measurement based on the report by someone other than the patient reporting as if he or she is the patient and are different from a PRO or ORO [15¹⁵].

According to US-FDA, a PRO is any report of the status of a patient's health condition that comes directly from the patient, without interpretation of the patient's response by a clinician or anyone else [15]. The European Medicines Agency's (EMA's) Reflection Paper on the Regulatory Guidance for the Use of Health Related Quality Of Life (HRQL) Measures in the Evaluation of Medicinal Products defines a PRO similarly as "any outcome directly evaluated by the patient and

based on patient's perception of a disease and its treatment[s]" [16¹⁶].

Although PROs are commonly used as an umbrella term to also include health related quality of life (HRQOL) some authors consider PROs to differ from HRQOL measurements for the following reasons. Firstly, HRQOL is multidimensional whereas a symptom is a one-dimensional property. Secondly, PROs are directly related to disease and treatment effect compared to HRQOL where there is an indirect relation to them. Thirdly, in the case of PRO concepts symptoms are often considered for behavioral objective measures but seldom for HRQOL. Thus, PRO concepts are simple whereas the concepts are complex in HRQOL [11].

The US-FDA has described the basic definitions related to PRO that are shown in **Table 1** [15]. PRO instruments can also be classified as generic, disease specific, dimension specific, region/site specific, individualized, utility measures, and summary items having their own advantages and disadvantages [11,17¹⁷].

Since the last ICI, electronic PROs (ePRO) have gained more importance since clinical trial managers and regulators prefer electronic collection of PRO data directly from the patient for PRO-based endpoints [18¹⁸]. It has been suggested that ePRO leads

a stronger test of the study objectives and a better picture of the patient's experience [20].

2. PRO QUESTIONNAIRE DEVELOPMENT AND VALIDATION

PRO questionnaires can be used to record the presence and severity of urinary and bowel symptoms, as well as the impact of symptoms on everyday activities and health-related quality of life (HRQL) and satisfaction with treatment, etc. To ensure that the results obtained with PROs are clinically useful, data must be gathered using valid and reliable instruments. Prasanna et al have reported the characteristics of an ideal PRO instrument that are shown in **Table 2** [11]. Questionnaire design and development is not a simple process. Developing such instruments requires a multistep, structured process that incorporates cognitive psychology, psychometric theory, and patient and clinician input. The process begins by determining the intent and purpose of the PRO and culminates in studies that demonstrate the measure's validity, reliability, and responsiveness. The specific steps required for developing a PRO questionnaire are outlined in the following section and are shown in **Figure 2** and each step is further detailed in **Table 3** [15].

The development of a PRO is a rigorous, scientific

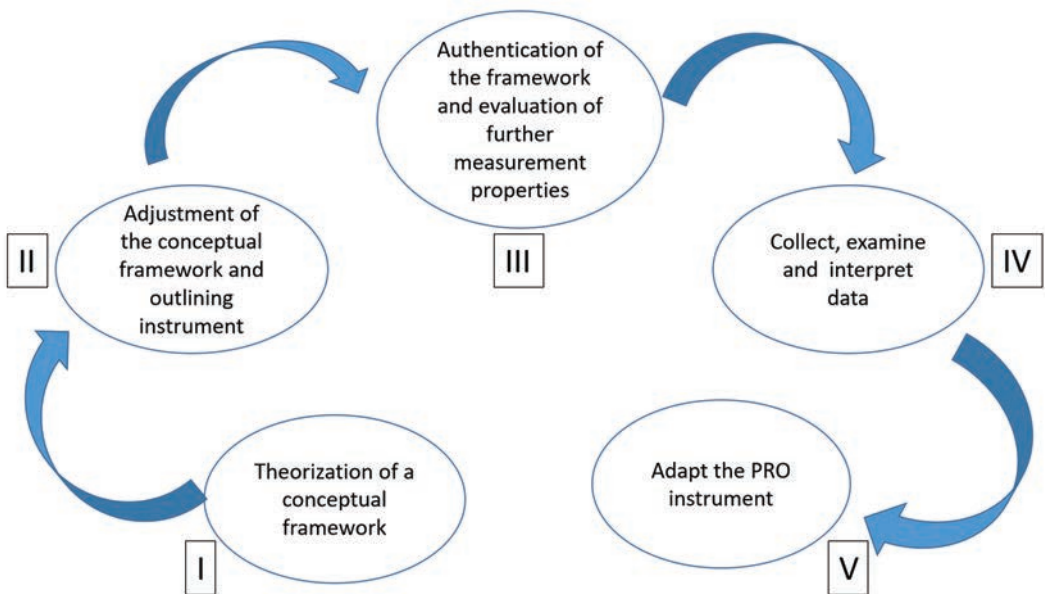

Figure 2: Five-step development of PRO instrument (adapted from ref 6)

to improved data quality, more complete data, less subject and administrative burden, as well as better implementation of skip patterns [19¹⁹,20²⁰]. Furthermore, it has been shown that electronic data collection yields more reliable and accurate data, allowing

process to provide confidence that the PRO is measuring what it is intended to measure, that it does this reliably, and is appropriate for use in the patient or population group under investigation. The final instrument must have demonstrated validity and reliability in the intended target population. PROs need to be

developed with patient and clinician input and have the psychometric, or measurement, properties of the PRO evaluated to determine that it is a valid outcome measure. To be a useful measurement tool, a PRO instrument must also be easy to administer, reliable, and valid. Only PROs that have undergone this process and have published validation data are discussed in this chapter.

2.1. Determining Questionnaire Intent and Purpose

The first task in developing a PRO measure is to determine why the instrument is needed. Given the current number of disease-specific questionnaires available in the field of incontinence and related pelvic disorders, a new PRO measure must fill a need that has not already been met by an existing instrument. Once the need for the measure is recognized, its purpose and clinical usefulness need to be considered because the purpose dictates the validation design process. For example, a symptom and a treatment satisfaction measure would be developed and validated differently because the outcome is different.

The development stage would focus on the outcome of interest (e.g., symptoms patients experience and the significance of each symptom, or what issues patients consider when determining how satisfied they are with treatment) with the items derived from the patient perspective and relating to the outcome of interest. Validation efforts would include designing a study focused on the outcome of interest with the appropriate patient inclusion/exclusion criteria to enhance generalizability while maintaining internal consistency and providing opportunities to test—at a minimum—reliability and validity.

2.2. Developing the Items

Designing a clinically useful PRO measure involves more than just developing a series of questions. In addition to clinician input and literature review, questionnaire items must be generated from a patient perspective and include patient views. This is obtained through focus groups or one-on-one interviews to provide qualitative data on issues pertinent to patients and to identify the words patients use to describe their symptoms or disease impact. Focus groups and one-on-one interviews should be carefully planned to address the goals of the questionnaire being developed. For example, if a measure is intended to assess symptom bother, interview questions should pertain to the patient's symptom experience. Importantly, rather than using clinical terminology which patients may not comprehend, the words used during the focus groups or interviews should be common to patients. The results of the qualitative patient interviews lead to item generation. After items are generated, the newly drafted questionnaire should be reviewed by other patients and experts to ensure its readability and content validity.

An alternative approach to questionnaire development is to adapt an existing measure to meet the needs of the desired questionnaire. Patients need to be involved in the questionnaire adaptation to ensure that the revised measure is pertinent to the population of interest. The adapted questionnaire must be validated on its own in the target population as the validity of the original questionnaire does not apply to an adapted measure.

For newly developed and adapted questionnaires, think out loud interviews or cognitive interviews should be used to ascertain the correctness and validity of the revised questionnaire. In a think out loud interview, patients are asked to review a question and describe what they are thinking as they cognitively process the question; the patients think out loud about what the question means to them and how they think through their response to the question. For a cognitive interview approach, patients review and respond to the questionnaire items, and then they are interviewed about what each item meant to them as they completed the questionnaire. Both approaches provide information about what patients consider when responding to each question.

2.3. Determining the Mode of Administration of a Questionnaire

When generating the PRO items, the mode of administration must be considered. Will the measure be completed by the patient (i.e., self-administered) or administered by an interviewer (i.e., interviewer-administered)? How the questionnaire will be completed needs to be determined before the validation stage because mode of administration can affect patient responses. For highly personal or intimate questions, a self-administered questionnaire is recommended to avoid response bias. Questionnaires that are self-administered are preferable to interviewer-administered questionnaires because the data collection burden is reduced and patients are more likely to provide unbiased information on self-administered questionnaires. Importantly, if a questionnaire has been validated for a particular mode of administration (self-administered pen and paper), this does not make the questionnaire valid for all modes of administration (e.g. electronic administration via web or hand held device). Should the mode of administration change from the original validation, processes must be undertaken to ensure no change in meaning or content have occurred with the format change. Guidelines for this type of adaptation are clearly outlined by Coons et al (2009) [21²¹].

2.4. Questionnaires' Psychometric Properties

All PRO measures must demonstrate reliability, validity, and responsiveness, which are described in detail below. This can be accomplished in several ways:

Perform a stand-alone cross-sectional study to validate the questionnaire in the patient population for which it was designed;

Administer the untested questionnaire in a clinical study and use the baseline data to perform psychometric validation (the end-of-study data can also be used to evaluate responsiveness); or

Perform a stand-alone longitudinal study with an intervention to determine the instrument's psychometric performance and responsiveness in a non-clinical trial setting.

The following psychometric properties must be tested for and demonstrated in a validated questionnaire.

Reliability refers to the ability of a measure to produce similar results when assessments are repeated (i.e., is the measure reproducible?). Reliability is critical to ensure that change detected by the measure is due to the treatment or intervention and not due to measurement error [22²²]. One measure of reliability is the questionnaire's internal consistency, which indicates how well individual items within the same domain [or subscale] correlate. Cronbach's alpha coefficient is used to assess internal consistency reliability, with higher alphas indicating greater correlation. Typically, Cronbach's alpha should be greater than 0.70 to indicate good internal consistency reliability [22, 23²³]. If the item-to-total alpha is less than 0.20, the question should be removed or rewritten.

Test-retest reliability, or reproducibility, indicates how well results can be reproduced with repeated testing. To assess test-retest reliability, the same patient completes the questionnaire more than once, at baseline and again after a period of time during which the impact of symptoms is unlikely to change (e.g., a few days or weeks) [22, 23]. The Spearman's correlation coefficient and intraclass correlation coefficient are used to demonstrate reproducibility. For group data, a Spearman's correlation coefficient or an intraclass correlation coefficient of at least 0.70 demonstrate good test-retest reliability [22, 23].

Inter-rater reliability indicates how well scores correlate when a measure is administered by different interviewers or when multiple observers rate the same phenomenon [22]. Demonstration of inter-rater reliability is not necessary for self-administered questionnaires but is necessary for instruments based on observer ratings or using multiple interviewers. A correlation of 0.80 or higher between raters indicates good inter-rater reliability [22].

Validity refers to the ability of an instrument to measure what it was intended to measure [22, 23]. A measure should be validated for each specific condition or outcome for which it will be used. For example a measure designed to assess stress incontinence would not be valid for OAB unless it were specifically validated in patients with OAB symptoms.

Content validity, convergent validity, discriminant validity, and criterion validity typically are required to validate a questionnaire [22, 23].

Content validity is a qualitative assessment of whether the questionnaire captures the range of the content it is intended to measure [22, 23]. For example, does a measure of symptom severity capture all the symptoms that patients with a particular condition have, and if so, is the measure capturing the items in a manner meaningful to patients in language patients can understand? To obtain content validity, patients review the measure and provide feedback as to whether the questions are clear, unambiguous, and comprehensive.

Convergent validity is a quantitative assessment of whether the questionnaire measures the theoretical construct it was intended to measure [22, 23]. Convergent validity indicates whether a questionnaire has stronger relationships with similar concepts or variables. Stronger relationships should be seen with the most closely related constructs and weaker relationships seen with less-related constructs [22, 23].

Discriminant validity indicates whether the questionnaire can differentiate between known patient groups (e.g., those with mild, moderate, or severe disease) [22, 23]. Generally, measures that are highly discriminative are also highly responsive.

Criterion validity reflects the correlation between the new questionnaire and an accepted reference, or gold standard [22, 24²⁴]. One difficulty in establishing criterion validity is that a gold-standard measure might not be available [22, 24]. When criterion validity can be established with an existing measure, the correlation should be 0.40 to 0.70; correlations approaching 1.0 indicate that the new questionnaire may be too similar to the gold-standard measure and therefore redundant [22, 24].

Responsiveness indicates whether the measure can detect change (for better or worse) in a patient's condition [25²⁵]. An aspect of responsiveness is determining not only whether the measure detects change but whether the change is meaningful to the patient. This can be done by determining the minimal important difference (MID) of the measure. The MID is the smallest change in a PRO questionnaire score that would be considered meaningful or important to a patient [26²⁶]. A treatment that is statistically significantly better than another may not necessarily have made a meaningful difference to the patient; the MID indicates whether the treatment made such a difference from a patient perspective.

Unfortunately, there is no scientific test for MID as it is an iterative process that involves two methodologies to determine the MID of a questionnaire: an anchor-based approach and a distribution-based approach [27²⁷, 28²⁸]. With the anchor-based approach, the MID is determined by comparing the measure to other measures (or "anchors") that have clinical relevance [27]. With the distribution-based approach, the

MID can be determined by the statistical distributions of the data [27], using analyses such as effect size, one-half standard deviation, and standard error of measurement [27, 28, 29²⁹].

Another methodology to evaluate treatment benefit is to examine the cumulative distribution function (CDF) of responses between treatment groups. The CDF provides plots to examine the treatment effect and mean improvements by treatment group to see if the mean improvement varies by patient subsets [15, 29].

2.5. Linguistic and Cultural Validation

Increasingly, PRO questionnaires are required to be used in a number of different populations and settings, however, questionnaires and their psychometric properties are not necessarily transferable [30³⁰, 31³¹]. A measure that is valid and reliable for a particular language and culture may not prove to be so after translation. Linguistic and cultural adaptation of a questionnaire can occur during the development phase before validation, or it can be done after the questionnaire is validated in the language in which it was initially developed, with the latter being the more common approach. Ensuring the linguistic and cultural validity of a questionnaire is especially important for measures used in multinational clinical trials [30, 31].

The principal steps in adapting a measure for different languages and cultures are as follows:

two forward translations of the original instrument into the new language;

quality-control procedures that may include a backward translation (translating the instrument back into the original language) [31];

adjudication of all translated versions;

discussion by an expert panel to ensure clarity of the translated questionnaire; and

testing the translated instrument in monolingual or bilingual patients to ensure that it measures the same concepts as the original instrument [31, 32³²].

However, if a backward translation of the measure does not produce a semantically equivalent instrument, then the instrument may need to be developed in the target language, rather than just translated [31].

After cultural and linguistic validation, PROs should also be psychometrically validated within the target language. Thus, reliability, validity, and responsiveness need to be assessed with each language translation to confirm the same measurement properties are present in the translated language(s) to ensure psychometric equivalence. If psychometric equivalence is not present (e.g., not achieving similar or better results in new language translation), the cultural and linguistic translations need to be reevaluated and perhaps a new instrument may need to be developed.

The ICIQ questionnaires and many of the other questionnaires discussed in this chapter have multiple linguistically validated versions making them useful for International implementation. It is also important to note that the step after linguistic validation, demonstrating psychometric equivalence, should also be demonstrated to ensure that the PRO performs equivalently in different languages and cultures (e.g., Coyne et al. 2008 [33³³]).

2.6. Regulatory Oversight

As clinicians and scientists have begun to appreciate and accept PROs as appropriate outcome measures, regulatory authorities have issued guidance documents on current best practices in the development and implementation of PRO in clinical trial settings [15, 34³⁴, 35³⁵]. For PROs to be acceptable outcome measures for regulatory authorities, documentation of measurement properties must be present as well as evidence of inclusion of the patient perspective and understanding of the PRO and a cohesive conceptual framework that stipulates how the PRO is related to the intervention. While PROs within this document may have a "recommended" status, they may not meet all of the required regulatory guidelines and may require additional validation work either from a qualitative or quantitative perspective. It is strongly suggested that regulatory authorities be contacted early in the process of selecting a PRO for clinical trials to ensure regulatory acceptance of the PRO.

2.7. Questionnaire Development Conclusion

PROs are the most suitable method for assessing the patient's perspective of their lower urinary tract, vaginal and bowel symptoms [27³⁶]. Questionnaires may be long and detailed for use in research, but need to be short and easy to use to be relevant for clinical practice. In addition to being valid and reliable, they need to be easy to complete, and, if they are being used to measure outcome, sensitive to change. Developing a new questionnaire and testing it thoroughly takes a great deal of time and is only necessary if there is not an existing instrument available.

There are many questionnaires currently available for use and these have been reviewed and described with recommendations from the Committee for their use in the last four ICI reports.

The major purpose of the ICI has been to provide a definitive international review and consultative opinion regarding the recommended measures to assess patient reported outcomes within the area of urinary incontinence and LUTS. To this end since the First Consultation, the ICI has worked to develop a modular format for the various patient reported outcomes allowing clinicians and researchers to select internationally recommended questionnaires for the assessment of their patients in both clinical practice and clinical trials. In this sixth ICI review, the ICIQ modular

questionnaires (supported by the International Consultation) are presented in detail and their use evaluated. Whilst some of the modular questionnaires are still currently under full evaluation their content and format are presented within this chapter.

III. RECOMMENDED PRO QUESTIONNAIRES

GRADES OF RECOMMENDATION FOR QUESTIONNAIRES 2016

As with previous Consultations, the Committee continues to use three grades of recommendation. However, we have added a + sign to indicate when published content validity is available for an instrument:

Questionnaires were 'highly recommended' and given a **Grade A** if the Committee found "Published data indicating that the questionnaire is valid, reliable and responsive to change following standard psychometric testing. Evidence must be published on all three aspects and questionnaires must be relevant for use with persons with incontinence. **Grade A + indicates there is additional evidence of published content validity.**"

Questionnaires were "recommended" and given a **Grade B** if the Committee found "Published data indicating that the questionnaire is valid and reliable following standard psychometric testing. Evidence must be published on two of the three main aspects (usually validity and reliability). **Grade B + indicates there is additional evidence of published content validity.**"

Questionnaires were considered to have "potential" and given **Grade C** if the Committee found "Published data (including abstracts) indicating that the questionnaire is valid or reliable or responsive to change following standard psychometric testing. **Grade C + indicates there is additional evidence of published content validity.**"

The Committee decided that evidence published in abstracts or posters could be used to indicate a developing questionnaire's potential, but was not sufficiently peer-reviewed to provide the basis for a stronger recommendation.

As decided in the Fourth Consultation the recommendation will be to preferably utilize questionnaires from the ICIQ modules described in detail below. Many, but not all, of these questionnaires are Grade A or A+ questionnaires by previously stipulated criteria. Within the description of the ICIQ modules below the grade assigned to each module is indicated.

Should none of the modular questionnaires be deemed appropriate for specific research or clinical purposes, ICI's recommendation is to use a Grade A+ or A questionnaire as previously recommended.

When no suitable instrument exists a Grade B or C questionnaire, performing additional validation as indicated prior to use if feasible, should be used.

For UI and UI/LUTS, the Committee examined the quality of the psychometric evidence. Only where published data were scientifically sound was the label 'with rigor' allowed. Where the Committee had concerns about the quality of evidence, this is noted in the descriptions of the questionnaires below. The Committee considered that the number of high quality questionnaires means that there are now sufficient questionnaires for most purposes and it is not necessary to encourage the development of new questionnaires, except for particular patient groups (see below).

Table 1: Important definitions of PRO according to US-FDA Industry Guidance (Ref 15)

PRO instrument	(i.e., a questionnaire plus the information and documentation that support its use) is a means to capture PRO data used to measure treatment benefit or risk in medical product clinical trials.
PRO concept	It is nothing but the thing or event being measured. It can be called as the specific goal of the instrument. e.g. symptom or group of symptoms
PRO domain	A subconcept represented by a score of an instrument that measures a larger concept comprised of multiple domains. e.g. depression
PRO item	An individual question, statement, or task (and its standardized response options) that is evaluated by the patient to address a particular concept. e.g. Are you feeling depressed?
Conceptual framework	The conceptual framework explicitly defines the concepts measured by the instrument in a diagram that presents a description of the relationships between items, domain (sub-concepts) and concepts measured and the scores produced by a PRO instrument.
Endpoint	The measurement that will be statistically compared among treatment groups to assess the effect of treatment and that corresponds with the clinical trial's objectives, design, and data analysis.
End point model	A diagram of the hierarchy of relationships among all endpoints, both PRO and non-PRO, that corresponds to the clinical trial's objectives, design, and data analysis plan.
Conceptual equivalence	It is the equivalence in relevance and meaning of the concepts being measured in different languages and /or cultures.
Health Related Quality of Life	In simple words HRQOL can be defined as personal health status of the individual. Actually, it is a multi-domain concept which represents the patient's general perception of the effect of illness and treatment on various aspects of life such as physical, psychological, and social. Some other aspects also can be predicted to affect HRQOL like- economical, disease symptoms, adverse drug reactions, patient-education, disease-treatment given to the patient.

Table 2: Ideal properties of PRO instrument (adapted from ref 20)

To be specific to the concept being measured.
To be based on <i>end-point model</i> .
To have conceptual equivalence.
To be based on the conceptual framework.
To contain optimum number of items.
To have easy and specific measurement properties i.e. use of the scales which is easiest for the intended population to understand.
To have proper evidences for the conceptual framework.
To maintain the confidentiality of the patient.
To be reproducible.

Table 3: A detailed description of PRO development phases (Adapted from ICI 2013 and ref 6)

Theorization of a conceptual framework	<ul style="list-style-type: none"> Outline hypothesized concepts and potential claims Determine intended population Determine intended application/characteristics (type of scores, mode and frequency of administration) Perform literature expert review Develop hypothesized conceptual framework Place PROs within preliminary endpoint model Document preliminary instrument development
Adjustment of the conceptual framework and outlining instrument	<ul style="list-style-type: none"> Obtain patient input Generate new Items Select recall period, response options and format Select mode/method of administration/data collection Conduct patient cognitive interviewing Pilot test draft instrument Document content validity
Authentication of the framework and evaluation of further measurement properties	<ul style="list-style-type: none"> Confirm conceptual framework with scoring rule Assess score reliability, construct validity, and ability to detect change Finalize instrument content, formats, scoring, procedures and training materials Document measurement development
Collect, examine and interpret data	<ul style="list-style-type: none"> Prepare protocol and statistical analysis plan (final endpoint model and responder model) Collect and analyze data Evaluate treatment response using cumulative distribution and responder definition Document interpretation of treatment benefit in relation to claim
Adapt the PRO instrument	<ul style="list-style-type: none"> Change wording of items, populations, response options, recall period, or mode/method of administration/data collection Translate and culturally adopt to other languages Evaluate modifications as appropriate Document all changes

IV. INTERNATIONAL CONSULTATION ON INCONTINENCE MODULAR QUESTIONNAIRE (ICIQ): WHAT IS THE ICIQ?

The ICIQ modular questionnaire was developed to meet the need for a universally applicable standard guide for the selection of questionnaires for use in clinical practice and clinical research for lower pelvic dysfunction [37³⁷, 38³⁸]. It was recognised that there were many good validated questionnaires each developed for a specific purpose and each subtly different. Although developers of the questionnaires were familiar with their content and use, the increasing number of questionnaires made appropriate selection difficult and limited the ability to compare similar clinical and research data due to different data collection methods.

The decision to develop standard questionnaire modules was taken by the Committee after the first ICI meeting in 1998, and resulted in the development of the ICIQ core questionnaires discussed in this section.

An international advisory board was established to continue the development of the modular ICI questionnaire outside the limits imposed by triennial convening of the ICI Committee. The advisory board consisted of clinicians and researchers with experience in the design and use of questionnaires representing the major societies involved in the assessment and research of lower genital tract, lower urinary tract and bowel function. The ICIQ modular questionnaire was then established. Researchers who have developed questionnaires that they would like to be reviewed by the advisory board for inclusion should send the questionnaires and relevant publications to www.iciq.net. The project is a series of living documents that will be continually updated.

1. AIMS AND OBJECTIVES

The ICIQ's objective is to provide international consensus on the use of patient completed questionnaires for the assessment of lower pelvic symptoms and their impact on patient's lives. Three aims underpin the ICIQ in order to achieve clarity over questionnaire use:

To recommend high quality self-completion questionnaires according to evidence of validation as stipulated by the five prior ICI Committees;

To promote wider use of questionnaires to standardise assessment of lower urinary tract and pelvic dysfunction and its impact on patients' lives, in order to;

Facilitate communication in different patient settings and different patient groups both in clinical practice and wider clinical research.

The ICIQ recognised that many high quality published questionnaires already existed and, with permission from the authors, those instruments were adopted into the modular project. It was not possible to adopt all available questionnaires and where more than one option existed, the most appropriate questionnaire for the purpose was included. Where high quality questionnaires were not available, the need to develop a new questionnaire was acknowledged. Questionnaires are developed according to rigorous methodology which complies with industry-standard guidance for PRO development [1]. Collaborative efforts to develop new questionnaires are welcome and encouraged.

The ICIQ's international nature requires that linguistically validated translations are available. More than 50 language versions of various modules have been validated to date and conducted according to established protocol.[39]³⁹

Sixteen ICIQ modules/questionnaires are currently available for use, with further modules in development (discussed in detail below). Clinicians or researchers are able to select module(s) to meet the particular requirements of their study or clinical practice. In order to simplify this selection process, modules have been categorised as shown in **Figure 3**. It must be stressed that although multiple questionnaires can and probably should be used they must be used in the format in which they were originally designed and the questionnaires cannot be merged together as this may affect their measurement capability.

In recent years, increasing advances have been made in the area of electronic documentation, particularly with regard to patient care. It is recognised that questionnaires requiring written completion by hand may lack versatility and therefore prevent uptake of the ICIQ, hampering attempts to promote standardisation of evaluation. Evaluations of electronic ICIQ modules have been completed, indicating equivalence of their measurement properties and acceptability to the target audiences.[40]⁴⁰ Cognitive interviewing was conducted with participants representative of potential respondents, namely men and women with lower urinary tract symptoms of varied cause and of varying age. Further participants completed electronic and paper versions of the questionnaires, in a randomised order, to provide comparison data and the opportunity to compare completion over the telephone was also included. Electronic versions demonstrated excellent equivalence with their paper counterparts, supporting use of these formats as long as they are prepared in the specific ICIQ format. Telephone completion was found to produce slightly poorer correlations although acceptable equivalence was still observed. This is as expected as these questionnaires are intended for self-completion but this

Figure 3: The ICIQ Modular Structure

CONDITION	RECOMMENDED MODULES	OPTIONAL MODULES	RECOMMENDED ADD-ON MODULES		
	A) Core modules		QoL	Sexual Matters	Post-Treatment
Urinary Symptoms	Males: ICIQ-MLUTS Females: ICIQ-FLUTS	Males: ICIQ-MLUTS LF Females: ICIQ-FLUTS LF	ICIQ-LUTSqol	Males: ICIQ-MLUTSsex Females: ICIQ-FLUTSsex	ICIQ-S* (satisfaction)
	ICIQ-Bladder diary				
Vaginal Symptoms	ICIQ-VS		ICIQ-VSqol*		
Bowel Symptoms	ICIQ-B	ICIQ-IBD			
Urinary Incontinence	ICIQ-UI SF	ICIQ-UI LF*	ICIQ-LUTSqol	Males: ICIQ-MLUTSsex Females: ICIQ-FLUTSsex	
CONDITION	B) Specific Patient Groups		QoL	Sexual Matters	
Nocturia	ICIQ-N		ICIQ-Nqol	Males: ICIQ-MLUTSsex Females: ICIQ-FLUTSsex	
OverActive Bladder	ICIQ-OAB		ICIQ-OABqol	Males: ICIQ-MLUTSsex Females: ICIQ-FLUTSsex	
Underactive Bladder	ICIQ-UAB/UAB PRO*				
Neurogenic	ICIQ-Neuro Bowel		ICIQ-Neuro bowel*		
Long term catheter	ICIQ-LTCqol				
Children	ICIQ-CLUTS*		ICIQ-CLUTSqol*		
Absorbent pads			ICIQ-Padprom*		
Cognitively impaired elderly	ICIQ-Qoldem*				
Inflammatory bowel disease incontinence	ICIQ-IBD				

**In development*

study has provided reassurance that their use over the telephone is acceptable if self-completion is not practicable.

In this chapter, questionnaires forming part of the ICIQ modular format are referred to as those preferred for usage. Although many of the modules are Grade A or A+ questionnaires, others are still under various phases of development and are graded appropriately. Questionnaires that are in early stages of development and have yet to reach Grade C are described as “in development”. Where an ICIQ module is not available it is recommended that a Grade A+, A,B or C questionnaire is used.

2. ICIQ MODULES

2.1. Core Modules

Questionnaires to assess the core symptoms and impact on health related quality of life (HRQL) of lower pelvic dysfunction are contained in this section, in addition to impact on sexual matters. Core modules (**Table 4**) provide evaluation of:

- Lower urinary tract symptoms
- Urinary incontinence
- Vaginal symptoms
- Bowel symptoms

Each symptom module is intended for the comprehensive yet succinct measurement of symptoms and associated 'bother'. The bother item attached to symptom items, where applicable, enables the individual to indicate areas that cause the greatest negative impact on HRQL as perceived by them. This can be a more sensitive indicator of treatment goals than frequency of symptoms alone. The HRQL questionnaires cover specific issues that are a consequence of symptoms, such as life limitations and emotional impact. Sexual matters modules specifically evaluate the impact of lower urinary tract symptoms on this aspect from the male and female perspective.

A further core module has been added that moves away from the retrospective questionnaire format in the form of a bladder diary. This is a fully validated prospective tool for the measurement of bladder events as they occur.

2.2. Specific Patient Group Modules

Questionnaires to assess specific conditions or symptom complexes such as nocturia, overactive bladder and underactive bladder, in addition to management strategies such as long term catheter and pad usage are contained in this section along with HRQL modules for these specific symptom complexes where available. This category also includes specific patient groups, for example, children. These instruments contain only question items characteristic of the symptom complex or have been developed specifically for use in a diverse group, which defines their context of use making the items/ questionnaire only utilisable in that population.

- Nocturia
- Overactive bladder
- Underactive bladder
- Neurogenic
- Inflammatory bowel disease
- Lower urinary tract symptoms in children
- Individuals using long term catheters

- Individuals using absorbent pads

2.3. Optional Modules

This category lies within the core symptoms and includes lengthier questionnaires for more in-depth evaluation of lower pelvic dysfunction. Whilst these questionnaires are suitable for use in clinical practice, they have not been shortened for clinical efficiency and are therefore more widely used in research studies where exploration of broader associated symptoms may be desired.

- Lower urinary tract symptoms
- Urinary incontinence

2.4. Post-treatment Module

The ICIQ module for post-treatment satisfaction is in the early stages of development. Assessment of a patient's satisfaction with treatment (behavioural, surgical or medication) provides information on treatment impact on their condition and life and includes their perception of effectiveness, tolerability and convenience. It is not yet clear if satisfaction following treatment can be characterised by a set of common question items that are applicable to all lower pelvic health conditions. As with HRQL, there are generic and disease specific questionnaires that assess satisfaction. Ongoing studies will provide further evidence on which to make suggestions regarding post treatment evaluation but it is likely that this will encompass both generic and condition specific measures. Ultimately, the development of post treatment modules will also rely on advice from regulatory authorities (e.g. FDA, EMA) to ensure that measures capture a recognised multidimensionality of satisfaction.

3. GUIDANCE FOR USE OF THE ICIQ

The ICIQ recommends the use of a symptom and HRQL module that match the intended purpose of a study in order to provide a comprehensive evaluation of these two perspectives. The extent of burden placed on the respondent and the study or clinical outcomes must be considered however and ultimately guide questionnaire selection. The characteristics of each module are summarised below, although more extensive information can be found on the project website, www.iciq.net. Modules currently under development are summarised in **Table 5**.

568 **Table 4. ICIQ Module Description**

Name	Scope of assessment	Domains	Items	Grade
ICIQ-MLUTS [41] ⁴¹ (ICS _{male} SF)	Male lower urinary tract symptoms and associated bother.	Voiding Incontinence Individual items evaluating frequency and nocturia	13	A
ICIQ-FLUTS [42] ⁴² (BFLUTS SF)	Female lower urinary tract symptoms and associated bother.	Filling Voiding Incontinence	12	A
ICIQ-Bladder [43 ⁴³ , 44 ⁴⁴] Diary	Prospective bladder events	Voided volumes Leaks Bladder sensations Fluid input Pad use	24 hour monitoring	A+
ICIQ-VS [45] ⁴⁵	Vaginal symptoms including prolapsed and associated bother.	Vaginal symptoms Sexual matters Quality of life	14	A
ICIQ-B [46 ⁴⁶ , 47 ⁴⁷]	Bowel symptoms including anal incontinence and associated bother	Bowel pattern Bowel control Quality of life	21	A+
ICIQ-UI Short Form [48 ⁴⁸]	Urinary incontinence.	Urinary incontinence frequency, overall interference Perceived cause of incontinence	4	A
ICIQ-LUTSqol[4, 48] (King'sHealth Questionnaire))	HRQL issues associated with urinary symptoms and associated bother.	Life restrictions Emotional aspects Preventive measures	22	A+
ICIQ-MLUTSsex[49 ⁴⁹] (ICS _{male})	Male sexual matters associated with urinary symptoms and associated bother.	Erection and ejaculation issues Overall interference	4	A
ICIQ-FLUTSsex[50 ⁵⁰] (BFLUTS)	Female sexual matters associated with urinary symptoms and related bother.	Pain and leakage with sexual intercourse Overall interference	4	A
ICIQ-FLUTS Long Form (BFLUTS)	Detailed assessment of female lower urinary tract symptoms and associated bother.	Varied lower urinary tract symptoms	18	A
ICIQ-MLUTS Long Form (ICS _{male})	Detailed assessment of male lower urinary tract symptoms and associated bother.	Varied lower urinary tract symptoms	23	A
ICIQ-N	Comprehensive assessment of symptoms of nocturia and associated bother.	Frequency Nocturia.	2	A
ICIQ-OAB	Comprehensive assessment of symptoms of overactive bladder and associated bother.	Frequency Nocturia Urgency Urgency incontinence	4	A

Table 4. ICIQ Module Description (continued)

Name	Scope of assessment	Domains	Items	Grade
ICIQ-OABqol (OAB-q) [5]	Detailed assessment of health- related quality of life issues associated with overactive bladder.	Coping Concern/Worry Sleep Social Interaction	25	A
ICIQ-Nqol (NQOL)[51 ⁵¹ ,52 ⁵²]	Detailed assessment of HRQL issues associated with nocturia.	Issues associated with sleep disturbance Life restrictions Preventive measures	13	A+
ICIQ-LTCqol [53] ⁵³	Detailed assessment fo HRQL associated with long term catheter use	Catheter function and concern Lifestyle impact	19	B

Table 5. ICIQ Description of modules in Development.

Name	Purpose	Current status
ICIQ-CLUTS [5454]	Assessment of urinary symptoms in children.	Validity testing published awaiting reliability and responsiveness evaluation.
ICIQ-Padprom	Assessment of use and HRQL associated with the use of absorbent pads	Validity and reliability established. Requires responsiveness evaluation.
ICIQ-UAB	Assessment of underactive bladder symptoms and their impact on HRQL.	Extensive qualitative development completed. Preliminary quantitative development undertaken. Requires responsiveness evaluation.
ICIQ-Neurogenic	Two modules in development: Assessment of urinary symptoms and impact on HRQL associated with specific management devices and related bother. Assessment of bowel symptoms and impact on HRQL associated with neurogenic disease.	Initial qualitative development completed. Requires quantitative evaluation. Validity, reliability and responsiveness explored, awaiting publication.
ICIQ-VSqol	Detailed assessment of HRQL issues associated with vaginal symptoms and related bother.	Initial qualitative development completed. Quantitative evaluation underway.
ICIQ-Satisfaction	Generic assessment of post- treatment satisfaction for lower pelvic dysfunction including surgical and conservative intervention.	Initial qualitative development completed. Quantitative evaluation underway.

4. ICIQ QUESTIONNAIRE IMPLEMENTATION

The ICIQ modular questionnaire has attracted considerable attention from both clinicians and researchers worldwide since its structure was finalised in 2004. More than 2000 requests for use of the various modules have been documented and over 350 published studies were identified up to June 2016. The most widely applied module is the ICIQ-UI Short Form, particularly to evaluate female urinary incontinence. Reports on further validation and translations of the ICIQ and related educational projects are growing in number. This is essential in order to achieve standardised evaluation of pelvic floor dysfunction, which is a primary aim of the initiative.

The ICIQ has also been applied to clinical and general practice settings, and has been adopted in national guidelines for the management of urinary incontinence in:

- women (NICE clinical guideline 171)
- primary care (SIGN 79)(www.sign.ac.uk/pdf/sign79.pdf)
- included in a primary care resource pack by the British Society of Urogynaecology

5. CONCLUSION

The ICIQ modular questionnaire project (www.iciq.net) provides a growing series of standardised questionnaires for the patient reported assessment of lower pelvic dysfunction symptoms and their impact on patients lives. The ICIQ provides clarity over the selection of questionnaires by recommending only those with evidence of high quality and robust psychometric validation including validity, reliability and sensitivity to change. Testing psychometric equivalence of the ICIQ electronic formats also provides reassurance of their rigorous measurement capabilities in specific alternative formats. This assurance provides the user with confidence in the results obtained, which is important in clinical practice and research where treatment decisions or trial outcomes depend on this evidence. Increasing awareness of the ICIQ aims to promote increased use of standardised questionnaires and further evaluation of existing modules in order to advance the evidence base supporting use of these tools. These efforts aim to increase communication between clinicians and researchers and enable more wide-spread comparisons between different treatments and patient groups worldwide. Collaboration with the ICIQ is encouraged among clinicians and researchers in order to further develop new and existing ICIQ modules and translations.

V. PATIENT-REPORTED OUTCOME (PRO) QUESTIONNAIRES TO ASSESS THE IMPACT OF URINARY INCONTINENCE, OAB AND LOWER

1. URINARY TRACT SYMPTOMS

There are a variety of PRO measures available for use in clinical practice and research that assess a range of concepts (e.g. HRQL, patient satisfaction, symptom bother, etc). Encouragingly, PROs awarded the highest ICI grade are being used widely in studies, with short forms that are easily accessible being preferred.[55]⁵⁵ This section provides an overview and assessment of these measures. Importantly, clinical practitioners and researchers need to clearly determine their clinical and research objectives before selecting a PRO as it is these objectives and the target patient population that will help determine which validated PRO is appropriate to use. **Tables 6 to 10** provide a brief overview of all current PRO measures for urinary incontinence and LUTS, their purpose, psychometric properties, translation availability, and recommended ICI grade.

Please note, as instrument development and validation is an ongoing process, the tables below contain publications through June 2016. As additional work may have been performed on a instrument, it is always prudent to conduct a further literature search and/or contact the instrument developer prior to selecting an outcome measure for your clinical practice or study. Further study-specific testing should also be considered to ensure a tool's appropriateness for the intended purpose. When using a questionnaire in a patient group other than the group in which it was initially developed, cognitive interviews with the new patient population should be held to review the applicability of the questionnaire to the new patient group. Several of the main questionnaires to be discussed below have now had modified versions published in the literature. The Committee's view is that although it may be appropriate to modify established questionnaires for use with some populations, it is advisable to keep such modifications to a minimum, and to use the original versions whenever possible. Any modifications of established questionnaires may result in changes (sometimes substantial) in the psychometric performance of the instrument, and thus all modified instruments should be subjected to the same psychometric testing as that employed in developing a completely new instrument. Specifically, modified instruments should report information regarding the instrument's construct validity, reliability, and test-retest reliability, at a minimum, and sensitivity to change, in intervention studies.

2. HEALTH-RELATED QUALITY OF LIFE MEASURES

Health-related quality of life (HRQL) measures help to assess the impact of disease and treatment on those aspects of quality of life related to health. UI is a symptomatic condition that has been shown to affect many aspects of a patient's life - physical, emotional, and social relations and cause concern and burden. As such, it is important to assess HRQL in clinical research and practice. **Table 6** provides a quick overview of the variety of HRQL measures available and their validity and characteristics to determine which measure is suitable for your objectives.

3. PATIENT SATISFACTION AND GOAL ATTAINMENT SCALING

Patient satisfaction and Goal Attainment Scaling are two important but separate types of PROs that allow for individualised assessment of disease impact and treatment. Patient satisfaction is the subjective, individual evaluation of treatment effectiveness and/or the service provided by the healthcare system. Goal attainment scaling (GAS) is a method developed to ascertain individual patient treatment goals and using those to facilitate patient-provider interaction and tailor the treatment plan based on those individual's goals [56]⁵⁶.

Measures of patient satisfaction can include evaluation of accessibility/convenience, availability of resources, continuity of care, efficacy, finances, humaneness, information gathering and giving processes, pleasantness of surroundings and perceived quality/competence of health care personnel [57]⁵⁷. At its most basic level, satisfaction is a comprehensive evaluation of several dimensions of health care based on patient expectations and provider and treatment performance. As an outcomes measure, patient satisfaction allows health care providers to assess the appropriateness of treatment according to patient expectations. In chronic diseases, where patients must live with treatment, patient satisfaction may be the distinguishing outcome among treatments with comparable efficacy [58]⁵⁸.

Table 7 at the end of the chapter presents a summary of satisfaction instruments identified in UI, OAB and other LUTS.

GAS has been used to measure clinically important change in several therapeutic areas. Although it was originally developed to assess health outcomes in mental health settings, it has recently been expanded to include evaluations in urogynaecology [59]⁵⁹, [60]⁶⁰, [61]⁶¹, [62]⁶², [63]⁶³. GAS has been linked to several possible benefits compared with traditional outcome

measures, such as improved clarity concerning treatment objectives for both the healthcare provider and the patient, active involvement of the patient in problem-solving efforts, establishment of realistic patient and healthcare provider expectations of treatment, and increased motivation of patients toward improving their health condition [56]. The end result of GAS is to clarify patients' expectations for their treatment, document goal achievement, and eventually increase patient satisfaction and improve therapeutic outcomes.

One GAS instrument for lower urinary tract symptoms has been well developed, the Self Assessment Goal Attainment (SAGA) questionnaire. Numerous linguistically validated translations are available at: <http://www.pfizerpatientreportedoutcomes.com> [64]⁶⁴.

4. SCREENING TOOLS

In order to improve the detection of incontinence, OAB and other LUTS, several screening tools have been developed (**Table 8**). These tools help patients self-describe symptoms and facilitate diagnosis of LUTS by the clinician. Only the B-SAQ has been designed to screen for general lower urinary tract symptoms (LUTS) rather than solely symptoms of one condition. The majority of patients with LUTS have mixed urinary symptoms, and therefore a questionnaire which can detect more than one symptom complex may be more functional as a screening tool in clinical practice than a highly specific questionnaire. The Leicester Impact Scale (LIS), OAB-V8, OAB-SS and QUID are all Grade A, short, simple to understand and complete, and easy to interpret. However the LIS is interviewer, not patient administered. Importantly, with screeners, responsiveness is not assessed, however the sensitivity and specificity of each tool is critical.

5. ASSESSING SYMPTOM BOTHER AND OVERALL BOTHER

Measures that can be used to assess how bothered patients are by urinary symptoms are included in **Table 9**. The Patient Perception of Bladder Condition (PPBC) [65]⁶⁵ and the Urogenital Distress Inventory are the only Grade A recommend instruments. However, there are several Grade B and C measures which assess bother for incontinence and LUTS.

6. ASSESSING THE IMPACT OF URGENCY

Several instruments have been developed specifically to assess urinary urgency, which is defined by the International Continence Society as "the complaint of a sudden compelling desire to pass urine

which is difficult to defer”[66]⁶⁶. Urgency is the driving symptom of OAB [67]⁶⁷, thus assessing the effect of treatment on this symptom and its impact on HRQL is important. With any measure designed to evaluate urgency, patients must be able to distinguish between the normal desire to urinate (urge) and the difficult-to-postpone need to urinate (urgency) [68⁶⁸, 69⁶⁹]. Wording thus becomes critical in the development of urgency assessment measures. Chapple and Wein [70]⁷⁰ make a case for describing urgency as a “compelling desire to void in which patients fear leakage of urine” as a means of distinguishing this abnormal sensation from the normal need to void. However, some patients may have a sensation of urgency without fear of leakage, further complicating attempts to define urgency. Importantly, with some of these scales, patients have the option of indicating that they experienced UUI (an event) rather than the strongest feeling of urgency (a sensation) itself. Several instruments have been developed to assess urinary urgency these are summarised in **Table 10**.

VI. QUESTIONNAIRES FOR SPECIFIC PATIENT GROUPS

Most studies and questionnaires have been developed for use with members of the general population or urology/gynaecology patients with incontinence or POP. However, some specific patient groups may experience particular problems with incontinence (for example, children, frail elderly or those who are severely disabled), which may require independent investigation and potentially the development of more specific measures or the addition of a new subset of items on already developed instruments. The Committee advises that researchers should use existing highly recommended or recommended questionnaires if possible as this aids comparison and to reduce the increasing proliferation of questionnaires. Many of the questionnaires developed below for particular conditions (e.g. prostate cancer) pre-dated the development of highly recommended questionnaires, and highly recommended questionnaires should be used preferentially.

1. OLDER PEOPLE

Urinary incontinence symptoms play an influential role on the overall HRQL in older people (>65) and causes a significant decrease in HRQL, as severe as that of many chronic disease states. Since the elderly commonly have a number of associated co-morbid conditions, it may be difficult to measure the impact of urinary incontinence with generic HRQL measures. The use of incontinence specific tools to measure patient-reported outcomes in the elderly, therefore, is of considerable importance. Validated incontinence-specific PRO questionnaires, such as IIQ, I-QOL or KHQ, are used for clinical trials or research on urinary incontinence including elderly people, but their validity has not been specifically assessed in this age

group. Okamura assessed symptoms and HRQL in older people (men and women) with lower urinary tract symptoms including incontinence, using the KHQ and IPSS. They demonstrated that symptoms and HRQL in the elderly with LUTS could be assessed by IPSS and KHQ and that urinary incontinence appeared to be more associated with a decreased HRQL in elderly women [71]⁷¹.

On the other hand, there are a variety of factors affecting older people, including physical, social, mental, economic or environmental conditions, which are different from those of the young. In frail elderly people with dementia or physical impairment, it may be difficult to assess the impact of urinary incontinence alone. Questionnaires specifically developed for the elderly may be of great importance in this respect. However, there is little relating to the development or validation of particular questionnaires for older people with urinary incontinence. Two questionnaires dealing with older people were found and are described below. No questionnaires dealing with patient outcomes specifically for frail older incontinent people were found.

1.1. The Urge Impact Scale (URIS) [Grade B]

The Urge Impact Scale (URIS) was designed and tested specifically for older persons with urgency incontinence. The URIS was developed and validated by DuBeau et al. [72]⁷² and included 32 items, reduced to 24 items (URIS-24). The URIS-24 was psychometrically assessed for validity and reliability in community-dwelling older (>65y) men and women with urgency incontinence. Cronbach’s alpha was 0.84 for the URIS-32 and 0.94 for the URIS-24. In assessment of test-retest reliability, interclass coefficient (ICC) was 0.88. The URIS-24 had modest but nearly significant correlation with the number of urgency incontinence episodes ($\rho=-0.39$, $p=0.05$). Factor analysis revealed 3 component structures corresponding to physiological burden, perception of personal control and self-concept. There was no analysis for responsiveness. They showed that the URIS-24 is an internally consistent, highly reproducible tool for the assessment of the QOL impact of urgency incontinence on older persons.

1.2. Caregivers

The Overactive Bladder Family Impact (OAB-FIM) scale was developed to assess the impact of OAB on family members of patients with OAB. This 19-item tool consists of 6 subscales [73]⁷³. Four subscales (Irritation, Activities, Travel, Concern) could be used for all family members; however 2 additional subscales (Sleep, Sex) should only be administered to spouses/significant others. The OAB-FIM was highly discriminating between OAB and control family members, with all OAB family members indicating significant impact (all $p<0.0001$). Internal consistency reliability (Cronbach’s alpha >0.71) and 2-week test-retest reliability (intra-class correlation coefficients >0.73) were high for all subscales. Concurrent validity of the OAB-FIM was demonstrated through statistically significant

($p < 0.001$) Spearman correlations with the OAB-q (coefficients ranging from 0.35 to 0.58) and the PPBC (0.31 to 0.56). No differences were noted on the OAB-FIM by patient incontinence status (none, urge vs. mixed). OAB-FIM scores also discriminated by family member perceptions of OAB severity, particularly among the Irritation, Activities and Travel subscales. Correlational analyses among the OAB-FIM and relationship quality measures suggest that greater OAB symptom impact on the family member was associated with increased problems in the patient–family member relationship. The responsiveness of the OAB-FIM is yet to be assessed. This measure can be found at www.pfizerpatientreportedoutcomes.com.

2. CHILDREN

Some questionnaires have been developed specifically to assess issues for children and can include parent and child versions of the questionnaire. Enuresis is a particular focus in addition to specific disorders such as Spina Bifida (ISI-P). See Chapter 9 (Children) and section on ICIQ modular questionnaire.

3. SPINAL CORD INJURED / NEUROLOGICAL IMPAIRMENT

Individuals who have a spinal cord injury or are neurologically damaged can experience particular difficulties with incontinence and the use of various devices. It would be useful to investigate whether Grade A questionnaires, developed for people without neurological damage, can be used in this group, or whether additional modules or instruments are required. New instruments available in this area are detailed below.

3.1. QUALAS-A: Quality of Life Assessment in Spina Bifida for Adults

The QUALAS-A was developed to evaluate quality of life associated with bladder and bowel disorders in adults with Spina Bifida [74]⁷⁴. Items were generated through interviews and a focus group and refined to develop the 53 item pilot instrument. International recruitment achieved a sample of 532 participants to evaluate validity and reliability to assist item reduction. The resulting 15 item questionnaire provides a comprehensive assessment organized within three domains: Health and relationships, Esteem and sexuality, and bladder and bowel.

3.2. IUI: Incontinence Utility Index

The IUI is a condition-specific preference-based measure for urinary symptoms related to neurogenic detrusor overactivity that provides population based utility scores to value health states [75]⁷⁵. The instrument was developed from the I-QoL and neurogenic module by applying Rasch modeling. 442 participants were interviewed to estimate social preferences and

explanatory models identified that demonstrated adequate predictive validity.

3.3. Qualiveen: Quality of Life Related to Urinary Problems in Spinal Cord Injury [Grade A]

The Qualiveen was developed to evaluate the specific impact of urinary dysfunction on the quality of life of spinal cord injury patients in France [76]⁷⁶. The initial items were developed following patient interviews, and were then assessed for validity and reliability in 281 spinal cord injury patients with urinary difficulties. The Qualiveen contains 30 items and has demonstrated good reliability and validity [76]. Further validation of the Qualiveen has occurred in multiple sclerosis patients [77]⁷⁷ and it has been translated and validated into English [78]⁷⁸, German [79]⁷⁹, and Portuguese [80]⁸⁰. The Qualiveen has demonstrated responsiveness in multiple sclerosis patients and has a suggested MID of 0.5 [81]⁸¹.

4. PROSTATE / BLADDER CANCER

Many PRO questionnaires are available for assessment in this area: Post-radical prostatectomy questionnaire [82]⁸², [83]⁸³, Cancer Rehabilitation Evaluation System - Short Form (CARES-SF) [84]⁸⁴, Prostate Cancer Treatment Outcome Questionnaire (PCTO-Q) [85]⁸⁵, Prostate Cancer Specific Quality of Life Instrument (PROSQOLI) [86]⁸⁶, Modified Southwest Oncology Group (SWOG) [87]⁸⁷, Functional Assessment of Cancer Therapy - (FACT-G), Bladder form (FACT-B) and Prostate form (FACT-P) [88]⁸⁸, Functional Assessment of Cancer Therapy Vanderviet Cystectomy Index (FACT-VCI) [89]⁸⁹, EORTC metastatic prostate cancer [85], Changes in Urinary Function [90]⁹⁰, Prostate-targeted Health Related Quality of Life [91]⁹¹. While it is beyond the scope of this chapter to review and recommend PROs in this area, the principles and guidelines discussed herein apply to selecting a PRO related to prostate and bladder cancer.

5. LOWER URINARY TRACT SYMPTOMS/BENIGN PROSTATE DISEASE

Many questionnaires have been developed to assess LUTS and benign prostate disease; however, most do not contain a full evaluation of UI. Perhaps the most widely known urology PRO is the AUA Symptom Index [92]⁹², I-PSS (International Prostate Symptom Score) [92, 93]⁹³. The IPSS has been utilised internationally to assess symptoms of prostate disease with documented reliability, validity and responsiveness. More recently a Visual Prostate Symptom Score [94]⁹⁴ has been developed and an app version of the IPSS has been evaluated, providing alternative approaches to the assessment of symptoms associated with prostate disease [95]⁹⁵. Additional PRO

measures for BPH are as follows: Patient-completed modification of the Boyarsky[96]⁹⁶, BPH Impact Index [97]⁹⁷[98]⁹⁸ and BPH Health-related QoL survey [99]⁹⁹

Table 6: Health-related Quality of Life measures for Lower Urinary Tract Symptoms

PRO Name/ICIQ Grade	Purpose/Description of Tool	Population Sample	Reliability		Validity				Responsiveness (Treatment Duration)	Instrument Access & Translation(s)
			Internal Consistency	Test-retest	Content (Item Generation)	Criterion	Concurrent	Discriminant		
BFLUTS (Bristol Female Lower Urinary Tract Symptoms Questionnaire). Currently the ICIQ-FLUTS (ICIQ-Female Lower Urinary Tract Symptoms); Grade A [42]	34-question tool used to assess female LUTS, particularly urinary incontinence, measure impact on quality of life and evaluate treatment outcome	Women, incontinence	√	√	√		√		None	www.iciq.net
Contilife® (Quality of Life Assessment Questionnaire Concerning Urinary Incontinence); Grade B [100]100	28-item tool used to assess the impact of urinary incontinence on HRQL. Originally developed in French and designed for women with UI (urge, stress and mixed UI)	Women, SUI	√	√ (ICC = 0.96)			√		√	www.proqolid.org
DAN-PSS-1 (Danish Prostatic Symptom Score); Grade A [101]101	15-item tool used to evaluate males with LUTS suggestive of uncomplicated BPH	Men, BPH	√	√	√		√			www.proqolid.org
EPIQ (Epidemiology of Prolapse and Incontinence Questionnaire); Grade B [102]102	49-item tool developed and validated in English and Spanish to assess the presence or absence of AI, OAB, SUI, and pelvic organ prolapse in female population	women, PFD	√	√	√	√	√	√		contact developer
ICIQ-UI Short Form (International Consultation on Incontinence Questionnaire - Urinary Incontinence Short Form (ICIQ-UI Short Form); Grade A[38]	4-item tool used to assess the symptoms and impact of urinary incontinence in clinical practice and research	men and women, Urinary symptoms	√	√	√		√	√	√ (8 weeks)	www.proqolid.org
ICSmale (ICIQ-	23-item tool used to	men with	√	√	√		√		√	www.proqolid.org

Table 6: Health-related Quality of Life measures for Lower Urinary Tract Symptoms (continued)

PRO Name/CIQ Grade	Purpose/Description of Tool	Population Sample	Reliability		Validity				Responsiveness (Treatment Duration)	Instrument Access & Translation(s)
			Internal Consistency	Test-retest	Content (Item Generation)	Criterion	Concurrent	Discriminant		
MLUTS) (International Continence Society - Male); Grade A [49]	provide a thorough evaluation of the occurrence and bothersomeness of lower urinary tract symptoms and their impact on the lives of men with benign prostatic disease	LUTS and possible BPH								org
ICSQoL (International Continence Society-Benign Prostatic Hyper-plasia study quality-of-life); Grade A [103] ¹⁰³	8-item tool used to assess impact of lower urinary tract symptoms on the lives of men with LUTS	men with LUTS and possible BPH	√	√	√		√			www.proqolid.org
IIQ (Incontinence Impact Questionnaire); Grade A [104] ¹⁰⁴	30-item tool developed to describe the severity of incontinence in a population. It was validated in a group of women aged 45 and over attending two continence clinics for SUI primarily. Used to assess the impact of urinary incontinence on HRQL.	Women, UI		√	√		√		√ (12Weeks)	contact developer
IIQ-7 (Incontinence Impact Questionnaire - short form); Grade A [105] ¹⁰⁵	7-item tool used to assess the impact of urinary incontinence on HRQL	*validation study on men after radical prostatectomy who had UI	√ (Cronbach's Alpha = 0.93)	√ (Spearman's Rho = 0.99; ICC = 0.75)	√	√	√	√		contact developer
IOQ (Incontinence Outcome Questionnaire); Grade B [106] ¹⁰⁶	27 question tool developed for assessing quality of life after surgery for stress urinary incontinence	Women SUI	√ (Cronbach's Alpha = 0.83)		√	√			√	contact developer

Table 6: Health-related Quality of Life measures for Lower Urinary Tract Symptoms (continued)

PRO Name/ICIQ Grade	Purpose/Description of Tool	Population Sample	Reliability		Validity				Responsiveness (Treatment Duration)	Instrument Access & Translation(s)
			Internal Consistency	Test-retest	Content (Item Generation)	Criterion	Concurrent	Discriminant		
I-QOL (ICIQ-Uqol) (Urinary Incontinence-Specific Quality of Life Instrument); Grade A [107 ¹⁰⁷ , 108 ¹⁰⁸]	22-item tool used to assess quality of life of women with UI	women, UI	√	√	√			√	www.proqolid.org	
ISI (Incontinence Severity Index); Grade C [109] ¹⁰⁹	2-item severity measure recommended by the World Health Organization for studying the epidemiology of incontinence and other LUTS; Developed in an epidemiologic study of 28,000 women in Norway.	Women, SUI				√	√		contact developer	
ISQ (Incontinence Stress Index: ISQ-P [Patient]; ISQ-SOPS [Staff Observation of Patient Stress]; ISQ-SR [Staff Reaction to UI]); Grade C [110] ¹¹⁰	40-item tool (20-items in short form) used to assess psychological stress associated with urinary incontinence	Women	√	√					www.proqolid.org	
ISS (Incontinence Symptom Severity Index); Grade A [111] ¹¹¹	8-item instrument used for the self-assessment of severity of female urinary storage and voiding symptoms, rather than symptom bother or effects of on quality of life	Females		√ (ICC = 0.62 - 0.91)			√	√ (Duration not specified)	contact developer	
KHQ (ICIQ-LUTSqol) (King's Health Question- naire); Grade A+ [4, 48]	21-item tool used to assess the symptoms impact of LUTS including urinary incontinence on HRQL. Developed in a clinical perspective to evaluate incontinence in women.	UI, OAB, men and women	√ (all domains except severity measure (Cronbach's Alpha = 0.60) demonstrated excellent IC)	√	√	√	√	√ (12Weeks)	www.proqolid.org	

Table 6: Health-related Quality of Life measures for Lower Urinary Tract Symptoms (continued)

PRO Name/CIQ Grade	Purpose/Description of Tool	Population Sample	Reliability		Validity				Responsiveness (Treatment Duration)	Instrument Access & Translation(s)
			Internal Consistency	Test-retest	Content (Item Generation)	Criterion	Concurrent	Discriminant		
LIS (The Leicester Impact Scale); Grade A [127] ¹¹²	21-item tool used as a quality of life measure for males and females with urinary storage symptoms of urgency, frequency, nocturia and incontinence.	men and women, LUTS	√	√	√		√		√	contact developer
LUTSS (Lower Urinary Tract Symptom Score) Grade A (113) ¹¹³	14-item tool used as a symptom evaluation for urinary storage symptoms (9 items), voiding symptoms (4 items) and associated bother (1 item).	Men and women, LUTS	√	√		√		√	√	Contact developer
M-ISI (Michigan Incontinence Symptom Index) [114] ¹¹⁴ Grade B	10-item tool used to measure urinary incontinence and its bother, including three sub-domains: stress and urge urinary incontinence, and pad use	Women, aged 35-64 UI	√		√		√	√		Contact developer
MUDI (Male Urogenital Distress Inventory); Grade B+ [115] ¹¹⁵ , [116] ¹¹⁶	27-item tool used to address the dimension of physical health, focusing on bother from multiple symptoms associated with UI in men. Created by eliminating four gender specific items from UDI and IIQ.	Men with LUTS following a radical prostatectomy for prostate cancer	√		√		√			www.proqolid.org
MUSIQ (Male Urinary Symptom Impact Questionnaire); Grade B+ [115, 116]	32-item tool used to capture mental/psychological health, social health, and global perceptions of function and well-being in men with urinary incontinence. Created by eliminating four gender specific items from UDI and IIQ.	Men, UI	√		√		√			www.proqolid.org

Table 6: Health-related Quality of Life measures for Lower Urinary Tract Symptoms (continued)

PRO Name/ICIQ Grade	Purpose/Description of Tool	Population Sample	Reliability		Validity				Responsiveness (Treatment Duration)	Instrument Access & Translation(s)
			Internal Consistency	Test-retest	Content (Item Generation)	Criterion	Concurrent	Discriminant		
Nocturia Impact Diary [117] ¹¹⁷	12-item, 3 day diary to evaluate the impact burden associated with nocturia and its treatment. To be completed in conjunction with a voiding diary.	Men and women with nocturia	√	√	√			√	Contact developer	
N-QoL (Nocturia Quality of Life Questionnaire); Grade A+ [51, 118] ¹¹⁸	13-item tool used to assess the impact of nocturia on the quality of life of patients	men and women	√	√	√		√	√	www.pfizerpatientreportedoutcomes.com	
OAB – q SF (OAB-q Short Form); Grade A [5] [119] ¹¹⁹	19-item tool (shortened version of the OAB-q) used to evaluate both continent and incontinent symptoms of OAB and their impact on HRQL	OAB, men and women	√	√	√		√	√ (12 Weeks)	www.pfizerpatientreportedoutcomes.com	
OAB-q (ICIQ-OABqol) (Overactive Bladder Questionnaire); Grade A [5, 120] ¹²⁰	33-item tool used to evaluate both continent and incontinent symptoms of OAB and their impact on HRQL. Developed from focus groups of men and women, clinician opinion, and a thorough literature review	Continent and incontinent OAB	√	√ (ICC = 0.93 for 4-week recall period)	√	√	√	√ (12 Weeks)	www.pfizerpatientreportedoutcomes.com	
PFDI (Pelvic Floor Distress Inventory); Grade A [120]	46-item tool used to assess presence of symptoms and HRQL in women with POP; 3 Scales (Urinary-28; Colorectal-17 Prolapse-16)	Females with symptomatic POP, UI	√ (Cronbach's Alpha = 0.88)	√ (ICC = 0.87)	√			√	contact developer	
PFDI-20 (Pelvic Floor Distress Inventory Short Form); Grade A [120]	20-item short form of the PFDI (Urinary-6; Colorectal-8; Prolapse-6)	Females with symptomatic POP, UI		√ (ICC = 0.93)	√			√	www.mapi-institute.com	
PFIQ (Pelvic Floor Impact Questionnaire); Grade A [120]	33-item functional status tool used to assess presence of symptoms and HRQL in women with POP; 3 Scales (Urinary-31, Colorectal-31, Prolapse-31)	Females with symptomatic POP, UI	√ (Cronbach's Alpha = 0.98)	√ (ICC = 0.86)	√			√	contact developer	

Table 6: Health-related Quality of Life measures for Lower Urinary Tract Symptoms (continued)

PRO Name/CIQ Grade	Purpose/Description of Tool	Population Sample	Reliability		Validity				Responsiveness (Treatment Duration)	Instrument Access & Translation(s)
			Internal Consistency	Test-retest	Content (Item Generation)	Criterion	Concurrent	Discriminant		
PFIQ-7 (Pelvic Floor Impact Questionnaire Short Form); Grade A [120]	21-item short form of the PFIQ used to assess presence of symptoms and QOL in women with POP; 3 Scales (Urinary-7, Colorectal-7, Prolapse-7)	Females with symptomatic POP, UI		√ (ICC = 0.77)	√				√	www.mapi-institute.com
PRAFAB (Protection, Amount, Frequency, Adjustment, Body Image); Grade A [121] ¹²¹	5 item questionnaire widely used in the Netherlands by physiotherapists and researchers used to evaluate treatment effects for UI in women	women with UI	√	√	√			√	√	contact developer
UIHI (Urinary Incontinence Handicap Inventory); Grade C [122] ¹²²	17-item tool used to identify difficulties patients may be experiencing because of their incontinence	Elderly women, UI due to detrusor instability	√ (Cronbach's Alpha = 0.87)	√				√		www.proqolid.org
UISS (Urinary Incontinence Severity Score); Grade A [123] ¹²³	10-item tool to assess symptom severity and impact of urinary incontinence	Women, UI		√	√	√	√		√	contact developer
Urolife (BPHQoL9) (Benign Prostatic Hypertrophy Health-Related Quality of Life Questionnaire); Grade A [124] ¹²⁴	9-item tool used to assess the impact of BPH and its treatment on the quality of life of patients	Men, BPH	√	√	√		√		√	www.proqolid.org
YIPS (York Incontinence Perceptions Scale); Grade B [125] ¹²⁵	8-item tool used to measure the psychosocial aspects of urinary incontinence and its management	Women, UI	√	√	√		√		√	www.proqolid.org

Table 7: Patient Satisfaction Measures for Lower Urinary Tract Symptoms

PRO Name/CIQ Grade	Purpose/Description of Tool	Population Sample	Reliability		Validity				Responsiveness (Treatment Duration)	Instrument Access & Translation(s)
			Internal Consistency	Test-retest	Content (Item Generation)	Criterion	Concurrent	Discriminant		
BSW (Benefit, Satisfaction with treatment, and Willingness); Grade B [126] ¹²⁶	3 single-item tool used to capture patients' perceived benefit, satisfaction with treatment, and the willingness to continue treatment	men and women, OAB						√	√	www.pfizerpatientreportedoutcomes.com
EPI (Estimated Percent Improvement); Grade C	Single-item tool used to gain a patient's improvement in a percent scale	Women, UI, SUI, MUI						√	√ (2-4 Weeks)	contact developer
GPI (Global Perception of Improvement); Grade C	Single-item tool used to assess patient's improvement	Women, UI, SUI, MUI						√		contact developer
OAB-S (Overactive Bladder Satisfaction measure); Grade B [127] ¹²⁷	51-items to assess following domains: expectations, control impact on daily living, medication tolerability, satisfaction and 5 overall assessments	men and women, OAB	√	√	√		√	√		contact developer
OAB-SAT-q OAB Satisfaction questionnaire; Grade B [137] ¹²⁸	10-item tool used to assess patients' satisfaction with overactive bladder treatment including medication or non-pharmaceutical options such as physical therapy or biofeedback. The pre-medication module is designed assess the patient's expectations with medication and impact on OAB on patient's day to day life.	Men and women, OAB	√	√	√		√	√		contact developer
PSQ (Patient Satisfaction Questionnaire);	Single-item tool used to measure how satisfied a subject was with a program	Women, UI, SUI, MUI						√		contact developer

Table 7: Patient Satisfaction Measures for Lower Urinary Tract Symptoms (continued)

PRO Name/CIQ Grade	Purpose/Description of Tool	Population Sample	Reliability		Validity				Responsiveness (Treatment Duration)	Instrument Access & Translation(s)
			Internal Consistency	Test-retest	Content (Item Generation)	Criterion	Concurrent	Discriminant		
SAGA (Self-Assessment Goal Achievement Questionnaire); GAS; Grade C [127] ¹²⁹	9-item tool on Goal Attainment related to lower urinary tract symptoms and the establishment of patients' goals concerning their treatment for lower urinary tract symptoms (LUTS)	Men and Women aged ≥18 years with OAB	Not Assessed	Not Assessed	√	√ (low to moderate)	√			www.pfizerpatientreportedoutcomes.com
TBS (Treatment Benefit Scale); Grade B [130] ¹³⁰	Single-item tool used to assess the patient-reported benefits of treatment of OAB	Men and Women OAB					√	√	√	contact developer

Table 8: Screening Tools for Lower Urinary Tract Symptoms

PRO Name/CIQ Grade	Purpose/Description of Tool	Population Sample	Reliability		Validity				Responsiveness (Treatment Duration)	Instrument Access & Translation(s)
			Internal Consistency	Test-retest	Content (Item Generation)	Criterion	Concurrent	Discriminant		
3IQ (Three Incontinence Questions Questionnaire); Grade C [131] ¹³¹	3-item tool used to classify urge and stress incontinence	Women, UI						√	N/A	None Found
ABSST (Actionable Bladder Symptom Screening Tool [132] ¹³²		Women, OAB	√				√	√		Contact developer

Table 8: Screening Tools for Lower Urinary Tract Symptoms (continued)

PRO Name/CIQ Grade	Purpose/Description of Tool	Population Sample	Reliability		Validity			Responsiveness (Treatment Duration)	Instrument Access & Translation(s)	
			Internal Consistency	Test-retest	Content (Item Generation)	Criterion	Concurrent			Discriminant
B-SAQ (Bladder Self-Assessment Questionnaire) or Bladder Control Self-Assessment Questionnaire (BCSQ); Grade A [133] ¹³³	8-item screening tool used for the presence of both- some LUTS in Women	Women	√	√		√	√	√	N/A	www.mapi- institute.com
CLSS (Core Lower Urinary Tract Symptom Score) Questionnaire; Grade C	10-item tool used in the overall assessment of lower urinary tract symptoms	Men & Women		√						contact developer
ISQ (Incontinence Screening Questionnaire); Grade B [135] ¹³⁵	5-item tool developed to screen for incontinence in women	Women, UI		√				√	N/A	contact developer
MESA (Medical, Epidemiological, and Social Aspects of Aging Questionnaire); Grade C [136] ¹³⁶	15-item screening tool used for urinary incontinence in female pelvic medicine and reconstructive surgery patients	Women, UI		√					N/A	www.ncbi.nlm.nih.gov
OAB-SS (Overactive Bladder Symptom Score); Grade A [137] ¹³⁷	7-item tool used to measure overall symptom severity due to the four index symptoms of OAB	Men and women, LUTS with or without OAB	√	√	√			√	√	contact developer

Table 8: Screening Tools for Lower Urinary Tract Symptoms (continued)

PRO Name/CIQ Grade	Purpose/Description of Tool	Population Sample	Reliability		Validity				Responsiveness (Treatment Duration)	Instrument Access & Translation(s)
			Internal Consistency	Test-retest	Content (Item Generation)	Criterion	Concurrent	Discriminant		
OAB-V8 (OAB Awareness Tool); Grade A [136] ¹³⁸	8-item screening tool for use in a primary care setting to identify patients who may have OAB	Men and women, OAB	√		√	√	√	√	N/A	www.pfizerpatientreportedoutcomes.com
OAB - V3 (OAB short form) A [139] ¹³⁹	3-Item awareness tool & shortened version of the OAB-q/OAB-V8	Men and women, OAB, UUI	√		√	√	√	√	n/a	www.pfizerpatientreportedoutcomes.com
PUF patient symptom scale (Pelvic Pain, Urgency, and Frequency); Grade C [147] ¹⁴⁰	8-item tool used to evaluate of patients with suspected IC/PBS	Women and women, IC/PBS						√	√	www.ncbi.nlm.nih.gov
QUID (Questionnaire for Urinary Incontinence Diagnosis); Grade A [141] ¹⁴¹	6-item tool used to diagnose stress and/or urge types of urinary incontinence	Women with UUI and SUI	√	√	√	√		√	√	contact developer
USP (Urinary Symptom Profile); Grade B [142] ¹⁴²	13-item tool used to assess urinary symptoms in male and female with stress, urge, frequency or urinary obstructive symptoms for use in clinical practice to complement clinical measures and diagnosis	Men and women stress UI, urge UI, frequency, low stream, combined symptoms	√	√	√		√	√	N/A	www.mapinstitute.com

Table 9: Symptom Bother Measures for Lower Urinary Tract Symptoms

PRO Name/CIQ Grade	Purpose/Description of Tool	Population Sample	Reliability		Validity				Responsiveness (Treatment Duration)	Instrument Access & Translation(s)
			Internal Consistency	Test-retest	Content (Item Generation)	Criterion	Concurrent	Discriminant		
I-PSS (International Prostate Symptom Score); Grade B [97]	8-item tool used to capture the severity of urinary symptoms related to benign prostatic hyperplasia. Originally developed from the American Urological Association Symptom Index.	Men	√	√			√	√	√	www.proqolid.org
LUSQ (Leicester Urinary Symptom Questionnaire); Grade A [143] ¹⁴³	10-item tool used to measure the presence and severity of storage abnormalities symptoms of incontinence, urgency, frequency and nocturia	Men and women	√	√	√	√	√	√	√	(12Weeks) contact developer
PGI-I and PGI-S (Patient Global Impression of Severity and of Improvement); Grade A [151] ¹⁴⁴ , [145] ¹⁴⁵	Two single-item global indices used to measure symptom bother related to urinary incontinence	Women with SUI	√	√			√	√	√	(12Weeks) contact developer
PMSES (Broome Pelvic Muscle Exercise Self-Efficacy Scale); Grade C [146] ¹⁴⁶	23-item tool used to measure self-efficacy for the performance of pelvic muscle exercises in females and males	Men and women					√	√		contact developer
POSQ (Primary OAB Symptom Questionnaire); Grade C [147] ¹⁴⁷	5-item tool used to assess which symptom of OAB is the most bothersome to patients	OAB, men and women		√	√					contact developer

Table 9: Symptom Bother Measures for Lower Urinary Tract Symptoms (continued)

PRO Name/CIQ Grade	Purpose/Description of Tool	Population Sample	Reliability		Validity			Responsiveness (Treatment Duration)	Instrument Access & Translation(s)
			Internal Consistency	Test-retest	Content (Item Generation)	Criterion	Concurrent		
PPBC (Patient Perception of Bladder Condition); Grade A [65]	Single-item tool used to assess patients' subjective impression of their current urinary problems. Developed as a global assessment of bladder condition	Men and women		√				√	www.pfizerpatientreportedoutcomes.com
PFBQ (Pelvic Floor Bother Questionnaire); Grade B [148]	9-item global instrument used to assess female patients over the age of 18 years with symptoms of urinary incontinence, urinary urgency, and frequency, urge incontinence, faecal incontinence, obstructed defecation, dyspareunia and pelvic organ prolapse	Women, Urinary Incontinence, UUI, SUI	√	√	√	√		√	contact developer
SPI (Symptom Problem Index); Grade B [97]	7-item tool used to measure how troublesome the patients find their urinary symptoms	Male, BPH	√	√	√				www.proqolid.org
SSI and SII (Symptom Severity Index and Symptom Impact Index for stress incontinence in women); Grade B [149]	3-item tool used to measure stress incontinence severity and impact or bothersome of symptoms. This question- naire was developed and administered to women undergoing stress incontinence surgery	Women, SUI		√	√			√	www.proqolid.org
UI-4 (Urinary Incontinence Questionnaire); Grade C [150]	4-item tool used to assess how patients are bothered by urinary incontinence	Women, UI						√	www.ncbi.nlm.nih.gov

Table 9: Symptom Bother Measures for Lower Urinary Tract Symptoms (continued)

PRO Name/CIQ Grade	Purpose/Description of Tool	Population Sample	Reliability		Validity			Responsiveness (Treatment Duration)	Instrument Access & Translation(s)
			Internal Consistency	Test-retest	Content (Item Generation)	Criterion	Concurrent		
UDI (Urogenital Distress Inventory); Grade A [104]	19-item tool used to assess symptom bother related to urinary incontinence. UDI is a complement to the ICIQ	Women, UI, SUI	√	√	√		√	√	contact developer
UDI-6 (Urogenital Distress Inventory - 6); Grade A [151] ¹⁵¹	6-item tool used to assess LUTS, including incontinence, in women.	Women	√	√	√	√	√	√	contact developer

Table 10: Urinary Urgency Measures for Lower Urinary Tract Symptoms

PRO Name/ICIQ Grade	Purpose/Description of Tool	Population Sample	Reliability		Validity				Responsiveness (Treatment Duration)	Instrument Access & Translation(s)
			Internal Consistency	Test-retest	Content (Item Generation)	Criterion	Concurrent	Discriminant		
IUSS (Indeveus Urgency Severity); Grade A [152] ¹⁵²	Single-item tool used to quantify the level of urgency associated with each toilet void as measured during standard voiding diaries.	OAB with urgency incontinence, men and women		√		√	√	√	√ (12 Weeks)	contact developer
PPIUS (Patients' Perception of Intensity of Urgency Scale); Grade B [153] ¹⁵³ [154] ¹⁵⁴	Single-item tool used to assess female patient perception of urgency intensity in those women with UUI	Women, UUI		√			√	√	√	contact developer
SUIQ (Stress/Urgency Incontinence Questionnaire); Grade B [155] ¹⁵⁵	2-item tool used to differentiate between symptoms of stress and urge urinary incontinence	Women, UI		√			√			contact developer
U-IIQ (Urge Incontinence Impact Questionnaire); Grade A [156] ¹⁵⁶	32-item tool used to assess the interference of urine leakage and bladder problems Developed for use in patients with all types of incontinence.	MUI, UUI	√	√			√	√	√ (12Weeks)	contact developer
UPS (Urgency Perception Score); Grade B [157] ¹⁵⁷	5-item OAB tool used for grading the urge to void and assessing the reason why individuals usually void	Men and women	√	√			√	√		contact developer
UPS (Urgency Perception Scale); Grade B [158] ¹⁵⁸	Single-item tool used to assess the severity of urgency – whether or not urgency, the sudden and compelling desire to urinate should have a severity measure is debated.	OAB, men and women			√		√	√	√	contact developer
UQ (Urgency Questionnaire); Grade B [147] ¹⁴⁷ [159] ¹⁵⁹	15-Likert Scale Item & 4-VAS tool used o assess the severity and impact of urinary urgency symptoms on HRQL. VAS scale is used to measure the impact of urinary urgency on overall HRQL, the severity, the intensity, and the discomfort of urgency.	Women, OAB	√	√	√		√	√	√ (10 Days)	contact developer

Table 10: Urinary Urgency Measures for Lower Urinary Tract Symptoms (continued)

PRO Name/ICIQ Grade	Purpose/Description of Tool	Population Sample	Reliability		Validity				Responsiveness (Treatment Duration)	Instrument Access & Translation(s)
			Internal Consistency	Test-retest	Content (Item Generation)	Criterion	Concurrent	Discriminant		
URIS-24 (Urge Impact Scale); Grade B [72]	24-item tool used to assess of the impact of the most common form of UI in older persons	Older persons, UI	√	√	√		√			contact developer
USIQ-QOL (Urgency Severity & Intensity Questionnaire: Symptom Severity); Grade B [160] ¹⁶⁰	To measure severity impact from urinary urgency	Females, POP, UI	√			√		√		contact developer
USIQ-S (Urgency Severity & Intensity Questionnaire: Quality of Life); Grade B [160]	To measure quality of life impact from urinary urgency	Females, POP, UI	√ (Cronbach's Alpha = 0.85)			√		√		contact developer
USS (Urinary Sensation Scale); Grade B [161] ¹⁶¹ , 162 ¹⁶²]	5-point scale used to assess the impact of urgency with patients with OAB derivation from EMA's recommended 5-point scale	Urologists or urologynecologists, Survey respondents with OAB symptoms	√ (Cronbach's Alpha = 0.85)	√	√		√	√	√	contact developer
UU Scale (10-item Scale to Measure Urinary Urgency); Grade A [163] ¹⁶³	10-item tool use to measure urinary urgency	Men and women		√			√		√	contact developer
U-UDI (Urge-Urogenital distress inventory); Grade A [156]	9-item tool used to assess the extent to which the patient is bothered by the symptoms of urge urinary incontinence or mixed urinary incontinence with a primary urge component.	Men and women		√	√		√		√	www.mapi-institute.com

Table 11: Summary of PRO Measures for Faecal incontinence and other bowel symptoms

PRO Name/ICIQ Grade	Purpose/Description of Tool	Population Sample	Reliability		Validity				Responsiveness (Treatment Duration)	Psychometric Validation in Other Languages	Available Languages
			Internal Consistency	Test-retest	Content (Item Generation)	Criterion	Concurrent	Discriminant			
Questionnaire for assessment of FI and constipation [164] ¹⁶⁴ Grade A	47-item general questionnaire for constipation and anal incontinence, also including abdominal and urinary symptoms and medical history	Men and women		√		√			√		Contact www.iciq.net
Bowel function questionnaire [165] ¹⁶⁵ Ungraded	28-item bowel specific questionnaire including 10 anal incontinence-specific items	Men and women									
Faecal Incontinence Questionnaire [166] ¹⁶⁶ Grade C	63-item general questionnaire for bowel habits including faecal incontinence, also urinary symptoms and medical history	Men and women		√							
BBUSQ (Birmingham Bowel and Urinary Symptom Questionnaire) [167] ¹⁶⁷ , [168] ¹⁶⁸ Grade A	22-item questionnaire for bowel and urinary symptoms including 4 faecal incontinence-specific items	women	√	√		√			√		
FICA (Faecal incontinence and constipation assessment) [169] ¹⁶⁹ Grade B	98-item general questionnaire for constipation and faecal incontinence, also including abdominal and urinary symptoms and medical history	women		√		√					
PFBQ (Pelvic floor bother questionnaire) [170] ¹⁷⁰ Grade B	9-item symptom and bother questionnaire for pelvic floor disorders	women	√	√		√	√				

Table 12: Summary of PRO Measures for Faecal incontinence and HRQL associated specifically

PRO Name/ICIQ Grade	Purpose/Description of Tool	Population Sample	Reliability		Validity				Responsive-ness (Treatment Duration)	Psycho-metric Validation in Other Languages	Available Languages
			Internal Consistency	Test-retest	Content (Item Generation)	Criterion	Concurrent	Discriminant			
ICIQ-B [46, 47] Grade A+	19-item anal incontinence symptoms and HRQL questionnaire	Men and women	√	√	√	√	√	√	√	Contact www.iciq.net	
FIQL (Faecal Incontinence Quality of life Index) [171] ¹⁷¹ Grade A	29-item faecal incontinence HRQL questionnaire	Men and women	√	√			√	√	√	Contact author	
MHQ (Manchester Health Questionnaire) [172] ¹⁷² Grade B	31-item anal incontinence HRQL questionnaire	Women	√	√			√				
Bowel control self-assessment questionnaire [173] ¹⁷³ Grade B	5-item faecal incontinence symptom and HRQL questionnaire	Men and women	√	√		√	√				

Table 13: Summary of PRO Measures for Faecal incontinence in specific patient groups

PRO Name/ICIQ Grade	Purpose/Description of Tool	Population Sample	Reliability		Validity				Responsive-ness (Treatment Duration)	Psycho-metric Validation in Other Languages	Available Languages
			Internal Consistency	Test-retest	Content (Item Generation)	Criterion	Concurrent	Discri-minant			
Postpartum flatal and faecal inconti-nence quality of life scale [174] ¹⁷⁴ Ungraded	68-item anal incontinence HRQL questionnaire (adaptation of FIQL for postpartum females)	Women			√						
Surgical outcome tool for faecal incontinence [175] ¹⁷⁵ Ungraded	10-item anal incontinence symptoms and HRQL questionnaire for evaluation of incontinence surgery	Women									
COREFO (Colorec- tal functional out- come question- naire) [176] ¹⁷⁶ Grade B	27-item anal incontinence symptom and HRQL questionnaire for evaluation of colorectal surgery	Men and women	√	√	√		√				
EBSQ (Elderly Bowel Symptom Questionnaire) [177] ¹⁷⁷ Grade B	56-item general questionnaire for gastrointestinal function including faecal incontinence, also including and medical history and HRQL	Men and women		√		√					

Table 14: Sexual Health and Quality of Life Measures

PRO Name/ICIQ Grade	Purpose/Description of Tool	Population Sample	Reliability		Validity				Responsiveness (Treatment Duration)	Instrument Access & Translation(s)
			Internal Consistency	Test-retest	Content (Item Generation)	Criterion	Concurrent	Discriminant		
FSFI (Female Sexual Function Index); Grade B [178] ¹⁷⁸	19-item tool used to assess the effects of incontinence on multiple dimensions of sexual function in sexually active, adult women	Women, OAB; SUI, MUI	√ (Cronbach' s Alpha >/= 0.82)	√ (r = 0.79 - 0.86)				√		contact developer
ICIQ-VS (International Consultation on Incontinence Questionnaire -Vaginal Symp- toms); Grade B [45]	14-item tool used to assess effects of vaginal symptoms and associated sexual matter on sexual quality of life for sexually active females	Women	√ (Cronbach' s Alpha = 0.81- 0.88)	√	√				√ (all items except 'leakage during intercourse')	contact developer
PISQ (PelvicOrganProlapse/Urinary Incontinence Sexual Question- naire); Grade B [179] ¹⁷⁹	31-item tool to assess sexual function after surgery in women with Pelvic Floor Dysfunction	Females with Pelvic Floor Dysfunc- tion	√ (Cronbach' s Alpha = 0.85)	√ (k = 0.56 - 0.93)		√			√	contact developer
SFQ (SexualFunction Questionnaire); Grade C [180] ¹⁸⁰	Generic Instrument used to assess the impact of OAB on sexual health/function in the male & female population	men& women with OAB								www.pfizerpati entreportedout comes.com
SQoL-F (Sexual Quality of Life– Female); Grade B [181] ¹⁸¹	To assess the impact of female sexual dysfunction on quality of life	women	√	√			√	√		www.pfizerpati entreportedout comes.com

VII. QUESTIONNAIRES TO ASSESS SYMPTOMS AND HRQOL IMPACT OF PELVIC ORGAN PROLAPSE

Women complaining of lower urinary tract symptoms often also complain of concomitant symptoms associated with urogenital prolapse and there are now a number of validated questionnaires available to use in the subjective assessment of women with prolapse symptoms. These questionnaires should be used in conjunction with the clinical assessment and standardised measurement of urogenital prolapse which is reported elsewhere in this section. In addition, given the number of conservative and surgical management options available for women with symptomatic prolapse standardisation of subjective outcome measurement is increasingly important.

This section will review the standardised symptom assessment tools for pelvic organ prolapse and, whilst the questionnaires described do not allow the clinical staging or planning of prolapse treatment they should be used alongside more objective tools to measure the subjective outcome of treatment. Evidence from previously reported studies [182]¹⁸² has shown the importance of patient reported outcome measures and subjective assessment may provide a more meaningful assessment tool when compared to more traditional objective measurements. The use of these subjective outcomes has been shown to be robust and correlated with objective assessments during long term follow up [183]¹⁸³.

Although the number of HRQoL questionnaires available to assess impact of urogenital prolapse is not as great as those associated with lower urinary tract dysfunction there are now a number of recommended and validated questionnaires available. However, it is important to consider that where specific problems associated with urogenital prolapse need to be considered, such as lower urinary tract symptoms or sexual function, then it may be preferable to consider the use of one of the questionnaires designed specifically for that purpose. In addition, as prolapse is often multidimensional, selecting questionnaires in the modular format of the ICIQ may be more useful in clinical practice.

Women who have symptomatic urogenital prolapse may also complain of sexual dysfunction and the Pelvic Organ Prolapse Urinary Incontinence Sexual Questionnaire (PISQ) is now available in short form (PISQ-12) and has been validated in Turkish [184]¹⁸⁴, French [185]¹⁸⁵, Chinese [186]¹⁸⁶, Swedish [187]¹⁸⁷, Portuguese [188]¹⁸⁸, Iranian [189]¹⁸⁹ and Dutch [190]¹⁹⁰.

More recently an IUGA revised version (PISQ-IR) for both sexually active and inactive women has been reported and has now been validated in

French[191]¹⁹¹, Japanese[192]¹⁹², Arabic[193]¹⁹³, Mandarin Chinese[194]¹⁹⁴, Hungarian[195]¹⁹⁵ and German[196]¹⁹⁶.

This update of the last triennial report has again examined the quality of the psychometric evidence and only where published data were scientifically sound were the questionnaires included in the overall report.

For this current report the previous literature search was updated using the Pubmed/Medline databases from January 2013 – August 2016 in addition to the website mapi-institute.com. The following key words were used either separately or in combination; ‘questionnaire’, ‘prolapse’ and ‘quality of life’. The grading of questionnaires was also reviewed and updated if new information had become available.

Whilst the search found no new HRQoL instruments for the assessment of urogenital prolapse a number of new linguistic validations have been reported including Spanish [197]¹⁹⁷, French[198]¹⁹⁸ Persian[199]¹⁹⁹ and Polish[200]²⁰⁰ versions of the Prolapse Quality of Life questionnaire (P-QoL). In addition the Pelvic Floor Impact Questionnaire (PFIQ-7) and Pelvic Floor Distress Inventory (PFDI-20) have recently been validated in Brazilian Portuguese[201]²⁰¹ Swedish [187] and Danish [202]²⁰².

Although HRQoL questionnaires remain the most commonly used form of patient related outcome measure that are used in patients with pelvic floor dysfunction other measures of outcome have also been developed and reported. The Patient Global Impression of Improvement (PGI-I) was initially developed for lower urinary tract symptoms [145] and has more recently been validated for use in patients with urogenital prolapse [144]. The use of a simple one answer patient reported outcome measure has also been used in studies using composite endpoints with the validated HRQoL questionnaires [203]²⁰³.

When reviewing the available HRQoL questionnaires the committee examined the quality of the psychometric evidence and only where the published data were robust were the instruments considered for recommendation [Box 1].

Box 1: Recommended questionnaires for the evaluation of symptoms and HRQoL impact of Pelvic Organ Prolapse

Grade A (recommended)

Pelvic Floor Distress Inventory (PFDI) [120]

Pelvic Floor Impact Questionnaire (PFIQ) [120]

Prolapse Quality of Life Questionnaire (P-QoL)²⁰⁴

Pelvic Organ Prolapse Urinary Incontinence Sexual Questionnaire (PISQ)²⁰⁵, (PISQ 12)²⁰⁶

Pelvic Organ Prolapse Urinary Incontinence Sexual Questionnaire –IUGA Revised (PISQ-IR)²⁰⁷

ICIQ vaginal symptoms questionnaire (ICIQ-VS)²⁰⁸

Grade B

The Austrian Pelvic Floor Questionnaire (AFPQ)²⁰⁹

Pelvic Floor Symptom Bother Questionnaire (PFBQ)²¹⁰

Electronic Personal Assessment Questionnaire-Pelvic Floor (ePAQ-PF)²¹¹

Grade C (with potential)

Pelvic Floor Dysfunction Questionnaire²¹²

Danish Prolapse Questionnaire²¹³

VIII. QUESTIONNAIRES TO ASSESS SYMPTOMS AND HRQL IMPACT OF FAECAL INCONTINENCE

There are now a number of patient reported outcome measures which have been developed for the assessment of patients with Anal Incontinence (AI) and Faecal Incontinence (FI). Due to the considerable overlap between faecal incontinence and other forms of pelvic floor dysfunction questionnaires used for urinary and prolapse symptoms may also contain domains for anal and faecal incontinence. Likewise, items relating to faecal incontinence may also be included in questionnaires used to evaluate colorectal disease. In addition, due to the wide variation in normal bowel function within, and between individuals, some of these questionnaires may lack sensitivity and specificity for more specific bowel disorders such as Irritable Bowel Syndrome (IBS), Irritable Bowel Disease (IBD) evacuation disorder and constipation.

Since anal incontinence, faecal incontinence and bowel evacuation are closely related to pelvic floor function it may be inappropriate to consider bowel function simply in terms of continence and constipation. Constipation and evacuation disorders may result from a number of different pathologies such as outlet obstruction and slow transit in addition to other mechanical, pharmacological, metabolic and neurogenic causes [214]²¹⁴.

Anal incontinence is known to occur in both men and women with the prevalence depending on age and the symptoms are known to be important in terms of the underlying pathophysiology. Faecal urgency and faecal urgency incontinence are thought to be associated with the loss of voluntary control due to impaired external sphincter function whereas passive faecal incontinence is thought to be associated with impairment of the smooth muscle of the internal anal sphincter [215]²¹⁵.

This update of the last triennial report has again examined the quality of the psychometric evidence and only where published data were scientifically sound were the questionnaires included in the overall report.

For this current report the previous literature search was updated using the Pubmed/Medline databases from January 2013 – August 2016 in addition to the website mapi-institute.com. The following key words were used either separately or in combination; 'questionnaire', 'faecal', 'anal', 'bowel' and 'quality of life'. The grading of questionnaires was also reviewed and updated if new information had become available.

The updated search found no new HRQoL instruments for the assessment of anal or faecal incontinence and, in addition there were no further validation studies reported on those questionnaires which were ungraded. Consequently the recommendations of this triennial report remain unchanged.

The grades of recommendation are as outlined in previous sections. **Box 2** summarises the questionnaires reviewed and grades of recommendation.

Box 2: Recommended questionnaires for the evaluation of symptoms and HRQoL impact of faecal incontinence

Grade A+

ICIQ-B [46,47]

Grade A

Faecal Incontinence Quality of Life Scale [171]

Birmingham Bowel and Urinary Symptom Questionnaire [167,168]

Questionnaire for assessment of Faecal Incontinence and Constipation [164]

Grade B

Colorectal Functional Outcome Questionnaire [176]

Manchester Health Questionnaire [172]

Bowel Control Self Assessment Questionnaire [173]

Pelvic Floor Bother Questionnaire [216]²¹⁶

Elderly Bowel Symptom Questionnaire [177]

Faecal Incontinence and Constipation Assessment [169]

Grade C

Faecal Incontinence Questionnaire [166]

Ungraded

Postpartum Flatal and Faecal Incontinence Quality of Life Scale [174]

Bowel Function Questionnaire [217]²¹⁷

Surgical Outcome Tool for Faecal Incontinence [175]

Tables 11, 12 and 13 provide details of the specific psychometric properties and development of each questionnaire

IX. QUESTIONNAIRES TO ASSESS SEXUAL FUNCTION/SEXUAL HEALTH AND URINARY SYMPTOMS

Sexual dysfunction affects many people and may be caused by psychological, emotional or physiological factors, often with multifactorial and interrelated etiologies. Sexual function may be regarded as a dimension or aspect of overall HRQL, for which a number of dimension-specific measures have been developed and validated. There is a wide choice of available instruments, the selection of which will depend on the clinical or research setting where the instrument is to be employed. Established and widely used measures that have been shown to be valid, reliable and responsive are clearly desirable, however the feasibility and appropriateness of using a particular instrument in a particular setting must also be considered. A large number of different instruments exist in this field, which aim to evaluate specific aspects of sexual function and sexual health.

While the importance of investigating male sexuality as part of a normal male urological assessment is established, this has not been established for female evaluation. Many physicians underestimate the prevalence of female sexual dysfunctions and do not routinely perform an assessment of sexual wellness as a part of their practice [218]²¹⁸, despite evidence that many women with LUTS have sexual problems [219]²¹⁹

In a comprehensive assessment of women with pelvic dysfunction sexual function should be investigated. However it may be a difficult issue to discuss during a consultation because of discomfort or embarrassment. Female discomfort may stem from personal embarrassment, a sense that sexual dysfunction is not a medical problem and this may be compounded by a lack of time during health care visits [220]²²⁰.

In addition many physicians report a lack of training in how to appropriately address sexual function with patients [221]²²¹. Clinicians who treat sexual problems often prefer to use unstructured rather than structured interviews or questionnaires in clinical practice as an unstructured approach allows the tailoring of questions to suit the couple or the individual being assessed. Unstructured interviews enable the clinician to support patients who feel vulnerable and encourage discussion. In this setting, vocabulary can be modified, as can the level of assertiveness and the depth of questioning to suit the needs of the individual. This flexibility is not readily achievable with questionnaires which individuals may also find difficult to complete due their impersonal nature or because of physical or mental impairment, cultural or language differences. However, some patients find the discussion of intimate issues with clinicians very difficult and

questionnaires may allow these issues to be measured in private, at ease and more effectively before subsequently exploring questionnaire responses in the clinical interview itself. Therefore there is a wide choice of available instruments, which could help the physician during history taking and the selection of an instrument will depend on the clinical or research setting where the instrument is to be employed.

Table 14 and Table 15 outline sexual health measures with a Grade A, B, C rating based on the criteria provided above, and the linguistic validations of each questionnaire are also documented.

This table includes the questionnaires useful to assess female and male sexual function in patients with any pelvic dysfunction and urinary symptoms. Questionnaires obtaining an A+ rating demonstrate reliability and validity and also that content was derived with patient input and responsiveness to treatment has been shown.

A Rated group: the Female Sexual Function Index (FSFI) [178,222²²²,223²²³], the Female Sexual Distress Scale (FSDS) [224]²²⁴, the International Consultation on Incontinence Questionnaire-Vaginal Symptoms (ICIQ-VS) [45] and the Derogatis Sexual Functioning Inventory (DISFI) [225]²²⁵. These questionnaires assess female sexual function and measure the quality of a patients current sexual functioning. The Menopausal Sexual Interest Questionnaire (MSIQ) [226]²²⁶ is also included in this group but only two domains. For male patients the International Index of Erectile Function (IIEF) [227]²²⁷ is recommended to assess men with erectile dysfunction. Most of the identified measures are self-reported, easy and quick to administer and many have various language versions available. The majority have also been previously used in incontinence populations

B Rated group: the Daily Log of Sexual Activities (DLSA) [228]²²⁸, the Female sexual distress scale-revised (FSDSr) [229]²²⁹, the Index of Sexual Functioning for women (BISF-W) [230]²³⁰, the Change in Sexual Functioning Questionnaire (CSFQ) [231²³¹,232²³²], and the Sexual Interest and Desire Inventory Female (SIDF-F) [233]²³³. They assess the sexual dysfunctions in women with sexual desire disorder and functional sexual arousal disorder. The Pelvic Organ Prolapse Urinary Incontinence Sexual Question (PISQ-12) [179] assesses sexual function after surgery in women with Pelvic Floor Dysfunction and has been validated in women with urinary incontinence and pelvic organ prolapse. The Sexual Quality of Life-Female (SQoL-F) [181] is useful to assess the impact of female sexual dysfunction on quality of life, while the Sexual Satisfaction Scale for Women (SSS-W) [234]²³⁴ measures the women's sexual satisfaction and distress in patients with pelvic floor dysfunction. The Sexual Function Questionnaire (SFQ) [180] is an instrument for both partners. This questionnaire also addresses some of the consequences of female sexual dysfunction for the woman, her partner and their relationship. Both the physical and the

cognitive aspects of sexual response are evaluated within the SFQ items. The Male Sexual Health Questionnaire (MSHQ) [235]²³⁵ assesses sexual function and satisfaction in older men with urogenital symptoms of LUTS and sexual dysfunctions.

C Rated group: The Women's Sexual Interest Diagnostic Interview--Short Form (WSID-SF) [228] is used to assess sexual function in adult women with hypoactive sexual desire disorder, The Pelvic Organ Prolapse/Incontinence Sexual Questionnaire, IUGA-Revised (PISQ-IR) [236]²³⁶, and the Sexual Health Outcomes in Women Questionnaire (SHOW-Q) [237]²³⁷ to assess the impact of pelvic problems on sexual desire, frequency, satisfaction, orgasm, and discomfort.

The choice of which tool to use will be dependent on the type of patient, age, type of pelvic dysfunction and on research hypothesis. For instance, if you wanted to assess impact of OAB on sexual function e.g. arousal in women then the FSFI should be used rather than the SQOL-F because the FSFI has a specific arousal domain whereas the SQOL-F assesses sexual quality of life.

Table 15. Additional Sexual Health and Quality of Life Measures (separate document)

<h2>X. RECOMMENDATIONS FOR RESEARCH</h2>
--

1. The selection of a PRO questionnaire must reflect study purpose and objectives.
2. Grade A recommended questionnaires should be used in all clinical trials evaluating treatments
3. The inclusion of the ICIQ modules is preferred in all studies in order to standardize outcome assessment
4. Continued PRO development, refinement, and usage should accurately and adequately report on the methods, samples, statistical analyses and psychometric properties of questionnaires in scientific journals. This includes documentation of validity, reliability and responsiveness and consequently the quality of each study can be assessed.
5. Researchers are encouraged to use existing questionnaires and refine for specific populations when required; such as frail elderly and children.
6. Researchers are also encouraged to participate in collaborative work with the ICIQ project allowing the development and refinement of modules and translations.

REFERENCES

1. Food and Drug Administration (FDA): Guidance for Industry on Patient-Reported Outcome Measures: Use in Medical Product Development to Support Labeling Claims. Federal Register, 2009. 74(235): p. 65132-65133.
2. Ware JE, Jr., Kosinski M, Bayliss MS, et al.: Comparison of methods for the scoring and statistical analysis of SF-36 health profile and summary measures: summary of results from the Medical Outcomes Study. *Med Care*, 1995. 33(4 Suppl): p. AS264-79.
3. Wyman JF, Harkins SW, Choi SC, Taylor JR, Fantl JA: Psychosocial impact of urinary incontinence in women. *Obstet Gynecol*, 1987. 70(3 Pt 1): p. 378-81.
4. Kelleher CJ, Cardozo LD, Khullar V, Salvatore S: A new questionnaire to assess the quality of life of urinary incontinent women. *Br J Obstet Gynaecol*, 1997. 104(12): p. 1374-9.
5. Coyne K, Revicki D, Hunt T, et al.: Psychometric validation of an overactive bladder symptom and health-related quality of life questionnaire: the OAB-q. *Qual Life Res*, 2002. 11(6): p. 563-74.
6. Berger M, et al.: Health care cost, quality and outcomes, in ISPOR Book of Terms. 2003. p. 195-97.
7. Ingolf G, Joanna C, Jackie B: Quality-Adjusted Life-Year Lack Quality in Pediatric Care: A Critical Review of Published Cost-Utility Studies in Child Health. *Pediatrics*, 2005. 115(5): p. e600.
8. Karen B, Magnus J: Incorporating quality of life changes into economic evaluations of health care: an overview. *Health Policy*, 1996. 36: p. 155-66.
9. Rasanen P, Roine E, Sintonen H, et al.: Use of quality-adjusted life years for the estimation of effectiveness of health care: A systematic literature review. *Int J Technol Assess Health Care*, 2006. 22(2): p. 235-41.
10. What is Patient-centred Health Care? A Review of Definitions and Principles. 2nd ed. London: IAPO; 2007. International Alliance of Patients' Organizations; pp. 1–34.
11. Prasanna R, Deshpande, Surulivel Rajan, B. Lakshmi Sudeepthi, and C. P. Abdul Nazir: Patient-reported outcomes: A new era in clinical research. *Perspect Clin Res*. 2011 Oct-Dec; 2(4): 137–144. doi: 10.4103/2229-3485.86879 PMID: PMC3227331.
12. Rodriguez LV, Blander DS, Dorey F, Raz S, Zimmern P: Discrepancy in patient and physician perception of patient's quality of life related to urinary symptoms. *Urology*, 2003. 62(1): p. 49-53.
13. Kozma CM, Reeder CE, Schulz RM. Economic, clinical, and humanistic outcomes: a planning model for pharmacoeconomic research. *ClinTher*. 1993;15:1121–32.discussion 1120.
14. Chin R, Lee BY. Economics and patient reported outcomes, *Principles and practice of clinical trial medicine*. London, Amsterdam, Burlington, San Diego: Elsevier Inc; 2008. pp. 145–66
15. U.S Department of Health and Human Services Food and Drug Administration Guidance for Industry: Patient-Reported Outcome Measures: Use in Medical Product Development to Support Labeling Claims. [Last Accessed on June 10, 2016];U.S. FDA, Clinical/Medical. 2009 available from: [<http://www.fda.gov/downloads/Drugs/GuidanceComplianceRegulatoryInformation/Guidances/UCM193282.pdf>] [PMCID: PMC1629006]
16. European Medicines Agency. Reflection paper on the regulatory guidance for the use of health related quality of life(HRQL) measures in the evaluation of medicinal products. 2005. Available from: http://www.emea.europa.eu/docs/en_GB/document_library/Scientific_guideline/2009/09/WC500003637.pdf. [Accessed February 22, 2011].
17. Fitzpatrick R, Davey C, Buxton MJ, Jones DR. Evaluating patient-based outcome measures for use in clinical trials. *Health Technol Assess*. 1998;2:1–74
18. Zbrozek A, Hebert J, Gogates G: Validation of Electronic Systems to Collect Patient-Reported Outcome (PRO) Data—Recommendations for Clinical Trial Teams: Report of the ISPOR ePRO Systems Validation Good Research Practices Task Force. *Value In Health*; 16(2013):480 – 489.
19. Coons SJ, Gwaltney CJ, Hays RD, et al. Recommendations on evidence needed to support measurement equivalence between electronic and paper-based patient-reported outcome (PRO) measures: ISPOR ePRO Good Research Practices Task Force Report. *Value Health* 2009;12:419- 29. Available from: http://www.ispor.org/workpaper/patient_reported_outcomes/Coons.pdf. [Accessed March 26, 2013].

20. Paty J, Stokes T. Electronic diaries, part 2: the role of the clinical protocol in developing and implementing electronic diaries. *Appl Clin Trials* 2003. Available from: <http://www.appliedclinicaltrials.com/appliedclinicaltrials/article/articleDetail.jsp?id=90715>. [Accessed March 23, 2011].
21. Coons SJ, Gwaltney CJ, Hays RD, et al.: Recommendations on evidence needed to support measurement equivalence between electronic and paper-based patient-reported outcome (PRO) measures: ISPOR ePRO Good Research Practices Task Force report. *Value Health*, 2009. 12(4): p. 419-29.
22. Streiner DL NG: *Health Measurement Scales*. 1989: Oxford: OUP.
23. Revicki DA, Osoba D, Fairclough D, et al.: Recommendations on health-related quality of life research to support labeling and promotional claims in the United States. *Qual Life Res*, 2000. 9(8): p. 887-900.
24. Kerlinger F, Lee H: *Foundations of Behavioral Research*. 4th ed. 1999: Wadsworth Publishing.
25. Murawski MM, Miederhoff PA: On the generalizability of statistical expressions of health related quality of life instrument responsiveness: a data synthesis. *Qual Life Res*, 1998. 7(1): p. 11-22.
26. Jaeschke R, Singer J, Guyatt GH: Measurement of health status. Ascertaining the minimal clinically important difference. *Control Clin Trials*, 1989. 10(4): p. 407-15.
27. Guyatt GH, Juniper EF, Walter SD, Griffith LE, Goldstein RS: Interpreting treatment effects in randomised trials. *BMJ*, 1998. 316(7132): p. 690-3.
28. Kazis LE, Anderson JJ, Meenan RF: Effect sizes for interpreting changes in health status. *Med Care*, 1989. 27(3 Suppl): p. S178-89.
29. Wyrwich KW, Norquist JM, Lenderking WR, Acaster S: Methods for interpreting change over time in patient-reported outcome measures. *Qual Life Res*, 2012.
30. Aquardo C, Conway K, Hareendran A, Aaronson N: Literature review of methods to translate health-related quality of life questionnaires for use in multinational clinical trials. *Value Health*, 2008. 11(3): p. 509-21.
31. Herdman M, Fox-Rushby J, Badia X: A model of equivalence in the cultural adaptation of HRQoL instruments: the universalist approach. *Qual Life Res*, 1998. 7(4): p. 323-35.
32. Wild D, Grove A, Martin M, et al.: Principles of Good Practice for the Translation and Cultural Adaptation Process for Patient-Reported Outcomes (PRO) Measures: report of the ISPOR Task Force for Translation and Cultural Adaptation. *Value Health*, 2005. 8(2): p. 94-104.
33. Coyne KS, Margolis MK, Thompson C, Kopp Z: Psychometric equivalence of the OAB-q in Danish, German, Polish, Swedish, and Turkish. *Value Health*, 2008. 11(7): p. 1096-101.
34. European Agency for the Evaluation of Medicinal Products CfPMP: Note for guidance on the clinical investigation of medicinal products for the treatment of urinary incontinence. . December 2002, London.
35. European Medicines Agency: Reflection paper on the regulatory guidance for the use of health-related quality of life (HRQL) measures in the evaluation of medicinal products, Committee for Medicinal Products for Human Use (CHMP), Editor. 2005, EMEA: London.
36. Aaronson NK: Quality of life assessment in clinical trials: methodologic issues. *Control Clin Trials*, 1989. 10(4 Suppl): p. 195S-208S.
37. Abrams P, Avery K, Gardener N, Donovan J: The International Consultation on Incontinence Modular Questionnaire: www.iciq.net. *J Urol*, 2006. 175(3 Pt 1): p. 1063-6; discussion 1066.
38. Avery K, Donovan J, Peters TJ, et al.: ICIQ: a brief and robust measure for evaluating the symptoms and impact of urinary incontinence. *Neurourol Urodyn*, 2004. 23(4): p. 322-30.
39. Acquadro C, Conway K, Giroudet C, Mear I. Linguistic validation manual for patient-reported outcomes (PRO) instruments. 2004 MAPI Institute, France.
40. Uren A, Cotterill N, Parke S, Abrams P. Psychometric equivalence of electronic and telephone completion of the ICIQ modules (Submitted for publication)
41. Donovan JL, Peters TJ, Abrams P, et al.: Scoring the short form ICSmaleSF questionnaire. *International Continence Society. J Urol*, 2000. 164(6): p. 1948-55.
42. Brookes ST, Donovan JL, Wright M, Jackson S, Abrams P: A scored form of the Bristol Female Lower Urinary Tract Symptoms questionnaire: data from a randomized controlled trial of surgery for women with stress incontinence. *Am J Obstet Gynecol*, 2004. 191(1): p. 73-82.
43. Bright E, Cotterill N, Drake M, Abrams P. Developing a validated urinary diary: phase 1. 2012 *NUU* 31(5):625-33

44. Bright E, Cotterill N, Drake M, Abrams P. Developing and validating the International Consultation on Incontinence Questionnaire Bladder Diary. 2014 *European Urology*. 66(2): 294-300
45. Price N, Jackson SR, Avery K, Brookes ST, Abrams P: Development and psychometric evaluation of the ICIQ Vaginal Symptoms Questionnaire: the ICIQ-VS. *Bjog*, 2006. 113(6): p. 700-12.
46. Cotterill N, Norton C, Avery KN, Abrams P, Donovan JL: A patient-centered approach to developing a comprehensive symptom and quality of life assessment of anal incontinence. *Dis Colon Rectum*, 2008. 51(1): p. 82-7.
47. Cotterill N, Norton C, Avery KN, Abrams P, Donovan JL: Psychometric evaluation of a new patient-completed questionnaire for evaluating anal incontinence symptoms and impact on quality of life: the ICIQ-B. *Dis Colon Rectum*, 2011. 54(10): p. 1235-50.
48. Margolis MK, Vats V, Coyne KS, Kelleher C: Establishing the content validity of the King's Health Questionnaire in men and women with overactive bladder in the US. *Patient*, 2011. 4(3): p. 177-87.
49. Donovan JL, Brookes ST, de la Rosette JJ, et al.: The responsiveness of the ICSmale questionnaire to outcome: evidence from the ICS-'BPH' study. *BJU Int*, 1999. 83(3): p. 243-8.
50. Jackson S, Donovan J, Brookes S, et al.: The Bristol Female Lower Urinary Tract Symptoms questionnaire: development and psychometric testing. *Br J Urol*, 1996. 77(6): p. 805-12.
51. Abraham L, Hareendran A, Mills IW, et al.: Development and validation of a quality-of-life measure for men with nocturia. *Urology*, 2004. 63(3): p. 481-6.
52. Coyne KS, Gelhorn H, Thompson C, Kopp ZS, Guan Z: The psychometric validation of a 1-week recall period for the OAB-q. *Int Urogynecol J*, 2011. 22(12): p. 1555-63.
53. Cotterill N, Fowler S, Avery M, Cottenden A, Wilde M, Long A, Fader M. Development and psychometric evaluation of the ICIQ-LTCqol: a self-report quality of life questionnaire for long-term indwelling catheter users. *Neurourology and Urodynamics* 2016. 35 (3): 423-428
54. De Gennaro M, Niero M, Capitanucci ML, et al.: Validity of the international consultation on incontinence questionnaire-pediatric lower urinary tract symptoms: a screening questionnaire for children. *J Urol*, 2010. 184(4 Suppl): p. 1662-7.
55. Treszezamsky AD, Ehsani N, Connell R, Dick-Biascoechea M, Fashokun T. Use of patient reported outcome questionnaires in the urogynecologic literature. 2013 *Neurourology and Urodynamics*. 32(4): 336-40.
56. Kiresuk T, Sherman R: Goal attainment scaling: a general method of evaluating comprehensive community mental health programs. *Community Ment Health J*, 1968. 4: p. 443-453.
57. Krowinski W, Steiber S: Measuring patient satisfaction. 2nd ed. 1996: American Hospital Publishing.
58. Weaver M, Patrick DL, Markson LE, et al.: Issues in the measurement of satisfaction with treatment. *Am J Manag Care*, 1997. 3(4): p. 579-94.
59. Brubaker L, Khullar V, Piau E, et al.: Goal attainment scaling in patients with lower urinary tract symptoms: development and pilot testing of the Self-Assessment Goal Achievement (SAGA) questionnaire. *Int Urogynecol J*, 2011. 22(8): p. 937-46.
60. Fianu-Jonasson A, Brubaker L, Kelleher C, et al.: Understanding Swedish patients' expectations for treatment of their urinary symptoms. in *Nordic Urogynecological Association*. 2009. Reykjavik, Iceland.
61. Hullfish KL, Bovbjerg VE, Gibson J, Steers WD: Patient-centered goals for pelvic floor dysfunction surgery: what is success, and is it achieved? *Am J Obstet Gynecol*, 2002. 187(1): p. 88-92.
62. Mahajan ST, Elkadry EA, Kenton KS, Shott S, Brubaker L: Patient-centered surgical outcomes: the impact of goal achievement and urge incontinence on patient satisfaction one year after surgery. *Am J Obstet Gynecol*, 2006. 194(3): p. 722-8.
63. Payne C, Allee T: Goal achievement provides new insights into interstitial cystitis/painful bladder syndrome symptoms and outcomes. *Neurourol Urodyn*, 2009. 28(1): p. 13-7.
64. Piau E, Doshi S, Brandt BA, et al.: Linguistic validation of translation of the Self-Assessment Goal Achievement (SAGA) questionnaire from English. *Health Qual Life Outcomes*, 2012. 10: p. 40.
65. Coyne KS, Matza LS, Kopp Z, Abrams P: The validation of the patient perception of bladder condition (PPBC): a single-item global measure for patients with overactive bladder. *Eur Urol*, 2006. 49(6): p. 1079-86.

66. Abrams P, Cardozo L, Fall M, et al.: The standardisation of terminology in lower urinary tract function: report from the standardisation subcommittee of the International Continence Society. *Urology*, 2003. 61(1): p. 37-49.
67. Brubaker L: Urgency: the cornerstone symptom of overactive bladder. *Urology*, 2004. 64(6 Suppl 1): p. 12-6.
68. Staskin DR: The urge to define urgency: a review of three approaches. *Curr Urol Rep*, 2004. 5(6): p. 413-5.
69. Brubaker L: Urinary urgency and frequency: what should a clinician do? *Obstet Gynecol*, 2005. 105(3): p. 661-7.
70. Chapple CR, Wein AJ: The urgency of the problem and the problem of urgency in the overactive bladder. *BJU Int*, 2005. 95(3): p. 274-5.
71. Okamura K, Usami T, Nagahama K, Maruyama S, Mizuta E: "Quality of life" assessment of urination in elderly Japanese men and women with some medical problems using International Prostate Symptom Score and King's Health Questionnaire. *Eur Urol*, 2002. 41(4): p. 411-9.
72. DuBeau CE, Levy B, Mangione CM, Resnick NM: The impact of urge urinary incontinence on quality of life: importance of patients' perspective and explanatory style. *J Am Geriatr Soc*, 1998. 46(6): p. 683-92.
73. Coyne KS, Matza LS, Brewster-Jordan J, Thompson C, Barendse T: The psychometric validation of the OAB family impact measure (OAB-FIM). *Neurourol Urodyn*, 2010. 29(3): p. 359-69.
74. Syzmanski KM, Misseri R, Whittam B, Raposo SM, King SJ, Kaefer M, Rink RC, Cain MP: Quality of life assessment in Spina Bifida for Adults (QUALAS-A): development and international validation of a novel health-related quality of life instrument. 2015 *Quality of Life Research*. 24(10): 2355-64
75. Cuervo J, Castejón N, Khalaf KM, Waweru C, Globe D, Patrick DL: Development of the Incontinence Utility Index: estimating population-based utilities associated with urinary problems from the Incontinence Quality of Life Questionnaire and Neurogenic Module. 2014 *Health Qual Life Outcomes*. 12:147
76. Costa P, Perrouin-Verbe B, Colvez A, et al.: Quality of life in spinal cord injury patients with urinary difficulties. Development and validation of qualiveen. *Eur Urol*, 2001. 39(1): p. 107-13.
77. Bonniaud V, Bryant D, Parratte B, Gallien P, Guyatt G: Qualiveen: a urinary disorder-specific instrument for use in clinical trials in multiple sclerosis. *Arch Phys Med Rehabil*, 2006. 87(12): p. 1661-3.
78. Bonniaud V, Jackowski D, Parratte B, et al.: Quality of life in multiple sclerosis patients with urinary disorders: discriminative validation of the English version of Qualiveen. *Qual Life Res*, 2005. 14(2): p. 425-31.
79. Pannek J, Mark R, Stohrer M, Schurch B: [Quality of life in German-speaking patients with spinal cord injuries and bladder dysfunctions. Validation of the German version of the Qualiveen questionnaire]. *Urologe A*, 2007. 46(10): p. 1416-21.
80. D'Ancona CA, Tamanini JT, Botega N, et al.: (2008 June 5 [Epub ahead of print]) Quality of life of neurogenic patients: translation and validation of the Portuguese version of Qualiveen. *Int Urol Nephrol*.
81. Bonniaud V, Bryant D, Parratte B, Guyatt G: Qualiveen, a urinary-disorder specific instrument: 0.5 corresponds to the minimal important difference. *J Clin Epidemiol*, 2008. 61(5): p. 505-10.
82. Fowler FJ, Jr., Barry MJ, Lu-Yao G, et al.: Patient-reported complications and follow-up treatment after radical prostatectomy. The National Medicare Experience: 1988-1990 (updated June 1993). *Urology*, 1993. 42(6): p. 622-9.
83. Fowler FJ, Jr., Barry MJ, Lu-Yao G, et al.: Effect of radical prostatectomy for prostate cancer on patient quality of life: results from a Medicare survey. *Urology*, 1995. 45(6): p. 1007-13; discussion 1013-5.
84. Schag CA, Ganz PA, Heinrich RL: Cancer Rehabilitation Evaluation System--short form (CARES-SF). A cancer specific rehabilitation and quality of life instrument. *Cancer*, 1991. 68(6): p. 1406-13.
85. da Silva F RE, Costa T, Denis L: Quality of life in patients with prostatic cancer. *Cancer*, 1993. 71(3): p. 113-1142.
86. Stockler MR, Osoba D, Goodwin P, Corey P, Tannock IF: Responsiveness to change in health-related quality of life in a randomized clinical trial: a comparison of the Prostate Cancer Specific Quality of Life Instrument (PROSQOLI) with analogous scales from the EORTC QLQ-C30 and a trial specific module. European Organization for Research and Treatment of Cancer. *J Clin Epidemiol*, 1998. 51(2): p. 137-45.

87. Clark JA, Inui TS, Silliman RA, et al.: Patients' perceptions of quality of life after treatment for early prostate cancer. *J Clin Oncol*, 2003. 21(20): p. 3777-84.
88. Cella D: *Manual of the Functional Assessment of Chronic Illness Therapy (FACIT) Measurement System*. Version 4 ed. 1997, Evanston IL: Center on Outcomes, Research and Education (CORE), Evanston Northwestern Health-care and Northwestern University
89. Cookson MS, Dutta SC, Chang SS, et al.: Health related quality of life in patients treated with radical cystectomy and urinary diversion for urothelial carcinoma of the bladder: development and validation of a new disease specific questionnaire. *J Urol*, 2003. 170(5): p. 1926-30.
90. Watkins-Bruner D, Scott C, Lawton C, et al.: RTOG's first quality of life study--RTOG 90-20: a phase II trial of external beam radiation with etanidazole for locally advanced prostate cancer. *Int J Radiat Oncol Biol Phys*, 1995. 33(4): p. 901-6.
91. Litwin MS, Hays RD, Fink A, et al.: Quality-of-life outcomes in men treated for localized prostate cancer. *Jama*, 1995. 273(2): p. 129-35.
92. Barry MJ, Fowler FJ, Jr., O'Leary MP, et al.: The American Urological Association symptom index for benign prostatic hyperplasia. The Measurement Committee of the American Urological Association. *J Urol*, 1992. 148(5): p. 1549-57; discussion 1564.
93. Cockett AT, Aso Y, Chatelain C, et al.: The international consultation on benign prostatic hyperplasia (BPH). 1991, Paris.
94. Selekman RE, Harris CR, Filippou P, Chi T, Alwaal A, Blaschko SD, Breyer BN. Validation of a Visual Prostate Symptom Score in Men with Lower Urinary Tract Symptoms in a Health Safety Net Hospital. *2015 Urology*. 86(2): 354-8
95. Kim JH, Kwon SS, Shim SR, Sun HY, Ko YM, Chun DI, Yang WJ, Song YS. Validation and reliability of a smartphone application for the International Prostate Symptom Score questionnaire: a randomized repeated measures crossover study. *2014 J Med Internet Res* 16(2).
96. Boyarsky S, Jones G, Paulson DF, Prout GR, Jr.: A new look at bladder neck obstruction by the food and drug administration regulators: guide lines for investigation of benign prostatic hypertrophy. *Trans Am Assoc Genitourin Surg*, 1976. 68: p. 29-32.
97. Barry MJ, Fowler FJ, Jr., O'Leary MP, et al.: Measuring disease-specific health status in men with benign prostatic hyperplasia. Measurement Committee of The American Urological Association. *Med Care*, 1995. 33(4 Suppl): p. AS145-55.
98. Kingery L, Martin ML, Naegeli AN, Khan S, Viktrup L. Content validity of the Benign Prostatic Hyperplasia Impact Index (BII); a measure of how urinary trouble and problems associated with BPH may impact the patient. *2012 Int J Clin Pract*. 66(9): 883-90
99. Epstein RS, Deverka PA, Chute CG, et al.: Urinary symptom and quality of life questions indicative of obstructive benign prostatic hyperplasia. Results of a pilot study. *Urology*, 1991. 38(1 Suppl): p. 20-6.
100. Amarenco G, Arnould B, Carita P, et al.: European psychometric validation of the CONTILIFE: a Quality of Life questionnaire for urinary incontinence. *Eur Urol*, 2003. 43(4): p. 391-404.
101. Hansen BJ, Flyger H, Brasso K, et al.: Validation of the self-administered Danish Prostatic Symptom Score (DAN-PSS-1) system for use in benign prostatic hyperplasia. *Br J Urol*, 1995. 76(4): p. 451-8.
102. Lukacz ES, Lawrence JM, Buckwalter JG, et al.: Epidemiology of prolapse and incontinence questionnaire: validation of a new epidemiologic survey. *Int Urogynecol J Pelvic Floor Dysfunct*, 2005. 16(4): p. 272-84.
103. Donovan JL, Kay HE, Peters TJ, et al.: Using the ICSOOL to measure the impact of lower urinary tract symptoms on quality of life: evidence from the ICS-'BPH' Study. International Continence Society--Benign Prostatic Hyperplasia. *Br J Urol*, 1997. 80(5): p. 712-21.
104. Hagen S, Hanley J, Capewell A: Test-retest reliability, validity, and sensitivity to change of the urogenital distress inventory and the incontinence impact questionnaire. *Neurourol Urodyn*, 2002. 21(6): p. 534-9.
105. Uebersax JS, Wyman JF, Shumaker SA, McClish DK, Fantl JA: Short forms to assess life quality and symptom distress for urinary incontinence in women: the Incontinence Impact Questionnaire and the Urogenital Distress Inventory. Continence Program for Women Research Group. *Neurourol Urodyn*, 1995. 14(2): p. 131-9.
106. Bjelic-Radisic V, Dorfer M, Tamussino K, et al.: The Incontinence Outcome Questionnaire: an instrument for assessing patient-reported outcomes after surgery for stress urinary incontinence. *Int Urogynecol J Pelvic Floor Dysfunct*, 2007. 18(10): p. 1139-49.

107. Bushnell DM, Martin ML, Summers KH, et al.: Quality of life of women with urinary incontinence: cross-cultural performance of 15 language versions of the I-QOL. *Qual Life Res*, 2005. 14(8): p. 1901-13.
108. Wagner TH, Patrick DL, Bavendam TG, Martin ML, Buesching DP: Quality of life of persons with urinary incontinence: development of a new measure. *Urology*, 1996. 47(1): p. 67-71; discussion 71-2.
109. Murphy M, Culligan PJ, Arce CM, et al.: Construct validity of the incontinence severity index. *Neurourol Urodyn*, 2006. 25(5): p. 418-23.
110. Yu LC, Kaltreider DL: Stressed nurses dealing with incontinent patients. *J Gerontol Nurs*, 1987. 13(1): p. 27-30.
111. Twiss C, Triaca V, Anger J, et al.: Validating the incontinence symptom severity index: a self-assessment instrument for voiding symptom severity in women. *J Urol*, 2009. 182(5): p. 2384-91.
112. Shaw C, Matthews RJ, Perry SI, et al.: Validity and reliability of a questionnaire to measure the impact of lower urinary tract symptoms on quality of life: the Leicester Impact Scale. *Neurourol Urodyn*, 2004. 23(3): p. 229-36.
113. Blavais JG, Tsui JF, Mekel G, Benedon MS, Li B, Friedman FM, Weinberger JM, Weedon J, Weiss JP. Validation of the Lower Urinary Tract Symptom Score. 2015 Canadian Journal of Urology. 22(5): 7952-8
114. Suskind AM, Dunn RL, Morgan DM, DeLancey JO, McGuire EJ, Wei JT. The Michigan Incontinence Symptom Index (M-ISI): a clinical measure for type, severity, and bother related to urinary incontinence. 2014 *Neurourology and Urodynamics*. 33(7): 1128-34.
115. Robinson JP, Avi-Itzhak T, McCorkle R: Psychometric properties of the Male Urogenital Distress Inventory (MUDI) and Male Urinary Symptom Impact Questionnaire (MUSIQ) in patients following radical prostatectomy. *Urol Nurs*, 2007. 27(6): p. 512-8.
116. Robinson JP, Shea JA: Development and testing of a measure of health-related quality of life for men with urinary incontinence. *J Am Geriatr Soc*, 2002. 50(5): p. 935-45.
117. Holm-Larsen T, Andersson F, van der Meulen E, Yankov V, Rosen RC, Nørsgaard JP. The Nocturia Impact Diary: a self-reported impact measure to complement the voiding diary. 2014 *Value Health*. 17(6):696-706
118. Mock LL, Parmelee PA, Kutner N, Scott J, Johnson TM, 2nd: Content validation of symptom-specific nocturia quality-of-life instrument developed in men: issues expressed by women, as well as men. *Urology*, 2008. 72(4): p. 736-42.
119. Coyne KS, Thompson CL, Lai J-S, Sexton CC. An overactive bladder symptom and health-related quality of life short-form: Validation of the OAB-q SF. 2015 *Neurourology and Urodynamics*. 34(3): 255-263
120. Barber MD, Kuchibhatla MN, Pieper CF, Bump RC: Psychometric evaluation of 2 comprehensive condition-specific quality of life instruments for women with pelvic floor disorders. *Am J Obstet Gynecol*, 2001. 185(6): p. 1388-95.
121. Hendriks EJ, Bernards AT, Berghmans BC, de Bie RA: The psychometric properties of the PRAFAB-questionnaire: a brief assessment questionnaire to evaluate severity of urinary incontinence in women. *Neurourol Urodyn*, 2007. 26(7): p. 998-1007.
122. Rai GS, Kiniors M, Wientjes H: Urinary incontinence handicap inventory. *Arch Gerontol Geriatr*, 1994. 19(1): p. 7-10.
123. Stach-Lempinen B, Kujansuu E, Laippala P, Metsanoja R: Visual analogue scale, urinary incontinence severity score and 15 D-psycho-metric testing of three different health-related quality-of-life instruments for urinary incontinent women. *Scand J Urol Nephrol*, 2001. 35(6): p. 476-83.
124. Lukacs B, Comet D, Grange JC, Thibault P: Construction and validation of a short-form benign prostatic hypertrophy health-related quality-of-life questionnaire. BPH Group in General Practice. *Br J Urol*, 1997. 80(5): p. 722-30.
125. Burgio KL, Goode PS, Richter HE, Locher JL, Roth DL: Global ratings of patient satisfaction and perceptions of improvement with treatment for urinary incontinence: validation of three global patient ratings. *Neurourol Urodyn*, 2006. 25(5): p. 411-7.
126. Pleil AM, Coyne KS, Reese PR, et al.: The validation of patient-rated global assessments of treatment benefit, satisfaction, and willingness to continue--the BSW. *Value Health*, 2005. 8 Suppl 1: p. S25-34.
127. Piau E, Evans CJ, Espindle D, et al.: Development and validation of the Overactive Bladder Satisfaction (OAB-S) Questionnaire. *Neurourol Urodyn*, 2008. 27(3): p. 179-90.
128. Margolis MK, Fox KM, Cerulli A, et al.: Psychometric validation of the overactive bladder satisfaction with treatment questionnaire (OAB-SAT-q). *Neurourol Urodyn*, 2009. 28(5): p. 416-22.

129. Brubaker L, Piau EC, Tully SE, Evans CJ, Bavendam T, Beach J, Yeh Y, Kopp ZS, Khullar V, Kelleher CJ, Trocio J. Validation study of the Self-Assessment Goal Achievement (SAGA) questionnaire for lower urinary tract symptoms. *2013 International Journal of Clinical Practice*. 67(4): 342-350
130. Colman S, Chapple C, Nitti V, et al.: Validation of treatment benefit scale for assessing subjective outcomes in treatment of overactive bladder. *Urology*, 2008. 72(4): p. 803-7.
131. Brown JS, Bradley CS, Subak LL, et al.: The sensitivity and specificity of a simple test to distinguish between urge and stress urinary incontinence. *Ann Intern Med*, 2006. 144(10): p. 715-23.
132. Cardozo L, Staskin D, Currie B, Wiklund I, Globe D, Signori M, Dmochowski R, MacDiarmid S, Nitti VW, Noblett K. Validation of a bladder symptom screening tool in women with incontinence due to overactive bladder. *2014 International Urogynecology Journal*. 25(12): 1655-63
133. Basra R, Artibani W, Cardozo L, et al.: Design and validation of a new screening instrument for lower urinary tract dysfunction: the bladder control self-assessment questionnaire (BSAQ). *Eur Urol*, 2007. 52(1): p. 230-7.
134. Homma Y, Yoshida M, Yamanishi T, Gotoh M: Core Lower Urinary Tract Symptom score (CLSS) questionnaire: a reliable tool in the overall assessment of lower urinary tract symptoms. *Int J Urol*, 2008. 15(9): p. 816-20.
135. Gunthorpe W, Brown W, Redman S: The development and evaluation of an incontinence screening questionnaire for female primary care. *Neurourol Urodyn*, 2000. 19(5): p. 595-607.
136. Diokno AC, Brock BM, Brown MB, Herzog AR: Prevalence of urinary incontinence and other urological symptoms in the noninstitutionalized elderly. *J Urol*, 1986. 136(5): p. 1022-5.
137. Blaivas JG, Panagopoulos G, Weiss JP, Somaroo C: Validation of the overactive bladder symptom score. *J Urol*, 2007. 178(2): p. 543-7; discussion 547.
138. Coyne KS, Zyczynski T, Margolis MK, Elinoff V, Roberts RG: Validation of an overactive bladder awareness tool for use in primary care settings. *Adv Ther*, 2005. 22(4): p. 381-94.
139. Coyne KS, Margolis MK, Bavendam T, Roberts R, Elinoff V: Validation of a 3-item OAB awareness tool. *Int J Clin Pract*, 2011. 65(2): p. 219-24.
140. Parsons CL, Dell J, Stanford EJ, et al.: Increased prevalence of interstitial cystitis: previously unrecognized urologic and gynecologic cases identified using a new symptom questionnaire and intravesical potassium sensitivity. *Urology*, 2002. 60(4): p. 573-8.
141. Bradley CS, Rovner ES, Morgan MA, et al.: A new questionnaire for urinary incontinence diagnosis in women: development and testing. *Am J Obstet Gynecol*, 2005. 192(1): p. 66-73.
142. Haab F, Richard F, Amarenco G, et al.: Comprehensive evaluation of bladder and urethral dysfunction symptoms: development and psychometric validation of the Urinary Symptom Profile (USP) questionnaire. *Urology*, 2008. 71(4): p. 646-56
143. Shaw C, Matthews RJ, Perry SI, et al.: Validity and reliability of an interviewer-administered questionnaire to measure the severity of lower urinary tract symptoms of storage abnormality: the Leicester Urinary Symptom Questionnaire. *BJU Int*, 2002. 90(3): p. 205-15.
144. Srikrishna S, Robinson D, Cardozo L: Validation of the Patient Global Impression of Improvement (PGI-I) for urogenital prolapse. *Int Urogynecol J*, 2010. 21(5): p. 523-8.
145. Yalcin I, Bump RC: Validation of two global impression questionnaires for incontinence. *Am J Obstet Gynecol*, 2003. 189(1): p. 98-101.
146. Broome BA: Psychometric analysis of the Broome Pelvic Muscle Self-Efficacy Scale in African-American women with incontinence. *Urol Nurs*, 2001. 21(4): p. 289-97.
147. Matza LS, Thompson CL, Krasnow J, et al.: Test-retest reliability of four questionnaires for patients with overactive bladder: the overactive bladder questionnaire (OAB-q), patient perception of bladder condition (PPBC), urgency questionnaire (UQ), and the primary OAB symptom questionnaire (POSQ). *Neurourol Urodyn*, 2005. 24(3): p. 215-25.
148. Peterson TV, Karp DR, Aguilar VC, Davila GW: Validation of a global pelvic floor symptom bother questionnaire. *Int Urogynecol J*, 2010. 21(9): p. 1129-35.
149. Black N, Griffiths J, Pope C: Development of a symptom severity index and a symptom impact index for stress incontinence in women. *Neurourol Urodyn*, 1996. 15(6): p. 630-40.
150. Badía Llach X CDD, Perales Cabañas L, Pena Outeriño JM, Martínez-Agulló E, Conejero Sugrañés J, Arañó Beltrán P, Marqués Queimadelos A, Roset Gamisans M, Perulero Escobar N: [The development and preliminary validation of the IU-4 questionnaire for the clinical classification of urinary incontinence]. *Actas Urol Esp.*, 1999. 23(7): p. 565-72.

151. Lemack GE, Zimmern PE: Predictability of urodynamic findings based on the Urogenital Distress Inventory-6 questionnaire. *Urology*, 1999. 54(3): p. 461-6.
152. Nixon A, Colman S, Sabounjian L, et al.: A validated patient reported measure of urinary urgency severity in overactive bladder for use in clinical trials. *J Urol*, 2005. 174(2): p. 604-7.
153. Cartwright R, Panayi D, Cardozo L, Khullar V: Reliability and normal ranges for the Patient's Perception of Intensity of Urgency Scale in asymptomatic women. *BJU Int*, 2010. 105(6): p. 832-6.
154. Mathias SD, Crosby RD, Nazir J, Klaver M, Drogendijk T, Hakimi Z, Odeyemi IA. Validation of the Patient Perception of Urgency Scale in patients. *2014 Value Health*. 17(8): 823-829
155. Bent AE, Gousse AE, Hendrix SL, et al.: Validation of a two-item quantitative questionnaire for the triage of women with urinary incontinence. *Obstet Gynecol*, 2005. 106(4): p. 767-73.
156. Lubeck DP, Prebil LA, Peeples P, Brown JS: A health related quality of life measure for use in patients with urge urinary incontinence: a validation study. *Qual Life Res*, 1999. 8(4): p. 337-44.
157. Blaivas JG, Panagopoulos G, Weiss JP, Somaroo C, Chai-kin DC: The urgency perception score: validation and test-retest. *J Urol*, 2007. 177(1): p. 199-202.
158. Cardozo L, Coyne KS, Versi E: Validation of the urgency perception scale. *BJU Int*, 2005. 95(4): p. 591-6.
159. Coyne KS, Sexton CC, Thompson C, Bavedam T, Brubaker L. Development and psychometric evaluation of the urgency questionnaire for evaluating severity and health-related quality of life impact of urinary urgency in overactive bladder. *2015 International Urogynecology Journal*. 26(3): 373-82
160. Lowenstein L, FitzGerald MP, Kenton K, et al.: Evaluation of urgency in women, with a validated Urgency, Severity and Impact Questionnaire (USIQ). *Int Urogynecol J Pelvic Floor Dysfunct*, 2009. 20(3): p. 301-7.
161. Coyne KS, Harding G, Jumadilova Z, Weiss JP: Defining urinary urgency: patient descriptions of "gotta go". *Neuro-rol Urodyn*, 2012. 31(4): p. 455-9.
162. Coyne KS, Margolis MK, Hsieh R, Vats V, Chapple CR: Validation of the urinary sensation scale (USS). *Neuro-rol Urodyn*, 2011. 30(3): p. 360-5.
163. Al-Buheissi S, Khasriya R, Maraj BH, Malone-Lee J: A simple validated scale to measure urgency. *J Urol*, 2008. 179(3): p. 1000-5; discussion 1005.
164. Osterberg A, Graf W, Karlbom U, Pahlman L: Evaluation of a questionnaire in the assessment of patients with faecal incontinence and constipation. *Scand J Gastroenterol*, 1996. 31(6): p. 575-80.
165. Hull TL, Floruta C, Piedmonte M: Preliminary results of an outcome tool used for evaluation of surgical treatment for fecal incontinence. *Dis Colon Rectum*, 2001. 44(6): p. 799-805.
166. Reilly WT, Talley NJ, Pemberton JH, Zinsmeister AR: Validation of a questionnaire to assess fecal incontinence and associated risk factors: Fecal Incontinence Questionnaire. *Dis Colon Rectum*, 2000. 43(2): p. 146-53; discussion 153-4
167. Hiller L, Bradshaw HD, Radley SC, Radley S: A scoring system for the assessment of bowel and lower urinary tract symptoms in women. *Bjog*, 2002. 109(4): p. 424-30.
168. Hiller L, Radley S, Mann CH, et al.: Development and validation of a questionnaire for the assessment of bowel and lower urinary tract symptoms in women. *Bjog*, 2002. 109(4): p. 413-23.
169. Bharucha AE, Locke GR, 3rd, Seide BM, Zinsmeister AR: A new questionnaire for constipation and faecal incontinence. *Aliment Pharmacol Ther*, 2004. 20(3): p. 355-64.
170. Norton C, Whitehead WE, Bliss D, Harari D, Lang J: Conservative and pharmacological management of faecal incontinence in adults. in *Incontinence: Proceedings of the Fourth International Consultation on Incontinence*. 2008. Paris, France: Health Publication Ltd.
171. Rockwood TH, Church JM, Fleshman JW, et al.: Fecal Incontinence Quality of Life Scale: quality of life instrument for patients with fecal incontinence. *Dis Colon Rectum*, 2000. 43(1): p. 9-16; discussion 16-7.
172. Bug GJ, Kiff ES, Hosker G: A new condition-specific health-related quality of life questionnaire for the assessment of women with anal incontinence. *Bjog*, 2001. 108(10): p. 1057-67.
173. Krysa J, Lyons M, Williams AB: A simple quality of life questionnaire for patients with faecal incontinence. *Int J Colorectal Dis*, 2009. 24(10): p. 1213-7.
174. Cockell SJ, Oates-Johnson T, Gilmour DT, Valis TM, Turnbull GK: Postpartum flatal and Fecal Incontinence Quality-of-Life Scale: a disease- and population-specific measure. *Qual Health Res*, 2003. 13(8): p. 1132-44.

175. Hull TL, Floruta C, Piedmonte M: Preliminary results of an outcome tool used for evaluation of surgical treatment for fecal incontinence. *Dis Colon Rectum*, 2001. 44(6): p. 799-805.
176. Bakx R, Sprangers MA, Oort FJ, et al.: Development and validation of a colorectal functional outcome questionnaire. *Int J Colorectal Dis*, 2005. 20(2): p. 126-36.
177. O'Keefe EA, Talley NJ, Tangalos EG, Zinsmeister AR: A bowel symptom questionnaire for the elderly. *J Gerontol*, 1992. 47(4): p. M116-21.
178. Rosen R, Brown C, Heiman J, et al.: The Female Sexual Function Index (FSFI): a multidimensional self-report instrument for the assessment of female sexual function. *J Sex Marital Ther*, 2000. 26(2): p. 191-208.
179. Rogers RG, Coates KW, Kammerer-Doak D, Khalsa S, Qualls C: A short form of the Pelvic Organ Prolapse/Urinary Incontinence Sexual Questionnaire (PISQ-12). *Int Urogynecol J Pelvic Floor Dysfunct*, 2003. 14(3): p. 164-8; discussion 168.
180. Quirk FH, Heiman JR, Rosen RC, et al.: Development of a sexual function questionnaire for clinical trials of female sexual dysfunction. *J Womens Health Gend Based Med*, 2002. 11(3): p. 277-89.
181. Symonds T, Boolell M, Quirk F: Development of a questionnaire on sexual quality of life in women. *J Sex Marital Ther*, 2005. 31(5): p. 385-97.
182. Srikrishna S, Robinson D, Cardozo L: A longitudinal study of patient and surgeon goal achievement 2 years after surgery following pelvic floor dysfunction. *BJOG* 2010; 117: 1504-1511.
183. Srikrishna S, Robinson D, Cardozo L, Thiagamoorthy G: Patient and surgeon goal achievement 10 years following surgery for pelvic organ prolapse and urinary incontinence. *Int Urogynecol J* 2015; 26: 1679-1686.
184. Cam C, Sancak P, Karahan N, Sancak A, Celik C, Karateke A: Validation of the short form of the Pelvic Organ prolapse/Sexual questionnaire (PISQ-12) in a Turkish population. *Eur J Obstet Gynaecol Reprod Biol* 2009; 146: 104-107.
185. Fatton B, Letouzey V, Lagrange E, mares P, Jacquelin B, de Tayrac R: Validation of a French version of the short form of the pelvic organ prolapse/urinary Incontinence Sexual Questionnaire (PISQ-12). *J gynecol Obstet Biol Reprod (Paris)* 2009; 38: 662-667
186. Su TH, Lau HH: Validation of a Chinese version of the short form of the pelvic organ prolapse/urinary Incontinence Sexual Questionnaire. *J Sex Med* 2010; 7: 3940-3945.
187. Teleman P, Stenzelius K, Iorizzo L, Jakobsson U: Validation of the Swedish forms of the Pelvic Floor Impact questionnaire (PFIQ-7), Pelvic Floor Distress Inventory (PFDI-20) and Pelvic Organ Prolapse/Urinary Incontinence sexual Questionnaire (PISQ-12). *Acta Obstet Gynaecol Scand* 2011; 90: 483-487.
188. Santana GW, Aoki T, Auge AP: Validation of a French version of the short form of the pelvic organ prolapse/urinary Incontinence Sexual Questionnaire (PISQ-12). *Int Urogynecol J* 2012; 23: 117-121
189. Momenimovahe Z, Pakgohar M, Montazeri A: Pelvic Organ Prolapse/urinary Incontinence Sexual Questionnaire (PISQ-12) psychometric validation of the Iranian version. *Int Urogynecol J* 2015; 26: 433-439.
190. 't Hoen LA, Utomo E, Steensma AB, Blok BF, Korlage IJ: The Pelvic Organ Prolapse/urinary Incontinence Sexual Questionnaire (PISQ-12): validation of the Dutch version. *Int Urogynecol J* 2015; 26: 1293-1303
191. Fatton B, Hermieu JF, Cour F, Wagner L, Jacquelin B, de Tayrac: French Language validation of the Pelvic Organ Prolapse/urinary Incontinence Sexual Questionnaire – IUGA revised (PISQ-IR). *Prog Urol* 2013; 23: 1464-1473.
192. Tomoe, H, Inoue M, Kimoto Y, Nagao K, homma Y, Takahashi S, Kobayashi M, Ikeda S: *Nihon Hinyokika Gakkai Zasshi* 2014; 105: 103-111.
193. El Azab AS, Ghoniem GM, Leu SY, Nguyen DV: Arabic Validation of the Pelvic Organ Prolapse/urinary Incontinence Sexual Questionnaire IUGA Revised (PISQ-IR). *Int Urogynecol J* 2015; 26: 1229-1237.
194. Wang H, Lau HH, Hung MJ, Huang WC, Zheng YW, Su TH: Validation of a Mandarin Chinese version of the Pelvic Organ Prolapse/urinary Incontinence Sexual Questionnaire IUGA Revised (PISQ-IR). *Int Urogynecol J* 2015; 26: 1695-1700.
195. Farkas B, Tiringier I, Farkas N, Kenyeres B, Nemeth Z: Hungarian language version of the Pelvic Organ Prolapse/urinary Incontinence Sexual Questionnaire IUGA Revised (PISQ-IR). *Int Urogynecol J* 2016. Epub ahead of print

196. Trutnovsky G, Nagele E, Ulrich D, Aigmuller T, Dorfner D, Geiss I, Reinstadler E, Angleitner-Flotzinger J, Ries JJ, Bjelic-Radicic V, Austrian Urogynaecology working Group. German Translation and validation of the Pelvic Organ Prolapse/urinary Incontinence Sexual Questionnaire IUGA Revised (PISQ-IR). *Int Urogynaecol J* 2016; 27: 1235-1244.
197. Flores-Espinoza C, Araya AX, Pizarro-Berdichevsky J, Santos V, Ferrer M, Garin O, swift S, Didesu GA. Validation of the Spanish version of the Prolapse Quality of Life questionnaire in Chilean women. *Int Urogynaecol J* 2015; 26: 123-130.
198. Veit-Rubin N, Digesu GA, Swift S, Khullar V, Kaelin Gambirasio, Dallenbach P, Boulvain M. Validation of the French version of the P-QoL questionnaire. *Eur J Obstet Gynaecol Reprod Biol* 2015; 192: 10-16.
199. Morovatdar N, Hghighi L, Najami Z, Hashemi A, Nojomi M. Response validity of Persian version of P-QoL questionnaire in patients with prolapse. *Eur J Obstet Gynaecol Reprod Biol* 2015; 193: 88-91.
200. Rzepka J, Zalewski K, Stefanowicz A, Khullar V, Digesu GA. Validation of the Polish version of the P-QoL questionnaire. *Ginekol Pol* 2016; 87: 477-483.
201. Arouca MA, Duarte TB, Lott DA, Magnani PS, Nogueira AA, Rosa-E-Silva JC, Brito LG. Validation and cultural translation for the Brazilian Portuguese version of the Pelvic Floor Impact Questionnaire (PFIQ-7) and Pelvic Floor Distress Inventory (PFDI-20). *Int Urogynaecol J* 2016; 27: 1097-1106
202. Due U, Brostrom S, Lose G. Validation of the Pelvic Floor Distress Inventory -20 and the Pelvic Floor Impact Questionnaire – 7 in Danish women with pelvic organ prolapse. *Acta Obstet Gynaecol Scand* 2013; 92: 1041-1048.
203. Srikrishna S, Robinson D, Cardozo L. Role of composite endpoints as an outcome assessment tool in urogenital prolapse. *J Obstet Gynaecol* 2012; 32: 276-279.
204. Digesu GA, Khullar V, Cardozo L, Robinson D, Salvatore S. P-QoL: a validated questionnaire to assess the symptoms and quality of life of women with urogenital prolapse. *Int Urogynaecol J Pelvic Floor Dysfunct* 2005; 176-181.
205. Rogers RG, Kammer-Doak D, Villareal A, Coates K, Qualls C. A new instrument to measure sexual function in women with urinary incontinence and/or pelvic organ prolapse. *Am J Obstet Gynaecol* 2001; 184: 552-558
206. Rogers RG, Coates KW, Krammerer-Doak D, Khalsa S, Qualls C. A sort form of the Pelvic Organ Prolapse/Urinary Incontinence sexual Questionnaire (PISQ-12). *Int Urogynaecol J* 2003; 14: 164-168.
207. Rogers RG, Rockwood TH, Constantine ML, Thakar R, Kammerer-Doak D, Pauls RN, Parekh M, Ridgeway B, Jha S, Pitkin J, Reid F, Sutherland SE, Luckacz ES, Domoney C, Sand P, Davila GW, Espuna-Pons ME. A new measure of sexual function in women with pelvic floor disorders (PFD): the Pelvic Organ Prolapse/Incontinence Sexual Questionnaire, IUGA-Revised (PISQ-IR). *Int Urogynaecol J* 2013; 24: 1091-1103.
208. Price N, Jackson SR, Avery K, Brookes ST, Abrams P. Development and psychometric evaluation of the ICIQ Vaginal Symptoms Questionnaire: the ICIQ-VS. *BJOG* 2006;113: 700-712.
209. Baessler K, O'Neill SM, Maher CF, Battistutta D. A validated self-administrated female pelvic floor questionnaire. *Int Urogynaecol J* 2010; 21: 163-172.
210. Peterson TV, Karp DR, Aguilar VC, Davila GW. Validation of a global pelvic floor symptom bother questionnaire. *Int Urogynaecol J* 2010; 21: 163-172.
211. Radley SCJ, Kubwalo GL, Stevens BE, Leathard V, Tanguy E. Feasibility and acceptability of electronic interview in urogynaecology. *Int Urogynaecol J* 2003; 14(suppl 1): 239
212. Elkermann RM, Cundiff GW, Melick CF et al. Correlation of symptoms with location and severity of pelvic organ prolapse. *Am J Obstet Gynaecol* 2001; 185: 1332-1337.
213. Mouritsen L, Larsen JP. Symptoms, bother and POPQ in women referred with pelvic organ prolapse. *Int Urogynaecol J Pelvic Floor Dysfunct* 2003; 14: 122-127.
214. Jorge JM WS. Aetiology and management of faecal incontinence. *Dis Colon Rectum* 1993; 36: 77-97.
215. Engel AF, Kamm MA, Bartram CI, Nicholls RJ. Relationship of symptoms in faecal incontinence to specific sphincter abnormalities. *Int J Colorectal Dis* 1995; 10: 152-155.
216. Peterson TV, Karp DR, Aguilar VC, Davila GW. Validation of a global pelvic floor symptom bother questionnaire. *Int Urogynaecol J* 2010; 21: 163-172.
217. Hallbrook O, Sjodahl R. Surgical approaches to obtaining optimal bowel function. *Semin Surg Oncol* 2000; 18:249-258

218. Bekker M, Beck J, Putter H, et al. The place of female sexual dysfunction in the urological practice: results of a Dutch survey. *J Sex Med* 2009;6:2979–87.
219. Elsamra S, Nazmy M, Shin D, et al. Female sexual dysfunction in urological patients: findings from a major metropolitan area in the USA. *BJU Int* 2010;106:524–6.
220. Nicolosi A, Laumann EO, Glasser DB, et al. Sexual activity, sexual disorders and associated help-seeking behavior among mature adults in five Anglophone countries from the Global Survey of Sexual Attitudes and Behaviors (GSSAB). *J Sex Marital Ther* 2006b;32:331–42.
221. Parish SJ, Rubio-Aurioles E. Education in sexual medicine: proceedings from the international consultation in sexual medicine, 2009. *J Sex Med* 2010;7:3305–14.
222. Meston CM. Validation of the Female Sexual Function Index (FSFI) in women with female orgasmic disorder and in women with hypoactive sexual desire disorder. *J Sex Marital Ther* 2003;29:39–46.
223. Revicki, PhD, Mary K. Margolis, MPH, MHA, Elizabeth N. Bush, MHS, Leonard R. DeRogatis, Vladimir Hanes, Content Validity of the Female Sexual Function Index (FSFI) in Pre- and Postmenopausal Women with Hypoactive Sexual Desire Disorder. *J Sex Med* 2011;8:2237–2245
224. Derogatis LR, Rosen R, Leiblum S, Burnett A, Heiman J The Female Sexual Distress Scale (FSDS): initial validation of a standardized scale for assessment of sexually related personal distress in women. *J Sex Marital Ther*. 2002 Jul-Sep;28(4):317-30 Leonard R. DeRogatis, Adam Allgood, PharmD, Peter
225. Auerbach, Dale Eubank, John Greist, Murtuza Bharmal, Lisa Zipfel, Chun-Yuan Guo, Validation of a Women's Sexual Interest Diagnostic Interview—Short Form (WSID-SF) and a Daily Log of Sexual Activities (DLSA) in Postmenopausal Women with Hypoactive Sexual Desire Disorder *J Sex Med* 2010;7:917–927
226. Rosen RC, Lobo RA, Block BA, Yang HM, Zipfel LM. Menopausal Sexual Interest Questionnaire (MSIQ): a unidimensional scale for the assessment of sexual interest in postmenopausal women. *J Sex Marital Ther*. 2004 Jul-Sep;30(4):235-50.
227. Rosen RC, Riley A, Wagner G, Osterloh IH, Kirkpatrick J, Mishra A. The international index of erectile function (IIEF): a multidimensional scale for assessment of erectile dysfunction. *Urology*. 1997 Jun;49(6):822-30
228. Leonard R. DeRogatis, Adam Allgood, PharmD, Peter Auerbach, Dale Eubank, John Greist, Murtuza Bharmal, Lisa Zipfel, Chun-Yuan Guo, Validation of a Women's Sexual Interest Diagnostic Interview—Short Form (WSID-SF) and a Daily Log of Sexual Activities (DLSA) in Postmenopausal Women with Hypoactive Sexual Desire Disorder *J Sex Med* 2010;7:917–927
229. Derogatis L, Clayton A, Lewis-D'Agostino D, Wunderlich G, Fu Y. Validation of the female sexual distress scale-revised for assessing distress in women with hypoactive sexual desire disorder. *J Sex Med*. 2008 Feb;5(2):357-64.
230. Taylor JF, Rosen RC, Leiblum SR. Self-report assessment of female sexual function: psychometric evaluation of the Brief Index of Sexual Functioning for Women. *Arch Sex Behav*. 1994 Dec;23(6):627-43.
231. Clayton AH, McGarvey EL, Clavet GJ The Changes in Sexual Functioning Questionnaire (CSFQ): development, reliability, and validity. *Psychopharmacol Bull*. 1997;33(4):731-45.
232. Keller A, McGarvey EL, Clayton AH. Reliability and construct validity of the Changes in Sexual Functioning Questionnaire short-form (CSFQ-14). *J Sex Marital Ther*. 2006 Jan-Feb;32(1):43-52
233. Clayton AH, Goldmeier D, Nappi RE, Wunderlich G, Lewis-D'Agostino DJ, Pyke R. Validation of the sexual interest and desire inventory-female in hypoactive sexual desire disorder. *Sex Med*. 2010 Dec;7(12):3918-28
234. Cindy Meston, Paul Trapnell, Development and Validation of a Five-Factor Sexual Satisfaction and Distress Scale for Women: The Sexual Satisfaction Scale for Women (SSS-W) *J Sex Med*. 2005 Jan; 2(1): 66–81.
235. Rosen RC, Catania J, Pollack L, Althof S, O'Leary M, Seftel AD. Male Sexual Health Questionnaire (MSHQ): scale development and psychometric validation. *Urology*. 2004 Oct;64(4):777-82
236. Rogers RG, Rockwood TH, Constantine ML A new measure of sexual function in women with pelvic floor disorders (PFD): the Pelvic Organ Prolapse/Incontinence Sexual Questionnaire, IUGA-Revised (PISQ-IR). *Int Urogynecol J*. 2013 Jul;24(7):1091-103.
237. Learman LA, Huang AJ, Nakagawa S, Gregorich SE, Kuppermann M Development and validation of a sexual functioning measure for use in diverse women's health outcome studies. *Am J Obstet Gynecol*. 2008 Jun;198(6):710.e1-8

URODYNAMIC TESTING

Chair

Peter F.W.M. Rosier (Netherlands)

Members

Hann-Chorng Kuo (Taiwan)

Enrico Finazzi Agro (Italy)

Mario De Gennaro (Italy)

Andrew Gammie (UK)

Hidehiro Kakizaki (Japan)

Hashim Hashim (UK)

Philip Tooze-Hobson (UK)

CONTENTS

ABBREVIATIONS	602	6. Filling Cystometry and Sensitivity and Specificity of Symptoms	612
INTRODUCTION	602	7. Provocative Manoeuvres	613
I. WHAT ARE URODYNAMIC STUDIES AND WHAT SHOULD, IN GENERAL BE THE ROLE OF URODYNAMIC STUDIES IN CLINICAL PRACTICE?	603	8. Clinical Applications of Urodynamic Studies	613
Introduction	603	IV. STRESS URINARY INCONTINENCE SYNDROME	613
Conclusion	604	1. Urethral Pressures and Severity Of Stress Urinary Incontinence	613
1. Uroflowmetry	604	2. Aspects of Urodynamic Studies Relevant to Therapy for Stress Urinary Incontinence	614
2. Filling Cystometry	604	3. Prediction of Failure of Surgery	615
3. Pressure-Flow Studies (Voiding Cystometry)	605	4. Voiding Difficulties After Surgery	615
4. Urethral Pressure Profilometry	605	5. Postoperative Urgency, Mixed Symptoms of Incontinence, or Overactive Bladder Syndrome	615
5. Abdominal Leak Point Pressure	605	6. The Role of Urodynamic Studies in Predicting Urinary Incontinence in Women After Surgical Management of Pelvic Organ Prolapse	615
II. TECHNOLOGICAL INNOVATIONS IN URODYNAMIC STUDIES	605	V. URGENCY URINARY INCONTINENCE AND OVERACTIVE BLADDER SYNDROME	616
1. Catheters for Pressure Measurement	605	1. Frequent Voiding and Urgency; Overactive Bladder Syndrome	616
2. Objective Assessment of Bladder Sensation	606	VI. URGENCY URINARY INCONTINENCE	617
3. Non-Invasive Pressure (& Flow) Measurements	607	1. Recommendations for Urodynamic Diagnosis in Women with Urinary Incontinence	617
4. Urethral Retro-Resistance Pressure	608	VII. PATIENT EVALUATION: MEN	617
5. Urethral Pressure Reflectometry	608	1. Urodynamic Testing of Men with Symptoms and Signs of Lower Urinary Tract Dysfunction	617
6. Ultrasound Imaging	609	2. LUTS and OAB-S in Male Patients	619
III. URODYNAMIC STUDIES: NORMAL VALUES, RELIABILITY AND DIAGNOSTIC PERFORMANCE; REPRODUCIBILITY AND RELIABILITY OF URODYNAMIC STUDIES (ESPECIALLY UROFLOWMETRY CYSTOMETRY AND PRESSURE-FLOW STUDY)	609	3. Urinary Incontinence After Transurethral Resection of the Prostate and Open Prostatectomy for Benign Disease	620
1. Cystometry: Normal Values and Test Retest Variation	609	4. (Robot Assisted) Retropubic Radical Prostatectomy	620
2. Reproducibility of Ambulatory Urodynamic Studies	610	5. UDS for Patients with Post (Radical) Prostatectomy Urinary Incontinence and	
3. Influence of Catheter on Voiding	611		
4. Urethral Pressure Measurements	611		
5. Leak Point Pressures	611		

	Persistent Symptoms of Lower Urinary Tract Dysfunction and or Failed Surgical Management	622
6.	Neurogenic Lower Urinary Tract Dysfunction	623
VIII.	PATIENT EVALUATION: CHILDREN WITH URINARY INCONTINENCE	626
<hr/>		
1.	Introduction	626
2.	NEUROGENIC LOWER URINARY TRACT DYSFUNCTION	627
3.	Anorectal Malformation and Persistent Cloacal Anomalies	631
4.	Anatomic Abnormalities	632
5.	Functional Disorders Of The Lower Urinary Tract.....	634
6.	Technical Concerns: Reliability and Reproducibility of Tests	637
IX.	PATIENT EVALUATION: FRAIL ELDERLY	638
<hr/>		
1.	Introduction	638
2.	Tests in the Geriatric or Frail Elderly Population	641
3.	Evidence that Performing Urodynamic Studies Improves Clinical Outcomes in the Geriatric Population.....	641
4.	The Practical Indications for Urodynamic Studies and Which Tests are Needed..	641
5.	The Urodynamic Parameters Important in Various Geriatric Conditions.....	642
	REFERENCES	644

URODYNAMIC TESTING

PETER F.W.M. ROSIER (NETHERLANDS)

*HANN-CHORNG KUO (TAIWAN), ENRICO FINAZZI AGRO (ITALY), MARIO DE GENNARO (ITALY),
ANDREW GAMMIE (UK), HIDEHIRO KAKIZAKI (JAPAN), HASHIM HASHIM (UK),
PHILIP TOOZS-HOBSON (UK)*

ABBREVIATIONS

ARM	anorectal malformation
AUS	artificial urinary sphincter
BOO	bladder outflow obstruction
BoNT-A	botulinum neurotoxin -A
BPH	benign prostatic hyperplasia
CIC	clean intermittent (self) catheterisation
DHIC	detrusor hyperactivity (=DO) & impaired contractile function (=DU)
DO	(urodynamic) detrusor overactivity
DU	(urodynamic) detrusor underactivity
EMG	electromyogram/electromyography
ICI	International Consultation on Incontinence
ICS	International Continence Society
ICCS	International Childrens Continence Society
IPSS	International prostate symptom score
LPP	leak point pressure
LUT	lower urinary tract
LUTD	lower urinary tract dysfunction
LUTS	lower urinary tract symptoms
MMC	myelodysplasia / meningomyelocele / (occult) spinal dysraphism
MS	multiple sclerosis
MUCP	maximum urethral closure pressure
NLUTD	neurogenic lower urinary tract dysfunction
OAB-S	overactive bladder syndrome
POP	pelvic organ prolapse
PVR	post-void residual urine (volume)
PUV	posterior urethral valves

RRP	(robot assisted -laparoscopic) radical retropubic prostatectomy
QoL	quality of life
SCI	spinal cord injury
sd	standard deviation
SUI	stress urinary incontinence
SUI-S	stress urinary incontinence syndrome
TOT	trans obturator tape
TURP	transurethral resection of the prostate
TVT	tension-free transvaginal retropubic tape
UDS	urodynamic studies / urodynamic investigation / urodynamics
UPP	urethral pressure profile/profilometry
UPR	urethral pressure reflectometry
URP	urethral retro-resistance pressure
UI	urinary incontinence
USUI	urodynamic stress urinary incontinence
UTI	urinary tract infection
UUI	urgency urinary incontinence
UUT	upper urinary tract
VV	voided volume
VUDS	video urodynamic study
VUR	vesico ureteral reflux

INTRODUCTION

This chapter is based on the 'Urodynamic Testing' chapter from the previous (ICI2013) consultation. The fifth consultation, ICI2013, updated the evidence for the technical performance, clinical utility and responsiveness to treatment of UDS for patients with UI. Testing for faecal incontinence was not included in the dynamic testing ICI2013. This ICI2016 chapter starts with a summary of the ICI2013 recommendations and conclusions in each of the paragraphs and

then provides relevant updates where from where we have evaluated the current evidence. Finally, the updated ICI2016 conclusions and recommendations are presented. Outdated references have been removed and new literature references are added. Publications less than one year before the consultation were deemed not to have stood the 'test of time' and so have not been included.

The primary aim of this chapter is to present what tests might be performed to elucidate the mechanism that causes UI in the individual and to make recommendations for practice. To this end, we present an overview of the best available recent scientific evidence about the role of UDS in clinical practice for patients presenting with UI. Based on the above, we provide recommendations, and the strength of the recommendation (A to D), for the current state of diagnostic assessment of the patient, or groups of patients with UI.

Each of the recommendations of the preceding consultation is re-evaluated and the discussion ends with new or renewed conclusions (with a level of evidence that follows the Modified Oxford Scale). Following on from that we present our new (ICI2016) graded recommendation(s) where necessary after considered judgement of the evidence (discussion). Where deemed useful we suggest topics(s) for research. Conclusion, recommendation and suggestions for research are highlighted in the text and are therefore suitable for 'express reading'.

The chapter considers the evidence around UDS for patients with signs and symptoms of UI by reviews of the literature regarding clinical UDS of diverse patient groups with UI; which include the following discrete groups; Women, men, children, neurogenic lower urinary tract dysfunction (NLUTD) and the frail elderly. UDS of voiding dysfunction is not addressed specifically and only described where deemed relevant (more specific: when related to the UI).

I. WHAT ARE URODYNAMIC STUDIES AND WHAT SHOULD, IN GENERAL BE THE ROLE OF URODYNAMIC STUDIES IN CLINICAL PRACTICE?

INTRODUCTION

Urodynamic testing should be performed to objectively measure and document the entire LUT *function and/or dysfunction*. UDS should be done only when it can have therapeutic consequences; will change the patient's management and/or when part of a surveillance or a research program. For this, the individual patient's symptoms, including their impact in terms of bother and degree of hinder they cause as well as the

impact of other relevant circumstances (like e.g. comorbidity or operability) should be kept in mind. UDS can show signs, not presented, such as e.g. (significant) postvoid-residual urine (PVR) or detrusor underactivity (DU), which may be relatively unnoticed by the patient, even when neurologically intact. UUT signs (dilatation) can exist or develop without any (new) symptoms, especially, but not uniquely in patients with relevant neurological abnormalities. Furthermore, the patient can present with complaints such as, 'urinary frequency', 'nocturia' or 'recurrent UTIs', which are difficult or impossible to reproduce in the usual UDS-laboratory. Nevertheless, in the usual setting of a UDS a feature of LUT function or dysfunction may be observed/measured that is relevant to these unnoticed phenomena and (therefore) explaining the person's symptoms. Finally, UDS may provide a basis for the prevention of (signs or) symptoms to arise that are at the time of the testing not presented by the patient; e.g. urinary retention or UUT dilatation or deterioration.

UDS allows direct assessment of LUT function by the measurement of relevant physiological parameters (ICS-ST2002^{1 2}) and invasive UDS is defined as any test that is invasive, i.e. involving insertion of one or more catheters or any other transducers into the bladder and/ or other body cavities, or insertion of probes or needles, for example for (needle-) EMG measurement³ (ICS-GUP2016).

The point of a clinical /biological test is that it will show a result on a continuum between what is considered normal physiology and pathology; and UDS is no exception to this. The key to determining the cause of the signs and/or symptoms of LUTD will be to reproduce the function and the dysfunction of the LUT of the individual patient. The implicit consequence of this is also that ideally at least one complete filling (storage) and pressure-flow (voiding) cycle, that adequately represents the patients problem (e.g. with regard to volumes) including post voiding features, (PVR, or after contraction) should be tested, analysed, and documented, even if only storage or only voiding signs or symptoms have been expressed by the patient. Last but not least: when LUT sensation is altered, as is frequently in patients with NLUT, the symptoms are even less reliable than those of patients with intact sensation, making UDS as an objective evaluation to advise or justify a specific management even more important.

The role of UDS in broad clinical perspective can be:

- a. To identify all factors that contribute to the LUT-dysfunction signs (e.g. UI) and/or are the origin of the symptoms (e.g. frequent voiding) and assess their relative importance;
- b. To obtain information about all other aspects of LUT function or dysfunction; whether or not expressed as a symptom or recognisable as a sign;

- c. To allow a prediction of the possible consequences of LUT D for the UUT;
- d. To allow a prediction of the outcome, including undesirable side effects, of a contemplated treatment;
- e. To confirm the effects of intervention or understand the mode of action of a particular type of treatment for a LUTD; especially a new and/or experimental (not routine) one;
- f. To understand the reasons for failure of previous treatments for UI, or for LUTD in general (after unsatisfactory treatment).

UDS is the gold standard to assess LUT function and dysfunction. Some studies have challenged UDS with a clinical diagnosis as the comparator. Specifically, the 'clinical diagnosis of SUI' was used as a predictor of outcome of suburethral tapes in a very selected group of patients.⁴ When this clinical diagnosis – not standardized in general and not for these trials- had been compared with one specific element (filling -cystometry) of the –not (always ICS) standard- UDS diagnosis (and also including patients with DO⁵ neither way of diagnosis has been superior for the patients recruited in this study with signs and/or symptoms of SUI-S. The question remains whether the overall outcome of the surgery (or alternatives for some of the patients) could have been better than the $\pm 65\%$ overall success rate (dry, without other symptoms e.g. frequent voiding), when a more structured clinical as well as UDS diagnosis and/or analysis had been used in these studies.^{4,6}

CONCLUSION

UDS in clinical practice evaluates a person's LUT function with at least one complete and representative filling-voiding-post voiding cycle by testing with relevant pressures and flowmetry. UDS includes quality control, subsequent analysis, and systematic documentation.

1. UROFLOWMETRY

This is the non-invasive measurement of urine flow rate applicable for both women and men, as well as for children. The general principles are identical although voiding position is relevant,⁷ and a small series of young men voiding in the healthy range shows that time after ejaculation may play a role.⁸ Uroflowmetry is also relevant for patients with neurological abnormalities, when they are able to (and do) use a toilet in the daily life situation. The patient voids into a flow meter in private, ideally with a normal to strong (but not uncomfortable) desire to empty their bladder.^{9, 10} Urine flow rate is continuously measured and displayed graphically. Various parameters from the trace are automatically calculated and printed out together with the trace. After control for artefacts in automated calculations, the maximum flow rate, the volume

voided and shape of the curve are usually the principal determinants of whether or not the patient is emptying their bladder in a normal way. Flow rate- volume dependency should be considered. If an abnormal voiding occurs, it is good clinical practice to repeat the assessment to attempt to reproduce normal behaviour. Several factors, such as patient apprehension, can give an abnormal recording in patients who have no voiding difficulty. Asking the patient about what she or he thinks about the voiding; whether the voiding was an adequate representation of their usual voiding, (if possible: comparison with the usual voiding diary -volume) must be regarded as good urodynamic practice. Repeating the assessment can remove such confounding factors. Unambiguous and careful instruction of the patient, privacy and a short meatus to flowmeter distance are all inherently relevant.¹¹ The committee has not found any relevant technical changes or innovations to uroflowmetry equipment since 2013.

2. FILLING CYSTOMETRY

This is the measurement of the pressure inside the bladder to assess its storage capabilities. It is an invasive test which involves a catheter being placed into the bladder, usually transurethraly, and another catheter being placed rectally, vaginally or through an abdominal stoma to measure abdominal pressure. Subtracting the indirectly measured abdominal pressure (p_{abd}) from the pressure measured inside the bladder (intravesical pressure, p_{ves}) gives a representation of pressure changes due to the action of the detrusor smooth muscle, the detrusor pressure, p_{det} ($= p_{ves} - p_{abd}$). During this assessment, the bladder is usually filled with normal saline solution, or x-ray contrast solution in the case of VUDS, either through a separate catheter placed transurethraly or through the filling lumen of a dual lumen catheter, if used. Usually the filling rate is much faster than physiological bladder filling (which is 1-2mL/min) and therefore referred to as non-physiological in ICS terms. The bladder will become filled in about 10 minutes when a 10% of 'estimated usual capacity –based on voiding diary (taking into account the PVR whenever possible)-' is taken as the filling rate (mL/m).³

The intravesical, abdominal pressure and the calculated detrusor pressure are monitored as the bladder is filled and before the patient has been given 'permission to void'. The storage ability of the bladder is assessed in terms of the volumes required to elicit various sensations from the patient, its cystometric capacity, its compliance (passive muscle adaptation to volume stretch and detrusor muscle relaxation), and the presence or the absence of phasic detrusor pressure rises. The filling (storage) phase of cystometry is the when USUI can be assessed by means of coughing or straining, on the request of the clinician.¹² Good urodynamic practice demands that all three of abdominal, intravesical and detrusor pressures are evaluated to diagnose urinary bladder storage function. The committee has not become aware of any

changes after 2013 in technique of cystometry. Pelvic muscle EMG during cystometry is not ICS standard and not further discussed in this chapter (see chapter on imaging and neurophysiological testing for this). Alternatives for ICS standard water (saline) filled catheters and tubing are being evaluated and will be discussed in a separate paragraph. Specific attention to artefact and errors merits attention and has been included in the update of the ICS Good Urodynamic Practices.^{13 14 15}

3. PRESSURE-FLOW STUDIES (VOIDING CYSTOMETRY)

This is a measurement of the mechanics of micturition. When the filling phase of cystometry is complete, the patient is given 'permission to void' and will empty their bladder into a flow meter whilst intravesical, abdominal and detrusor pressures are being recorded. The simultaneous measurement of flow rate and pressure enables voiding to be assessed and pressure flow analysis can help determine whether a slow urine stream is due to BOO or to DU or to a combination of both. Pressure-flow studies can also assist in the diagnosis of detrusor-sphincter dyssynergia and a clearer description of dysfunctional voiding and/or quantification of outlet dynamics during voiding. Similar precautions as for uroflowmetry must be taken regarding representativeness, artefacts and patient apprehension. Since 2013 no new studies have been published about the technique of pressure flow testing. Analysis of pressure flow regarding detrusor (underactive –DU-) contraction or 'contractility' during voiding has received increased attention and is suggested to be of future relevance.^{16 17}

4. URETHRAL PRESSURE PROFILOMETRY

This is a test to estimate the urethra and the surrounding structures' ability to maintain a closed bladder outlet, allowing the body system to contain urine within the bladder. A catheter is placed transurethrally into the bladder and then withdrawn along the urethra (usually by a mechanical puller at a constant rate). Catheters that use water perfusion but also catheters with microtip pressure sensors or catheters with air filled ('charged') balloons are used to this aim. The pressure along the length of the urethra is measured and interpreted relative to the pressure inside the bladder or abdomen. The maximum pressure measured in the urethra is assumed to give an indication of the urethral closure function. The clinical relevance of UPP is frequently discussed in the literature and alternative technical systems to measure urethral pressure or function have been published and will be discussed in following paragraphs.

5. ABDOMINAL LEAK POINT PRESSURE

This test estimates the urethra's ability to contain urine within the bladder. Intra-abdominal pressure is measured whilst the patient is asked to increase their abdominal pressure by Valsalva or by coughing. The abdominal pressure required to produce leakage from the bladder gives an indication of the closure function of the urethra. Diverse methods as well as reference pressures are used. New evidence (since ICI2013) for the relevance of LPP measurements and variants of LPP will be discussed in the specific paragraphs of this report.

II. TECHNOLOGICAL INNOVATIONS IN URODYNAMIC STUDIES

1. CATHETERS FOR PRESSURE MEASUREMENT

Traditionally, UDS is done with water-filled catheters and tubing and external pressure sensors and this has become the ICS Standard method. A variety of catheter-tip microtip or optical sensors have been evaluated in the past and new sensors are being developed. Also, sensors that are placed in the bladder wall (not lumen) itself are tested in animal labs. Single-use, air-filled catheters have been developed for clinical use and are discussed here.

Air filled catheters have a small balloon on the tip and a lumen attached to a pressure system. After introduction, the balloon is 'charged' with air and measurement can take place. Air filled catheters (T-Doc® Air charged™ catheters, Laborie, Mississauga, Canada) can be used for intravesical, intra-urethral as well as for abdominal pressure measurement in UDS and are CE (Conformité Européenne) marked and FDA (US-Food and Drug Administration) approved for their technical safety for use in human.

1.1. Conclusions and Recommendations 2013

ICI2013 concluded that air-filled catheters may provide an acceptable alternative to other techniques for measuring the urethral closing pressure, although studies to show whether air-filled catheters provide an alternative to water-filled lines for measuring intravesical and intra-abdominal pressure in UDS were not available at that time. The recommendations of the ICI2013 were that investigators planning to use air-filled catheters for intravesical and intra-abdominal pressure in UDS are advised to check for themselves that they have an equivalent performance to their current system for measuring pressure.

ICI2013 also advised evaluation of how their system compares to the standard reference values for clinical relevant limits of pressures obtained with the ICS standard water-filled systems.

Studies comparing measurement of urethral pressure by air-filled catheters with measurement by microtip catheters have indicated that the values obtained are statistically significantly different, but are more reproducible with the air-filled systems.^{18 19 20} In laboratory bench-top studies, water-filled catheters were reported to act as an under damped system, and sensitive to motion artefacts, whilst air-filled catheters acted as an over damped system; while less sensitive to artefacts, they were slower in response.²¹ Another report concluded however that the signal could be adjusted to compensate for this difference.²² Air-filled catheters have several practical advantages over water-filled pressure lines because there is no hydrostatic pressure effect (as is occurring in –the tubing of - a water-filled system) to account for, so that there is no need to position external sensors at a standard reference level. (Which is the level of the symphysis pubis by ICS convention.) Air filled system have no requirement to fluid flush the system to exclude air, a process that is essential in a water-filled tubes pressure-sensing environment. Also, there are no pressure (tube wagging or knocking) artefacts produced when the patients move. In order to compare water-filled systems with the air-filled systems during live UDS, two studies conducted pressure measurements in female patients with both systems simultaneously, one study with 20 patients²³ and one with 51 patients.²⁴ Both studies reported that the systems were not interchangeable, since values obtained from each were significantly different, the larger study stating that p_{det} values could vary between systems by up to 10 cmH₂O (the 95% limits of agreement). Pressure offset, as observed, differences are not particularly relevant in (urodynamic graph) pattern analysis, however when absolute (subtracted) pressures become relevant as in pressure flow analysis or urethral pressure profiles the possibility of clinically relevant differences exists. Studies that refute or confirm this are not yet available. Thus, more recently, a review paper has recommended that further validation of measurement techniques with air-filled systems should be done before its clinical similarity can be established.²⁵ Further research must be carried out in order to identify what has caused the observed differences in pressure readings obtained, by evaluating the potential sources in the air-filled system however also in the (ICS standard) water-filled system.

1.2. Conclusions

- Air-filled catheters may provide an acceptable alternative to other techniques for measuring the pressure closing the female urethra however normal –or reference- values have not been established. (level 3)
- Studies show that air-filled catheters record different pressure values to water-filled lines in

UDS and are therefore not interchangeable. (level 2)

- Air-filled catheters have not been tested in men or in children, or in patients with NLUTD.

1.3. Recommendation (Grade C)

- Investigators planning to use air-filled catheters for intravesical and intra-abdominal pressure in UDS are advised to check for themselves that they have an equivalent performance to their current system for measuring pressure.
- Investigators planning to use air-filled catheters for intravesical and intra-abdominal pressure in UDS are advised to check for themselves how the performance of their system compares to the standard reference values for clinical relevant limits (of pressures obtained with the classical systems).
- Clinicians using UDS should be well aware of the technical demands of measuring with a water-filled –external pressure system and should be able to (prevent and correct and) recognize these, also in post test evaluation.

1.4. Topic for Research

- Studies to compare the performance of air-filled catheters with (ICS- standard) water-filled pressure lines in the measurement of intravesical and intra-abdominal pressure during filling and voiding cystometry, to include ‘fast’ events such as coughing, in male, neurological and paediatric patients as well as analysis of test-retest reliability.
- Studies to determine the cause(s) of the earlier observed differences in pressure readings between water-filled and air-filled systems.
- Studies to determine the clinical relevance of difference in pressure readings between water-filled and air-filled systems.
- Studies to demonstrate the technical stability and clinical reliability of practice with the water- filled external pressure reference UDS systems.
- Studies to establish standard values for filling cystometry and pressure flow study in women.

2. OBJECTIVE ASSESSMENT OF BLADDER SENSATION

2.1. Conclusions and Recommendations 2013

Based on published results ICI2013 noted that there was a significant variation in clinical practice to determine bladder filling sensation landmarks and maximum cystometric capacity despite the standardisa-

tion of terms. The committee concluded that strategies to derive bladder filling sensation parameters in a more automated and objective way (with patient controlled electronic analogue scale registration), have been showing plausible and applicable results. ICI2013 stated that these were however not sufficiently tested with regard to reliability, relevance, investigator independency or test retest robustness.

Bladder sensation during UDS is usually recorded by the simple expedient of asking the patient to inform the investigator when they experience different sensations. This is ICS standardised, but subjective, measurement that can be confounded by the investigators inadvertently or deliberately distracting the patient whilst bladder filling is being carried out. Investigators can also bias the measurement by inadvertent prompting, or by causing too much 'concentration' and unrepresentative awareness of the patient.²⁶ Bladder filling sensation has received increasing attention since urinary urgency and early filling sensation are clinically important and some treatments are believed to influence LUT sensation.^{27 28}

A patient-activated, keypad 'urge score' device to measure sensations during bladder filling was introduced²⁹ that provided reliable and repeatable measures of different bladder sensations, however this never found its way into clinical routine. Filling sensations during conventional UDS were marked on a body map and this study suggested that women's bladder sensations vary in relation to their bladder condition.³⁰

Daily life bladder sensation can be evaluated by a sensation related bladder diary and during cystometric bladder filling. 185 women with SUI-S, OAB-S or mixed UI filled out a 3-day bladder diary grading bladder sensation and measuring VV at each micturition. The maximum cystometric sensation (FS and ND) volumes were significantly larger than the diary VVs for corresponding bladder sensations, and this in all groups, leading to the conclusion that symptoms relate more to the diary.³¹ In the development of the ICIQ bladder diary, the data from 264 patients diary recordings of urinary urgency showed weak agreement with questionnaire responses and UDS observations.³² Although cystometry is regarded the gold standard to assess bladder filling sensation there is a paucity of evidence regarding its clinical relevance; also the question whether cystometry or alternative (diary -like) evaluations are more relevant remains unanswered.

Research has provided some in vivo evidence of the specific brain areas that are involved in LUT sensation, control and modulation, but this type of observations cannot yet be regarded as a replacement of cystometry, because up to now no brain pattern has been shown to correlate with a specific UDS abnormality.³³

Many studies consistently show that the correlation between objective and subjective features of detrusor

adaptation to volume increment, bladder proprioception and the subjective interpretation of filling is weak.^{35 36 37 38 39 40 41} In fact these observations also demonstrate that UDS is adding new and objective diagnostic information to what has been gathered with history, voiding diary and clinical investigation. Both UDS, as well as signs and symptoms, are relevant to select further treatment, for instance in the identification of DU.⁴²

2.2. Conclusion (Level 3-4)

- Based on published results, a significant variation exists in clinical practice to determine bladder filling sensation landmarks and maximum cystometric capacity, despite the standardisation of terms.
- Strategies to derive bladder filling sensation parameters in a more automated and objective way, have been published and show plausible and applicable results, however these have not been sufficiently tested regarding reliability, relevance, investigator independency or test retest robustness.

2.3. Heart Rate Variability

Heart rate variability was evaluated to serve as a monitor of the autonomic nervous system as an objective measure (indicator) for LUTD and/or bladder filling sensation, without arriving at a clinical application yet.^{43 44 45}

2.4. Conclusions (Level 3-4)

- None of the analysis or testing methods of the autonomic nervous system has, to date, shown any relevance for the objective diagnosis of LUT function in neurologically intact persons.

3. NON-INVASIVE PRESSURE (& FLOW) MEASUREMENTS

Non-invasive measurements of bladder pressure during voiding in men by the penile cuff or condom catheter have been shown to correlate with traditional invasive measurement of bladder pressure. ICI2013 concluded (grade B) that non-invasive measurements of bladder or detrusor 'voiding- pressure' can be considered in clinical experiments in order to evaluate voiding function when the male patient is not required to undergo an invasive assessment of the storage function of the LUT. The ICI2013 did not recommend condom or penile cuff pressure, nor near infrared detrusor spectroscopy, for the diagnosis UI, or of LUTD.^{46 47} Recently a device to measure isovolumic (maximum) pressure during voiding at the location of the fossa navicularis. The pressures obtained correlated with BOOI based on detrusor pressure at maximum flow rate, but have not been tested for relevance for UI.^{48 49} Measurement of perineal noise during voiding as another way of non-invasively quantifying male BOO has been evaluated but has also not

demonstrated relevance for the diagnosis of (male) UI.⁵⁰

Transabdominal wall near-infrared spectroscopy was used to detect the haemodynamic changes that are associated with detrusor contractile activity. This has been demonstrable in a highly selective set of feasibility recordings and may lead the way for non-invasive detection of detrusor (over-) activity.^{51 52} Another group has however not been able to replicate this.⁵³ The use of perineal ultrasound to detect turbulent flow in the male urethra has been reported.⁵⁴ Both near infrared spectroscopy and perineal ultrasound have not been tested, or are not applicable, for patients with UI.

3.1. Conclusions (Level 3)

- Non-invasive measurements of bladder pressure during voiding in men by the penile cuff or condom catheter have been shown to correlate with traditional invasive measurement of bladder pressure. None of these studies have shown any applicability in the diagnosis of UI.
- Near-infrared detrusor spectroscopy has in very selected recordings shown a relation with detrusor (over)activity but this has not been reproducible in an independent clinical follow up evaluation.

3.2. Recommendation (Grade B)

- The committee endorses that in clinical experiments non-invasive measurements of bladder or detrusor pressure may be considered in order to evaluate voiding function when the male patient is not required to undergo an invasive assessment of the storage (and continence) LUT functions.
- The committee does not recommend condom or penile cuff pressure, nor near infrared detrusor spectroscopy, for the diagnosis of UI, or of LUTD.

4. URETHRAL RETRO-RESISTANCE PRESSURE

In the measurement of urethral retro-resistance pressure (URP), a small meatal plug is inserted just inside the female urethra and saline is pumped into the urethra until the pressure reaches the value sufficient to overcome the resistance offered by the urethra when the fluid flows into the bladder. The pressure required to achieve and maintain an open bladder outlet is taken to be a measure of urethral closure function. The basic principle behind the technique has its origins in 1923 when Bonney made an attempt to measure the efficiency of urethral closure.⁵⁵ Slack et al studied 258 SUI-S women with the URP technique in comparison with MUCP and Valsalva LPP. The URP, in a group of 61 women, without symptoms of UI and who had negative standing UI tests, was significantly higher than in a group of women with SUI-S who had

been tested previously.⁵⁶ This study also provided some test-retest data, which showed that URP measurements were consistent in individuals. Measurements of URP on 165 women with various UDS diagnoses were published subsequently.⁵⁷ Women with USUI had significantly lower URP than women with competent urethral sphincters. In the mixed symptoms group, URP mean values were not significantly different from those with DO competent sphincters, or those with USUI. The authors concluded that whilst there are significantly different URP measurements between women with DO and those with USUI, URP is not a diagnostic tool. An analysis of URP in 48 women with (clinical) SUI-S and also USUI, without pelvic organ prolapse (POP) before and after anti-UI surgery (colposuspension n = 8, TVT n = 6, TOT n = 34) and another study to compare URP with 'established measures of UI severity' showed that preoperative URP did not correlate with SUI-S in all women, had no predictive value and did not correlate with the outcome of anti-UI surgery.^{58 59} As for women, retrograde pressures are obtainable for men also and have shown to correlate with 24-hour pad test volume.⁶⁰

4.1. Conclusion (Level 2/3)

- After positive first reports of urethral retro-resistance pressure measurements it was shown that this measurement does not give any better information about urethral closure function than the urethral pressure profile or Valsalva LPP.

4.2. Recommendation (Grade B/C)

- The committee recommends that urethral retro-resistance pressure measurements are not used in clinical routine as an alternative to cystometry or (when deemed necessary for) urethral pressure measurements made with conventional urodynamic equipment to diagnose female UI.

5. URETHRAL PRESSURE REFLECTOMETRY

Urethral pressure reflectometry was evaluated in an in vitro study for the simultaneous measurement of cross-sectional area and pressure in a collapsible biological tube to assess the female urethra.⁶¹ The team postulated that these parameters had the potential to provide more physiological information about the urethra than could be obtained from conventional urethral studies. These investigators compared UPR with urethral pressure profilometry (UPP) in 143 women (105 patients and 38 healthy volunteers).⁶² UPR was measured supine, both while relaxed and during 'squeeze', and while upright and relaxed, and compared with UPP using the perfusion technique, with the patient supine and relaxed. Short-term reproducibility and long-term reproducibility were also assessed. The authors showed that UPR measured the same pressure as UPP but the UPR was more reproducible, however clinical relevance of

this observation was not specifically discussed. Subsequently UPR parameters of in 30 SUI-S women and 30 volunteers (23 'continent' and 7 'nearly continent') were reported and compared with UPP.⁶³ A feasibility study using the technique has now been reported in 10 male patients.⁶⁴

5.1. Conclusion (Level 3)

- Preclinical measurements of urethral pressure reflectometry opening pressure and cross sectional area ('dynamics') have provided some insight into urethral closure function and dynamics, but, as yet have no clinical relevance in the diagnosis of UI.

5.2. Recommendation (Grade C)

- The committee recommends that urethral pressure reflectometry is not used in clinical practice for the diagnosis of UI before clinical relevance, non-inferiority and/or superiority over current UDS has been demonstrated.

6. ULTRASOUND IMAGING

Imaging and ultrasound in relation to UI will be discussed in a separate chapter of this book. We will only give a short summary of ultrasound in relation with UDS observations.

The measurement of detrusor wall thickness has been used in several studies as a screening test for DO or for BOO with a variety of measurement techniques using transvaginal, transabdominal or trans perineal ultrasound. Different protocols were used and measured different parts of the bladder. This has resulted in contradictory data. Some data showed a smaller cystometric capacity in OAB-S -wet or DO, and an association between increased detrusor wall thickness and DO on UDS. Also, observations of an association of ultrasound detrusor wall thickness and BOO have been reported. Most researchers conclude that overlap of the results and the relatively low predictive value should be improved before bladder wall thickness is used in clinical practice.^{65 66 67 68 69 70 71 72 73 74 75 76} Especially the specificity of detrusor wall thickness for UI (or DO) is not determined and probably unlikely. Studies of specific (other) patient groups have been reported. One, in SCI patients, concluded that detrusor wall thickness could not be used in such patients⁷⁷ and another in nocturnally enuretic children suggested that detrusor wall thickness could be applied as a screening tool to select children with DO.⁷⁸

Twenty men (mean ± SD age 66 ± 6 years) with LUTS were included in a study to evaluate radio frequency ultrasound imaging -detrusor wall strain. This bladder wall strain correlated positively with detrusor pressure in some patients with a (urodynamic) isovolumic and/or voiding detrusor contraction. It has however

been difficult to continuously measure the bladder wall in a large proportion of the patients.⁷⁹

6.1. Conclusion (Level 3)

- There is some evidence that detrusor wall thickness is related to BOO as well as to DO.
- There is no evidence that ultrasound detrusor wall thickness analysis can discriminate between DO (with or without UI) and BOO. Detrusor wall thickness has a relatively low predictive value to discriminate from normal LUT function.
- There is a large overlap between normal and abnormal values in detrusor wall thickness and a lack of standardisation in ultrasound detrusor wall thickness measurement.

6.2. Recommendation (Grade C)

- The committee recommends that ultrasound detrusor wall thickness not be used in routine clinical practice for the diagnosis of LUTD related to UI.

III. URODYNAMIC STUDIES: NORMAL VALUES, RELIABILITY AND DIAGNOSTIC PERFORMANCE; REPRODUCIBILITY AND RELIABILITY OF URODYNAMIC STUDIES (ESPECIALLY UROFLOWMETRY CYSTOMETRY AND PRESSURE-FLOW STUDY)

1. CYSTOMETRY: NORMAL VALUES AND TEST RETEST VARIATION

1.1. Conclusions and Recommendations 2013

The ICI2013 concluded that various studies have been helpful in giving normal values and test retest variation of UDS parameters in healthy volunteers. But also, that there has been some evidence that evaluation of filling sensation may be different between laboratories, (thus: 'may be observer dependent'), making data exchange as well as generalization and interpretation of published data difficult. The ICI2013 recommended (Grade B) that investigators and clinicians bear in mind the results of UDS in healthy persons and to recognize 'normal' test-retest variation as well as the differences and/or variations between 'usual lower urinary tract behaviour', ambu-

latory monitoring and office UDS. The ICI2013 furthermore suggested that clinicians should be sufficiently aware of the normal variation, and normal values of LUT function and UDS and recommended further standardisation and a practical objective means of recognizing and recording the parameters relevant to sensation during bladder filling.

The ICI2013 has reported that several studies have been showing test retest variation of $\pm 10\text{-}15\%$ for various parameters (volume, pressure or flow) and observations; It was concluded that this can be regarded as the physiological variation of UDS. However also was concluded that various studies demonstrated clinically relevant practice variation and inter-rater/observer variation. In ICI2013 the committee recommended (grade B) that investigators and clinicians consider the inherent physiological variability of UDS and furthermore that investigators and clinicians evaluate the representativeness of the tests (which is an evaluation based on the patient's perception as to how well the tests have reproduced their usual LUTS and (dys)function, helped e.g. by the voiding diary. The ICI2013 had recommended that examiners strive towards maximal representativeness. Also, the ICI2013 recommended the sitting/upright position during cystometry to be most sensitive to reproducing DO. The ICI2013 recommended persistent attention to the standardisation of techniques, to education, and to practice quality evaluation, and consistency of interpretation of results, especially to reduce intra and inter-practice variation and inter-observer variability.

1.2. New Evidence 2016

The committee has not found new evidence regarding normal values of urodynamic tests.

The committee has also not found new evidence about test retest reliability of standard UDS. One health care system has proposed a national quality standard for UDS.⁸⁰

1.3. Conclusions

The committee concludes that limits of normality of urodynamic tests are well established. (level 2)

The committee also concludes that precise limits for abnormal (reduced) compliance are not exactly known. (level 3)

The committee concludes that LPP has many variations (also without cystometry) and that standardization of technique(s) is lacking. (level 3)

1.4. Discussion

Normal function and physiology of the LUT is the basis for diagnosis of abnormality and dysfunction. Based on the commonly accepted limits of normality a specific dysfunction can be diagnosed.

There is a risk for UTI after UDS. A systematic review evaluated nine randomized controlled trials and concluded that prophylactic antibiotics did reduce the risk

of bacteriuria after UDS but there was not enough evidence to suggest that this effect reduced symptomatic UTI.⁸¹

1.5. Recommendations (Grade C)

Persons diagnosing LUT function and dysfunction should be sufficiently aware of normal variation in the results of UDS. Persons should also be sufficiently aware of normal values and normal variation of LUT function and dysfunction.

Routine antibiotic prophylaxis should not be prescribed for UDS testing; the procedure should be performed sterile and aseptic as per good clinical practice.

2. REPRODUCIBILITY OF AMBULATORY URODYNAMIC STUDIES

2.1. Conclusions and Recommendations 2013

At the time of ICI2013 there has not been published data on the reproducibility or test retest differences of ambulatory UDS. Recently test-retest repeatability of the UDS parameters commonly utilized in ambulatory UDS for patients with NLUTD was evaluated on 64 consecutive patients with stable SCI who underwent two AM studies 24 hr apart. AM parameters were reliable for the reproduction of the main UDS parameters investigated in patients with NLUTD, except for the end filling detrusor pressure. Balancing (zeroing) the abdominal and vesical pressures was reported to be a problem in this study.⁸²

2.2. Conclusion (Level 3)

One single centre study reported reproducibility of some parameters resulting from ambulatory UDS for patients with a NLUTD.

2.3. Discussion

Movement artefacts, pressure calibrating, and assessment of fill volume as well as prevention of urodynamic catheters to dislocate are challenging in ambulatory monitoring and standardization of the test is likely of relevance.⁸³

2.4. Recommendations (Grade B-C)

- The committee does not recommend ambulatory UDS as a routine diagnostic test for patients with UI.
- The committee recommends greater attention to test retest differences of ambulatory monitoring
- The committee recommends standardization of the practice and the (technical quality-) analysis of ambulatory UDS.

3. INFLUENCE OF CATHETER ON VOIDING

3.1. Conclusions and Recommendations 2013

There is evidence that, in general, flow is reduced when voiding with a urodynamic catheter in the urethra and that this reduction is partially caused by the size of the catheter and it has been the opinion of ICI2013 that single catheters 6-8Fr incorporating both a filling channel and a pressure-sensing channel should be used for intravesical pressure measurement during cystometry (i.e. double lumen catheters in the case of using water-filled pressure lines). The ICI2013 recommended that investigators interpret pressure-flow voiding parameters and the subsequent PVR together with the free flow (not catheterised, representative) voiding parameters. Furthermore the 'standard' use of, as thin as possible, 'one-catheter-systems' (dual lumen if water-filled) for filling and pressure recording during UDS was recommended by ICI2013.

The committee found one new study that confirmed differences between free flow and UDS (catheterized pressure) flow. The differences were large and VV differences were not given, nor the voiding position or representativeness were reported.⁸⁴ A small single centre series concluded that the effect of a 4Fr catheter has been negligible.⁸⁵

3.2. Conclusion (Level 3)

Recent studies have confirmed that the transurethral catheter that is necessary for pressure flow caused an effect on voiding and flow rate that is more or less proportional to the size of the catheter.

3.3. Discussion

Both test retest variation as well as variation in circumstances (e.g. position; privacy; (pre) VV) play a role in 'dynamic differences' between two flow rates. And especially the potential effect of position (for men) and privacy has not been reported in flow-pressure flow study. Also, differences may be large, especially in relatively high flow rates (>15mL/s) without clinical relevance. The committee considered that a dual catheter system is disadvantageous because of the manipulation just before the voiding as well as for the need for re-catheterisation when a second test is deemed to be necessary. 6-8Fr catheters are ICS standard and pressure flow categories are based on measurements with catheters of this size, however only in male patients.

3.4. Recommendations (Grade A-B)

- The committee recommends that investigators interpret pressure-flow voiding parameters and the subsequent PVR together with the free flow

(not catheterised, representative) voiding parameters when relevant in the diagnosis of concurrent LUTD, together with the complaint of UI.

- Standard of, as thin as possible, 'one-catheter-systems' (dual lumen if water-filled) for filling and pressure recording during UDS are recommended. If such system is not available, a double catheter system with removal of the filling line, before voiding or while testing stress- or DO UI (-LPP) is acceptable.

4. URETHRAL PRESSURE MEASUREMENTS

4.1. Recommendations 2013

ICI2013 concluded that diverse studies have shown considerable test-retest variation of all urethral pressure measurements or parameters and that normal and pathological values of urethral pressure parameters are largely overlapping. Furthermore, it was concluded that urethral pressures depend on the pressure recording catheter used and its orientation within the urethra and depend on patient position, volume of fluid in the bladder and position of the patient. The ICI2013 recommended that investigators and clinicians recognize the poor sensitivity and specificity of urethral pressure measurements and their significant test retest variation. The committee did not recommend urethral pressure measurement as the only UDS in patients with UI either to confirm or to refute USUI and that these measurements are judged in relation to other UDS (such as cystometry) and to the clinical examination.

5. LEAK POINT PRESSURES

5.1. Introduction

5.2. Recommendations 2013

ICI2013 concluded that diverse (definitions and) techniques to determine (urine) LPP exist and also that there is a weak association between abdominal LPP and the patient experienced or measured severity of bother, or amount of UI. Studies have shown that different techniques and patient positions influence the results of LPP. Studies evaluated by ICI2013 showed that the parameters from abdominal LPP measurements are not very helpful as predictors of success from surgery with either tension free vaginal tape or transobturator tape in patients with SUI-S. The ICI2013 did not recommend abdominal LPP measurement as a single UDS in patients with UI either to reject the diagnosis of USUI, or to select treatment and recommended that the result of abdominal LPP, when performed on patients with UI, should be judged in relation to other UDS such as cystometry

and to the clinical examination. The ICI2013 considers 'detrusor leak point pressure' in patients with NLUTD a relevant parameter. This is discussed in section III (neurogenic LUTD) and in section IV (patient evaluation: children).

5.3. New Evidence

Valsalva (abdominal) LPP was used in a study to evaluate the effect of urethral submucosal injection of bulking agent in patients with SUI-S (no further-UDS was done) but no changes were reported although 50% of patients considered themselves as dry 1 year after the treatment.⁸⁶ In another study, to relate preoperative Valsalva LPP to the outcome of the single-incision midurethral sling procedure in female USIU, 112 patients were evaluated according to preoperative LPP >90cmH₂O (mean 106cmH₂O) and LPP 60-90cmH₂O (mean 75cmH₂O). The overall subjective cure rates were respectively 65% and 63% (P = .744), with 'satisfied' -rates 59% and 69% (P = .600) with identical complication rates. Concluded was that preoperative VLPP values were not predicting outcomes of this treatment.⁸⁷ With regard to post RRP UI, Valsalva LPP was evaluated as a predictor of outcome in a retrospective cohort of 87 men. The primary study questioned whether a difference between intraoperative urethral circumference and artificial urinary sphincter cuff size affects postoperative outcomes. But LPP before AUS did not show any relevance with regard to outcome.⁸⁸ Valsalva LPP was found to increase while an intravesical balloon was placed but the amount of LPP change was not associated with UI and/or pad-test volume urine loss in a prospective study of 166 women with SUI-S of whom one third received sham treatment.⁸⁹

5.4. Conclusion (Level 2-3)

New studies showed no evidence that (the height of) abdominal LPP is helpful as predictor of success of surgery in patients with SUI-S or patients with post RRP UI.

5.5. Recommendation (Grade B)

- The committee does not recommend abdominal LPP measurement as a single UDS in patients with UI.

6. FILLING CYSTOMETRY AND SENSITIVITY AND SPECIFICITY OF SYMPTOMS

6.1. Recommendations 2013

Many studies evaluated by ICI2013 showed a weak correlation between symptoms and the result of UDS, especially filling cystometry, in patients with UI. The ICI2013 concluded that the sensitivity and the specificity of the symptoms, when systematically assessed and voiding diary is included, is at best and in the

'most typical patients', around 60-70%, in comparison with the result of the objective results of UDS.

In general, the ICI2013 committee considered the correlation of the SUI-S (expressed, or questioned) with the result of UDS is somewhat better than the correlation of urgency or UUI (expressed, or questioned) with UDS and concluded that especially when frequent voiding, urgency and/or UUI is part of the symptom complex of patients with UI, UDS is of value to obtain an objective (urodynamic) diagnosis, prior to invasive therapy. Taking into account the variation between various institutes and the test-retest variation, the ICI2013 considered it relevant that investigators and clinicians judge also how adequate the results of the performed tests represent the individual patients' symptoms. The ICI2013 recommended (grade B) UDS in patients with UI when an objective diagnosis is warranted. This is commonly the case when symptoms do not exclusively direct to SUI-S, or when (for all types of UI) conservative measures have not been successful, or when relevant co morbidity exist or relevant previous surgery has been performed. The ICI2013 recommended interpretation of the results of the complete UDS in relation with the symptoms, signs from the clinical (or other) examinations in conjunction with the voiding diary in all patients.

6.2. New Evidence 2016

UDS is the gold standard to assess LUT function and dysfunction. Some studies have challenged UDS with a clinical diagnosis as the comparator. Specifically, clinical diagnosis of SUI-S was used as a predictor of outcome of suburethral tapes in the VALUE trial. When this clinical diagnosis – not standardized for these trials- had been compared with one specific element (filling -cystometry) of the –not always ICS-standard- UDS diagnosis, neither way of diagnosis has been superior for the patients recruited in this study with SUI-S.⁴ By doing UDS, it was reported in an abstract⁵ (only, not in the published VALUE-study⁴ report) that a significant proportion of patients had DO demonstrating the poor specificity of the clinical diagnosis even in expert centres.

Distinguishing or defining characteristics of detrusor overactivity

6.3. Recommendations 2013

Studies summarized in ICI2013 have not been able to show relevant differences in patterns or characteristics of DO whether the cause of overactivity (associated with UI- or not) is neurogenic or idiopathic and diverse studies have not been able to reliably quantify the severity of DO (with or without UI), in a clinically or scientifically applicable way. The ICI2013 recommended (grade C) that neither the cause (neurogenic or idiopathic) nor the severity of DO is diagnosed on the basis of parameters from urodynamic investigation (cystometry).

6.4. New Evidence 2016

No further evidence about quantification or objective reproducibility of the detrusor filling phase pattern, related to the diagnosis of the LUTD leading to UI, has been published.

6.5. Recommendation (Grade C)

- The committee recommends that neither the cause ('neurogenic' or 'idiopathic') nor the severity of DO is diagnosed on the basis of parameters from urodynamic investigation (cystometry).

7. PROVOCATIVE MANOEUVRES

7.1. Recommendations 2013

A systematic review available at ICI2013 concluded that more DO is seen when the patient is in the sitting position during cystometry, when compared to the supine position. There has also been some evidence that moving to a toilet, and also hand washing, is strongly provocative of DO.

Evidence suggests that ice-water cystometry can be applied to elicit DO in patients with NLUTD and that a detrusor contraction during filling with ice-water can be interpreted as a sign of pathologic (existing only in patients with relevant neurology) C-fibre reflex activity. It has, however, also been shown in this regard that false-negative tests do occur.

The ICI2013 recommended that the results of provocative cystometry are interpreted in the light of the patients' symptoms and to bear in mind whether the results obtained are representative. The ICI2013 recommended the performance of UDS in the sitting position whenever possible, because of the better sensitivity for filling phase abnormalities, but also because of the greater possibility of representative voiding and better patient comfort. The ICI2013 recommended that the position of the patient during filling cystometry is always taken into account because it can influence the demonstration of DO and recommended that repeating the cystometry in a different position can be helpful when it is deemed clinically necessary.

7.2. New Evidence 2016

The committee has not found new evidence regarding the position of the patient during cystometry.

7.3. Recommendations (Grade C)

- The committee recommends that the results of provocative cystometry are interpreted in the light of the patients' symptoms and to bear in mind whether the results obtained are representative.
- The committee recommends the performance of UDS in the sitting position whenever possible, because of the better sensitivity for filling phase abnormalities, but also because of the greater possibility

of representative voiding and better patient comfort.

8. CLINICAL APPLICATIONS OF URODYNAMIC STUDIES

8.1. Women with Urinary Incontinence

The diagnostic rationale for UDS in women with UI in association with the currently changing management paradigm has been debated for some time. The think tanks of the International Consultation of Incontinence Research Society (ICI-RS) have discussed this diagnostic rationale and suggest that the patients' presentation can be more precisely delineated as syndromes. E.g. that the SUI syndrome (SUI-S), the overactive bladder syndrome (OAB-S), and the neurogenic LUT dysfunction syndrome (NLUTD-S) are suggested as more precise and descriptive terms that can be used to delineate categories of patients based on symptoms and signs. The diagnostic process for patients with LUTD should be carefully implemented and personalized to rationally select patients for invasive UDS and improve the outcome of initial management.⁹⁰

8.2. Urodynamic Evaluation is Recommended

- When a patient presents with symptoms and signs of LUTD (especially UI) that are not typically 'SUI-S' or 'overactive bladder (wet) syndrome' or not (typical) nocturnal enuresis (syndrome).
- When a patient presents with new or persisting symptoms and signs of LUTD after initial (or subsequent) management or when a patient, after initial management expresses the wish for alternative (and/or more invasive and/or irreversible) management.

IV. STRESS URINARY INCONTINENCE SYNDROME

1. URETHRAL PRESSURES AND SEVERITY OF STRESS URINARY INCONTINENCE

1.1. Recommendations 2013

Various studies have shown a weak association between UI severity and urethral function tests (LPPs and urethral closure pressures) and cohort studies have shown that UI volume and intravesical volume at leakages are poorly associated with symptoms' severity and/or with patients' quality of life. Furthermore, ICI2013 concluded that studies have shown that ure-

thral function tests (LPPs and urethral closure pressures) are of very little value in predicting the outcome of treatment with suburethral tapes. Studies to demonstrate any relevance of urethral function tests (LPP and urethral closure pressures) in predicting the outcome of non-surgical or other treatments for SUI-S are lacking.

The ICI2013 recommended (grade C) that urethral function measurements of LPPs and urethral closure pressures are not used as a single factor to grade the severity of UI and therefore did not recommend the use of contemporary urethral function tests for prediction the outcome of any surgical treatment for SUI-S.

1.2. New Evidence 2016

A new study published showed, validating the earlier evidence, that urethral pressure and/or LPP did not have a predictive value towards outcome after 6 months of TVT surgery, apart from the 6% patients with very low urethral pressures (<20cmH₂O).⁹¹

Two expert opinion reviews have discussed the lack of evidence specifically for the management of patients with very low urethral, (leak point or closure) pressures and both have concluded that the many possible surgical solutions do not differ very much in outcome.^{92 93}

1.3. Recommendation (Grade C)

The committee does recommend that LPP and urethral closure pressures are not used as a single factor to grade the severity of UI

The committee does not recommend the use of contemporary urethral function tests for prediction the outcome of any surgical treatment for SUI-S.

2. ASPECTS OF URODYNAMIC STUDIES RELEVANT TO THERAPY FOR STRESS URINARY INCONTINENCE

2.1. Conclusion and Recommendations 2013

ICI2013 reported that it has been concluded in a model study, based on a selected retrospective cohort that UDS is not cost effective in the *primary* health care setting for women with predominant SUI-S symptoms. The model demonstrated however also, that in a *referred* population UDS is the most accurate way to obtain an objective diagnosis in an individual patient with UI symptoms. The ICI2013 summarized that it has been concluded in retrospective and prospective cohort studies that symptoms of 'pure SUI' do not exclude other LUTD.

2.2. New Evidence 2016

Mixed UI has repeatedly been shown to have a poorer outcome than SUI-S alone in surgical trials.⁹⁴

Despite this in one study OAB-S symptoms were reported to be more likely to improve rather than deteriorate after TVT in one study.⁹⁵ However 'de novo' OAB-S symptoms were reported to arise in another.⁹⁶ A study found in follow up of 200 patients after 10 years that persisting or new onset OAB-S is an important reason for dissatisfaction.⁹⁷

The question is whether there is any role in predicting outcome other than differentiating mixed from pure USUI. Detrusor opening pressures have been investigated in outcome for colposuspension and fascial slings and found not to help⁹⁸ whereas another study⁹⁹ suggested opening pressures were predictive of outcome of retropubic tape surgery. These findings were supported by a further study the following year.¹⁰⁰ A recent systematic review asked the question 'does preoperative UDS improve outcomes of women undergoing surgery for SUI-S?'¹⁰¹ This review was importantly influenced by the VALUE study and concluded that the current evidence suggests that UDS does not influence the outcome of SUI-S surgery. The review supported the need for new properly constructed RCT's for this. They highlighted the results of the VALUE study where, in a non-inferiority design, 93% of the 630 patients underwent surgery.⁴ They did demonstrate that 18 patients had the choice of surgery changed based on UDS, although the protocol -design intended to omit the UDS results. A second study was again a non-inferiority design looking expressly at where the UDS findings were discordant with symptoms including 578 patients of which 268 were discordant. 126 women were randomised to surgery direct or individual tailored therapy.⁶ A further secondary analysis of the women VALUE study concluded that UDS did significantly change clinical diagnosis but that UDS -as was planned- infrequently changed treatment plan or influenced surgical decisions.¹⁰² This position has been further evaluated by the INVESTIGATE 1 study.¹⁰³ This study was designed to demonstrate the feasibility of a RCT into the role of UDS for patients with SUI-S. The investigators concluded such a trial was feasible and their pilot data indicated that there was a change in practice based on UDS with 80% versus 95% undergoing surgery. The study wasn't powered to demonstrate significance and the authors concluded that 450 patients would be needed in each arm to answer the question, which is more than the 2 (prospective) studies which have reported to date.

ICI2013 Initial assessment -committee has suggested 'a simplified accurate and reproducible system for anatomic changes and establishing the likelihood or presence of SUI' (p377-378: General recommendations in the female patient) as a research recommendation. In the absence of such system, to date, it is impossible to establish the need for UDS in a reliable manner. At present the predictive value of a clinical diagnosis towards the selection and the outcome of management are unknown. UDS can only be disputed (or discarded) as the gold standard when prospectively compared to its alternative; a (reproducible)systematically derived clinical assessment or

a well-defined 'stress urinary incontinence syndrome', and/or a precisely defined 'urgency urinary incontinence syndrome' (or 'overactive bladder –wet syndrome').

2.3. Recommendation (Level B)

The committee recommends that UDS is kept in mind when discussing costs (risks, harm) and benefit (objectivity of the diagnosis) of the various methods (clinical or UDS) of diagnosis for (LUTD and/or) UI, in relation to the method of treatment.

3. PREDICTION OF FAILURE OF SURGERY

3.1. Recommendations 2013

ICI2013 found that LPPs are reported not to correlate with failure (or success) rates of colposuspensions, transobturator and retropubic suburethral, bone-anchored suburethral slings and that there is conflicting evidence that low urethral closure pressures are associated with poorer success rates of sub-urethral slings. The ICI2013 recommended that measurements of urethral function (LPP and urethral closure pressures) are not used to predict the likelihood of success after surgical treatment for women with uncomplicated primary SUI-S.

3.2. New Evidence 2016

ICI2016 did not find any new evidence. The committee, however, reviewed some studies that commented on the new onset or persistence of OAB-S in women with mixed symptoms of UI. An extensive review of the outcome of all little invasive surgical techniques after minimal 2 years showed that 'storage LUTS' and 'voiding LUTS' had an overall similar prevalence of about 15%.¹⁰⁴ A –very- long-time follow up study observed that the likelihood of being storage symptom- free declined steadily after each year until $\pm 30\%$ after 10 years, whereas voiding symptoms stabilised after the first year but further increased in prevalence after 6 years.¹⁰⁵

4. VOIDING DIFFICULTIES AFTER SURGERY

4.1. Recommendations 2013

ICI2013 concluded that female voiding dysfunction has been defined in many ways throughout the many publications, with consistency in UDS criteria- and analysis lacking. ICI2013 also concluded that test methods have been unable to reliably predict which patients will develop voiding difficulties after surgery for SUI. In particular, normal UDS do not predict absence of voiding difficulties after sub-urethral tape. However, it was found that flow rates, if abnormal, may be useful in predicting post-operative voiding dysfunction and retention following retropubic and

transobturator suburethral slings. ICI2013 recommended that patients are informed that it is difficult to predict who will develop voiding difficulty following surgery for SUI and recommended that patients with poor flow rates before (intended) surgery are informed that they have a higher likelihood of having voiding problems following suburethral tape placement for USUI.

4.2. New Evidence 2016

A review has confirmed the ICI2013 conclusions.¹⁰⁶

5. POSTOPERATIVE URGENCY, MIXED SYMPTOMS OF INCONTINENCE, OR OVERACTIVE BLADDER SYNDROME

5.1. Recommendations 2013

The prospective studies that were available at ICI2013 indicated that OAB-S, mixed symptoms of UI and/or DO during UDS at presentation have a negative effect on the outcome of (all available) surgical interventions for SUI-S. ICI2013 concluded that test methods have been unable to reliably predict which patients will develop de-novo urinary urgency (OAB-S) after surgery for SUI-S. Post hoc evidence suggests that procedures for the treatment of SUI-S which are more 'obstructing' produce a higher chance of de novo urinary urgency (OAB-S).

The ICI2013 recommended (grade B) that patients with SUI-S are informed that the chance of developing urinary urgency (OAB-S) following surgery is unpredictable and recommended also that patients are counselled before surgical intervention regarding the possibility of a lesser success rate when OAB-S and/or (UDS) signs of DO (or reduced compliance and/or cystometric capacity) exist.

5.2. New Evidence 2016

A new study showed that also patients with 'obvious' symptoms of SUI-S may have DO, and that these patients are successfully managed without surgery.¹⁰⁷ Another recent study demonstrated that when TVT-O was done only in patients with USUI without (UDS-) DO the cure rate after 10 years was markedly higher (95%) than the usual reported $\pm 75-80\%$.¹⁰⁸

6. THE ROLE OF URODYNAMIC STUDIES IN PREDICTING URINARY INCONTINENCE IN WOMEN AFTER

SURGICAL MANAGEMENT OF PELVIC ORGAN PROLAPSE

6.1. Recommendations 2013

Various studies summarized for ICI2013 have shown that symptoms of SUI can appear after surgery for POP. A variety of methods to uncover 'occult stress urinary incontinence' in women with POP had been reported and in prospective studies it has been demonstrated that all have different sensitivities and specificities. Standardisation of these tests was considered necessary. The ICI2013 recommended that patients with POP are informed about the relatively unpredictable chance of developing SUI after surgery for POP.

6.2. New evidence 2016

Two recent studies added to the body of evidence regarding the unpredictability of SUI after POP repair.^{109 110} A systematic review found that voiding problems were more incident after combined and/or preventative surgery.¹¹¹

6.3. Conclusions (Level 2-3)

Prospective studies showed that cystometry does not predict outcome of suburethral tape surgery (continence or not) when patients are selected for surgical intervention on the basis of the 'clinical diagnosis' SUI.

UDS is referred to as the gold standard for the diagnosis of LUTD in all teaching books. (level 1) However it is yet not precisely determined in which type of patients a urodynamic diagnosis ('above' clinical diagnosis) is needed for long term -effective and safe management.

Specific reproducible and uniformly agreed upon criteria for clinical diagnosis of SUI are not available, also not specific criteria for complex or complicated SUI.

6.4. Discussion

Earlier consultations have recommended UDS for all patients with symptoms of SUI. Based on the recent trials' conclusions, but also already without or before the publication of those trials many patients underwent suburethral tape surgery for diagnosis of SUI established on the basis of signs and symptoms. Systematically collected long term follow up is scarce, difficult, because of patients lost and the now available publications usually report single centre expert outcomes. Nevertheless, there is also not much -epidemiological- evidence that the management of patients with 'clinical uncomplicated SUI' without UDS is very risky. It should be borne in mind however that the recruitment rate for the published trials evaluating the need of UDS, notably, in the expert centres, has been fairly low. This seems to allow the interpretation that the incidence of patients with 'uncomplicated SUI' has been relatively low and that a large percentage of

patients with the complaint of UI, or with SUI symptoms plus other LUT-symptoms, signs and or (complicating) factors, deserves UDS.

6.5. Recommendations (Grade 2)

- The committee recommends to consider to manage a patient with SUI-S without UDS diagnosis, and to individually discuss the likelihood of success and or the possibility of side effects or failure of surgical management (with suburethral tape) based on the available clinical diagnosis.
- The committee recommends to consider to manage a patient with SUI-S not without UDS diagnosis when clinical signs of not typical or not uncomplicated or complex SUI exist.
- The committee recommends to consider to include the complete and systematically gathered results of UDS in the management plan for patients with SUI-S when UDS is done.

V. URGENCY URINARY INCONTINENCE AND OVERACTIVE BLADDER SYNDROME

1. FREQUENT VOIDING AND URGENCY; OVERACTIVE BLADDER SYNDROME

1.1. Recommendations 2013

Studies have not been able to show a strong association between OAB-S and DO. Various studies have directly or indirectly concluded that the individual prediction of the response to treatment for OAB-S, on the basis of the characterization or quantification of DO during UDS, is impossible. The ICI2013 recommended (Grade B/C) that investigators and clinicians discuss with patients with DO that neither the quantity nor specific characteristics of DO predicts the response to any of the therapeutic approaches.

1.2. New evidence 2016

A single centre retrospective study with good power confirmed the lack of association between subjective symptom severity and bother and objective measurements reinforcing the need for objective assessment, especially in proof of principle studies. However, it was also observed that UDS cystometric capacity, compliance as well as onset of first contraction were associated with perceived severity of symptoms.¹¹² Another well powered multicentre study demonstrated that subjective symptom assessment for women with LUTS was not reliable to uncover the pathophysiology that caused the symptoms.¹¹³

1.3. Recommendation (Grade B)

- The committee recommended that investigators and clinicians discuss with patients with OAB-S that neither the quantity nor specific characteristics of OAB-S predicts the response to any of the therapeutic approaches.
- The committee recommended that investigators and clinicians discuss with patients with OAB-S that when UDS is performed neither the quantity nor specific characteristics of DO predicts the response to any of the therapeutic approaches, but that the absence of DO is relevant for further management.

VI. URGENCY URINARY INCONTINENCE

1. RECOMMENDATIONS FOR URODYNAMIC DIAGNOSIS IN WOMEN WITH URINARY INCONTINENCE

1.1. Recommendations 2013

The ICI2013 recommended non-invasive UDS (voiding and UI diary, PVR, and possibly uroflowmetry) for all patients with UI and suggested that non-invasive and simply reversible treatment based on symptoms and signs is offered in situations where one of the two types of UI is likely to exist, without invasive UDS, if the patient accepts the uncertainty margins of the diagnosis and there is no symptom or sign for coexisting dysfunctions or complicating factors. The ICI2013 provided the following examples:

- Uncomplicated symptoms of SUI with normal bladder diary, normal uroflowmetry and without relevant PVR. (Symptomatic pure SUI with no symptoms or signs of voiding difficulties), for treatment with pelvic floor muscle training.
- Uncomplicated symptoms of UUI or OAB-S, with a bladder diary in accordance with these symptoms, with normal uroflowmetry and without relevant PVR. (Symptomatic pure UUI with no symptoms or signs of voiding difficulties), for treatment by bladder training with or without combined pharmacotherapy.

The ICI2013 has recommended that, whenever surgical intervention is planned, whenever there is doubt about the pathophysiology, or about whether the UI is uncomplicated or not, that invasive UDS should be performed in order to provide the knowledge on which rational treatment decisions and prognosis can be based. The ICI2013 also recommended UDS for patients that have had failed first therapies. The investi-

gation should be tailored to the individual patient; typically, this means that it will be a comprehensive examination of multiple aspects of storage and voiding function, and not just of the UI itself.

1.2. New Evidence 2016

New studies have attempted to better define the role of clinical diagnosis in women with (predominant) symptoms and signs of SUI^{4 6} but have regrettably not been very generalizable (or reproducible) because of little standardisation in both experimental arms (clinical diagnosis as well as UDS), because of preselection (inclusion) and also because of crossing over within the trial.

1.3. Recommendations (Grade B)

- The committee recommends that that invasive UDS should be considered for women with SUI-S or in order to provide the knowledge on which rational treatment decisions can be based.
- The committee recommends to perform UDS whenever there is doubt about the pathophysiology causing (UI, the SUI-S or) the LUTS, whether the UI is uncomplicated or not.
- The recommendeds UDS for patients that have had failed first (pragmatic) therapy.
- The recommendeds (complete, standard) UDS for women that have LUTS and or UI and representative ineffective voiding (significant PVR) and or reduced flow rate.

VII. PATIENT EVALUATION: MEN

1. URODYNAMIC TESTING OF MEN WITH SYMPTOMS AND SIGNS OF LOWER URINARY TRACT DYSFUNCTION

1.1. UDS for Male LUTS and / or UI

1.2. Conclusions and Recommendations 2013

Epidemiologic studies have shown that LUTS in men >50 years of age are highly prevalent and that storage LUTS are relatively more reported than voiding or post-micturition symptoms. Case series available at ICI2013 indicate that in male patients, OAB-S -wet is associated with (a UDS diagnosis of) DO. OAB-S dry might involve other LUTD or be the result of obstructed and/or ineffective voiding. Guidelines at that time suggested that the initial treatment for male LUTS could be based on the predominant symptoms, without UDS and recommend, on the basis of expert opinion, UDS when the initial management fails to resolve the storage LUTS.

Various studies indicate that male LUTS including UI may be due to detrusor dysfunction and/or BOO and that DO and urethral sphincter dysfunction should also be considered in young men with LUTS or in men with a small prostate. Mono and multi-centre cohorts show that although UDS do not unequivocally predict outcomes of pharmacological or surgical treatment, treatment results are, however shown to be better predicted in patients who have had objective UDS and objective evidence of BOO. ICI2013 recommended (grade C) that all elderly male patients with UI should receive a complete UDS when conservative measures fail, to understand the problem.

1.3. New Evidence 2016

OAB-S and LUTS associated with prostate enlargement and BOO in men increase with age.^{114 115} Coexistence of UI in men with BOO and DO increases with age and with the degree of BOO.¹¹⁶ In addition to BOO associated UI, other pathological conditions such as nocturnal enuresis and post-micturition dribble are also clinically relevant in men.¹¹⁷ Evaluation for men with LUTS and UI starts with symptoms assessment,¹¹⁸ further discussed in the diagnosis chapter of this book. The best independent predictors of USUI, apart from clinical history were the patient's age and the ICIQ-UI-SF.¹¹⁹ ICI questionnaire and 3-day bladder diary have been shown to be valid, reliable, and responsive to change.¹²⁰ Non-invasive investigations such as uroflowmetry and measurement of PVR are easy to perform but cannot distinguish BOO from DU.^{121 122}

Surgical intervention, to relieve BOO and associated LUTS, based on UDS diagnosis of outflow obstruction resulted in an improvement of flow rate and reduction of symptoms.¹²³ Preoperative UDS diagnosis of DO is associated with significantly more storage symptoms than the patient without DO.¹²⁴ Multivariate analysis revealed that a low MUCP at baseline UDS was the independent predictor of de novo UI after HoLEP (laser prostate enucleation) for BPH-BOO.¹²⁵ In an expert group discussion, it was concluded that UDS is indicated for proof of principle and for the evaluation of effectiveness of new treatment modalities for elderly male patients.¹²⁶

DO can be characterized as phasic DO and terminal DO. Phasic DO has been reported to occur more frequently in young individuals with OAB-S.¹²⁷ For patients with OAB-S without response on empirical treatment, UDS can provide definite information that can identify associated pathologies and/or alter the treatment course.¹²⁸ Clinically, video-UDS or UDS had also been used to evaluate the (continence) function of the (intracorporeally reconstructed orthotopic) U-shape ileal neobladder,¹²⁹ and the Studer orthotopic ileal neobladder,¹³⁰ or investigation of pouch UI. The functional length, static and dynamic closure pressure and pouch capacity.¹³¹

A retrospective study of UDS involving men with OAB-S (with or without UI) revealed that 43% of men with OAB-S had evidence of BOO. There was weak

correlation between (OAB-S) symptoms and UDS findings, underscoring the relevance of UDS.¹³² An assessment of UDS patterns in post stroke UI found UDS patterns vary depending on timing of the study, suggesting spontaneous changes, and the relevance of UDS-timing, but also test retest variability.¹³³

Although there has been no definite definition of reduced and increased bladder sensation (which may be associated with OAB-S), it was considered helpful in one single centre study when reduced bladder sensation was defined as a bladder volume at first sensation >300 mL and increased bladder sensation as bladder volume at the first sensation <100 mL.¹³⁴

Retrograde LPP has been introduced to test the tightness of virtue quadratic sling for post RRP UI while prepubic tensioning, and after transobturator and prepubic arms were secured in place.¹³⁵ The efficacy and clinical application of current urethral function tests were however recently also discussed by the ICI-RS and this committee reported that each of the methods currently in use has limitations as to its use and proof of reliability.¹³⁶

Ambulatory UDS is sensitive for the detection of DO, however prone to artefacts and time consuming. Nevertheless, the method is considered valuable by some experts when all other diagnostic means have failed.¹³⁷ This was demonstrated in patients with suspected detrusor acontractility on UDS and UI of unclear origin; however, the UDS graphs with this manuscript do also show significant technical flaws.¹³⁸ Ambulatory UDS has been shown reliable for the reproduction of the main UDS parameters in patients with NLUTD-S, except for the end filling detrusor pressure.¹³⁹

1.4. Conclusions

UDS for (elderly) men with LUTS has demonstrated relevance for the diagnosis of bladder sensation, and volume adaptation (bladder compliance and detrusor relaxation) it has also demonstrated relevance in the quantification of BOO.

UDS is in all guidelines referred to as the gold standard test to evaluate men with signs and symptoms of LUTD.

Most elderly men who present with OAB-S have voiding symptoms also and a consistently reported large percentage has – UDS - evidence of BOO.

BOO, DO, reduced cystometric capacity, PVR and/or DU can occur in any combination per individual, independent of the symptoms presented, and can all be quantified on the basis of UDS.

Specific evidence that UDS improves outcome is limited, and pragmatic or 'symptom oriented' management is demonstrated to be very well possible in many men. Nevertheless, UDS is the basis for therapy when it is desired to be directly aimed at the pathophysiology that is responsible for the symptoms if the patient and/or the physician consider that relevant.

1.5. Recommendations (Grade C)

- The committee recommends invasive UDS for a patient for which objective elucidation of the pathophysiology of the LUTD is deemed relevant.
- In general, this shall be relevant when invasive management is considered. But it may also be relevant in relatively symptomatic men with relatively young age and/or relatively small prostates and/or relatively good flow rates and/or with relatively large volume of PVR, when initial management fails.
- The committee recommends invasive UDS for patients that have experienced failure of surgery for LUTS.

2. LUTS AND OAB-S IN MALE PATIENTS

2.1. Conclusions and Recommendations 2013

ICI2013 concluded that symptoms and signs of “new onset” UI or nocturnal enuresis in men are unspecific with regard to the underlying dysfunction, also when large PVR or retention are excluded and recommended UDS of men with symptoms and signs of UI.

2.2. New Evidence 2016

OAB-S symptoms (with or without UI) are highly prevalent in men and the prevalence increased with age.^{140 141} LUTS, believed to represent bladder storage (dys)function were more prevalent than voiding - symptoms or post-micturition –symptoms in men. The most prevalent LUTS was nocturia.^{142 143} A longitudinal study showed that OAB-S and UI symptom severity progresses over time.¹⁴⁴ The overall incidence of DO was 76% in male patients with OAB-S symptoms, 63% of men with urgency (OAB-S dry) had DO, while 93% of men with urgency and UI (OAB-S wet) had DO.^{145 146} Men who received invasive UDS were less likely to undergo surgery as treatment for LUTS.¹⁴⁷ Urethral closure pressure had a significant association with BOO and also micturition urethral pressure profilometry, but not with UI in men.¹⁴⁸ Most of patients with BPH and (urodynamically demonstrated) BOO have OAB-S which can be relieved after TURP, however, one study found that the presence of pre-operative terminal (end filling-) DO might be negatively associated with the improvement of OAB-S and or UI.¹⁴⁹ In patients who received vaporisation of the prostate for BPH-BOO, a study found the number of patients with moderate to severe storage LUTS decreased from 60% to 49% at week 6 to 12% at month 6 but DO has not been a predictor in this series.¹⁵⁰

UDS has been used to evaluate outcome of medical treatment for OAB-S in men and may demonstrate objective improved LUT function, or not. In a study including both genders, combined low and standard

dose tiroprium and solifenacin has shown to provide good clinical effects associated with UDS changes.¹⁵¹ On the other hand, in evaluation of the therapeutic efficacy of once daily tadalafil in men with LUTS, a randomized, placebo controlled 12-week clinical trial revealed that, although there had been a symptom response, no objective UDS changes were found. Especially no change in any of the relevant cystometric (DO) or pressure flow study parameters (BOO) was observed.¹⁵²

Systematic review of percutaneous tibial nerve stimulation (PTNS) concluded that PTNS has been efficacious for symptoms of frequency and/or UUI in most cohort studies.¹⁵³ 77% of participants with an initial positive response to 12 weekly PTNS treatments safely sustained symptoms improvement to 3 years with an average of 1 treatment per month.¹⁵⁴ PTNS treatment also leads to improvement in open label uncontrolled studies patients with multiple sclerosis¹⁵⁵ which was observed to persist for one year in one recent study.¹⁵⁶ A review shows that UDS proof of (PTNS-) effects is observed (evaluated) in a very limited number of studies and patients and has demonstrated some improvement of cystometric capacity and occasionally reduction of DO.¹⁵⁷

In a systematic review of the mean outcomes for the use of BoNT-A in the management of LUTD it was shown that the cystometric capacity increased 60% and maximum filling phase pressures reduced by 40%, with its clinical relevance demonstrated in voiding (emptying) diary parameters.¹⁵⁸

EAU guideline advised initial treatment of LUTS and OAB-S is conservative and of empirical nature, including lifestyle interventions, physiotherapy, physical therapy, pharmacotherapy.¹⁵⁹

AUA/SUFU guideline for diagnosis and treatment of non-neurogenic OAB-S in adults has provided expert opinion supplement from the 2012 original version to 2015 version with recommendations for refractory OAB-S¹⁶⁰ however with an undefined role of UDS, and with ambiguous definitions of ‘treatment resistance’.¹⁶¹

2.3. Conclusions

LUTS in men >50 years of age are highly prevalent and storage LUTS are frequently reported. In male patients, OAB-S wet symptoms are associated with DO. UI in elderly male may be due to DU /urinary retention and/or BOO.

UDS has been demonstrated to be able to differentiate storage dysfunction (DO reduced compliance) and outflow dysfunction (bladder neck obstruction, DU and BOO) or combinations of these, in men with LUTS.

LUTS –storage symptoms, with or without (U)UI, diminished gradually over time after vaporisation of the prostate. Patients with preoperative terminal DO might have lesser rapid improvement of OAB-S symptoms after TURP.

Epidemiology shows that non- urologic causes for nocturia are prevalent and nocturnal polyuria can be diagnosed with a 24 h frequency-volume chart.

UDS in elderly men indicate however that DO and BOO with ineffective voiding may play a role in a proportion of patients with nocturnal enuresis and or UI.

UDS has shown that use of a phosphodiesterase inhibitor initiates no objective changes of the LUT function in men, although it does affect symptoms.

New onset, night time UI, in an elderly male, warrants urgent urodynamic pressure-flow analysis.

2.4. Recommendations 2016

- The committee recommends UDS for objective diagnosis of male LUT function, especially in elderly men with UI or in (young) men with LUTS and relatively small prostates not responding to management or medical treatment based on clinical examination.
- The committee recommends to consider UDS for objective diagnosis of LUT function in men with prostate enlargement to ensure specific management of the dysfunction causing the LUTS.

3. URINARY INCONTINENCE AFTER TRANSURETHRAL RESECTION OF THE PROSTATE AND OPEN PROSTATECTOMY FOR BENIGN DISEASE

3.1. Conclusions and Recommendations 2013

Case series have concluded that UI after prostatectomy may be attributed to bladder storage dysfunction and can exist in association with (neo-bladder neck) BOO although the most prevalent cause is sphincteric dysfunction. Retrospective studies have shown that UDS cannot predict which patient will develop SUI or DO (with or without UUI) after surgical treatment for prostatic BOO. Studies have shown that UDS can identify the aetiology(ies) of UI (or other LUTD) after surgical treatment for prostatic BOO, however the predictive value for the outcome of subsequent treatment is unknown. Good evidence shows that more than 90% of post prostatectomy UI is SUI, with or without co-existing LUT dysfunction.

The ICI2013 recommended (grade C) to consider UDS for the diagnosis of concomitant LUT dysfunction in patients with clinical stress UI after prostatectomy, but especially if further surgical or invasive treatment is considered. The ICI2013 committee also recommended definition of UDS cystometric capacity (technique, 'end of filling' and evaluation) specific for patients with post prostatectomy UI.

3.2. New Evidence 2016

The most common aetiology of UI after surgery for BPH-BOO was sphincter weakness or deficiency, followed by sphincter weakness plus DO, reduced compliance alone.^{162 163} Approximately 1% of patients who have undergone TURP or laser TURP suffer from UI.^{164 165} Kuo urodynamically evaluated 185 men aged from 55 to 91 years who had variable LUTS after TURP and found that UI was present in 74 patients (40%), BOO and DO with DU were the most common findings associated with UI, followed by DO.¹⁶⁶ UDS in UI showed no significant change in filling or voiding parameters when suburethral male-slings were implanted.¹⁶⁷

3.3. Conclusions 2016

Many case series show that sphincter weakness is the most common aetiology of male UI after prostatectomy (TURP). However, case series and reviews show that other LUTD besides sphincter incompetence play an incident role in post prostatectomy UI.

Case cohorts show conflicting evidence whether DO before prostatectomy is an important indicator for the postoperative persisting incidence of UI, or for the outcome of interventions to treat the UI.

3.4. Recommendations

- The committee recommends UDS when elderly male patients have persisting LUTS and/or UI after surgical treatment for prostatic BOO if further surgical or invasive treatment is planned.

4. (ROBOT ASSISTED) RETROPUBLIC RADICAL PROSTATECTOMY

4.1. Conclusions and Recommendations 2013

Case series and reviews show that the main cause of UI after RRP is sphincter weakness and that DO contributes in only a small proportion of those patients and show also that higher maximal urethral closure pressures or abdominal LPPs, indicating greater urethral sphincter resistance is not of utmost clinical relevance. UI after RRP will improve with time. A study concluded that postoperative urethral pressure profile after 6 months may be predictive for persistent UI. The ICI2013 recognised that UDS for UI after RRP is not particularly important for the diagnosis of sphincter dysfunction (SUI) in patients with post RRP UI. However, the ICI2013 recommended that UDS is considered in patients where other dysfunctions of the LUT (obstructed voiding, significantly reduced bladder compliance and/or DO) cannot be excluded on the basis of signs and symptoms.

4.2. New Evidence 2016

UI after retropubic (robotic assisted) radical prostatectomy (RRP) is prevalent despite improvement in surgical techniques. Changes of the detrusor and

urethral function after RRP deserve attention to improve continence. Approximately 10-14% of patients, suffer UI 2-5 years after RRP.¹⁶⁸ UI after brachytherapy was reported by 4 to 6% of patients at 1 to 2 years after treatment.¹⁶⁹ Comparative studies indicate that UI is the most common adverse effect of RRP.¹⁷⁰ Preoperative DO was not associated with worse post RRP UI outcomes, or increased incidence of UI. Single centre observations suggest that even if DO is present in men with USUI after RRP they may be considered for a male sling procedure.¹⁷¹ After RRP, Q_{max} was reported to increase, and detrusor voiding pressure and the urethral resistance factor to decrease significantly. In univariate analysis, DO was found in 34% of patients who were still incontinent 6 months postoperatively and only in 5% of patients who were not.¹⁷² After RRP, the functional profile length (FPL) decreased by 64%, because the prostate was removed, but also maximum urethral closure pressure (MUCP) decreased by 41% on average. Non-nerve sparing technique was a prognostic factor for a higher relative decrease of MUCP after RRP.¹⁷³ UDS can identify aetiologies of post RRP UI such as sphincter weakness. Neo bladder neck outflow obstruction, DO and mixed symptoms of UI may also be contributing to post RRP UI.¹⁷⁴ UDS parameters change after RRP by reducing BOO without affecting overall detrusor contractility. Urinary continence rates were gradually improved to a satisfactory level in more than 80% of patients by 12 months after RRP.¹⁷⁵ DU is relatively common in patients with post RRP UI, 40% of patients demonstrating an isovolumetric detrusor pressure of <50 cmH₂O.¹⁷⁶ Although DU was found in 49% of patients preoperatively, DU did not affect UDS parameters and LUTS improvement after RRP.¹⁷⁷ Another large cohort study also demonstrated DU and Valsalva voiding was observed in 41% of patients after RRP, which might reduce (longer term) success of treatment for post RRP UI.¹⁷⁸ In a longitudinal observational cohort study, patients with bladder neck contracture after RRP presented with preoperative DU.¹⁷⁹

Urethral sphincter insufficiency was the most common UDS abnormality after RRP (88%), followed by DO, neo bladder neck obstruction, impaired detrusor contractility, and normal findings.¹⁸⁰ Co-existing detrusor dysfunction had to be taken into consideration, as well as intrinsic sphincter deficiency, in order to properly treat persistent post RRP UI^{181 182} but also postoperative UPP after 6 months may be predictive for persistent UI.¹⁸³ The abdominal LPP was considered a relatively poor predictor of UI severity and, therefore, is reported to have limited value in the UDS evaluation of post RRP UI.¹⁸⁴

Preoperative UDS may help to estimate the likelihood of postoperative UI^{185 186 187} although it remains undetermined how to clinically implement this knowledge.¹⁸⁸ In robot-assisted RRP series, the outcomes of continence rate improved from 75% to 93% for cases 501-700, suggesting that surgeons experience is relevant (or 'confounding' UDS evaluations).¹⁸⁹ The role of UDS on predicting continence

outcome after RRP remains controversial. Small cohort studies drew different conclusions that preoperative UD DO may have influence on post RRP UI.¹⁹⁰ Investigation before and after RRP revealed 25% of patients had DO in associated with decreased bladder compliance, diminished FPL and MUCP after operation, 22% of patients had detrusor hypoactivity.¹⁹² Nerve sparing (NS) RRP significantly affected urine loss immediately after RRP compared with non-NS surgery.

Increased urine loss immediately after RRP was noted in 86% of patients, which could be attributable to decreased MUCP and abdominal LPP.¹⁹³ In addition to a lower MUCP, a reduced bladder compliance was shown in 27% and idiopathic DO in 31% of patients with post RRP UI.¹⁹⁴ Chronological UDS of patients with UI after RRP revealed that LUT worsens immediately after RRP and recovers over time.¹⁹⁵ In one small cohort study, 21% of patients had UI at 1 year after RRP. Bladder compliance <28 ml/cmH₂O, MUCP <50 cmH₂O and BOO are reported to be independent UDS factors correlating with UI after RRP.¹⁹⁶

The aetiology of UI following RRP, either stress or UUI, also cannot be predicted by the ICIQ-UI-SF survey.¹⁹⁷ UDS have been done to demonstrate the UI in many reports but also recently, to better show the detrusor storage function, mimicking the situation after AUS placement (and preventing incontinence during cystometry). In practice, this may be more relevant than the demonstration of UI in patients with post RRP UI.¹⁹⁸

In patients receiving radiotherapy for prostatic cancer, patients with larger prostatic volumes (> 35 mL) and/or with UDS confirmed BOO were more prone to problems after brachytherapy.¹⁹⁹ A high PVR (> 100 mL) is associated with slower resolution of voiding symptoms, prolonged (more than 3 days) catheter dependency, and increased post-brachytherapy surgical intervention for BOO.²⁰⁰ Men after brachytherapy were, in a single centre retrospective cohort, reported to have a relatively high incidence of DO, prostatic and urethral strictures and prostatic urethral stones.²⁰¹ Compared to patients with prostate cancer receiving RRP, high dose external beam radiation therapy and brachytherapy iodine implantation as monotherapy had a better rate of urinary continence and sexual function however more bowel and urinary irritation.²⁰²

UDS prior to AUS implantation revealed that DO was much more prevalent in the group with radiation (26%) than in group without radiation (5%). Post-operative urinary urgency with or without UUI was found in similar proportions of the 2 groups, suggesting that pre-operative DO did not predict outcome in this group.²⁰³ Patients with post RRP UI, with adverse UDS findings such as DO, low compliance, low detrusor contractility, or decreased cystometric capacity and first sensation of filling were reported to have similar outcomes after AUS implantation to those just with USUI.^{204 205} The presence of LUTD was also not predictive

of surgical outcome in one other series and preoperative use of few pads, less severe post RPP UI, and a longer interval between RRP and post RPP UI surgery were associated with a successful outcome.²⁰⁶ Patients with postoperative retrograde LPP < 50 cm H₂O and DO were however seen to be associated with failure in another series.²⁰⁷ The transobturator -tape for treatment of post RPP UI was shown to be effective with an improved mean MUCP and high cure rate.²⁰⁸ UDS after a bulbourethral composite suspension revealed a significant increase of MUCP (40 v 58 cmH₂O), and functional urethral length (31 v 40 mm), the Q_{max} was slightly reduced (16 v 12 ml/s); however pressure flow study was reported to show not obstructive voiding in all patients.²⁰⁹ A functional pelvic cine-MRI study in patients with a bulbourethral composite suspension revealed that this procedure was associated with an increase in urethral length, urethral coaptation zone and bladder neck elevation, implying a non-compressive mode of action. However, no difference on imaging was noted between patients showing clinical success or failure.^{210 211} Using the Argus T adjustable system for treatment of post RPP UI, at 30 month follow-up 88% of patients were dry or improved. The retrograde LPP increased from 18 to 35 cmH₂O after intraoperative adjustment. Transient inguinal or perineal pain was reported by 61% of patients and postoperative infection occurred in 6%.²¹² The overall cure rate for the AdVance and AdVanceXP transobturator male sling was reported to be 80%. This procedure was safe and efficient in patients with mild UI after RRP.²¹³ Using an Advance transobturator male sling for post RRP UI, among 38 patients 28 (74%) reported successful 3 months after operation. A small cystometric capacity was reported to have potential impact on the success of the procedure.²¹⁴ Patients with a preoperative Valsalva LPP of >100 cmH₂O have a high degree of predictability for success for AdVance sling procedure.²¹⁵ Among 35 patients who underwent AUS implantation for post RPP UI, 16 (46%) had postoperative urinary retention requiring CIC but this resolved within 7 days with no reported effect on continence outcome.²¹⁶ A cadaver model demonstrated that a tandem cuff as such did not improve retrograde LPP, but that proximal bulbar urethral circumference was greater than distal circumference and therefore the addition of a more proximal cuff was improving efficacy.²¹⁷ In men who failed to demonstrate incontinence during intubated UDS prior to AUS placement for post RRP UI a high rate of anastomosis stricture (and history of radiotherapy treatment) was observed, but anti-incontinence outcome for these was not affected by this.²¹⁸ However, another study showed, although transobturator male sling provides good continence outcomes for post RPP UI on average, previous pelvic irradiation seems to compromise the effectiveness of the procedure.²¹⁹ Volume adjustable balloons implantation was used to treat post RPP UI with a success rate of 37/49 (75%). A longer duration of UI, the use of >5 pads daily, and a small cystometric capacity predicted unsuccessful clinical outcome of this technique.²²⁰

4.3. 2016 Conclusions (Level 2-3)

The main cause of UI after RRP is sphincter weakness, but reduced compliance and DO with or without neo-bladderneck outflow obstruction contribute in an unknown proportion of those patients.

UDS have demonstrated value to identify the aetiology of LUTD after surgical or radiotherapy treatment of prostatic carcinoma.

Both urethral and detrusor (adaptation) function are prone to be affected after retropublic or RRP. Decreased bladder compliance, lower detrusor pressure during voiding, higher Q_{max}, and reduced maximal urethral closure pressure are noticeable immediately after RRP.

DU is commonly observed in patients with UI after RRP, and may be a risk factor for the development of neo- bladder neck (stricture).

Leak point pressures and urethral pressures, measured in their various ways, are consistently reported to be improved after anti -incontinence treatment using the various surgical techniques, and their improvement is associated with cure or reduction of UI volume and/or pads use.

Clinical indicators for reduced chance of success of post RPP UI -surgery are lesser amounts of urine loss, less pad use, and higher preoperative Valsalva LPP however precise action limits for these are not available.

Anastomosis stricture (may also prevent UI to be demonstrable during UDS), reduced compliance and DO as well as Valsalva voiding are urodynamic predictors of failure although with unknown specificity.

Retrograde LPP may be a good tool for adjustment of male sling tension to balance the resistance during post RPP UI -surgery.

Anti-incontinence male sling, composite suspension apparatus and AUS device have been shown good surgical outcome for post RRP UI.

4.4. Recommendations (Grade 3)

- This committee recommends that UDS should be performed when RRP UI has not spontaneously improved and conservative measures have failed.
- The committee recommends that UDS for patients with RRP UI is not only done to evaluate USUI but that it is also done specifically to evaluate bladder storage function. (Thus: to do cystometry with the prevention of early/massive leakage during the test and with filling until practically acceptable volumes, e.g. 3-400mL, to 'predict' the situation after regaining continence).

5. UDS FOR PATIENTS WITH POST (RADICAL) PROSTATECTOMY

URINARY INCONTINENCE AND PERSISTENT SYMPTOMS OF LOWER URINARY TRACT DYSFUNCTION AND OR FAILED SURGICAL MANAGEMENT

5.1. Conclusions and Recommendations 2013

ICI2013 concluded that studies LPPs and urethral pressures, measured in their various ways, are consistently reported to be improved after anti-incontinence treatment using different surgical techniques, and their improvement is associated with cure or reduction of UI volume and/or pad usage. Most single centre reports conclude that UDS variables, used to evaluate voiding, do not show clinically significant change after suburethral sling procedures or AUS implantation. The ICI2013 committee recognised (grade B) that UDS for UI after RRP is not particularly important for the diagnosis of sphincter dysfunction (SUI) in patients with post RRP UI but recommended that UDS is considered in patients where other dysfunctions of the LUT (BOO, valsalva voiding, significantly reduced bladder compliance and/or DO) cannot be excluded on the basis of signs and symptoms.

5.2. New Evidence 2016

Other dysfunction may be more prevalent in patients with persistence of LUTS and or UI after surgical management of their post RRP UI. The committee has however not found specific (new) evidence. Recent series and reviews have little or not elaborated on UDS evaluation for recurrent LUTD and or UI after RRP.^{221 222 223 224}

Recommendation

- The committee recommends that UDS is considered in patients with post RRP UI.
- The committee recommends UDS for patients with post RRP UI when co-existing dysfunctions of the LUT (neo bladder neck BOO, valsalva voiding, significantly reduced bladder compliance and/or DO) cannot be excluded on the basis of clinical history, e.g. radiotherapy, signs and/or non-invasive UDS and symptoms.

6. NEUROGENIC LOWER URINARY TRACT DYSFUNCTION

6.1. Recommendations 2013

The ICI2013 found expert agreement, on the basis of many case series, that UDS is of great relevance to establish the management and to achieve the best long term clinical outcome for patients with NLUTD and found also that VUDS is necessary when anatomical information is deemed clinically relevant.

ICI2013 concluded that case series have indicated that it is possible to monitor patients without anatomic abnormalities (absence of a high likelihood of VUR and or bladder diverticulae) of the LUT (especially adult age SCI and unaffected LUT function before the lesion) with cystometry and ultrasound of the UUT.

No specific reports about the optimal frequency and techniques of follow-up UDS in patients with NLUTD has been available at the time of ICI2013. No conclusive evidence exists about the predictive value for treatment with regard to ice-water testing, or of ambulatory monitoring of patients with NLUTD. Some evidence from centres of excellence indicates that 'one channel, cystometry' can be applicable in the monitoring (follow-up) of a selected group of patients with complete SCI.

The 2013 committee recommended that patients with signs and symptoms of LUTD and relevant neurological abnormalities should receive UDS (including filling and voiding cystometry) if initial treatment will be affected as a consequence of the diagnosis, or if 'simple' first line diagnosis and management have been unsuccessful.

This committee also recommended that at least at a baseline, to establish the state and function of the LUT in patients with NLUTD, VUDS evaluation is indicated if relevant anatomical abnormalities are to be expected.

The 2013 committee recommends that the frequency of testing and the techniques applied in the follow-up of patients with NLUTD be critically analysed and optimised, and recommended to develop guideline recommendations on the basis of those analyses. The committee recommended that UDS in patients with NLUTD be done with special attention to the specific needs of the patients. It is highly preferable that all professionals involved are specifically trained for that purpose.

6.2. New Evidence 2016

Any disturbance of the nervous system, can result in signs and symptoms of LUTD. The extent and location of the neurological dysfunction will determine the type of LUTD, which can be symptomatic or asymptomatic. Neuro-urological symptoms can cause a variety of long-term complications; the most significant being deterioration of renal function.²²⁵

Neurogenic lower urinary tract dysfunction applies to a spectrum of clinical conditions and refers to the presence of LUTD symptoms 'when there is a relevant neurological condition'.²²⁶ UDS can measure LUTD caused by a lesion in the brain and or spinal cord or peripheral nerves; associated with a congenital condition (e.g. MMC), an acquired, stable condition (e.g., stroke, SCI), or an acquired, progressive condition (e.g., multiple sclerosis [MS], Parkinson's disease, dementia).²²⁷ Because not all patients with neurogenic conditions develop LUTD or have abnormal UDS findings, a specific understanding of the dysfunction in each individual is a prerequisite for the

correct choice of therapy. The aim of the diagnostic tests is to describe the (dys)function of the bladder, the urethra and the pelvic floor, their coordination during filling and voiding and their influence on other conditions (e.g. autonomic dysreflexia) or organ systems (e.g. renal function). Patients with neurologic disease known to be associated with NLUTD should be evaluated for the presence of LUTD.²²⁸

6.3. Urodynamics in NLUTD

A lesion above the lumbosacral cord level (e.g., due to SCI or MS) is characterized by UI due to NDO and the loss in voluntary control of micturition, initially, in the spinal shock phase, leading to an areflexive bladder and urinary retention due to detrusor sphincter spasm.²³⁷ In the case of suprasacral lesion above the lumbosacral cord level, the patient will lose voluntary and supraspinal control of micturition, and this usually leads to NDO which is characterized by spinal reflex pathways mediated by formerly silent capsaicin-sensitive unmyelinated C fibres.²²⁹ In these cases, bladder contractions are poorly sustained and there is dyssynergia between the urethra and bladder.²³⁷

DO in association with neurological disease, may lead to UI. Observed during UDS, this type of UI is termed *neurogenic DOI*. The corresponding clinical sign or symptom is however variable: if the DO is accompanied by sensation (desire to void) it might be termed UUI; frequently however any sensation is absent, and so the term *urgency incontinence* is an incorrect description of the situation. For this reason, the term '*reflex incontinence*' was introduced by Abrams in 1988,²³⁰ implying uncontrolled but complete emptying of the bladder without sensation. However, this term is no longer recommended.²⁵⁴ NDO is often accompanied by DSD, which is a neurogenically determined failure of pontine coordination of detrusor and bladder outlet. In DSD the failure of the urethral sphincter and/or the pelvic floor to relax completely and sustained, when the detrusor contracts, causes a dynamic type of BOO which may not only prevent complete bladder emptying, but can also lead to chronic and/or intermittent high detrusor pressures observable with UDS. 'Overflow incontinence'²⁶³ is another term that is no longer recommended.²⁵⁴ It meant continuous or intermittent (-stress 'like') leakage from a constantly overdistended bladder.²⁶³ However, neither what constitutes 'overdistended' nor the cause of the leakage are defined by the term 'overflow incontinence'. The presenting symptom is usually characterised by small amounts of UI, exacerbated by increased abdominal pressure, together with an inability to empty the bladder by voiding. Whilst UI appears as a problem of LUT storage function, 'overflow incontinence' originates from a dysfunction of voiding. Overflow incontinence can exist in combination with BPE and BOO but also exists in conditions with relevant neurologic pathology. Incontinence due to neurogenic DU (or acontractility) or DSD, with incomplete emptying, and neurogenic in-

complete voiding with UI, are clinical (UDS) descriptions and have not been officially defined in the current standardization documents.

During UDS a frequent observation is low compliance and little or no detrusor activity until it reaches a pressure value sufficient to overcome urethral resistance and open the urethral sphincter with urine loss as the consequence. Clinically, this variable is usually reported as the detrusor LPP. If this pressure is elevated, and if similar pressures are attained during UI in daily life, then renal function is endangered because the constantly high detrusor pressure hinders outflow of urine from the ureters into the bladder. Conventionally, DLPP's of 40 cm H₂O or more are believed to increase the likelihood of UUT deterioration. There is evidence (mostly from paediatric studies with children with MMC) that UUT deterioration is more probable when DLPP is elevated above that 40cmH₂O.²³¹ However, the evidence for a cut-off at 40 cm H₂O seems less clear and an expert opinion appears to introduce 'as low as reasonably achievable' and a 'safe' detrusor pressure of below 20 cmH₂O, over the entire 'daily' volume range, when CIC is part of the treatment, is advised.²³²

Except in diseases where empirical, conservative therapy can safely be instituted (e.g. post-stroke or Parkinson's disease, some MS patients), UDS is usually deemed to be required, based on clinical practice guidelines and expert reviews. In the appropriate clinical setting, a neurological evaluation may be recommended in a patient with unexplained LUTS and no known neurological disturbance. This is particularly true in the case of a young patient with idiopathic LUTS after proper office evaluation for common aetiologies. Relevant investigations include; voiding diary, UDS (cystometry EMG, VUDS, uroflowmetry, pressure-flow study), diagnostic imaging with voiding cystourethrography and ultrasonography.

Urodynamics is advised to provide the understanding of the situation on which rational treatment must be based. UDS is the only method that can objectively assess the function and dysfunction of the LUT. In patients, with NLUTD, UDS may be more provocative than in patients without relevant neurology. Even when empirical therapy is instituted without UDS, experts usually agree that the patient must be carefully monitored to determine whether and when UDS is needed.^{227 233 234 235} UDS involve functional and dynamic assessment of the LUT and are used to assess detrusor and bladder outlet function.

In patients at risk for autonomic dysreflexia, it is advisable to immediately stop filling when this occurs, and it may be prudent to measure blood pressure during the UDS.²³⁶ The rectal ampulla should be empty of stool before the start of the investigation. All UDS findings must be reported in detail and performed according to ICS technical recommendations and standards.^{227 236 237}

A large proportion of patients with congenital neurological conditions show anatomical abnormalities that

involve the LUT, especially those born with abnormal neurology (MMC-see in children section of this chapter), and do have congenital relevant 'end organ (LUT)-sequelae' that can be demonstrated by imaging. VUDS is the test of choice usually advised on the basis of expert opinion when anatomic information is needed to establish treatment.²⁶⁸ VUDS combines a fluoroscopic voiding cystourethrogram with multi-channel UDS, allowing anatomic and functional assessment of the bladder and outlet. VUDS importance has been recently underlined by Marks et al who assessed that it should be considered in patients with neurologic findings or diseases as well as those with obstructed voiding, congenital genitourinary anomalies, or a history of genitourinary reconstruction.²³⁸

6.4. Special Tests

LUT function or dysfunction can be provoked by coughing, triggered voiding, or anal stretch. Fast-filling cystometry with cooled saline (the 'ice-water test') is sometimes used in an attempt to identify NDO or to demonstrate the integrity of the detrusor muscle function and/or its innervation.^{239 240} Patients develop a detrusor contraction reaction on cooling if the detrusor and/or the reflex pathway are intact. Patients with myogenic dysfunction or (iatrogenic) detrusor muscle damage, will not demonstrate contraction. Hüscher et al in their recent review assessed that the ice-water test is a reliable possibility to identify NDO subsequent to standard cystometry,²³ the clinical relevance of the ice-water test is however undetermined and in patients with high level SCI the test can aggravate autonomic dysreflexia.^{241 242}

A positive bethanechol test (detrusor contraction >25cmH₂O) was thought to indicate detrusor denervation hypersensitivity and the muscular integrity of an acontractile detrusor. However, in practice, the test has given inconclusive results.²⁴³

One channel cystometry is reported to be feasible and reliable in patients with complete SCI that do not generate much (abdominal or other) muscle activity below the lesion level. Intravesical pressure will reasonably adequate represent detrusor (relaxation or) activity and allow cystometry pattern analysis in this situation.²⁴⁴

6.5. Reproducibility and Reliability of Tests

Since many patients with NLUTD have infra-pontine neuropathy, the influence of the emotional (limbic) nervous system on LUT function is reduced or eliminated; thus, UDS observations may be less influenced by the test circumstances than those made in individuals with an intact nervous system.²⁴⁵ Nevertheless, the test conditions (e.g. the rate of filling the bladder) do affect the results, and should be chosen carefully.²⁴⁶ Some advocate ambulatory monitoring to increase the representativeness of cystometry.²⁴⁷ However, tests of longer duration with natural filling, did not relevantly assist in the diagnosis and selection

of treatment in patients with SCI in a single centre prospective comparison.²⁴⁸

6.6. Does Urodynamic Testing Help to Select (Optimal) Treatment?

The aims of therapy for NLUTD are to achieve the most physiological filling and voiding conditions possible, as well as a management situation acceptable to the patient in their daily life. Long periods of elevated detrusor pressure during bladder storage phase or (abnormally prolonged and/or high pressure) voiding put the UUT at risk.^{230 249} The primary aim of therapy in patients with such problems is conversion to a low pressure bladder during filling,^{233 250} achieve continence, and to manage incomplete emptying due to (medically induced) DU or detrusor acontractility, with CIC.²⁶⁸

The primary aims for treatment of neuro-urological symptoms and their priorities can be summarized as follows:²⁵¹

- protection of the UUT
- achievement (or maintenance) of urinary continence
- restoration of the LUT function
- improvement of the patient's QoL

Adequate management depends on whether the detrusor is overactive or has reduced compliance, and only UDS can answer those questions. Timely and adequate diagnosis is of paramount importance for the patient's QoL, as well as for safety.^{252 253} There is expert agreement that UDS is essential to monitor the effects of any treatment and in the follow up of any sequelae of the disease and its management. UDS is certainly needed to document the effects of new treatments or management strategies for patients with NLUTD. Changes in UDS do not always relate to clinically relevant improvements in these patients.^{241 246} A retrospective study shows with 80 SCI patients and a minimum follow-up of 5 years that it is possible to manage continence and preserve (100% of) UUT with ultrasound monitoring and repeated UDS.²⁵⁴ Another retrospective observation indicates, in a series of 200 children with various types of NLUTD, that the intensity (frequency) of UDS follow up can be adapted according to the estimation of the risk for UUT deterioration on the basis of UDS parameters achieved at a baseline.²⁵⁵

6.7. Conclusions Level 3:

- Case series indicate that it is possible to monitor patients with NLUTD, without anatomic abnormalities of the LUT (especially adult age SCI) with cystometry and ultrasound of the UUT.
- Uncontrolled cohort studies indicate that non-invasive tests are less sensitive to relevant abnormalities in comparison with UDS and investigators have concluded that UDS is necessary when

LUTS arise in patients with neurologic abnormalities.

- No specific reports about the optimal frequency and techniques of follow –up UDS in patients with NLUTD exist
- No conclusive evidence exists about the predictive value towards better diagnosis or (the outcome of) treatment with regard to ice-water testing or ambulatory UDS of patients with NLUTD.
- Nocturia, nocturnal enuresis or LUTS may be the first, or an early, sign of Parkinsonism in elderly male patients, and may occur also in patients e.g. with MS, or other neurology and UDS is of value to establish a diagnosis of the LUT dysfunction(s) responsible for the symptoms.
- LUTD in male patients with Parkinsonism (or MS, or other neurology) can be the result of DO, (benign prostatic) BOO, dyssynergic voiding or PVR or any combination thereof.
- DO and DU, with or without urethral sphincter dyssynergia, are commonly found in male patients with Parkinson's disease.
- BOO is not specific to Parkinson's disease. For male patients with Parkinson's disease and LUTS(D), UDS and evaluation of prostate size are recommended to select appropriate treatment strategy.

6.8. Recommendations 2016

- This committee recommends that UDS evaluation should be considered at the time of first evaluation of patients with signs and symptoms or with suspicion of NLUTD and that VUDS is considered when anatomical abnormalities with the NLUTD are not unlikely.
- The committee recommends that the frequency of testing and the techniques applied in the follow up of patients with NLUTD be critically analysed and optimised, and continues to recommend that guideline recommendations on the basis of those analyses should be developed.
- The committee recommends that UDS in patients with NLUTD is done with special attention to the specific needs of the patients. It is highly preferable that all professionals involved are specifically trained for that purpose.

6.9. Recommendations for Research

- Comprehensive UDS should remain an integral part of the evaluation of new therapies and management strategies for NLUTD whether conservative, medical or surgical. The first goal of this should be to monitor the safety of the (developed) approach for the patient and the secondary goals of this UDS should be the efficacy outcomes (preferably on predefined UDS criteria).

- The frequency of UDS in the follow up of patients with NLUTD should be evaluated and optimised in the different neurologic conditions.
- Specific UDS diagnosis categories and diagnostic techniques need to be developed to quantify detrusor sphincter dyssynergia and neurogenic DU. Diagnostic techniques need to be developed to objectively evaluate bladder sensation.

VIII. PATIENT EVALUATION: CHILDREN WITH URINARY INCONTINENCE

1. INTRODUCTION

1.1. Conclusions and Recommendations 2013

ICI2013 concluded that retrospective and prospective studies have shown that symptoms and signs (in UI) do not adequately represent LUT dysfunction and UDS diagnosis in children. This is observed in otherwise healthy children with LUT signs and symptoms, in children with MMC, with ARM, with SCI, spinal cord tethering, cerebral palsy / spasticity, sacro-coccygeal teratoma, and also in children with urethral valves, VUR or bladder extrophy. Retrospective and prospective studies have shown that management of children with MMC is depending on UDS diagnosis and expert consensus exists in this regard and single centre retrospective (selected) series have shown that UDS-diagnosis is frequently relevant in children with the above -mentioned pathology but also that initial conservative management of (otherwise healthy) children with UI is possible without UDS-diagnosis.

No good evidence existed in 2013 to support optimal selection of VUDS (versus UDS) in most situations of children with UI, apart from MMC and VUR or to support individual decisions regarding UDS or VUDS (technique and timing) for follow-up in children. At the previous consultation also no positive evidence existed for the routine use of any of the new non-invasive UDS methods in children. Some (expert and/or single centre) evidence has been emerging for flow + EMG evaluation and follow-up in children.

The 2013 committee recommended managing children with UI, with a minimum of a bladder diary plus 3 representative flow-PVR –measurements and to use this information also to act as a reference for cystometric capacity and/or filling rate.

The committee also recommended to consider VUDS (only) when relevant anatomical abnormalities are (to be) expected and recommended the need to improve pelvic patch EMG technique, standards and evaluation/reporting.

The 2013 committee recommended that patients with symptoms and signs of LUT dysfunction with relevant

neurologic abnormalities receive (V)UDS when it is considered possible to initiate treatment as a consequence of the diagnosis based on the (V)UDS and when first line management has failed. The committee recommended to use bladder diary as the basis for cystometry but for patients with relevant neurological abnormalities also or specifically to use the catheterisation volumes (also). The ICI2013 committee does not recommend routine use of non-invasive UDS or ambulatory UDS in patients with relevant neurological abnormalities.

The committee recommends that UDS in patients with NLUTD is done with special attention to the specific needs of these patients and recommended specific (V)UDS -practice guideline(s) and training for (V)UDS in patients with (LUTD and) relevant neurological abnormalities.

1.2. New Evidence 2016

The indications for UDS evaluation in children are usually neurological, anatomical and/or functional abnormalities, with the types of studies to be performed being based on the presumed underlying patho(physio)logical conditions rather than on the presenting symptoms. UI in children is relatively more often seen (compared to adults) in combination with other LUT (or lower bowel or pelvic floor) dysfunctions. On the other hand, urinary continence and the development of 'full-grown' LUT function are the result of a normal maturation process that can be delayed in some, and may 'spontaneously cure' (or 'resolve') without requiring medical intervention. UDS is used to establish as clearly as possible the baseline situation where needed, so that changes as a result of treatment and/or growth can be assessed, and some guidance is obtained in the choice of treatment. Perhaps more clearly than in any other patient group, the aim of UDS in children is to provide objective knowledge about LUT function and dysfunction as well as to provide understanding to the care-giver and to the patient (and her or his parents).

Paediatric UDS implies a different approach than in adults and applications are unique in this population. Nevertheless, there has not been a validated guideline on the use of UDS in children but a publication of 2015 by the International Children Continence Society summarized the available evidence and expert based knowledge, and provided expert recommendations.²⁵⁶ Also a specific standardized expert report for VUDS was presented in 2016.²⁵⁷

More extensively than in other ages, non-invasive UDS are initially explored, not only because they are more easily accepted and more applicable for children, but also to have comparable parameters during follow-up, and to exactly identify those children and clinical conditions that will benefit from further invasive exams. Essential are a meticulous and complete history, physical examination including clinical neurological testing and assessment by voiding diaries. The exact role and reproducibility of uroflowmetry have been strongly under consideration during the

last years, especially if associated with pelvic floor EMG. Additionally, flow plus EMG is recommended in the ICS- Childrens Good Urodynamic Practices.²⁵⁶

Furthermore, ultrasonography is considered a useful tool with acceptable reproducibility for initial assessment when evaluating LUTS in children. Ultrasound LUT-studies in children include not only PVR and bladder volume but also bladder wall thickness (BWT).^{258 259} The use of ultrasound is not only limited to a morphological analysis of the LUT, but also a dynamic one, with evaluation of the full and of the empty bladder,²⁶⁰ and evaluation of the pelvic floor muscles movements and contraction endurance.²⁶¹

2. NEUROGENIC LOWER URINARY TRACT DYSFUNCTION

2.1. Myelodysplasia

2.1.1 ICI2013 Conclusions and Recommendations

Retrospective and prospective studies have shown that the UDS diagnosis of (neurogenic) DO and/or reduced detrusor compliance in patients with myelodysplasia or (occult) spinal dysraphism is not predictable on the basis of clinical signs or symptoms. Many retrospective and prospective studies have shown that regularly repeated UDS in patients (children) with MMC reveals clinically relevant results regarding medical and surgical management. Based on expert opinion, VUDS testing is preferable above UDS without X-ray video; however, the exact advantage (e.g. in repeated investigation) is not substantiated. Various studies have shown that LUT function in children with MMC may change over time and with physical growth. No studies have been published that are a help to determine the optimal timing and frequency of UDS follow-up. ICI2013 recommended (grade B/C) that comprehensive UDS is advised in all patients with MMC throughout the entire life on a regular basis from earliest childhood and further that on indication, unscheduled UDS should be considered when relevant lower body half and/or LUT clinical or neurological signs or symptoms arise or when significant management, medical or surgical treatment changes have been instigated.

ICI2013 also recommended that the advantages and disadvantages of the addition of x-ray to UDS should be considered in children with MMC on an individual basis. Timing and technique of UDS in patients with MMC must be selected on an individual basis. To help identify children at risk for subsequent UUT and/or LUT deterioration or a changing neurological picture, initial UDS, very early in the neonatal period, are recommended for children with MMC. The ICI2013 recommended on the basis of expert opinion that anorectal function or dysfunction is simultaneously evaluated with LUT function in children with MMC (see also the chapter on faecal incontinence).

2.1.2 Discussion and New Evidence 2016

Treatment of NLUTD by intradetrusor BoNT-A injection gained growing consideration, also in children, with the mechanism of action now better known²⁶² Despite studies attesting to the good results of BoNTA in adult neuropathic DO and FDA approval, studies on its effectiveness on NLUTD in children remain controversial, and only scarce reports comment on the specific features of the disease process among patients and reasons for failure in some.^{263 264} The evidence from uncontrolled studies was recently reviewed.²⁶⁵ In a study aiming to investigate UDS parameters that predict outcome of intradetrusor BoNT-A injection in 37 children with NDO, preoperative bladder compliance (P .030) and open bladder neck (P .031) were found as important predictors of poor response at a regression analysis of outcome.²⁶⁶ In another well conducted study on 16 children with NDO, who underwent intradetrusor BoNT-A injection, the patients with typical DO showed a significant increase in both the cystometric capacity (from 53% to 74% of age related capacity) and the compliance (from 4.7 to 8.6 ml/cm H₂O) This resulted in 56% of patients with complete dryness between CIC. Among the patients that displayed (very) low compliance and no detrusor contraction at all, none demonstrated any notable clinical improvement.²⁶⁰

Another point is that, also because of the extensive use of BoNT-A, some less aggressive surgical procedures (i.e. without bladder augmentation) are attempted, and they may require preoperative UDS. In a cohort of 79 patients studied by UDS before bladder neck surgery without augmentation for neurogenic sphincter incompetence, despite sustained pressures >40 cmH₂O and then assessed at 3 years, UUT changes developed in only 35% of patients, and resolved with medical management or minimally invasive interventions. This provided evidence for a statement that end pressures should not be used as an independent indication for augmentation.²⁶⁷

For children followed since birth, initial UDS in the neonatal period had been recommended for children with myelodysplasia, the basis being that they help identify children at risk for subsequent urinary tract deterioration or a changing neurological picture.^{268 269} This concept has been confirmed by the recent ICCS recommendations for initial diagnostic evaluation and follow-up of congenital neuropathic bladder.²⁷⁰ Approximately 90% of children born with MMC will have a preserved UUT at birth. Over time, many children who have not received proactive urological care develop UUT and/or LUT deterioration, as an acquired phenomenon secondary to the development or progression of various LUT hostility factors such as DO, reduced bladder compliance, detrusor-sphincter dys-synergia and/or high LPP. The main identified risk factors from UDS which relate to increase of the occurrence and grades of UUT dilatation are decreased bladder compliance of <9 mL/cmH₂O, increased DLPP of >40 cmH₂O and acontractile detrusor.²⁷¹ The presence of severe bladder trabeculation has

been coined as a parameter of BOO in incontinent children with NLUTD.²⁷² Bladder wall thickness measurement was also found as a predictor of LUT impairment in a case-control study on 80 children with myelodysplasia, decreasing the need for UDS.²⁷³ When conservative treatment - as CIC, anticholinergic drugs and BoNT-A injections - are not sufficient, bladder augmentation is performed to relief or prevent UUT deterioration and/or VUR, usually without necessity of simultaneous anti-reflux repair.²⁷⁴ Cystometry follow-up should be used to evaluate the effect of this treatment.^{275 276}

Single centre studies suggest that prevention of high bladder filling pressure (before UUT dilatation is observed) is necessary and feasible even before any UDS diagnosis.^{277 278} Expert reviews have recommend periodic cystometry when new onset hydro-nephrosis, VUR or UI develops.^{279 280} A considerable number of myelodysplastic children can develop a change in neurological impairment, early in infancy or as they grow up and reach puberty, thus they need UDS follow-up to check changes^{281 282} however, the interval and frequency of follow up UDS are not precisely established. In closed MMC, as lipomeningocele, UDS and the presence of neurological impairment were considered to have had crucial roles in determining the optimal timing of surgery in patients with lipomeningocele, and in diagnosing the onset of tethered cord,²⁸³ UDS is also reported to be more relevant towards the outcome of neurosurgical interventions (untethering) than pelvic floor muscle needle EMG.²⁸⁴

In a long-term perspective of drugs use, UDS has been relevant to evaluate the treatment efficacy and tolerability of propiverine²⁸⁵ and, over a period of 15 years, intravesical oxybutynin treatment showed adequate suppression of detrusor activity, cystometric capacity increase from the 5% percentile to the 25-50% percentiles for age, mean end-filling pressure from 24.5 ± 14.4 cm H₂O, had returned to the safe zone.²⁸⁶

Because renal transplantation in patients with myelodysplasia and persistent LUT dysfunction carries increased (post -renal) risks for the grafted kidney, the existence or creation (augmentation cystoplasty) of a UDS confirmed low pressure bladder with adequate cystometric capacity before transplantation is deemed necessary.²⁸⁷

2.2. Occult spinal dysraphism

Lumbar cutaneous stigmata in infants may be associated with occult spinal dysraphism and often prompt urological evaluation, including UDS is needed. Series of children with occult spinal dysraphisms have documented abnormalities in striated urethral sphincter function (denervation and/or detrusor-sphincter dyssynergia) in 20 - 35% of babies under 2 years of age with normal neurological examinations in; thus emphasising the need for UDS in these children.^{288 289 290} There is however also a correlation of 70–90% between an abnormal neurological examination and

the likelihood of finding an abnormality on UDS in older children.^{291 292} In the past, several studies demonstrated the usefulness of UDS to diagnose sacral cord function; better EMG activity (in up to 60% of the children corrected before 2 years of age) and or progressive changes in urethral sphincter function with very few of these patients having detectable alterations on physical examination.^{293 294 295} A UDS before neurosurgical intervention was found to identify LUTD in clinically silent cases and also identified deterioration in these patients.²⁹⁶ The usefulness of UDS in detecting lesions and during follow-up in children with known spinal cord abnormalities and/or tethered cord is still controversial. The association between abnormal UDS findings and need for tethered cord release was studied in a large series of 123 children, mainly (91%) non toilet trained infants. 19% of these had abnormal UDS, 85% abnormal spinal MRI and 96% abnormal spinal ultrasound: a significant association was found between abnormal UDS (P .002) and MRI (P .05), while ultrasound of the spine, was not associated with intervention for tethered cord release (P 1.0).²⁹⁷ Taking into account the large spectrum of spinal cord lesions, a multivariate analysis was carried out on a uniform set of 59 patients with a fatty filum terminale and/or low-lying cord: UDS results were categorized by three urologists, blinded for the neurological diagnosis and it was found that pre and post untethering UDS do not predict continence status.²⁹⁸ In a retrospective study on 149 tethered cord patients, operated also if asymptomatic when primary and also the symptomatic ones with re-tethering, UDS and prone MRI were considered to be the best tools for screening those patients at risk of symptomatic retethering.²⁹⁹ The utility of UDS in preoperative work-up, monitoring for retethering, and long-term urologic follow-up is confirmed but requires further examination.

2.2.1 Conclusions (Level 2/3)

- Retrospective and prospective studies have shown that the UDS diagnosis of (neurogenic) DO and/or reduced detrusor compliance in patients with myelodysplasia or (occult) spinal dysraphism is not predictable on the basis of clinical signs or symptoms.
- Many retrospective and prospective studies have shown that UDS in patients (children) with meningomyelocele or (occult) spinal dysraphism, both initial as well as in the follow-up reveals clinical relevant results with regard to management and surgical or medical treatment.
- Evidence for the optimal interval and frequency of (V)UDS follow-up in patients with children with NLUTD is lacking.
- On the basis of expert opinion, VUDS testing is preferable above UDS without x-ray video, however the exact advantage of repeated VUDS in

the follow-up of children with known (morphological or anatomical) abnormalities is not substantiated.

- Various studies have shown that LUT function in children with myelodysplasia or (occult) spinal dysraphism may change over time (and physical growth) (Level of Evidence: 3)
- No studies have been published that help to determine the optimum of timing and frequency of UDS follow-up.

2.2.2 Recommendations (Grade B/C)

- Comprehensive UDS is advised in all patients with myelodysplasia or (occult) spinal dysraphism throughout the entire life on a regular basis from earliest childhood.
- UDS should be also be considered by a change in signs and symptoms, when relevant lower body half and/or urinary tract) clinical or neurologic signs or symptoms arise or when significant (surgical or medical) treatment changes have been instigated.

2.2.3 Recommendations (Grade C)

- The advantages and disadvantages of the addition of video (x-ray) to UDS should be considered in children with myelodysplasia or (occult) spinal dysraphism on an individual basis.
- Timing and technique of UDS in patients with myelodysplasia or (occult) spinal dysraphism must be selected on an individual basis.
- To help identify children at risk for subsequent urinary tract deterioration or a changing neurological picture, initial UDS very early in the neonatal period (e.g. starting from 3 months age), should be considered for children with myelodysplasia or (occult) spinal dysraphism.
- The committee recommends on the basis of expert opinion that anorectal function or dysfunction is simultaneously evaluated with LUT function in children with myelodysplasia or (occult) spinal dysraphism (see also the chapter on faecal incontinence in the book).
- The committee recommends research to determine the optimum of interval and frequency of follow up UDS in children with NLUTD.

2.3. Sacral Agenesis

2.3.1 ICI2013 Conclusions and Recommendations

ICI2013 concluded (Grade 3) that case series have shown that UDS evaluation of LUT function in children with (partial) sacral agenesis reveals a substantial incidence of clinically hidden dysfunction. It is shown that approximately one third of children with

ARM have spinal dysraphism and/or tethered spinal cord associated with UDS demonstrable LUTD.

ICI2013 recommended that clinicians should consider UDS in children with sacral agenesis and also after (surgery for) sacrococcygeal teratoma, and that clinicians must consider that in children with LUTD, otherwise clinically silent sacral agenesis can exist.

2.3.2 Discussion and New Evidence 2016

No significant new evidence or observations arose during the last 3 years. Sacral agenesis, absence of the lower most vertebral bony segments, is a rare lesion that can be missed in infancy because of its sometimes subtle, clinical manifestations, with generally no loss of lower extremity motor and sensory function.³⁰⁰ Urinary and/or faecal incontinence usually manifests at an older age when the child fails to toilet train on time. A careful physical examination noting flattened buttocks and a short gluteal crease is pathognomonic for the diagnosis. UDS studies had been shown to be 90% accurate in delineating the neurological deficit, which could not be predicted by the level of absent vertebrae. Sacral agenesis also shows variable association with ARM and/or spinal cord anomalies.^{301 302 303} These studies reveal that 30 to 40% of these patients have a lesion type with DO and an intact, but dyssynergic, sphincter while 25 to 50% have areflexic detrusor and denervation in the sphincter, but 15-20% may have normal LUT function.³⁰⁴ MRI is for the evaluation of all patients that have sacral agenesis in the basis of a single expert centre review,³³⁶ confirmed by another team, who found the extension of the sacral defect as a prognostic factor for retethering.³⁰⁵ When MRI shows sacral or spinal cord anomalies, UDS should be considered, preceded by neurological exam and considering neurophysiological (evoked potentials) testing. The authors of this and subsequent studies recommend a non-invasive evaluation for all other children, and UDS when NLUTD is suspected.³⁰⁶

2.3.3 Conclusions (Level 3)

- Case series have shown that UDS of LUT function in children with (partial) sacral agenesis reveals a substantial incidence of clinically hidden dysfunction.
- It is shown that approximately one third of children with ARM have MMC and/or tethered spinal cord have UDS demonstrable and clinically relevant NLUTD.

2.3.4 Recommendations (Grade C)

- Clinicians should consider UDS in all children with sacral agenesis and also after (surgery for) sacrococcygeal teratoma. (see section f – Tumours)
- Clinicians must consider that in children with LUTD, otherwise clinically silent sacral agenesis can exist.

2.4. Spinal Cord Injury

2.4.1 ICI2013 Conclusions and Recommendations

Retrospective studies have shown that UDS of all children with SCI is relevant. Retrospective studies have shown that UDS of children with SCI results in diagnoses and treatment similar to adults with SCI. The ICI2013 recommended that UDS in children with SCI is planned on an individual basis, but no earlier than 6 weeks after injury

2.4.2 Discussion and New Evidence 2016

No further studies with evidence are available during the last three years. The scarcity variability of SCI in children makes it difficult to propose any one treatment program unless the specific type of LUT function is known on the basis of UDS.³⁰⁷ It is important to measure detrusor compliance in order to determine the potential risk for VUR and hydroureteronephrosis.³⁰⁸ All studies are single centre, retrospective and use historical controls for comparison. In the presence of elevated UDS filling and voiding pressures, a 30% incidence of UUT deterioration can be expected,³⁰⁹ while effective voiding with pressures below 40 cm H₂O in the absence of detrusor-sphincter dyssynergia ensures a stable UUT.³¹⁰ UDS monitoring has been demonstrated to be relevant in the follow up and prevention of UUT deterioration.³¹¹ In another study on 17 children aged 6 months-18 years with cervical (4), thoracic (8) and lumbar (5) SCI, all but one showed DO on first evaluation, which was changed to acontractile and/or compliant detrusor pattern by medical treatment; 7 had increased cystometric capacity and 8 decreased DLPP at follow-up; only 2/17 developed minor UUT impairment.³¹² UDS, undertaken no earlier than 6 weeks after injury, allows for the manifestation of the extent of the neurological injury.³¹³ As in adult patients autonomic dysreflexia can occur also in children and adolescents.³¹⁴

Conclusion (level 2/3)

- Retrospective studies have shown that UDS of all children with SCI is relevant.
- Retrospective studies have shown that UDS of children with SCI results in diagnoses and treatment similar to adults with SCI.

2.4.3 Recommendations (Grade C)

- The committee recommends that UDS in children with SCI is planned on an individual basis, but no earlier than 6 weeks after injury.

2.5. Cerebral Palsy

2.5.1 ICI2013 Conclusions and Recommendations

ICI2013 has concluded on the basis of cohorts with historical/ literature -control groups that clinically unexpected LUTD – predominantly dysfunctional voiding and reduced cystometric capacity - can occur in

children with cerebral palsy an has recommended that clinicians should carefully evaluate voiding in children with cerebral palsy and should consider complete UDS when dysfunction is suspected. ICI2013 recommended that UDS is considered in all patients with spastic cerebral palsy.

Discussion and New Evidence 2016

A recent systematic review on 27 studies, describing prevalence of LUTS or UDS findings, found that 55% of the patients have at least one LUTS: storage symptoms are more common, and patients with pelvic floor overactivity are more prone to progress to UUT dysfunction in adult life.³¹⁵ Bladder (cystometric) capacity is decreased in most children with cerebral palsy, and PVR is present in an important proportion. Uroflowmetry and PVR are considered first line evaluation of LUT function in children with cerebral palsy.³¹⁶ UDS can direct management; Negative prognostic factors are the spastic subtype with quadriplegic distribution, moderate to severe functional impairment (Gross Motor Function Classification System [I-V; V= Severely handicapped/wheelchairbound] III or higher) and severe cognitive impairment.³¹⁷ A careful study by uroflowmetry on 57 patients showed that the symptomatic children (52%) had lower Q_{max} (P .013) and abnormal flow rate curves (P .022),³¹⁸ indicating non-invasive testing as a good screener tool. The vast majority of the children with cerebral palsy tend to gain normal LUT function, but often at an age that is later than expected for from DO.³¹⁹ A meta-analysis of UDS performed in 117 children with either persistent UI despite frequent toileting, or UTI, revealed normal function in 15% or DO in 73%.^{320 321} In some recent studies, detrusor-sphincter dyssynergia was present in higher prevalence than earlier reports (11% versus 5%),^{322 323} and normal function was less prevalent (only 15%) in the more recent case series.³²⁴ Therefore, it has been suggested on the basis of expert opinion that cystometry and sphincter EMG are to be considered, but only when frequent toileting or anticholinergic therapy fails to control incontinent episodes, the child develops UTI from ineffective voiding, or when ultrasonography reveals hydronephrosis.

VUDS assessment can be considered in all patients with infantile cerebral palsy. The decision should not be based on clinical symptoms because at least half of the children with spastic cerebral palsy have clinically silent bladder dysfunction. 100% of children had clinical improvement postoperatively (selective dorsal rhizotomy), 71% who were incontinent preoperatively became continent and none had deterioration on UDS.^{325 326} There is a spectrum of clinical and UDS LUT (dys) function in children with cerebral palsy; e.g. 77% void spontaneously but have UI. Children with UI have a significantly lower age related cystometric capacity,³¹² and also lesser than expected for age voided volumes on uroflowmetry (plus PVR).³¹³

2.5.2 Conclusion (Level 3)

- Some studies have shown that clinically unexpected LUTD can occur in children with cerebral palsy, especially when voiding symptoms are present.
- Observation and non-invasive testing are helpful, but UDS should be considered when UTIs or UUT dilation occurs in children with cerebral palsy.

2.5.3 Recommendations (Grade C)

- Clinicians should evaluate voiding in children with cerebral palsy and should consider complete UDS when dysfunction is suspected.
- UDS is to be considered in all patients with spastic cerebral palsy. Undiagnosed and untreated patient's bladder dysfunction remains pathological and potentially dangerous, and may damage the UUT.

2.6. Tumours

2.6.1 ICI2013 Conclusions and Recommendations

According to ICI2013, it was shown in single centre cohorts that UDS testing is relevant after resection of a sacrococcygeal teratoma. A study showed that all children with central nervous system tumours can have LUTD regardless of the location of the tumour.

LUTD exists after sacrococcygeal teratoma resection and recently again it was proposed, on the basis of a single centre cohort, that UDS is necessary for those children.^{327 328} A recent study showed that children with central nervous tumours can have UDS abnormalities, whether the tumour is in the spinal cord or not. A single centre and selected cohort study concluded that a child with a central nervous system tumour needed urological investigation including UDS regardless of tumor location.³²⁹

2.6.2 Conclusion (Level 3)

- It was shown in single centre cohorts that UDS is relevant after resection of a sacrococcygeal teratoma.
- A study showed that all children with central nervous system tumours can have LUTD regardless of the location of the tumour.

3. ANORECTAL MALFORMATION AND PERSISTENT CLOACAL ANOMALIES

3.1. ICI2013 Conclusions and Recommendations

ICI2013 concluded that various studies have shown that a significant proportion of children with an ARM

have primary or secondary dysfunction of the LUT and/or LUT innervation abnormalities or pelvic floor dysfunction. ICI2013 recommended that clinicians should consider UDS in children with imperforate anus or ARM when clinical signs of LUTD exist and also should consider UDS in children where, on the basis of an MRI, or on the basis of clinical examination, relevant neurological structural abnormalities exist, before and/or after reconstructive surgery independent of (the existence of) LUTS.

3.2. Discussion and New Evidence 2016

In the past, imperforate anus repair for high lesions frequently resulted in (stress-) UI due to a pudendal nerve injury that often occurs from surgical perineal approach. With the advent of the posterior sagittal anoplasty this complication has been eliminated as a cause for subsequent UI, although bladder neck incompetence may be a consequence of extensive mobilisation of the sigmoid colon to transfer the rectum to its final location.³³⁰

UI and LUTD may result from iatrogenic injury or from a pre-existing congenital neurological lesion. UI after definitive repair is reported as to be the result ineffective emptying causing 'overflow urinary incontinence' and underactive or acontractile detrusor, rather than urinary sphincter injury. Similarly, it has been reported, on the reconstruction of cloacal anomalies, that the main clinical characteristic of bladder dysfunction was a failure to empty,^{331 332} presumably due to iatrogenic injury from extensive dissection, which can lead to peripheral nerve damage. In 2004, Warne et al prospectively studied the effect of surgical reconstruction by posterior sagittal approach and total urogenital mobilisation in either causing or worsening bladder dysfunction, in new patients with cloacal anomalies and ARM: those with cloacal malformation had a high incidence of innate LUTD, and a significant deterioration (frequently a change to DU) in bladder function.³³³ In a prospective study on children with ARM, prior to, and following definitive procedure, only 9 of the 19 patients had normal UDS pre-operatively, and LUT function worsened postoperatively.³³⁴

UDS is required to evaluate LUTD in patients following repair of ARM (and Cloacal anomalies). The reliability and reproducibility of findings among the various studies analysed confers an important role for VUDS as an integral part of the evaluation and management of these children.

Moreover, reports of spinal MRI's reveal a 35% incidence of distal spinal cord abnormalities in children with an imperforate anus.³³⁵ NLUTD occurs in 50%,³³⁶ and 40-60% of those patients who have tethered cord needed untethering.³³⁷ Evaluation of all patients with ARM using MRI is recommended and when MRI shows sacral or spinal cord anomalies, non-invasive should be done, and UDS when NLUTD is suspected.³³⁸ To detect spinal cord abnormalities in neonates, spinal ultrasound has been largely used as a screening test up in children to 5 months of age; a study on 244 ARMs showed a 100% specificity but a

very low sensitivity (15%), thus stating that ultrasound is not suitable as a screening test for MMC in ARM, with MRI being necessary when symptoms occur.³³⁹

In summary; imperforate anus may occur as an isolated lesion but also in conjunction with spinal cord pathology and/or sacral anomalies (and associated cardiac, esophageal, bony ones), which was reported to occur in 38% of cases of ARM.^{340 341} By combining the incidences in 3 studies it was found that the presence of an abnormal sacrum increases the likelihood of LUTD to as high as 76% (38 of 50 children).^{342 343} When the rectum ends above the levator ani muscle there is a much greater chance of LUTD than when it ends below the pelvic floor³⁴⁵ and the older the child is at the time of UDS the more likely he/she is to have abnormal LUT function.³⁴⁶

3.3. Conclusions (Level 3)

- Various studies have shown that a significant proportion of children with ARM has primary or secondary dysfunction of the LUT, LUT innervation abnormalities or pelvic floor dysfunction.

3.4. Recommendations (Grade C)

- Clinicians should consider UDS in children with imperforate anus when clinical signs of LUTD exist.
- Clinicians should consider UDS in children where, on the basis of an MRI, or on the basis of clinical examination, relevant neurological abnormalities exist, before and/or after reconstructive surgery independent of (the existence of) LUTS.

4. ANATOMIC ABNORMALITIES

4.1. ICI2013 Conclusions and Recommendations

ICI2013 has observed that many case series have demonstrated frequent UDS abnormalities, predominantly DO and reduced bladder compliance or large capacity bladder with impaired filling sensation, in children with PUV, urethral stricture, ectopic ureterocele, VUR or bladder exstrophy and that proper UDS has been shown to be of help to determine when further medical or surgical management is indicated in children with these abnormalities. ICI2013 concluded that the use of UDS has aided in an objective measurement of success or failure of treatments for these abnormalities.

ICI2013 recommended that clinicians should consider complete UDS of the filling and voiding phases, at least once, in children with PUV, urethral stricture, ectopic ureterocele, VUR or bladder exstrophy and also that clinicians should consider regular uroflowmetry and PVR assessment in the follow-up and further management of children with PUV, urethral stricture ectopic ureterocele, VUR or bladder exstrophy.

4.2. Discussion and New Evidence 2016

No further major evidence arose during last 3 years regarding usefulness of UDS in congenital anatomical anomalies, apart from the general tendency to use non-invasive tools as much as possible in conditions which are not treated with surgical correction (i.e. VUR and/or valve patients); while major abnormalities (i.e. extrophies or ARM or cloacal anomalies) need UDS evaluation prior to decide complex corrections. The evidence still consists of uncontrolled case series and expert opinions although many clinicians now feel its usefulness is beyond question.

4.3. Posterior Urethral Valves

In the past UDS had been essential to understand (functional) obstruction, LUT dysfunction, persistence of UI and UUT (and renal) impairment evolution in boys with PUV.^{347 348}

The importance of bladder neck secondary obstruction remains one of the principal issues,³⁴⁹ which may require further intervention on the basis of the UDS observation that DO and high maximum voiding detrusor pressures decreased consistently after bladder neck incision.³⁵⁰

In a series of UDS after valve ablation, the type of bladder function observed, correlates with the time elapsed from surgery; DO was the predominant pattern initially,³⁵¹ but changes are noted in both DO and compliance over time.^{352 353 354} Myogenic failure, in conjunction with increasing capacity and poor emptying, are primarily a later phenomenon, and are most likely to be secondary to increased urine production and decreased frequency of voiding with advancing age.³⁵⁵ Despite early valve ablation, a large proportion of boys treated for PUV have gradual detrusor 'decompensation' and/or secondary bladder neck outlet obstruction leading to obstructive voiding and finally DU or acontractility.

The persistence of UUT changes is related to the bladder's unresponsiveness to medical therapy for the DO and/or for DU (usually CIC). However, it is possible that this condition is secondary to insufficiently frequent voiding in the face of increased urine production. BOO from a secondary hypertrophied bladder neck can also occur, requiring further intervention.³⁵⁶ Several studies have shown the predictability of the development of renal failure based on specific detrusor patterns seen on UDS: persistent poor compliance, high detrusor pressures, BOO and/or chronic failure of the detrusor to adequately contract during voiding with increased PVR.^{357 358} The extended use of antenatal diagnosis selected a 'new generation' of patients with PUV, who undergo proper early ablation of obstructing valves allowing normal cycling, which helps 'bladder healing'.

Nowadays, knowing the LUT conditions which are at risk for UUT deterioration, it is reasonable to follow the patients who underwent neonatal valve ablation

and aggressive and early bladder training, by non-invasive UDS exams. In a case-control study two age-matched group of patients were followed by cystometry and pressure-flow study at least every 3 years or were monitored annually by non invasive tests from age 5: neither the prevalence of LUTD nor late onset renal failure differed significantly between the two groups.³⁵⁹ In another multivariate analysis study, detrusor thickness greater than 1.3 mm was considered the only independent risk factor for later impaired bladder function.³⁶⁰ Noninvasive UDS seems to be as safe and effective as invasive UDS in the long-term management of boys with PUV, and invasive UDS may be reserved for cases of progressive deterioration of LUTD or renal function.

4.4. Bladder Exstrophy

Once the exstrophied bladder is closed it may be difficult to manage persistent UI, UUT dilation or VUR. Whether and when to further improve continence function and whether to perform augmentation cystoplasty for a small capacity, poorly compliant bladder are challenging issues. In addition, as more children undergo complete primary repair of the exstrophic bladder in the neonatal period, the most accurate assessment of bladder function is by UDS; compliance reduces in up to 50% after surgery.^{361 362} Studies have correlated UI with age related cystometric capacity, compliance, DO and/or LPP.³⁶³ UDS remain helpful to evaluate LUT before (and after) further surgical procedures and for research matters. To check potential injury to pelvic neurourological anatomy after complete primary repair of bladder exstrophy, needle-EMG was done on 13 children to evaluate the external urethral sphincter response to sacral reflex stimulation and during voiding, finding normal individual motor unit action.³⁶⁴

4.5. Ectopic Ureterocele

UDS in babies with an ectopic ureterocele had shown that several cases had a larger than normal cystometric capacity and DU,³⁶⁵ but in a multicentre analysis of 616 children it was found that LUTD is present only in ectopic ureterocele.³⁶⁶ Recently, there is an increasing agreement in favour of conservative management of paediatric duplex system ureteroceles, by mean of simple endoscopic puncture followed by close surveillance: VUR can resolve spontaneously in a significant number of patients, and bladder function should be conserved,³⁶⁷ and even if secondary bladder surgery is needed, significant bladder dysfunction is rare.³⁶⁸

4.6. Vesicoureteral Reflux

It had been shown that VUR may be a secondary phenomenon resulting from LUT dysfunction and not (only) a primary anatomic abnormality at the ureterovesical junction in a significant proportion of children.^{369 370 371} There is evidence that DO may lead to VUR in a marginally competent ureterovesical junction mechanism.^{372 373} This DO may be a natural phenomenon in the infant bladder, especially in boys,

due to the presence of higher voiding pressures^{374 375} and/or a learned dysfunction in older children. DO tends to resolve with increasing age³⁷⁶ going from an immature pattern with high pressure levels in the first two years or life, to a high capacity bladder with incomplete voiding.³⁷⁷ Among UDS parameters, *high bladder pressure* at the onset of VUR was found a positive prognostic factor for spontaneous resolution of VUR (P .0005), independently of VUR grade.³⁷⁸ The highest degree of VUR was found associated with highest detrusor pressure (P .038) in the group with 'urgency syndrome',³⁷⁹ and no differences in resolution rates observed from grades I to V VUR in children with LUT conditions, patients with dysfunctional voiding having the most improvement and greatest (70%) resolution of VUR.³⁸⁰ Another prognostic finding regarding the spontaneous resolution of VUR is intravesical volume at the onset of VUR: large cystometric capacity correlated with VUR during filling, while VUR at voiding correlated with low cystometric capacity, with the first pattern showing a lower resolution rate within the third year of life, in a longitudinal study by videocystometry.³⁸¹ There is ample evidence to show that treating the DO and/or voiding dysfunction leads to a faster rate of resolution of VUR (63-92% within 1 year)^{382 383} than treating only with antibiotics (25-54%).³⁸⁴ UUT damage is more likely to occur in children with abnormal LUT function.³⁸⁵ In this setting, history taking about voiding habits and accurate non-invasive UDS evaluation become paramount. Question remains if cystometry with pressure flow studies in older children are advised. In a study on 40 patients, VUDS showed LUTD in 76% of the children,³⁸⁶ and in a recent prospective study of 147 children with high grade VUR, normal patterns were found in only 23% of them.³⁸⁷ In patients who had post-treatment UDS, biofeedback, pelvic floor muscle training and treatment with antimuscarinics effectively decreased detrusor pressure, increased cystometric capacity and maximum flow rate, and reduced the grade of VUR.³⁸⁸ It is nowadays reasonable to diagnose LUTD by non invasive tests and to consider VUDS in therapy resistant patients, paying attention to bladder neck dysfunction, which was shown to be relevant in a randomized trial.³⁸⁹ Many clinicians advocate UDS especially for those patients that still have UI, renal damage, or who are about to undergo surgical correction,^{390 391} even if precise UDS (pressure flow) criteria for outlet conditions in children are still undefined.

4.7. Urethral Stricture

Urethral stricture disease in boys is rare, usually arising from a previously unsuspected straddle injury or the late result of hypospadias repair. Uroflowmetry can accurately predict the presence of a urethral stricture in 88% of affected males.³⁹² A urethral obstruction after hypospadias repair may develop asymptomatic and uroflowmetry can be helpful³⁹³ demonstrated by significantly different pre- and post-meotomy findings of Q_{max} (P .001) and voiding times (P .03).³⁹⁴ Follow-up uroflowmetry, analysing and comparing the maximum flow rate, voiding times and

curve pattern may alert the clinician to early signs of (re-)stricturing but the precise interval, frequency (and efficacy) of periodic uroflowmetry testing in these patients have not been corroborated.³⁹⁵

4.8. Conclusions (Level 3)

- Many case series have demonstrated frequent UDS abnormalities, predominantly DO and reduced bladder compliance or large cystometric capacity with impaired filling sensation, in children with PUV, urethral stricture, ectopic ureterocele, VUR or with bladder exstrophy.
- Proper UDS has been shown to be of help to determine when further medical or surgical management is indicated in children with these abnormalities.
- The use of UDS has aided in an objective measurement of success or failure of treatments for these abnormalities.

4.9. Recommendations (Grade C)

- Clinicians should consider complete UDS of the filling and voiding function, at least once, in children with PUV, urethral stricture, ectopic ureterocele, VUR or with bladder exstrophy.
- UDS in children should be done with special attention to their specific needs, and with careful attention to minimize mental trauma and to ensure representativeness as much as possible.
- Clinicians should consider regular uroflowmetry and PVR assessment in the follow-up and further management of children with PUV, urethral stricture ectopic ureterocele, VUR or with bladder exstrophy.
- Clinicians should consider the necessity of follow-up UDS on an individual basis and as less frequent as possible.

5. FUNCTIONAL DISORDERS OF THE LOWER URINARY TRACT

5.1. ICI2013 Conclusions and Recommendations

ICI2013 found that various studies had been showing that treatment of children with functional UI (and of the, frequently associated, bowel elimination problems) can be initiated on the basis of history, clinical exam, bladder diaries, bladder ultrasound and (free) uroflowmetry with PVR assessment. Furthermore various studies, reviews and guidelines agree on the relevance of UDS in children with UI and nocturnal enuresis resistant to initial (conservative) treatment.

The ICI2013 recommended (Grade B) uroflowmetry and PVR assessment (until -for the individual child-representative values are obtained, if possible) as 'non-invasive urodynamic'-screening and evaluation

in all children with LUTS, UI and/or with nocturnal enuresis resistant to first line therapy. ICI2013 suggested urological signs and symptoms assessment in children with chronic constipation and ICI2013 recommended complete UDS in children with UI and/or with nocturnal enuresis resistant to conservative treatment, if invasive or clinical (dry-bed training) treatments are contemplated.

5.2. Discussion and New Evidence 2016

When assessing functional disorders involving the LUT in children, one must take into account the dynamics of the maturing nervous system, learned habits of elimination for bladder and bowel function and social influences

5.3. Diurnal Incontinence

UDS (invasive) has a limited place in diurnal (day and night) UI. This condition is not considered worrisome before age 5 or 6.³⁹⁶ UI in children can have many causes, and history and clinical investigation are very important in this regard. Therefore, it is imperative to formulate a 'urodynamic question(s)' following a comprehensive history, careful physical examination, and standard urological investigations, possibly with the aid of validated questionnaires.^{397 398 399} It is well known since several years that UI can also coincide with dysfunctional voiding and/or bowel elimination problems.⁴⁰⁰ Treating these bladder and bowel dysfunctions, with behavioural modification, biofeedback training, drug therapy, is necessary before considering UDS. Nowadays, the expression 'Elimination syndrome' has been substituted by Bowel/Bladder Dysfunction (BBD), to better underline a clinical condition involving abnormal habits and dysfunction of both the lower urinary and bowel tracts.⁴⁰¹

Uroflowmetry with a PVR urine and simultaneous EMG determination are the the tests of choice, and results from uroflowmetry should be compared with information from the

patient's Frequency/Volume Charts. Bladder volume may affect uroflowmetry: it was theorized that Q_{max} is physiologically dependent on bladder volume, thus researchers are trying to identify other factors that may be more important in what determines Q_{max} .⁴⁰² Sonographic estimation of PVR volume should complete the assessment: in children <6 years, a repetitive PVR of >20 ml or >10% cystometric capacity is considered elevated; while in children >7 years, repetitive PVR >10ml or 6% cystometric capacity is regarded as elevated.⁴⁰³ Some (expert and/or single centre) evidence is emerging for uroflowmetry + EMG evaluation and investigators have looked at the time differential between relaxation of the external urethral sphincter (as measured by patch perineal electrodes) and the opening of the bladder neck on VUDS. This parameter (labeled 'lagtime') was not corrected for meatus to flowmeter distance but was nevertheless considered a sign of DO, when prolonged >2 seconds

and it was suggested that this lag time could also indicate bladder neck dysfunction if the time exceeded 6 seconds.⁴⁰⁴

In all children with non-neurogenic LUTS non-invasive UDS is warranted to determine the presence of different forms of LUTD, and to assess bowel dysfunction as well. Bowel dysfunction, in the absence of any anatomical or neurological deficit, often affects LUT function and contributes to UI in a number of ways. Constipation had been shown in the past to be associated with DO and a reduced functional bladder capacity.⁴⁰⁵ Understanding and eliminating this possible aetiology can normalise LUT function, as stated by the report from the Standardisation Committee of the International Children's Continence Society⁴⁰⁶ In a recent prospective study from urological and gastroenterological clinics in one center, 68% of subjects referred with UI, and/or constipation and/or faecal incontinence and included, had at least a 50% reduction in number of daytime UI episodes and 27% became completely urine -continent by successful relief of bowel (constipation and/or faecal incontinence) dysfunction.⁴⁰⁷

Persistent daytime and night-time UI, resistant to conventional therapy may require (V)UDS. In several reports over 20 years, different UDS findings had been found, with DO (in 57%), dysfunctional voiding (in 22%) and also normal findings in 14%.^{408 409} Dysfunctional voiding was also reported associated with DO in up to in incidence of 76%.^{410 411} Many of those studies use terms that are outdated now and those should be replaced ('transformed' where possible) with the new.⁴¹²

Apart from the above mentioned NLUTD, co-morbidities other than bowel dysfunction may be present such as psychiatric and psychosocial ones. Several recent studies well designed by validated questionnaires, were conducted, including a case-controlled one on autism spectrum disorders which showed a significant incidence of LUTS, with a total problem score of 70% (versus 2% in controls) and concluded that screening for UI and, if indicated, treatment of the dysfunction(s) is recommended.⁴¹³ In a study on 68 children with attention deficit-hyperactivity disorder (ADHD), the total dysfunctional voiding score in the ADHD symptoms group was significantly higher (P .05) than in non-ADHD children.⁴¹⁴ Other social and behavioral conditions were investigated in children referred with signs and symptoms of LUTD, such as obesity or underweight;⁴¹⁵ bullying (a quarter of American school children are regularly bullied);⁴¹⁶ and sexual abuse and found these to have a higher LUTS-score and/or a higher incidence of UI.⁴¹⁷ Regarding bullying, UI is more frequent in females and in those children with higher bullying scores; physical forms of bullying accounted for worse voiding severity scores.⁴¹⁸

Greater attention has been recently paid to check the prevalence of LUTS and UI in a series of genetic dis-

orders with cognitive/behavioral or potential neurological problems, in order to reassure the families and to screen the cases which may require treatment. For example, in a case-control study, out of 326 children with Down's syndrome, it was found that there is a marked delay in toilet training (average 5.5 years), and UI was reported in 46% of (versus 24% in controls) previously toilet trained children.⁴¹⁹ Children with Williams syndrome, which comprises mild intellectual disability, have high rates of daytime UI and enuresis, reducing with age: daytime UI decreased from 18% in children to 0% in adults, while enuresis (45% in children) persisted in 4% of adults.⁴²⁰

UDS has clearly improved our understanding of the aetiology of diurnal UI but no study has shown that UDS characterisation of any abnormality has improved the efficiency of treatment for these children. In any case, pretreatment UDS is considered to be required before invasive treatments in children with therapy resistant diurnal UI. Sacral neuromodulation has been demonstrated to improve refractory bowel bladder dysfunction,⁴²¹ with more benefit if DO is shown on UDS.^{449 422}

5.4. Enuresis (Nocturnal)

Night-time wetting (nocturnal enuresis) is a condition that is common in children aged 5 years but which improves with time, so that less than 15% of pubertal boys and 5% of pubertal girls continue to be affected.⁴²³ Multiple causes for the persistent wetting have been implicated, ranging from genetic factors, to maturational delays, sleep disturbances, social causes, psychiatric conditions (as attention deficit disorders),⁴²⁴ to LUTD and/or abnormal vasopressin secretion.^{425 426}

It is now commonly considered essential to discriminate Monosymptomatic Nocturnal Enuresis (MNE) from Non-Monosymptomatic one (NMNE). According to the ICCS definitions, NMNE consists of two different disorders: nocturnal enuresis and LUTD identical to those with daytime UI except that daytime UI does not occur.⁴²⁷ It is generally not necessary to conduct UDS until adolescence, to determine why the UI has not abated. Non-invasive exams are important for enuresis subtyping, relevant for selection of treatment modality.⁴²⁸ An abnormal micturition history, or dysfunctional voiding symptoms like squatting and/or abnormal voiding charts, predicted abnormal UDS results correctly, with a sensitivity of 81% and specificity of 86%.⁴²⁹ A bladder volume and bladder wall thickness index less than 70 was a predictor for the presence of DO at cystometry in one cohort.⁴³⁰ A bladder capacity at night (enuretic capacity) was significantly less in those with nocturnal enuresis versus those without.⁴³¹ A recent study from a series of 720 children showed significant differences between MNE and NMNE patients as both maximal VV and nocturnal urine volume, which were lower ($P < 0.001$) in NMNE patients. Out of 500 patients who were initially referred as desmopressin resistant, 33% of these be-

came dry on desmopressin monotherapy, demonstrating how relevant is the UDS diagnosis of enuresis subtyping for selection of treatment.⁴³² On this regard, it was shown that treating the non monosymptomatic child using antimuscarinic agents can be very effective (as high as 77% cure) when based on the findings of UDS.^{433 434}

An emerging issue which requires further research, is the progression of enuretic children into adulthood. Enuretic children were found more likely to have nocturia and urinary urgency if they had nocturnal enuresis when > 12 years of age.⁴³⁵ In a retrospective case-control study, 57 women were investigated using a validated questionnaire. The results demonstrated that the prevalence of LUTS was much higher (mainly UI, $P .0001$) in patients who initially presented for LUTS/UI in childhood than in age-matched controls (school nurses).⁴³⁶

5.5. Conclusions (Level 2/3)

- Various studies show that treatment for children with functional UI (and of the, frequently associated, bowel dysfunction) can be initiated on the basis of history, clinical exam, bladder diaries, bladder ultrasound and uroflowmetry with PVR assessment.
- Various studies, reviews and guidelines agree on the relevance of UDS in children with UI and nocturnal enuresis resistant to initial (conservative) treatment.
- There is evidence from epidemiological studies, carried out by validated questionnaires, that several neurological/cognitive/behavioural disorders (i.e. genetical diseases, autism, ADHD) have an association with LUTS and UI.
- There is evidence that also social and/or behavioural conditions (i.e. obesity, bullying) have a significant incidence of high LUTS-score and/or UI.
- The neurological diseases and social conditions with potential LUTS and UI should be evaluated at least by bladder diaries and questionnaires, possibly by non-invasive UDS.
- The potential risk factor for adult women to have UI if they suffered from LUTS as girls may require long-term accurate follow-up.

5.6. Recommendations (Grade B/C)

- The committee recommends uroflowmetry with pelvic floor EMG and PVR assessment as 'non-invasive urodynamic'-screening and evaluation in all children with LUTS, UI and/or with nocturnal enuresis resistant to first line therapy.
- The committee suggests urological signs and symptoms assessment in children with chronic constipation and/or fecal incontinence.

- The committee recommends complete UDS in children with UI and/or with nocturnal enuresis resistant to conservative treatment, if invasive or clinical (dry-bed training) treatments are contemplated.

5.7. Suggestion for Research

- The committee suggests that further integrated approaches to the diagnosis (and management) of children with bowel dysfunction, in combination with LUTD are undertaken.
- Longitudinal studies on persistence of LUTS/UI in adults are suggested, to be integrated with retrospective studies in adults suffering of UI, in order to evaluate if having LUTS in children is a risk factor for UI in adulthood.

between methods, more diverse voiding patterns were identified in AU, suggesting that UDS may not be sensitive enough to the variability of LUT pathophysiology in children.⁴³⁷ 'Functional' bladder capacity (as derived from the voiding diary, without the first void in the morning) is presented as a relevant parameter for the clinician in the ICCS definitions.⁴³⁸ Confirmed by the subsequent ICCS revised document.⁴³⁹

In the UK health care system a minimum number of tests is considered of relevance for the maintenance of sufficient expertise which is also specified for the number of children (30 /annum) to ensure quality.⁷⁸

Following the above clinical assessment by diaries - as underlined in the paragraph 'Diurnal Incontinence' - efforts have been done in the recent years to better standardize non-invasive tests. Uroflowmetry, which is the indispensable first-line test for children with suspected LUT dysfunction, must be accompanied by ultrasound PVR measurement. Uroflowmetry should be evaluated according to precise criteria and may be performed in conjunction with pelvic floor EMG. More accurate nomograms were recently stated for uroflowmetry analyzing, 721 records,⁴⁴⁰ and for PVR, analyzing (single and dual) PVR in healthy school children.⁴⁴¹ Unfortunately, there is still a tremendous amount of intra- and interobserver variation in defining the shape of curves, but studies are showing how uroflowmetry-analysis can be more reproducible using standardized evaluation and using a 'flow index'.⁴⁴² Uroflowmetry may be also more reliable if performed with simultaneous EMG;^{443 444 445} inter-rater agreement in a study on 84 uroflow-EMG studies was suboptimal and disagreement may be lowered by simplifying diagnostic criteria and allowing assignment of multiple diagnoses.⁴⁴⁶ Ultrasound bladder wall thickness measurement is gaining interest: in a prospective study on 324 children; healthy and dysfunctional voiders, a good sensitivity (based on anterior wall thickness: 67% and based on posterior wall thickness 83%) for symptoms of dysfunctional voiding was obtained.⁴⁴⁷ Another study in children with BOO (PUV), found detrusor thickness greater than 1.3 mm in a multivariate analysis as the only independent risk factor (P .004) for later impaired bladder function.⁴⁴⁸ Dynamic pelvic floor ultrasound is under evaluation for normative values of endurance and direction of pelvic floor movements.⁴⁴⁹ A cut-off diagnosis for specific non-neurogenic dysfunction for any of the non-invasive tools would be desirable.

Invasive UDS are considered to be indicated when non-invasive investigation raises suspicion of neurogenic detrusor-sphincter dysfunction (occult spinal dysraphism), obstruction (i.e., PUV), genitourinary abnormalities (i.e., exstrophy, epispadias), profound non-neuropathic detrusor-sphincter dysfunction (children with dilating VUR and recurrent febrile UTI), or significant PVR of unknown cause.⁴⁵⁰ To assess the voiding phase, pressure flow studies are performed immediately after filling cystometry. In children, the

6. TECHNICAL CONCERNS: RELIABILITY AND REPRODUCIBILITY OF TESTS

6.1. ICI2013 Conclusions and Recommendations

The ICI2013 concluded (on the basis of various studies to determine normal and test retest values for UDS in children) that, within the limits also provided for adults, UDS in children is reliable and reproducible. Although it is plausible and considered useful to reduce filling speed and catheter size in relation to patient size, the exact values can not be given and the influence of the transurethral catheter size on (children's) voiding is unknown. The ICI2013 concluded that standards for pressure flow analysis in children are lacking.

The ICI2013 recommended (Grade C) that the specific demands of children, physically, as well as psychologically, be taken into account, before UDS is carried out, as well as during the testing. The ICI2013 advises specialised workers, units and equipment to ensure this. The ICI2013 recommended that invasive diagnostic tests should be done if indicated by the results of non-invasive procedures and should be done only when the outcome will or can alter management and recommended that clinicians take into account the variability and test retest differences of UDS in children and also take into account the effect of the (apparent psychologically stressing) laboratory-situation on the child's behaviour, and the implications for the results of the tests.

6.2. Discussion and New Evidence 2016

Often, differences in UDS parameters exist from one study to another. In pediatric patients there is concern that the reliability of measurements could be influenced by development effects and measurement variability, as well as by the unfamiliar clinical environment. A recent study, comparing (conventional) UDS with Ambulatory UDS: even if flow rates were similar

transition from filling to voiding is not as easily managed as in adults. To avoid missing this important transition, cystometry and pressure-flow/EMG measurements should preferably be performed as one continuous study. Available reports on detrusor pressure during voiding in symptom free children is reported to give a wide range, that is between ± 50 - 60 cmH₂O in one study.⁴⁵¹ In infants the average detrusor pressure at voiding was reported another study to be 127cmH₂O in boys and 72 cmH₂O in girls on standard fill cystometry,⁴⁵² similar to what found in another study by natural fill cystometry.⁴⁵³

When filling by catheter, slow fill cystometry (5–10 percent of estimate bladder capacity per minute, or <10 ml/min) is recommended, as compliance (predominantly) and DO (possibly) may be significantly altered by faster rates of filling.^{454 455 456} In infants, temperature of the infusate may influence cystometric capacity and DO; however, its clinical relevance remains unknown.⁴⁵⁷ Most children readily tolerate a 6- or 7- Fr. double lumen transurethral catheter to fill the bladder and record pressure. In selected cases, a suprapubic catheter may be inserted under general anesthesia the previous day or several hours earlier on the same day, but risks need to be juxtaposed against benefits of this approach.⁴⁵⁸ It has been postulated that transurethral catheters (6 or 7 Fr.) do not significantly obstruct the urethra.⁴⁵⁹

Avoiding general anesthesia is important as this affects the natural state and eliminates the chance for voiding.⁴⁶⁰ Most children can undergo UDS without pre-medication; only the most agitated may require some degree of sedation.⁴⁶¹ To reduce anxiety, the study may also be performed with the child seated, watching a video or DVD and accompanied by one or both parents. Following previous consultation recommendation,^{462 463 464} the ICCS standardiation on UDS studies of the LUT in children confirmed that UDS in children are best performed under the auspices of a knowledgeable urologist or trained urodynamacists; so that children should receive comprehensive UDS in a laboratory that is specialised in paediatric UDS with appropriately trained personnel.^{465 466}

6.3. Conclusions (Level 3)

- The committee concludes (on the basis of various studies to determine normal and test retest values for UDS in children) that within the limits also provided for adults, UDS in children is reliable and reproducible.
- Non-invasive tests are gradually achieving more evidence level, by constructing normative values and more standardized performing of the tests
- Although it is plausible and considered useful to reduce filling speed and catheter size in relation to patient size, the exact values cannot be given and the influence of the transurethral catheter size on voiding is unknown in children.

- The committee concludes that standards for pressure flow analysis, and information on non-invasive PFS in children are lacking.

6.4. Recommendations (Grade C)

- The committee recommends that the specific demands of children, physically as well as psychologically are taken into account, before UDS is carried out as well as during the testing. The committee advises specialised workers, units and equipment to ensure this.
- The committee recommends that non-invasive diagnostic tests should be preferred, and invasive ones should be done only if indicated by the results of non-invasive procedures, in neurogenic lesions to discover risk conditions, and when the outcome will or can alter management.
- The committee recommends that clinicians take into account the variability and test-retest differences of UDS in children and also take into account the effect of the (apparent psychologically stressing) laboratory-situation on the child's behaviour, and the implications for the results of the tests.

6.5. Suggestion for research

- The committee suggests to elaborate on standardisation of UDS evaluations and on criteria to judge how the 'laboratory' circumstances have influenced the child's (LUT) behaviour, with the aim to better include how well UDS have represented the actual LUTD, in the evaluation of the test.
- The committee suggest to verify if, how and when non-invasive tests can substitute UDS in the accuracy of diagnosis of functional LUTD in children.

IX. PATIENT EVALUATION: FRAIL ELDERLY

1. INTRODUCTION

1.1. 2013 Recommendations and Conclusions

ICI2013 concluded that UI in the frail elderly commonly has diverse and multiple coexisting factors. Retrospective ('clinical cohort') single centre reports confirm that general health, mobility neurologic diseases, medications and 'direct' effect of aging on the LUT all have effect on LUT function. Also in the frail elderly, symptoms and signs are unreliable to predict LUT (UDS) dysfunction. The committee concluded that bedside UDS (one channel cystometry) has inherent unreliability and no evidence exists to quantify the risks (of false positive diagnosis) versus the advantages ('simplicity'). The committee concluded also

that determination of PVR is considered relevant in all frail elderly with LUT dysfunction on the basis of expert opinion and good clinical practice -guidelines.

The 2013 committee recommended that frail elderly, with UI, are evaluated by a clinician skilled in the care of those patients and that all contributing factors are managed, before further urological diagnostics are started. The committee recommended also that (standard) UDS should be offered to all elderly regardless of the comorbidity (not responding to relevant management) if specific further treatment is deemed appropriate (possible).

1.2. New Evidence 2016

Also in the elderly UI is associated negatively with HRQoL and with similar impact in both men and women, mostly noticed in the dimensions of energy, social isolation, and physical mobility.⁴⁶⁷ OAB-S is common in older adults and associated with impairment in mental health and HR-QoL, but rates of treatment seeking behavior are low.⁴⁶⁸ OAB-S and UUI symptoms severity progress dynamically and are also sustained over time, although in a 5 years period also symptoms reduction may be observed.⁴⁶⁹ Elderly patients with OAB-S and DU might also develop a large PVR volume after antimuscarinic treatment.⁴⁷⁰ The role of urothelium is, also in the elderly, considered of relevance in the pathophysiology of LUTD⁴⁷¹ and urinary inflammatory proteins have generated some attention.⁴⁷² The frail elderly are reported to have a higher risk of developing DO and/or DU.⁴⁷³ UDS findings in the (frail) elderly tend to demonstrate DO.⁴⁷⁴ ⁴⁷⁵ even in individuals that do not spontaneously report symptoms or bother. There may also be a reduction in cystometric capacity, urinary flow rate and detrusor contractility.⁴⁷⁶ The invasive nature of conventional UDS becomes a relatively more important factor in the old or frail elderly, who may be more vulnerable to any intervention than younger people. There was a significant association between age and the presence of asymptomatic bacteriuria before cystometry and between the bacteriuria and urinary urgency (without DO) on cystometry.⁴⁷⁷ Elderly patients with DU may have large bladder volume, but small VV and large PVR volume, suggesting diminished central sensitivity to volume afferent activity in the aged bladder.⁴⁷⁸ In patients with DM, the PVR volume was significantly increased, in addition to OAB-S in the elderly.⁴⁷⁹

Some recent reviews have summarized medication use, especially polypharmacy and the effect on the lower urinary tract. Contrary to, or before adding another medicine (or management) in a frail elderly person with LUTS or LUTD, it might be wise to consider reducing other medication to ameliorate medicine (side effect) associated -LUTD and symptoms.⁴⁸⁰ ⁴⁸¹ ⁴⁸²

UDS is reserved for patients in whom conservative management and medical management, directly or indirectly aimed at LUT-function improvement, has failed or has proved inadequate, and in whom more

intensive or invasive therapy is being considered. The place of UDS in the frail elderly with UI is less precisely established. There is very little objective evidence for or against clinical UDS in this population group. UDS should be performed in the workup of vulnerable elders when surgical intervention is considered according to the guideline of American geriatrics.⁴⁸³

- As UI in frail elderly people may be the result of a number of contributory factors, many of which are reversible by simple measures, such patients should be first evaluated by a clinician skilled in the care of older people before any invasive investigations or more potentially harmful medications are given.
- There is direct and indirect evidence that UI in the (frail) elderly often has diverse and/or multiple coexisting factors.
- Apart from general health, mobility, neurological diseases and medications, the LUT is directly affected by aging of the detrusor, and the detrusor muscle function can be(come) both overactive during storage as well as underactive during voiding. Furthermore growth of the prostate; aging of the bladder outlet and decline in striated pelvic floor muscle function are commonly of relevance.
- In common with all patients, but maybe even more relevant; symptoms are not synonymous with the abnormalities that can be measured with UDS.
- Every test or (invasive) procedure can cause harm in the (vulnerable) elderly but there is no published evidence that UDS cause significantly more harm in the elderly.
- Simple bedside UDS has an inherent unreliability, and it is unclear whether the risk of misdiagnosis outweighs the 'simplicity' over conventional UDS.
- Especially, but not exclusively, male elderly patients, with central neurological disease, can have urologic disease (e.g. prostatic BOO) as a cause for UI or other LUTD.

1.3. Recommendations (Grade B-C)

- PVR measurement by a non-invasive method is recommended before institution of pharmacological or surgical treatment of UI. It should be repeated to monitor the effect of such treatment. Uroflowmetry should be used to screen for voiding abnormalities prior to invasive treatment in the elderly.
- Simple cystometry can be considered as a 'screening test' for non- invasive, or other low risk treatments, when a urethral or suprapubic catheter is already present for management.

- The committee recommends offering comprehensive UDS to all elderly, with due consideration to any co-morbidity, that may have not responded to management of relevant contributing factors, and/or behavioural or pharmacological therapy, and in whom further invasive therapy is considered.
- Frail elderly patients are more vulnerable to complications and UDS -data specific for the treatment of OAB-S in the frail elderly is limited.

1.4. Urinary Urgency Incontinence in Frail Elderly Patients

1.4.1 Recommendations 2013

In non-systematic reviews on pharmacotherapy UDS do not play an important role to initiate treatment for OAB-S in the frail elderly.^{484 485 486} Among the frail elderly, UI is the paramount troublesome symptom, in both men and women, with a steeply rising incidence after age 80.⁴⁸⁷ The type of UI appears to be predominantly UUI.

The symptoms of UUI are, also, or especially, in elderly women, frequently the result of DO, which can be shown with filling cystometry. The reason to perform UDS might therefore be to confirm this abnormality but identification of coexisting or alternative abnormalities may be of importance. Two industry supported reviews have found a paucity of specific evidence for the risks and efficacy of pharmacotherapy for DO or OAB-S in the frail elderly but have also not found that pharmacotherapy or conservative (behavioural) management is very risky in these patients.^{486 488} Reduced bladder sensation or 'awareness' in the frail elderly may lead to reduced warning (time) of impending leakage, and it is postulated that a (cognitive/cerebral) neurological cause may be co-existing and responsible for LUT symptoms in the elderly.^{489 490}

In symptomatic elderly people, UUI frequently coexists with incomplete bladder emptying. Incomplete emptying may be a sign of impaired bladder contractility, now termed by the ICS as detrusor underactivity. The UDS abnormality underlying UUI with incomplete emptying (assuming no BOO) has been introduced some decennia ago as 'DHIC (detrusor hyperactivity with impaired contractile function)'.⁴⁹¹ Its significance is that the standard pharmacological treatment of UUI – with antimuscarinics – may affect bladder emptying thus reducing the effect on symptoms of frequent voiding, by increasing PVR. In frail elderly women, DO is reported to be the commonest UDS diagnosis in a large retrospective series of referred elderly women.⁴⁹²

With regard to male elderly patients, a total of 185 men who had persistent LUTS after TURP were evaluated with VUDS in one single center study. A normal VUDS tracing was found in 9%, pure DO in 10%, DU in 19%, DHIC in 14%, poor relaxation of the urethral sphincter in 19%, and recurrent or remaining BOO in

28%.⁴⁹³ A significant proportion of patients might develop (transient) de novo UUI after photoselective vaporization of the prostate. Pretreatment UDS demonstrated that small bladder volume at first desire to void and small maximal cystometric capacity are predictive factors for this.⁴⁹⁴ Older age was, apart from UDS predictors also a risk factor for posttreatment UUI in this study but transurethral laser treatment is not considered extremely risky in the very old in another evaluation.⁴⁹⁵ A lower long-term success rate and an increased risk of large PVR after intradetrusor BoNT-A injection for refractory idiopathic DO has however been noted in frail elderly patients although safety and short time efficacy were similar between elderly patients without frailty and younger patients.⁴⁹⁶

1.4.2 Conclusions

- No evidence exists that age by itself or frailty are contraindication to UDS and guidelines recommend UDS for the elderly following the principles similar to the younger; in general UDS is reserved for patients in whom non-invasive diagnosis and conservative and/or medical management have failed and in whom more intensive or invasive therapy is being considered.
- DO, DU and/or reduced filling sensation may co-exist also in elderly or frail patients with UI. In addition, elderly men (and lesser prevalent, women) may have BOO.
- It has been shown that voiding efficiency and PVR should carefully be monitored in the elderly patients and especially in frail elderly men during treatment with antimuscarinics as well as with intradetrusor BoNT-A injection.

1.5. Stress Urinary Incontinence in Frail Male Elderly Patients

Among older men, SUI is almost entirely confined to RRP patients. Approximately 1% of patients who have undergone TURP or laser TURP suffer from post RPP UI.^{497 498} The majority of SUI after RRP is caused by urethral sphincter damage during operation the effect of exercise programs was not observable in urethral pressure profile measurements.⁴⁹⁹ UDS in post RPP UI showed no significant change in filling or voiding parameters when suburethral 'male'-slings were implanted.⁵⁰⁰ Sequential UDS evaluation of patients with post RRP UI revealed urethral sphincter and bladder function worsen immediately after RRP and recover over time.⁵⁰¹ The urinary continence rates were gradually improved to a satisfactory level in more than 80% of patients by 12 months after RRP.⁵⁰² In addition to a lower MUCP, a reduced bladder compliance, de novo DO, and DU are commonly observed in patients with post RRP UI.^{503 504} However, DU did not affect UDS parameters and LUTS improvement after RRP.⁵²⁸

1.6. Conclusions

- UI in elderly men may be the consequence of ineffective emptying and BOO.

- UI in elderly is however also frequently iatrogenic; caused by RRP or transurethral resection of the prostate.
- UI after prostate surgery may recover spontaneously and/or with conservative management within a period of 12 months in the predominance of men.
- Patients with post RPP UI might have a low MUCP, a reduced bladder compliance, de novo DO, or DU, and UDS may have an important role in identifying the bladder and urethral dysfunction in patients with prolonged post RPP UI in order to establish appropriate treatment strategy.
- UDS may have a role in identifying the bladder and urethral dysfunction in patients with prolonged post RPP UI in order to establish appropriate treatment strategy.
- There is paucity of evidence about reproducibility and reliability of UDS in the elderly.

2. TESTS IN THE GERIATRIC OR FRAIL ELDERLY POPULATION

2.1. Filling Cystometry

In a prospective 3 arm study with oxybutynin, biofeedback-assisted behavioural training and a placebo control condition in women with a mean age of 67 years, UDS parameters (filling sensation, cystometric capacity and voided volumes) improved in all. The improvement in UI was however related to the UDS changes observed in this small series, probably because of diverse UDS diagnoses at inclusion, as well as a consequence of the variability of the UDS outcome.⁵⁰⁵

2.2. Post-Void Residual Urine

PVR is believed to depend on the presence of BOO as well as to relate to DU.⁵⁰⁶ Thus, in a man, the presence of substantial PVR (> 100 mL), in the absence of a large prostate, and/or severe BOO, may suggest that the increased PVR is mainly due to a reduction in detrusor contractility.⁵⁰⁷ PVR volume varies in a given individual and can wax and wane over time. Significant daily variations have been observed in elderly patients of both sexes, with larger PVRs (up to 40% greater) being measured in the early morning.⁵⁰⁸ Elderly patients with DU may have small VV and large PVR volume, suggesting diminished central sensitivity to volume afferent activity in the aged bladder.⁵⁰⁹ In patients with diabetes mellitus, the PVR volume was significantly increased, which might increase the distress of voiding dysfunction, in addition to OAB-S in the elderly.⁵¹⁰

2.3. Pressure-Flow Studies

Driving a contraction to its maximum load (and zero contraction velocity) in a manner to evaluate muscle force, and stop-flow test is the practical way to do this.

Voluntary stop test are not clinically validated to evaluate DU, but occlusion stop tests can be of relevance to evaluate the effect of treatments that affect detrusor voiding contraction in the elderly.⁵¹¹

3. EVIDENCE THAT PERFORMING URODYNAMIC STUDIES IMPROVES CLINICAL OUTCOMES IN THE GERIATRIC POPULATION

Pre-operative UDS was not able to predict the outcome of a popular SUI procedure in older women in this single centre uncontrolled cohort.⁵¹² Regarding the diagnostic evaluation of LUTS in older men, an International Consultation on New Development in Prostate Cancer and Prostate Diseases concluded that the frequency volume chart is recommended when nocturia is a bothersome symptom to exclude nocturnal polyuria. The use of UDS and transrectal ultrasound can be limited to situations in which the results are likely to benefit the patient such as in selection for surgery.⁵¹³ DO or LUTD with or without BOO are present in patients with Parkinson's disease. UDS is recommended for men with Parkinson's disease with symptoms of LUTD since early and effective treatment can improve the bladder function and quality of life.⁵¹⁴

The therapeutic efficacy and tolerability of a beta 3 adreno antagonist (mirabegron) were similar between patients with >65 and >75 years of age with OAB-S (with and without UI); UDS evaluation was not performed in this study.⁵¹⁵ In a randomized trial for men with LUTS and BOO, mirabegron was demonstrated not to adversely affect voiding UDS (maximum urinary flow and detrusor pressure at maximum urinary flow) compared with placebo after 12 weeks of treatment.⁵¹⁶

4. THE PRACTICAL INDICATIONS FOR URODYNAMIC STUDIES AND WHICH TESTS ARE NEEDED

4.1. Post-Void Residual Urine

In the elderly, PVR urine measurement is indicated before treatment of UI either with anticholinergic medication or by SUI surgery. A consistently large PVR certainly is a reason for caution, and careful monitoring of bladder emptying is needed.⁵¹⁷ After intradetrusor BoNT-A injection for OAB-S, large PVR volume (greater than 150 ml) after BoNT-A injection was significantly higher in the frail elderly group than in the non-frail elderly or younger patient groups (61% versus 40% and 36%, respectively, (P .018)).⁵¹⁸ PVR monitoring was considered to be relevant after intradetrusor BoNT-A injections in the frail elderly.

4.2. Uroflowmetry

Uroflowmetry is a simple and non-invasive test. A normal uroflowmetry pattern without much PVR probably rules out significant BOO or DU, but this finding is unusual in the elderly. Uroflowmetry (with PVR measurement) may be a useful screening tool prior to instituting therapy. However, in a retrospective study of hundred women tested, the first free flow was inconclusive in 44% but was interpretable in 91% on the second free flow.⁵¹⁹

4.3. Pressure-Flow Studies

There is weak evidence to suggest that prostatectomy may improve the continence if UDS shows 'severe' BOO in Parkinson's disease patients.⁵²⁰ If BOO is equivocal or absent, then there is little point in performing surgery in an attempt to alleviate the signs and LUTS (presumed to be) 'related to BOO'. After screening with uroflowmetry and PVR measurement, pressure-flow studies may be indicated in older men in whom BOO cannot be ruled out otherwise and surgery is at least contemplated.

4.4. Recommendations (Grade C)

- PVR measurement by a non-invasive method is recommended before institution of pharmacological or surgical treatment of UI. It should be repeated to monitor the effect of such treatment.
- Uroflowmetry should be used to screen for voiding abnormalities prior to invasive treatment in the elderly.
- Filling cystometry, as a single investigation, has limited value in this patient population. 'Simple cystometry' is not recommended.
- Simple cystometry can be considered as a 'screening test' for non-invasive, or other low risk treatments, when a urethral or suprapubic catheter is already present for management. However, the low specificity and sensitivity towards complete UDS diagnosis must be taken into account.
- The ICI2013 recommended offering comprehensive UDS to all elderly, with due consideration of any co morbidity, that have not responded to management of relevant contributing factors, and/or behavioural or pharmacological therapy, and in whom further invasive therapy is considered.
- The ICI2013 recommended that comprehensive UDS be performed in centres with a special interest in UI in the frail elderly, by trained and certified staff who frequently perform UDS of patients referred with suspected LUTD.
- To maintain adequate expertise in this difficult-to-examine patient population and to provide a background of 'regular' patients against whom specific patients can be judged, it is essential

that centres examine substantial numbers of patients for LUTD; frail elderly as well as 'routine' patients.

5. THE URODYNAMIC PARAMETERS IMPORTANT IN VARIOUS GERIATRIC CONDITIONS

UDS can be of relevance to determine the most important cause of the LUTS in the elderly, where central nervous system disease is a frequently occurring comorbidity and where clinical signs and symptoms of LUTD are regularly more difficult to obtain or to isolate. Brain disorders such as stroke, Parkinson's disease and white matter disease may decrease the tolerance of bladder filling and also increase the prevalence of OAB-S in the elderly population.^{521 522} In a community health survey, 31% of patients with central nervous system disease reported OAB-S, and the overall prevalence of neurogenic OAB-S was 1%. Patients with neurogenic OAB-S have a poorer HR-QoL compared to patients with idiopathic OAB-S.⁵²³ The pathogenesis of OAB-S in cerebral events involves not only sensory perception but also the impairment of detrusor (voiding) contractility. Patients with a cerebrovascular accident or Parkinson's disease have DO and inadequate contractility or DU resulting in increased PVR volumes.⁵²⁴

5.1. Parkinson's Disease

DO associated with Parkinson's disease is reported to occur at smaller bladder volumes than DO in BOO-related DO. The duration and severity of Parkinson's disease were reported not to be related to the UDS results. Patients with Parkinson's disease have a higher risk of falls and falls, but not the frequency of urination were associated with urinary urgency in a prospective observational study.⁵²⁵

DO or LUTD, with or without BOO, are present in patients with Parkinson's disease. UDS is recommended in men with Parkinson's disease with LUTD. Early and effective treatment can improve the LUT function and quality of life.⁵²⁶ Another group found that the majority of patients with Parkinson's disease (72%) or multiple system atrophy (100%) had symptoms of LUTD. DO was more common in Parkinson's disease and DSD was reported to be specific for multiple system atrophy in this cohort. BOO (pressure flow BOO > 40) was more common in Parkinson's disease than in multiple system atrophy. DU was less common in Parkinson's disease than in multiple system atrophy and PVR (> 100 mL) was only present in (47%) patients with multiple system atrophy.⁵²⁷ By correlating the LUTD and motor function impairment in patients with Parkinson's disease, detrusor weakness was found relevant to motor impairment, and OAB-S were found relevant to (disease specific) quality of life.⁵²⁸

5.2. Other CNS Disorders

Acute urinary retention and/or voiding difficulty are frequently encountered signs of LUTD in stroke patients. The majority of stroke patients ($\pm 60\%$) had remained able to void spontaneously at rehabilitation-admission. During rehabilitation this percentage increased, partially because UDS had provided the arguments to remove the indwelling catheter. At discharge $\pm 20\%$ of the patients depended on intermittent or indwelling catheter or on condom conduit.⁵²⁹

The most common type of UI in patients with Alzheimer's disease is UUI. In a cohort of 144 Alzheimer's disease patients with UI, DO was found in 58% of patients on UDS. The presence of DO could be predicted using Clinical Dementia Rating and Barthel's Activity of Daily Living Score.⁵³⁰

Patients with central nervous system lesion and OAB-S might also have DU. One recent study of 100U BoNT-A injected to the detrusor, including the trigone, in 20 patients with Parkinson's disease with PVR $< 50\%$ on free flowmetry, demonstrated a small reduction of voiding frequency, a reduction of voided volume and some increase of PVR, however without the need for CIC.⁵³¹ The efficacy and safety of intradetrusor 100U BoNT-A treatment was also evaluated in 40 elderly patients with chronic LUTD after cerebrovascular accident or Parkinson's disease and/or dementia. Intradetrusor BoNT-A injections reduced OAB-S and UUI. The treatment resulted in UDS cystometric capacity increase, with modest change in pressure flow parameters and some increase of PVR, but without the occurrence of urinary retention. An increased need to strain-void was noted in the (23) patients with LUTD after cerebrovascular accident. The long-term effects had been comparable to a retrospectively assessed cohort of patients with OAB-S managed with 'standard' treatment in the same clinics. Nonetheless the authors of this study stress the need for careful evaluation before choosing intradetrusor BoNT-A injections for this very vulnerable population.⁵³²

5.3. Topics for research

- Establishment of the reproducibility and reliability of UDS specific for the frail elderly.
- Further investigation of the associations between clinically observed LUTD and UDS assessed DO; DU and/or PVR in the frail elderly.

REFERENCES

1. Abrams P, Cardozo L, Fall M, Griffiths D, Rosier P, Ulmsten U, Van Kerrebroeck P, Victor A, Wein A; Standardisation Sub-Committee of the International Continence Society.. The standardisation of terminology in lower urinary tract function: report from the standardisation sub-committee of the International Continence Society. *Urology*. 2003 Jan;61(1):37-49. Review. PubMed PMID: 12559262.
2. Schäfer W, Abrams P, Liao L, Mattiasson A, Pesce F, Spangberg A, Sterling AM, Zinner NR, van Kerrebroeck P; International Continence Society.. Good urodynamic practices: uroflowmetry, filling cystometry, and pressure-flow studies. *Neurourol Urodyn*. 2002;21(3):261-74. PubMed PMID: 11948720.
3. Rosier PF, Schaefer W, Lose G, Goldman HB, Guralnick M, Eustice S, Dickinson T, Hashim H. International Continence Society Good Urodynamic Practices and Terms 2016: Urodynamics, uroflowmetry, cystometry, and pressure-flow study. *Neurourol Urodyn*. 2016 Dec 5. doi: 10.1002/nau.23124.[Epub ahead of print] Review. PubMed PMID: 27917521.
4. Nager CW, Brubaker L, Litman HJ, Zyczynski HM, Varner RE, Amundsen C, Sirls LT, Norton PA, Arisco AM, Chai TC, Zimmern P, Barber MD, Dandreo KJ, Menefee SA, Kenton K, Lowder J, Richter HE, Khandwala S, Nygaard I, Kraus SR, Johnson HW, Lemack GE, Mihova M, Albo ME, Mueller E, Sutkin G, Wilson TS, Hsu Y, Rozanski TA, Rickey LM, Rahn D, Tennstedt S, Kusek JW, Gormley EA; Urinary Incontinence Treatment Network.. A randomized trial of urodynamic testing before stress-incontinence surgery. *N Engl J Med*. 2012 May 24;366(21):1987-97. doi: 10.1056/NEJMoa1113595. PubMed PMID: 22551104; PubMed Central PMCID: PMC3386296.
5. Zimmern, Nager, Albo, Fitzgerald, Mohr McDermott Urinary Incontinence Treatment Network (UITN) Urodynamic inter-rater reliability between local and central physician reviewers for the filling cystometogram in the stress incontinence surgical treatment efficacy trial; Abstract 16 ICS/IUGA 2004
6. van Leijssen SA, Kluivers KB, Mol BW, Hout Ji, Milani AL, Roovers JP, Boon Jd, van der Vaart CH, Langen PH, Hartog FE, Dietz V, Tiersma ES, Hovius MC, Bongers MY, Spaans W, Heesakkers JP, Vierhout ME; Dutch Urogynecology Consortium.. Value of urodynamics before stress urinary incontinence surgery: a randomized controlled trial. *Obstet Gynecol*. 2013 May;121(5):999-1008. doi: 10.1097/AOG.0b013e31828c68e3. PubMed PMID: 23635736.
7. Rane A, Iyer J. Posture and micturition: does it really matter how a woman sits on the toilet? *Int Urogynecol J*. 2014 Aug;25(8):1015-21. doi: 10.1007/s00192-013-2284-7. Epub 2013 Dec 18. PubMed PMID: 24346813.
8. Cindolo L, De Nunzio C, Sountoulides P, Bantis A, Tubaro A, Schips L. The influence of ejaculation and abstinence on urinary flow rates. *Neurourol Urodyn*. 2011 Nov;30(8):1571-5. doi: 10.1002/nau.21157. Epub 2011 Jul 20. PubMed PMID: 21780169.
9. Schäfer W, Abrams P, Liao L, Mattiasson A, Pesce F, Spangberg A, Sterling AM, Zinner NR, van Kerrebroeck P; International Continence Society.. Good urodynamic practices: uroflowmetry, filling cystometry, and pressure-flow studies. *Neurourol Urodyn*. 2002;21(3):261-74. PubMed PMID: 11948720.
10. Kaynar M, Kucur M, Kiliç O, Akand M, Gul M, Goktas S. The effect of bladder sensation on uroflowmetry parameters in healthy young men. *Neurourol Urodyn*. 2016 Jun;35(5):622-4. doi: 10.1002/nau.22762. Epub 2015 Apr 7. PubMed PMID: 25850360.
11. Addla SK, Marri RR, Daayana SL, Irwin P. Avoid cruising on the uroflowmeter: evaluation of cruising artifact on spinning disc flowmeters in an experimental setup. *Neurourol Urodyn* 2010 Sep;29(7):1301-1305.
12. Ward RM, Hampton BS, Blume JD, Sung VW, Rardin CR, Myers DL. The impact of multichannel urodynamics upon treatment recommendations for female urinary incontinence. *Int Urogynecol J Pelvic Floor Dysfunct* 2008 Sep;19(9):1235-1241.
13. [Hogan S, Jarvis P, Gammie A, Abrams P. Quality control in urodynamics and the role of software support in the QC procedure. *Neurourol Urodyn*. 2011 Nov;30(8):1557-64. doi: 10.1002/nau.21133. Epub 2011 Jun 14. Review. PubMed PMID: 21674600.
14. Hogan S, Gammie A, Abrams P. Urodynamic features and artefacts. *Neurourol Urodyn*. 2012 Sep;31(7):1104-17. doi: 10.1002/nau.22209. Epub 2012 Mar 30. PubMed PMID: 22473568.

15. Gammie A, D'Ancona C, Kuo HC, Rosier PF. ICS teaching module: Artefacts in urodynamic pressure traces (basic module). *Neurourol Urodyn*. 2015 Sep 15. doi: 10.1002/nau.22881. Review. PubMed PMID: 26372678.]
16. Cucchi A, Quaglini S, Rovereto B. Proposal for a urodynamic redefinition of detrusor underactivity. *J Urol*. 2009 Jan;181(1):225-9. doi: 10.1016/j.juro.2008.09.018. Epub 2008 Nov 14. PubMed PMID: 19013594.
17. Osman NI, Chapple CR, Abrams P, Dmochowski R, Haab F, Nitti V, Koelbl H, van Kerrebroeck P, Wein AJ. Detrusor underactivity and the underactive bladder: a new clinical entity? A review of current terminology, definitions, epidemiology, aetiology, and diagnosis. *Eur Urol*. 2014 Feb;65(2):389-98. doi: 10.1016/j.eururo.2013.10.015. Epub 2013 Oct 26. Review. PubMed PMID: 24184024.
18. Walter JS, Wheeler JS, Wang X, Wurster RD. A Balloon-Tipped Catheter for Measuring Urethral Pressures. *The Journal of Spinal Cord Medicine*. 2009;32(5):578-582.
19. Pollak JT, Neimark M, Connor JT, Davila GW. Air-charged and microtransducer urodynamic catheters in the evaluation of urethral function. *Int Urogynecol J Pelvic Floor Dysfunct* 2004 Mar-Apr;15(2):124-8; discussion 128.
20. Zehnder P, Roth B, Burkhard FC, Kessler TM. Air charged and microtip catheters cannot be used interchangeably for urethral pressure measurement: a prospective, single-blind, randomized trial. *J Urol* 2008 Sep;180(3):1013-1017.
21. Cooper MA, Fletter PC, Zaszczurynski PJ, Damaser MS. Comparison of air-charged and water-filled urodynamic pressure measurement catheters. *Neurourol Urodyn* 2011 Mar;30(3):329-334.
22. Awada, H. K., Fletter, P. C., Zaszczurynski, P. J., Cooper, M. A. and Damaser, M. S. (2015), Conversion of urodynamic pressures measured simultaneously by air-charged and water-filled catheter systems. *Neurourol. Urodyn.*, 34: 507–512.
23. Digesu GA, Derpapas A, Robshaw P, Vijaya G, Hendricken C, Khullar Vet al., 2014, Are the measurements of water-filled and air-charged catheters the same in urodynamics?, *Int Urogyn J*, 25: 123-130.
24. Gammie, A., Abrams, P., Bevan, W., Ellis-Jones, J., Gray, J., Hassine, A., Williams, J. and Hashim, H. (2015), Simultaneous in vivo comparison of water-filled and air-filled pressure measurement catheters: Implications for good urodynamic practice. *Neurourol. Urodyn.* doi: 10.1002/nau.22827. Epub ahead of publication.
25. Abrams P, Damaser MS, Niblett P, Rosier PF, Toozs-Hobson P, Hosker G, Kightley R, Gammie A. Air filled, including "air-charged," catheters in urodynamic studies: does the evidence justify their use? *Neurourol Urodyn*. 2016 Aug 31. doi: 10.1002/nau.23108. [Epub ahead of print] Review. PubMed PMID: 27580083.
26. Frenkl TL, Railkar R, Palcza J, Scott BB, Alon A, Green S, et al. Variability of urodynamic parameters in patients with overactive bladder. *Neurourol Urodyn* 2011 Nov;30(8):1565-1569.
27. De Wachter SG, Heeringa R, van Koevinge GA, Gillespie JI. On the nature of bladder sensation: the concept of sensory modulation. *Neurourol Urodyn* 2011 Sep;30(7):1220-1226.
28. Heeringa R, de Wachter SG, van Kerrebroeck PE, van Koevinge GA. Normal bladder sensations in healthy volunteers: a focus group investigation. *Neurourol Urodyn* 2011 Sep;30(7):1350-1355.
29. Craggs MD. Objective measurement of bladder sensation: use of a new patient-activated device and response to neuromodulation. *BJU Int* 2005 Sep;96 Suppl 1:29-36.
30. Digesu GA, Basra R, Khullar V, Hendricken C, Camarata M, Kelleher C. Bladder sensations during filling cystometry are different according to urodynamic diagnosis. *Neurourol Urodyn* 2009;28(3):191-196.
31. Naoemova I, Van Meel T, De Wachter S, Wyndaele JJ. Does sensory bladder function during cystometry differ from that in daily life? A study in incontinent women. *Neurourol Urodyn* 2009;28(4):309-312.
32. Bright E, Cotterill N, Drake M, Abrams P. Developing and Validating the International Consultation on Incontinence Questionnaire Bladder Diary. *Eur Urol*. 2014 66(2):294-300.
33. Krhut J, Tintera J, Holy P, Zachoval R, Zvara P. A preliminary report on the use of functional magnetic resonance imaging with simultaneous urodynamics to record brain activity during micturition. *J Urol*. 2012; 188(2):474-9.
34. Griffiths D, Clarkson B, Tadic SD, Resnick NM. Brain Mechanisms Underlying Urge Incontinence and its Response to Pelvic Floor Muscle Training. *J Urol*. 2015;194(3):708-15.

35. Chung SD, Liao CH, Chen YC, Kuo HC. Urgency severity scale could predict urodynamic detrusor overactivity in patients with overactive bladder syndrome. *Neurourol Urodyn* 2011 Sep;30(7):1300-1304.
36. van Meel TD, Wyndaele JJ. Reproducibility of urodynamic filling sensation at weekly interval in healthy volunteers and in women with detrusor overactivity. *Neurourol Urodyn* 2011 Nov;30(8):1586-1590.
37. Clemens JQ, Bogart LM, Liu K, Pham C, Suttorp M, Berry SH. Perceptions of "urgency" in women with interstitial cystitis/bladder pain syndrome or overactive bladder. *Neurourol Urodyn* 2011 Mar;30(3):402-405.
38. Tsunoyama K, Sakakibara R, Yamaguchi C, Uchiyama T, Yamamoto T, Yamanishi T, et al. Pathogenesis of reduced or increased bladder sensation. *Neurourol Urodyn* 2011 Mar;30(3):339-343.
39. Coyne KS, Margolis MK, Hsieh R, Vats V, Chapple CR. Validation of the urinary sensation scale (USS). *Neurourol Urodyn* 2011 Mar;30(3):360-365.
40. Deffontaines Rufin S, Jousse M, Verollet D, Guinet A, Ismael SS, Amarenco G. Cold perception of the bladder during ice water test. Study on 120 patients. *Ann Phys Rehabil Med* 2010 Nov;53(9):559-567.
41. Honjo H, Kawauchi A, Nakao M, Ukimura O, Kitakoji H, Miki T. Impact of convenience void in a bladder diary with urinary perception grade to assess overactive bladder symptoms: a community-based study. *Neurourol Urodyn* 2010 Sep;29(7):1286-1289.
42. Gammie A, Kaper M, Dorrepaal C, Kos T, Abrams P. Signs and Symptoms of Detrusor Underactivity: An Analysis of Clinical Presentation and Urodynamic Tests From a Large Group of Patients Undergoing Pressure Flow Studies. *Eur Urol*. 2016; 69(2):361-9.
43. Mehnert U, Knapp PA, Mueller N, Reitz A, Schurch B. Heart rate variability: an objective measure of autonomic activity and bladder sensations during urodynamics. *Neurourol Urodyn* 2009;28(4):313-319.
44. Ben-Dror I, Weissman A, Leurer MK, Eldor-Itskovitz J, Lowenstein L. Alterations of heart rate variability in women with overactive bladder syndrome. *Int Urogynecol J*. 2012 Aug;23(8):1081-6.
45. Park SG, Chung BH, Lee SW, Park JK, Park K, Cheon J, Lee KS, Kim HJ, Seong DH, Oh SJ, Kim SW, Lee JY, Choo SH, Choi JB. Alpha-Blocker Treatment Response in Men With Lower Urinary Tract Symptoms Based on Sympathetic Activity: Prospective, Multicenter, Open-Labelled, Observational Study. *Int Neurourol J*. 2015 Jun;19(2):107-12. doi: 10.5213/inj.2015. 19.2.107. PubMed PMID: 26126440; PubMed Central PMCID: PMC4490311
46. Malde S, Nambiar AK, Umbach R, Lam TB, Bach T, Bachmann A, Drake MJ, Gacci M, Gratzke C, Madersbacher S, Mamoulakis C, Tikkinen KA, Gravas S; European Association of Urology Non-neurogenic Male LUTS Guidelines Panel.. Systematic Review of the Performance of Noninvasive Tests in Diagnosing Bladder Outlet Obstruction in Men with Lower Urinary Tract Symptoms. *Eur Urol*. 2016 Sep 26. pii: S0302-2838(16)30661-3. doi: 10.1016/j.eururo.2016.09.026. [Epub ahead of print] Review. PubMed PMID: 27687821.
47. van Mastrigt R, Huang Foen Chung JW. Bladder volume sensitivity of isovolumetric intravesical pressure. *Neurourol Urodyn* 2006;25(7):744-751.
48. Reis LO, Barreiro GC, Prudente A, Silva CM, Bassani JW, D'Ancona CA. A novel intraurethral device diagnostic index to classify bladder outlet obstruction in men with lower urinary tract symptoms. *Adv Urol*. 2009;406012. doi: 10.1155/2009/406012. PubMed PMID: 19125194; PubMed Central PMCID: PMC2610250.
49. D'Ancona CA, Bassani JW, Querne FA, Carvalho J, Oliveira RR, Netto NR Jr. New method for minimally invasive urodynamic assessment in men with lower urinary tract symptoms. *Urology*. 2008 Jan;71(1):75-8. doi: 10.1016/j.urol.2007.08.036. PubMed PMID: 18242369.
50. Idzenga T, Pel JJ, van Mastrigt R. A biophysical model of the male urethra: comparing viscoelastic properties of polyvinyl alcohol urethras to male pig urethras. *Neurourol Urodyn* 2006;25(5):451-460.
51. Farag FF, Martens FM, D'Hauwers KW, Feitz WF, Heesakkers JP. Near-infrared spectroscopy: a novel, noninvasive, diagnostic method for detrusor overactivity in patients with overactive bladder symptoms--a preliminary and experimental study. *Eur Urol* 2011 May;59(5):757-762.
52. Zhang P, Yang Y, Wu ZJ, Zhang CH, Zhang XD. Diagnosis of bladder outlet obstruction in men using a near-infrared spectroscopy instrument as the noninvasive monitor for bladder function. *Urology*. 2013; 82:1098-102.

53. Mastoroudes H, Giarenis I, Vella M, Srikrishna S, Robinson D, Cardozo L, Karrouze I, Campbell A, Macnab A. Use of near infrared spectroscopy as an alternative to VUDS to detect DO in women with the OABs. *Urology*. 2012 Sep;80(3):547-50. doi: 10.1016/j.urolgy.2012.05.036. PubMed PMID: 22840868.
54. Arif M, Groen J, Boevé ER, de Korte CL, Idzenga T, van Mastrigt R. Noninvasive Diagnosis of Bladder Outlet Obstruction in Patients with Lower Urinary Tract Symptoms Using Ultrasound Decorrelation Analysis. *J Urol*. 2016 Aug;196(2):490-7. doi: 10.1016/j.juro.2016.02.2966. PubMed PMID: 26947433.
55. Bonney V., On diurnal incontinence of urine in women. *J Obstet Gynaecol Br Empire*, 1923. 30: p. 358-365.
56. Slack M, Culligan P, Tracey M, Hunsicker K, Patel B, Sumeray M. Relationship of urethral retro-resistance pressure to urodynamic measurements and incontinence severity. *Neurourol Urodyn* 2004;23(2):109-114.
57. Digesu GA, Athanasiou S, Chaliha C, Michalas S, Salvatore S, Selvaggi L, et al. Urethral retro-resistance pressure and urodynamic diagnoses in women with lower urinary tract symptoms. *BJOG* 2006 Jan;113(1):34-38.
58. Tunn R, Marschke J, Wildt B, Gauruder-Burmester A. Clinical experience with urethral retro-resistance pressure measurement: a prospective pre- and postoperative evaluation in women with stress urinary incontinence. *Neurourol Urodyn* 2007;26(2):262-266.
59. Roderick T, Paul M, Christopher M, Douglas T. Urethral retro-resistance pressure: association with established measures of incontinence severity and change after midurethral tape insertion. *Neurourol Urodyn* 2009;28(1):86-89.
60. Solomon E, Kass-Iliyya A, Malde S, Kirkham AP, Greenwell TJ, Ockrim JL. The correlation between retrograde leak point pressure and 24-hour pad weight. *Neurourol Urodyn*. 2016 Jul 4. doi: 10.1002/nau.23063. [Epub ahead of print] PubMed PMID: 27376718.
61. Klarskov N, Rasmussen SB, Lose G. Pressure reflectometry: in vitro recordings with a new technique for simultaneous measurement of cross-sectional area and pressure in a collapsible tube. *Physiol Meas* 2005 Jun;26(3):269-280.
62. Klarskov N, Lose G. Urethral pressure reflectometry; a novel technique for simultaneous recording of pressure and cross-sectional area in the female urethra. *Neurourol Urodyn* 2007;26(2):254-261.
63. Klarskov N, Lose G. Urethral pressure reflectometry and pressure profilometry in healthy volunteers and stress urinary incontinent women. *Neurourol Urodyn* 2008;27(8):807-812.
64. Aagaard M, Klarskov N, Sønksen J, Bagi P, Colstrup H, Lose G. Urethral pressure reflectometry; a novel technique for simultaneous recording of pressure and cross-sectional area: a study of feasibility in the prostatic urethra. *BJU Int*. 2012 Oct;110(8):1178-83.
65. Lekskulchai O, Dietz HP. Detrusor wall thickness as a test for detrusor overactivity in women. *Ultrasound Obstet Gynecol* 2008 Sep;32(4):535-539.
66. Kuo HC. Measurement of detrusor wall thickness in women with overactive bladder by transvaginal and transabdominal sonography. *Int Urogynecol J Pelvic Floor Dysfunct* 2009 Nov;20(11):1293-1299.
67. Panayi DC, Khullar V, Digesu GA, Hendricken C, Fernando R, Tekkis P. Is ultrasound estimation of bladder weight a useful tool in the assessment of patients with lower urinary tract symptoms? *Int Urogynecol J Pelvic Floor Dysfunct* 2009 Dec;20(12):1445-1449.
68. Panayi DC, Khullar V, Fernando R, Tekkis P. Transvaginal ultrasound measurement of bladder wall thickness: a more reliable approach than transperineal and transabdominal approaches. *BJU Int* 2010 Nov;106(10):1519-1522.
69. Oelke M, Mamoulakis C, Ubbink DT, de la Rosette JJ, Wijkstra H. Manual versus automatic bladder wall thickness measurements: a method comparison study. *World J Urol* 2009 Dec;27(6):747-753.
70. Chung SD, Chiu B, Kuo HC, Chuang YC, Wang CC, Guan Z, et al. Transabdominal ultrasonography of detrusor wall thickness in women with overactive bladder. *BJU Int* 2010 Mar;105(5):668-672.
71. Ozawa H, Igarashi T, Uematsu K, Watanabe T, Kumon H. The future of urodynamics: non-invasive ultrasound videourodynamics. *Int J Urol* 2010 Mar;17(3):241-249.
72. Kuhn A, Bank S, Robinson D, Klimek M, Kuhn P, Raio L. How should bladder wall thickness be measured? A comparison of vaginal, perineal and abdominal ultrasound. *Neurourol Urodyn* 2010 Nov;29(8):1393-1396.
73. Almeida FG, Freitas DG, Bruschini H. Is the ultrasound-estimated bladder weight a reliable method for evaluating bladder outlet obstruction? *BJU Int* 2011 Sep;108(6):864-867.

74. Serati M, Salvatore S, Cattoni E, Soligo M, Cromi A, Ghezzi F. Ultrasound measurement of bladder wall thickness in different forms of detrusor overactivity. *Int Urogynecol J* 2010 Nov;21(11):1405-1411.
75. Güzel Ö, Aslan Y, Balci M, Tuncel A, Keten T, Erkan A, Atan A. Can Bladder Wall Thickness Measurement Be Used for Detecting Bladder Outlet Obstruction? *Urology*. 2015 Sep;86(3):439-44. doi: 10.1016/j.urolgy.2015.06.023. PubMed PMID: 26142716.
76. Presicce F, De Nunzio C, Gacci M, Finazzi Agrò E, Tubaro A. Non-invasive ultrasound measurements in male patients with luts and benign prostatic obstruction: implication for diagnosis and treatment: a systematic review. *Minerva Urol Nefrol*. 2016 Oct 5. [Epub ahead of print] PubMed PMID: 27706123.
77. Silva JA, Gonsalves Mde C, de Melo RT, Carerette FB, Damião R. Association between the bladder wall thickness and urodynamic findings in patients with spinal cord injury. *World J Urol*. 2015; 33(1):131-5.
78. Charalampous S, Printza N, Hashim H, Bantouraki M, Rompis V, Ioannidis E, Papacristou F. Bladder wall thickness and urodynamic correlation in children with primary nocturnal enuresis. *J Pediatr Urol*. 2013; 9(3):334-8.
79. Idzenga T, Farag F, Heesakkers J, Feitz W, de Korte CL. Noninvasive 2-dimensional monitoring of strain in the detrusor muscle in patients with LUTS using ultrasound strain imaging. *J Urol*. 2013 Apr;189(4):1402-8. doi: 10.1016/j.juro.2012.09.165. PubMed PMID: 23041458.
80. Singh, G., Lucas, M., Dolan, L., Knight, S., Ramage, C. and Hobson, P. T. (2010), Minimum standards for urodynamic practice in the UK. *Neurourol. Urodyn.*, 29: 1365–1372. doi:10.1002/nau.20883
81. Foon R, Toozs-Hobson P, Latthe P. Prophylactic antibiotics to reduce the risk of urinary tract infections after urodynamic studies. *Cochrane Database Syst Rev* 2012;10:CD008224.
82. Vírseda M, Salinas J, Esteban M, Méndez S. Reliability of ambulatory urodynamics in patients with spinal cord injuries. *Neurourol Urodyn*. 2013 Apr;32(4):387-92. doi: 10.1002/nau.22303. PubMed PMID: 23002043.
83. Digesu GA, Gargasole C, Hendricken C, Gore M, Kocjancic E, Khullar V, Rosier PF. ICS teaching module: Ambulatory urodynamic monitoring. *Neurourol Urodyn*. 2015 Nov 23. doi: 10.1002/nau.22933. [Epub ahead of print] PubMed PMID: 26594872.
84. Sharma AK, Poonawala A, Girish GN, Kamath AJ, Keshavmurthy R, Nagaraja NH, Venkatesh GK, Ratkal CS. A quantitative comparison between free uroflow variables and urodynamic data, and the effect of the size of urodynamic catheters on its interpretation. *Arab J Urol*. 2013 Dec;11(4):340-3. doi: 10.1016/j.aju.2013.06.004. PubMed PMID: 26558102; PubMed Central PMCID: PMC4442998.
85. Harding C, Horsburgh B, Dorkin TJ, Thorpe AC. Quantifying the effect of urodynamic catheters on urine flow rate measurement. *Neurourol Urodyn*. 2012 Jan;31(1):139-42. doi: 10.1002/nau.21188. PubMed PMID: 21953734.
86. Sokol ER, Karram MM, Dmochowski R. Efficacy and safety of polyacrylamide hydrogel for the treatment of female stress incontinence: a randomized, prospective, multicenter North American study. *J Urol*. 2014 Sep;192(3):843-9. doi: 10.1016/j.juro.2014.03.109. PubMed PMID: 24704117.
87. Han SB, Kim JC, Lee DH, Kim HS, Koh JS, Hur WS, Cho KJ. The Effect of Valsalva Leak Point Pressure on Outcomes of the Needleless ©System in Female Stress Urinary Incontinence. *Urol J*. 2015 Sep 4;12(4):2251-5. PubMed PMID: 26341767.
88. Rothschild J, Chang Kit L, Seltz L, Wang L, Kaufman M, Dmochowski R, Milam DF. Difference between urethral circumference and artificial urinary sphincter cuff size, and its effect on postoperative incontinence. *J Urol*. 2014 Jan;191(1):138-42. doi: 10.1016/j.juro.2013.06.052. PubMed PMID: 23820053.
89. Rovner ES, Dmochowski RR, Leach GE, Jayne C, Snyder JA. A randomized, controlled clinical trial of a novel intravesical pressure attenuation device for the treatment of stress urinary incontinence. *J Urol*. 2013 Dec;190(6):2243-50. doi: 10.1016/j.juro.2013.06.042. PubMed PMID: 23796570.
90. Rosier PF, Giarenis I, Valentini FA, Wein A, Cardozo L. Do patients with symptoms and signs of lower urinary tract dysfunction need a urodynamic diagnosis? ICI-RS 2013. *Neurourol Urodyn*. 2014 Jun;33(5):581-6. doi:10.1002/nau.22580. Review. PubMed PMID: 24844430.
91. Moe K, Schiøtz HA, Kulseng-Hanssen S. Outcome of TVT operations in women with low maximum urethral closure pressure. *Neurourol Urodyn*. 2016 May 31. doi: 10.1002/nau.23044. [Epub ahead of print] PubMed PMID: 27241193.

92. Hillary CJ, Osman N, Chapple C. Considerations in the modern management of stress urinary incontinence resulting from intrinsic sphincter deficiency. *World J Urol.* 2015 Sep;33(9):1251-6. doi: 10.1007/s00345-015-1599-z. Review. PubMed PMID: 26060138.
93. Burden H, Warren K, Abrams P. Leak point pressures: how useful are they? *Curr Opin Urol.* 2015 Jul;25(4):317-22. doi: 10.1097/MOU.0000000000000176. Review. PubMed PMID: 26049875.
94. Bing MH, Gimbel H, Greisen S, Paulsen LB, Soerensen HC, Lose G. Clinical risk factors and urodynamic predictors prior to surgical treatment for stress urinary incontinence: a narrative review. *Int Urogynecol J.* 2015 Feb;26(2):175-85. doi: 10.1007/s00192-014-2489-4. Review. PubMed PMID: 25248411.
95. Abdel-Fattah M, Hopper LR, Mostafa A. Evaluation of transobturator tension-free vaginal tapes in the surgical management of mixed urinary incontinence: 3-year outcomes of a randomized controlled trial. *J Urol.* 2014 Jan;191(1):114-9. doi: 10.1016/j.juro.2013.07.035. PubMed PMID: 23892190.
96. Serati M, Bauer R, Cornu JN, Cattoni E, Braga A, Siesto G, Lizée D, Haab F, Torella M, Salvatore S. TVT-O for the treatment of pure urodynamic stress incontinence: efficacy, adverse effects, and prognostic factors at 5-year follow-up. *Eur Urol.* 2013 May;63(5):872-8. doi: 10.1016/j.eururo.2012.12.022. PubMed PMID: 23274106.
97. Aigmueller T, Bjelic-Radisic V, Kargl J, Hinterholzer S, Laky R, Trutnovsky G, Kolovetsiou-Kreiner V, Tamussino K. Reasons for dissatisfaction ten years after TVT procedure. *Int Urogynecol J.* 2014 Feb;25(2):213-7. doi: 10.1007/s00192-013-2213-9. PubMed PMID: 24030215.
98. Kirby AC, Nager CW, Litman HJ, FitzGerald MP, Kraus S, Norton P, Sirls L, Rickey L, Wilson T, Dandreo KJ, Shepherd JP, Zimmern P; Urinary Incontinence Treatment Network. Preoperative voiding detrusor pressures do not predict stress incontinence surgery outcomes. *Int Urogynecol J.* 2011 Jun;22(6):657-63. doi: 10.1007/s00192-010-1336-5. PubMed PMID: 21153471; PubMed Central PMCID:PMC3097343.
99. Salvatore S, Serati M, Khullar V, Ghezzi F, Triacca P, Digesù A, Beretta P, Bolis PF. Opening vesical pressure: a new test to discriminate urethral sphincter deficiency? *Int Urogynecol J Pelvic Floor Dysfunct.* 2007 Dec;18(12):1435-8. PubMed PMID: 17479203.
100. Guerette NL, Bena JF, Davila GW. Transobturator slings for stress incontinence: using urodynamic parameters to predict outcomes. *Int Urogynecol J Pelvic Floor Dysfunct.* 2008 Jan;19(1):97-102. PubMed PMID: 17549430.
101. Rachaneni S, Latthe P. Does preoperative urodynamics improve outcomes for women undergoing surgery for stress urinary incontinence? A systematic review and meta-analysis. *BJOG.* 2015 Jan;122(1):8-16. doi: 10.1111/1471-0528.12954. Review. PubMed PMID: 25041381.
102. Sirls LT, Richter HE, Litman HJ, Kenton K, Lemack GE, Lukacz ES, Kraus SR, Goldman HB, Weidner A, Rickey L, Norton P, Zyczynski HM, Kusek JW; Urinary Incontinence Treatment Network. The effect of urodynamic testing on clinical diagnosis, treatment plan and outcomes in women undergoing stress urinary incontinence surgery. *J Urol.* 2013 Jan;189(1):204-9. doi: 10.1016/j.juro.2012.09.050. PubMed PMID: 22982425; PubMed Central PMCID: PMC4363108.
103. Hilton P, Armstrong N, Brennand C, Howel D, Shen J, Bryant A, Tincello DG, Lucas MG, Buckley BS, Chapple CR, Homer T, Vale L, McColl E; INVESTIGATE studies group. INVESTIGATE-I (INvasive Evaluation before Surgical Treatment of Incontinence Gives Added Therapeutic Effect?): a mixed-methods study to assess the feasibility of a future randomised controlled trial of invasive urodynamic testing prior to surgery for stress urinary incontinence in women. *Health Technol Assess.* 2015 Feb;19(15):1-273, vii-viii. doi: 10.3310/hta19150. PubMed PMID: 25714493; PubMed Central PMCID: PMC4781411.
104. Novara G, Galfano A, Boscolo-Berto R, Secco S, Cavalleri S, Ficarra V, Artibani W. Complication rates of tension-free midurethral slings in the treatment of female SUI-S: a systematic review and meta-analysis of randomized controlled trials comparing tension-free midurethral tapes to other surgical procedures and different devices. *Eur Urol.* 2008 Feb;53(2):288-308. Review. PubMed PMID: 18031923.
105. Costantini E, Kocjancic E, Lazzeri M, Giannantoni A, Zucchi A, Carbone A, Bini V, Palleschi G, Pastore AL, Porena M. Long-term efficacy of the trans-obturator and retropubic mid-urethral slings for stress urinary incontinence: update from a randomized clinical trial. *World J Urol.* 2016 Apr;34(4):585-93. doi: 10.1007/s00345-015-1651-z. PubMed PMID: 26231286.
106. Bing, M.H., Gimbel, H., Greisen, S. et al. *Int Urogynecol J* (2015) 26: 175. doi:10.1007/s00192-014-2489-4

107. Serati M, Cattoni E, Siesto G, Braga A, Sorice P, Cantaluppi S, Cromi A, Ghezzi F, Vitobello D, Bolis P, Salvatore S. Urodynamic evaluation: can it prevent the need for surgical intervention in women with apparent pure stress urinary incontinence? *BJU Int.* 2013 Aug;112(4):E344-50. doi: 10.1111/bju.12007. PubMed PMID: 23421421.
108. Serati M, Braga A, Athanasiou S, Tommaselli GA, Caccia G, Torella M, Ghezzi F, Salvatore S. Tension-free Vaginal Tape-Obturator for Treatment of Pure Urodynamic Stress Urinary Incontinence: Efficacy and Adverse Effects at 10-year Follow-up. *Eur Urol.* 2016 Sep 2. pii: S0302-2838(16)30527-9. doi: 10.1016/j.eururo.2016.08.054. [Epub ahead of print] PubMed PMID: 27597239.
109. Schierlitz L, Dwyer PL, Rosamilia A, De Souza A, Murray C, Thomas E, Hiscock R, Achtari C. POP surgery with and without tension-free vaginal tape in women with occult or asymptomatic urodynamic stress incontinence: a randomised controlled trial. *Int Urogynecol J.* 2014 Jan;25(1):33-40. doi: 10.1007/s00192-013-2150-7. PubMed PMID: 23812579.
110. Manodoro S, Spelzini F, Frigerio M, Nicoli E, Verri D, Milani R. Is Occult Stress Urinary Incontinence a Reliable Predictive Marker? *Female Pelvic Med Reconstr Surg.* 2016 Jul-Aug;22(4):280-2. doi: 10.1097/SPV.0000000000000272. PubMed PMID: 27054787.
111. van der Ploeg JM, van der Steen A, Oude Rengerink K, van der Vaart CH, Roovers JP. POP surgery with or without stress incontinence surgery for POP: a systematic review and meta-analysis of randomised trials. *BJOG.* 2014 Apr;121(5):537-47. doi: 10.1111/1471-0528.12509. Review. PubMed PMID: 24382099.
112. Giarenis I, Zacchè M, Robinson D, Cardozo L. Is there any association between urodynamic variables and severity of overactive bladder in women with idiopathic detrusor overactivity? *Neurourol Urodyn.* 2016 Apr 19. doi: 10.1002/nau.23023. [Epub ahead of print] PubMed PMID: 27092808.
113. Serati M, Topazio L, Bogani G, Costantini E, Pietropaolo A, Palleschi G, Carbone A, Soligo M, Del Popolo G, Li Marzi V, Salvatore S, Finazzi Agrò E. Urodynamics useless before surgery for female stress urinary incontinence: Are you sure? Results from a multicenter single nation database. *Neurourol Urodyn.* 2016 Sep;35(7):809-12. doi: 10.1002/nau.22804. PubMed PMID: 26061435.
114. Kondo, A., Lin, TL., Nordling, J. et al., Conservative treatment in men, in *Incontinence: 2nd International Consultation on Incontinence*, P. Abrams, Cardozo, L., Khoury, S., Wein, A., Editor. 2002: Plymouth (UK).
115. Egan KB. The Epidemiology of Benign Prostatic Hyperplasia Associated with Lower Urinary Tract Symptoms: Prevalence and Incident Rates. *Urol Clin North Am.* 2016 Aug;43(3):289-97. doi: 10.1016/j.ucl.2016.04.001. Review. PubMed PMID:27476122.)
116. Oelke M, Baard J, Wijkstra H, de la Rosette JJ, Jonas U, Hofner K. Age and bladder outlet obstruction are independently associated with detrusor overactivity in patients with benign prostatic hyperplasia. *Eur Urol* 2008 Aug;54(2):419-426.
117. Coyne KS, Sexton CC, Kopp ZS, Ebel-Bitoun C, Milsom I, Chapple C. The impact of overactive bladder on mental health, work productivity and health-related quality of life in the UK and Sweden: results from EpiLUTS. *BJU Int.* 2011 Nov;108(9):1459-71. doi: 10.1111/j.1464-410X.2010.10013.x. PubMed PMID: 21371240.
118. Utomo E, Korfage IJ, Wildhagen MF, Steensma AB, Bangma CH, Blok BF. Validation of the Urogenital Distress Inventory (UDI-6) and Incontinence Impact Questionnaire (IIQ-7) in a Dutch population. *Neurourol Urodyn* 2015;34:24-31.
119. Timmermans L, Falez F, Mélot C, Wespes E. Validation of use of the International Consultation on Incontinence Questionnaire-Urinary Incontinence-Short Form (ICIQ-UI-SF) for impairment rating: a transversal retrospective study of 120 patients. *Neurourol Urodyn* 2013;32:974-9.
120. Bright E, Cotterill N, Drake M, Abrams P. Developing and validating the International Consultation on Incontinence Questionnaire bladder diary. *Eur Urol* 2014;66:294-300.
121. Chancellor MB, Blaivas JG, Kaplan SA, Axelrod S. Bladder outlet obstruction versus impaired detrusor contractility: the role of outflow. *J Urol* 1991 Apr;145(4):810-812.
122. Chapple CR, Osman NI. Crystallizing the Definition of Underactive Bladder Syndrome, a Common but Under-recognized Clinical Entity. *Low Urin Tract Symptoms.* 2015 May;7(2):71-6. doi: 10.1111/luts.12101. Review. PubMed PMID: 26663685.
123. Gnanapragasam VJ, Leonard A. Does a pre-operative urodynamic diagnosis of bladder outflow obstruction improve outcomes from palliative transurethral prostatectomy? *Urol Int* 2011 Feb;86(1):85-89.

124. Monoski MA, Gonzalez RR, Sandhu JS, Reddy B, Te AE. Urodynamic predictors of outcomes with photoselective laser vaporization prostatectomy in patients with benign prostatic hyperplasia and preoperative retention. *Urology* 2006 Aug;68(2):312-317.
125. Cho MC, Park JH, Jeong MS, Yi JS, Ku JH, Oh SJ, et al. Predictor of de novo urinary incontinence following holmium laser enucleation of the prostate. *Neurourol Urodyn* 2011 Sep;30(7):1343-1349.
126. Bosch JL, Cardozo L, Hashim H, Hilton P, Oelke M, Robinson D. Constructing trials to show whether urodynamic studies are necessary in lower urinary tract dysfunction. *Neurourol Urodyn* 2011 Jun;30(5):735-740.
127. Valentini FA, Marti BG, Robain G. Idiopathic and neurogenic detrusor overactivity: do the different patterns have urodynamic characteristics related to gender or neurological condition? *Int Braz J Urol* 2013; 39:663-70.
128. Rutman MP, Cha DY, Blaivas JG. How do urodynamics findings influence the treatment of the typical patient with overactive bladder? *Curr Urol Rep* 2012; 13:370-8.
129. Palleschi G, Pastore AL, Ripoli A, Silvestri L, Petrozza V, Carbone A. Videourodynamic evaluation of intracorporeally reconstructed orthotopic U-shaped ileal neobladders. *Urology*. 2015;85:883-9.
130. Nam JK, Kim TN, Park SW, Lee SD, Chung MK. The Studer orthotopic neobladder: long-term (more than 10 years) functional outcomes, urodynamic features, and complications. *Yonsei Med J*. 2013; 54:690-5.
131. Latz S, Achterberg M, Ellinger J, Engels T, Hauser S, Rogenhofer S, Müller SC, Fechner G. Diagnostic meaning of urodynamic studies in pouch incontinence: results of a small series. *Urol Int* 2014; 92:237-41.
132. Al-Zahrani AA, Gajewski JB. Association of symptoms with urodynamic findings in men with overactive bladder syndrome. *BJU Int* 2012;110:E891-5.
133. Pizzi A, Falsini C, Martini M, Rossetti MA, Verdesca S, Tosto A. Urinary incontinence after ischemic stroke: clinical and urodynamic studies. *Neurourol Urodyn* 2014;33:420-5.
134. Tsunoyama K, Sakakibara R, Yamaguchi C, Uchiyama T, Yamamoto T, Yamanishi T, et al. Pathogenesis of reduced or increased bladder sensation. *Neurourol Urodyn* 2011 Mar;30(3):339-343.
135. Comiter CV, Nitti V, Elliot C, Rhee E. A new quadratic sling for male stress incontinence: retrograde leak point pressure as a measure of urethral resistance. *J Urol* 2012; 187:563-8.
136. Gammie A, Bosch R, Djurhuus JC, Goping I, Kirschner-Hermanns R. Do we need better methods of assessing urethral function: ICI-RS 2013? *Neurourol Urodyn* 2014; 33:587-90.
137. Pannek J, Pieper P. Clinical usefulness of ambulatory urodynamics in the diagnosis and treatment of lower urinary tract dysfunction. *Scand J Urol Nephrol* 2008;42(5):428-432.
138. Rademakers KL, Drossaerts JM, Rahnama'i MS, van Koeveringe GA. Differentiation of lower urinary tract dysfunctions: The role of ambulatory urodynamic monitoring. *Int J Urol* 2015;22:503-7.
139. Virseda M, Salinas J, Esteban M, Méndez S. Reliability of ambulatory urodynamics in patients with spinal cord injuries. *Neurourol Urodyn* 2013;32:387-92.
140. Coyne KS, Sexton CC, Vats V, Thompson C, Kopp ZS, Milsom I. National community prevalence of overactive bladder in the United States stratified by sex and age. *Urology* 2011 May;77(5):1081-1087.
141. Markland AD, Goode PS, Redden DT, Borrud LG, Burgio KL. Prevalence of urinary incontinence in men: results from the national health and nutrition examination survey. *J Urol* 2010 Sep;184(3):1022-1027.
142. Lee YS, Lee KS, Jung JH, Han DH, Oh SJ, Seo JT, et al. Prevalence of overactive bladder, urinary incontinence, and lower urinary tract symptoms: results of Korean EPIC study. *World J Urol* 2011 Apr;29(2):185-190.
143. Irwin DE, Kopp ZS, Agatep B, Milsom I, Abrams P. Worldwide prevalence estimates of lower urinary tract symptoms, overactive bladder, urinary incontinence and bladder outlet obstruction. *BJU Int* 2011 Oct;108(7):1132-1138.
144. Irwin DE, Milsom I, Kopp Z, Abrams P, Artibani W, Herschorn S. Prevalence, severity, and symptom bother of lower urinary tract symptoms among men in the EPIC study: impact of overactive bladder. *Eur Urol* 2009 Jul;56(1):14-20.
145. Al-Ghazo MA, Ghalayini IF, Al-Azab R, Hani OB, Matani YS, Haddad Y. Urodynamic detrusor overactivity in patients with overactive bladder symptoms. *Int Neurourol J* 2011 Mar;15(1):48-54.

146. Chung SD, Liao CH, Chen YC, Kuo HC. Urgency severity scale could predict urodynamic detrusor overactivity in patients with overactive bladder syndrome. *Neurourol Urodyn* 2011 Sep;30(7):1300-1304.
147. Clement KD, Burden H, Warren K, Lapitan MC, Omar MI, Drake MJ. Invasive urodynamic studies for the management of lower urinary tract symptoms (LUTS) in men with voiding dysfunction. *Cochrane Database Syst Rev* 2015;4:CD011179.
148. Jain S, Agarwal MM, Mavuduru R, Singh SK, Mandal AK. Micturitional urethral pressure profilometry for the diagnosis, grading, and localization of bladder outlet obstruction in adult men: a comparison with pressure-flow study. *Urology* 2014;83:550-5.
149. Zhao YR, Liu WZ, Guralnick M, Niu WJ, Wang Y, Sun G, Xu Y. Predictors of short-term overactive bladder symptom improvement after transurethral resection of prostate in men with benign prostatic obstruction. *Int J Urol* 2014;21:1035-40.
150. Dybowski BA, d'Ancona FC, Langenhuijsen JF, Heesakkers JP. Detrusor overactivity does not predict bothersome storage symptoms after photoselective vaporization of the prostate with lithium triborate laser. *Urology* 2014;84:898-903.
151. Kosilov KV, Loparev SA, Ivanovskaya MA, Kosilova LV. Comparative effectiveness of combined low- and standard-dose tiroprium and solifenacin for moderate overactive bladder symptoms in elderly men and women. *Urol Int* 2014;93:470-3.
152. Dmochowski R, Roehrborn C, Klise S, Xu L, Kaminetsky J, Kraus S. Urodynamic effects of once daily tadalafil in men with lower urinary tract symptoms secondary to clinical benign prostatic hyperplasia: a randomized, placebo controlled 12-week clinical trial. *J Urol* 2013;189(1 Suppl):S135-40.
153. Moosdorff-Steinhauser HF, Berghmans B. Effects of percutaneous tibial nerve stimulation on adult patients with overactive bladder syndrome: a systematic review. *Neurourol Urodyn* 2013;32:206-14.
154. Peters KM, Carrico DJ, Wooldridge LS, Miller CJ, MacDiarmid SA. Percutaneous tibial nerve stimulation for the long-term treatment of overactive bladder: 3-year results of the STEP study. *J Urol* 2013;189:2194-201.
155. Zecca C, Digesu GA, Robshaw P, Singh A, Elneil S, Gobbi C. Maintenance percutaneous posterior nerve stimulation for refractory lower urinary tract symptoms in patients with multiple sclerosis: an open label, multicenter, prospective study. *J Urol* 2014;191:697-702.
156. Canbaz Kabay S, Kabay S, Mestan E, Cetiner M, Ayas S, Sevim M, Ozden H, Karaman HO. Long term sustained therapeutic effects of percutaneous posterior tibial nerve stimulation treatment of neurogenic overactive bladder in multiple sclerosis patients: 12-months results. *Neurourol Urodyn*. 2015 Sep 9. doi: 10.1002/nau.22868. [Epub ahead of print] *Pub-Med* PMID: 26352904.
157. Burton C, Sajja A, Latthe PM. Effectiveness of percutaneous posterior tibial nerve stimulation for overactive bladder: a systematic review and meta-analysis. *Neurourol Urodyn*. 2012 Nov;31(8):1206-16. doi: 10.1002/nau.22251. Review. *PubMed* PMID: 22581511.
158. Mangera A, Apostolidis A, Andersson KE, Dasgupta P, Giannantoni A, Roehrborn C, Novara G, Chapple C. An updated systematic review and statistical comparison of standardised mean outcomes for the use of botulinum toxin in the management of lower urinary tract disorders. *Eur Urol* 2014;65:981-90.
159. Thuroff JW, Abrams P, Andersson KE, Artibani W, Chapple CR, Drake MJ, et al. EAU guidelines on urinary incontinence. *Eur Urol* 2011 Mar;59(3):387-400.
160. Gormley EA, Lightner DJ, Faraday M, Vasavada SP; American Urological Association; Society of Urodynamics, Female Pelvic Medicine. Diagnosis and treatment of overactive bladder (non-neurogenic) in adults: AUA/SUFU guideline amendment. *J Urol* 2015;193:1572-80.
161. Phé V, de Wachter S, Rouprêt M, Chartier-Kastler E. How to define a refractory idiopathic overactive bladder? *Neurourol Urodyn*. 2015 Jan;34(1):2-11. doi: 10.1002/nau.22512. Epub 2013 Oct 24. Review. *PubMed* PMID: 24155183.
162. Porena M, Mearini E, Mearini L, Vianello A, Giannantoni A. Voiding dysfunction after radical retropubic prostatectomy: more than external urethral sphincter deficiency. *Eur Urol* 2007 Jul;52(1):38-45.
163. Huckabay C, Twiss C, Berger A, Nitti VW. A urodynamics protocol to optimally assess men with post-prostatectomy incontinence. *Neurourol Urodyn* 2005;24(7):622-626.

164. Mebust, W., Holtgrewe, HL., Current status of transurethral prostatectomy: a review of the AUA National Cooperative Study. *World Journal of Urology*, 1989. 6: p. 194
165. Krambeck AE, Handa SE, Lingeman JE. Experience with more than 1,000 holmium laser prostate enucleations for benign prostatic hyperplasia. *J Urol* 2010 Mar;183(3):1105-1109.
166. Kuo HC. Analysis of the pathophysiology of lower urinary tract symptoms in patients after prostatectomy. *Urol Int* 2002;68(2):99-104.
167. Wadie BS. Retropubic bulbourethral sling for post-prostatectomy male incontinence: 2-year followup. *J Urol* 2010 Dec;184(6):2446-2451.
168. Penson DF, McLerran D, Feng Z, Li L, Albertsen PC, Gilliland FD, et al. 5-Year Urinary and Sexual Outcomes After Radical Prostatectomy: Results from the Prostate Cancer Outcomes Study. *J Urol* 2005 May;173(5):1701-1705.
169. Sanda MG, Dunn RL, Michalski J, Sandler HM, Northouse L, Hembroff L, et al. Quality of life and satisfaction with outcome among prostate-cancer survivors. *N Engl J Med* 2008 Mar 20;358(12):1250-1261.
170. Wilt TJ, MacDonald R, Rutks I, Shamliyan TA, Taylor BC, Kane RL. Systematic review: comparative effectiveness and harms of treatments for clinically localized prostate cancer. *Ann Intern Med* 2008 Mar 18;148(6):435-448.
171. Ballert KN, Nitti VW. Association between detrusor overactivity and postoperative outcomes in patients undergoing male bone anchored perineal sling. *J Urol* 2010 Feb;183(2):641-645.
172. Dubbelman Y, Groen J, Wildhagen M, Rikken B, Bosch R. Quantification of changes in detrusor function and pressure-flow parameters after radical prostatectomy: relation to postoperative continence status and the impact of intensity of pelvic floor muscle exercises. *Neurourol Urodyn.* 2012 Jun;31(5):637-41. doi: 10.1002/nau.21199. PubMed PMID: 22488499.
173. Dubbelman YD, Groen J, Wildhagen MF, Rikken B, Bosch JL. Urodynamic quantification of decrease in sphincter function after radical prostatectomy: relation to postoperative continence status and the effect of intensive pelvic floor muscle exercises. *Neurourol Urodyn.* 2012 Jun;31(5):646-51. doi: 10.1002/nau.21243. PubMed PMID: 22488800.
174. McCallum TJ, Moore KN, Griffiths D. Urinary incontinence after radical prostatectomy: implications and urodynamics. *Urol Nurs* 2001 Apr;21(2):113-9, 124.
175. Mitsui T, Tanaka H, Harabayashi T, Moriya K, Maruyama S, Abe T, Sazawa A, Shinohara N, Nonomura K. Changes in Urodynamics and Lower Urinary Tract Symptoms after Radical Prostatectomy: Implications of Preoperative Detrusor Contractility. *Low Urin Tract Symptoms.* 2012 May;4(2):82-6. doi: 10.1111/j.1757-5672.2011.00133.x. PubMed PMID: 26676531
176. Elliott CS, Comiter CV. Maximum isometric detrusor pressure to measure bladder strength in men with postprostatectomy incontinence. *Urology* 2012;80:1111-5.
177. Mitsui T, Tanaka H, Harabayashi T, Moriya K, Maruyama S, Abe T, Sazawa A, Shinohara N, Nonomura K. Changes in Urodynamics and Lower Urinary Tract Symptoms after Radical Prostatectomy: Implications of Preoperative Detrusor Contractility. *Low Urin Tract Symptoms.* 2012 May;4(2):82-6. doi: 10.1111/j.1757-5672.2011.00133.x. PubMed PMID: 26676531
178. Chung DE, Dillon B, Kurta J, Maschino A, Cronin A, Sandhu JS. Detrusor underactivity is prevalent after radical prostatectomy: A urodynamic study including risk factors. *Can Urol Assoc J* 2013;7:E33-7.
179. Mucciardi G, Galì A, Inferrera A, Di Benedetto A, Macchione L, Mucciardi M, Magno C. Longitudinal observational cohort study about detrusor underactivity as a risk factor for bladder neck contracture after retropubic radical prostatectomy: preliminary results. *Int Urol Nephrol* 2013;45:721-6.
180. Groutz A, Blaivas JG, Chaikin DC, Weiss JP, Verhaaren M. The pathophysiology of post-radical prostatectomy incontinence: a clinical and video urodynamic study. *J Urol* 2000 Jun;163(6):1767-1770.
181. McCallum TJ, Moore KN, Griffiths D. Urinary incontinence after radical prostatectomy: implications and urodynamics. *Urol Nurs* 2001 Apr;21(2):113-9, 124.
182. Lai HH, Hsu EI, Boone TB. Urodynamic testing in evaluation of postradical prostatectomy incontinence before artificial urinary sphincter implantation. *Urology* 2009 Jun;73(6):1264-1269.
183. Bentzon DN, Graugaard-Jensen C, Borre M. Urethral pressure profile 6 months after radical prostatectomy may be diagnostic of sphincteric incontinence: preliminary data after 12 months' follow-up. *Scand J Urol Nephrol* 2009;43(2):114-118.
184. Twiss C, Fleischmann N, Nitti VW. Correlation of abdominal leak point pressure with objective incontinence severity in men with post-radical prostatectomy stress incontinence. *Neurourol Urodyn* 2005;24(3):207-210.

185. Castille Y, Opsomer RJ, Tombal B, Van Cangh PJ. Contribution of the preoperative urodynamic findings in the determination of risks factors of urinary incontinence after radical retropubic prostatectomy. *Ann Readapt Med Phys* 2003 Mar;46(2):79-83.
186. Kadono Y, Ueno S, Yaegashi H, Ofude M, Izumi K, Maeda Y, Mizokami A, Miwa S, Miyagi T, Namiki M. Urodynamic evaluation before and immediately after robot-assisted radical prostatectomy. *Urology*. 2014 Jul;84(1):106-11. doi: 10.1016/j.urology.2014.04.005. PubMed PMID: 24976226.
187. Kim M, Park M, Shim M, Choi SK, Lee SM, Lee ES, Song C, Choo MS, Ahn H. Effect of preoperative urodynamic detrusor overactivity on post-prostatectomy incontinence: a systematic review and meta-analysis. *Int Urol Nephrol*. 2016 Jan;48(1):53-63. doi: 10.1007/s11255-015-1141-7. Review. PubMed PMID: 26507516.
188. Murray S, Lemack GE. Defining the role of urodynamics in predicting voiding dysfunction after anti-incontinence surgery: a work in progress. *Curr Opin Urol*. 2010 Jul;20(4):285-90. doi: 10.1097/MOU.0b013e328339ada1. Review. PubMed PMID: 21475071.
189. Frank SJ, Pisters LL, Davis J, Lee AK, Bassett R, Kuban DA. An assessment of quality of life following radical prostatectomy, high dose external beam radiation therapy and brachytherapy iodine implantation as monotherapies for localized prostate cancer. *J Urol* 2007 Jun;177(6):2151-6; discussion 2156.
190. Aboseif SR, Konety B, Schmidt RA, Goldfien SH, Tanagho EA, Narayan PA. Preoperative urodynamic evaluation: does it predict the degree of urinary continence after radical retropubic prostatectomy? *Urol Int* 1994;53(2):68-73.
191. Kleinhans B, Gerharz E, Melekos M, Weingartner K, Kable T, Riedmiller H. Changes of urodynamic findings after radical retropubic prostatectomy. *Eur Urol* 1999;35(3):217-21; discussion 221-2.
192. Barnoiu OS, Vozmediano-Chicharro R, García-Galisteo E, Soler-Martinez J, del Rosa-Samaniego JM, Machuca-Santacruz J, Baena-Gonzalez V. Urodynamic assessment of bladder and urethral sphincter function before and after robot-assisted radical prostatectomy. *Actas Urol Esp* 2014;38:78-83.
193. Kadono Y, Ueno S, Yaegashi H, Ofude M, Izumi K, Maeda Y, Mizokami A, Miwa S, Miyagi T, Namiki M. Urodynamic evaluation before and immediately after robot-assisted radical prostatectomy. *Urology* 2014;84:106-11.
194. Lee H, Kim KB, Lee S, Lee SW, Kim M, Cho SY, Oh SJ, Jeong SJ. Urodynamic assessment of bladder and urethral function among men with lower urinary tract symptoms after radical prostatectomy: A comparison between men with and without urinary incontinence. *Korean J Urol* 2015;56:803-10.
195. Kadono Y, Ueno S, Iwamoto D, Takezawa Y, Nohara T, Izumi K, Mizokami A, Namiki M. Chronological Urodynamic Evaluation of Changing Bladder and Urethral Functions After Robot-assisted Radical Prostatectomy. *Urology* 2015;85:1441-7.
196. Barnoiu OS, Garcia Galisteo E, Baron Lopez F, Vozmediano Chicharro R, Soler Martinez J, Del Rosa Samaniego JM, Machuca Santacruz J, Baena Gonzalez V. Prospective urodynamic model for prediction of urinary incontinence after robot-assisted radical prostatectomy. *Urol Int* 2014;92:306-9.
197. Reis RB, Cologna AJ, Machado RD, Machado MT, Nogueira L, Reis LO, Carvalho G, Rodrigues Jr AA, Kaplan SA, Faria EF. Lack of association between the ICIQ-SF questionnaire and the urodynamic diagnosis in men with post radical prostatectomy incontinence. *Acta Cir Bras* 2013;28(Suppl 1):37-42.
198. Solomon E, Veeratterapillay R, Malde S, Harding C, Greenwell TJ. Can filling phase urodynamic parameters predict the success of the bulbar artificial urinary sphincter in treating post-prostatectomy incontinence? *Neurourol Urodyn*. 2016 Sep 27. doi: 10.1002/nau.23147. [Epub ahead of print] PubMed PMID: 27673430.
199. Henderson A, Cahill D, Laing RW, Langley SE. (125)Iodine prostate brachytherapy: outcome from the first 100 consecutive patients and selection strategies incorporating urodynamics. *BJU Int* 2002 Oct;90(6):567-572.
200. Beekman M, Merrick GS, Butler WM, Wallner KE, Allen ZA, Galbreath RW. Selecting patients with pretreatment postvoid residual urine volume less than 100 mL may favorably influence brachytherapy-related urinary morbidity. *Urology* 2005 Dec;66(6):1266-1270.
201. Blaivas JG, Weiss JP, Jones M. The pathophysiology of lower urinary tract symptoms after brachytherapy for prostate cancer. *BJU Int* 2006 Dec;98(6):1233-7; discussion 1237.
202. Frank SJ, Pisters LL, Davis J, Lee AK, Bassett R, Kuban DA. An assessment of quality of life following radical prostatectomy, high dose external beam radiation therapy and brachytherapy iodine implantation as monotherapies for localized prostate cancer. *J Urol* 2007 Jun;177(6):2151-6; discussion 2156.

203. Gomha MA, Boone TB. Artificial urinary sphincter for post-prostatectomy incontinence in men who had prior radiotherapy: a risk and outcome analysis. *J Urol* 2002 Feb;167(2 Pt 1):591-596.
204. Thiel DD, Young PR, Broderick GA, Heckman MG, Wehle MJ, Igel TC, et al. Do clinical or urodynamic parameters predict artificial urinary sphincter outcome in post-radical prostatectomy incontinence? *Urology* 2007 Feb;69(2):315-319.
205. Lai HH, Hsu EI, Boone TB. Urodynamic testing in evaluation of postradical prostatectomy incontinence before artificial urinary sphincter implantation. *Urology* 2009 Jun;73(6):1264-1269.
206. Holm HV, Fosså SD, Hedlund H, Schultz A, Dahl AA. Severe postprostatectomy incontinence: Is there an association between preoperative urodynamic findings and outcome of incontinence surgery? *Scand J Urol* 2015;49:250-9.
207. Lai HH, Hsu EI, Boone TB. Urodynamic testing in evaluation of postradical prostatectomy incontinence before artificial urinary sphincter implantation. *Urology* 2009 Jun;73(6):1264-1269.
208. Rehder P, Gozzi C. Transobturator sling suspension for male urinary incontinence including post-radical prostatectomy. *Eur Urol* 2007 Sep;52(3):860-866.
209. Horstmann M, Fischer I, Vollmer C, Horton K, Kurz M, Padevit C, John H. Pre- and postoperative urodynamic findings in patients after a bulbourethral composite suspension with intraoperative urodynamically controlled sling tension adjustment for postprostatectomy incontinence. *Urology* 2012;79:702-7.
210. Horstmann M, John H, Horton K, Graf N, Reischauer C, Doert A, Hergan K, Gutzeit A. Comparison of standardized pre- and postoperative functional pelvic cine-MRI in patients with a bulbourethral composite suspension due to post-prostatectomy incontinence. *Int Urol Nephrol* 2013;45:967-73.
211. Suskind AM, DeLancey JO, Hussain HK, Montgomery JS, Latini JM, Cameron AP. Dynamic MRI evaluation of urethral hypermobility post-radical prostatectomy. *Neurourol Urodyn* 2014;33:312-5.
212. Romano SV, Huebner W, Rocha FT, Vaz FP, Muller V, Nakamura F. A transobturator adjustable system for male incontinence: 30-month follow-up of a multicenter study. *Int Braz J Urol* 2014;40:781-9.
213. Collado Serra A, Resel Folkersma L, Domínguez-Escrig JL, Gómez-Ferrer A, Rubio-Briones J, Solsona Narbón E. AdVance/AdVance XP transobturator male slings: preoperative degree of incontinence as predictor of surgical outcome. *Urology* 2013;81:1034-9.
214. Warner JN, Grimsby GM, Tyson MD, Wolter CE. Bladder capacity on preoperative urodynamics may impact outcomes on transobturator male slings. *Neurourol Urodyn* 2012;31:1124-7.
215. Barnard J, van Rij S, Westenberg AM. Valsalva leak-point pressure of >100?cmH2O is associated with greater success in AdVance™ sling placement for the treatment of post-prostatectomy urinary incontinence. *BJU Int* 2014;114(Suppl 1):34-7.
216. Hall M, Polland A, Weissbart S, Mock S, Grafstein N. Prognostic value of postoperative urinary retention after male sling insertion. *Can J Urol* 2014;21:7344-9.
217. Manka MG, Wright EJ. Does Use of a Second Cuff Improve Artificial Urinary Sphincter Effectiveness? Evaluation Using a Comparative Cadaver Model. *J Urol* 2015;194:1688-91.
218. Weissbart SJ, Coutinho K, Chughtai B, Sandhu JS. Characteristics and outcomes of men who fail to leak on intubated urodynamics prior to artificial urinary sphincter placement. *Can J Urol* 2014;21:7560-4.
219. Torrey R, Rajeshuni N, Ruel N, Muldrew S, Chan K. Radiation history affects continence outcomes after advance transobturator sling placement in patients with post-prostatectomy incontinence. *Urology* 2013;82:713-7.
220. Utomo E, Groen J, Vroom IH, van Mastrigt R, Blok BF. Urodynamic effects of volume-adjustable balloons for treatment of postprostatectomy urinary incontinence. *Urology* 2013;81:1308-14.
221. Fuller TW, Ristau BT, Benoit RM. Simultaneous cuff revision and placement of an AdVance male sling for persistent post-prostatectomy urinary incontinence initially managed with AMS 800 artificial urinary sphincter. *Can J Urol*. 2014 Oct;21(5):7507-9. PubMed PMID: 25347378.
222. Chung E, Cartmill R. Diagnostic challenges in the evaluation of persistent or recurrent urinary incontinence after artificial urinary sphincter (AUS) implantation in patients after prostatectomy. *BJU Int*. 2013 Nov;112 Suppl 2:32-5. doi: 10.1111/bju.12207. Review. PubMed PMID: 24127674.

223. Chung E, Smith P, Malone G, Cartmill R. Adjustable versus non-adjustable male sling for post-prostatectomy urinary incontinence: A prospective clinical trial comparing patient choice, clinical outcomes and satisfaction rate with a minimum follow up of 24 months. *Neurourol Urodyn*. 2016 Apr;35(4):482-6. doi:10.1002/nau.22731. PubMed PMID: 25683567.
224. James MH, McCammon KA. Artificial urinary sphincter for post-prostatectomy incontinence: a review. *Int J Urol*. 2014 Jun;21(6):536-43. doi: 10.1111/iju.12392. Review. PubMed PMID: 24528387.
225. Blok B, Pannek J, Castro-Diaz D, del Popolo G, Groen J, Hamid R, Karsenty G, Kessler TM. European Association of Urology (EAU) Guidelines on Neuro-Urology. EAU; 2016.
226. Abrams P, Cardozo L, Fall M, Griffiths D, Rosier P, Ulmsten U, et al. The standardisation of terminology of lower urinary tract function: report from the Standardisation Sub-committee of the International Continence Society. *Neurourol Urodyn* 2002;21(2):167-178.
227. Drake M, Apostolidis A, Emmanuel A, et al. Neurologic urinary and faecal incontinence. In: Abrams P, Cardozo L, Khoury S, et al., editors. *Incontinence (5th Ed)*. ICUD-EAU; 2013. p 827–1000.
228. Dorsher PT, McIntosh PM. Neurogenic bladder. *Adv Urol*. 2012; 2012:816274.
229. Abrams P, Blaivas JG, Stanton SL, Andersen JT. The standardisation of terminology of lower urinary tract function. The International Continence Society Committee on Standardisation of Terminology. *Scand J Urol Nephrol Suppl* 1988;114:5-19.
230. McGuire EJ, Cespedes RD, O'Connell HE. Leak-point pressures. *Urol Clin North Am* 1996 May;23(2):253-262.
231. Naoemova I, De Wachter S, Wuyts FL, Wyndaele JJ. Reliability of the 24-h sensation-related bladder diary in women with urinary incontinence. *Int Urogynecol J Pelvic Floor Dysfunct*. 2008;19: 955-959.
232. Tarcan T, Sekerci CA, Akbal C, Tinay I, Tanidir Y, Sahan A, Sahin B, Top T, Simsek F. Is 40?cm?H(2) O detrusor leak point pressure cut-off reliable for upper urinary tract protection in children with myelodysplasia? *Neurourol Urodyn*. 2016 Apr 15. doi: 10.1002/nau.23017. [Epub ahead of print] PubMed PMID: 27080436.
233. McGuire EJ. Urodynamics of the neurogenic bladder. *Urol Clin North Am* 2010 Nov;37(4):507-516.
234. Schäfer W, Abrams P, Liao L, Mattiasson A, Pesce F, Spangberg A, Sterling AM, Zinner NR, van Kerrebroeck P; International Continence Society. Good urodynamic practices: uroflowmetry, filling cystometry, and pressure-flow studies. *Neurourol Urodyn*, 2002. 21: 261.
235. Gammie A, Clarkson B, Constantinou C, Damaser M, Drinnan M, Geleijnse G, Griffiths D, Rosier P, Schäfer W, Van Mastrigt R; International Continence Society Urodynamic Equipment Working Group. International Continence Society guidelines on urodynamic equipment performance. *Neurourol Urodyn*, 2014. 33: 370.
236. Walter, M., et al. Autonomic dysreflexia and repeatability of cardiovascular changes during same session repeat urodynamic investigation in women with spinal cord injury. *World J Urol*, 2015.
237. Marks BK, Goldman HB. Videourodynamics: indications and technique. *Urol Clin North Am*. 2014 Aug;41(3):383-91, vii-viii.
238. Geirsson G, Fall M, Lindström S. The ice-water test--a simple and valuable supplement to routine cystometry. *Br J Urol*. 1993 Jun;71(6):681-5.
239. Al-Hayek S, Abrams P. The 50-year history of the ice water test in urology. *J Urol*. 2010 May;183(5):1686-92.
240. Hüscher T, Neuerburg T, Reitz A, Haferkamp A. The ice water test and bladder cooling reflex: Physiology, pathophysiology and clinical importance. *Urologe A*. 2016 Apr;55(4):499-505.
241. Huwylar M, Schurch B, Knapp PA, Reitz A. Can the ice-water test predict the outcome of intradetrusor injections of botulinum toxin in patients with neurogenic bladder dysfunction? *World J Urol* 2007 Dec;25(6):613-617.
242. Chancellor MB, Lavelle J, Ozawa H, Jung SY, Watanabe T, Kumon H. Ice-water test in the urodynamic evaluation of spinal cord injured patients. *Tech Urol* 1998 Jun;4(2):87-91.
243. Lapedes, J. Neurogenic bladder. Principles of treatment. *Urol Clin North Am*, 1974. 1: 81.
244. Wyndaele JJ, Thi HV, Pham BC, Kovindha A, Huong VT, Weerts E. The use of one-channel water cystometry in patients with a spinal cord lesion: practicalities, clinical value and limitations for the diagnosis of neurogenic bladder dysfunction. *Spinal Cord* 2009 Jul;47(7):526-530.
245. Ockrim J, Laniado ME, Khoubehi B, Renzetti R, Finazzi Agrò E, Carter SS, Tubaro A. Variability of detrusor overactivity on repeated filling cystometry in men with urge symptoms: comparison with spinal cord injury patients. *BJU Int*. 2005 Mar;95(4):587-90.

246. Homma Y, Kondo Y, Takahashi S, Kitamura T, Kawabe K. Reproducibility of cystometry in overactive detrusor. *Eur Urol* 2000 Dec;38(6):681-685.
247. Pannek J, Hilfiker R, Goecking K, Bersch U. Preoperative urodynamic assessment in patients with spinal cord lesions undergoing sphincterotomy: is success predictable? *Urol Int* 2009;83(4):386-391.
248. Martens FM, van Kuppevelt HJ, Beekman JA, Heijnen IC, D'Hauwers KW, Heesakkers JP. No primary role of ambulatory urodynamics for the management of spinal cord injury patients compared to conventional urodynamics. *Neurourol Urodyn* 2010 Nov;29(8):1380-1386.
249. Tanaka H, Kakizaki H, Kobayashi S, Shibata T, Ameda K, Koyanagi T. The relevance of urethral resistance in children with myelodysplasia: its impact on upper urinary tract deterioration and the outcome of conservative management. *J Urol* 1999 Mar;161(3):929-932.
250. Stöhrer M, Blok B, Castro-Diaz D, Chartier-Kastler E, Del Popolo G, Kramer G, Pannek J, Radziszewski P, Wyndaele JJ. EAU guidelines on neurogenic lower urinary tract dysfunction. *Eur Urol*. 2009 Jul;56(1):81-8. doi:10.1016/j.eururo.2009.04.028. PubMed PMID: 19403235.
251. Drake, M., et al., Conservative management in neuropathic urinary incontinence, in *Incontinence*, P. Abrams, L. Cardozo, S. Khoury & A. Wein, Editors. 2013, Health Publication: Plymouth: 2013; pp. 827-1000.
252. Bomalaski MD, Teague JL, Brooks B. The long-term impact of urological management on the quality of life of children with spina bifida. *J Urol* 1995 Aug;154(2 Pt 2):778-781.
253. Cardenas DD, Mayo ME, Turner LR. Lower urinary changes over time in suprasacral spinal cord injury. *Paraplegia* 1995 Jun;33(6):326-329.
254. Nosseir M, Hinkel A, Pannek J. Clinical usefulness of urodynamic assessment for maintenance of bladder function in patients with spinal cord injury. *Neurourol Urodyn* 2007;26(2):228-233.
255. Wang QW, Wen JG, Song DK, Su J, Che YY, Zhang P, et al. Is it possible to use urodynamic variables to predict upper urinary tract dilatation in children with neurogenic bladder-sphincter dysfunction? *BJU Int* 2006 Dec;98(6):1295-1300.
256. Bauer SB, Nijman RJM, Drzewiecki BA, Sillen U, Hoebeke P. International Children's Continence Society Standardization Report on Urodynamic Studies of the Lower Urinary Tract in Children. *Neurourol Urodyn*. 2015; 34:640-647
257. Spinoit AF, Decalf V, Ragolle I, Ploumidis A, Claeys T, Groen LA, Van Laecke E, Hoebeke P. Urodynamic studies in children: Standardized transurethral video-urodynamic evaluation. *J Ped Urol*. 2016 12: 67-68
258. Bower WF, Swithinbank L, de Jong T, de Kort LM, Marschall-Kehrel D. Assessment of non-neurogenic incontinence and lower urinary tract symptoms in adolescents and young adults. *Neurourol Urodyn* 2010 Jun;29(5):702-707.
259. Drzewiecki BA, Bauer SB. Urodynamic testing in children: indications, technique, interpretation and significance. *J Urol* 2011 Oct;186(4):1190-1197.
260. Tangal S, Gökçe MI, Özayar A, Gülpinar B, Haliloglu AH, Burgu B, Özdiler E. Evaluation of a new ultrasound measurement tool for the diagnosis of dysfunctional voiding in pediatric population: full/empty bladder wall thickness ratio. *Urology*. 2014 Jun;83(6):1369-72.
261. Godbole P, Raghavan A, Searles J, Roberts J, Walters SJ. Dynamic pelvic floor ultrasound for lower urinary tract symptoms in children--initial report on normative values *J Pediatr Urol*. 2013 Dec;9(6 Pt A):950-4.
262. Schulte-Baukloh H, Priefert J, Knispel HH, Lawrence GW, Miller K, Neuhaus J. Botulinum toxin A detrusor injections reduce postsynaptic muscular M2, M3, P2X2, and P2X3 receptors in children and adolescents who have neurogenic detrusor overactivity: a single-blind study. *Urology*. 2013 May;81(5):1052-7.
263. Tiryaki S, Yagmur I, Parlar Y, Ozel K, Akyildiz C, Avanoğlu A, Ulman I. Botulinum injection is useless on fibrotic neuropathic bladders. *J Pediatr Urol*. 2015 Feb;11(1):27.e1-4. doi: 10.1016/j.jpuro.2014.08.009. PubMed PMID: 25448589.
264. Khan MK, VanderBrink BA, DeFoor WR, Minevich E, Jackson E, Noh P, Reddy PP. Botulinum toxin injection in the pediatric population with medically refractory neuropathic bladder. *J Pediatr Urol*. 2016 Apr;12(2):104.e1-6. doi: 10.1016/j.jpuro.2015.08.018. PubMed PMID: 26778185
265. Hascoet J, Manunta A, Brochard C, Arnaud A, Dampousse M, Menard H, Kerdraon J, Journel H, Bonan I, Odent S, Fremont B, Siproudhis L, Gamé X, Peyronnet B; French Referral Network of Spina Bifida. Outcomes of intra-detrusor injections of botulinum toxin in patients with spina bifida: A systematic review. *Neurourol Urodyn*. 2016 May 17. doi: 10.1002/nau.23025. [Epub ahead of print] Review. PubMed PMID: 27187872

266. Kim SW, Choi JH, Lee YS, Han SW, Im YJ. Preoperative urodynamic factors predicting outcome of botulinum toxin-A-intradetrusor injection in children with neurogenic detrusor overactivity. *Urology*. 2014 Dec;84(6):1480-4
267. Snodgrass W, Villaneuva C, Jacobs M, Gargollo P. Upper tract changes in patients with neurogenic bladder and sustained pressures >40 cm following bladder neck surgery without augmentation. *J Pediatr Urol*. 2014 Aug;10(4):744-8
268. Sidi AA, Dykstra DD, Gonzalez R. The value of urodynamic testing in the management of neonates with myelodysplasia: a prospective study. *J Urol* 1986 Jan;135(1):90-93.
269. Thorup, J., Biering-Sorensen, F. and Cortes, D. (2011), Urological outcome after myelomeningocele: 20 years of follow-up. *BJU International*, 107: 994–999. doi:10.1111/j.1464-410X.2010.09681.x
270. Bauer SB, Austin PF, Rawashdeh YF, et al. International children's continence society's recommendations for initial diagnostic evaluation and follow-up of congenital neuropathic bladder and bowel dysfunction in children. *Neurourol Urodyn*. 2012;31:610–4.
271. Wang QW, Wen JG, Song DK, Su J, Che YY, Zhang P, et al. Is it possible to use urodynamic variables to predict upper urinary tract dilatation in children with neurogenic bladder-sphincter dysfunction? *BJU Int* 2006
272. Khoury AE, Dave S, Peralta-Del Valle MH, Braga LH, Lorenzo AJ, Bagli D. Severe bladder trabeculation obviates the need for bladder outlet procedures during augmentation cystoplasty in incontinent patients with neurogenic bladder. *BJU Int* 2008 Jan;101(2):223-226.
273. Sekerci ÇA, Isbilen B, Isman F, Akbal C, Simsek F, Tarcan T. Urinary NGF, TGF-β1, TIMP-2 and bladder wall thickness predict neurourological findings in children with myelodysplasia. *J Urol*. 2014 Jan;191(1):199-205.
274. Soygur T, Burgu B, Zumrutbas A, Suer E. The need for ureteric re-implantation during augmentation cystoplasty: video-urodynamic evaluation. *BJU Int* 2010 Feb;105(4):530-532.
275. Almodhen F, Capolicchio JP, Jednak R, El Sherbiny M. Postpubertal urodynamic and upper urinary tract changes in children with conservatively treated myelomeningocele. *J Urol* 2007 Oct;178(4 Pt 1):1479-1482.
276. Lima SV, Araujo LA, Vilar Fde O, Lima RS, Lima RF. Nonsecretory intestincystoplasty: a 15-year prospective study of 183 patients. *J Urol* 2008 Mar;179(3):1113-6; discussion 1116-7.
277. Dik P, Klijn AJ, van Gool JD, de Jong-de Vos van Steenwijk, C.C., de Jong TP. Early start to therapy preserves kidney function in spina bifida patients. *Eur Urol* 2006 May;49(5):908-913.
278. de Jong TP, Chrzan R, Klijn AJ, Dik P. Treatment of the neurogenic bladder in spina bifida. *Pediatr Nephrol* 2008 Jun;23(6):889-896.
279. Bauer SB, Austin PF, Rawashdeh YF, et al. International children's continence society's recommendations for initial diagnostic evaluation and follow-up of congenital neuropathic bladder and bowel dysfunction in children. *Neurourol Urodyn*. 2012;31:610–4.
280. Geraniotis E, Koff SA, Enrile B. The prophylactic use of clean intermittent catheterization in the treatment of infants and young children with myelomeningocele and neurogenic bladder dysfunction. *J Urol* 1988 Jan;139(1):85-86.
281. Lais A, Kasabian NG, Dyro FM, Scott RM, Kelly MD, Bauer SB. The neurosurgical implications of continuous neurourological surveillance of children with myelodysplasia. *J Urol* 1993 Dec;150(6):1879-1883.
282. Tarcan T, Bauer S, Olmedo E, Khoshbin S, Kelly M, Darbey M. Long-term followup of newborns with myelodysplasia and normal urodynamic findings: Is followup necessary? *J Urol* 2001 Feb;165(2):564-567.
283. Rendeli C, Ausili E, Tabacco F, Focarelli B, Massimi L, Caldarelli M, et al. Urodynamic evaluation in children with lipomeningocele: timing for neurosurgery, spinal cord tethering and followup. *J Urol* 2007 Jun;177(6):2319-2324.
284. Maher CO, Bauer SB, Goumnerova L, Proctor MR, Madsen JR, Scott RM. Urological outcome following multiple repeat spinal cord untethering operations. Clinical article. *J Neurosurg Pediatr* 2009 Sep;4(3):275-279.
285. Schulte-Baukloh H, Murtz G, Heine G, Austin P, Miller K, Michael T, et al. Urodynamic effects of propiverine in children and adolescents with neurogenic bladder: Results of a prospective long-term study. *J Pediatr Urol* 2011 Sep 8.
286. Humblet M, Verpoorten C, Christiaens MH, Hirche H, Jansen K, Buyse G, van Gool JD. Long-term outcome of intravesical oxybutynin in children with detrusor-sphincter dyssynergia: with special reference to age-dependent parameters. *Neurourol Urodyn*. 2015 Apr;34(4):336-42.
287. Bilginer Y, Aki FT, Topaloglu R, Tekgul S, Demirkaya E, Duzova A, et al. Renal transplantation in children with lower urinary tract dysfunction of different origin: a single-center experience. *Transplant Proc* 2008 Jan-Feb;40(1):85-86.

288. Keating MA, Rink RC, Bauer SB, Krarup C, Dyro FM, Winston KR, et al. Neurourological implications of the changing approach in management of occult spinal lesions. *J Urol* 1988 Nov;140(5 Pt 2):1299-1301.
289. Torre M, Planche D, Louis-Borrione C, Sabiani F, Lena G, Guys JM. Value of electrophysiological assessment after surgical treatment of spinal dysraphism. *J Urol* 2002 Oct;168(4 Pt 2):1759-62; discussion 1763.
290. Kumar R, Singhal N, Gupta M, Kapoor R, Mahapatra AK. Evaluation of clinico-urodynamic outcome of bladder dysfunction after surgery in children with spinal dysraphism - a prospective study. *Acta Neurochir (Wien)* 2008 Feb;150(2):129-137.
291. Hsieh MH, Perry V, Gupta N, Pearson C, Nguyen HT. The effects of detethering on the urodynamics profile in children with a tethered cord. *J Neurosurg* 2006 Nov;105(5 Suppl):391-395.
292. Kumar R, Singhal N, Gupta M, Kapoor R, Mahapatra AK. Evaluation of clinico-urodynamic outcome of bladder dysfunction after surgery in children with spinal dysraphism - a prospective study. *Acta Neurochir (Wien)* 2008 Feb;150(2):129-137.
293. Kondo A, Kato K, Kanai S, Sakakibara T. Bladder dysfunction secondary to tethered cord syndrome in adults: is it curable? *J Urol* 1986 Feb;135(2):313-316.
294. Satar N, Bauer SB, Shefner J, Kelly MD, Darbey MM. The effects of delayed diagnosis and treatment in patients with an occult spinal dysraphism. *J Urol* 1995 Aug;154(2 Pt 2):754-758.
295. Yip CM, Leach GE, Rosenfeld DS, Zimmermann P, Raz S. Delayed diagnosis of voiding dysfunction: occult spinal dysraphism. *J Urol* 1985 Oct;134(4):694-697.
296. Kumar R, Singhal N, Gupta M, Kapoor R, Mahapatra AK. Evaluation of clinico-urodynamic outcome of bladder dysfunction after surgery in children with spinal dysraphism - a prospective study. *Acta Neurochir (Wien)* 2008 Feb;150(2):129-137.
297. Lavallée LT, Leonard MP, Dubois C, Guerra LA. Urodynamic testing--is it a useful tool in the management of children with cutaneous stigmata of occult spinal dysraphism? *J Urol*. 2013 Feb;189(2):678-83. doi: 10.1016/j.juro.2012.08.203. PubMed PMID: 22982430.
298. Fraihey BT, Yerkes EB, Menon VS, Gong EM, Meyer TA, Bowman RM, McLone DG, Cheng EY. Predictors of urinary continence following tethered cord release in children with occult spinal dysraphism. *J Pediatr Urol*. 2014 Aug;10(4):627-33. doi: 10.1016/j.jpurol.2014.06.008. PubMed PMID: 25067798.
299. Valentini LG, Selvaggio G, Erbetta A, Cordella R, Pecoraro MG, Bova S, Boni E, Beretta E, Furlanetto M. Occult spinal dysraphism: lessons learned by retrospective analysis of 149 surgical cases about natural history, surgical indications, urodynamic testing, and intraoperative neurophysiological monitoring. *Childs Nerv Syst*. 2013 Sep;29(9):1657-69. doi: 10.1007/s00381-013-2186-5. PubMed PMID: 24013336.
300. Borrelli M, Bruschini H, Nahas WC, Figueiredo JA, Prado MJ, Spinola R, et al. Sacral agenesis: why is it so frequently misdiagnosed? *Urology* 1985 Oct;26(4):351-355.
301. Boemers TM, Beek FJ, van Gool JD, de Jong TP, Bax KM. Urologic problems in anorectal malformations. Part 1: Urodynamic findings and significance of sacral anomalies. *J Pediatr Surg* 1996 Mar;31(3):407-410.
302. Mosiello G, Capitanucci ML, Gatti C, Adorisio O, Lucchetti MC, Silveri M, et al. How to investigate neurovesical dysfunction in children with anorectal malformations. *J Urol* 2003 Oct;170(4 Pt 2):1610-1613.
303. Taskinen S, Valanne L, Rintala R. Effect of spinal cord abnormalities on the function of the lower urinary tract in patients with anorectal abnormalities. *J Urol* 2002 Sep;168(3):1147-1149.
304. Guzman L, Bauer SB, Hallett M, Khoshbin S, Colodny AH, Retik AB. Evaluation and management of children with sacral agenesis. *Urology* 1983 Nov;22(5):506-510.
305. Kim SM, Chang HK, Lee MJ, Shim KW, Oh JT, Kim DS, et al. Spinal dysraphism with anorectal malformation: lumbosacral magnetic resonance imaging evaluation of 120 patients. *J Pediatr Surg* 2010 Apr;45(4):769-776.
306. Borg H, Holmdahl G, Olsson I, Wiklund LM, Silen U. Impact of spinal cord malformation on bladder function in children with anorectal malformations. *J Pediatr Surg* 2009 Sep;44(9):1778-1785.
307. Chou FH, Ho CH, Chir MB, Linsenmeyer TA. Normal ranges of variability for urodynamic studies of neurogenic bladders in spinal cord injury. *J Spinal Cord Med* 2006;29(1):26-31.

308. Pannek J, Diederichs W, Botel U. Urodynamically controlled management of spinal cord injury in children. *Neurourol Urodyn* 1997;16(4):285-292.
309. Kurzrock EA, Polse S. Renal deterioration in myelodysplastic children: urodynamic evaluation and clinical correlates. *J Urol* 1998 May;159(5):1657-1661.
310. Fanciullacci F, Zanollo A, Sandri S, Catanzaro F. The neuropathic bladder in children with spinal cord injury. *Paraplegia* 1988 Apr;26(2):83-86.
311. Generao SE, Dall'era JP, Stone AR, Kurzrock EA. Spinal cord injury in children: long-term urodynamic and urological outcomes. *J Urol* 2004 Sep;172(3):1092-4, discussion 1094.
312. Silveri M, Salsano L, Pierro MM, Mosiello G, Capitanucci ML, De Gennaro M. Pediatric spinal cord injury: approach for urological rehabilitation and treatment. *J Pediatr Urol* 2006 Feb;2(1):10-15.
313. Iwatsubo E, Iwakawa A, Koga H, Imamura A, Yamashita H, Komine S. Functional recovery of the bladder in patients with spinal cord injury--prognosticating programs of an aseptic intermittent catheterization. *Hinyokika Kyo* 1985 May;31(5):775-783.
314. Canon S, Shera A, Phan NM, Lapicz L, Scheidweiler T, Batchelor L, Swearingen C. Autonomic dysreflexia during urodynamics in children and adolescents with spinal cord injury or severe neurologic disease. *PediatrUrol*. 2015 Feb;11(1):32-35.
315. Richardson I, Palmer LS. Clinical and urodynamic spectrum of bladder function in cerebral palsy. *J Urol*. 2009 Oct;182(4 Suppl):1945-8. doi:10.1016/j.juro.2009.04.081. PubMed PMID: 19695619.
316. Ersoz M, Kaya K, Erol SK, Kulakli F, Akyuz M, Ozel S. Noninvasive evaluation of lower urinary tract function in children with cerebral palsy. *Am J Phys Med Rehabil* 2009 Sep;88(9):735-741.
317. Samijn B, Van Laecke E, Renson C, Hoebeke P, Plasschaert F, Vande Walle J, Van den Broeck C. Lower urinary tract symptoms and urodynamic findings in children and adults with cerebral palsy: A systematic review. *Neurourol Urodyn*. 2016 Feb 19. doi: 10.1002/nau.22982.
318. Fernandes Silva JA, Borges Carrerette F, Damião R. Uroflowmetry in the management of lower urinary tract symptoms of children and adolescents with cerebral palsy. *J Pediatr Urol*. 2014 Jun;10(3):413-7.
319. Reid CJ, Borzyskowski M. Lower urinary tract dysfunction in cerebral palsy. *Arch Dis Child*. 1993 Jun;68(6):739-42. PubMed PMID: 8333762; PubMed Central PMCID: PMC1029364.
320. Decter RM, Bauer SB, Khoshbin S, Dyro FM, Krarup C, Colodny AH, et al. Urodynamic assessment of children with cerebral palsy. *J Urol* 1987 Oct;138(4 Pt 2):1110-1112.
321. Mayo ME. Lower urinary tract dysfunction in cerebral palsy. *J Urol* 1992 Feb;147(2):419-420.
322. Karaman MI, Kaya C, Caskurlu T, Guney S, Ergenekon E. Urodynamic findings in children with cerebral palsy. *Int J Urol* 2005 Aug;12(8):717-720.
323. Bross S, Honeck P, Kwon ST, Badawi JK, Trojan L, Alken P. Correlation between motor function and lower urinary tract dysfunction in patients with infantile cerebral palsy. *Neurourol Urodyn* 2007;26(2):222-227.
324. Silva JA, Alvares RA, Barboza AL, Monteiro RT. Lower urinary tract dysfunction in children with cerebral palsy. *Neurourol Urodyn* 2009;28(8):959-963.
325. Bross S, Honeck P, Kwon ST, Badawi JK, Trojan L, Alken P. Correlation between motor function and lower urinary tract dysfunction in patients with infantile cerebral palsy. *Neurourol Urodyn*. 2007;26(2):222-7. PubMed PMID: 17009254.
326. Houle AM, Vernet O, Jednak R, Pippi Salle JL, Farmer JP. Bladder function before and after selective dorsal rhizotomy in children with cerebral palsy. *J Urol*. 1998 Sep;160(3 Pt 2):1088-91. PubMed PMID: 9719282.
327. Mosiello G, Gatti C, De Gennaro M, Capitanucci ML, Silveri M, Inserra A, et al. Neurovesical dysfunction in children after treating pelvic neoplasms. *BJU Int* 2003 Aug;92(3):289-292.
328. Berger M, Heinrich M, Lacher M, Hubertus J, Stehr M, von Schweinitz D. Postoperative bladder and rectal function in children with sacrococcygeal teratoma. *Pediatr Blood Cancer* 2011 Mar;56(3):397-402.
329. Nguyen HT, Sencan A, Silva A, Carvas FA, Bauer SB. Urodynamic studies are recommended in children with central nervous system tumors regardless of location. *J Urol* 2010 Dec;184(6):2516-2520.
330. Pena A. Posterior sagittal approach for the correction of anorectal malformations. *Adv Surg* 1986;19:69-100.

331. Shimada K, Matsumoto F, Tohda A, Ainoya K. Urinary control after the definitive reconstruction of cloacal anomaly. *Int J Urol* 2005 Jul;12(7):631-636.
332. Camanni D, Zaccara A, Capitanucci ML, Mosiello G, Iacobelli BD, De Gennaro M. Bladder after total urogenital mobilization for congenital adrenal hyperplasia and cloaca--does it behave the same? *J Urol* 2009 Oct;182(4 Suppl):1892-1897.
333. Warne SA, Godley ML, Wilcox DT. Surgical reconstruction of cloacal malformation can alter bladder function: a comparative study with anorectal anomalies. *J Urol* 2004 Dec;172(6 Pt 1):2377-81; discussion 2381.
334. Kumar A, Agarwala S, Mitra DK. Occult neurovesical dysfunction with anorectal malformations. *Indian J Pediatr* 2006 Nov;73(11):999-1003.
335. Kakizaki H, Nonomura K, Asano Y, Shinno Y, Ameda K, Koyanagi T. Preexisting neurogenic voiding dysfunction in children with imperforate anus: problems in management. *J Urol* 1994 Apr;151(4):1041-1044.
336. Boemers TM, Beek FJ, van Gool JD, de Jong TP, Bax KM. Urologic problems in anorectal malformations. Part 1: Urodynamic findings and significance of sacral anomalies. *J Pediatr Surg* 1996 Mar;31(3):407-410.
337. Kim SM, Chang HK, Lee MJ, Shim KW, Oh JT, Kim DS, et al. Spinal dysraphism with anorectal malformation: lumbosacral magnetic resonance imaging evaluation of 120 patients. *J Pediatr Surg* 2010 Apr;45(4):769-776.
338. Mosiello G, Capitanucci ML, Gatti C, Adorasio O, Lucchetti MC, Silveri M, et al. How to investigate neurovesical dysfunction in children with anorectal malformations. *J Urol* 2003 Oct;170(4 Pt 2):1610-1613.
339. Scottoni F, Iacobelli BD, Zaccara AM, Totonelli G, Schingo AM, Bagolan P. Spinal ultrasound in patients with anorectal malformations: is this the end of an era? *Pediatr Surg Int*. 2014 Aug;30(8):829-31.
340. Boemers TM, Beek FJ, van Gool JD, de Jong TP, Bax KM. Urologic problems in anorectal malformations. Part 1: Urodynamic findings and significance of sacral anomalies. *J Pediatr Surg* 1996 Mar;31(3):407-410.
341. Emir H, Soylet Y. Neurovesical dysfunction in patients with anorectal malformations. *Eur J Pediatr Surg* 1998 Apr;8(2):95-97.
342. Boemers TM, Beek FJ, van Gool JD, de Jong TP, Bax KM. Urologic problems in anorectal malformations. Part 1: Urodynamic findings and significance of sacral anomalies. *J Pediatr Surg* 1996 Mar;31(3):407-410.
343. Emir H, Soylet Y. Neurovesical dysfunction in patients with anorectal malformations. *Eur J Pediatr Surg* 1998 Apr;8(2):95-97.
344. Capitanucci ML, Rivosecchi M, Silveri M, Lucchetti MC, Mosiello G, De Gennaro M. Neurovesical dysfunction due to spinal dysraphism in anorectal anomalies. *Eur J Pediatr Surg* 1996 Jun;6(3):159-162.
345. Mosiello G, Capitanucci ML, Gatti C, Adorasio O, Lucchetti MC, Silveri M, et al. How to investigate neurovesical dysfunction in children with anorectal malformations. *J Urol* 2003 Oct;170(4 Pt 2):1610-1613.
346. De Gennaro M, Rivosecchi M, Lucchetti MC, Silveri M, Fariello G, Schingo P. The incidence of occult spinal dysraphism and the onset of neurovesical dysfunction in children with anorectal anomalies. *Eur J Pediatr Surg* 1994 Dec;4 Suppl 1:12-14.
347. Mitchell, M., Persistent ureteral dilation following valve resection, in *Dialogues in Pediatric Urology*. 1982.
348. Glassberg KI. The valve bladder syndrome: 20 years later. *J Urol* 2001 Oct;166(4):1406-1414.
349. Androulakakis PA, Karamanolakis DK, Tsaouridis G, Stefanidis AA, Palaeodimos I. Myogenic bladder decompression in boys with a history of posterior urethral valves is caused by secondary bladder neck obstruction? *BJU Int* 2005 Jul;96(1):140-143.
350. Kajbafzadeh AM, Payabvash S, Karimian G. The effects of bladder neck incision on urodynamic abnormalities of children with posterior urethral valves. *J Urol* 2007 Nov;178(5):2142-7; discussion 2147-9.
351. Bauer SB, Dieppa RA, Labib KK, Retik AB. The bladder in boys with posterior urethral valves: a urodynamic assessment. *J Urol* 1979 Jun;121(6):769-773.
352. Holmdahl G, Sillen U, Hanson E, Hermansson G, Hjalmas K. Bladder dysfunction in boys with posterior urethral valves before and after puberty. *J Urol* 1996 Feb;155(2):694-698.
353. De Gennaro M, Mosiello G, Capitanucci ML, Silveri M, Capozza N, Caione P. Early detection of bladder dysfunction following posterior urethral valves ablation. *Eur J Pediatr Surg* 1996 Jun;6(3):163-165.

354. De Gennaro M, Capitanucci ML, Mosiello G, Caione P, Silveri M. The changing urodynamic pattern from infancy to adolescence in boys with posterior urethral valves. *BJU Int* 2000 Jun;85(9):1104-1108.
355. Holmdahl G, Sillen U, Hanson E, Hermansson G, Hjalmas K. Bladder dysfunction in boys with posterior urethral valves before and after puberty. *J Urol* 1996 Feb;155(2):694-698.
356. Kajbafzadeh AM, Payabvash S, Karimian G. The effects of bladder neck incision on urodynamic abnormalities of children with posterior urethral valves. *J Urol* 2007 Nov;178(5):2142-7; discussion 2147-9.
357. Lopez Pereira P, Martinez Urrutia MJ, Espinosa L, Lobato R, Navarro M, Jaureguizar E. Bladder dysfunction as a prognostic factor in patients with posterior urethral valves. *BJU Int* 2002 Aug;90(3):308-311.
358. Ansari MS, Gulia A, Srivastava A, Kapoor R. Risk factors for progression to end-stage renal disease in children with posterior urethral valves. *J Pediatr Urol* 2010 Jun;6(3):261-264.
359. Capitanucci ML, Marciano A, Zaccara A, La Sala E, Mosiello G, De Gennaro M. Long-term bladder function followup in boys with posterior urethral valves: comparison of noninvasive vs invasive urodynamic studies. *J Urol*. 2012 Sep;188(3):953-7
360. Lee YS, Jung HJ, Im YJ, Hong CH, Han SW. The significance of detrusor wall thickness as a prognostic factor in pediatric bladder outlet obstruction. *J Pediatr Surg*. 2012 Sep;47(9):1682-7.
361. Diamond DA, Bauer SB, Dinlenc C, Hendren WH, Peters CA, Atala A, et al. Normal urodynamics in patients with bladder exstrophy: are they achievable? *J Urol* 1999 Sep;162(3 Pt 1):841-4; discussion 844-5.
362. Burki T, Hamid R, Duffy P, Ransley P, Wilcox D, Mushtaq I. Long-term followup of patients after redo bladder neck reconstruction for bladder exstrophy complex. *J Urol* 2006 Sep;176(3):1138-41; discussion 1141-2.
363. Gargollo PC, Borer JG, Diamond DA, Hendren WH, Rosoklija I, Grant R, et al. Prospective followup in patients after complete primary repair of bladder exstrophy. *J Urol* 2008 Oct;180(4 Suppl):1665-70; discussion 1670.
364. Borer JG, Strakosha R, Bauer SB, Diamond DA, Pennison M, Rosoklija I, Khoshbin S. Combined cystometrography and electromyography of the external urethral sphincter following complete primary repair of bladder exstrophy. *J Urol*. 2014 May;191(5 Suppl):1547-52
365. Abrahamsson K, Olsson I, Sillen U. Urodynamic findings in children with myelomeningocele after untethering of the spinal cord. *J Urol* 2007 Jan;177(1):331-4; discussion 334.
366. Holmes NM, Coplen DE, Strand W, Husmann D, Baskin LS. Is bladder dysfunction and incontinence associated with ureterocele congenital or acquired? *J Urol* 2002 Aug;168(2):718-719.
367. Jesus LE, Farhat WA, Amarante AC, Dini RB, Leslie B, Bagli DJ, et al. Clinical evolution of vesicoureteral reflux following endoscopic puncture in children with duplex system ureteroceles. *J Urol* 2011 Oct;186(4):1455-1458.
368. Paye-Jaouen A, Pistolesi F, Botto N, Enezian G, Grapin-Dagorno C, Peycelon M1, El-Ghoneimi A. Long-term bladder function after ureterocele decompression in children. *J Urol*. 2015 May;193(5 Suppl):1754-9
369. Sillen U, Bachelard M, Hansson S, Hermansson G, Jacobson B, Hjalmas K. Video cystometric recording of dilating reflux in infancy. *J Urol* 1996 May;155(5):1711-1715
370. Capitanucci ML, Silveri M, Mosiello G, Zaccara A, Capozza N, de Gennaro M. Prevalence of hypercontractility in male and female infants with vesico-ureteral reflux. *Eur J Pediatr Surg* 2000 Jun;10(3):172-176.
371. Podesta ML, Castera R, Ruarte AC. Videourodynamic findings in young infants with severe primary reflux. *J Urol* 2004 Feb;171(2 Pt 1):829-33; discussion 833.
372. Khoury AE, Dave S, Peralta-Del Valle MH, Braga LH, Lorenzo AJ, Bagli D. Severe bladder trabeculation obviates the need for bladder outlet procedures during augmentation cystoplasty in incontinent patients with neurogenic bladder. *BJU Int* 2008 Jan;101(2):223-226.
373. Chandra M, Maddix H. Urodynamic dysfunction in infants with vesicoureteral reflux. *J Pediatr* 2000 Jun;136(6):754-759.
374. Sillen U, Bachelard M, Hermansson G, Hjalmas K. Gross bilateral reflux in infants: gradual decrease of initial detrusor hypercontractility. *J Urol* 1996 Feb;155(2):668-672.
375. Yeung CK, Godley ML, Dhillon HK, Gordon I, Duffy PG, Ransley PG. The characteristics of primary vesico-ureteric reflux in male and female infants with pre-natal hydronephrosis. *Br J Urol* 1997 Aug;80(2):319-327.
376. Nielsen JB. Lower urinary tract function in vesicoureteral reflux. *Scand J Urol Nephrol Suppl* 1989;125:15-21.

377. Sjoström S, Bachelard M, Sixt R, Sillen U. Change of urodynamic patterns in infants with dilating vesicoureteral reflux: 3-year followup. *J Urol* 2009 Nov;182(5):2446-2453.
378. Van Arendonk KJ, Madsen MT, Austin JC, Hawtrey CE, Graham MM, Cooper CS. Nuclear cystometrogram-determined bladder pressure at onset of vesicoureteral reflux predicts spontaneous resolution. *Urology* 2007 Apr;69(4):767-770.
379. Acar B, Arıkan Fİ, Germiyanoglu C, Dallar Y. Influence of high bladder pressure on vesicoureteral reflux and its resolution. *Urol Int* 2009;82(1):77-80.
380. Fast AM, Nees SN, Van Batavia JP, Combs AJ, Glassberg KI. Outcomes of targeted treatment for vesicoureteral reflux in children with nonneurogenic lower urinary tract dysfunction. *Urol*. 2013 Sep;190(3):1028-32.
381. Wahll L, Bachelard M, Sjoström S, Sillen U. Is the mode of occurrence of vesicoureteral reflux correlated to bladder function and spontaneous resolution? *J Pediatr Urol* 2009 Jun;5(3):170-177.
382. Homsy YL, Nsouli I, Hamburger B, Laberge I, Schick E. Effects of oxybutynin on vesicoureteral reflux in children. *J Urol* 1985 Dec;134(6):1168-1171.
383. Batista Miranda JE, Arano Bertran P, Caffaratti J, Regalado Pareja R, Garat Barredo JM, Errando Smet C, et al. Efficacy of oxybutynin chloride in children with vesico-ureteral reflux and detrusor instability. *An Esp Pediatr* 1997 Sep;47(3):251-257.
384. Ural Z, Ulman I, Avanoglu A. Bladder dynamics and vesicoureteral reflux: factors associated with idiopathic lower urinary tract dysfunction in children. *J Urol* 2008 Apr;179(4):1564-1567.
385. Leonardo CR, Filgueiras MF, Vasconcelos MM, Vasconcelos R, Marino VP, Pires C, et al. Risk factors for renal scarring in children and adolescents with lower urinary tract dysfunction. *Pediatr Nephrol* 2007 Nov;22(11):1891-1896.
386. Kuo HC, Liu HT. Investigation of dysfunctional voiding in children with urgency frequency syndrome and urinary incontinence. *Urol Int* 2006;76(1):72-76.
387. Karami H, Razi A, Mazloomfard MM, Javanmard BIs there any role for urodynamic study in children with high-grade vesicoureteral reflux? . *Urology*. 2012 Apr;79(4):888-91.
388. Ramamurthy HR, Kanitkar M. Non invasive urodynamic assessment in children--are they reliable? Validation of non-invasive urodynamics in children with functional voiding disorders. *Indian J Pediatr* 2010 Dec;77(12):1400-1404.
389. Kajbafzadeh AM, Baradaran N, Sadeghi Z, Tourchi A, Saeedi P, Madani A, Ataei N, Taghavinejad AM, Mohsseni MJ. Vesicoureteral reflux and primary bladder neck dysfunction in children: urodynamic evaluation and randomized, double-blind, clinical trial on effect of a-blocker therapy. *J Urol*. 2010 Nov;184(5):2128-33. doi: 10.1016/j.juro.2010.06.132. PubMed PMID: 20850812.
390. Musquera Felip M, Errando Smet C, Prados Saavedra M, Arano Bertran P, Villavicencio Mavrich H. False postvoid residual volume diagnosed by videourodynamics. *Actas Urol Esp* 2004 Nov-Dec;28(10):792-795.
391. Fötter R, Riccabona M. Functional disorders of the lower urinary tract in children. *Radiologe* 2005 Dec;45(12):1085-1091.
392. Martín-Crespo Izquierdo R, Luque Mialdea R, Cerda Berrocal J, Arrojo Vila F. Indications for urodynamic studies in childhood: our experience with 214 surgical patients. *Cir Pediatr* 1995 Jan;8(1):31-36.
393. Kaya C, Kucuk E, Ilktac A, Ozturk M, Karaman Mİ. Value of urinary flow patterns in the follow-up of children who underwent Snodgrass operation. *Urol Int* 2007;78(3):245-248.
394. VanderBrink BA, Gitlin J, Palmer LS. Uroflowmetry parameters before and after meatoplasty for primary symptomatic meatal stenosis in children. *J Urol* 2008 Jun;179(6):2403-6; discussion 2406.
395. Bukurov NS, Stefanovic KB, Marinkovic JM. Uroflow via stenotic urethra. *Int Urol Nephrol* 1992;24(1):55-63.
396. Austin PF, Bauer SB, Bower W, et al. The standardization of terminology of lower urinary tract function in children and adolescents: update report from the standardization committee of the international children's continence society. *J Urol*. 2014;191:1863-5
397. Farhat W, Bagli DJ, Capolicchio G, et al. The Dysfunctional voiding scoring system: Quantitative standardization of dysfunctional voiding symptoms in children. *J Urol* 2000;164:1011-5.
398. Bower WF, Wong EMC, Yeung CK. Development of a validated quality of life tool specific to children with bladder dysfunction. *Neurourol Urodynam*. 2006;25:221-7.
399. De Gennaro M, Niero M, Capitanucci ML, von Gontard A, Woodward M, Tubaro A, Abrams P. Validity of the International Consultation on Incontinence Questionnaire-Pediatric Lower Urinary Tract Symptoms:A Screening Questionnaire for Children. *JUrol* 2010 Oct;184,1662-1667.

400. Koff SA, Wagner TT, Jayanthi VR. The relationship among dysfunctional elimination syndromes, primary vesicoureteral reflux and urinary tract infections in children. *J Urol* 1998 Sep;160(3 Pt 2):1019-1022.
401. Austin PF, Bauer SB, Bower W, et al. The standardization of terminology of lower urinary tract function in children and adolescents: update report from the standardization committee of the international children's continence society. *J Urol*. 2014;191:1863-5
402. Franco I, Franco J, Lee YS, Choi E, Han SW. Can a quantitative means be used to predict flow patterns: Agreement between visual inspection vs flow index derived flow patterns. *J Pediatr Urol*. 2016 Jun 11. pii: S1477-5131(16)30115-2.
403. Chang SJ, Chiang IN, Hseih CH, et al. Age and gender specific nomograms for single and dual post void residual urine in healthy children. *Neurorol Urodynam*. 2013;32:1014-8.
404. Combs AJ, Van Batavia JP, Horowitz M, Glassberg KI. *J Urol*. Short pelvic floor electromyographic lag time: a novel noninvasive approach to document detrusor overactivity in children with lower urinary tract symptoms. 2013 Jun;189(6):2282-6.
405. Kasirga E, Akil I, Yilmaz O, Polat M, Gozmen S, Egemen A. Evaluation of voiding dysfunctions in children with chronic functional constipation. *Turk J Pediatr* 2006 Oct-Dec;48(4):340-343.
406. Burgers RE, Mugie SM, Chase J, et al. Management of functional constipation in children with lower urinary tract symptoms: report from the Standardisation Committee of the International Children's Continence Society. *J Urol* 2013;190:29-36.
407. Borch L, Hagstroem S, Bower WF, Siggaard Rittig C, Rittig S. Bladder and bowel dysfunction and the resolution of urinary incontinence with successful management of bowel symptoms in children. *Acta Paediatr*. 2013 May;102(5):e215-20.
408. Borzyskowski M, Mundy AR. Videourodynamic assessment of diurnal urinary incontinence. *Arch Dis Child* 1987 Feb;62(2):128-131.
409. Rodriguez E, Delucchi A, Holzer J, Valdes B, Valenzuela C. Urodynamics in children with recurrent urinary infection, enuresis and bladder incontinence. *Rev Chil Pediatr* 1989 Sep-Oct;60(5):283-286.
410. Kuo HC, Liu HT. Investigation of dysfunctional voiding in children with urgency frequency syndrome and urinary incontinence. *Urol Int* 2006;76(1):72-76.
411. Zajaczkowska M, Moulhee NM, Piechuta L, Majewski M, Borzecka H. Dysfunctional voiding and urodynamic disorders in children with recurrent urinary tract infection. *Ann Univ Mariae Curie Sklodowska Med* 2004;59(2):385-391
412. Austin PF, Bauer SB, Bower W, et al. The standardization of terminology of lower urinary tract function in children and adolescents: update report from the standardization committee of the international children's continence society. *J Urol*. 2014;191:1863-5.
413. von Gontard A, Niemczyk J, Borggrefe-Mousavian S, Wagner C, Curfs L, Equit M1. Incontinence in children, adolescents and adults with Williams syndrome. *Neurourol Urodyn*. 2015 Sep 14. doi: 10.1002/nau.22866.
414. Yang TK, Guo YJ, Chang HC, Yang HJ, Huang KH. Attention deficit-hyperactivity disorder symptoms and daytime voiding symptoms in children with primary enuresis: an observational study to evaluate the effectiveness of desmopressin treatment. *Scientific World Journal*. 15;2015:356121.
415. Oliver JL, Campigotto MJ, Coplen DE, Traxel EJ, Austin PF. Psychosocial comorbidities and obesity are associated with lower urinary tract symptoms in children with voiding dysfunction. *J Urol*. 2013 Oct;190(4 Suppl):1511-5.
416. Zhao PT, Velez D, Faiena I, Creenan EM, Barone JG. Bullying has a potential role in pediatric lower urinary tract symptoms. *J Urol*. 2015 May;193(5 Suppl):1743-8.
417. Cour F, Robain G, Claudon B, Chartier-Kästler E. Childhood sexual abuse: how important is the diagnosis to understand and manage sexual, anorectal and lower urinary tract symptoms. *Prog Urol*. 2013 Jul;23(9):780-92.
418. Ching CB, Lee H, Mason MD, Clayton DB, Thomas JC, Pope JC 4th, Adams MC, Brock JW 3rd, Tanaka ST. Bullying and lower urinary tract symptoms: why the pediatric urologist should care about school bullying. *J Urol*. 2015 Feb;193(2):650-4.
419. Powers MK, Brown ET, Hogan RM, Martin AD, Ortenberg J, Roth CC. Trends in Toilet Training and Voiding Habits among Children with Down Syndrome. *J Urol*. 2015 Sep;194(3):783-7. doi: 10.1016/j.juro.2015.03.114. PubMed PMID: 25849603.
420. von Gontard A, Niemczyk J, Borggrefe-Mousavian S, Wagner C, Curfs L, Equit M1. Incontinence in children, adolescents and adults with Williams syndrome. *Neurourol Urodyn*. 2015 Sep 14. doi: 10.1002/nau.22866.

421. Mason MD, Stephany HA, Casella DP, Clayton DB, Tanaka ST, Thomas JC, Adams MC, Brock JW 3rd, Pope JC 4th. Prospective Evaluation of Sacral Neuromodulation in Children: Outcomes and Urodynamic Predictors of Success. *J Urol*. 2016 Apr;195(4 Pt 2):1239-44. doi: 10.1016/j.juro.2015.11.034. PubMed PMID: 26926536.
422. Schober MS, Sulkowski JP, Lu PL, Minneci PC, Deans KJ, Teich S, Alpert SA. Sacral Nerve Stimulation for Pediatric Lower Urinary Tract Dysfunction: Development of a Standardized Pathway with Objective Urodynamic Outcomes. *J Urol*. 2015 Dec;194(6):1721-6. doi: 10.1016/j.juro.2015.06.090. PubMed PMID: 26141849.
423. Fergusson DM, Horwood LJ, Shannon FT. Factors related to the age of attainment of nocturnal bladder control: an 8-year longitudinal study. *Pediatrics*. 1986 Nov;78(5):884-90. PubMed PMID: 3763302.
424. Yang TK, Guo YJ, Chang HC, Yang HJ, Huang KH. Attention deficit-hyperactivity disorder symptoms and daytime voiding symptoms in children with primary enuresis: an observational study to evaluate the effectiveness of desmopressin treatment. *ScientificWorldJournal*. 2015;2015:356121. doi: 10.1155/2015/356121. PubMed PMID: 25866838; PubMed Central PMCID: PMC4381655.
425. Hoebeke P, Van Laecke E, Raes A, Renson C, Theunis M, Vande Walle J. Bladder function and non-neurogenic dysfunction in children: classification and terminology. *Acta Urol Belg* 1995 May;63(2):93-98.
426. Neveus T, von Gontard A, Hoebeke P, Hjalmas K, Bauer S, Bower W, et al. The standardization of terminology of lower urinary tract function in children and adolescents: report from the Standardisation Committee of the International Children's Continence Society. *J Urol* 2006 Jul;176(1):314-324.
427. Franco I, von Gontard A, De Gennaro M; International Children's Continence Society: Evaluation and treatment of nonmonosymptomatic nocturnal enuresis: a standardization document from the International Children's Continence Society. *J Pediatr Urol*. 2013 Apr;9(2):234-43. doi: 10.1016/j.jpuro.2012.10.026. PubMed PMID: 23260268.
428. Rittig N, Hagstroem S, Mahler B, Kamperis K, Siggaard C, Mikkelsen MM, Bower WF, Djurhuus JC, Rittig S. Outcome of a standardized approach to childhood urinary symptoms-long-term follow-up of 720 patients. *Neurourol Urodyn*. 2014 Jun;33(5):475-81. doi: 10.1002/nau.22447. PubMed PMID: 23765698.
429. Sehgal R, Paul P, Mohanty NK. Urodynamic evaluation in primary enuresis: an investigative and treatment outcome correlation. *J Trop Pediatr* 2007 Aug;53(4):259-263.
430. Sreedhar B, Yeung CK, Leung VY, Chu CW. Ultrasound bladder measurements in children with severe primary nocturnal enuresis: pre-treatment and posttreatment evaluation and its correlation with treatment outcome. *J Urol* 2008 Apr;179(4):1568-72; discussion 1572.
431. Kawauchi A, Tanaka Y, Naito Y, Yamao Y, Ukimura O, Yoneda K, et al. Bladder capacity at the time of enuresis. *Urology* 2003 May;61(5):1016-1018.
432. Rittig N, Hagstroem S, Mahler B, Kamperis K, Siggaard C, Mikkelsen MM, Bower WF, Djurhuus JC, Rittig S. Outcome of a standardized approach to childhood urinary symptoms-long-term follow-up of 720 patients. *Neurourol Urodyn*. 2014 Jun;33(5):475-81. doi: 10.1002/nau.22447. PubMed PMID: 23765698.
433. Neveus T, Eggert P, Evans J, Macedo A, Rittig S, Tekgul S, et al. Evaluation of and treatment for monosymptomatic enuresis: a standardization document from the International Children's Continence Society. *J Urol* 2010 Feb;183(2):441-447.
434. Hoebeke P, Bower W, Combs A, De Jong T, Yang S. Diagnostic evaluation of children with daytime incontinence. *J Urol* 2010 Feb;183(2):699-703.
435. Akashi S, Tomita K. The impact of a history of childhood nocturnal enuresis on adult nocturia and urgency. *Acta Paediatr*. 2014 Sep;103(9):e410-5. doi: 10.1111/apa.12694. PubMed PMID: 24834790.
436. Petrangeli F, Capitanucci ML, Marciano A, Mosiello G, Alvaro R, Zaccara A, Finazzi-Agro E, De Gennaro M. A 20-year study of persistence of lower urinary tract symptoms and urinary incontinence in young women treated in childhood. *J Pediatr Urol*. 2014 Jun;10(3):441-5. doi: 10.1016/j.jpuro.2014.01.003. PubMed PMID: 24560802.

437. Lu YT, Jakobsen LK, Djurhuus JC, Bjerrum SN, Wen JG, Olsen LH. What is a representative voiding pattern in children with lower urinary tract symptoms? Lack of consistent findings in ambulatory and conventional urodynamic tests. *J Pediatr Urol.* 2016 Jun;12(3):154.e1-7. doi: 10.1016/j.jpuro.2016.02.006. PubMed PMID: 26944608.
438. Neveus T, von Gontard A, Hoebeke P, Hjalmas K, Bauer S, Bower W, et al. The standardization of terminology of lower urinary tract function in children and adolescents: report from the Standardisation Committee of the International Children's Continence Society. *J Urol* 2006 Jul;176(1):314-324.
439. Austin PF, Bauer SB, Bower W, Chase J, Franco I, Hoebeke P, Rittig S, Vande Walle J, von Gontard A, Wright A, Yang SS, Nevéus T. The standardization of terminology of lower urinary tract function in children and adolescents: update report from the Standardization Committee of the International Children's Continence Society. *J Urol.* 2014 Jun;191(6):1863-1865.e13. doi: 10.1016/j.juro.2014.01.110. Review. PubMed PMID: 24508614.
440. Gupta DK, Sankhwar SN, Goel A. Uroflowmetry nomograms for healthy children 5 to 15 years old. *J Urol.* 2013 Sep;190(3):1008-13. doi: 10.1016/j.juro.2013.03.073. PubMed PMID: 23538243.
441. Chang SJ, Chiang IN, Hsieh CH, Lin CD, Yang SS. Age- and gender-specific nomograms for single and dual post-void residual urine in healthy children. *Neurourol Urodyn.* 2013 Sep;32(7):1014-8. doi: 10.1002/nau.22342. PubMed PMID: 23595887.
442. Franco I, Shei-Dei Yang S, Chang SJ, Nussenblatt B, Franco JA. A quantitative approach to the interpretation of uroflowmetry in children. *Neurourol Urodyn.* 2016 Sep;35(7):836-46. doi: 10.1002/nau.22813. PubMed PMID: 26175192.
443. Wenske S, Combs AJ, Van Batavia JP, Glassberg KI. Can staccato and interrupted/fractionated uroflow patterns alone correctly identify the underlying lower urinary tract condition? *J Urol.* 2012 Jun;187(6):2188-93. doi: 10.1016/j.juro.2012.01.126. PubMed PMID: 22503030.
444. Combs AJ, Van Batavia JP, Horowitz M, Glassberg KI. Short pelvic floor electromyographic lag time: a novel noninvasive approach to document detrusor overactivity in children with lower urinary tract symptoms. *J Urol.* 2013 Jun;189(6):2282-6. doi: 10.1016/j.juro.2013.01.011. PubMed PMID: 23313197.
445. Alizadeh F, Shirani S, Zargham M. Flowmetry/pelvic floor electromyographic findings in patients with detrusor overactivity. *Int Braz J Urol.* 2015 May-Jun;41(3):521-6. doi: 10.1590/S1677-5538.IBJU.2014.0204. PubMed PMID: 26200545.
446. Faasse MA, Nosnik IP, Diaz-Saldano D, Hodgkins KS, Liu DB, Schreiber J, Yerkes EB. Uroflowmetry with pelvic floor electromyography: inter-rater agreement on diagnosis of pediatric non-neurogenic voiding disorders. *J Pediatr Urol.* 2015 Aug;11(4):198.e1-6. doi: 10.1016/j.jpuro.2015.05.012. PubMed PMID: 26159493.
447. Tangal S, Gökçe MI, Özayar A, Gülpinar B, Haliloglu AH, Burgu B, Özdiler E. Evaluation of a new ultrasound measurement tool for the diagnosis of dysfunctional voiding in pediatric population: full/empty bladder wall thickness ratio. *Urology.* 2014 Jun;83(6):1369-72.
448. Lee YS, Jung HJ, Im YJ, Hong CH, Han SW. The significance of detrusor wall thickness as a prognostic factor in pediatric bladder outlet obstruction. *J Pediatr Surg.* 2012 Sep;47(9):1682-7. doi: 10.1016/j.jpedsurg.2012.03.051. PubMed PMID: 22974606.
449. Godbole P, Raghavan A, Searles J, Roberts J, Walters SJ. Dynamic pelvic floor ultrasound for lower urinary tract symptoms in children—initial report on normative values. *J Pediatr Urol.* 2013 Dec;9(6 Pt A):950-4. doi: 10.1016/j.jpuro.2013.01.009. PubMed PMID: 23466045.
450. Bauer SB, Nijman RJM, Drzewiecki BA, Sillen U, Hoebeke P. International Children's Continence Society Standardization Report on Urodynamic Studies of the Lower Urinary Tract in Children. *Neurourol Urodyn.* 2015; 34:640–647
451. Wen JG, Li Y, Wang QW. Urodynamic investigation of valve bladder syndrome in children. *J Pediatr Urol.* 2007 Apr;3(2):118-21. doi: 10.1016/j.jpuro.2006.06.008. PubMed PMID: 18947714.
452. Bachelard M, Sillén U, Hansson S, Hermanson G, Jodal U, Jacobsson B. Urodynamic pattern in asymptomatic infants: siblings of children with vesicoureteral reflux. *J Urol.* 1999 Nov;162(5):1733-7; discussion 1737-8. PubMed PMID: 10524925.
453. Yeung CK, Godley ML, Ho CK, Ransley PG, Duffy PG, Chen CN, Li AK. Some new insights into bladder function in infancy. *Br J Urol.* 1995 Aug;76(2):235-40.
454. Hoebeke P, Raes A, Vande Walle J, Van Laecke E. Urodynamics in children: what and how to do it? *Acta Urol Belg* 1998 May;66(2):23-30.

455. Yeung CK. Continuous real-time ambulatory urodynamic monitoring in infants and young children using infrared telemetry. *Br J Urol* 1998 May;81 Suppl 3:76-80.
456. Sillen U, Hellstrom AL, Hermanson G, Abrahamson K. Comparison of urodynamic and free voiding pattern in infants with dilating reflux. *J Urol* 1999 Jun;161(6):1928-1933.
457. Chin-Peuckert L, Komlos M, Rennick JE, Jednak R, Capolicchio JP, Salle JL. What is the variability between 2 consecutive cystometries in the same child? *J Urol* 2003 Oct;170(4 Pt 2):1614-1617.
458. Bauer SB, Nijman RJM, Drzewiecki BA, Sillen U, Hoebeke P. International Children's Continence Society Standardization Report on Urodynamic Studies of the Lower Urinary Tract in Children. *Neurourol Urodyn*. 2015; 34:640-647
459. Griffiths, D., Scholtmeijer, R.J. Detrusor instability in children. *Neurourol and Urodyn*, 1982. 1: p. 187.
460. Bauer SB, Nijman RJM, Drzewiecki BA, Sillen U, Hoebeke P. International Children's Continence Society Standardization Report on Urodynamic Studies of the Lower Urinary Tract in Children. *Neurourol Urodyn*. 2015; 34:640-647.
461. Bozkurt P, Kilic N, Kaya G, Yeker Y, Elicevik M, Söylet Y. The effects of intranasal midazolam on urodynamic studies in children. *Br J Urol*. 1996 Aug;78(2):282-6.
462. Ramamurthy HR, Kanitkar M. Non invasive urodynamic assessment in children--are they reliable? Validation of non-invasive urodynamics in children with functional voiding disorders. *Indian J Pediatr* 2010 Dec;77(12):1400-1404.
463. Bael A, Verhulst J, Lax H, Hirche H, van Gool JD, European Bladder Dysfunction Study EU BMH1-CT94-1006. Investigator bias in urodynamic studies for functional urinary incontinence. *J Urol* 2009 Oct;182(4 Suppl):1949-1952.
464. Uluocak N, Oktar T, Ander H, Ziylan O, Acar O, Rodoplu H, et al. Which method is the most reliable in determination of bladder capacity in children with idiopathic overactive bladder? A comparison of maximum voided volume, uroflowmetry and maximum cystometric capacity. *J Pediatr Urol* 2009 Dec;5(6):480-484.
465. Rantell A, Dolan L, Bonner L, Knight S, Ramage C, Toozs-Hobson P. Minimum standards for continence care in the UK. *Neurourol Urodyn*. 2016 Mar;35(3):400-6. doi: 10.1002/nau.22717. Review. PubMed PMID: 25597395.
466. Bauer SB, Nijman RJM, Drzewiecki BA, Sillen U, Hoebeke P. International Children's Continence Society Standardization Report on Urodynamic Studies of the Lower Urinary Tract in Children. *Neurourol Urodyn*. 2015; 34:640-647
467. Bedretidnova D, Fritel X, Zins M, Ringa V. The effect of urinary incontinence on health-related quality of life: is it similar in men and women? *Urology*. 2016 Jan 28. pii: S0090-4295(15)01186-3. doi: 10.1016/j.urolgy.2015.12.034. [Epub ahead of print]
468. Sexton CC, Coyne KS, Thompson C, Baven-dam T, Chen CI, Markland A. Prevalence and effect on health-related quality of life of overactive bladder in older Americans: results from the epidemiology of lower urinary tract symptoms study. *J Am Geriatr Soc* 2011;59:1465-70.
469. Chuang FC, Liu HT, Wang LY, Kuo HC. Overactive bladder changes with time: a 5-year longitudinal followup of changes in overactive bladder symptoms, urodynamic studies and urinary nerve growth factor levels. *J Urol* 2014;192:458-63.
470. Andersson KE. Antimuscarinic mechanisms and the overactive detrusor: an update. *Eur Urol* 2011;59:377-86.
471. Gibson W, Wagg A. New horizons: urinary incontinence in older people. *Age Ageing* 2014;43:157-63.
472. Tyagi P, Tyagi V, Qu X, Lin HT, Kuo HC, Chuang YC, Chancellor M. Association of inflammaging (inflammation + aging) with higher prevalence of OAB in elderly population. *Int Urol Nephrol* 2014;46:871-7.
473. Park J, Lavelle JP, Palmer MH. Voiding dysfunction in older women with overactive bladder symptoms: A comparison of urodynamic parameters between women with normal and elevated post-void residual urine. *Neurourol Urodyn*. 2014 Nov 14. doi: 10.1002/nau.22689. [Epub ahead of print]
474. Jones KW, Schoenberg HW. Comparison of the incidence of bladder hyperreflexia in patients with benign prostatic hypertrophy and age-matched female controls. *J Urol* 1985 Mar;133(3):425-426.
475. Resnick NM, Yalla SV, Laurino E. The pathophysiology of urinary incontinence among institutionalized elderly persons. *N Engl J Med* 1989 Jan 5;320(1):1-7.
476. Homma Y, Imajo C, Takahashi S, Kawabe K, Aso Y. Urinary symptoms and urodynamics in a normal elderly population. *Scand J Urol Nephrol Suppl* 1994;157:27-30.

477. Okorochoa I, Cumming G, Gould I. Female urodynamics and lower urinary tract infection. *BJU Int* 2002 Jun;89(9):863-867.
478. Smith PP, Chalmers DJ, Feinn RS. Does defective volume sensation contribute to detrusor underactivity? *Neurourol Urodyn* 2014 Sep 14. doi: 10.1002/nau.22653. [Epub ahead of print]
479. Bang WJ, Lee JY, Koo KC, Hah YS, Lee DH, Cho KS. Is type-2 diabetes mellitus associated with overactive bladder symptoms in men with lower urinary tract symptoms? *Urology* 2014;84:670-4.
480. Hashimoto M, Hashimoto K, Ando F, Kimura Y, Nagase K, Arai K. Prescription rate of medications potentially contributing to lower urinary tract symptoms and detection of adverse reactions by prescription sequence symmetry analysis. *J Pharm Health Care Sci.* 2015 Feb 15;1:7. doi: 10.1186/s40780-014-0004-1. PubMed PMID: 26819718; PubMed Central PMCID: PMC4728807.
481. Kashyap M, Tu le M, Tannenbaum C. Prevalence of commonly prescribed medications potentially contributing to urinary symptoms in a cohort of older patients seeking care for incontinence. *BMC Geriatr.* 2013 Jun 10;13:57. doi: 10.1186/1471-2318-13-57. PubMed PMID: 23758756; PubMed Central PMCID: PMC3684540.
482. Ness J, Hoth A, Barnett MJ, Shorr RI, Kaboli PJ. Anticholinergic medications in community-dwelling older veterans: prevalence of anticholinergic symptoms, symptom burden, and adverse drug events. *Am J Geriatr Pharmacother.* 2006 Mar;4(1):42-51. PubMed PMID: 16730620.
483. Fung CH, Spencer B, Eslami M, Crandall C. Quality indicators for the screening and care of urinary incontinence in vulnerable elders. *J Am Geriatr Soc* 2007 Oct;55 Suppl 2:S443-9.
484. Kraus SR, Bavendam T, Brake T, Griebing TL. Vulnerable elderly patients and overactive bladder syndrome. *Drugs Aging* 2010 Sep 1;27(9):697-713.
485. Staskin DR. Overactive bladder in the elderly: a guide to pharmacological management. *Drugs Aging* 2005;22(12):1013-1028 .
486. Wagg AS, Cardozo L, Chapple C, De Ridder D, Kelleher C, Kirby M, et al. Overactive bladder syndrome in older people. *BJU Int* 2007 Mar;99(3):502-509
487. Hunskaar, S., Burgio, K., Diokno, AC., et al., Epidemiology and natural history of urinary incontinence, in *Incontinence: 2nd International Consultation on Incontinence*, C.L. Abrams P, Khoury S, Wein A, Editor. 2002, Plymbridge Distributors Ltd. p. 203.
488. Kraus SR, Bavendam T, Brake T, Griebing TL. Vulnerable elderly patients and overactive bladder syndrome. *Drugs Aging* 2010 Sep 1;27(9):697-713.
489. Griffiths D. Clinical studies of cerebral and urinary tract function in elderly people with urinary incontinence. *Behav Brain Res* 1998 May;92(2):151-155.
490. Griffiths DJ, McCracken PN, Harrison GM, Gormley EA, Moore KN. Urge incontinence and impaired detrusor contractility in the elderly. *Neurourol Urodyn* 2002;21(2):126-131.
491. Resnick NM, Yalla SV. Detrusor hyperactivity with impaired contractile function. An unrecognized but common cause of incontinence in elderly patients. *JAMA* 1987 Jun 12;257(22):3076-3081.
492. Valentini FA, Robain G, Marti BG, Nelson PP. Urodynamics in a community-dwelling population of females 80 years or older. Which motive? Which diagnosis? *Int Braz J Urol* 2010 Mar-Apr;36(2):218-224.
493. Kuo HC. Analysis of the pathophysiology of lower urinary tract symptoms in patients after prostatectomy. *Urol Int* 2002;68(2):99-104.
494. Bae J, Kang HW, Lee HW, Lee KS, Cho MC. Predictors of de novo urge urinary incontinence after photoselective vaporization of the prostate. *World J Urol* 2016;34:413-8.
495. Elshal AM, Elmansy HM, Elhilali MM. Transurethral laser surgery for benign prostate hyperplasia in octogenarians: safety and outcomes. *Urology.* 2013 Mar;81(3):634-9. doi: 10.1016/j.urology.2012.11.042. PubMed PMID: 23332997
496. Liao CH, Kuo HC. Increased risk of large post-void residual urine and decreased long-term success rate after intravesical onabotulinumtoxinA injection for refractory idiopathic detrusor overactivity. *J Urol* 2013; 189:1804-10.
497. Mebust, W., Holtgrewe, HL., Current status of transurethral prostatectomy: a review of the AUA National Cooperative Study. *World Journal of Urology*, 1989. 6: p. 194.
498. Krambeck AE, Handa SE, Lingeman JE. Experience with more than 1,000 holmium laser prostate enucleations for benign prostatic hyperplasia. *J Urol* 2010 Mar;183(3):1105-1109.

499. Dubbelman Y, Groen J, Wildhagen M, Rikken B, Bosch R. Quantification of changes in detrusor function and pressure-flow parameters after radical prostatectomy: relation to postoperative continence status and the impact of intensity of pelvic floor muscle exercises. *Neurourol Urodyn.* 2012 Jun;31(5):637-41. doi: 10.1002/nau.21199. PubMed PMID: 22488499.
500. Wadie BS. Retropubic bulbourethral sling for post-prostatectomy male incontinence: 2-year followup. *J Urol* 2010 Dec;184(6):2446-2451.
501. Kadono Y, Ueno S, Iwamoto D, Takezawa Y, Nohara T, Izumi K, Mizokami A, Namiki M. Chronological Urodynamic Evaluation of Changing Bladder and Urethral Functions After Robot-assisted Radical Prostatectomy. *Urology.* 2015 Jun;85(6):1441-7. doi: 10.1016/j.urology.2015.02.029. PubMed PMID: 25863842.
502. Mitsui T, Tanaka H, Harabayashi T, Moriya K, Maruyama S, Abe T, Sazawa A, Shinohara N, Nonomura K. Changes in Urodynamics and Lower Urinary Tract Symptoms after Radical Prostatectomy: Implications of Preoperative Detrusor Contractility. *Low Urin Tract Symptoms.* 2012 May;4(2):82-6. doi: 10.1111/j.1757-5672.2011.00133.x. PubMed PMID: 26676531.
503. Lee H, Kim KB, Lee S, Lee SW, Kim M, Cho SY, Oh SJ, Jeong SJ. Urodynamic assessment of bladder and urethral function among men with lower urinary tract symptoms after radical prostatectomy: A comparison between men with and without urinary incontinence. *Korean J Urol.* 2015 Dec;56(12):803-10. doi: 10.4111/kju.2015.56.12.803. PubMed PMID: 26682020; PubMed Central PMCID: PMC4681757.
504. Elliott CS, Comiter CV. Maximum isometric detrusor pressure to measure bladder strength in men with postprostatectomy incontinence. *Urology.* 2012 Nov;80(5):1111-5. doi: 10.1016/j.urology.2012.07.025. PubMed PMID: 22990061.
505. Goode PS, Burgio KL, Locher JL, Umlauf MG, Lloyd LK, Roth DL. Urodynamic changes associated with behavioral and drug treatment of urge incontinence in older women. *J Am Geriatr Soc* 2002 May;50(5):808-816.
506. Abrams P, Chapple C, Khoury S, Roehrborn C, de la Rosette J, International Scientific Committee. Evaluation and treatment of lower urinary tract symptoms in older men. *J Urol* 2009 Apr;181(4):1779-1787.
507. Rosier PF, de Wildt MJ, Debruyne FM, Wijkstra H, de la Rosette JJ. Evaluation of detrusor activity during micturition in patients with benign prostatic enlargement with a clinical nomogram. *J Urol.* 1996 Aug;156(2 Pt 1):473-8; discussion 478-9. PubMed PMID: 8683707
508. Griffiths DJ, Harrison G, Moore K, McCracken P. Variability of post-void residual urine volume in the elderly. *Urol Res.* 1996;24(1):23-6. PubMed PMID: 8966837.
509. Smith PP, Chalmers DJ, Feinn RS. Does defective volume sensation contribute to detrusor underactivity? *Neurourol Urodyn* 2014 Sep 14. doi: 10.1002/nau.22653.
510. Bang WJ, Lee JY, Koo KC, Hah YS, Lee DH, Cho KS. Is type-2 diabetes mellitus associated with overactive bladder symptoms in men with lower urinary tract symptoms? *Urology* 2014;84:670-4.
511. Tan TL, Bergmann MA, Griffiths D, Resnick NM. Which stop test is best? Measuring detrusor contractility in older females. *J Urol* 2003 Mar;169(3):1023-1027.
512. Sevestre S, Ciofu C, Deval B, Traxer O, Amarenco G, Haab F. Results of the tension-free vaginal tape technique in the elderly. *Eur Urol* 2003 Jul;44(1):128-131.
513. Abrams P, Chapple C, Khoury S, Roehrborn C, de la Rosette J; International Consultation on New Developments in Prostate Cancer and Prostate Diseases. Evaluation and treatment of lower urinary tract symptoms in older men. *J Urol* 2013;189(1 Suppl):S93-S101.
514. Xue P, Wang T, Zong H, Zhang Y. Urodynamic analysis and treatment of male Parkinson's disease patients with voiding dysfunction. *Chin Med J (Engl).* 2014;127:878-81.
515. Wagg A, Cardozo L, Nitti VW, Castro-Diaz D, Auerbach S, Blauwet MB, et al. The efficacy and tolerability of the β 3-adrenoceptor agonist mirabegron for the treatment of symptoms of overactive bladder in older patients. *Age Ageing.* 2014;43:666-75.
516. Nitti VW, Rosenberg S, Mitcheson DH, He W, Fakhoury A, Martin NE. Urodynamics and safety of the β 3-adrenoceptor agonist mirabegron in males with lower urinary tract symptoms and bladder outlet obstruction. *J Urol* 2013;190:1320-7.
517. Thuroff JW, Abrams P, Andersson KE, Artibani W, Chapple CR, Drake MJ, et al. EAU guidelines on urinary incontinence. *Eur Urol* 2011 Mar;59(3):387-400.

518. Liao CH, Kuo HC. Increased risk of large post-void residual urine and decreased long-term success rate after intravesical onabotulinumtoxinA injection for refractory idiopathic detrusor overactivity. *J Urol* 2013; 189:1804-10.
519. Valentini FA, Robain G, Marti BG, Nelson PP. Urodynamics in a community-dwelling population of females 80 years or older. Which motive? Which diagnosis? *Int Braz J Urol* 2010 Mar-Apr;36(2):218-224.
520. Gormley EA, Griffiths DJ, McCracken PN, Harrison GM, McPhee MS. Effect of transurethral resection of the prostate on detrusor instability and urge incontinence in elderly males. *Neurourol Urodyn* 1993;12(5):445-453.
521. Sakakibara R, Panicker J, Fowler CJ, Tateno F, Kishi M, Tsuyusaki Y, et al. Is overactive bladder a brain disease? The pathophysiological role of cerebral white matter in the elderly. *Int J Urol* 2014;21:33-8.
522. Pizzi A, Falsini C, Martini M, Rossetti MA, Verdesca S, Tosto A. Urinary incontinence after ischemic stroke: clinical and urodynamic studies. *Neurourol Urodyn* 2014;33:420-5.
523. Tapia CI, Khalaf K, Berenson K, Globe D, Chancellor M, Carr LK. Health-related quality of life and economic impact of urinary incontinence due to detrusor overactivity associated with a neurologic condition: a systematic review. *Health Qual Life Outcomes* 2013 Jan 31;11:13. doi: 10.1186/1477-7525-11-13.
524. Terayama K, Sakakibara R, Ogawa A, Haruta H, Akiba T, Nagao T, et al. Weak detrusor contractility correlates with motor disorders in Parkinson's disease. *Mov Disord* 2012; 27: 1775-80.
525. Sakushima K, Yamazaki S, Fukuma S, Hayashino Y, Yabe I, Fukuhara S, Sasaki H. Influence of urinary urgency and other urinary disturbances on falls in Parkinson's disease. *J Neurol Sci* 2016 Jan 15;360:153-7. doi: 10.1016/j.jns.2015.11.055. Epub 2015 Nov 30.
526. Xue P, Wang T, Zong H, Zhang Y. Urodynamic analysis and treatment of male Parkinson's disease patients with voiding dysfunction. *Chin Med J (Engl)*. 2014;127:878-81.
527. Sakakibara R, Hattori T, Uchiyama T, Yamanishi T. Videourodynamic and sphincter motor unit potential analyses in Parkinson's disease and multiple system atrophy. *J Neurol Neurosurg Psychiatry* 2001 Nov;71(5):600-606.
528. Liu Z, Uchiyama T, Sakakibara R, Yamamoto T. Underactive and overactive bladders are related to motor function and quality of life in Parkinson's disease. *Int Urol Nephrol*. 2015;47:751-7.
529. Ersoz M, Erhan B, Akkoc Y, Zinnuroglu M, Yildiz N, Gok H, Özdolap S, Tunc H, Kaya K, Alemdaroglu E, Susuzer S, Gunduz B, Bardak AN, Ozcan S, Yesil H, Uygunol K, Konukcu S, Gunes N, Ege F; Turkish Neurogenic Bladder Research Group. An evaluation of bladder emptying methods and the effect of demographic and clinical factors on spontaneous voiding frequency in stroke patients. *Neurol Sci* 2013;34:729-34.
530. Lee SH, Cho ST, Na HR, Ko SB, Park MH. Urinary incontinence in patients with Alzheimer's disease: relationship between symptom status and urodynamic diagnoses. *Int J Urol* 2014;21:683-7.
531. Anderson RU, Orenberg EK, Glowe P. OnabotulinumtoxinA office treatment for neurogenic bladder incontinence in Parkinson's disease. *Urology* 2014;83:22-7.
532. Jiang YH, Liao CH, Tang DL, Kuo HC. Efficacy and safety of intravesical onabotulinumtoxinA injection on elderly patients with chronic central nervous system lesions and overactive bladder. *PLoS One* 2014;9:e105989.

IMAGING, NEUROPHYSIOLOGICAL TESTING AND OTHER TESTS

Chair

V. Khullar (UK)

Members

G. Amarenco (France)
S.K. Doumouchtsis (UK)
A. Derpapas (Greece)
R. Fernando (UK)
N. Sekido (Japan)
S.A. Shobeiri (USA)
A. Tubaro (Italy)
D.B. Vodusek (Slovenia)

Consultants

Simon Podnar (Slovenia)

CONTENTS

ABBREVIATIONS	673	VII. CONCLUSIONS	762
I. INTRODUCTION	675	REFERENCES	764
II. IMAGING IN URINARY INCONTINENCE AND PELVIC FLOOR DYSFUNCTION	676	I. INTRODUCTION	764
1. Imaging of the Upper Urinary Tract	676	II. IMAGING IN URINARY INCONTINENCE AND PELVIC FLOOR DYSFUNCTION	764
2. Imaging of the Lower Urinary Tract	679	1. Imaging of the Upper Urinary Tract	764
3. Special Issues	721	2. X-Ray Imaging of the Lower Urinary Tract	766
III. IMAGING IN ANAL INCONTINENCE	731	III. IMAGING IN ANAL INCONTINENCE	792
1. Indications	731	IV. PAD TESTING	794
2. Imaging Modalities	731	V. NEUROPHYSIOLOGY	797
3. Sphincteric Disorders	737	VI. OTHER INVESTIGATIONS	803
4. Conclusions	738	1. Urinalysis	803
5. Consensus Statements	739	2. Blood tests	803
6. Future Research Areas	739	3. Tissue analysis	804
IV. PAD TESTING	739		
1. Definition	739		
2. Indication and methodology	739		
3. Office-Based Pad Testing	740		
4. Home Based Pad Testing	741		
5. CONCLUSIONS	744		
6. CONSENSUS STATEMENTS	744		
7. Future Research Areas	744		
V. NEUROPHYSIOLOGY	745		
1. Introduction	745		
2. Clinical Neurophysiological Tests	746		
3. Evidence Based Use of Clinical Neurophysiological Tests	758		
4. Consensus Statement	759		
VI. OTHER INVESTIGATIONS	760		
1. Urinalysis	760		
2. Blood Tests	760		
3. Tissue Analysis	761		

IMAGING, NEUROPHYSIOLOGICAL TESTING AND OTHER TESTS

V. KHULLAR (UK)

G. AMARENCO (FRANCE), S.K. DOUMOCHTSIS (UK), A. DERPAPAS (GREECE),
R. FERNANDO (UK), N. SEKIDO (JAPAN), S.A. SHOBEIRI (USA), A. TUBARO (ITALY),
D. B. VODUŠEK (SLOVENIA)
SIMON PODNAR (SLOVENIA)

ABBREVIATIONS

2D	two dimensional	CMCT	central motor conduction time
3D	three dimensional	CNEMG	concentric needle electromyography
4D	four dimensional	CT	computerised tomography
AA	African American	DMSA	dimercaptosuccinic acid
ACC	anterior cingulate cortex	DO	detrusor overactivity
ACG	anterior cingulate gyrus	DLPP	detrusor leak point pressure
ADH	anti diuretic hormone	dMRI	dynamic magnetic resonance imaging
AI	anal incontinence	DTI	diffusor tensor imaging
ARJ	anorectal junction	EAS	external anal sphincter
ATFP	arcus tendineus fascia pelvis	EAUS	endoanal ultrasound ultrasound sonography
ATLA	arcus tendineus levator ani	ED	erectile dysfunction
ATT	alpha-1 antitrypsin	eGFR	estimated glomerular filtration rate
BBI	bladder base insufficiency	EMG	electromyography
BCR	bulbocavernosus reflex	EPI	echo planar imaging
BMI	body mass index	FI	faecal incontinence
BOO	bladder outlet obstruction	FISP	fast imaging with steady-state precession
BS	bulbospongiosus	FOV	field of view
BWT	bladder wall thickness	HASTE	single-shot turbo spin echo
CCC	concordance correlation coefficient	HOXA	Homebox A
CCP	cystocolpoproctography	IAS	internal anal sphincter
CE	clinical examination	ICC	intraclass correlation
CIN	contrast induced nephropathy	ICM	iliococcygeal muscle
CKD	chronic kidney disease	ICTP	carboxy-terminal telopeptide of type I collagen
CL	cardinal ligament	IIQ-7	incontinence impact questionnaire
CM	contrast medium	IP	interference pattern
CMAP	compound muscle action potential	ISD	intrinsic sphincter deficiency
		IVU	intra venous urography

IVS	intravaginal sling	SE	spin echo
LAM	levator ani muscle	SEP	somatosensory evoked potential
LLM	longitudinal layer muscle	SERMS	selective estrogen-receptor modulators
LMR	longitudinal muscle of the rectum	SFEMG	single fibre electromyography
LUT	lower urinary tract	SII	symptom impact index
LUTD	lower urinary tract dysfunction	SMA	supplementary motor area
LUTS	lower urinary tract symptoms	SO	symphysis orifice (distance)
MCC	maximum cystometric capacity	SSF	sacrospinous fixation
MEP	motor evoked potential	SSFSE	single-shot fast spin echo
MMPS	matrix metalloproteinases	STP	superficial transverse perineal muscle
MRI	magnetic resonance imaging	SSI	symptom severity index
MPL	midpubic line	SSR	sympathetic skin responses
MSA	multiple system atrophy	STARD	Standards for Reporting of Diagnostic Accuracy
MU	motor unit	SUI	stress urinary incontinence
MUP	motor unit potential	T/A	turns/amplitude
NSF	nephrogenic systemic fibrosis	TE	echo time
PA	puboanalis	TGF-β	transforming growth factor-β
PAG	periacqueductal grey	TIMP	tissue inhibitor of metalloproteinases
PCL	pubococcygeal line	TOT	transobturator tape
PD	Parkinson's disease	TPUS	transperineal ultrasound
PET	positron emission tomography	TR	repetition time
PFMT	pelvic floor muscle training	TVT	tension free vaginal tape
PGPI	patient global perception of improvement	UAR	urethral axis at rest
PICP	propeptide of type I procollagen	UAS	urethral axis straining
PIIINP	amino-terminal propeptide of procollagen III	UEBW	ultrasound estimated bladder weight
PIVS	posterior intravaginal slingplasty	UI	urinary incontinence
PMC	pontine micturition centre	UP	urethropelvic (angle)
POP	pelvic organ prolapse	UPP	urethral pressure profile
POP-Q	pelvic organ prolapse quantification	USI	urodynamic stress incontinence
PFMT	pelvic floor muscle training	USL	uterosacral ligament
PNTML	puddendal nerve terminal motor latency	USS	ultrasonography
PRM	puborectalis muscle	UTI	urinary tract infection
PUV	posterior urethrovesical (angle)	UUT	upper urinary tract
PVM	pubovisceral muscle	VB	vestibular bulb
PVR	post-void residual	VCCU	voiding colpo cystourethrography
QST	quantitative sensory testing	VCUG	voiding cystourethrogram
RCT	randomised controlled trial	WA	white American
SCP	sacrocolpopexy		
SCr	serum creatinine		

I. INTRODUCTION

The Committee was given the task of updating the evidence on imaging, neurophysiological testing and other tests in the field of urinary and anal incontinence. The Medline, Embase and Cochrane databases were searched for the relevant subjects from February 2012 to January 2016. All references obtained from the database search were screened for relevance, full text papers were obtained and reference list were used as additional source of evidence where appropriate.

The chapter covers different issues including: imaging, neurophysiological testing, and other investigations (laboratory tests, tissue analysis and pad test) in the paediatric and adult population, male and female subjects, neurogenic and non-neurogenic patients.

The following keywords were used for the difference subjects:

- **Imaging:** the Medline database was searched using the following keywords: imaging, urinary incontinence, continence, anal incontinence and faecal incontinence; the search has been limited to period from 2012 to 2016.
- **Neurophysiology:** clinical neurophysiology, conventional urodynamics, neurourology, urinary dysfunction.
- **Other investigations:** keywords including urinary incontinence, continence, pad test, urinalysis, urine culture, cystoscopy and tissue analysis were used.

Members of the committee were allocated the different topics of the chapter based on their specific expertise in the field. The first draft of the chapter was reviewed by all committee members, the final draft was then edited first by the Committee Chair and then by the book Editors.

Diagnostic techniques were evaluated with reference to the technique and its standardisation, intraobserver and interobserver variability, diagnostic accuracy, cost/benefit ratio and clinical benefit. The level of evidence was graded taking into consideration that imaging, neurophysiological testing and the other tests pertain to the area of "diagnosis" and the quality of the published papers was graded according to the criteria specific for this area. Areas of future research were identified.

Notwithstanding the large body of evidence, research on imaging in anal and urinary incontinence, its clinical benefit remains questionable. Test-retest, intraobserver and interobserver accuracy are often provided for diagnostic tests although diagnostic accuracy is difficult to evaluate due to a lack of a gold standard. When ultrasound is used to measure bladder volume, catheterisation can be used as a reference standard and accuracy can be easily calculated but when

sphincter volume is calculated with ultrasonography, there is no solid reference standard except another imaging technique (e.g.: MRI) or the validity of an imaging measurement is tested against another weak test such as Valsalva Leak Point pressure or the maximum urethral closure pressure. Imaging can either be performed to better understand the pathophysiology of incontinence and pelvic organ prolapse and it may be of importance, although no immediate clinical benefit is evident (e.g.: calculation of sphincter volume with ultrasound). It can be performed as a diagnostic test in patients undergoing surgery so that quantification of the clinical benefit requires complex clinical trials (e.g.: MRI of pelvic organ prolapse in patient undergoing prolapse repair) in which different reference standards can be used (e.g.: physical examination or anatomic finding during surgery). Although imaging can sometimes offer a better understanding of the anatomy underlying the condition (e.g.: presence of an enterocele) the clinical benefit of this additional information may not be observed in all patients.

Although imaging is clearly a difficult area for research, the consensus regarding introduction of a diagnostic test into our daily practise must rely on the evidence of clinical benefit in terms of safety, outcome or cost-benefit ratio.

Imaging studies belong to the area of diagnostic studies, they should follow the suggestions of the STARD initiative and they differ substantially from other types of clinical trials (1). The aim of clinical studies of diagnostic tests should be to provide information regarding the diagnostic accuracy of the proposed test although, this is not always possible.

A few considerations regarding the levels of evidence in imaging studies may be instrumental in reading this chapter and are summarised herewith.

Imaging of parameters with known prognostic value (e.g. PVR)

- The first issue is to prove that imaging studies image what they are supposed to image. Although the issue may be trivial in case of PVR imaging or anal sphincter imaging, the issue is relevant in other areas (eg: enterocele imaging) and should be approached by using imaging in cadavers or other approaches such as intraoperative confirmation of the observed condition as a gold standard.
- When the imaging is quantitative, accuracy versus a quantitative gold standard technique should be provided. When the imaging is qualitative (e.g. presence or absence of vaginal vault prolapse) the diagnostic value should be provided (sensitivity, specificity, positive and negative predictive value, accuracy, interrater and intrarater variability).
- Once validity has been proven, one can assume that the predictive value of the imaging study is

equal to that observed for the parameter measured with the gold standard. The same applies to its value for patient management.

Imaging of parameters with unknown prognostic value (e.g. MRI of the pelvic floor)

- When the imaging is qualitative (eg: intact versus damaged levator ani), once validity is proven, the diagnostic value should be investigated providing sensitivity, specificity, positive and negative predictive value, accuracy, interrater and intrarater variability in cadavers or patients undergoing surgery.
- Once validity is proved, the prognostic value for patient management should be investigated.
- Confirmation of the proposed imaging study by independent groups is required ideally for both validity and prognostic value or at least for the latter parameter (we can assume that confirmation of the prognostic value is obtained, validity of the imaging technique can be inferred).

II. IMAGING IN URINARY INCONTINENCE AND PELVIC FLOOR DYSFUNCTION

This is a broad area that often requires a multiprofessional and multidisciplinary approach. The patient population is heterogeneous including children, female and male subjects suffering congenital malformation of the genital and urinary tract, neurogenic disorders, iatrogenic conditions and traumatic lesions. Clinical guidelines always refer to the so called “standard patient” but the majority of subjects referred to secondary and tertiary referral centres cannot be defined as such and their management sometimes requires deviation from guideline recommendations. The large variability and the uniqueness of the observed cases may justify the adoption of a knowledge-based management in the absence of proven clinical benefit. Research on imaging of urinary incontinence (UI) and genital prolapse remains very active. Although all guidelines recommend not to use imaging in the evaluation of the standard patient, many clinicians believe this is an ideal adjunct to physical examination in evaluating the anatomical condition of the individual subject.

1. IMAGING OF THE UPPER URINARY TRACT

Urinary incontinence is defined as the complaint of any involuntary leakage of urine, it can be urethral or extraurethral (1). This latter condition either results from congenital anomalies such as ectopic ureters (inserting in the female distal urethra or vagina), iatrogenic or traumatic conditions such as fistula. In some patients, lower urinary tract dysfunction (LUTD)

causing UI, might compromise the transport of urine from the kidneys to the bladder resulting in hydronephrosis and renal failure. The relationship between high bladder storage pressure and renal deterioration was first identified in myelodysplastic children and then considered to apply in all neurogenic patients (2) and automatically transferred to male and female patients with or without neurogenic problems; the value of 40 cmH₂O of bladder pressure as threshold value at which the upper urinary tract (UUT) is at risk should therefore be used with caution. In male patients, chronic retention of urine can be associated with UI and lead to chronic renal failure. Lewis et al. reported that renal function at baseline and at the time of catheterisation were significantly worse in patients with chronic retention than with acute retention (3). Therefore, UUT imaging is needed in patients with urinary retention, especially with chronic retention. In women, severe urogenital prolapse may cause angulation of the pelvic ureter by the uterine arteries leading to hydronephrosis (4)

1.1. Indications

Generally speaking, there is no need for UUT imaging in patients with UI unless any of the previously described conditions is suspected or diagnosed. In children with extraurethral incontinence imaging of the UUT helps to identify the underlying cause.

The objectives of UUT in the incontinent patient are as follows:

Evaluation of the UUT when the presence of an ectopic ureter or ureterovaginal fistula are suspected.

Evaluation of the kidneys whenever UI is related to bladder dysfunction with high storage pressures (e.g. in neurogenic voiding dysfunction, chronic retention with overflow or low compliance bladders)

Exclusion of hydronephrosis in cases of UI associated with severe uterine prolapse.

1.2. Techniques

UUT imaging modalities include intravenous urography (IVU), ultrasound sonography (USS), computerized tomography (CT scan), magnetic resonance imaging (MRI), and isotope scanning. No data regarding reproducibility, specificity, sensitivity, positive and negative predictive value in relation with the diagnosis and management of UI are available. The choice of the imaging modality also depends on availability, expertise, and local management policies. Generally speaking, low cost and low risk techniques such as USS are preferred. Unless otherwise described, the following considerations regarding the different imaging modalities are based on expert opinion.

1.2.1 Ultrasonography

USS is the gold standard technique for primary imaging of the UUT because of the relatively low cost of the equipment and the examination, its wide

availability, the lack of any exposure to ionizing radiation. Renal USS is independent on kidney function and provides a good evaluation of kidney morphology. Concomitant renal disorders such as urinary lithiasis and neoplasms can also be diagnosed. In patients with LUTD, the detection of hydronephrosis is of importance and it can be related to either vesico-ureteral reflux or obstruction. USS is used for the first line evaluation of the UUT conditions in neuropathic patients. Sixteen percent of chronic spinal cord injured patients with hyperreflexic bladder had UUT deterioration revealed by USS, while 17.5% of patients with areflexic bladder also had it (5). UUT deterioration more frequently occurred in hyperreflexic bladder with higher reflex detrusor contraction pressure (115 vs. 72 cm H₂O) mostly accompanied by type 3 detrusor external sphincter dyssynergia, and in areflexic bladder with higher storage detrusor pressure (58 vs. 24 cm H₂O). In patients adequately managed with clean intermittent catheterization annual USS monitoring without routine urodynamic testing was suggested to be an effective surveillance strategy (6). UUT deterioration was demonstrated in 70 of 193 myelodysplastic patients who underwent USS, voiding cystourethrography, DMSA scan, and urodynamics at three years old (7). The sensitivity and specificity for UUT damage were 91.4% and 22.3% in DLPP >20 cm H₂O, 77.1% and 32.0% in DLPP >30 cm H₂O, and 52.9% and 51.8% in DLPP >40 cm H₂O, respectively. Therefore, a DLPP cut-off value of 20 cm H₂O showed a higher sensitivity to predict UUT damage instead of 40 cm H₂O. In the cross-sectional survey of Dutch urologists 91.5% of them performed USS at least once every 1-5 years during the follow-up of adult myelodysplastic patients (8).

USS is also used to detect hydronephrosis in prolapse patients. Hydronephrosis was revealed by USS in 5%-50% of patients with pelvic organ prolapse (POP) that reconstructive surgeries were indicated for (9). The proposed mechanisms for hydronephrosis are 1) ureteric compression between the uterine body and the urogenital hiatus, and 2) ureteral kinking caused by the cardinal ligament (9). It was reported that hydronephrosis occurred in 12.6%-22.4% of patients with severe ureterovaginal prolapse as well as 3.9%-7.1% of patients with severe vault prolapse, indicating that hydronephrosis developed after hysterectomy (10, 11). It was supposed that the ureters may be pulled down and kinked by the downward traction of prolapse upon the bladder (9). Dancz et al. reported that 30.6% of their POP patients had hydronephrosis, and that Ba-point (OR 1.68, 95% CI, 1.22-2.12), not C-point, and maximum cystometric capacity (OR 1.50, 95% CI, 1.08-2.07) were associated with hydronephrosis on a multivariate analysis (9). On the other hand, Beverly (11) and Gemer (12) reported that 7.7% and 17.4% of patients, respectively, had hydronephrosis, and that uterine prolapse was associated with hydronephrosis on multivariate analysis (OR 3.8, 95% CI, 1.4-10.5 and OR 1.9, 95% CI, 1.1-3.2,

respectively). The presence of hydronephrosis do not affect the surgical procedures for POP repair and hydronephrosis improves in 70-100% of patients after surgery (10, 13). Therefore, USS should be performed in women with advanced POP, especially when surgical intervention is not indicated or delayed (9).

Although, no strict correlation exists between the degree of dilatation and the severity of obstruction, the grade of hydronephrosis is correlated with the extent of cortical damage (14). In children, kidneys with a pelvic diameter >20 mm are considered to be at risk for deterioration and require intervention (15). Measurement of the resistive index in the interlobar and arciform arteries of the kidney has been proposed for the diagnosis of urinary obstruction but this is rarely used in the evaluation of the incontinent patient (16). Whenever hydronephrosis is diagnosed on USS, other imaging modalities are often used to evaluate renal function, the degree of obstruction or vesico-ureteral re ux. USS is an ideal technique to follow the degree of hydronephrosis over time or the response to treatment.

1.2.2 Intravenous Urography

IVU is the original radiographic examination of the UUT which allows evaluation of UUT anatomy and function. Recent Canadian guidelines recommended that a serum creatinine level (SCr) should be obtained, and an estimated glomerular filtration rate (eGFR) should be calculated within 6 months as an outpatient who is stable or within 1 week for inpatients and patients who are not stable (17). Patients with an eGFR of ≥ 60 mL/min have an extremely low risk of contrast-induced nephropathy (CIN) (17). Fluid volume loading remains the single most important measure, and hydration regimens that use sodium bicarbonate or normal saline solution should be considered when GFR < 45 mL/min in patients who receive intravenous contrast (17). Patients are most at risk for CIN when eGFR < 30 mL/min (17). Additional preventative measures include the following: avoid dehydration, avoid contrast medium (CM) when appropriate, minimise CM volume and frequency, avoid high osmolar CM, and discontinue nephrotoxic medications 48 hours before administration of CM (17). Also, Japanese guidelines showed that chronic kidney disease (CKD, eGFR < 60 mL/min/1.73 m²) is the most important risk factor to predict the risk of CIN in patients receiving iodinated contrast media (18). In addition, aging and diabetes associated with CKD are risk factors for the development of CIN (18). Recent systematic review recognised pre-existing CKD, diabetes, age, and cardiovascular comorbidity as risk factors (19). The existing guidance documents agreed in recommending pre-hydration as the main preventive measure, but there was difference in recommended total volumes, composition, rate and duration of the infused solutions (19). There was no consensus on the use of sodium bicarbonate and none recommended N-acetylcysteine as solitary preventive measure (19). Recent guidance

documents recommend avoiding hypertonic contrast media, but did not recommend preference of iso-osmolar over low-osmolar contrast media (19). During IVU successful examination is dependent upon adequate renal capacity to concentrate urine, the poor concentration capacity of an impaired kidney limits the possibility to delineate the collecting system. A number of different conditions such as renal dysfunction, obstruction, congenital anomalies, fistula, stones and tumors may be detected. IVU is the appropriate first study in cases of extraurethral incontinence. When ectopic ureter is suspected (although this condition can also be responsible for urethral incontinence), delayed films and tomography are important because the renal unit or moiety associated with an ectopic ureter is often poorly functioning. In fact, IVU is sometimes unable to detect a small, malfunctioning moiety associated with a duplication and ectopic ureter or a poorly functioning or abnormally located kidney with a single ectopic system (20-22). In such cases where the diagnosis of ectopia is still suspected after IVU, another imaging modality such as CT, MRI or isotope scanning should be considered (23- 25). IVU is the appropriate first imaging study when uretero-vaginal fistula is suspected, usually after pelvic surgery. Typically, one sees ureteropyelocaliectasis proximal to the level of the fistula. This finding has been reported in 84-92% of cases (26, 27). Sometimes extravasation can be seen. Confirmation of the presence of the fistula, its size and exact location is often obtained with retrograde ureteropyelography.

1.2.3 Computerised Tomography (CT scan)

High quality information of the UUT anatomy can be obtained using multidetector helical CT scans and 3D reconstruction software. Differently from IVU which only acquires images in the anteroposterior or oblique CT acquires images in the axial plane. Pictures can then be reconstructed in 2D along any plane or in 3D whenever required. CT scan can be used irrespective of renal function when no iodinated contrast medium is used. Whenever hydronephrosis is present, urine can be used to delineate the collecting system reducing the need for contrast agents. In general, intravenous contrast medium is required to highlight specific anatomic characteristics. CT scan is often used after the first line evaluation with USS and it has replaced IVU almost entirely. Several authors have reported the use of CT scan to detect ectopic ureter, in cases where the diagnosis is suspected, despite a normal IVU and ultrasound (28). In these cases the small size and poor function of the ectopic moiety make diagnosis difficult by IVU.

1.2.4 Magnetic Resonance Imaging (MRI)

MRI shares some of the advantages of CT over IVU in the evaluation of the UUT. Furthermore acquisition can be performed along any plane and pictures can then be presented in a 2D or 3D fashion. The paramagnetic contrast medium is free of allergic reaction risk although its use in the UUT remains

dependent upon renal function and concerns about its nephrotoxicity have been recently raised (29). Low risk gadolinium contrast agents should be the choice, and dosage should be kept to a minimum, as higher doses have been linked to the development of nephrogenic systemic fibrosis (NSF)(30). While a pre-existing pro inflammatory state in the renal impaired is a high risk factor, liver insufficiency in itself is not a contraindication; however, patients may also have coexisting renal insufficiency and thus carry a risk of NSF (30). The development of the uro-MRI technique has gained an increasing role for the technology in the evaluation of hydronephrosis and urinary tract anomalies as an alternative to IVU. The use of MRI in the diagnosis of ectopic ureter has recently been described (31-35).

1.2.5 Isotopes

Isotopes are used primarily to examine morphological and functional characteristics of the upper urinary tract. Isotope scanning can be used to identify the location of a small kidney which is otherwise difficult to image with radiological techniques. Renography is used to examine the differential function of the two kidneys, to identify disorders of urine transit and to quantify obstruction of the upper urinary tract. There are many physiological factors and technical pitfalls that can influence the outcome including the choice of radio-nucleotide, timing of diuretic injection, state of hydration and diuresis, fullness or back pressure from the bladder, variable renal function and compliance of the collecting system (36, 37). Diuresis renography with bladder drainage is recommended when obstructive uropathy is suspected (38). Renal scintigraphy may be useful in the evaluation of ectopic ureters associated with hypoplastic kidneys (39). Detection rates of dysplastic kidney in single system ectopic ureter were 95.5% on DMSA, 95.5% on CT scan, 50% on USS, and 50% on MRI (40). DMSA would be a preferred option in this setting, because of its high detection rate and not requiring contrast medium.

1.2.6 Conclusions

Imaging of the UUT is rarely required in UI unless the condition originates from a malformation, a traumatic or an iatrogenic problem of the UUT. More rarely a condition of the lower urinary tract may endanger renal function, the preservation of which is required to guarantee a normal life expectancy in patients with UI.

1.2.7 Consensus Statement

- Imaging of the UUT is NOT indicated in the evaluation of non-neurogenic stress, urgency or mixed UI. (**Level of Evidence 3, Grade of Recommendation C**)
- Imaging of the UUT is indicated in cases of:
 - neurogenic UI with high risk of renal damage (due to high storage and/or voiding detrusor pressure, e.g. myelodysplasia, spinal cord

injury) (**Level of Evidence 3, Grade of Recommendation C**)

- chronic retention with UI (**Level of Evidence 3, Grade of Recommendation C**)
- severe uterine prolapse, vault prolapse, or anterior vaginal wall prolapse, especially when surgical intervention is not indicated or delayed (**Level of Evidence 3, Grade of Recommendation C**)
- suspicion of extra-urethral UI by upper tract anomaly (**Level of Evidence 3, Grade of Recommendation C**)
- The choice of the imaging techniques and their sequence depend on the clinical question and their availability. The least invasive techniques should be preferred and should precede the more invasive, also taking into consideration cost effectiveness. (**Level of Evidence 3, Grade of Recommendation C**)

1.2.8 Suggested Research Areas

Prevalence of upper tract deterioration in various UI populations

- Natural history of upper tract changes
- Relation between upper tract dilation imaging, renal damage and bladder function

2. IMAGING OF THE LOWER URINARY TRACT

The use of imaging of the LUT in patients with UI dates back 40 years more than that e.g. Jeffcoate 1950's, particularly in female patients. The techniques have changed, over the decades from static to dynamic imaging, from qualitative to quantitative information. Although some of the techniques are now more than 50 years old their clinical value remains at best, unclear.

2.1. X-Ray Imaging

Voiding cystourethrogram (VCUG) was the mainstay of x-ray imaging of the LUT but it has been replaced almost entirely by USS because of its ease of use, low cost and availability. While CT has not gained acceptance because of the exposure of ionising radiation, MRI took the lead as the most promising imaging modality because it offered a comprehensive view of the pelvis and enabled visualisation of the position of visceral organs in relation to bony reference points. 3- and 4D USS recently offered volume acquisition with limitations in the depth of ultrasound wave penetration and the volume that can be imaged. Progressive technical developments in imaging technology and techniques have made this research area particularly interesting.

In males the purpose of voiding cystourethrography has been mainly to locate infravesical obstruction separating the bladder neck from benign prostatic obstruction although it may play a role in the management of post-prostatectomy incontinence (1). In children the diagnosis and classification of reflux and diagnosis of posterior urethral valves have been the primary goals (2). The severity of the vesicoureteric reflux on one side determines the development of contralateral reflux and indicates a poorer resolution rate for reflux (3).

Positive-pressure urethrography has been used for the diagnosis of female urethral diverticula, it was shown to be more sensitive than voiding cystourethrography (4-6) although MRI is the gold standard for the diagnosis of diverticula and planning surgical repair (7, 8).

The rationale for imaging studies of the lower urinary tract in this field derives from the hypothesis that stress UI is caused by urethral hypermobility. This was the theoretical basis of the classification of UI published by Green in 1968 and then modified by Blaivas and Olsson in 1998 (9, 10). Investigation into cohorts of continent and incontinent patients failed to provide evidence to support the hypothesis and imaging techniques aiming at measuring bladder neck displacement during straining have been abandoned. The same applies to outcome research in urinary incontinence where surgery that limits bladder neck displacement does not necessarily lead to cure of the condition. A renewed interest derived from the availability of USS which took imaging out of the radiology suites and moved it into the urological and gynaecological outpatient clinics opening new opportunities for clinical research in this field. The possibility of imaging what was usually perceived during physical examination such as bladder neck mobility or POP increased the usefulness of USS. Research in the field of MRI first assessed the possibility of fast dynamic acquisition to image the displacement of visceral organs during effort to better quantify POP and then the morphological imaging of the pelvic organs muscular support to investigate the physiopathology of genital prolapse.

2.1.1 Female Cystourethrography

X-ray imaging of the urinary bladder and urethra has been used to assess the female urinary tract in women suffering UI to evaluate urethral/bladder neck hypermobility and to assess associated conditions such as urethral obstruction, vesico-urethral reflux, diverticula, fistulae, stones and tumours. In males the purpose of voiding cystourethrography has been mainly to locate infravesical obstruction (1, 11).

The diagnosis and classification of reflux and diagnosis of posterior urethral valves in children have been the primary goals (2). In a study comparing cystourethrography with direct radionuclide voiding cystourethrography and voiding urosonography with contrast

medium were compared. Voiding sonography and direct radionuclide voiding cystography were shown to be the most sensitive (12).

2.1.1.1 Background

History and methodology of cystourethrography in females had been reviewed by Olesen (6). The technique is now over 70 years old. Voiding cystourethrography with lateral projection was first done by Mikulicz-Radecki in 1931 (13). The use of a metallic bead chain to identify the urethra was introduced by Stevens and Smith in 1937, and in 1956 Ardran, Simmons and Stewart reported on a cinematographic technique with contrast media also in the vagina and rectum (14, 15). In an attempt to combine qualitative and quantitative information regarding the function of the lower urinary tract, the combined use of fluoroscopy and pressure-flow recordings was proposed during the nineteen sixties and seventies (16-20).

2.1.1.2 Methodology (projection, positioning and exposures)

Bladder neck displacement is best viewed and quantified in true lateral projection although image quality is sometimes poor because of the increased body mass and the overlap of bony structures with the bladder neck area. Consequently, oblique projections are sometimes used notwithstanding the lack of quantitative information. Achieving a quasi-physiological voiding in a radiology suite is difficult because of the inevitable impact of the environment. The use of a sitting position is recommended for micturition studies as voiding while standing or lying will increase the embarrassment and therefore many impair the quality of the examination (13). Especially in patients with large body mass index, imaging of female urethra in a true lateral projection is difficult, it necessitates high radiation doses as the central x-ray beam must penetrate the trochanteric regions and further because the urethrovesical junction is sometimes overshadowed by the lateral parts of the bladder. A significant improvement in this area has been brought about by digital imaging which allows the subtraction of the bony structures. The position and mobility of the urethrovesical junction as well as urine leakage are supposed to be influenced by the filling volume as has been demonstrated on ultrasonography and leak point pressure measurements (21, 22). However, in VCUG the bladder is filled to capacity. Addition of a urethral bead chain or catheter and vaginal contrast to improve the visualisation of the urethra, bladder neck and trigone has been abandoned. Contrast in the rectum is not necessary for urinary incontinence purposes. Exposures at rest should be supplemented with provocative manoeuvres to test bladder neck mobility by contracting and relaxing the pelvic floor (e.g. coughing, straining, and squeezing). Whenever possible, pictures while the patient is voiding should be obtained. It is important to consider that coughing and straining result in a different effect on the pelvic floor. Straining might be associated with relaxation or

contraction of the pelvic floor, and the imaging can change accordingly.

During coughing there is a reflex contraction of the pelvic floor, but coughs are of a short duration and difficult to capture on spot films. Bladder suspension defects were diagnosed at rest in 49% of 420 examinations, while coughing and micturition disclosed a further number of 20% and 4% respectively (13). Squeezing can demonstrate pelvic floor awareness and contraction (23).

2.1.1.3 Combined imaging and urodynamics

Videourodynamics has been regarded by some as the "gold standard" in the evaluation of LUTD (23). Reproducibility of the combined examination has not been assessed and further the radiation dose has to be considered (15,20,24-26). One study has attempted to compare videourodynamics with saline cystometry (23). Independent observers carried out the two procedures with 75 women having the saline cystometry first and a further 75 women had videourodynamics first. The degree of bladder descent noted on screening was greater than on clinical examination. Nineteen women had trabeculation and a further 11 women had bladder or urethral diverticula, urethral stenosis and vesicoureteric reflux (1,11,14). Only seven of the eleven women could have been predicted by a selective imaging policy based on history alone which would image 43% of the 150 women. This suggests that a selective policy of screening will unnecessarily expose patients to radiation while not using the optimal technique for investigation for all patients who need the test. Nevertheless simultaneous videomonitoring along with tracings of pressure and urine flow rate are important to ensure that the exposures are made at appropriate moments so that the radiographs can be representative of the various functional states (13, 18, 27, 28).

Patients with Parkinson's disease and multiple system atrophy are best evaluated by videourodynamics with sphincter motor unit potential analyses to identify the characteristic features of these conditions including: external sphincter denervation, neurogenic sphincter motor unit potentials, open bladder neck at rest and detrusor-external sphincter dyssynergia (29). Neurogenic patients show severe bladder trabeculation with diverticula and pseudodiverticula, pelviureteric reflux, widening bladder neck and proximal urethra, and narrowing at the level of the membranous urethra can suggest, the presence of neurogenic dysfunction of the lower urinary tract (occult spinal dysraphism, non-neurogenic neurogenic bladder (also known as the Hinman syndrome) even in the absence of neurogenic symptoms and signs (30-32). Urodynamic parameters in children do not discriminate between those with or without vesicoureteral reflux thus videourodynamics has been considered essential. Additionally children with non-neurogenic voiding dysfunction are found to have a number of

abnormalities with videourodynamics (33,34). Indications for videourodynamics include previous continence and vaginal surgery, neurological disorders and suspicion of urethral diverticula.

2.1.1.4 Normal and defective bladder support

The whole issue about the clinical value of VCUg is about the pathophysiology of defective bladder support in the pathophysiology of SUI in female patients and the relation between the surgical correction of such a defect and cure. The concept of urethral hypermobility was central to the classification of SUI and the concept that impaired transmission of abdominal pressure to female urethra could be responsible for the observed leakage. Little remains regarding the concept of urethral hypermobility in a modern view of female SUI and this contributed to the decreasing use of VCUg in the evaluation of a standard female patient.

The normal resting bladder has a smooth surface although bladder trabeculation is often seen in elderly women and not necessarily related to any pathological condition. The internal urethral orifice is located just above a horizontal line through the lowermost part of the symphysis in a coronal projection. The urethra is straight and runs anteriorly and caudally toward the external meatus.

On coughing and straining, relaxation of the pelvic floor results in downward movement of the bladder neck, which can be associated with a backward movement of the bladder neck resulting in a change in urethral axis. Squeezing (and sometimes also straining) results in contraction of the pelvic floor muscle with a cranial movement of the bladder neck. During voiding the bladder base is usually lowered about 1 cm, the angle between the urethra and the trigone is straightened, making a funnelled appearance of the proximal urethra and the bladder base, the bladder contour is rounded and a fine sawtooth irregularity of the mucosa becomes visible above the trigone. Angles and distances between the urethra, bladder base and symphysis pubis have been assessed radiologically. The following parameters have been assessed for reliability:

1. The posterior urethrovesical angle (PUV) is defined by lines along the posterior urethra and the trigone (35). Cut off values were usually 115° or more (36, 37);
2. The urethral inclination is between the proximal urethral axis and the vertical plane, which is a plane outside the patient and, therefore, the angle also varies with pelvic inclination. In Green type I and type II descent the angle is less or more than 45° respectively (37);
3. The urethropelvic (UP) angle is measured during voiding as the anterior angle between a line through the middle of the internal urethral orifice

and the urethral knee and a line through the posterior surface of the symphysis through the lowermost part of the obturator foramen closest to the film. In normal subjects the mean UP is about 95° and the cut off point for bladder descent are values below 70° (13);

4. Symphysis orifice (SO) distance is measured at rest as the distance on a horizontal line from the symphysis to the internal urethral orifice. Normal values are 31 ± 6 mm (mean \pm SD) and values less than 20 mm are the cut off points for descent (13);
5. The urethral axis at rest (UAR) and during straining (UAS)

Funnelling of the proximal urethra and flatness of the bladder base (both anterior and posterior to the internal urethral orifice) and the most dependent portion of the bladder base (the urethrovesical junction or a point posterior to that) are important qualitative parameters estimated on straining films (36).

Anterior bladder suspension defects or bladder base insufficiency (BBI) is defined as $SO < 20$ mm with a normally positioned vagina at rest, during coughing or micturition and/or funnelling of the bladder base at rest or with coughing. BBI can be graded 1-3, which corresponds to Green's type I descent (13, 38). The supportive defect is supposed to be in the fascial and ligamentous system and their abnormal detachments (eg., paravaginal defects).

Posterior bladder suspension defects are defined as a posterior-inferior bladder displacement and a UP of less than 70° (13). It corresponds to Green's type II (39). Sometimes only the trigone and posterior part of the bladder is involved. The supportive defect is supposed to be in the muscular pelvic floor, that is, the pubo-vesical part of the pubococcygeus muscle or in paravaginal detachment.

Interestingly, when UAR and UAS were examined in a group of 76 continent women and correlated with age, a perfect linear regression was noted between UAR and age ($R^2=0.28$). Patients with stress urinary incontinence were found to have an average UAR value of 25° with a mean UAS of 43° leading to a threshold value of hypermobility of about 20°. When standing cystourethrograms were repeated 3 to 6 months after surgery for SUI, UAR and UAS values were found to be close to normal suggesting a relation between the correction of the defective bladder support and cure (39). A more structured definition of cystocele (ranked by height in centimetres) was also obtained, adding to the emerging data that the reliability of the pelvic organ prolapse quantification (POP-Q) system increases when measurements are performed in a more upright position (39).

2.1.1.5 Reproducibility

The observer variation has been evaluated in four university uro-gynecological units (Table 1) (23, 36, 40, 41). The inter-observer agreement was 43-79%

and the intra-observer agreement was 53-99%. These figures are in the same range as has been found for other diagnostic tests (42).

2.1.1.6 Accuracy for the diagnosis of SUI and post-operative results

Evaluation of accuracy is the mainstay in the evaluation of a diagnostic technique. The sensitivity and specificity of a diagnostic technique depend on intrinsic factors such as reproducibility (as measured by intraobserver and interobserver variation) and extrinsic factors such as the characteristic of the patient cohort used to assess accuracy.

The accuracy of the previously mentioned radiological criteria have been measured by comparing imaging data with the 'so called' index-test which in this case was a clinical diagnosis of urodynamic stress in-

continence and expressed as specificity and sensitivity or as predictive values. Unfortunately, the diagnosis of SUI is controversial and might be based on subjective criteria, urodynamic tests, or measurement of leakage. Even radiological criteria have been included in the diagnosis.

Reproducibility (e.g. test-re-test agreement) has not been measured, but intra- and inter-observer variation has been calculated and adjusted for expected chance agreement (kappa coefficient). The predictive values and the kappa coefficient are supposed to depend on the prevalence, and therefore, comparison between different materials are difficult (42).

No consensus has been reached in the peer-review literature as to the lack of discriminant value of VCUG between SUI and continence, the majority of published papers are consistently negative although new promising data have been published (37, 39, 43-45)

Table 1: Inter- and intra-observer variation (agreement) on cystourethrography in females with urinary incontinence.

Type of examination, patients and observers	Inter-observer variation	Intra-observer variation
Bead-chain ¹ stress & urgency incontinence n°92 3 observers on 5 landmarks	45.8-80.7 %	
VCCU ² stress incontinence n° 52 1 observer on type of descent	79% 95% c.l. 65-89	
VCCU ³ stress incontinence n° 29 2 observers on type of descent	70% 95% c.l. 75-89	53% 95% c.l. 27-78
VCCU ⁴ n° 93 stress & urgency incontinence 6 observers on type of descent	43-60% kappa 20-39%	72-99% kappa 57-98%
VCUG ⁵ Stress incontinence n° 11 2 observers on urethral angle shift from rest to straining	r = 0.83 (p=0.001) for UAR r = 0.82 (p=0.002) for UAS	

1: static bead-chain cystourethrography with straining (36). The 5 landmarks were the posterior urethrovaginal angle, urethral inclination, funnelling of the proximal urethra, flatness of the bladder base and most dependent position of the bladder base;

2: voiding colpo-cystourethrography (VCCU) at rest and with coughing, straining, micturition and squeezing; one observer against original diagnosis (that is, normal appearance or anterior, posterior or combined suspension defects) made by a few senior radiologists (22);

3: voiding colpo-cystourethrography at rest and with coughing, straining, squeezing and micturition. Possible diagnoses were: normal appearance or anterior, posterior or combined descent respectively (41).

4: voiding colpo-cystourethrography at rest, coughing, with holding and voiding. Possible diagnoses were: normal appearance and anterior or posterior descent respectively (40);

5: standing voiding cystourethrography, urethral angle was measured at rest (UAR) and during straining (UAS) (39).

The specificity of 5 radiological parameters on static bead chain VCUG was 44-76% and the sensitivity 53-100% (45, 46). Neither was the degree of SUI correlated with the type or degree of suspension defects

(23, 40, 47). The positive and negative predictive values for a bladder suspension defect were 0.70 (95% C.I.: 0.62-0.78) and 0.52 (95% C.I. 0.41-0.63) respectively on voiding colpo-cystourethrography (38, 48).

In a later publication on 159 women, positive and negative predictive values of 0.56 and 0.74 were obtained (45). Evaluation of the urethral angle at rest and during stress in controls and in patients with SUI and various grades of anterior vaginal prolapse show a significant relationship between UAR and aging (from $2.4^\circ \pm 14.9^\circ$ in the third decade to $29^\circ \pm 9.2^\circ$ in the 9th decade; $r^2= 0.28$). In patients with SUI, UAR and UAS decreased from $25.7^\circ \pm 13.6^\circ$ and $42.6^\circ \pm 15.9^\circ$ to $16.6^\circ \pm 14.7^\circ$ and $23.8^\circ \pm 17.5^\circ$, respectively; the observed changes were found to be statistically significant. A similarly significant difference was found in patients with moderate to grade 3 cystocele and urethral hypermobility (at least 5 cm descent of the bladder base below the inferior ramus of the pubic symphysis on the lateral view of a standing VCUg): UAR and UAS decreased from $48.1^\circ \pm 16.5^\circ$ and $64.4^\circ \pm 16.8^\circ$ to $22.3^\circ \pm 26.9^\circ$ and $29.8^\circ \pm 22.8^\circ$, respectively.

Comparison of a randomly selected control cohort (aged-matched) with patients suffering SUI showed a significant difference of UAR and UAS at diagnosis while similar values were found after surgery. This was similar to patients with grade 3 cystocele in whom both UAR and UAS were significantly different from controls at baseline while showed similar values in the postoperative follow-up.

Measurement of the cystocele height obtained as the distance between the inferior border of the pubic symphysis and the inferior edge of the cystocele in controls and patients with mild and severe cystocele showed a significant difference between the two cohorts (16.63 ± 10.9 versus 27.4 ± 12.3 mm versus 73.4 ± 15.6 mm, respectively). Following formal cystocele repair, a significant change of cystocele height values was found in patient with mild and severe cystocele (from 27.4 ± 12.3 mm to 13.9 ± 18.0 mm and from 73.4 ± 15.6 mm to 25.4 ± 24.6 mm, respectively ($p<0.001$)).

These are the first data supporting the use of standing VCUg as an outcome measured, previous peer-review papers suggested the inability of its technique to distinguish postoperative failures from success (13, 23, 42, 44, 46, 49-52).

2.1.1.7 Comparison of cystourethrography and ultrasonography

The development of USS techniques for the evaluation of the lower urinary tract raised the question of the relationship between X-ray and USS imaging. Static bead chain cystourethrography has been compared with transrectal and perineal USS and voiding colpo-cystourethrography has been compared with perineal USS (46, 47, 53, 54). The findings correlated well regarding bladder neck position and mobility, PUV, urethral inclination, SO distance and rotation angle.

Specificity, sensitivity and interobserver agreement were also comparable for the two methods. All the

authors seem to prefer the sonographic modality because imaging can be performed at the same time as the physical examination. This has also been the case in men with neuromuscular dysfunction (11). Simple and extensive funnelling is more easily imaged in upright patients during cystourethrography than in the supine position frequently used for ultrasound studies (30).

2.1.1.8 Comparison of cystourethrography and MRI

The introduction of MRI in the assessment of the LUT required adequate comparison of this technique with standard X-ray imaging. The comparison of cystourethrography and colpocystourethrography with dynamic MRI showed comparable data on bladder neck position and cystocele extension (55, 56). Although there is an obvious concern about the fact that dynamic MRI imaging is usually performed with the patient lying in a dorsal lithotomy position, comparison of standing and lying colpocystourethrography did not show any significant difference (56).

2.1.1.9 Conclusions

VCUG does not have a major role in the evaluation of the standard female patient with UI confirmatory results on the clinical utility of measuring urethral angle and cystocele height in patients with UI and POP who are scheduled for surgery still missing. Defective bladder support can be diagnosed on VCUg with a reliability comparable with other diagnostic tests.

Dependent on local facilities the method might be considered if the choice of a surgical procedure is based on type and degree of supporting tissue deficiencies and possibly if new procedures are evaluated for the ability to restore this deficiency.

2.1.1.10 Consensus statement

Cystourethrography is NOT indicated in primary uncomplicated stress, urgency or mixed female urinary incontinence (**Level of Evidence 3, Grade of Recommendation C**).

Cystourethrography may be a reasonable option in the preoperative evaluation of complicated or recurrent female urinary incontinence (**Level of Evidence 3, Grade of Recommendation C**).

2.1.1.11 Suggested Research Areas

Variation of VCUg parameters in patients with SUI +/- ISD and prognostic value for surgical repair.

VCUG parameters in re-do surgery for SUI compared with controls

2.2. Ultrasonography

Ultrasonography has been used in the evaluation of urinary incontinence as early as 1980 (1). Over the past three decades the quality of the ultrasound image and its processing has improved beyond what could have been imagined during the 70's. Various

new developments, such as the use of contrast medium, colour Doppler, 360 degree transducers and three- and four dimensional imaging have been introduced and have led to the more widespread use of ultrasonography in the evaluation of the lower urinary tract and pelvic floor disorders.

A number of studies have reported good correlations between ultrasonography and x-ray in the evaluation of urinary incontinence (2-11). In particular, the position of the bladder neck at rest and during Valsalva (10, 12) manoeuvre has frequently been compared, and all authors agree on a good correlation. Some authors even found better accuracy for ultrasound (5), especially in obese women (2). Ultrasonography is cheaper than X-ray imaging, it is often preferred by physicians because the imaging studies can be performed in their own office as part of the physical examination and it is also more acceptable to patients because of the lack of radiation exposure. However, ultrasound itself produces problems by needing the probe to be in direct contact with the patient even during dynamic manoeuvres and the resolution is dependent on the frequency of the probe used. The higher the ultrasound frequency, the better the resolution but there is reduced penetration into the tissues.

2.2.1 Types of Ultrasonography

Different imaging approaches have been used, such as abdominal, transvaginal, transrectal, perineal and transurethral. Synonyms for the perineal approach are transperineal, introital, labial or translabial access, all use a similar method and there does not appear to be a substantive difference between these terms, a common agreed term needs to be decided upon.

Abdominal ultrasonography is generally not considered to be helpful in pelvic floor and urethral imaging because of the acoustic shadow caused by the pubic bones particularly in the obese patient (1). All approaches in ultrasound have a problem of distorting the tissue being imaged due to compression. With vaginal ultrasonography this risk is probably highest (13), although this has also been denied (14). Most recent studies report on perineal ultrasonography that

allows the visualisation of all three compartments in one image but again compression of the urethra may occur and imaging is impaired with vaginal prolapse or gas in the rectum.

The development of three-dimensional ultrasonographic systems has brought increased accuracy to measuring volumes of irregular structures as well as reconstructed images from novel directions and allowing pelvic floor imaging. Three-dimensional ultrasonography was first described for the female urethra in 1999 (15); the three-dimensional image can either be evaluated as a separate entity on the screen, or in combination with each of the two-dimensional planes from which it is derived (**Figure 1**). These three two dimensional planes are at orthogonal to each other being the sagittal, coronal and axial planes. Three-dimensional images are built up as a rendered image of a self defined region of interest, major advantages over 2D imaging include the possibility of reviewing the acquired images from any investigator and the ability to analyse the acquired volume through any plane (similar to CT scans or MRI) (**Figure 2**). This means that the levator ani muscle can be easily visualised. However interest has focused on the absence of the pelvic floor being imaged and a defect being implied.

Ultrasound produces images by its waves being reflected by a tissue. These reflective surfaces produce images of great clarity and resolution which are independent of the ultrasonic frequency. However once the tissue is perpendicular to the direction of travel of the ultrasound waves axial resolution is effective, limiting the accuracy and the ability for tissues to be imaged. This highlights the importance of testing all ultrasound imaging modalities against a gold standard such as cadaveric dissection or comparing them to another medium such as MRI or CT. Four-dimensional imaging involves a volume of tissue being continuously scanned, thus inevitably involving time delay; albeit not truly "real-time", it incorporates the enormous improvement in speed of three-dimensional systems over the last few years and it makes three-dimensional assessment of the dynamic relation of the pelvic organs on Valsalva manoeuvre and pelvic floor contraction possible.

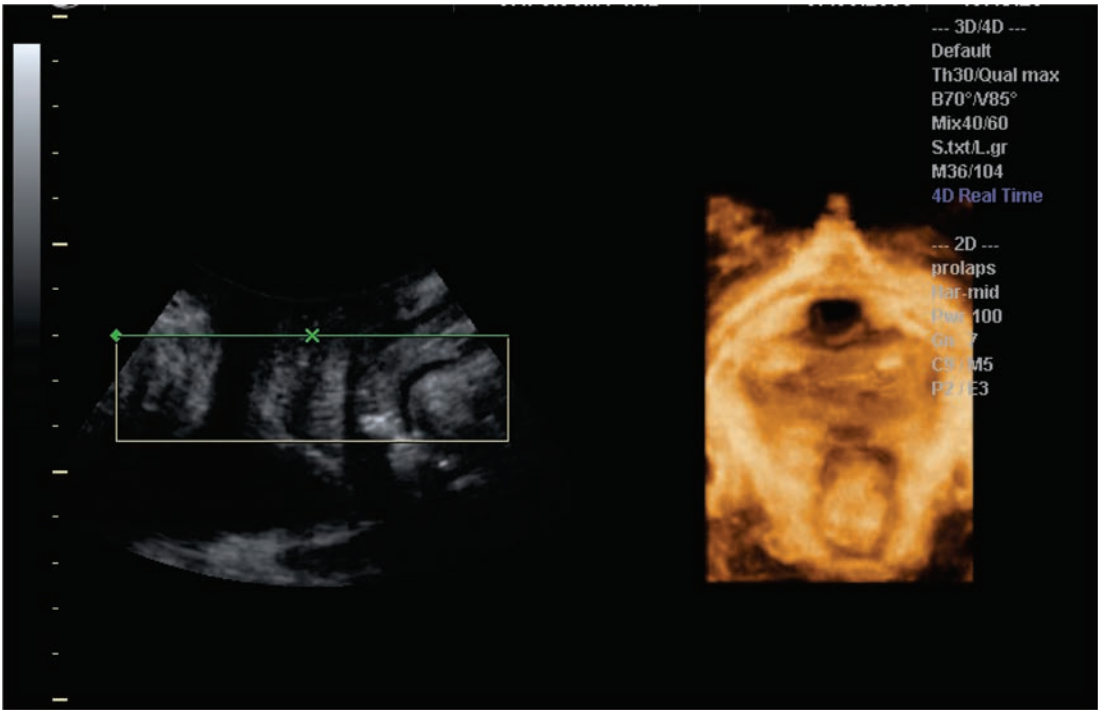

Figure 1: Perineal midsagittal two-dimensional view and three-dimensional rendered image. Normal anatomy.

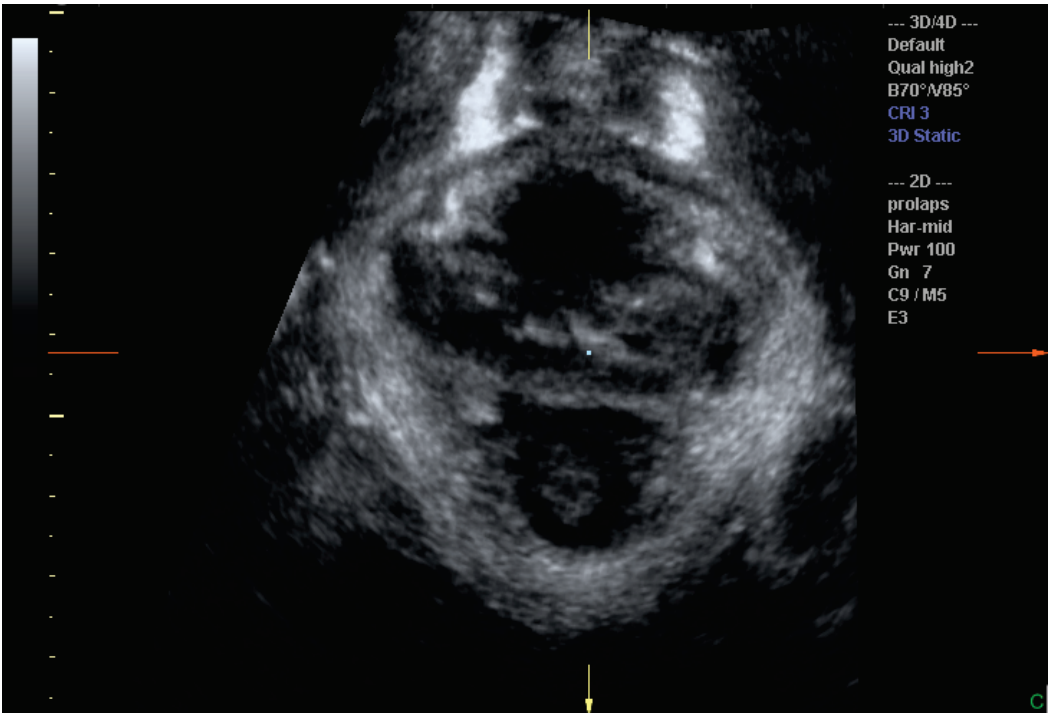

Figure 2 Perineal midsagittal two-dimensional view. Normal anatomy of the levator ani muscle.

2.2.2 Standardisation

No consensus has been reached as to the standardisation of image orientation. Some prefer orientation with cranial structures above (**Figure 3a**) (15) whereas others prefer presentation of the cranial parts below (**Figure 3b**) (16-17). All authors agree that the symphysis pubis, and its inferior border in particular, is a well recognisable and fixed reference point. This point can be used in the evaluation of the various aspects of relevant structures at rest and during dynamic imaging. In general, ultrasonographic studies are performed in the supine position (**Figure 4**). Small differences between the supine and standing position of the patient have been documented, although these differences disappeared during a Valsalva manoeuvre (18). Only a few studies have been performed in the standing position (19). There is no clear consensus on the amount of bladder filling, some authors prefer significant bladder filling, others prefer a nearly empty bladder because an empty bladder seems to descend more on Valsalva manoeuvre compared with a full bladder (19,20). Attempts to standardise Valsalva manoeuvre, ideally with intra-abdominal pressure measurements, has not been widely accepted (14,21). In one study (19), a peak flow meter has been used, where women were asked to “huff” maximally and to reach the same force during a number of “huffs”. It has been shown that the mobility of the bladder neck differs between coughing and Valsalva manoeuvre (22). Co-activation of the pelvic floor muscles during Valsalva manoeuvre has been documented and is one of the reasons for the lack of standardisation (22, 23).

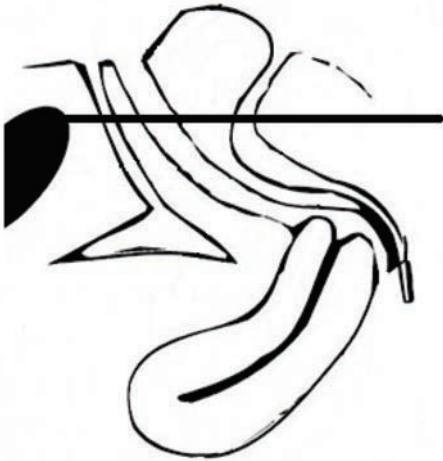

Figure 3a Perineal midsagittal two-dimensional ultrasound view on three compartments and horizontal reference line according to Dietz.

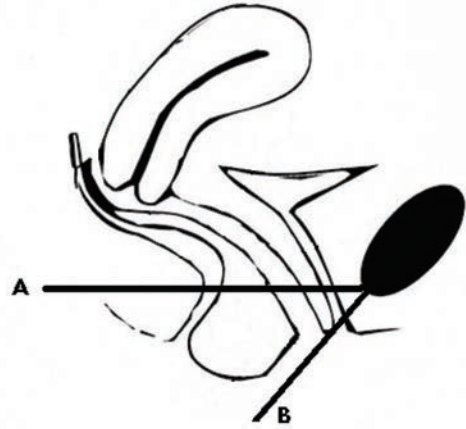

Figure 3b Perineal midsagittal two-dimensional ultrasound view on three compartments and reference lines according to Tunn and Schaefer.

A= horizontal reference line

B= central line of the symphysis as reference line for bladder neck descent

2.2.3 The Urethra and Bladder Neck

When collagen fibres and muscle fibres are located parallel to the ultrasound beam, the structure becomes hypoechoic. These same structures will become hyperechoic, however, when the fibres are located perpendicular to the beam. Ultrasonography may result in variable images of the urethra, since the echogeneity of the structures depends on the position of the transducer in relation to the urethra. This may produce confusing images, especially in the dynamic process of pelvic floor contraction and Valsalva manoeuvre. In the midsagittal plane on perineal ultrasonography, and with normal anatomical position of the urethra at rest, the internal sphincter and inner urothelial layer of the urethra will appear hypoechoic (Figure 1), thus making these structures indistinguishable on ultrasonography. In the midsagittal plane and with normal anatomical position of the urethra at rest, the striated external sphincter or rhabdosphincter will appear hyperechoic, and can hardly be distinguished from the surrounding structures. It will, however, be easily visible as a hyperechoic circular structure in the axial plane as seen on three-dimensional ultrasonography (24,25). The rhabdosphincter has been found to be thinner dorsally (15), and both ventrally and dorsally (26) by various authors and more difficult to distinguish from the internal sphincter ventrally and dorsally compared with laterally (27). These differences may be due to the approach used to image the structures as well as types of probes applied but this has not been addressed in any study to date.

With the use of ultrasonography, thickness and length of the urethral sphincter muscle can be measured and urethral volume calculated (17,27-28).



Figure 4 Perineal ultrasound examination in the supine position.

Intra-urethral ultrasonography has been used for this purpose although complete imaging of the lateral parts of the sphincter are difficult due to the higher frequencies emitted by these probes (29), others have used two- or three-dimensional ultrasonography of the urethra (15, 24,26,30).

Comparison of transvaginal and transrectal approach showed a lower degree of urethral compression with the latter approach (26,31). Ultrasound measurement of the female urethra has been found to be reproducible (15, 24,32). Sphincter volume may differ significantly when 2D or 3D imaging is used (24). Urethral volumes, measured by 3D ultrasonography, were positively correlated with the actual volumes in cadavers (30,32). A significant and positive correlation between rhabdosphincter volumes and symptoms and signs of urinary incontinence has been reported (15); correlation with the urethral pressure profile (UPP) measures has also been found (25,27,28,30) but these data could not be reproduced (33). Ultrasonography imaging during micturition has been explored with the aid of a remote control systems (34). The use of intra-urethral ultrasonography with rotating probes (360°) has been proposed by various authors although no advantages over perineal US could be identified and incomplete imaging appears to be a problem due to the high ultrasound frequency emitted (29,35-38).

The advantage of preoperative and intraoperative three-dimensional ultrasound scanning in women with urethral diverticula has been outlined by Yang et al. (39-40).

2.2.4 Bladder Neck

The bladder neck and proximal urethra are easily visible on all types of ultrasonography without the need for catheterisation (Figure 1). Measurements are usually taken at rest, during straining (Valsalva manoeuvre), and sometimes during a cough and squeeze. The position and movements are measured in relation to the lower margin of the symphysis pubis. The

difference between rest and strain is referred to as the bladder neck descent (the distance between the bladder neck and a horizontal line through the lower end of the symphysis pubis) (Figure 5). On Valsalva manoeuvre the bladder neck rotates in a posterior and inferior direction away from the symphysis pubis. The axis of the urethra in relation to a vertical or horizontal line can be measured in degrees and provide the degrees of urethral rotation or bladder neck mobility. Other parameters are the posterior urethrovesical angle and the anterior urethrovesical angle. A number of studies have validated the use of ultrasonography in the assessment of the position and mobility of the bladder neck and proximal urethra. Good results for this validity testing have been reported although the clinical value of such measurements is still elusive (4, 14, 41-43). Normal values of bladder neck mobility have not been fully defined, since there is a great range in mobility even in young nulliparous women. In one study amongst nulliparous continent women of approximately 20 years of age, the bladder neck descent varied between 1mm and 40mm (44).

Others (41) found an average descent of 15 mm on Valsalva manoeuvre and 8 mm on a cough. Brandt et al. have found an average bladder neck descent of only 5 mm in 16 year old girls (45). More recently Naranjo-Ortiz et al proposed 25mm of bladder neck descent as cut off for "normality" as further descent was associated with SUI and USUI (46).

Racial differences have been demonstrated, with white women having greater bladder neck mobility compared with black women (47). Genetic determination of bladder neck mobility has been suggested (48). Numerous studies have found greater bladder neck mobility in parous compared with nulliparous women (14, 33, 49-51). Bladder neck hypermobility, however defined, is considered to be related to stress urinary incontinence (17,33,46). A large number of studies have correlated ultrasonographic findings with urodynamic parameters (46, 51-60). Specificity and sensitivity of ultrasonography for the diagnosis of stress incontinence were 83 and 68% in one study (54) and 92 and 96% in another study (61). Other studies have demonstrated that ultrasonographic findings of bladder neck descent and rotation of the retro-vesical angle increase the odds for SUI by 2.5, however they concluded that ultrasonography's low a diagnostic value does not allow it to replace urodynamics (62). In one study in which ultrasound-measured movement of the bladder neck on coughing and Valsalva was used as a marker inpatients undergoing pelvic floor exercises, response to treatment was not associated with changes to the bladder neck mobility (63) underlining this is probably an associated phenomenon and not the cause for stress urinary incontinence.

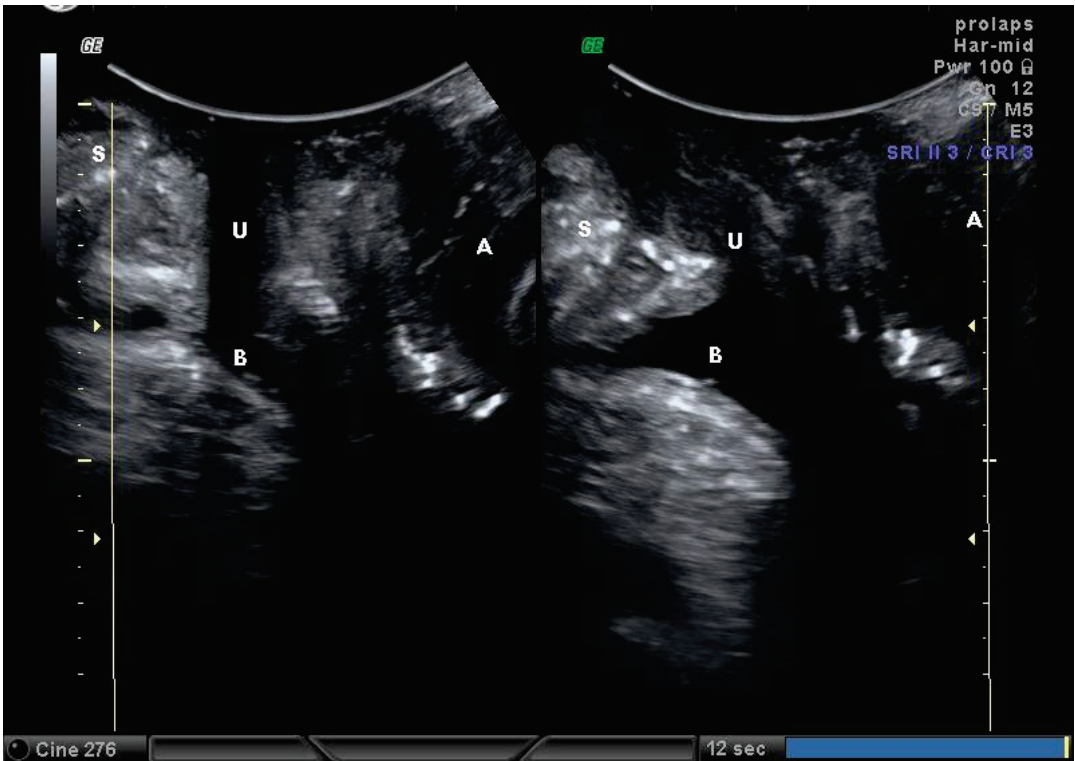

Figure 5 Perineal midsagittal two-dimensional view at rest and on Valsalva manoeuvre. Bladder neck descent. (S= symphysis pubis; U= urethra; B= bladder; A= anal canal.)

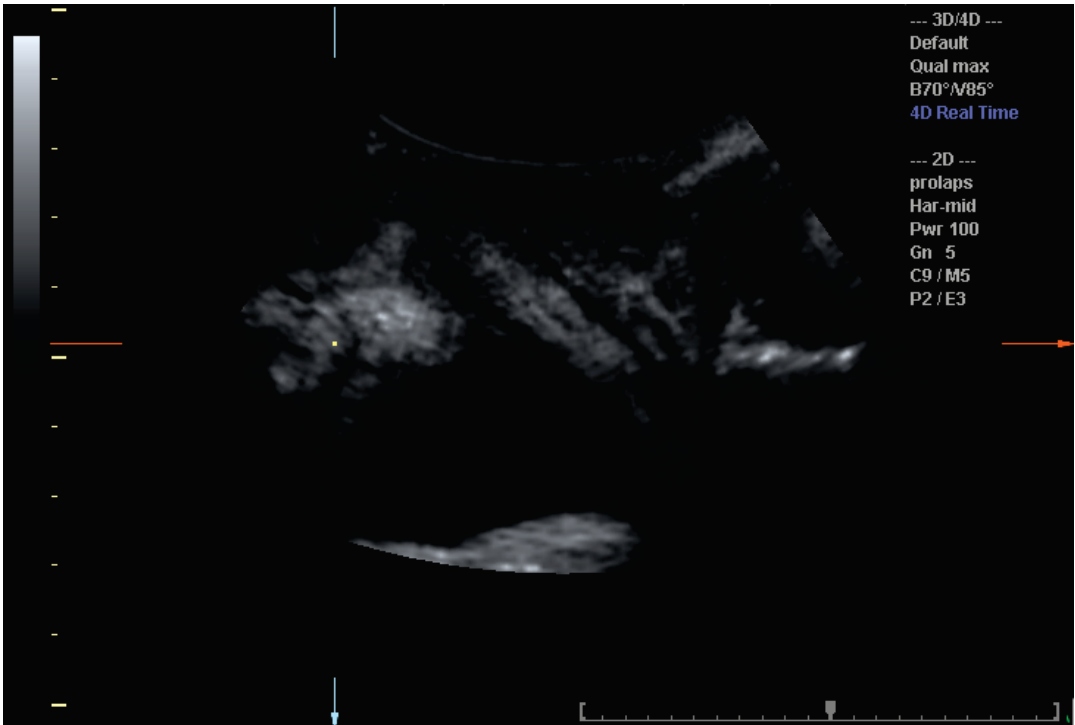

Figure 6 Perineal midsagittal two-dimensional view. Urethral funnelling.

Other researchers have contradicted these data by demonstrating that women with SUI who conducted physiotherapist-guided pelvic floor exercises showed reduced bladder neck mobility during coughing and increased cross-sectional area of their urethra as compared to before the training (64).

Further data from a RCT in primigravidae suggested that PFMT can play a preventative role in reducing the risk for SUI despite not conveying a significant change in bladder neck descent (65).

One research group has specifically investigated simultaneous perineal ultrasonography and urethrometry. They demonstrated that the variations in urethral pressure were caused by the activity of the urethral sphincter as well the pelvic floor muscles (66). The contractions from the urethral sphincter during acute stress events such as coughing are thought to be due to fast contractions. Some studies have used ultrasonography to optimise patient management, but despite the abundant literature on the use of ultrasonography in the investigation of women with urinary incontinence, disappointingly, a clinical advantage in terms of patient outcome has not been reported until now (67,68).

Urethral funnelling can be observed on ultrasonography (**Figure 6**) particularly with the use of contrast agents. It is a typical finding in women with stress urinary incontinence but can be seen in asymptomatic women as well (69-71). In a study on stress incontinent women, funnelling was found to be present in nearly all women (70,72). Urinary incontinence can be demonstrated by the use of colour Doppler of the urethra (73-74). Colour Doppler has, furthermore, been used to visualise the periurethral vasculature in nulliparous women (75) and differences have been described between continent and incontinent women (76-77) and before and after oestrogen supplementation in postmenopausal women. More recent data with the use of high frequency endovaginal ultrasonography have highlighted differences in urethral vascularity amongst continent women with parity (78). Doppler velocimetry has recently been used in a study on the vascularisation of the levator ani musculature and a correlation has been found between the absence of an end-diastolic flow and the presence of stress urinary incontinence (79). The blood flow around the urethra and bladder has been studied with Doppler before and after insertion of tension free vaginal tape and the transobturator tape. The blood flow decreases only after insertion of the tensional free vaginal tape whereas the blood flow was unchanged after insertion of the transobturator tape which may relate to the direction of urethral compression (80). More recent data showed no difference in urethral vascular indices measured by endovaginal ultrasound between women with SUI who were managed surgically or conservatively (81).

2.2.5 Determination of the Post Void Residual Urine and Bladder Wall Thickness

Ultrasonography is the gold standard technique for measuring bladder volume and post-void residual urine (82-86). Ultrasonographic data have been compared with residual volumes obtained by in and out catheterisation under ultrasound control and were found satisfactory. Although there is no universally accepted definition of high urine residual volume, there is consensus on the need for a short interval between voiding and post-void residual (PVR) measurement and the preference of ultrasound bladder volume measurement over urethral catheterization (87). However, Khan et al. have challenged the methodology of some studies and found deficiencies in all reports on the topic (88). A simple formula often used is $(\text{Height} * \text{Width} * \text{Depth cm}) * 0.7 = \text{Volume (ml)}$ in which the factor 0.7 is the correction for the non-spherical shape of the bladder. Automated ultrasound systems for measuring bladder volume and post-void residual have been developed and found to be more accurate than standard ultrasound measurements, furthermore they can be used by health care providers with no training in ultrasound imaging (89). However, measurement of bladder volume can easily and accurately be facilitated by use of cheap, standard 2D ultrasound machines, irrespective of the calculation formula used, even in women with severe pelvic organ prolapse (90). Automated bladder scanners are widely used and are, in general, experienced as reliable enough for clinical use, however, in the case of ascites (91) or an ovarian cyst (92) for example, the estimated urinary volumes can be incorrect, and in post partum women.

Recently the normal values for the post void residual urinary volumes in asymptomatic women have been presented; in 60 year-old women, the median residual volume was 19 ml, and 95% of women had a post void residual volume of less than 100 ml (83). The ICS Urodynamics Committee has recently published its Good Urodynamic Practice recommendations regarding PVR measurement suggesting that for clinical practice a PVR <30 ml can be considered insignificant, while residual volumes persistently >50 ml could be regarded as important. They also suggested that large PVR (>200–300 ml) often indicates LUTD, acknowledging however that no level of residual urine, of itself, mandates invasive therapy and no PVR threshold is yet established for decision-making (87).

Ultrasound measurement of bladder wall thickness (BWT) and ultrasound estimated bladder weight (UEBW). Ultrasound measurement of BWT was first proposed as a non-invasive method for diagnosing infravesical obstruction in children (93). More recently, BWT has been used to predict the outcome of children with primary nocturnal enuresis (93-95). BWT has also been proposed as a risk factor for upper urinary tract deterioration in children with myelodysplasia (96). Measurement of BWT was also proposed to diagnose bladder dysfunction (detrusor overactivity

and detrusor hypocontractility versus normal detrusor function) in children with urinary tract infections (97-98). Additional parameters such as the bladder wall thickness index (length x width x depth of the bladder at full bladder/average BWT) were proposed and a nomogram for the paediatric population provided (99).

In the adult population, higher BWT values have been measured in men than in women. Thickness may certainly differ depending the measurement technique; values of 3.3 +/- 1.1 mm and 3.0 +/- 1.0 mm, respectively were reported by Hackenberg and co-workers (100). Oelke confirmed a significant difference between male and female detrusor thickness (1.4 versus 1.2 mm, respectively) (101). A small increase of detrusor hypertrophy with age has been reported in both genders (99). In men, measurement of bladder wall thickness proved to be the most sensitive parameter (outperforming uroflowmetry) to diagnose BOO in patients suffering LUTS (102-103). These findings were corroborated by the results of more recent ultrasonographic studies by use of automated bladder scanners (104).

Transvaginal ultrasound was first proposed in 1994 for the measurement of BWT in women with bladder volume of less than 20 ml. A significant difference was shown in patients with DO and USI (6.7 +/- 0.6 versus 3.5 +/- 0.6 mm, respectively). Low intraobserver and interobserver variability were measured: 0.02 mm in both with a 95% confidence interval of -0.22 to 0.18 and -0.32 to 0.35 mm, respectively (105). In 1996, Khullar and co-workers showed how ultrasound measurement of BWT is a sensitive method for diagnosing DO in symptomatic women without bladder outlet obstruction with 94% of women with BWT greater than 5 mm having involuntary detrusor contractions on videocystourethrography or ambulatory urodynamics (106). In 2002, the same group showed no overlap in the 95% confidence intervals of BWT between patients with DO and USI in women with storage symptoms, confirming the potential of this parameter for diagnosing DO (107). More recent data on the diagnostic value of transvaginal ultrasound in patients with overactive bladder symptoms confirmed a sensitivity of 90 % and specificity of 78 % for predicting OAB, when a cut off value of 4.78 mm was used (AUC = 0.905) (108). Conversely, a large UK-based cross-sectional test accuracy study found no evidence that BWT had any relationship with DO, regardless of the cut-off point, nor any relationship to symptoms as measured by the ICIQ-OAB; the authors concluded that despite patients' wide acceptability of the method BWT measurement was not sufficiently reliable or reproducible to predict DO (109).

In 2003, a study on ultrasound cystourethrography in women confirmed a significant association between age and intravesical pressure at maximum flow with BWT (110). Researchers have also demonstrated reduction in BWT following urethrolisis in women with bladder outlet obstruction resulting from anti-inconti-

nence surgery (111). Methodological and technical issues in the ultrasound measurement of bladder wall thickness and weight remain open and constitute a major limitation for a more widespread use of these parameters. In 2005 Chalana and co-workers published an early report on automatic measurement of the ultrasound estimated bladder weight from three-dimensional ultrasound. An average value of 42 +/- 6 g was measured in healthy male subjects. A standard deviation of 4 g was seen among measurements performed in the same subject at different bladder volumes (200 to 400 ml) (112). Normative values for UEBW and BWT in healthy female volunteers were calculated by another group by use of an automated bladder scan device showing mean values of 32.23g (SD +/- 4.9) and 1.62 (SD +/- 0.34), respectively (113). Further research in this area is certainly needed and further improvement in the accuracy of automated systems is eagerly awaited.

Although data published in the peer review literature on this subject are quite consistent, two discordant papers were recently published from Australia. Blatt and co-worker showed uniform values of BWT measured using an abdominal approach among men and women with non-neurogenic voiding dysfunction suggesting this parameter cannot be used to diagnose storage or voiding dysfunction; this may reflect the thinning of the bladder wall with increasing bladder volume (114-116). A retrospective study on women undergoing translabial ultrasonography suggests a significant association between BWT and DO although a low diagnostic accuracy was shown for the diagnosis of DO (117), which could be due to translabial ultrasound being a less reliable technique (118).

The association between detrusor hypertrophy and bladder dysfunction (DO and BOO) is a well established fact in Urology. Ultrasound measurement of BWT and UEBW is an interesting alternative approach that may avoid invasive urodynamics in some patients. (119). As, previously mentioned, The reduction in bladder wall thickness has been found after the relief of bladder outlet obstruction (111). The development of automated ultrasound systems for measuring UEBW is instrumental to foster further research in this area, particularly in the management of patients with LUTS (120) and in the evaluation of bladder response to pharmacological treatment (119).

2.2.6 Pelvic Floor Muscles

Ultrasonography can be used to assess pelvic floor muscles and their function. Contraction of the pelvic floor results in displacement of pelvic structures that can easily be imaged on ultrasound (**Figure 7**) such as the cranial lift of the urethra in relation to the symphysis pubis during a maximal squeeze (18, 122) but also the dimensions of the genital hiatus or the posterior ano-rectal angle can serve this purpose (123). Comparison with traditional measurements of pelvic floor muscle strength has been performed (122), and good correlations with palpation and perineometry have been found (124-125). Ultrasonography has

been used to evaluate the effects of pelvic floor muscle training. A higher resting position of the bladder neck and a reduction in the rotational excursion of the urethra during Valsalva manoeuvre have been found with pelvic floor training (126). Another research group has reported that the thickness of pelvic floor muscles increased after training (127). A number of studies have assessed healthy female volunteers to establish normal values (47,127), and one study has specifically compared elite athletes with normal volunteers (128). Measurements of the levator ani muscle, with the use of two-dimensional imaging, has been recently described, and although direct comparisons to three dimensional ultrasonography are lacking, the acquired data were comparable (129). However, one study has compared three-dimensional ultrasound of the levator ani hiatus at rest and during contraction in a number of different groups of women with prolapse, urodynamic stress incontinence and asymptomatic women suggesting that these measurements are not sensitive enough to discriminate between different groups (130).

Almost half of women are unable to perform an optimal contraction of the pelvic floor muscles. Ultrasonography can be used in pelvic floor training to provide women with a visual feedback of their exercise (18,131). In one study, 57% of the women who were not able to perform a proper pelvic floor contraction, were able to do so with the help of visual biofeedback of ultrasonography to observe bladder neck movement (18). This does not appear to produce better outcomes of changes with pelvic floor physiotherapy (132). Another prospective study in women receiving physiotherapist-guided PFMT due to pelvic floor dysfunction, however, did demonstrate that the vast majority of patients would improve muscle contractility after the programme; amongst the non responders ("non-contractors") almost 67% were found to have levator ani defects on transperineal ultrasound (133). The contraction of the pelvic floor muscle just before and during a cough, "the knack", can also be visualised (134). It has been demonstrated that the knack can significantly reduce urethral mobility during a cough.

Direct measurement of the pelvic floor muscles is possible with the use of two and three-dimensional perineal ultrasonography. An alternative technique makes use of a 360 degree rectal probe intravaginally (**Figure 8**) (129). Most studies, however, have used three-dimensional perineal ultrasonography for this purpose (19, 123, 128, 135-136). The thickness of the pelvic floor muscles as well as the hiatal area can be measured. Hiatal dimensions and pelvic floor muscle thickness have been extensively validated and have good test retest and inter observer characteristics (19). There is a learning curve to measurement of the levator ani hiatus needing over ten sets of scans to

perform the measurement. However, measurements of the pubic arch were not accurate suggesting that measurements of levator avulsion may require more training (137).

The pelvic floor muscles were thinner in women with pelvic organ prolapse (17, 129, 138) and with urinary incontinence (139), whereas their genital hiatus was larger (140); interestingly this finding does not produce a significantly reduced maximal voluntary contraction even with pubovisceral muscle defects (141). Well trained women have thicker pelvic floor muscles compared with controls (128), and Chinese women had thinner muscles compared with Caucasian women (136). In nulliparous Chinese women, the anterior/posterior hiatal diameter was significantly increased in women with a higher body mass index (136).

Very recent studies looked at the usefulness of real time trans-abdominal ultrasound scan (TAUS) in assessing pelvic floor muscle strength before and after a structured PFMT; a RCT in 140 incontinent women demonstrated that TAUS was accurate in detecting even minor differences in pelvic floor muscle strength between the PFMT and non-intervention groups and this correlated very well with assessment by digital palpation (142). By using this imaging modality as biofeedback, another research group from Japan established that women with postpartum SUI were less successful in achieving good pelvic floor muscle strength following an intensive PFMT in comparison to their continent counterparts, despite no morphological differences in the LAM between the groups before and after intervention (143).

Pelvic floor biomechanics were investigated with ultrasound using the position of the bladder neck in combination with continuous vaginal pressure measurements (144-145). A novel biosensor was used to measure the force as well as the displacement of the pelvic floor during contraction (146). Another research group has inserted a water filled plastic bag to study the shape of the vagina during contraction (147). Others (148) have assessed elasticity by means of the correlation of the dynamic dimensions of the hiatal circumferences and direct palpation of the muscles. Real time biomechanics of the pelvic floor have been compared between women with and without pelvic organ prolapse with the use of translabial 3D ultrasound and standardised Valsalva effort; significant pelvic organ prolapse was associated with a less compliant levator ani muscle close to its origin from the pubic ramus (median maximum strain 26% vs 32%, respectively, $P=0.03$) (149).

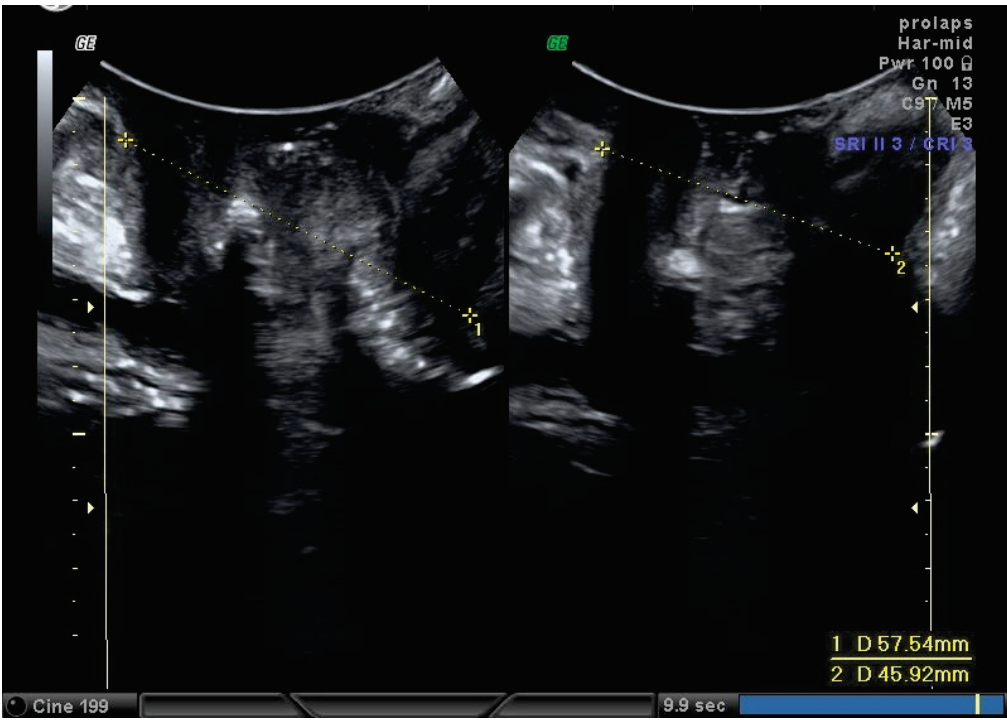

Figure 7 Perineal midsagittal two-dimensional view at rest and on contraction. Levator contraction with ventro-cranial displacement of the urethra. Measurement of minimal dimension of genital hiatus (from symphysis pubis to levator ani muscle)

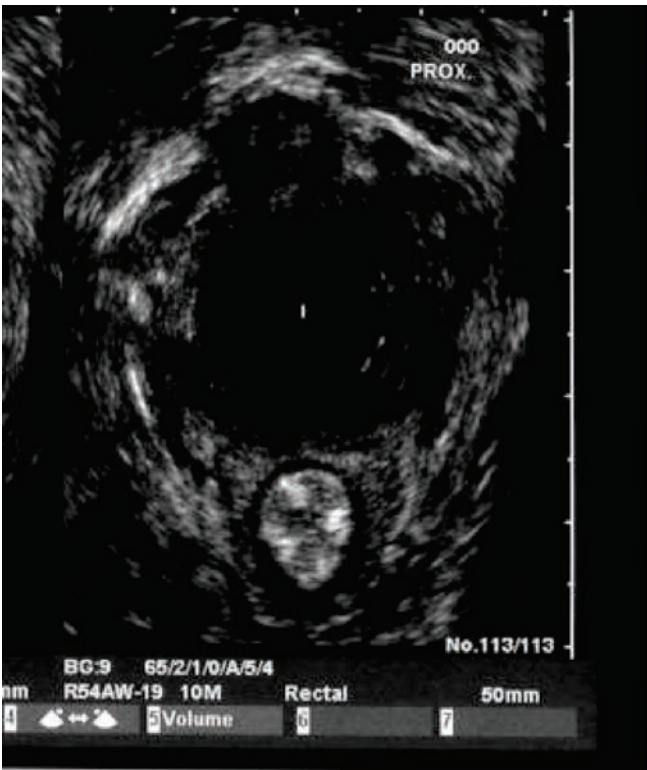

Figure 8 Intravaginal 360 degree ultrasound imaging. Levator ani muscle, urethra and anal sphincter complex.

2.2.6.1 Levator Trauma

Using three dimensional transperineal ultrasound avulsion of the levator ani muscle from the symphysis pubis has been described in up to 36% of parous women (150). The integrity of the attachment of the pelvic floor muscle to the symphysis pubis can be visualised (**Figure 2 and 9a**).

A systematic review of diagnosing pubovisceral avulsions on ultrasound and MRI has been published which showed an association with pelvic organ prolapse and recurrence after surgery. However there was no association between pubovisceral avulsions and urinary symptoms or anorectal dysfunction (151). A recent prospective comparison study in primiparous women found that obstetricanal sphincter injuries (OASIS) do not constitute a risk factor for LAM avulsion (152). This is similar to results from MRI studies, where it has been shown that the risk of pelvic organ prolapse further increases when the levator injury goes together with vaginal architectural distortion (153-154).

Although these defects have recently been identified during labour, it is not known whether there is any reasonable (preventive) treatment for these women (155-156). There is an increase of the occurrence of levator muscle trauma with maternal age at first delivery (157). There was a strong correlation between the presence of levator muscle avulsion and poorer muscle strength (158). It has, however, been shown that the correlation between the clinical assessment (palpation of the muscle) and three-dimensional ultrasonographic assessment of muscular defects was only poor (159), as well as the inter-observer repeatability of the palpation of defects (160). A quantification method for levator muscle defects on ultrasonography (tomographic ultrasound imaging) (**Figure 9a and 9b**) has been described (135). Another parameter, which has been found to be related to the severity of pelvic organ prolapse, was the size of the inner circumference at minimal hiatal dimension of the levator ani muscle on Valsalva manoeuvre (129, 135, 155). The area of the levator hiatus on Valsalva manoeuvre ranges from 6 to 36 cm² in nulliparous women, with an outlier of almost 50 cm² in a young nulliparous athlete (128, 140). An area of more than 30 cm², 35 cm² and 40 cm² on Valsalva manoeuvre has been described as mild, moderate and severe ballooning of the genital hiatus respectively (**Figure 10**) (161). The assessment of the levator hiatus has been shown to be a reproducible measurement (19, 150), whereas the reproducibility was less for muscle diameter measurements (19, 123, 140). Despite the recommendations for adherence to universal protocols in depicting LAM defects, significant variation in the reported prevalence of LAM defects exists in literature; transperineal ultrasonography 13–36%, needle electromyography 30% and MRI 20% (162). Hence direct

comparison between similar studies, which would allow for drawing meaningful conclusions is difficult due to variable patient selection, differences in demographics and most importantly lack of consistency in the definition and classification of LAM injuries. A very recent cadaveric study has questioned the validity of pelvic floor ultrasound in depicting true levator muscle avulsions; whilst 3D introital ultrasound detected complete “avulsion” in 36.7% of the cadavers no detachment of the levator ani muscle from the pelvic side wall was identified in any of the cadaveric dissections with a 0% incidence on both left and right sides. No avulsion was found either upon dissecting an additional thirty-nine cadavers at multiple international centres, raising the hypothesis that what appears to be an “avulsed” LAM on scan most likely represents an imaging artefact due to the inability of the ultrasound to resolve the smaller insertion sites (163).

Comparisons of the hiatal diameters and hiatal area as measured by three-dimensional ultrasonography and MRI revealed good correlations, especially for the measurements at rest. The correlation for hiatal diameter at Valsalva manoeuvre was lower, which is most likely due to the difficulty to reach the correct plane of the levator ani muscle on MRI (164). However, at rest using MRI to alter the angle of acquisition plane has been shown to change the area of the levator hiatus by 10% (165). This has been supported by subsequent papers showing a good inter and intra-observer relationship when measuring the levator hiatus with ultrasound and MRI (166) and even with interdisciplinary readers (167) though the latter group did find only fair agreement when measuring the anorectal angle with ultrasound. The width of the levator ani hiatus on 3D transperineal ultrasound has been found to wider in black women than white women and the urethral sphincter volumes were significantly larger in black women than white women (168).

The presence and clinical relevance of paravaginal defects represent a controversial issue amongst urogynaecologists, and there is a lack of scientific proof for the concept. In a study by Reisinger et al., an echogenic layer in the lower anterior vagina, which was thought to be a part of the endopelvic fascia, could be identified reproducibly in nulliparous and parous women by transrectal three-dimensional ultrasonography (169). According to more recent insights, however, previously described paravaginal defects with loss of the H-shape of the vagina in the axial plane on three-dimensional ultrasonography (158, 170-171) could represent the detachment of the levator ani muscle from the symphysis pubis (172). In a study comparing ultrasound and MRI to assess levator avulsion there was only a moderate correlation with ultrasound showing a higher number of complete avulsions and MRI showing a higher number of partial avulsions (173).

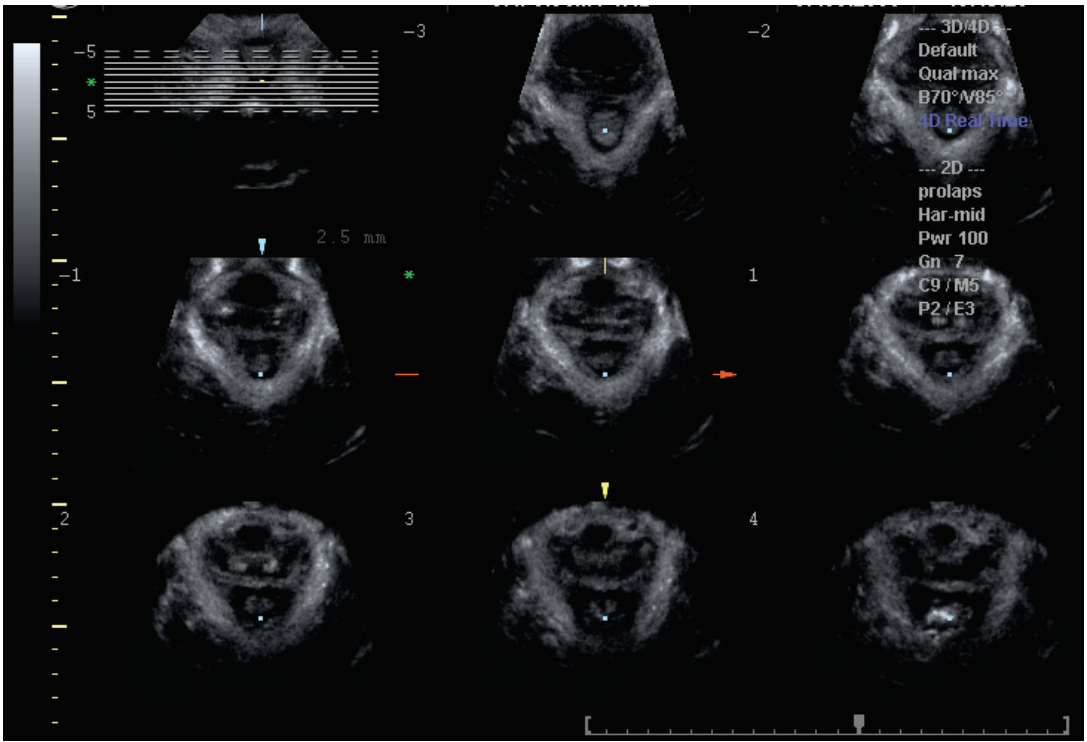

Figure 9a Tomographic ultrasound imaging in oblique axial plane. Normal attachment of the levator ani muscle.

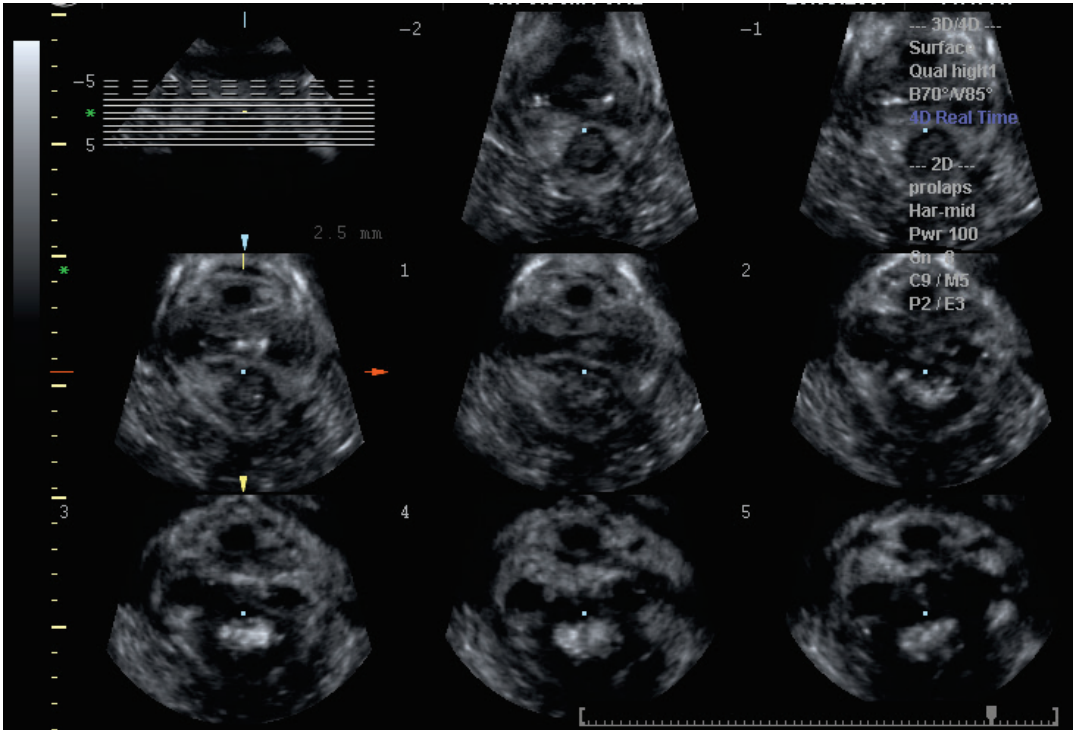

Figure 9b Tomographic ultrasound imaging in oblique axial plane. Bilateral avulsion of the levator ani muscle from the symphysis pubis.

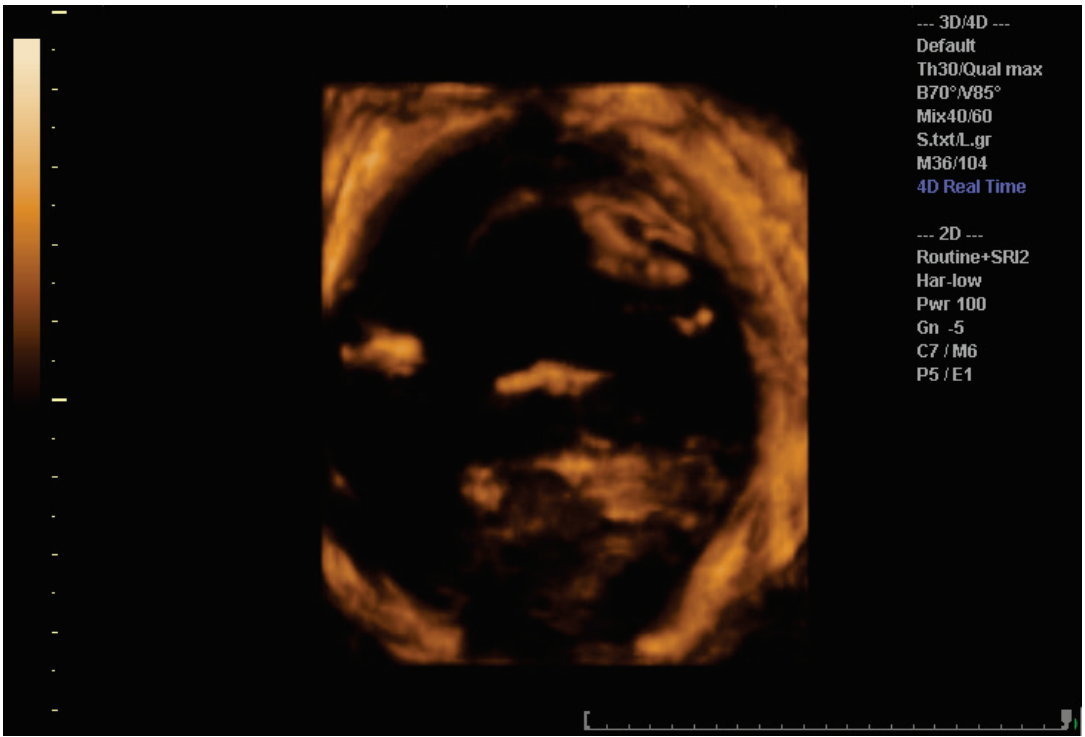

Figure 10 Perineal three-dimensional rendered image. Ballooning of the genital hiatus.

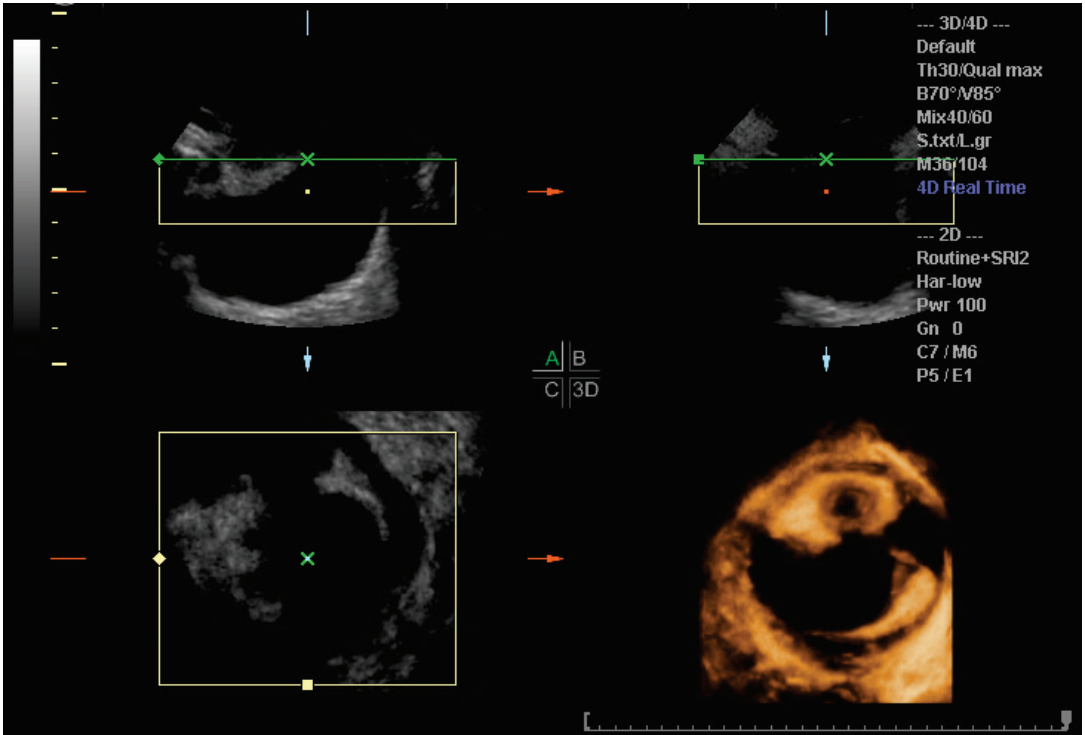

Figure 11 Perineal midsagittal (left upper), coronal (right upper) and axial (left lower) two-dimensional view and three-dimensional rendered image (right lower) . Cystocele.

Vergeldt TF et al confirmed the difference in LAM defects classification between MRI and perineal ultrasound, showing higher grades of LAM damage on US compared with MRI despite the very good agreement in depicting such defects with both imaging modalities (174). In an attempt to increase validity of the levator avulsion diagnosis, a minimum criteria have been set (175), but even with these more stringent rules two out of three normal women were considered false positives, where they were thought to have full avulsions. It is important to note that MRI studies tend to image thinning or aplasia rather than avulsion perhaps indicating that transperineal ultrasound may not have the resolution to visualise very thin levator ani muscles (176). This finding was corroborated in a very recent comparison study by Notten et al, which showed 78% sensitivity and 86% specificity in detecting major levator ani defects with translabial three-dimensional ultrasonography compared with MRI (177).

2.2.7 Pelvic Organ Prolapse

In cases of mild and moderate pelvic organ prolapse, perineal ultrasonography can be used, for the investigation of the prolapse. Ultrasonography should, however, only be used in addition to the patient's history and clinical examination. In cases of severe pelvic organ prolapse, ultrasonographic assessment is not possible due to transducer dislocation by the prolapse. The ultrasonographic imaging of the anterior compartment (i.e. bladder, bladder neck and urethra) is the easiest to perform and the majority of scientific studies deal with this compartment (**Figure 11**).

Correlations with clinical examination (154, 155) are also highest for this compartment. Reproducibility of ultrasonographic imaging of prolapse in the anterior compartment were shown to be good (155). This reproducibility has not been studied for the other two compartments until now.

In two studies amongst 83 and 117 women with the uterus in situ, the uterus could be visualized on perineal ultrasonography in 82% and 97% of cases, respectively (**Figure 12**) (155, 156).

A number of studies have focused on the posterior compartment (157-165). The distinction between enterocele (**Figure 13**) and rectocele (**Figure 14**) is known to be difficult on clinical assessment. In these cases, two-dimensional ultrasonographic imaging in the midsagittal plane can be helpful. The ultrasonographic visualisation of an enterocele has been confirmed with defaecography as well as intraoperative findings (157). It has not been shown, until now, however, whether this extra ultrasonographic investigation leads to superior clinical outcomes of prolapse surgery. Interestingly anterior compartment prolapse is related to levator ani area whereas posterior compartment prolapse is not as well as prolapse symptoms not being associated with levator ani hiatus area (166).

In a study on ultrasonography of the posterior compartment a differentiation between true rectocele, enterocele and perineal hypermobility has been made (160). Intussusception can also be visualised on ultrasonography (167). Perineal hypermobility and an enterocele was seen as descent of the rectovaginal septum or abdominal contents on Valsalva manoeuvre respectively, below a horizontal line through the inferior margin of the symphysis pubis (see below for more information on these measurements). Ultrasonographic staging was significantly correlated with clinical staging and the presence of symptoms of obstructed defaecation (15, 161). In one third of the patients with clinically diagnosed rectocele, however, no ultrasonographic abnormality could be found. As far as interrater reliability was concerned, two expert ultrasonographers have reached moderate to good interrater reliability for the detection of a rectovaginal septum defect, descent of rectal ampulla, and the depth and width of a rectocele (160). In one study, rectocele and perineal hypermobility were present in nulliparous women in 12 and 13% respectively the significance of these findings has not yet been determined (162). The posterior anorectal angle, which is the angle between the anal canal and the posterior rectal wall can be measured at rest and under dynamic circumstances such as straining and squeezing. A number of studies have compared these findings with defaecography and found a generally good correlation (164, 165, 168) but one study found poor inter-rater reliability (146).

2.2.7.1 Quantitative Assessment of Pelvic Organ Prolapse

In the quantitative assessment of prolapse in the various compartments, a reference line, such as the hymen in POP-Q is needed. For ultrasonography, a horizontal line drawn from the inferior margin of the symphysis pubis is the most widely used reference line for this purpose (**Figure 3a**). A disadvantage of this line is that there is only one fixed point through which the reference line can be drawn and the horizontal line may change with the rotation of a handheld transducer.

The effect of rotation is obviously increased with increasing distance from the fixed point, and consequently there is greatest error in the posterior compartment (179). Although this problem has been overcome in research settings with the use of motion tracking systems, at the moment this is not a realistic option for routine use in clinical practice (195). For quantitative assessment of rectoceles, the depths of the rectocele as measured in relation to a line through the anterior anal canal, may be more useful as compared with the descent in relation to the horizontal reference line (196).

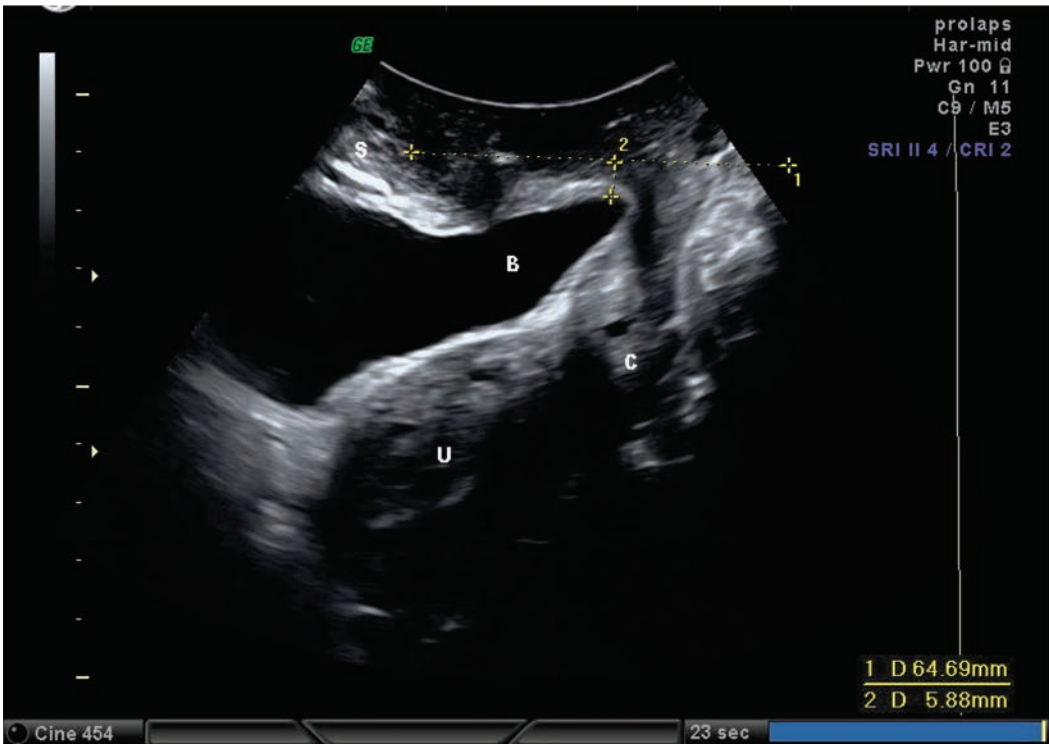

Figure 12 Perineal midsagittal two-dimensional view. Cystocele and descending uterus. (S= symphysis pubis; B= bladder; U= Uterus; C= cervix.)



Figure 13 Perineal midsagittal two-dimensional view and three-dimensional rendered image. Enterocele. (S= symphysis pubis; B= bladder; E= enterocele; R= rectum; A= anal canal.)

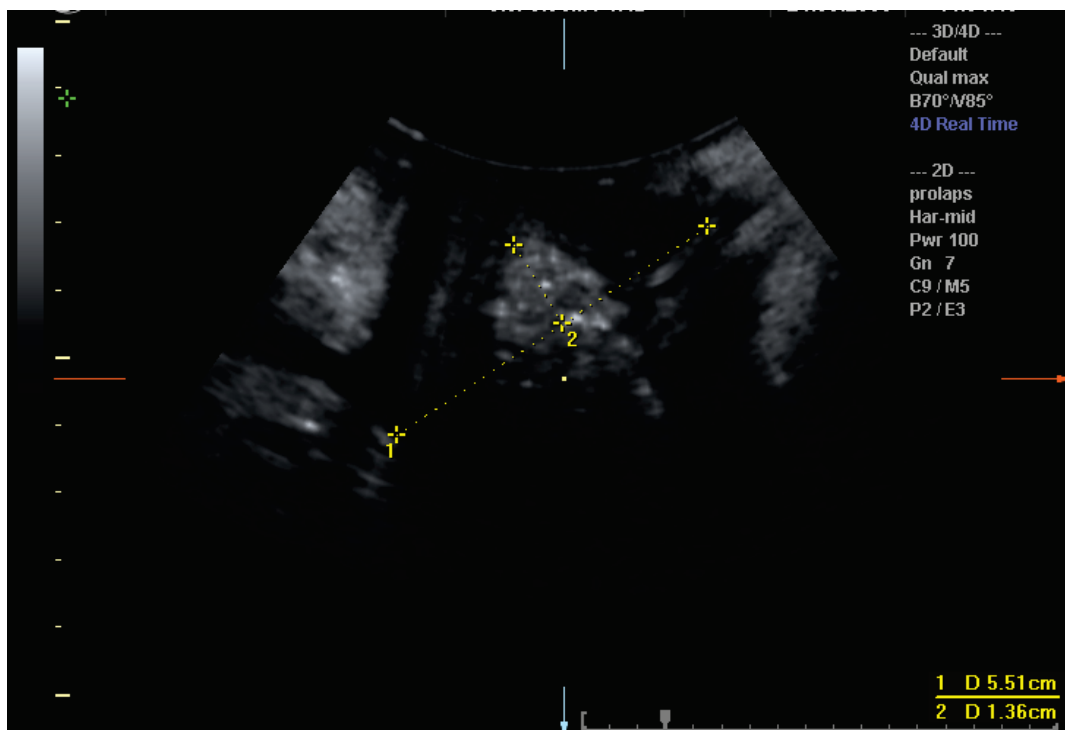

Figure 14 Perineal midsagittal two-dimensional view. Measurement of the depth of the rectocele, perpendicular to a straight line through the anterior border of the anal sphincter complex, i.e. 14 mm.

More recently, Hennemann J et al proposed a new reference line for pelvic floor biometry, which passes between two fixed points on the symphysis pubis and should improve efforts for standardisation of ultrasound measurements of anatomical indices since it has excellent reproducibility, allows for visualisation of markers in all three vaginal compartments and avoids angle errors due to probe movement (197).

Since pelvic organ prolapse can be visualised well with the use of ultrasonography, it raises the question whether this assessment modality is superior to others, such as clinical examination. In a recent study on the relationship between prolapse symptoms and the most dependent point of the prolapse on POP-Q and on ultrasonographic assessment, POP-Q performed better in the prediction of prolapse symptoms with increasing stages of prolapse (196). This finding has been replicated in all compartment underlining the superiority of clinical assessment over ultrasound (180). In a previous study, where only women with a single compartment prolapse were studied, the area under the receiver operating curve was good at 0.86 and 0.82 for the anterior and posterior compartment respectively (198). In both studies the cut-off value for symptomatic prolapse averaged 15 mm below the horizontal reference line through the symphysis pubis. Larger anterior vaginal wall prolapses do have larger levator ani hiatuses and are more likely to have avulsions (69% compared with 35%) (199).

As far as dynamic MRI and X-ray defecography are concerned, there are only a few studies available as

yet, on comparison with ultrasonography. For enterocele detection in women with obstructed defaecation, perineal ultrasonography has been compared with X-ray defaecography, but not with the clinical findings (190). In cases where an enterocele had been detected by either method, an enterocele was detected by both ultrasonography and X-ray in 71% of women. In this study, perineal ultrasonography showed more severe stages of enterocele compared with X-ray defaecography. In another recent study from a different research group, X-ray defaecography has been compared with perineal ultrasonography using a vaginal probe in women with impairment of the posterior pelvic floor. Good to excellent concordance has been found for the assessment of the anorectal angle, rectocele and intussusception. The authors claimed, however, that rectoceles with a depth less than 20 mm could not be detected on ultrasonography (185), which is discordant with most other publications (180-181) on the topic and as well as the authors' experience.

2.2.8 Ultrasonography in Relation to Pregnancy and Delivery

Vaginal delivery is commonly accepted as the major risk factor for the development of pelvic organ prolapse in later life. In nulligravid women, there is a wide variation in pelvic organ descent for all three compartments (146, 182, 200-202). In a study of 169 women who underwent ultrasonography during and after pregnancy, a significant increase in pelvic organ mobility (downwards displacement) was found in all

three compartments (203). The increase in mobility was significantly correlated with the length of second stage of labour and the mode of delivery. The greatest mobility was found in women who underwent an operative vaginal delivery, but no association was found with the gestation at delivery, length of the first stage of labour and birth weight, although birth weight reached borderline significance. In a similar study, focusing on the posterior compartment in 52 nulliparous pregnant women, 8 women developed de novo true rectoceles, and the descent of the rectovaginal septum increased with 22 mm for the entire group, which was statistically significant (204). On the other hand, in a study amongst 207 women, of whom half had a clinically diagnosed rectocele, no relationship was found with vaginal parity and only a weak correlation was found with age for a posterior vaginal wall prolapse as assessed with ultrasonography (186). This suggests that the effect of vaginal parity on pelvic organ descent, is most evident in the anterior and central compartments, and may have another pathophysiology compared with the posterior compartment (203).

Concerning bladder neck descent, it has been shown that the first delivery caused the most marked changes compared with the subsequent deliveries, with the most marked changes resulting from forceps delivery (205). This is supported by two different research groups, who have reported that an increased antenatal ultrasonographic bladder neck descent was associated with normal vaginal delivery (206-207). Furthermore, vaginal delivery was strongly associated with a larger and more distensible antenatal levator hiatus (206). The underlying reason remains hypothetical, but more antenatal laxity of the structures may allow for a smoother delivery. Women with increased bladder neck mobility also have an increased risk of de novo urinary incontinence post partum (21) but the risk can be halved by antenatal pelvic floor exercises (208). Avulsion of the levator ani muscle from the symphysis pubis, as outline above, is typically found in vaginally parous women only (Figure 9b) (150, 209-210). It has, furthermore, been shown that a higher maternal age at first vaginal delivery is strongly related to an increased risk of these avulsions (150, 210). Mode of delivery has a strong association with the incidence of levator ani injury such that vaginal delivery 15.4% are affected, 33.3% after ventouse delivery and 71.4% after a forceps delivery but there were no levator injuries detected in the Caesarean section group (211); similar findings have been reported by other groups (212-215). The timing of the levator ani damage appears to be as the head crowns (216). The levator ani hiatus has been reported as enlarging after vaginal delivery (217-218) and this enlargement being maintained for up to three years later (219) but other groups have not found it enlarged nine months after delivery compared with antenatal measurements. However, forceps delivery did lead to long term enlargement of the levator ani

hiatus (220). The risk of levator ani avulsions increased with enlarged head circumference and prolonged second stage in labour (221).

In a large prospective cohort in nulliparous women, amongst which 15.1% suffered a LAM injury postnatally, the only independent risk factor after multivariate analysis of pelvic floor biometry was a smaller antenatal anteroposterior diameter of the levator hiatus (222). Other researchers have found that a combination of risk factors increase the odds for LAM avulsion injuries in primiparous women who delivered vaginally; women who had sustained a protracted labour, forceps delivery and OASIS had a 75% chance of suffering a complete or incomplete LAM avulsion (223). Fetal head circumference and length of first stage of labour have been suggested as additional risk factors for LAM injury, suggesting that the longer the pelvic floor is subjected to high stretch forces the more likely the occurrence of minor or major LAM defects (224). Conversely, greater levator hiatal dimensions in the third trimester of pregnancy had a significant association with a shorter active second stage of labor and a spontaneous vaginal delivery (225).

Another interesting concept of the relationship between vaginal delivery and LAM injury is the early postnatal ultrasound imaging findings and the subsequent changes. van Delft *et al* observed that all LAM haematomas seen on 3D transvaginal ultrasound as early as 4 days postpartum went on to form complete avulsion injuries 3 months after delivery. Interestingly, further avulsions noted at 3-month scans were not originally seen during the early assessment and, moreover, muscle haematomas, which were further away from the attachment point to the pubic bone did not evolve into avulsions (226). When these women with avulsions were further followed up, however, 1 year after their deliveries, more than 60% of the injuries had resolved (227). Similar findings were reported by an earlier MRI study (228) and recent ultrasound studies demonstrating recovery of the hiatal biometry for a significant proportion of women within 1 year of delivery, although not necessarily to pre-pregnancy (pre-delivery) levels (229-230). Such results have been contradicted by other researchers who demonstrated persistence of sonographically depicted LAM defects, identified in the immediate postpartum period for months or years after delivery (231), again pointing out the huge variation and inconsistency in the classification of pelvic floor injuries and lack of standardisation in reporting those.

2.2.9 Pelvic Floor Surgery

Ultrasonography has been used during anti incontinence surgery with the aim of obtaining optimal results from surgery, for example during Burch colposuspension (232-233). On an individual basis, the bladder neck was lifted between 1 mm and 10 mm. The authors have obtained excellent results with a 94% continence rate after 1 year, but unfortunately no control group was incorporated in the study. Levator ani avulsions have been found to be associated with

persistent vaginal prolapse even after attempted surgical repair (234). Lone and co-authors compared 2D transperineal ultrasound - assisted ad hoc by additional 3D endovaginal ultrasound - with clinical examination for pelvic floor disorders and found that TPUS enhanced the differential diagnosis in the anterior compartment by distinguishing vaginal cysts and urethral diverticulae from pelvic organ prolapse (235). Perhaps the pre-operative value of TPUS is even greater when it comes to defects in the posterior compartment; improvement in diagnosis of enterocele with multi-compartmental pelvic floor scan, missed on clinical examination was demonstrated by use of TPUS of the pelvic floor. Diagnosis of enterocele and intussusception was further enhanced following primary surgical correction of the prominent prolapse in any of the vaginal compartments (235).

2.2.9.1 Slings and Meshes

Monofilament meshes, for example polypropylene meshes, are easier to visualise on ultrasonography compared with multifilament meshes, such as IVS (236). Ultrasonography has been widely used to localise the exact position of tension free midurethral tapes (Figure 15) (206, 237-242). The tape is generally easily visible as an hyperechogenic structure under the urethra and is easy to recognise, which contrasts with the poor images of polypropylene on MRI (243). Exact midurethral position of the tape is not essential for proper function (244). Despite the fact that the tape was located in the midurethra in only two-third of cases, this had no relation to postoperative continence status (245). A more recent ultrasound study, however, has challenged these findings, demonstrating a higher recurrence stress incontinence rate in cases where the suburethral sling was placed at the bladder neck in comparison to placement of the tape at the proximal and middle urethra (241). During Valsalva manoeuvre, the tape moves in a semicircle movement around the inferior margin of the symphysis pubis (246). This results in a position closer to the symphysis, which consequently leads to a certain degree of mechanical compression during Valsalva manoeuvre. Another mechanism of action is kinking of the urethra around the tape (247). A number of studies have looked at transobturator tape and compared these with retropubic tapes (236, 242, 248-251). Two studies could not detect any differences between the two types of tape (236, 242, 251), whereas in the other two studies (248,250), subtle differences with no apparent clinical consequences were found.

Imaging both tension-free and transobturator tape procedures during straining show a reduction in the diameter of the hypoechoic urethral core and the di-

ameter became significantly smaller only in the successful procedures (252) and a reduction in the symphysis pubis to tape distance led to continence (253). Other authors have suggested optimal positions of the tape being between the distal third and middle of the urethra with a tape-urethral distance of 2mm, greater than 3.9mm distance led to failure of the procedure. The tape to urethral distance can be reliably assessed using 4D ultrasound (254). Midurethral tapes impinging on the urethra has been reported as being associated with voiding difficulty and the "V" shape of the tape was the same regardless of the insertion method (ie TOT compared to TVT) (255). Tunitsky-Bitton et al. found that the RP sling angle was significantly more acute than the angles of the TOT and TVT-O slings on 3D pelvic floor ultrasound, however no difference was noted between the 2 transobturator slings (242). Tapes sited around the midurethra resulted in a reduction in flow rate compared with a distal tape position under the urethra which did not change flow rates (256) and this positional information has been used to determine the management of de novo symptoms after surgery (257). Muati and Shobeiri have proposed the use of 3D pelvic floor ultrasonography intraoperatively for releasing the mid-urethral part of a sling to overcome voiding dysfunction (258).

The bladder neck is displaced during insertion of a midurethral by using a rigid guide during insertion of a tension-free vaginal tape. Ultrasound has been used to determine that the bladder neck is moved by 1.4cm by this technique (259).

Recently, ultrasonographic localisation of polypropylene mesh as used in prolapse surgery has been described (Figure 16 and 17) (260). These meshes are usually easily visible on ultrasonography. It appears that the ultrasonographic appearance of the mesh is significantly shorter and narrower than the size at implantation within six weeks of the procedure (261). It is unclear whether this is due to shrinkage of the mesh or represents difficulties in visualising the full extent of the implanted mesh. The failure of mesh to support vaginal prolapse was associated with mesh shrinkage (262-263).

The differentiation between recurrent herniation and the detachment of the mesh arms from the pelvic sidewall for example, will aid in the better understanding of the mode of action of these meshes (264).

2.2.9.2 Bulking Agents / Injectables

Periurethral bulking agents/injectables, such as microparticulate silicone (Macropastique), various gels (e.g. Durasphere, and collagen) can be visualised by imaging techniques. For MRI, an overview of appearances of periurethral bulking agents is already available (265).

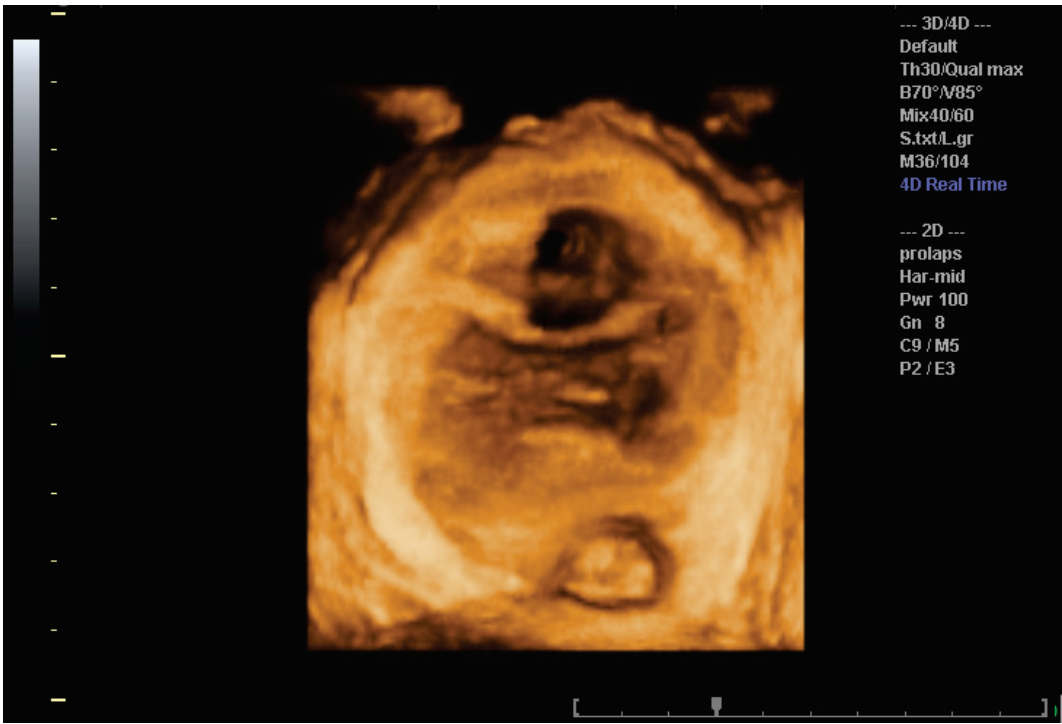

Figure 15 Perineal three-dimensional rendered image. Polypropylene mesh (TVT-O) after one-sided incision of the tape.

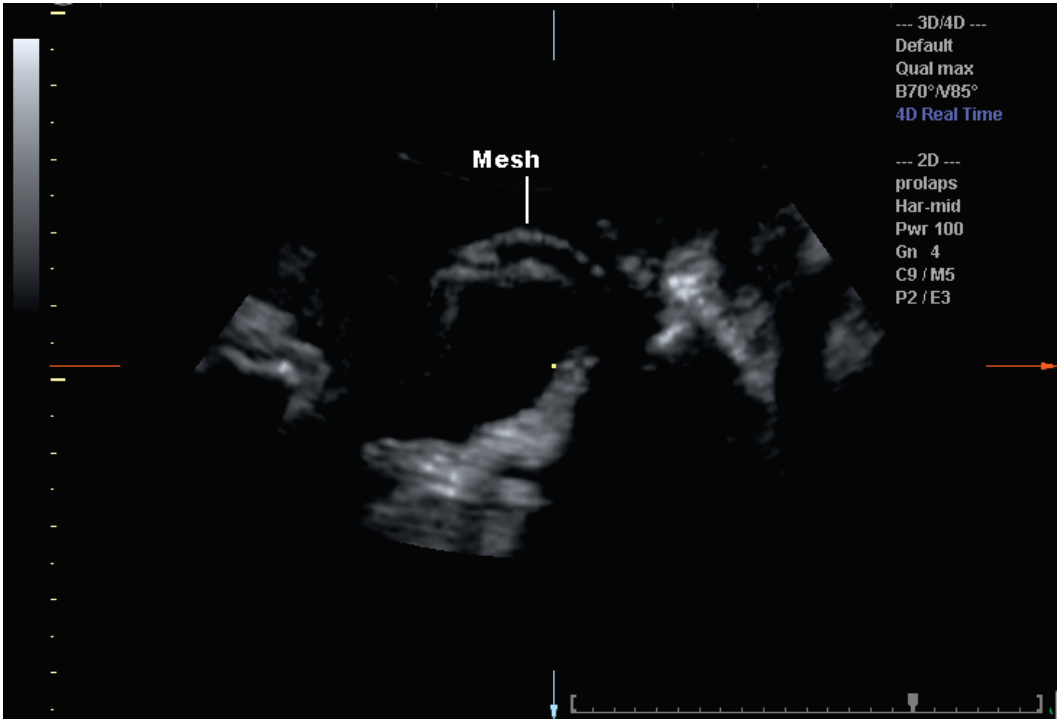

Figure 16 Perineal midsagittal two-dimensional view. Polypropylene mesh of the anterior vaginal wall (Prolift anterior).

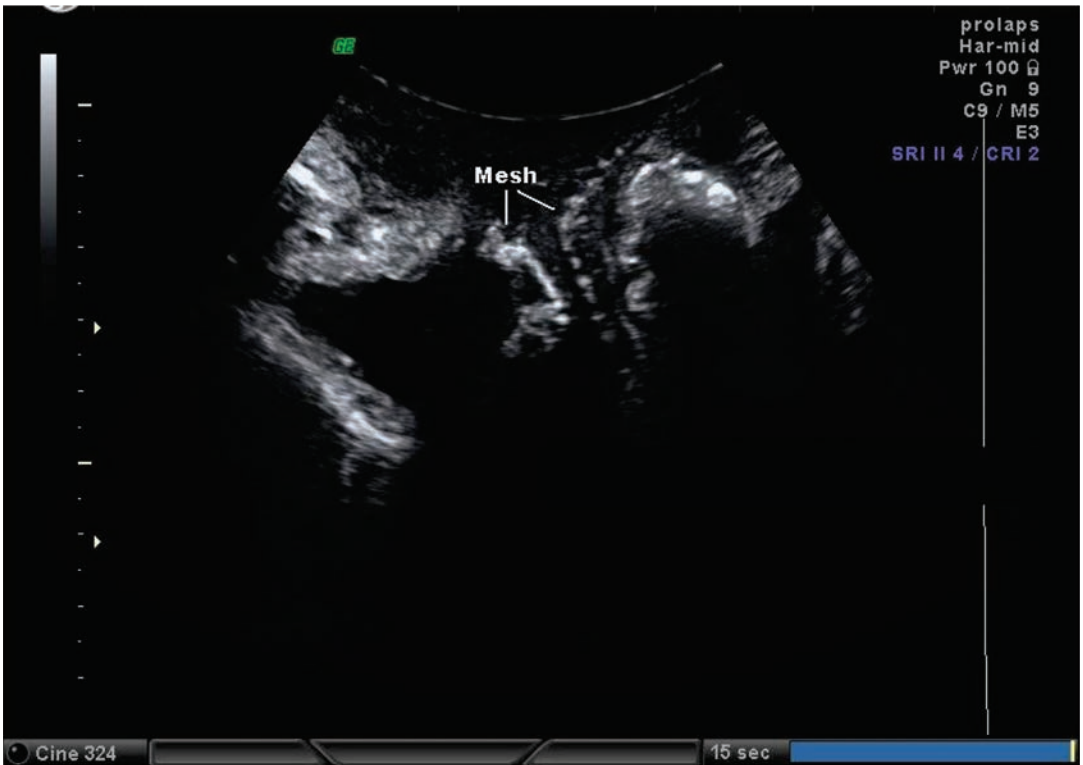

Figure 17 Perineal midsagittal two-dimensional view. Polypropylene mesh of the anterior and posterior vaginal wall (Prolift).

On ultrasonography, the injectables appear hypoechoic after injection, and become more hyperechoic over time due to dehydrogenation. Good intra-observer variability of repeated measurements of periurethral collagen volumes have been found (266).

The location in relation to the bladder neck and a circumferential distribution of collagen injectables around the urethra, as well as the height and volumes of the injected periurethral collagen bumps, were associated with the treatment success of periurethral bulking agents (266-268). Using an endovaginal probe Elia and Bergman found that optimal location of collagen implant was less than 7 mm from the bladder neck (268). It appears that optimal periurethral collagen location is a circumferential distribution around the urethra, while an asymmetric distribution is associated with a significantly smaller improvement in incontinence symptoms (267). A recent prospective study by Hegde et al confirmed these findings demonstrating that best short outcomes occur with a combination of circumferentially distributed and proximally located Macropastique (269). Although the volume range was wide, a collagen volume of 2.8 cc on three dimensional ultrasonography has been assessed as optimum volume from a continence point of view. Poon et al. have published a decision tree, in which a combination of the patients' symptoms after collagen injection and the configuration and volume of the periurethral collagen on three-dimensional ultrasonography, assist in the decision for further

treatment of women with intrinsic sphincter deficiency (266). In this algorithm, women with asymmetric deposition and/or low collagen volumes were offered further treatment with injectables as this is associated with failure (270).

Ultrasonography has not only been used for follow-up, but also during placement of periurethral injections. Transurethral ultrasonography-guided injection of autologous stem cells has been used in women and men with stress urinary incontinence. The technique allowed precise injection of the myoblasts directly into the rhabdosphincter and was more effective in the resolution of incontinence compared with urethroscopic guided collagen injectables in the submucosa in a randomized controlled trial (271-272). The use of stem cells in the management of urinary incontinence is of great interest although the subject remains controversial and confirmatory studies are eagerly awaited.

2.2.10 Conclusions

Research in US imaging of the pelvic floor has flourished over the last decade although the clinical benefit of it remains uncertain. Standardisation of imaging techniques and terminology are eagerly awaited. Imaging of pelvic floor muscle in relation to POP is a promising area because of the possible insight into the pathophysiology of the condition and treatment outcome. Research suffers from a lack of coordination among different research groups and a more

structured approach to research on imaging of UI and POP is advisable

2.2.11 Consensus statement

- Ultrasound is not recommended in the primary evaluation of patients with urinary incontinence and/or pelvic organ prolapse (rectal prolapse is dealt with in a different section). **(Level of evidence 3, Grade of recommendation C)**
- Ultrasound is an optional test in the evaluation of patients with complex or recurrent urinary incontinence and/or pelvic organ prolapse. **(Level of evidence 3, Grade of recommendation C)**
- Ultrasound is recommended for measuring post-void residual and assessing pelvic floor muscle training **(Level of evidence 2, Grade of recommendation B)**

2.2.12 Future research areas

- Standardisation of terminology of pelvic floor US imaging
- Internal and external validity of techniques of pelvic floor imaging
- Confirmatory studies to validate previously published evidence on imaging of UI and POP
- Accuracy of US diagnosis of levator ani injury
- Prognostic value of preoperative US imaging and outcome of POP surgery
- Health technology assessment of pelvic floor imaging in the management of UI and POP.

2.3. MRI (The evolving role of MRI in the assessment of the female pelvic floor).

2.3.1 Introduction

The role of magnetic resonance imaging (MRI) in evaluating pelvic floor disorders has been established in recent years and continues to evolve. This technique provides unparalleled images of pelvic floor muscles, connective tissue, and organs. In addition to the detailed static picture of the pelvic organ support system anatomy, MR can also reveal the downward movement of each pelvic compartment during increases in abdominal pressure. Advances in MR imaging, equipment and software have significantly improved image quality and now MRI provides ever more detailed pictures of anatomy and function. At present active investigation is ongoing to see how this imaging might result in a better understanding of these diseases and improve their diagnosis and management.

Although women might present with symptoms isolated to one of the pelvic compartments, they often have concomitant defects in other compartments or pelvic structures. In these women, imaging can

provide information to extend what can be determined on physical examination (1). Furthermore, surgical failures could result from lack of a thorough preoperative evaluation of the female pelvis and inadequate diagnosis and staging of pelvic floor deformation and dysfunction (2). Accurate diagnosis of coexisting abnormalities is therefore essential in planning reconstructive and anti-incontinence procedures. Although most diagnoses of pelvic floor prolapse are made on detailed physical exam, the sensitivity and specificity of the pelvic exam in diagnosing various forms of pelvic floor prolapse is low(3)(4)(5). Ultrasound and fluoroscopy have been used to improve diagnosis (6)(7) and the role of MRI in pelvic floor dysfunction is rapidly developing. A systematic review suggests that prolapse assessment on dynamic MR imaging may be useful in the posterior compartment, although clinical assessment and dynamic MR imaging seem interchangeable in the anterior and central compartment (8).

MRI provides detailed images of bladder neck and urethral mobility, rectocele, cystocele, enterocele and uterine prolapse, in a single non-invasive study without exposing the patient to ionizing radiation (9)(10)(11)(12)(13)(14)(15)(16)(17)(18). MRI also provides a multiplanar thorough evaluation of pelvic organs including the uterus, ovaries, ureters, kidneys, and levator muscles, as well as the urethra, that is unavailable by any other imaging modality (11)(13)(14)(15)(16)(17)(19)(20). MRI can identify ureteral obstruction, hydronephrosis, and uterine and ovarian pathology. In addition, MRI remains the study of choice for the evaluation of urethral diverticula.

The following measurements using MRI in urogynecology and female urology have been highlighted in the IUGA/ICS Joint Report on the Terminology for Female Pelvic Floor Dysfunction (21):

- Bladder neck and cervical descent/mobility:
 - Position of bladder neck and cervix at rest and on Valsalva.
 - Pubo-coccygeal line: A line extending from the inferior border of the pubic symphysis to the last joint of the coccyx. Bladder neck or cervical descent >2 cm below this line with straining indicates weakness of the pelvic floor. If alternative landmarks are used in scientific papers they should be clearly described.
- Intercurrent pelvic pathology: For example, fibroids, ovarian pathology.
- Uterine version: Anteverted or retroverted; flexion at the isthmus.
- Bladder abnormalities: For example, tumor; foreign body.
- Urethral abnormality: For example, diverticulum.

- Postoperative findings: For example, bladder neck mobility.
- Pelvic floor measurements/levator defects: Assessment of the configuration of pelvic floor muscles, in particular, the levator ani.
- Descent of pelvic organs.

2.3.2 Technique

2.3.2.1 Conventional MRI

Standard MRI consists of two dimensional image acquisitions. Usually conventional T1 images and spin echo T2 weighted images are obtained. Proton density T2 weighted scans provide excellent soft-tissue definition (Figure 18). However, the long imaging time of conventional MRI hampers its ability to evaluate the movement of organs that are characteristic of POP.

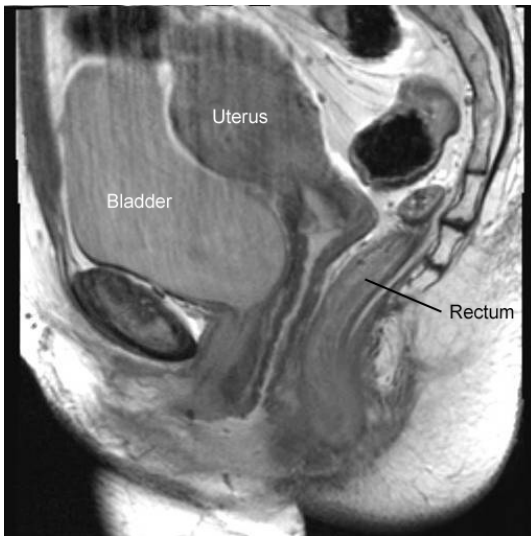

Figure 18: Sagittal mid pelvic section showing anatomical detail visible in static images made with Proton Density sequence.

2.3.2.2 Ultra Fast Image Acquisition and MR Sequences

Pelvic organ movement during Valsalva is identifiable using very fast single-shot MR sequences and the technical aspects have been summarized in a previous report (Figure 19) (ICI 2009). (15)(16)(22)(23). These sequential images are obtained approximately once per second, either as a series of images covering the entire pelvis (static imaging) or repetitively in one plane while the patient is straining (dynamic imaging). The patients are placed in the supine position with legs slightly spread apart, and knees bent and supported by a pillow.

Most pelvic floor details can be seen without the need for bowel preparation, premedication, instrumentation or contrast medium but often, especially with MR defecography, ultrasound gel or other suitable agents are used to enhance visibility of the rectum and vagina. The MRI torso coil is centered at the symphysis pubis. Images are acquired in the sagittal plane using single-shot fast spin echo (SSFSE) or half Fourier acquisition, single shot turbo spin echo (HASTE) sequences. Single, mid sagittal views are obtained during 3 seconds of apnea with the patient relaxed and during various degrees of progressive abdominal straining.

Steady-state free precession gradient-echo imaging provides an alternative T2-like imaging contrast (T2- and T1-weighted imaging) with robust signal and a rapid acquisition time of less than 1 second, thereby permitting near real-time continuous imaging. This is an improvement on the HASTE approach that requires 1–2 seconds between acquisitions to allow T1 recovery; therefore, real-time imaging is not possible. Comparisons of the degree of POP shown on dynamic true fast imaging with steady-state precession (FISP) versus HASTE sequences in symptomatic patients reveal a greater degree of prolapse in all three compartments with a dynamic true FISP sequence. Near real-time continuous imaging with a dynamic true FISP sequence may therefore be useful to evaluate pelvic floor dysfunction in addition to dynamic multiplanar HASTE sequences (24).

During a typical study of pelvic organ movement two sets of images are obtained. The first set consists of static sagittal and para-sagittal images covering the pelvis from left to right sidewall. These images are used to select the mid-sagittal plane for the dynamic second set of images. This static sequence also allows for anatomic delineation of the pelvic sidewalls and muscular and fascial components of the pelvic floor (15)(16)(22)(23). The perineal membrane and the levator ani musculature, as well as the anal sphincter anatomy, are also clearly demonstrated(25)(26). The static set consists of 17-20 sequential images independently acquired in a total of about 18 seconds.

The second set of images consists of relaxed and straining mid-sagittal images used to assess the degree of pelvic floor relaxation and organ prolapse. Images can then be looped for viewing on a digital station as a cine stack.

Dynamic MRI allows detection of POP that may not be evident on conventional static sequences, as it permits both structural and functional evaluation. For example, in women with lower urinary tract symptoms, evaluation of the urethra may be of added value.(27)

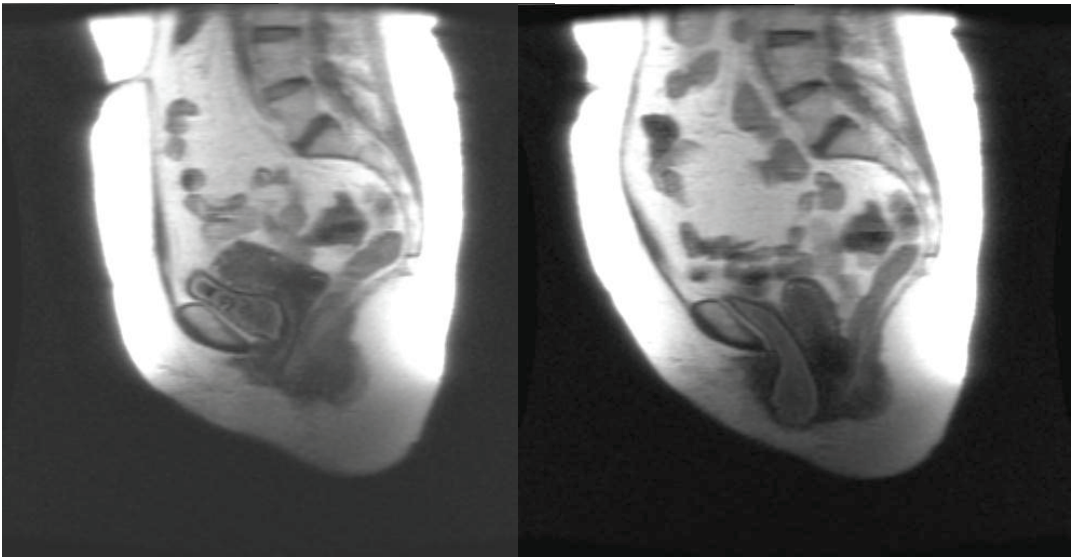

Figure 19: The rest and strain image taken from a mid-sagittal dynamic MR sequence revealing cystocele and uterine descent using SSFSE sequence.

The first time a woman performs a Valsalva maneuver, she may not get the prolapse to protrude to its maximal extent. Forty per cent of women have a greater than 2cm increase in prolapse size from their first to third Valsalva attempt and 95% of women extend their prolapse further with a third Valsalva(28). As with clinical examination, several attempts may therefore be required to have maximal anterior compartment prolapse present during dynamic MRI of the pelvic floor. Delaney et al evaluated whether the use of a speculum blade modifies the evaluation of pelvic organ prolapse (POP) as assessed by dynamic MRI. Twenty-seven women with POP Quantification (POPQ) stage II or greater, scheduled for POP surgery, were evaluated using MRI. The procedure was repeated using the posterior blade of a standard plastic Grave's speculum to successively retract the anterior and posterior vaginal walls. Standard POPQ was 15% stage II (n=4), 59% stage III (n=16) and 26% stage IV (n=7). The use of a blade evidenced hidden pelvic prolapsed compartments in 59% (n=16) of cases. For 48% of patients (n=13), the variation of the leading edge of at least one additional prolapsed compartment was diagnosed as more than 20 mm. In this series, the use of a speculum blade during dynamic MRI modified the POP evaluation in a large proportion of patients with POP stage > or =II (29).

More recently, open magnetic resonance imaging (MRO) with vertical magnets, has allowed imaging in a variety of upright postures. A pilot study compared distances between the lowest point of the bladder to the pubococcygeal (PC) and pubopromontoreal (PP) lines as well as the ratio of bladder area under the PC and PP lines to the total bladder area. Significant elongation between the PC line and lowest point of the bladder was evident in women with POP comparing supine and standing images ($p = 0.03$),

but not controls ($p = 0.07$). Similarly, this axis was significantly longer in women with cystocele versus controls only in the standing position. Bladder area under the PC line was significantly increased between supine and standing positions only among women with cystocele ($p < 0.01$), and significantly larger among the study group in the standing position ($p < 0.005$), less significant in the supine position ($p = 0.015$), and not significant in the sitting position ($p = 0.3$)(30).

2.3.2.3 Three Dimensional MRI

Three dimensional (3-D) MRI provides precise detail of the bony and muscular pelvic structures (**Figure 20**) so that 3D models can be constructed based on these detailed images. In this technique, static or dynamic images are reconstructed using consecutive planes in the axial, sagittal and coronal dimensions. Anatomic variations of the insertion and path of the pubococcygeus and iliococcygeus muscles can be seen. Fielding et al. made 3D models of the pelvic viscera and supporting muscles and bones with the marching-cubes algorithm and a surface-rendering method in nulliparous continent female volunteers and found that the muscle morphology, signal intensity and volume are relatively uniform (25). They described an average volume of the levator ani of 46.6 cc, width of the levator hiatus of 41.7 mm and an average posterior urethrovesical angle of 143.5°. In addition, these 3D models made from multi-slice scans during a maximal Valsalva have allowed direct measurements of changes in the relationship between the vagina and pelvic walls.



Figure 20: Pelvic Organs as seen from caudal on a three-dimensional reconstruction from Magnetic resonance images. Copyright Mosby Inc.

3D MRI enables evaluation of paravaginal defects, apical descent and vaginal widening. Larson et al (31) studied the relative contributions of "midline defects" (widening of the vagina) and "paravaginal defects" (separation of the lateral vagina from the pelvic sidewall) in women with anterior prolapse using 3D MRI models of the anterior vaginal wall and found that changes in lateral anterior vaginal wall were considerably greater than changes in vaginal width in cases vs controls. These "paravaginal defects" were also highly correlated with apical descent.

The geometry of the arcus tendineus fascia pelvis (ATFP) and arcus tendineus levator ani (ATLA) in women with unilateral levator ani muscle defects and associated "architectural distortion" has been studied using 3D MRI. In those women, the ventral arcus anatomy is significantly altered in the presence of levator defects as well as architectural distortion, resulting in change of the supportive force direction along the lateral anterior vaginal wall, thus increasing the risk for anterior vaginal wall prolapse. (32)

Luo et al (33) developed a method to evaluate changes in apical ligament lengths and lines of action from rest to maximal Valsalva using 3D stress magnetic resonance imaging (MRI). In a case-control study, 3D reconstructions of the uterus and vagina, cardinal ligament (CL), deep uterosacral ligament (USL(d)), and pelvic bones were created using 3D Slicer software. At maximal Valsalva, CL elongation was greater in cases than controls, whereas USL(d) was not; CL also exhibited greater changes in ligament length, and USL(d) exhibited greater changes in ligament inclination angle.

Following studies that reported diffusion tensor imaging (DTI) as a method for detecting alterations in tissue organization of injured striated skeletal muscles, the clinical application of DTI and fibre tractography in pelvic floor imaging was assessed by Zijta et al. (34) A two-dimensional (2D) spin-echo (SE)

echo-planar imaging (EPI) sequence of the pelvic floor was acquired. Offline fibre tractography and morphological analysis of pelvic magnetic resonance imaging (MRI) were performed. Inter-rater agreement for quality assessment of fibre tracking results was evaluated. DTI with fibre tractography seems to enable 3D visualisation and quantification of elements of the female pelvic floor.

2.3.3 Normal Pelvic Floor Functional Anatomy

2.3.3.1 MR Imaging of Normal Pelvic Support Structures

MRI studies of normal subjects have improved our understanding of normal pelvic anatomy, its variations (25)(26)(35) as well as anatomic changes in pelvic floor dysfunction (20)(36)(37).

In the supine position the female pelvic floor is dome shaped at rest (37)(38). During voluntary pelvic floor contractions the levator musculature straightens and becomes more horizontal. With bearing down the muscle descends, the pelvic floor becomes basin-shaped, and the width of the genital hiatus widens.

With MRI the specific structures are identified and their normal variations described (Figure 21). Tan (36) demonstrated the anatomy of the female pelvic floor with MRI. The pelvic and the urogenital diaphragm were well depicted as were urethral supporting structures—the peri-urethral and paraurethral ligaments, and the zonal anatomy of the urethra. The MRI findings in volunteers correlated with the endovaginal MR findings and gross anatomy in cadavers. Chou (39) studied the urethral support structures relative to the arcuate pubic ligament including the arcus tendineus fasciae pelvis, the perineal membrane, the pubococcygeal levator ani muscle and its vaginal and bony attachments, and the pubovesical muscle. Tunn et al (40) showed that 2- to 3-fold differences occur in distance, area, or volume measures of continence system morphologic features in continent nulliparous women with normal pelvic organ support and urodynamics. The uterosacral ligaments also exhibit greater anatomic variation than their name would imply (41). Three dimensional simplified biomechanical models constructed from MRI scans showed that the CL is parallel to the body axis. The US ligament is dorsally directed. The tensions on these ligaments seem to be affected by their orientations according to this study (42).

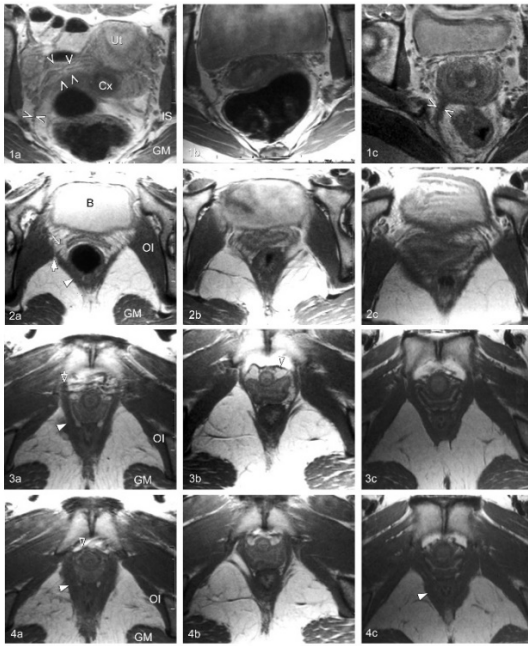

Figure 21: Axial images according to age, in 22-year-old (A, D, G, and J), 24-year-old (B, E, H, and K), and 34-year-old (C, F, I, and L) nulliparous women without urogynecologic problems. A-C, Level of cervix (Cx) and ischial spine (IS); uterus (Ut) with bright endometrium is also seen. Paracolpium and parametrium suspend (open tips) vagina and cervix from lateral and posterior pelvic sidewall. Smooth muscle of uterosacral ligament (open tips) is best seen in C. GM, Gluteus maximus muscle. D-F, Level of bladder (B) base. Upper vagina between bladder and rectum (R) and its attachment to pelvic sidewall by vascular and connective tissue mesentery (small arrow) are seen. Levator ani muscle (iliococcygeal part, filled arrowhead) arises from arcus tendineus of levator ani muscle (filled arrow). Ol, Obturator internus muscle. G-I, At level of proximal urethra, levator ani muscle (pubovisceralis part, filled arrowhead) arises from pubic bone (open arrow). Pubovesicalis muscle (open arrowhead) is clearly seen in H. Vessels (white gap) are visualised between smooth muscle layer of lateral vaginal wall and levator ani muscle at this level. J-L, At level of middle urethra, pubovesicalis muscle is seen as shown in J (open arrowhead). Vessel layer (white gap) between lateral vaginal wall and levator ani muscle (filled arrowhead) has disappeared; direct connection between vagina and levator ani muscle is seen at this level. Small white gap in levator ani suggests fascia between puborectalis and pubococcygeal muscles (especially in J and L). (123)

Characteristic anatomic features of the posterior compartment and perineal body have been studied with MR cross-sectional anatomy and can be further elucidated and integrated with 3-D anatomy. In nulliparous asymptomatic women the posterior compartment's upper, mid, and lower segments are best visualized in MRI in the axial plane. It is bounded

inferiorly by the perineal body, ventrally by the posterior vaginal wall, and dorsally by the levator ani muscles and coccyx. In the upper portion, the compartment is bordered laterally by the uterosacral ligaments, whereas in the middle portion, there is more direct contact with the lateral levator ani muscles. In the lower portion, the contact becomes obliterated because the vagina and levator ani muscles become fused to each another and to the perineal body (43)(figure 22). The perineal body anatomy has been possible to study using 2mm MR images. Visualisation of perineal body anatomy in living women and development of 3-D models enhanced our understanding of its 3 different regions: superficial, mid, and deep (44). The three distinct perineal body regions are (1) a superficial region at the level of the vestibular bulb, (2) a midregion at the proximal end of the superficial transverse perineal muscle, and (3) a deep region at the level of the midurethra and puborectalis muscle. Structures are best visualised on axial scans, whereas craniocaudal relationships are appreciated on sagittal scans. In the superficial portion at the level of the vestibular bulb (VB), the bulbospongiosus (BS) inserts into the lateral margins of the perineal body, whereas the superficial transverse perineal muscle (STP) and external anal sphincter (EAS) traverse the region. In the perineal body's midregion at the proximal end of the superficial transverse perineal muscle, the puboperinealis muscle inserts into the lateral margins of the perineal body and in some individuals can be seen to cross the midline. This region also contains the distal internal anal sphincter. The puboanalis muscle is also visible as it inserts in the intersphincteric groove between internal and external anal sphincters. The puboanalis muscle and internal anal sphincter extend into the perineal body's most deep region at the level of the midurethra. Here the pubovaginalis muscle also becomes visible as it fuses with the vaginal side wall, sending fibres posteriorly to the perineal body. In this location, the longitudinal muscle of the rectum may be visible in the midline. The puborectalis muscle forms a loop behind the rectum at this level but does not contribute fibers to the perineal body. (Figures 23&24)

One of the key anatomical contributions MRI has made to the understanding of normal pelvic floor structure, regards the ability to make images of a wide variety of normal living women. The pelvic floor is greatly distorted in cadavers due to loss of muscle tone and pressures during embalming. Otcenasek et al have used MR images of a normal nulliparous woman to establish geometry and then added details from dissection to produce an anatomically based topographically normal 3-D model that displays the features of pelvic floor anatomy (Figure 25) (45).

Nardos et al (46) compared levator hiatus measurements between pelvic magnetic resonance imaging (MRI) and 3-dimensional pelvic ultrasound (US) in 37 asymptomatic nulliparous women.

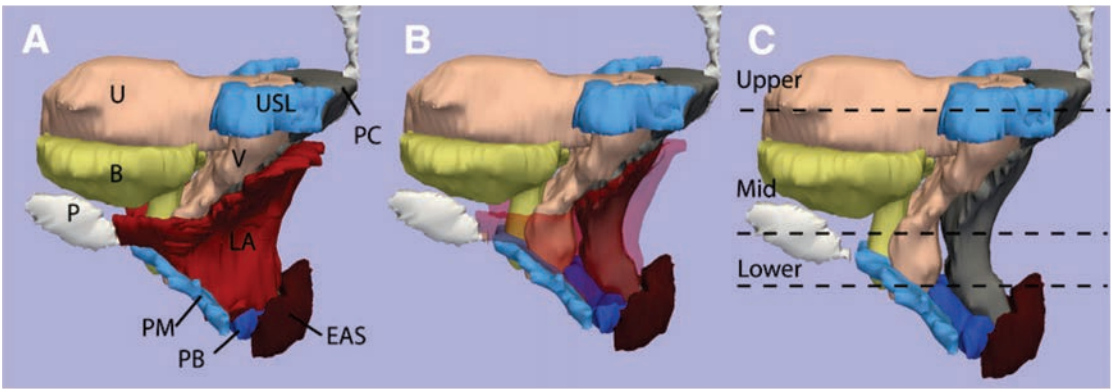

Figure 22: The outline of the midsagittal pubic bone (P) is shown. The bladder (B) is yellow; the uterus (U) and vagina (V) are pink; the uterosacral ligament (USL) and perineal membrane (PM) are turquoise blue; the levator ani muscle (LA) is red; the perineal body (PB) is royal blue; the external anal sphincter (EAS) is dark red; and the posterior compartment (PC) is gray. Image A, All organs are shown. B, Levator ani muscles have been faded to show the underlying structures. C, Levator ani muscles have been removed. The locations of the upper, mid, and lower axial cross-sections are shown(39). Reprinted with permission from John O. L. DeLancey.

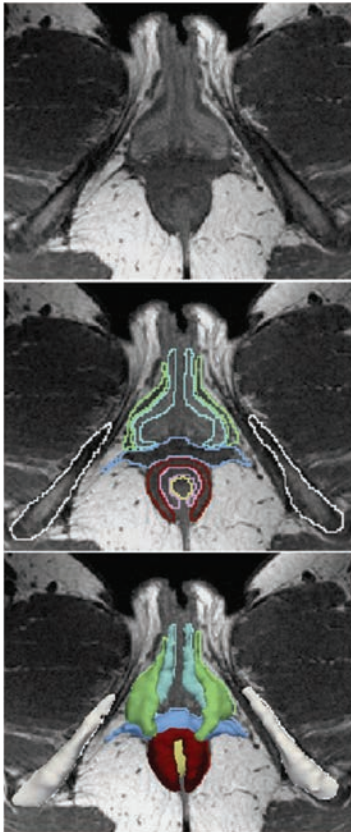

Figure 23: 3D Model of the perineal body (40)

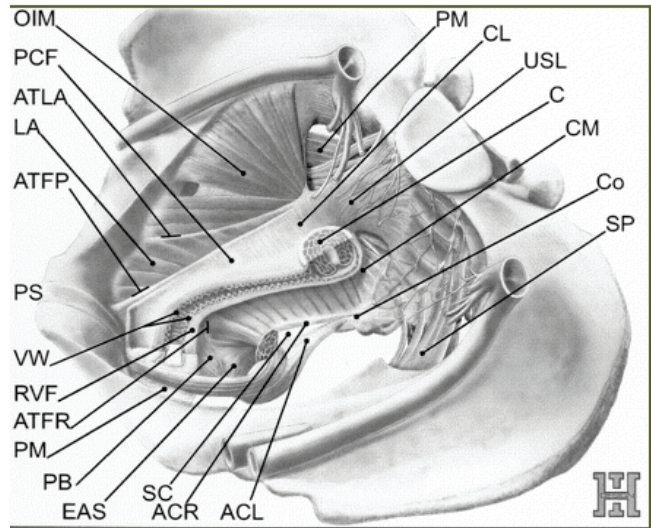

Figure 25: Left lateral view from above the female pelvis. The vagina, endopelvic fascia, and levator ani muscle are cut in the sagittal plane. Urethra, urinary bladder, and rectum have been removed. OIM, obturator internus muscle; PCF, pubocervical fascia; ATLA, arcus tendineus levator ani; LA, levator ani muscle; ATFP, arcus tendineus fasciae pelvis; PS, pubic symphysis; VW, vaginal wall; RVF, rectovaginal fascia; ATFR, arcus tendineus fasciae rectovaginalis; PM, perineal membrane; PB, perineal body; EAS, external anal sphincter; SC, space of Courtney; ACR, anococcygeal raphe; ACL, anococcygeal ligament; PM, piriformis muscle; CL, cardinal ligament; USL, uterosacral ligament; C, cervix of the uterus; CM, coccygeus muscle; Co, coccyx; SP, sacral plexus. Illustration: Ivan Helekal (41).

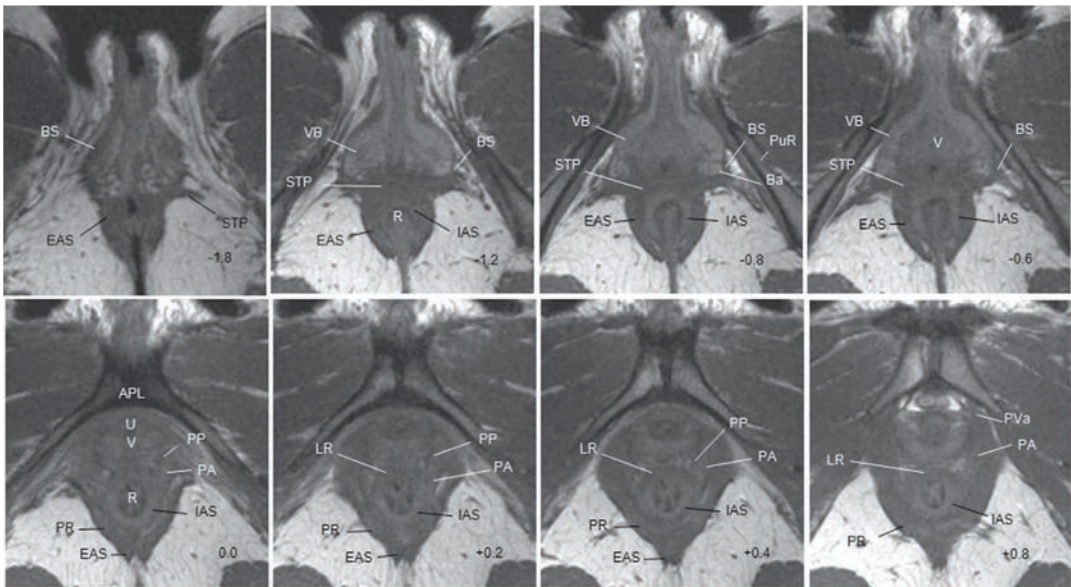

Figure 24: Arcuate pubic ligament (APL) as reference slice. Negative numbers are caudal and positive numbers are cephalad to APL.

B, bladder; Ba, Bartholins; IAS, internal anal sphincter; IC, iliococcygeus; PB, perineal body; PR, puborectalis; PS, pubic symphysis; PuR, pubic rami; R, rectum; U, urethra; V, vagina; VB, vestibular bulb (40).

They found that the MRI measurements obtained from the sagittal images were consistently greater than the ones obtained by US. However, there was no such difference between MRI and US for the axial images. The authors attributed this observation to acquisition planes for axial images or interpretation of landmarks for the sagittal images.

2.3.3.2 Levator Ani Muscle Functional Anatomy

Evidence from MR and CT images in volunteers and cadavers shows that the anterior transverse portion of the levator muscle is basin-shaped; the middle transverse portion funnel-shaped, while the posterior transverse portion dome-shaped. The puborectalis appears u-shaped outside the vertical portion(47). On MR images of the five Terminologia Anatomica-listed levator ani components: pubovisceral (pubovaginal, puboperineal, and puboanal), puborectal and iliococcygeal portions of the levator ani muscle muscles in women with normal pelvic support., the puborectal muscle can be seen lateral to the pubovisceral muscle and decussating dorsal to the rectum in the axial plane. The course of the puboperineal muscle near the perineal body is also seen best in the axial plane. The coronal view is perpendicular to the fibre direction of the puborectal and pubovisceral muscles and shows them as "clusters" of muscle on either side of the vagina. The sagittal plane consistently demonstrates the puborectal muscle passing dorsal to the rectum to form a sling that can be seen as a "bump". This plane

is also parallel to the pubovisceral muscle fiber direction and shows the puboperineal muscle(48)(Figure 26).

Betschart et al (49) described a technique to quantify muscle fascicle directions in the levator ani (LA): Among levator subdivisions, significant angle differences were observed between PVM and PRM (60 degrees), and between ICM and PRM (52 degrees). An 84 degrees difference was observed between PVM and EAS. The smallest angle difference was between PVM and ICM (8 degrees). The difference between PRM and EAS was 24 degrees.

2.3.4 Pathophysiology of Pelvic Floor Disorders

2.3.4.1 Levator Ani (LA) Muscle Defects

Lammers et al (50) assessed the inter- and intraobserver reliability of the diagnosis of pubovisceral muscle avulsions and measurements of the levator hiatus on MRI and confirmed that pubovisceral muscle avulsions and levator hiatus measurements can be assessed with good to excellent reliability on MRI.

In (51) a case-control study with group matching for age, race, and hysterectomy status, women with prolapse (cases) were compared to those with normal support (controls). Major defects were those that lost more than 50% of the muscle bulk. Cases were more likely to have major levator ani defects than controls

(55% compared with 16%), but equally likely to have minor defects (16% compared with 22%) (Figure 27,28). Women with defects generated less vaginal closure force during a pelvic muscle contraction than women without defects (2.0 Newtons compared with 3.1 Newtons) and women with prolapse also generated less vaginal closure force during pelvic muscle contraction than controls (2.0 Newtons compared with 3.2 Newtons). This confirmed earlier uncontrolled observations with ultrasound (52).

It is important to distinguish between muscle thickness and muscle damage. A woman with a normally thin but intact muscle may have less muscle substance than a woman with naturally bulky muscles who has a defect that has involved 25% of her muscle bulk. The issue of muscle damage is relevant to seeing who is injured, while that of muscle bulk, with the capability of the muscle to close the hiatus. Hoyte et al (53) examined 10 women with prolapse, 10 with urodynamic stress incontinence, and 10 asymptomatic volunteers. Mean 3-dimensional parameters in the 3 groups showed levator volumes of 32.2, 23.3, and 18.4 cm³ (P <0.005); hiatus widths of 25.7, 34.7, and 40.3 mm (P <0.005); left levator sling muscle gaps of 15.6, 20.3, and 23.8 mm (P =0.03), right levator sling muscle gaps of 15.6, 22.5, and 30.8 mm, (P =.003), and levator shape (90%, 40%, and 20% dome shaped; P <0.005). Subsequently, using a novel thickness mapping (54), they found thicker, bulkier anterior portions of the levators in asymptomatic women, compared with women with prolapse or urodynamic stress incontinence while the more posterior portions of the muscle were not affected.

Hsu and colleagues quantified levator ani muscle cross-sectional area as a function of prolapse and muscle defect status (55). Using muscle cross-sections from 3-D reconstructions they found that women with visible levator ani defects on MR have less muscle ventrally compared with women with intact muscles. Women with major levator ani defects had larger cross-sectional areas in the dorsal component than women with minor or no defects indicating a compensatory hypertrophy in this area. Furthermore, after controlling for prolapse, women with levator defects appear to have a more caudal location of their perineal structures and larger hiatuses at rest, maximum contraction, and maximum Valsalva maneuver (56).

Among women with POP, those with major LAD appear less likely to experience stress incontinence when "coughing, laughing, or sneezing" (odds ratio (OR) 0.27) and when "twisting, reaching, lifting, or bending over" (OR 0.26) than women with normal

muscles. They are less likely to have obstructive symptoms characterised by assuming an "unusual toileting position" or "changing positions...to start or complete urination" (OR 0.27). Women with minor LAD appear more likely to experience stress incontinence with exercise (OR 3.1) and urge incontinence (OR 4.0) than those with normal muscles. Lower urinary tract symptoms are therefore less common among women with prolapse and major levator ani defects and more common among those with minor defects (57). This may be explained by the fact that the women with major LA defects have larger prolapses than those who do not have major LA defects. It is a clinical observation that prolapse often reduces the occurrence of stress incontinence (urethral kinking?) and this hypothesis is consistent with the observations mentioned above.

Cai et al (58) evaluated levator ani morphology and function in healthy nulliparous women using static and dynamic MRI. They found no morphologic abnormality in healthy nulliparous women. However, in 15% (12/80) of women, pelvic organ descent below the pubococcygeal line was observed. In these women, the width of the pubic portion of the levator ani was significantly reduced during straining, whereas the levator plate angle, the levator hiatus area, and the H and M line lengths were enlarged. These changes were associated with weakened levator ani function and pelvic floor laxity.

2.3.4.2 Identifying the Injury Zone within the Levator Ani Muscle Most Often Involved by Injury

MRI based 3D models show that in women with bilateral puborectal muscle avulsion after vaginal delivery, the damage affects the pubic origin of the muscle. This structural change alters the support to the whole endopelvic fascia and destabilises both the anterior and the posterior vaginal walls(59). In women with significant muscle on one side and damaged muscle in the same individual(60)the injury involves the muscle's origin from the posterior pubic bone (Figure 29).Distortion of the surrounding connective tissue with lateral spilling of the vagina towards the obturator internus muscle is observed in 50% of women. The defect is right sided in 71% of patients. The average difference of the amount of muscle lost in these types of injury between the normal side and the defective side is up to 81% at locations nearest the pubic origin(61). Almost all of the volume difference (13.7%, P=0.0004) is attributable to a reduction in the pubic portion (24.6%), not the iliococcygeal portion of the muscle.

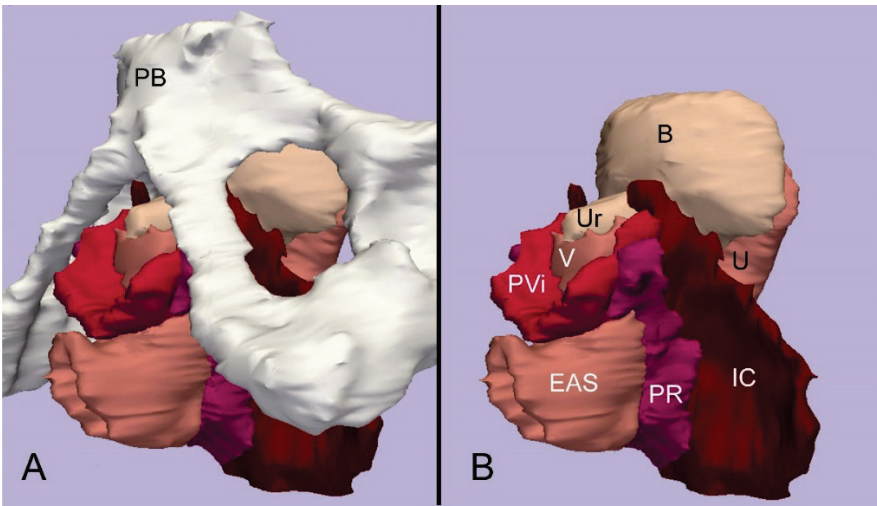

Figure 26: Three-dimensional model of levator ani subdivisions including the pubic bone and pelvic viscera. This model was created by using the magnetic resonance images shown in Figures 2, 3, and 4. The pubovaginal, puboperineal, and puboanal muscles are all combined into a single structure, the pubovisceral muscle. Inferior, left 3-quarter view. B. The same model without the pubic bone. PB, pubic bone; V, vagina; U, uterus; Ur, urethra; B, bladder; IC, iliococcygeus muscle; PR, puborectal muscle; PVi, pubovisceral muscle; EAS, external anal sphincter. © DeLancey 2006. Margulies (43).

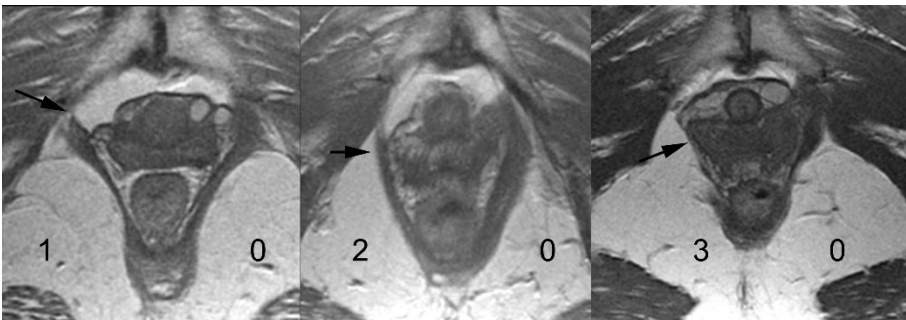

Figure 27: Examples of grades of defects in the pubovisceral portion of the levator ani muscle in axial magnetic resonance images at the level of the mid urethra. These were selected to illustrate degrees of defects in individuals with a normal contralateral pubovisceral muscle. The score for each side is indicated on the figure, and the black arrows indicate the location of the missing muscle. A. A grade 1 defect; B. A grade 2 defect; and C. A grade 3 defect. © DeLancey 2006 (44)

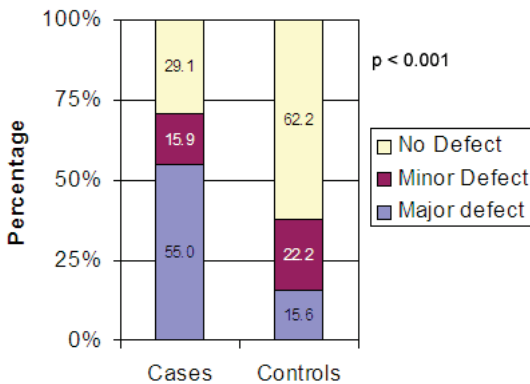

Figure 28: Percentages of cases and controls with no defects, minor defects, and major defects; $p < 0.001$. © DeLancey 2006 (44)

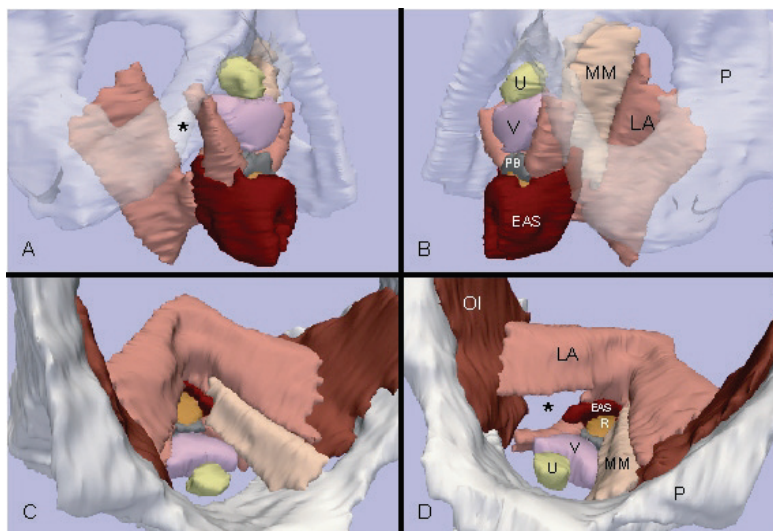

Figure 29: Three-dimensional model generated from the axial MR scans shown in Figure 1. A, and B, Oblique right and left inferolateral views, similar to the dorsal lithotomy position, are shown. In these panels the pubic bone is semitransparent and the obturator internus muscle is not shown. C, and D, Oblique right and left views peering over the pubic bone and down to the pelvic floor are shown. The urethra, vagina, and rectum have been truncated so as not to obscure the views of the levator muscles. EAS, external anal sphincter; LA, levator ani; MM, mirror image of the missing muscle; P, pubis; PB, perineal body; U, urethra; V, vagina. The missing muscle in A and D is denoted (asterisk). © DeLancey 2006 (52) .

2.3.4.3 Changes in the Hiatus Size and Levator Plate Angle with Prolapse

The levator ani muscle's constant activity closes the genital hiatus. In addition to evaluating defect status and muscle bulk, MRI has revealed changes to the levator hiatus and angle of the levator plate (that midline portion of the muscle between the anus and the coccyx) which is presumed to be influenced by muscle action. Hsu and colleagues (62) studied 68 women with pelvic organ prolapse and 74 normal controls. During Valsalva, controls had a mean levator plate angle of 44.3 degrees. Cases had 9.1 degrees (21%) more caudally directed levator plate angle compared to controls (53.4 degrees vs. 44.3 degrees), 15% larger levator hiatus length (7.8 cm vs 6.8 cm), and 24% more caudal perineal body location (6.8 cm vs 5.5 cm). Increases in levator plate angle were correlated with increased levator hiatus length ($r = 0.42$) and perineal body location ($r = .51$). The bladder neck descent at straining is also correlated with the levator plate angle at rest, hiatus length at rest and at straining(63). Uterine cervix descent at straining is correlated with increased hiatus length and width at straining, and greater levator plate angle ($p=0.007$) at straining. Paradoxically anterior rectal bulging at straining is inversely correlated with the hiatus width at rest ($p = 0.04$).

Perineal descent and localised outward bulging of the levator ani during Valsalva was evaluated by Gearhart and colleagues (64). In this study, dynamic MRI of symptomatic patients with pelvic floor prolapse demonstrated unsuspected levator ani hernia. Patients with POP, fecal and/or urinary

incontinence, or chronic constipation were evaluated. Fifteen percent of patients (12/80) had unilateral ($n = 8$) or bilateral ($n = 4$) levator ani hernias on MRI. Perineal descent on physical examination was associated with a levator ani hernia in nine patients.

2.3.4.4 MRI and the Bony Pelvis

Studies of the bony pelvis dimensions and their associations with POP, levator ani defects and stress incontinence have recently been undertaken. Stein et al showed that bony pelvis dimensions are similar at the level of the muscular pelvic floor in white women with and without POP (65). Further evaluation of the bony pelvis using MRI scans has also improved our understanding of the natural history of stress urinary incontinence as well as the associations of the bony pelvis dimensions with the prevalence of levator defects (66). Other studies investigating the role that different pelvis shapes play for specific diseases will be described in subsequent sections of this review.

2.3.4.5 MRI of Pelvic Floor After Vaginal Delivery

There are changes observed in the levator ani and pelvic floor musculature immediately after delivery, which change over time. Boreham (67) evaluated the normal visibility of the levator in post term nulliparas using 3-dimensional (3-D) MRI. LA insertion into the symphysis was visible in 93%, and the iliococcygeus muscle assumed a convex shape (arch) in 92% of 84 nulliparas. Mean LA volume was 13.5 (3.7) cm³. Interestingly there was a positive association between LA volume and higher fetal station with increasing BMI. The muscle signal intensity appears

increased at 1 day postpartum on T2 weighted images, but normal by 6 months. The urogenital and levator hiatus decreases significantly by 2 weeks postpartum(68). Lienemann (69) found thinning of the puborectal muscle in primiparous women after vaginal delivery (0.6 cm vs. 0.8 cm) and increased descent of the bladder, vaginal fornix, and anorectal junction during straining compared to healthy asymptomatic nulliparous volunteers.

The descent of the bladder and cervix on straining appears greater in women who delivered vaginally compared to those who had cesarean delivery and to nulliparous women. There is a positive correlation between the duration of labor and the area of the levator sling and also between birthweight and the descent of the cervix on straining(70).

The role of levator ani muscle damage and stress soon after birth has also been studied. An investigation of 80 nulliparous asymptomatic women and 160 vaginally primiparous women half of whom had new stress incontinence after their first birth was conducted 9 months after delivery. A visible defect in the levator ani muscle was identified in 32 primiparous. Twenty-nine of these 32 defects were in the pubovisceral portion of the levator and three were in the iliooccygeal portion. None of the nulliparous women showed these abnormalities(71). In a further study of this cohort (72) evaluation of obstetric factors associated with levator ani injury after first vaginal birth showed increased odds ratios for levator defect: forceps use 14.7, anal sphincter rupture 8.1 and episiotomy 3.1 but not vacuum delivery (0.9) epidural use (0.9) or oxytocin use (0.8). Women with levator injury were 3.5 years older and had a 78-minute longer second stage of labor. Differences in gestational age, birth weight, and head circumference were not statistically significant.

Dannecker (73) compared women after spontaneous vaginal delivery to those delivered by vacuum extraction and a control group of healthy nulliparous volunteers. Significant differences for individual POPQ component measurements were noted for points Aa and Ba, TVL, and GH (spontaneous delivery versus control) and in addition for Ap, Bp, and D (vacuum extraction versus control). Significant differences were observed for the position of bladder base, bladder neck, posterior vaginal fornix, anorectal junction, hiatus perimeter and depth of rectocele. Looking into comparisons with the spontaneous vaginal delivery group, on clinical examination, there was more evidence of anterior vaginal wall descent after vaginal delivery, and TVL and GH. Differences between the groups with regard to points Ap and Bp reached only marginal significance. With MRI measurements primiparous women who underwent spontaneous vaginal delivery as compared to nulliparous women showed considerable and statistically significant descent of almost all assessed structures at rest and on straining. Bladder base, bladder neck and the anorectal junction descended

even below the respective reference lines. The bladder neck

showed considerably increased mobility, and the genital hiatus showed an increased change on straining. The depth of rectocele increased more than three times. One of 26 women (4%) had a rectocele >3 cm. POPQ measurements that differed significantly between primiparous women after vacuum extraction and nulliparous women of the control group indicated more evidence of anterior and posterior vaginal wall descent after vacuum extraction. In addition TVL and GH was increased and PB was decreased after vacuum extraction. MRI measurements after vacuum extraction, showed considerably increased descent and mobility of the bladder base and bladder neck on straining, and descent of the anorectal junction was prominent. The mean depth of rectocele was four times bigger than in the nulliparous group. Four of 49 women (9%) had a rectocele >3 cm.

Branham and colleagues (74) evaluated postpartum changes in the levator ani muscle in relation to obstetric events. In those subjects recovering to normal MR by 6 months an average of nearly 60% increase in right puborectalis muscle thickness compared with that seen at 6 weeks indicated the extent of the injury. Younger white primiparous women had a better recovery at 6 months than older white women. Subjects experiencing more global injury, in particular to the iliooccygeous, tended not to recover muscle bulk.

Heilbrun and colleagues investigated the correlation between the presence of major LAM injuries on MRI with faecal incontinence (FI), POP, and urinary incontinence (UI) in primiparous women 6-12 months postpartum using a scoring system to characterise LAM injuries on MRI. Major LAM injuries were observed in 19.1% women who delivered vaginally with external anal sphincter (EAS) injuries, 3.5% who delivered vaginally without EAS injury, and 0% who delivered by cesarean section before labor ($P=0.0005$). Among women with EAS injuries, those with major LAM injuries trended toward more FI, 35.3% vs. 16.7% ($P=1.0$) and POP, 35.3% vs 15.5% ($P=0.09$), but not UI ($P=1.0$). These data confirm that both EAS and LAM are important for faecal continence and that multiple injuries contribute to pelvic floor dysfunction (75).

Handa and colleagues used MRI to measure bony and soft tissue pelvic dimensions in 246 primiparas, 6-12-months postpartum. A deeper sacral hollow was significantly associated with fecal incontinence ($P = 0.005$). Urinary incontinence was marginally associated with a wider intertuberous diameter ($P = 0.017$) and pelvic arch ($P = 0.017$). There were no significant differences in pelvimetry measures between women with and without prolapse in this study(76).

2.3.4.6 MRI and Biomechanical Investigation of the Pelvic Floor

MRI has allowed anatomically based biomechanical models to be constructed. Simulations have demonstrated important interactions between muscle and connective tissue in providing anterior vaginal wall support (77). MRI has enabled construction of finite element analysis (78)(79). It has also allowed for capture of 3D shape variation of the levator ani during straining where complete volumetric imaging is prohibited by the inherent temporal resolution of the scanning technique (80).

Chen recently developed and validated a 3D finite element computer model of the anterior vaginal wall and its supports based on spatial data from MR scans of normal women. They determined the combinations of muscle and connective tissue impairments that result in cystocele formation, as observed on dynamic MRI geometry from a healthy nulliparous woman. It included simplified representations of the anterior vaginal wall, levator muscle, cardinal and uterosacral ligaments, arcus tendineus fascia pelvis and levator ani, paravaginal attachments, and the posterior compartment. The authors found that development of a cystocele requires a levator muscle impairment, an increase in abdominal pressure, and weakening of apical and paravaginal support (81). These simulations provide a way to see what specific changes in structural components do to pelvic organ support in ways that would be impossible to study in living women.

Peng et al (82) assessed urethral support by developing a pelvic model from an asymptomatic female patient's MR images using the finite element method. Weakening the vaginal walls, puborectalis muscle, and pubococcygeus muscle generated the top three largest urethral excursion angles. Weakening all three levator ani components together caused a larger weakening effect than the sum of each individually weakened component, indicating a nonlinearly additive pattern. The authors concluded that the vaginal walls, puborectalis, and pubococcygeus are the most important individual structures in providing urethral support. The levator ani muscle group therefore provides urethral support in a well-coordinated way with a nonlinearly additive pattern according to the authors of this study.

2.3.4.7 Racial Differences in Pelvic Dimensions

There are differences in pelvic dimensions that exist in women from different racial backgrounds. Several groups have evaluated racial differences in the bony pelvis and the levator ani muscles (83)(84)(85). In a study by Handa et al (83), a wider transverse diameter (odds ratio 3.4) and a shorter obstetrical conjugate (odds ratio 0.2) were associated with pelvic floor dysfunction after controlling for age, race, and parity. Hoyte and colleagues found that levator ani volume was significantly greater in African-American (AA) asymptomatic nulliparous women without pelvic

floor dysfunction compared to white American (WA) ones (mean = 26.8 vs. 19.8 cm³, P = .002). The levator-symphysis gap was smaller in the AA (left-18.2, right-18.8 mm) versus the WA group (22.4, 22.6 mm, P = .003, .048) on the left and right. Significant differences were also seen in bladder neck position, urethral angle, and the pubic arch angle(84). In another study with 3D MRI levator thickness was significantly greater bilaterally in black nulliparas compared to white ones, yet obturator internus muscle thicknesses were similar(85)..

Handa found that the pelvic inlet was wider among white women than African-American women (10.7+/-0.7 cm compared with 10.0+0.7 cm, P<.001). The outlet was also wider (mean intertuberous diameter 12.3+/-1.0 cm compared with 11.8+/-0.9 cm, P<.001). There were no significant differences between racial groups in interspinous diameter, angle of the subpubic arch, anteroposterior conjugate, levator thickness, or levator hiatus.(86).

A broader group of races was studied by Rizk et al with MR in asymptomatic multiethnic nulliparous young volunteers from 5 ethnic groups (Emirati, other Arab, Filipino, Indian/Pakistani, and European/white volunteers), with the white volunteers as the reference group (87). The white volunteers were taller (P<.0001) than the other women. Their levator hiatus was longer than the Emirati women (P=.03) and wider than the Filipino women (P=.04). The bladder neck descent on straining was also greater than the other groups (P<.00001). The white women also had the longest transverse diameter of the pelvic inlet (P=.002). Their sagittal outlet diameter was longer than the Emirati and Arab women (P=.02), and their interspinous diameter was longer than the Arab women (P=.002).

2.3.5 Pelvic Organ Prolapse

MRI has proven to be a key assessment for understanding pelvic organ prolapse; a problem that arises from damage to connective tissue, muscles, and nerves that are invisible on standard radiography. With the advent of 3D ultrasound and MRI, the actual structures involved in the cause of prolapse can be seen and examined. This is possible not only in static scans that reveal morphological details of the pelvic structure, but also in dynamic scans where the movements of the various organs can be studied.

Evaluation of the degree of anterior compartment (bladder) and apical compartment (cervix) prolapse at maximal Valsalva using dynamic MRI showed a strong correlation between how far the bladder base and uterine cervix were below normal with $r^2 = 0.53$ indicating that slightly over half of the observed variation in anterior compartment support may be explained by apical support (88). Further analysis in the same patients showed that vaginal length was the strongest secondary factor determining 30% of the variation after apical descent was taken into account. This finding that a longer vaginal wall was associated

with increasing cystocele size was unexpected, but seems consistent with clinical observations (89).

Hsu et al found that vaginal thickness is similar in women with and those without pelvic organ prolapse. However, in prolapse patients the vaginal perimeter and cross-sectional areas are 11% and 20% larger respectively (90).

Broekhuis et al studied the relationship between patient symptoms using questionnaires' domain scores and the perineal position on dynamic MR imaging of 69 women. They found that POP symptoms were associated with the degree of descent of the perineum but perineal descent was not related to anorectal and/or urinary incontinence symptoms (91).

In another study examining correlations of patients' symptoms with findings on clinical examination and dynamic MR imaging of the pelvic floor, only the domain score genital prolapse was significantly correlated in the positive direction with the degree of POP as assessed by POP-Q and dynamic MR imaging ($r(s) = 0.64$ and 0.27 , respectively), whereas the domain score urinary incontinence was inversely correlated ($r(s) = -0.32$ and -0.35 , respectively). The sensation or visualisation of a bulge in the vagina was the only symptom which correlated positively with the degree of POP, with clinical examination and dynamic MR imaging showing similar correlation in this respect (92).

Broekhuis et al concluded that correlations for the POP staging with the use of POP-Q, dynamic MR imaging, and perineal ultrasonography are only observed in the anterior compartment (93).

MRI for clinical evaluation of prolapse

2.3.5.1 Enterocele

In the past, enteroceles were usually only appreciated on radiographic examination after repeated straining after evacuation and usually required opacification of the vagina in order to demonstrate the insinuation of small bowel loops between the rectum and vagina (94). MRI has proven to be a much simpler and less invasive technique for the evaluation of enteroceles. In comparisons between physical examination, intraoperative findings and MR images in women with and without

prolapse. MRI was significantly superior in detecting enterocele when compared to physical examinations with a sensitivity of 87%, specificity of 80%, and positive predictive value of 91%(16). (Figure 30). Similarly, MRI had a much higher sensitivity for detection of enteroceles when compared to physical exam and dynamic cystoproctography (95). Whether or not this technique alters clinical outcome remains to be seen.

2.3.5.2 Cystocele

MRI has a sensitivity of 100%, specificity of 83%, and positive predictive value of 97% when evaluating for cystocele compared to intraoperative findings. In addition, urethral hypermobility and post-void urine residual can be documented, as well as evaluation of ureteric obstruction, hydroureteronephrosis and other pelvic abnormalities. Figures 31a, b

MRI can also be helpful in documenting the status of pelvic organ support as part of a program to assess operative efficacy (96)(97) and differentiating such problems as Müllerian remnant cysts from cystocele (98).

Larson et al showed that in women with anterior wall prolapse, Valsalva causes downward translation of the vagina along its length. A transition point separates a proximal region supported by levator muscles and a distal, unsupported region no longer in contact with the perineal body. In this latter region, sagittal and frontal plane "cupping" occurs. The distal vagina rotates inferiorly along an arc centered on the inferior pubis. Downward translation, cupping, and distal rotation are therefore novel characteristics of cystocele demonstrated by 3-D MR imaging (99). (figure 32,33)

In cystoceles, the distal anterior vaginal wall (AVW) may no longer be in contact with the posterior vaginal wall or perineal body as it bulges through the introitus. The exposed vaginal wall length has been quantified using dynamic MR imaging. The authors found a bilinear relationship between exposed vaginal wall length and most dependent bladder location as well as apical location. It is when the bladder descent is beyond the inflection point that exposed vaginal wall length increases significantly (100).

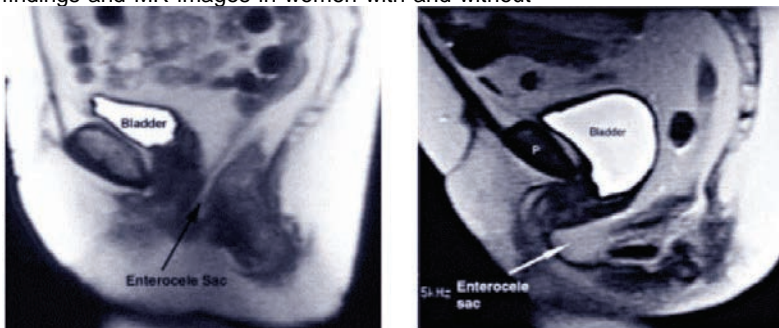

Figure 30: Pelvic floor MRI: Enterocele at rest a) and during Valsalva b).

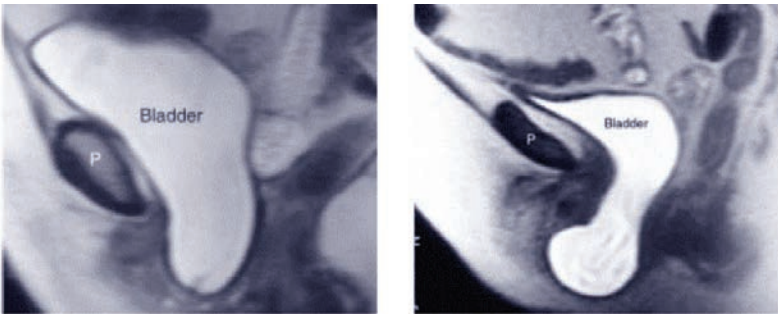

Figure 31: Pelvic floor MRI: grade 2 (a) and grade 3 (b) cystocele

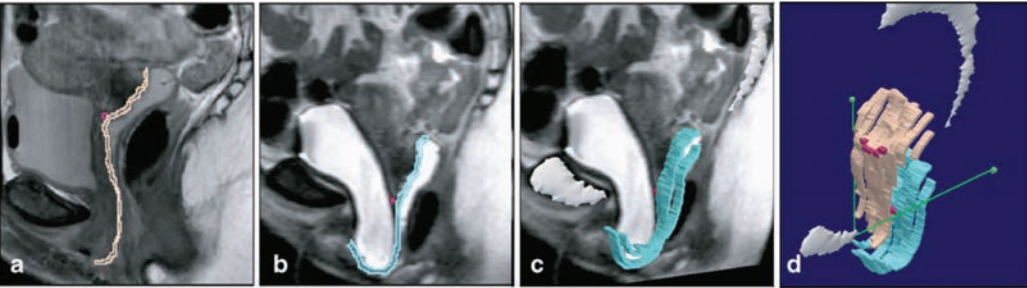

Figure 32: Anterior vaginal wall models at rest and with Valsalva. A Midsagittal MR slice with subsequent outline of vaginal wall at rest (pink) and with Valsalva (turquoise, panel b). Uterovaginal junction shown with dark pink square. c Addition of midsagittal pelvic bones (white) and anterior vaginal wall model. d Powerpoint image of both resting and straining anterior vaginal wall models and their relationship to the normalised ATFP, shown here as green line extending from the pubic symphysis to the ischial spines (green square), or the P-IS line. © DeLancey 2009 (89).

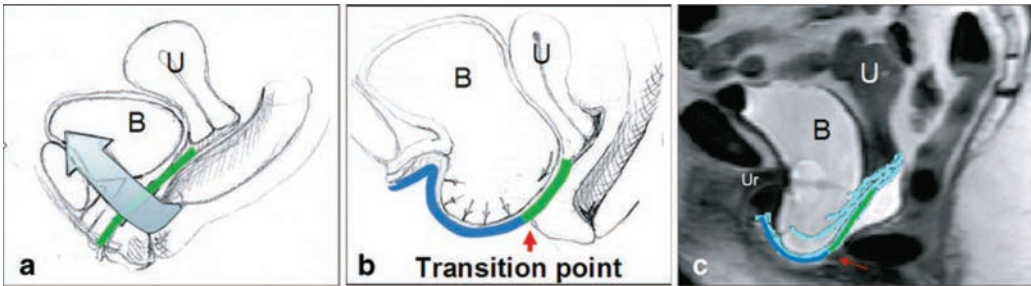

Figure 33: Midsagittal view of pelvis with normal support (a) and with prolapse (b). Green represents area where levators (blue arrow) provide cranial reaction forces to counteract the action of intraabdominal pressure and caudal movement of the anterior wall. The red arrow delineates the transition to unsupported region lacking this opposing set of reaction forces (blue line), thereby creating a pressure differential acting caudally on that region. c Red arrow illustrates this point on midsagittal MRI with modeled anterior vaginal wall. U uterus, B bladder, Ur urethra. © DeLancey 2009 (89).

2.3.5.3 Rectocele

The reported sensitivity of pelvic examination for diagnosis of rectocele ranges from 31% to 80% (3)(4)(6)(101)(102). This is usually secondary to organ competition for space in the vagina with other significant prolapse (7). In addition, it is often difficult to reliably distinguish an enterocele from a high rectocele. **Figure 34** shows a rectocele diagnosed by dynamic MRI. A rectocele is easily seen when filled with gas, fluid, or gel. Although highly specific, when no rectal or vaginal opacification is used, MRI can miss up to 24% of rectoceles (16). When rectal opacification is used, a correct diagnosis of rectocele

can be made in 100% of patients studied when compared to intraoperative findings (19). Rectal opacification by introducing sonographic transmission gel or gadolinium into the rectum is therefore necessary to increase MRI's ability to diagnose rectocele.. In complex situations such as rectal intussusception (103) MR can provide important information by distinguishing mucosal from full-thickness descent. MR defecography also shows movements of the whole pelvic floor. In this study, 30% of the patients studied were found to have associated abnormal anterior and/or middle pelvic organ descent that would not necessarily be seen in

traditional evacuation proctography (unless opacification of vaginal, bladder and intestine are carried out).

At maximal Valsalva on MRI, structures are more caudal and the hiatus longer in women with posterior prolapse. The posterior vaginal wall is longer; this length and point Bp strongly correlate with MRI prolapse size ($r=0.5$; $P=.002$; $r=0.7$; $P<.001$, respectively) (104).

What remains unclear is the relationship between anatomical findings and functional problems. The diagnosis of an anatomical abnormality does not mandate surgery. Simply identifying a rectocele on an imaging study based on the location of the intestinal lumen to a reference line does not mean that correction of the rectocele will cure defecation problems. Rectocele surgery is not without complications and the risk of dyspareunia after posterior colporrhaphy is real. Attention should be paid to make sure that symptoms are truly depending on stool trapping and the condition must be shown on imaging.

2.3.5.4 Uterine Prolapse

Although uterine prolapse is easily diagnosed on physical examination MRI is an excellent modality to record the structural relationships with the bladder and rectum in patients with uterine prolapse (Figure 35). In addition to depicting the position of the uterus and adjacent organs, it has the ancillary benefits of evaluating uterine size, position, orientation (retroversion) and pathology (fibroids, tumors, Nabothian cysts. etc.), but also ovarian pathology (cyst or mass) which may sometimes prove useful if these problems have not been picked up on physical examination. This is helpful information in determining the route of hysterectomy. Furthermore, MR imaging provides information on the presence or absence of cystocele, rectocele, urethral hypermobility and urethral diverticula, and evaluates for ureteral obstruction(10)(11)(14)(15)(16)(105). Gousse et al. report a sensitivity of 83%, a specificity of 100% and a positive predictive value of 100% when comparing dynamic MR imaging to intraoperative findings. These numbers were similar when compared to physical examination alone(16). More importantly, MRI was able to clearly define the other

compartments of the pelvic floor and diagnose uterine and/or ovarian disorders in 30 of 100 patients evaluated(16).

2.3.5.5 Grading of pelvic floor relaxation

A number of studies have described reference values for grading POP(15)(16)(18). In order to evaluate pelvic organ descent, certain anatomic landmarks are used. The pubococcygeal line (PCL) marks the distance from the pubis to the coccyx and serves as a fixed anatomical reference. In the nomenclature used by Comiter et al. (15), Gousse et al. (16), and Barbaric (23), the width of the levator hiatus is measured as the distance from the pubis to the pubococcygeus muscle (H-line). The hiatus is formed by the puborectalis muscle and encompasses urethra, vagina, and rectum. The M-line depicts the relaxation of the muscular pelvic floor by measuring the descent of the levator plate from the PCL. Using these three simple measurements, an MRI classification for degree of POP has been described (15)(23). In the normal population, during straining, the hiatus (H-line) is less than 6 cm long and does not descend (M-line) more than 2 cm below the PCL. The upper urethra, urethrovaginal junction, bladder, upper vagina, uterus, small bowel, sigmoid colon, mesenteric fat and rectum are all above the H-line. A combination of hiatal enlargement and pelvic floor descent constitutes relaxation. As the pelvic floor descends, so do the organs above it. The grading system for prolapse of any pelvic organ is based on 2 cm increments below the H-line. By determining the degree of visceral prolapse beyond the H-line, the degree of rectocele, enterocele, cystocele, and uterine descent can be graded in a 0 to 3 scale as follows: 0=none, 1=minimal, 2=moderate, and 3=severe (Table 1). Other similar systems have been described (18)highlighting the need for standardization of nomenclature and grading of organ prolapse using MRI. In a small study, Ginath et al showed that MRI measurements of pelvic landmark angles can differentiate between women with and without uterine prolapse and correlate best with POPQ point C (106).

Novellas and colleagues evaluated two classification systems (using the PCL and the midpubic line, MPL) in 30 patients with symptoms of POP.

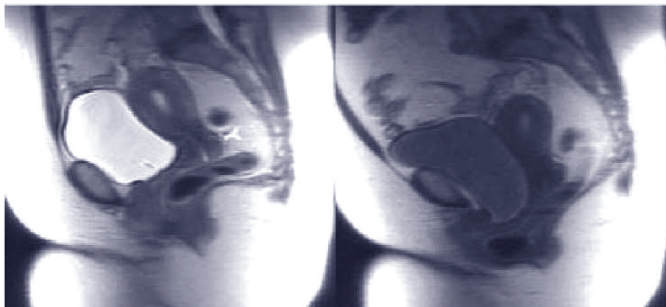

Figure 34: Resting (a) and straining (b) midline sagittal section showing a rectocele that traps intestinal contents.

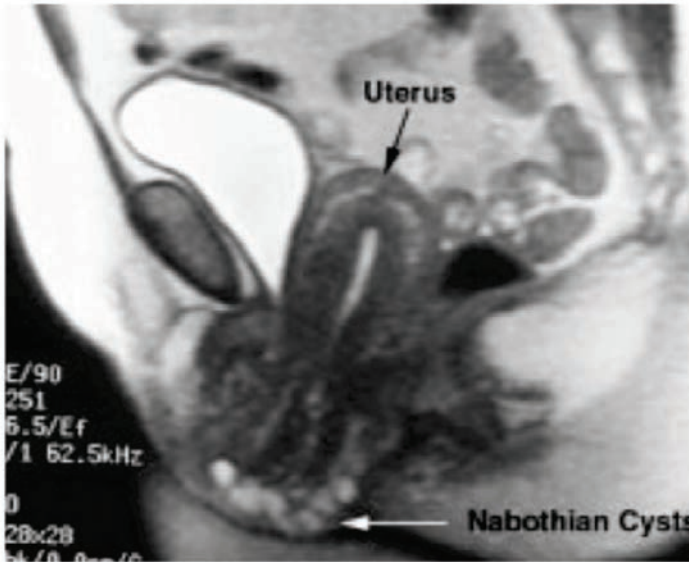

Figure 35: Pelvic Floor MRI: Uterine Prolapse

For prolapse detection, the correlation between clinical examination and MRI ranged between 74 and 89%. For prolapse staging, the correlation was poor to moderate. Inter-observer agreement was good to very good (kappa between 0.67 and 0.95). It was slightly better at the mid stage, with both systems (kappa between 0.83 and 0.97). Comparison of the inter-observer agreement between both MRI classification systems showed better results for the system using the pubococcygeal line ($p < 0.005$). The classification system based on the pubococcygeal line appeared more reliable and simple for the evaluation of pelvic prolapse on MRI (107). In another study, agreement between clinical and PCL staging was fair in the anterior (kappa = 0.29) and poor in the apical (kappa = 0.03) and posterior (kappa = 0.08) compartments. Agreement between clinical and MPL staging was fair in the anterior (kappa = 0.37), apical (kappa = 0.31), and posterior (kappa = 0.25) compartments. The MPL had higher agreement with clinical staging than the PCL in this study. However, neither reference line had good agreement with clinical staging (108). The intra- and interobserver reliability of dynamic MR staging in POP patients has also been evaluated using various anatomical landmarks in relation to the PCL, H-line, and MPL. Clinical measurement points were assessed in relation to the mid-pubic line. Overall, the intra- and interobserver reliability of MR imaging measurements was excellent to good. The PCL showed superior reliability (intraclass correlation coefficients-ICC range 0.70-0.99). The reliability of clinical measurement points, however, were only moderate (ICC range 0.20-0.96). The intra- and interobserver reliability of quantitative prolapse staging on dynamic MR imaging were good to excellent. The PCL appeared the most reliable to use (109).

Singh et al (110) compared a new technique of grading POP by using dynamic MRI with the clinical staging proposed by the POP-Q system (111). A new reference line, the mid-pubic line, was drawn on the MR image to correspond to the hymenal ring marker used in the clinical staging. The proposed staging by MRI showed good correlation with the clinical staging (kappa = 0.61). Torricelli (112) also used MRI to evaluate functional disorders of female pelvic floor. In symptomatic women MRI confirmed the pelvic examination findings in all cases; MRI also detected additional alterations (4 cases of uterine prolapse and 3 of enterocele) that had been missed at clinical evaluation. Deval (113) compared dynamic MR imaging with physical examination as an alternative to dynamic cystoproctography for the evaluation of POP. PCL and puborectalis muscle were the reference points. The grading system is based on degree of organ prolapse through the hiatus and the degree of puborectalis descent and hiatal enlargement. They also used, the mid pubic line, which was drawn on the MR image to correspond to the hymenal ring marker used in clinical staging. Intra-operative findings were considered the gold standard against which physical examination, dynamic colpoproctodefecography and MRI were compared. The sensitivity, specificity and positive predictive value of MRI were 70%, 100%, 100% for cystocele; 42%, 81%, 60% for vaginal vault or uterine prolapse; 100%, 83%, 75% for enterocele; 87%, 72% and 66% for rectocele. More recently Etlik (114) found physical examination and MR findings to be very concordant in the diagnosis of pelvic prolapse. Statistical correlations in the stages of prolapse between both of the methods were significant for anterior and middle compartment ($P < 0.01$), as well as for posterior compartment ($P < 0.05$).

Rosenkrantz et al evaluated the prevalence of pelvic organ prolapse as an incidental finding on dynamic magnetic resonance imaging (MRI) using the pubococcygeal line (PCL) and mid-pubic line (MPL) to diagnose and grade prolapse in all three pelvic compartments. Sixty women with symptoms unrelated to pelvic floor dysfunction who underwent dynamic MRI were included. In asymptomatic women, dynamic MRI identified the greatest degrees of prolapse in the posterior compartment. The MPL consistently yielded greater frequency of prolapse than the PCL. These findings however are of uncertain significance, requiring correlation with clinical examination (115).

Semiautomated pelvic floor measurement algorithmic models on dynamic MRI images have been developed and compared with manual pelvic floor measurements for pelvic organ prolapse (POP) evaluation. These models were shown to provide highly consistent and accurate locations for all reference points on MRI. The reference points can also be identified faster compared to manual-point identification. (116). A fully automated localization method for multiple pelvic bone structures on magnetic resonance images (MRI) has been developed by the same group. Identifying structures of interest such as the pubic bone, sacral promontory, and coccyx correctly, by a fully automated identification method may result in improved diagnosis of female pelvic organ prolapse according to the authors (117).

2.3.6 Assessing Treatment Outcome

2.3.6.1 Pelvic Organ Prolapse Operations

Several studies have evaluated the anatomic changes seen after surgical procedures using MRI to better understand how surgical therapies affect pelvic support and structures. Lienemann et al. (118) evaluated women after abdominal sacrocolpopexy and found that functional MRI identified the exact sacral fixation points after the procedure and easily identified the axis of the vagina and the exact position of the synthetic material used for the repairs. Sze (119) used MRI to study vaginal configuration on MR after abdominal sacrocolpopexy and sacrospinous ligament suspension. This study demonstrated the differences in the geometry of these two operations and should prove helpful in establishing outcome variables for different surgical procedures. Similarly Rane (120) used MRI to compare the vaginal configuration following transvaginal sacrospinous fixation (SSF), posterior intravaginal slingplasty (PIVS) (infracoccygeal sacropexy) and sacrocolpopexy (SCP) and demonstrated improvements in the restoration of vaginal configuration and differences between the procedures in final anatomy. Boukerrou (121) compared outcomes of 1) abdominal sacral cervicopexy, 2) vaginal hysterectomy with paravaginal repair, sacrospinous suspension and posterior colporrhaphy and 3) sacrospinous

suspension and posterior repair without paravaginal suspension with MRI. The correction provided by vaginal route was found to result in a return of the bladder and the vaginal apex to their normal positions. In addition, vaginal shortening and postoperative change in vaginal orientation were not present postoperatively.

Nicolau-Toulouse et al (122) evaluated the anatomic outcomes of bilateral sacrospinous vault fixation (BSSVF) with synthetic, polypropylene mesh arms using MRI in a small case series of women with symptomatic pelvic organ prolapse (POP) with and without uterus. They confirmed that BSSVF with synthetic mesh restores the anatomy between the vagina and the ischial spines.

Relationships between assessment of surgical correction studied with MR imaging and symptoms have been studied. Gufler (123) compared preoperative evaluations with those two to four months after surgery. Of the seven patients who had symptoms postoperatively, only two had abnormal findings on physical examination but MRI showed pathologic findings in five of the seven patients. Huebner et al assessed symptomatic changes after anterior levatorplasty with morphologic changes visualized by MR defecography (124). Anterior levatorplasty improved quality of life in patients with symptomatic rectocele and correction of rectocele is accurately documented by MRdefecography, however only moderate correlation between morphologic and clinical improvements was observed.

MRI has also been used for the evaluation of the effectiveness of POP surgical mesh procedures.

Dynamic MRI may evaluate the support of anterior and posterior pelvic floor structures by anterior and posterior polypropylene implant respectively. But dynamic MRI evaluations in a small series by Siegmann and colleagues suggest that if one compartment of the pelvic floor is repaired another compartment frequently (73.3%) develops dysfunction. These results did not correspond to clinical symptoms on short-term follow-up (3 months) indicating the need for long-term follow-up studies to prove if dynamic MRI can reliably identify significant POP after surgery and before the onset of symptoms (125). In another small series of ten women by Kasturi et al (126) undergoing intervention for POP with Prolift, postoperative MRIs supported the inert nature of polypropylene mesh.

Larson et al examined structural relationships between anterior mesh kit suspension points and the upper vagina in women with normal support. Using MRI generated 3D models, they found that the anterior vagina extended above superior attachment points in 100% of women at rest and in 73% during Valsalva. It extended posterior to them in 82% and 100% (rest and Valsalva, respectively). The mean percentage of anterior vaginal length above superior anchoring sites was 40 +/- 14% at rest and 29 +/- 12%

during Valsalva. The upper vagina was therefore found to lie above and posterior to superior suspension points in the majority of women with normal support (127).

In an observational study, the 1-year outcomes after mesh repair in patients with POP were evaluated using clinical examination (CE), dynamic magnetic resonance imaging (dMRI), and the prolapse quality-of-life (P-QOL) questionnaire. Sixty-nine women were treated with Seratom(R) or Perigee mesh implants. Advanced cystoceles and enteroceles were underestimated by CE using the POP-Q system compared to dMRI ($P = 0.003$ and $P < 0.001$), vice versa dMRI overestimated POP compared to CE. (128).

2.3.6.2 Pelvic Muscle Exercises

Studies on the effects of pelvic muscle training on the pelvic floor (129) demonstrate reduced levator ani surface area and volume encircled by the levator ani muscle during contraction. When elite athletes are compared to normal women significant differences appear in the cross-sectional area and width of the pelvic floor muscles, (130). These types of studies are being facilitated by improved techniques of aligning contracted and non-contracted muscle (131).

2.3.6.3 Comparison of MRI with other Examinations and Assessment of Reliability

Dynamic contrast roentography and multiphasic fluoroscopic cystocolpoproctography (CCP) have previously been considered the best radiological studies for detecting POP. These studies rely on the opacification with contrast material of the bladder, vagina, small bowel, and rectum with all organs opacified together or in phases with each organ opacified individually prior to each straining phase(4)(120)(124)(129). These studies fail to detect up to 20 percent of all enteroceles (105)(132)(133)(134). Therefore, MRI has proven to be a much simpler and less invasive technique for the evaluation of enteroceles. In addition, MRI is able to differentiate the enteroceles according to their contents (small bowel, large bowel, rectosigmoidocele or mesenteric fat). MRI is also an excellent study to differentiate high rectoceles from enteroceles, thus allowing adequate surgical planning and safer planes of dissection (15)(16)(19)(95). Although multiphasic MRI with opacification of organs and multiphasic fluoroscopic cystocolpoproctography have similar detection rates for enterocele (132), excellent images can be obtained from dynamic MRI without contrast for opacification of the small bowel or rectal contrast. Thus the minimal added information obtained by contrast administration does not seem to warrant the invasiveness of organ opacification at this time (16)(94)(133). However, MRI without rectal contrast shows statistically fewer pelvic floor abnormalities than CCP. Except for enteroceles, MRI with rectal

contrast shows statistically similar frequency of POP as CCP (135).

Evacuation proctography has been used to diagnose enterocele, rectoceles, perineal descent and rectal intussusception. Dynamic contrast roentography or fluoroscopic cystocolpoproctography have also been used (4)(101)(102)(132)(136) to diagnose rectoceles. The disadvantages of these techniques are the inability to visualise the soft tissue planes comprising the pelvic floor, their invasiveness, and their use of significant levels of ionizing radiation. Without the use of rectal opacification, MRI appears to be a poor choice for the evaluation of rectoceles missing up to 25% of such defects. With rectal opacification a correct diagnosis of rectocele can be made in 100% of patients in comparison to intraoperative findings (19). Triphasic dynamic MRI and triphasic fluoroscopic cystocolpoproctography have similar detection rates for rectocele (132). Upright dynamic MR defecating proctography has been reported (137). Although these studies might prove to be more sensitive in detecting anorectal anomalies, their utility seems to be more pronounced in patients with disorders of defecation include anismus, intussusception, and others, and may be too invasive to justify their routine use in the evaluation of rectocele.

Kaufman (138) evaluated dynamic pelvic MRI and dynamic cystocolpoproctography in the surgical management of females with complex pelvic floor disorders. Physical examination, dynamic MRI, and dynamic cystocolpoproctography were concordant for rectocele, enterocele, cystocele, and perineal descent in only 41% of patients. Dynamic imaging lead to changes in the initial operative plan for 41% of patients. Dynamic MR was the only modality that identified levator ani hernias. Dynamic cystocolpoproctography identified sigmoidoceles and internal rectal prolapse more often than physical examination or dynamic MR. Whether this type of imaging creates measurably better outcomes remains to be seen. Singh et al (110) showed a reasonably good correlation between clinical staging and MRI staging ($Kappa = 0.61$) with the mid pubic line being used as a surrogate for the hymenal ring. In addition, specific features such as the levator-vaginal angle the area of the genital hiatus could be assessed quantitatively on MRI.

Toricelli (112) studied ten healthy volunteers and 30 patients with suspected pelvic floor deficiency with and without POP. They found good concordance between physical examination and MRI with four cases of uterine prolapse and three cases of enterocele seen on MRI that had not been suspected on pelvic examination. Whether these would have been detected at the time of surgery was not discussed. Deval (113) compared intraoperative findings as a gold standard for MRI based diagnosis. The sensitivity, specificity, and positive predictive value of MRI were 70%, 100%, 100% for cystoceles; 42%, 81%, 60% for vaginal vault or uterine prolapse;

100%, 83%, 75% for enteroceles; 87%, 72%, 66% for rectocele. Although all of these measurements are somewhat subjective, these figures show that it is possible to quantify the individual elements of pelvic floor dysfunction in reasonable parameters.

In a recent study, the value of dynamic pelvic floor MRI was assessed in comparison to standard clinical examination in treatment decisions made by an interdisciplinary team of specialists including a urologist, gynecologist, a proctological, and colorectal surgeon. The authors concluded that MRI has the advantage of allowing diagnosis of clinically occult enteroceles. In addition, in nearly half of cases, MRI changed management or the surgical approach relative to the clinical evaluation. (139).

2.3.7 Conclusions

Proof that MR imaging has value will eventually need to come from increased operative success rates. Better documentation of preoperative and postoperative anatomy could allow us to seek reasons of operative failure. Because MR provides a detailed picture of a woman's pre-operative anatomy, once operative failures are discovered, it would be possible to look back at images from women with successful and unsuccessful operations to seek anatomical explanations for failure.

Advancements in MRI technology with the addition of 3D imaging as well as studies correlating imaging findings with clinical examination and symptom scores may establish further the clinical applications of these modalities.

2.3.8 Consensus Statement

MRI is not yet indicated in the routine evaluation of patients with (uncomplicated primary) pelvic organ prolapse. However data concerning the causes of prolapse are rapidly accumulating and this may change soon. It can provide useful information concerning complex prolapses and can be used in difficult cases. **(Level of evidence 3, Grade of Recommendation C)**

2.3.9 Future Research Areas

Studies that identify specific defects in the connective tissue and the muscles of the pelvic floor that correlate these findings with the clinical presentation in prolapse are needed.

Additional studies comparing MRI of healthy volunteers and patients with pelvic organ prolapse are needed to better evaluate the anatomical changes involved in pelvic floor prolapse.

Quality control in MRI, including: what manoeuvres are required to produce a maximal prolapse during MRI, bowel condition, bladder filling, pushing instructions, etc.)

3. SPECIAL ISSUES

3.1. Post-Void Residual

Post-void residual urine (PVR) is defined as "the volume of urine left in the bladder at the end of micturition(1). Evaluation of PVR prevalence in women with symptomatic pelvic floor dysfunction suggests that 81% have a post-void residual of 30 ml or less (2). This is not significantly different from asymptomatic perimenopausal and postmenopausal women in whom 15% of subjects had a PVR greater than 50 ml (3). If symptoms cannot predict elevated PVR, a urogenital prolapse beyond the hymen seems to be associated with incomplete bladder emptying (4). Among patients older than 55 years with symptoms of overactive bladder, previous incontinence surgery, history of multiple sclerosis and vaginal prolapse stage 2 or greater, were found to be independent predictors of elevated PVR (5). Similar data were obtained by Fitzgerald in patients with urgency incontinence, the presence of pelvic organ prolapse \geq stage 2, symptoms of voiding difficulty and absence of stress incontinence symptoms predicted 82% of patients with elevated PVR (6). Higher prevalence of post-void residual was found in patients with stress urinary incontinence with 35.5% of women having a PVR $>$ 50 ml suggesting they have some degree of voiding dysfunction (7). Although elevated PVR and bacteriuria are common among elderly residents in nursing homes, no association between the two was observed in a Swedish study (8). Analysis of elderly patients with urinary incontinence failed to identify any significant association between PVR and any other clinical or urodynamic parameter (9). Sanders and co-workers addressed the issue of the real need for measuring flow rates and post-void residual urine in women with urinary incontinence. Analysis of 408 women suggested a 4% incidence of PVR 200 ml or greater and a 6% rate of PVR 149 ml or greater. The authors calculated that only 1.5% of patients (6 of 408) had their management modified because of the results of free uroflowmetry and PVR measurement. In their opinion, these data do not justify the inclusion of these tests in the "minimal care" programme for assessing primary, uncomplicated, urinary incontinence in female patients (10).

PVR is often considered a safety parameter, which needs to be monitored in the follow-up of medical or surgical management of urinary incontinence. A number of studies have addressed the effect of antimuscarinic treatment in men with symptoms of overactive bladder to rule out the old dogma that banned the use of these drugs in elderly men. Actually, all published data suggest that antimuscarinic treatment is safe for men with benign prostatic enlargement and no significant change in PVR values was found in active treatment groups compared to placebo (11, 12). In male patients with bladder outlet obstruction, antimuscarinic treatment may result in a significantly larger PVR

(25 vs. 0 ml) that seems to be of no clinical relevance and with higher incidence of adverse events (13).

Measuring PVR is of importance in patients receiving intravesical injections of Botulinum toxin A for UUI. Significant increase of post void residual urine is observed following injection of onabotulinumtoxinA in patients with neurogenic urinary incontinence due to detrusor overactivity with 30 to 42% of patients needing to start clean intermittent catheterisation compared to 12 % in the placebo group (14). In patients with idiopathic UUI, increase of PVR was observed in those receiving onabotulinumtoxinA compared to placebo although only 8 of 70 patients required CIC and only 3 patients had a PVR >200 ml at day 8 and only one at 6 months (15).

Although the prevalence of incomplete bladder emptying among male and female patients with urinary incontinence and pelvic floor dysfunction is low, there is a general consensus that PVR should be measured in incontinent patients (16) although the evidence suggests that only patients with UI and symptoms of voiding dysfunction are at risk (17).

3.1.1 Measuring PVR

The measurement of PVR can be performed by invasive and noninvasive means. Invasive methods include: in-and-out catheterisation and endoscopy. Noninvasive means are transabdominal ultrasonography with real-time ultrasound or fully automated systems, and radioisotope studies. In-and-out catheterisation has been considered for some time, the goldstandard for the measurement of PVR. Nevertheless the method is subject to inaccuracies, if the person performing the catheterisation is not fully instructed as to the procedures and techniques to assure complete emptying (moving the catheter in and out slowly, twisting it, suctioning with syringe, suprapubic pressure), especially in cases of bladder diverticula and vesicoureteric reflux (18). The interval between voiding and PVR measurement should be as short as possible. It is advisable to ask the patients if the voiding was similar to a typical micturition in his/her daily life. Stoller and Millard showed inaccuracies in 26% of 515 male patients evaluated by full-time urology nurses with a mean difference between the initial and the actual residual volume of 76 ml in those measurements that were found to be inaccurate (19). After further education of the nurses, inaccurate assessments were reduced to 14% with a mean difference of 85 ml. PVR can be measured at the time of endoscopy, provided there is a blinded insertion of the instrument to avoid irrigation fluid inflow. Both invasive means are usually performed with local anaesthesia and carry a small risk of urethral damage and urinary infection. Before the era of ultrasonography, PVR was measured non-invasively by the phenolsulfonphthaleine excretion test or with isotopes (20, 21).

In 1967, Holmes described the use of ultrasonography in the evaluation of bladder volume and this technique rapidly gained widespread acceptance as a

satisfactory level of accuracy was demonstrated (22, 23). Using either three diameters (length, height, width) or the surface area in the transverse image and the length obtained in the longitudinal image, various volume formulae for a spherical or ellipsoid body are utilised to estimate the bladder volume (Table 3). Twenty-one different formulae have been proposed over the years making assumptions about bladder shape which have often been questioned (24) r volumes obtained using different formulae did not result in any significant difference amongst the various calculations (25) report sufficient accuracy with ultrasound estimation of PVR (23, 24, 26-29) (30) by portable ultrasound with measurements by catheterisation, the mean absolute error of the scanner was 52 ml (31) s suggest a good level of accuracy in both female and paediatric populations (32, 33) ly referred to as an absolute value, but it can be measured as a percentage of bladder capacity. ly referred to as an absolute value, but it can be measured as a percentage of bladder capacity.

The intra-individual variability of PVR is high from day to day and even within a 24 hours period. This was reported in men with BPH by Birch et al. and by Bruskevitz et al. (34, 35). Griffiths et al. examined the variability of PVR among 14 geriatric patients (mean age 77 years), measured by ultrasound at three different times of day on each of two visits separated by 2-4 weeks (36). Within-patient variability was large (SD 128 ml) because of a large systematic variation with time of day, with greatest volumes in the early morning. The inherent random variability of the measurement was much smaller (SD 44 ml). Several factors can influence PVR variability: voiding in unfamiliar surroundings, voiding on command with a partially filled or overfilled bladder, the interval between voiding and the estimation of residual (it should be as short as possible), the presence of vesicoureteric reflux or bladder diverticula. Several studies reported the questionable value of PVR as an important outcome prognosticator in male patients with benign prostatic enlargement and benign prostatic obstruction (37-42). The cause of PVR is probably multifactorial, and no consensus exists on the relation of PVR, bladder outlet obstruction and detrusor contractility.

Table 3. Comparison of different formulae to assess PVR by transabdominal ultrasound in 30 men with BPH scanned three times(35).

Author/reference	Method	Standard error	95% Confidence limits
Hakenberg et al (43)	$625 \times H \times W \times (D1+D2)/2$	17.5	34.3
Poston et al (44)	$7 \times H \times W \times D1$	20.0	39.2

Author/ref-erence	Method	Stand-ard er-ror	95% Con-fidence limits
Hartnell et al (45)	625 x H x W x D1	17.0	33.3
Rageth and Langer (46)	Nomogram based on areas	15.0	29.4

Modified from the Proceedings of the 4th International Consultation on Benign Prostatic Hyperplasia p. 205

3.1.2 Conclusions

Knowledge regarding pathophysiology of PVR remains unclear. In patients with urinary incontinence there is no consensus as to its value as a safety parameter and particularly its relationship with upper tract dilatation, bacteriuria and urinary infection. The intra-individual variability of PVR has been investigated mainly in male patients with bladder outlet obstruction but little information is available as to its variability in patients with urinary incontinence.

Ultrasound is the recommended method for assessing PVR because it is the least invasive and it is sufficiently accurate for clinical purposes yet it is the most expensive. In-and-out catheterisation is invasive and can be inaccurate even if carefully performed.

The general opinion is that PVR measurement forms an integral part of the study of urinary incontinence, as a safety parameter to exclude voiding dysfunction associated with incontinence. Measurement of PVR is recommended in guidelines and recommendations on the management of LUTS and urinary incontinence, but the level of evidence for this measurement is not high. This manuscript summarises the evidence and provides practice recommendations for teaching purposes in the framework of an ICS teaching module (48).

3.1.3 Consensus Statements

1. Residual urine measurement is recommended in the initial assessment of urinary incontinence as a safety parameter and in the evaluation of treatment outcome (**Level of evidence 3- Grade of recommendation C**)
2. Measurements should be performed using realtime sonography or a portable scanner or in and-out catheterisation (**Level of evidence 3- Grade of recommendation C**).
3. Due to intra-individual variability, in cases where significant PVR is detected by the first measurement, several measurements should be performed (**Level of evidence 3- Grade of recommendation C**)
4. The method of measurement should be recorded

3.1.4 Future Research Areas

1. Pathophysiology of PVR in male and female populations with UI;
2. Circadian variation of residual urine in patients with UI;
3. Determination of the cut off value of significant residual urine in different patient populations with UI
4. Residual urine as a prognostic indicator of outcome in the treatment of incontinence

3.2. Open Bladder Neck and Proximal Urethra at Rest

The significance of open bladder neck and proximal urethra at rest observed during a voiding cystourethrogram or pelvic floor ultrasound scan remains doubtful (1) and the peer-reviewed literature is equally divided into papers associating such a condition with storage disorders and those suggesting this is a chance finding with no negative implications.

A 21% prevalence in nulliparous asymptomatic women has been reported (2). In the non-neurogenic population there is no pathophysiological correlation between this and urinary incontinence. Digesu and co-workers reported a prevalence of 1:3 amongst females suffering LUTS. An open bladder neck at rest is not pathognomonic of sphincter incompetence although it is associated with USI (3). In patients with stress incontinence, but also in asymptomatic women (4), funnelling of the internal urethral meatus may be observed on Valsalva (Fig. 5) and sometimes even at rest; funnelling is often associated with leakage. However, funnelling may also be observed in urgency incontinence and cannot be used to prove USI. Marked funnelling has been shown to be associated with poor urethral closure pressures (5, 6). Furthermore Shobeiri et al investigated the association between the levator ani muscle atrophy (levator ani deficiency) and the urethral sphincter muscle measurements using 3D endovaginal ultrasonography in female patients found no significant association. The authors concluded that although the rhabdomyosphincter deteriorated along with the levator ani muscle, this was not statistically significant. The most valuable finding was that the smooth muscle was significantly smaller in patients with levator ani deficiency, and that patients with levator ani deficiency were more likely to have urodynamic stress urinary incontinence.

Reports in the peer reviewed literature suggest that an open bladder neck and proximal urethra at rest, during the storage phase, may be observed during cystography, videourodynamics or bladder ultrasound, both in patients with and without neurological disease and is interpreted as a sign of internal sphincter denervation as occurs in 53% of patients with Multiple System Atrophy (7). Distal spinal cord injury has been associated with an open smooth sphincter area, but whether this is due to sympathetic or parasympathetic decentralisation or defunctionalisation remains

uncertain (8). Relative incompetence of the smooth sphincter area may also result from interruption of the peripheral reflex arc very similar to the dysfunction observed in the distal spinal cord injury. Twenty-one out of 54 patients with spinal stenosis were found to have an open bladder neck at rest (9). In a review of 550 patients (10), 29 out of 33 patients with an open bladder neck had neurological disease. Although the association was more commonly seen in patients with thoracic, lumbar and sacral lesions, the difference when compared to cervical and supraspinal lesions was not significant. Damage to the sympathetic innervation to the bladder was also frequently observed in patients undergoing major pelvic surgery, such as, abdominal perineal resection of the rectum. Patients with myelodysplasia had an inordinately high incidence of open bladder neck (10 out of 18 patients versus 19 out of 290 having different neurological disorders).

Patients with sacral agenesis are included in the larger category of myelodysplastic patients and suffer from an open bladder neck with an underactive bladder. Shy-Drager syndrome is a Parkinson-like disorder with peripheral autonomic dysfunction. Neurogenic detrusor overactivity is usually found in association with an open bladder neck at rest and a denervated external sphincter (11). Peripheral sympathetic injury results in an open bladder neck and proximal urethra from a compromised alpha-adrenergic innervation to the smooth muscle fibres of the bladder neck and proximal urethra (12). Although it can occur as an isolated injury it is usually associated with partial detrusor denervation and preservation of sphincter EMG activity. The loss of bladder neck closure suggests an autonomic neural deficit. The site and nature of the requisite deficit is unclear.

Most authors agree on the importance of the sympathetic system in maintaining the integrity of the bladder neck (13-16) although the possible role of parasympathetic innervation has been proposed by others (17, 18). An open bladder neck at rest in children or in women without neurological disease can represent a different disorder, either related to a congenital anomaly or secondary to an anatomical pelvic floor defect. Stanton and Williams (19) described an abnormality in girls with both diurnal incontinence and bed-wetting, based primarily on voidingcystourethrography, in which the bladder neck was wide open at rest. Murray et al (20) reported the "wide bladder neck anomaly" in 24.5% of the girls (35) and 9.3% of the boys (10) out of 251 children (143 girls and 108 boys) undergoing videourodynamics for the assessment of non-neurogenic bladder dysfunction (mainly diurnal incontinence). The authors considered the anomaly congenital and made the hypothesis that wide bladder neck anomaly in girls may provide a basis for the development of USI in later life.

The presence of an open bladder neck has been proposed to explain the pathophysiology of urinary incontinence but such hypothesis did not stand the test

of time. An open bladder neck was a key point in defining type III stress incontinence according to the classification of Blaivas and Olsson (21). This classification, no longer used in our daily practice, was based on history, imaging, and urodynamics, and distinguished five diagnostic categories of stress incontinence. Incontinence type III was diagnosed by the presence of an open bladder neck and proximal urethra at rest in the absence of any detrusor contraction suggesting an intrinsic sphincter deficiency.

In pelvic fracture with membranous urethral distraction defects, when cystography (and/or cystoscopy) reveals an open bladder neck before urethroplasty, the probability of postoperative urinary incontinence may be significant, although the necessity of a simultaneous (or sequential) bladder neck reconstruction is controversial (22-24). Skala and co-workers suggest that an open bladder neck at rest is associated with an increased risk of postoperative complications and failure after open colposuspension (25).

3.2.1 Conclusions

In conclusion, the diagnosis of open bladder neck at rest does not seem to be helpful to diagnose the underlying cause of urinary incontinence.

3.2.2 Consensus Statements

When observing an open bladder neck and proximal urethra at rest in male patients, during the storage phase, whatever imaging technique is used, it may be worthwhile to evaluate the possibility of an underlying autonomic neural deficit. **(Level of Evidence 3, Grade of Recommendation C)**

3.2.3 Future Research Areas

1. The relation of open bladder neck and proximal urethra at rest to the different neurogenic disorder
2. Longitudinal study of wide bladder neck and proximal urethra at rest in asymptomatic women
3. Evaluate the prognostic value of the open bladder neck and proximal urethra at rest

3.3. Female Urethral Diverticula

The prevalence of urethral diverticula ranges between 1 and 6% with rates up to 10% in among symptomatic women from tertiary referral centres (1, 2). The suspicion of a urethral diverticulum stems from LUTS or urethral masses on physical examination. Urethral masses include leiomyoma, vaginal cysts, malignancy, ectopic ureter, granuloma and urethral diverticula. The first case of female urethral diverticulum was reported in 1805 (3). Since the report from Davis and Cian in 1956 (4) using positive-pressure urethrography (PPU), the diagnosis has become much more common even though, despite increased clinical awareness, this pathology continues to be frequently overlooked. Urinary incontinence is often associated with a urethral diverticulum. Incontinence may be a sequel to urine loss from the diverticulum

itself with stress manoeuvres, USI or UUI (5). Aldrige et al. (6) reported urethral diverticula in 1.4% of patients with SUI.

The presenting symptoms of a urethral diverticulum have classically been described as the three Ds (Dysuria, postvoid Dribbling, and Dyspareunia). Since most patients present with nonspecific lower urinary tract symptoms, and the pathognomonic presentation (postvoid dribbling, urethral pain, tender periurethral mass and expression of pus from the urethra) is very uncommon, these patients undergo extensive evaluation and treatment before a correct diagnosis is established (7, 8). The diagnosis of a urethral diverticulum may be achieved by physical examination, voiding cystourethrography, positive-pressure (double-balloon) urethrography, urethroscopy, endocavitary (transurethral or transvaginal) or pelvic floor ultrasonography, urethral pressure profile or MRI. Positive pressure urethrography is usually accomplished using a double balloon catheter according to the method described by Davis and Cian (4). Two different models exist: the Davis-TelLinde and the Tratner catheter. Positive-pressure urethrography (and voiding urethrography) may result in a false negative study when the inflammation of the diverticulum neck prevents contrast medium from flowing into the diverticulum cavity.

The accuracy of a diagnostic test may depend upon the characteristics of the study population and conflicting data are often reported in the peer-review literature. Blaivas et al reported a diagnostic accuracy of VCUG of 97% in a series of 66 patients and similar results (95%) were obtained by Ganabathi et al. (7, 9). Less favourable results have been reported by

others. Comparison of VCUG versus PPU in the diagnosis of urethral diverticula showed a clear superiority of the latter with good consistency among different studies (10, 11). In some patients, VCUG only delineated the lower part of the diverticulum (12). Ultrasound scanning and MRI should theoretically be free of such false negative imaging. Particularly, the emergence of high definition 3D endovaginal probes enables the operator to place the probe directly adjacent to the area of interest.

Chancellor et al. (13) described the use of intraoperative intraluminal echographic evaluation which may be of help in dissecting the diverticulum and achieving complete excision without damaging the bladder neck and urethra. A number of studies have shown that MRI is better than both voiding cystourethrography and positive-pressure urethrography and can be considered, if available, the imaging of choice when the diagnosis of urethral diverticulum is suspected (14-19) (Figure 36). MRI is superior to VCUG or double-balloon urethrography, particularly in diagnosing diverticula with narrow, noncommunicating necks (15, 16). MRI proved to be superior to radiological studies because diverticula can go undiagnosed on voiding cystourethrogram, furthermore size and complexity of the diverticulum is better defined on MRI (17). Endoluminal MRI is considered to be of particular importance in the diagnosis of a circumferential urethral diverticulum, a condition that is relatively rare but the diagnosis may increase with the increased use of this imaging technique.

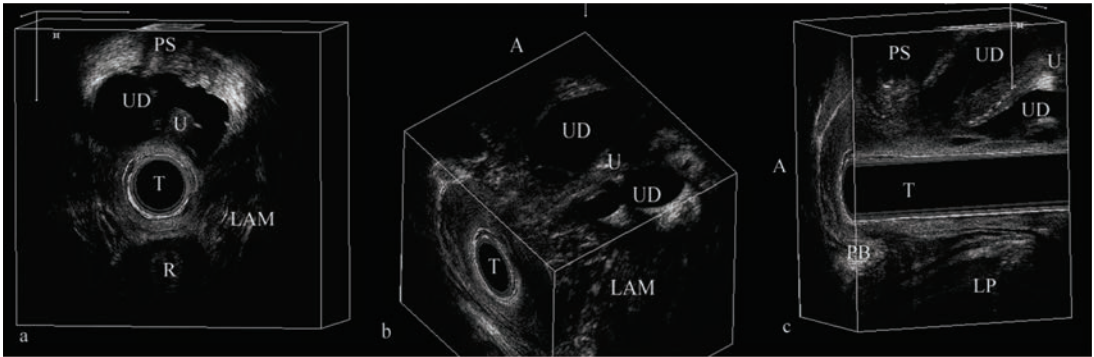

Figure 36: Urethral diverticulum. Probe 2052 was used for 360° endovaginal sonography. *a*, Axial view of the urethral diverticulum. The urethra is surrounded by the diverticulum. Anatomic landmarks are the pubic symphysis and pubic ramus superiorly, urethra medially, and vagina inferiorly. *b*, Coronal view showing the diverticulum along both sides of the middle and proximal parts of the urethra. Cephalad extension of the diverticulum can be evaluated in this view. *c*, Midsagittal view confirming the diagnosis, with an anechoic cavity adjacent to the urethra that starts in the middle third of the urethra and extends near to the bladder. A indicates anterior; LAM, levator ani muscle; LP, levator plate; PB, perineal body; PS, pubic symphysis; R, rectum; T, transducer; U, urethra; and UD, urethral diverticulum.

Proper evaluation of the anatomy of the diverticulum is essential in planning reconstructive surgery (1, 20). MRI also proved to be useful in diagnosing inflamma-

tion or tumour in the diverticulum (21, 22). Endoluminal MRI with either a vaginal or rectal coil, may provide even better image quality than simple MRI (18).

A comparison of MRI versus urethrography and urethroscopy, in a group of 20 women with urethral diverticulum, reported a 69 and 77 per cent accuracy of the two latter imaging studies versus MRI (14). When surgical findings were compared to MRI, urethrography and urethroscopy, the diagnostic ability of the three methods was 70, 55 and 55 per cent, respectively. Diverticula ostia could not be identified by MRI notwithstanding the use of contrast material. Neitlich et al. (15) reported in a series of 19 patients that MRI (using a fast spin echo T2-weighted pulse sequence and a dedicated pelvic multicoil) had a higher sensitivity for detecting urethral diverticula and a higher negative predictive rate in comparison to double balloon urethrography. Blander et al. (17), compared MRI and VGUG in 27 patients with urethral diverticula and found that endoluminal (endorectal or endovaginal) MRI was extremely accurate in determining the size and extent of urethral diverticula compared to VCUG; the related information can be critical when planning surgical approach, dissection and reconstruction. In conclusion, review of the peer reviewed literature suggests that positive pressure urethrography is still a valuable tool to diagnose female urethra diverticula notwithstanding both ultrasound sonography and particularly MRI represent better alternatives with a significantly higher diagnostic accuracy.

In males, both VCUG and ultrasonography can be successfully used to diagnose syringocele (cystic dilatation of the Cowper's gland), congenital and acquired diverticula (23).

3.3.1 Conclusions

Proper imaging of female diverticula is essential to diagnose the condition and, in planning and conducting proper surgical repair. Ultrasonography may suffice to identify size and location of the diverticulum although MRI imaging is preferable whenever available.

3.3.2 Consensus Statements

In cases of female urinary incontinence if a urethral diverticulum is suspected, appropriate imaging (positive pressure urethrography, voiding cystourethrography, urethroscopy, ultrasound, MRI) is recommended. (The choice of the type of imaging depends on their availability. Data show a higher accuracy of MRI.) **(Level of Evidence 3 – Grade of Recommendation C)**

3.3.3 Future Research Areas

Properly conducted prospective studies are needed to compare the accuracy of ultrasonography and MRI in the diagnosis and staging of female and male diverticula

3.4. Imaging of the Nervous System

Lower urinary tract dysfunction often depends upon derangements of its neural control mechanism. Imaging of the spinal chord and central nervous system may help identifying occult neurological conditions or

the site and extent of known neural damage. Functional imaging of the nervous system is a formidable research tool to better understand mechanisms of signal integration at the central level and its possible malfunctioning.

3.4.1 Lumbosacral Spine X-Rays

In children with lower urinary tract dysfunction and urinary incontinence, the presence of a spinal dysraphism must be ruled out. Although in most of the cases abnormalities of the lumbosacral region and/or legs and foot are clearly visible, antero-posterior and lateral films of the lumbosacral spine have to be evaluated in order to identify vertebral anomalies. Sacral agenesis involves the congenital absence of part or all of two or more sacral vertebrae. In the absence of two or more sacral vertebrae a neurogenic bladder is usually found. Spina bifida occulta has a variable significance. Simple failure to fuse the laminae of the fourth and fifth lumbar vertebrae is unlikely to be important, but if the spinal canal is noticeably widened, there may be cord involvement (diastematomyelia, tethered cord syndrome).

3.4.2 CT, MRI, SPECT and PET

Numerous papers refer to rare neurological conditions presenting with different symptoms including urinary incontinence in which CT scan, MRI, SPECT, and PET imaging were carried out to identifying the underlying CNS disease. These references have little impact on daily practice although they can be helpful in occasional difficult cases.

With regards to the clinical diagnostic use of CT or MRI, a few papers evaluated the role of fetal MRI imaging. Fetal MRI has higher contrast resolution than prenatal sonography and allows better identification of normal and abnormal tissue. Moreover, MRI can diagnose some abnormalities such as cerebral malformations and destructive lesions which can be occult on prenatal sonography, where the more anterior cerebral hemisphere cannot be properly evaluated due to reverberations by the overlying structures (2). Common indications for fetal MRI include the evaluation of all the sonographically diagnosed abnormalities of ventriculi, corpus callosum, or posterior fossa, as well as all those fetuses at increased risk for brain abnormalities, such as in families with a history of a prior child or fetus with anomalies, genetic disorders, complications of monochorionic twinning, and maternal illness (such as maternal infection or major cardiac event). Moreover, with recent advances in fetal surgical techniques, fetal MRI is being increasingly used before surgical intervention (3). The results of fetal MRI, whether verifying absence of abnormality, confirming sonographically detected abnormalities, or discovering additional abnormalities that were not apparent by sonography, have been shown to affect clinical decision-making during pregnancy, both by physicians and parents, resulting in changes in pregnancy management in nearly half of cases (2). With regard to myelomeningocele, prenatal ultrasound can easily identify the absence of posterior elements of

the vertebral bodies at affected levels and extension of the subarachnoid space posteriorly through the bony spina bifida, as well as the frequently associated presence of small posterior fossa alteration and herniation of cerebellar tissue into the cervical subarachnoid, which define the Chiari II malformation. However, fetal MRI can be a helpful adjunct when sonography analysis is limited, such as in cases of large maternal body habitus, oligohydramnios, low position of the fetal head, or when the fetal spine is positioned posteriorly with respect to the mother. Moreover, fetal MRI can be very useful to detect additional associated anomalies, such as callosal agenesis or hypogenesis, periventricular nodular heterotopia, cerebellar dysplasia, syringohydromyelia, and diastematomyelia (3). If fetal surgery will be shown to improve long-term outcome, fetal MRI will surely become a routine examination for affected fetuses.

MRI is also recommended in children with anorectal abnormalities as abnormalities of the spine and of the spinal cord are diagnosed in 42 to 46% of cases and in about 50% of cases the spinal cord is involved (1). Wraige et Borzyskowski suggested that spinal cord imaging should be considered in children in whom day-time wetting is associated with impaired bladder sensation or poor bladder emptying even in the absence of clinical or radiological suspicion of lumbosacral spine abnormalities. Four out of 10 children with these symptoms had a spinal cord defect diagnosed on MRI(4).

MRI of the lumbar spine is now the gold standard for evaluating children with spina bifida and adults in which an occult form of spina bifida is suspected. A potential technical update might be the use of intrathecal contrast medium to perform cisternography and ventriculography contrast-enhanced MRI. Munoz et al., evaluated a series of 10 patients with complex cerebrospinal fluid diseases, where other imaging techniques had been unclear or inconclusive, performing MRI with intrathecal administration of gadopentate dimeglumine. In 8 out of the 10 patients, imaging findings influenced or changed the clinical decision-making program and the surgical planning (5).

Sharma et al. recently evaluated with MRI the surgical outcome in patients with spinal dysraphism. Specifically, MRI spectroscopy was used to evaluate the composition of cerebrospinal fluid before and after surgery. Before surgery, high levels of lactate, alanine, acetate, glycerophosphorylcholine, and choline were observed in the cerebrospinal fluid of patients with spinal dysraphism, while these levels normalised postoperatively to those observed in control subjects. However, in those patients where cord tethering occurred, increased concentrations of lactate and alanine were found, suggesting that MRI spectroscopy might be a promising tool in the assessment of surgical outcomes in patients with spinal dysraphism (6).

Several papers refer to the use of CNS imaging in clinical research of voiding dysfunction and pathophysiology. Positron emission tomography (PET) and

functional MRI studies provided information on specific brain structures involved in micturition in humans. During micturition an increase in regional blood flow was shown in the dorsomedial part of the pons close to the fourth ventricle, in the pontine micturition centre (PMC), in the mesencephalic periaqueductal grey (PAG) area, as well as in the hypothalamus including the preoptical area (1). A good review on CNS imaging and lower urinary tract function was recently published by Drake and co-workers (7)

A couple of significant original studies have been published recently on the role of functional MRI in stress and urgency urinary incontinence. Specifically, previous brain imaging studies showed that during pelvic floor muscle contraction there was activity in the superior medial precentral gyrus, anterior cingulate cortex (ACC), cerebellum, supplementary motor cortex (SMA) and the thalamus (8, 9). Similarly, during anal sphincter contractions multifocal cerebral activity was shown in the primary and secondary sensory/motor cortices, the insula as well as the cingulate gyrus, prefrontal cortex, and the parietooccipital region (10). Di Gangi Herms et al. evaluated the neuroplastic changes of cortical representation of pelvic floor motor function induced with pelvic floor muscle training (PFMT) by biofeedback in patients with SUI (11). Specifically, the authors used functional MRI to evaluate 10 patients with SUI before and after a 12-week PFMT with EMG-biofeedback program. In the MRI performed before the beginning of PFMT, the authors identified significant brain activation in superior lateral and medial precentral gyrus and the superior lateral postcentral gyrus, in the SMA, the left premotor area, and in the left and middle cerebellum, as well as in the insula and in the ACC. In the MRI film after PFMT, less brain areas were activated, mainly the superior lateral and medial precentral gyrus, superior lateral postcentral gyrus and the insula. In other words, after PFMT there was more focused activation in the primary motor (superior lateral and superior medial precentral gyrus) and somatosensory areas, which is consistent with automation of the relearned skillful behavior (11). PFMT with biofeedback may improve muscular strength therefore enhancing support of the urethra and also optimise central muscular control of the pelvic floor, modulate bladder sensation, and reflect the emotional neutralisation related to symptom reduction.

With regard to UUI, Tadic et al. reported a small study, which used functional MRI to investigate 11 patients with UUI and 10 healthy controls. Specifically, the connections of the right insula (RI) and anterior cingulate gyrus (ACG) to other cortical area were evaluated, based on the assumption that the two areas were among the most important regions of the supraspinal neuronal network controlling the bladder. In normal subjects, there were significant positive effective connections with many of the regions involved in supraspinal bladder control, including left insula and frontotemporal and parietal regions, thalamus, putamen and claustrum, posterior cortex, cerebellum,

pontine micturition centre and mesencephalic periaqueductal grey. Vice versa, in the patients with urgency incontinence, significant negative connections to left parieto-temporal lobes, hippocampus, parahippocampal gyrus and cerebellum were found, with few positive connections (12). In subjects with normal bladder function, RI and/or ACG have been reconfirmed to have effective connections with many of the brain regions involved in bladder control such as the frontotemporal and sensorimotor regions, thalamus, putamen, cerebellum and midbrain, as well as to the posterior cortex, a region which may have a role in the control of bladder function. Vice versa, in the patients with urgency incontinence, the connections were shifted to an alternative complex of brain regions, such as left parieto-temporal lobes, parahippocampal gyrus and parts of cerebellum, which might represent expression of the recruitment of accessory pathways in order to control urgency and the voiding reflex as well as the emotional charge due to the abnormal sensation of urgency (12). On the whole the data from these recently published studies have improved our knowledge of nervous functional anatomy related to vesicourethral function and dysfunction but, to date, have no clear clinical relevance.

In conclusion, central nervous system imaging is rarely indicated in urinary incontinence. Spinal cord imaging is recommended in cases of children with anorectal malformation and whenever spina bifida occulta is suspected. In the case of clinical neurological signs and/or symptoms suggestive of central nervous lesions, imaging may be indicated along with more specific neurophysiological tests (e.g., signal latency, testing, evoked potential, etc.). Further improvements in the knowledge of the correlation between morphological and functional evaluation of the CNS is foreseeable using present CNS functional imaging technology.

3.4.3 Consensus Statements

In patients with suspected congenital neurogenic incontinence, with or without abnormalities of neurourological physical examination, lumbo-sacral spine anteroposterior and lateral radiological evaluation (or MRI) is indicated. (Level Evidence 3, Grade of Recommendation C)

Neuroimaging should be considered when a nervous system disorder is suspected on the basis of clinical and/or neurophysiologic test findings (Level of Evidence 3 - Grade of Recommendation C)

3.4.4 Future Research Areas

To investigate the effect of antimuscarinics and neuromodulation on brain activity;

To standardise bladder filling parameters to investigate brain activity during different types and levels of bladder sensations;

To investigate the effect of environmental and behavioural factors on brain activity in patients with UUI

To define the sequence of brain activation during bladder filling.

3.5. Endoscopy of the Lower Urinary Tract

Since the introduction of the cystoscope by Bozzini in 1805, endoscopy has played a critical role in the evaluation of lower urinary tract disorders (1). Many investigators have proposed the routine use of urethrocytostcopy in the evaluation of urinary incontinence. These recommendations have rarely been based on evidence. There are five specific areas pertaining to urinary incontinence in which urethrocytostcopy has been advocated.

1. Observation of the female urethral sphincter to assess its ability to close and coapt. Urethrocytostcopy has been advocated in the static state to assess intrinsic sphincter deficiency (ISD) as well as in the dynamic state, when the patient is straining, to evaluate hypermobility and urethral closure while the patient is straining. It has been reported that sluggish closure of the bladder neck during periods of a rise in intra-abdominal pressure is associated with anatomical stress urinary incontinence. Intrinsic sphincter deficiency has classically been described as a fibrotic or pipe-stem urethra. It has been suggested that endoscopy can even help to differentiate between the hypermobile urethra and the intrinsically damaged urethra.
2. Assessment of the bladder, to rule out concomitant bladder conditions which may be the cause of DO and UI or may simply require treatment.
3. Search of extraurethral causes of urinary incontinence, such as vesico-vaginal fistula and ectopic ureter.
4. Intraoperative cystourethroscopy during correction of USI to assess for bladder damage and ureteral patency.
5. Evaluation of the membranous and prostatic urethra in male patients with post-prostatectomy stress incontinence to evaluate possible iatrogenic damage of the external sphincter region. Assessment of bladder outlet in males with urgency incontinence considered to be secondary to bladder outlet obstruction to appraise prostate morphology.

3.5.1 Evaluation of the Female Bladder Outlet

Robertson described the procedure of dynamic urethroscopy to evaluate the bladder neck (2). In this procedure a gas urethroscope is used to observe the urethra, bladder neck, and portions of the bladder. During visualisation manometric recording can be performed. Robertson described the appearance of SUI as a sluggish closure of the bladder neck and the appearance of the overactive bladder as a bladder neck that closes and then opens like the shutter of a camera. This procedure was reported to be extremely

useful in patients with urinary incontinence as the bladder neck can then be observed at rest, with straining, and Valsalva manoeuvres. Unfortunately, in Robertson's original description of this procedure, it was never compared to other standard methods of measuring outlet resistance. Others who advocate the technique of Robertson reported that only 43% of patients with SUI actually had loss of bladder neck support on urethroscopy (3). Scotti, et al performed a retrospective review of 204 patients who underwent dynamic urethroscopy for the evaluation of USI (4). Of the 204 patients, 99 had USI. Urethroscopy was found to be an imprecise predictor of USI with a 62% sensitivity, a 74.6% positive predictive value and a specificity of 79.1%. Moreover, there were many equivocal studies. The authors concluded that urodynamic evaluation rather than urethroscopy was a more accurate predictor of stress incontinence. Sand, and associates compared supine urethroscopic cystometry (dynamic urethroscopy) to the gold standard of multichannel urethrocystometry (5). They found a sensitivity of only 24.6% and a positive predictive value of only 65.2% in predicting detrusor overactivity.

Horbach and Ostergard tried to predict urethral sphincter insufficiency in women with SUI using urethroscopy (6). They retrospectively reviewed the records of 263 women who had a diagnosis of USI. They defined ISD as a maximal urethra closure pressure of 20 cm H₂O or less with the patient upright with a symptomatically full bladder. They then divided patients into two groups, those with ISD and those with maximal urethral closure pressures of more than 20 cm H₂O. Based on this classification, 132 women, or 50.2%, had evidence of ISD. However, when urethral function was assessed by endoscopy, only six of 132 patients with ISD were found to have an open or partially open proximal urethra and urethrovaginal junction at rest during urethrocystometry. Clinically, these patients had very low urethral pressures and reported difficulty with continuous leakage of urine. Endoscopy appeared to have little predictive value for ISD as defined by urethral pressure profilometry. Govier et al compared cystoscopic appearance of the female urethral sphincter mechanism to videourodynamic studies in 100 consecutive women with complex types of UI (7). Sphincter dysfunction was classified as minimal, moderate, and severe based on the radiographic appearance of the bladder neck with straining. Urethrocystometry underestimated the degree of sphincter deficiency 74% of the time in patients with moderate sphincter dysfunction and 44% of the time in patients with severe sphincter dysfunction. The authors concluded that cystoscopy is inadequate to judge the functional integrity of the bladder outlet. Furthermore, cystoscopy alone will underestimate intrinsic sphincter deficiency in a large number of patients.

3.5.2 Evaluation of the Bladder

Is cystoscopy necessary to rule out concomitant bladder pathology in patients with urinary incontinence? Langmade and Oliver reported on 253 patients who

were operated on for SUI (8). They used a simple evaluation that consisted of history, stress tests, and urinalysis alone. They did, however, recommend cystoscopic evaluation if the patient also complained of symptoms of urgency. Although this dogmatic approach was recommended, it was never clearly stated if it made a difference to the treatment or outcome in these patients. Fischer-Rasmussen, et al performed extensive evaluation of women with urinary incontinence (9). This included cystoscopy in 190 patients. They found cystoscopy to be abnormal in only 12 patients, 8 who had SUI and 4 who had other types of UI. Abnormal findings were trabeculated bladder in five patients, benign bladder papillomas in four, and metaplasia of the trigone in two. None of these was considered to be a significant finding. The authors concluded that cystoscopic examination did not contribute to the classification of incontinence in any case. Cardozo and Stanton evaluated 200 patients with SUI and detrusor overactivity (10). Cystoscopy revealed no abnormalities amongst the 100 patients with USI. Fourteen of the 100 patients with detrusor overactivity had cystoscopic abnormalities, eg trabeculation-11, injected mucosa- 1, saccululation ≥ 1 , a bladder capacity of less than 100 cc-1. However, in none of these patients was the treatment affected by the results of cystoscopy. In support of these findings, Mundy has stated that there is no direct diagnostic value of endoscopy in a patient with an overactive bladder. It may sometimes be helpful to look for and exclude a cause of hypersensitivity when this is in the differential diagnosis (11). Duldulao and colleagues found this necessary only in patients with haematuria (12). They performed urinalysis, urine cytology, and cystoscopy on 128 women who presented with urgency incontinence and/or storage voiding symptoms. Of these, 68 patients had UUI, 35 of whom also had microscopic haematuria. One patient with UUI and haematuria was found to have a transitional cell carcinoma of the bladder. None of the patients with urgency incontinence (or storage symptoms only) and no haematuria were found to have significant cystoscopic findings. This would support the routine use of cystoscopy for patients with urgency incontinence only if haematuria is present.

3.5.3 Extra-Urethral Urinary Incontinence

Endoscopy can be an invaluable tool in the diagnosis and treatment of extraurethral incontinence due to vesico-vaginal fistula and ectopic ureter. With respect to vesico-vaginal fistula, cystoscopy can precisely localise the fistula site in the bladder and help plan surgical correction. Occasionally, a small fistula that is not seen on physical examination or radiographic studies, can only be diagnosed by cystoscopy. Incontinence due to ectopic ureter in the female is usually diagnosed by radiographic studies. However, the exact location of the ureteral orifice in urethra or vagina can be identified by cystourethroscopy and/or vaginoscopy. This can be extremely helpful in the planning corrective surgery.

3.5.4 Intraoperative Lower Urinary Tract Evaluation

Several authors have studied the value of routine cystoscopy during operative procedures for incontinence and prolapse. The approach may be transurethral (13) or transvesical(14). The American College of OB/GYN has published a Bulletin on Operative Lower Urinary Tract Injuries (15) in which is stated “at the conclusion of the procedure, when hemostasis has been ensured, both ureters and the bladder should be inspected to confirm their integrity.” Harris and co-workers (13) reported 9 unsuspected ureteral or bladder injuries during urogynaecological surgery, which included 6 ureteral ligations, with four of these occurring after Burch cystourethropexy. Burch sutures were also found in the bladder as well as fascia lata from a sling procedure.

3.5.5 Evaluation of the Male Bladder Outlet

Urgency incontinence is one of the lower urinary tract symptoms associated with benign prostatic hyperplasia, bladder outlet obstruction, and aging in the male population. Based on the available evidence and world literature, The World Health Organisation Fifth International Consultation on BPH made the following recommendation: “Diagnostic endoscopy of the lower urinary tract is an optional test in the standard patient with LUTS (lower urinary tract symptoms) because: 1) the outcomes of intervention are unknown, 2) the benefits do not outweigh the harms of the invasive study, 3) the patients’ preferences are expected to be divided. However, endoscopy is recommended as a guideline at the time of surgical treatment to rule out other pathology and to assess the shape and size of the prostate, which may have an impact on the treatment modality chosen” (16). Several contemporary series have described the value of urodynamics in the diagnosis of post-prostatectomy UI (17-21). However, only one describes the routine use of urethrocytostcopy. In that series 67% of patients had urethral fibrosis confirmed by endoscopy (18). However, how this finding affected treatment was not discussed. In the study by Leach and Yun treatment of incontinence was based solely on urodynamic findings and was successful in 87% of patients (22). Anastomotic strictures may be suspected based on uroflow and urodynamic (pressure-flow) studies and can be confirmed by voiding cystourethrogram or videourodynamics as well as by endoscopy. However, if intervention for the stricture is deemed necessary, endoscopy would be a more critical part of the evaluation. Furthermore if surgical treatment of incontinence, such as, an artificial urinary sphincter, is planned it would seem to make good clinical sense to evaluate the urethro-vesical anastomosis with endoscopy prior to surgery.

3.5.6 Evaluation of Urethral Sphincter in Post-Prostatectomy Incontinence.

Iatrogenic UI in males usually occurs after prostate surgery for benign and malignant conditions. The pathophysiology of UI following transurethral surgery

for BPH includes sphincter damage from extending the resection too distal, particularly in the ventral aspect of the sphincter where muscle fibres are more abundant. Endoscopy in post-TURP incontinence reveals insufficient closure at rest with tissue loss in the ventral aspect of the sphincter area, voluntary muscle recruitment is often good. The pathophysiology of UI in post-radical prostatectomy patients is unclear. Numerous studies have investigated the relationship between parameters of urethral pressure profile, morphology of the prostate apex and length of the external sphincter area to post-prostatectomy incontinence. Although the results of these studies suggest a relationship between sphincter competence and UI, no consensus has been reached regarding the gold standard test to be performed prior to surgery to assess the individual patient risk of incontinence. Recently, Gozzi and Rehder suggested that post-radical prostatectomy incontinence may be related to prolapse of the sphincter complex and that repositioning of it by a transobturator sling may be successful. Pre-operative selection of surgical candidates for such intervention include endoscopy of membranous urethra testing whether manual push-up of the centrum tendineus perinei results in recruitment of the sphincter fibres comparable to a voluntary contraction. Contraction of the sphincter muscle upon repositioning in a more cranial position is used as an indication for a transobturator sling with the Gozzi and Rehder technique (23-25). Further research is required to confirm such an interesting pathophysiological explanation of post-radical prostatectomy UI and to support the role of endoscopy in the evaluation of these patients.

3.5.7 Consensus Statements

- Routine urethro-cystoscopy is NOT indicated in primary female UI, when other pathologies are not suspected (**Level of Evidence 3, Grade of Recommendation C**)
- Endoscopy can be considered (**Level of Evidence 3, Grade of Recommendation C**):
 - in urgency incontinence to rule out other pathologies, especially in case of microscopic haematuria (e.g., bladder tumour, interstitial cystitis, etc)
 - in the evaluation of recurrent or iatrogenic cases when surgery is indicated and planned
- Endoscopy is indicated in the evaluation of vesico vaginal fistula and extra-urethral urinary incontinence (**Level of Evidence 3, Grade of Recommendation C**).
- Endoscopy is indicated intraoperatively in incontinence surgery to look for ureteral or vesical injury (**Level of Evidence 3, Grade of Recommendation C**).

B.3.e.8 FUTURE RESEARCH AREAS

- The relationship between of bladder endoscopy and idiopathic detrusor overactivity
- The relationship between of bladder endoscopy and aging
- The relationship between bladder endoscopy and symptoms of voiding dysfunction in female patients with UI

III. IMAGING IN ANAL INCONTINENCE

Anal incontinence may result from anatomical and/or neurological disruption of the anal sphincter complex. Prior to the development of anorectal imagining techniques, anal sphincter disruption was detected by digital palpation supported by EMG needle mapping and ano-rectal manometry. Use of endoanal ultrasonography (EAUS) for anal sphincter imaging was first described by Wild in 1956 (1) but remained neglected for many decades because of the limitation of technology then available (2). In 1989 Law and Bartum defined the technique of EAUS and endosonographic anatomy of the anal sphincter complex (3). Since then EAUS has become the gold standard of imaging the anal sphincter complex.

Development of 3-D rendering technique over the last decade has enabled better quality imaging of the anal sphincter complex using the EAUS. Recently other imaging modalities such as transvaginal, transperineal and translabial ultrasonography, MRI, Defaecography and Sonoelastography have been described to assess the anal sphincter complex in patients with anal incontinence.

1. INDICATIONS

Anal sphincter imaging has become an integral part of the assessment of anal incontinence. Following detailed history and examination, the patient should be offered anal sphincter imaging (either 2D or 3D EAUS) depending on the availability of imaging modalities and the expertise. Even though ano-rectal physiological studies indicate dysfunction of the anal sphincter complex, they do not identify the anatomical site and the degree of anal sphincter disruption. EAUS has been the gold standard for detecting anal sphincter disruption or atrophy. EAUS is also used in the follow up of women after obstetric anal sphincter injuries to assess the success of the primary repair and to advise on subsequent delivery⁴. EAUS has been used intra-operatively to identify the damaged EAS prior to secondary repair and also to identify the IAS defects prior to injecting bulking agents.

2. IMAGING MODALITIES

2.1. Ultrasonography

The increased availability of ultrasound scanners to urologists and urogynaecologists and its high resolution in the near field makes this the perfect tool to investigate patients with anal incontinence as a part of their physical examination.

2.1.1 Endoanal Ultrasound (EAUS)

EAUS is performed using a 360° rotating rectal probe with a 7 - 10 MHz transducer (focal range 2-4.5cm) with minimum beam width of 1.1mm. Several systems are currently available, and recently integrated 3D systems are also available (B&K Medical, Sandofte 9, 2820 Gentofte, Denmark). Women should be examined prone with an endoanal system to minimise anatomical distortion. Figure 37 shows a schematic diagram of the anal sphincter complex in relation to the endoanal probe (4).

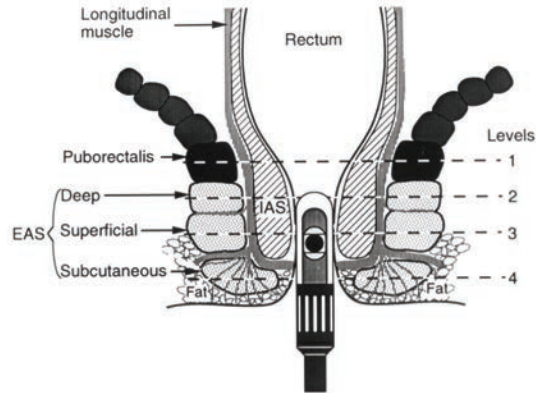

Figure 37: A schematic diagram of the anal sphincter complex in relation to endoanal probe.

The standard EAUS image of the anal canal is of 4 layers (Figure 38):

1. The subepithelial layer is moderately reflective.
2. The internal sphincter is the most obvious landmark and is a well-defined low reflective ring. The internal sphincter varies in thickness with age, being <1mm in neonate, 1-2mm in young adults, 2-3 in middle age and >3mm in the elderly.
3. The longitudinal layer is a complex structure with a large fibroelastic and muscle component, the latter formed from the puboanalis as well as the longitudinal muscle of the rectum (Figure 38).
4. The external sphincter is better defined in men than women, where it tends to be less hypochoic. It is distinguished mainly by interface reflections between muscle/fat planes either side (Figure 38). In women the external sphincter is shorter anteriorly than posteriorly, which must not be misinterpreted as a tear. The transverse

perineii muscles fuse anterior with the sphincter, whereas in men they remain separate.

With experience the examination can be performed in about 5 minutes and provides an ideal method for a rapid assessment of sphincter integrity and thickness.

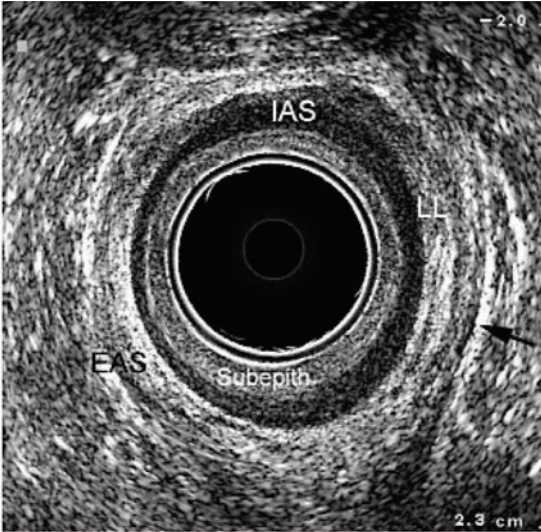

Figure 38: Axial endosonography in the mid canal in a normal 38yr old female. Subepith: subepithelial

layer; IAS: internal anal sphincter; LL: longitudinal layer; EAS: external anal sphincter. The outer border of the external sphincter is defined by an interface reflection at the fat/muscle boundary (arrow).

2.1.2 3-Dimensional Endoanal Ultrasonography (3-D EAUS)

With 3D-EAUS, the anal canal is scanned in a conventional manner, and dedicated software provides a final 3D appearance (3D rendering). The data obtained from a series of closely spaced EUS images (0.25 mm) are combined to create a 3D volume displayed as a cube. The image can then be freely rotated and it is possible to visualise defects at different angles and to obtain the most information from the data (5). The advent of 3D ultrasonographic multiplanar reconstruction of the anal canal has further improved the detection of anal sphincter injuries with nearly 95-100% sensitivity and specificity⁶. With 3D-EAUS, the aspect, localisation (circumference involved, height), size (in degrees or percentage of circumference) and number of sphincter defects can be described in detail, together with a calculation of the volume of such defects⁷. Defects of the puborectalis fibres of the levator ani are less common and these can be seen as heterogeneous remodelling or shortening of the two bands is visible after episiotomy or pelvic floor injury during vaginal delivery.

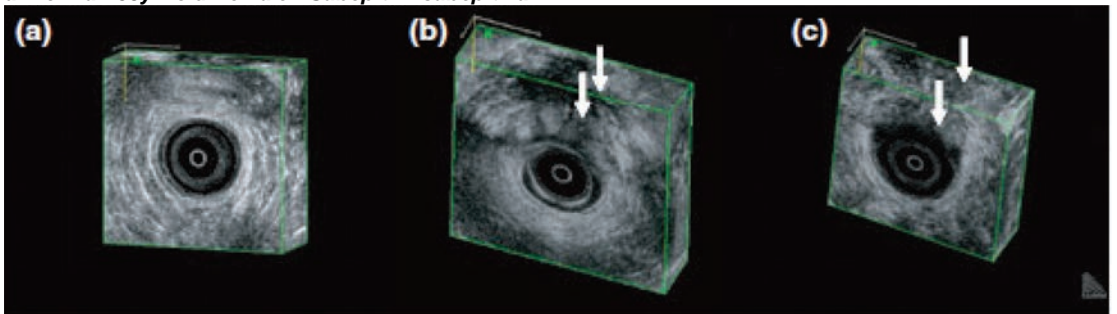

Figure 39: Three-dimensional endoanal ultrasound showing no (a), partial (b) or complete EAS defect (c). Arrows indicate an EAS defect in the sagittal view (10).

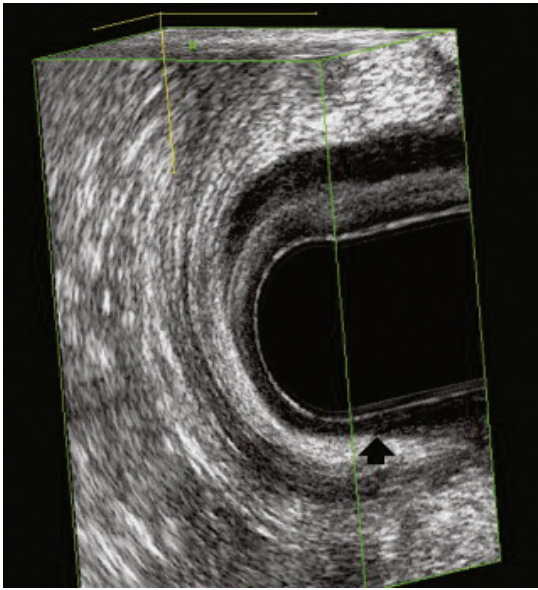

Figure 40: Complete defect of the internal anal sphincter (6).

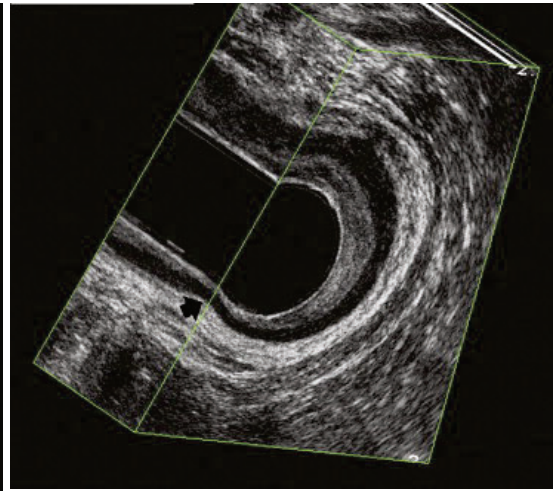

Figure 41: Partial defect of the internal anal sphincter (6).

Its role in the development of AI is probably underestimated and characterisation, particularly in terms of volume, would be of interest to assess the functional impact (6). Two scoring systems has been introduced to objectively evaluate the anal sphincter defects detected in 3D EAUS (8, 9) and both these scoring system have shown acceptable intra observer and inter observer agreement (9).

Although EAUS has been accepted as the gold standard of imaging anal sphincter complex, the equipment and the expertise may not be readily available in some centres. Some patients may find EAUS technique embarrassing and unacceptable. Hard endoanal cone of EAUS may cause the disruption of normal anal canal anatomy. Because of these drawbacks, other imaging modalities such as endovaginal, transperineal and translabial ultrasonography have been evaluated to assess the anal sphincter complex.

Sultan et al first described the vaginal use of 360° rotating probe used for the EAUS and obtained clear images of anal sphincter complex (11). Since then different types of probes including side-fire transrectal probe, a standard transvaginal probe and modified vaginal probe has been used to evaluate the anal sphincter complex with variable sensitivity and specificity for detecting anal sphincter injury (12).

2.1.3 Transperineal ultrasonography

Transperineal ultrasonography (TPU) to image the anal sphincter complex was first described by Peschers et al. (13) and found to have a good inter observer reliability in detecting IAS and EAS defects compared with EAUS (14). A recent study by Roos et al. (12)

comparing endovaginal and transperineal ultrasonography to detect obstetric anal sphincter have concluded that neither of these modalities is sensitive enough to detect anal sphincter defects.

2.1.4 Translabial Ultrasonography

Translabial ultrasound (TLU) offers an alternative imaging modality of the anal sphincter complex and has proven to be well-tolerated by patients. It has been used to describe anal sphincter complex integrity (13, 15). Hall et al evaluated 60 women with TLU and reported that mean sphincter measurements are given for symptomatic and asymptomatic intact women and are comparable to previously reported endoanal MRI and endoanal ultrasound measurements(16). The advantages of TLU are that the equipment needed is readily available to all gynaecology and radiology imaging laboratories.

2.1.5 Integrated Multicompartmental Pelvic Floor Ultrasonography

Pelvic organ dysfunction includes multiple conditions such as pelvic organ prolapse, urinary incontinence, anal incontinence, defaecatory disorders and sexual dysfunction. Based on this concept integrated multicompartmental Pelvic Floor imaging including two-dimensional (2D), three-dimensional (3D) and 4D pelvic floor ultrasonography as well as transvaginal, endoanal and transperineal techniques, has been described from a global and multicompartmental perspective (17). The value of this approach in routine assessment of pelvic floor dysfunction is yet to be evaluated.

2.1.6 Dynamic Anorectal Endosonography (DAE).

DAE uses a rigid biplane transrectal probe with a frequency of 7 MHz with the tip of the probe covered with a water-filled balloon to maintain the acoustic window for the ultrasound waves. By slowly and manually rotating the linear probe through 360°, various layers constituting the anal wall (mucosa, internal anal sphincter, and external anal sphincter), the layer forming the rectal wall, and the perirectal tissues (puborectalis muscle, bladder, and vagina, or prostate) has been demonstrated. After the initial examination, the patient simulates defaecation with the probe left in the same position (18). In a study of 56 women using DAE and Dynamic MRI Defaecography significantly more internal anal sphincter defects were found with DAE than with dynamic MRI defaecography, but there was no significant difference for the diagnosis of external anal sphincter defects (18).

2.1.7 Sonoelastography

Sonoelastography is a new imaging technique based on differences in radiofrequency signals following endogenous/exogenous compression due to different elastic properties of the targeted tissues or organs (19). This technique has been evaluated in pathological conditions of breast, thyroid, pancreas and prostate. The elastographic pictures registered simultaneously with conventional grayscale B-mode images during sonography or endosonography are assumed to distinguish malignant from inflamed areas and thus facilitate diagnosis. Based on this concept it is assumed that Sonoelastography is able to diagnose different conditions causing anal incontinence. However there is only one published study comparing the con-

ventional endoanal ultrasonography and elastography (20). This prospective study included 50 patients with faecal incontinence following ano-rectal surgery and Crohn's disease. Elastogram colour distribution within the sphincter representing elastic properties was quantified using a visual analogue scale and an off-line computerised area calculation program. The IAS, a smooth muscle, and the EAS, a striated muscle, have different elastogram colour distributions, probably reflecting their different elastic properties. The absence of significant correlations with the major clinical and functional parameters suggests that in routine clinical practice ultrasound real-time elastography may not yield additional information in patients with faecal incontinence except in patients who have had radiation.

2.2. MRI

Anatomy of the anal sphincter complex has been re-defined over the past 20 years by the use of body coil, endoanal coil and phased-array coil magnetic resonance imaging (MRI). However these different MRI techniques have led to conflicting anatomical descriptions of the anal sphincter complex (21). Endoanal coil MRI studies by Rociu et al. (22, 23) have suggested that the levator ani muscle has only a transverse portion and that the EAS muscle is composed of only a subcutaneous and a superficial portion describing five image layers. (Fig 41)

However, body coil MRI studies by Guo and Li (24) suggested that the levator ani muscle also has a vertical portion (vertical levator), and separate body coil MRI studies by Hsu et al. (25) suggested that the EAS muscle has 3 separate components which has been identified in EAUS as well.

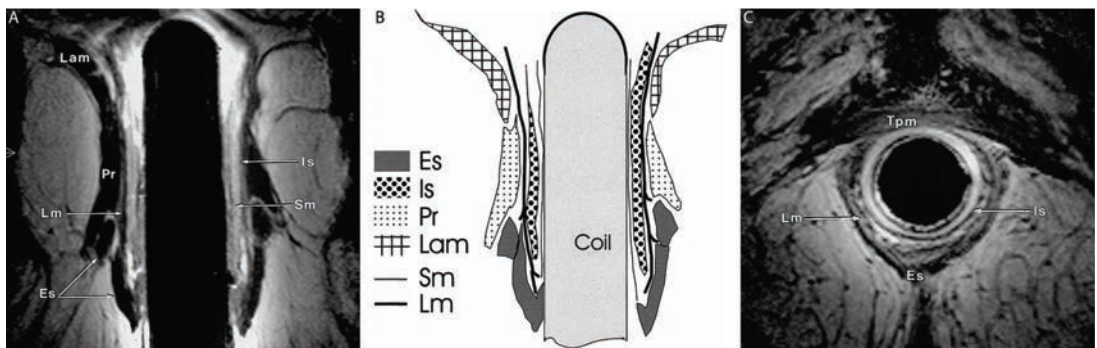

FIGURE 42:T2-weighted turbo spin-echo endoanal coil MRI studies by Rociu et al.

A: "5-layer" anal region and blind zone of the endoanal coil MRI.

B: Drawing of anal midcoronal section.

C: Inner intersphincteric space with high signal intensity is mislabeled as the internal sphincter.

Es - external sphincter; Is - internal sphincter; Lam - levator ani muscle; Lm -longitudinal rectal muscle; Pr - puborectalis; Sm –submucosa

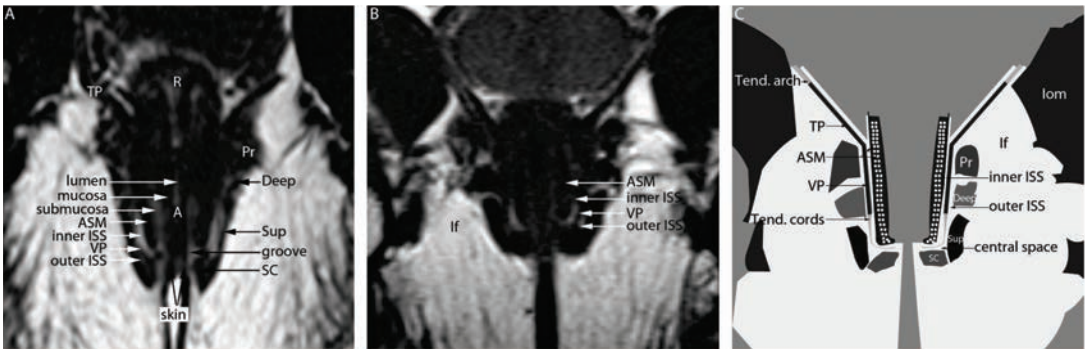

Figure 43: Midcoronal T1-weighted turbo spin-echo body coil MRI images.

A, 7-layer anal region.

B, 3-layer intersphincteric space.

C, Drawing of anal midcoronal section.

A - imaging anal canal; ASM - anal smooth muscle; Deep -deep sphincter; If -ischioanal fossa; lom -internal obturator muscle; ISS -intersphincteric space; Pr -puborectalis; R -rectum; SC -SC sphincter; Sup -superficial sphincter; TP- transverse levator; VP -vertical portion of the levator ani. (26)

More recent study by Guo et al. (26) using multiplanar body-coil MRI studies demonstrated that the anal region actually has 7 image layers: the mucosa, submucosa, anal smooth muscle, inner space, vertical levator, outer space, and the EAS muscle (Figure 42). The authors reported that endoanal MRI does not reliably outline the superficial layers of the anal region because a blind zone is created in the anal canal near the coil. This blind zone led investigators to effectively ignore the mucosa, submucosa, anal smooth muscle, intersphincteric groove, and subcutaneous sphincter and this accounts for the early endoanal MRI description of the anal region as comprising only 5 image layers. Images of the anal sphincter complex obtained using endoanal MRI are thought to be superior to MRI performed with a body coil because of increased signal to noise ratio resulting in high spatial resolution images. Although the endoanal MRI allows comprehensive assessment of atrophy and focal defects of the external canal, the internal sphincter has been less well defined (27). A meta analysis of nine studies, comparing endoanal MRI with endoanal ultrasound or surgical diagnosis in 157 patients by Tan et al. (28) has shown that endoanal MRI was sensitive and specific for the detection of external sphincter injury and especially sphincter atrophy. It may be useful as an alternative to endoanal ultrasound in patients presenting with faecal incontinence. However, the limited availability of dedicated endoanal coils outside specialist units has resulted in less widespread familiarity with this technique and further clinical studies are needed to identify its best application in clinical practice.

In addition to the damage to the anal sphincter complex, levator ani muscle (LAM) injury has also been postulated as a cause for anal incontinence especially after childbirth. A recent MRI study by Helliburn et al. (29) reported major LAM injuries in 19% of women who delivered vaginally with external anal

sphincter (EAS) injuries compared to 3% delivered vaginally without EAS injury, and 0% delivered by caesarean section before labour. Among women with EAS injuries, those with major LAM injuries tend to have more anal incontinence symptoms than those who did not have LAM injury. These data suggest that both EAS and LAM are important to maintain faecal continence.

2.3. Evacuation Defaecography (Proctography)

Evacuation defaecography is indicated in patients with constipation, and in those with obstructive defaecation associated with anal incontinence caused by overflow incontinence or post defaecation leakage. In these patients, defaecography is useful to visualise outlet obstruction due to an anatomical (e.g. enterocele, rectocele, intussusception) or a functional (e.g. anismus) cause. Evacuation defaecography is also useful to demonstrate bladder and uterovaginal prolapse as well as pelvic floor descent (Figure 43 a-b) but gives limited information as to rectal function. Evacuation defaecography has shown good reproducibility in the diagnoses of enterocele, anterior rectocele and their grading in patients with faecal incontinence (30).

The rectum is opacified with 120 mls of a barium paste and the small bowel with a dilute barium suspension given orally about 30mins before defaecography starts. The patient is seated sideways within the fluoroscopic unit on a radiolucent commode. Evacuation of the barium paste is recorded either on video or on cut film at 1 frame/sec using a low dose protocol. At rest the anorectal junction is at the level of the ischial tuberosities and the anal canal closed. Evacuation is rapid (<30sec) and the rectum below the main fold should be emptied completely. During

evacuation the anorectal angle widens as the anorectal junction descends and the anal canal opens. At the end of evacuation pelvic floor tone returns and the puborectalis pulls the anorectal junction upwards and forwards back to the resting position. Intra-anal intussusception creates a thick double fold of rectum, which impacts into the anal canal on straining at the end of rectal evacuation. Rectal prolapse represents an extension of this process, with passage of the intussusception through the anal canal and inversion of the rectum (Figure 44 a-c)

Compared to conventional evacuation defaecography, dynamic MR defaecography at a vertical open magnet unit has become popular recently as it produces multiplanar images with increased soft tissue contrast and avoids radiation exposure. However the comparative results between conventional defaecography and dynamic MR defaecography in patients with prolapse and anal incontinence are variable (31, 32). Some of these variations have been attributed to the difference in technique. The main drawback of MR defaecography is the supine position required which causes sub optimal assessment of prolapse and evacuation (31). Since vertical open-magnet MR imaging units are not widely available, the role of MR defaecography in the diagnostic work-up of faecal incontinence is still limited.

Figure 44: Sagittal views from a dynamic MRI examination.

The dotted line indicates the position of the pubo-coccygeal line. At rest (a) there is some descent as the anorectal junction (ARJ) is more than 1 cm below this. During pelvic stress (b) there is marked pelvic floor descent, with descent of the cervix (Cx) and bladder base (Bl).

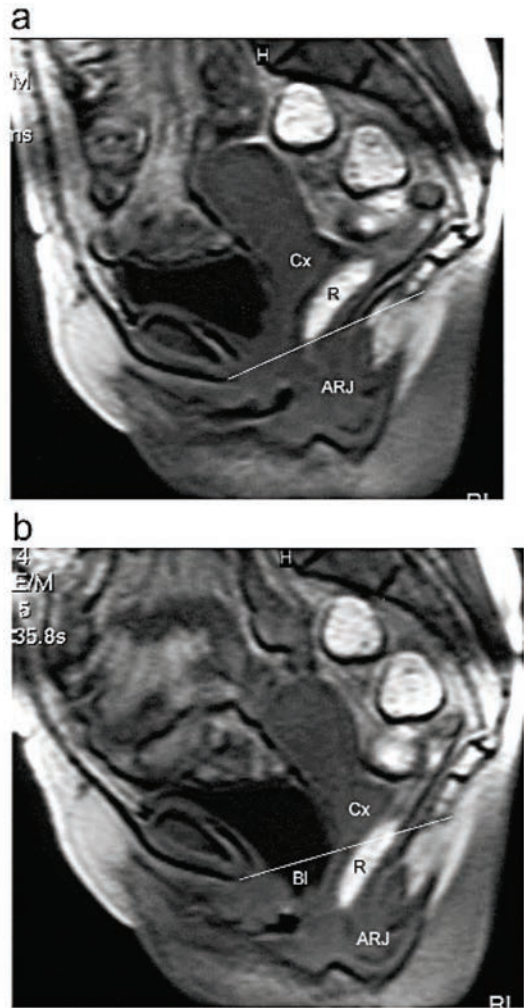

Figure 45: Evacuation proctogram showing the development of rectal prolapse. Intussusception starts at the end of rectal emptying (a) and rapidly passes through the anal canal (b) to form the external prolapse(c).

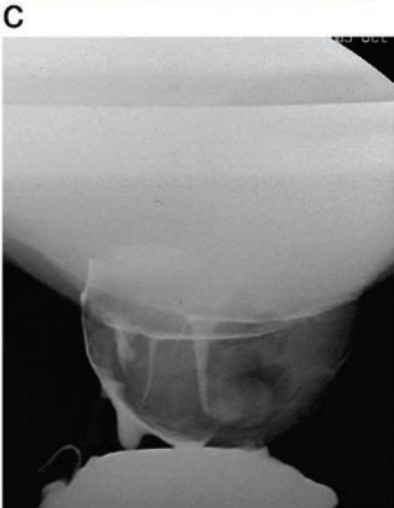
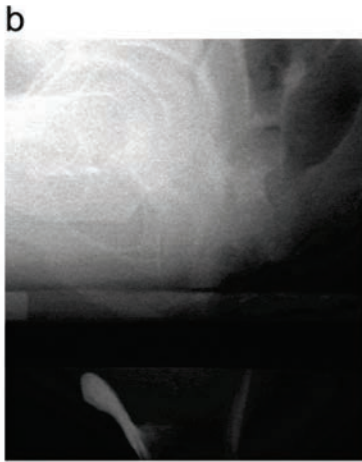
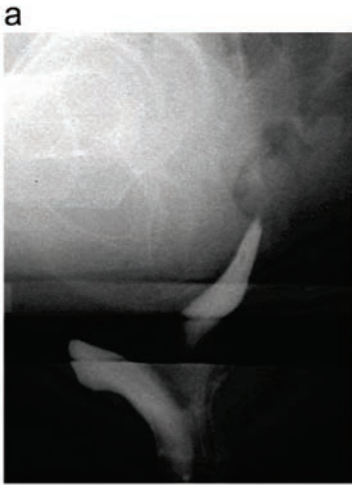
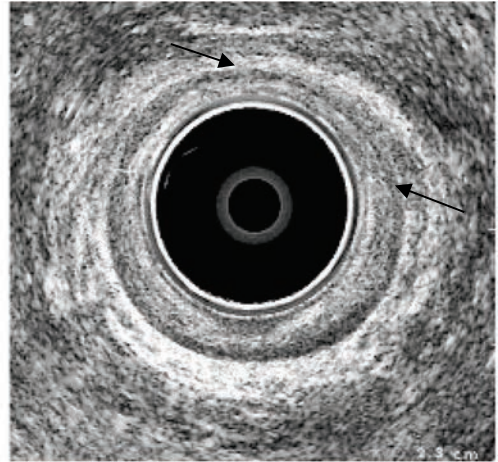

Figure 46: Endosonography with an axial image in the mid canal of an elderly patient, aged 73yrs with passive faecal incontinence. The internal sphincter measures only 1.1mm (markers) indicative of internal sphincter degeneration.



3. SPHINCTERIC DISORDERS

3.1. The Internal Anal Sphincter (IAS)

IAS is responsible for the maintenance of resting anal pressure and plays a vital role in maintaining anal continence. Isolated IAS defects are associated with surgery for ano-rectal malignancies, anal fissure and undetected obstetric anal sphincter injuries. These patients may present with passive faecal soiling and seepage rather than frank faecal incontinence.

Abnormalities of thickness are usually related to the patient's age. A sphincter less than 2mm thick in a patient more than 50 years of age is indicative of internal sphincter degeneration (Figure 45) and is associated with passive faecal incontinence.

Obstetric trauma to the internal sphincter parallels that of the external sphincter in extent, but should always be in the anterior half, so that any defect between 3 and 9 is due to some other cause.

Sphincterotomy may be more extensive than was planned, particularly in women, and 3D studies are especially helpful to assess the longitudinal extent of the defect. The length of the sphincter divided relates directly to the risk of incontinence (33). Dilatation procedures are hazardous and may completely fragment (Fig 46) the internal sphincter.

3.2. The External Anal Sphincter

When striated muscle is stretched beyond the limits of its elasticity fibres rupture and heal with granulation tissue and eventually fibrosis. Most chronic tears are seen with scar formation, and present as a uniform area of low reflectivity distorting and obliterating normal anatomical planes (Figure 44). A key to the diagnosis is lack of symmetry with the anterior part of the

external sphincter not fusing at 12 o'clock as the probe is moved slowly down the canal. This may also be seen on 3D studies in the coronal plane (Figure 45). Other perineal structures, such as the puboanalis and transverse perineii are frequently torn and distinguishing these tears from external sphincter trauma requires experience, and again may be helped by 3D multiplanar imaging. The distinction is important as tears of the puboanalis or transverse perineii are not associated with a significant fall in squeeze pressure (34), and it is only damage to the external sphincter that results in a significant change. Childbirth damage to the puborectalis part of the levator ani muscle with intact EAS and IAS has been reported as a distinct cause of anal incontinence. 3-D EAUS is reported to be superior in detecting this type of injury (35).

In healthy young adults a good correlation has been found between measurements of layers thicknesses on endosonography and endocoil MRI, with an Ri of 0.96 for the external sphincter (36). The outer border of the external sphincter is easier to see on MRI, but fibrosis is not so markedly different in signal from normal muscle, so that the conspicuity of tears may not be as obvious as with endosonography.

Atrophy of EAS is a more difficult problem. Determining the thickness of the external sphincter on EAUS depends on visualising its borders from interface reflections between the longitudinal layer on the inside and subadventitial fat on the outer border. As atrophy involves a reduction of muscle fibres and an increase in fat, the outer interface reflection is lost and the thickness of the external sphincter cannot be measured. Such loss of definition of the outer border of the external sphincter on endosonography has a positive predictive value of 71% for atrophy (37). Using 3D EAUS and a grading system based on definition (Figure 47) and echogenicity of the external sphincter showed a comparable accuracy to endocoil MRI in detecting atrophy (38).

4. CONCLUSIONS

Claims for superiority of one or other modality for the detection of sphincter tears probably depend largely on individual experience, but the relative low cost and speed of EAUS makes this an ideal screening procedure to assess sphincter integrity. A leading issue is the significance of occult sphincter tears (diagnosed on endosonography but not apparent clinically) following vaginal delivery. Although these may be detected by careful examination immediately post partum (39), retrospective detection will still require EAUS. A meta-analysis of 717 vaginal deliveries revealed a 26.9% incidence of anal sphincter tears in primiparous, with 8.5% new tears in multiparous women. Overall 29.7% of women with tears were symptomatic, compared to only 3.4% without tears. The probability of faecal incontinence being due to a sphincter tear was 76.8-82.8% (40). Recent studies confirm the strong relationship between obstetric sphincter damage and faecal incontinence (41), and

its late onset (42,43). Subsequent deliveries increase the risk of incontinence particularly if there has been a tear at the first delivery (44). Tears that involve the internal sphincter increase the severity of incontinence (45). A sphincter tear at EAUS is therefore an important finding, but how this is used to decide management is a little more controversial. Secondary anal sphincter repair has fallen out of fashion following the finding that results deteriorate over a few years⁴⁶, although a more recent study (47) suggests a better response.

Fluoroscopic studies have little role in faecal incontinence, unless there is an underlying rectal abnormality such as obstructive defaecatory symptoms and prolapse. Dynamic MRI studies have the added value of demonstrating prolapse in the rest of the pelvis, but apart from the lack of ionising radiation, has no real advantage for studying rectal function.

EAUS therefore remains the first line imaging investigation for anal incontinence, giving accurate information regarding the external and/or internal sphincter tears and the likelihood of atrophy. Dynamic studies of rectal evacuation are required only if there is some other problem suspected, such as prolapse. The advantages of using MRI are the lack of ionising radiation and a global view of the pelvic floor. Although imaging gives hard evidence of sphincter damage, this is really only part of a much more complex functional problem, and colorectal abnormalities may be just as important (48) with tears accounting for perhaps only 45% of incontinence (49).

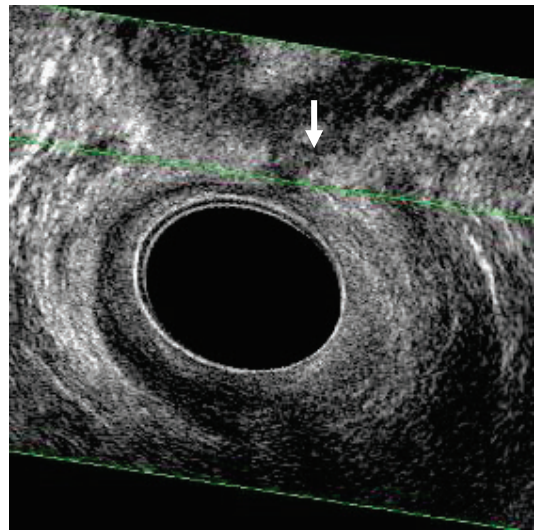

Figure 47: 3D EAUS of a small tear to the external sphincter (arrow).

5. CONSENSUS STATEMENTS

- EAUS is the first line imaging investigation for faecal incontinence providing accurate information regarding external and/or internal sphincter tears and the likelihood of atrophy. (Level of Evidence 3, Grade of Recommendation C).
- 3-D EAUS offer better quality images and diagnosis of the depth of anal sphincter injury. (Level of Evidence 3, Grade of Recommendation C)
- Routine use of 3-D EAUS is not recommended because of the cost. (Level of Evidence 3, Grade of Recommendation C)
- Routine use of transperineal, transvaginal and translabial ultrasonography to image the anal sphincter complex are not recommended. (Level of Evidence 3, Grade of Recommendation C).
- Dynamic imaging of rectal function is required when rectal abnormalities such as prolapse are suspected (Level of Evidence 3, Grade of Recommendation C).
- MRI offers no advantage over other imaging modalities except for the lack of ionising radiation and global view of the pelvis (Level of Evidence 3, Grade of Recommendation C)

6. FUTURE RESEARCH AREAS

Better image quality with 3D EAUS and MRI have improved our understanding of pelvic floor anatomy, and this in turn has enabled sonographic anatomy to be re-evaluated, however, conflicting views of anal sphincter anatomy remain.

- Are clinical symptoms related to the size and the site of anal sphincter defect (50) or not (51)?
- Significance of imaging in detecting anal sphincter injury especially immediately after childbirth in preventing future anal incontinence (39,52).
- The value of ano-rectal physiological studies combined with imaging in assessing the success of surgical repair of the anal sphincter complex (53).
- Identify (and modify) the risk factors leading to anal sphincter injury especially during childbirth and develop preventive strategies (54).

The most valuable aspect of 3-D ultrasonography and MRI imaging is that they give a global view of the pelvis, capable of investigating urological, gynaecological and coloproctological problems at the same time (17). Many patients do not have faecal incontinence as an isolated symptom, but also have urinary, prolapse or defaecatory problems. The overview provided by imaging sets the way for a combined approach to the pelvic floor and should be the prime area of future investigation (17).

IV. PAD TESTING

The use of a perineal electronic nappy using electrical conductivity to estimate the amount of urine leakage was first proposed by James et al. (1, 2). Accuracy of this technique was, however, questioned by others and the technique was improved (3-8). Walsh & Mills and Sutherst et al. introduced a more simple approach by estimating leakage by perineal pad weight gain (9, 10). These tests were not standardised until Bates et al. described a "structured" one hour pad test which was endorsed by the International Continence Society in 1988 (11). This test, however, was shown to have poor interdepartmental correlation and to be highly dependent on bladder volume (12, 13). In an attempt to make pad tests more reliable 24 hour and 48 hour pad tests were developed. A more precise estimation of urine loss was shown, but they were more cumbersome. The Pyridium pad test was also proposed for diagnosing urinary incontinence (14).

1. DEFINITION

The pad test is a diagnostic method to detect and quantify urine loss based on weight gain of absorbent pads during a test period under standardised conditions.

2. INDICATION AND METHODOLOGY

A pad test allows the detection and quantification of urine loss, but it is not diagnostic of the cause of the incontinence. Several different standards have been developed. Tests can be divided into four groups according to the length of the test: <1h, 1h, 24h and 48 h. (Table 4)

Table 4: types of pad test

Author	Time	Bladder load	Exercise
Hahn & Fall (15)	20 min	50% of MCC*	stair climbing, 100 steps, coughing (10x), running (1 min), wash hands (1 min) jumping(1 min)
ICS (11)	1h	Drink 500 ml (15 min) before test	walking & stair climbing (30 min), standing up 10x, coughing (10x), running (1 min), bending (5x), wash hands (1 min)
Jorgensen et al. (16)	24h		Everyday activities
Jakobseny et al. (17)	48h		Everyday activities

*Maximum Cystometric Capacity

3. OFFICE-BASED PAD TESTING

Pad tests up to 2 hours were developed to be performed in outpatient clinics or hospital wards under supervised conditions. Bladder volume is predefined to reduce variability and a structured set of exercises is usually implemented to elicit the occurrence of urine loss.

3.1. Short Pad Test

Quantification:

These tests are based on a fixed bladder volume and a standard set of activities to facilitate the occurrence of urine loss, if any, over a short period of time. Jakobseny et al. found that the 40 minute test with a bladder volume of 75% maximum cystometric capacity and similar activities as a 1-hour ward test produced consistently larger amounts of urine loss than a standard 1-hour ward test (17). The difference was attributed to significantly larger bladder volumes during performance of physical activity in a 40 minute pad test.

Kinn & Larsson reported no correlation between a short 10 minute test with fixed bladder volume and the degree of incontinence as judged from the symptoms (18).

Hahn & Fall in a 20 minute test with half cystometric capacity showed no false negative results in 50 women with stress urinary incontinence although there was a discrepancy in 12% of patients between the perception of incontinence severity and pad test results (15).

These data suggest that short pad tests are more provocative than activities of daily living.

Reproducibility:

The correlation factor (Pitman's nonparametric permutation test) between two separate 20 minute tests was 0.94 ($p < 0.001$) (15). Kinn and Kinn & Larsson showed that the 10 minute test with a fixed pre-test bladder volume of 75% of maximal capacity was moderately reproducible ($r = 0.74$) (18). Using a 1 hour pad

test, a standardised bladder volume of 300ml and standardised physical activity mean differences of leakage was 8.5 ml and coefficient of repeatability was 33.6 ml (19).

3.2. One-Hour Pad Test

The use of a one-hour pad test has been investigated thoroughly for validity, reproducibility and sensitivity to change.

Quantification

Jakobseny et al. reported that a one hour test detected less leakage at 3 g compared to a 40 minute (7 g) and a 48 hour pad test (37 g) (17). In the elderly, a one-hour ward test did not demonstrate incontinence in 66% of those complaining of incontinence compared to 90% with a 24 in-patient monitoring of urine leakage (20). A one hour pad test was found to reflect everyday incontinence in only 48% of patients in comparison to 81% with a 48 hour test and 77% with a 40 minute test. Jorgensen et al. noted that 90% completed the test and 69% had test results which correlated with daily leakage (16). Lose et al. found a poor to moderate correlation of the modified one-hour test (200-300 ml in the bladder) with a history of stress urinary incontinence ($n = 31$) (21). Mouritsen et al. showed that a 1-hour ward pad test did not detect grade I stress incontinence in 46%, grade II in 27% and grade III in 66% (22). Thind & Gerstenberg compared a 1-hour ward pad test to a 24-hour home pad test and found that a 1-hour pad test had a 36% false-negative rate as compared to a 24-hour home pad test (23).

Reproducibility

Klarskov & Hald demonstrated in 3 consecutive 1-hour pad tests, a correlation coefficient of 0.75 and 0.97 depending on the activity regimen (24). The test, however, was quite demanding and a lot of patients did not complete the full testing. Christensen et al. compared a one-hour pad test in two different urological and one obstetrics & gynaecological departments (20 women) (13). The test results in two urological departments did not differ with an average pad gain of 24g and 21 g ($p > 0.1$). However, pad test results

between the departments of urology and gynaecology differed significantly, with average pad weight gain 9 g and 24 g respectively ($p < 0.05$).

Lose and co-workers showed a significant variation between 1-hour ward test and retest in 18 patients (correlation coefficient 0.68) (12). In 50% of patients the leakage volume was variable due to differing bladder volume. When the results of the 1-hour pad test were corrected for urine volume, the correlation coefficient value increased to 0.96. Simons et al found the reproducibility of the standard 1 hour pad test to be poor (25).

Validity

Walsh & Mills in the elderly and Holm-Bentzen et al. in patients with an AMS artificial sphincter showed that the one hour pad test did not correlate with subjective patient satisfaction but this may be due to other lower urinary tract symptoms (9, 26).

Bladder volume

Jorgensen et al showed test-retest correlation was improved when the bladder volume was taken into account and the correlation value (r) raised from 0.68 to 0.93 (16). Fantl et al used a one hour test with the bladder filled to capacity and had a test-retest correlation of 0.97 which was improved if the fluid loss was expressed as a percentage of bladder volume (27). Lose et al. using a 1-hour pad test with standardised bladder volume of 50% of maximal cystometric capacity (MCC) showed in 25 women a test retest correlation of 0.97 but the intertest variation was up to 24g (28). Jakobsen et al. compared a 1-hour pad test with a bladder filled to 50% and 75% of maximal cystometric capacity and found that the final bladder volume was equal in both groups showing the importance of diuresis even with equal starting bladder capacities (29). The amount of leakage in both groups was the same. Simons et al. found the volume in the bladder after a standard 1 hour pad test varies by -44 to +66g in a test-retest situation (25). The fluid volume in the bladder appears to be critical in making the pad test reproducible and increasing the sensitivity of the test for detecting leakage.

Aslan et al compared a 1 hour pad test loss with the symptom impact index (SII) and the symptom severity index (SSI) (30). Only the SSI showed a relationship between the severity of the score and the pad test loss. The 1 hour pad test has also been used in assessing the validity of the Incontinence Impact Questionnaire and the Urogenital Distress Inventory unfortunately both had poor correlations with the pad test (31). This is to be expected as the questionnaires assess other urinary symptoms rather than just leakage.

Diagnosis

Fluid loss was significantly greater in patients with detrusor overactivity in comparison to urodynamic stress incontinence (27, 32). The reverse finding was reported by Matharu and co-workers (33). There is

high variability in patients with detrusor overactivity making the test impractical as a diagnostic tool.

Sensitivity to change

The 1 hour pad test has been shown to be useful in detecting significant improvements after pelvic floor exercises for men suffering urinary incontinence after radical prostatectomy (34). Ward et al. found the standard 1 hour pad test to show significant reductions in loss after tension free vaginal tape procedures from 18g (IQR 6-37) and Burch colposuspension from 16g (IQR 6-38) both decreasing to 0g (IQR 0) (35). The 1 hour pad test has also been tested for the reduction in loss after conservative and surgical therapy (36). The changes were significant but there was moderate correlation ($r = 0.53$) with the changes in the St. George Urinary Incontinence Score.

3.3. Two-Hour Pad Test

A test period of 60-120 minutes after a 1 litre fluid load was proposed as the optimal duration for the pad test because of a consistently high bladder volume (37). Han et al showed, however, that a 1-hour pad test is more practical (38). In children a 2-hour ward pad test yielded 70% positive results for incontinence (39). Richmond et al. compared two exercise regimens with a 2-hour pad test and showed no significant differences regarding which order the exercises were performed (40). Walters et al. performed a 2-hour pad test with standard exercise in 40 women with SUI showing 78% positive tests (>1g pad gain) after 1 hour and 98% after the second hour (41). Overall, the two-hour pad test was found to be superior to the one-hour one. There was no correlation between pad test results and the severity of a symptoms score.

4. HOME BASED PAD TESTING

These tests were developed to diagnose and measure urine loss in a situation as close as possible to standard daily life of the patient. The longer observation period usually requires a less structured procedure.

4.1. 12-Hour Pad Test

Quantification:

Hellstrom et al. demonstrated in 30 children with incontinence a positive 12-hour home pad test in 68%. When a standard fluid load (13 ml/kg) was instituted in 20 children, the frequency of the positive test increased to 80% (39).

4.2. 24-Hour Pad Test

Quantification:

Lose et al. found a 90% correlation of a 24-hour pad test with a history of stress incontinence in 31 women (21). This was better than the results of a 1-hour test. Thirteen of 31 patients were found to be continent after a 1-hour ward test in comparison to only 3 with a 24-hour home pad test. Mouritsen et al. showed that

the 24-h home test was well tolerated and as good at detecting incontinence as a 48-h test (22). Griffiths et al. found only a 10% false negative rate of a 24-hour pad test in an elderly population (20). Using non-parametric coefficient of correlation, they found a significant difference between the 1-hour test and the 24-hour test. Lose et al. found that a 24h home test performed during daily activities was more sensitive than a 1-hour ward test with standardised bladder volume of 200-300 ml (21). High fluid intake did not change the results of a 24-h home test, but a low fluid intake reduced a positive test by 56% (42). Ryhammer et al. showed that 24-h test is superior to subjective self-reported assessment of urinary incontinence (43).

Reproducibility

Lose et al showed poor correlation in a test-retest study with a variation of more than 100% (21) although Groutz et al. using Lin's concordance correlation coefficient (CCC), found the 24-h test to be very reliable instrument (44). Increasing test duration to 48 and 72 hours slightly improved reliability but decreased patient compliance.

The values for the pad test increase in asymptomatic men and women were reported by Karantanis et al with the median value 0.3g (IQR 0.2 – 0.6; 95th centile 1.3g). It is surprising that the loss is so low and the same for men and women (45).

Diagnosis

Matharu et al found women with urodynamic stress incontinence leaked more than women with detrusor overactivity but the amounts were not diagnostic for the individual abnormalities (33). Pad test loss is unaffected by the degree of hypermobility however there is increased loss associated with urethral sphincter incompetence diagnosed by a vesical leak point pressure less than 60 cmH₂O (46).

Validity

Karantanis et al found the 24-hour pad test was poorly correlated in women with urodynamic stress incontinence with incontinence episodes on a 3 day urinary diary (Kendall's corr coeff b = 0.4) and the ICIQ-SF (r = 0.4) (47). Singh et al. reported that fewer (52%) women after surgery were willing to complete a 24 hour pad test at follow up (48).

4.3. 48-Hour Pad Test

Quantification:

Jakobseny et al. showed that 48-hour pad test reflects everyday incontinence in 81% of patients (17). No statistical analysis data were given. Ekelund et al., found patients own weighing correlate well to control weighing at the clinic in 48-h pad test (r=0.99) (49).

Table 5: test-retest correlation

Author	Test	Correlation coefficient	Symptoms
Klarskov &Hald 1984 (24)	1-h	0.96	SUI&UUI
Lose et al 1986 (12)	1-h	0.68	SUI & MIX
Fantl et al. 1987 (27)	1-h (vol)	0.97	SUI
Fantl et al. 1987 (27)	1-h (vol)	0.84	SUI & UUI
Lose et al. 1988 (28)	45-m (vol)	0.97	SUI & MIX
Victor et al. 1987 (50)	24-h	0.66	SUI
Lose et al. 1989 (21)	24-h	0.82	LUTS
Mouritsen et al. 1989 (22)	24-h	0.87	MIX
Versi et al. (1996) (51)	24-h	0.9	LUTS
Groutz et al. (2000) (44)	24-h	0.89	LUTS
Victor et al. 1987 (50)	48-h	0.9	SUI
Versi et al. (1996) (51)	48-h	0.94	LUTS

Author	Test	Correlation coefficient	Symptoms
Groutz et al. (2000) (44)	48-h	0.95	LUTS

Table 6. Pad-weight gain (g) in normal women

Author	Time	No	Mean (g)	Range (g)	SD	SEM	Note
Hahn & Fall 1991 (52)	20 min	10	0.0				
Nygaard & Zmolek, 1995 (53)	39.5 min	14	3.19	0.1-12.4	3.16		Exercise
Versi & Cardozo 1986 (54)	1h	90	0.39	0-1.15		0.04	
Sutherst et al. 1981 (55)	1h	50	0.26	0-2.1	0.36		
Walsh & Mills, 1981 (9)	2h	6	1.2	0.1-4.0	1.35		Daily activity
Lose et al. 1989 (21)	24h	46	4.0	0-10			
Jorgensen et al. 1987 (16)	24h	23	4.0	0-10			
Mouritsen et al. 1989 (22)	24h	25	2.6	0-7			
Karantanis et al. 2003 (45)	24h	120	0.3	0-1.3			
Versi et al. 1996 (51)	48h	15	7.13		4.32		

Nygaard and Zmolek in 14 continent women showed a mean pad weight, attributed to sweat for all exercise sessions of 3.19 ± 3.16 g (the Kendall coefficient of concordance of the test-retest reliability was 0.96) but there was a lot of variation between patients (53). Pyridium staining was not helpful in increasing specificity. Similar results with Pyridium were reported by Wall et al. in a 1-hour ward test (14). In his study (n=18) the Pyridium test was 100% positive in patients with SUI but had false positive results in normal women (52%).

Mean pad weight loss due to evaporation or leakage (was calculated to be 1.003 g, and ranged from -6.5 to +3.85 g (SD 1.85 g) (9). Lose et al. showed no evidence of evaporation over 7 days if the pad was stored in a plastic bag (21). Versi et al. showed pads wetted with saline showed no difference in weight after 1 week and less than 10% weight loss after 8 weeks (51). Twelve pads were weighed by the patient and a healthcare worker with a coefficient of variance =1.55% with a mean deviation of 49%.

Comments

Pad tests can either be used as a qualitative diagnostic tool to diagnose urinary incontinence and as a quantitative test to grade its severity. Pad test is unable to distinguish among different types of inconti-

nence such as stress, urgency or mixed urinary incontinence. The ICS definition of urinary incontinence (the complaint of any involuntary leakage of urine) does not describe how the diagnosis is made but clearly refers to a patient's complaint that excludes urodynamics and rather points at the patient perception of the condition. Following this line of thought, research in this area has moved away from the evaluation of diagnostic accuracy of pad test versus a urodynamic diagnosis of UI and entered the more interesting field of the relationship between the patient perception of UI and pad test. Franco and co-workers in London, UK tested the correlation between different questionnaires for UI and 1-hour pad test showing that only the ICIQ-SF reached statistical significance with a Kendall's τ_b of 0.177 and a P value of 0.037 while no significant correlation was found for a 0 to 10 Vas score, a patient-based 3-point symptom severity scale, Stamey grade, Urogenital Distress Inventory and the Incontinence Impact Questionnaire (IIQ-7) (56). In another study from Wijma and co-workers, the diagnostic accuracy of pad test for self-reported symptoms of UI was evaluated during pregnancy and after childbirth and the authors conclude that the diagnostic value of pad testing has no clinical relevance in this setting (57). A similar analysis, performed in a male population undergoing sling surgery for post-radical prostatectomy incontinence suggested a good correlation between ICIQ-SF and the Patient Global

Perception of Improvement (PGPI) with a 24-hour pad test (58).

Studies from the Urinary Incontinence Treatment Network in US investigated the relation between different measures of incontinence severity and showed how pad weight from a 24-hour test had a good correlation with the incontinence episode frequency derived from a 3-day bladder diary (Spearman correlation coefficient 0.61 but a much lower degree of correlation was found with questionnaires such as the Medical, Epidemiological, and Social Aspect of Aging ($r=0.33$), the Urogenital Distress Inventory ($r=0.17$) and the Incontinence Impact Questionnaire ($r=0.34$) (59). In the same study, the use of pad testing as a prognostic parameter for treatment outcome was investigated but 24-hour pad testing showed no prognostic value for treatment failure in a study of Burch colposuspension versus autologous rectus fascia sling (60). An interesting result was obtained in a predominantly female population of patients receiving neuromodulation for refractory urgency incontinence in which a 24-hour pad test performed after the initial test stimulation was able to predict long term satisfaction in this difficult patient population (61). In this, as in other studies, the number of pads used per day proved to be an unreliable measure of urinary incontinence (62).

A couple of important methodological issues have been raised concerning the use of pad testing. Khan & Chien eloquently pointed out that test-retest comparison should include methods of blinding and use of an appropriate index of degree of agreement which is the intra-class correlation coefficient. In most of the literature this was not implemented (63). Kromann-Andersen et al. argued that with considerable inter- and intra-individual variation of urine loss, the correlation of test/retest results may be overestimated and suggested different trials for small, modest and large leakage in large numbers of patients(64). This trial has not been carried out.

A recent Health Technology Assessment of pad testing concluded that although high sensitivity and specificity for the diagnosis of UI was reported in some studies, it was difficult to draw any conclusions about the diagnostic accuracy for SUI because of the differences existing in pad test methodology. The number of studies comparing the same pad tests with adequate reporting is insufficient and no formal pooling of published data could be performed (65).

Role of the investigation

The test has been standardised by ICS in 1988 for quantification of urine loss and suggested uses for assessment and comparison of treatment results for different types of urinary incontinence in different centres. Also, the AUA report on Surgical Management of Female Stress Urinary Incontinence includes a pad test (pretreatment evaluation) as a standard of efficiency for clinical trials (66). The Urodynamic Society included a pad test in a Standards of Efficacy for Eval-

uation of Treatment Outcomes in Urinary Incontinence (67). No suggestion was made in the last two reports of which test to use.

5. CONCLUSIONS

- The 1-hour pad test is not very accurate unless a fixed bladder volume is applied
- Set exercises during the test improve test-retest reliability
- The sequence of exercises has little effect on test results
- A pad weight gain ≥ 1 g suggests a positive 1h test
- A 24 hour test correlates well with symptoms of incontinence
- A 24-hour test has good reproducibility but poorer compliance
- A pad weight gain $\geq 1.3g$ = positive 24 h test
- A test lasting longer than 24 h has little advantage
- A pad test cannot distinguish between USI and DO

6. CONSENSUS STATEMENTS

- The pad test is an optional investigative tool in the routine evaluation of UI (**Level of Evidence 3, Grade of Recommendation C**)
- Pad test is a useful outcome measure in clinical trials and research studies. (**Level of Evidence 3, Grade of Recommendation C**)

The following standards are suggested:

- 20 min-1 h ward/office test with fixed bladder volume (pad weight gain $\geq 1g$ = positive test) (**Level of Evidence 3, Grade of Recommendation C**)
- 24 h home pad test during daily activity (pad weight gain $\geq 1.3g/24h$ = positive test) (**Level of Evidence 3, Grade of Recommendation C**)

7. FUTURE RESEARCH AREAS

Proper validation analysis using the coefficient of variability

Evaluation of the ability to detect all the spectrum of urinary incontinence (from mild to severe)

Sensitivity to change in time of incontinence status for 24 hour pad tests

Validity of pad tests with other measures of incontinence such as urinary diaries and symptom questionnaires.

V. NEUROPHYSIOLOGY

1. INTRODUCTION

Neurophysiological investigations of muscles and nerves in the perineum and pelvis originated in the 1930-ties, and have evolved with the developments in general clinical neurophysiology. The data from these investigations can assist clinicians in diagnosing neurological disease or injury; the tests can be used intraoperatively for identification of nerves and muscles.

This text details the investigations, their applications and limitations, enabling investigators and clinicians to make a well informed decision about using these tests.

The present text is based on the previous chapter on clinical neurophysiology prepared for the International Consultations on Incontinence (1), which has been updated by a literature search in Medline using key words incontinence, clinical neurophysiology, electromyography, reflex, evoked potentials, autonomic nervous system tests.

1.1. Classification of Clinical Neurophysiological Tests

Although different types of tests may be included under the term "neurophysiological", it is particularly the electrophysiological tests that shall be discussed in the present text.

Electrophysiological tests are an extension of the clinical examination, and a functional anatomic approach to classification makes most sense. For the purpose of this categorisation, the nervous system is divided into the somatic and the autonomic nervous systems. The somatic nervous system provides motor innervation to the skeletal muscles and joints, and sensory innervation from skin and muscle spindles. The autonomic nervous system provides motor innervation to the viscera and other end-organs not under voluntary control (e.g., sweat glands). Its sensory fibres are referred to as visceral afferents. Both systems have central pathways (neurons participating in spinal cord and supraspinal control) and peripheral nerves (those going to and from end-organs).

Thus, electrophysiological tests can be divided into: a) somatic motor system tests (EMG, terminal motor latency measurements/ motor nerve conduction studies, and motor evoked potentials (MEP)); b) somatosensory system tests (sensory neurography, somatosensory evoked potentials (SEP)); c) reflexes; and d) the autonomic nervous system tests (for sympathetic or parasympathetic fibres).

Electrophysiological tests may also be categorised "technically" into those limited to simple recording some bioelectrical activity (for instance: electromyography), and those which record particular biological

responses to anatomically localised stimulation (these may be subsumed under the term "conduction tests").

1.2. Biological Correlates Of Electrophysiological Tests

1.2.1 Conduction Tests: Nerve Conduction, Evoked Potential and Reflex Studies

The electrophysiological responses obtained on stimulation are compound action potentials and relate to populations of biological units (neurons, axons, motor units, muscle fibres, etc.). Latency and amplitude are commonly measured parameters of responses during neurophysiological testing. If the onset of the potential is measured, the latency of a compound potential represents the fastest conduction through a particular neural channel. As a general rule, latency measurements are not markedly affected by technical factors, but provide little information about the loss of biological units (e.g., motor neurons or axons). The amplitude of the compound potential correlates with the number of activated biological units. In theory, the amplitudes are the more relevant physiological parameter, as they reflect the functional or structural loss of biological units. Unfortunately, amplitudes are also strongly influenced by many poorly controllable technical factors. Measurements of latencies and amplitudes of evoked potentials and reflex responses, including sympathetic skin responses, relate not only to conduction in peripheral and central neural pathways, but also to trans-synaptic transmission.

1.2.2 Electromyography (EMG)

Knowledge of the structure and function of the motor unit (Figure 47) is fundamental to understanding the application of EMG. Motor neurons, which innervate striated muscle, lie in the anterior horn of the spinal cord and are called "lower motor neurons". (Neurons that innervate the sphincters lie in Onuf's nucleus in the sacral spinal cord; they are somewhat smaller than those innervating skeletal limb and trunk muscles). Within the muscle, the motor axon branches to innervate a certain number of muscle fibres, which are scattered throughout the muscle. All muscle fibres innervated by one lower motor neuron are activated simultaneously; all these constituents together are called "motor unit". The innervation of muscle fibres is such that it is unlikely that muscle fibres that are part of the same motor unit will be adjacent to one another.

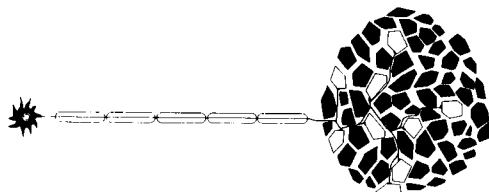

Figure 47: Schematic representation of a motor unit. The alpha motor neuron with its cell body, its myelinated axon and the peripheral nerve endings is shown. The muscle fibres innervated by this alpha motor neuron are shown in white. (Note that the muscle fibres from one motor unit are intermingled with motor fibres from other motor units).

It is difficult to estimate the number of muscle fibres innervated by a single axon (i.e., the “innervation ratio”) or the number of motor units supplying a muscle, by clinically available neurophysiological techniques.

1.3. General Methodological Considerations

To date, there are no universally accepted standards for conducting individual uro-genital-anal neurophysiological tests, but the variations of testing in different laboratories are minor.

There are technical standards on equipment safety.

1.3.1 Equipment

Clinical neurophysiological tests are conducted with complex electronic instruments and various devices that come into contact with the patient. Though this equipment is mostly standard, some specially constructed electrodes or stimulating devices have been devised to conform to uro-genito-anal anatomy. As long as the standards of electrical safety are adhered to, the risk to patients is negligible.

Surface electrodes, which are applied to skin or mucosal surfaces, or needle electrodes are used for electrical stimulation and to record bioelectrical activity. The important neurophysiological difference between surface and needle electrodes is their selectivity, and the practical difference is their invasiveness. The choice and application of electrodes is guided by the need for selective recording or stimulation. Less commonly, special devices are used for magnetic and mechanical stimulation.

The electrical stimulation should be specified and characterised both in technical (e.g., rectangular electrical pulse, 0.2 ms, 15 mA) and physiological terms (e.g., 3-times sensory threshold). A stimulus with defined technical parameters may have variable biological effects because of the variable influences of electrode condition, contact, tissue conductivity etc. Supramaximal stimulation is preferred to elicit a compound muscle action potential (CMAP) or sensory nerve action potential. Supramaximal stimuli yield responses with the largest amplitude and shortest latency, and are the least variable and most reproducible. The sites at which stimulation electrodes are applied should be described using anatomical terms.

1.3.2 Recording

1.3.2.1 Apparatus settings

For recording, the apparatus settings (gain, sweep speed) have to be adapted to the known range of amplitudes, latencies, and duration of the response and

it has to be appropriately displayed for analysis. Particularly important is the frequency setting of filters: for surface electrode recordings it is typically 2 Hz – 1 kHz; for concentric needle EMG recordings, it is 5 Hz – 10 kHz.

Placement of electrodes on the scalp for evoked potential recordings is defined according to the 10-20 International EEG System

1.3.2.2 Reproducibility and Reliability

Any potential recorded should be reproducible; therefore, as a rule, at least two to three consecutive recording procedures need to be performed. To improve the signal-to-noise ratio some small amplitude responses need to be averaged. Therefore, many repetitions of stimulation/recording need to be done (typically 100-200). Even such an averaged recording needs to be repeated at least twice. Responses whose nervous pathways include synapses may show marked fatigability with stimulus repetition (e.g., SSR), others are facilitated (the bulbocavernosus reflex).

1.3.2.3 Waveform Analysis

For a particular recorded potential, its shape, latency, and amplitude are analysed. Morphologically, a particular response (or part of it) needs to be recognised as present or absent. The shape of potentials is important to accurately determine the latency and duration (if applicable) and amplitude of the response. The onset of the response obtained on stimulation (for M-waves, MEP and sacral reflex testing) or the individual peaks of the potentials (for SEP) are used to determine the latency. The amplitudes are analysed relative to the baseline or “peak to peak”.

2. CLINICAL NEUROPHYSIOLOGICAL TESTS

2.1. Somatic Motor System Tests

2.1.1 Electromyography (EMG)

The term “EMG” is used for several different procedures, the common denominator of which is the recording of bioelectrical activity from muscle. In practice, EMG is used a) to record the activity of a particular striated muscle as a functional unit (as for instance in combined urethral sphincter EMG and a pressure-flow study - see kinesiological EMG); b) to indicate that a particular muscle has been activated, either by stimulation applied to its motor innervation (M-wave, MEP) or to sensory pathways (reflex response); c) to differentiate between normal, denervated, reinnervated, and myopathic striated muscle; and d) to measure neuromuscular transmission (the later is not relevant for clinical diagnostics in pelvic floor muscles).

EMG recordings from smooth muscles are as yet only experimental.

2.1.1.1 General Technique for Needle EMG in Pelvic Floor Striated Muscles

All tests requiring needle electrodes are invasive and some pain is inevitable, even with use of local anaesthetics. Local anaesthesia is infrequently used for needle EMG examination. Intramuscular electrodes need to be appropriately placed in the target muscle.

The pelvic floor and perineal muscles can be examined, including the levator ani, the bulbocavernosus muscle and the striated anal and urethral sphincter muscle. Facility with needle examination requires some practice. As a rule, several sites from one or more skin penetrations are sampled, which is difficult in small muscles.

The audio output from the loudspeaker of the EMG apparatus helps in assessment of the quality of recording as well as in recognition of the electrophysiological phenomena.

2.1.1.2 Concentric needle EMG (CNEMG)

The examination is conducted with a single use, disposable electrode, and all different "types of EMG" mentioned above can be performed with this electrode. It consists of a central insulated platinum wire inserted through a steel cannula and the tip ground to give an elliptical area which can record spike or near activity from about 20 muscle fibres.² What's this? The number of motor units recorded therefore depends both upon the local arrangement of motor units within the muscle fascicle and the level of contraction of the muscle.

In principle, CNEMG can provide information on a) muscle insertion activity, b) abnormal spontaneous activity within the muscle (FIGURE 48), c) MUPs, d) interference pattern (IP), neuromuscular jitter.

In normal striated muscle, needle movement elicits a short burst of "insertion activity," which is due to mechanical stimulation of excitable muscle cell membranes. This is recorded at a gain setting of 50 μ V per division (sweep speed 5 – 10 ms/division), which is also used to record spontaneous activity. Absence of insertion activity with appropriately placed needle electrode usually means a complete denervation atrophy of the examined muscle.

The amount of recruitable motor units during voluntary and reflex activation can also be estimated. Normally, MUPs should intermingle to produce an "interference" pattern on the oscilloscope during muscle contraction, and during a strong cough. In addition, the number of continuously active MUPs during relaxation,³ MUP variability (neuromuscular jitter) as well as MUP recruitment on reflex and voluntary activation (kinesiological parameters) can be observed.⁴

MUPs (and occasionally encountered end-plate activity) are recordable in normal resting sphincter muscles in a relaxed subject. This is in contrast to limb muscles where relaxation is associated with "electrical silence" by EMG. In addition to continuously firing

motor units, new MUPs are recruited voluntarily and reflexly in the sphincters. It has been shown that the two MUP populations differ in their characteristics: reflexly or voluntarily activated "high-threshold MUPs" being larger than continuously active "low-threshold MUPs". As a consequence, standardised level of activity at which a template based multi-MUP analysis obtains 3-5 MUPs on a single muscle site was suggested.⁵

Although EMG abnormalities of striated muscle are detected as a result of a host of different lesions and diseases, there are in principle only two standard manifestations which can occur: a) disease of the muscle fibres themselves ("myogenic" changes), and b) changes in their innervation ("neuropathic" changes).

Myogenic changes may result from muscle disease, probably also from direct trauma (e.g., the anal sphincter tear during vaginal delivery). Neurogenic changes may be attributable to injury at any level along the lower motor neuron supplying the particular muscle, extending from the motor neuron body, sacral nerve roots to the small branches within the muscle. (In the pelvic floor muscles, only neurogenic changes are well recognised and routinely evaluated).



Figure 48: Concentric needle EMG recording from right bulbocavernosus muscle of a 49-year-old male with urinary incontinence diagnosed as possible Multiple system atrophy. Pathological spontaneous activity (a burst of positive sharp waves) is shown.

In partially denervated sphincter muscle there is – by definition – a loss of motor units (MUs).

This can be estimated during relaxation by counting the number of continuously firing low-threshold MUPs. In patients with cauda equina or conus medullaris lesions, fewer MUPs fire continuously during relaxation,⁶ probably due to partial axonal loss. The main obstacle to qualified assessment of reduced number of activated MUs and activation of MUs at increased firing rates (as occurs in limb muscles) is a lack of concomitant measurement of level of contraction of the examined muscle (this can be readily assessed when studying limb muscles).

There are two approaches to analysing the bioelectrical activity of motor units: either analysis of individual motor unit potentials (MUPs), or analysis of the overall activity of intermingled MUPs. (This is the so called “interference pattern” – IP. Exploring different sites of the activated muscle with a needle electrode provides “samples” of intermingled motor unit potentials (IP epochs), which can be analysed).

Generally three different techniques of MUP analysis (manual-MUP, single-MUP and multi-MUP) and 1 technique of IP analysis (turn/amplitude – T/A) are available on advanced EMG systems.⁶

It is easy to grasp the “motor unit potential analysis”, as it is simply a measurement (by different methods) of the “parameters” of single individual MUPs (ie. its amplitude, duration, number of phases...). The changes in MUP parameters furthermore are “direct” results of understandable physiological changes, and are thus “meaningful” to the interpreter.

The changes in IP parameters are, however, less readily grasped. These are: numbers of turns per second (any peak or trough of the signal where the activity changes by more than 100 μ V); amplitude/turn (change in volts between two turns); number of short segments (parts of signal that has “sharp” activity) percent activity (percent of epoch with sharp activity); envelope (peak to trough amplitude exceeded by 1% of peaks/troughs). These parameters relate both to MUP parameters and to the activation level of the muscle. Recorded data are log transformed and linear regression lines are created. Amplitude/turn, and number of turns/second data from normal subjects can be used to create upper and lower boundaries (95 % confidence intervals) for assembly of future data from individual patients. Individual data create a scatter plot (“cloud”) which compares to the normative boundaries. (See Figure 49). It has been asserted that this approach does not require a standardised muscle contraction, but the shape of the “cloud” is dependent on the strength of muscle contraction. Therefore it has been suggested to standardise the method by measuring pressure exerted by the contracting sphincter.⁷

Both the template based multi-MUP analysis of MUP and T/A analysis of IP are fast (5-10 and 2-3 minutes

per muscle, respectively), easy to apply, and, technically, represent clinically useful techniques.

2.1.1.2.1 CNEMG Findings Due to Denervation and Reinnervation

After complete denervation, all motor unit activity ceases. In a denervated muscle, complete “electrical silence” is noted in the first days after such an event. The diagnosis of complete denervation is confirmed by the absence of muscle response during electrical stimulation. Because motor axons take days to degenerate after injury, this proof is not available for up to 5-7 days after a denervation injury. However, it is rarely necessary to demonstrate complete denervation in the acute stage because the clinical condition is usually obvious. Denervated muscle fibres become hyperexcitable and start to fire spontaneously giving rise to abnormal spontaneous activity, but these may take up to three weeks to appear. The “insertion activity” becomes prolonged and short biphasic spikes (fibrillation potentials) and biphasic potentials with prominent positive deflections (positive sharp waves) appear (Fig 48). Thus, concentric needle EMG (CNEMG) correlates of denervation are pathologically prolonged insertion activity and pathological spontaneous activity. Completely denervated muscle may be reinnervated by axonal regrowth from the proximal nerve stump with few muscle fibres constituting “nascent” motor units. These are short, bi- and triphasic, soon becoming polyphasic, serrated and with prolonged duration. In partially denervated muscle, collateral reinnervation takes place. Surviving motor axons will sprout and grow out to reinnervate those muscle fibres that have lost their nerve supply. This results in a change in the arrangement of muscle fibres within the unit. Whereas in healthy muscle, it is unusual for two adjacent muscle fibres to be part of the same motor unit, following reinnervation, several muscle fibres belonging to the same motor unit come to be adjacent to one another. CNEMG correlates are changes in MUPs (duration, amplitude, number of phases, turns, etc). Early in the process of reinnervation, the newly outgrown motor sprouts are thin. Therefore, they conduct slowly such that the time taken for excitatory impulses to spread through the axonal tree is abnormally prolonged. Moreover, the neuromuscular transmission is unstable due to immaturity of the motor end-plates. The CNEMG correlate is instability of long-duration complex potentials.

In partially denervated muscle, some MUPs remain and mingle eventually with abnormal spontaneous activity. Changes due to collateral reinnervation are reflected by: prolongation of the wave form of the MUP (Fig 49) which may have small, late components (“satellite potentials”). MUPs show “instability” due to insecure transmission in newly formed axon sprouts and end-plates. This “instability of potentials” (meaning both “jitter” and “blocking” of individual components in a complex potential) is not routinely assessed during sphincter EMG.⁸ In striated muscle, the diameter of reinnervating axonal sprouts and conduction velocity increase with time, thereby improving

synchrony of activation in the reinnervated motor unit. Thus MUP amplitude increases while MUP duration reverts towards normal. However, in degenerative neurological diseases (such as multiple system atrophy), long duration motor units are a prominent feature of anal sphincter reinnervation.⁹ It is important to note that in patients with more severe neurogenic lesions, reinnervation may be inefficient resulting in MUP with parameters below confidence limits describing size (area, duration).¹⁰

The changes in MUP parameters (along with changed number of MUPs and changes in activation

frequency of MUPs) will be reflected also in IP parameters.

Abnormalities of parameters evaluated by needle EMG are in principle non-specific, i.e. most abnormalities can occur both in neuropathic or myopathic conditions. It is the overall clinical picture that dictates interpretation of results. It has been suggested that the combination of MUP thickness and number of turns might be even more accurate¹¹ than previously suggested combination of MUP area, duration, and number of turns.¹²

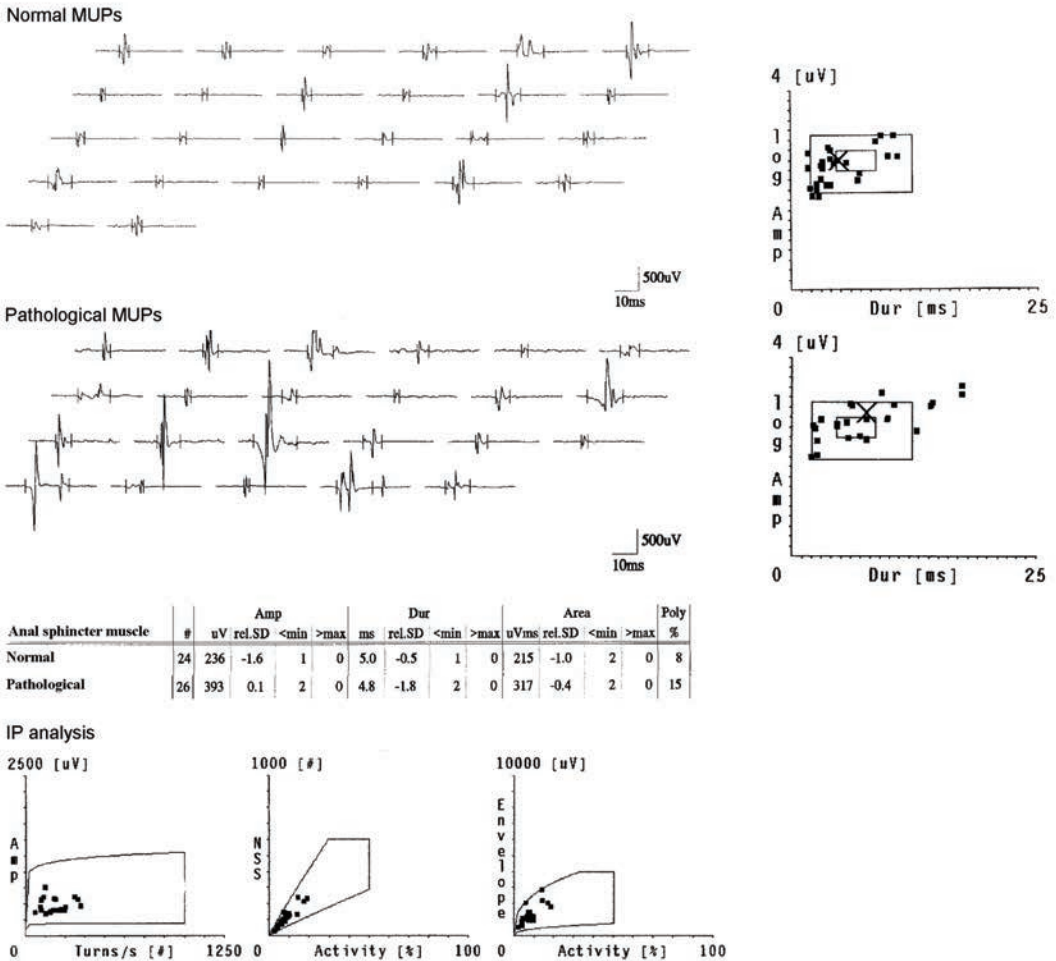

Figure 49: Comparison of normal (above) and pathological (below) motor unit potentials (MUPs) sampled by multi-MUP analysis from the right halves of the subcutaneous parts of the external anal sphincter (EAS) muscles. To the right logarithm (amplitude) vs. duration plots of the MUPs are shown; the inner rectangle presents normative range for mean

2.1.1.2.2 CNEMG of the External Anal Sphincter

The external anal sphincter (EAS) is the most practical indicator muscle for sacral myotomes because it is easy to access, has enough muscle bulk for exact

EMG analysis, and its examination is not too uncomfortable.

The needle electrode is inserted into the subcutaneous EAS muscle about 1 cm from the anal orifice, to

a depth of a 3-6 mm under the non-keratinised epithelium. For the deeper part of the EAS muscle 1-3 cm deep insertions are made at the anal orifice, at an angle of about 30° to the anal canal axis.¹³ In most patients only examination of the subcutaneous EAS muscle is necessary. Separate examinations of the left and right EAS muscles are recommended. The needle is inserted into the middle of the anterior and posterior halves of each side ("quadrants") of the EAS muscle. After insertion in two positions on each side the electrode is turned backwards and forwards in a systematic manner. At least 4 sites in each of the subcutaneous and/or the deeper EAS muscle are thus analysed.^{13, 14}

Use of quantitative MUP and IP analyses of the EAS is further facilitated by the availability of normative values¹⁵ that can be introduced into the EMG systems' software. It has been shown that normative data are not significantly affected by age, gender,¹⁵ number of uncomplicated vaginal deliveries,¹⁶ mild chronic constipation,¹⁷ and the part of EAS muscle (i.e. subcutaneous or deeper) examined.¹⁶

Intramuscular electrode insertion into other perineal muscles and pelvic floor muscles is not standardized and is described in textbooks and primary literature.

2.1.1.3 Single fibre EMG (SFEMG)

SFEMG is nowadays used practically only in diagnostics of neuromuscular transmission disorders, and not anymore in the pelvic floor muscles.

The SFEMG electrode has similar external proportions to a concentric needle electrode, but with a smaller recording surface. It will pick up activity from within a hemispherical muscle volume 300 µm in diameter, much smaller than the volume of 2-3 mm di-

ameter from which a concentric needle electrode records.² Apart from the neuromuscular jitter it can also record data which reflect motor unit morphology (muscle fiber density)⁸ but for this purpose it has several disadvantages in comparison to the concentric needle EMG.

2.1.1.4 Kinesiological EMG

Kinesiological EMG is the term for the type of EMG recording aimed only to assess the pattern of an individual muscle's activity/inactivity during defined manoeuvres (Fig 50), typically during urodynamics. Any type of electrode can be used to make kinesiological recordings. The electrical activity of a muscle is described as present or absent (and can also be quantified). Technical issues will be dealt here; the relevance for diagnostics will be discussed in the Chapter on dynamic testing.

Although either standard EMG equipment or EMG facilities contained within urodynamic systems can be used, the better visual and audio control provided by standard EMG equipment facilitate optimal electrode placement and improve recordings.¹⁸ When using surface electrodes there are problems related to validity of signal (e.g., artefacts, contamination from other muscles). The quality of the EMG recorded from the external urethral sphincter (EUS) muscle is improved by a catheter-mounted surface electrode device that applies mild suction.¹⁹ With intramuscular electrodes, the procedure is more invasive, and there are questions as to whether the whole muscle in large pelvic floor muscles is properly represented by the sampled muscle portions. Intramuscular electrodes should ideally be fine wire electrodes, as they do not dislodge, and no pain is induced with muscle contraction.

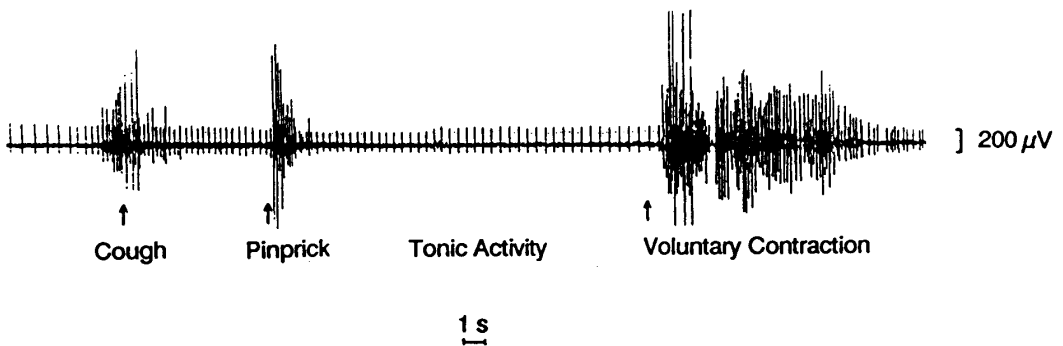

Figure 50: Kinesiological EMG recording from the urethral sphincter muscle of a healthy 53 years old continent female. Recruitment of motor units on reflex manoeuvres and on a command to contract is shown; regular continuous activity of motor units represents "tonic activity". (Recorded with concentric needle electrode).

The kinesiological sphincter EMG recordings in health show continuous activity of MUPs at rest. It can be recorded in many but not all detection sites of the levator ani muscle. The urethral and anal sphincter as well as the other pelvic floor musculature (e.g. pubococci) can be voluntarily activated typically for less

than 1 minute.²⁰ Timely activation of the levator ani muscle has been demonstrated to be an important aspect of stable bladder neck support; its activation precedes activity of other muscles in the cough re-

flex.21 A consistent contraction sequence of the superficial and deep pelvic floor muscles is found in continent but not in incontinent women.22

Sphincter activity during voiding is characterised by the cessation of all EMG activity prior to detrusor contraction. Needle electrodes are more useful than perineal patch electrodes to demonstrate MU quiescence during voiding.23,24

Pathologic incoordination of the detrusor and sphincter is called detrusor sphincter dyssynergia. In selected patients with neurogenic detrusor overactivity, EMG of the EUS muscle can be used to demonstrate the onset of detrusor contractions.20

Apart from polygraph urodynamic recordings to assess detrusor-sphincter coordination, the diagnostic usefulness of kinesiologic EMG has not been established.

2.1.1.4.1 Surface Electromyography Using Noninvasive Electrode Arrays

Surface EMG recording using noninvasive electrode arrays and multichannel EMG amplifiers can localize muscle innervation zones and asymmetry in muscle innervation,25 and analyze discharge patterns of MUPs, and propagation velocities along the muscle fibers.26 While it is expected that the new sophisticated computer assisted analysis techniques will help diagnosing sphincter function (for instance the “circumferential urinary sphincter surface electromyography”27) the clinical value of new methods has not yet been widely explored and validated.

2.1.1.5 Clinical application of EMG

2.1.1.5.1 Neurogenic Conditions

Trauma, surgery (for instance: radical prostatectomy 28), and neurological disease have all been implicated in denervation of pelvic floor and perineal muscles and pelvic organs. In a series of 194 consecutive patients referred for electrodiagnostic evaluation, quantitative needle EMG of the EAS muscles supported a diagnosis of a cauda equina or conus medullaris lesion in 36 patients, a lesion of the EAS muscle in 6, a pudendal nerve lesion in 2, and a sacral plexus lesion in 1 patient. Furthermore, neuropathic findings in the EAS were compatible with a diagnosis of multisystem atrophy in 11, and were most probably caused by severe polyneuropathy in 2 patients. In another 11 patients, the aetiology of the pathological findings could not be established at time of electrodiagnostic testing.29

Lesions of the cauda equina or conus medullaris commonly cause pelvic floor dysfunction. These have mainly been a consequence of neural compression within the spinal canal caused by intervertebral disc herniation, spinal fractures, epidural hematomas, and intraspinal tumours; or a result of spinal surgery, mainly on lumbar discs.30 Electrodiagnostic tests are also useful in the assessment of neurogenic lesions in children with spinal dysraphism.31 After

detailed clinical examination of the lumbosacral segments (with particular emphasis on perianal sensation), neurophysiological testing assesses the severity of the lesion and may clarify the diagnosis. In the authors' series, 10 percent of patients with cauda equina lesions reported normal perianal sensation.32 Electrodiagnostic tests that need to be considered are bilateral needle EMG of the EAS muscle and the bulbocavernosus muscle in subacute situations; and electrophysiological evaluation of the bulbocavernosus reflex33,34 Detection of spontaneous denervation activity by needle EMG (in the bulbocavernosus muscle!) is common from approximately 3 weeks to several months after injury. Later, MUP analysis becomes more important for demonstrating reinnervation. Most of these lesions cause partial denervation; a traumatic lesion to the lumbosacral spine or pelvis is probably the only acquired condition in which complete denervation of the perineal muscles can be observed.35, 36, 37

Following a cauda equina or a conus medullaris lesion, the MUP of pelvic floor and perineal muscles are prolonged and polyphasic, of increased amplitude, area, number of turns.6 Surgical dissections can also affect the innervation of the sphincter and lead to loss of motor units and reinnervation of those surviving.38 After pelvic trauma, gross changes of denervation and reinnervation may be detected in pelvic floor muscles. Abnormalities in polyneuropathy, as for instance diabetic, are usually minor.39

Neuropathic changes can be recorded in sphincter muscles of patients with multiple system atrophy (MSA), a progressive neurodegenerative disease, which can be mistaken for Parkinson's disease (PD).40 Among 30 patients with a pathological diagnosis of multisystem atrophy, 24 had abnormal, 5 had a borderline, and only 1 had a normal sphincter EMG.41 Sphincter EMG has been **proposed** to distinguish MSA from Parkinson's disease, but is probably not specific in the later stages of parkinsonism, and may not be sensitive enough in the early phase of the disease,42 43 44 Some studies have failed to demonstrate the effectiveness of MUP analysis in sphincter muscles,45, 46 probably because of the exclusion of late components from MUP duration.9 Extensive discussion on the subject can be found elsewhere.47 The changes of chronic reinnervation may also be found in progressive supranuclear palsy,48, 49 and in Machado-Joseph disease,50 in which neuronal loss in Onuf's nucleus has also been demonstrated histologically.51

In patients with acute idiopathic autonomic neuropathy and lower urinary tract (LUT) dysfunction the EMG of external sphincter muscles was reported as normal.52

2.1.1.5.2 Changes in Primary Muscle Disease

In skeletal muscle, the “typical” features of a myopathy are small, low amplitude polyphasic units recruited at mild effort. There are few reports of pelvic floor muscle EMG in generalised myopathy. In a nulliparous woman with limb-girdle muscular dystrophy, histology revealed involvement of pelvic floor muscles, but concentric needle EMG of the urethral sphincter was normal.⁵³ Myopathic EMG changes were observed in the puborectalis and the EAS in patients with myotonic dystrophy,⁵⁴ but not in another group of patients with myopathy.⁵⁵

2.1.1.5.3 Stress Incontinence

Pelvic floor muscle denervation has been implicated in the pathophysiology of ? USI (GSI).⁵⁶ EMG techniques have been used to identify sphincter injury after childbirth and to evaluate women with USI. SUI and POP were associated with partial denervation of the pelvic floor.⁵⁷ The changes were most marked in women who were incontinent after delivery, who had a prolonged second stage of labour, and had given birth to heavier babies. In a recent study, nearly all EMG parameters showed significant differences between continent and SUI women consistent with better motor unit recruitment in continent women. Continent women had larger-amplitude, longer-duration MUPs with increased turns and better MUP recruitment during bladder filling ($P < 0.05$).⁵⁸

Myogenic histological changes in pelvic floor muscles after vaginal delivery were also reported,⁵⁹ with some EMG support by another group.⁶⁰ “Myopathic EMG changes” (i.e. short, small MUPs) may, however, be a consequence of deficient reinnervation.³⁵ There were claims urethral sphincter EMG can assist in selecting the type of surgery for patients with intrinsic sphincter deficiency.⁵⁹

Although CNEMG of the urethral sphincter seems the logical choice in patients with urinary incontinence of possibly neurogenic origin, only a small amount of pathological muscle tissue remains in many incontinent parous women, which makes EMG of the muscle impractical.³⁸ CNEMG findings generally will not affect therapeutic considerations.⁶¹

2.1.1.5.4 Idiopathic Faecal Incontinence

“Idiopathic” faecal incontinence refers to patients in whom this symptom is not attributable to an underlying disorder, but it has been often implied that it is a neurogenic condition. Vaginal delivery is proven to cause structural sphincter defects; it may cause out-right sphincter denervation in rare cases, but its more widespread implication in causing “idiopathic” incontinence is controversial.

CNEMG may be helpful in selected patients with faecal incontinence if a specific neurogenic condition (e.g., trauma or disease affecting the conus, sacral roots, sacral plexus or pudendal nerves) is suspected on clinical grounds.

External anal sphincter muscle innervation pattern evaluation by multichannel surface EMG has been claimed to offer information to the obstetrician to prevent damaging episiotomies.⁶²

2.1.1.5.5 Idiopathic Urinary Retention in Women

In the external urethral sphincter of young women with urinary retention (or obstructed voiding) complex repetitive discharges (and decelerating bursts) in profuse amounts have been described.^{63, 64} The abnormality was reported to be a predictor of the long-term success of therapeutic sacral neuromodulation.⁶⁵ In a group of such women an occult generalised dysautonomia was found.⁶⁶

It has been known before that repetitive discharges develop in chronically partially denervated sphincters, and that they are present even in a proportion of asymptomatic women. Recently, it has been shown that this activity changes during the menstrual cycle (more commonly found in the luteal phase of the menstrual cycle in asymptomatic women). The importance of this »abnormal«EMG activity in the aetiology of urinary retention in young women remains uncertain.⁶⁷

Currently, the diagnosis of Fowler syndrome remains a clinical one, based on a multimodal assessment of the patient.

2.1.1.5.6 EMG in Urodynamic and Functional Anorectal Studies

In health, voiding is characterised by cessation of motor unit firing in the urethral sphincter prior to detrusor contraction, as can be demonstrated by recording of “kinesiological EMG”. Bladder-sphincter coordination is impaired with lesions between the lower sacral segments and the upper pons. Consequently, sphincter activity is not inhibited, and often increases before detrusor contraction (i.e., ‘detrusor-sphincter dyssynergia’). On the basis of the temporal relationship between urethral sphincter and detrusor contractions, three types of dyssynergia have been described.⁶⁸

There are other clinical situations that mimic detrusor sphincter dyssynergia. Sphincter contraction or at least failure of relaxation during involuntary detrusor contractions can be seen in patients with Parkinson’s disease. The pelvic floor muscle contractions of the so-called nonneurogenic voiding dyssynergia may be a learned abnormal behaviour,⁶⁹ and are a feature of dysfunctional voiding.⁶⁴ There is insufficient data to determine the nature of the non-relaxation of sphincter activity as demonstrated by EMG signals during micturition (often seen in children and females) by EMG as such. The EMG recording has to be interpreted in the light of the overall clinical picture of the examinee.

The pubococcygeus in the healthy female reveals similar activity patterns to the urethral and anal sphincters at most detection sites: continuous activity at rest, often some increase of activity during bladder

filling, and reflex increases in activity during any activation manoeuvre performed by the subject such as talking, deep breathing, coughing. The pubococcygeus relaxes during voiding; the muscles on either side act in unison.²⁰ In stressincontinent patients, the patterns of activation and the co-ordination between the two sides can be lost.⁷⁰ A delay in muscle activation on coughing has also been demonstrated, as compared to continent women.²¹

Little is known about the complex activity patterns of different pelvic floor muscles (the urethral sphincter, urethrovaginal sphincter, anal sphincter muscle, different parts of the levator ani) during different manoeuvres. It is generally assumed that they all act in a co-ordinated fashion functionally as one muscle. However there are demonstrable differences between the intra- and peri-urethral sphincter in healthy females⁷¹ and in activation of the levator ani and the urethral sphincter.⁷² Co-ordinated behaviour is frequently lost in abnormal conditions.

Kinesiological needle EMG analysis of the urethra with the patient at rest and coughing may predict the outcome after certain types of incontinence surgery.⁷³ However, other studies found that preoperative EMG did not predict patients at risk for postoperative voiding dysfunction. (Kirby AC, Nager, CW, Litman, HJ et al. Perineal Surface Electromyography Does Not Typically Demonstrate Expected Relaxation During Normal Voiding Neurology and Urodynamics 30:1591–1596 (2011))

Indeed, while kinesiological EMG (particularly when combined with other urodynamic tests) promises theoretically relevant data, technical standards are lacking, and findings have been reported in single center studies. Further basic research is necessary to delineate the correlation of EMG signals and their interpretation in terms of clinical significance (the significance of EMG data for defining overall LUT function).

Current concepts suggest that defecation requires increased rectal pressure co-ordinated with relaxation of the anal sphincters and pelvic floor muscles. Pelvic floor relaxation allows opening of the anorectal angle and perineal descent, facilitating faecal expulsion. During defecation puborectalis activity is as a rule inhibited, but was unchanged in 9 % and increased in 25 % of healthy subjects.⁷⁴ Thus, while “paradoxical” puborectalis contraction during defecation is used to diagnose pelvic floor dyssynergia in patients with typical symptoms, this finding may be a variation of the normal.

Same considerations regarding the lack of controlled studies, technical standards, etc. apply as stated above for kinesiological EMG in studies of LUT function.

2.1.2 Pudendal Nerve Conduction Tests

Measurement of motor conduction velocity is routinely used to evaluate limb nerves, distinguishing between a demyelinating and axonal neuropathy. To

make the measurement requires access to the nerve at two well-separated points and measurement of the distance between them, a requirement that cannot be met in the pelvis. Another way to evaluate peripheral motor nerve function is the measurement of the latency of a muscle response, requiring only a single stimulation site. The muscle response is the compound muscle action potential (CMAP) or M-wave. Because in limb nerves the site of stimulation to obtain only the motor latency (without measuring the actual conduction velocity) is as a rule placed distally on the nerve, it is also called the distal (or terminal) latency. For the pudendal nerve the site of stimulation may be more or less “distally”, but the term distal or terminal has – in accordance to general clinical neurophysiology – become generally used. Distal motor latency can be measured by recording with a concentric needle electrode from the bulbocavernosus, the EAS and the EUS muscles in response to bipolar surface stimulation placed in the perianal/perineal region, or with needle electrode stimulation of the pudendal nerve in the perineum. The most widely employed technique to obtain pudendal nerve terminal motor latency (PNTML) relies on stimulation with a special surface electrode assembly fixed on a gloved index finger, known as the St Mark's stimulator.⁷⁵ It consists of a bipolar stimulating electrode on the tip of the gloved finger with the recording electrode pair placed proximally on the base of the finger. The finger is inserted into the rectum or vagina and stimulation is applied close to the ischial spine. It is assumed that, using this approach, the pudendal nerve is stimulated close to the ischial spine, and that the response recorded is of the EAS muscle. In women, intravaginal stimulation and recording from the bulbocavernosus muscles has also been undertaken, with similar distal latencies.⁷⁶ However, the latency of such a response is typically only around 2 msec, which seems unusually short compared with the perineal technique and with conduction in the much thicker motor fibers of peripheral nerves in the limbs. It seems unlikely that the PNTML using the St. Mark's electrode really evaluates conduction along the last 8 cm of the pudendal nerve. Stimulation of the terminal pudendal branches or pelvic floor muscles near their motor points seems more likely, and this is supported by the much longer PNTML (3.7 ± 0.9 msec) obtained with a monopolar intrarectal stimulation electrode.⁷⁷ If a catheter-mounted electrode is used for recording, EMG responses from the striated muscle of the urethral sphincter can be obtained. Experts differ in their estimation of validity of this test. A prospective evaluation of anorectal physiologic tests in 90 patients with faecal incontinence did not find that PNTML results changed treatment decisions.⁷⁸ Indeed, the American Gastroenterological Association statement indicated that “PNTML

2.1.3 Anterior Sacral Root (Cauda Equina) Stimulation

Anterior root stimulation has been used to study conduction of the sacral nerve roots. Electrical stimulation with needle electrodes at vertebral laminae Th12-

LI elicits M-waves in the bulbocavernosus and EAS muscle.⁸⁰

Transcutaneous stimulation of deeply situated nervous tissue became possible with development of special electrical and magnetic stimulators. When applied over the spine, these stimulators activate the roots as they exit the vertebral canal. Needle EMG rather than non-selective surface electrodes should be used to record pelvic floor and particularly sphincter responses to electrical or magnetic stimulation of the cauda equina. These stimuli non-selectively depolarise underlying neural structures, thereby activating several muscles innervated by lumbosacral segments.⁸¹ Lumbosacral stimulation often evokes a large stimulus artifact that can be decreased by positioning the ground electrode between the stimulating and recording electrodes.⁸² Invasive percutaneous stimulation of individual roots in sacral foramina is used to identify patients with lower urinary and anorectal dysfunction who are likely to benefit from long-term stimulation, e.g. with the Interstim (Medtronic, Inc., Minneapolis, USA). Electrical stimulation of nerve roots at the level of the appropriate sacral foramina results in observable muscle contraction in the foot and perineum. These responses can be identified as MEP or reflex responses on the basis of their latency. Selective stimulation of individual sacral roots is possible by appropriate positioning of surface stimulating electrodes.⁸³

In conclusion, demonstrating the presence of a perineal MEP on stimulation over lumbosacral spine may occasionally be helpful in patients without voluntarily activated muscles. It also identifies the particular nerve root before introducing therapeutic electrical stimulation. However, the clinical value of the test has yet to be established and there are no sensitivity and specificity data on test results in individual patients.

2.1.4 Motor Evoked Potentials

Using magnetic or electric stimulation, it is possible to depolarise the motor cortex and record a response from the pelvic floor. Magnetic cortical stimulation is better tolerated than electrical stimulation, which has been abandoned in awake subjects, but may be useful for intraoperative monitoring.

By performing the stimulation at two different sites (brain and spinal roots), it is possible to record three different conduction times: a total conduction time, a peripheral conduction time, and a central conduction time (Fig 51). The total conduction time corresponds to the transit time from brain to target muscle. The peripheral conduction time is the transit time from sacral roots to the muscle. The central conduction time is obtained by subtracting the peripheral conduction time from the total conduction time. The total conduction time can be measured both at rest and during a facilitation procedure. MEPs from the EAS, the urethral sphincter, the bulbocavernosus muscle, and the levator ani muscle have been reported, but normative values have only been obtained (for transcranial magnetic stimulation) for the urethral sphincter and

the puborectal muscle in adult women.⁸⁴ A central conduction time of 15 to 16 msec without and 13 to 14 msec with facilitation is obtained for pelvic floor and sphincter muscles.^{85, 86, 87} The necessity to use concentric needle EMG for recording has been reconfirmed.⁸⁸

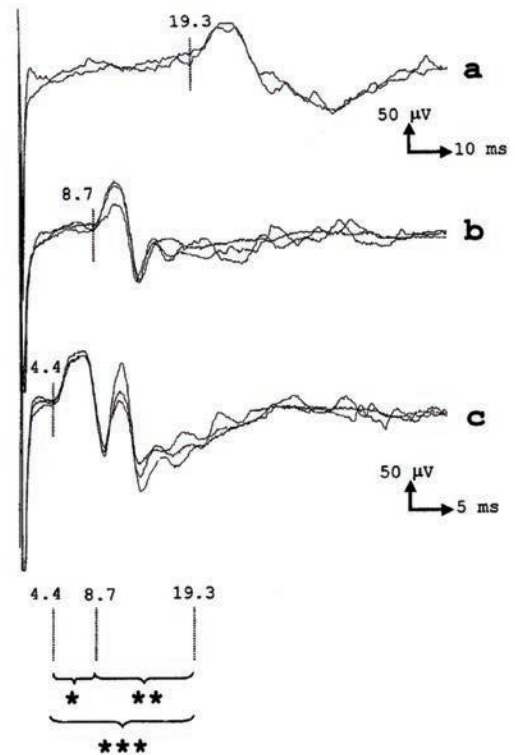

Figure 51: MEPs recorded by concentric needle in the external urethral sphincter of a 51-year-old woman. Cortical (a), thoracic (b), and sacral (c) stimulation. Central motor conduction time (CMCT) is calculated as cortical - lumbar latency (= 10.6 ms). Cauda equina motor conduction time is calculated as lumbar - sacral latency (* = 4.3 ms). (From Brostrom et al., 2003a), with permission).**

Substantially longer central conduction times have been found in patients with multiple sclerosis and spinal cord lesions as compared to healthy controls.^{87, 88, 89} However all patients in this study had clinically recognisable cord disease. Nevertheless, MEPs may be useful in patients with unclear localization of spinal lesions.⁸⁷

Conceptually, MEP may help to differentiate between involvement of motor and sensory pathways. However, the clinical utility of these measurements is not established. MEP have opened an avenue of research on excitability of motor cortex. It has been demonstrated that in comparison to the motor area for hand muscles the anal sphincter motor cortex has less intracortical inhibition.⁹⁰

2.2. Sensory System Tests

There are several methods of sensory testing for the perineum, the genitourinary and ano-rectal tract. Clinical testing includes perineal and external genital skin sensation for light touch and pinprick, and sensation of bladder filling during cystometry. Ano-rectal sensory testing can be clinically assessed through rating of applied stimuli. More objective sensory testing can be performed with quantitative sensory testing (QST), which assesses sensory perception. For evaluation of the integrity of sensory pathways sensory neurography, and somatosensory evoked potentials (SEP) can be used.

2.2.1 Sensory Measurements During Cystometry

During routine cystometry bladder sensation is assessed by recording first sensation of bladder filling, first desire to void and strong desire to void.

Although not strictly a neurophysiologic test, measurement of electrical thresholds adds clinically non-obtainable information on sensory function of the lower urinary tract.⁹¹ Bladder and urethral sensory thresholds have also been measured using electrical stimulation,⁹¹ and mechanical traction on the bladder trigone.⁹² Electrical currents are applied to the bladder, urethra or genital skin using catheter-mounted or surface electrodes. High-frequency stimulation (> 20 Hz), with a stimulus duration of 0.5 or 1 msec is used because it is more easily perceived in the lower urinary tract. Measurement of sensory thresholds with such stimulation is reproducible, and normative data have been published.⁹¹ To date it has been used in only a few conditions (e.g., painful bladder syndrome⁹³). There is no established clinical use for any of these tests other than simple reporting of sensation during cystometry.

In addition, palmar SSR and perineal surface EMG recordings can be used for more objectively demonstrating sensations during cystometry. The activity of both appears and increases in parallel with the first sensation of bladder filling, and with the first desire to void, respectively.⁹⁴ Further studies using these methods are needed to establish their clinical utility.

2.2.2 Assessment of Ano-rectal Sensation

Rectal sensation is assessed by progressively distending a balloon manually or by a barostat while measuring thresholds for first perception, desire to defaecate, and severe discomfort. The intensity of perception during rectal distension can be recorded by a visual analogue scale during phasic distensions of graded intensity.⁹⁵ The rate and pattern of distension affect rectal perception and internal sphincter relaxation.⁹⁶

Anal sensation can be assessed by determining the perception threshold to an electrical stimulus or temperature change in the anal canal. Electrical testing does not activate mucosal receptors. Anal sensitivity

to temperature change has been reported reduced in faecal incontinence.⁹⁷

2.2.3 Quantitative Sensory Testing

Quantitative sensory testing (QST) of the urogenito-anal system should provide more objective and reproducible data than routine clinical testing. QST sensory modalities applied to the evaluation of urogenital function include vibration,⁹⁸ temperature,⁹⁹ and electrical current.¹⁰⁰ (See also Sensory Measurements During Cystometry). There is no commonly accepted, detailed, standardised test, and the specificity and sensitivity of the tests are not known. The relationship of cutaneous quantitative sensory tests to bladder and urethral sensation and function is unknown. The physiological, psychophysiological and methodological issues and controversies will not be addressed in this chapter.

2.2.4 Sensory Neurography

Nerve conduction velocities of the dorsal nerve of the penis can be calculated by placing a pair of stimulating electrodes across the glans and a pair of recording electrodes across the base of penis. A nerve action potential can be recorded with an amplitude of about 10 μ V. It can also be recorded by stimulating the nerve trans-rectally or transperineally. There is no known association between penile sensory neuropathy and bladder/sphincter dysfunction.

A few studies have recorded activity in sacral roots during electrical stimulation. Intraoperatively, when the sacral roots are exposed, compound sensory action potentials on stimulation of dorsal penile and clitoral nerve may be recorded directly.¹⁰¹ This helps to preserve roots mediating perineal sensation in spastic children undergoing dorsal rhizotomy, and reduce the incidence of postoperative voiding dysfunction.¹⁰² These tests are limited to their very specific intraoperative indications.

2.2.5 Somatosensory Evoked Potentials (SEP)

Somatosensory evoked potentials are electric waveforms of biological origin elicited by stimulation of a sensory nerve (or a sensory innervated skin area – dermatome). The most commonly performed tests in the urogenitoanal region are pudendal somatosensory evoked potentials (SEP), which assesses conduction in large fibre pathways between the site of nerve stimulation and the parietal sensory cortex. Potentials can also be measured at the spinal level (spinal SEP).

Visceral (thin) fibre pathways are assessed by recording SEPs while stimulating the proximal urethra and bladder, although this is technically not depolarisation of nerves, but a mesh of afferents.

2.2.5.1 Pudendal Somatosensory Evoked Potentials

2.2.5.1.1 Cerebral Pudendal SEP

On electrical stimulation of the dorsal penile/clitoral or perineal nerve, a cerebral SEP can be recorded. (Fig 52) This SEP is as a rule of highest amplitude at the central recording site (Cz - 2 cm : Fz of the International 10-20 EEG System) and is highly reproducible. The first positive peak at about 40 ms (called P40) is usually clearly defined in healthy subjects using a stimulus 2-4 times stronger than the sensory threshold.¹⁰³ The presence and amplitude of subsequent negative and positive waves are quite variable between subjects. Classically described pudendal SEP techniques stimulate both dorsal penile/clitoral nerves, thus reducing the sensitivity of the test. However, techniques of pudendal SEP that isolate each dorsal penile/clitoral nerve may be more sensitive for identifying pathology.¹⁰⁴

Pudendal SEPs have been advocated in patients with neurogenic bladder dysfunction, e.g. in multiple sclerosis.¹⁰⁵ However, even in patients with multiple sclerosis and bladder symptoms, the tibial cerebral SEP was more often abnormal than the pudendal SEP. The combination of an abnormal pudendal SEP

with a normal tibial SEP suggests isolated conus involvement.¹⁰⁶ The pudendal SEP was less useful than neurological examination for identifying neurological disease in patients with uro-genital symptoms.¹⁰⁷ Following spinal cord injury, tibial and pudendal SEPs may be of some value for predicting recovery in bladder control.¹⁰⁸ Cerebral SEP during penile/clitoral stimulation may be useful for intraoperative monitoring. Pudendal SEP were used to study the mechanism of sacral neuromodulation.¹⁰⁹

2.2.5.1.2 Spinal Pudendal SEP

Stimulating the dorsal penile nerve and recording with surface electrodes at the level of the Th12-L2 vertebrae (and the S1, Th6 or iliac spine as reference) reveals the postsynaptic segmental spinal cord activity (the spinal SEP). Unfortunately, this spinal SEP may be difficult to record even in normal (particularly obese) subjects.

2.3. Sacral Reflexes

Clinically, two reflexes are commonly elicited in the lower sacral segments: (1) the penilo- or clitorio-cavernosus (i.e. bulbocavernosus) reflex; and (2) the anal reflex.¹¹⁰

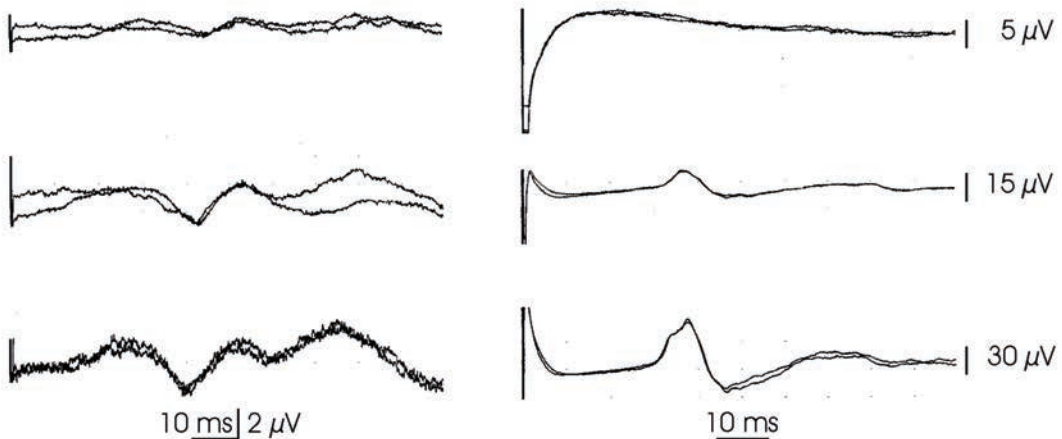

Figure 52: SEPs (traces on the left) and sacral reflexes (traces on the right) in a healthy woman. Cerebral SEPs are recorded from Cz - 2 cm; sacral reflexes from the anal sphincter. The dorsal clitoral nerve is being stimulated with rectangular electrical pulses at 2 Hz. Stimulation and recording is performed with surface electrodes. The cerebral SEP and sacral reflex are recorded simultaneously. In the upper row the stimulation is just above sensory threshold, in the middle row the stimulation is 1.5, and in the lower row at 2-times sensory threshold (pulse duration 0.2 ms; two consecutive averages of 128 responses are superimposed).

To elicit sacral reflexes, electrical,^{111, 112, 113, 114, 115, 116, 117, 118} mechanical,^{115,116, 119} or magnetic¹²⁰ stimulation can be used. Whereas the latter two modalities have only been applied to the penis,^{117, 118, 119} clitoris, electrical stimuli can be applied to various sites: to the dorsal penile or clitoral nerve; perianally; and, using a catheter-mounted ring electrode, to the bladder neck/proximal urethra.¹²¹

2.3.1 Sacral Reflex on Electrical Stimulation

Electrical stimulation of the dorsal penile or clitoral nerve elicits (somato-somatic) sacral reflexes in perineal muscles with a typical latency approx. 33 ms (29.9 ± 5.7 msec in one study in men¹¹⁷), traditionally called the bulbocavernosus reflex (Fig 52). In addition to single-pulse electrical stimulation, two identical electrical pulses separated by a 3-msec interval

can be used (i.e., double-pulse electrical stimulation).^{117, 118} Double-pulse electrical stimulation is more efficient in eliciting sacral reflexes.¹¹⁷ Stimulation of the perianal skin, bladder neck or proximal urethra elicits sacral reflexes with latencies above 50 ms. This latency is longer compared to responses conveyed by the pudendal nerve, suggesting that the afferent limb for these responses involves visceral afferent fibres accompanying the pelvic nerves, which are thinly myelinated and have a slower conduction velocity than the thicker pudendal afferents. With visceral denervation (e.g. following radical hysterectomy) the viscerosomatic reflexes (from both bladder and urethral stimulation) may be lost while the bulbocavernosus (penilo-/clitro-cavernosus) reflex is preserved. Loss of bladder-urethral reflex with preservation of bladder-anal reflex has been described with urethral afferent injury after recurrent urethral surgeries.¹²²

The longer latency anal reflex (the contraction of the EAS on stimulation of the perianal region) is quite variable thus limiting its usefulness as a diagnostic tool.

On perianal stimulation, a short latency response can also be recorded, as a result of depolarisation of motor branches to the EAS, possibly involving antidromic travelling of the depolarisation, with "returning" of the depolarisation orthodromically to the sphincter at a branching point of the motor axon.

EMG recording of the sacral reflex has been shown to be more reliable than the clinically assessed response (e.g. observing and palpating the contraction) in males and particularly in females.¹²³ In men, value of 40, 36 and 36 msec have been suggested as the upper limit of normal for the shortest latency obtained on eliciting a series of reflex responses using single, double and mechanical stimulation, respectively.¹¹⁷

In men with cauda equina lesions penilo-cavernosus reflex could not be elicited in 64%, 47% and 47% of patients on single electrical, double electrical, and mechanical stimulation, respectively. Measurement of the reflex latency increased the sensitivity to record abnormalities for 17%, 36%, and 34%, respectively. Furthermore, it has been shown that sacral reflex measurement increase sensitivity of quantitative EMG of the EAS muscles from 73% to 81-83% using the different stimulation techniques mentioned.¹¹⁸

Sacral reflex testing has been studied extensively and is used in many laboratories in everyday practice to demonstrate objectively the integrity of the S2-S4 reflex arc. The sacral reflex evoked on dorsal penile or clitoral nerve stimulation (the bulbocavernosus or penilo-/clitro-cavernosus reflex) was shown to be a complex response, often forming two components. The first component with a typical latency of about 33 ms, is the response that has been most often called the bulbocavernosus reflex. It is stable, does not habituate, and has other attributes of an oligosynaptic reflex response.¹¹² The second component has latency similar to the sacral reflexes evoked by stimulation perianally or from the proximal urethra, and is

not always demonstrable as a discreet response. In those subjects in whom the first reflex component is difficult to elicit, stimulation strength should be increased, but preferably double electrical stimuli should be used. A complete reflex arc lesion should not be inferred by absence of a response if only single pulse is used for stimulation.

During voiding sacral reflexes are un-elicitable but in presence of spinal cord lesions such as myelodysplasia this normal suppression is lost.

Sacral reflex responses recorded with needle or wire electrodes can be analysed separately for each side from the EAS or bulbocavernosus muscle. Using unilateral dorsal penile nerve blocks, the existence of two unilateral BCR arcs has been demonstrated. Thus by detection from the left and right bulbocavernosus (and also the EAS) muscles separate testing of right and left reflex arcs can be performed. Some authors reported that sensitivity of the test can be increased by use of the inter-side latency difference (normative limits: < 3 ms), but finding could not be confirmed by others (normative limits: < 7.2 ms).¹¹⁷ In cases of unilateral (sacral plexopathy, pudendal neuropathy) or asymmetrical lesions (cauda equina), a healthy reflex arc may obscure a pathological one on clinical elicitation, but not on neurophysiologic measurements of the sacral reflexes.

As described above, penilo-cavernosus reflexes were absent in 47-64%, and delayed in additional 17-19% of patients with conus/cauda lesions. Of these patients 47% were incontinent for urine and 47% for faeces. However, a reflex with a normal latency does not exclude the possibility of an axonal lesion in its reflex arc, as demonstrated by pathologic quantitative EMG of the EAS in 79-86% of patients with conus/cauda lesions.¹¹⁸ Furthermore, much delayed sacral reflex responses are compatible with normal bladder and sexual function as found in patients with hereditary motor and sensory demyelinating neuropathy. In a proportion of women with non-neurogenic sacral dysfunction clitro-cavernosus reflex latencies were found to be much longer compared to those obtained in women with intact sacral function.¹²⁴

Sacral reflex recording is suggested as a complementary test to CNEMG examination of pelvic floor muscles in patients with suspected peripheral nervous lesions.⁴

In addition to latency, a number of other parameters can also be measured using electrical, but not mechanical stimulation. These are the sensory threshold (i.e., the stimulus strength (mA) at which subjects feels stimulation), and reflex threshold (i.e., the stimulus strength (mA) at which the reproducible penilo-/clitro-cavernosus reflex appears on the screen). They evaluate lower sacral sensory pathways, and excitation level of the sacral reflex pathway, respectively. Although for men normative data for these parameters is available,¹¹⁷ their utility in clinical situation remains unclear.

Continuous intraoperative recording of sacral reflex responses on penis/clitoris stimulation is feasible if double pulses or a train of stimuli are used.¹²⁵

2.3.2 Sacral Reflex on Mechanical Stimulation

Mechanical stimulation has been used to elicit BCR in both sexes and found to be a robust technique. Either a standard reflex hammer or a customised electromechanical hammer can be used. Using a reflex hammer, the stimulus is applied to a wooden spatula placed on the glans penis or clitoris.^{117, 118} Such stimulation is painless and can be used in children.¹¹⁹ The latency of the BCR elicited mechanically is comparable to the electrically elicited reflex in the same patients, but depends on the electromechanical device used.^{117, 119}

2.4. Autonomical Function Tests

Most uro-neurophysiological methods discussed so far assess myelinated fibres, but not the autonomic nervous system, especially the parasympathetic component, which is most relevant for pelvic organ functions. Methods for evaluating the autonomic nerves innervating the pelvic viscera are not available. Cystometry indirectly evaluates the parasympathetic innervation to the bladder. However, from a clinical neurophysiological point of view direct electrophysiological testing would be desirable.

2.4.1 Tests in Generalised Autonomic Neuropathy

Cardiovascular autonomic function tests are useful for identifying generalised autonomic dysfunction in patients with bladder or gastrointestinal motility disturbances.

In cases when a general involvement of thin fibres is expected, an indirect way to examine autonomic fibres is to assess thin sensory fibre function. Thin visceral sensory fibres are tested by stimulating the proximal urethra or bladder, and by recording sacral reflex responses or cerebral SEP.

2.4.2 Dartos reflex

In men, another approach to test lumbosacral sympathetic function is by neurophysiologic measurement of the dartos reflex obtained by electrical cutaneous stimulation of the thigh. The dartos muscle is a sympathetically innervated dermal layer within the scrotum, distinct from the somatically innervated cremasteric muscle. A reliable and reproducible dartos reflex (i.e., scrotal skin contraction) with a latency of about 5 seconds has been demonstrated in healthy men.¹²⁶

Technical problems have so far limited smooth muscle electromyography of the detrusor muscle, and of genital smooth muscle. Recently, successful intrinsic (smooth muscle) anal sphincter muscle EMG recordings on electric autonomic nerve stimulations were

reported to spare the autonomic nerve supply during surgery in pigs.¹²⁷

2.4.3 Sympathetic Skin Response (SSR)

The sympathetic nervous system mediates sweat gland activity in the skin. Changes in sweat gland activity lead to changes in skin resistance. On noxious stimulation (such as a sudden noise, electrical pulse, etc.) a potential shift can be recorded with surface electrodes from the skin of the palms and the soles, and has been reported to be a useful parameter in assessment of neuropathy involving non-myelinated nerve fibres. The response, known as the SSR, can also be recorded from perineal skin and the penis. Similarly, the SSR can be recorded from the genital region in women. The SSR is a reflex, which consists of myelinated sensory fibres, a complex central integrative mechanism and a sympathetic efferent limb with postganglionic nonmyelinated C fibres. SSR is the only electrophysiological method directly testing sympathetic fibres; recording from the perineal region assesses sympathetic nerve function of thoracolumbar segments. Limited literature exists regarding the relationship between SSR results and bladder dysfunction. A correlation has been shown between the absence of the SSR response in the foot and bladder neck dyssynergia following spinal cord injury.¹²⁸

Only complete absence of response can be regarded as abnormal. Its utility in evaluating bladder and urethral dysfunction is not established.

3. EVIDENCE BASED USE OF CLINICAL NEUROPHYSIOLOGICAL TESTS

Evidence-based medicine is founded on the assessment of evidence for and against the efficacy of particular types of therapeutic intervention. Clinical neurophysiology testing should thus demonstrate evidence that testing improves outcome (through treatment choice and patient selection). However, testing and therapeutic intervention are different concepts, and neurophysiological testing has another important objective. It is to generate knowledge about the situation to be treated in a given patient, so that the practitioner can formulate rational treatment options based on knowledge rather than do so blindfold; that is, he or she can practice “knowledge-based medicine”.

To judge the importance of this second objective different criteria are needed. Particularly in the referral setting, the physician is confronted with complicated cases in which the underlying pathophysiology is quite uncertain, and what is required is to identify all the factors that may be contributing. Neurophysiology is helpful in assessment of neurogenic dysfunction because it contributes to “knowledge-based medicine”, whether or not there is narrowly-defined “evidence” that it improves outcomes.

Of course, it remains true that we should seek evidence of the conventional kind for and against testing. Any test should be subjected to three questions:

1. Does the test have good technical performance?
2. Does the test have good diagnostic performance, ideally against a “gold standard” measure?
3. Does the test have good therapeutic performance, that is, does the use of the test alter clinical management, does the use of the test improve outcome?

Clinical diagnosis requires that measures obtained in individual patients be compared to population norms with the intent of determining whether they are “normal” or “abnormal”. Data can be classified as “abnormal” only with the understanding that they are compared to a sample from the normal population. Predictive statements are made possible by the use of tolerance limits. For most clinical neurophysiological tests, one-tailed tolerance limits are recommended. For any given limit of normality, there is a certain probability of falsely interpreting values (obtaining false-positives or false-negatives). Further confounding these issues is the practice of applying multiple criteria of abnormality. But ultimately, the adequacy of any given normal limit in discriminating between normal and abnormal must be supported by appropriate clinical or clinico-pathological correlations; for uro-neurophysiological techniques, such data are scarce.

3.1. Usefulness of Clinical Neurophysiological Tests in Evaluation of Individual Patients

Whenever pathophysiology is uncertain or unpredictable, and especially if irreversible treatment is necessary or contemplated, it seems logical to gather quantitative knowledge of the dysfunction in order to make a rational treatment choice.

In most patient groups with neurogenic incontinence, the pathophysiology is unpredictable and comprehensive urodynamic evaluation is essential in order to practice knowledge-based medicine. In selected patients from these groups, clinical neurophysiological testing will clarify issues related to the neural control of lower urinary tract, relevant for understanding pathophysiology.¹²⁹

As is generally true for electrophysiological tests, uro-neurophysiological examinations are particularly useful for substantiating the clinical diagnosis of a peripheral nerve lesion. The potential usefulness of testing in an individual patient needs to be analysed in the overall clinical setting. The indications for testing are guided primarily by expert opinion, not on definitely established criteria derived from controlled studies.

In the incontinent patient without other signs or symptoms of a neurological condition, as in most patients with stress/urgency, or mixed urinary incontinence

electrophysiological testing is as a rule non-contributory.⁶¹

Neurophysiological methods may have other uses, as for instance using the EMG signal for correct needle positioning for infiltration of sphincter muscle with botulinum toxin,¹³⁰ or using tests for intraoperative identification and monitoring of nerves and muscles.¹²⁶

3.2. Usefulness of Clinical Neurophysiological Tests in Research

As understanding pathophysiology of neural control of lower urinary tract is essential in the application of more sophisticated therapeutic methods, such as electrical stimulation techniques,^{131,132} there is a continuing place for clinical neurophysiology in research on neurogenic urinary and anorectal dysfunction and their therapy.

There is ongoing research on already described techniques to validate their usefulness in diagnostics¹³³, and in intraoperative monitoring.¹³⁴

4. CONSENSUS STATEMENT

4.1. Recommendation for Clinical Neurophysiological Testing

The information gained by clinical examination and urodynamic testing may be enhanced by uro-neurophysiological tests in selected patient groups with suspected neurogenic urinary incontinence with lesions within the nervous reflex arcs of sacral segments 2 – 5. Concentric needle EMG to diagnose denervation and reinnervation of pelvic floor and perineal muscles, and sacral reflex testing to assess the continuity of the sacral reflex arc, are the recommended tests.

Level of evidence: 2b

Level of recommendation: B

Clinical neurophysiological testing should be performed in accredited laboratories, by trained and certified staff, with formal control of the quality of the results. Ideally, the uro-neurophysiologist should be in liaison with general clinical neurophysiologists.

It seems optimal to create interdisciplinary teams between urology, urogynecology, proctology, and neurology departments.

4.2. Recommendation for Technical Standards

Even in the more widely used “general” clinical neurophysiology there is no universal standardisation of tests. This is mainly due to different historical backgrounds of testing developed in different countries. The need to standardise methods is, however, recognised.

Proposals for standardisation for external anal sphincter CNEMG⁴ and the bulbocavernosus

(penilo/clitro-cavernosus) reflex¹¹⁷ have been made, and seem to be widely adopted.

Level of evidence: 2b

Level of recommendation: B

4.3. Future Research Areas

Clinical neurophysiological methods should be further explored and used to better define the neural control in lower urinary tract function, demonstrating both the nervous system's "hardware" (integrity of anatomy)¹³⁵ as well as "software" (level of activity, excitation thresholds) for co-ordinated urinary storage and voiding, in physiological and in pathological conditions.¹³⁶

There is as yet no standardisation of the technical aspects of (kinesiological) EMG within urodynamic (and anorectal) function testing. Furthermore, more research is needed to shed light on the relationship between the EMG signals, pelvic floor muscle function, and overall LUT (anorectal) function (Anding et al. When Should Video and EMG Be Added to Urodynamics in Children With Lower Urinary Tract Dysfunction and Is This Justified by the Evidence? ICI-RS 2014. *Neurourology and Urodynamics* 35:331–335 (2016) References at end and anorectal function.

There are also challenges to validate the use of the described techniques for intraoperative identification of structures and monitoring nervous function,¹³⁷ to define neurophysiological changes induced by therapeutic electrostimulation, and to develop tests to assess directly the sacral parasympathetic system.

VI. OTHER INVESTIGATIONS

1. URINALYSIS

"Urinalysis is a fundamental test that should be performed in all urological patients" (1). In patients with urinary incontinence, urinalysis is not a diagnostic test for the condition, but it is rather used to screen for haematuria, glucosuria, pyuria and bacteriuria. Even in the absence of controlled studies, there is general expert consensus that the benefits of urinalysis clearly outweigh the costs involved (2). A positive urinalysis will prompt infection treatment and/or the use of additional tests such as endoscopy and urinary tract imaging. In the evaluation of urinary incontinence in the female, urinalysis is recommended since 60% of women develop urgency symptoms at the time of urinary tract infection (UTI). Pyuria was found to be common among incontinent but otherwise asymptomatic, female patients. Pyuria was not necessarily associated with UTI, the significance of sterile pyuria in the elderly population is still unclear (3).

A Norwegian survey of general practitioners' management of female urinary incontinence suggested that urinalysis is the most frequently performed test

(73%) and is far more frequent than gynaecological examination (54%) (4). Another survey suggested that urinalysis is one of the three-part assessment of UI together with patient history and physical examination (5). The same apply, according to Stricker, for patient selection for collagen implant (6). A minority of the reviewed papers suggested that urine culture should be carried out together with urinalysis (3, 7). Urinalysis is also considered of importance in the evaluation of nursing home residents who are incontinent (8), in peri- and postmenopausal women (9), in older women reporting urinary incontinence (10). Belmin et al, suggested that significant urine samples can even be obtained from disposable pads in elderly incontinent women (11, 12). It is recommended that geriatric incontinent patients undergo history, physical examination, tests of lower urinary tract function and urinalysis. The latter test is proposed to rule out the presence of UTI (12). The clinical relevance of asymptomatic bacteriuria in the elderly is controversial. Although DuBeau and Resnick suggest the use of urinalysis in the diagnostic algorithm to identify asymptomatic bacteriuria in incontinent residents of nursing homes (13), others consider that the condition does not require any treatment (11). Urinalysis is less sensitive and specific for urinary tract infection in women who have had radiotherapy but the combination of leucocyte esterase and nitrites still has a positive predictive value of 95% (14). Urinalysis in patients with stents and patients on haemodialysis has not been found to be an effective screening test and routine culture is recommended (15, 16).

1.1. Consensus Statement

- It is considered standard practice to perform a urinalysis either by using a dipstick test or examining the spun sediment. (Level of Evidence 3, Grade of Recommendation C)
- If a dipstick test is used, it is recommended choosing of a "multiproperty" strip that includes testing for haematuria, proteinuria, glucose and ketones, leukocytes esterase (indicating the presence of leukocytes in the urine) and nitrite tests (suggesting bacteriuria). (Level of Evidence 3, Grade of Recommendation C)

1.2. Future Research Areas

- Needed to screen analysis of urinalysis in the diagnosis and treatment of UI, MUI and SUI

2. BLOOD TESTS

The prevalence of renal damage or of biochemical abnormalities in the general population of patients with urinary incontinence is very low, but there are subgroups of patients where the prevalence can be higher (e.g., neurogenic incontinence, overflow incontinence). The routine use of a battery of common chemical and/or haematological tests in patients with

UI appears to be a prudent rule of good clinical practice in the following situations:

- chronic retention with incontinence
- neurogenic LUT dysfunction
- when surgery is contemplated
- when there is a clinical suspicion
- sodium plasma concentration may be reduced in patients on desmopressin.

Special tests such as measurement of anti diuretic hormone (ADH) and atrial natriuretic polypeptide have proven useful in research of enuresis in childhood and nocturia in the elderly (1, 2). Changes in the circadian rhythm of these, and probably also other hormones regulating the renal excretion of water, will in the future contribute to a better understanding of pathophysiology. Synthetic ADH analogues have already come into clinical use for the treatment of nocturnal enuresis. However, the clinical value of these specific tests remains to be established.

3. TISSUE ANALYSIS

Since the last report of the International Consultation on Incontinence in 2012, several papers have been published based on the analysis of sample of tissues coming from patients with SUI and/or pelvic organ prolapse aiming at evaluating the molecular bases of these conditions. The main targets of both preclinical and clinical research have been the pelvic floor-supporting tissues and the role of steroid hormones, with some intriguing linkages between the two lines of research.

Pelvic floor-supporting tissues are composed mainly of connective tissue in which fibrous elements such as collagen and elastic fibres and visco-elastic matrix based on proteoglycans are the predominant components of the so called extracellular matrix. Extracellular matrix is a complex network of numerous macromolecules that fulfill a large number of mechanical, chemical and biological functions (1). While collagens and elastin fibres confer strength and elasticity to tissues, respectively, structural proteoglycans allow tissue cohesiveness. Specifically, collagen is the most prevalent component, with type I fibres usually well organised and associated with ligamentous tissue, while type III collagen is more common in the loose areolar tissue, which makes up the vaginal wall adventitia and surrounds the pelvic organs (2). According to the molecular weight, indeed, proteoglycans are distinguished into large molecules (aggrecan, versican and perlecan) and small molecules, such as decorin, fibromodulin, biglycan, lumican and chondroadherin (3).

The organised structure of the matrix is due to a clear balance between the production of the different constituents and their breakdown. There are many proteolytic enzymes capable of degrading the elements of

the extracellular matrix, falling into into three groups: the serine proteases, the cysteine proteases, and matrix metalloproteinases (MMPs) (4).

Several authors evaluated the expression of the different proteins as well as of their precursors and fragments of degradation. With regards to the metabolism of collagen, some studies seem to indicate that women with SUI have a reduced total collagen content in the skin and urogenital tissue (5-7), while other studies reported higher total collagen concentration and higher levels of mRNAs for type I and type III collagen in paraurethral connective tissue (8). Chen et al., evaluating cultures of fibroblasts taken from endopelvic fascia and skin biopsies in 14 patients with stress urinary incontinence and 12 controls, showed that the overall collagen synthesis and the ratio of type III and type I fibres were not significantly different between fibroblasts obtained from women with or without SUI (4), indicating that alteration in the collagen synthesis might not be involved in SUI.

On the other hand, a few studies reported change in the relative percentages of the different fibres, with a decrease in type I and increase in type III ones (9, 10). In women with SUI, Skorupski et al. evaluated the transcription factor Sp1-binding site in the gene encoding α -1 chain of type I collagen, and suggested that the observed G-T polymorphism is a risk factor for incontinence (11). Again at molecular level, some studies evaluated the cycle regulatory proteins in patients with pelvic organ prolapse, showing controversial results. Some papers reported reduced expression of proteins such as p53 and p21 which normally cause cycle G1 arrest suggesting an increase in proliferation capacities for fibroblasts derived from human cardinal ligaments of patients with prolapse (2).

Other authors evaluated markers of collagen degradation. Specifically, Edwall et al. evaluated markers of collagen synthesis and breakdown such as the carboxy-terminal propeptide of type I procollagen (PICP), the carboxy-terminal telopeptide of type I collagen (ICTP), and the amino-terminal propeptide of procollagen III (PIIINP) in urogenital tissue homogenates and peripheral serum from 71 patients with SUI and 31 healthy control women (12). After adjusting for age, BMI, parity, and hormonal status, the patients with SUI had significantly lower serum concentrations of PICP and significantly lower tissue concentrations of PIIINP and ICTP than the controls, suggesting reducing breakdown in the presence of unchanged synthesis of type I collagen and, regarding type III collagen, a potential reduction in either synthesis or breakdown, the second being considered more probable (12). These data may lead to the hypothesis that SUI might be associated with impaired degradation of collagen, leading to reduced turnover and accumulation of aging collagen, negatively affecting the strength and elasticity of urogenital tissue. Further studies on transforming growth factor- β (TGF- β) identified the molecular basis of such mechanism, suggesting that overexpression of TGF- β might trigger the accumula-

tion of aging collagen, inhibiting the expression of collagenases and increasing the production of the tissue inhibitor metalloproteinase (13-15). Moreover, some genes, such as those of the Homeobox A (HOXA) family, encoding transcription factors that regulate mammalian embryonic growth and development of the urogenital tract, have been shown to be underexpressed in patients with pelvic organ prolapse, suggesting a further molecular basis for the alterations in collagens (16).

Some other studies investigated the role of proteinases that may degrade elements of the extracellular matrix. Chen et al., evaluating full-thickness peri-urethral vaginal wall tissues from patients with SUI or prolapsed and matched control women, found significant decrease in mRNA and protein expressions of alpha-1 antitrypsin (ATT), a neutrophil elastase inhibitor in tissues from affected women, while no difference was found in neutrophil elastase and cathepsin K expressions (17). Similarly, Gabriel et al. studied the expression of different MMPs in 17 women with prolapse and 18 control, identifying higher expression of MMP2 in patients with prolapse (18). These studies allowed to hypothesize that altered catabolism of some components of the extracellular matrix might contribute to the connective tissue alterations observed in pelvic floor dysfunction.

Other studies were focused on the expression of small proteoglycans. Wen et al. studied mRNA and protein levels of biglycan, decorin, and fibromodulin in vaginal wall tissue from women with SUI and menstrual-cycle matched continent women (1). Specifically, the authors demonstrated that the mRNA expression of fibromodulin was significantly lower in patients in the proliferative phase compared to controls, while decorin mRNA expression was higher both in the proliferative and secretory phases in the patients with SUI, supporting the hypothesis that the expression of such small proteoglycans was hormonally modulated and may contribute to the altered pelvic floor connective tissues of women with SUI (1).

Oestrogens interact with specific receptors which, when activated by the ligand, have conformational change, dimerisation and recruitment of co-factors, once translocated into the nucleus, these promote the expression of region of oestrogen-responsive genes, called the oestrogen response elements, leading to the synthesis of proteins (19). More recently, selective modulators of oestrogens receptors have been identified, that act modulating the activity of the receptors, working as agonists, partial agonists, or antagonists in a tissue-dependent manner (20). Studies on these molecules supported a new role of oestrogens in SUI and pelvic organ prolapse. Specifically, in a randomised controlled trial testing one of these molecules (levormeloxifene) as osteoporosis treatment, a 3.4-fold increase in the reporting of POP and an almost 5-fold increase in the reporting of UI have been observed (21). To explain such effect, the expression of more than 500 proteins have been studied in the rat model, showing that oestradiol induced

the expression of metalloproteinase 7 and 14, reduced the expression of their inhibitors such as TIMP-3, while selective modulators of oestrogens receptors such as raloxifene had minimal effects on metalloproteinase 7, and maintained or restored expression of the mRNA for tissue inhibitor of metalloproteinases-3 (TIMP-3) and other components of the extracellular matrix, such as glypican, and biglycan (19). Although the role of selective oestrogen-receptor modulators (SERMs) in the expression of the component of extracellular matrix has to be further clarified, these findings support the hypothesis that the increased occurrence of urinary incontinence and pelvic organ prolapse observed with oestrogen therapy and SERMs such as levormeloxifene may be related to changes in expression of genes regulating collagen turnover that ultimately weaken the normal structural integrity and support for the genitourinary system (19).

3.1. Consensus Statement

To date, all these tissue analyses are not part of the everyday clinical practice

3.2. Future Research Areas

The relationship between tissue composition and risk of UI and POP

The relationship between tissue composition and treatment outcome in patients with UI and POP

VII. CONCLUSIONS

Clinical research involving diagnostic accuracy and clinical benefit of imaging studies and other diagnostic tests is particularly difficult. Recommendation of a diagnostic test is based upon the evidence that the outcome of it provides valuable information for patient management and this often involves evaluating the outcome of surgery. Implementation of good clinical research in this area remains difficult and sometimes lacks adequate founding. We acknowledge that only a few of the imaging techniques and other investigations we reviewed in the current chapter have been properly evaluated with respect to reproducibility, specificity, sensitivity and predictive value in connection with the diagnosis and management of urinary incontinence. Nevertheless, we acknowledge the great amount of work performed in the last four years and the continuous advancement in this field. The use of imaging and other investigations, described in this chapter, remains mostly based on expert opinion, common sense, availability and local expertise, rather than on evidence based clinical research. The diagnostic tests we considered can be subdivided into safety tests, tests with specific and selected indications, investigational tests.

Safety tests - Intended to protect patients' health, they are indicated in all patients complaining of urinary incontinence. They include urinalysis and measurement of post-void residual urine. While a consensus is easily achieved for urinalysis, the clinical benefit

and cost-effectiveness of PVR measurement in the primary evaluation of urinary incontinence needs to be confirmed in prospective studies.

Tests with specific and selected indications. Upper urinary tract imaging (as well as renal function assessment) may be indicated in cases of neurogenic urinary incontinence with risk of renal damage, chronic retention with incontinence, incontinence associated with severe genitourinary prolapse and suspicion of extraurethral incontinence. No other imaging technique is recommended in the primary evaluation of uncomplicated urinary incontinence and/or pelvic organ prolapse. Cystourethrography remains a reasonable option only in the preoperative evaluation of complicated and/or recurrent cases. Video urodynamics, is the gold standard in the evaluation of neurogenic incontinence, particularly in the paediatric population, although the clinical benefit of it remains unclear. In female urinary incontinence videourodynamics is not recommended except under specific complex circumstances. MRI remains the gold standard for the diagnosis of urethral diverticula although ultrasonography is a good alternative option. Lumbosacral spine X-rays have specific indications in children with suspect neurogenic incontinence without gluteo-sacral stigmata. Imaging of the CNS should be considered when a neurological disorder is suspected on the basis of clinical, imaging and neurophysiological findings. Urethrocystoscopy is indicated in cases of incontinence with microscopic haematuria, in the evaluation of recurrent or iatrogenic cases, in the evaluation of vesico-vaginal fistula and extra-urethral urinary incontinence.

Endoanal ultrasound and endocoil MRI are the gold standard for the evaluation of anal sphincter disorders, dynamic X-ray imaging remains the standard for evaluating rectal prolapse.

Investigational tests Pelvic floor ultrasound is widely used as an adjunct to physical examination in patients with urinary incontinence and/or pelvic organ prolapse. Although the technique is rapidly evolving and much progress has been made in clinical research in this field, ultrasonography remains optional as evidence of its clinical benefit is not there yet.

MRI of the pelvic floor is rapidly gaining popularity in the evaluation of enteroceles and in the morphological analysis of pelvic floor muscles although evidence of its clinical benefit is still lacking. Both ultrasonography and MRI are the most rapidly evolving techniques and hold promises for potential future clinical applications.

Research in this area is also performed to improve our understanding of the pathophysiology of continence disorders and POP. Functional neuroimaging continues to provide new insight regarding functional anatomy of CNS related to vesicourethral function and dysfunction. The content of the draft reflects the composition of the Committee is made up of clinicians with a particular interest in a specific area of imaging and neurophysiology. The chapter certainly reveals

the enthusiasm the authors poured in clinical research into this area but we believe that the methodology implemented by the Consultation is the best guarantee of a balanced opinion and evidence based recommendations. We hope that this chapter will stimulate clinical research in this field and will inspire those involved in the management of continence disorders and POP.

Neurophysiological testing should be part of the armamentarium available in the management of neurogenic incontinence and the establishment of good collaboration with neurophysiologists is recommended.

REFERENCES

I. INTRODUCTION

1. Bossuyt PM, Reitsma JB, Bruns DE, Gatsonis CA, Glasziou PP, Irwig LM et al. The STARD statement for reporting studies of diagnostic accuracy: explanation and elaboration. *Clin. Chem.* 2003 Jan;49(1): 7-18.

II. IMAGING IN URINARY INCONTINENCE AND PELVIC FLOOR DYSFUNCTION

1. IMAGING OF THE UPPER URINARY TRACT

1. Abrams P, Cardozo L, Fall M, Griffiths D, Rosier P, Ulmsten U, van Kerrebroeck P, Victor A, and Wein A. The standardisation of terminology of lower urinary tract function: Report from the Standardisation Sub-committee of the International Continence Society. *NeuroUrology&Urodynamics* 2002; 21:167-178.
2. McGuire EJ, Woodside JR, Borden TA, Weiss RM. Prognostic value of urodynamic testing in myelodysplastic patients. *J Urol.* 1981 Aug;126(2):205-9.
3. Lewis JM, Yalla SV, Stanitski KE, Sullivan MP. Spectrum of urodynamic abnormalities and renal function changes in adult men with non-neurogenic urinary retention. *NeuroUrology&Urodynamics*. 2012 Apr;31(4):544-8.
4. Kontogeorgos L, Vassilopoulos P, Tentis A. Bilateral severe hydronephrosis due to uterine prolapse. *Br J Urol.* 1985 Jun;57(3):360-1.
5. Gerritzen RG, Thijssen AM, Dehoux E. Risk factors for upper tract deterioration in chronic spinal cord injury patients. *J Urol.* 1992 Feb;147(2):416-8.
6. Edokpolo LU, Foster HE Jr. Renal tract ultrasonography for routine surveillance in spinal cord injury patients. *Top Spinal Cord Inj Rehabil.* 2013 Winter;19(1):54-60.
7. Tarcan T, Sekerci CA, Akbal C, Tinay I, Tanidir Y, Sahan A, Sahin B, Top T, Simsek F. Is 40 cm H₂O detrusor leak point pressure cut-off reliable for upper urinary tract protection in children with myelodysplasia? *NeuroUrology&Urodynamics*. 2016 Apr 15.
8. Veenboer PW, Ruud Bosch JL, de Kort LM. Assessment of bladder and kidney functioning in adult spina bifida patients by Dutch urologists: a survey. *NeuroUrology&Urodynamics*. 2014 Mar;33(3):289-95.
9. Dancz CE, Walker D, Thomas D, Özel B. Prevalence of Hydronephrosis in Women With Advanced Pelvic Organ Prolapse. *Urology*. 2015 Aug;86(2):250-4.
10. Wee WW, Wong HF, Lee LC, Han HC. Incidence of hydronephrosis in severe uterovaginal or vault prolapse. *Singapore Med J.* 2013 Mar;54(3):160-2.
11. Beverly CM, Walters MD, Weber AM, Piedmonte MR, Ballard LA. Prevalence of hydronephrosis in patients undergoing surgery for pelvic organ prolapse. *Obstet Gynecol.* 1997 Jul;90(1):37-41.
12. Gemer O, Bergman M, Segal S. Prevalence of hydronephrosis in patients with genital prolapse. *Eur J Obstet Gynecol Reprod Biol.* 1999 Sep;86(1):11-3.
13. Leanza V, Ciotta L, Vecchio R, Zanghi G, Maiorana A, Leanza G. Hydronephrosis and uterovaginal prolapse in postmenopausal women: management and treatment. *GChir.* 2015 Nov-Dec;36(6):251-6.
14. Konda R, Sakai K, Ota S, Abe Y, Hatakeyama T, Orikasa S. Ultrasound grade of hydronephrosis and severity of renal cortical damage on 99m technetium dimercapto-succinic acid renal scan in infants with uni-lateral hydronephrosis during followup and after pyeloplasty. *J Urol.* 2002 May;167(5):2159-63.
15. Dhillon HK. Prenatally diagnosed hydronephrosis - the Great Ormond Street experience. *Br J Urol* 1998; 81 (Suppl 2): 39-44.
16. Platt JF, Rubin JM, Ellis JH. Distinction between obstructive and nonobstructive pelvocaliectasis with duplex Doppler sonography. *AJR Am J Roentgenol.* 1989 Nov;153(5):997-1000.
17. Owen RJ, Hiremath S, Myers A, Fraser-Hill M, Barrett BJ. Canadian Association of Radiologists consensus guidelines for the prevention of contrast-induced nephropathy: update 2012. *Can Assoc Radiol J.* 2014 May;65(2):96-105.

18. Ohno I, Hayashi H, Aonuma K, Horio M, Kashihara N, Okada H, Komatsu Y, Tamura S, Awai K, Yamashita Y, Kuwatsuru R, Hirayama A, Saito Y, Murohara T, Tamaki N, Sato A, Takayama T, Imai E, Yasuda Y, Koya D, Tsu-bakihara Y, Horie S, Korogi Y, Narumi Y, Hayakawa K, Daida H, Node K, Kubota I; Jap-anese Society of Nephrology, Japan Radio-logical Society, and Japanese Circulation Society Science Advisory and Coordinating Committee. Guidelines on the use of iodinat-ed contrast media in patients with kidney disease 2012: digest version : JSN, JRS, and JCS Joint Working Group.Clin-ExpNephrol. 2013 Aug;17(4):441-79.
19. Vanommeslaeghe F, De Mulder E, Van de Bruaene C, Van de Bruaene L, Lameire N, Van Biesen W. Selecting a strategy for prevention of contrast-induced nephropathy in clinical practice: an evaluation of different clinical practice guidelines using the AGREE tool. *Nephrol Dial Transplant*. 2015 Aug;30(8):1300-6.
20. Braverman RM, Lebowitz RL. Occult ectopic ureter in girls with urinary incontinence: diagnosis by using CT. *AJR Am J Roentgenol*. 1991 Feb;156(2):365-6.
21. Utsunomiya M, Itoh H, Yoshioka T, Okuyama A, Itatani H. Renal dysplasia with a single vaginal ectopic ureter: the role of computerized tomography. *J Urol*. 1984 Jul;132(1):98-100.
22. Prewitt LH, Jr., Lebowitz RL. The single ectopic ureter. *AJR Am J Roentgenol*. 1976 Dec;127(6):941-8.
23. Borer JG, Bauer SB, Peters CA, Diamond DA, Decter RM, Shapiro E. A single-system ectopic ureter draining an ectopic dysplastic kidney: delayed diagnosis in the young fe-male with continuous urinary incontinence. *Br J Urol*. 1998 Mar;81(3):474-8.
24. Bozorgi F, Connolly LP, Bauer SB, Neish AS, Tan PE, Schoeld D, et al. Hypoplastic dysplastic kidney with a vaginal ectopic ure-ter identified by technetium-99m-DMSA scin-tigraphy. *J Nucl Med*. 1998 Jan;39(1):113-5.
25. Carrico C, Lebowitz RL. Incontinence due to an infraspincteric ectopic ureter: why the delay in diagnosis and what the radiologist can do about it. *PediatrRadiol*. 1998 Dec;28(12):942-9.
26. Mandal AK, Sharma SK, Vaidyanathan S, Goswami AK. Ureterovaginal fistula: summary of 18 years' experience. *Br J Urol*. 1990 May;65(5):453-6.
27. Murphy DM, Grace PA, O'Flynn JD. Ureterovaginal fistula: a report of 12 cases and review of the literature. *J Urol*. 1982 Nov;128(5):924-5.
28. Pantuck AJ, Barone JG, Rosenfeld DL, Fleisher MH. Occult bilateral ectopic vaginal ureters causing urinary incontinence: diagnosis by computed tomography. *Abdom Im-ag-ing*. 1996 Jan-Feb;21(1):78-80.
29. Perazella MA. Gadolinium-contrast toxicity in patients with kidney disease: nephrotoxi-city and nephrogenic systemic fibrosis. *Curr Drug Saf*. 2008 Jan;3(1):67-75.
30. Khawaja AZ, Cassidy DB, Al Shakarchi J, McGrogan DG, Inston NG, Jones RG. Revis-iting the risks of MRI with Gadolinium based contrast agents-review of literature and guide-lines. *Insights Imaging*. 2015 Oct;6(5):553-8.
31. Leyendecker JR, Barnes CE, Zagoria RJ. MR urography: techniques and clinical appli-cations. *Radiographics*. 2008 Jan-Feb;28(1):23-46; discussion -7.
32. Avni EF, Matos C, Rypens F, Schulman CC. Ectopic vaginal insertion of an upper pole ure-ter: demonstration by special se-quences of magnetic resonance imaging. *J Urol*. 1997 Nov;158(5):1931-2.
33. Kaneko K, Ohtsuka Y, Suzuki Y, Yabuta K, Yamataka A, Miyano T. Masked ureteral dupli-cation with ectopic ureter detected by mag-netic resonance imaging. *Acta Paediatr Jpn*. 1996 Jun;38(3):291-3.
34. Tang M, Wang Q, Liu B, Li J, Lu Q, Song N, Wang Z, Zhang W. Single ectopic ureteral or-ifice with bilateral duplicated renal collect-ing systems in an adult girl: Diagnosis by magnetic resonance urography. *Can Urol Assoc J*. 2015 Jul-Aug;9(7-8):E554-8.
35. Wang MH. Persistent Urinary Inconti-nence: A Case Series of Missed Ectopic Ure-ters. *Urol Case Rep*. 2015 Aug 25;3(6):223-5.
36. Conway JJ. "Well-tempered" diuresis re-nography: its historical development, phys-iological and technical pit- falls, and stand-ardized technique protocol. *SeminNucl Med*. 1992 Apr;22(2):74-84.
37. O'Reilly PH. Diuresis renography. Recent ad-vances and recommended protocols. *Br J Urol*. 1992 Feb;69(2):113-20.
38. Ruikka I. Residual urine in aged women and its influence on the phenolsulfonphtalein excretion test. *Ger- ontolClin (Basel)*. 1963;5:65-71.
39. Pattaras JG, Rushton HG, Majd M. The role of 99mtechnetium dimercaptosuccinic acid renal scans in the evaluation of occult ectopic ureters in girls with paradoxical in-continence. *J Urol*. 1999 Sep;162(3 Pt 1):821-5.

40. Lee YS, Im YJ, Kim SW, Kim MJ, Lee MJ, Lim NL, Han SW. The vagaries of proper im-aging in diagnosing single-system ectopic ureter in children with continuous inconti-nence and out-comes of simple nephrectomy. *J Pediatr Surg.* 2016 Mar;51(3):469-74.

2. X-RAY IMAGING OF THE LOWER URINARY TRACT

1. Andersen JT. Prostatism: Clinical, radiological, and urodynamic aspects. *Neurourol Urodyn.* 1982;1(3):241-93.
2. Bellinger MF. The management of vesicoureteric reflux. *Urol Clin North Am.* 1985;12(1):23-9.
3. Barroso U, Jr., Barroso VA, de Bessa J, Jr., Calado AA, Zerati Filho M. Predictive factors for contralateral reflux in patients with conserva-tively treated unilateral vesicoureteral reflux. *J Urol.* 2008;180(1):297-9; discussion 9.
4. Jacoby K, Rowbotham RK. Double balloon positive pressure urethrography is a more sen-sitive test than voiding cystourethrography for diagnosing urethral diverticulum in women. *J Urol.* 1999;162(6):2066-9.
5. Romanzi LJ, Groutz A, Blaivas JG. Urethral di-verticulum in women: diverse presentations re-sulting in diagnostic delay and mismanage-ment. *J Urol.* 2000;164(2):428-33.
6. Olesen KP. Descent of the female urinary blad-der. A radiological classification based on colpo-cysto-urethrography. *Dan Med Bull.* 1983;30(2):66-84.
7. Neitlich JD, Foster HE, Jr., Glickman MG, Smith RC. Detection of urethral diverticula in women: comparison of a high resolution fast spin echo technique with double balloon ure-thrography. *J Urol.* 1998;159(2):408-10.
8. Foster RT, Amundsen CL, Webster GD. The utility of magnetic resonance imaging for diag-nosis and surgical planning before transvaginal periurethral diverticulectomy in women. *Int Uro-gynecol J Pelvic Floor Dysfunct.* 2007;18(3):315-9.
9. Green TH, Jr. Classification of stress urinary in-continance in the female: an appraisal of its current status. *Obstet Gynecol Survey.* 1968(23):632-4.
10. Blaivas JG, Olsson CA. Stress incontinence: classification and surgical approach. *J Urol.* 1988;139:727-31.
11. Shapeero LG, Friedland GW, Perakash I. Transrectal sonographic voiding cystourethrog-raphy: studies in neuromuscular bladder dys-function. *AJR Am J Roentgenol.* 1983;141(1):83-90.
12. Piscitelli A, Galiano R, Serrao F, Concolino D, Vitale R, D'Ambrosio G, et al. Which cys-tography in the diagnosis and grading of vesicoureteral reflux? *Pediatr Nephrol.* 2008;23(1):107-10.
13. v. Mikulicz-Radecki F. Röntgenologische studien zur ätiologie der urethralen inkontinenz. *Zbl Gynäk.* 1931;55:795-810.
14. Stevens WE, Smith SP. Roentgenological ex-amination of the female urethra. *J Urol.* 1937;37:194-2001.
15. Ardran GM, Simmons CA, Stewart JH. The clo-sure of the female urethra. *J Obstet Gynaecol Br Emp.* 1956;63(1):26-35.
16. Enhoerning G, Miller ER, Hinman F, Jr. Ure-thral Closure Studied with Cinerentgenogra-phy and Simultaneous Bladder-Urethra Pres-sure Recording. *Surg Gynecol Obstet.* 1964;118:507-16.
17. Palm L. Bladder Function in women with dis-eases of the lower urinary tract. Thesis. Copen-hagen 1971.
18. Shopfner CE. Cystourethrography: methodol-ogy, normal anatomy and pathology. *J Urol.* 1970;103(1):92-103.
19. Bates CP, Whiteside CG, Turner-Warwick R. Synchronous cine-pressure-flow-cysto-ure-thrography with special reference to stress and urge incontinence. *Br J Urol.* 1970;42(6):714-23.
20. Olesen KP, Walter S. Colpo-cysto-urethrogra-phy: a radiological method combined with pres-sure-flow measurements. *Dan Med Bull.* 1977;24(3):96-101.
21. Theofrastous JP, Cundiff GW, Harris RL, Bump RC. The effect of vesical volume on Valsalva leak-point pressures in women with genuine stress urinary incontinence. *Obstet Gynecol.* 1996;87(5 Pt 1):711-4.
22. Klarskov P, Vedel Jepsen P, Dorph S. Reliabil-ity of voiding colpo-cysto-urethrography in fe-male urinary stress incontinence before and af-ter treatment. *Acta Radiol.* 1988;29(6):685-8.
23. Barnick CG, Cardozo LD, Benness C. Use of routine videocystourethrography in the eval-uation of female lower urinary tract dysfunction. *Neurourol Urodyn.* 1989;8(5):447-9.
24. Pick EJ, Davis R, Stacey AJ. Radiation dose in cinecystourethrography of the female. *Br J Ra-di-ol.* 1960;33:451-4.

25. Westby M, Ulmsten U, Asmussen M. Dynamic urethrocytography in women. *Urol Int*. 1983;38(6):329-36.
26. Rud T, Ulmsten U, Westby M. Initiation of micturition: a study of combined urethrocytometry and urethrocytography in healthy and stress incontinent females. *Scand J Urol Nephrol*. 1979;13(3):259-64.
27. de Goeij WBKMV. Incontinence of urine in women. Thesis. Meppel 1976.
28. Aldridge A, Jeffcoate TN, Roberts H. Stress incontinence of urine. *J Obstet Gynaecol Br Emp*. 1952;59(5):681-720.
29. Sakakibara R, Hattori T, Uchiyama T, Yamanishi T. Videourodynamic and sphincter motor unit potential analyses in Parkinson's disease and multiple system atrophy. *J Neurol Neurosurg Psychiatry*. 2001;71(5):600-6.
30. Hinman F. Urinary tract damage in children who wet. *Pediatrics*. 1974;54(2):143-50.
31. Allen TD. The non-neurogenic neurogenic bladder. *J Urol*. 1977;117(2):232-8.
32. Williams DI, Hirst G, Doyle D. The occult neuropathic bladder. *J Pediatr Surg*. 1974;9(1):35-41.
33. Podesta ML, Castera R, Ruarte AC. Videourodynamic findings in young infants with severe primary reflux. *J Urol*. 2004;171(2 Pt 1):829-33; discussion 33.
34. Soygur T, Arikan N, Tokatli Z, Karaboga R. The role of video-urodynamic studies in managing non-neurogenic voiding dysfunction in children. *BJU Int*. 2004;93(6):841-3.
35. Fantl JA, Hurt WG, Beachley MC, Bosch HA, Konerding KF, Smith PJ. Bead-chain cystourethrogram: an evaluation. *Obstet Gynecol*. 1981;58(2):237-40.
36. Drutz HP, Shapiro BJ, Mandel F. Do static cystourethrograms have a role in the investigation of female incontinence? *Am J Obstet Gynecol*. 1978;130(5):516-20.
37. Green TH, Jr. Development of a plan for the diagnosis and treatment of urinary stress incontinence. *Am J Obstet Gynecol*. 1962;83:632-48.
38. Gjorup T. Reliability of diagnostic tests. *Acta Obstet Gynecol Scand Suppl*. 1997;166:9-14.
39. Showalter PR, Zimmern PE, Roehrborn CG, Lemack GE. Standing cystourethrogram: an outcome measure after anti-incontinence procedures and cystocele repair in women. *Urology*. 2001;58(1):33-7.
40. Fischer-Rasmussen W, Hansen RI, Stage P. Predictive values of diagnostic tests in the evaluation of female urinary stress incontinence. *Acta Obstet Gynecol Scand*. 1986;65(4):291-4.
41. Gordon D, Pearce M, Norton P, Stanton SL. Comparison of ultrasound and lateral chain urethrocytography in the determination of bladder neck descent. *Am J Obstet Gynecol*. 1989;160(1):182-5.
42. Greenwald SW, Thornbury JR, Dunn LJ. Cystourethrography as a diagnostic aid in stress incontinence. An evaluation. *Obstet Gynecol*. 1967;29(3):324-7.
43. Kitzmiller JL, Manzer GA, Nebel WA, Lucas WE. Chain cystourethrogram and stress incontinence. *Obstet Gynecol*. 1972;39(3):333-40.
44. Pelsang RE, Bonney WW. Voiding cystourethrography in female stress incontinence. *AJR Am J Roentgenol*. 1996;166(3):561-5.
45. Bergman A, McKenzie C, Ballard CA, Richmond J. Role of cystourethrography in the preoperative evaluation of stress urinary incontinence in women. *J Reprod Med*. 1988;33(4):372-6.
46. v. Christ F, Meyer-Delpho W. Röntgendiagnostik bei der weiblichen Harninkontinenz. *Fortschr Röntgenstr*. 1981;134:551-6.
47. Mouritsen L, Strandberg C, Jensen AR, Berget A, Fridodt-Møller C, Folke K. Inter- and intra-observer variation of colpo-cysto-urethrography diagnoses. *Acta Obstet Gynecol Scand*. 1993;72(3):200-4.
48. Stage P, Fischer-Rasmussen W, Hansen RI. The value of colpo-cysto-urethrography in female stress- and urge incontinence and following operation. *Acta Obstet Gynecol Scand*. 1986;65(5):401-4.
49. Ala-Ketola L, Kauppila A, Jouppila P, Ylikorkala O. Pre- and postoperative bead chain urethrocytography in female stress urinary incontinence. *Acta Obstet Gynecol Scand*. 1981;60(4):369-74.
50. Thunedborg P, Fischer-Rasmussen W, Jensen SB. Stress urinary incontinence and posterior bladder suspension defects. Results of vaginal repair versus Burch colposuspension. *Acta Obstet Gynecol Scand*. 1990;69(1):55-9.
51. Meyhoff HH, de Nully MB, Olesen KP, Lindahl F. The effects of vaginal repair on anterior bladder suspension defects. A radiological and clinical evaluation. *Acta Obstet Gynecol Scand*. 1985;64(5):433-5.
52. Thind PO, Lose G, Falkenlove P, Egeblad M. Assessment of micturition cystourethrography. Intra- and inter-observer variation. *Ugeskr Læger*. 1991;153(5):338-40.

53. Kolbl H, Bernaschek G, Wolf G. A comparative study of perineal ultrasound scanning and urethrocytography in patients with genuine stress incontinence. *Arch Gynecol Obstet.* 1988;244(1):39-45.
 54. Dietz HP, Wilson PD. Anatomical assessment of the bladder outlet and proximal urethra using ultrasound and videocystourethrography. *Int Urogynecol J Pelvic Floor Dysfunct.* 1998;9(6):365-9.
 55. Gufler H, DeGregorio G, Allmann KH, Kundt G, Dohnicht S. Comparison of cystourethrography and dynamic MRI in bladder neck descent. *J Comput Assist Tomogr.* 2000;24(3):382-8.
 56. Gufler H, Ohde A, Grau G, Grossmann A. Colpocystoproctography in the upright and supine positions correlated with dynamic MRI of the pelvic floor. *Eur J Radiol.* 2004;51(1):41-7.
- 2.2 Ultrasonography Imaging**
1. White RD, McQuown D, McCarthy TA, Ostergard DR. Realtime ultrasonography in the evaluation of urinary stress incontinence. *Am J Obstet Gynecol.* 1980;138(2):235-7.
 2. Shah W, Honeck P, Kwon ST, Badawi JK, Alken P, Bross S. The role of perineal ultrasound compared to lateral cysturethrogram in urogynecological evaluations. *Aktuelle Urol.* 2007;38(2):144-7.
 3. Troeger C, Gugger M, Holzgreve W, Wight E. Correlation of perineal ultrasound and lateral chain urethrocytography in the anatomical evaluation of the bladder neck. *Int Urogynecol J Pelvic Floor Dysfunct.* 2003;14(6):380-4.
 4. Schaer GN, Koechli OR, Schuessler B, Haller U. Perineal ultrasound for evaluating the bladder neck in urinary stress incontinence. *Obstet Gynecol.* 1995;85(2):220-4.
 5. Mouritsen L, Strandberg C. Vaginal ultrasonography versus colpo-cysto-urethrography in the evaluation of female urinary incontinence. *Acta Obstet Gynecol Scand.* 1994;73(4):338-42.
 6. Kohorn EI, Scioscia AL, Jeanty P, Hobbins JC. Ultrasound cystourethrography by perineal scanning for the assessment of female stress urinary incontinence. *Obstet Gynecol.* 1986;68(2):269-72.
 7. Bergman A, Koonings P, Ballard CA, Platt LD. Ultrasonic prediction of stress urinary incontinence development in surgery for severe pelvic relaxation. *Gynecol Obstet Invest.* 1988;26(1):66-72.
 8. Koelbl H, Bernaschek G. A new method for sonographic urethrocytography and simultaneous pressure-flow measurements. *Obstet Gynecol.* 1989;74(3 Pt 1):417-22.
 9. Bernaschek G, Kratochwil A. Sonographic method for the measurement of the posterior urethrovesical angle. *Gynakol Rundsch.* 1980;20 Suppl 2:208-11.
 10. Voigt R, Halaska M, Michels W, Martan A, Starker K, Voigt P. Examination of the urethrovesical junction using perineal sonography compared to urethrocytography using a bead-chain. *Int Urogynecol J* 1994;5:212-4.
 11. Kiilholma PJ, Makinen JI, Pitkanen YA, et al. Perineal ultrasound: An alternative for radiography for evaluating stress urinary incontinence in females. *Ann Chir Gynaecol Suppl* 1994;208:43-5.
 12. Thompson JA, O'Sullivan PB, Briffa K, Neumann P, Court S. Assessment of pelvic floor movement using transabdominal and transperineal ultrasound. *Int Urogynecol J Pelvic Floor Dysfunct* 2005;16:285-92.
 13. Wise BG, Burton G, Cutner A, Cardozo LD. Effect of vaginal ultrasound probe on lower urinary tract function. *Br J Urol.* 1992 Jul;70(1):12-6.
 14. Hol M, van Bolhuis C, Vierhout ME. Vaginal ultrasound studies of bladder neck mobility. *Br J Obstet Gynaecol.* 1995;102(1):47-53.
 15. Athanasiou S, Khullar V, Boos K, Salvatore S, Cardozo L. Imaging the urethral sphincter with three-dimensional ultrasound. *Obstet Gynecol.* 1999;94(2):295-301.
 16. Tunn R, Schaer G, Peschers U, Bader W, Gauruder A, Hanzal E, et al. Updated recommendations on ultrasonography in urogynecology. *Int Urogynecol J Pelvic Floor Dysfunct.* 2005;16(3):236-41.
 17. Dietz HP. Ultrasound imaging of the pelvic floor. Part I: Two dimensional aspects. *Ultrasound Obstet Gynecol.* 2004;23(1):80-92.
 18. Dietz HP, Wilson PD, Clarke B. The use of perineal ultrasound to quantify levator activity and teach pelvic floor muscle exercises. *Int Urogynecol J Pelvic Floor Dysfunct.* 2001;12(3):166-8.
 19. Braekken IH, Majida M, Ellstrom-Eng M, Dietz HP, Umek W, Bo K. Test-retest and intra-observer repeatability of two-three- and four-dimensional perineal ultrasound of pelvic floor muscle anatomy and function. *Int Urogynecol J Pelvic Floor Dysfunct.* 2008;19(2):227-35.
 20. Dietz HP, Wilson PD. The influence of bladder volume on the position and mobility of the urethrovesical junction. *Int Urogynecol J Pelvic Floor Dysfunct.* 1999;10(1):3-6.

21. Martan A, Drbohlav P, Masata M, Halaska M, Voigt R. Changes in the position of the urethra and bladder neck during pregnancy and after delivery. *Ceska Gynekol.* 1996;61(1):35-9.
22. King JK, Freeman RM. Is antenatal bladder neck mobility a risk factor for postpartum stress incontinence? *Br J Obstet Gynaecol.* 1998;105(12):1300-7.
23. Howard D, Miller JM, Delancey JO, Ashton-Miller JA. Differential effects of cough, valsalva, and continence status on vesical neck movement. *Obstet Gynecol.* 2000;95(4):535-40.
24. Oerno AK, Dietz HP (2007) Levator co-activation is a significant confounder of pelvic organ descent on Valsalva maneuver. *Ultrasound Obstet Gynecol* 30(3):346–350
25. Toozs-Hobson P, Khullar V, Cardozo L. Three-dimensional ultrasound: a novel technique for investigating the urethral sphincter in the third trimester of pregnancy. *Ultrasound Obstet Gynecol.* 2001 May;17(5):421-4.
26. Khullar V, Salvatore S, Cardozo L. Three dimensional ultrasound of the urethra and urethral pressure profiles. *Eur Urol* 1994;5:319.
27. Umek WH, Laml T, Stutterecker D, Obermair A, Leodolter S, Hanzal E. The urethra during pelvic floor contraction: observations on three-dimensional ultrasound. *Obstet Gynecol.* 2002;100(4):796-800.
28. Kondo Y, Homma Y, Takahashi S, Kitamura T, Kawabe K. Transvaginal ultrasound of urethral sphincter at the mid urethra in continent and incontinent women. *J Urol.* 2001;165(1):149-52.
29. Wiseman OJ, Swinn MJ, Brady CM, Fowler CJ. Maximum urethral closure pressure and sphincter volume in women with urinary retention. *J Urol.* 2002;167(3):1348-51.
30. Kirschner-Hermanns R, Klein HM, Muller U, Schafer W, Jakse G. Intra-urethral ultrasound in women with stress incontinence. *Br J Urol.* 1994;74(3):315-8.
31. Robinson D, Toozs-Hobson P, Cardozo L, Digesu A. Correlating structure and function: three-dimensional ultrasound of the urethral sphincter. *Ultrasound Obstet Gynecol.* 2004;23(3):272-6.
32. Umek WH, Obermair A, Stutterecker D, Hausler G, Leodolter S, Hanzal E. Three-dimensional ultrasound of the female urethra: comparing transvaginal and transrectal scanning. *Ultrasound Obstet Gynecol.* 2001;17(5):425-30.
33. Shobeiri SA, White DE, Quiroz LH, Nihira MA (2012) Anterior and posterior compartment 3D endovaginal ultrasound anatomy based on direct histologic comparison. *Int Urogynecol J* 23(8):1047–1053.
34. Tunn R, Petri E. Introital and transvaginal ultrasound as the main tool in the assessment of urogenital and pelvic floor dysfunction: an imaging panel and practical approach. *Ultrasound Obstet Gynecol.* 2003;22(2):205-13.
35. Schaer GN, Siegwart R, Perucchini D, DeLancey JO. Examination of voiding in seated women using a remote controlled ultrasound probe. *Obstet Gynecol.* 1998;91(2):297-301.
36. Major H, Culligan P, Heit M. Urethral sphincter morphology in women with detrusor instability. *Obstet Gynecol.* 2002;99(1):63-8.
37. Heit M. Intraurethral ultrasonography: correlation of urethral anatomy with functional urodynamic parameters in stress incontinent women. *Int Urogynecol J Pelvic Floor Dysfunct.* 2000;11(4):204-11.
38. Heit M. Intraurethral sonography and the test-retest reliability of urethral sphincter measurements in women. *J Clin Ultrasound.* 2002;30(6):349-55.
39. Frauscher F, Helweg G, Strasser H, Enna B, Klausner A, Knapp R, et al. Intraurethral ultrasound: diagnostic evaluation of the striated urethral sphincter in incontinent females. *Eur Radiol.* 1998;8(1):50-3.
40. Yang JM, Huang WC, Yang SH. Transvaginal sonography in the diagnosis, management and follow-up of complex paraurethral abnormalities. *Ultrasound Obstet Gynecol.* 2005;25(3):302-6.
41. Yang JM, Yang SH, Huang WC. Two- and three-dimensional sonographic findings in a case of distal urethral obstruction due to a paraurethral tumor. *Ultrasound Obstet Gynecol.* 2005;25(5):519-21.
42. Peschers UM, Fanger G, Schaer GN, Vodusek DB, DeLancey JO, Schuessler B. Bladder neck mobility in continent nulliparous women. *BJOG.* 2001;108(3):320-4.
43. Mouritsen L, Bach P. Ultrasonic evaluation of bladder neck position and mobility: the influence of urethral catheter, bladder volume, and body position. *Neurourol Urodyn.* 1994;13(6):637-46.
44. Mouritsen L, Rasmussen A. Bladder neck mobility evaluated by vaginal ultrasonography. *Br J Urol.* 1993;71(2):166-71.
45. Dietz HP, Steensma AB, Vancaillie TG. Levator function in nulliparous women. *Int Urogynecol J Pelvic Floor Dysfunct.* 2003 Feb;14(1):24-6.

46. Brandt FT, Albuquerque CD, Lorenzato FR, Amaral FJ. Perineal assessment of urethrovesical junction mobility in young continent females. *Int Urogynecol J Pelvic Floor Dysfunct.* 2000;11(1):18-22.
47. Naranjo-Ortiz C, Shek KL, Martin AJ, Dietz HP. What is normal bladder neck anatomy? *Int Urogynecol J.* 2016 Jun;27(6):945-50.
48. Howard D, Delancey JO, Tunn R, Ashton-Miller JA. Racial differences in the structure and function of the stress urinary continence mechanism. *Obstet Gynecol.* 2000;95(5):713-7.
49. Dietz HP, Hansell NK, Grace ME, Eldridge AM, Clarke B, Martin NG. Bladder neck mobility is a heritable trait. *BJOG.* 2005;112(3):334-9.
50. Quinn MJ, Beynon J, Mortensen NJ, Smith PJ. Transvaginal endosonography: a new method to study the anatomy of the lower urinary tract in urinary stress incontinence. *Br J Urol.* 1988;62(5):414-8.
51. Petri E, Koelbl H, Schaer G. What is the place of ultrasound in urogynecology? A written panel. *Int Urogynecol J Pelvic Floor Dysfunct.* 1999;10(4):262-73.
52. Dietz HP, Clarke B. The urethral pressure profile and ultrasound imaging of the lower urinary tract. *Int Urogynecol J Pelvic Floor Dysfunct.* 2001;12(1):38-41.
53. Yalcin OT, Hassa H, Ozalp S. Effectiveness of ultrasonographic parameters for documenting the severity of anatomic stress incontinence. *Acta Obstet Gynecol Scand.* 2000;79(5):421-6.
54. Kiilholma PJ, Makinen JI, Pitkanen YA, Varpula MJ. Perineal ultrasound: an alternative for radiography for evaluating stress urinary incontinence in females. *Ann Chir Gynaecol Suppl.* 1994;208:43-5.
55. Chen GD, Su TH, Lin LY. Applicability of perineal sonography in anatomical evaluation of bladder neck in women with and without genuine stress incontinence. *J Clin Ultrasound.* 1997;25(4):189-94.
56. Chang HC, Chang SC, Kuo HC, Tsai TC. Transrectal sonographic cystourethrography: studies in stress urinary incontinence. *Urology.* 1990;36(6):488-92.
57. Bergman A, Vermesh M, Ballard CA, Platt LD. Role of ultrasound in urinary incontinence evaluation. *Urology.* 1989;33(5):443-4.
58. Bergman A, Ballard CA, Platt LD. Ultrasonic evaluation of urethrovesical junction in women with stress urinary incontinence. *J Clin Ultrasound.* 1988;16(5):295-300.
59. Bergman A, McKenzie CJ, Richmond J, Ballard CA, Platt LD. Transrectal ultrasound versus cystography in the evaluation of anatomical stress urinary incontinence. *Br J Urol.* 1988;62(3):228-34.
60. Bai SW, Kwon JY, Chung da J, Park JH, Kim SK. Differences in urodynamic study, perineal sonography and treatment outcome according to urethrovesical junction hypermobility in stress urinary incontinence. *J Obstet Gynaecol Res.* 2006;32(2):206-11.
61. Bai SW, Lee JW, Shin JS, Park JH, Kim SK, Park KH. The predictive values of various parameters in the diagnosis of stress urinary incontinence. *Yonsei Med J.* 2004;45(2):287-92.
62. Pregazzi R, Sartore A, Bortoli P, Grimaldi E, Troiano L, Guaschino S. Perineal ultrasound evaluation of urethral angle and bladder neck mobility in women with stress urinary incontinence. *BJOG.* 2002;109(7):821-7.
63. Dietz HP, Nazemian K, Shek KL, Martin A. Can urodynamic stress incontinence be diagnosed by ultrasound? *Int Urogynecol J.* 2013 Aug;24(8):1399-403.
64. Hung HC, Chin SY, Tsauo JY. Exercise adherence to pelvic floor muscle strengthening is not a significant predictor of symptoms reduction for women with stress urinary incontinence. *Arch Phys Med Rehabil.* 2012 Oct;93(10):1795-800.
65. McLean L, Varette K, Gentilcore-Saulnier E, Harvey MA, Baker K, Sauerbrei E. Pelvic floor muscle training in women with stress urinary incontinence causes hypertrophy of the urethral sphincters and reduces bladder neck mobility during coughing. *Neurourol Urodyn.* 2013 Nov;32(8):1096-102.
66. Reilly ET, Freeman RM, Waterfield MR, Waterfield AE, Steggles P, Pedlar F. Prevention of postpartum stress incontinence in primigravidae with increased bladder neck mobility: a randomised controlled trial of antenatal pelvic floor exercises. *BJOG.* 2014 Dec;121 Suppl 7:58-66.
67. Schaer GN, Koechli OR, Schuessler B, Haller U. Can simultaneous perineal sonography and urethrocytometry help explain urethral pressure variations? *Neurourol Urodyn.* 1997;16(1):31-8.
68. Enzelsberger H, Kurz C, Adler A, Schatten C. Effectiveness of Burch colposuspension in females with recurrent stress incontinence—a urodynamic and ultrasound study. *Geburtshilfe Frauenheilkd.* 1991;51(11):915-9.

69. Richmond DH, Sutherst JR. Burch colposuspension or sling for stress incontinence? A prospective study using transrectal ultrasound. *Br J Urol.* 1989;64(6):600-3.
70. Schaer GN, Perucchini D, Munz E, Peschers U, Koechli OR, Delancey JO. Sonographic evaluation of the bladder neck in continent and stress-incontinent women. *Obstet Gynecol.* 1999;93(3):412-6.
71. Schaer GN, Koechli OR, Schuessler B, Haller U. Usefulness of ultrasound contrast medium in perineal sonography for visualization of bladder neck funneling—first observations. *Urology.* 1996;47(3):452-3.
72. Huang WC, Yang JM. Bladder neck funneling on ultrasound cystourethrography in primary stress urinary incontinence: a sign associated with urethral hypermobility and intrinsic sphincter deficiency. *Urology.* 2003;61(5):936-41.
73. Schaer GN, Koechli OR, Schuessler B, Haller U. Improvement of perineal sonographic bladder neck imaging with ultrasound contrast medium. *Obstet Gynecol.* 1995;86(6):950-4.
74. Dietz HP, Clarke B. Translabial color Doppler urodynamics. *Int Urogynecol J Pelvic Floor Dysfunct.* 2001;12(5):304-7.
75. Dietz HP, McKnoulty L, Clarke B. Translabial color Doppler for imaging in urogynecology: a preliminary report. *Ultrasound Obstet Gynecol.* 1999;14(2):144-7.
76. Wieczorek AP, Wozniak MM, Stankiewicz A, Santoro GA, Bogusiewicz T, Scholbach J. Quantitative assessment of urethral vascularity in nulliparous females using high-frequency endovaginal ultrasonography. *World J Urol.* 2011; 29 (5): 625-32.
77. Tsai E, Yang C, Chen H, Wu C, Lee J. Bladder neck circulation by Doppler ultrasonography in postmenopausal women with urinary stress incontinence. *Obstet Gynecol.* 2001;98(1):52-6.
78. Liang CC, Chang SD, Chang YL, Wei TY, Wu HM, Chao AS. Three-dimensional power Doppler measurement of perfusion of the periurethral tissue in incontinent women — a preliminary report. *Acta Obstet Gynecol Scand.* 2006;85(5):608-13.
79. Lone F, Sultan AH, Stankiewicz A, Thakar R, Wieczorek AP. Vascularity of the urethra in continent women using colour doppler high-frequency endovaginal ultrasonography. *Springerplus.* 2014 Oct 20;3:619.
80. Oliveira E, Castro RA, Takano CC, Bezerra LR, Sartori MG, Lima GR, et al. Ultrasonographic and Doppler velocimetric evaluation of the levator ani muscle in premenopausal women with and without urinary stress incontinence. *Eur J Obstet Gynecol Reprod Biol.* 2007;133(2):213-7.
81. Caruso S, Panella MM, Cianci S, Rampello L, Bandiera S, Giordano R, Matarazzo MG, Cianci A. TOT does not affect the urethral sphincter innervation: a pilot study. *Int Urogynaecol J.* 2011; 22 (6): 739-42.
82. Lone F, Thakar R, Wieczorek AP, Sultan AH, Stankiewicz A. Assessment of urethral vascularity using 2D colour Doppler high-frequency endovaginal ultrasonography in women treated for symptomatic stress urinary incontinence: 1-year prospective follow-up study. *Int Urogynecol J.* 2016 Jan;27(1):85-92.
83. Nwosu CR, Khan KS, Chien PF, Honest MRI. Is real-time ultrasonic bladder volume estimation reliable and valid? A systematic overview. *Scand J Urol Nephrol.* 1998;32(5):325-30.
84. Gehrich A, Stany MP, Fischer JR, Buller J, Zahn CM. Establishing a mean postvoid residual volume in asymptomatic perimenopausal and postmenopausal women. *Obstet Gynecol.* 2007;110(4):827-32.
85. Choe JH, Lee JY, Lee KS. Accuracy and precision of a new portable ultrasound scanner, the BME-150A, in residual urine volume measurement: a comparison with the BladderScan BVI 3000. *Int Urogynecol J Pelvic Floor Dysfunct.* 2007;18(6):641-4.
86. Teng CH, Huang YH, Kuo BJ, Bih LI. Application of portable ultrasound scanners in the measurement of post-void residual urine. *J Nurs Res.* 2005;13(3):216-24.
87. Haylen BT, Frazer MI, MacDonald JH. Assessing the effectiveness of different urinary catheters in emptying the bladder: an application of transvaginal ultrasound. *Br J Urol.* 1989;64(4):353-6.
88. Asimakopoulos AD, De Nunzio C, Kocjancic E, Tubaro A, Rosier PF, Finazzi-Agrò E. Measurement of post-void residual urine. *Neurourol Urodyn.* 2016 Jan;35(1):55-7.
89. Khan KS, Chien PF, Honest MR, Norman GR. Evaluating measurement variability in clinical investigations: the case of ultrasonic estimation of urinary bladder volume. *Br J Obstet Gynaecol.* 1997;104(9):1036-42.
90. Resnick B. A bladder scan trial in geriatric rehabilitation. *Rehabil Nurs.* 1995;20(4):194-6, 203.

91. Cassadó J, Espuña-Pons M, Díaz-Cuervo H, Rebollo P; GISPEM Group. How can we measure bladder volumes in women with advanced pelvic organ prolapse? *Ultrasound Obstet Gynecol.* 2015 Aug;46(2):233-8.
92. Yucel S, Kocak H, Sanli A, Tosun O, Tuncer M, Ersoy F, et al. How accurate is measuring postvoid residual volume by portable abdominal ultrasound equipment in peritoneal dialysis patient? *Neurourol Urodyn.* 2005;24(4):358-61.
93. Tan TL, Ding YY, Lieu PK. False positive findings in the ultrasound assessment of postvoid residual urine volume. *Age Ageing.* 2003;32(3):356.
94. Kaefer M, Barnewolt C, Retik AB, Peters CA. The sonographic diagnosis of infravesical obstruction in children: evaluation of bladder wall thickness indexed to bladder filling. *J Urol.* 1997;157(3):989-91.
95. Miyazato M, Sugaya K, Nishijima S, Owan T, Ogawa Y. Location of spina bifida occulta and ultrasonographic bladder abnormalities predict the outcome of treatment for primary nocturnal enuresis in children. *Int J Urol.* 2007;14(1):33-8.
96. Yeung CK, Sreedhar B, Leung VT, Metreweli C. Ultrasound bladder measurements in patients with primary nocturnal enuresis: a urodynamic and treatment outcome correlation. *J Urol.* 2004;171(6 Pt 2):2589-94.
97. Tanaka H, Matsuda M, Moriya K, Mitsui T, Kitta T, Nonomura K. Ultrasonographic measurement of bladder wall thickness as a risk factor for upper urinary tract deterioration in children with myelodysplasia. *J Urol.* 2008;180(1):312-6.
98. Yeung CK, Sreedhar B, Leung YF, Sit KY. Correlation between ultrasonographic bladder measurements and urodynamic findings in children with recurrent urinary tract infection. *BJU Int.* 2007;99(3):651-5.
99. Liu JX, Leung VY, Chu WC, Sreedhar B, Metreweli C, Yeung CK. Characteristics of the bladder in infants with urinary tract infections: an ultrasound study. *Pediatr Radiol.* 2008;38(10):1084-8.
100. Leung VY, Chu WC, Yeung CK, Sreedhar B, Liu JX, Wong EM, et al. Nomograms of total renal volume, urinary bladder volume and bladder wall thickness index in 3,376 children with a normal urinary tract. *Pediatr Radiol.* 2007;37(2):181-8.
101. Hakenberg OW, Linne C, Manseck A, Wirth MP. Bladder wall thickness in normal adults and men with mild lower urinary tract symptoms and benign prostatic enlargement. *Neurourol Urodyn.* 2000;19(5):585-93.
102. Oelke M, Hofner K, Jonas U, Ubbink D, de la Rosette J, Wijkstra H. Ultrasound measurement of detrusor wall thickness in healthy adults. *Neurourol Urodyn.* 2006;25(4):308-17.
103. Oelke M, Hofner K, Jonas U, de la Rosette JJ, Ubbink DT, Wijkstra H. Diagnostic accuracy of noninvasive tests to evaluate bladder outlet obstruction in men: detrusor wall thickness, uroflowmetry, postvoid residual urine, and prostate volume. *Eur Urol.* 2007;52(3):827-34.
104. Manieri C, Carter SS, Romano G, Trucchi A, Valenti M, Tubaro A. The diagnosis of bladder outlet obstruction in men by ultrasound measurement of bladder wall thickness. *J Urol.* 1998;159(3):761-5.
105. Bright E, Pearcy R, Abrams P. Automatic evaluation of ultrasonography-estimated bladder weight and bladder wall thickness in community-dwelling men with presumably normal bladder function. *BJU Int.* 2012 Apr;109(7):1044-9.
106. Khullar V, Salvatore S, Cardozo L, Bourne TH, Abbott D, Kelleher C. A novel technique for measuring bladder wall thickness in women using transvaginal ultrasound. *Ultrasound Obstet Gynecol.* 1994;4(3):220-3.
107. Khullar V, Cardozo LD, Salvatore S, Hill S. Ultrasound: a noninvasive screening test for detrusor instability. *Br J Obstet Gynaecol.* 1996;103(9):904-8.
108. Dudley R, Kate A, Cardozo L, Bidmead J, Toozs-Hobson P, Khullar V. Can ultrasound replace ambulatory urodynamics when investigating women with irritative urinary symptoms? *BJOG.* 2002;109(2):145-8.
109. Abou-Gamrah A, Fawzy M, Sammour H, Tadros S. Ultrasound assessment of bladder wall thickness as a screening test for detrusor instability. *Arch Gynecol Obstet.* 2014 May;289(5):1023-8.
110. Rachaneni S, McCooty S, Middleton LJ, Parker VL, Daniels JP, Coomarasamy A, Verghese TS, Balogun M, Goranitis I, Barton P, Roberts TE, Deeks JJ, Latthe P; Bladder Ultrasound Study (BUS) Collaborative Group. Bladder ultrasonography for diagnosing detrusor overactivity: test accuracy study and economic evaluation. *Health Technol Assess.* 2016 Jan;20(7):1-150. doi: 10.3310/hta20070.
111. Yang JM, Huang WC. Bladder wall thickness on ultrasonographic cystourethrography: affecting factors and their implications. *J Ultrasound Med.* 2003;22(8):777-82.
112. Kuhn A, Brandner S, Kuhn P, Robinson D, Raio L. Does bladder wall thickness decrease when obstruction is resolved? *Int Urogynecol J.* 2012 Sep;23(9):1239-44.

113. Chalana V, Dudycha S, Yuk JT, McMorrow G. Automatic Measurement of Ultrasound-Estimated Bladder Weight (UEBW) from Three-Dimensional Ultrasound. *Rev Urol.* 2005;7 Suppl 6:S22-8.
114. Al-Shaikh G, Al-Mandeel H. Ultrasound estimated bladder weight in asymptomatic adult females. *J.Urol* 2012;9(3):586-91.
115. Blatt AH, Titus J, Chan L. Ultrasound measurement of bladder wall thickness in the assessment of voiding dysfunction. *J Urol.* 2008;179(6):2275-8; discussion 2278-9.
116. Oelke M, Hofner K, Jonas U, Ubbink D, de la Rosette J, Wijkstra H. Ultrasound measurement of detrusor wall thickness in healthy adults. *Neurourol Urodyn.* 2006; 25 (4): 308-17.
117. Oelke M. international consultation on incontinence-research society (ICI-RS) report on non-invasive urodynamics: the need of standardization of ultrasound bladder and detrusor wall thickness measurements to quantify bladder wall hypertrophy. *Neurourol Urodyn.* 2010; 29 (4): 634-9.
118. Lekskulchai O, Dietz HP. Detrusor wall thickness as a test for detrusor overactivity in women. *Ultrasound Obstet Gynecol.* 2008;32(4):535-9.
119. Panayi DC, Khullar V, Fernando R, Tekkis P. transvaginal ultrasound measurements of bladder wall thickness: a more reliable approach than transperineal and transabdominal approaches. *BJU Int.* 2010; 106 (10): 1519-22
120. Oelke M, Hofner K, Jonas U, Ubbink D, de la Rosette J, Wijkstra H. diagnostic accuracy of noninvasive test to evaluate bladder outlet obstruction in men: detrusor wall thickness, uroflowmetry, postvoid residual urine, and prostate volume. *Eur Urol.* 2007; 52 (3): 627-34.
121. Panayi DC, Khullar V, Digesu GA, Hendricken C, Fernando R, Tekkis P. is ultrasound estimation of bladder weight a useful tool in the assessment of patients with lower urinary tract symptoms? *Int Urogynecol J Pelvic Floor Dysfunct.* 2009; 20 (12): 1445-9.
122. Akino H, Maekawa M, Nakai M, Shioyama R, Ishida H, Oyama N, Miwa Y, Yokoyama O. ultrasound-estimated bladder weight predicts risk of surgery for benign prostatic hyperplasia in men using alpha-adrenoreceptor blocker for LUTS. *Urology.* 2008; 72 (4): 817-20.
123. Dietz HP, Jarvis SK, Vancaillie TG. The assessment of levator muscle strength: a validation of three ultrasound techniques. *Int Urogynecol J Pelvic Floor Dysfunct.* 2002;13(3):156-9.
124. Weinstein MM, Jung SA, Pretorius DH, Nager CW, den Boer DJ, Mittal RK. The reliability of puborectalis muscle measurements with 3-dimensional ultrasound imaging. *Am J Obstet Gynecol.* 2007;197(1):68 e1-6.
125. Thompson JA, O'Sullivan PB, Briffa NK, Neumann P. Comparison of transperineal and transabdominal ultrasound in the assessment of voluntary pelvic floor muscle contractions and functional manoeuvres in continent and incontinent women. *Int Urogynecol J Pelvic Floor Dysfunct.* 2007 Jul;18(7):779-86.
126. Peschers UM, Gingelmaier A, Jundt K, Leib B, Dimpfl T. Evaluation of pelvic floor muscle strength using four different techniques. *Int Urogynecol J Pelvic Floor Dysfunct.* 2001;12(1):27-30.
127. Balmforth JR, Mantle J, Bidmead J, Cardozo L. A prospective observational trial of pelvic floor muscle training for female stress urinary incontinence. *BJU Int.* 2006;98(4):811-7.
128. Bernstein IT. The pelvic floor muscles: muscle thickness in healthy and urinary-incontinent women measured by perineal ultrasonography with reference to the effect of pelvic floor training. *Estrogen receptor studies. Neurourol Urodyn.* 1997;16(4):237-75.
129. Kruger JA, Dietz HP, Murphy BA. Pelvic floor function in elite nulliparous athletes. *Ultrasound Obstet Gynecol.* 2007;30(1):81-5.
130. Athanasiou S, Chaliha C, Tooze-Hobson P, Salvatore S, Khullar V, Cardozo L. Direct imaging of the pelvic floor muscles using two-dimensional ultrasound: a comparison of women with urogenital prolapse versus controls. *BJOG.* 2007;114(7):882-8.
131. Chen R, Song Y, Jiang L, Hong X, Ye P. the assessment of voluntary pelvic floor muscle contraction by three-dimensional transperineal ultrasonography. *Arc Gynecol Obstet.* 2011; 284 (4): 931-6.
132. Whittaker JL, Thompson JA, Teyhen DS, Hodges P. Rehabilitative ultrasound imaging of pelvic floor muscle function. *J Orthop Sports Phys Ther.* 2007;37(8):487- 98.
133. Hung HC, Hsiao SM, Chih SY, Lin HH, Tsauo JY. Effect of pelvic floor muscle strengthening on bladder neck mobility: a clinical trial. *Phys Ther.* 2011; 91 (7): 1030-8.
134. Kim S, Wong V, Moore KH. Why are some women with pelvic floor dysfunction unable to contract their pelvic floor muscles? *Aust N Z J Obstet Gynaecol.* 2013 Dec;53(6):574-9.

135. Miller JM, Perucchini D, Carchidi LT, DeLancey JO, Ashton- Miller J. Pelvic floor muscle contraction during a cough and decreased vesical neck mobility. *Obstet Gynecol.* 2001;97(2):255-60.
136. Dietz HP. Quantification of major morphological abnormalities of the levator ani. *Ultrasound Obstet Gynecol.* 2007;29(3):329-34.
137. Yang JM, Yang SH, Huang WC. Biometry of the pubovisceral muscle and levator hiatus in nulliparous Chinese women. *Ultrasound Obstet Gynecol.* 2006;28(5):710-6.
138. Siafarikas F, Staer-Jensen J, Braekken I, Bo K, Ellström Engh M. Learning process for performing and analysing 3/4D transperineal ultrasound imaging and inter-rater reliability study. *Ultrasound Obstet Gynecol.* 2013 Mar;41(3):312-7.
139. Dietz HP. Ultrasound imaging of the pelvic floor. Part II: three-dimensional or volume imaging. *Ultrasound Obstet Gynecol.* 2004;23(6):615-25.
140. Morkved S, Salvesen KA, Bo K, Eik-Nes S. Pelvic floor muscle strength and thickness in continent and incontinent nulliparous pregnant women. *Int Urogynecol J Pelvic Floor Dysfunct.* 2004;15(6):384-9.
141. Dietz HP, Shek C, Clarke B. Biometry of the pubovisceral muscle and levator hiatus by three-dimensional pelvic floor ultrasound. *Ultrasound Obstet Gynecol.* 2005;25(6):580-5.
142. Majida M, Braekken IH, Bo K, Engh ME. Levator hiatus dimension and pelvic floor function in women with and without major defect of the pubovisceral muscle. *Int Urogynecol J.* 2012; 23 (6): 707-14.
143. Tosun OC, Solmaz U, Ekin A, Tosun G, Gezer C, Ergenoglu AM, Yeniel AO, Mat E, Malkoc M, Askar N. Assessment of the effect of pelvic floor exercises on pelvic floor muscle strength using ultrasonography in patients with urinary incontinence: a prospective randomized controlled trial. *J Phys Ther Sci.* 2016 Jan;28(2):360-5.
144. Yoshida M, Murayama R, Hotta K, Higuchi Y, Sanada H. Differences in motor learning of pelvic floor muscle contraction between women with and without stress urinary incontinence: Evaluation by transabdominal ultrasonography. *Neurourol Urodyn.* 2015 Sep 9. [Epub ahead of print]
145. Wijma J, Potters AE, de Wolf BT, Tinga DJ, Aarnoudse JG. Anatomical and functional changes in the lower urinary tract following spontaneous vaginal delivery. *BJOG.* 2003;110(7):658-63.
146. Wijma J, Weis Potters AE, van der Mark TW, Tinga DJ, Aarnoudse JG. Displacement and recovery of the vesical neck position during pregnancy and after childbirth. *Neurourol Urodyn.* 2007;26(3):372-6.
147. Constantinou CE, Omata S. Direction sensitive sensor probe for the evaluation of voluntary and reflex pelvic floor contractions. *Neurourol Urodyn.* 2007;26(3):386-91.
148. Jung SA, Pretorius DH, Padda BS, Weinstein MM, Nager CW, den Boer DJ, et al. Vaginal high-pressure zone assessed by dynamic 3-dimensional ultrasound images of the pelvic floor. *Am J Obstet Gynecol.* 2007;197(1):52 e1-7.
149. Thyer I, Shek C, Dietz HP. New imaging method for assessing pelvic floor biomechanics. *Ultrasound Obstet Gynecol.* 2008;31(2):201-5.
150. Derpapas A, Digesu AG, Vijaya G, Fernando R, Khullar V. Real-time in vivo assessment of levator ani muscle deformation in women. *Eur J Obstet Gynecol Reprod Biol.* 2012 Dec;165(2):352-6.
151. Dietz HP, Lanzarone V. Levator trauma after vaginal delivery. *Obstet Gynecol.* 2005;106(4):707-12.
152. Lammers K, Futterer JJ, Prokop M, Vierhout ME, Kluivers KB. Diagnosing pubovisceral avulsions: a systematic review of the clinical relevance of a prevalent anatomical defect. *Int Urogynecol J.* 2012 Dec;23(12):1653-64.
153. Simó González M, Cassadó Garriga J, Dosouto Capel C, Porta Roda O, Perelló Capó J, Gich Saladich I. Is obstetric anal sphincter injury a risk factor for levator ani muscle avulsion in vaginal delivery? *Ultrasound Obstet Gynecol.* 2015 epub
154. Huebner M, Margulies RU, Delancey JO. Pelvic architectural distortion is associated with pelvic organ prolapse. *Int Urogynecol J Pelvic Floor Dysfunct.* 2008;19(6):863-7.
155. Margulies RU, Hsu Y, Kearney R, Stein T, Umek WH, DeLancey JO. Appearance of the levator ani muscle subdivisions in magnetic resonance images. *Obstet Gynecol.* 2006;107(5):1064-9.
156. Dietz HP. Why pelvic floor surgeons should utilize ultrasound imaging. *Ultrasound Obstet Gynecol.* 2006;28(5):629-34.
157. Dietz HP. Levator trauma in labor: a challenge for obstetricians, surgeons and sonologists. *Ultrasound Obstet Gynecol.* 2007;29(4):368-71.

158. Dietz HP, Simpson JM. Does delayed child-bearing increase the risk of levator injury in labour? *Aust N Z J Obstet Gynaecol.* 2007;47(6):491-5.
159. Dietz HP, Shek C. Levator avulsion and grading of pelvic floor muscle strength. *Int Urogynecol J Pelvic Floor Dysfunct.* 2008;19(5):633-6.
160. Dietz HP, Hyland G, Hay-Smith J. The assessment of levator trauma: a comparison between palpation and 4D pelvic floor ultrasound. *Neurourol Urodyn.* 2006;25(5):424-7.
161. Dietz HP, Shek C. Validity and reproducibility of the digital detection of levator trauma. *Int Urogynecol J Pelvic Floor Dysfunct.* 2008;19(8):1097-101.
162. Dietz HP, Hoyte LP, Steensma AB. Atlas of pelvic floor ultrasound. 1st ed. ed. London: Springer-Verlag; 2008.
163. Schwertner-Tiepelmann N, Thakar R, Sultan AH, Tunn R. Obstetric levator ani muscle injuries: current status. *Ultrasound Obstet Gynecol.* 2012 Apr;39(4):372-83.
164. Da Silva AS, Digesu GA, Dell'Utri C, Fritsch H, Piffarotti P, Khullar V. Do ultrasound findings of levator ani "avulsion" correlate with anatomical findings: A multicenter cadaveric study. *Neurourol Urodyn.* 2016 Aug;35(6):683-8.
165. Kruger JA, Heap SW, Murphy BA, Dietz HP. Pelvic floor function in nulliparous women using three-dimensional ultrasound and magnetic resonance imaging. *Obstet Gynecol.* 2008;111(3):631-8.
166. Gregory WT, Nardos R, Worstel T, Thurmond A. Measuring the levator hiatus with axial MRI sequences: adjusting the angle of acquisition. *Neurourol Urodyn.* 2011; 30 (1): 113-6.
167. Majida M, Braekken IH, Umek W, Bo K, Saltyte Benth J, Ellström Engh M. Interobserver repeatability of three- and four-dimensional ultrasound assessment of pelvic floor muscle anatomy and function. *Ultrasound Obstet Gynecol.* 2009; 33 (5): 567-73.
168. Santoro GA, Wiczorek AP, Shobeiri SA, Mueller ER, Pilat J, Stankiewicz A, Battistella G. Interobserver and interdisciplinary reproducibility of 3D endovaginal ultrasound assessment of pelvic floor anatomy. *Int Urogynecol J.* 2011; 22 (1): 53-9.
169. Derpapas A, Ahmed S, Gopalan V, Digesu A, Regan L, Fernando R, Khullar V. racial differences in female urethral morphology and levator hiatal dimensions: an ultrasound study. *Neurourol Urodyn.* 2012; 31 (4). 502-7
170. Reisinger E, Stummvoll W. Visualization of the endopelvic fascia by transrectal three-dimensional ultrasound. *Int Urogynecol J Pelvic Floor Dysfunct.* 2006;17(2):165-9.
171. Wisser J, Schar G, Kurmanavicius J, Huch R, Huch A. Use of 3D ultrasound as a new approach to assess obstetrical trauma to the pelvic floor. *Ultraschall Med.* 1999;20(1):15-8.
172. Dietz HP, Steensma AB, Hastings R. Three-dimensional ultrasound imaging of the pelvic floor: the effect of parturition on paravaginal support structures. *Ultrasound Obstet Gynecol.* 2003;21(6):589-95.
173. Dietz HP, Pang S, Korda A, Benness C. Paravaginal defects: a comparison of clinical examination and 2D/3D ultrasound imaging. *Aust N Z J Obstet Gynaecol.* 2005;45(3):187-90.
174. Zhuang RR, Song YF, Chen ZQ, Ma M, Huang HU, Chen JH, Li YM. Levator avulsion using a tomographic ultrasound and magnetic resonance-based model. *Am J Obstet Gynecol.* 2011;205(3):232.e1-8.
175. Vergeldt TF, Weemhoff M, Notten KJ, Kessels AG, Kluivers KB. Comparison of two scoring systems for diagnosis levator ani muscle damage. *Int Urogynecol J.* 2013 Sep;24(9):1501-6.
176. Adisuroso T, Shek KL, Dietz HP. Tomographic ultrasound imaging of the pelvic floor in nulliparous pregnant women: limits of normality. *Ultrasound Obstet Gynecol.* 2012; 39 (6): 698-703.
177. Loubeyre P, Copercini M, Petignat P, Dubuisson JB. Levator ani muscle complex: anatomic findings in nulliparous patients at thin-section MR imaging with double opacification. *Radiology.* 2012; 262 (2): 538-43
178. Notten KJ, Kluivers KB, Fütterer JJ, Schweitzer KJ, Stoker J, Mulder FE, Beets-Tan RG, Vliegen RF, Bossuyt PM, Kruitwagen RF, Roovers JP, Weemhoff M. Translabial three-dimensional ultrasonography compared with magnetic resonance imaging in detecting levator ani defects. *Obstet Gynecol.* 2014 Dec;124(6):1190-7.
179. Dietz HP, Eldridge A, Grace M, Clarke B. Does pregnancy affect pelvic organ mobility? *Aust N Z J Obstet Gynaecol.* 2004;44(6):517-20.
180. Dietz HP, Haylen BT, Broome J. Ultrasound in the quantification of female pelvic organ prolapse. *Ultrasound Obstet Gynecol.* 2001;18(5):511-4.

181. Lone FW, Thakar R, Sultan AH, Stankiewicz A. Accuracy of assessing pelvic organ prolapse quantification points using dynamic 2D transperineal ultrasound in women with pelvic organ prolapse. *Int Urogynecol J.* 2012;23(11):1555–60.
182. Dietz HP, Kamisan Atan I, Salita A. Association between ICS POP-Q coordinates and translabial ultrasound findings: implications for definition of 'normal pelvic organ support'. *Ultrasound Obstet Gynecol.* 2016 Mar;47(3):363-8.
183. Dietz HP, Eldridge A, Grace M, Clarke B. Pelvic organ descent in young nulligravid women. *Am J Obstet Gynecol.* 2004;191(1):95-9.
184. Vierhout ME, van der Plas-de Koning YW. Diagnosis of posterior enterocele: comparison of rectal ultrasonography with intraoperative diagnosis. *J Ultrasound Med.* 2002;21(4):383-7; quiz 389.
185. Karaus M, Neuhaus P, Wiedenmann TB. Diagnosis of enteroceles by dynamic anorectal endosonography. *Dis Colon Rectum.* 2000;43(12):1683-8.
186. Grasso RF, Piciucchi S, Quattrocchi CC, Sammarra M, Ripetti V, Zobel BB. Posterior pelvic floor disorders: a prospective comparison using introital ultrasound and colpocystodefecography. *Ultrasound Obstet Gynecol.* 2007;30(1):86-94.
187. Dietz HP, Steensma AB. Posterior compartment prolapse on two-dimensional and three-dimensional pelvic floor ultrasound: the distinction between true rectocele, perineal hypermobility and enterocele. *Ultrasound Obstet Gynecol.* 2005;26(1):73-7.
188. Dietz HP, Korda A. Which bowel symptoms are most strongly associated with a true rectocele? *Aust N Z J Obstet Gynaecol.* 2005;45(6):505-8.
189. Dietz HP, Clarke B. Prevalence of rectocele in young nulliparous women. *Aust N Z J Obstet Gynaecol.* 2005;45(5):391-4.
190. Bruscianno L, Limongelli P, Pescatori M, Napolitano V, Gagliardi G, Maffettone V, et al. Ultrasonographic patterns in patients with obstructed defaecation. *Int J Colorectal Dis.* 2007;22(8):969-77.
191. Beer-Gabel M, Assoulin Y, Amitai M, Bardan E. A comparison of dynamic transperineal ultrasound (DTP-US) with dynamic evacuation proctography (DEP) in the diagnosis of cul de sac hernia (enterocele) in patients with evacuatory dysfunction. *Int J Colorectal Dis.* 2008;23(5):513-9.
192. Beer-Gabel M, Teshler M, Schechtman E, Zbar AP. Dynamic transperineal ultrasound vs. defecography in patients with evacuatory difficulty: a pilot study. *Int J Colorectal Dis.* 2004;19(1):60-7.
193. Majida M, Braekken I, Bo K, Benth J, Engh M. Anterior but not posterior compartment prolapse is associated with levator hiatus area: a three- and four-dimensional transperineal ultrasound study. *BJOG.* 2011; 118 (3): 329-37.
194. Pracros JP, Tran-Minh VA, Wright C. Ultrasound in diagnosis of intussusception. *Lancet.* 1985;2(8457):733-4.
195. Barthet M, Portier F, Heyries L, Orsoni P, Bouvier M, Houtin D, et al. Dynamic anal endosonography may challenge defecography for assessing dynamic anorectal disorders: results of a prospective pilot study. *Endoscopy.* 2000;32(4):300-5.
196. Peng Q, Jones R, Shishido K, Constantinou CE. Ultrasound evaluation of dynamic responses of female pelvic floor muscles. *Ultrasound Med Biol.* 2007;33(3):342-52.
197. Kluivers KB, Hendriks JC, Shek C, Dietz HP. Pelvic organ prolapse symptoms in relation to POPQ, ordinal stages and ultrasound prolapse assessment. *Int Urogynecol J Pelvic Floor Dysfunct.* 2008;19(9):1299-302.
198. Hennemann J, Kennes LN, Maass N, Najjari L. Evaluation of established and new reference lines for the standardization of transperineal ultrasound. *Ultrasound Obstet Gynecol.* 2014 Nov;44(5):610-6.
199. Dietz HP, Lekskulchai O. Ultrasound assessment of pelvic organ prolapse: the relationship between prolapse severity and symptoms. *Ultrasound Obstet Gynecol.* 2007;29(6):688-91.
200. Eisenberg VH, Chantarasorn V, Shek KL, Dietz HP. Does levator ani injury affect cystocele type? *Ultrasound Obstet Gynecol.* 2010; 36 (5): 618-23.
201. Costantini S, Esposito F, Nadalini C, Lijoi D, Morano S, Lantieri P, Mistrangelo E. Ultrasound imaging of the female perineum: the effect of vaginal delivery on pelvic floor dynamics. *Ultrasound Obstet Gynecol.* 2006;27(2):183-7.
202. Reed H, Freeman RM, Waterfield A, Adekanmi O. Prevalence of bladder neck mobility in asymptomatic non-pregnant nulliparous volunteers. *BJOG.* 2004;111(2):172-5.
203. Peschers U, Schaer G, Anthuber C, Delancey JO, Schuessler B. Changes in vesical neck mobility following vaginal delivery. *Obstet Gynecol.* 1996;88(6):1001-6.

204. Dietz HP, Bennett MJ. The effect of childbirth on pelvic organ mobility. *Obstet Gynecol.* 2003;102(2):223-8.
205. Dietz HP, Steensma AB. The role of childbirth in the aetiology of rectocele. *BJOG.* 2006;113(3):264-7.
206. Dietz HP, Wilson PD. Childbirth and pelvic floor trauma. *Best Pract Res Clin Obstet Gynaecol.* 2005;19(6):913-24.
207. Toozs-Hobson P, Balmforth J, Cardozo L, Khullar V, Athanasiou S. The effect of mode of delivery on pelvic floor functional anatomy. *Int Urogynecol J Pelvic Floor Dysfunct.* 2008;19(3):407-16.
208. Dietz HP, Lanzarone V, Simpson JM. Predicting operative delivery. *Ultrasound Obstet Gynecol.* 2006;27(4):409-15.
209. Reilly ET, Freeman RM, Waterfield AE, Stegges P, Pedlar F. prevention of postpartum stress incontinence in primigravidae with increased bladder neck mobility: a randomized controlled trial of antenatal pelvic floor exercises. *BJOG.* 2002; 109 (1): 68-75.
210. Dietz HP, Steensma AB. The prevalence of major abnormalities in the levator ani in urogynaecological patients. *BJOG.* 2006; 113 (2):225-30.
211. Otcenasek M, Halaska M, Krcmar M, Maresova D, Halaska MG. New approach to the urogynecological ultrasound examination. *Eur J Obstet Gynecol Reprod Biol.* 2002;103(1):72-4.
212. Chan SS, Cheung RY, Yiu AK, Lee LL, pang AW, Choy KW, Leung TY, Chung TK. Prevalence of levator ani muscle injury in Chinese women after first delivery. *Ultrasound Obstet Gynecol.* 2012; 39 (6): 704-9.
213. Shek KL, Dietz HP. The effect of childbirth on hiatal dimensions. *Obstet Gynecol.* 2009; 113 (6): 1272-8.
214. Krofta L, Otcenasek M, Kasikova E, Feyereisl J. Pubococcygeus-puborectalis trauma after forceps delivery: evaluation of the levator ani muscle with 3D/4D ultrasound. *Int Urogynecol J Pelvic Floor Dysfunct.* 2009; 20 (10): 1175-81.
215. Cassado Garriga J, Pessarrodona Isern A, Espuna Pons M, Duran Retamal M, Felgueroso Fabrega A, Rodriguez Carballeira M, Jordà Santamaria I. Four-dimensional sonographic evaluation of avulsion of the levator ani according to delivery mode. *Ultrasound Obstet Gynecol.* 2011; 38 (6): 701-6.
216. Albrich SB, laterza RM, Skala C, Salvatore S, Koelbl H, Naumann G. Impact of mode of delivery on levator morphology: a prospective observational study with three dimensional ultrasound early in the postpartum period. *BJOG.* 2012; 119 (1): 51-60.
217. Blasi J, Fuchs I, D'Amico R, Vinci V, la Sala GB, Mazza V, Henrich W. Intrapartum translabial three-dimensional ultrasound visualization of levator trauma. *Ultrasound Obstet Gynecol.* 2011;37(1):88-92.
218. Toozs-Hobson P, Balmforth J, Cardozo L, Khullar V, Athanasiou S. the effect of mode of delivery on pelvic floor functional anatomy. *Int Urogynecol J Pelvic Floor Dysfunction.* 2008; 19 (3): 407-16.
219. Falkert A, Endress E, Weigl M, Seelbach-Gobel B. three-dimensional ultrasound of the pelvic floor 2 days after first delivery: influence of constitutional and obstetric factors. *Ultrasound Obstet Gynecol.* 2010; 35 (5): 583-8.
220. Shek KI, Chantarasorn V, Langer S, Dietz HP. Does levator trauma "heal"? *Ultrasound Obstet Gynecol.* 2012, 40 (5): 570-5.
221. Cassado Garriga J, Pessarrodona Isern A, Espuna Pons M, Duran Retamal M, Felgueroso Fabregas A, Rodrigues-Carballera M. Tridimensional sonographic anatomical changes on pelvic floor muscle according to the type of delivery. *Int Urogynecol J.* 2011, 22 (8): 1011-8.
222. Valsky DV, lipschuetz M, Bord A, Eldar I, messing B, Hochner-Celnikier D, Lavy Y, Cohen Sm, Yagel S. Fetal head circumference and length of second stage of labor are risk factors for levator ani muscle injury, diagnosed by 3-dimensional transperineal ultrasound in primiparous women. *Am J Obstet Gynecol.* 2009; 201 (1): 91.e1-7.
223. Chan SS1, Cheung RY1, Yiu KW1, Lee LL1, Chung TK1. Antenatal pelvic floor biometry is related to levator ani muscle injury. *Ultrasound Obstet Gynecol.* 2015 Oct 20.
224. van Delft K1, Thakar R, Sultan AH, Schwertner-Tiepelmann N, Kluivers K. Levator ani muscle avulsion during childbirth: a risk prediction model. *BJOG.* 2014 Aug;121(9):1155-63; discussion 1163.
225. Aydın S, Aydın ÇA. Evaluation of labor-related pelvic floor changes 3 months after delivery: a 3D transperineal ultrasound study. *Int Urogynecol J.* 2015 Dec;26(12):1827-33.
226. Sifarikas F, Stær-Jensen J, Hilde G, Bø K, Ellström Engh M. Levator hiatus dimensions in late pregnancy and the process of labor: a 3- and 4-dimensional transperineal ultrasound study. *Am J Obstet Gynecol.* 2014 May;210(5):484.e1-7.

227. van Delft K, Thakar R, Shobeiri SA, Sultan AH. Levator hematoma at the attachment zone as an early marker for levator ani muscle avulsion. *Ultrasound Obstet Gynecol.* 2014 Feb;43(2):210-7.
228. van Delft KW, Thakar R, Sultan AH, IntHout J, Kluivers KB. The natural history of levator avulsion one year following childbirth: a prospective study. *BJOG.* 2015 Aug;122(9):1266-73.
229. Branham V, Thomas J, Jaffe T, Crockett M, South M, Jamison M, et al. Levator ani abnormality 6 weeks after delivery persists at 6 months. *Am J Obstet Gynecol* 2007;197:65.e1-6.
230. Chan SS, Cheung RY, Yiu KW, Lee LL, Chung TK. Effect of levatorani muscle injury on primiparous women during the first year after childbirth. *Int Urogynecol J* 2014;25:1381-8.
231. Stær-Jensen J1, Siafarikas F, Hilde G, Benth JŠ, Bø K, Engh ME. Postpartum recovery of levator hiatus and bladder neck mobility in relation to pregnancy. *Obstet Gynecol.* 2015 Mar;125(3):531-9.
232. Valsky DV, Lipschuetz M, Cohen SM, Daum H, Messing B, Yagel I, Yagel S. Persistence of levator ani sonographic defect detected by three-dimensional transperineal sonography in primiparous women. *Ultrasound Obstet Gynecol.* 2015 Dec;46(6):724-9.
233. Viereck V, Bader W, Skala C, Gauruder-Burmester A, Emons G, Hilgers R, Krauss T. Determination of bladder neck position by intraoperative introital ultrasound in colposuspension: outcome at 6-month follow-up. *Ultrasound Obstet Gynecol.* 2004;24(2):186-91.
234. Viereck V, Bader W, Krauss T, Oppermann M, Gauruder-Burmester A, Hilgers R, Hackenberg R, Hatzmann W, Emons G. Intra-operative introital ultrasound in Burch colposuspension reduces post-operative complications. *BJOG.* 2005;112(6):791-6.
235. Model AN, Shek KL, Dietz HP. Levator defects are associated with prolapse after pelvic floor surgery. *Eur J Obstet Gynecol Reprod Biol.* 2010; 153 (2): 220-3.
236. Lone F, Sultan AH, Stankiewicz A, Thakar R. The value of pre-operative multicompart ment pelvic floor ultrasonography: a 1-year prospective study. *Br J Radiol.* 2014 Aug;87(1040) 114-8.
237. Dietz HP, Barry C, Lim YN, Rane A. Two-dimensional and three-dimensional ultrasound imaging of suburethral slings. *Ultrasound Obstet Gynecol.* 2005;26(2):175-9.
238. Yalcin OT, Hassa H, Tanir M. A new ultrasonographic method for evaluation of the results of anti-incontinence operations. *Acta Obstet Gynecol Scand.* 2002;81(2):151-6.
239. Lo TS, Horng SG, Liang CC, Lee SJ, Soong YK. Ultrasound assessment of mid-urethra tape at three-year follow-up after tension-free vaginal tape procedure. *Urology.* 2004;63(4):671-5.
240. Lo TS, Wang AC, Horng SG, Liang CC, Soong YK. Ultrasonographic and urodynamic evaluation after tension free vagina tape procedure (TVT). *Acta Obstet Gynecol Scand.* 2001;80(1):65-70.
241. Virtanen HS, Kiilholma P. Urogynecologic ultrasound is a useful aid in the assessment of female stress urinary incontinence—a prospective study with TVT procedure. *Int Urogynecol J Pelvic Floor Dysfunct.* 2002;13(4):218-22.
242. Jiang YH, Wang CC, Chuang FC, Ke QS, Kuo HC. Positioning of a suburethral sling at the bladder neck is associated with a higher recurrence rate of stress urinary incontinence. *J Ultrasound Med.* 2013 Feb;32(2):239-45.
243. Tunitsky-Bitton E, Unger CA, Barber MD, Goldman HB, Walters MD. Ultrasound Evaluation of Midurethral Sling Position and Correlation to Physical Examination and Patient Symptoms. *Female Pelvic Med Reconstr Surg.* 2015 Sep-Oct;21(5):263-8.
244. Schuettoff S, Beyersdorff D, Gauruder-Burmester A, Tunn R. Visibility of the polypropylene tape after tension-free vaginal tape (TVT) procedure in women with stress urinary incontinence: comparison of introital ultrasound and magnetic resonance imaging in vitro and in vivo. *Ultrasound Obstet Gynecol.* 2006;27(6):687-92.
245. Dietz HP, Mouritsen L, Ellis G, Wilson PD. How important is TVT location? *Acta Obstet Gynecol Scand.* 2004;83(10):904-8.
246. Ng CC, Lee LC, Han WH. Use of three-dimensional ultrasound scan to assess the clinical importance of midurethral placement of the tension-free vaginal tape (TVT) for treatment of incontinence. *Int Urogynecol J Pelvic Floor Dysfunct.* 2005;16(3):220-5.
247. Dietz HP, Wilson PD. The 'iris effect': how two-dimensional and three-dimensional ultrasound can help us understand anti-incontinence procedures. *Ultrasound Obstet Gynecol.* 2004;23(3):267-71.
248. Sarlos D, Kuronen M, Schaer GN. How does tension-free vaginal tape correct stress incontinence? Investigation by perineal ultrasound. *Int Urogynecol J Pelvic Floor Dysfunct.* 2003;14(6):395-8.

249. Long CY, Hsu CS, Lo TS, Liu CM, Chen YH, Tsai EM. Ultrasonographic assessment of tape location following tension-free vaginal tape and transobturator tape procedure. *Acta Obstet Gynecol Scand.* 2008;87(1):116-21.
250. Foulot H, Uzan I, Chopin N, Borghese B, Chapron C. Monarc transobturator sling system for the treatment of female urinary stress incontinence: results of a post-operative transvaginal ultrasonography. *Int Urogynecol J Pelvic Floor Dysfunct.* 2007;18(8):857-61.
251. Cotte B, Dumoussat E, Boda C, Mansoor A. Comparison of transobturator tape (TOT) and tension-free vaginal tape (TVT) using perineal ultrasound. *Gynecol Obstet Fertil.* 2006;34(4):298-303.
252. de Tayrac R, Deffieux X, Resten A, Doumerc S, Jouffroy C, Fernandez H. A transvaginal ultrasound study comparing transobturator tape and tension-free vaginal tape after surgical treatment of female stress urinary incontinence. *Int Urogynecol J Pelvic Floor Dysfunct.* 2006;17(5):466-71.
253. Lin KL, Juan YS, Lo TS, Liu CM, Tsai EM, Long CY. Three-dimensional ultrasonographic assessment of compression effect on urethra following tension-free vaginal tape and transobturator tape procedures. *Ultrasound Obstet Gynecol.* 2012; 39 (4): 452-7.
254. Chantarasorn V, Shek KL, Dietz HP. Sonographic appearance of transobturator slings: implications for function and dysfunction. *Int Urogynecol J.* 2011; 22 (4): 493-8
255. Yang JM, Yang SH, Huang WC. Dynamic interaction involved in the tension-free vaginal tape obturator procedure. *J Urol.* 2008, 180 (5): 2081-7
256. Chene G, Cotte B, Tardieu AS, Savary D, Mansoor A. clinical and ultrasonographic correlations following three surgical anti-incontinence procedures (TOT, TVT and TVT-O). *Int Urogynecol J Pelvic Floor Dysfunct.* 2008; 19 (8): 1125-31.
257. Duckett J, basu M, Papanikolaou N. Transperineal ultrasound to assess the effect of tension-free vaginal tape position on flow rates. *Ultrasound Obstet Gynecol.* 2010; 36 (3): 379-83
258. Mouracade P, El Abiad S, Roy C, Lang H, Jacqmin D, Saussine C. correlation of introital ultrasound with LUTS after sling surgery. *Int Urogynecol J.* 2010; 21 (10): 1261-4
259. Mukati MS, Shobeiri SA. Transvaginal sling release with intraoperative ultrasound
260. Abbasy SA, Kenton K, Brubaker L, Mueller ER. Measurements of transurethral bladder neck displacement during tension-free vaginal tape procedure. *Int Urogynecol J.* 2011; 22 (6): 721-4.
261. Tunn R, Picot A, Marschke J, Gauruder-Burmester A. Sonomorphological evaluation of polypropylene mesh implants after vaginal mesh repair in women with cystocele or rectocele. *Ultrasound Obstet Gynecol.* 2007;29(4):449-52.
262. Tunn R, Picot A. Marschke J, Gauruder-Burmester A. Sonomorphological evaluation of polypropylene mesh implants after vaginal mesh repair in women with cystocele or rectocele. *Ultrasound Obste gynecol.* 2007; 29 (4): 449-52.
263. Velemir L, Amblard J, Fatton B, Savary D, Jacquetin B. Transvaginal mesh repair of anterior and posterior vaginal wall prolapse: a clinical and ultrasonographic study. *Ultrasound Obstet Gynecol.* 2010; 35 (4): 474-80.
264. Svabik K, Martan A, Masata J, El-Haddad R, Hubka P, Pavlikova M. Ultrasound appearances after mesh implantation—evidence of mesh contraction or folding. *Int urogynecol J.* 2011; 22 (5): 529-33.
265. Shek C, Dietz HP. Transobturator mesh anchoring for the repair of large or recurrent cystocele. *Neurourolog Urodyn.* 2006;25:554.
266. Bridges MD, Petrou SP, Lightner DJ. Urethral bulking agents: imaging review. *AJR Am J Roentgenol.* 2005;185(1):257-64.
267. Poon CI, Zimmern PE. Role of three-dimensional ultrasound in assessment of women undergoing urethral bulking agent therapy. *Curr Opin Obstet Gynecol.* 2004;16(5):411-7.
268. Defreitas GA, Wilson TS, Zimmern PE, Forte TB. Threedimensional ultrasonography: an objective outcome tool to assess collagen distribution in women with stress urinary incontinence. *Urology.* 2003;62(2):232-6.
269. Elia G, Bergman A. Periurethral collagen implant: ultrasound assessment and prediction of outcome. *Int Urogynecol J Pelvic Floor Dysfunct.* 1996;7(6):335-8.
270. Hegde A, Smith AL, Aguilar VC, Davila GW. Three-dimensional endovaginal ultrasound examination following injection of Macroplastique for stress urinary incontinence: outcomes based on location and periurethral distribution of the bulking agent. *Int Urogynecol J.* 2013 Jul;24(7):1151-9.
271. Isom-batz G, Zimmern PE. Collagen injection for female urinary incontinence after urethral or periurethral surgery. *J Urol.* 2009; 181 (2): 701-4.

272. Strasser H, Marksteiner R, Margreiter E, Pinggera GM, Mitterberger M, Frauscher F, Ulmer H, Fussenegger M, Kofler K, Bartsch G. Autologous myoblasts and fibroblasts versus collagen for treatment of stress urinary incontinence in women: a randomised controlled trial. *Lancet*. 2007;369(9580):2179-86.
273. Strasser H, Marksteiner R, Margreiter E, Mitterberger M, Pinggera GM, Frauscher F, Fussenegger M, Kofler K, Bartsch G. Transurethral ultrasonography-guided injection of adult autologous stem cells versus transurethral endoscopic injection of collagen in treatment of urinary incontinence. *World J Urol*. 2007 Aug;25(4):385-92.
- ### 2.3 MRI
1. Maglinte, D. D., Kelvin, F. M., Fitzgerald, K., Hale, D. S., and Benson, J. T. 1999. Association of compartment defects in pelvic floor dysfunction. *AJR Am J Roentgenol* 172:439.
 2. Safir, M. H., Gousse, A. E., Rovner, E. S., Ginsberg, D. A., and Raz, S. 1999. 4-Defect repair of grade 4 cystocele. *J Urol* 161:587.
 3. Kelvin, F. M. and Maglinte, D. D. 1997. Dynamic cystoproctography of female pelvic floor defects and their interrelationships. *AJR Am J Roentgenol* 169:769.
 4. Kelvin, F. M., Hale, D. S., Maglinte, D. D., Patten, B. J., and Benson, J. T. 1999. Female pelvic organ prolapse: diagnostic contribution of dynamic cystoproctography and comparison with physical examination. *AJR Am J Roentgenol* 173:31.
 5. Stovall, D. W. 2000. Transvaginal ultrasound findings in women with chronic pelvic pain. *Obstet Gynecol* 95:S57.
 6. Raz, S., Erickson, D., and Sussman, E. 1992. Operative repair of rectocele, enterocele and cystocele. *Adv Urol* 5:121.
 7. Siproudhis, L., Ropert, A., Vilotte, J., Bretagne, J. F., Heresbach, D., Raoul, J. L., and Gosselin, M. 1993. How accurate is clinical examination in diagnosing and quantifying pelvic floor disorders? A prospective study in a group of 50 patients complaining of defecatory difficulties. *Dis Colon Rectum* 36:430.
 8. Broekhuis, S. R., Futterer, J. J., Barentsz, J. O., Vierhout, M. E., and Kluivers, K. B. 2009. A systematic review of clinical studies on dynamic magnetic resonance imaging of pelvic organ prolapse: the use of reference lines and anatomical landmarks. *Int Urogynecol J Pelvic Floor Dysfunct* 20:721.
 9. Klutke, C., Golomb, J., Barbaric, Z., and Raz, S. 1990. The anatomy of stress incontinence: magnetic resonance imaging of the female bladder neck and urethra. *J Urol* 143:563.
 10. Yang, A., Mostwin, J. L., Rosenshein, N. B., and Zerhouni, E. A. 1991. Pelvic floor descent in women: dynamic evaluation with fast MR imaging and cinematic display. *Radiology* 179:25.
 11. Goodrich, M. A., Webb, M. J., King, B. F., Bampton, A. E., Campeau, N. G., and Riederer, S. J. 1993. Magnetic resonance imaging of pelvic floor relaxation: dynamic analysis and evaluation of patients before and after surgical repair. *Obstet Gynecol* 82:883.
 12. Strohbehm, K., Ellis, J. H., Strohbehm, J. A., and DeLancey, J. O. 1996. Magnetic resonance imaging of the levator ani with anatomic correlation. *Obstet Gynecol* 87:277.
 13. Ozasa, H., Mori, T., and Togashi, K. 1992. Study of uterine prolapse by magnetic resonance imaging: topographical changes involving the levator ani muscle and the vagina. *Gynecol Obstet Invest* 34:43.
 14. Lienemann, A., Anthuber, C., Baron, A., Kohz, P., and Reiser, M. 1997. Dynamic MR colpocystorectography assessing pelvic-floor descent. *Eur Radiol* 7:1309.
 15. Comiter, C. V., Vasavada, S. P., Barbaric, Z. L., Gousse, A. E., and Raz, S. 1999. Grading pelvic prolapse and pelvic floor relaxation using dynamic magnetic resonance imaging. *Urology* 54:454.
 16. Gousse, A. E., Barbaric, Z. L., Safir, M. H., Madjar, S., Marumoto, A. K., and Raz, S. 2000. Dynamic half Fourier acquisition, single shot turbo spin-echo magnetic resonance imaging for evaluating the female pelvis. *J Urol* 164:1606.
 17. Rouanet, J. P., Mares, P., Courtieu, C., and Maubon, A. 2000. [Static and dynamic MRI of the normal and pathological female pelvic floor]. *J Gynecol Obstet Biol Reprod (Paris)* 29:237.
 18. Lienemann, A., Sprenger, D., Janssen, U., Anthuber, C., and Reiser, M. 2000. [Functional MRI of the pelvic floor. The methods and reference values]. *Radiologe* 40:458.
 19. Tunn, R., Paris, S., Taupitz, M., Hamm, B., and Fischer, W. 2000. MR imaging in posthysterectomy vaginal prolapse. *Int Urogynecol J Pelvic Floor Dysfunct* 11:87.
 20. Healy, J. C., Halligan, S., Reznick, R. H., Watson, S., Phillips, R. K., and Armstrong, P. 1997. Patterns of prolapse in women with symptoms of pelvic floor weakness: assessment with MR imaging. *Radiology* 203:77.

21. Haylen, B. T., de Ridder, D., Freeman, R. M., Swift, S. E., Berghmans, B., Lee, J., Monga, A., Petri, E., Rizk, D. E., Sand, P. K., and Schaer, G. N. 2010. An International Urogynecological Association (IUGA)/International Continence Society (ICS) joint report on the terminology for female pelvic floor dysfunction. *Neurourol Urodyn* 29:4.
22. Busse, R. F., Riederer, S. J., Fletcher, J. G., Bharucha, A. E., and Brandt, K. R. 2000. Interactive fast spin-echo imaging. *Magn Reson Med* 44:339.
23. Barbaric, Z. L., Marumoto, A. K., and Raz, S. 2001. Magnetic resonance imaging of the perineum and pelvic floor. *Top Magn Reson Imaging* 12:83.
24. Hecht, E. M., Lee, V. S., Tanpitukpongse, T. P., Babb, J. S., Taouli, B., Wong, S., Rosenblum, N., Kanofsky, J. A., and Bennett, G. L. 2008. MRI of pelvic floor dysfunction: dynamic true fast imaging with steady-state precession versus HASTE. *AJR Am J Roentgenol* 191:352.
25. Fielding, J. R., Dumanli, H., Schreyer, A. G., Okuda, S., Gering, D. T., Zou, K. H., Kikinis, R., and Jolesz, F. A. 2000. MR-based three-dimensional modeling of the normal pelvic floor in women: quantification of muscle mass. *AJR Am J Roentgenol* 174:657.
26. Goh, V., Halligan, S., Kaplan, G., Healy, J. C., and Bartram, C. I. 2000. Dynamic MR imaging of the pelvic floor in asymptomatic subjects. *AJR Am J Roentgenol* 174:661.
27. Bennett, G. L., Hecht, E. M., Tanpitukpongse, T. P., Babb, J. S., Taouli, B., Wong, S., Rosenblum, N., Kanofsky, J. A., and Lee, V. S. 2009. MRI of the urethra in women with lower urinary tract symptoms: spectrum of findings at static and dynamic imaging. *AJR Am J Roentgenol* 193:1708.
28. Tumbarello, J. A., Hsu, Y., Lewicky-Gaupp, C., Rohrer, S., and DeLancey, J. O. 2010. Do repetitive Valsalva maneuvers change maximum prolapse on dynamic MRI? *Int Urogynecol J Pelvic Floor Dysfunct* 21:1247.
29. Delaney, S., Fernandez, P., N'Guyen, A., Salomon, L., Carbonne, B., Laissy, J. P., and Ansquer, Y. 2009. Effect of a speculum blade on dynamic MRI evaluation of pelvic organ prolapse. *Acta Obstet Gynecol Scand* 88:831.
30. Friedman, B., Stothers, L., Lazare, D., and Macnab, A. 2015. Positional pelvic organ prolapse (POP) evaluation using open, weight-bearing magnetic resonance imaging (MRI). *Can Urol Assoc J* 9:197.
31. Larson, K. A., Luo, J., Guire, K. E., Chen, L., Ashton-Miller, J. A., and Delancey, J. O. 2011. 3D analysis of cystoceles using magnetic resonance imaging assessing midline, paravaginal, and apical defects. *Int Urogynecol J*.
32. Larson, K. A., Luo, J., Yousuf, A., Ashton-Miller, J. A., and Delancey, J. O. 2012. Measurement of the 3D geometry of the fascial arches in women with a unilateral levator defect and "architectural distortion". *Int Urogynecol J* 23:57.
33. Luo, J., Betschart, C., Chen, L., Ashton-Miller, J. A., and DeLancey, J. O. 2014. Using stress MRI to analyze the 3D changes in apical ligament geometry from rest to maximal Valsalva: a pilot study. *Int Urogynecol J* 25:197.
34. Zijta, F. M., Lakeman, M. M., Froeling, M., van der Paardt, M. P., Borstlap, C. S., Bipat, S., Montauban van Swijndregt, A. D., Strijkers, G. J., Roovers, J. P., Nederveen, A. J., and Stoker, J. 2012. Evaluation of the female pelvic floor in pelvic organ prolapse using 3.0-Tesla diffusion tensor imaging and fibre tractography. *Eur Radiol* 22:2806.
35. Myers, R. P., Cahill, D. R., Kay, P. A., Camp, J. J., Devine, R. M., King, B. F., and Engen, D. E. 2000. Puboperineales: muscular boundaries of the male urogenital hiatus in 3D from magnetic resonance imaging. *J Urol* 164:1412.
36. Tan, I. L., Stoker, J., Zwamborn, A. W., Entius, K. A., Calame, J. J., and Lameris, J. S. 1998. Female pelvic floor: endovaginal MR imaging of normal anatomy. *Radiology* 206:777.
37. Hjartardottir, S., Nilsson, J., Petersen, C., and Lingman, G. 1997. The female pelvic floor: a dome--not a basin. *Acta Obstet Gynecol Scand* 76:567.
38. Hugosson, C., Jorulf, H., Lingman, G., and Jacobsson, B. 1991. Morphology of the pelvic floor. *Lancet* 337:367.
39. Chou, Q. and DeLancey, J. O. 2001. A structured system to evaluate urethral support anatomy in magnetic resonance images. *Am J Obstet Gynecol* 185:44.
40. Tunn, R., Delancey, J. O., Howard, D., Ashton-Miller, J. A., and Quint, L. E. 2003. Anatomic variations in the levator ani muscle, endopelvic fascia, and urethra in nulliparas evaluated by magnetic resonance imaging. *Am J Obstet Gynecol* 188:116.
41. Umek, W. H., Morgan, D. M., Ashton-Miller, J. A., and DeLancey, J. O. 2004. Quantitative analysis of uterosacral ligament origin and insertion points by magnetic resonance imaging. *Obstet Gynecol* 103:447.

42. Chen, L., Ramanah, R., Hsu, Y., Ashton-Miller, J. A., and Delancey, J. O. 2013. Cardinal and deep uterosacral ligament lines of action: MRI based 3D technique development and preliminary findings in normal women. *Int Urogynecol J* 24:37.
43. Hsu, Y., Lewicky-Gaup, C., and DeLancey, J. O. 2008. Posterior compartment anatomy as seen in magnetic resonance imaging and 3-dimensional reconstruction from asymptomatic nulliparas. *Am J Obstet Gynecol* 198:651 e1.
44. Larson, K. A., Yousuf, A., Lewicky-Gaup, C., Fenner, D. E., and DeLancey, J. O. 2010. Perineal body anatomy in living women: 3-dimensional analysis using thin-slice magnetic resonance imaging. *Am J Obstet Gynecol* 203:494 e15.
45. Otcenasek, M., Baca, V., Krofta, L., and Feyereisl, J. 2008. Endopelvic fascia in women: shape and relation to parietal pelvic structures. *Obstet Gynecol* 111:622.
46. Nardos, R., Thurmond, A., Holland, A., and Gregory, W. T. 2014. Pelvic floor levator hiatus measurements: MRI versus ultrasound. *Female Pelvic Med Reconstr Surg* 20:216.
47. Guo, M. and Li, D. 2007. Pelvic floor images: anatomy of the levator ani muscle. *Dis Colon Rectum* 50:1647.
48. Margulies, R. U., Hsu, Y., Kearney, R., Stein, T., Umek, W. H., and DeLancey, J. O. 2006. Appearance of the levator ani muscle subdivisions in magnetic resonance images. *Obstet Gynecol* 107:1064.
49. Betschart, C., Kim, J., Miller, J. M., Ashton-Miller, J. A., and DeLancey, J. O. 2014. Comparison of muscle fiber directions between different levator ani muscle subdivisions: in vivo MRI measurements in women. *Int Urogynecol J* 25:1263.
50. Lammers, K., Kluivers, K. B., Vierhout, M. E., Prokop, M., and Futterer, J. J. 2013. Inter- and intraobserver reliability for diagnosing levator ani changes on magnetic resonance imaging. *Ultrasound Obstet Gynecol* 42:347.
51. DeLancey, J. O., Morgan, D. M., Fenner, D. E., Kearney, R., Guire, K., Miller, J. M., Hussain, H., Umek, W., Hsu, Y., and Ashton-Miller, J. A. 2007. Comparison of levator ani muscle defects and function in women with and without pelvic organ prolapse. *Obstet Gynecol* 109:295.
52. Dietz, H. P. and Steensma, A. B. 2006. The prevalence of major abnormalities of the levator ani in urogynaecological patients. *BJOG* 113:225.
53. Hoyte, L., Schierlitz, L., Zou, K., Flesh, G., and Fielding, J. R. 2001. Two- and 3-dimensional MRI comparison of levator ani structure, volume, and integrity in women with stress incontinence and prolapse. *Am J Obstet Gynecol* 185:11.
54. Hoyte, L., Jakab, M., Warfield, S. K., Shott, S., Flesh, G., and Fielding, J. R. 2004. Levator ani thickness variations in symptomatic and asymptomatic women using magnetic resonance-based 3-dimensional color mapping. *Am J Obstet Gynecol* 191:856.
55. Hsu, Y., Chen, L., Huebner, M., Ashton-Miller, J. A., and DeLancey, J. O. 2006. Quantification of levator ani cross-sectional area differences between women with and those without prolapse. *Obstet Gynecol* 108:879.
56. Clark, N. A., Brincat, C. A., Yousuf, A. A., and Delancey, J. O. 2010. Levator defects affect perineal position independently of prolapse status. *Am J Obstet Gynecol* 203:595 e17.
57. Morgan, D. M., Cardoza, P., Guire, K., Fenner, D. E., and DeLancey, J. O. 2010. Levator ani defect status and lower urinary tract symptoms in women with pelvic organ prolapse. *Int Urogynecol J Pelvic Floor Dysfunct* 21:47.
58. Cai, X. R., Qiu, L., Wu, H. J., and Liu, S. R. 2013. Assessment of levator ani morphology and function in asymptomatic nulliparous women via static and dynamic magnetic resonance imaging. *Int J Gynaecol Obstet* 121:233.
59. Otcenasek, M., Krofta, L., Baca, V., Grill, R., Kucera, E., Herman, H., Vasicka, I., Drahonovsky, J., and Feyereisl, J. 2007. Bilateral avulsion of the puborectalis muscle: magnetic resonance imaging-based three-dimensional reconstruction and comparison with a model of a healthy nulliparous woman. *Ultrasound Obstet Gynecol* 29:692.
60. Margulies, R. U., Huebner, M., and DeLancey, J. O. 2007. Origin and insertion points involved in levator ani muscle defects. *Am J Obstet Gynecol* 196:251 e1.
61. Chen, L., Hsu, Y., Ashton-Miller, J. A., and DeLancey, J. O. 2006. Measurement of the pubic portion of the levator ani muscle in women with unilateral defects in 3-D models from MR images. *Int J Gynaecol Obstet* 92:234.
62. Hsu, Y., Summers, A., Hussain, H. K., Guire, K. E., and Delancey, J. O. 2006. Levator plate angle in women with pelvic organ prolapse compared to women with normal support using dynamic MR imaging. *Am J Obstet Gynecol* 194:1427.

63. Ansquer, Y., Fernandez, P., Chapron, C., Frey, C., Bennis, M., Roy, C., Salomon, L., Mandelbrot, L., and Carbonne, B. 2006. Static and dynamic MRI features of the levator ani and correlation with severity of genital prolapse. *Acta Obstet Gynecol Scand* 85:1468.
64. Gearhart, S. L., Pannu, H. K., Cundiff, G. W., Buller, J. L., Bluemke, D. A., and Kaufman, H. S. 2004. Perineal descent and levator ani hernia: a dynamic magnetic resonance imaging study. *Dis Colon Rectum* 47:1298.
65. Stein, T. A., Kaur, G., Summers, A., Larson, K. A., and DeLancey, J. O. 2009. Comparison of bony dimensions at the level of the pelvic floor in women with and without pelvic organ prolapse. *Am J Obstet Gynecol* 200:241 e1.
66. Berger, M. B., Doumouchsis, S. K., and Delancey, J. O. 2013. Are bony pelvis dimensions associated with levator ani defects? A case-control study. *Int Urogynecol J*.
67. Boreham, M. K., Zaretsky, M. V., Corton, M. M., Alexander, J. M., McIntire, D. D., and Twickler, D. M. 2005. Appearance of the levator ani muscle in pregnancy as assessed by 3-D MRI. *Am J Obstet Gynecol* 193:2159.
68. Tunn, R., DeLancey, J. O., Howard, D., Thorp, J. M., Ashton-Miller, J. A., and Quint, L. E. 1999. MR imaging of levator ani muscle recovery following vaginal delivery. *Int Urogynecol J Pelvic Floor Dysfunct* 10:300.
69. Lienemann, A., Fischer, T., Anthuber, C., and Reiser, M. 2003. [Functional MRI of the pelvic floor: postpartum changes of primiparous women after spontaneous vaginal delivery]. *Rofo* 175:1100.
70. Baytur, Y. B., Serter, S., Tarhan, S., Uyar, Y., Inceboz, U., and Pabuscu, Y. 2007. Pelvic floor function and anatomy after childbirth. *J Reprod Med* 52:604.
71. DeLancey, J. O., Kearney, R., Chou, Q., Speights, S., and Binno, S. 2003. The appearance of levator ani muscle abnormalities in magnetic resonance images after vaginal delivery. *Obstet Gynecol* 101:46.
72. Kearney, R., Miller, J. M., Ashton-Miller, J. A., and DeLancey, J. O. 2006. Obstetric factors associated with levator ani muscle injury after vaginal birth. *Obstet Gynecol* 107:144.
73. Dannecker, C., Lienemann, A., Fischer, T., and Anthuber, C. 2004. Influence of spontaneous and instrumental vaginal delivery on objective measures of pelvic organ support: assessment with the pelvic organ prolapse quantification (POPQ) technique and functional cine magnetic resonance imaging. *Eur J Obstet Gynecol Reprod Biol* 115:32.
74. Branham, V., Thomas, J., Jaffe, T., Crockett, M., South, M., Jamison, M., and Weidner, A. 2007. Levator ani abnormality 6 weeks after delivery persists at 6 months. *Am J Obstet Gynecol* 197:65 e1.
75. Heilbrun, M. E., Nygaard, I. E., Lockhart, M. E., Richter, H. E., Brown, M. B., Kenton, K. S., Rahn, D. D., Thomas, J. V., Weidner, A. C., Nager, C. W., and Delancey, J. O. 2010. Correlation between levator ani muscle injuries on magnetic resonance imaging and fecal incontinence, pelvic organ prolapse, and urinary incontinence in primiparous women. *Am J Obstet Gynecol* 202:488 e1.
76. Handa, V. L., Lockhart, M. E., Kenton, K. S., Bradley, C. S., Fielding, J. R., Cundiff, G. W., Salomon, C. G., Hakim, C., Ye, W., and Richter, H. E. 2009. Magnetic resonance assessment of pelvic anatomy and pelvic floor disorders after childbirth. *Int Urogynecol J Pelvic Floor Dysfunct* 20:133.
77. Chen, L., Ashton-Miller, J. A., Hsu, Y., and DeLancey, J. O. 2006. Interaction among apical support, levator ani impairment, and anterior vaginal wall prolapse. *Obstet Gynecol* 108:324.
78. Lee, S. L., Darzi, A., and Yang, G. Z. 2005. Subject specific finite element modelling of the levator ani. *Med Image Comput Comput Assist Interv* 8:360.
79. Noakes, K. F., Bissett, I. P., Pullan, A. J., and Cheng, L. K. 2008. Anatomically realistic three-dimensional meshes of the pelvic floor & anal canal for finite element analysis. *Ann Biomed Eng* 36:1060.
80. Lee, S. L., Horkaew, P., Caspersz, W., Darzi, A., and Yang, G. Z. 2005. Assessment of shape variation of the levator ani with optimal scan planning and statistical shape modeling. *J Comput Assist Tomogr* 29:154.
81. Chen, L., Ashton-Miller, J. A., and DeLancey, J. O. 2009. A 3D finite element model of anterior vaginal wall support to evaluate mechanisms underlying cystocele formation. *J Biomech* 42:1371.
82. Peng, Y., Khavari, R., Nakib, N. A., Boone, T. B., and Zhang, Y. 2016. Assessment of urethral support using MRI-derived computational modeling of the female pelvis. *Int Urogynecol J* 27:205.
83. Handa, V. L., Pannu, H. K., Siddique, S., Gutman, R., VanRooyen, J., and Cundiff, G. 2003. Architectural differences in the bony pelvis of women with and without pelvic floor disorders. *Obstet Gynecol* 102:1283.

84. Hoyte, L., Thomas, J., Foster, R. T., Shott, S., Jakob, M., and Weidner, A. C. 2005. Racial differences in pelvic morphology among asymptomatic nulliparous women as seen on three-dimensional magnetic resonance images. *Am J Obstet Gynecol* 193:2035.
85. Downing, K. T., Hoyte, L. P., Warfield, S. K., and Weidner, A. C. 2007. Racial differences in pelvic floor muscle thickness in asymptomatic nulliparas as seen on magnetic resonance imaging-based three-dimensional color thickness mapping. *Am J Obstet Gynecol* 197:625 e1.
86. Handa, V. L., Lockhart, M. E., Fielding, J. R., Bradley, C. S., Brubaker, L., Cundiff, G. W., Ye, W., and Richter, H. E. 2008. Racial differences in pelvic anatomy by magnetic resonance imaging. *Obstet Gynecol* 111:914.
87. Rizk, D. E., Czechowski, J., and Ekelund, L. 2004. Dynamic assessment of pelvic floor and bony pelvis morphologic condition with the use of magnetic resonance imaging in a multiethnic, nulliparous, and healthy female population. *Am J Obstet Gynecol* 191:83.
88. Summers, A., Winkel, L. A., Hussain, H. K., and DeLancey, J. O. 2006. The relationship between anterior and apical compartment support. *Am J Obstet Gynecol* 194:1438.
89. Hsu, Y., Chen, L., Summers, A., Ashton-Miller, J. A., and DeLancey, J. O. 2008. Anterior vaginal wall length and degree of anterior compartment prolapse seen on dynamic MRI. *Int Urogynecol J Pelvic Floor Dysfunct* 19:137.
90. Hsu, Y., Chen, L., Delancey, J. O., and Ashton-Miller, J. A. 2005. Vaginal thickness, cross-sectional area, and perimeter in women with and those without prolapse. *Obstet Gynecol* 105:1012.
91. Broekhuis, S. R., Hendriks, J. C., Futterer, J. J., Vierhout, M. E., Barentsz, J. O., and Kluivers, K. B. 2010. Perineal descent and patients' symptoms of anorectal dysfunction, pelvic organ prolapse, and urinary incontinence. *Int Urogynecol J Pelvic Floor Dysfunct* 21:721.
92. Broekhuis, S. R., Futterer, J. J., Hendriks, J. C., Barentsz, J. O., Vierhout, M. E., and Kluivers, K. B. 2009. Symptoms of pelvic floor dysfunction are poorly correlated with findings on clinical examination and dynamic MR imaging of the pelvic floor. *Int Urogynecol J Pelvic Floor Dysfunct* 20:1169.
93. Broekhuis, S. R., Kluivers, K. B., Hendriks, J. C., Futterer, J. J., Barentsz, J. O., and Vierhout, M. E. 2009. POP-Q, dynamic MR imaging, and perineal ultrasonography: do they agree in the quantification of female pelvic organ prolapse? *Int Urogynecol J Pelvic Floor Dysfunct*.
94. Weidner, A. C. and Low, V. H. 1998. Imaging studies of the pelvic floor. *Obstet Gynecol Clin North Am* 25:825.
95. Lienemann, A., Anthuber, C., Baron, A., and Reiser, M. 2000. Diagnosing enteroceles using dynamic magnetic resonance imaging. *Dis Colon Rectum* 43:205.
96. Rodriguez, L. V., Bukkapatnam, R., Shah, S. M., and Raz, S. 2005. Transvaginal paravaginal repair of high-grade cystocele central and lateral defects with concomitant suburethral sling: report of early results, outcomes, and patient satisfaction with a new technique. *Urology* 66:57.
97. Cortes, E., Reid, W. M., Singh, K., and Berger, L. 2004. Clinical examination and dynamic magnetic resonance imaging in vaginal vault prolapse. *Obstet Gynecol* 103:41.
98. Montella, J. M. 2005. Vaginal mullerian cyst presenting as a cystocele. *Obstet Gynecol* 105:1182.
99. Larson, K. A., Hsu, Y., Chen, L., Ashton-Miller, J. A., and DeLancey, J. O. 2010. Magnetic resonance imaging-based three-dimensional model of anterior vaginal wall position at rest and maximal strain in women with and without prolapse. *Int Urogynecol J Pelvic Floor Dysfunct* 21:1103.
100. Yousuf, A., Chen, L., Larson, K., Ashton-Miller, J. A., and DeLancey, J. O. 2014. The length of anterior vaginal wall exposed to external pressure on maximal straining MRI: relationship to urogenital hiatus diameter, and apical and bladder location. *Int Urogynecol J* 25:1349.
101. Altringer, W. E., Saclarides, T. J., Dominguez, J. M., Brubaker, L. T., and Smith, C. S. 1995. Four-contrast defecography: pelvic "floor-oscopy". *Dis Colon Rectum* 38:695.
102. Cundiff, G. W., Nygaard, I., Bland, D. R., and Versi, E. 2000. Proceedings of the American Urogynecologic Society Multidisciplinary Symposium on Defecatory Disorders. *Am J Obstet Gynecol* 182:S1.
103. Dvorkin, L. S., Hetzer, F., Scott, S. M., Williams, N. S., Gedroyc, W., and Lunniss, P. J. 2004. Open-magnet MR defaecography compared with evacuation proctography in the diagnosis and management of patients with rectal intussusception. *Colorectal Dis* 6:45.
104. Lewicky-Gaupp, C., Yousuf, A., Larson, K. A., Fenner, D. E., and Delancey, J. O. 2010. Structural position of the posterior vagina and pelvic floor in women with and without posterior vaginal prolapse. *Am J Obstet Gynecol* 202:497 e1.

105. Gufler, H., DeGregorio, G., Allmann, K. H., Kundt, G., and Dohnicht, S. 2000. Comparison of cystourethrography and dynamic MRI in bladder neck descent. *J Comput Assist Tomogr* 24:382.
106. Ginath, S., Garely, A., Luchs, J. S., Shahryarinejad, A., Olivera, C., Zhou, S., Ascher-Walsh, C., Condrea, A., Brodman, M., and Vardy, M. 2010. MRI pelvic landmark angles in the assessment of apical pelvic organ prolapse. *Arch Gynecol Obstet*.
107. Novellas, S., Mondot, L., Bafghi, A., Fournol, M., Baudin, G., Coco, L., Bongain, A., and Chevallier, P. 2009. [Evaluation of two classifications systems for pelvic prolapse on dynamic MRI]. *J Radiol* 90:1717.
108. Woodfield, C. A., Hampton, B. S., Sung, V., and Brody, J. M. 2009. Magnetic resonance imaging of pelvic organ prolapse: comparing pubococcygeal and midpubic lines with clinical staging. *Int Urogynecol J Pelvic Floor Dysfunct* 20:695.
109. Broekhuis, S. R., Kluivers, K. B., Hendriks, J. C., Vierhout, M. E., Barentsz, J. O., and Futterer, J. J. 2009. Dynamic magnetic resonance imaging: reliability of anatomical landmarks and reference lines used to assess pelvic organ prolapse. *Int Urogynecol J Pelvic Floor Dysfunct* 20:141.
110. Singh, K., Reid, W. M., and Berger, L. A. 2001. Assessment and grading of pelvic organ prolapse by use of dynamic magnetic resonance imaging. *Am J Obstet Gynecol* 185:71.
111. Bump, R. C., Mattiasson, A., Bo, K., Brubaker, L. P., DeLancey, J. O., Klarskov, P., Shull, B. L., and Smith, A. R. 1996. The standardization of terminology of female pelvic organ prolapse and pelvic floor dysfunction. *Am J Obstet Gynecol* 175:10.
112. Torricelli, P., Pecchi, A., Caruso Lombardi, A., Vetrucchio, E., Vetrucchio, S., and Romagnoli, R. 2002. Magnetic resonance imaging in evaluating functional disorders of female pelvic floor. *Radiol Med* 103:488.
113. Deval, B., Vulierme, M. P., Poilpot, S., Menu, Y., and Levardon, M. 2003. [Imaging pelvic floor prolapse]. *J Gynecol Obstet Biol Reprod (Paris)* 32:22.
114. Etlik, O., Arslan, H., Odabasi, O., Odabasi, H., Harman, M., Celebi, H., and Sakarya, M. E. 2005. The role of the MR-fluoroscopy in the diagnosis and staging of the pelvic organ prolapse. *Eur J Radiol* 53:136.
115. Rosenkrantz, A. B., Lewis, M. T., Yalamanchili, S., Lim, R. P., Wong, S., and Bennett, G. L. 2014. Prevalence of pelvic organ prolapse detected at dynamic MRI in women without history of pelvic floor dysfunction: comparison of two reference lines. *Clin Radiol* 69:e71.
116. Onal, S., Lai-Yuen, S., Bao, P., Weitzenfeld, A., Greene, K., Kedar, R., and Hart, S. 2014. Assessment of a semiautomated pelvic floor measurement model for evaluating pelvic organ prolapse on MRI. *Int Urogynecol J* 25:767.
117. Onal, S., Lai-Yuen, S., Bao, P., Weitzenfeld, A., and Hart, S. 2014. Fully automated localization of multiple pelvic bone structures on MRI. *Conf Proc IEEE Eng Med Biol Soc* 2014:3353.
118. Lienemann, A., Sprenger, D., Anthuber, C., Baron, A., and Reiser, M. 2001. Functional cine magnetic resonance imaging in women after abdominal sacrocolpopexy. *Obstet Gynecol* 97:81.
119. Sze, E. H., Meranus, J., Kohli, N., Miklos, J. R., and Karram, M. M. 2001. Vaginal configuration on MRI after abdominal sacrocolpopexy and sacrospinous ligament suspension. *Int Urogynecol J Pelvic Floor Dysfunct* 12:375.
120. Rane, A., Lim, Y. N., Withey, G., and Muller, R. 2004. Magnetic resonance imaging findings following three different vaginal vault prolapse repair procedures: a randomised study. *Aust N Z J Obstet Gynaecol* 44:135.
121. Boukerrou, A. M., Mesdagh, B. P., Ego, A. A., Lambaudie, A. E., Crepin, A. G., Robert, B. Y., and Cosson, A. M. 2005. An MRI comparison of anatomical changes related to surgical treatment of prolapse by vaginal or abdominal route. *Eur J Obstet Gynecol Reprod Biol* 121:220.
122. Nicolau-Toulouse, V., Tiwari, P., Lee, T., Cundiff, G. W., and Geoffrion, R. 2014. Does bilateral sacrospinous fixation with synthetic mesh recreate nulliparous pelvic anatomy? An MRI evaluation. *Female Pelvic Med Reconstr Surg* 20:222.
123. Gufler, H., DeGregorio, G., Dohnicht, S., Allmann, K. H., and Rohr-Reyes, A. 2002. Dynamic MRI after surgical repair for pelvic organ prolapse. *J Comput Assist Tomogr* 26:734.
124. Hubner, M., Hetzer, F., Weishaupt, D., Hahnloser, D., Clavien, P. A., and Demartines, N. 2006. A prospective comparison between clinical outcome and open-configuration magnetic resonance defecography findings before and after surgery for symptomatic rectocele. *Colorectal Dis* 8:605.

125. Siegmann, K. C., Reisenauer, C., Speck, S., Barth, S., Kraemer, B., and Claussen, C. D. 2010. Dynamic magnetic resonance imaging for assessment of minimally invasive pelvic floor reconstruction with polypropylene implant. *Eur J Radiol*.
 126. Kasturi, S., Lowman, J., Kelvin, F. M., Akisik, F., Terry, C., and Hale, D. S. 2010. Pelvic magnetic resonance imaging for assessment of the efficacy of the Prolift system for pelvic organ prolapse. *Am J Obstet Gynecol* 203:504 e1.
 127. Larson, K. A., Hsu, Y., and DeLancey, J. O. 2009. The relationship between superior attachment points for anterior wall mesh operations and the upper vagina using a 3-dimensional magnetic resonance model in women with normal support. *Am J Obstet Gynecol* 200:554 e1.
 128. Brocker, K. A., Alt, C. D., Rzepka, J., Sohn, C., and Hallscheidt, P. 2015. One-year dynamic MRI follow-up after vaginal mesh repair: evaluation of clinical, radiological, and quality-of-life results. *Acta Radiol* 56:1002.
 129. Dumoulin, C., Peng, Q., Stodkilde-Jorgensen, H., Shishido, K., and Constantinou, C. 2007. Changes in levator ani anatomical configuration following physiotherapy in women with stress urinary incontinence. *J Urol* 178:970.
 130. Kruger, J. A., Murphy, B. A., and Heap, S. W. 2005. Alterations in levator ani morphology in elite nulliparous athletes: a pilot study. *Aust N Z J Obstet Gynaecol* 45:42.
 131. Bendova, P., Ruzicka, P., Peterova, V., Fricova, M., and Springrova, I. 2007. MRI-based registration of pelvic alignment affected by altered pelvic floor muscle characteristics. *Clin Biomech (Bristol, Avon)* 22:980.
 132. Kelvin, F. M., Maglinte, D. D., Hale, D. S., and Benson, J. T. 2000. Female pelvic organ prolapse: a comparison of triphasic dynamic MR imaging and triphasic fluoroscopic cystocolpoproctography. *AJR Am J Roentgenol* 174:81.
 133. Brubaker, L., Retzky, S., Smith, C., and Saclarides, T. 1993. Pelvic floor evaluation with dynamic fluoroscopy. *Obstet Gynecol* 82:863.
 134. Hock, D., Lombard, R., Jehaes, C., Markiewicz, S., Penders, L., Fontaine, F., Cusumano, G., and Nelissen, G. 1993. Colpocystodefecography. *Dis Colon Rectum* 36:1015.
 135. Pannu, H. K., Scatarige, J. C., and Eng, J. 2009. Comparison of supine magnetic resonance imaging with and without rectal contrast to fluoroscopic cystocolpoproctography for the diagnosis of pelvic organ prolapse. *J Comput Assist Tomogr* 33:125.
 136. Takano, M. and Hamada, A. 2000. Evaluation of pelvic descent disorders by dynamic contrast roentgenography. *Dis Colon Rectum* 43:S6.
 137. Lamb, G. M., de Jode, M. G., Gould, S. W., Spouse, E., Birnie, K., Darzi, A., and Gedroyc, W. M. 2000. Upright dynamic MR defaecating proctography in an open configuration MR system. *Br J Radiol* 73:152.
 138. Kaufman, H. S., Buller, J. L., Thompson, J. R., Pannu, H. K., DeMeester, S. L., Genadry, R. R., Bluemke, D. A., Jones, B., Rychcik, J. L., and Cundiff, G. W. 2001. Dynamic pelvic magnetic resonance imaging and cystocolpoproctography alter surgical management of pelvic floor disorders. *Dis Colon Rectum* 44:1575.
 139. Attenberger, U. I., Morelli, J. N., Budjan, J., Herold, A., Kienle, P., Kleine, W., Hacker, A., Baumann, C., Heinzlbecker, J., Schoenberg, S. O., and Michaely, H. J. 2015. The value of dynamic magnetic resonance imaging in interdisciplinary treatment of pelvic floor dysfunction. *Abdom Imaging* 40:2242.
 140. Tunn, R., DeLancey, J. O., and Quint, E. E. 2001. Visibility of pelvic organ support system structures in magnetic resonance images without an endovaginal coil. *Am J Obstet Gynecol* 184:1156.
- 3.1 Post-Void Residual**
1. Abrams P, Cardozo L, Fall M, Griffiths D, Rosier P, Ulmsten U, van Kerrebroeck P, Victor A, Wein A. The standardisation of terminology of lower urinary tract function: report from the Standardisation Sub-committee of the International Continence Society". *Neurourol Urodyn* 2002;21:167-178.
 2. Haylen BT, Lee J, Logan V, Husselbee S, Zhou J, Law M. Immediate postvoid residual volumes in women with symptoms of pelvic floor dysfunction". *Obstet Gynecol* 2008;111:1305-1312.
 3. Gehrich A, Stany MP, Fischer JR, Buller J, Zahn CM. Establishing a mean postvoid residual volume in asymptomatic perimenopausal and postmenopausal women". *Obstet Gynecol* 2007;110:827-832.
 4. Lukacz ES, DuHamel E, Menefee SA, Luber KM. Elevated postvoid residual in women with pelvic floor disorders: prevalence and associated risk factors". *Int Urogynecol J Pelvic Floor Dysfunct* 2007;18:397-400.
 5. Milleman M, Langenstroer P, Guralnick ML. Post-void residual urine volume in women with overactive bladder symptoms". *J Urol* 2004;172:1911-1914.

6. Fitzgerald MP, Jaffar J, Brubaker L. Risk factors for an elevated postvoid residual urine volume in women with symptoms of urinary urgency, frequency and urge incontinence". *Int Urogynecol J Pelvic Floor Dysfunct* 2001;12:237-239; discussion 239-240.
7. Tseng LH, Liang CC, Chang YL, Lee SJ, Lloyd LK, Chen CK. Postvoid residual urine in women with stress incontinence". *Neurourol Uro-dyn* 2008;27:48-51.
8. Barabas G, Molstad S. No association between elevated post-void residual volume and bacteriuria in residents of nursing homes". *Scand J Prim Health Care* 2005;23:52-56.
9. Griffiths DJ, McCracken PN, Harrison GM, Gormley EA, Moore KN. Urge incontinence and impaired detrusor contractility in the elderly". *Neu-rourol Urodyn* 2002;21:126-131.
10. Sander P, Mouritsen L, Andersen JT, Fischer-Rasmussen W. Should measurement of maximum urinary flow rate and residual urine volume be a part of a "minimal care" assessment programme in female incontinence?". *Scand J Urol Nephrol* 2002;36:124-127.
11. Roehrborn CG, Kaplan SA, Jones JS, Wang JT, Bavendam T, Guan Z. Tolterodine Extended Release With or Without Tamsulosin in Men With Lower Urinary Tract Symptoms Including Overactive Bladder Symptoms: Effects of Prostate Size". *Eur Urol* 2008.
12. Hofner K, Burkart M, Jacob G, Jonas U. Safety and efficacy of tolterodine extended release in men with overactive bladder symptoms and presumed non-obstructive benign prostatic hyperplasia". *World J Urol* 2007;25:627-633.
13. Abrams P, Kaplan S, De Koning Gans HJ, Millard R. Safety and tolerability of tolterodine for the treatment of overactive bladder in men with bladder outlet obstruction". *J Urol* 2006;175:999-1004; discussion 1004.
14. Cruz F, Herschorn S, Aliotta P, Brin M, Thompson C, Lam W, Daniell G, Heesakkers J, Haag-Molkenteller C. Efficacy and safety of onabotulinumtoxinA in patients with urinary incontinence due to neurogenic detrusor overactivity: a randomised, double-blind, placebo-controlled trial". *European urology* 2011;60:742-750.
15. Denys P, Le Normand L, Ghout I, Costa P, Chartier-Kastler E, Grise P, Hermieu JF, Amarenco G, Karsenty G, Saussine C, Barbot F. Efficacy and safety of low doses of onabotulinumtoxinA for the treatment of refractory idiopathic overactive bladder: a multicentre, double-blind, randomised, placebo-controlled dose-ranging study". *European urology* 2012;61:520-529.
16. Gormley EA. Evaluation of the patient with incontinence". *Can J Urol* 2007;14 Suppl 1:58-62.
17. Lucas MG, Bosch JLHR, Cruz FR, Madden TB, Nambiar A, Neisius A, Pickard RS, de Ridder DJMK, Tubaro A, Turner WH. Guidelines on Urinary Incontinence 2012.
18. Purkiss SF. Assessment of residual urine in men following catheterisation". *Br J Urol* 1990;66:279-280.
19. Asimakopoulos AD, De Nunzio C, Kocjancic E, Tubaro A, Rosier PF, Finazzi-Agro E. Measurement of post-void residual urine". *Neu-rourol Urodyn* 2016;35:55-57.
20. Stoller ML, Millard RJ. The accuracy of a catheterized residual urine". *J Urol* 1989;141:15-16.
21. Ruikka I. Residual urine in aged women and its influence on the phenolsulfonphthalein excretion test". *Gerontol Clin (Basel)* 1963;5:65-71.
22. Mulrow PJ, Huvos A, Buchanan DL. Measurement of residual urine with I-131-labeled Di-odrast". *J Lab Clin Med* 1961;57:109-113.
23. Holmes JH. Ultrasonic studies of the bladder". *J Urol* 1967;97:654-663.
24. McLean GK, Edell SL. Determination of bladder volumes by gray scale ultrasonography". *Radiology* 1978;128:181-182.
25. Pedersen JF, Bartrum RJ, Grytter C. Residual urine determination by ultrasonic scanning". *Am J Roentgenol Radium Ther Nucl Med* 1975;125:474-478.
26. Simforoosh N, Dadkhah F, Hosseini SY, Asgari MA, Nasser A, Safarinejad MR. Accuracy of residual urine measurement in men: comparison between real-time ultrasonography and catheterization". *J Urol* 1997;158:59-61.
27. Beacock CJ, Roberts EE, Rees RW, Buck AC. Ultrasound assessment of residual urine. A quantitative method". *Br J Urol* 1985;57:410-413.
28. Griffiths CJ, Murray A, Ramsden PD. Accuracy and repeatability of bladder volume measurement using ultrasonic imaging". *J Urol* 1986;136:808-812.
29. Widder B, Kornhuber HH, Renner A. [Measurement of residual urine in outpatient clinics with a small ultrasound device)". *Dtsch Med Wochenschr* 1983;108:1552-1555.
30. Piters K, Lapin S, Bessman AN. Ultrasonography in the detection of residual urine". *Diabetes* 1979;28:320-323.

31. Roehrborn CG, Chinn HK, Fulgham PF, Simpkins KL, Peters PC. The role of transabdominal ultrasound in the preoperative evaluation of patients with benign prostatic hypertrophy". *J Urol* 1986;135:1190-1193.
 32. Ding YY, Sahadevan S, Pang WS, Choo PW. Clinical utility of a portable ultrasound scanner in the measurement of residual urine volume". *Sin-gapore Med J* 1996;37:365-368.
 33. De Gennaro M, Capitanucci ML, Di Ciommo V, Adorisio O, Mosiello G, Orazi C, Tubaro A. Reliability of bladder volume measurement with BladderScan in paediatric patients". *Scand J Urol Nephrol* 2006;40:370-375.
 34. Bano F, Arunkalaivanan AS, Barrington JW. Comparison between bladderscan, real-time ultrasound and suprapubic catheterisation in the measurement of female residual bladder volume". *J Obstet Gynaecol* 2004;24:694-695.
 35. Bruskwitz RC, Iversen P, Madsen PO. Value of postvoid residual urine determination in evaluation of prostatism". *Urology* 1982;20:602-604.
 36. Birch NC, Hurst G, Doyle PT. Serial residual volumes in men with prostatic hypertrophy". *Br J Urol* 1988;62:571-575.
 37. Griffiths DJ, Harrison G, Moore K, McCracken P. Variability of post-void residual urine volume in the elderly". *Urol Res* 1996;24:23-26.
 38. Abrams PH, Griffiths DJ. The assessment of prostatic obstruction from urodynamic measurements and from residual urine". *Br J Urol* 1979;51:129-134.
 39. Andersen JT. Prostatism: Clinical, radio-logical, and urodynamic aspects". *Neurourol Uro-dyn* 1982;1:241-293.
 40. Barry MJ, Cockett AT, Holtgrewe HL, McConnell JD, Sihelnik SA, Winfield HN. Relationship of symptoms of prostatism to commonly used physiological and anatomical measures of the severity of benign prostatic hyperplasia". *J Urol* 1993;150:351-358.
 41. Dunsmuir WD, Feneley M, Corry DA, Bryan J, Kirby RS. The day-to-day variation (test-retest reliability) of residual urine measurement". *Br J Urol* 1996;77:192-193.
 42. el Din KE, Kiemeny LA, de Wildt MJ, Rosier PF, Debruyne FM, de la Rosette JJ. The correlation between bladder outlet obstruction and lower urinary tract symptoms as measured by the international prostate symptom score". *J Urol* 1996;156:1020-1025.
 43. Leblanc G, Tessier J, Schick E. The importance and significance of post-micturitional bladder residue in the evaluation of prostatism". *Prog Urol* 1995;5:511-514.
 44. Hakenberg OW, Ryall RL, Langlois SL, Marshall VR. The estimation of bladder volume by sonocystography". *J Urol* 1983;130:249-251.
 45. Poston GJ, Joseph AE, Riddle PR. The accuracy of ultrasound in the measurement of changes in bladder volume". *Br J Urol* 1983;55:361-363.
 46. Hartnell GG, Kiely EA, Williams G, Gibson RN. Real-time ultrasound measurement of bladder volume: a comparative study of three methods". *Br J Radiol* 1987;60:1063-1065.
 47. Rageth JC, Langer K. Ultrasonic assessment of residual urine volume". *Urol Res* 1982;10:57-60.
- 3.2 Open Bladder Neck and Proximal Urethra at Rest**
1. Versi E. The significance of an open bladder neck in women". *Br J Urol* 1991;68:42-43.
 2. Chapple CR, Helm CW, Blease S, Milroy EJ, Rickards D, Osborne JL. Asymptomatic bladder neck incompetence in nulliparous females". *Br J Urol* 1989;64:357-359.
 3. Digesu GA, Khullar V, Cardozo L, Salvatore S. The open bladder neck: a significant finding?". *Int Urogynecol J Pelvic Floor Dysfunct* 2004;15:336-339.
 4. Schaer GN, Perucchini D, Munz E, Peschers U, Koechli OR, Delancey JO. Sonographic evaluation of the bladder neck in continent and stress-incontinent women". *Obstet Gynecol* 1999;93:412-416.
 5. Dietz HP, Clarke B. The urethral pressure profile and ultrasound imaging of the lower urinary tract". *Int Urogynecol J Pelvic Floor Dysfunct* 2001;12:38-41.
 6. Huang WC, Yang JM. Bladder neck funneling on ultrasound cystourethrography in primary stress urinary incontinence: a sign associated with urethral hypermobility and intrinsic sphincter deficiency". *Urology* 2003;61:936-941.
 7. Santiago AC, O'Leary DE, Quiroz LH, Shobeiri SA. Is there a correlation between levator ani and urethral sphincter complex status on 3D ultrasonography?". *Int Urogynecol J* 2015;26:699-705.
 8. Sakakibara R, Hattori T, Uchiyama T, Yamanishi T. Videourodynamic and sphincter motor unit potential analyses in Parkinson's disease and multiple system atrophy". *J Neurol Neurosurg Psychiatry* 2001;71:600-606.

9. Wein AJ, Levin RM, Barrett DM. Voiding Dysfunction: Relevant Anatomy, Physiology and Pharmacology. In: Gillenwater Y, Grayhack JT, Howard SS, Duckett JW editors. *Adult and Pediatric Urology*. Chicago: Year Book Medical Publisher, Inc. ; 1992. pp. 800-862.
 10. Wein AJ. Neuromuscular Dysfunction of the Lower Urinary Tract. In: Walsh PC, Retik AB, Stamey TA, Vaughan ED editors. *Campbell's Urology*. Philadelphia: Saunders Company; 1992. pp. 573-642.
 11. Barbalias GA, Blaivas JG. Neurologic implications of the pathologically open bladder neck". *J Urol* 1983;129:780-782.
 12. Salinas JM, Berger Y, De La Rocha RE, Blaivas JG. Urological evaluation in the Shy Drager syndrome". *J Urol* 1986;135:741-743.
 13. Blaivas JG, Barbalias GA. Characteristics of neural injury after abdominoperineal resection". *J Urol* 1983;129:84-87.
 14. De Groat WC, Steers WD. Autonomic Regulation of the Urinary Bladder and Sexual organs. In: Loewry AD, Spyers KM editors. *Central regulation of the Autonomic Functions*. Oxford: Oxford University Press; 1990. pp. 313.
 15. Nordling J. Influence of the Sympathetic Nervous System on Lower Urinary Tract in Men". *Neurourol Urodyn* 1983;2:3.
 16. McGuire EJ. Combined radiographic and manometric assessment of urethral sphincter function". *J Urol* 1977;118:632-635.
 17. McGuire EJ. The effects of sacral denervation on bladder and urethral function". *Surg Gynecol Obstet* 1977;144:343-346.
 18. Nordling J, Meyhoff HH, Olesen KP. Cystourethrographic appearance of the bladder and posterior urethra in neuromuscular disorders of the lower urinary tract". *Scand J Urol Nephrol* 1982;16:115-124.
 19. Gosling JA, Dixon JS, Lendon RG. The autonomic innervation of the human male and female bladder neck and proximal urethra". *J Urol* 1977;118:302-305.
 20. Stanton SL, Williams D. The wide bladder neck in children". *Br J Urol* 1973;45:60.
 21. Murray K, Nurse D, Borzyskowski M, Mundy AR. The "congenital" wide bladder neck anomaly: a common cause of incontinence in children". *Br J Urol* 1987;59:533-535.
 22. Blaivas JG, Olsson CA. Stress incontinence: classification and surgical approach". *J Urol* 1988;139:727-731.
 23. MacDiarmid S, Rosario D, Chapple CR. The importance of accurate assessment and conservative management of the open bladder neck in patients with post-pelvic fracture membranous urethral distraction defects". *Br J Urol* 1995;75:65-67.
 24. Iselin CE, Webster GD. The significance of the open bladder neck associated with pelvic fracture urethral distraction defects". *J Urol* 1999;162:347-351.
 25. Shivde SR. Re: The significance of the open bladder neck associated with pelvic fracture urethral distraction defects". *J Urol* 2000;163:552.
 26. Skala C, Emons G, Krauss T, Hilgers R, Gauruder-Burmester A, Lange R, Bader W, Viereck V. Postoperative funneling after anti-incontinence surgery--a prognostic indicator?--Part 1: colpo-suspension". *Neurourol Urodyn* 2004;23:636-642.
- 3.3 Female Urethral Diverticulum**
1. Rovner ES. Urethral diverticula: a review and an update". *Neurourol Urodyn* 2007;26:972-977.
 2. Lorenzo AJ, Zimmern P, Lemack GE, Nurenberg P. Endorectal coil magnetic resonance imaging for diagnosis of urethral and periurethral pathologic findings in women". *Urology* 2003;61:1129-1133; discussion 1133-1124.
 3. Hey W. *Practical Observations in Surgery*. Philadelphia: Humphries, J.; 1805.
 4. Davis HJ, Cian LG. Positive pressure urethrography: a new diagnostic method". *J Urol* 1956;75:753.
 5. Leach GE, Trockmann BA. Surgery for vesicovaginal and urethrovaginal fistula and urethral diverticulum. In: Walsh PC, Retik AB, Vaughan DE, Wein A editors. *Campbell's Urology*: WB Saunders Company; 1998. pp. 1135-1153.
 6. Aldridge CW, Jr., Beaton JH, Nanzig RP. A review of office urethroscopy and cystometry". *Am J Obstet Gynecol* 1978;131:432-437.
 7. Ganabathi K, Leach GE, Zimmern PE, Dmochowski R. Experience with the management of urethral diverticulum in 63 women". *J Urol* 1994;152:1445-1452.
 8. Romanzi LJ, Groutz A, Blaivas JG. Urethral diverticulum in women: diverse presentations resulting in diagnostic delay and mismanagement". *J Urol* 2000;164:428-433.
 9. Blaivas JG, Flisser AJ, Bleustein CB, Panagopoulos G. Periurethral masses: etiology and diagnosis in a large series of women". *Obstet Gynecol* 2004;103:842-847.

10. Jacoby K, Rowbotham RK. Double balloon positive pressure urethrography is a more sensitive test than voiding cystourethrography for diagnosing urethral diverticulum in women". *J Urol* 1999;162:2066-2069.
 11. Wang AC, Wang CR. Radiologic diagnosis and surgical treatment of urethral diverticulum in women. A reappraisal of voiding cystourethrography and positive pressure urethrography". *J Re-prod Med* 2000;45:377-382.
 12. Golomb J, Leibovitch I, Mor Y, Morag B, Ramon J. Comparison of voiding cystourethrography and double-balloon urethrography in the diagnosis of complex female urethral diverticula". *Eur Radiol* 2003;13:536-542.
 13. Shobeiri SA, Rostaminia G, White D, Qui-roz LH, Nihira MA. Evaluation of vaginal cysts and masses by 3-dimensional endovaginal and endo-anal sonography". *J Ultrasound Med* 2013;32:1499-1507.
 14. Chancellor MB, Liu JB, Rivas DA, Karasick S, Bagley DH, Goldberg BB. Intraoperative endoluminal ultrasound evaluation of urethral diverticula". *J Urol* 1995;153:72-75.
 15. Kim B, Hricak H, Tanagho EA. Diagnosis of urethral diverticula in women: value of MR imaging". *AJR Am J Roentgenol* 1993;161:809-815.
 16. Neitlich JD, Foster HE, Jr., Glickman MG, Smith RC. Detection of urethral diverticula in women: comparison of a high resolution fast spin echo technique with double balloon urethrography". *J Urol* 1998;159:408-410.
 17. Daneshgari F, Zimmern PE, Jacomides L. Magnetic resonance imaging detection of symptomatic noncommunicating intraurethral wall diverticula in women". *J Urol* 1999;161:1259-1261; discussion 1261-1252.
 18. Blander DS, Broderick GA, Rovner ES. Images in clinical urology. Magnetic resonance imaging of a "saddle bag" urethral diverticulum". *Urology* 1999;53:818-819.
 19. Blander DS, Rovner ES, Schnall MD, Ramchandani P, Banner MP, Broderick GA, Wein AJ. Endoluminal magnetic resonance imaging in the evaluation of urethral diverticula in women". *Urology* 2001;57:660-665.
 20. Takano M, Hamada A. Evaluation of pelvic descent disorders by dynamic contrast roentgenography". *Dis Colon Rectum* 2000;43:S6-11.
 21. Rovner ES, Wein AJ. Diagnosis and reconstruction of the dorsal or circumferential urethral diverticulum". *J Urol* 2003;170:82-86; discussion 86.
 22. Khati NJ, Javitt MC, Schwartz AM, Berger BM. MR imaging diagnosis of a urethral diverticulum". *Radiographics* 1998;18:517-522.
 23. Greenberg M, Stone D, Cochran ST, Bruskewitz R, Pagani JJ, Raz S, Barbaric ZM. Female urethral diverticula: double-balloon catheter study". *AJR Am J Roentgenol* 1981;136:259-264.
 24. Pavlica P, Barozzi L, Menchi I. Imaging of male urethra". *Eur Radiol* 2003;13:1583-1596.
- 3.4.2 Imaging of the Nervous System: CT, MRI, SPECT and PET**
1. Glenn OA, Barkovich AJ. Magnetic resonance imaging of the fetal brain and spine: an increasingly important tool in prenatal diagnosis, part 1". *AJNR Am J Neuroradiol* 2006;27:1604-1611.
 2. Glenn OA, Barkovich J. Magnetic resonance imaging of the fetal brain and spine: an increasingly important tool in prenatal diagnosis: part 2". *AJNR Am J Neuroradiol* 2006;27:1807-1814.
 3. Tubaro A, Artibani W, Bartram C, Delancey JD, Dietz HP, Khullar V, Zimmern P. Imaging and other investigations. In: Abrams P, Cardozo L, Khoury S, Wein A editors. *Incontinence - 3rd International Consultation on Incontinence*. Plymouth: Health Publication Ltd; 2005. pp. 707-797.
 4. Wraige E, Borzyskowski M. Investigation of daytime wetting: when is spinal cord imaging indicated?". *Arch Dis Child* 2002;87:151-155.
 5. Munoz A, Hinojosa J, Esparza J. Cisternography and ventriculography gadopentate dimeglumine-enhanced MR imaging in pediatric patients: preliminary report". *AJNR Am J Neuroradiol* 2007;28:889-894.
 6. Sharma U, Pal K, Pratap A, Gupta DK, Jagannathan NR. Potential of proton magnetic resonance spectroscopy in the evaluation of patients with tethered cord syndrome following surgery". *J Neurosurg* 2006;105:396-402.
 7. Blok BF, Sturms LM, Holstege G. A PET study on cortical and subcortical control of pelvic floor musculature in women". *J Comp Neurol* 1997;389:535-544.
 8. Blok BF, Sturms LM, Holstege G. Brain activation during micturition in women". *Brain* 1998;121 (Pt 11):2033-2042.
 9. Kern MK, Arndorfer RC, Hyde JS, Shaker R. Cerebral cortical representation of external anal sphincter contraction: effect of effort". *Am J Physiol Gastrointest Liver Physiol* 2004;286:G304-311.

10. Di Gangi Herms AM, Veit R, Reisenauer C, Herms A, Grodd W, Enck P, Stenzl A, Birbaumer N. Functional imaging of stress urinary incontinence". *Neuroimage* 2006;29:267-275.
 11. Tadic SD, Griffiths D, Schaefer W, Resnick NM. Abnormal connections in the supraspinal bladder control network in women with urge urinary incontinence". *Neuroimage* 2008;39:1647-1653.
- 3.5 Endoscopy of the Lower Urinary Tract**
1. Robertson JR. Urethroscopy - the ne-glected gynecologic procedure". *Clin Obstet Gy-necol* 1976;19:315-340.
 2. Aldridge CW, Jr., Beaton JH, Nanzig RP. A review of office urethroscopy and cystometry". *Am J Obstet Gynecol* 1978;131:432-437.
 3. Scotti RJ, Ostergard DR, Guillaume AA, Kohatsu KE. Predictive value of urethroscopy as compared to urodynamics in the diagnosis of gen-uine stress incontinence". *J Reprod Med* 1990;35:772-776.
 4. Sand PK, Hill RC, Ostergard DR. Supine urethroscopic and standing cystometry as screening methods for the detection of detrusor instability". *Obstet Gynecol* 1987;70:57-60.
 5. Horbach NS, Ostergard DR. Predicting intrinsic urethral sphincter dysfunction in women with stress urinary incontinence". *Obstet Gynecol* 1994;84:188-192.
 6. Govier FE, Pritchett TR, Kornman JD. Correlation of the cystoscopic appearance and functional integrity of the female urethral sphincteric mechanism". *Urology* 1994;44:250-253.
 7. Langmade CF, Oliver JA, Jr. Simplifying the management of stress incontinence". *Am J Obstet Gynecol* 1984;149:24-28.
 8. Fischer-Rasmussen W, Hansen RI, Stage P. Predictive values of diagnostic tests in the evaluation of female urinary stress incontinence". *Acta Obstet Gynecol Scand* 1986;65:291-294.
 9. Cardozo LD, Stanton SL. Genuine stress incontinence and detrusor instability--a review of 200 patients". *Br J Obstet Gynaecol* 1980;87:184-190.
 10. Mundy AR. The unstable bladder". *Urol Clin North Am* 1985;12:317-328.
 11. Duldulao KE, Diokno AC, Mitchell B. Value of urinary cytology in women presenting with urge incontinence and/or irritative voiding symptoms". *J Urol* 1997;157:113-116.
 12. Harris RL, Cundiff GW, Theofrastous JP, Yoon H, Bump RC, Addison WA. The value of intraoperative cystoscopy in urogynecologic and reconstructive pelvic surgery". *Am J Obstet Gyne-col* 1997;177:1367-1369; discussion 1369-1371.
 13. Timmons MC, Addison WA. Suprapubic teloscopy: extraperitoneal intraoperative technique to demonstrate ureteral patency". *Obstet Gynecol* 1990;75:137-139.
 14. Lower urinary tract operative injuries". *ACOG Technical Bulletin* 1997;238.
 15. Roehrborn CG, Andersen JT, Correa RJ, Di Silverio F, Kaplan SA, K.H. K, Rubben H, Torp-Pedersen ST, Watanabe H, Zerbib M. Initial diagnostic evaluation of men with lower urinary tract symptoms. In: Cockett ATK, Khoury S, Aso Y, Chat-elain C, Denis L, Griffiths K, Murphy G editors. *The 3rd International Consultation on benign Prostatic Hyperplasia (BPH) - Proceedings: Scientific Com-munication International Ltd.*; 1995. pp. 167-254.
 16. Leach GE, Trockman B, Wong A, Hamilton J, Haab F, Zimmern PE. Post-prostatectomy incontinence: urodynamic findings and treatment outcomes". *J Urol* 1996;155:1256-1259.
 17. Desautel MG, Kapoor R, Badlani GH. Sphincteric incontinence: the primary cause of post-prostatectomy incontinence in patients with prostate cancer". *Neurourol Urodyn* 1997;16:153-160.
 18. Gudziak MR, McGuire EJ, Gormley EA. Urodynamic assessment of urethral sphincter function in post-prostatectomy incontinence". *J Urol* 1996;156:1131-1134; discussion 1134-1135.
 19. Chao R, Mayo ME. Incontinence after radical prostatectomy: detrusor or sphincter caus-es". *J Urol* 1995;154:16-18.
 20. Goluboff ET, Chang DT, Olsson CA, Kaplan SA. Urodynamics and the etiology of post-prostatectomy urinary incontinence: the initial Columbia experience". *J Urol* 1995;153:1034-1037.
 21. Leach GE, Yun SK. Post-prostatectomy incontinence: Part II. The results of treatment based on urodynamic evaluation. ". *Neurourol Urodyn* 1992;11:99.
 22. Gozzi C, Bauer RM, Becker AJ, Schorsch I, May F, Rehder P, Stief CG, Bastian PJ. Functional retrourethral sling. A change of paradigm in the treatment of stress incontinence after radical pros-tatectomy.". *Urologe A* 2008;47:1224-1228.

23. Rehder P, Gozzi C. Transobturator sling suspension for male urinary incontinence including post-radical prostatectomy". *Eur Urol* 2007;52:860-866.
24. Rehder P, Gozzi C. Re: Surgical technique using AdVance sling placement in the treatment of post-prostatectomy urinary incontinence". *Int Braz J Urol* 2007;33:560-561.
11. Wasserberg N, Mazaheri A, Petrone P, Tulchinsky H and Kaufman HS. Three-dimensional endoanal ultrasonography of external anal sphincter defects in patients with faecal incontinence correlation with symptoms and manometry *Colorectal Diseases*;13:449-53.2011.
12. Roos AM, Abdool Z, Sultan AH, Thakar R. The diagnostic accuracy of endovaginal and transperineal ultrasound for detecting anal sphincter defects: The PREDICT study. *Clinical Radiology*;66:597-604.2011.

III. IMAGING IN ANAL INCONTINENCE

1. Wild JJ, Reid JM. Diagnostic use of ultrasound. *Br J Phys Med*.19:248-57.1956
2. Papachrysostomou M, Pye SD, Wild SR, Smith AN (1993) Anal endosonography in asymptomatic subjects. *Scandinavian Journal of Gastroenterology* 28:551-6
3. Law PJ, Bartram CI. Anal endosonography: Technique & normal anatomy. *Gastrointestinal Radiology* 14: 349-353. 1989.
4. Sultan AH, Thakar R. Lower genital tract and anal sphincter trauma. *Best Practice & Research in Clinical Obstetrics & Gynaecology* 16:99-115.2002.
5. (Parangama C, Anu E, Sukria N. Endoanal ultrasound assessment of sphincter defects and thinning--correlation with anal manometry. *Arab J Gastroenterol*. 2014 Mar;15(1):27-31.
6. Santoro GA, Di Falco G. Endoanal ultrasonography in the staging of anal carcinoma. In: *Atlas of endoanal and endorectal ultrasonography*. Milan: Springer-Verlag; 2004.
7. Etienney I & de Parades V. Three-dimensional endoanal ultrasonography in daily proctological practice. *Clinics in Hepatology & Gastroenterology* 35:260-270.2011.
8. West RL, Felt-Bersma RJ, Hansen BE, Schouten WR, Kuipers EJ. Volume measurements of the anal sphincter complex in healthy controls and fecal-incontinent patients with a three-dimensional reconstruction of endoanal ultrasonography images. *Dis Colon Rectum*;48:540—8.2005
9. Stark M, Bohe M, Valentin L. Effect of vaginal delivery on endosonographic anal sphincter morphology. *Eur J Obstet Gynecol Reprod Biol*;130:193—201.2007.
10. Norderval S, Dehli T, Vonon B. Three-dimensional endoanal ultrasonography: intraobserver and interobserver agreement using scoring systems for classification of anal sphincter defects. *Ultrasound Obstet Gynecol*.33:337—43.2009.
13. Peschers UM, DeLancey JO, Schaer GN, Schuessler B. Exoanal ultrasound of the anal sphincter: normal anatomy and sphincter defects. *Br J Obstet Gynaecol* 104(9):999–1003. 1997.
14. Oom DM1, West RL, Schouten WR, Steensma AB. Detection of anal sphincter defects in female patients with fecal incontinence: a comparison of 3-dimensional transperineal ultrasound and 2-dimensional endoanal ultrasound. *Dis Colon Rectum*. 2012 Jun;55(6):646-52.
15. Falkert A1, Willmann A, Endress E, Meint P, Seelbach-Göbel B. Three-dimensional ultrasound of pelvic floor: is there a correlation with delivery mode and persisting pelvic floor disorders 18-24 months after first delivery? *Ultrasound Obstet Gynecol*. 2013 Feb;41(2):204-9.
16. Roche B, Deleaval J, Fransioli A, et al. Comparison of transanal and external perineal ultrasonography. *Eur Radiol*;11:1165.2001.
17. Zetterström JP, Mellgren A, Madoff RD, Kim DG, Wong WD. Perineal body measurement improves evaluation of anterior sphincter lesions during endoanal ultrasonography. *Dis Colon Rectum* 41(6):705–713.1998.
18. R. J. Hall : R. G. Rogers : L. Saiz : C. Qualls. Translabial ultrasound assessment of the anal sphincter complex: normal measurements of the internal and external anal sphincters at the proximal, mid-, and distal levels. *Int Urogynecol J* 18:881–888. 2007.
19. Santoro GA, Wiczorek AP, Dietz HP, Mellgren A, Sultan AH, Shobeiri SA, Stankiewicz A, Bartram C. State of the art: an integrated approach to pelvic floor ultrasonography. *Ultrasound Obstet Gynecol*. 37(4):381-96.2011.
20. Rostaminia G1, White D, Quiroz LH, Shobeiri SA. 3D pelvic floor ultrasound findings and severity of anal incontinence. *Int Urogynecol J*. 2014 May;25(5):623-9.
21. Vitton V, Vignally P, Barthet M, Cohen V, Durieux O, Bouvier M, Grimaud JC. Dynamic anal endosonography and MRI defecography in diagnosis of pelvic floor disorders: comparison with conventional defecography. *Dis Colon Rectum*. 54(11):1398-404.2011.

22. Frey H, Dietrich CF. Sonoelastography: a new ultrasound modality for assessing tissue elasticity. In: Dietrich CF, editor. Endoscopic ultrasound. Stuttgart, Germany: ThiemeVerlag; p. 56–69.2008.
23. Allgayer H, Ignee A, Dietrich CF Endosonographicelastography of the anal sphincter in patients with fecal incontinence.. Scand J Gastroenterol.;45(1):30-8.2010.
24. Stranding S, Ellis H, Healy J, Johnson D, Williams A, eds. Gray's Anatomy: The Anatomical Basis of Clinical Practice, 40th ed. NewYork: Elsevier Churchill Livingstone; 2008.
25. Rociu E, Stoker J, Eijkemans MJ, Lameris JS. Normal anal sphincter anatomy and age- and sex-related variations at highspatial resolution endoanal MR imaging. Radiology.;217:395–401.2000.
26. Stoker J, Rociu E, Zwamborn AW, Schouten WR, Lameris JS. Endoluminal MR imaging of the rectum and anus: technique, applications, and pitfalls. Radiographics.19:383–398.1999.
27. Guo M, Li D. Pelvic floor images: anatomy of the levatorani muscle. Dis Colon Rectum.;50:1647–1655. 2007.
28. Hsu Y, Fenner DE, Weadock WJ, DeLancey JO. Magnetic resonance imaging and 3-dimensional analysis of external anal sphincter anatomy. ObstetGynecol.;106:1259 –1265.2005.
29. Guo M, Gao C, Li D, Guo W, Shafik AA, Zbar AP, Pescatori M. MRI anatomy of the anal region. Dis Colon Rectum. 53(11):1542-8.2010.
30. Malouf AJ, Williams AB, Halligan S, Bartram CI, Dhillon S, Kamm MA. Prospective assessment of accuracy of endoanal MR imaging and endosonography in patients with fecal incontinence. AJR Am J Roentgenol 175(3):741–745.2000.
31. Tan E; Anstee A; Koh DM; Gedroyc W; Tekkis PP. Diagnostic precision of endoanal MRI in the detection of anal sphincter pathology: a meta-analysis.Int J Colorectal Dis. 23:641-65.2008.
32. Heilbrun ME, Nygaard IE, Lockhart ME, Richter HE, Brown MB, Kenton KS, Rahn DD, Thomas JV, Weidner AC, Nager CW, Delancey JO. Correlation between levatorani muscle injuries on magnetic resonance imaging and fecal incontinence, pelvic organ prolapse, and urinary incontinence in primiparous women. Am J ObstetGynecol.202(5):488. 2010
33. Dobben AC, Wiersma TG, Janssen LW et al. Prospective assessment of interobserver agreement for defecography in fecal incontinence. AJR Am J Roentgenol 185:1166–1172. 2005.
34. Terra MP, Beets-Tan RG, Vervoorn I, Deutekom M, Wasser MN, Witkamp TD, DobbenAC, Baeten CG, Bossuyt PM, Stoker J. Pelvic floor muscle lesions at endoanal MR imaging in female patients with faecal incontinence. EurRadiol. 18(9):1892-901.2008.
35. Schoenenberger AW, Debatin JF, Guldenschuh I, Hany TF, Steiner P,Krestin GP. Dynamic MR defecography with a superconducting, open-configuration MR system. Radiology 206:641–646.1998.
36. Garcia-Aguilar, J., Belmonte, Montes C., Perez, J. J., Jensen, L., Madoff, R. D., Wong, and WD. Incontinence after lateral internal sphincterotomy: anatomic and functional evaluation. Diseases of the Colon & Rectum41, 423-427.1998
37. Williams, A. B., Bartram, C. I., Halligan, S., Spencer, J. A.,Nicholls, R. J., and Kmiot, W. A.. Anal sphincter damage after vaginal delivery using three-dimensional endosonography. Obstet.Gynecol.97, 770-775.2001.
38. Williams, A. B., Bartram, C. I., Halligan, S., Marshall, M. M.,Nicholls, R. J., and Kmiot, W. A.. Endosonographic anatomyof the normal anal canal compared with endocoil magnetic resonance imaging. Dis. Colon Rectum 45, 176-183.2002
39. Thomas C, Etienney I, Atienza P. Evaluation of the role of the puborectal part of the levatorani muscle in anal incontinence: a prospective study of 78 female patients with anal incontinence.Dis Colon Rectum. 54(9):1129-33.2011.
40. Williams, A. B., Bartram, C. I., Modhwadia, D., Nicholls, T.,Halligan, S., Kamm, M. A., Nicholls, R. J., and Kmiot, W. A..Endocoil magnetic resonance imaging quantification ofexternal anal sphincter atrophy. Br.J.Surg.88, 853-859.2001.
41. Cazemier, M., Terra, M. P., Stoker, J., de Lange-de Klerk ES, Boeckxstaens, G. E., Mulder, C. J., and Felt-Bersma, R. J..Atrophy and defects detection of the external anal sphincter: comparison between three-dimensional anal endosonography and endoanal magnetic resonance imaging. Dis.Colon Rectum49, 20-27.2006
42. Andrews, V., Sultan, A. H., Thakar, R., and Jones, P. W.Occult anal sphincter injuries—myth or reality? BJOG.113, 195-200.2006
43. Oberwalder, M., Connor, J., and Wexner, S. D.. Meta-analysis to determine the incidence of obstetric anal sphincter damage. Br.J.Surg.90, 1333-1337.2003

44. de Leeuw, J. W., Vierhout, M. E., Struijk, P. C., Hop, W. C., and Wallenburg, H. C.. Anal sphincter damage after vaginal delivery: functional outcome and risk factors for fecal incontinence. *Acta Obstet.Gynecol.Scand.*80, 830-834.2001
45. Oberwalder, M., Dinnewitzer, A., Baig, M. K., Thaler, K., Cotman, K., Nogueras, J. J., Weiss, E. G., Efron, J., Vernava, A. M., III, and Wexner, S. D.. The association between late onset fecal incontinence and obstetric anal sphincter defects. *Arch.Surg.*139, 429-432.2004
46. Damon, H., Bretones, S., Henry, L., Mellier, G., and Mion, F.. Long-term consequences of first vaginal delivery-induced anal sphincter defect. *Dis.Colon Rectum*48, 1772-1776.2005
47. Faltin, D. L., Sangalli, M. R., Roche, B., Floris, L., Boulvain, M., and Weil, A.. Does a second delivery increase the risk of anal incontinence? *BJOG.*108, 684-688.2001
48. Mahony, R., Behan, M., Daly, L., Kirwan, C., O'Herlihy, C., and O'Connell, P. R.. Internal anal sphincter defect influences continence outcome following obstetric anal sphincter injury. *Am.J.Obstet.Gynecol.*196, 217-5.2007
49. Malouf, A. J., Norton, C. S., Engel, A. F., Nicholls, R. J., and Kamm, M. A.. Long-term results of overlapping anterior analsphincter repair for obstetric trauma. *Lancet*355, 260-265.2000
50. Norderval, S., Oian, P., Revhaug, A., and Vonon, B.. Anal incontinence after obstetric sphincter tears: outcome of anatomic primary repairs. *Dis.Colon Rectum*48, 1055-1061.2005
51. Bharucha, A. E., Fletcher, J. G., Harper, C. M., Hough, D., Daube, J. R., Stevens, C., Seide, B., Riederer, S. J., and Zinsmeister, A. R.. Relationship between symptoms and disordered continence mechanisms in women with idiopathic faecal incontinence. *Gut*54, 546-555.2005
52. Abramowitz, L., Sobhani, I., Ganansia, R., Vuagnat, A., Benifla, J. L., Darai, E., Madelenat, P., and Mignon, M.. Are sphincter defects the cause of anal incontinence after vaginal delivery? Results of a prospective study. *Dis.Colon Rectum*43, 590-596.2000.
53. Damon, H., Henry, L., Barth, X., and Mion, F..Fecal incontinence in females with a past history of vaginal delivery: significance of anal sphincter defects detected by ultrasound. *Dis.Colon Rectum*45, 1445-1450.2002
54. Voyvodic, F., Rieger, N. A., Skinner, S., Schloithe, A. C., Saccone, G. T., Sage, M. R., and Wattoo, D. A. Endosonographic imaging of anal sphincter injury: does the size of the tear correlate with the degree of dysfunction? *Dis.Colon Rectum* 46, 735-741.2003.
55. Starck, M., Bohe, M., and Valentin, L.. Results of endosonographic imaging of the anal sphincter 2-7 days after primary repair of third- or fourth-degree obstetricsphincter tears. *Ultrasound Obstet.Gynecol.*22, 609-615.2003.
56. Nazir, M., Carlsen, E., Jacobsen, A. F., and Nesheim, B. I..Is there any correlation between objective anal testing, rupture grade, and bowel symptoms after primary repair of obstetric anal sphincter rupture?: an observational cohort study. *Dis.Colon Rectum*45, 1325-1331.2002
57. Rizk DE. Minimizing the risk of childbirth-induced pelvic floor dysfunctions in the developing world: "preventive" urogynecology. *IntUrogynecol J Pelvic Floor Dysfunct* 20(6):615-617.2009.

IV. PAD TESTING

1. James ED, Flack FC, Caldwell KP, Martin MR. Continuous measurement of urine loss and frequency in incontinent patients. Preliminary report. *Br J Urol.* 1971;43(2):233-7.
2. Caldwell K. Proceedings: Clinical use of recording nappy. *Urol Int.* 1974;29(3):172-3.
3. Eadie AS, Glen ES, Rowan D. The Urilos recording nappy system. *Br J Urol.* 1983;55(3):301-3.
4. James ED, Flack FC. Proceedings: Assessment of recording nappy. *Urol Int.* 1974;29(3):174-5.
5. Rowan D, Deehan C, Glen ES. Detection of urine loss using the Exeter recording nappy and other similar devices. *Urol Int.* 1976;31(1-2):70-7.
6. Stanton SL. Urilos: the practical detection of urine loss. *Am J Obstet Gynecol.* 1977;128(4):461-3.
7. Wilson PD, Al Samarrai MT, Brown AD. Quantifying female incontinence with particular reference to the Urilos System. *Urol Int.* 1980;35(4):298-302.
8. Mayne CJ, Hilton P. The distal urethral electrical conductance test: Standardisation of method and clinical reliability. *Neurourol Urodyn.* 1988;7(1):55-60.

9. Walsh JB, Mills GL. Measurement of urinary loss in elderly incontinent patients. A simple and accurate method. *Lancet*. 1981;1(8230):1130-1.
10. Sutherst JR, Brown MC, Richmond D. Analysis of the pattern of urine loss in women with incontinence as measured by weighing perineal pads. *Br J Urol*. 1986;58(3):273-8.
11. Abrams P, Blaivas JG, Stanton SL, Andersen JT. The standardization of terminology of lower urinary tract function. International Continence Society Committee on Standardisation of Terminology. *Neurourol Urodyn*. 1988;7:403-26.
12. Lose G, Gammelgaard J, Jørgensen TJ. The one-hour pad-weighing test: Reproducibility and the correlation between the test result, the start volume in the bladder, and the diuresis. 1986;5(1):17-21.
13. Christensen SJ, Colstrup H, Hertz JB, Lenstrup C, Frimodt-Møller C. Inter- and intra-departmental variations of the perineal pad weighing test. *Neurourol Urodyn*. 1986;5(1):23-8.
14. Wall LL, Wang K, Robson I, Stanton SL. The Pyridium pad test for diagnosing urinary incontinence. A comparative study of asymptomatic and incontinent women. *J Reprod Med*. 1990;35(7):682-4.
15. Hahn I, Fall M. Objective Quantification of stress urinary incontinence: A short reproducible, provocative Pad-Test. *Neurourol Urodyn*. 1991;10:475-81.
16. Jorgensen L, Lose G, Andersen JT. One-hour pad-weighing test for objective assessment of female urinary incontinence. *Obstet Gynecol*. 1987;69(1):39-42.
17. Jakobsen H, Vedel P, Andersen JT. Objective assessment of urinary incontinence: An evaluation of three different pad-weighing tests. *Neurourol Urodyn*. 1987;6(4):325-30.
18. Kinn AC, Larsson B. Pad test with fixed bladder volume in urinary stress incontinence. *Acta Obstet Gynecol Scand*. 1987;66(4):369-71.
19. Persson J, Bergqvist CE, Wolner-Hanssen P. An ultra-short perineal pad-test for evaluation of female stress urinary incontinence treatment. *Neurourol Urodyn*. 2001;20(3):277-85.
20. Griffiths DJ, McCracken PN, Harrison GM. Incontinence in the elderly: objective demonstration and quantitative assessment. *Br J Urol*. 1991;67(5):467-71.
21. Lose G, Jorgensen L, Thunedborg P. 24-hour home pad weighing test versus 1-hour ward test in the assessment of mild stress incontinence. *Acta Obstet Gynecol Scand*. 1989;68(3):211-5.
22. Mouritsen L, Berild G, Hertz J. Comparison of different methods for quantification of urinary leakage in incontinent women. *Neurourol Urodyn*. 1989;8(6):579-86.
23. Thind P, Gerstenberg TC. One-hour ward test vs. 24-hour home pad weighing test in the diagnosis of urinary incontinence. *Neurourol Urodyn*. 1991;10(3):241-5.
24. Klarskov P, Hald T. Reproducibility and reliability of urinary incontinence assessment with a 60 min test. *Scand J Urol Nephrol*. 1984;18(4):293-8.
25. Simons AM, Yoong WC, Buckland S, Moore KH. Inadequate repeatability of the one-hour pad test: the need for a new incontinence outcome measure. *BJOG*. 2001;108(3):315-9.
26. Holm-Bentzen MH, Klarskov P, Opsomer RJ, Maegaard EM, Hald T. Objective assessment of urinary incontinence after successful implantation of AMS artificial urethral sphincter. *Neurourol Urodyn*. 1985;4:9-13.
27. Fantl JA, Harkins SW, Wyman JF, Choi SC, Taylor JR. Fluid loss quantitation test in women with urinary incontinence: a test-retest analysis. *Obstet Gynecol*. 1987;70(5):739-43.
28. Lose G, Rosenkilde P, Gammelgaard J, Schroeder T. Pad-weighing test performed with standardized bladder volume. *Urology*. 1988;32(1):78-80.
29. Jakobsen H, Kromann-Andersen B, Nielsen KK, Maegaard E. Pad weighing tests with 50% or 75% bladder filling. Does it matter? *Acta Obstet Gynecol Scand*. 1993;72(5):377-81.
30. Aslan E, Beji NK, Coskun A, Yalcin O. An assessment of the importance of pad testing in stress urinary incontinence and the effects of incontinence on the life quality of women. *Int Urogynecol J Pelvic Floor Dysfunct*. 2003;14(5):316-9; discussion 20.
31. Harvey MA, Kristjansson B, Griffith D, Versi E. The Incontinence Impact Questionnaire and the Urogenital Distress Inventory: a revisit of their validity in women without a urodynamic diagnosis. *Am J Obstet Gynecol*. 2001;185(1):25-31.
32. Prajsner A, Radziszewski P. Ambulatory diagnosis of urinary incontinence among women: the role of a one-hour pad weigh test. *Wiad Lek*. 1998;51(5-6):254-9.
33. Matharu GS, Assassa RP, Williams KS, Donaldson M, Matthews R, Tincello DG, et al. Objective assessment of urinary incontinence in women: comparison of the one-hour and 24-hour pad tests. *Eur Urol*. 2004;45(2):208-12.

34. Floratos DL, Sonke GS, Rapidou CA, Alivizatos GJ, Deliveliotis C, Constantinides CA, et al. Biofeedback vs verbal feedback as learning tools for pelvic muscle exercises in the early management of urinary incontinence after radical prostatectomy. *BJU Int.* 2002;89(7):714-9.
35. Ward KL, Hilton P. A prospective multicenter randomized trial of tension-free vaginal tape and colposuspension for primary urodynamic stress incontinence: two-year follow-up. *Am J Obstet Gynecol.* 2004;190(2):324-31.
36. Blackwell AL, Yoong W, Moore KH. Criterion validity, test-retest reliability and sensitivity to change of the St George Urinary Incontinence Score. *BJU Int.* 2004;93(3):331-5.
37. Haylen BT, Frazer MI, Sutherst JR. Diuretic response to fluid load in women with urinary incontinence: optimum duration of pad test. *Br J Urol.* 1988;62(4):331-3.
38. Han HC. One-hour or two-hour perineal pad test, which would you choose? Proceedings of the Annual Meeting of the International Continence Society - Athens. 1996:382.
39. Hellstrom AL, Andersson K, Hjalmas K, Jodal U. Pad tests in children with incontinence. *Scand J Urol Nephrol.* 1986;20(1):47-50.
40. Richmond DH, Sutherst JR, Brown MC. Quantification of urine loss by weighing perineal pads. Observation on the exercise regimen. *Br J Urol.* 1987;59(3):224-7.
41. Walters MD, Dombroski RA, Prihoda TJ. Perineal pad testing in the quantitation of urinary incontinence. *Int Urogynecol J.* 1990;1(1):3-6.
42. Rasmussen A, Mouritsen L, Dalgaard A, Fridmodt-Moller C. Twenty-four hour pad weighing test: reproducibility and dependency of activity level and fluid intake. *Neurourol Urodyn.* 1994;13(3):261-5.
43. Ryhammer AM, Laurberg S, Djurhuus JC, Hermann AP. No relationship between subjective assessment of urinary incontinence and pad test weight gain in a random population sample of menopausal women. *J Urol.* 1998;159(3):800-3.
44. Groutz A, Blaivas JG, Chaikin DC, Resnick NM, Engleman K, Anzalone D, et al. Noninvasive outcome measures of urinary incontinence and lower urinary tract symptoms: a multicenter study of micturition diary and pad tests. *J Urol.* 2000;164(3 Pt 1):698-701.
45. Karantanis E, O'Sullivan R, Moore KH. The 24-hour pad test in continent women and men: normal values and cyclical alterations. *BJOG.* 2003;110(6):567-71.
46. Fleischmann N, Flisser AJ, Blaivas JG, Panagopoulos G. Sphincteric urinary incontinence: relationship of vesical leak point pressure, urethral mobility and severity of incontinence. *J Urol.* 2003;169(3):999-1002.
47. Karantanis E, Fynes M, Moore KH, Stanton SL. Comparison of the ICIQ-SF and 24-hour pad test with other measures for evaluating the severity of urodynamic stress incontinence. *Int Urogynecol J Pelvic Floor Dysfunct.* 2004;15(2):111-6; discussion 6.
48. Singh M, Bushman W, Clemens JQ. Do pad tests and voiding diaries affect patient willingness to participate in studies of incontinence treatment outcomes? *J Urol.* 2004;171(1):316-8; discussion 8-9.
49. Ekelund P, Bergstrom H, Milsom I, Norlen L, Rignell S. Quantification of urinary incontinence in elderly women with the 48-hour pad test. *Arch Gerontol Geriatr.* 1988;7(4):281-7.
50. Victor A, Larsson G, Asbrink AS. A simple patient-administered test for objective quantitation of the symptom of urinary incontinence. *Scand J Urol Nephrol.* 1987;21(4):277-9.
51. Versi E, Orrego G, Hardy E, Seddon G, Smith P, Anand D. Evaluation of the home pad test in the investigation of female urinary incontinence. *Br J Obstet Gynaecol.* 1996;103(2):162-7.
52. Hahn I, Fall M. Objective quantification of stress urinary incontinence: a short reproducible, provocative pad-test. *Neurourol Urodyn.* 1991;10:475-81.
53. Nygaard I, Zmolek G. Exercise pad testing in continent exercisers: reproducibility and correlation with voided volume, pyridium staining, and type of exercise. *Neurourol Urodyn.* 1995;14(2):125-9.
54. Versi E, Cardozo LD. Perineal pad weighing versus videographic analysis in genuine stress incontinence. *Br J Obstet Gynaecol.* 1986;93(4):364-6.
55. Sutherst J, Brown M, Shawer M. Assessing the severity of urinary incontinence in women by weighing perineal pads. *Lancet.* 1981;1(8230):1128-30.
56. Franco AV, Lee F, Fynes MM. Is there an alternative to pad tests? Correlation of subjective variables of severity of urinary loss to the 1-h pad test in women with stress urinary incontinence. *BJU Int.* 2008;102(5):589-90.

57. Wijma J, Weis Potters AE, Tinga DJ, Aar-noudse JG. The diagnostic strength of the 24-h pad test for self-reported symptoms of urinary incontinence in pregnancy and after childbirth. *Int Urogynecol J Pelvic Floor Dysfunct*. 2008;19(4):525-30.
58. Twiss CO, Fischer MC, Nitti VW. Comparison between reduction in 24-hour pad weight, International Consultation on Incontinence-Short Form (ICIQ-SF) score, International Prostate Symptom Score (IPSS), and Post-Operative Patient Global Impression of Improvement (PGI-I) score in patient evaluation after male perineal sling. *Neurourol Urodyn*. 2007;26(1):8-13.
59. Albo M, Wruck L, Baker J, Brubaker L, Chai T, Dandreo KJ, et al. The relationships among measures of incontinence severity in women undergoing surgery for stress urinary incontinence. *J Urol*. 2007;177(5):1810-4.
60. Richter HE, Diokno A, Kenton K, Norton P, Albo M, Kraus S, et al. Predictors of treatment failure 24 months after surgery for stress urinary incontinence. *J Urol*. 2008;179(3):1024-30.
61. Foster RT, Sr., Anoja EJ, Webster GD, Amundsen CL. In patients undergoing neuromodulation for intractable urge incontinence a reduction in 24-hr pad weight after the initial test stimulation best predicts long-term patient satisfaction. *Neurourol Urodyn*. 2007;26(2):213-7.
62. Dylewski DA, Jamison MG, Borawski KM, Sherman ND, Amundsen CL, Webster GD. A statistical comparison of pad numbers versus pad weights in the quantification of urinary incontinence. *Neurourol Urodyn*. 2007;26(1):3-7.
63. Khan KS, Chien PF. Evaluation of the home pad test in the investigation of female urinary incontinence. *Br J Obstet Gynaecol*. 1996;103(7):720.
64. Kromann-Andersen B, Jakobsen H, Thorup Andersen J. Pad-weighing tests: A literature survey on test accuracy and reproducibility. 1989;8(3):237-42.
65. Martin JL, Williams KS, Abrams KR, Turner DA, Sutton AJ, Chapple C, et al. Systematic review and evaluation of methods of assessing urinary incontinence. *Health Technol Assess*. 2006;10(6):1-132, iii-iv.
66. Leach GE, Dmochowski RR, Appell RA, Blaivas JG, Hadley HR, Luber KM, et al. Female Stress Urinary Incontinence Clinical Guidelines Panel summary report on surgical management of female stress urinary incontinence. The American Urological Association. *J Urol*. 1997;158(3 Pt 1):875-80.
67. Blaivas JG, Appell RA, Fantl JA, Leach G, McGuire EJ, Resnick NM, et al. Standards of efficacy for evaluation of treatment outcomes in urinary incontinence: recommendations of the Urodynamic Society. *Neurourol Urodyn*. 1997;16(3):145-7.

V. NEUROPHYSIOLOGY

1. Tubaro A, Vodusek D B, Amarenco G, Doumouchtsis S K, DeLancey J O L, Fernando R et al. Imaging, Neurophysiological Testing and Other Tests. In: Abrams P, Cardozo L, Wein A (Eds). *Incontinence*, 5th Ed. ICUD – EAU 2013; 507-622.
2. Nandedkar SD, Barkhaus PE, Sanders DB, Stålberg EV. Analysis of amplitude and area of concentric needle EMG motor unit action potentials. *Electroencephalogr Clin Neurophysiol* 1988a;69:561-7.
3. Podnar S, Mrkaic M, Vodusek DB. Standardization of anal sphincter electromyography: quantification of continuous activity during relaxation. *Neurourol Urodyn* 2002a;21:540-5.
4. Podnar S, Vodusek DB. Protocol for clinical neurophysiologic examination of the pelvic floor. *Neurourol Urodyn* 2001;20:669-82.
5. Podnar S, Vodusek DB. Standardisation of anal sphincter EMG: high and low threshold motor units. *Clin Neurophysiol* 1999;110:1488-91.
6. Podnar S, Vodusek DB, Stålberg E. Comparison of quantitative techniques in anal sphincter electromyography. *Muscle Nerve* 2002c;25:83-92.
7. Gregory WT, AL Clark, K Simmons, JS Lou. Determining the shape of the turns-amplitude cloud during anal sphincter quantitative EMG. *Int Urogynecol J* 2008;19:971-6.
8. Stålberg E, Trontelj JV. *Single Fiber Electromyography: Studies in Healthy and Diseased Muscle* (2nd edition). New York: Raven Press, 1994.
9. Podnar S, Fowler CJ. Sphincter electromyography in diagnosis of multiple system atrophy: technical issues. *Muscle Nerve* 2004;29:151-6.
10. Podnar S, Oblak C, Vodusek DB. Sexual function in men with cauda equina lesions: a clinical and electromyographic study. *J Neurol Neurosurg Psychiatry* 2002b;73:715-20.
11. Pino LJ, Stashuk DW, Podnar S. Bayesian characterization of external anal sphincter muscles using quantitative electromyography. *Clin Neurophysiol* 2008;119:2266-73.

12. Podnar S, Mrkaić M. Predictive power of motor unit potential parameters in anal sphincter electromyography. *Muscle Nerve* 2002;26:389-94.
13. Podnar S, Rodi Z, Lukanovič A, Tršinar B, Vodušek DB. Standardization of anal sphincter EMG: technique of needle examination. *Muscle Nerve* 1999;22:400-3.
14. Podnar S, Vodušek DB. Standardization of anal sphincter electromyography: uniformity of the muscle. *Muscle Nerve* 2000b;23:122-5.
15. Podnar S, Vodušek DB, Stålborg E. Standardization of anal sphincter electromyography: normative data. *Clin Neurophysiol* 2000b;111:2200-7.
16. Podnar S, Lukanovič A, Vodušek DB. Anal sphincter electromyography after vaginal delivery: neuropathic insufficiency or normal wear and tear? *Neurourol Urodyn* 2000a;19:249-57.
17. Podnar S, Vodušek DB. Standardization of anal sphincter electromyography: effect of chronic constipation. *Muscle Nerve* 2000a;23:1748-51.
18. De EJ, Patel CY, Tharian B, et al.: Diagnostic discordance of electromyography (EMG) versus voiding cystourethrogram (VCUG) for detrusor-external sphincter dyssynergy (DESD). *Neurourol Urodyn* 2005;24:616-21.
19. Stafford RE, Sapsford R, Ashton-Miller J, Hodges PW: A novel transurethral surface electrode to record male striated urethral sphincter electromyographic activity. *J Urol* 2010;183:378-85.
20. Deindl FM, Vodušek DB, Hesse U, Schussler B. Activity patterns of pubococcygeal muscles in nulliparous continent women. *Br J Urol* 1993;72:46-51.
21. Podnar S, Barbič M. Non-neurogenic urinary retention (Fowler's syndrome) in two sisters. *Neurourol Urodyn* 2006;25:739-41; discussion 42-3.
22. Devreese A, Staes F, Janssens L, et al.: Incontinent women have altered pelvic floor muscle contraction patterns. *J Urol* 2007;178:558-62.
23. Mahajan ST, Fitzgerald MP, Kenton K, Shott S, Brubaker L: Concentric needle electrodes are superior to perineal surface-patch electrodes for electromyographic documentation of urethral sphincter relaxation during voiding. *BJU Int* 2006;97:117-20.
24. Kirby AC, Nager CW, Litman HJ, Fitzgerald MP, Kraus S, Norton P, Sirls L, Rickey L, Wilson T, Dandreo KJ, Shepherd J, Zimmern P; Urinary Incontinence Treatment Network. Perineal surface electromyography does not typically demonstrate expected relaxation during normal voiding. *Neurourol Urodyn* 2011;30(8):1591-6.
25. Enck P, Franz H, Davico E, et al.: Repeatability of innervation zone identification in the external anal sphincter muscle. *Neurourol Urodyn* 2010;29:449-57.
26. Merletti R, Holobar A, Farina D: Analysis of motor units with high-density surface electromyography. *J Electromyogr Kinesiol* 2008;18:879-90.
27. Heesakkers J, Gerretsen R, Izeta A, Sievert KD, Farag F. Circumferential urinary sphincter surface electromyography: A novel diagnostic method for intrinsic sphincter deficiency. *Neurourol Urodyn*. 2016 Feb;35(2):186-91.
28. Hacad CR, Glazer HI, Zambon JP, Burti JS, Almeida FG. Is there any change in pelvic floor electromyography during the first 6 months after radical retropubic prostatectomy? *Appl Psychophysiol Biofeedback*. 2015 Mar;40(1):9-15.
29. Podnar S: Which patients need referral for anal sphincter electromyography? *Muscle Nerve* 2006;33:278-82.
30. Podnar S: Cauda equina lesions as a complication of spinal surgery. *Eur Spine J* 2010;19:451-7.
31. Torre M, Planche D, Louis-Borrione C, et al.: Value of electrophysiological assessment after surgical treatment of spinal dysraphism. *J Urol* 2002;168:1759-62.
32. Podnar S: Saddle sensation is preserved in a few patients with cauda equina or conus medullaris lesions. *Eur J Neurol* 2007;14:48-53.
33. Podnar S. Utility of sphincter electromyography and sacral reflex studies in women with cauda equina lesions. *Neurourol Urodyn*. 2014 Apr;33(4):426-430.
34. Podnar S: Clinical and neurophysiologic testing of the penile-cavernosus reflex. *Neurourol Urodyn* 2008;27:399-402.
35. Podnar S: Electromyography of the anal sphincter: which muscle to examine? *Muscle Nerve* 2003;28:377-9.
36. Podnar S, Oblak C, Vodusek DB: Sexual function in men with cauda equina lesions: a clinical and electromyographic study. *J Neurol Neurosurg Psychiatry* 2002;73:715-20.

37. Podnar S, Vodusek DB, Stalberg E: Comparison of quantitative techniques in anal sphincter electromyography. *Muscle Nerve* 2002;25:83-92.
38. Hale DS, Benson JT, Brubaker L, Heidkamp MC, Russell B. Histologic analysis of needle biopsy of urethral sphincter from women with normal and stress incontinence with comparison of electromyographic findings. *Am J Obstet Gynecol* 1999;180:342-8.
39. Jian F, Pan H, Zhang Z, Lin J, Chen N, Zhang L, Wu Q, Wang H, Wang Y, Cui L, Tang X. Sphincter electromyography in diabetes mellitus and multiple system atrophy. *NeuroUrol Urodyn*. 2015 Sep;34(7):669-74.
40. Eardley I, Quinn NP, Fowler CJ, Kirby RS, Parkhouse HF, Marsden CD, Bannister R. The value of urethral sphincter electromyography in the differential diagnosis of parkinsonism. *Br J Urol* 1989;64:360-2.
41. Paviour DC, Williams D, Fowler CJ, Quinn NP, Lees AJ: Is sphincter electromyography a helpful investigation in the diagnosis of multiple system atrophy? A retrospective study with pathological diagnosis. *Mov Disord* 2005;20:1425-30.
42. Stocchi F, Carbone A, Inghilleri M, et al.: Urodynamic and neurophysiological evaluation in Parkinson's disease and multiple system atrophy. *J Neurol Neurosurg Psychiatry* 1997;62:507-11.
43. Yamamoto T, Sakakibara R, Uchiyama T, et al.: When is Onuf's nucleus involved in multiple system atrophy? A sphincter electromyography study. *J Neurol Neurosurg Psychiatry* 2005;76:1645-8.
44. Linder J, Libelius R, Nordh E, Holmberg B, Stenlund H, Forsgren L. Anal sphincter electromyography in patients with newly diagnosed idiopathic parkinsonism. *Acta Neurol Scand*. 2012 Oct;126(4):248-55.
45. Schwarz J, Kornhuber M, Bischoff C, Straube A: Electromyography of the external anal sphincter in patients with Parkinson's disease and multiple system atrophy: frequency of abnormal spontaneous activity and polyphasic motor unit potentials. *Muscle Nerve* 1997;20:1167-72.
46. Giladi N, Simon ES, Korczyn AD, et al.: Anal sphincter EMG does not distinguish between multiple system atrophy and Parkinson's disease. *Muscle Nerve* 2000;23:731-4.
47. Vodusek DB. Sphincter EMG and differential diagnosis of multiple system atrophy. *Mov Disord* 2001;16:600-7.
48. Valldeoriola F, Valls-Sole J, Tolosa ES, Marti MJ: Striated anal sphincter denervation in patients with progressive supranuclear palsy. *Mov Disord* 1995;10:550-5.
49. Winge K, Jennum P, Lokkegaard A, Werdelin L: Anal sphincter EMG in the diagnosis of parkinsonian syndromes. *Acta Neurol Scand* 2010;121:198-203.
50. Shimizu H, Yamada M, Toyoshima Y, et al.: Involvement of Onuf's nucleus in Machado-Joseph disease: a morphometric and immunohistochemical study. *Acta Neuropathol* 2010;120:439-48.
51. Scaravilli T, Pramstaller PP, Salerno A, et al.: Neuronal loss in Onuf's nucleus in three patients with progressive supranuclear palsy. *Ann Neurol* 2000;48:97-101.
52. Sakakibara R, Uchiyama T, Asahina M, Suzuki A, Yamanishi T, Hattori T. Micturition disturbance in acute idiopathic autonomic neuropathy. *J Neurol Neurosurg Psychiatry* 2004;75:287-91.
53. Dixon PJ, Christmas TJ, Chapple CR. Stress incontinence due to pelvic floor muscle involvement in limb-girdle muscular dystrophy. *Br J Urol* 1990;65:653-4.
54. Herbaut AG, Nogueira MC, Panzer JM, Zegers de Beyl D. Anorectal incontinence in myotonic dystrophy: a myopathic involvement of pelvic floor muscles. *Muscle Nerve* 1992;15:1210-1.
55. Caress JB, Kothari MJ, Bauer SB, Shefner JM. Urinary dysfunction in Duchenne muscular dystrophy. *Muscle Nerve* 1996;19:819-22.
56. Snooks SJ, Setchell M, Swash M, Henry MM. Injury to innervation of pelvic floor sphincter musculature in childbirth. *Lancet* 1984;2:546-50.
57. Smith AR, Hosker GL, Warrell DW. The role of partial denervation of the pelvic floor in the aetiology of genitourinary prolapse and stress incontinence of urine. A neurophysiological study. *Br J Obstet Gynaecol* 1989;96:24-8.
58. Kenton K, Mueller E, Brubaker L. Continent women have better urethral neuromuscular function than those with stress incontinence. *Int Urogynecol J* 2011;22:1479-84.
59. Jundt K, Kiening M, Fischer P, Bergauer F, Rauch E, Janni W, Peschers U, Dimpfl T. Is the histomorphological concept of the female pelvic floor and its changes due to age and vaginal delivery correct? *NeuroUrol Urodyn* 2005;24:44-50.

60. Takahashi S, Homma Y, Fujishiro T, Hosaka Y, Kitamura T, Kawabe K. Electromyographic study of the striated urethral sphincter in type 3 stress incontinence: evidence of myogenic-dominant damages. *Urology* 2000;56:946-50.
61. Vodusek DB. The role of electrophysiology in the evaluation of incontinence and prolapse. *Curr Opin Obstet Gynecol* 2002;14:509-14.
62. Cescon C, Riva D, Začesta V, Drusany-Starič K, Martsidis K, Protsepko O, Baessler K, Merletti R. Effect of vaginal delivery on the external anal sphincter muscle innervation pattern evaluated by multichannel surface EMG: results of the multicentre study TASI-2. *Int Urogynecol J*. 2014 Nov;25(11):1491-9.
63. Fowler CJ, Christmas TJ, Chapple CR, Parkhouse HF, Kirby RS, Jacobs HS. Abnormal electromyographic activity of the urethral sphincter, voiding dysfunction, and polycystic ovaries: a new syndrome? *Br Med J* 1988;297:1436-8.
64. Deindl FM, Bischoff C, Vodusek DB, Hartung C. Two different forms of dysfunctional voiding in women: predominance of the pelvic floor or the external urethral sphincter? *Neurourol Urodynam* 1996;15:358.
65. De Ridder D, Ost D, Bruyninckx F: The presence of Fowler's syndrome predicts successful long-term outcome of sacral nerve stimulation in women with urinary retention. *Eur Urol* 2007;51:229-33.
66. Amarenco G, Raibaut P, Ismael SS, Rene-Corail P, Haab F: Evidence of occult dysautonomia in Fowler's syndrome: alteration of cardiovascular autonomic function tests in female patients presenting with urinary retention. *BJU Int* 2006;97:288-91.
67. Tawadros C, Burnett K, Derbyshire LF, Tawadros T, Clarke NW, Betts CD. External urethral sphincter electromyography in asymptomatic women and the influence of the menstrual cycle. *BJU Int*. 2015 Sep;116(3):423-31. doi: 10.1111/bju.13042. Epub 2015 May 4.
68. Blaivas JG, Zayed AA, Labib KB. The bulbocavernosus reflex in urology: a prospective study of 299 patients. *J Urol* 1981;126:197-9.
69. Rudy DC, Woodside JR. Non-neurogenic neurogenic bladder: The relationship between intravesical pressure and the external sphincter electromyogram. *Neurourol Urodyn* 1991;10:169.
70. Deindl FM, Vodusek DB, Hesse U, Schussler B. Pelvic floor activity patterns: comparison of nulliparous continent and parous urinary stress incontinent women. A kinesiological EMG study. *Br J Urol* 1994;73:413-7.
71. Chantraine A, de Leval J, Depireux P. Adult female intra- and periurethral sphincter-electromyographic study. *Neurourol Urodyn* 1990;9:139-44.
72. Kenton K, Brubaker L. Relationship between levator ani contraction and motor unit activation in the urethral sphincter. *Am J Obstet Gynecol* 2002;187:403-6.
73. Kenton K, FitzGerald MP, Shott S, Brubaker L. Role of urethral electromyography in predicting outcome of Burch retropubic urethropexy. *Am J Obstet Gynecol* 2001;185:51-5.
74. Fucini C, Ronchi O, Elbetti C. Electromyography of the pelvic floor musculature in the assessment of obstructed defecation symptoms. *Dis Colon Rectum* 2001;44:1168-75.
75. Kiff ES, Swash M. Normal proximal and delayed distal conduction in the pudendal nerves of patients with idiopathic (neurogenic) faecal incontinence. *J Neurol Neurosurg Psychiatry* 1984;47:820-3.
76. Cavalcanti GA, Manzano GM, Giuliano LM, et al.: Pudendal nerve latency time in normal women via intravaginal stimulation. *Int Braz J Urol* 2006;32:705-11.
77. Lefaucheur J, Yiou R, Thomas C: Pudendal nerve terminal motor latency: age effects and technical considerations. *Clin Neurophysiol* 2001;112:472-6.
78. Liberman H, Faria J, Tement CA, Blatchford GJ, Christensen MA, Thorson AG. A prospective evaluation of the value of anorectal physiology in the management of fecal incontinence. *Dis Colon Rectum* 2001;44:1567-74.
79. AGA. American Gastroenterological Association medical position statement on anorectal testing techniques. *Gastroenterology* 1999;116:732-60.
80. Ertekin C, Mungan B. Sacral spinal cord and root potentials evoked by the stimulation of the dorsal nerve of penis and cord conduction delay for the bulbocavernosus reflex. *Neurourol Urodyn* 1993;12:9-22.
81. Sato T, Nagai H. Pudendal nerve "complete" motor latencies at four different levels in the anal sphincter system in young adults. *Dis Colon Rectum* 2002;45:923-7.
82. Lefaucheur JP: Intrarectal ground electrode improves the reliability of motor evoked potentials recorded in the anal sphincter. *Muscle Nerve* 2005;32:110-2.

83. Pelliccioni G, Scarpino O: External anal sphincter responses after S3 spinal root surface electrical stimulation. *Neurourol Urodyn* 2006;25:788-91.
84. Brostrom S, Jennum P, Lose G. Motor evoked potentials from the striated urethral sphincter and puborectal muscle: normative values. *Neurourol Urodyn* 2003a;22:306-13.
85. Opsomer RJ, Caramia MD, Zarola F, Pesce F, Rossini PM: Neurophysiological evaluation of central-peripheral sensory and motor pudendal fibres. *Electroencephalogr Clin Neurophysiol* 1989;74:260-70.
86. Brostrom S: Motor evoked potentials from the pelvic floor. *Neurourol Urodyn* 2003;22:620-37.
87. Schmid DM, Curt A, Hauri D, Schurch B: Motor evoked potentials (MEP) and evoked pressure curves (EPC) from the urethral compressive musculature (UCM) by functional magnetic stimulation in healthy volunteers and patients with neurogenic incontinence. *Neurourol Urodyn* 2005;24:117-27.
88. Brostrom S, Jennum P, Lose G. Motor evoked potentials from the striated urethral sphincter: a comparison of concentric needle and surface electrodes. *Neurourol Urodyn* 2003b;22:123-9.
89. Eardley I, Nagendran K, Lecky B, Chapple CR, Kirby RS, Fowler CJ. Neurophysiology of the striated urethral sphincter in multiple sclerosis. *Br J Urol* 1991;68:81-8.
90. Lefaucheur J-P. Excitability of the motor cortical representation of the external anal sphincter. *Exp Brain Res* 2005;160:268-72.
91. Wyndaele JJ, Van Eetvelde B, Callens D. Comparison in young healthy volunteers of 3 different parameters of constant current stimulation used to determine sensory thresholds in the lower urinary tract. *J Urol* 1996;156:1415-7.
92. Gillman GS, Schaitkin BM, May M, Klein SR. Bell's palsy in pregnancy: a study of recovery outcomes. *Otolaryngol Head Neck Surg* 2002;126:26-30.
93. Fitzgerald MP, Koch D, Senka J: Visceral and cutaneous sensory testing in patients with painful bladder syndrome. *Neurourol Urodyn* 2005;24:627-32.
94. Reitz A, Schmid DM, Curt A, et al.: Electrophysiological assessment of sensations arising from the bladder: are there objective criteria for subjective perceptions? *J Urol* 2003;169:190-4.
95. Law NM, Bharucha AE, Undale AS, Zinsmeister AR. Cholinergic stimulation enhances colonic motor activity, transit and sensation in humans. *Am J Physiol Gastrointestinal and Liver Physiology* 2001;281:G1228-37.
96. Sun WM, Read NW, Prior A, Daly JA, Cheah SK, Grundy D. Sensory and motor responses to rectal distention vary according to rate and pattern of balloon inflation. *Gastroenterology* 1990;99:1008-15.
97. Salvioi B, Bharucha AE, Rath-Harvey D, Pemberton JH, Phillips SF. Rectal compliance, capacity, and rectoanal sensation in fecal incontinence. *Am J Gastroenterol* 2001;96:2158-68.
98. Ganzer H, Madersbacher H, Rimpl E. Cortical evoked potentials by stimulation of the vesicourethral junction: clinical value and neurophysiological considerations. *J Urol* 1991;146:118-23.
99. Gerstenberg TC, Klarskov P, Hald T. Pudendal somatosensory, urethral and bladder wall evoked potentials in normals. *Proceedings of ICS, 1982.* pp 150-77.
100. Schmid DM, Reitz A, Curt A, Hauri D, Schurch B. Urethral evoked Sympathetic Skin Responses (SSR) and Viscerosensory Evoked Potentials (VSEP) as a diagnostic tool to evaluate urogenital autonomic afferent innervation in spinal cord injured patients. *J Urol* 2004;171:1156-60.
101. Vodušek DB, Deletis V, Abbott R, Epstein FJ, Turndorf HH. Intraoperative monitoring of pudendal nerve function. In: Rother M, Zwiener U, editors. *Quantitative EEG Analysis – Clinical Utility and New Methods.* Jena: Universitätsverlag Jena, 1993:309-12.
102. Huang JC, Deletis V, Vodušek DB, Abbott R. Preservation of pudendal afferents in sacral rhizotomies. *Neurosurgery* 1997; 41(2): 411-5.
103. Vodušek DB. Pudendal SEP and bulbocavernosus reflex in women. *Electroencephalogr Clin Neurophysiol* 1990a;77:134-6.
104. Yang CC, Bowen JR, Kraft GH. Cortical evoked potentials of the dorsal nerve of the clitoris and female sexual dysfunction in multiple sclerosis. *J Urol* 2000;164:2010.
105. Sau G, Siracusano S, Aiello I, d'Aloia G, Liguori G, Stener S, Lissiani A, Belgrano E. The usefulness of the Somatosensory evoked potentials of the pudendal nerve in diagnosis of probable multiple sclerosis. *Spinal Cord* 1999;37:258-63.
106. Rodi Z, Vodušek DB, Denišlić M. Clinical uro-neurophysiological investigation in multiple sclerosis. *Eur J Neurol* 1996b;3:574-80.
107. Delodovici ML, Fowler CJ. Clinical value of the pudendal somatosensory evoked potential. *Electroencephalogr Clin Neurophysiol* 1995;96:509-15.

108. Curt A, Rodic B, Schurch B, Dietz V. Recovery of bladder function in patients with acute spinal cord injury: significance of ASIA scores and somatosensory evoked potentials. *Spinal Cord* 1997;35:368-73.
109. Malaguti S, Spinelli M, Giardiello G, Lazzeri M, Van Den Hombergh U. Neurophysiological evidence may predict the outcome of sacral neuromodulation. *J Urol* 2003;170:2323-6.
110. Podnar S: Nomenclature of the electrophysiologically tested sacral reflexes. *Neurourol Urodyn* 2006;25:95-7.
111. Vodusek DB, Janko M, Lokar J: Direct and reflex responses in perineal muscles on electrical stimulation. *J Neurol Neurosurg Psychiatry* 1983;46:67-71.
112. Vodušek DB, Janko M. The bulbocavernosus reflex – a single motor neuron study. *Brain* 1990;113(III):813-20.
113. Hanson P, Rigaux P, Gilliard C, Biset E: Sacral reflex latencies in tethered cord syndrome. *Am J Phys Med Rehabil* 1993;72:39-43.
114. Amarenco G, Kerdraon J: Clinical value of ipsi- and contralateral sacral reflex latency measurement: a normative data study in man. *Neurourol Urodyn* 2000;19:565-76.
115. Podnar S. Clinical elicitation of the penilo-cavernosus reflex in circumcised men. *BJU Int.* 2012 Feb;109(4):582-5.
116. Amarenco G, Ismael SS, Bayle B, Kerdraon J: Dissociation between electrical and mechanical bulbocavernosus reflexes. *Neurourol Urodyn* 2003;22:676-80.
117. Granata G, Padua L, Rossi F, De Franco P, Coraci D, Rossi V. Electrophysiological study of the bulbocavernosus reflex: normative data. *Funct Neurol.* 2013 Oct-Dec;28(4):293-5.
118. Podnar S: The penilo-cavernosus reflex: Comparison of different stimulation techniques. *Neurourol Urodyn* 2007b;27:244-8.
119. Podnar S, Vodušek DB, Tršinar B, Rodi Z. A method of uro-neurophysiological investigation in children. *Electroenceph Clin Neurophysiol* 1997;104:389-92.
120. Loening-Baucke V, Read NW, Yamada T, Barker AT: Evaluation of the motor and sensory components of the pudendal nerve. *Electroencephalogr Clin Neurophysiol* 1994;93:35-41.
121. Hansen MV, Ertekin C, Larsson LE: Cerebral evoked potentials after stimulation of the posterior urethra in man. *Electroencephalogr Clin Neurophysiol* 1990;77:52-8.
122. Benson JT. Clinical neurophysiologic techniques in urinary and fecal incontinence. In: Bent AE, editor. *Ostergaard's Urogynecology and Pelvic Floor Dysfunction*. 5 ed. Philadelphia: Lippincott Williams & Wilkins, 2003:71.
123. Wester C, FitzGerald MP, Brubaker L, Welgoss J, Benson JT. Validation of the clinical bulbocavernosus reflex. *Neurourol Urodyn* 2003;22:589-92.
124. Podnar S. Neurophysiologic studies of the sacral reflex in women with "non-neurogenic" sacral dysfunction. *Neurourol Urodyn* 2011;30:1603-8.
125. Skinner SA, Vodušek DB. Intraoperative recording of the bulbocavernosus reflex. *J Clin Neurophysiol.* 2014 Aug;31(4):313-22.
126. Yilmaz U, Yang CC, Berger RE: Dartos reflex: a sympathetically mediated scrotal reflex. *Muscle Nerve* 2006;33:363-8.
127. Kauff DW, Wachter N, Heimann A, Krüger TB, Hoffmann KP, Lang H, Kneist W. Surface Electromyography Reliably Records Electrophysiologically Evoked Internal Anal Sphincter Activity: A More Minimally Invasive Approach for Monitoring Extrinsic Innervation. *Eur Surg Res.* 2016;57(1-2):81-8.
128. Rodic B, Curt A, Dietz V, Schurch B. Bladder neck incompetence in patients with spinal cord injury: significance of sympathetic skin response. *J Urol* 2000;163:1223-7.
129. Tankisi H, Pughahl K, Rasmussen MM, Clemmensen D, Rawashdeh YF, Christensen P, Krogh K, Fuglsang-Frederiksen A. Pelvic floor electrophysiology in spinal cord injury. *Clin Neurophysiol.* 2016 May;127(5):2319-24.
130. Panicker JN, Seth JH, Khan S, Gonzales G, Haslam C, Kessler TM, Open-label study evaluating outpatient urethral sphincter injections of onabotulinumtoxinA to treat women with urinary retention due to a primary disorder of sphincter relaxation (Fowler's syndrome). *BJU Int.* 2016 May;117(5):809-13.
131. McLennan MT. The role of electrodiagnostic techniques in the reprogramming of patients with a delayed suboptimal response to sacral nerve stimulation. *Int Urogynecol J Pelvic Floor Dysfunct* 2003;14:98-103.
132. Romaniszyn M, Wałęga P. Graciloplasty, electrostimulation, electromyography. Clinical implications of electrophysiological phenomena in the neo-sphincter created from the gracilis muscle. *Pol Przegl Chir.* 2016 Mar 1;88(2):68-76.

133. Wang ZY, Chen YH, Xu YY, Wang X, Shao B, Niu XT, Chen BC, Huang HJ. Altered bulbocavernosus reflex in patients with multiple system atrophy. *Neurol Res.* 2016 Feb;38(2):138-43.
134. Sala F, Squintani G, Tramontano V, Arcaro C, Faccioli F, Mazza C. Intraoperative neurophysiology in tethered cord surgery: techniques and results. *Childs Nerv Syst.* 2013 Sep;29(9):1611-24.
135. Kolenc M, Kobal J, Podnar S. No electrophysiological evidence for Onuf's nucleus degeneration causing bladder and bowel symptoms in Huntington's disease patients. *Neurourol Urodyn.* 2014 Jun;33(5):524-30.
136. Podnar S, Vodušek DB. Place of perineal electrophysiologic testing in multiple sclerosis patients. *Ann Phys Rehabil Med.* 2014 Jul;57(5):288-96.
137. Eccher MA. Below the belt: sensory mapping and monitoring in the sacral-pudendal region. *J Clin Neurophysiol.* 2014 Aug;31(4):323-5.
7. Stein M, Discippio W, Davia M, Taub H. Bio-feedback for the treatment of stress and urge incontinence. *J Urol.* 1995;153(3 Pt 1):641-3.
8. Ouslander JG, Schnelle JF. Incontinence in the nursing home. *Ann Intern Med.* 1995;122(6):438-49.
9. Young SB, Pingeton DM. A practical approach to perimenopausal and postmenopausal urinary incontinence. *Obstet Gynecol Clin North Am.* 1994;21(2):357-79.
10. McIntosh LJ, Richardson DA. 30-minute evaluation of incontinence in the older woman. *Geriatrics.* 1994;49(2):35-8, 43-4.
11. Midthun SJ, Paur RA, Lindseth G, Von Duvillard SP. Bacteriuria detection with a urine dip-stick applied to incontinence pads of nursing home residents. *Geriatr Nurs.* 2003;24(4):206-9.
12. Ouslander JG. Geriatric urinary incontinence. *Dis Mon.* 1992;38(2):65-149.
13. DuBeau CE, Resnick NM. Evaluation of the causes and severity of geriatric incontinence. A critical appraisal. *Urol Clin North Am.* 1991;18(2):243-56.
14. Shuford RA, Dulaney CR, Burnett OL, 3rd, Byram KW, McDonald AM. Evaluating the Role of Urinalysis for Suspected Cystitis in Women Undergoing Pelvic Radiotherapy. *Int J Gynecol Cancer.* 2016.
15. Pooli A, Cook G, Isharwal S, Desai V, LaGrange C. Urinalysis findings are not predictive of positive urine culture in patients with indwelling stents. *Can J Urol.* 2016;23(5):8446-50.
16. Oikonomou KG, Alhaddad A. The Diagnostic Value of Urinalysis in Hemodialysis Patients with Fever, Sepsis or Suspected Urinary Tract Infection. *J Clin Diagn Res.* 2016;10(10):OC11-OC3.

VI. OTHER INVESTIGATIONS

1. URINALYSIS

1. Nitti VW, Blaivas JG. Urinary incontinence: epidemiology, pathophysiology, evaluation, and management overview. . In: Wein JA, Kavoussi LR, Novick AC, Partin AW, Peters CA, editors. *Campbell-Walsh Urology.* 9th ed: Elsevier; 2007.
2. Tubaro A, Artibani W, Bartram C, Delancey JD, Dietz HP, Khullar V, et al. Imaging and other investigations. In: Abrams P, Cardozo L, Khoury S, Wein A, editors. *Incontinence - 3rd International Consultation on Incontinence.* Plymouth: Health Publication Ltd; 2005. p. 707-97.
3. Ouslander JG, Schapira M, Schnelle JF, Fingold S. Pyuria among chronically incontinent but otherwise asymptomatic nursing home residents. *J Am Geriatr Soc.* 1996;44(4):420-3.
4. Sandvik H, Hunskaar S. General practitioners' management of female urinary incontinence. Medical records do not reflect patients' recall. *Scand J Prim Health Care.* 1995;13(3):168-74.
5. Kennedy KL, Steidle CP, Letizia TM. Urinary incontinence: the basics. *Ostomy Wound Manage.* 1995;41(7):16-8, 20, 2 passim; quiz 33-4.
6. Stricker PD. Proper patient selection for Contigen Bard Collagen implant. *Int J Urol.* 1995;2 Suppl 1:2-6; discussion 16-8.
1. Rittig S, Knudsen UB, Norgaard JP, Pedersen EB, Djurhuus JC. Abnormal diurnal rhythm of plasma vasopressin and urinary output in patients with enuresis. *Am J Physiol.* 1989;256(4 Pt 2):F664-71.
2. Matthiesen TB, Rittig S, Norgaard JP, Pedersen EB, Djurhuus JC. Nocturnal polyuria and natriuresis in male patients with nocturia and lower urinary tract symptoms. *J Urol.* 1996;156(4):1292-9.

2. BLOOD TESTS

3. TISSUE ANALYSIS

1. Wen Y, Zhao YY, Li S, Polan ML, Chen BH. Differences in mRNA and protein expression of small proteoglycans in vaginal wall tissue from women with and without stress urinary incontinence. *Hum Reprod.* 2007;22(6):1718-24.
2. Chung da J, Bai SW. Roles of sex steroid receptors and cell cycle regulation in pathogenesis of pelvic organ prolapse. *Curr Opin Obstet Gynecol.* 2006;18(5):551-4.
3. Levens E, Luo X, Ding L, Williams RS, Chegini N. Fibromodulin is expressed in leiomyoma and myometrium and regulated by gonadotropin-releasing hormone analogue therapy and TGF-beta through Smad and MAPK-mediated signalling. *Mol Hum Reprod.* 2005;11(7):489-94.
4. Chen Y, DeSautel M, Anderson A, Badlani G, Kushner L. Collagen synthesis is not altered in women with stress urinary incontinence. *Neurourol Urodyn.* 2004;23(4):367-73.
5. Keane DP, Sims TJ, Abrams P, Bailey AJ. Analysis of collagen status in premenopausal nulliparous women with genuine stress incontinence. *Br J Obstet Gynaecol.* 1997;104(9):994-8.
6. Rechberger T, Postawski K, Jakowicki JA, Gunja-Smith Z, Woessner JF, Jr. Role of fascial collagen in stress urinary incontinence. *Am J Obstet Gynecol.* 1998;179(6 Pt 1):1511-4.
7. Liapis A, Bakas P, Pafiti A, Frangos-Plemenos M, Arnoyannaki N, Creatsas G. Changes of collagen type III in female patients with genuine stress incontinence and pelvic floor prolapse. *Eur J Obstet Gynecol Reprod Biol.* 2001;97(1):76-9.
8. Falconer C, Ekman-Ordeberg G, Blomgren B, Johansson O, Ulmsten U, Westergren-Thorsson G, et al. Paraurethral connective tissue in stress-incontinent women after menopause. *Acta Obstet Gynecol Scand.* 1998;77(1):95-100.
9. Bakas PG, Liapis AE, Zervolea I, Voutsinas G, Kletsas D, Creatsas G. mRNA assessment for procollagen production in women with genuine stress urinary incontinence. *Int Urogynecol J Pelvic Floor Dysfunct.* 2004;15(6):429-31; discussion 31.
10. Gabriel B, Denschlag D, Gobel H, Fittkow C, Werner M, Gitsch G, et al. Uterosacral ligament in postmenopausal women with or without pelvic organ prolapse. *Int Urogynecol J Pelvic Floor Dysfunct.* 2005;16(6):475-9.
11. Skorupski P, Krol J, Starega J, Adamiak A, Jankiewicz K, Rechberger T. An alpha-1 chain of type I collagen Sp1-binding site polymorphism in women suffering from stress urinary incontinence. *Am J Obstet Gynecol.* 2006;194(2):346-50.
12. Edwall L, Carlstrom K, Jonasson AF. Markers of collagen synthesis and degradation in urogenital tissue from women with and without stress urinary incontinence. *Neurourol Urodyn.* 2005;24(4):319-24.
13. Koslowski R, Seidel D, Kuhlisch E, Knoch KP. Evidence for the involvement of TGF-beta and PDGF in the regulation of prolyl 4-hydroxylase and lysyloxidase in cultured rat lung fibroblasts. *Exp Toxicol Pathol.* 2003;55(4):257-64.
14. Arendt E, Ueberham U, Bittner R, Gebhardt R, Ueberham E. Enhanced matrix degradation after withdrawal of TGF-beta1 triggers hepatocytes from apoptosis to proliferation and regeneration. *Cell Prolif.* 2005;38(5):287-99.
15. Suzme R, Yalcin O, Gurdol F, Gungor F, Bilir A. Connective tissue alterations in women with pelvic organ prolapse and urinary incontinence. *Acta Obstet Gynecol Scand.* 2007;86(7):882-8.
16. Connell KA, Guess MK, Chen H, Andikyan V, Bercik R, Taylor HS. HOXA11 is critical for development and maintenance of uterosacral ligaments and deficient in pelvic prolapse. *J Clin Invest.* 2008;118(3):1050-5.
17. Chen B, Wen Y, Polan ML. Elastolytic activity in women with stress urinary incontinence and pelvic organ prolapse. *Neurourol Urodyn.* 2004;23(2):119-26.
18. Gabriel B, Watermann D, Hancke K, Gitsch G, Werner M, Tempfer C, et al. Increased expression of matrix metalloproteinase 2 in uterosacral ligaments is associated with pelvic organ prolapse. *Int Urogynecol J Pelvic Floor Dysfunct.* 2006;17(5):478-82.
19. Cox DA, Helvering LM. Extracellular matrix integrity: a possible mechanism for differential clinical effects among selective estrogen receptor modulators and estrogens? *Mol Cell Endocrinol.* 2006;247(1-2):53-9.
20. McDonnell DP. The molecular determinants of estrogen receptor pharmacology. *Maturitas.* 2004;48 Suppl 1:S7-12.
21. Goldstein SR, Nanavati N. Adverse events that are associated with the selective estrogen receptor modulator levormeloxifene in an aborted phase III osteoporosis treatment study. *Am J Obstet Gynecol.* 2002;187(3):521-7.

PHARMACOLOGICAL TREATMENT OF URINARY INCONTINENCE

Chair

K-E. Andersson (USA)

Members

L. Cardozo (UK)
F. Cruz (Portugal)
K-S. Lee (Korea)
Arun Sahai (UK)
AJ Wein (USA)

CONTENTS

I. INTRODUCTION	807	3. Other Hormones	899
1. Publication Searches	807	4. Desmopressin	900
2. Central Nervous Control	808	VI. <u>CONSIDERATIONS IN THE ELDERLY</u>	903
3. Peripheral Nervous Control	808	1. Antimuscarinic Agents – Efficacy and Tolerability	903
4. Pathogenesis of Bladder Control Disorders	811	2. Antimuscarinic Agents – Cognitive Safety	904
5. Bladder Contraction	811	3. Antimuscarinic Agents – Cardiac Safety	905
II. <u>DRUGS USED FOR TREATMENT OF OVERACTIVE BLADDER SYMPTOMS/DETRUSOR OVERACTIVITY</u>	814	4. Antimuscarinic Agents – Drug/Drug Interactions in the Elderly	906
1. Antimuscarinic (Anticholinergic) Drugs	815	5. β_3 -AR agonists (Mirabegron)	906
2. β -Adrenoceptor Agonists	839	6. Desmopressin – Efficacy and Safety in the Elderly	906
3. Drugs Acting on Membrane Channels	845	7. BoNT/A in Older Adults	906
4. α -Adrenoceptor (AR) Antagonists	846	8. Other	906
5. Phosphodiesterase (PDE) Inhibitors	847	REFERENCES	907
6. Antidepressants	849		
7. Cyclooxygenase (COX) Inhibitors	850		
8. Toxins	850		
9. Other Drugs	870		
10. Combinations	870		
11. Future Possibilities	876		
III. <u>DRUGS USED FOR TREATMENT OF STRESS INCONTINENCE</u>	887		
1. Stress Incontinence in Women	887		
2. Stress Urinary Incontinence in Men	892		
IV. <u>DRUGS TO TREAT UNDERACTIVE BLADDER/DETRUSOR UNDERACTIVITY</u>	892		
1. Pharmacological Principles Used for Treatment	893		
V. <u>HORMONAL TREATMENT OF URINARY INCONTINENCE</u>	896		
1. Oestrogens	896		
2. Genitourinary Syndrome of Menopause	899		

PHARMACOLOGICAL TREATMENT OF URINARY INCONTINENCE

K-E. ANDERSSON (USA)

L. CARDOZO (UK), F. CRUZ (PORTUGAL), K-S. LEE (KOREA), ARUN SAHAI (UK), AJ WEIN (USA)

I. INTRODUCTION

The function of the lower urinary tract (LUT) is to store and periodically release urine, and is dependent on the activity of smooth and striated muscles in the bladder, urethra, and pelvic floor. These structures form a functional unit, which is controlled by a complex interplay between the central and peripheral nervous systems and local regulatory factors [Andersson, 1993; de Groat and Yoshimura, 2001; 2015; Andersson and Wein, 2004; see, Andersson and Michel., 2011]. Ma

ifunction at various levels may result in bladder control disorders, which roughly can be classified as disturbances of filling/storage or disturbances of voiding/emptying. Failure to store urine may lead to various forms of incontinence (mainly urgency and stress incontinence), and failure to empty can lead to urinary retention, which may result in detrusor underactivity (DU) and underactive bladder (UAB). A disturbed filling/storage function can, at least theoretically, be improved by agents decreasing detrusor activity, increasing bladder capacity, and/or increasing outlet resistance [Wein, 2012].

Many drugs have been tried, but the results are often disappointing, partly due to poor treatment efficacy and/or side effects. The development of pharmacologic treatment of the different forms of urinary incontinence has been slow, but several promising targets

and drug principles have been identified [Andersson 2007; 2011c; 2015; 2016; Colli et al., 2007; Athanasopoulos and Cruz, 2011; Yeo et al., 2013; Zacche et al 2014; Sacco and Bientinesi, 2015; Bechis et al. 2015].

In this report, we update the recommendations from the 2012 International Consensus meeting [Andersson et al., 2013]. The most relevant information obtained since the last meeting is briefly reviewed and summarised. Agents specifically used for treatment of urinary tract infections and interstitial cystitis, have not been included. Our clinical drug recommendations are based on evaluations made using a modification of the Oxford system (Table 1). The terminology used is that recommended by the International Continence Society (ICS) [Abrams et al., 2002].

1. PUBLICATION SEARCHES

The review undertook a comprehensive search of all major literature databases and the abstract books from several major conferences: American Urological Association, ICS, European Association of Urology, International Urogynaecological Association, International Consultation of Incontinence and Societe Internationale d'Urologie.

Table 1. ICI assessments 2008: Oxford guidelines (modified)

Levels of evidence
Level 1: Systematic reviews, meta-analyses, good quality randomized controlled clinical trials (RCTs) Level 2: RCTs, good quality prospective cohort studies Level 3: Case-control studies, case series Level 4: Expert opinion
Grades of recommendation
Grade A: Based on level 1 evidence (highly recommended) Grade B: Consistent level 2 or 3 evidence (recommended) Grade C: Level 4 studies or "majority evidence" (optional) Grade D: Evidence inconsistent/inconclusive (no recommendation possible) or the evidence indicates that the drug should not be recommended

There were no restrictions on the inclusion of publications by language; publications in languages other than English were translated into English.

2. CENTRAL NERVOUS CONTROL

In the adult individual, the normal micturition reflex is mediated by a spinobulbospinal pathway, which passes through relay centers in the brain (Figures 1-4).

In infants, the central pathways seem to be organised as on-off switching circuits, but after the age of four to six years, voiding is initiated voluntarily by the cerebral cortex [de Groat et al., 1999; Beckel and Holstege, 2011]. Studies in humans and animals have identified areas in the brainstem and diencephalon (Figure 5) that are specifically implicated in micturition control, including Barrington's nucleus or the pontine micturition center (PMC) in the dorsomedial pontine tegmentum [Fowler et al., 2008]. These structures directly excite bladder motoneurons and indirectly inhibit urethral sphincter motoneurons via inhibitory interneurons in the medial sacral cord. The periaqueductal grey (PAG) receives bladder filling information, and the pre-optic area of the hypothalamus is probably involved in the initiation of micturition. According to PET-scan and functional imaging studies in humans, these supraspinal regions are active during micturition [Blok et al., 1998; Nour et al., 2000; Athwal et al., 2001; Griffiths et al., 2007; 2008; Hruz et al., 2008; Mehnert et al., 2008; Tadic et al., 2008; Griffiths, 2011; Deruyver et al., 2016].

3. PERIPHERAL NERVOUS CONTROL

Bladder emptying and urine storage involve a complex pattern of efferent and afferent signalling in parasympathetic, sympathetic, somatic, and sensory nerves. These nerves are parts of reflex pathways, which either keep the bladder in a non-contracted state, enabling urine storage at low intravesical pressure, or which initiate micturition by relaxing the outflow region and contracting the bladder smooth muscle. Contraction of the detrusor smooth muscle and relaxation of the outflow region result from activation of *parasympathetic* neurones located in the sacral parasympathetic nucleus (SPN) in the spinal cord at the level of S2-S4 [de Groat et al., 1993; Beckel and Holstege, 2011]. The postganglionic neurones in the pelvic nerve mediate the excitatory input to the human detrusor smooth muscle by releasing acetylcholine (ACh) acting on muscarinic receptors. However, an atropine-resistant component has been demonstrated, particularly in functionally and morphologically altered human bladder tissue (see below). The pelvic nerve also conveys parasympathetic fibres to

the outflow region and the urethra. These fibres exert an inhibitory effect and thereby relax the outflow region. This is mediated partly by release of nitric oxide [Andersson and Persson, 1993], although other transmitters might be involved [Bridgewater and Brading, 1993; Hashimoto et al., 1993; Werkström et al., 1995].

Most of the *sympathetic* innervation of the bladder and urethra originates from the intermediolateral nuclei in the thoraco-lumbar region (T10-L2) of the spinal cord [Beckel and Holstege, 2011]. The axons travel either through the inferior mesenteric ganglia and the hypogastric nerve, or pass through the paravertebral chain and enter the pelvic nerve. Thus, sympathetic signals are conveyed in both the hypogastric and pelvic nerves [Lincoln and Burnstock, 1993].

The predominant effects of the sympathetic innervation of the lower urinary tract are inhibition of the parasympathetic pathways at spinal and ganglion levels (demonstrated in animals), and mediation of contraction of the bladder base and the urethra (shown in animals and man, see Andersson, 1993). However, the adrenergic innervation of the bladder body is believed to inactivate the contractile mechanisms in the detrusor directly. Noradrenaline (norepinephrine) is released in response to electrical stimulation of detrusor tissues *in vitro*, and the normal response of detrusor tissues to released noradrenaline is relaxation [Andersson, 1993].

The *somatic* innervation of the urethral rhabdosphincter and of some perineal muscles (for example compressor urethrae and urethrovaginal sphincter), is provided by the pudendal nerve [Beckel and Holstege, 2011]. These fibers originate from sphincter motor neurons located in the ventral horn of the sacral spinal cord (levels S2-S4) in a region called Onuf's (Onufrowicz's) nucleus).

Most of the *sensory* innervation of the bladder and urethra reaches the spinal cord via the pelvic nerve and dorsal root ganglia (Kanai and Andersson, 2010; De Wachter, 2011). In addition, some afferents travel in the hypogastric nerve. The sensory nerves of the striated muscle in the rhabdosphincter travel in the pudendal nerve to the sacral region of the spinal cord [Lincoln and Burnstock, 1993].

The most important afferents for the micturition process are myelinated A δ -fibres and unmyelinated C-fibres travelling in the pelvic nerve to the sacral spinal cord, conveying information from receptors in the bladder wall to the spinal cord. The A δ -fibres respond to passive distension and active contraction, thus conveying information about bladder filling [Janig and Morrison, 1986]. C-fibres have a high mechanical threshold and respond primarily to chemical irritation of the bladder mucosa [Habler et al., 1990] or cold [Fall et al., 1990].

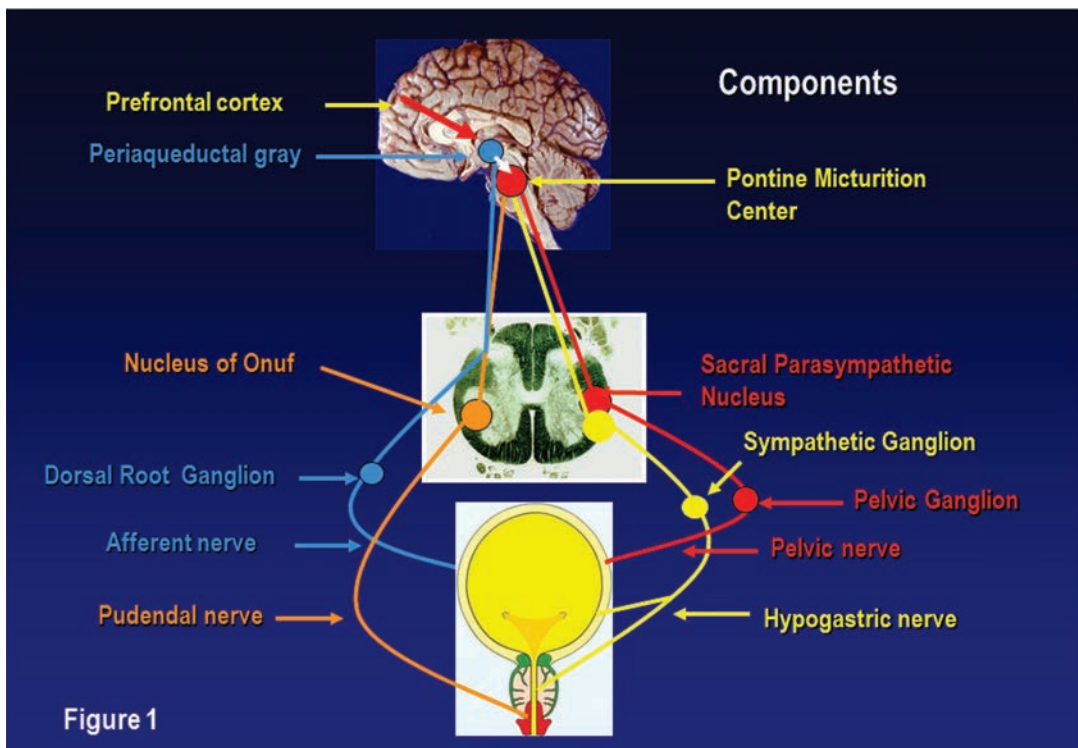

Figure 1: Components of the micturition reflex.

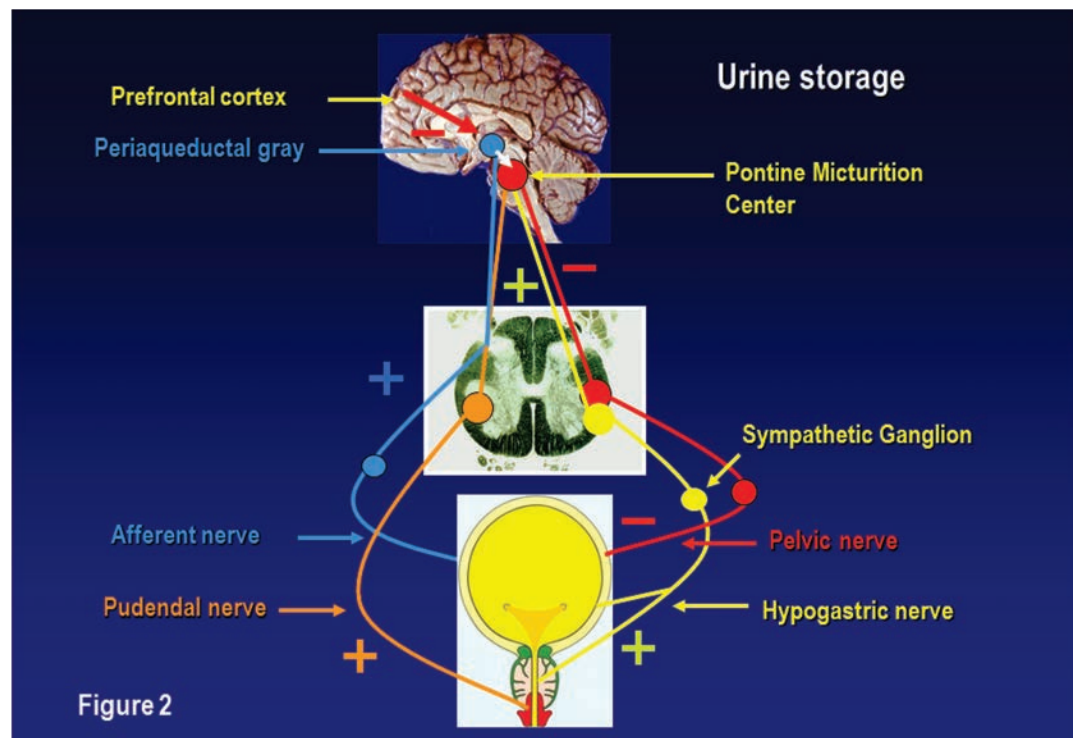

Figure 2: Activity in the micturition reflex during storage. The pontine micturition center is inhibited by impulses from the prefrontal cortex, afferent impulses unable to initiate micturition. Activities in the hypogastric and pudendal nerves keep the bladder relaxed and the outflow region contracted.

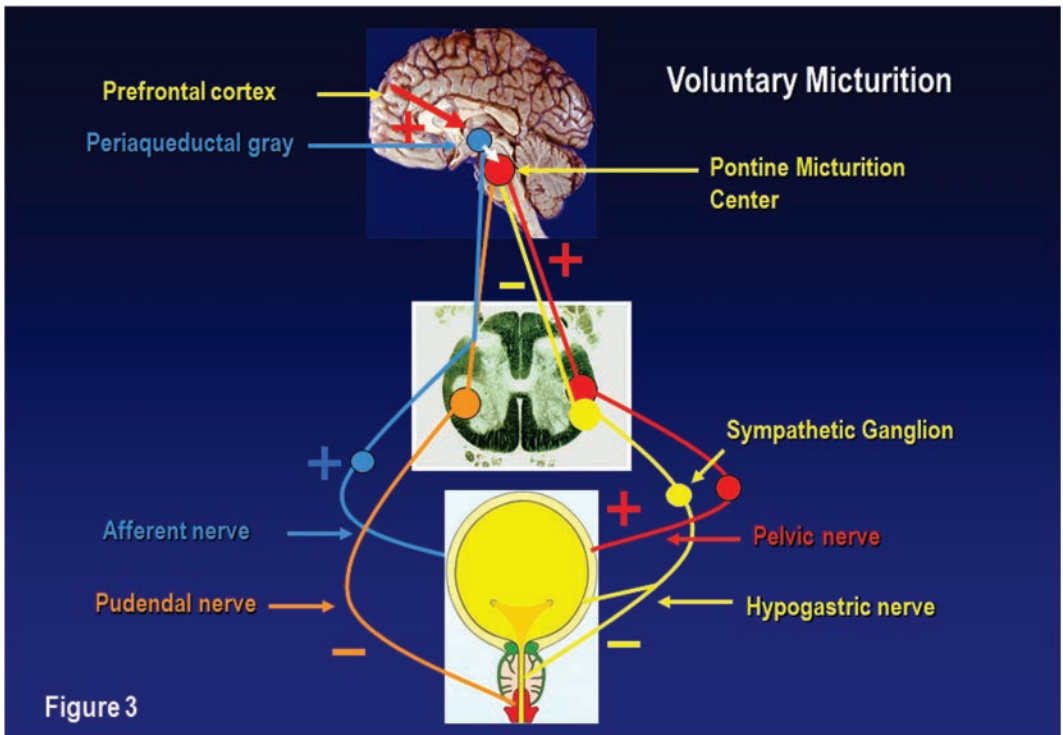

Figure 3: Activity in the micturition reflex during voluntary voiding. The inhibitory impulses from the prefrontal cortex pontine micturition center are removed and afferent impulses are able to initiate micturition. Activities in the hypogastric and pudendal nerves are inhibited, the outflow region is relaxed, and the bladder is contracted by the activity in the pelvic nerve.

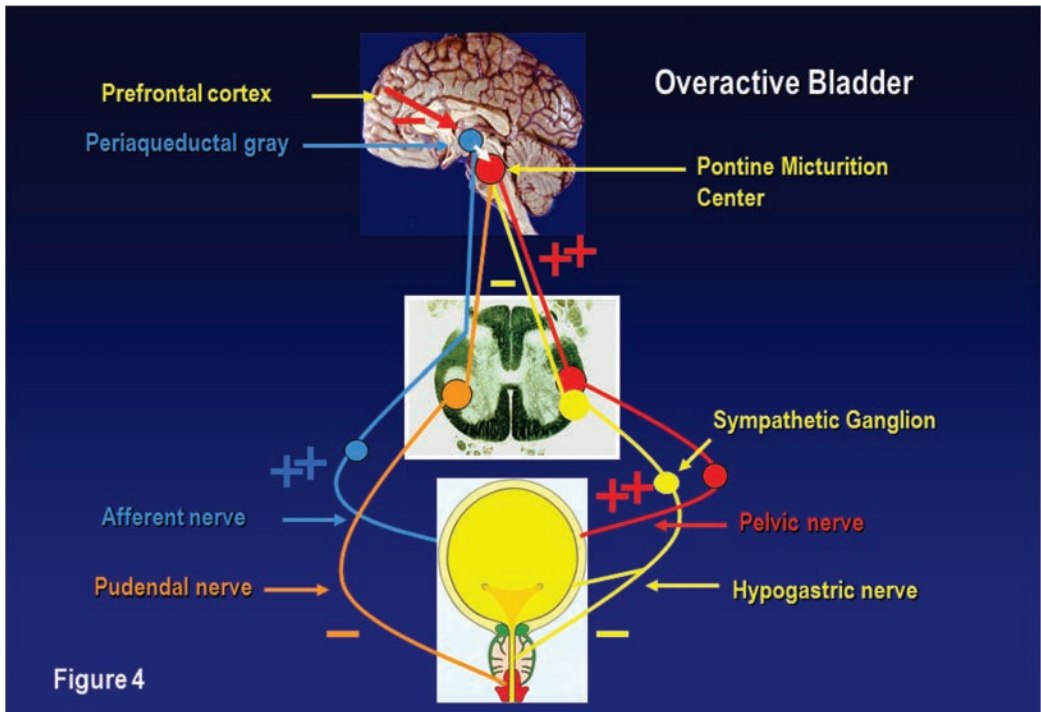

Figure 4: Detrusor overactivity. Despite the inhibitory impulses from the prefrontal to the cortex pontine micturition center the enhanced (?) afferent impulses are able to initiate micturition.

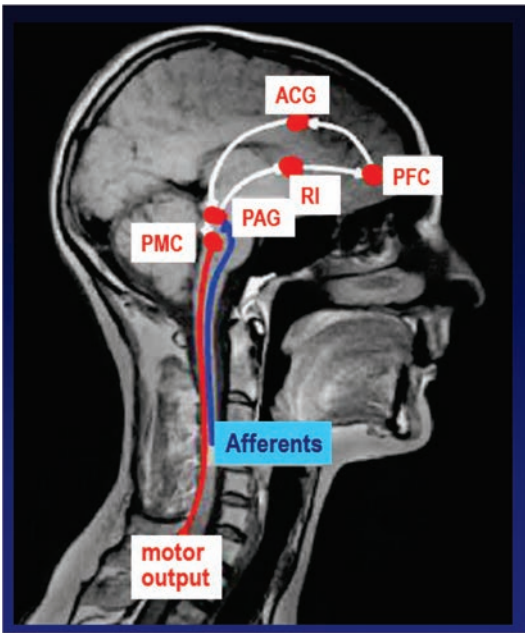

Figure 5: Simplified model of the supraspinal control system of micturition. Secondary bladder afferents synapse in the Periaqueductal Gray (PAG) and are relayed to the Insula (RI), forming the substrate for sensation. Insula representation may have slight right-sided predominance. The Anterior Cingulate Gyrus (ACG) is responsible for monitoring, arousal, and efferent output to the PAG and the Pontine Micturition Center (PMC). The prefrontal cortex (PFC) is involved in voluntary decision about voiding and generates efferent signals to control ACG and ultimately PMC. PMC provides motor output to cause voiding. Modified from Griffiths and Tadic, *NeuroUrol Urodyn*, 2008;27:466-474

Following chemical irritation, the C-fibre afferents exhibit spontaneous firing when the bladder is empty and increased firing during bladder distension [Habler et al., 1990]. These fibres are normally inactive and are therefore termed "silent fibres" [de Groat and Yoshimura, 2001; 2015].

4. PATHOGENESIS OF BLADDER CONTROL DISORDERS

As pointed out previously, bladder control disorders can be divided into two general categories: disorders of filling/storage and disorders of voiding [Wein, 2012]. Storage problems can occur as a result of weakness or anatomical defects in the urethral outlet, causing stress urinary incontinence. Failure to store also occurs if the bladder is overactive, as in the overactive bladder (OAB) syndrome. The prevalence varies with the criteria used for diagnosis, but according to Irwin et al. (2006), using the ICS definition of 2002 [Abrams et al., 2002], the overall prevalence of OAB, based on computer assisted telephone interviews (the EPIC study) was 11.8%; rates were similar in

men and women and increased with age [Irwin et al., 2006]. A similar study based on a cross Canada telephone survey found the prevalence of OAB to be 13 % in men and 14.7% in women [Herschorn et al., 2008]. In a Finnish study, taking into account bother, the prevalence of *clinically meaningful OAB*, was much lower than reported in these studies [Vaughan et al., 2011].

OAB (symptomatic diagnosis) is often assumed to be caused by detrusor overactivity (DO; urodynamic diagnosis), even if this does not always seem to be the case [Hyman et al., 2001; Digesu et al., 2003; Hashim and Abrams, 2004]. DO/OAB can occur as a result of sensitization of afferent nerve terminals in the bladder or outlet region, changes of the bladder smooth muscle secondary to denervation, or consequent upon damage to the central nervous system (CNS) inhibitory pathways, as can be seen in various neurological disorders, such as multiple sclerosis, cerebrovascular disease, Parkinson's disease, brain tumors, and spinal cord injury [Andersson and Pehrson, 2003; Ouslander, 2004; Banakhar et al., 2012; Meng et al., 2012; Wein and Dmochowski, 2012; Michel and Igawa, 2015]. Urinary retention and overflow incontinence can be observed in patients with urethral outlet obstruction (e.g. prostate enlargement), decreased detrusor contractility, or both), neural injury, and/or diseases that damage nerves (e.g. diabetes mellitus), or in those who are taking drugs that depress the neural control of the bladder or bladder smooth muscle directly [Wein, 2012].

5. BLADDER CONTRACTION

Normal bladder contraction in humans is mediated mainly through stimulation of muscarinic receptors in the detrusor muscle [Andersson and Wein, 2004] (Figure 6). Atropine resistance, i.e. contraction of isolated bladder muscle in response to electrical nerve stimulation after pretreatment with atropine, has been demonstrated in most animal species, but seems to be of little importance in normal human bladder muscle [Andersson, 1993; Bayliss et al., 1999; Rouget et al., 2014]. However, atropine-resistant (non-adrenergic, non-cholinergic: NANC) contractions have been reported in normal human detrusor and may be caused mainly by adenosine triphosphate (ATP) [Andersson, 1993; Bayliss et al., 1999, Andersson and Wein, 2004; Kennedy et al., 2007]. ATP acts on two families of purinergic receptors: an ion channel family (P2X) and a G-protein-coupled receptor family (P2Y). Seven P2X subtypes and eight P2Y subtypes have been identified. In several species (rabbit, cat, rat, and human), various studies suggested that multiple purinergic excitatory receptors are present in the bladder [de Groat and Yoshimura, 2001; Ford and Cockayne, 2011; Burnstock, 2013; Ford and Udem., 2013; North and Jarvis, 2013; Andersson, 2015]]. Immunohistochemical experiments with specific antibodies for different P2X receptors showed that P2X1 receptors are the dominant subtype in membranes of

rat detrusor muscle and vascular smooth muscle in the bladder. Excitatory receptors for ATP are present in parasympathetic ganglia, afferent nerve terminals, and urothelial cells [de Groat and Yoshimura, 2001]. P2X3 receptors, which have been identified in small-diameter afferent neurons in dorsal root ganglia, have also been detected immunohistochemically in the wall of the bladder and ureter in a suburothelial plexus of afferent nerves. In P2X3 knockout mice, afferent activity induced by bladder distension was significantly reduced [Cockayne et al., 2000; Ford et al., 2006; Ruggieri et al., 2006; Ford and Cockayne, 2011; Burnstock, 2013]. These data indicate that purinergic receptors are involved in mechanosensory signaling in the nonprimate mammalian bladder.

A significant degree of atropine resistance may exist in morphologically and/or functionally changed bladders, and has been reported to occur in hypertrophic bladders [Sjögren et al., 1982], interstitial cystitis [Paleara et al., 1993], neurogenic bladders [Wammack et al., 1995], and in the aging bladder [Yoshida et al., 2001]. The importance of the NANC component to detrusor contraction *in vivo*, normally, and in different micturition disorders, remains to be established [Andersson, 2006].

The neurotransmitter ACh acts on two classes of receptors, the nicotinic and the muscarinic receptors. While the former plays a role in the signal transduction between neurones or between neurones and skeletal muscle (e.g. in the distal urethra), the signal

transduction between parasympathetic nerves and smooth muscle of the detrusor involves muscarinic receptors [Abrams and Andersson, 2007]. Importantly, the endogenous muscarinic receptor agonist ACh is not necessarily derived only from parasympathetic nerves in the urinary bladder, but can also be formed and released non-neuronally by the urothelium [Bschleiper et al., 2007; Mansfield et al., 2005; Zarghooni et al., 2007; Andersson, 2011a; Birder and Andersson, 2013]. Five subtypes of muscarinic receptors have been cloned in humans and other mammalian species, which are designated M₁₋₅ [Caulfield and Birdsall 1998; Giglio and Tobin, 2009]. Based upon structural criteria and shared preferred signal transduction pathways, the subtypes can be grouped into M₁, M₃ and M₅ on the one hand and the subtypes M₂ and M₄ on the other. The former prototypically couple via pertussis toxin-insensitive Gq proteins to stimulation of a phospholipase C followed by elevation of intracellular calcium and activation of a protein kinase C, whereas the latter prototypically couple via pertussis toxin-sensitive Gi proteins to inhibition of adenylyl cyclase and modulation of several ion channels [Caulfield and Birdsall 1998]. While sensitive molecular techniques such as reverse transcriptase polymerase chain reaction can detect mRNA for all five subtypes in the mammalian bladder [Abrams et al., 2006; Hegde, 2006], studies at the protein level, e.g. based upon radioligand binding, have typically detected only M₂ and M₃ receptors, with the former dominating quantitatively [Abrams et

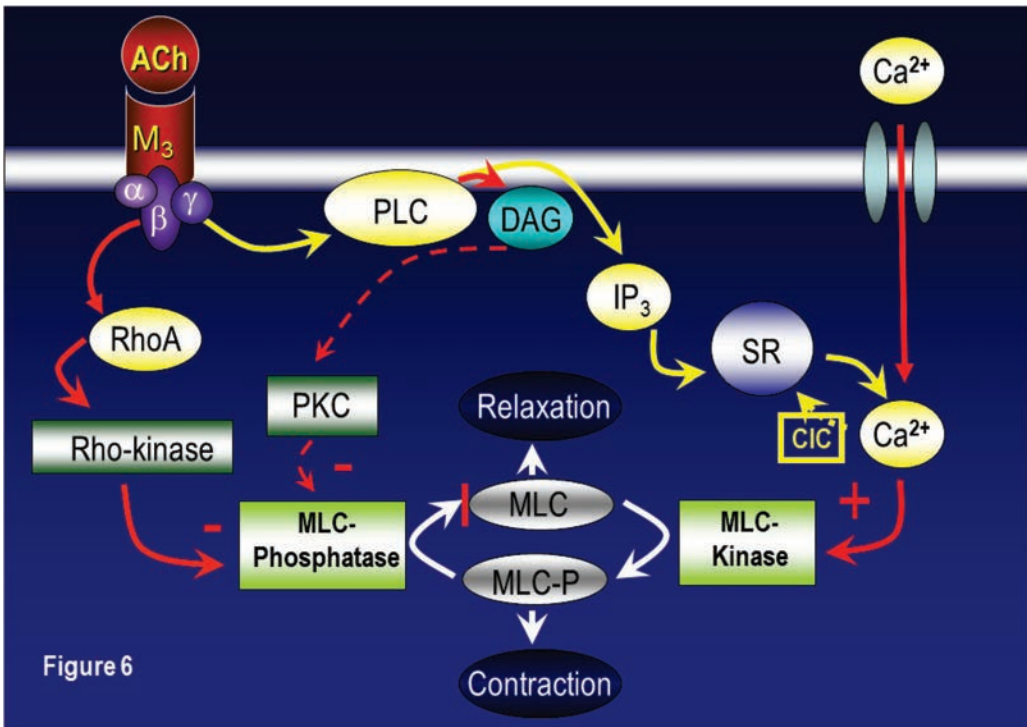

Figure 6: Muscarinic M3 receptor-mediated detrusor activation. Calcium influx and activation of the Rho-kinase system are the main pathways mediating activation of the contractile system in the detrusor.

al., 2006; Hegde et al., 1997; Hegde, 2006, Andersson, 2011]. Inhibitory pre-junctional muscarinic receptors have been classified as M₂ in the rabbit and rat, and M₄ in the guinea-pig, rat and human (d'Agostini et al., 1997; see Andersson, 2011) bladder. These receptors appear to be of the M₁ subtype in the rat and rabbit urinary bladder, but have also been detected in human bladders. The muscarinic facilitatory mechanism seems to be upregulated (M₃ receptors) in overactive bladders from chronic spinal cord transected rats.

Apparently, most muscarinic receptors in the bladder are found on the smooth muscle cells of the detrusor. While the detrusor expresses far more M₂ than M₃ receptors, it appears that detrusor contraction under physiological conditions is largely if not exclusively mediated by the M₃ receptor [Hegde et al., 1997; Chess-Williams et al., 2001; Fetscher et al., 2002; Kories et al., 2003; Schneider et al., 2004a; b]. Studies in knock-out mice confirm this conclusion [Matsui et al., 2000; 2002; Stengel et al., 2002; Ehler et al., 2007]. Under physiological conditions M₂ receptor-selective stimulation causes little contraction [Schneider et al., 2005a], but rather appears to act mainly by inhibiting β -adrenoceptor-mediated detrusor relaxation [Hegde et al., 1997; Ehler et al., 2007; Matsui et al., 2003]. It has been proposed that M₂ receptors can also directly elicit bladder contraction under pathological conditions [Braverman et al., 1998a, b; 2002; 2003; 2006; Pontari et al., 2003], but such observations have not been confirmed by other investigators using distinct methodological approaches [Schneider et al., 2005a; b].

Based upon the prototypical signalling pathway of M₃ receptors [Caulfield and Birdsall, 1998] and the presence of phospholipase C stimulation by muscarinic agonists in the bladder [Kories et al., 2003; Schneider et al., 2005a] it had originally been believed that muscarinic receptor-mediated contraction is largely mediated by an activation of phospholipase C [Ouslander, 2004]. While some earlier data had supported this concept, it now appears clear that, at least in rat, mice and humans, muscarinic receptor-mediated bladder contraction occurs largely independent of phospholipase C [Schneider et al., 2004a; b; Wegener et al., 2004; Frazier et al., 2007]. Rather, alternative signalling pathways such as opening of L-type calcium channels and activation of a rho-kinase (Figure 6) appear to contribute to muscarinic receptor-mediated bladder contraction in a major way [Frazier et al., 2008]. More recently, muscarinic receptors have also been identified in the urothelium [Chess-Williams, 2002; Kumar et al., 2005]. Similarly to the findings in bladder smooth muscle, the muscarinic receptors in the urothelium mainly belong to the M₂ and M₃ subtype, with the former dominating quantitatively [Mansfield et al., 2005; Bschieper et al., 2007]. At present the functional role of muscarinic receptors in the urothelium has largely been studied indirectly, i.e. by investigating the effects of urothelium removal or of administration of pharmacological inhibitors. These data indicate that muscarinic stimulation of the

urothelium causes release of an as yet unidentified factor which inhibits detrusor contraction [Hawthorn et al., 2000; Wuest et al., 2005; Sadananda et al., 2008]. Some data indicate that muscarinic receptors in the urothelium may partly act by releasing nitric oxide (NO) [Andersson et al., 2008]. Muscarinic receptor blockade in urothelial cells may also reduce ATP release induced by stretch [Young et al., 2012]. Thus, it appears that muscarinic receptors in the urothelium also contribute to the regulation of overall bladder function but their specific roles in health and disease have not been fully established.

Assuming an involvement of muscarinic receptors in physiological voiding contractions of the bladder, numerous studies have explored whether an overactivity of the muscarinic system may play a causative role in bladder dysfunction. This could involve, e.g., an enhanced expression of such receptors and/or an increased functional responsiveness. In vitro, an increased sensitivity to muscarinic receptor stimulation was found in both idiopathic and neurogenic overactive human detrusors [Stevens et al. 2006]. However, according to Michel and Barendrecht [2008] the overall balance of available studies suggests that the muscarinic receptor system is not hyperactive under conditions of DO and, if anything, can be even hypoactive [Michel and Barendrecht, 2008b]. This does not exclude a contribution to DO of ACh and muscarinic receptor stimulation during bladder filling (see below). It appears that the contribution of muscarinic mechanisms to the overall regulation of bladder contractility decreases in favour of non-cholinergic mechanisms under pathological conditions [Yoshida et al., 2001; 2008; Rapp et al., 2005]. These observations may help to explain the moderate efficacy of muscarinic receptor antagonists relative to placebo in controlled clinical studies [Herbison et al., 2003; Chapple et al., 2005; 2008; Novara et al., 2008; Shamlilyan et al., 2008; Buser et al., 2012].

II. DRUGS USED FOR TREATMENT OF OVERACTIVE BLADDER SYMPTOMS/DETRUSOR OVERACTIVITY

used for treatment (Table 2). Helfand and co-workers showed that in a cohort of 7,244,501 patients over 45 years with an OAB diagnosis, 24.4% of these were treated mainly with antimuscarinic agents; 75.6% went untreated. Only 25.6% of those treated were men. (Helfand et al., 2010). As underlined by several other subcommittees, drugs may be efficacious in some patients, but they do have side effects, and frequently are not continued indefinitely. Hence it would be worth considering them as an adjunct to conservative therapy.

It has been estimated that more than 50 million people in the developed world are affected by urinary incontinence, and an abundance of drugs has been

Table 2: Drugs used in the treatment of LUTS/OAB/ DO. Assessments according to the Oxford system (modified)

	Level of Evidence	Grade of Recommendation
Antimuscarinic drugs 		
Atropine, hyoscyamine	3	C
Darifenacin	1	A
Fesoterodine	1	A
Imidafenacin	1	A
Propantheline	2	B
Solifenacin	1	A
Tolterodine	1	A
Trospium	1	A
Drugs with mixed actions		
Oxybutynin	1	A
Propiverine	1	A
Flavoxate	2	D
Drugs acting on membrane channels		
Calcium antagonists	2	D
K-Channel openers	2	D
Antidepressants		
Imipramine	3	C
Duloxetine	2	C
Alpha-AR antagonists		
Alfuzosin	3	C
Doxazosin	3	C
Prazosin	3	C
Terazosin	3	C
Tamsulosin	3	C
Silodosin	3	C
Naftopidil	3	C

	Level of Evidence	Grade of Recommendation
Beta-AR antagonists		
Terbutaline (beta 2)	3	C
Salbutamol (beta 2)	3	C
Mirabegron (beta 3)	1	A
PDE-5 Inhibitors+		
(Sildenafil, Tadalafil, Vardenafil)	1	B
COX-inhibitors		
Indomethacin	2	C
Flurbiprofen	2	C
Toxins		
Botulinum toxin (neurogenic)***	1	A
Botulinum toxin (idiopathic)***	1	A
Capsaicin (neurogenic)**	2	C
Resiniferatoxin (neurogenic)**	2	C
Other drugs		
Baclofen*	3	C
Hormones		
Estrogen	2	C
Desmopressin#	1	A

+(male LUTS/OAB); * intrathecal; ** intravesical; * bladder wall; #nocturia (nocturnal polyuria), caution hyponatremia, especially in the elderly!**

1. ANTIMUSCARINIC (ANTICHOLINERGIC) DRUGS

Mechanism of action. Antimuscarinics block, more or less selectively, muscarinic receptors irrespective of location [Abrams and Andersson, 2007; Andersson, 2011a; Sellers and Chess-Williams, 2012] (Figure 7). The common view is that in OAB/DO, the drugs act by blocking the muscarinic receptors on the detrusor muscle, which are stimulated by ACh, released from activated cholinergic (parasympathetic) nerves. Thereby, they decrease the ability of the bladder to contract. However, antimuscarinic drugs act mainly during the storage phase, decreasing urgency and increasing bladder capacity, and during this phase, there is normally no parasympathetic input to the lower urinary tract [Andersson, 2004, 2011b]. Furthermore, antimuscarinics are usually competitive antagonists.

This implies that when there is a massive release of ACh, as during micturition, the effects of the drugs should be decreased, otherwise the reduced ability of the detrusor to contract would eventually lead to uri-

nary retention. Undeniably, high doses of antimuscarinics can produce urinary retention in humans, but in the dose range used for beneficial effects in OAB/DO (Figure 8), there is little evidence for a significant reduction of the voiding contraction [Finney et al., 2006]. However, there is good experimental evidence that the drugs act during the storage phase by decreasing the activity in afferent nerves (both C- and A δ -fibres) from the bladder [De Laet et al., 2006; Iijima et al., 2007] (Figure 9).

As mentioned previously, muscarinic receptors are found on bladder urothelial cells where their density can be even higher than in detrusor muscle. The role of the urothelium in bladder activation has attracted much interest [Andersson, 2002a; Birder and de Groat, 2007, Birder and Andersson, 2013], but whether the muscarinic receptors on urothelial cells can influence micturition has not yet been established. Yoshida and colleagues [2004; 2006; 2008] found that there is basal ACh release in human bladder. This release was resistant to tetrodotoxin and much diminished when the urothelium was removed; thus, the released ACh was probably of non-neuronal origin and, at least partly, generated by the urothelium. There is also indirect clinical evidence for release of ACh during bladder filling. Smith et al. [1974]

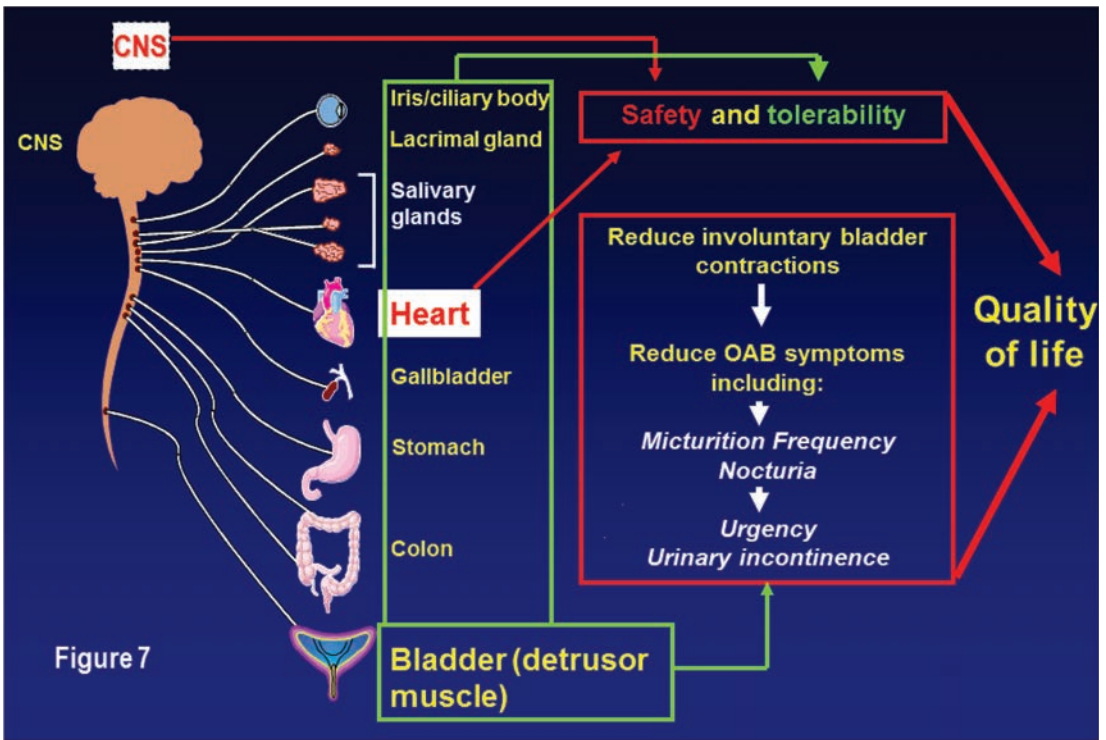

Figure 7: Important sites of action of antimuscarinics.

found that in patients with recent spinal-cord injury, inhibition of ACh breakdown by use of cholinesterase inhibitors could increase resting tone and induce rhythmic contractions in the bladder. Yossepowitch et al. [2001] inhibited ACh breakdown with edrophonium in a series of patients with disturbed voiding or urinary incontinence. They found a significant change in sensation and decreased bladder capacity, induction or amplification of involuntary detrusor contractions, or significantly decreased detrusor compliance in 78% of the patients with the symptom pattern of overactive bladder, but in no patients without specific complaints suggesting DO. Thus, during the storage phase, ACh and ATP may be released from both neuronal and non-neuronal sources (eg, the urothelium) and directly or indirectly (by increasing detrusor smooth muscle tone excite afferent nerves in the suburothelium and within the detrusor. These mechanisms may be important in the pathophysiology of OAB/DO and represent possible targets for antimuscarinic drugs.

Pharmacologic properties. Generally, antimuscarinics can be divided into tertiary and quaternary amines [Guay, 2003; Abrams and Andersson, 2007]. They differ with regards to lipophilicity, molecular charge, and even molecular size, tertiary compounds generally having higher lipophilicity and molecular charge than quaternary agents. Atropine, darifenacin, fesoterodine (and its active metabolite 5-hydroxymethyl-tolterodine), oxybutynin, propiverine, solifenacin, and tolterodine, are tertiary amines. They are generally well absorbed from the gastrointestinal tract and

should theoretically be able to pass into the CNS, dependent on their individual physicochemical properties. High lipophilicity, small molecular size, and less charge will increase the possibilities to pass the blood brain barrier, but in some cases, such as darifenacin, that is compensated by active transport out of the CNS by the product of the MDR1 gene. Quaternary ammonium compounds, like propantheline and trospium, are not well absorbed, pass into the CNS to a limited extent, and have a low incidence of CNS side effects [Guay, 2003]. They still produce well-known peripheral antimuscarinic side effects, such as accommodation paralysis, constipation, increases in heart rate, and dryness of mouth.

Many antimuscarinics are metabolized by the P450 enzyme system to active and/or inactive metabolites [Guay, 2003]. The most commonly involved P450 enzymes are CYP2D6, and CYP3A4. The metabolic conversion creates a risk for drug-drug interactions, resulting in either reduced (enzyme induction) or increased (enzyme inhibition, substrate competition) plasma concentration/effect of the antimuscarinic and/or interacting drug. Antimuscarinics secreted by the renal tubules (eg trospium) may theoretically be able to interfere with the elimination of other drugs using this mechanism. Some antimuscarinics and their active metabolites are excreted in urine in amounts that may affect the mucosal muscarinic receptors from the luminal side. This has not yet been demonstrated to imply superior clinical efficacy [Andersson et al., 2008b].

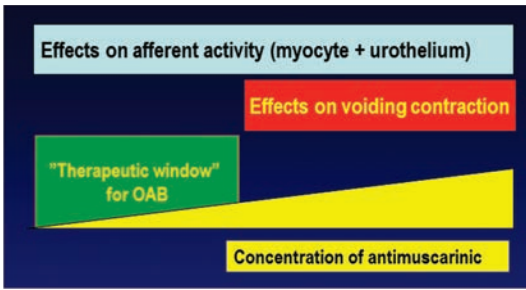

Figure 8: Rationale for use of antimuscarinics for treatment of OAB/DO. Blockade of muscarinic receptors at both detrusor and nondetrusor sites may prevent OAB symptoms and DO without depressing the contraction during voiding. The "Therapeutic window for OAB" can be obtained in most patients with recommended doses of antimuscarinics

Antimuscarinics are still the most widely used treatment for urgency and urgency incontinence [Andersson, 2004, Andersson et al., 2009]. However, currently used drugs lack selectivity for the bladder, and effects on other organ systems may result in side effects, which limit their usefulness. For example, all antimuscarinic drugs are contraindicated in untreated narrow angle glaucoma.

Theoretically, drugs with selectivity for the bladder could be obtained, if the subtype(s) mediating bladder contraction, and those producing the main side effects of antimuscarinic drugs, were different. Unfortunately, this does not seem to be the case. One way of avoiding many of the antimuscarinic side effects is to administer the drugs intravesically. However, this is practical only in a limited number of patients.

Several antimuscarinic drugs are and have been used for treatment of OAB/DO. For some of them, documentation of effects is not based on randomized controlled trials (RCTs) satisfying currently required criteria, and some drugs can be considered as obsolete (e.g., emepronium). Information on these drugs has not been included, but can be found elsewhere [Andersson, 1988; Andersson et al., 1999].

1.1. Antimuscarinics with "Specific" Action

Below data on the different antimuscarinics are presented. These drugs are assumed to block only muscarinic receptors (motivating the term "specific"). The amount of information for the individual drugs varies, and so does the degree of details from the different studies presented. However, the information has been chosen to give a reasonable efficacy and adverse effect profile of each individual drug.

1.1.1 Atropine Sulfate

Atropine (dl-hyoscyamine) is rarely used for treatment of OAB/DO because of its systemic side effects, which preclude its use as an oral treatment. However, in patients with neurogenic DO, intravesical atropine

may be effective for increasing bladder capacity without causing any systemic adverse effects, as shown in open pilot trials [Ekström et al., 1992; Glickman et al., 1995; Deaney et al., 1998; Enskat et al., 2001; Fader et al 2007]. It appears that intravesical atropine may be as effective as intravesical oxybutynin in patients with neurogenic DO [Fader et al., 2007].

The pharmacologically active antimuscarinic component of atropine is l-hyoscyamine. Although still used, few clinical studies are available to evaluate the antimuscarinic activity of l-hyoscyamine sulfate [Muskat et al., 1996]. For assessment, see Table 2.

1.1.2 Darifenacin Hydrobromide

Darifenacin is a tertiary amine with moderate lipophilicity, well absorbed from the gastrointestinal tract after oral administration, and extensively metabolised in the liver by the cytochrome P450 isoforms CYP3A4 and CYP2D6, the latter saturating within the therapeutic range [Skerjanec, 2006]. UK-148,993, UK-73,689, and UK-88862 are the three main circulating darifenacin metabolites of which only UK-148,993 is said to have significant anti-muscarinic activity. However, available information suggests that various metabolites of darifenacin contribute little to its clinical effects [Michel and Hegde, 2006]. The metabolism of darifenacin by CYP3A4 suggests that co-administration of a potent inhibitor of this enzyme

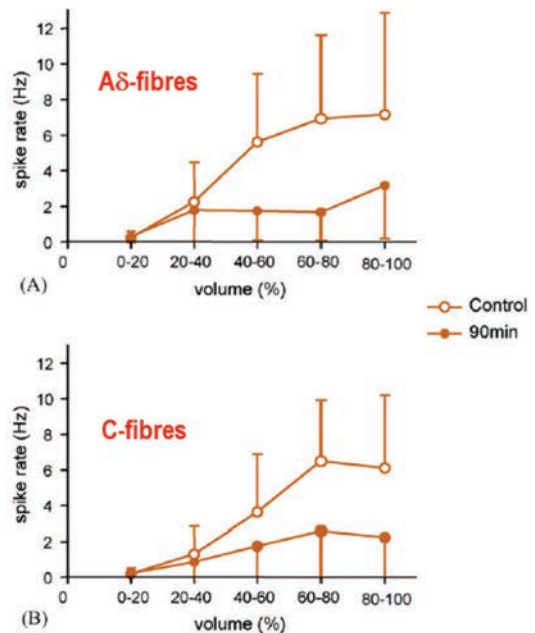

Figure 9: Effects of darifenacin on volume-related nerve activity in A δ afferents (A) and C afferents (B) in the rat pelvic nerve. From Iijima et al. Eur Urol. 2007 Sep;52(3):842

(e.g. ketoconazole) may lead to an increase in the circulating concentration of darifenacin [Kerbusch et al., 2003].

Darifenacin is a relatively selective muscarinic M₃ receptor antagonist. In vitro, it is selective for human cloned muscarinic M₃ receptors relative to M₁, M₂, M₄ or M₅ receptors. Theoretically, drugs with selectivity for the M₃ receptor can be expected to have clinical efficacy in OAB/DO with reduction of the adverse events related to the blockade of other muscarinic receptor subtypes [Andersson, 2002b]. However, the clinical efficacy and adverse effects of a drug are dependent not only on its profile of receptor affinity, but also on its pharmacokinetics, and on the importance of muscarinic receptors for a given organ function.

Darifenacin has been developed as a controlled-release formulation, which allows once-daily dosing. Recommended dosages are 7.5 and 15 mg per day. The clinical effectiveness of the drug has been documented in several RCTs [Haab et al., 2004; Cardozo and Dixon 2005; Steers et al., 2005; Chapple et al., 2005; Foote et al., 2005; Hill et al., 2006; Haab et al., 2006; Zinner et al., 2006, Chapple et al., 2007; Abrams et al., 2008, Chancellor et al., 2008; Dwyer et al., 2008; for reviews, see Guay, 2005; Zinner, 2007; Novara et al., 2008; Chapple et al., 2008b]. Haab et al. [2004] reported a multicentre, double-blind, placebo-controlled, parallel-group study which enrolled 561 patients (19–88 years; 85% female) with OAB symptoms for more than 6 months, and included some patients with prior exposure to antimuscarinic agents. After washout and a 2-week placebo run-in, patients were randomised (1:4:2:3) to once-daily oral darifenacin controlled-release tablets: 3.75 mg (n=53), 7.5 mg (n=229) or 15 mg (n=115) or matching placebo (n=164) for 12 weeks. Patients recorded daily incontinence episodes, micturition frequency, bladder capacity (mean volume voided), frequency of urgency, severity of urgency, incontinence episodes resulting in change of clothing or pads and nocturnal awakenings due to OAB using an electronic diary during weeks 2, 6 and 12 (directly preceding clinic visits). Tolerability data were evaluated from adverse event reports. Darifenacin 7.5 mg and 15 mg had a rapid onset of effect, with significant improvement compared with placebo being seen for most parameters at the first clinic visit (week 2). Darifenacin 7.5 mg and 15 mg, respectively, was significantly superior to placebo for (median) improvements in micturition frequency (7.5 mg: -1.6; 15 mg: -1.7; placebo -0.8, frequency of urgency per day (-2.0; -2.0; -0.9), and number of incontinence episodes leading to a change in clothing or pads (-4.0; -4.7; -2.0). There was no significant reduction in nocturnal awakenings due to OAB. The most common adverse events were mild-to-moderate dry mouth and constipation with a CNS and cardiac safety profile comparable to placebo. No patients withdrew from the study as a result of dry mouth and discontinuation related to constipation was rare (0.6% placebo versus 0.9% darifenacin).

In a dose titration study on 395 OAB patients, darifenacin, allowing individualized dosing (7.5 or 15 mg), was found to be effective and well-tolerated [Steers et al., 2005]. A 2-year open label extension study of these investigations [i.e., Haab et al., 2004; Steers et al., 2005], confirmed a favorable efficacy, tolerability and safety profile [Haab et al., 2006].

A review of the pooled darifenacin data from the three phase III, multicentre, double blind clinical trials in patients with OAB was reported by Chapple et al. [2005] After a 4-week washout/run-in period, 1,059 adults (85% female) with symptoms of OAB (urgency incontinence, urgency and frequency) for at least six months were randomized to once-daily oral treatment with darifenacin: 7.5 mg (n = 337) or 15 mg (n = 334) or matching placebo (n = 388) for 12 weeks. Efficacy was evaluated using electronic patient diaries that recorded incontinence episodes (including those resulting in a change of clothing or pads), frequency and severity of urgency, micturition frequency, and bladder capacity (volume voided). Safety was evaluated by analysis of treatment-related adverse events, withdrawal rates and laboratory tests. Relative to baseline, 12 weeks of treatment with darifenacin resulted in a dose-related significant reduction in median number of incontinence episodes per week (7.5 mg, -8.8 [-68.4%; placebo -54%, P<0.04]; 15 mg, -10.6 [-76.8%; placebo 58%, p<0.001]. Significant decreases in the frequency and severity of urgency, micturition frequency, and number of incontinence episodes resulting in a change of clothing or pads were also apparent, along with an increase in bladder capacity. Darifenacin was well tolerated. The most common treatment-related adverse events were dry mouth and constipation, although together these resulted in few discontinuations (darifenacin 7.5 mg 0.6% of patients; darifenacin 15 mg 2.1%; placebo 0.3%). The incidence of CNS and cardiovascular adverse events were comparable to placebo. The results were confirmed in other RCTs, including also a pooled analysis of three phase III studies in older patients (≥65 years), showing that darifenacin (7.5 and 15 mg) had an excellent efficacy, tolerability and safety profile [Foote et al., 2005, Zinner et al., 2005; Hill et al. 2006].

The time-to effect with darifenacin was analysed in a pooled analysis of efficacy and safety data from 1,059 patients participating in three double-blind 12-week studies Khullar et al [2011]. Darifenacin significantly improved all OAB symptoms as early as 6 to 8 days.

One of the most noticeable clinical effects of antimuscarinics is their ability to reduce urgency and allow patients to postpone micturition. A study was conducted to assess the effect of darifenacin, on the 'warning time' associated with urinary urgency. This was a multicenter, randomized, double-blind, placebo-controlled study consisting of 2 weeks' washout, 2 weeks' medication-free run-in and a 2-week treatment phase [Cardozo and Dixon, 2005]. Warning time was defined as the time from the first sensation of urgency to voluntary micturition or incontinence

and was recorded via an electronic event recorder at baseline (visit 3) and study end (visit 4) during a 6-hour clinic-based monitoring period, with the subject instructed to delay micturition for as long as possible. During each monitoring period, up to three urgency-void cycles were recorded. Of the 72 subjects who entered the study, 67 had warning time data recorded at both baseline and study end and were included in the primary efficacy analysis (32 on darifenacin, 35 on placebo). Darifenacin treatment resulted in a significant ($p < 0.004$) increase in mean warning time with a median increase of 4.3 minutes compared with placebo (darifenacin group from 4.4 to 1.8 minutes; placebo from 7.0 to -1.0 minutes). Overall, 47% of darifenacin-treated subjects compared with 20% receiving placebo achieved a $\geq 30\%$ increase in mean warning time. There were methodological problems associated with this study; it utilized a dose of 30 mg (higher than the dose recommended for clinical use), the treatment period was short, it was conducted in a clinical-centred environment, the methodology carried with it a significant potential training effect, and the placebo group had higher baseline values than the treatment group. In another warning time study [Zinner et al., 2006] on 445 OAB patients, darifenacin treatment (15 mg) resulted in numerical increases in warning time, however, these were not significant compared to placebo.

Further studies have demonstrated that darifenacin treatment is associated with clinically relevant improvements on health related quality of life (HRQoL) in patients with OAB [Abrams et al., 2008], and such improvements were sustained as shown in a two-year extension study [Dwyer et al., 2008]. It was shown that neither the positive effects on micturition variables, nor on HRQoL produced by darifenacin (7.5 and 15 mg) were further enhanced by a behavioural modification programme including timed voiding, dietary modifications and Kegel exercises [Chancellor et al., 2008a].

Since darifenacin is a substrate for the P-glycoprotein drug efflux transporter [Miller et al., 2011; Chancellor et al., 2012], which is present both in the blood-brain and blood-ocular barriers, several clinical studies have been devoted to investigate possible effect of darifenacin on cognition. Neither in healthy volunteers (19-44 years) and healthy subjects (≥ 60 years), nor in volunteers 65 years or older, could any effect of darifenacin (3.75-15mg daily) be demonstrated, compared to placebo [Kay and Wesnes, 2005; Lipton et al., Kay et al., 2006; Kay and Ebinger 2008; Chancellor et al., 2012].

To study whether darifenacin had any effect on QT/QTc intervals [Serra et al., 2005] performed a 7-day, randomized, parallel-group study ($n = 188$) in healthy volunteers receiving once-daily darifenacin at steady-state therapeutic (15 mg) and suprathereapeutic (75 mg) doses, alongside controls receiving placebo or moxifloxacin (positive control, 400 mg) once daily. No significant increase in QTcF interval could be demonstrated compared with placebo. Mean

changes from baseline at pharmacokinetic T_{max} versus placebo were -0.4 and -2.2 milliseconds in the darifenacin 15mg and 75 mg groups, respectively, compared with +11.6 milliseconds in the moxifloxacin group ($P < .01$). The conclusion was that darifenacin does not prolong the QT/QTc interval.

Darifenacin 15 mg per day given to healthy volunteers did not change heart rate significantly compared to placebo [Olshansky et al., 2008].

The impact of darifenacin on constipation has been assessed in an analysis of the Phase III, IIIb and IV darifenacin published trials [Tack et al., 2012]. The pooled Phase III data, suggested 14.8% (50/337) of patients on darifenacin 7.5 mg/day and 21.3% (71/334) on 15 mg/day experienced constipation. Only 0.6% and 1.2% of patients taking darifenacin 7.5mg/day and 15mg /day, respectively, stopped treatment as a result of constipation. Furthermore, 3.3% [11/337] and 6.6% [22/334], in the darifenacin 7.5 mg/day and 15 mg/day, groups required concomitant laxative medications. At the end of a long-term study (2 years), the incidence of constipation was 20.9% (150/716) and 5.6% (40/716) of patients initiated use of fiber supplements, stool softeners or laxatives [Tack et al. 2012].

Assessment

Darifenacin has a well-documented beneficial effect in OAB/DO (Table 2), and tolerability and safety seems acceptable.

1.1.3 Fesoterodine Fumarate

Fesoterodine functions as an orally active prodrug that is converted to the active metabolite 5-hydroxymethyltolterodine (5-HMT) by non-specific esterases [Michel, 2008a; Malhotra et al., 2009a]. This compound, which is chemically identical to the 5-hydroxy metabolite of tolterodine, is a non-subtype selective muscarinic receptor antagonist [Ney et al., 2008]. All of the effects of fesoterodine in man are thought to be mediated via 5-HMT, since the parent compound remains undetectable upon oral dosing. 5-HMT is metabolized in the liver, but a significant part of 5-HMT is excreted renally without additional metabolism. Since the renal clearance of 5-HMT is about 250 mL/min, with $>15\%$ of the administered fesoterodine dose excreted as unchanged 5-HM, this raises the possibility that 5-HMT also could work from the luminal side of the bladder [Michel, 2008]. The bioavailability of fesoterodine, averaging 52%, was independent of food intake and the drug may be taken with or without a meal [Malhotra et al., 2009b]. Peak plasma concentration of 5-HMT is reached at 5 h following oral administration and has a half-life of 7-9 h [Malhotra et al., 2008]. The suggested starting dose, 4 mg/day, can be used in patients with moderately impaired renal or hepatic function due to the combination of renal excretion and hepatic metabolism of 5-HMT [Malhotra et al., 2009c; de Mey et al., 2011].

The clinical efficacy and tolerability of fesoterodine have been documented in several RCTs [Chapple et al., 2007; 2008c, Nitti et al., 2007; Dmochowski et al., 2010a; Herschhorn et al., 2010; Kaplan et al., 2011; Nitti et al., 2010; see Dell'Utri et al., 2012]. In a multicenter, double-blind, double-dummy RCT with tolterodine ER, 1132 patients were enrolled and received treatment [Chapple et al., 2007]. The trial showed that both the 4 and 8 mg doses of fesoterodine were effective in improving symptoms of OAB, with the 8 mg dose having a greater effect at the expense of a higher rate of dry mouth. There appeared to be little difference between fesoterodine 4 mg and tolterodine ER. Only one subject from the fesoterodine 8 mg group and one subject from the tolterodine ER group withdrew from the study due to dry mouth. The dose-response relationship was confirmed in another study that pooled data from two phase III RCTs [Khullar et al., 2008]. Fesoterodine 8 mg performed better than the 4 mg dose in improving urgency and UUI as recorded by 3-day bladder diary, offering the possibility of dose titration. Subsequently the Eight Trial, a large randomised double blind placebo controlled trial compared fesoterodine 8 and 4mgs (n=1745; who completed the study) (Chapple et al., 2014). At 12 weeks UUI, urgency, micturition frequency, diary dry rates, PPBC, UPS and OAB-q scores were significantly better with fesoterodine 8mg compared to 4mg or placebo. Dry mouth and constipation rates were 26.1% and 4%, 12.9% and 1.5%, 3.4% and 1.8% in the fesoterdoine 8mg, 4mg and placebo groups, respectively (Chapple et al., 2014).

A head to head placebo controlled trial has been completed comparing fesoterodine 8mg to tolterodine extended release 4mg and placebo [Herschhorn et al., 2010]. The study randomized 1,590 patients to assess the primary outcome of reduced urgency incontinence episodes at 12 weeks. Fesoterodine produced statistically significant improvements in urgency incontinence episodes, complete dry rates (64.0% vs. 57.2%, $p = 0.015$), mean voided volume per void (+32.9 ml vs. +23.5 ml, $p = 0.005$), and in patients' assessments of bladder related problems as measured by OAB questionnaire (except sleep domain), Patient Perception of Bladder Condition (40% vs. 33% with > 2 point improvement, $p < 0.001$), and Urgency Perception Scale (46% vs. 40% with improvement, $p = 0.014$) compared with tolterodine. The clinical significance of these statistically significant findings is questionable as there was no difference between agents with respect to number of micturitions, urgency episodes, and frequency-urgency sum per 24 hours. The improved efficacy of fesoterodine came at the cost of greater dry mouth (27.8% vs. 16.4%), headache (5.6% vs. 3.4%), constipation (5.4% vs. 4.1%), and withdrawal rates (6% vs. 4%). Nonetheless, this first head to head trial comparing two drugs in class supports the use of fesoterodine 8mg for additional benefit over tolterodine ER 4 mg.

Wyndaele et al. [2009] reported the first flexible-dose open-label fesoterodine trial, which was conducted at 80 different centres worldwide and comprised 516

participants (men and women) >18 years who self-reported OAB symptoms for at least 3 months before screening and had been treated with either tolterodine or tolterodine ER within 2 years without symptom improvement. Approximately 50% opted for dose escalation to 8 mg at week 4. Significant improvements from baseline to week 12 were observed in micturitions, urgency urinary incontinence episodes, micturition-related urgency episodes and severe micturition-related urgency episodes per 24 h. Significant improvements from baseline were observed in QoL parameters. Dry mouth (23%) and constipation (5%) were the most common adverse events; no safety issues were identified.

The largest double-blind, double-dummy, flexible-dose fesoterodine RCT, which was conducted at 210 different centres with a total of 2,417 patients enrolled, was performed by Kaplan et al. [2010]. All patients were healthy, >18 years of age and self-reported OAB symptoms for at least 3 months. The 960 patients who received fesoterodine 8 mg showed significantly greater mean improvements at week 12 in most efficacy parameters (diary variables) than those receiving either tolterodine ER or placebo; UUI and urgency episodes, micturition frequency and MVV. No statistically significant changes were shown in reduction of nocturnal micturitions compared with the tolterodine group, whereas when comparing the mean changes in nighttime micturition with the placebo group a significant difference was found. This phase III study confirmed the superiority of fesoterodine 8 mg over tolterodine ER 4 mg for improving of UUI and urgency episodes and 24-h micturitions but not for MVV and nocturia. In another RCT of flexible-dose fesoterodine, Dmchowski et al. [2010] reported statistically significant improvements at week 12 in the mean number of micturition per 24 h and in both UUI and urgency episodes. Between groups, difference in nocturnal micturition was not statistically significant.

A subsequent pooled analysis of 2 phase III trials confirmed superiority of fesoterodine 8mg to tolterodine ER 4mg [Ginsberg et al., 2013]. In women fesoterodine 8mg was superior to tolterodine at 12 weeks in UUI, urgency, micturition episodes, diary dry rates, PPBC, UPS and OAB-q scores. In men superiority with fesoterodine 8mg was only demonstrated for severe urgency and the symptom bother domain of the OAB-q. In women, dry mouth rates were 29%, 15%, 6%, constipation rates were 5%, 4%, 2%, urinary retention rates were <1%, <1%, 0% for fesoterdoine 8mg, tolterodine ER 4mg and placebo, respectively. In men, dry mouth rates were 21%, 13%, 5%, constipation rates were 5%, 3%, 1% and urinary retention rates were 2%, <1%, 2% for fesoterdoine 8mg, tolterodine ER 4mg and placebo, respectively [Ginsberg et al., 2013].

Kaplan et al. [2014] assessed fesoterodine 8mg and placebo in patients who had not responded to tolterodine ER 4mg (<50% reduction in UUI). At week 12 UUI and urgency episodes were significantly better in

the fesoterodine group but micturition episodes and diary dry rates were statistically no different compared to placebo. Patients with > 50% and >70% UUI episodes were greater in the fesoterodine 8mg group at 8 weeks. Furthermore, at 12 weeks, improvements in favor of fesoterodine compared to placebo were seen in PPBC, UPDS and OAB-q. Dry mouth and constipation were seen in 16.6 and 3.9% in the fesoterodine group and 4 and 1.3% in the placebo group, respectively [Kaplan et al., 2014].

Little is known on the impact of antimuscarinics on nocturnal urgency. Weiss et al. [2013], explored this in a multi-center randomized double blind placebo controlled 12-week flexible dosing trial in the US. In the fesoterodine group 61% were escalated at the clinicians' discretion to the 8mg dose. Nocturnal urgency episodes (-1.28 vs -1.07), nocturnal micturition episodes, nocturnal frequency-urgency sum (urgency sensations were rated on a 1-5 scale), were significantly better in the fesoterodine group. Interestingly, UUI per 24 hours was not statistically different between fesoterodine and placebo in this trial and the authors acknowledge there is no minimally important difference in nocturnal urgency episodes to ascertain clinical significance definitively. However, in an Asian post-hoc analysis of a double-blind placebo controlled trial of fesoterodine 4 and 8 mg involving 555 patients, fesoterodine was not statistically better than placebo in reducing nocturnal micturition episodes at 12 weeks [Yokoyama et al. 2014]. If patients with a nocturnal polyuria index of > 33% were excluded, fesoterodine 8mg was statistically better than placebo in reducing nocturnal micturition episodes. Undisturbed sleep increased in both fesoterodine arms (4mg – 80 minutes; 8mg – 74 minutes) but was only statistically significant in the 4mg dose compared with placebo (54 minutes). Significant improvements in the sleep / energy domain of the KHQ was seen in both fesoterodine groups compared to placebo.

Nitti et al. [2010] determined whether the presence of DO in patients with OAB and urgency urinary incontinence was a predictor of the response to treatment with fesoterodine in a phase 2 randomized, multicentre, placebo-controlled trial. They concluded that regardless of the presence of DO, the response to fesoterodine treatment was dose-proportional and associated with significant improvements in OAB symptoms, indicating that the response to OAB pharmacotherapy in patients with UUI was independent of the urodynamic diagnosis of DO.

Kelleher et al. [2008] evaluated the effect of fesoterodine on HRQoL in patients with OAB syndrome. Pooled data from two randomized placebo-controlled phase III studies [Chapple et al., 2007; Nitti et al., 2007] were analysed. Eligible patients were randomized to placebo or fesoterodine 4 or 8 mg for 12 weeks; one trial also included tolterodine extended release (tolterodine-ER) 4 mg. By the end of treatment, all active-treatment groups had significantly improved HRQoL compared with those on placebo. In a post hoc analysis of data pooled from these studies,

significant improvements in all KHQ domains, ICIQ-SF scores, and bladder related problems were observed at months 12 and 24 compared to open label baseline [Kelleher et al., 2012]. The authors concluded that treatment satisfaction was high throughout the open-label treatment regardless of gender and age.

A large post marketing study from Korea has confirmed the efficacy of fesoterodine in OAB [Kim et al. 2016]. The mean duration of symptoms was 165 days but interestingly, 63% had symptom duration of less than a week. Of the patients included, 92.7% (2879/3107), 76.8% (2387/3107), and 37.5% (1164/3107) reported having symptoms of urinary frequency, urgency, and UUI, respectively and mean fesoterodine treatment duration was 83.2±75.3 days. Frequency, urgency and UUI per 24 hours declined from 12.1 to 8.0, 3.7 to 1.3, and 1.1 to 0.3, respectively (all $p < 0.001$). Utilising the PPBC questionnaire the majority of patients reported their bladder condition caused some very minor problems (43.0%, 1265/2939) or no problems at all (22.2%, 651/2939). Adverse events were reported in 8.2%, with dry mouth in 5.4% and constipation in 1.5% [Kim et al. 2016].

Longer term effects were analysed in a pooled analysis of 2 open label extension studies which demonstrated sustained improvement in OAB with fesoterodine [Sand et al. 2012]. Mean duration of exposure was 21 months with 51% of patients receiving fesoterodine for ≥ 24 months. 77% elected to remain on fesoterodine 8mg during the open label extension. Discontinuations were seen in 51% before the 24-month visit with insufficient clinical response, adverse events or withdrawal of consent being the main reasons for stopping treatment. Significant improvements were seen in UUI, urgency and micturition episodes over the study period compared to open label baseline. The most common adverse events were dry mouth and constipation. Significant improvements in all KHQ domains (except general health domain), ICIQ-SF and perception of bladder related problems were seen at 12 and 24 months compared to the open label baseline [Kelleher et al. 2012]. During the extension study treatment satisfaction was seen in 96% and 97% at 12 and 24 months, respectively.

A post-hoc analysis of 2 fixed dose trials, stratified by age, suggested fesoterodine 4 and 8 mg doses were efficacious compared to placebo in those < 75 years of age, but only fesoterodine 8mg in those ≥ 75 years of age [Kraus et al. 2010]. As a result, the SOPHIA trial recruited patients ≥ 65 years of age with at least 30% of the population being older than 75 years of age, in this flexible fesoterodine dosing placebo controlled study [Wagg et al., 2013]. At week 4, 52% and 66% opted for dose escalation in the fesoterodine 4mg and placebo groups, respectively. At week 8 de-escalation was allowed and occurred in 4% and 3% in the fesoterodine and placebo groups, respectively. Urgency, severe urgency, micturition and nocturnal micturition episodes, as well as pad use significantly

improved in the fesoterodine group compared to placebo at 12 weeks. However, in the 46% who were OAB wet no significant difference in UUI episodes were demonstrated between the groups. Patient reported outcomes using the TBS, PPBC, UPS, OAB-S were significantly greater in the fesoterodine group compared to placebo. Age stratification ie less than or greater than 75 years of age did not alter the results. Mini mental state examination did not change from baseline to end of study and was not different between groups. Dry mouth and constipation rates were 33.9% vs 5.3% and 8.9% vs 2.5% in the fesoterodine and placebo groups, respectively. Central nervous system adverse events occurred very rarely and 6 patients went into retention (5 in the active arm). The authors concluded that fesoterodine was tolerated well and was efficacious in an elderly population [Wagg et al., 2013; 2015]). Subsequently Wagg et al. [2014], have published on a 12-week open label extension of this trial. Of the original 655 patients in the SOPHIA trial, 581 completed the open label extension with approximately half the population being male. Significant improvements were observed in bladder diary measures as well as patient reported outcome measures in those that originally had placebo who switched to fesoterodine and efficacy was maintained in those that were originally treated with fesoterodine by study end. Treatment withdrawal due to emergent adverse events were 9.1% in those switched to fesoterodine from placebo and 1.3% in those that continued with fesoterodine [Wagg et al. 2014]. Dubeau et al. [2014], looked at the use of fesoterodine with dose escalation/de-escalation design vs placebo in a vulnerable elderly population with complex co-morbidities. Patients had to have moderate bladder problems based on PPBC, UUI 2-15 episodes, daytime frequency ≥ 8 , vulnerable elderly score (VES-13) of ≥ 3 and a MMSE ≥ 20 . The proportion of patients who completed the study were similar in both groups. Approximately 50% of the population were greater than 75 years of age and both groups had complex patients with functional impairment and polypharmacy. Significant reductions in daytime micturition, daytime and nocturnal urgency, UUI episodes per 24 hours and a reduction for the need of absorbent products was seen with fesoterodine compared to placebo. A greater proportion reported improvements in their bladder condition based on PPBC and OAB-q scores and satisfaction were better in the fesoterodine group compared to placebo. In the fesoterodine group 9.3% vs 5% in the placebo group discontinued treatment due to adverse events. Dry mouth and constipation rates were 23.5% and 11%, respectively, in the fesoterodine group. Urinary retention occurred in 3.2% in those treated with fesoterodine but only 3/9 patients were catheterized. No significant changes in MMSE were observed. No significant changes in blood pressure or heart rate were observed in either group until end of study and there were no deaths [Dubeau et al. 2014].

Malhotra et al. [2010] performed a thorough QT study to investigate the effects of fesoterodine on cardiac

repolarization in a parallel-group study. Subjects were randomly assigned to receive double-blind fesoterodine 4 mg, fesoterodine 28 mg, or placebo or open-label moxifloxacin 400 mg (positive control) for 3 days. Electrocardiograms (ECGs) were obtained on Days -1 (baseline), 1, and 3. The primary analysis was the time-averaged changes from baseline for Fridericia's-corrected QT interval (QTcF) on Day 3. Among 261 subjects randomized to fesoterodine 4 mg (n = 64), fesoterodine 28 mg (n = 68), placebo (n = 65), or moxifloxacin 400 mg (n = 64), 256 completed the trial. The results indicated that fesoterodine is not associated with QTc prolongation or other ECG abnormalities at either therapeutic or supratherapeutic doses.

Assessment

Fesoterodine has a well-documented beneficial effect in OAB (Table 2) and has been studied in a variety of patient populations, and the adverse event profile seems acceptable.

1.1.4 Imidafenacin

Imidafenacin (KRP-197/ONO-8025,4-(2-methyl-1H-imidazol-1-yl)-2,2-diphenylbutanamide) is an antagonist for the muscarinic ACh receptor with higher affinities for M₃ and M₁ receptors than for the M₂ receptor. Metabolites of imidafenacin (M-2, M-4 and M-9) had low affinities for muscarinic ACh receptor subtypes [Kobayashi et al., 2007a, b]. The drug blocks pre- as well as postjunctional muscarinic receptors and was shown to block both detrusor contractions and acetylcholine release [Murakami et al., 2003]. The receptor binding affinity of imidafenacin in vitro was found to be significantly lower in the bladder than submaxillary gland or colon [Yamada et al., 2011], and in rats orally administered imidafenacin distributes predominantly to the bladder and exerts more selective and longer-lasting effect here than on other tissues. Whether this can be translated to the human situation has to be established before claims of clinical bladder selectivity can be made.

Imidafenacin is well absorbed from the gastrointestinal tract and its absolute bioavailability in human is 57.8% [Ohmori et al. 2007; Ohno et al. 2008]. It is rapidly absorbed with maximum plasma concentration occurring 1-3h after oral administration [Ohno et al. 2008]. Metabolites in the plasma are produced mainly by first-pass effects. The major enzymes responsible for the metabolism of the drug are CYP3A4 and UGT1A4. The oxidative metabolism is reduced by concomitant administration of CYP3A4 inhibitors. In contrast, imidafenacin and its metabolites have no inhibitory effect on the CYP-mediated metabolism of concomitant drugs [Kanayama et al. 2007].

Kitagawa et al. [2011] reported that the subjective efficacy of imidafenacin was observed from 3 days after the commencement of administration and that mean total OABSS decreased gradually during 2 weeks after administration.

A randomized, double-blind, placebo-controlled phase II dose-finding study in Japanese OAB patients was performed to evaluate the efficacy, safety/tolerability, and dose-response relationship of imidafenacin [Homma et al., 2008a]. Overall, 401 patients were enrolled and randomized for treatment with 0.1 mg of imidafenacin/day (99 patients), 0.2 mg of imidafenacin/day (100), 0.5 mg of imidafenacin/day (101), or a placebo (101). After 12 weeks of treatment, the number of incontinence episodes was reduced in a dose-dependent manner, and a significant difference between the imidafenacin treatment and the placebo was observed ($P < 0.0001$). Compared with the placebo, imidafenacin caused significant reductions in urgency incontinence, voiding frequency, and urinary urgency, and a significant increase in the urine volume voided per micturition. Imidafenacin was also well tolerated. The incidence of dry mouth in the imidafenacin groups increased dose-dependently. Even though the percentage of patients receiving 0.5 mg/day who discontinued treatment due to dry mouth was high (8.9%), the percentages in the 0.1 mg/day and 0.2 mg/day groups (1.0% and 0.0%, respectively) were comparable with that in the placebo group (0.0%).

A randomized, double-blind, placebo- and propiverine-controlled trial of 781 Japanese patients with OAB symptoms were conducted by Homma et al. [2009]. They were randomized to imidafenacin 0.1mg twice daily (324), propiverine 20mg once daily (310), or a placebo (147). After 12 weeks of treatment, a significantly larger reduction in the mean number of incontinence episodes was observed in the imidafenacin group than in the placebo group ($P < 0.0001$). The non-inferiority of imidafenacin compared with propiverine was confirmed for the reduction in using incontinence episodes ($P = 0.0014$, non-inferiority margin: 14.5%). Imidafenacin was well tolerated. The incidence of adverse events with imidafenacin was significantly lower than with propiverine ($P = 0.0101$). Dry mouth, the most common adverse event, was significantly more common in the propiverine group than in the imidafenacin group. There were no significant increases in either the imidafenacin or placebo group in the mean QTc interval, whereas there was a significant increase in the mean QTc interval in the propiverine group ($P < 0.0001$). However, there were no clinical arrhythmia and clinical arrhythmic events in any of the treatment groups. Similar results have also been published in a population of OAB patients in Korea [Park et al., 2014]. In this non-inferiority trial comparing imidafenacin (0.1mg twice daily) to propiverine (20 mg once daily), both drugs significantly improved OAB parameters and quality of life measures. Severity of dry mouth was better in the imidafenacin group. The authors concluded that imidafenacin was non-inferior to propiverine with a better adverse event profile [Park et al. 2014]. The long-term safety, tolerability, and efficacy imidafenacin 0.1 mg twice daily was studied in Japanese OAB patients [Homma and Yamaguchi, 2008b], of whom 478 received treatment

and 376 completed a 52-week program. Imidafenacin was well tolerated, the most common adverse event being a dry mouth (40.2% of the patients). Long-term treatment did not produce an increase in the frequency of adverse events compared with short-term treatment. A significant efficacy of the drug was observed from week 4 through week 52. After 52 weeks, imidafenacin produced mean changes from baseline in the number of incontinence episodes (-83.51%), urgency incontinence episodes (-84.21%), voiding frequency (-2.35 micturitions/day), urgency episodes (-70.53%), and volume voided per micturition (28.99 mL). There were also significant reductions from baseline in all domains of the King's Health Questionnaire. received the treatment and 376 patients completed the 52-week program. Imidafenacin had no significant effects on the corrected QT interval, vital signs, results from laboratory tests, or post-void residual volume. A 52-week prospective, open randomized comparative study to evaluate the efficacy and tolerability of imidafenacin (0.2 mg/day) and solifenacin (5 mg/day) was conducted in a total of 41 Japanese patients with untreated OAB [Zaito et al., 2011]. They were randomly assigned to imidafenacin and solifenacin groups. There was no difference in OABSS and KHQ scores between the two groups, but the severity and incidence of adverse events caused by the drugs showed increased differences between the groups with time. The severity of dry mouth and the incidence of constipation were significantly lower in the imidafenacin group ($P = 0.0092$ and $P = 0.0013$, resp.). An important limitation of this study is the low number of patients. Only 25 patients (17 males 8 females) were available for long-term analysis. Similar results were reported by Yokoyama et al. [2013] in their comparative long term study with equivalent efficacy and better tolerability for imidafenacin compared to solifenacin but high discontinuation rates in both arms at study end.

Two small open labelled studies and a post-hoc analysis of a large multi-center RCT of imidafenacin have suggested benefits on nocturia and/or nocturnal polyuria [Kadekawa et al., 2012; Wada et al., 2012; Yokoyama et al., 2013]. Wada et al. [2012] reported improvements in OAB symptoms, Pittsburgh Sleep Quality Index scores, nocturia episodes and nocturnal polyuria in patients older than 75 years with imidafenacin 0.1 mg twice daily. Patients whose main complaint was nocturia were treated with 0.1mg daily and after 4 weeks were allowed a dose escalation to 0.2 mg daily if required. This group showed significant improvements with regards to nocturia as well as other OAB parameters, OAB symptom score and IPSS-QoL index score [Kadekawa et al., 2012]. A stratified analysis of a large RCT showed that in 46 patients with nocturia and nocturnal polyuria (>33% urine production at night) imidafenacin 0.1mg twice daily after 12 weeks of treatment significantly reduced night-time micturition, nocturnal percentage of 24-hour production, and the interval to the first night-time void was significantly longer compared to placebo [Yokoyama et al., 2013].

In Korea a multi-center a non-inferiority phase IV trial of imidafenacin 0.1mg twice daily versus fesoterodine 4mg was conducted [Lee et al., 2013]. No significant differences were observed between the 2 treatments for OAB symptoms of KHQ scores. Dry mouth rates were 39.4 and 37.3% in the imidafenacin and fesoterodine groups, respectively and no statistically differences were shown for adverse events, blood pressure, pulse or residual volume between the groups. In another post marketing surveillance study imidafenacin was shown to be safe with dry rates of 8.5% and no significant deterioration in MMSE at 48 weeks, with an acceptable mild cognitive impairment conversion to dementia rate (3.6%) [Sakakibara et al., 2014].

Assessment

Imidafenacin is effective and has an acceptable tolerability (Table 2). However, the drug is not yet widely available in the Western countries.

1.1.5 Propantheline Bromide

Propantheline is a quaternary ammonium compound, non-selective for muscarinic receptor subtypes, which has a low (5 to 10%) and individually varying biological availability. It is metabolized (metabolites inactive) and has a short half-life (less than 2 h) [Beer-mann et al., 1972]. It is usually given in a dose of 15 to 30 mg 4 times daily, but to obtain an optimal effect, individual titration of the dose is necessary, and often higher dosages are required. Using this approach in 26 patients with detrusor overactivity contractions [Blaivas et al., 1980] in an open study obtained a complete clinical response in all patients but one, who did not tolerate more than propantheline 15 mg four times daily. The range of dosages varied from 7.5 to 60 mg four times daily. In contrast, Thüroff et al. [1991] comparing the effects of oxybutynin 5 mg three times daily, propantheline 15 mg three times daily, and placebo, in a randomized, double-blind, multicenter trial on the treatment of frequency, urgency and incontinence related to DO (154 patients), found no differences between the placebo and propantheline groups. In another randomized comparative trial with crossover design (23 women with idiopathic DO), and with dose titration, Holmes et al. [1991] found no differences in efficacy between oxybutynin and propantheline. Controlled randomized trials (n=6) reviewed by Thüroff et al [1998], confirmed a positive, but varying, response to the drug.

Assessment

Although the effect of propantheline on OAB/DO has not been well documented in controlled trials satisfying standards of today, it can be considered effective, and may, in individually titrated doses, be clinically useful (Table 2). No new studies on the use of this drug for treatment of OAB/DO seem to have been performed during the last decade.

1.1.6 Solifenacin Succinate

Solifenacin succinate (YM905) is a tertiary amine and well absorbed from the gastrointestinal tract (absolute bioavailability 90%). The mean terminal half-life is 45-68 hours [Kuipers et al., 2002; Smulders et al., 2002; 2004]. It undergoes significant hepatic metabolism involving the cytochrome P450 enzyme system (CYP3A4). In subjects who received a single oral dose of 10 mg solifenacin on day 7 of a 20-day regimen of ketoconazole administration (200 mg) C_{max} and AUC_{0-inf} were increased by only approximately 40% and 56%, respectively [Swart et al., 2006]. Solifenacin has a modest selectivity for M3 over M2 (and M1) receptors [Abrams and Andersson, 2007]. Supporting an effect on sensory function by solifenacin, 15 women with DO receiving 10 mg/day of the drug showed an increase in the area under the bladder-volume sensation curve [Lowenstein et al., 2012] Solifenacin also increased maximum bladder capacity, a finding in agreement with other studies [Tanaka et al., 2010; Hsiao et al., 2011]

Two large-scale phase 2 trials with parallel designs, comprising men and women, were performed [Smith et al., 2002; Chapple et al., 2004a]. The first dose-ranging study evaluated solifenacin 2.5 mg, 5 mg, 10 mg, and 20 mg and tolterodine (2 mg twice daily) in a multinational placebo-controlled study of 225 patients with urodynamically confirmed DO [Chapple et al., 2004a]. Patients received treatment for 4 weeks followed by 2 weeks of follow-up. Inclusion criteria for this and subsequent phase 3 studies of patients with OAB included at least 8 micturitions per 24 hours and either one episode of incontinence or one episode of urgency daily as recorded in 3-day micturition diaries. Micturition frequency, the primary efficacy variable, was statistically significantly reduced in patients taking solifenacin 5 mg (-2.21), 10 mg (-2.47), and 20 mg (-2.75), but not in patients receiving placebo (-1.03) or tolterodine (-1.79). This effect was rapid with most of the effect observed at the earliest assessment visit, 2 weeks after treatment initiation. In addition, there was numerically greater reductions in episodes of urgency and incontinence when compared with placebo. Study discontinuations due to adverse events were similar across treatment groups, albeit highest in the 20-mg solifenacin group. As the 5 mg and 10 mg doses caused lower rates of dry mouth than tolterodine, and superior efficacy outcomes relative to placebo, these dosing strengths were selected for further evaluation in large-scale phase 3 studies.

The second dose-ranging study of solifenacin 2.5 mg to 20 mg was carried out in the United States (USA) [Smith et al., 2002]. This trial included 261 evaluable men and women receiving solifenacin or placebo for 4 weeks followed by a 2-week follow-up period. Micturition frequency was statistically significantly reduced relative to placebo in patients receiving 10 mg and 20 mg solifenacin. The number of micturitions per 24 hours showed reductions by day 7 and continued to decrease through day 28; day 7 was the earliest time point tested in solifenacin trials and these findings demonstrate efficacy as early as one week. The 5 mg, 10 mg, and 20 mg dosing groups experienced statistically significant increases in volume voided; the 10 mg solifenacin dose was associated with statistically significant reductions in episodes of incontinence.

In one of the early RCTs, a total of 1077 patients were randomized to 5 mg solifenacin, 10 mg solifenacin, tolterodine (2 mg twice daily), or placebo [Chapple et al., 2004b]. It should be noted that this study was powered only to compare active treatments to placebo. Compared with placebo (-8%), mean micturitions/24 h were significantly reduced with solifenacin 10 mg (-20%), solifenacin 5 mg (-17%), and tolterodine (-15%). Solifenacin was well tolerated, with few patients discontinuing treatment. Incidences of dry mouth were 4.9% with placebo, 14.0% with solifenacin 5 mg, 21.3% with solifenacin 10 mg, and 18.6% with tolterodine 2 mg twice daily.

Cardozo et al. [2004] randomized 911 patients to 12-week once daily treatment with solifenacin 5 mg, solifenacin 10 mg or placebo. The primary efficacy variable was change from baseline to study end point in mean number of micturitions per 24 hours. Secondary efficacy variables included changes from baseline in mean number of urgency, nocturia and incontinence episodes per 24 hours, and mean volume voided per micturition. Compared with changes obtained with placebo (-1.6), the number of micturitions per 24 hours was statistically significantly decreased with solifenacin 5 mg (-2.37) and 10 mg (-2.81). A statistically significant decrease was observed in the number of all incontinence episodes with both solifenacin doses (5 mg: -1.63, 61%; 10 mg: -1.57, 52%), but not with placebo (-1.25, 28%). Of patients reporting incontinence at baseline, 50% achieved continence after treatment with solifenacin (based on a 3-day micturition diary, placebo responses not given). Episodes of nocturia were statistically significantly decreased in patients treated with solifenacin 10 mg versus placebo. Episodes of urgency and mean volume voided per micturition were statistically significantly reduced with solifenacin 5 mg and 10 mg. Treatment with solifenacin was well tolerated. Dry mouth, mostly mild in severity, was reported in 7.7% of patients receiving solifenacin 5 mg and 23% receiving solifenacin 10 mg (vs 2.3% with placebo). A 40-week follow up of these studies [i.e., Chapple et al., 2004b and Cardozo et al., 2004a] demonstrated that the favourable profile, both in terms of efficacy and

tolerability was maintained over the study period [Haab et al., 2005].

The STAR trial [Chapple et al., 2005; 2007] was a prospective, double blind, double-dummy, two-arm, parallel-group, 12-week study was conducted to compare the efficacy and safety of solifenacin 5 or 10 mg and TOLT-ER 4 mg once daily in OAB patients. The primary effect variable was micturition frequency. After 4 weeks of treatment patients had the option to request a dose increase, but were dummied throughout as approved product labelling only allowed an increase for those on solifenacin. The results showed that solifenacin, with a flexible dosing regimen, was "non-inferior" to tolterodine concerning the primary effect variable, micturition frequency. However, solifenacin showed significant greater efficacy to tolterodine in decreasing urgency episodes (-2.85 vs -2.42), incontinence (-1.60 vs -.83), urgency incontinence (-1.42 vs -0.83), and pad usage (-1.72 vs -1.19). More solifenacin treated patients became continent by study endpoint (59 vs 49%) and reported improvements in perception of bladder condition (-1.51 vs -1.33) assessments. However, this was accompanied by an adverse event incidence which was greater with solifenacin than with tolterodine. Dry mouth and constipation (mild + moderate + severe) were the most common (solifenacin 30 and 6.4%, tolterodine 23 and 2.5%). The majority of side effects were mild to moderate in nature, and discontinuations were comparable and low (5.9 and 7.3%) in both groups. In the SUNRISE trial solifenacin 5/10mg was significantly effective in reducing urgency and urgency bother when compared to placebo with changes noticeable as early as day 3 [Cardozo et al. 2008]. In this flexible dosing trial, 591 patients received solifenacin 5mg at 8 weeks, and 46.5% requested a dose increase to 10mg and were further randomized for 8 weeks into solifenacin 5 or 10 mgs [Cardozo et al. 2013]. Those that requested dose escalation had a greater severity of OAB at baseline. Solifenacin 10 mg at end of study compared to week 8 was statistically better than solifenacin 5mg for maximum urgency intensity, total urgency score and micturition frequency. PPBC and treatment satisfaction were not statistically different between the groups. Adverse events were generally low and dry mouth rates were 0.7 and 5.7% for solifenacin 5 and 10 mg, respectively [Cardozo et al. 2013].

Luo et al. [2012] performed a systematic review and meta-analysis of solifenacin RCTs and provided a comprehensive assessment regarding the efficacy and safety of the drug. Their results which largely confirmed what could be deduced from previously published information, indicated that solifenacin could significantly decrease the number of urgency episodes per 24 h, micturitions per 24 h, incontinence episodes per 24 h, nighttime micturitions per 24 h, and UII episodes per 24 h, and improve volume voided per micturitions compared with the placebo or tolterodine treatment.

A number of studies and reviews have further documented the effects of solifenacin [Cardozo et al., 2006; Chapple et al., 2006; 2007; Maniscalco et al., 2006, see also Chapple et al., 2005; Novara et al., 2008; Toglia et al., 2009; Vardy et al., 2009; Bolduc et al., 2010; Serels et al., 2010; Luo et al., 2012], including men with OAB without bladder outlet obstruction [Kaplan et al., 2010;] In a pooled analysis of four RCTs, Abrams and Swift [2005] demonstrated positive effects on urgency, frequency and nocturia symptoms in OAB dry patients. In an analysis of four phase III clinical trials, Brubaker and FitzGerald [2007] confirmed a significant effect of solifenacin 5 and 10 mg on nocturia in patients with OAB (reductions of nocturia episodes with 5 mg: -0.6, $p < 0.025$; with 10 mg: -0.6, $p < 0.001$ vs placebo: -0.4) but without nocturnal polyuria. A positive impact on nocturia and sleep quality in patients with OAB treated with solifenacin has also been reported in other studies [Takao et al., 2011; Yokoyama et al., 2011; Kelleher et al. [2006] and Staskin and Te [2006] presented data showing efficacy in patients with mixed incontinence.

A pooled analysis of four studies confirmed the efficacy and tolerability of solifenacin 5 and 10 mg in elderly (≥ 65 years) patients, and also showed a high level of persistence in a 40-week extension trial [Wagg et al., 2006]. Post-hoc analysis of two 12-week, open label, flexible-dosing studies on 2645 patients over 65 years of age with OAB, revealed that solifenacin was associated with improvements in measures assessing patients' perception of their bladder problems, symptom bother, and aspects of health-related quality of life [Capo et al., 2011]. Solifenacin was equally well tolerated in younger (< 65 years) and older (> 65 years) patients [Herschorn et al., 2001b]. An exploratory pilot study with single doses of solifenacin 10 mg to 12 elderly volunteers suggested no clear propensity to impair cognitive functions [Wesnes et al., 2009]. In the SENIOR study 26 patients with mild cognitive impairment were assessed with 3 treatments of 21 days each (solifenacin 5 mg, oxybutynin 5 mg twice daily and placebo) with suitable washout periods between treatments [Wagg et al., 2013]. Neither solifenacin nor oxybutynin was associated with significant changes from baseline in power of attention, continuity of attention, quality of working memory, quality of episodic memory, and speed of memory. However, in a post-hoc secondary analysis, oxybutynin was associated with significant decreases in power and continuity of attention versus placebo at 1-2h post-dose.

Improvement of QoL by solifenacin treatment has been documented in several studies [Kelleher et al., 2005; Garely et al., 2006]. In 30 patients with multiple sclerosis, van Rey and Heesakkers [2011] improved OAB symptoms as well as neurogenic disease-specific QoL measures.

Recently the SONIC trial assessed efficacy and tolerability of solifenacin in patients with multiple sclerosis (MS) and spinal cord injury (SCI) in a prospective ran-

domized phase IIIb/IV parallel group study [Amarenco et al., 2015]. Approximately a quarter of the patients were taking muscle relaxants to help with spasticity. Patients were randomized to solifenacin 5mg, solifenacin 10mg, oxybutynin 5mgs three times daily or placebo for 4 weeks after a placebo run-in. The primary analysis was solifenacin 10mg vs placebo. The majority of MS patients were female and the majority of SCI patients were male. The primary endpoint of maximum cystometric capacity was significantly increased with solifenacin 10mg (134 mL) compared with placebo (5 mL). Furthermore, significant improvements were also observed with regards to bladder volume at first contraction and at first leak as well as detrusor pressure at first leak. PPBC and I-QoL sub scales significantly improved in favor of solifenacin 10mg compared to placebo. Significant improvements were also seen for oxybutynin compared to placebo but the trial was not designed to compare outcomes of the different active treatments [Amarenco et al. 2015]. The overall incidence of adverse events were low and dry mouth rates were 2.3%, 4.2%, 7.8% and 17% for placebo, solifenacin 5 mg, solifenacin 10mg and oxybutynin 5 mgs three times daily, respectively.

Persistence with solifenacin use has recently been assessed in a 12-month multi-center observational study involving 1018 OAB patients from Korea [Kim et al. 2016]. At the final study follow-up at 52 weeks only 22.1% of patients were still using solifenacin. Persistence rates were 72.4%, 45.8% and 31.1% at 12, 24 and 36 weeks. Reasons for discontinuation included symptom improvement in 30.4%, lack of efficacy in 13.4% and switch to another antimuscarinic in 10.8%. Older patients and females were more likely to persist with the treatment and nocturia episodes was negatively associated with persistence [Kim et al. 2016].

A non-interventional observational study in men alone ($n=799$) was conducted in multiple centers in Germany in a real life practice setting [Burger et al. 2014]. In this 12 week study the majority were taking solifenacin 5mg at study end (71%) and only 1.9% discontinued the treatment. Significant improvement in OAB symptoms were observed. In a subgroup of men with mild to moderate dementia, MMSE did not change significantly over the 12 weeks. Unusually dry mouth was only reported in 1.1% and mean PVR did not change. In 80% PVR did not change and in only 2.2% was the change ≥ 50 mL. No retention of urine was observed [Burger et al., 2014].

A recent trial assessed the use of solifenacin 5mg in patients with de novo OAB symptoms after an obturator mid urethral synthetic sling and compared this to a group who was stress incontinence treatment naïve [Serati et al., 2014]. Women with a pre-existing diagnosis of DO or who had OAB symptoms were excluded as were patients with significant voiding dysfunction or persistent stress incontinence. At 3-month follow-up, interestingly, the reduction in all OAB symptoms, PGI-I and OAB-q SF scores were

significantly better in the stress incontinent naïve group compared with the de novo OAB group [Serati et al., 2014].

Information on solifenacin treatment in children is scarce. Chart review of 138 children with therapy resistant OAB, treated with solifenacin, increased mean voided volume and improved continence [Hoebeke et al., 2009]. Recently an open labelled study utilizing solifenacin doses 1.25-10mg in children with refractory incontinence was reported [Nadeau et al., 2014]. In total 112 girls and 132 boys were included (191 had IDO and 53 NDO) with mean age of 9.2 years at start of treatment. Significant improvements were seen in urodynamic parameters, PPBC, UI episodes with the dry rate being 36%. Treatment outcomes were more successful for IDO than NDO. The majority of patients reported no side effects (n=175).

In female volunteers, aged 19 to 79 years, the effect of 10 mg and 30 mg solifenacin on the QT interval was evaluated at the time of peak solifenacin plasma concentration in a multi-dose, randomized, double-blind, placebo and positive-controlled (moxifloxacin 400 mg) trial [Product monograph, Vesicare]. The QT interval prolonging effect appeared greater for the 30 mg (8 msec, 4, 13: 90%CI) compared to the 10 mg (2 msec, -3, 6) dose of solifenacin. Although the effect of the highest solifenacin dose (three times the maximum therapeutic dose) studied did not appear as large as that of the positive control moxifloxacin at its therapeutic dose, the confidence intervals overlapped. This study was not designed to draw direct statistical conclusions between the drugs or the dose levels.

Michel et al. [2008] studied cardiovascular safety and overall tolerability of solifenacin in routine clinical use in a 12-week, open-label, post-marketing surveillance study. They concluded that “in real-life conditions, i.e. with inclusion of large numbers of patients with cardiovascular co-morbidities and taking comedications, therapeutically effective doses of solifenacin did not increase heart rate or blood pressure”.

Assessment

Solifenacin has a well-documented beneficial effect in OAB/DO (Table 2), and the adverse event profile seems acceptable.

1.1.7 Tolterodine Tartrate

Tolterodine is a tertiary amine, rapidly absorbed and extensive metabolized by the cytochrome P450 system (CYP 2D6). The major active 5-hydroxymethyl metabolite (5-HMT) has a similar pharmacological profile as the mother compound [Nilvebrant et al., 1997a], and significantly contributes to the therapeutic effect of tolterodine [Brynne et al., 1997; Brynne et al., 1998]. Both tolterodine and 5-HMT have plasma half-lives of 2-3 h, but the effects on the bladder seem to be more long-lasting than could be expected from the pharmacokinetic data. Urinary excretion of tolterodine accounted for <1-2.4 % of the dose; 5 – 14% of

5-HMT is eliminated in the urine (Brynne et al., 1997). Whether or not the total antimuscarinic activity of unchanged tolterodine and 5-HMT excreted in urine is sufficient to exert any effect on the mucosal signaling mechanisms has not been established. However, the preliminary studies by Kim et al. [2006] and Chuang et al. [2008], do not support such an effect.

The relatively low lipophilicity of tolterodine and even lesser one of 5-HMT, implies limited propensity to penetrate into the CNS, which may explain a low incidence of cognitive side effects [Hills et al., 1998; Clemett et al., 2001; Salvatore et al., 2008]. However, tolterodine may disturb sleep in subjects unable to form the even less lipophilic 5-HMT due to a low activity of CYP 2D6 [Diefenbach et al., 2008].

Tolterodine has no selectivity for muscarinic receptor subtypes, but is claimed to have functional selectivity for the bladder over the salivary glands [Stahl et al., 1995; Nilvebrant et al. 1997b]. In healthy volunteers, orally given tolterodine in a high dose (6.4 mg) had a powerful inhibitory effect on micturition and also reduced stimulated salivation 1 hour after administration of the drug [Stahl et al., 1995]. However, 5 hours after administration, the effects on the urinary bladder were maintained, whereas no significant effects on salivation could be demonstrated.

Animal experiments have suggested that antimuscarinics may affect signaling from the bladder [Anderson, 2011b]. Confirming data in humans were found by Vijaya et al. [2012]. In a randomized, placebo-controlled study, they evaluated the effect of tolterodine on urethral and bladder afferent nerves in women with DO in comparison to placebo by studying the changes in the current perception threshold (CPT). They found a significantly increased CPT value at 5 (described as urgency) and 250 Hz upon both urethral and bladder stimulation after 1 week of treatment. When compared with placebo, women taking tolterodine had significantly increased bladder CPT values at 5 Hz (P-value <0.05).

Tolterodine is available as immediate-release (TOLT-IR; 1 or 2 mg; twice daily dosing) and extended-release (TOLT-ER) forms (2 or 4 mg; once daily dosing). The ER form seems to have advantages over the IR form in terms of both efficacy and tolerability [Van Kerrebroeck et al. 2001].

Several randomised, double blind, placebo-controlled studies on patients with OAB/DO (both idiopathic and neurogenic DO), have documented a significant reduction in micturition frequency and number of incontinence episodes [Hills et al., 1998; Clemett et al., 2001; Salvatore et al., 2008]. Comparative RCTs such as the OBJECT (Overactive Bladder: Judging Effective Control and Treatment), and the OPERA (Overactive Bladder; Performance of Extended Release Agents) studies have further supported its effectiveness.

The OBJECT trial compared oxybutynin ER (OXY-ER) 10 mg once daily with TOLT-IR 2 mg twice daily

[Appell et al., 2001] in a 12-week randomized, double blind, parallel-group study including 378 patients with OAB. Participants had between 7 and 50 episodes of urgency incontinence per week and 10 or more voids in 24 hours. The outcome measures were the number of episodes of urgency incontinence, total incontinence, and micturition frequency at 12 weeks adjusted for baseline. At the end of the study, OXY-ER was found to be significantly more effective than TOLT-IR in each of the main outcome measures adjusted for baseline (see also below: oxybutynin chloride). Dry mouth, the most common adverse event, was reported by 33% and 28% of participants taking OXY-ER and TOLT-IR, respectively. Rates of central nervous system and other adverse events were low and similar in both groups. The authors concluded that OXY-ER was more effective than TOLT-IR and that the rates of dry mouth and other adverse events were similar in both treatment groups.

In the OPERA study [Diokno et al., 2003], OXY-ER at 10 mg/d or TOLT-ER at 4 mg/d were given for 12 weeks to women with 21 to 60 urgency incontinence episodes per week and an average of 10 or more voids per 24 hours. Episodes of incontinence episodes (primary end point), total (urgency and non-urgency) incontinence, and micturition were recorded in seven 24-hour urinary diaries at baseline and at weeks 2, 4, 8 and 12 and compared. Adverse events were also evaluated. Improvements in weekly urgency incontinence episodes were similar for the 790 women who received OXY-ER (n=391) or TOLT-ER (n=399). OXY-ER was significantly more effective than TOLT-ER in reducing micturition frequency, and 23.0% of women taking OXY-ER reported no episodes of urinary incontinence compared with 16.8% of women taking TOLT-ER. Dry mouth, usually mild, was more common with OXY-ER. Adverse events were generally mild and occurred at low rates, with both groups having similar discontinuation of treatment due to adverse events. The conclusions were that reductions in weekly urgency incontinence and total incontinence episodes were similar with the two drugs. Dry mouth was more common with OXY-ER, but tolerability was otherwise comparable, including adverse events involving the central nervous system.

In the ACET (Antimuscarinic Clinical Effectiveness Trial) [Sussman and Garely, 2002] study, which consisted of two trials, patients with OAB were randomized to 8 weeks of open-label treatment with either 2 mg or 4 mg of once-daily TOLT-ER (study one) and to 5 mg or 10 mg of OXY-ER (study two). A total of 1289 patients were included. Fewer patients prematurely withdrew from the trial in the TOLT-ER 4 mg group (12%) than either the OXY-ER 5 mg (19%) or OXY-ER 10 mg groups (21%). More patients in the OXY-ER 10 mg group than the TOLT-ER 4 mg group withdrew because of poor tolerability (13% vs. 6%). After 8 weeks, 70% of patients in the TOLT-ER 4 mg group perceived an improved bladder condition, compared with 60% in the TOLT-ER 2 mg group, 59% in the OXY-ER 5 mg group and 60% in the OXY-ER 10 mg group. Dry mouth was dose-dependent with both

agents, although differences between doses reached statistical significance only in the oxybutynin trial (OXY-ER 5 mg vs. OXY-ER 10 mg; $p=0.05$). Patients treated with TOLT-ER 4 mg reported a significantly lower severity of dry mouth compared with OXY-ER 10 mg. The conclusion that the findings suggest improved clinical efficacy of TOLT-ER (4 mg) than of OXY-ER (10 mg) is weakened by the open label design of the study.

Zinner et al. [2002] evaluated the efficacy, safety, and tolerability of TOLT-ER in older ($>$ or $=65$) and younger (<65) OAB patients, in a 12-week RCT including 1015 patients with urgency incontinence and urinary frequency. Patients were randomized to treatment with TOLT-ER 4 mg once daily ($n = 507$) or placebo ($n = 508$) for 12 weeks. Efficacy, measured with micturition charts (incontinence episodes, micturitions, volume voided per micturition) and subjective patient assessments, safety, and tolerability endpoints were evaluated, relative to placebo. Compared with placebo, significant improvements in micturition chart variables with TOLT-ER showed no age-related differences. Dry mouth (of any severity) was the most common adverse event in both the TOLT-ER and placebo treatment arms, irrespective of age (<65 : ER 22.7%, placebo 8.1%; $>$ or $=65$: ER 24.3%, placebo 7.2%). A few patients ($< 2\%$) experienced severe dry mouth. No central nervous system (cognitive functions were not specifically studied), visual, cardiac (per electrocardiogram), or laboratory safety concerns were noted in this study. Withdrawal rates due to adverse events on TOLT-ER 4 mg qd were comparable in the two age cohorts (<65 : 5.5%; $>$ or $=65$: 5.1%).

The central symptom in the OAB syndrome is urgency. Freeman et al. [2003] presented a secondary analysis of a double-blind, placebo-controlled study evaluating the effect of once-daily TOLT-ER on urinary urgency in patients with OAB. Patients with urinary frequency (eight or more micturitions per 24 hours) and urgency incontinence (five or more episodes per week) were randomized to oral treatment with TOLT-ER 4 mg once daily ($n=398$) or placebo ($n=374$) for 12 weeks. Efficacy was assessed by use of patient perception evaluations. Of patients treated with TOLT-ER, 44% reported improved urgency symptoms (compared with 32% for placebo), and 62% reported improved bladder symptoms (placebo, 48%). The proportion of patients unable to hold urine upon experiencing urgency was decreased by 58% with TOLT-ER, compared with 32% with placebo ($P<.001$).

In the Improvement in Patients: Assessing symptomatic Control with Tolterodine ER (IMPACT) study [Elinoff et al., 2005], the efficacy of TOLT-ER for patients' most bothersome OAB symptom was investigated in an open label, primary care setting. Patients with OAB symptoms for ≥ 3 months received TOLT-ER (4 mg once daily) for 12 weeks. By week 12, there were significant reductions in patients' most bothersome symptom: incontinence, urgency episodes,

nocturnal and daytime frequency. The most common adverse events were dry mouth (10%) and constipation (4%), and it was concluded that in primary care practice, bothersome OAB symptoms can be effectively and safely treated with TOLT-ER, even in patients with comorbid conditions.

Various aspects of the efficacy and tolerability of tolterodine have been further documented in a number of RCTs [Abrams et al., 2006; Dmochowski et al., 2007a; b; Bharucha et al., 2008; Choo et al., 2008; Coyne et al., 2008; Kaplan et al., 2008a; Rogers et al., 2008; Rovner et al., 2008a; b see further: Novara et al., 2008; Chapple et al., 2008]. Importantly, the QTc effects of tolterodine were determined in a cross-over-designed QT study of recommended (2 mg twice daily) and suprathreshold (4 mg twice daily) doses of tolterodine, moxifloxacin (400 mg once daily), and placebo was performed. No subject receiving tolterodine exceeded the clinically relevant thresholds of 500 ms absolute QTc or 60ms change from baseline, and it was concluded that tolterodine does not have a clinically significant effect on QT interval [Malhotra et al., 2007].

Olshansky et al. [2008] compared the effects on heart rate of TOLT-ER 4 mg/day with those of darifenacin 15 mg/day in healthy volunteers. They found that tolterodine, but not darifenacin, significantly increased mean heart rate per 24 hours. The proportion of subjects with an increase >5 beats/min was significantly greater in those receiving TOLT-ER (25% than with darifenacin (8.9%).

Hsiao et al. [2011] compared the urodynamic effects, therapeutic efficacy and safety of solifenacin [5 mg] versus tolterodine ER [4 mg] treatment in women with the OAB syndrome. Both solifenacin and tolterodine had similar urodynamic effects, therapeutic efficacy and adverse events, however, tolterodine had a greater effect in increasing heart rate than solifenacin.

In a prospective, open study, Song et al. [2006] compared the effects of bladder training and/or tolterodine as first line treatment in female patients with OAB. One hundred and thirty-nine female patients with OAB were randomized to treatment with bladder training (BT), tolterodine (2 mg twice daily) or both for 12 weeks. All treatments were efficacious, however, combination therapy was the most effective. Mattiasson et al. [2003] compared the efficacy of tolterodine 2 mg twice daily plus simplified bladder training (BT) with tolterodine alone in patients with OAB in a multicenter single blind study. At the end of the study the median percentage reduction in voiding frequency was greater with tolterodine + BT than with tolterodine alone (33% vs. 25%; $p < 0.001$), while the median percentage increase in volume voided per void was 31% with tolterodine + BT and 20% with tolterodine alone ($p < 0.001$). There was a median of 81% fewer incontinence episodes than at baseline with tolterodine alone, which was not significantly different from that with tolterodine + BT (-87%). It was

concluded that the effectiveness of tolterodine 2mg twice daily can be augmented by a simplified BT regimen. However, Millard et al. [2004] investigated whether the combination of tolterodine plus a simple pelvic floor muscle exercise program would provide improved treatment benefits compared with tolterodine alone in 480 patients with OAB. Tolterodine therapy for 24 weeks resulted in significant improvement in urgency, frequency, and incontinence, however, no additional benefit was demonstrated for a simple pelvic floor muscle exercise program. In a 16-week, multicenter, open label study tolterodine extended release plus behavioral intervention resulted in high treatment satisfaction and improved bladder diary variables in patients who had previously been treated and were dissatisfied with tolterodine or other antimuscarinics [Klutke et al., 2009]. More recently the combination of intravaginal oestradiol and tolterodine has been assessed to ascertain its impact on OAB [Ellington et al., 2016]. After 12 weeks of monotherapy with either tolterodine ER 4mg or oestradiol no significant differences in OAB symptom score or bladder diary was seen between the groups although within group changes were observed. In the extension study the addition of tolterodine ER to intravaginal oestradiol significantly improved OAB symptom bother score when compared to oestradiol alone [Ellington et al., 2016].

A large, 26-week, multicenter, randomized, double-blind, placebo-controlled, three-period crossover study enrolled women aged ≥ 18 years that were diagnosed with OAB and reported ≥ 8 micturitions/24 hr and ≥ 4 urgency episodes/week on 5-day bladder diary at baseline [Marenca et al. [2011]. Subjects were randomized to 1 of 10 treatment sequences and received three of five treatments, each for 4 weeks with 4-week washout periods: standard-dose pregabalin/tolterodine ER (150 mg twice daily [BID]/4 mg once daily [QD], $n=102$), pregabalin alone (150 mg BID, $n=105$), tolterodine ER alone (4 mg QD, $n=104$), low-dose pregabalin/tolterodine ER (75 mg BID/2 mg QD, $n=105$), and placebo ($n=103$). Subjects completed 5-day diaries at the end of treatment and washout periods. The primary endpoint was change from baseline to week 4 in mean voided volume (MVV) per micturition. Baseline-adjusted changes in MVV were significantly greater after treatment with standard-dose pregabalin/tolterodine ER (39.5 ml) versus tolterodine ER alone (15.5 ml; $P < 0.0001$), and with pregabalin alone (27.4 ml) versus tolterodine ER alone ($P=0.005$) and placebo (11.9 ml; $P=0.0006$). Treatments were generally well tolerated; discontinuation rates due to adverse events were 4%, 2%, 5%, 0%, and 1% with standard- and low-dose pregabalin/tolterodine ER, pregabalin, tolterodine ER, and placebo, respectively. See further section on Combinations].

Dmochowski et al. [2014] have recently assessed a new formulation of IR tolterodine 2mg with delayed release pilocarpine 9mg slow release twice daily. In this double-blind crossover trial with open label extension, combination of tolterodine and pilocarpine and

tolterodine alone were better than placebo at improving daily incontinence and micturition episodes, however were no different compared to each other. Dry mouth as assessed by VAS (0-100) were 20.9, 28.7 and 40.4 for placebo, tolterodine / pilocarpine and tolterodine alone, respectively. Other parameters such as general discomfort around the mouth and difficulty swallowing / chewing showed similar trends. The incidence of dry mouth in tolterodine / pilocarpine was similar to placebo (3.9% vs 5.3%). In the extension study patients were randomized to tolterodine 3mg and pilocarpine 13.5 mg twice daily or tolterodine ER 4mg once daily. Incidence of dry mouth were similar in the 2 groups despite the tolterodine / pilocarpine combination having 50% more tolterodine [Dmochowski et al. 2014].

Assessment

Both the IR and ER forms of tolterodine have a well-documented effect in OAB/DO (Table 2), and are well tolerated.

1.1.8 Trospium Chloride

Trospium is a quaternary ammonium compound with a biological availability less than 10% [Fusgen and Hauri, 2000; Doroshenko et al., 2005]. The drug has a plasma half-life of approximately 20 h, and is mainly (60% of the dose absorbed) eliminated unchanged in the urine. The concentration obtained in urine seems to be enough to affect the mucosal signaling system in a rat model [Kim et al., 2005]. Whether or not it contributes to the clinical efficacy of the drug remains to be established.

Trospium is not metabolized by the cytochrome P450 enzyme system [Beckmann-Knopp et al., 1999; Doroshenko et al., 2005]. It is expected to cross the blood-brain to a limited extent since it is a substrate for the drug-efflux transporter P-glycoprotein, which restricts its entry into the brain [Geyer et al., 2009]. This was demonstrated by Staskin et al. [2010], showing that trospium chloride levels in CSF samples were undetectable on Day 10 at steady-state peak plasma concentration concurrent with measurable peak plasma values. Clinically, trospium seems to have no negative cognitive effects [Fusgen and Hauri, 2000; Todorova et al., 2001; Wiedemann et al., 2002; Staskin et al., 2010; Chancellor et al., 2012].

Trospium has no selectivity for muscarinic receptor subtypes. In isolated detrusor muscle, it was more potent than oxybutynin and tolterodine to antagonize carbachol-induced contractions [Uckert et al., 2000].

Several RCTs have documented positive effects of trospium both in neurogenic [Stöhrer, et al., 1991; Madersbacher et al., 1995; Menarini et al., 2006] and non-neurogenic DO [Allousi et al., 1998; Cardozo et al., 2000; Junemann et al., 2000; Halaska et al., 2003; Zinner et al., 2004a; Rudy et al., 2006; Staskin et al., 2007; Dmochowski et al., 2008]. In a placebo-controlled, double blind study on patients with neurogenic DO [Stöhrer et al., 1991], the drug was given

twice daily in a dose of 20 mg over a 3-week period. It increased maximum cystometric capacity, decreased maximal detrusor pressure and increased compliance in the treatment group, whereas no effects were noted in the placebo group. Side effects were few and comparable in both groups. In another RCT including patients with spinal cord injuries and neurogenic DO, trospium and oxybutynin were equieffective; however, trospium seemed to have fewer side effects [Madersbacher et al., 1995].

The effect of trospium in urgency incontinence has been documented in several RCTs. Allousi et al. [1998] compared the effects of the drug with those of placebo in 309 patients in a urodynamic study of 3-weeks duration. Trospium 20 mg was given twice daily. Significant increases were noted in volume at first involuntary contraction and in maximum bladder capacity. Cardozo et al. [2000] investigated 208 patients with DO, who were treated with trospium 20 mg twice daily for two weeks. Also in this study, significant increases were found in mean volume at first unstable contraction (from 233 to 299 ml; placebo 254 to 255 ml) and in maximum bladder capacity (from 329 to 356 ml; placebo 345 to 335 ml) in the trospium treated group. Trospium was well tolerated with similar frequency of adverse effects as in the placebo group. Junemann et al. [2000] compared trospium 20 mg twice daily with tolterodine 2 mg twice daily in a placebo-controlled double-blind study on 232 patients with urodynamically proven DO, urgency incontinence without demonstrable DO, or mixed incontinence. Trospium reduced the frequency of micturition, which was the primary endpoint, more than tolterodine and placebo, and also reduced the number of incontinence episodes more than the comparators. Dry mouth was comparable in the trospium and tolterodine groups (7 and 9%, respectively).

Halaska et al. [2003] studied the tolerability and efficacy of trospium chloride in doses of 20 mg twice daily for long-term therapy in patients with urgency syndrome. The trial comprised a total of 358 patients with urgency syndrome or urgency incontinence. After randomisation in the ratio of 3:1, participants were treated continuously for 52 weeks with either trospium chloride (20 mg twice daily) or oxybutynin (5 mg twice daily). Urodynamic measurements were performed at the beginning, and at 26 and 52 weeks to determine the maximal cystometric bladder capacity. Analysis of the micturition diary clearly indicated a reduction of the micturition frequency, incontinence frequency, and a reduction of the number of urgency episodes in both treatment groups. Mean maximum cystometric bladder capacity increased during treatment with trospium chloride by 92 ml after 26 weeks and 115 ml after 52 weeks (P=0.001). Further comparison with oxybutynin did not reveal any statistically significant differences in urodynamic variables between the drugs. Adverse events occurred in 65% of the patients treated with trospium and 77% of those treated with oxybutynin. The main symptom encountered in both treatment groups was dryness of the mouth. An overall assessment for each of the drugs

revealed a comparable efficacy level and a better benefit-risk ratio for trospium than for oxybutynin due to better tolerability.

Zinner et al. [2004a] treated 523 patients with symptoms associated with OAB and urgency incontinence with 20 mg trospium twice daily or placebo in a 12-week, multicenter, parallel, double-blind, placebo controlled trial. Dual primary end points were change in average number of toilet voids and change in urgency incontinent episodes per 24 hours. Secondary efficacy variables were change in average of volume per void, voiding urgency severity, urinations during day and night, time to onset of action and change in Incontinence Impact Questionnaire. By week 12, trospium significantly decreased average frequency of toilet voids per 24 hours (-2.37) and urgency incontinent episodes 59% compared to placebo (-1.29; 44%). It significantly increased average volume per void (32 ml; placebo: 7.7) ml, and decreased average urgency severity and daytime frequency. All effects occurred by week 1 and all were sustained throughout the study. Nocturnal frequency decreased significantly by week 4 (-0.43; placebo: 0.17) - and Incontinence Impact Questionnaire scores improved at week 12. Trospium was well tolerated. The most common side effects were dry mouth (21.8%; placebo 6.5%), constipation (9.5%; placebo 3.8%) and headache (6.5%; placebo 4.6%). In a large US multicenter trial with the same design, and including 658 patients with OAB, Rudy et al. [2006] confirmed the data by Zinner et al [2004a], both with respect to efficacy and adverse effects.

Dose escalation seems to improve therapeutic efficacy. In a 12-week, randomised, double-blind, phase IIIb study including 1658 patients with urinary frequency plus urgency incontinence received trospium chloride 15 mg TID (n = 828) or 2.5 mg oxybutynin hydrochloride TID (n = 830). After four weeks, daily doses were doubled and not readjusted in 29.2% (242/828) of patients in the trospium group, and in 23.3% (193/830) in the oxybutynin group, until the end of treatment. At study end, there were no relevant differences between the "dose adjustment" subgroups and the respective "no dose adjustment" subgroups (trospium: P = 0.249; oxybutynin: P = 0.349). After dose escalation, worsening of dry mouth was higher in both dose adjusted subgroups compared to the respective "no dose adjustment" subgroups (P < 0.001). Worsening of dry mouth was lower in the trospium groups than in the oxybutynin groups [Bödeker et al., 2010].

An extended release formulation of trospium allowing once daily dosing, has been introduced [Silver et al., 2010], and its effects tested in controlled trials [Dmochowski et al., 2008; Staskin et al., 2009; Chancellor et al., 2010; MacDiarmid et al., 2011; Sand et al., 2011a; b; Zinner et al., 2011]. These studies demonstrated similar efficacy as found with previous formulations, but include experiences in e.g., elderly patients (>75 years), obese patients, and in patients who use multiple concomitant medications. In the

pooled analysis of 2 large phase III trials (n=1027), trospium chloride extended release 60 mg once daily significantly improved micturition and UUI episodes per 24 hours compared to placebo [Staskin et al. 2009]. Furthermore, trospium was superior to placebo in OAB symptom composite score, urgency episodes and mean voided volume. Dry mouth and constipation were the 2 commonest adverse events being 10.7% and 8.5% with trospium compared to 3.7% and 1.5% with placebo. The pooled analysis of the long-term extension study (n=667) with extended release once daily trospium chloride 60 mg daily also showed benefit in managing OAB [Zinner et al. 2011]. Significant improvements were seen in the placebo to trospium group and efficacy maintained in the trospium to trospium group by end of study. Approximately 85% of the population felt their symptoms were improved with trospium chloride treatment. Furthermore, significant improvements in quality of life were demonstrated when using the KHQ.

Intravesical application of trospium may be an interesting alternative. Frölich et al. [1998] performed a randomised, single-blind, placebo-controlled, monocentre clinical trial in 84 patients with urgency or urgency incontinence. Compared to placebo, intravesical trospium produced a significant increase in maximum bladder capacity and a decrease of detrusor pressure accompanied by an increase of residual urine. There was an improvement in uninhibited bladder contractions. No adverse events were reported. Interestingly, intravesical trospium does not seem to be absorbed [Walter et al., 1999], thus offering an opportunity for treatment with minimal systemic antimuscarinic effects.

Assessment

Trospium has a well-documented effect in OAB/DO, and tolerability and safety seems acceptable (Table 2).

1.2. Antimuscarinics with "Mixed" Action

Some drugs used for treatment of the OAB syndrome/DO have been shown to have more than one mechanism of action. They all have a more or less pronounced antimuscarinic effect and, in addition, an often poorly defined "direct" action on bladder muscle. For several of these drugs, the antimuscarinic effects can be demonstrated at much lower drug concentrations than the direct action, which may involve blockade of voltage operated Ca²⁺ channels. Most probably, the clinical effects of these drugs can be explained mainly by an antimuscarinic action. Among the drugs with mixed actions was terodiline, which was withdrawn from the market because it was suspected to cause polymorphic ventricular tachycardia (torsade de pointes) in some patients [Connolly et al., 1991; Stewart et al., 1992].

1.2.1 Oxybutynin Chloride

Oxybutynin is a tertiary amine that is well absorbed, and undergoes extensive upper gastrointestinal and

first-pass hepatic metabolism via the cytochrome P-450 system (CYP3A4) into multiple metabolites. The primary metabolite, N-desethyloxybutynin (DEO) has pharmacological properties similar to the parent compound [Waldeck et al., 1997], but occurs in much higher concentrations after oral administration [Hughes et al., 1992]. It has been implicated as the major cause of the troublesome side effect of dry mouth associated with the administration of oxybutynin. It seems reasonable to assume that the effect of oral oxybutynin to a large extent is exerted by the metabolite. The occurrence of an active metabolite may also explain the lack of correlation between plasma concentration of oxybutynin itself and side effects in geriatric patients reported by Ouslander et al. [1988]. The plasma half-life of the oxybutynin is approximately 2 hours, but with wide interindividual variation [Hughes et al., 1992; Douchamps et al., 1988].

Oxybutynin has several pharmacological effects *in vitro*, some of which seem difficult to relate to its effectiveness in the treatment of DO. It has both an antimuscarinic and a direct muscle relaxant effect, and, in addition, local anesthetic actions. The latter effect may be of importance when the drug is administered intravesically, but probably plays no role when it is given orally. *In vitro*, oxybutynin was 500 times weaker as a smooth muscle relaxant than as an antimuscarinic agent [Kachur et al., 1988]. Most probably, when given systemically, oxybutynin acts mainly as an antimuscarinic drug. Oxybutynin has a high affinity for muscarinic receptors in human bladder tissue and effectively blocks carbachol-induced contractions [Waldeck et al., 1997; Nilvebrant et al., 1988]. The drug was shown to have slightly higher affinity for muscarinic M₁ and M₃ receptors than for M₂ receptors [Nilvebrant et al., 1986; Norhona-Blob et al., 1991], but the clinical significance of this is unclear.

The immediate release (IR) form of oxybutynin (OXY-IR) is recognized for its efficacy and most of the newer anti-muscarinic agents have been compared to it once efficacy over placebo has been determined. In general, the new formulations of oxybutynin and other anti-muscarinic agents offer patients efficacy roughly equivalent to that of OXY-IR, and the advantage of the newer formulations lies in improved dosing schedules and side-effect profile [Appell et al., 2001; Diokno et al., 2003; Dmochowski et al., 2002]. An extended release oxybutynin (OXY-ER) once daily oral formulation and an oxybutynin transdermal delivery system (OXY-TDS) are available. OXY-TDS offers a twice-weekly dosing regimen and the potential for improved patient compliance and tolerability. Some of the available formulations of oxybutynin were overviewed by McCrery and Appell [2006].

1.2.1.1 Immediate-Release Oxybutynin (OXY-IR)

Several controlled studies have shown that OXY-IR is effective in controlling DO, including neurogenic DO [Yarker et al., 1995; Andersson and

Chapple, 2001]. The recommended oral dose of the IR form is 5 mg three times daily or four times daily, even if lower doses have been used. Thüroff et al. [1998] summarized 15 randomized controlled studies on a total of 476 patients treated with oxybutynin. The mean decrease in incontinence was recorded as 52% and the mean reduction in frequency per 24 h was 33% (data on placebo not presented). The overall "subjective improvement" rate was reported as 74 % (range 61% - 100%). The mean percent of patients reporting an adverse effect was 70 (range 17% - 93%). Oxybutynin, 7.5 to 15 mg/day, significantly improved quality of life of patients suffering from overactive bladder in a large open multicenter trial. In this study, patients' compliance was 97% and side effects, mainly dry mouth, were reported by only 8% of the patients [Amarenco et al., 1998]. In nursing home residents (n=75), Ouslander et al. [1995] found that oxybutynin did not add to the clinical effectiveness of prompted voiding in a placebo-controlled, double blind, cross-over trial. On the other hand, in another controlled trial in elderly subjects (n=57), oxybutynin with bladder training was found to be superior to bladder training alone [Szonyi et al., 1995].

Several open studies in patients with spinal cord injuries have suggested that oxybutynin, given orally or intravesically, can be of therapeutic benefit [Szollar et al., 1996; Kim et al., 1996].

The therapeutic effect of OXY-IR on DO is associated with a high incidence of side effects (up to 80% with oral administration). These are typically antimuscarinic in nature (dry mouth, constipation, drowsiness, blurred vision) and are often dose-limiting [Baigrie et al., 1988; Jonville et al., 1992]. The effects on the electrocardiogram of oxybutynin were studied in elderly patients with urinary incontinence [Hussain et al., 1998]; no changes were found. It cannot be excluded that the commonly recommended dose 5 mg x 3 is unnecessarily high in some patients, and that a starting dose of 2.5 mg x 2 with following dose-titration would reduce the number of adverse effects [Amarenco et al., 1998].

1.2.1.2 Extended Release Oxybutynin (OXY-ER)

This formulation was developed to decrease liver metabolite formation of desethyloxybutynin (DEO) with the presumption that it would result in decreased side effects, especially dry mouth, and improve patient compliance with remaining on oxybutynin therapy [see Arisco et al., 2009]. The formulation utilizes an osmotic system to release the drug at a controlled rate over 24 hours distally primarily into the large intestine where absorption is not subject to first-pass metabolism in the liver. This reduction in metabolism is meant to improve the rate of dry mouth complaints when compared to OXY-IR. DEO is still formed through the hepatic cytochrome P-450 enzymes, but clinical trials have indeed demonstrated improved dry mouth rates compared with OXY-IR [Appell et al.,

2003]. Salivary output studies have also been interesting. Two hours after administration of OXY-IR or TOLT-IR, salivary production decreased markedly and then gradually returned to normal. With OXY-ER, however, salivary output was maintained at predose levels throughout the day [Chancellor et al., 2001].

The effects of OXY-ER have been well documented [Siddiqui et al., 2004]. In the OBJECT study [Appell et al., 2001], the efficacy and tolerability of 10 mg OXY-ER was compared to a twice daily 2 mg dose of TOLT-IR. OXY-ER was statistically more effective than the TOLT-IR in weekly urgency incontinence episodes (OXY-ER from 25.6 to 6.1%; TOLT-IR 24.1 to 7.8), total incontinence (OXY-ER from 28.6 to 7.1%; TOLT-IR 27.0 to 9.3), and frequency (OXY-ER from 91.8 to 67.1%; TOLT-IR 91.6 to 71.5) and both medications were equally well tolerated. The basic study was repeated as the OPERA study [Diokno et al., 2003] with the difference that this study was a direct comparison of the two extended-release forms, OXY-ER (10 mg) and TOLT-ER (4 mg) and the results were quite different. In this study there was no significant difference in efficacy for the primary endpoint of urgency incontinence, however, TOLT-ER had a statistically lower incidence of dry mouth. OXY-ER was only statistically better at 10 mg than TOLT-ER 4 mg in the reduction of the rate of urinary frequency. These studies made it clear that in comparative studies IR entities of one drug should no longer be compared with ER entities of the other.

Greater reductions in urgency and total incontinence have been reported in patients treated in dose-escalation studies with OXY-ER. In two randomized studies, the efficacy and tolerability of OXY-ER were compared with OXY-IR. In a 1999 study [Anderson et al., 1999], 105 patients with urgency or mixed incontinence were randomized to receive 5-30 mg OXY-ER once daily or 5 mg of OXY-IR 1-4 times/day. Dose titrations began at 5 mg and the dose was increased every 4-7 days until one of three endpoints was achieved. These were 1) the patient reported no urgency incontinence during the final two days of the dosing period; 2) the maximum tolerable dose was reached; the maximum allowable dose (30 mg for OXY-ER or 20 mg for OXY-IR) was reached. The mean percentage reduction in weekly urgency and total incontinence episodes was statistically similar between OXY-ER and OXY-IR but dry mouth was reported statistically more often with OXY-IR. In the 2000 study [Versi et al., 2000], 226 patients were randomized between OXY-ER and OXY-IR with weekly increments of 5 mg daily up to 20 mg daily. As in the 1999 study, OXY-ER again achieved a >80% reduction in urgency and total incontinence episodes and a significant percentage of patients became dry. A negative aspect of these studies is that there were no naïve patients included, as all patients were known responders to oxybutynin. Similar efficacy results have been achieved, however, with OXY-ER in a treatment-naïve population [Gleason et al., 1999].

In an RCT comparing different daily doses of oxybutynin (5, 10 and 15 mg), Corcos et al. [2006] found a significant dose-response relationship for both urgency incontinence episodes and dry mouth. The greatest satisfaction was with 15 mg oxybutynin/day.

In a multicentre, prospective, observational, flexible-dosing Korean study, Yoo et al. [2012] investigate the prescription pattern and dose distribution of OXY-ER in patients the OAB syndrome in actual clinical practice. The dosage of for each patient was adjusted after discussions of efficacy and tolerability between doctor and patient, over a 12-week treatment period. Efficacy was measured by administering the Primary OAB Symptom Questionnaire (POSQ) before and after treatment. Patients were also administered, the patient perception of treatment benefit (PPTB) questionnaire at the end of the study. Of the 809 patients enrolled, 590 (73.2%) continued to take study medication for 12 weeks. Most patients were prescribed 5–10 mg / day oxybutynin ER as both starting and maintenance doses, with a dose escalation rate of only 14.9%. All OAB symptoms evaluated by the POSQ were improved; 94.1% of patients reported benefits from treatment and 89.3% were satisfied.

1.2.1.3 Transdermal Oxybutynin (OXY-TDS)

Transdermal delivery also alters oxybutynin metabolism reducing DEO production to an even greater extent than OXY-ER. A study [Davila et al., 2001] comparing OXY-TDS with OXY-IR demonstrated a statistically equivalent reduction in daily incontinent episodes (from 7.3 to 2.3: 66% for OXY-TDS, and 7.4 to 2.6: 72% for OXY-IR), but much less dry mouth (38% for OXY-TDS and 94% for OXY-IR). In another study [Dmochowski et al., 2002] the 3.9-mg daily dose patch significantly (vs placebo) reduced the mean number of daily incontinence episodes (from 4.7 to 1.9; placebo from 5.0 to 2.9), while reducing average daily urinary frequency confirmed by an increased average voided volume (from 165 to 198 ml; placebo from 175 to 182 ml). Furthermore, dry mouth rate was similar to placebo (7% vs 8.3%). In a third study [Dmochowski et al., 2003a] OXY-TDS was compared not only to placebo but to TOLT-ER. Both drugs equivalently and significantly reduced daily incontinence episodes and increased the average voided volume, but TOLT-ER was associated with a significantly higher rate of antimuscarinic adverse events. The primary adverse event for OXY-TDS was application site reaction pruritis in 14% and erythema in 8.3% with nearly 9% feeling that the reactions were severe enough to withdraw from the study, despite the lack of systemic problems.

The pharmacokinetics and adverse effect dynamics of OXY-TDS (3.9 mg/day) and OXY-ER (10 mg/day) were compared in healthy subjects in a randomized, 2-way crossover study [Appell et al., 2003]. Multiple blood and saliva samples were collected and pharmacokinetic parameters and total salivary output were assessed. OXY-TDS administration resulted in greater systemic availability and minimal metabolism

to DEO compared to OXY-ER which resulted in greater salivary output in OXY-TDS patients and less dry mouth symptomatology than when taking OXY-ER.

Dmochowski et al. [2005] analyzing the combined results of two RCTs concluded that transdermal oxybutynin was shown to be efficacious and well tolerated. The most common systemic side effect was dry mouth (7.0 % vs placebo 5.3%). Application site erythema occurred in 7% and pruritus in 16.1 %. Also Cartwright and Cardozo [2006], reviewing published and presented data concluded that transdermal oxybutynin has a good balance between efficacy and tolerability with a rate of systemic antimuscarinic side effects lower than with oral antimuscarinics – however, this benefit was offset by the rate of local skin reaction. The reviews of Sahai et al. [2008] and Staskin and Salvatore [2010] largely confirmed these conclusions, which also have been supported by further studies [Cartwright et al., 2011].

In a Japanese population of OAB an alternative daily 73.5mg transdermal oxybutynin patch was assessed against propiverine 20mg daily and placebo [Yamaguchi et al., 2014]. Approximately 570 patients were in the active arms and 380 in placebo. At 12 weeks, the oxybutynin patch was significantly superior than placebo and non-inferior to propiverine for daily micturition episodes. Urgency and voided volume was better compared to placebo for transdermal oxybutynin, however urgency incontinence episodes and nocturia were no different. Furthermore 8 out of 9 domains assessed utilising the KHQ were better for transdermal oxybutynin compared to placebo suggesting better quality of life in this group. Dry mouth and constipation were seen in 6.5% and 0.7%, 13.2% and 5%, and 1.8% and 1% in the transdermal oxybutynin, propiverine and placebo groups, respectively. In the transdermal oxybutynin group application site dermatitis was seen in 31.8%, with site erythema in 5.6%.

Recently the transdermal patch (3.9mg/day) has been shown to be subjectively effective in a small paediatric population but with 35% skin site irritation and 20% discontinuation rate [Gleason et al., 2014].

1.2.1.4 Oxybutynin Topical Gel

Given the efficacy and tolerability of the transdermal application, limited only by skin site reactions, a gel formulation was developed. oxybutynin topical gel (OTG) was approved by the US FDA in January 2009. OTG is applied once daily to the abdomen, thigh, shoulder, or upper arm area [Staskin et al., 2009]. The 1g application dose delivers approximately 4 mg of drug to the circulation with stable plasma concentrations and a "favorable" N-desethyloxybutynin metabolite: oxybutynin ratio believed to minimizing antimuscarinic side effects [Staskin and Robinson, 2009]. In a multicenter RCT, 789 patients (89% women) with urgency-predominant incontinence were assigned to OTG or placebo once daily for 12 weeks [Staskin et al., 2009]. The mean number of urgency episodes, as recorded by 3-day voiding diary, was reduced by 3.0

episodes per day versus 2.5 in the placebo arm ($P < 0.0001$). Urinary frequency decreased by 2.7 episodes per day and voided volume increased by 21 mL (versus 2.0 episodes [$P = 0.0017$] and 3.8 mL [$P = 0.0018$], respectively, in the placebo group). Dry mouth was reported in 6.9% of the treatment group versus 2.8% of the placebo group. Skin reaction at the application site was reported in 5.4% of the treatment group versus 1.0% in the placebo arm. It was felt that improved skin tolerability of the gel over the OXY transdermal patch delivery system was secondary to lack of adhesive and skin occlusion. The gel dries rapidly upon application and leaves no residue; person-to-person transference via skin contact is largely eliminated if clothing is worn over the application site [Dmochowski et al., 2011]. The evolution of the transdermal gel allows greater patient tolerability and improved compliance. This was confirmed by Sand et al. [2012] showing that in 704 women with OAB OTG significantly reduced the number (mean \pm standard deviation) of daily incontinence episodes (OTG, -3.0 ± 2.8 episodes; placebo, -2.5 ± 3.0 episodes), reduced urinary frequency, increased voided volume, and improved select health-related quality-of-life domains vs placebo. Dry mouth was the only drug-related adverse event significantly more common with OTG (7.4%) than with placebo (2.8%).

A newer 3% topical oxybutynin gel has been assessed in a phase III randomised placebo controlled trial (randomised $n=626$) [Goldfischer et al. 2015]. This product is administered via a metered dose pump dispenser and was hypothesised to have less adverse events. Furthermore, it is made with propylene glycol to help with skin permeation. Two doses of 84mg/day and 56 mg/day of the 3% topical oxybutynin were assessed against placebo gel in this population of patients with urgency and / or urge predominant mixed incontinence. The 84 mg / day dose was statistically better than placebo after 12 weeks in improving weekly UI episodes (primary endpoint) and also daily urinary frequency and urine voided volumes. The lower dose of 56mg / day was not statistically better than placebo. Dry mouth and application site erythema was seen in 12.1% and 3.3% in the 84 mg / day group compared to 5% and 0.5% in the placebo arm.

1.2.1.5 Other Administration Forms

Rectal administration [Collas and Malone-Lee, 1997] was reported to have fewer adverse effects than the conventional tablets.

Administered intravesically, oxybutynin has in several studies been demonstrated to increase bladder capacity and produce clinical improvement with few side effects, both in neurogenic and in other types of DO, and both in children and adults [Lose and Norgaard, 2001; Fader et al., 2007; George et al., 2007; Guerra et al., 2008], although adverse effects may occur [Kasabian et al., 1994; Palmer et al., 1997]. More recently a phase II exploratory randomized placebo controlled trial ($n=323$) of intra-vaginal oxybutynin

ring was conducted based on the premise that there is a shared lymphovascular network between the vagina and bladder [Gittelman et al. 2014]. Approximately one quarter of the patients had an accidental fallout of the ring. Both formulations of 4 and 6 mg were better than placebo at reducing weekly UI episodes when compared to placebo. Dry rates, frequency and UUI episodes were also statistically better in the 6mg intravaginal oxybutynin group compared to placebo. UTI, dry mouth and vaginal discharge were the commonest adverse events. UTI and dry mouth rates were 11.6% and 10.2% in the 6mg oxybutynin group, 9.1% and 4.9% in the 4mg oxybutynin group and 4.5% and 2.6% in the placebo groups.

2.1.6 Effects on Cognition

Several studies have documented the possibility that oxybutynin may have negative effects on cognitive functions, particularly in the elderly population [see section on “Considerations in the Elderly”], but also in adults and in children [see, e.g., Kay et al., 2006; Klausner and Steers, 2007; Kay and Ebinger, 2008]. This factor should be taken into consideration when prescribing the drug.

Assessment

Oxybutynin has a well-documented efficacy in the treatment of OAB/DO (Table 2). Despite the adverse effect profile, it is still an established therapeutic option.

1.2.2 Propiverine Hydrochloride

Several aspects of the preclinical, pharmacokinetic, and clinical effects of propiverine were reviewed by Madersbacher and Murz [2001]. The drug is rapidly absorbed (t_{max} 2 h), but has a high first pass metabolism, and its biological availability is about 50%. Propiverine is an inducer of hepatic cytochrome P450 enzymes in rats in doses about 100-times above the therapeutic doses in man [Walter et al., 2003]. Several active metabolites are formed which quantitatively and qualitatively differ from the mother compound [Haustein et al., 1988; Muller et al., 1993; Wuest et al., 2006; Zhu et al., 2008; Sugiyama et al., 2008]. Most probable these metabolites contribute to the clinical effects of the drug, but their individual contributions have not been clarified [Michel and Hegde, 2006]. The half-life of propiverine itself is about 11-14 h. An extended release preparation was shown to be effective [Junemann et al., 2006; May et al., 2008]. Oral absorption of propiverine is site dependent and influenced by dosage form and circadian time-dependent elimination processes [May et al., 2008].

Propiverine has combined antimuscarinic and calcium antagonistic actions [Haruno, 1992; Tokuno et al., 1993]. The importance of the calcium antagonistic component for the drug's clinical effects has not been established. Propiverine has no selectivity for muscarinic receptor subtypes. The effects of propiverine on

cardiac ion channels and action potentials were investigated by Christ et al. [2008]. Propiverine blocked in a concentration-dependent manner HERG channels expressed in HEK293 cells, as well as native I(Kr) current in ventricular myocytes of guinea pig. However, action potential duration was not prolonged in guinea-pig and human ventricular tissue, and the investigators concluded that their results did not provide evidence for an enhanced cardiovascular safety risk with the drug.

Propiverine has been shown to have beneficial effects in patients with DO in several investigations. Thüroff et al [1998] collected 9 randomized studies on a total of 230 patients, and found a 17% reduction in micturitions per 24 hours, a 64 ml increase in bladder capacity, and a 77% (range 33-80%) subjective improvement. Side effects were found in 14 % (range 8-42%). In patients with neurogenic DO, controlled clinical trials have demonstrated propiverine's superiority over placebo [Stöhrer et al., 1999]. Propiverine also increased bladder capacity and decreased maximum detrusor contractions. Controlled trials comparing propiverine, flavoxate and placebo [Wehnert et al., 1989], and propiverine, oxybutynin and placebo [Wehnert et al., 1992; Madersbacher et al., 1999], have confirmed the efficacy of propiverine, and suggested that the drug may have equal efficacy and fewer side effects than oxybutynin. In a comparative RCT including 131 patients with neurogenic DO, propiverine and oxybutynin were compared [Stöhrer et al., 2007]. The drugs were found to be equally effective in increasing bladder capacity and lowering bladder pressure. Propiverine caused a significantly lower frequency of dry mouth than oxybutynin. Recently the once daily extended release formulation of propiverine was compared to immediate release propiverine in a trial with 66 patients suffering with NDO [Stohrer et al. 2013]. The primary endpoint was change in reflex volume which was improved and comparable between the two formulations. However, continence rates were statistically better in the ER group compared to IR. Adverse events were similar with dry mouth rates 27% and 24% for ER and IR formulations, respectively.

Also in children and adolescents with neurogenic DO, propiverine was found to be effective [Schulte-Baukloh et al., 2006; Grigoleit et al., 2006], with a low incidence rate of adverse events: <1.5% [Grigoleit et al., 2006]. A randomized, double-blind, placebo-controlled trial with parallel-group design in children aged 5–10 yr was performed by Marschall-Kehrel et al. [2009]. Of 171 randomized children, 87 were treated with propiverine and 84 with placebo. Decrease in voiding frequency per day was the primary efficacy parameter; secondary endpoints included voided volume and incontinence episodes. There was a significant decrease in voiding frequency episodes for propiverine versus placebo. Superiority could also be demonstrated for voided volume and incontinence episodes per day. Propiverine was well-tolerated: 23% of side-effects were reported for propiverine and 20% for placebo.

In a randomised, double-blind, multicentre clinical trial, patients with idiopathic DO were treated with 15 mg propiverine twice daily or 2 mg TOLT-IR twice daily over a period of 28 days [Junemann et al., 2005]. The maximum cystometric capacity was determined at baseline and after 4 weeks of therapy. The difference of both values was used as the primary endpoint. Secondary endpoints were voided volume per micturition, evaluation of efficacy (by the investigator), tolerability, post void residual urine, and quality of life. It was found that the mean maximum cystometric capacity increased significantly ($p < 0.01$) in both groups. The volume at first urgency and the frequency/volume chart parameters also showed relevant improvements during treatment. The most common adverse event, dry mouth, occurred in 20 patients in the propiverine group and in 19 patients in the tolterodine group. The scores for the quality of life improved comparably in both groups.

Madersbacher et al. [1999] compared the tolerability and efficacy of propiverine (15 mg three times daily) oxybutynin (5 mg twice daily) and placebo in 366 patients with urgency and urgency incontinence in a randomized, double-blind placebo-controlled clinical trial. Urodynamic efficacy of propiverine was judged similar to that of oxybutynin, but the incidence of dry mouth and the severity of dry mouth were judged less with propiverine than with oxybutynin. Dorschner et al. [2000] investigated in a double-blind, multicentre, placebo-controlled, randomized study, the efficacy and cardiac safety of propiverine in 98 elderly patients (mean age 68 years), suffering from urgency, urgency incontinence or mixed urgency-stress incontinence. After a 2-week placebo run-in period, the patients received propiverine (15 mg three times daily) or placebo (three times daily) for 4 weeks. Propiverine caused a significant reduction of the micturition frequency (from 8.7 to 6.5) and a significant decrease in episodes of incontinence (from 0.9 to 0.3 per day). The incidence of adverse events was very low (2% dryness of the mouth under propiverine – 2 out of 49 patients). Resting and ambulatory electrocardiograms indicated no significant changes. The cardiac safety of propiverine was further studied by Donath et al. [2011] in two comprehensively designed monocentric ECG studies (including 24 healthy females, followed by a second study on 24 male patients with coronary heart disease (CHD) and a pathological Pardee-Q-wave in the ECG). Both studies were placebo-controlled and compared the effects of single (30 mg s.i.d.) and multiple dosing (15 mg t.i.d.) of propiverine hydrochloride in a crossover design over 6 and 13 days, respectively. They were performed to investigate the influence of propiverine hydrochloride and its main metabolite propiverine-N-oxide on cardiac function with regard to QTc prolongation, QTc dispersion and T-wave shape. No negative effects on cardiac safety could be demonstrated.

Abrams et al. [2006] compared the effects of propiverine and oxybutynin on ambulatory urodynamic monitoring parameters, safety, and tolerability in OAB patients. Patients (n=77) received two of the following

treatments during two 2-week periods: propiverine 20 mg once daily, propiverine 15 mg three times daily, oxybutynin 5 mg three times daily, and placebo. They found that oxybutynin 15 mg was more effective than propiverine 20 mg in reducing symptomatic and asymptomatic involuntary detrusor contractions in ambulatory patients. Oxybutynin had a higher rate of dry mouth, and propiverine had a more pronounced effect on gastrointestinal, cardiovascular, and visual function.

Yamaguchi et al. [2007] performed a multicentre, 12-week, double-blind phase III trial in Japanese men and women with OAB (1593 patients were randomized and 1584 were treated), comparing solifenacin 5 or 10 mg, propiverine 20 mg, and placebo. Changes at endpoint in number of voids/24 hours, urgency, incontinence, urgency incontinence and nocturia episodes, volume voided/void, restoration of continence and quality of life (QoL) were examined. It was found that at endpoint, there were greater reductions in mean (SD) voids/24 hours with all drug regimens than with placebo. All active treatments improved the volume voided and QoL vs placebo; solifenacin 10 mg reduced nocturia episodes and significantly improved urgency episodes and volume voided vs propiverine 20 mg, and solifenacin 5 mg caused less dry mouth. Solifenacin 10 mg caused more dry mouth and constipation than propiverine 20 mg. Wada et al. [2011] performed a prospective nonrandomized crossover study of female OAB patients, assigned alternately to treatment with propiverine (20 mg) for 8 weeks then solifenacin (5 mg) for 8 weeks or solifenacin for 8 weeks then propiverine for 8 weeks. At baseline, 8th week and 16th week, symptoms were assessed using overactive bladder symptom score (OABSS). Of the 121 patients enrolled 83 were analysed. Both drugs were effective. Urgency was further improved after switching from propiverine to solifenacin, but not after switching from solifenacin to propiverine. Solifenacin was better tolerated than propiverine.

In another multicenter, prospective, parallel, double blind, placebo-controlled trial, Lee et al. [2010] studied the effects of 30 mg propiverine/day in 264 OAB patients (mean age 52.2 years), 221 of whom had efficacy data available from baseline and at least one on-treatment visit with >75 compliance. The study was focused on improving urgency. Overall, among patients treated with propiverine, 39% rated their treatment as providing 'much benefit', compared with 15% in the placebo group. Adverse events reported by 32 (22.5%) and 10 (12.7%) patients in the propiverine and placebo group were all tolerable.

Recently the extended release formulation of propiverine was compared to the extended release formulation of tolterodine in a non-inferiority trial with approximately 150 patients in each study arm [Leng et al., 2016]. Statistically more significant reductions were seen for propiverine ER compared with tolterodine ER. Discontinuation rates because of adverse events were more in the tolterodine ER group compared to propiverine ER (7.4% vs 3.1%). Based on

the way the study was designed and powered the authors concluded that ER propiverine was non-inferior to ER tolterodine [Leng et al., 2016].

Masumori et al. [2011] examined prospectively the efficacy and safety of propiverine 20mg/day in patients with OAB symptoms who poorly responded to previous treatment with solifenacin, tolterodine or imidafenacin. Of 73 patients enrolled (29 males and 44 females, median age 71 years), 52 completed the protocol treatment. The OABSS was significantly improved by propiverine treatment. The scores of OAB symptoms (nighttime frequency, urgency and urge incontinence) except daytime frequency also improved significantly. No increase in PVR was observed. The most frequent adverse event was dry mouth (13.7%), followed by constipation (6.8%).

In a non-controlled study in patients with wet OAB the efficacy of propiverine on symptoms and quality of life was confirmed [Komatsu et al. [2009].

Assessment

Propiverine has a documented beneficial effect in the treatment of OAB/DO (Table 2), and seems to have an acceptable side effect profile.

1.2.3 Flavoxate Hydrochloride

Flavoxate is often discussed as a drug with mixed actions, however, its main mechanism of action may not be antimuscarinic. Flavoxate is well absorbed, and oral bioavailability appeared to be close to 100% [Guay, 2003]. The drug is extensively metabolized and plasma half-life was found to be 3.5 h [Sheu et al., 2001]. Its main metabolite (3-methylflavone-8-carboxylic acid, MFCA) has been shown to have low pharmacological activity [Cazzulani et al., 1988; Caine et al., 1991]. The main mechanism of flavoxate's effect on smooth muscle has not been established. The drug has been found to possess a moderate calcium antagonistic activity, to have the ability to inhibit phosphodiesterase, and to have local anesthetic properties; no antimuscarinic effect was found [Guarneri et al., 1994]. Uckert et al. [2000], on the other hand, found that in strips of human bladder, the potency of flavoxate to reverse contraction induced by muscarinic receptor stimulation and by electrical field stimulation was comparable. It has been suggested that pertussis toxin-sensitive G-proteins in the brain are involved in the flavoxate-induced suppression of the micturition reflex, since intracerebroventricularly or intrathecally administered flavoxate abolished isovolumetric rhythmic bladder contractions in anesthetized rats [Oka et al., 1996].

The clinical effects of flavoxate in patients with DO and frequency, urgency and incontinence have been studied in both open and controlled investigations, but with varying rates of success [Ruffman, 1988]. Stanton [1973] compared emepronium bromide and flavoxate in a double-blind, cross-over study of patients with detrusor overactivity and reported improvement rates of 83% and 66% after flavoxate or

emepronium bromide, respectively, both administered as 200 mg 3 times daily. In another double-blind, cross-over study comparing flavoxate 1200 mg/day with that of oxybutynin 15 mg daily in 41 women with idiopathic motor or sensory urgency, and utilising both clinical and urodynamic criteria, Milani et al. [1993] found both drugs effective. No difference in efficacy was found between them, but flavoxate had fewer and milder side effects. Other investigators, comparing the effects of flavoxate with those of placebo, have not been able to show any beneficial effect of flavoxate at dosages up to 400 mg three times daily [Briggs et al., 1980; Chapple et al., 1990; Dahm et al., 1995]. In general, few side effects have been reported during treatment with flavoxate. On the other hand, its efficacy, compared to other therapeutic alternatives, is not well documented (Table 2).

Assessment

No RCTs seem to have been performed with flavoxate during the last decade. The scarcity of documented clinical efficacy should be considered before using the drug.

1.3. Clinical Use of Antimuscarinics

The clinical relevance of efficacy of antimuscarinic drugs relative to placebo has been questioned. Herbison et al. [2003] stated in a widely discussed article: "Anticholinergics produce significant improvements in overactive bladder symptoms compared with placebo. *The benefits are, however, of limited clinical significance*" Large meta-analyses of studies performed with the currently most widely used drugs [Chapple et al., 2005; 2008; Novara et al., 2008], clearly show that antimuscarinics are of significant clinical benefit. Novara et al. [2008] reviewed 50 RCTs and 3 pooled analyses, which they considered of good methodological quality. They concluded that still more clinical studies are needed to decide which of the drugs should be used as first-, second-, or third-line treatment. Reviewing information from more than 12,000 references, Chapple et al. [2008], based their conclusions ("antimuscarinics are efficacious, safe, and well tolerated treatments") on 73 RCTs selected for their meta-analysis. It was recommended that since the profiles of each drug (see below) and dosage differ, these factors should be considered in making treatment choices.

The durability of the effects of antimuscarinics is not known and the relapse rate of symptoms after discontinuation of treatment has not been systematically studied. In 173 women with OAB symptoms for >6 months, Lee et al. [2011a] studied in a prospective, randomized, open-label, trial what happened 3 months after the patients had been successfully treated for 1, 3, or 6-months. The relapse rate was 62%, and the request for treatment was 65 %, indirectly suggesting an efficacy of treatment. None of the antimuscarinic drugs in common clinical use (darifenacin, fesoterodine, imidafenacin, oxybutynin, propiverine, solifenacin, tolterodine or trospium) is ideal as

a first-line treatment for *all* OAB/DO patients. Optimal treatment should be individualized, implying that the patient's co-morbidities and concomitant medications, and the pharmacological profiles of the different drugs, should be taken into consideration [Chapple et al., 2008].

To compare the effects of different antimuscarinic drugs for OAB symptoms, Madhuvrata et al. [2012] analysed 86 trials, 70 with parallel and 16 with cross-over designs (31,249 adults). They concluded that when the prescribing choice is between oral immediate release oxybutynin or tolterodine, tolterodine might be preferred for reduced risk of dry mouth. ER preparations of oxybutynin or tolterodine might be preferred to immediate release preparations because there is less risk of dry mouth. Comparing solifenacin and immediate release tolterodine, solifenacin might be preferred for better efficacy and less risk of dry mouth. Fesoterodine might be preferred over ER tolterodine for superior efficacy, but has higher risk of withdrawal due to adverse events and higher risk of dry mouth.

Several studies have documented that the persistence with prescribed antimuscarinic therapy for overactive bladder is low [Kelleher et al., 2005; Basra et al., 2008; Sears et al., 2010; Wagg et al., 2012]. The most common causes seem to be lack of efficacy and adverse effects. However, there is some evidence suggesting that the tolerability of the different antimuscarinics may differ. Wagg et al. [2012] analysed prescription data for patients receiving antimuscarinics for treatment of the OAB syndrome over a 12-month period. At 12 months, they found that the proportions of patients still on their original treatment were: solifenacin 35%, tolterodine ER 28%, propiverine 27%, oxybutynin ER 26%, trospium 26%, tolterodine IR 24%, oxybutynin IR 22%, darifenacin 17%, and flavoxate 14%. The longest mean persistence was reported for solifenacin (187 days versus 77 – 157 days for the other treatments). Similar trends in other healthcare systems have been reported [Mauseth et al., 2013; Kalder et al. 2014]. Gomes et al. [2012] compared the persistence of oxybutynin or tolterodine therapy among older patients newly prescribed one of these drugs. This was a retrospective cohort study of Ontarians aged 66 years and older. Persistence with treatment was defined on the basis of refills for the drug within a grace period equal to 50% of the prescription duration. The authors identified 31,996 patients newly treated with oxybutynin and 24,855 newly treated with tolterodine. After 2 years of follow-up, persistence on oxybutynin (9.4%) was significantly lower than that on tolterodine (13.6%, $p < 0.0001$). The median time to discontinuation of oxybutynin and tolterodine was 68 and 128 days, respectively. Kessler et al. [2011] analysed 69 trials enrolling 26'229 patients with OAB with the aim was to compare adverse events of antimuscarinics using a network meta-analytic approach that overcomes shortcomings of conventional analyses. They found similar overall adverse event profiles for darifenacin, fesoterodine, transdermal oxybutynin,

propiverine, solifenacin, tolterodine, and trospium chloride, but not for oxybutynin orally administered when currently used starting dosages were compared. They concluded that most currently used antimuscarinics seem to be equivalent first choice drugs to start the treatment of OAB, except for oral oxybutynin dosages of ≥ 10 mg/day, which may have more unfavorable adverse event profiles. Another systematic review concluded that persistence rates regardless of antimuscarinic was generally poor, with median rates 12-39.4% at 12 months and 6-12% at 24 months [Veenboer and Bosch, 2014]. Risk factors for discontinuation included younger age group, use of IR formulations and oxybutynin.

Even if the use of antimuscarinics is associated with many adverse effects, they are generally considered to be 'safe' drugs. However, among the more serious concerns related to their use is the risk of cardiac adverse effects, particularly QT prolongation and induction of polymorphic ventricular tachycardia (torsade de pointes), and increases in heart rate (HR) [Andersson and Olshansky, 2007; Andersson et al., 2011].

QT prolongation and its consequences are not related to blockade of muscarinic receptors, but rather linked to inhibition of the hERG potassium channel in the heart.

However, the experiences with terodiline, an antimuscarinic drug that caused torsade de pointes in patients [Connolly et al., 1991; Stewart et al., 1992], have placed the whole drug class under scrutiny.

The parasympathetic actions on the heart (Figure 10) oppose the excitatory actions of the sympathetic nervous system, and slows the heart rate (Figure 11). An elevated resting HR has been linked to overall increased morbidity and mortality, particularly in patients with cardiovascular diseases. The prevalence of CV comorbidities was found to be significantly higher in patients with than without OAB [Andersson et al., 2010]. Since mean changes in HR reported in population studies might not be applicable to an individual patient, and particularly in patients at risk of cardiac disease, even moderate increases in HR might be harmful. The potential of the different antimuscarinic agents to increase HR and/or prolong the QT time has not been extensively explored for all agents in clinical use. Differences between drugs cannot be excluded, but risk assessments based on available evidence are not possible.

Antimuscarinics are recommended in treating OAB when lifestyle interventions have failed. However, many guidelines would recommend when one antimuscarinic fails due to lack of efficacy or poor tolerability that a second and even third should be tried. A recent retrospective medicine and pharmacy claims analysis in the US linked to a one-time patient survey of members with OAB-wet was recently reported with the specific aim of assessing antimuscarinic treatment patterns and outcomes [Chancellor et al., 2016]. A total of 620 patients were finally included after ex-

clusions. Patients cycled through 1-6 unique antimuscarinics. In general adherence to the medication was poor and 35% of the population used ≥ 2 antimuscarinics. Moreover, UI episodes and burden was fairly-consistent despite antimuscarinic cycling and whether patients continued or discontinued their medication. Discontinuation rates were high being 71% of the whole population at study end. Approximately 89% of patients continued to be bothered by their bladder symptoms and requested additional help, whether or not they remained on antimuscarinics. The study suggests that antimuscarinic cycling does not have a positive impact on patients in terms of UI. As a result, alternative therapies should be sought for patients who have failed 1-2 antimuscarinics. It seems logical that if there is inadequate efficacy with 1 antimuscarinic that the maximum dose should be trialed in those with a flexible dosing option especially if the lower dose had an acceptable adverse event profile.

In those where tolerability is an issue switching to an alternative muscarinic is also reasonable. However, thereafter treatment should be escalated to include non antimuscarinic options.

The use of antimuscarinics to treat the storage component of lower urinary tract symptoms in combination with other classes of drugs is increasing. Furthermore, the evidence base to support this is also expanding. Details of the use of antimuscarinics in combination with β_3 -AR agonist agents to treat refractory OAB, in combination with alpha blockers and 5 alpha reductase inhibitors to combat lower urinary tract symptoms attributable to benign prostatic enlargement are covered in later sections of this chapter (see section on Combinations).

2. β -ADRENOCEPTOR AGONISTS

In isolated human bladder, non-subtype selective β -AR agonists like isoprenaline have a pronounced inhibitory effect, and administration of such drugs can increase bladder capacity in man [Andersson, 1993]. However, the β -ARs of the human bladder were shown to have functional characteristics typical of neither β_1 -, nor β_2 - ARs, since they could be blocked by propranolol, but not by practolol or metoprolol (β_1) or butoxamine (β_2) [Nergard et al., 1977; Larsen, 1979].

On the other hand, early receptor binding studies using subtype selective ligands, suggested that the β -ARs of the human detrusor are primarily of β_2 subtype [Andersson, 1993], and favourable effects on DO were reported in open studies with selective β_2 -AR agonists such as terbutaline [Lindholm and Lose, 1986]. In a double-blind investigation clenbuterol 0.01 mg 3 times daily was shown to have a good therapeutic effect in 15 of 20 women with DO [Gruneberger, 1984]. Other investigators, however, have not been able to show that non-subtype selective β -ARs ago-

nists represent an effective therapeutic principle in elderly patients with DO [Castleden and Morgan, 1980], or in young patients with myelodysplasia and DO [Naglo et al., 1981].

However, three subtypes (β_1 , β_2 , and β_3) have been identified in the detrusor of most species, including humans [Andersson and Arner, 2004; Michel and Vrydag, 2006]. Also the human urothelium contains all three receptor subtypes [Otsuka et al., 2008]. Studies, using real-time RT-PCR, have revealed a predominant expression of β_3 -AR mRNA in human detrusor muscle [Nomiya and Yamaguchi, 2003; Michel and Vrydag, 2006; Igawa et al., 2010] and the functional evidence for an important role in both normal and neurogenic bladders is convincing [Fujumura et al., 1999; Igawa et al., 1999; Takeda et al., 1999; Morita et al., 2000; Igawa et al., 2001; 2010; Biers et al., 2006; Michel and Vrydag, 2006; Badawi et al., 2007; Leon et al., 2008].

The human detrusor also contains β_2 -ARs, and most probably both receptors are involved in the physiological effects (relaxation) of noradrenaline in this structure [Andersson and Arner 2004; Michel and Vrydag, 2006; Igawa et al., 2010].

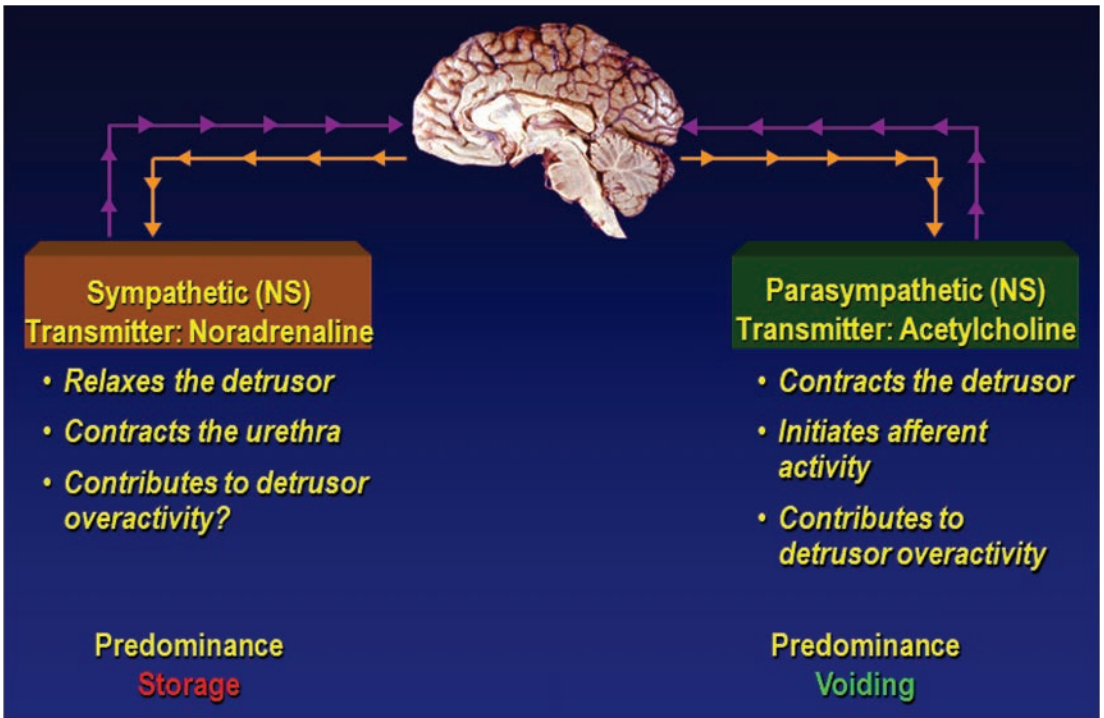

Figure 10: Cardiac control via the autonomic nervous system. Acetylcholine, released from parasympathetic nerve terminals activate muscarinic receptors that mediate decrease in heart rate, decrease in force of contraction, and decrease in conduction velocity

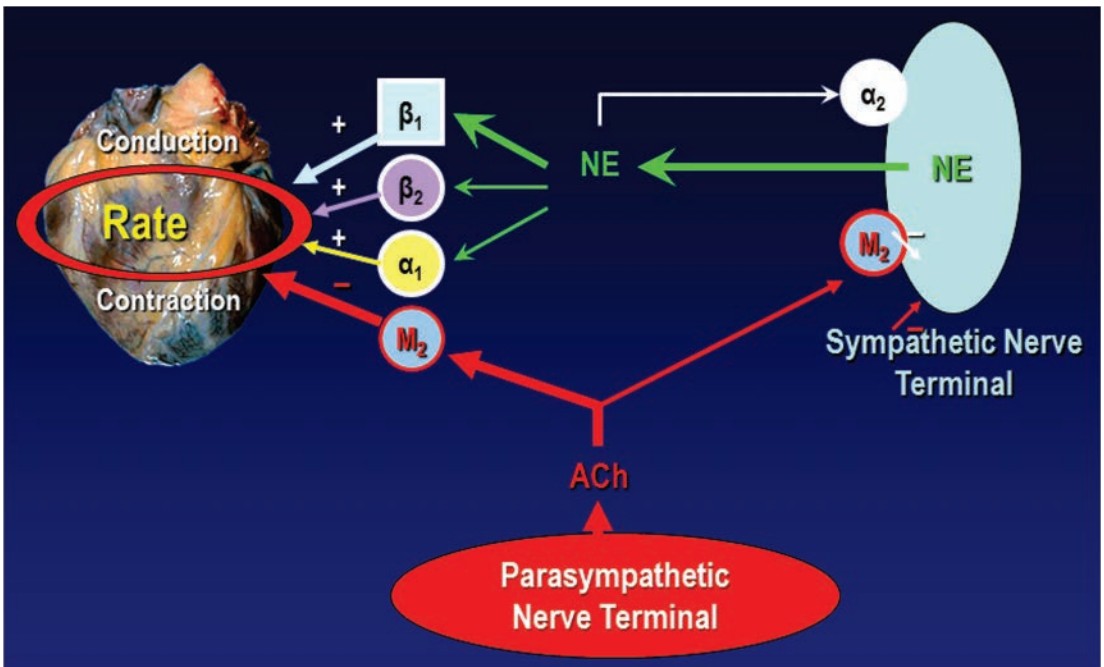

Figure 11: Autonomic receptors controlling heart rate. Acetylcholine, released form parasympathetic nerve terminals, activate muscarinic M_2 receptors that mediate a decrease in heart rate. Inhibition of these receptors by antimuscarinics may increase heart rate.

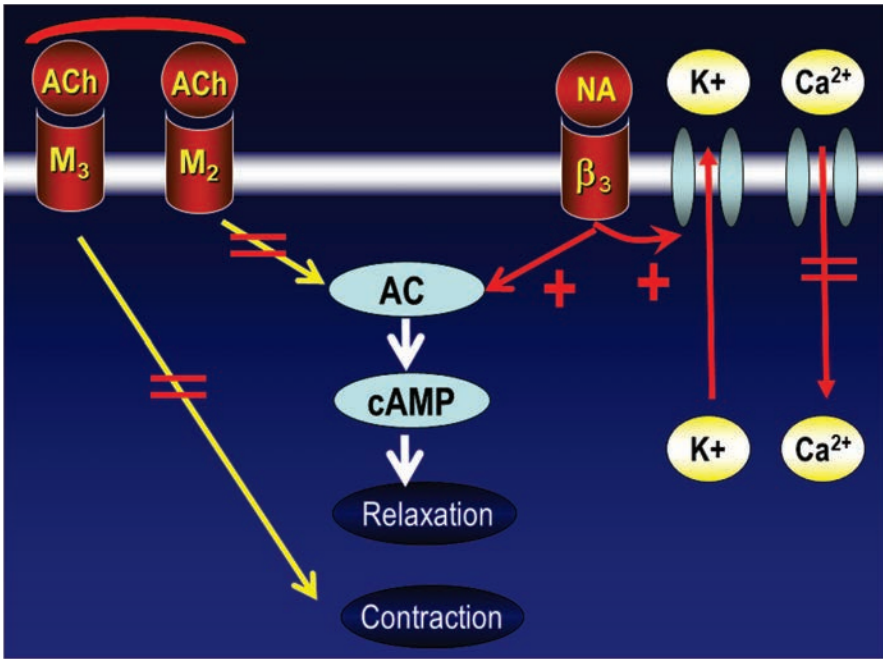

Figure 12: During bladder filling, there is normally no parasympathetic nervous outflow to the bladder and no release of acetylcholine (ACh). The sympathetic nervous system is active and releases noradrenaline (NA) that via β₃ adrenoceptors stimulates adenylyl cyclase (AC) and generation of cyclic AMP (cAMP) which mediates relaxation of the bladder. In addition, β₃-adrenoceptor stimulation activate K⁺ channels, stimulating outflow of K⁺, which causes hyperpolarisation and inhibition of Ca²⁺ inflow.

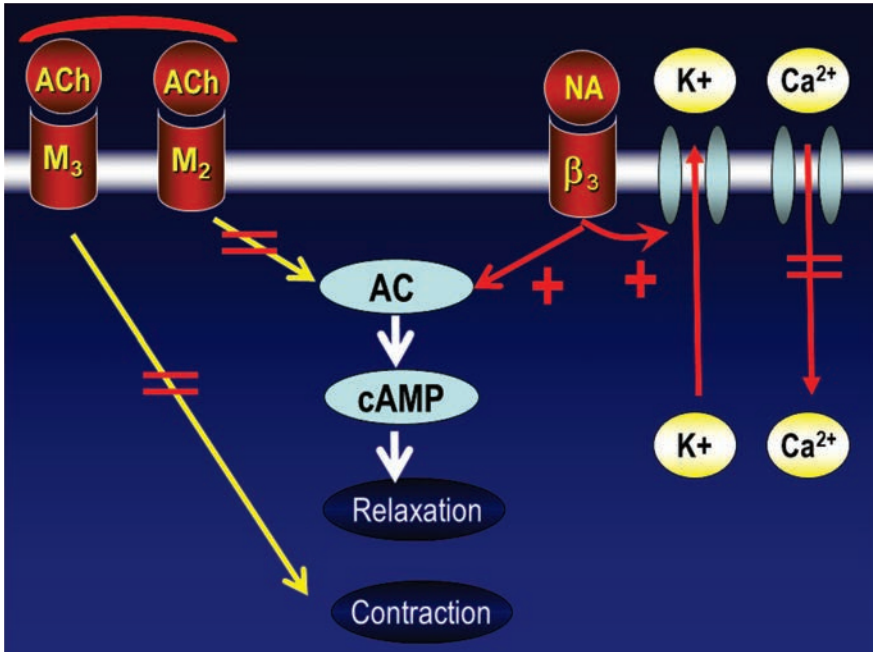

Figure 13: During voiding, the parasympathetic system is activated, releasing acetylcholine (ACh) which causes bladder contraction, directly via muscarinic M₃ receptor stimulation, and indirectly by inhibition of adenylyl cyclase (AC) via stimulation of muscarinic M₂ receptors. The sympathetic nerve activity is turned off. In vivo exogenous stimulation of the β₃-adrenoceptors by β₃-adrenoceptor agonists is not sufficient to inhibit the muscarinic receptor mediated activation, which implies that the voiding contraction is not compromised.

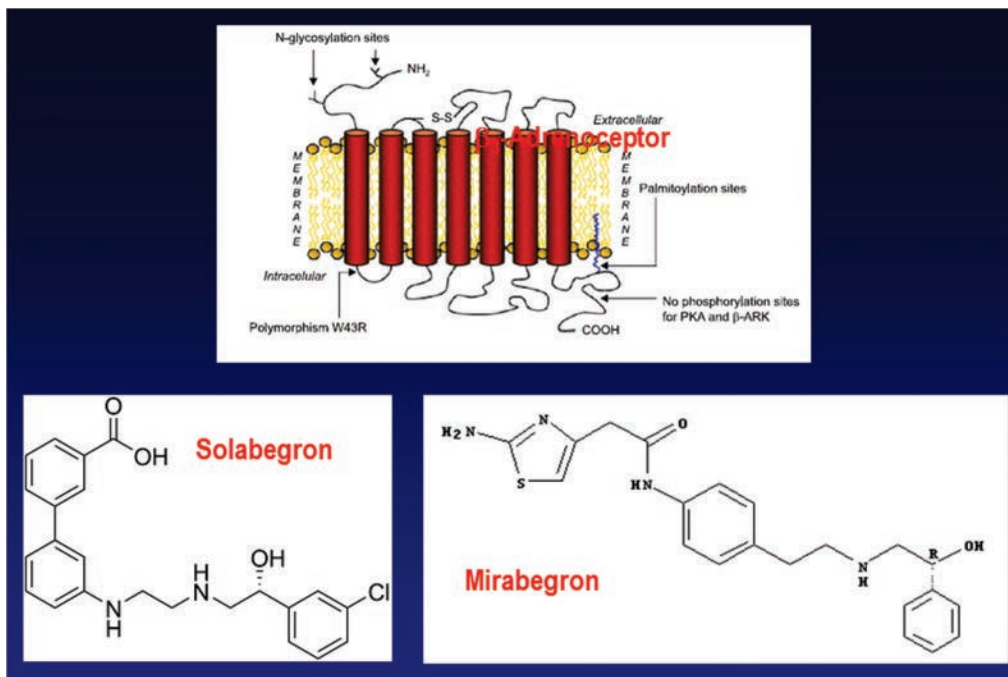

Figure 14: The β_3 -adrenoceptor is the predominant β -adrenoceptor subtype in different structures of the bladder (mucosa, detrusor smooth muscle) and they can be stimulated by highly selective β_3 -adrenoceptor agonists like mirabegron and solabegron.

The generally accepted mechanism by which β -ARs induce detrusor relaxation in most species, is activation of adenylyl cyclase with the subsequent formation of cAMP (Figures 12 and 13).

However, there is evidence suggesting that in the bladder K^+ channels, particularly BK_{Ca} channels, may be more important in β -AR mediated relaxation than cAMP [Hudman et al., 2000; Frazier et al., 2005; Uchida et al., 2005; Frazier et al., 2008]. β_3 -AR agonists have generally been considered to relieve OAB symptoms by relaxing detrusor muscle, inhibiting spontaneous contractile activity in the detrusor (*in vitro*: microcontractions; *in vivo*: non-voiding contractions), and reducing bladder afferent activity (Figure 14) [Biers et al., 2006; Takasu et al., 2007; Aizawa et al., 2012; Gillespie et al., 2012; Hatanaka et al., 2013; Igawa and Michel, 2013].

However, Gillespie and colleagues have questioned the accepted view on the mode and site of action of β_3 -AR agonists [Eastham and Gillespie, 2013; Gillespie et al., 2015a; 2015b; Granato et al., 2015], and suggested that effects on neither spontaneous microcontractions, nor on non-voiding contractions in e.g., obstructed rats, can fully explain the effects of mirabegron. Assuming that acetylcholine (ACh) release from cholinergic terminals during bladder filling contributes to OAB symptoms, the finding that activation of pre-junctional β_3 -ARs may down-regulate ACh release resulting in an inhibitory control of parasympathetic activity, may be of importance [Rouget et al., 2014; D'Agostino et al., 2015].

Since β -ARs are present in the urothelium, their possible role in bladder relaxation has been investigated [Murakami et al., 2007; Otsuka et al., 2008]. Murakami et al. [2007] found that the relaxation responses of the detrusor were not influenced by the urothelium. However, isoprenaline was more potent at inhibiting carbachol contractions in the presence of the urothelium than in its absence. It was suggested that this might reflect the release of an inhibitory factor from the urothelium. Further support for this hypothesis was given by Otsuka et al. [2008]. However, to what extent a urothelial signaling pathway contributes *in vitro* and *in vivo* to the relaxant effects of β -AR agonists in general, and β_3 -AR agonists specifically, remains to be elucidated.

The *in vivo* effects of β_3 -AR agonists on bladder function have been studied in several animal models. It has been shown that compared with other agents (including antimuscarinics), β_3 -AR agonists increase bladder capacity with no change in micturition pressure and the residual volume [Fujimura et al., 1999; Woods et al., 2001; Takeda et al., 2002; Kaidoh et al., 2002; Igawa et al., 2010]. For example, Hicks et al. [2007] studied the effects of the selective β_3 -AR agonist, GW427353, in the anesthetized dog and found that the drug evoked an increase in bladder capacity under conditions of acid evoked bladder hyperactivity, without affecting voiding.

A number of β_3 -AR selective agonists are currently being evaluated as potential treatment for OAB (Fig-

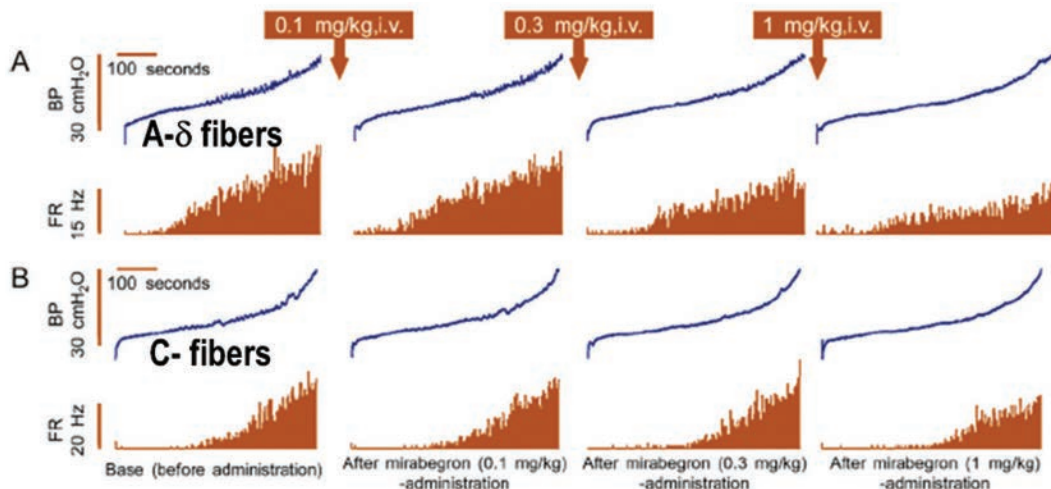

Figure 15: Stimulation by highly selective β_3 -adrenoceptor agonists like mirabegron may inhibit bladder afferent activity in both A δ - and C-fibers. From Aizawa et al., *Eur Urol.* 2012 Dec;62(6):1165-73

ure 15) but so far the only drug approved for treatment in humans is mirabegron. The effects of mirabegron in men and women with OAB have been summarised in several recent reviews [Chapple et al., 2014; Cui et al., 2014; Rossanese et al., 2015], and also in men with both voiding and OAB symptoms [Suarez et al. 2013; Otsuki et al, 2013].

2.1. Mirabegron

Takusagawa et al. [2012] found that mirabegron was rapidly absorbed after oral administration. It circulates in the plasma as the unchanged form, its glucuronic acid conjugates and other metabolites. Of the administered dose, 55% is excreted in urine, mainly as the unchanged form, and 34% is recovered in feces, almost entirely as the unchanged form. Mirabegron is highly lipophilic and is metabolised in the liver via multiple pathways, mainly by cytochrome P450 3A4 and 2D6 (CYP2D6) [van Gelderen et al., 2009]. In a Phase I pharmacokinetic study, sixteen healthy volunteers, phenotyped as either poor or extensive metabolisers of CYP2D6 were enrolled. They received a 160-mg single oral dose after overnight fasting. Poor metabolisers excreted a slightly higher urinary fraction of mirabegron (15.4 \pm 4.2%) than extensive metabolisers (11.7 \pm 3.0%). T_{max} in both extensive and poor metabolizers was about 2 hours and the terminal elimination half-life ($t_{1/2}$) approximately 23-25 hours.

Chapple et al. [2008] reported the results of a phase IIA trial of mirabegron in patients with OAB. The Blossom trial, conducted in several European countries, was a proof of concept study. It enrolled 314 patients with OAB symptoms - 262 patients were randomly assigned to 4 groups: placebo, mirabegron 100 mg bid, mirabegron 150 mg bid, and tolterodine 4 mg qd for a 4-week treatment period. The primary endpoint was efficacy, and the primary efficacy variable was the change in the mean number of micturitions per 24

hours as recorded on a frequency/volume chart. In both mirabegron groups significant improvements in the mean number of micturitions per 24 hours were found compared with the placebo group (-2.19 and -2.21 vs. -1.18, respectively). Mean volume voided was dose-dependently increased in the mirabegron groups, and the change reach significance in the mirabegron 150 mg group. Urgency episodes per 24 hours decreased significantly in both mirabegron groups compared with the placebo group. No severe adverse events were reported and treatment was generally well tolerated. A small, mean increase in pulse rate with mirabegron 150 mg (5 beats per minute) was demonstrated, but this was not associated with a clinically significant increase in adverse events such as tachycardia and palpitations. This successful phase IIA trial was followed by a phase IIB trial in OAB patients carried out in Europe [Chapple et al., 2010]. This trial was a dose-ranging study of once-daily mirabegron (an extended release formula of mirabegron) with multiple arms (placebo, mirabegron 25 mg, 100 mg, 150 mg, and 200 mg qd, for a 12-week treatment period), and the primary endpoint was to evaluate the dose-response relationship on efficacy.

The mean number of micturitions per 24 hours decreased dose-dependently, and the decreases were statistically significant with mirabegron 50 mg, 150, and 200 mg compared with placebo. The mean volume voided per micturition increased dose-dependently, and the increases were significant with mirabegron 50 mg and more. Adverse events were experienced by 45.2% of the patients - the incidence of adverse events was similar among all treatment groups (placebo 43.2% vs. mirabegron 43.8-47.9%). The overall discontinuation rate owing to adverse events was 3.2% (placebo 3.0% vs. mirabegron 2.4-5.3%). The most commonly reported adverse events considered treatment-related was gastrointestinal

disorders, including constipation, dry mouth, dyspepsia, and nausea. There was no patient-reported acute retention. No significant difference in ECG parameters between the groups was demonstrated. However, a small but significant increase in mean pulse rate was observed after mirabegron 100 mg and 200 mg (1.6 and 4.1 beats per minute, respectively), although this was not associated with an increase in cardiovascular adverse events.

Nitti et al. [2011] reported on a phase III multicentre, randomized, double-blind, parallel-group, placebo-controlled trial of mirabegron in North America. They enrolled 1328 patients ≥ 18 years with OAB symptoms for ≥ 3 months. Patients who completed a 2-week, single-blind, placebo run-in and had ≥ 8 micturitions/24 h and ≥ 3 urgency episodes/72 h (with or without incontinence) during a 3-day micturition diary period, were randomized to receive placebo, or mirabegron 50 or 100 mg once daily for 12 weeks. Co-primary endpoints were change from baseline to final visit (study end) in the mean number of incontinence episodes/24 h and micturitions/24 h. Efficacy was assessed according to patient micturition diaries and safety assessments included adverse event (AE) reporting. Patients were randomized and received study drug (placebo: n=453; mirabegron 50 mg: n=442; mirabegron 100 mg: n=433). Mean age was 60.1 years, 74.3% were female, 29.7% had urgency incontinence, 38.1% had mixed stress/urgency incontinence with urgency predominant and 32.2% had frequency without incontinence. At the final visit, mirabegron 50 and 100 mg showed statistically significant improvements in the co-primary efficacy endpoints and mean volume voided/micturition compared with placebo. Statistically significant benefits were achieved at the first-measured time point of Week 4. The incidence of AEs was similar across the placebo and mirabegron 50 and 100 mg groups (50.1, 51.6 and 46.9%, respectively). The most common ($\geq 3\%$) AEs in any treatment group were hypertension (6.6, 6.1 and 4.9%, respectively), urinary tract infection (1.8, 2.7 and 3.7%), headache (2.0, 3.2 and 3.0%) and nasopharyngitis (2.9, 3.4 and 2.5%).

Khullar et al. [2011] performed a similarly designed study in Europe and Australia, enrolling 1978 patients, which included a fourth arm in which tolterodine SR 4 mg was used as a comparator. Like the American study, Khullar et al. [2011] found that mirabegron caused a statistically significant improvement from baseline compared with placebo in the number of urgency incontinence episodes and number of micturitions per 24 hours. Mirabegron 50 and 100 mg was numerically superior to tolterodine in these two key OAB symptoms, but the study was not powered for further analysis. Mirabegron 50 and 100 mg was well tolerated, no differences being found between the placebo arm and the two mirabegron arms. In particular the incidence of hypertension or UTI were identical. In contrast with tolterodine, no increased dry mouth incidence was observed with mirabegron.

Otsuki et al. [2013] reported on the efficacy and safety of mirabegron in a predominantly male population of OAB patients. In this prospective, non-randomized, controlled study, patients with at least one episode of urgency per week and scoring at least 2 for urinary urgency in the Overactive Bladder Symptom Score (OABSS) were enrolled. Fifty-two patients (36 men) with newly diagnosed OAB received mirabegron 50 mg once daily, and 45 (36 men) with OAB refractory to antimuscarinics switched to mirabegron, and another 27 patients (18 men) with newly diagnosed OAB received antimuscarinics and served as controls. Patients on a stable α_1 -AR blocker dose for treatment of LUTS were allowed in the study, but those with a PVR greater than 100 ml were excluded. Mirabegron achieved significant improvements in all efficacy outcomes (OABSS: Overactive Bladder Symptom Score and IPSS: International Prostate Symptom Score). In patients with newly diagnosed OAB, improvements were not significantly different to those achieved by antimuscarinics. Mirabegron was well tolerated and did not significantly change PVRs. However, these encouraging results for mirabegron in treating male OAB should be interpreted with caution in view of the limitations of the study, which included small patient numbers, lack of randomization, and a suboptimal treatment period for the indication.

In a study by Chapple et al. [2013] assessing the 12-months safety and efficacy of mirabegron, tolterodine was used as active control. There were no significant differences in efficacy between drugs. However, whether mirabegron has similar efficacy to antimuscarinics awaits direct comparison studies. Mirabegron seems to have definite advantages over the antimuscarinics with respect to adverse events. Dry mouth and constipation are essentially non-existent in comparison to placebo [Chapple et al., 2013; 2014; Cui et al., 2014; Rossanese et al., 2015].

Mirabegron 50 mg and solifenacin 5 mg were recently compared in OAB patients dissatisfied with previous antimuscarinic treatment. The Beyond study [Batista et al., 2015] was a randomized, double-blind, phase IIIb, noninferiority study that enrolled male and female patients aged ≥ 18 years old, with symptoms of OAB for ≥ 3 months, who were dissatisfied with their previous antimuscarinic drug due to lack of efficacy

Assessment

Mirabegron has a documented beneficial effect in the treatment of OAB/DO (Table 2), and seems to have an acceptable side effect profile.

2.2. New Developments

Thiagamorthy et al. [2015] reviewed "novel and putative" β_3 -AR agonists for management of OAB, including CL-316243, TRK-380, AJ-9677, BRL37344. Another agent, vibegron, was claimed to have an overall superior preclinical profile compared to MK-0634, which was discontinued due to unacceptable

structure-based toxicity in preclinical species [Edmonson et al., 2016]. Even if these agents have been reported as being in development, no clinical data have been published, and it may be questioned whether any of them can be regarded as “novel and putative”. Phase II and III randomised, double blind, placebo controlled studies of ritobegron in patients with OAB has been initiated and completed, but the results have not been published and it seems that that the primary efficacy endpoint of the studies was not met. No new clinical trials with ritobegron seem to have been initiated.

Efficacy and safety of solabegron (GW427353) have been reported in a phase II multicenter, randomized, proof-of-concept trial in 258 women with wet OAB. The drug produced a statistically significant difference in percent change from baseline to week 8 in incontinence episodes over 24 h (primary outcome) when compared with placebo ($p=0.025$) and was well tolerated [Ohlstein et al., 2012].

There seems to be a number of β_3 -AR agonists in the pipeline some of which are under development. However, it is uncertain which, if any, will come to market and be available for the management of OAB.

3. DRUGS ACTING ON MEMBRANE CHANNELS

3.1. Calcium Antagonists.

Calcium channels play an important role in the regulation of free intracellular calcium concentrations and thereby contribute to the regulation of smooth muscle tone [Berridge, 2008]. Two major groups of calcium channels include the voltage-gated [Caterall et al., 2003] and the store-operated channels [Leung et al., 2008]. While both can contribute to the maintenance of smooth tone in general, store-operated calcium channels apparently contribute only to a limited if any extent to the regulation of bladder smooth muscle tone [Schneider et al., 2004 a; b]. On the other hand, various types of voltage-operated calcium channels have been implicated in the regulation of bladder smooth muscle including Q-type [Frew and Lundy, 1995] and L-type channels [Wuest et al., 2007]. The latter appears to be of particular importance as inhibitors of L-type channels have repeatedly been shown to inhibit bladder contraction in vitro with tissue from multiple mammalian species, including humans [Frazier et al., 2008]. However, the relative importance of L-type channels may be somewhat less in humans than in other mammalian species [Wuest et al., 2007]. In confirmation of the role of L-type calcium channels, it has been shown that knock-out mice lacking a crucial subunit of this channel exhibit a markedly impaired bladder contractility [Wegener et al., 2004].

While these in vitro data suggest a possible role for calcium channel inhibitors, particularly those of L-type channels, in the treatment of DO and incontinence,

only limited clinical studies are available in this regard. One urodynamic study compared the effects of intravesical installation of the calcium channel inhibitor verapamil, the muscarinic receptor antagonists oxybutynin and trospium and placebo to patients with urgency or urgency incontinence. While the two muscarinic receptor antagonists significantly increased bladder capacity, verapamil treatment was not associated with relevant changes in bladder function [Fröhlich et al., 1998]. In a clinical study of limited size the calcium channel inhibitor nimodipine (30 mg per day) did not significantly improve the number of incontinence episodes as compared to placebo [Naglie et al., 2002]. Larger studies with clinical endpoints related to effects of calcium channel inhibitors have not been reported in incontinent patients (based upon a Medline search using the MeSH terms “calcium channel blockers” and “urinary incontinence”). Moreover, it should be noted that despite a long-standing and wide-spread use of calcium channel inhibitors in the treatment of cardiovascular disease, there are no major reports on impaired bladder contractility as a side effect of such treatment. The reasons for the discrepancy between the promising in vitro and the lack of clinical data are not fully clear, but it may relate to pharmacokinetic properties of the currently used drugs which may insufficiently either reach or penetrate bladder tissue in therapeutically administered doses.

At present, there is no clinical evidence to support a possible use of calcium channel inhibitors in the treatment of bladder dysfunction (Table 2). No new information has been added since the assessment in 2008 [Andersson et al., 2009; 2013].

3.2. Potassium Channel Openers

In a similar fashion to calcium channels, potassium channels also contribute to the membrane potential of smooth muscle cells and hence to the regulation of smooth muscle tone. Numerous types of potassium channels exist [Gutman et al., 2003; Petkov et al., 2012; 2014]. With regard to bladder function, ATP-dependent (K_{ATP}) and big calcium-activated (BK_{Ca}) channels have been studied most intensively. The BK_{Ca} channels also appear to be important physiologically as their activation can cause hyperpolarization of bladder smooth muscle cells and by this mechanism they can contribute to the relaxation of bladder smooth muscle by, e.g., β -adrenoceptor agonists [Frazier et al., 2008]. Openers of both K_{ATP} [Howe et al., 1995; Hu et al., 1997; Martin et al., 1997] and BK_{Ca} channels [Hu et al., 1997; Sheldon et al., 1997; Petkov et al., 2012; 2014] have been shown to induce bladder smooth muscle relaxation in various mammalian species, but the density of some types of potassium channels may differ markedly between species. Some potassium channel openers have also been shown to suppress non-voiding detrusor contractions in vivo in animal models of DO [Howe et al., 1995; Martin et al., 1997; Tanaka et al., 2003] and this also includes activators of the KCNQ type of potassium channels [Streng et al., 2004]. Although potassium

channel openers are believed to mainly act directly on smooth muscle cells [Gopalakrishnan and Shieh, 2004; Petkov et al., 2012; 2014], they may also at least in part affect bladder function by modulating the activity of afferent neurones [Tanaka et al., 2003].

While the above data demonstrate the potential of potassium channel openers to inhibit non-voiding detrusor contractions, these channels are expressed not only in bladder, but also e.g. in vascular smooth muscle. Therefore, potassium channel openers may also affect cardiovascular function, and in effective doses may considerably lower blood pressure [Howe et al., 1995; Shieh et al., 2007]. While some compounds of this class have a certain degree of selectivity for the bladder as compared to the cardiovascular system, it remains unclear whether the degree of selectivity offers a sufficiently large therapeutic window for clinical use. This consideration has led to a considerable hesitancy to study potassium channel openers in OAB patients. Nevertheless, one randomized, placebo-controlled clinical study on the K_{ATP} opener ZD0947 has been reported [Chapple et al., 2006]. While ZD0947 at the chosen dose did not lower blood pressure or cause adverse events typical for a vasodilating drug, it also failed to achieve superiority relative to placebo for the treatment of OAB symptoms. Therefore, despite promising preclinical efficacy data, potassium channel openers at present are not a therapeutic option and may never become one due to a lack of selectivity for bladder over cardiovascular tissues (Table 2).

Another way to use potassium channels to normalize bladder function was suggested by Christ et al. [2001] in a rat model of detrusor hyperactivity. They injected "naked" hSlo/pcDNA3 (maxiK channel) into the bladder and found a significant amelioration of the hyperactivity. As to whether this principle can be therapeutically useful in man is currently under investigation.

4. α -ADRENOCEPTOR (AR) ANTAGONISTS

It is well documented that α_1 -AR antagonists can ameliorate lower urinary tract symptoms in men, and currently used α_1 -AR antagonists are considered effective for treatment of both storage and voiding symptoms in men with LUTS associated with or suggestive of BPH [Andersson, 2002; McVary et al., 2011; Oelke et al., 2011; Lepor et al., 2012; Fonseca and Martins da Silva., 2015]. However, in a study where tamsulosin was given alone, or together with tolterodine, to patients with male LUTS and OAB symptoms, monotherapy with the drug was not effective [Kaplan et al., 2006]. In an RCT from Korea, doxazosin monotherapy resulted in only minimal effects in IPSS storage subscore, urgency episodes and no improvement in the patient perception of bladder condition (PPBC) [Lee et al., 2011b]. Thus,

there is no convincing evidence that α -AR antagonists, given as monotherapy, are effective in patients with storage symptoms only.

A pivotal question is if better efficacy and/or tolerability can be obtained by highly subtype selective drugs than with the commonly used alternatives. α_1 -ARs include three receptor subtypes, α_{1A} , α_{1B} , and α_{1D} , that are structurally and pharmacologically distinct and have different tissue distributions [Andersson and Gratzke, 2007]. α_{1A} -ARs are the predominant subtype in the human prostate, where they mediate smooth muscle contraction. A fourth subtype, α_{1L} , also present in human prostate, is derived from the same gene as α_{1A} , but α_{1L} - and α_{1A} -receptors have different pharmacologic properties and bind some α -AR antagonists with different affinities. The precise structural relationship between the two subtypes remains to be elucidated.

Selectivity for α_{1B} -AR has been considered disadvantageous from a cardiovascular point of view [Schwinn et al., 2004; Schwinn and Roehrborn, 2008]. Kojima et al. [2008] studied the expression of α_1 -AR in the transitional zone of prostates from 55 patients with BPH, comparing patients treated with tamsulosin presumed to block α_{1A} -ARs and naftopidil presumed to block α_{1D} -ARs. However, the selectivity of naftopidil for α_{1D} - vs α_{1A} -ARs is modest [Take et al., 1998] and its use as a tool to separate between α_1 -AR subtypes is questionable. Nevertheless, the tamsulosin and naftopidil groups were classified as α_{1A} -AR dominant (22 and 12 patients) and α_{1D} -AR dominant (11 and 16, respectively). The efficacy of tamsulosin and naftopidil differed depending on the dominant expression of the α_1 -AR subtype in the prostate. Tamsulosin was more effective in patients with dominant expression of the α_{1A} -AR subtype, whereas naftopidil was more effective in those with dominant expression of the α_{1D} -AR subtype. In another study, the same group assessed whether there was a direct correlation between the prostatic expression of α_1 -AR subtype mRNA and severity of LUTS or bladder outlet obstruction [Kojima et al., 2010]. They found no direct correlation between the expression of α_1 -AR subtype mRNA in the prostate and severity of LUTS or BOO, although there was a significant regression of this expression with patient age. Kojima et al. [2010] concluded that the expression level of α_1 -AR subtype mRNA in the prostate could be a predictor of the efficacy of subtype selective α_1 -AR antagonists in patients with BPH, and suggested that genetic differences were responsible for the diverse responses to the drugs.

Silodosin (KD-3213), which has a high selectivity for α_{1A} -ARs [Tatemichi et al., 2006a; b; Lepor and Hill, 2010; Yoshida et al., 2011], had clinically good effects on both voiding and storage symptoms in men with BPH [Kawabe et al., 2005; Yoshida et al., 2007; Marks et al., 2009a;b; Chapple et al., 2010; Morganroth et al., 2010; Yoshida et al., 2011; Novara et al., 2014; Montorsi et al., 2016]. Chapple et al. [2010] conducted a multicenter double-blind,

placebo- and active-controlled parallel group study comparing silodosin, tamsulosin, and placebo. A total of 1228 men ≥ 50 yr of age with an International Prostate Symptom Score (IPSS) ≥ 13 and a urine maximum flow rate (Q_{max}) >4 and ≤ 15 ml/s were selected at 72 sites in 11 European countries. The patients were entered into a 2-wk wash-out and a 4-wk placebo run-in period. A total of 955 patients were randomized (2:2:1) to silodosin 8 mg ($n=381$), tamsulosin 0.4 mg ($n=384$), or placebo ($n=190$) once daily for 12 wk. Its overall efficacy was not inferior to tamsulosin. Only silodosin showed a significant effect on nocturia over placebo. There was no significant difference between the two α_1 -AR antagonists and the placebo in terms of Q_{max} . There was also no difference between the two α -AR antagonists for the QoL parameter, whereas both were better than the placebo. Active treatments were well tolerated, and discontinuation rates due to adverse events were low in all groups (2.1%, 1.0%, and 1.6% with silodosin, tamsulosin, and placebo, respectively). The most frequent adverse event with silodosin was a reduced or absent ejaculation during orgasm (14%), a reversible effect as a consequence of the potent and selective α_{1A} -AR antagonism of the drug. The incidence was higher than that observed with tamsulosin (2%); however, only 1.3% of silodosin-treated patients discontinued treatment due to this adverse event. Silodosin treatment improved DO and obstruction grade by decreasing detrusor opening pressure, detrusor pressure at Q_{max} , bladder outlet obstruction index and Schafer's obstruction class significantly [Yamanishi et al., 2009]. In a different open, nonblinded prospective study silodosin 8 mg lead to a significant increase in bladder capacity at first desire to void with no significant change in maximum cystometric capacity. In the voiding phase mean detrusor pressure at maximum flow significantly decreased, mean bladder outlet obstruction index decreased significantly and obstruction grade as assessed by the Schaefer nomogram improved significantly [Matsukawa et al., 2009].

It thus seems that selective blockade of α_{1A} -ARs is a clinically effective approach (Table 2), and silodosin is an effective and well-tolerated treatment for the relief of both voiding and storage symptoms in male patients with LUTS, even if treatment is associated with a high incidence of ejaculatory dysfunction.

Interest has also been focussed on the α_1 -ARs (α_{1D}), specifically in the bladder [Schwinn et al., 2004; Schwinn and Roehrborn, 2008], assuming that these receptors were responsible for storage symptoms. However, the inter-relationship between the α_{1D} -ARs in the human detrusor smooth muscle and the pathophysiology of LUTS is unclear. Naftopidil was shown to significantly improve the OAB symptom score [Sakai et al., 2011] and urgency episodes [Yokoyama et al., 2009]. Ikemoto et al. [2003] gave tamsulosin and naftopidil to 96 patients with BPH for 8 weeks in a crossover study. Whereas naftopidil monotherapy decreased the I-PSS for storage symptoms,

tamsulosin monotherapy decreased the I-PSS for voiding symptoms. However, this difference (which was suggested to depend on differences in affinity for α_1 -AR subtypes between the drugs) could not be reproduced in a randomized head to head comparison between the drugs [Gotoh et al, 2005]. Based on available evidence, it therefore cannot be concluded that the α_{1D} -ARs on the detrusor smooth muscle are the main therapeutic target. However, α_{1D} -ARs may have effects on different locations in the bladder beside the detrusor smooth muscle: the detrusor vasculature, the urothelium, and the afferent and efferent nerve terminals and intramural ganglia [Andersson and Gratzke, 2007]. The importance and functional role of this observation remain to be established.

In females, treatment with OAB, α_1 -AR antagonists seem to be ineffective. In an RCT, comprising 364 women with OAB, no effect of tamsulosin vs placebo could be demonstrated [Robinson et al., 2007]. On the other hand, voiding symptoms in women with functional outflow obstruction, or LUTS, were treated (with modest success) with an α_1 -AR antagonist [Kessler et al., 2006, Low et al., 2008]. It should be remembered that in women, these drugs may produce stress incontinence [Dwyer and Teele, 1992].

In patients with neurogenic DO, treatment with α_1 -AR antagonists was moderately successful [Abrams et al., 2003].

5. PHOSPHODIESTERASE (PDE) INHIBITORS

Drugs stimulating the generation of cAMP are known to relax smooth muscles, including the detrusor [Andersson, 1999; Andersson and Wein, 2004]. It is also well established that drugs acting through the NO/cGMP system can relax the smooth muscle of the bladder outflow region [Andersson and Arner, 2004]. Use of PDE inhibitors to enhance the presumed cAMP- and cGMP-mediated relaxation of LUT smooth muscles (detrusor prostate, urethra) should then be a logical approach (Andersson et al., 1997; 2007; 2011). There are presently 11 families of PDEs, some of which preferentially hydrolyse either cAMP or cGMP [Uckert et al., 2006].

As a basis for PDE inhibitor treatment of LUTS, Uckert et al. [2006] investigated human bladder tissue, revealing messenger RNA for PDEs 1A, 1B, 2A, 4A, 4B, 5A, 7A, 8A, and 9A; most of these PDEs preferably inhibit the breakdown of cAMP. In vitro, human detrusor muscle responded poorly to sodium nitroprusside, and to agents acting via the cGMP system [Truss et al., 2000]. However, significant relaxation of human detrusor muscle, paralleled by increases in cyclic nucleotide levels, was induced by papaverine, vinpocetine (a low affinity inhibitor of PDE 1), and forskolin (stimulating the generation of cAMP), suggest-

ing that the cAMP pathway and PDE 1 may be important in regulation of detrusor smooth muscle tone [Truss et al., 2001]. Significant dose-dependent relaxations were also induced by human cAMP analogs [Truss et al., 2001]. With these studies as a background, Truss et al. presented preliminary clinical data with vinpocetine in patients with urgency/urgency incontinence or low compliance bladders, and not responding to standard antimuscarinic therapy (Truss et al., 2000). This initial open pilot study suggested a possible role for vinpocetine in the treatment of OAB. However, the results of a larger RCT in patients with DO showed that vinpocetine only showed statistically significant results for one parameter [Truss et al., 2001]. Studies with other PDE 1 inhibitors than vinpocetin (which may not be an optimal drug for elucidation the principle) do not seem to have been performed.

PDE 4 (which also preferably hydrolyses cAMP) has been implicated in the control of bladder smooth muscle tone. PDE 4 inhibitors reduced the in vitro contractile response of guinea pig [Longhurst et al., 1997] and rat [Kaiho et al., 2008] bladder strips, and also suppressed rhythmic bladder contractions of the isolated guinea pig and rat bladder [Gillespie and Drake, 2004; Nishiguchi et al., 2007]. Xin et al. [2014] found that that selective pharmacological inhibition of PDE4 increases the frequency of Ca^{2+} sparks and their functionally coupled BK channels, which lead to the attenuation of DSM excitability and contractility and suggested that PDE4 isoforms might be valuable therapeutic targets for the treatment of overactive bladder. However, previous experiences with selective PDE 4 inhibitors showed emesis to be a dose-limiting effect [Giembycz, 2005]. If this side action can be avoided, PDE 4 inhibition seems to be a promising approach.

Oger and co-workers showed that PDE5-inhibitor sildenafil-induced relaxation of human detrusor smooth muscle involved cGMP-, cAMP- and K(+) channel-dependent signalling pathways, with a minor contribution from NO [Oger et al., 2010]. In combination with the alpha-blocker doxazosin, sildenafil reduced adrenergic tone of prostatic and cavernosal smooth muscle and their combination provided a significant benefit when targeting relaxation of both tissues [Oger et al., 2008].

In-vivo, several studies have indicated a role for PDE5-inhibitors in the regulation of micturition function. Systemic vardenafil reduced both non-voiding contractions and bladder afferent nerve firing in unanesthetized, decerebrate, spinal cord injury rats, indicating potential mechanisms by which PDE5-Is improve storage symptoms in SCI patients [Behr-Roussel et al., 2010]. The effect of vardenafil on OAB-symptoms could be related to a cGMP-dependent RhoA/ROCK signaling inhibition, as shown in spontaneously hypertensive rats (SHR) [Morelli et al., 2009a; Morelli et al., 2009b]. Using the same animal model, bladder hypoxia was significantly reduced by acute vardenafil treatment

[Morelli et al., 2009b]. Thus, besides relaxing muscular wall, PDE5 inhibition may positively affect urinary bladder blood perfusion. In the same respect, tadalafil was shown to increase prostate tissue oxygenation in SHR and human vesicular-deferential artery is characterized by a high expression and activity of PDE5, which was inhibited by tadalafil in vitro; these results suggest another possible mechanism through which PDE5i exert beneficial effects on LUT symptoms [Morelli et al., 2011; Celtek et al., 2014].

NO has been demonstrated to be an important inhibitory neurotransmitter in the smooth muscle of the urethra and its relaxant effect is associated with increased levels of cyclic GMP [Andersson and Arner, 2004]. However, few investigations have addressed the cAMP- and cGMP-mediated signal transduction pathways and its key enzymes in the mammalian urethra. Morita et al. examined the effects of isoproterenol, prostaglandin E₁ and E₂, and SNP on the contractile force and tissue content of cAMP and cGMP in the rabbit urethra [Morita et al., 1994]. They concluded that both cyclic nucleotides can produce relaxation of the urethra. Werkström et al. [2006] characterized the distribution of PDE 5, cGMP and PKG1 in female pig and human urethra, and evaluated the effect of pharmacological inhibition of PDE-5 in isolated smooth muscle preparations. After stimulation with the NO donor, DETA NONO-ate, the cGMP-immunoreactivity (IR) in urethral and vascular smooth muscles increased. There was a wide distribution of cGMP- and vimentin-positive interstitial cells between pig urethral smooth muscle bundles. PDE-5 IR could be demonstrated within the urethral and vascular smooth muscle cells, but also in vascular endothelial cells that expressed cGMP-IR. Nerve-induced relaxations of urethral preparations were enhanced at low concentrations of sildenafil, vardenafil and tadalafil, whereas there were direct smooth muscle relaxant actions of the PDE-5 inhibitors at high concentrations. Fibbi et al. [2009] confirmed that the highest expression and biological activity of PDE5 was found in bladder. However, a consistent PDE5 expression and activity was also found in prostatic urethra. In contrast, the prostate gland showed the lowest PDE5 abundance and cultures derived from this tissue were less sensitive to vardenafil. Using a different animal model associated with C-fibre afferent activation, it was shown that the NO/cGMP signalling pathway is involved in the regulation of the micturition reflex, with an action that seems more predominant on the sensory rather on the motor component of the micturition reflex [Caremel et al., 2010].

The observation that patients treated for erectile dysfunction with PDE5 inhibitors had an improvement of their LUTS, has sparked a new interest in using these drugs also for treatment of LUTS and OAB. After the report in an open study that treatment with sildenafil appeared to improve urinary symptom scores in men with ED and LUTS [Sairam et al., 2002], this observation has been confirmed in several well designed and conducted RCTs.

6. ANTIDEPRESSANTS

A number of RCTs are available comparing the effect of PDE5 inhibitors alone to placebo and the combination of α -AR antagonists and PDE5 inhibitors vs α -AR antagonists alone [Bechara et al., 2008; Gacci et al., 2011; Kaplan et al., 2007; Liguori et al., 2009; McVary et al., 2007a; b; Porst et al., 2009; 2011; Roehrborn et al., 2008; Stief et al., 2008; Tamimi et al., 2010; Tuncel et al., 2010; see Gacci et al., 2016]. In these studies, different PDE5 inhibitors and different doses were administered. PDE5-inhibitors significantly improve IPSS and IIEF scores, but not Qmax when compared to placebo. According to a meta-analysis by Gacci and co-workers, differences in IPSS score were significantly lower in older and obese patients [Gacci et al., 2011]. The combination of PDE5-inhibitors and α -AR-blockers lead to significant improvements of the IPSS and IIEF score as well as Qmax when compared to the use of α -AR-blockers alone. Dmochowski showed that tadalafil once daily for LUTS had no significant effect on bladder function as measured by detrusor pressure at maximum urinary flow rate or such as maximum detrusor pressure and bladder outlet obstruction index while improving IPSS [Dmochowski et al., 2010b]. PDE5-inhibitors were generally shown to be safe and well tolerated.

The mechanism behind the beneficial effect of the PDE inhibitors on LUTS/OAB and their site(s) of action largely remain to be elucidated. There is *in vitro* evidence that PDE5 inhibition might relax the smooth muscle of the prostate, bladder, and urethra, dilate the pelvic vasculature (including the microvasculature), and modulate sensory bladder functions [Andersson et al., 2011; Giuliano et al., 2013; Cellek et al., 2014]. Improvement of bladder blood flow to the LUT has been suggested [Cellek et al., 2014], and this has been supported by studies in animals with chronic bladder ischemia [Nomiya et al., 2013]. However, Pinggera et al. [2014], using transrectal ultrasonography, compared the effects of tadalafil 5 mg/day and placebo given for 8 weeks to men with moderate to severe LUTS/BPH. They found no differences between the treatments, but did not exclude that changes in blood flow may have occurred which for several reasons could not be detected. Previously, Pinggera et al. [2008], using the same methodology, quite convincingly showed that tamsulosin could increase perfusion to the LUT.

Currently, tadalafil is the only FDA approved PDE-5 inhibitor for treatment of male LUTS even of e.g, sildenafil and vardenafil have been shown to be effective. However, there are several other drugs belonging to the same class that are used for treating erectile dysfunction, including avanafil, udenafil, mirodenafil, gisadenafil [Gacci et al., 2014], and there are no reasons to believe that they should not be effective in relieving male LUTS. To what extent new molecules with ability to inhibit PDE-5 [Sawant et al., 2015] will be developed for future clinical application remains to be seen.

Several antidepressants have been reported to have beneficial effects in patients with DO [Lose et al., 1989; Martin and Schiff, 1984]. However, the use of antidepressants was shown to be an independent risk factor for LUTS suggestive of benign prostatic hyperplasia in a community based population of healthy aging men (Krimpen Study) [Kok et al., 2009]. In a prospective trial, and in total, 205 consecutive female (113 patient taking antidepressants for various disorders and 92 healthy controls), Albayrak et al. [2015] found that the prevalence of OAB was significantly higher in antidepressant users (64 %) than in the control group (33 %) ($p = 0.003$). They suggested that since each SSRI and SNRI has a unique pharmacological profile, this could explain the opposing reports in the literature.

6.1. Imipramine

Imipramine is the only drug that has been widely used clinically to treat this disorder. Imipramine has complex pharmacological effects, including marked systemic antimuscarinic actions [Baldessarini, 1985] and blockade of the reuptake of serotonin and noradrenaline [Maggi et al., 1989], but its mode of action in DO has not been established [Hunsballe and Djurhuus, 2001]. Even if it is generally considered that imipramine is a useful drug in the treatment of DO, no good quality RCTs that can document this have been retrieved. It has been known for a long time that imipramine can have favourable effects in the treatment of nocturnal enuresis in children with a success rate of 10-70 % in controlled trials [Glazener et al., 2003; Hunsballe and Djurhuus, 2001]. It is well established that therapeutic doses of tricyclic antidepressants, including imipramine, may cause serious toxic effects on the cardiovascular system (orthostatic hypotension, ventricular arrhythmias). Imipramine prolongs QTc intervals and has an antiarrhythmic (and proarrhythmic) effect similar to that of quinidine [Bigger et al., 1977; Giardina et al., 1979]. Children seem particularly sensitive to the cardiotoxic action of tricyclic antidepressants [Baldessarini, 1985]. The risks and benefits of imipramine in the treatment of voiding disorders do not seem to have been assessed. Very few studies have been performed during the last decade [Hunsballe and Djurhuus, 2001; Natalin et al., 2009]. No good quality RCTs have documented that the drug is effective in the treatment DO. However, a beneficial effect has been documented in the treatment of nocturnal enuresis.

A prospective (no controls) study the impact of the "three-drug therapy" (antimuscarinic, alpha-blocker and tricyclic antidepressants) on the treatment of refractory detrusor overactivity (DO) showed a significant increase on bladder capacity and decreases on urgency, urge-incontinence and frequency. Objective urodynamic data as well as symptom score improved significantly with triple therapy [Natalin et al., 2009].

Selective serotonin-reuptake-inhibitors (SSRIs) have been tested with regard to their effects on OAB symptoms. Milnacipran hydrochloride, a serotonin-norepinephrine reuptake inhibitor (SNRI), or paroxetine hydrochloride, a selective serotonin reuptake inhibitor, were analysed in a prospective open trial in neurogenic OAB-patients. Milnacipran reduced daytime urinary frequency, improved the quality of life index and increased bladder capacity as shown in urodynamic studies. No such changes were noted in the other categories of the lower urinary tract symptoms questionnaire or urodynamic studies, or in the paroxetine group [Sakakibara et al., 2008].

In a retrospectively Hillelsohn et al [2014] evaluated 43 patients who were treated with desipramine for OAB refractory to antimuscarinic therapy. Twelve patients (28%) discontinued desipramine, 9 due to perceived lack of efficacy. Still, the authors concluded that desipramine is a potential useful treatment for patients with OABsymptoms, e.g., those with pain. To confirm any useful effect of desipramine, RCTs are needed.

6.2. Duloxetine

Duloxetine hydrochloride is a combined norepinephrine and serotonin reuptake inhibitor, which has been shown to significantly increase sphincteric muscle activity during the filling/storage phase of micturition in the cat acetic acid model of irritated bladder function [Katofiasc et al., 2002; Thor and Katofiasc, 1995]. Bladder capacity was also increased in this model, both effects mediated centrally through both motor efferent and sensory afferent modulation (Fraser and Chancellor, 2003). In a placebo-controlled study, the drug showed efficacy in patients with OAB [Steers et al., 2007]. The number of micturition episodes, the primary outcome, was reduced by 2 in the duloxetine arm and by 0.5 in the placebo arm. Episodes of urgency incontinence were also significantly reduced by duloxetine. These data have not been reproduced so far in another trial. However, the high withdrawal rate observed across all studies in which the drug was evaluated fou SU1, affecting 20-40% of the patients at short-term and up to 90% in long-term studies, do not predict clinical utility of duloxetine in OAB.

7. CYCLOOXYGENASE (COX) INHIBITORS

Prostanoids (prostaglandins and thromboxanes) are synthesized by cyclooxygenase (COX) from a common precursor, arachidonic acid. Prostanoids may be involved in the control of bladder function under normal and pathological conditions, including DO and OAB. Human bladder mucosa has the ability to synthesize eicosanoids [Jeremy et al., 1987], and these agents can be liberated from bladder muscle and mucosa in response to different types of trauma [Downie and Karmazyn, 1984; Leslie et al., 1984]. Even if prostaglandins cause contraction of human

bladder muscle, it is still unclear whether prostaglandins contribute to the pathogenesis of unstable detrusor contractions. More important than direct effects on the bladder muscle may be sensitization of sensory afferent nerves, increasing the afferent input produced by a given degree of bladder filling. Involuntary bladder contractions can then be triggered at a small bladder volume. If this is an important mechanism, treatment with prostaglandin synthesis inhibitors could be expected to be effective. However, clinical evidence for this is scarce.

Cardozo et al. performed a double-blind controlled study of 30 women with DO using the prostaglandin synthesis inhibitor flurbiprofen at a dosage of 50 mg 3 times daily [Cardozo et al., 1980a]. The drug was shown to have favourable effects, although it did not completely abolish DO. There was a high incidence of side effects (43%) including nausea, vomiting, headache and gastrointestinal symptoms. Palmer studied the effects of flurbiprofen 50 mg x 4 versus placebo in a double-blind, cross-over trial in 37 patients with idiopathic DO (27% of the patients did not complete the trial) [Palmer, 1983]. Active treatment significantly increased maximum contractile pressure, decreased the number of voids and decreased the number of urgent voids compared to baseline. Indomethacin 50 to 100 mg daily was reported to give symptomatic relief in patients with DO, compared with bromocriptine in a randomized, single-blind, cross-over study [Cardozo and Stanton, 1980b]. The incidence of side effects was high, occurring in 19 of 32 patients.

Although these early clinical studies with nonselective COX inhibitors showed some promise in the treatment of these disorders, the drugs were not further developed for this indication mainly due to side effects. The interest in the use of selective COX-2 inhibitors was hampered by concerns about long-term cardiovascular toxicity with these drugs.

No recent clinical studies on the use of COX-inhibitors for treatment of LUTS/OAB seem to have been published.

8. TOXINS

Intravesical pharmacological therapy for LUTS stems from the fact that circumventing systemic administration of active compounds offers two potential advantages. First, high concentrations of pharmacological agents can be given to the bladder tissue producing enhanced local effects. Second, drugs inappropriate for systemic administration due to off target effects can be safely used. Attractive as it may be, intravesical pharmacological therapy should still be considered as a second line treatment in patients refractory to oral therapy or that do not tolerate its systemic side effects. However, this statement is based on the assumption that intervention therapy should follow oral medication. Research aiming at defining if

patients subgroups will benefit of intravesical therapy as first line is clearly necessary.

8.1. Botulinum Toxin

Mechanism of action. Botulinum toxin (BoNT) is a neurotoxin produced by *Clostridium botulinum*. Of the seven subtypes of BoNT, sub-type A (BoNT/A) has the longest duration of action, making it the most relevant clinically. BoNT/A is available in different commercial forms, with the proprietary names of Botox®, Dysport®, Xeomin®, and Prosigne. Although the toxin is the same, it is wrapped by different proteins which modify the relative potency of each brand. This was the basis for the introduction of the non-proprietary names onabotulinum toxin A (onabotA), abobotulinum toxin A (abobotA) and incobotulinum toxin A (incobotA) for Botox®, Dysport® and Xeomin®, respectively. Prosigne is the proprietary name of a BoNT/A produced in China, which currently does not have a known non-proprietary name.

The current approved method to estimate the potency of a BoNT/A brand is the mouse LD50 (lethal dose 50%); that is, the mass of toxin (expressed in ng/kg of body weight) that kills 50% of mice. More recently, a cell-based potency assay was approved specifically for onabotulinum toxin assay which uses differentiated human neuroblastoma SiMa cells and replicates all steps in BoNT/A mechanism of action. The assay measures the BoNT/A-dependent intracellular increase of cleaved SNAP-25. The EC50, that is, the concentration of toxin required to provoke a response halfway between the baseline and maximum response for OnabotA, is about 1–0.4 U per well [Fernandez-Salas et al., 2012].

Although potency of each toxin brand is expressed in units (U) the doses are not interchangeable and conversion ratios between the different brands do not exist. Estimates from studies carried in the skeletal muscle suggest that onabotA is roughly three times more potent than abobotA and equivalent to incobotA. Nevertheless, these equivalences should be approached with caution. Comprehensive reviews have been produced during the last few years. The interested reader is also invited to read [Chapple and Patel., 2006; Nitti, 2006; Patel et al., 2006; Karsenty et al., 2008; Apostolidis et al., 2009; Silva and Cruz, 2009b; Dowson et al., 2010; Duthie et al., 2011; Mangera et al., 2011].

In a recent experimental study in the mice the capacity of 1 U of onabotA and 1 U of abobotA to cleave SNAP25 were compared after one single injection in the bladder wall. The average number of cleaved SNAP-25 positive fibers was higher after onabotA, than after abobotA, the difference suggesting that when injected in the bladder wall, in the same unit amount and same volume, the conversion ratio between onabotA and abobotA should be around 1:1.6 [Oliveira et al., 2015].

Most of the information available about intravesical application of BoNT/A derives from the use of onabotA (Botox®). However, in addition to sub-type A, some studies have investigated the effect of detrusor injection sub-type B, rimabotulinumtoxinB (proprietary names being Miobloc™ or Neurobloc™ depending on country). For further details, see below.

8.1.1 BoNT/A

BoNT consists of a heavy and a light chain linked by a disulphide bond. As the BoNT/A gene may differ in nucleotides, four A subtypes have been classified based on up to 15% variation in the amino acid composition. The amino acid sequence of the BoNT/A light chain constitutes a catalytic Zn-dependent endopeptidase domain. The heavy chain is subdivided into three portions (HN, HCN, and HCC), but only two have clear functions. The HCC is associated both with the recognition of neuronal-specific areas and toxin internalization. The HN is responsible for translocation of the light chain from synaptic vesicles into the neuronal cytoplasm. In the synaptic cleft BoNT/A binds predominately to the isoform C of the synaptic vesicle protein or SV2 (SV2C) [Dong et al., 2006, Dolly et al., 2014], or to the FGF Receptor 3 [Jacky et al., 2013] by the heavy chain. The importance of the latter toxin receptor is still unclear.

The most well studied process involves SV2 binding before being internalized by the nerve terminal during the recycling process of synaptic vesicles (Figure 16). The two chains are then cleaved and the light chain passes into the cytosol, where it cleaves the attachment proteins involved with the mechanism of fusion of synaptic vesicles to the cytoplasmic membrane necessary for neurotransmitter release. Attachment protein (SNARE or soluble N-ethylmaleimide-sensitive fusion attachment protein receptor) include synaptosome associated protein 25 kD (SNAP 25), syntaxin, and SNAP-25 (vesicle associated membrane protein - VAMP) and syntaxin. BoNT/A cleaves SNAP 25 rendering the SNARE complex inactive (Figure 17) [Humeau et al., 2000; Chancellor et al., 2008b]. Subtype B, acts preferentially through the inactivation of VAMP [Humeau et al., 2000]. Interestingly, BoNT/A cleaves SNAP 25 always in the same position, cutting the 9 terminal amino-acids of the C terminal of the protein [Dolly et al., 2014]

BoNT/A application was extensively evaluated in striated muscle. In this tissue paralysis occurs by prevention of acetylcholine (ACh) release from cholinergic motor nerve endings [Humeau et al., 2000]. Accumulation of neurotransmitter containing synaptic vesicles is followed by terminal axonal degeneration. Striated muscle paralysis recovers within 2 to 4-months time. During this time axons develop lateral

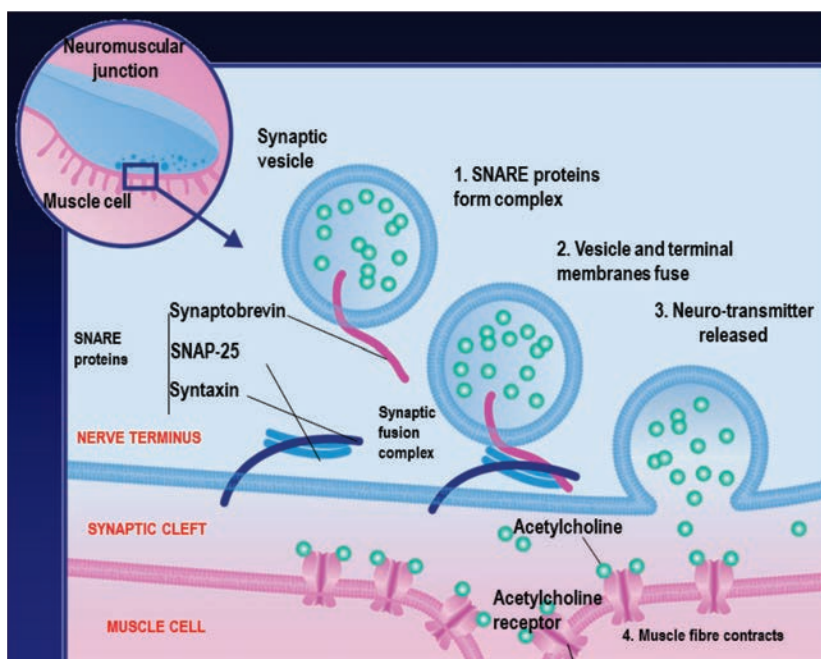

Figure 16: Mechanism of action of botulinum toxin (BoNT). BoNT consists of a heavy and a light chain linked by a disulphide bond. In the synaptic cleft the toxin binds to synaptic vesicle protein or SV2 by the heavy chain before being internalized by the nerve terminal along with the recycling process of synaptic vesicles. The two chains are then cleaved and the light chain passes into the cytosol, where it cleaves the attachment proteins involved with the mechanism of fusion of synaptic vesicles to the cytoplasmic membrane necessary for neurotransmitter release. Attachment protein (SNARE or soluble N-ethylmaleimidesensitive fusion attachment protein receptor) include synaptosome associated protein 25 kD (SNAP 25), synaptobrevin (vesicle associated membrane protein -VAMP) and syntaxin.

sprouts and eventually regenerate completely [de Paiva et al., 1999].

In the human bladder SV2 and SNAP-25 expression has been demonstrated in parasympathetic, sympathetic and sensory fibers [Coelho et al., 2010; 2012a; b]. Almost all parasympathetic nerves express the two proteins [Coelho et al., 2012b]. As these nerves play a fundamental role for detrusor contraction during voiding, the blockade of ACh release is believed to play an essential role in detrusor hypo- or a contractility that follows BoNT/A injection in the bladder. In accordance with this view it was shown that in normal or SCI animals BoNT/A treatment decreased the bladder contractions evoked by electrical stimulation of spinal nerves without altering intrinsic contractions [Ikeda et al., 2012]. However cholinergic axon sprouting concomitant with clinical remission could not be documented in the detrusor [Haferkamp et al., 2004].

Bladder sensory impairment is also expected to play an important role in the final effect of BoNT/A bladder injection (Figure 18). About half of the peptidergic sensory fibers express SV2 and SNAP25 [Coelho et al., 2010]. BoNT/A inhibits the spinal cord release of glutamate, substance P (SP) and CGRP from sensory nerves [Purkiss et al., 2000; Aoki et al., 2005; Meng et al., 2007] as well as the release of neuropeptides at the peripheral extremities [Rapp et al., 2006; Lucioni et al., 2008]. BoNT/A has also been shown to

reduce the suburothelium immunoreactivity for TRPV1 or P2X3 [Apostolidis et al., 2005]. BoNT/A also impedes TRPV1 trafficking from intracellular vesicles to the neuronal membrane, as this process is also dependent on SNARE proteins [Morenilla Palao et al., 2004; Shimizu et al., 2012]. All these mechanisms may contribute to the recent observation that BoNT/A reduces afferent firing from bladder afferents and antidromic release of neuropeptides [Ikeda et al., 2012].

In the human bladder SV2 and SNAP-25 expression by immunohistochemistry could not be demonstrated [Coelho et al., 2010]. In another study using immunoblot analysis the existence of SV2 in isolated human urothelial cells also was not demonstrated although SV2 was present in the human bladder mucosa (which contains sub-urothelial connective layer). SNAP 25 was present in both isolated human urothelial cells and human bladder mucosa [Hanna-Mitchell et al., 2013]. Another SNARE protein, SNAP 23 was identified in the human urothelial cells and may contribute to the activity of BoNT/A in the urothelium [Hanna-Mitchell et al., 2013; Cruz, 2014]. As a matter of fact urothelial function seems also compromised after BoNT/A administration. BoNT/A has been shown to inhibit ATP release from urothelium in animal models of spinal cord injury [Khera et al., 2004; Smith et

al., 2008]. Therefore, it is not surprising that administration of BoNT/A to inflamed rat bladders reduces spinal *c-fos* counts at the L6 and S1 spinal cord segments [Vemulakonda et al., 2005].

Cleaved, inactive SNAP-25 appears rapidly after BoNT/A injection. In the guinea-pig a robust expression of cleaved SNAP 25 could be detected already at 12 hours and maximum intensity could be detected at 24 hours with little changes afterwards. In guinea-pigs cleaved SNAP-25 expression was restricted to nerve fibers. Almost all parasympathetic fibers, either preganglionic and postganglionic were affected while less than half of the sensory fibers express the cleaved protein [Coelho et al., 2012a; b]. In the human urinary bladder cleaved SNAP 25 could be detected in NDO patients up to 11 months after BoNT/A injection. [Schulte-Baukloh et al., 2007].

BoNT/A has a unique long lasting effect. The structural basis for this remarkable persistence remains poor explained. The enzymatic capacity of the light chain is long lasting apparently due to presence of two leucines near the C terminus of the protease light chain of A toxin [Wang et al., 2011b]. The duration of effect of BoNT/A in the detrusor smooth muscle, longer than in striated muscles, has currently no firm explanation. However, the longer persistence of the inactive form of SNAP-25 plus the involvement of pre and post-ganglionic parasympathetic neurons may contribute to persistence of the BoNT/A effect in the bladder.

Myofibroblasts form a syncytium through extensive coupling via the gap-junction protein connexin 43 and have close contacts with sensory nerves. These facts led to the hypothesis that myofibroblasts act as modulators of bladder behaviour [Wiseman et al., 2003; Apostolidis et al., 2006]. However, the expression of connexin 43 is not altered by BoNT/A [Roosen et al., 2009]. Hence, currently a firm evidence for the action of BoNT/A on myofibroblasts is scant.

BoNT/A may decrease the levels of neurotrophic agents in the bladder tissue. Levels of Nerve Growth Factor (NGF) [Giannantoni et al., 2006; Liu et al., 2009] and Brain-derived Neurotrophic Factor (BDNF) [Pinto et al., 2010] have been shown to decrease in the bladder and/or urine following BoNT/A injections. As both neurotrophins have paramount roles for growth, maintenance and plasticity of peptidergic sensory nerves, these findings may point toward another mechanism whereby BoNT/A acts upon the bladder.

8.1.1.1 BoNT/A Effects on Bladder Histology

There is no evidence that repeated injections of nbotA into the detrusor muscle cause inflammatory infiltrates, fibrotic activity or apoptosis within the bladder wall [Comperat et al., 2006; Apostolidis et al., 2008; Kessler et al., 2010]. Rather the reverse, one study demonstrated that NDO patients treated with BoNT/A had less fibrosis than nontreated patients [Compérat et al., 2006]. The presence of eosinophilic infiltrate

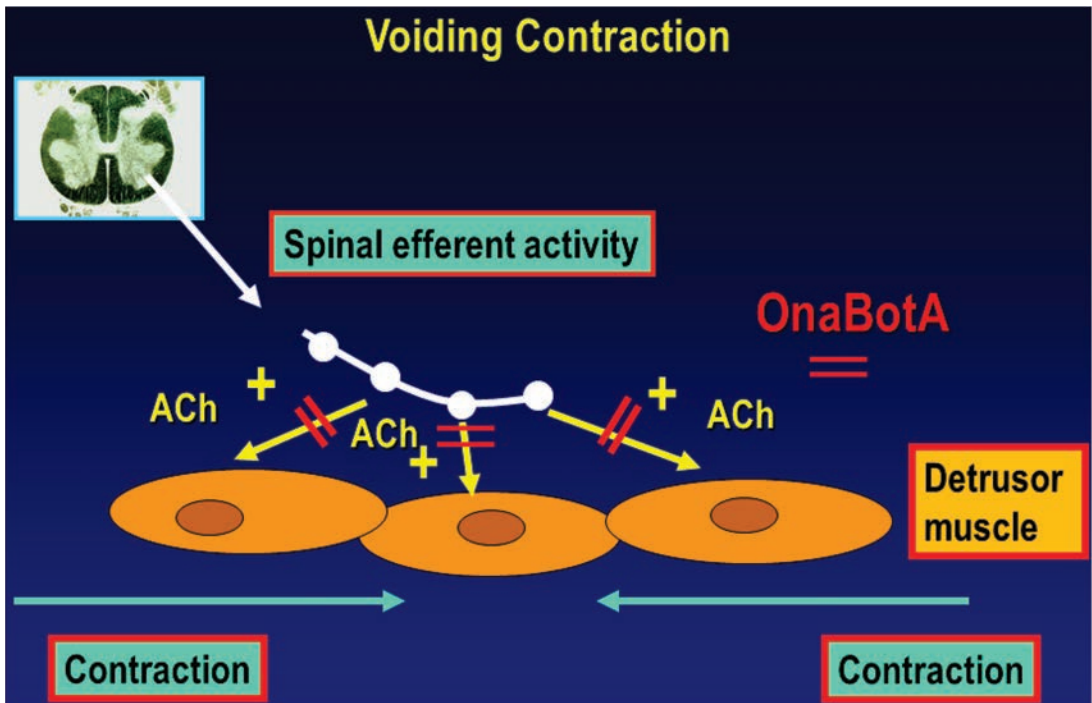

Figure 17: Onabotulinum toxin A inhibition of acetylcholine (ACh) release decreases detrusor smooth muscle contraction.

was shown to increase in specimens of patients receiving multiple treatments, a finding that could not be fully explained [Apostolidis et al., 2008].

BoNT/A injection protocol in the bladder wall.

When the treatment was first described in 1999 for NDO patients, onabotA was diluted in normal saline in order to obtain a concentration of 10 units/ml [Schurch et al., 2000a; b]. Under visual control through a rigid cystoscope and a flexible 6 Fr injection needle, 30 injections of 1 ml (10 units of botulinum-A toxin) were done in 30 different bladder wall locations above the trigone to prevent vesico-urethral reflux. Additional refinements have been added to this technique along the following years, including the use of a local anaesthetic agent (4% lidocaine) and a flexible cystoscope [Harper et al., 2003].

The pivotal studies [Cruz et al, 2011; Ginsberg et al., 2012] which included more than 700 NDO patients led to the approval of a dose of onabotA 200 U applied in 30 injection sites above the trigone (1ml saline each 6.66 U/ml). The studies showed that 300 U produced the same results and had the same duration of effect but caused more adverse events than the 200 U dose [Cruz et al., 2011; Ginsberg et al., 2012]. When considering OAB/IDO two large pivotal studies have been published after enrolling more than 1000 patients. The protocol was first investigated in a dose finding study which led to the conclusion that

100 U was the ideal dose [Dmochowski et al., 2010c]. The toxin was administered via cystoscopy as 20 intradetrusor injections of 0.5 ml, evenly spaced but avoiding the trigone [Chapple et al., 2013; Nitti et al., 2013]. Following the approval of 100 U of onabotA for the treatment of refractory incontinence in OAB patients, this protocol should be considered standard while those reviewed in previous systematic reviews for OAB/IDO should be considered off-label. This includes the use of 200 U or abobotA 500 U [see Mangera et al., 2011; Karsenty et al., 2014 for review of other protocols].

Despite the existence of an approved protocol for onabotA injection in the bladder wall, in NDO and OAB/IDO, several variations have been investigated.

One variable at stake is the trigone injection, the rationale for the injection being the dense sensory innervation of this part of the bladder. The suggested risks of ureteral reflux after injecting bladder trigone were never demonstrated, whether onabotA or abobotA was used [Karsenty et al., 2007; Citeri et al., 2008; Mascarenhas et al., 2008; Pinto et al., 2010]. A few studies have, therefore, compared trigonal vesus trigonal sparing protocols in IDO patients. A recent trial randomised 22 IDO patients to receive abobotA 500 U administration in 20 injections (1ml each) sparing the trigone against 15 off the trigone plus 5 injections in the trigone [Manecksha et al., 2012]. Mean

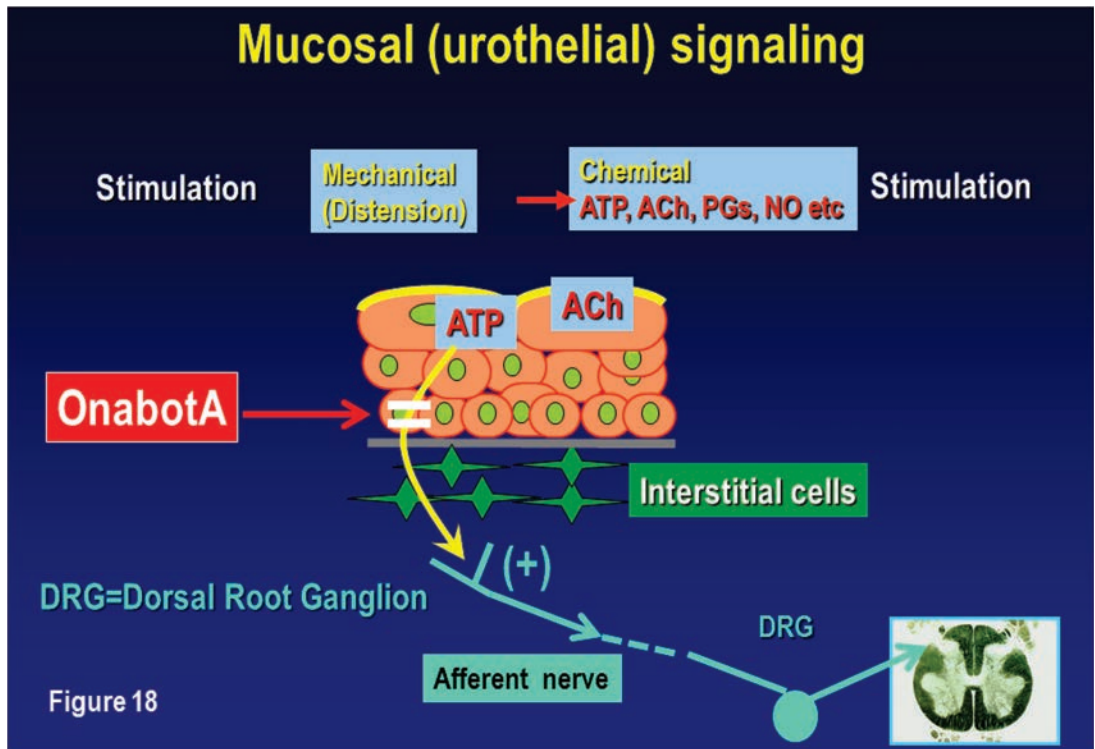

Figure 18: Onabotulinum toxin A inhibition of the release of adenosin triphosphate (ATP) from the urothelium decreases bladder afferent activity.

postvoid residual volumes and clean intermittent self-catheterisation rates between the two groups were similar. However, the change from baseline of the OABSS score was greater in the trigone injected group.

One study compared 10 trigonal injections versus 40 injections into the detrusor or suburothelium of 100 U of OnabotA in IDO patients [Kuo, 2007a]. The most effective protocol was the 40 detrusor injections because it brought more robust symptomatic improvement which lasted longer. The trigone injection only protocol was the less effective and durable of the three, although the risk of urinary retention was null [Kuo, 2007a]. The suburothelial protocol brought intermediate results, worse than the detrusor but better than the trigone only technique [Kuo, 2007a]. Pinto et al. [2010] injected 100 U distributed by 10 sites only in the trigone in 26 women with BPS/IC: No cases of voiding dysfunction were observed. PVR remained normal and bladder contractility index was not changed by OnabotA.

In patients with BPS/IC, pilot studies used onabotA 100 U injected in 10 sites in the trigone to treat bladder pain in patients with and without Hunner's lesions. This protocol was not associated with urinary retention or clinically relevant increase of PVR (Pinto et al., 2010; Pinto et al., 2013).

Another variable under investigation is the reduction of injection sites while increasing the dose in each site. One study randomized NDO patients to receive 300 U either in 10 or 30 sites [Karsenty et al., 2005]. The authors reported that 10 site injection was quicker and less painful and that no differences in efficacy between the two procedures could be detected up to 24 weeks. In another study, it was found that patients receiving 300 U of onabotA distributed over 30 injection sites (30 ml of fluid in total) or the same dose of toxin distributed over 10 injection sites (10 ml of fluid in total) had a similar distribution of the fluid, as determined by MRI. About 1/3 to 1/4 of the total detrusor volume was covered by the two protocols, respectively [Mehnert et al., 2009].

More recently forty-five patients (22 IDO, 23 NDO) were treated with 100–300U of onabotA injected on 1 or 3 injection sites in the posterior bladder wall. ICIQ-SF score improvement of >5 points was achieved in 73% of them (IDO 55%, NDO 91%) and the subjective success rate was 69% (50% IDO, 87%NDO). Full continence was achieved in 52% of NDO patients. Increase of PVR was modest and urinary retentions were not reported. Urinary tract infection occurred in 11.1%. Mean duration of effect was 31 weeks. It is unclear if this protocol has already been applied in other centers.

Another variable in the injection protocol is the volume of the saline used to reconstitute the toxin. Most studies used 1.0 mL per injection, although a few used 0.5 mL [Grosse et al., 2005; Schulte-Baukloh et al., 2005], 0.2 mL [Kuo et al., 2004], 0.25 ml [Grise et al., 2010] or even 0.1 mL per injection site [Rapp et

al., 2004]. In a recent experimental study, the amount of cleaved SNAP-25 induced by a fixed amount of OnabotA was directly related with the volume of the injection [Coelho et al., 2012a]. Thus, more controlled studies designed to compare different number and locals of injection and the volume of each injection are necessary.

BoNT/A does not cross the rat urothelium if instilled in the bladder [Coelho et al., 2012a]. OnabotA instillation in the bladder encapsulated in liposomes may however overcome the urothelial barrier and induced distinctive bladder effects [Chuang et al., 2009].

Recently the liposome encapsulation technology to deliver onabotA was tested in humans. The study used the change of total urinary frequency per 3-day bladder diary at 1 mo after treatment as the primary end-point. A small group of 24 patients were randomized to intravesical instillation of Lipotoxin containing 80 mg liposomes and 200 U BoNT-A or normal saline. Patients were retreated with Lipotoxin 1 month later if they failed the first treatment. At 1 month after treatment, the change of urinary frequency per 3d was significantly improved in the Lipotoxin group. Urgency episodes also showed a significant decrease in the Lipotoxin group. Although no adverse events were reported, the duration of the effect was unfortunately short lasting [Kuo et al., 2014].

Electromotive administration may also help to carry the large botulinum toxin molecule across the urothelium. In 15 children with NDO due to myelomeningocele, a 10F indwelling catheter containing a silver spiral electrode was placed in the bladder, after providing a local transurethral anaesthesia with 2% lidocaine. The bladder was filled with saline and 10 U/kg of abobotA was added. A maximal current of 10 mA (100 mA increment/s) for 15 minutes was applied using abdominal pads [Kajbafzadeh et al., 2010]. The urodynamic and symptomatic results were excellent. Skin erythema and burning sensation were the only side effects reported with this method. If this technique can be applied to adults it is not known. However, it would certainly simplify BoNT/A administration.

AbobotA administration remains off-label. Nevertheless, in larger cohorts coming from several institutions abobotA was applied in the bladder wall by similar technique albeit the number of injections was only 20 [del Popolo et al., 2008; Grise et al., 2010]. A total of 500-1000 U of abobotA are injected [del Popolo et al., 2008]. The volume of saline at each injection site is commonly 1 ml but volumes so low as 0.25 ml per site were also used [Grise et al., 2010].

In the pivotal RCT with NDO some type of antibiotic prophylaxis was allowed for onabotulinum toxin injection in the bladder wall on the presumption that bacteriuria reduced the efficacy of the toxin [Cruz et al., 2011; Ginsberg et al., 2012]. However, many of injected SCI patients relied on some type of bladder catheterisation and presented therefore chronic bacteriuria. Thus, the relevance of antibiotic prophylaxis

before botulinum toxin injection in SCI patients was investigated in 154 SCI patients undergoing a total of 273 treatments with onabotA for refractory NDO. Patients with no clinical signs of UTI underwent injections without antibiotic prophylaxis. Bacteriuria was found in 73% (200/273) of all patients pre-treatment. Following treatment, symptomatic UTI occurred in 7% (5/73) of cases with sterile urine culture and in 5% (9/200) with bacteriuria. These results suggest that routine antibiotic prophylaxis is not required prior to botulinum toxin injection in asymptomatic SCI patients [Leitner et al., 2016]. Is patients non-catheterizing at treatment, however, the high risk of UTI recommends that antibiotic prophylaxis should be maintained together with a careful exclusion of active UTI at the moment of injection. TI screening after each BoNT/A bladder treatment remains justifiable until further study.

Effect of BoNT/A on NDO adult patients. OnabotA 200 U is the only dose approved by FDA and by European Authorities to treat NDO in SCI and MS patients. This was in part the consequence of the findings of two large pivotal phase 3 studies where efficacy and safety of onabot A in about 700 patients with NDO was compared against placebo in patients with NDO and incontinence caused by multiple sclerosis (EDSS \leq 6.5) or spinal cord injury below T1 [Cruz et al., 2011; Ginsberg et al., 2012]. These studies were preceded by small exploratory RCT [Schurch et al., 2005; Schurch et al., 2007]. Two doses, 200 and 300 U of onabotA were compared against placebo. Primary outcome measure was the change from baseline in week episodes of urinary incontinence at week 6 after treatment. Secondary outcome measures included the change from baseline in maximum cystometric capacity, maximum detrusor pressure during first involuntary detrusor contraction and quality of life using the I-QOL total score. Both studies yielded similar findings, and indicated that 200 and 300 U provided the same effect and had the same duration of action. In the first study [Cruz et al., 2011] onabotA significantly reduced UI and improved QOL in both MS and SCI patients, with no clinically relevant differences between the two doses. At week 6 mean change from baseline in weekly incontinence episodes was -21.8 in onabotA 200U, -19.4 with 300U and -13.2 with placebo ($p < 0.01$). At the same time point 7.6%, 38.0%, and 39.6% of patients in the placebo, 200U, and 300U onabotA groups, respectively, were fully continent. The proportion of patients without IDC was around 60% after onabotA 200 and 300 groups but only 17.4% after placebo. In the second study [Ginsberg et al., 2012], onabotA resulted in a 23.0%, 26.7% and 27.4% change from baseline in the incontinence episodes in the placebo, and 200 and 300 groups, respectively. Furthermore, 36% and 41% of patients in the 200 and 300 U groups, respectively, achieved dry status, contrasting with 10% in the placebo arm. In both studies, detrusor pressure and cystometric capacity increased significantly with the two onabotA doses, without clinically relevant differences between them [Cruz et al., 2011; Ginsberg et al.,

2012]. Patients could request a retreatment 12 weeks after initial treatment. Median time for saline treated patients was about 90 days and 250 to 300 days for those treated with 200 or 300 onabotA, without differences between the two doses [Cruz et al., 2011; Ginsberg et al., 2012]. No differences were found between patients with SCI or MS in terms of clinical response to onabotA [Cruz et al., 2011; Ginsberg et al., 2012].

When pooled data were analysed by etiology, both MS and SCI patients treated with the toxin exhibited decreases from baseline in urinary incontinence episodes that were significantly larger than in those treated with placebo. A significantly higher percentage of MS and SCI patients were dry during week 6 after treatment than in the placebo group [Ginsberg et al., 2013]. The change in the number of voluntary voids per week was examined only in MS patients, the majority of whom did not use intermittent self-catheterization at study entrance. Following onabotA 200 U treatment, a decrease from baseline of 2 micturitions per day at week 6 and around 3 micturitions per day at week 12 was detected [Ginsberg et al., 2013]. There was no difference in terms of continence between patients on or off anticholinergic medication [Ginsberg et al., 2013]. Antibody formation against onabotA were not detected in the pivotal RCT during the first treatment cycle [Cruz et al., 2011; Ginsberg et al., 2012].

As a consequence of the symptomatic improvement detected after onabotA injection, NDO patients of both MS and SCI etiologies found a significant improvement in quality of life whether analysed by the I-QoL Questionnaire (Ginsberg et al., 2012; 2013), the 3 domain scores of the I-QoL Questionnaire (avoidance and limiting behavior, psychosocial, and social embarrassment), the modified Overactive Bladder Patient Satisfaction with Treatment Questionnaire (OAB-PSTQ), or the Patient Global Assessment [Chancellor et al., 2013]. The change from baseline in I-QOL score was analysed in patients who did not perform CIC at baseline. Surprisingly, the magnitude of the I-QoL improvement was similar whether they did or did not require this maneuver after toxin administration [Ginsberg et al., 2012].

The symptomatic improvement brought by BoNT/A injection in the bladder does not coincide with the moment of injection. The onset of BoNT/A effect was evaluated in a small open-label prospective study that specifically investigated the chronology of the symptomatic changes. Some improvement in urgency, nocturia and frequency could already be demonstrated as soon as 2 days after neurotoxin injection in NDO patients [Kalsi et al., 2008]. In a large RCT with SCI and MS patients treated with OnabotA, 200 or 300U, significant decrease in the number of incontinence episodes over placebo were first detected at week 2 after injection [Cruz et al., 2011; Ginsberg et al., 2012].

About 60% of the patients were taking antimuscarinics and maintained the same dose throughout the pivotal studies. A recent subanalysis of the pooled data of the 2 pivotal studies showed that similar reductions in urinary incontinence episodes and proportion of patients fully dry were achieved, regardless of anti-cholinergic use. Moreover, increment of maximal cystometric, decrease in detrusor pressure, improvement in quality of and median time to patient request for re-treatment were similar in anticholinergic users and non-users [Ginsberg et al., 2013; Sievert et al., 2012]. These observations go along with previously made suggestions by Reitz et al. [2004a; b] and Grosse et al. [2005] that a substantial proportion of SCI patients could reduce or interrupt anti-muscarinic medication after BoNT/A injection.

Doses of onabotA below 200 U were tested in patients with SCI below T1. Patients (n= 73) with NDO and UI (C14 UI episodes/week) received 30 intradetrusor injections of onabotA (50 U [n = 19], 100 U [n = 21], or 200 U [n = 17]) or placebo (n = 16) via cystoscopy, avoiding the trigone for the treatment of NDO. Linear dose response for UI episodes/week was identified with a maximal effect detected with 200 U and no effect observed in patients treated with 50U [Apostolidis et al., 2013].

A consequence of BoNT/A treatment in NDO patients is the decrease in the incidence of severe urinary tract infections. In 30 SCI patients Gamé et al. [2008] observed that the number of pyelonephritis, orchitis and prostatitis in the 6 month before onabotA 300U, 1.75 ± 1.87 per patient, decreased to 0.2 ± 0.41 in the first 6 month after treatment. In 17 SCI patients that received onabotA injections for a period of 6 years, the number of urinary tract infection at the sixth year was 1.8 ± 0.5 per year, significantly lower than at baseline, 6.7 ± 2.1 [Giannantoni et al., 2008]. In a multicentre, cross-sectional retrospective cohort study, data from 214 NDO patients treated in 7 German centers were collected. The rate of urinary tract infections in 12 months preceding and in the 12 months following onabotA was 68% and 28%, respectively [Boy et al., 2008]. The reason for these findings is unclear but may lie in a decreased maximum detrusor pressure resulting in less bladder wall ischemia and vesicoureteral reflux [Wefer et al., 2009].

Multiple Sclerosis patients represent a particular subgroup of patients in whom a careful analysis of the efficacy and safety of BoNT/A requires additional attention if voluntary voiding is present before treatment. The first cohort studies used onabotA 300 U and while this dose was effective in improving or curing urinary incontinence most patients non-catheterizing at baseline had to initiate CIC [Kalsi et al., 2007; Khan et al., 2011]. Despite this drawback, improvements in quality of life were quite remarkable indicating that patients may prefer CIC to incontinence [Kalsi et al., 2007; Khan et al., 2011]. The large pivotal phase 3 studies [Cruz et al., 2011; Ginsberg et al., 2012] showed that 200 and 300 U of onabotA had exactly the same efficacy in terms of continence and

duration of effect but 200 U had a much lower risk of urinary retention and de novo CIC.

The efficacy and safety of 100 U of onabotA in MS patients non-catheterising before onabotA injection was recently compared against placebo. Injections of 1ml each were carried out in 30 places above the trigone containing onabotA (n=66) or saline (n=78). OnabotA 100U significantly improved UI episodes/day compared with placebo (-3.3 vs -1.1; $P<.001$), and improved all the key urodynamic parameters like maximal cystometric capacity and maximal detrusor pressure. Improvements in I-QOL total score with onabotA were 4 times higher than placebo (40.4 vs 9.9; $P<.001$). Median duration of effect was 11.9 for onabotA and 2.9 months for placebo ($P<.001$). The risk of UTI (25.8%) and de novo CIC (15.2%) after 100 U onabotA was half of that observed with 200 U of toxin injections [Chartier Kastler et al., 2016]. This RCT confirmed therefore the small pilot studies that investigated onabotA 100 U in non-catheterising MS patients [Mehnert et al., 2010] and points out to such dose as the ideal to start treatment of in MS patients with NDO resistant to oral pharmacotherapy but not requiring any form of bladder catheterization. From the initial pivotal trials, it was possible to conclude that there is no risk of MS exacerbation after onabotA administration. The annualized event rate was 0.36 and 0.19 in the onabotA and placebo populations, respectively, therefore in the lower range of the annualized rate known for the general MS population risk, that varies between 0.2 and 1.2 in general MS population [da Silva et al., 2015].

Although not officially approved for NDO, abobotA has been the object of investigation in a few comparative clinical trials. A small study randomized a total of 31 NDO patients due to spinal cord injury, myelomeningocele, trauma at birth, multiple sclerosis and myelitis to intravesical injections of abobotA 500 U or placebo [Ehren et al., 2007]. Patients in the abobotA arm had a significantly higher cystometric capacity at 6 and 12 weeks, lower maximum detrusor pressure and episodes of urinary incontinence and less consumption of antimuscarinic drugs. Efficacy and safety of abobotA were, additionally, investigated in NDO patients that had abandoned anticholinergic therapy. Two doses, 500 U (n = 39) or 750 U (n = 38) were compared. Complete continence at day 30 was observed in 22 patients (56.4%) and 28 patients (73.7%) receiving 500U or 750U. The median delay in the reappearance of leakages was 168 days. Although there was a trend towards a greater improvement with 750 U, no statistically significant differences in terms of clinical and urodynamic variables and QoL were found between the treatment groups. Excellent tolerability was reported for both doses.

A single-center retrospective study investigated 750 U intradetrusor injection of abobotA in 81 consecutive patients performing CIC. Six weeks after the first injection, the success rate, defined as a combination of no incontinence episode, a number of catheterization <8 reported in a 3-day bladder diary and the lack of

detrusor overactivity, was reported in 64.2 %. Mean reinjection number was 3.9 and mean interval between reinjection was 8.8 ± 3 months. The clinical efficacy rate after each reinjection (up to fourteen) was at least 86.7 % [Peyronnet et al., 2016].

Recently a phase IIa, randomised, placebo controlled, pilot study enrolled 47 patients with NDO and urinary incontinence resulting from spinal cord injury (SCI) or multiple sclerosis (MS). Patients were treated with 15 intra-detrusor injections of abobotA 750 U or the equivalent placebo (n = 16 and 7) or 30 injections of AbobotA 750 U or the equivalent placebo (n = 17 and 7). Primary endpoint was change from baseline in mean number of daily incontinence episode frequency at day 84. Adjusted mean changes from baseline were -3.2 and -1.7 in the 15 injections group for abobotA and placebo respectively. In the 30 injections group the change was -3.2 and -2.6, respectively for the toxin and placebo. Statistically significant improvements in maximum cystometric capacity, maximum detrusor pressure and volume at first contraction were reported in the toxin groups compared with placebo. Three muscle weakness episodes were reported as serious adverse events in two tetraplegic and one paraplegic patient, all in the 15 injections group [Denys et al., 2016].

8.1.1.2 BoNT/A in IDO Patients

The enthusiasm of investigators rapidly produced a reasonable number of pilot studies investigating BoNT/A in patients with IDO refractory to antimuscarics. Although proper dose-escalating studies capable of defining ideal doses were lacking, investigators opted for the administration of BoNT/A in doses smaller than those initially used in NDO. That is the reason why most pilot studies used either onabot 200 U or abobot 500 U ([see list at the end, see also Mangera et al., 2011] and 4 RCT trials compared onabotA 200 U against placebo [Kuo, 2005b; Sahai et al., 2007; Brubaker et al., 2008; Flynn et al., 2009; Tincello et al., 2012]. Due to high incidence of voiding dysfunction associated with the use of onabotA 200U in IDO patients one large cohort, 100 patients, investigated the effect of onabot 100 U.

Two large well designed dose escalating placebo controlled studies investigated the ideal dose of onabotA. Dmochowski et al. [2010d; see also Rovner, 2011] enrolled 313 OAB wet and experiencing 8 or more urinary urgency incontinence episodes a week and 8 or more micturitions daily at baseline. They received 50, 100, 150, 200 or 300 U intradetrusor onabotA, or placebo. Durable efficacy was observed for all groups treated with 100 U dose or higher but in dose response curve doses greater than 150 U contributed minimally to the symptomatic improvement. As the use of CIC was also dose dependent, 100 U offered the best balance between efficacy and safety. Denys et al. [2012] randomised 99 OAB patients to receive a single injection of either placebo or onabotA 50 U,

100 U or 150 U. A >50% improvement versus baseline in urgency and urge urinary incontinence (UUI) in 65% and 56% of patients who respectively received 100 and 150 U. Complete continence was observed in 55% and 50% patients after 100 U and 150 U. The dose of 100 U seemed to offer the best balance between efficacy and increase of PVR.

A few additional studies contributed to defined 100 U as the ideal dose for refractory OAB treatment. Cohen et al. [2009] randomized 44 OAB-dry and wet patients to receive 100 U or 150 U. No significant differences in clinical or urodynamic outcome measures were noted between the two doses. QOL was significantly improved in both groups with no difference between 100 U or 150 U. Altaweel et al. [2011] randomized 11 patients for onabotA 100U and 11 patients to onabotA 200 U. No clinical or urodynamic differences were detected between the 2 groups at 3-months follow-up. Urinary retention occurred in 2 patients in the 200 U and in 1 patient in the 100 U arm. The same conclusion was withdrawn by Schmid et al. [2006] who injected onabotA 100 U in 100 IDO patients refractory to antimuscarinic therapy. Treatment remained highly effective, incontinence and urgency sensation disappearing in 86% and 82% of patients, respectively, during an average period of 6 months. Temporary urinary retention only occurred in 4% of the cases, with additional 15% reporting moderate voiding difficulties

Data from two large pivotal phase 3 studies in which patients were randomized to receive 20 injections of 0.5 mL each above the trigone, containing 5 U per injection with a total of 100 U or only saline are now available [Chapple et al., 2013; Nitti et al., 2013]. These studies enrolled mostly female patients with idiopathic OAB with ≥ 3 urgency urinary incontinence (UUI) episodes over 3 days and ≥ 8 micturitions per day and a postvoid residual less than 100 mL who were inadequately managed by anticholinergics. The co-primary efficacy end points were change from baseline in the number of UI episodes and the proportion of patients with a positive treatment response on the treatment benefit scale (TBS) at week 12.

The Chapple et al. [2013] study randomized 277 patients to onabotA and 271 for saline injection. At baseline the average number of daily UI episodes was above 5 per day. OnabotA significantly decreased UI episodes per day at (-2.95 for onabotA versus -1.03 for placebo; $p < 0.001$). Significant reductions in frequency, urgency episodes per day and nocturia were also observed. Changes in TBS indicate that patients perceived a significant improvement in their condition (62.8% for onabotA versus 26.8% for placebo; $p < 0.001$). Clinically meaningful improvements from baseline in all I-QOL and KHQ multi-item domains indicated positive impact on quality of life.

The Nitti et al. [2013] study randomised 280 for onabotA and 277 for saline. In average patients experienced more than 5 episodes of UI per day. At week 12 there were greater decreases from baseline in the

mean daily UI in the active group (-2.65 for onabotA and -0.87 for saline, $p < 0.001$). The percentage of fully dry patients at week 12, was 22.9% after onabotA and 6.5% with saline. The other key OAB symptoms, frequency, urgency and nocturia also improved after onabotA. Of interest, all changes in OAB symptoms detected at week 12 were already present at week 2. A higher proportion of onabotA treated patients reported a positive treatment response on the TBS vs those on placebo. Large, clinically significant improvements in all I-QOL and KHQ multi-item domain scores were noted after onabotA.

A pooled analysis of the two pivotal phase 3 studies [Sievert et al., 2014] included a population of 1,105 patients randomized to onabotulinumtoxinA 100 U ($n = 557$) or placebo ($n = 548$) confirmed the results of the 2 RCT and allowed additional insights into the effect of onabotA 100 U in OAB patients. Patients treated with onabotA 100 U had an average decline of 2.8 episodes of urinary incontinence per day whereas the reduction in the placebo group was only 0.95 episodes per day ($p < 0.001$). In the group submitted to onabotA the rate of dry patients at week 12 was 27.1%, significantly higher than the rate of 8.4% in the placebo group ($p < 0.001$). Moreover, 60.5% of onabotA treated patients reported a reduction $\geq 50\%$ from baseline in urinary incontinence episodes compared to 31% in the placebo group ($p < 0.001$). Other key OAB symptoms were also substantially improved by toxin treatment. The decrease from baseline in the number of episodes of urinary urgency per day was 3.30 and 1.23 in the onabotA and placebo groups, respectively. As to urinary frequency, there was a decrease of 2.35 and 0.87 micturitions per day, respectively. The median time to request retreatment was 24 weeks following treatment with onabotA compared with 13 weeks with placebo.

Further breakdown of the pooled data [Sievert et al., 2014] showed that the number of previous anticholinergic drugs does not seem to influence the outcome of onabotA treatment. The number of prior anticholinergics also did not affect the improvement caused by onabotA in urinary urgency episodes per day and in the number of micturitions per day. The rate of satisfaction was also independent from the number of previously used anticholinergic drugs. When analysing the efficacy of onabotA by the reasons why the anticholinergic treatment was stopped, insufficient efficacy or intolerable side effects, the symptomatic improvement and patient satisfaction after onabotA was similar in the two subgroups and comparable with the results achieved by the overall pooled population [Sievert et al., 2014]. However, the latter data should be compared with those of a retrospective analysis of a single center cohort that evaluated the efficacy of 100-150 U of onabotA injections in 85 patients. Results were superior in patients who did not tolerate anticholinergics than in those who abandoned the medication due to poor efficacy (86% vs. 60%, respectively) [Makovey et al., 2011].

Drake et al. [2015] conducted another post hoc analysis of the two pivotal phase 3 studies where the effect of the treatment was examined according to the severity of the incontinence at study entry. Patients with < 2 , between 2 and 5 or > 5 UUI episodes per day had decreases in incontinence episodes of 2.7, 3.0 and 3.8, respectively. The percentages of patients with a reduction of more than 50% in the urinary incontinence episodes in each subgroup were 56.6%, 66.5% and 56.7%, respectively. All these numbers were significantly better than in the placebo groups, indicating that OnabotA is effective regardless of the grade of urinary incontinence at baseline.

A large placebo controlled RCT was conducted in 8 centers in UK (the RELAX study) and randomised a total of 240 women with refractory DO to receive onabotA 200 U or placebo distributed by 20 bladder wall sites above the trigone (10 U/1ml) [Tincello et al., 2012]. Primary outcome was voiding frequency per 24 h at 6 months. Secondary outcomes included urgency and incontinence episodes and quality-of-life data. A total of 122 women received onabotA and 118 received placebo. Median leakage episodes were already significantly reduced by week 6 and at 6 months were 1.67 in onabotA vs 6.0 in the placebo group. Continence was more common after onabotA (31% vs 12%). Significant decreases also occurred in voiding frequency (8.3 vs 9.67) and in daily urgency episodes (3.83 vs 6.33). Quality of life scores were better in the toxin group.

Other small RCTs have been conducted on IDO using onabotA 200 U [Sahai et al., 2007, Brubaker et al. 2008] or a combination onabotA 200 or 300 U [Flynn et al., 2009]. These studies were extensively reviewed in the 2013 edition of this book, but their relevance after the large RCTs of Chapple et al. and Nitti et al. make their detailed analysis today superfluous. Only safety data of these small studies will be mentioned below. A small open-label prospective study specifically investigated the chronology of the effect of onabot 200 U in IDO patients. Urgency, nocturia and frequency improved as soon as 4 days in IDO patients, a time-period slightly longer than that reported in NDO cases [Kalsi et al., 2008].

Successful OAB treatment with onabotA does not appear to be related to the existence of DO. In a sub-analysis of the dose finding study for onabotA, no differences in outcomes were found between those with and those without baseline DO [Rovner et al., 2011]. Likewise, in a cohort of 5 male and 27 female patients with OAB and without DO, improvement in frequency and urinary incontinence was observed after treatment with onabotA [Kanagarajah et al., 2012]. Two doses were tested, 100 and 150 U, without no clinically relevant differences between them [Kanagarajah et al., 2012]. Thus, in clinical practice there is little justification to indicate routinely urodynamic testing in subjects with OAB symptoms refractory to oral medication to decide onabotA administration.

8.1.1.3 Adverse events in OAB and NDO Patients After BoNT/A Injection

In NDO the most common adverse events were UTI and de novo CIC [Cruz et al., 2011; Ginsberg et al., 2012; 2013].

In the SCI population, the majority of which was performing CIC at baseline, the incidence of UTI was similar across all treatment groups (around 50%). In the MS population, the rate of UTI was highest in the onabotA 300 U arm (saline 32%, 200U: 58.5%, 300U: 70%) in the study by Cruz et al. [2011] whereas the incidence of UTI was similar, around 50%, after 200 and 300 onabotA doses in the study by Ginsberg et al., [2012]. The high incidence of UTI among MS patients in the pivotal studies was related with dose dependent increase in PVR and necessity of de novo CIC. The latter was considered necessary in 12.2% of the patients after saline, 29.5 after 200 U, and 42.2 after 300U in the study by Cruz et al. [2011]. Ginsberg et al. [2012] observed that the incidence of de novo CIC in patients not catheterizing at baseline was dose 10% on placebo, 35% on 200 U and 42% on 300 U, and also mainly affected MS patients. The pooled data of the two pivotal studies showed that the incidence of UTIs was similar among all treatment groups for SCI patients ($P = 0.534$), but was higher in the onabotA-treated MS patients compared with placebo ($P < 0.001$). However, very few complicated UTIs were reported: pyelonephritis was reported in one MS patient (onabotA 300U group) and in two SCI patients (both in the placebo group), and urosepsis was reported in two SCI patients (both in the placebo group). Among patients non-catheterizing at baseline that received 200 U of onabotA about 1/3 required CIC. The period of time in which CIC was required was long lasting (>36 weeks) in about half of them [Ginsberg et al., 2013]. The risk of urinary retention and de novo CIC in MS patients non-catheterising before treatment may be substantially decreased by using a lower dose of the toxin. Using 100U of OnabotA in non-catheterising MS patients de novo CIC (15.2%) and the rate of UTI (25.8%) was half of that observed with 200 U of toxin injections [Chartier Kastler et al., 2016]

Paralysis of the striated musculature due to systemic leakage of the toxin has never been reported with the doses tested in the several studies reviewed here. Transient muscle weakness was, nevertheless, reported with AbobotA application in several studies [Wyndaele and Van Dromme, 2002; Akbar et al., 2007; Del Popolo et al., 2008]. Among 199 NDO patients followed during 8 years, 5 developed hypostenia when injected with after abotbotA 1000 U [Del Popolo et al., 2008]. In another study with 44 patients, 3 adults also treated with 1000 U developed muscular weakness which subsided after 5 to 7 weeks [Akbar et al., 2007]. In a recent phase IIa RCT with abobotA 750 U, 3 cases of muscle weakness episodes were reported in two tetraplegic and one paraplegic patient among 15 NDO patients who received the toxin in 15 injection sites [Denys et al., 2016]. No such cases

were reported with onabotA by Karsenty et al. [2008]. The reason for the less frequent transient muscle weakness among onabotA-treated patients is unclear but might be related with the larger size of its molecule which limits diffusion into the blood stream or a dose of abobotA which is more powerful than the doses used with onabotA. Anyway, the risk of hypostenia associated with abobotA might be avoided by using lower doses of the toxin, no more than 750 U for adults and 20 units/kg for children [Akbar et al., 2007, Del Popolo et al., 2008] or by avoiding high amounts of toxin per injection site. In addition, caution should be used in selecting high risk patients for botulism including children, patients with low pulmonary reserve or patients with myasthenia gravis. Aminoglycosides should be avoided during BoNT-A treatment since they might block motor plates and therefore enhance BoNT/A effect.

Episodes of autonomic dysreflexia in SCI patients during injection were rare. Ginsberg et al. [2012] in 167 injected patients reported 7 events of autonomic dysreflexia.

Data from long-term studies that followed the large RCT are now available. In NDO, most common adverse events during 4-year follow-up were urinary tract infections and urinary retention. De novo CIC rates were 29.5%, 3.4%, and 6.0% (200U), and 43.0, 15.0, and 4.8% (300U) for treatments 1–3, respectively; de novo CIC rates were 0% for treatments 4–6 [Kennelly et al., 2015]. UTI ranged between 20% and 30% along the follow-up without relevant differences between patients treated with 200 U or 300 U [Kennelly et al., 2015]. In OAB studies UTI was the most common adverse event and ranged between 17.0% after treatment cycle 1 and 14.4% after treatment 6. CIC was necessary in 4.0% after the first treatment but this incidence decreased in all subsequent treatment cycles and was below 1% after treatment cycle 5 and 6. The median duration of CIC ranged from 3.1 to 8.3 weeks [Nitti et al., 2016].

Although it is a concern frequently raised by caregivers, at this moment there is no evidence that repeated BoNT/A injections cause detrusor atrophy or bladder wall fibrosis. Whether onabotA or abobotA were used, repeated injections in NDO patients in the short to medium term did not decrease bladder compliance which would presumably be the case if fibrosis were to develop [Reitz et al., 2007; Del Popolo et al., 2008]. Histological inspection of injected bladders did not show inflammatory changes, fibrosis, or dysplasia after repeated treatments and independently of the neurogenic or non-neurogenic origin of the detrusor overactivity [Haferkamp et al., 2004; Compérat et al., 2006; Apostolidis et al., 2008]. Rather the reverse, one study demonstrated that NDO patients treated with BoNT/A had less fibrosis than nontreated patients [Compérat et al., 2006]. Curiously, the presence of eosinophilic infiltrate was shown to increase in specimens of patients receiving multiple treatments, a finding that could not be fully explained [Apostolidis et al., 2008].

In OAB, the dose finding study conducted by Dmochowski et al. [2010] the proportion of patients with posttreatment PVR of 200 ml or greater was dose dependent and patients requiring CIC were 0%, 3.6%, 9.1%, 12.7%, 18.2% and 16.4% after placebo or 50, 100, 150, 200 and 300 U onabotA injections. In what concerned UTI this complication occurred in 16.3%, 33.9%, 44%, 48.1% and 34.5% patients after placebo, and 50, 100, 150, 200 and 300 U onabotA injections, respectively.

In the pivotal studies the most common adverse event was uncomplicated UTI followed by urinary retention. In the Chapple et al. [2013] study, UTI occurred in 24.1% of the onabotA patients and 9.6% in the placebo group. The majority of patients treated with onabotA (75.8%) did not have an increase from baseline in PVR exceeding 100 ml and only 8.8% had PVR increases exceeding 200 ml. The proportion of patients who initiated CIC in the first 12 weeks after treatment was 6.9% following onabotA and 0.7% after placebo injection. In the Nitti et al study [2013] UTI, again the most frequently reported AE occurred in 15.5% for onabotA and 5.9% for placebo in the first 12 weeks after treatment. All UTIs were uncomplicated, coursing without pyelonephritis. Other notable adverse events that occurred in the first 12 weeks at a higher incidence in patients treated with onabotA were dysuria (12.2%) asymptomatic bacteriuria (5.0%) and urinary retention (5.4%). PVR significantly increased in patients treated with the toxin, with the highest increase being detected at week 2 (49.5 ml). A total of 8.7% had a 200 ml or greater increase from baseline in PVR. CIC was necessary in 6.1% patients treated with onabotA and in none in the placebo group. For more than half the patients who initiated CIC the duration was 6 weeks or less.

In the RELAX study, as mentioned before, the dose of onabotA used was 200 U. UTI occurred in 31% vs 11% in the onabotA and placebo groups, respectively. Voiding difficulty requiring CIC occurred in 16% of cases that received the toxin and in 4% of patients that received placebo [Tincello et al., 2012].

In a small RCT, CIC was required in 37.5% of patients treated with 200 U of onabotA [Sahai et al., 2007]. In another small RCT comparing onabotA 200U vs placebo, PVR increased above 200 ml in 43% of the women in the BONT/A group and UTI developed in 75% of these women [Brubaker et al., 2008].

Currently it is not possible to identify beforehand patients who will develop voiding difficulties after BoNT/A injection. The positive or negative status of the ice water test does not correlate with the risk of urinary retention after onabotA injection in NDO patients [Huwyler et al., 2007]. A retrospective analysis of 217 patients receiving their first intravesical BoNT/A injection for refractory IDO in a tertiary center concluded that risk factors for dysfunctional voiding and urinary retention included male gender ($p = 0.013$), baseline postvoid residual (PVR) > 100 ml ($p = 0.003$) and onabotA > 100 U ($p = 0.029$) [Kuo et al.,

2010]. Also in a retrospective analysis of a cohort of 67 patients with IDO treated with onabotA 200 U CIC was necessary in 19 (28%). When compared to those not requiring CIC, those that started CIC had lower pretreatment maximum flow rate (15 vs 22 mL/s, $P=0.003$), lower projected isovolumetric pressure (43 vs 58, $P=0.02$) and lower bladder contractility index (113 vs 180, $P=0.001$) [Sahai et al., 2009].

Hematuria may occur after toxin injection in the bladder wall of OAB or NDO patients but in most of the times is mild in nature and does not require any active treatment.

8.1.1.4 BONT/A in Children and Elderly Patients

In children, the dose of BoNT/A should be calculated according to body weight. Doses of between 12 U/kg of weight up to a maximum dose of 300 U [Schulte-Baukloh et al., 2002] and 4 U/Kg [Corcos et al., 2002] have been used for onabotA. The maximum suggested for abobotA is 20 U/kg up to a maximum of 400 U [Altaweel et al., 2006; Akbar et al., 2007]. BoNT/A has been essentially assayed in children with myelomeningocele [Schulte-Baukloh et al., 2002; 2003; Corcos et al., 2002; Riccabona et al., 2004; Kajbafzadeh et al., 2006; Altaweel et al., 2006]. Like in adults, the toxin increased bladder capacity and decreased maximal detrusor pressure. In 26 children with a mean age of 6,9 years, 19 of them (73%) became completely dry between clean intermittent catheterizations while 88% reported a global improvement in urine incontinence. Interestingly, in 11 (73%) out of the 15 children who had vesicoureteral reflux before injection, reflux either disappeared or decreased in grade. BONT/A also improved bowel function in 66% of the children with intestinal problems [Kajbafzadeh et al., 2006]. The success rate in terms of continence and cessation of anticholinergic medication may, however, be substantially inferior to that seen in adults, potentially due to irreversible bladder wall changes associated with longstanding detrusor overactivity [Altaweel et al., 2006]. In a group of 20 children with myelomeningocele continence was achieved in only 13 children. At a second injection, this number also did not change appreciably [Altaweel et al., 2006].

A recent systematic review found a total of 13 studies reported on 368 children receiving BoNTA for NDO, none with a placebo comparator arm. The only parameters reported with consistency between studies were the MCC and MDP, which changed by between 42 to 59% [Mangera et al., 2014].

To date, two case series have looked at the use of BoNT/A in children with non-neurogenic OAB refractory to the anti-cholinergics. Both studies have shown an excellent response to treatment [Hoebeke et al., 2006; Marte et al., 2010]. Data have been updated recently [McDowell et al., 2011]. A total of 57 children of both gender received abobotA 12 U/kg up to a maximum dose of 480 U in multiple bladder sites. A total disappearance of OAB symptoms occurred in

66% and a partial improvement in 19% of the patients. About half of the cases had repeated injections after a mean time slightly exceeding 6 months. No cases of voiding dysfunction or UTI were reported [McDowell et al., 2011].

Electromotive administration of BoNT/A may represent a substantial breakthrough among children. In 15 children with NDO due to myelomeningocele, electromotive administration of abobotA instilled in the bladder in a dose of 10 U/kg, proved very effective and safe. The mean reflex volume (99 ± 35 ml to 216 ± 35 ml) and maximal bladder capacity (121 ± 39 ml to 262 ± 41 ml) increased substantially while maximal detrusor pressure decreased from 75 ± 16 cm H₂O to 39 ± 10 cm H₂O. Urinary incontinence improved in 12 patients (80%) [Kajbafzadeh et al., 2011].

Elderly patients represent, as well, a very special population where urgency and incontinence are not only very distressful but also particularly prevalent. Nevertheless, only one study specifically addressed efficacy and safety of BoNT/A in elderly patients. Twenty-one patients with refractory IDO (18 females and 3 males) with a mean age of 81.2 years (range 75 to 92) received onabotA 200 U in 20 bladder sites [White et al., 2008]. A significant decrease in the number of daily voids, from 11.4 ± 1.67 to 5.19 ± 0.83 and incontinence pads per day, from 4.0 ± 0.89 to 1.3 ± 0.60 , occurred. One month after treatment 16 of the 21 patients (76%) reported greater than 50% improvement in symptoms after 1 injection while only 3 did not show improvement after 2 injections [White et al., 2008]. Mean time to deterioration was 7.12 months. There were no treatment related complications.

8.1.1.5 Effect of BoNT/A on Quality of Life

Firm evidence that BoNT/A bladder injection in NDO and IDO patients increases quality of life can be extracted from several RCT in which QoL changes were in most cases a secondary outcome parameter.

One pivotal phase 3 study in NDO patients used the I-QoL questionnaire to evaluate quality of life changes in SCI and MS patients randomized to 200 and 300 U of onabotA or placebo. Change from baseline was 24 points for both onabotA doses at 6 and 12 weeks but only 11 points at week 6 and 8 points at week 12 in the placebo group. The I-QoL questionnaire requires that a minimum change of 11 point occur in order to QoL to be detectable by patients, a barrier that was overcome by both OnabotA doses [Cruz et al., 2011]. Improvements were present both in SCI and MS patients. In another large phase 3 trial these data were totally confirmed [Ginsberg et al., 2012]. Interestingly, a comparison in QoL in patients performing and non-performing CIC in the placebo, 200U and 300U arms did not show differences in patient perception, indicating that improvement in the continence condition was a more relevant outcome [Ginsberg et al., 2012]. Improvements from baseline in the avoidance, limiting behavior, psychosocial and

social embarrassment domains of the I-QoL Questionnaire were greater after onabotA treatment. Responses to the OAB-PSTQ and to the Patient Global Assessment also demonstrated superior mean improvements from baseline in 200 U onabotA than in placebo treated group [Chancellor et al., 2013]. The Canadian multicenter double-blind study [Herschorn et al., 2011a] that randomized to onabotA 300 U or placebo 57 incontinent patients with NDO secondary to spinal cord injury or multiple sclerosis also found significant advantage of onabotA in terms of I-QoL score. A small exploratory, multicenter, randomized, double blind placebo controlled trial by Schurch et al. [2007] which randomized 59 NDO patients with urinary incontinence for onabotA 200U or 300U or placebo found that I-QoL scores improved significantly over placebo, at all time points whether 300U or 200U were used.

The importance of continence for patients' quality of life is also confirmed by the study of 43 MS patients treated with onabotA 300 U [Kalsi et al., 2007]. Although 98% of patients had to perform CIC after treatment, there were sustained improvements in all quality-of-life scores with a mean duration of effect was 9.7 months. Results were maintained with repeat treatments for 11.7 months. These results were confirmed in a larger MS cohort by Khan et al. [2011]. Urogenital Distress Inventory and Incontinence Impact Questionnaire 7 scores showed considerable improvement 4 weeks after onabotA 300 U treatment even when repeated 6 times. Again, the fact that 76% of the patients were dry seemed more relevant for QoL score than the necessity of CIC that was required by almost all patients [Khan et al., 2011].

Improvement in QoL was also found in a study that compared abobot 500 U versus /750 in a NDO population predominantly suffering from SCI. A disease- and organ-specific Qualiveen questionnaire with four domains (limitations, constraints, fears, and feelings) was used to assess the Specific Impact of Urinary Problems on QoL. The initial evaluation was repeated at days 30, 90, 180, and 360. Identical improvements were detected for the two doses [Grise et al., 2010]. A single center, double blind, placebo controlled study performed by Ehren et al. [2007] randomized 37 NDO patients with incontinence to abobotA 500 U or placebo. Patients in the AbobotA group showed greater improvement in quality-of-life parameters compared to the placebo group. A more recent study that compared 750 U of abobotA injected in 15 or 30 sites showed increases in I-QoL scores were observed in both groups and to a lesser extent the placebo groups at day 14 and 84 after injection which were statistically significant differences only for the 15 injection sites group [Denys et al., 2016].

In IDO/OAB, the dose finding study by Dmochowski et al. [2010] in which placebo and onabotA 50, 100, 150, 200 and 300 U were compared showed a sustained improvement in the King's Health Questionnaire score only in patients that received doses of 100

U or higher. In contrast, patients randomized to onabotA 50 U had changes similar to those observed after placebo [Dmochowski et al., 2010]. The dose finding study by Denys et al. [2012] showed an I-QoL improvement in patients receiving onabotA 100 U and 150 U, though at some time points scores were only numerically higher than in placebo or 50U groups. The general health status, as measured by the EQ-5D visual analogue scale also improved in patients that received 100 or 150 U [Denys et al., 2012].

In the pivotal study conducted by Chapple et al. [2013] in OAB patients there were significant improvements in the I-QOL total summary score and all three domain scores in the onabotA group vs placebo. The improvement far exceeded the predefined minimal important difference (MID) of a 10-point increase. Improvements from baseline in all seven multi-item domains of the KHQ were also greater in the onabotA group. The same was observed by Nitti et al. [2013]. Large, clinically significant improvements in all I-QOL and KHQ multi-item domain scores were noted after onabotA vs placebo treatment in OAB patients. Improvements from baseline for onabotA, in contrast to placebo, were considerably greater than the predefined minimal important differences.

The RELAX study [Tincello et al., 2012] showed significant improvement in ICIQ-SF and I-QoL scores. However, none of the questionnaires were restored to the normal score (0 for ICIQ; 100 for IQOL) [Tincello et al., 2012].

Two small RCT with OAB/IDO patients [Sahai et al., 2009] used the King's Health Questionnaire (KHQ) at baseline and at 4 and 12 weeks, after injection of onabotA 200 U or saline in 16 and 18 patients of both genders. Overall QoL was significantly improved in the onabotA treated patients compared with placebo in the KHQ subdomains, 'Incontinence Impact', 'Emotions', 'Physical limitations', 'Social Limitations' and 'Severity Measures' at the two time-points.

8.1.1.6 Repeated Injections in NDO Patients

Median time for NDO patients due to SCI or MS to request a retreatment was around 300 days after onabotA 200 or 300 U but only 92 days after placebo [Cruz et al., 2011]. Therefore, for patients that respond to BoNT/A a programme of reinjections is inevitable.

With the objective of evaluating the long-term efficacy and safety of repeated onabotA injections, patients who completed the two pivotal phase III studies were invited to participate in a long-term study. At the start of the extension study, patients that had received onabotA 200 U or 300 U continued with the same dose while dose on placebo were randomized to receive the active compound in one of the two doses. Later, with the license of 200 U, all patients were converted to this dose. The primary assessment was the change from baseline in urinary incontinence episodes during the week 6 after each injection. The first analysis was carried out after 5 treatment cycles

[Kennelly et al., 2013]. Update of the long-term study in patients that were treated up to 4 years was reported recently [Kennelly et al., 2015]. OnabotA 200 U consistently reduced UI episodes/day, ranging from -3.2 to -4.1 across six treatments (variations from baseline). Volume/void consistently increased, nearly doubling after treatment. I-QOL improvements were consistently greater than twice the minimally important difference. Overall median duration of effect was 9.0 months for patients treated with 200 U. In the reduced number of cases treated with 300 U results were similar [Kennelly et al., 2015]. However, patients did not request the same number of treatments along the 4 years follow-up. While some patients required 8 re-injections, others asked only for 2. Patients with fewer treatments had a slightly fewer baseline episodes of incontinence per day than those that required 7 or 8 treatments. Nonetheless, the daily episodes that were observed in week 6 after each treatment indicated a similar efficacy of onabotA, regardless of the number of injections requested. This suggests that patient preference for retreatment was not motivated by a different degree of toxin efficacy.

Rovner et al. [2016] reanalysed this large cohort looking only to the 227 patients who did not abandon the study and therefore completed the 4-year period of analysis. Patients reported 4.3 urinary incontinence episodes per day at baseline and received 1.4 to 1.5 onabotA treatments per year. The decrease in urinary incontinence following onabotA consistently ranged from -3.4 to -3.9 episodes per day across 4 years. A high proportion of patients achieved 50% or greater and 100% urinary incontinence reductions in each year (range 86.6% to 94.1% and 43.6% to 57.4%, respectively). Consistent and clinically relevant improvements in I-QOL scores were observed in each treatment year. The overall median duration of effect of onabotA range between 3.0 to 49.2 months and 26.0% or more of patients experienced a duration of effect of 12 months or greater. The most common adverse event was urinary tract infection with no increased incidence with time the proportion of UTI in the years 1 to 4 were 21.5%, 20.9%, 17.3% and 18.9%, respectively [Rovner et al., 2016].

Toxin-neutralizing antibody formation (i.e., seroconversion), occurred in three patients who received onabotA 200U (one in each of cycles 2, 8, and 9) and five patients who received 300U [Kennelly et al., 2015].

It may be interesting to compare this study with data extracted from real-life practice, in a population of NDO subjects mainly composed by SCI and MS patients. The number of patients requesting retreatments substantially decrease during follow-up and 5 years after the initial injection only 10% of the original cohort remained on treatment. The explanation for such decrease includes the progression of the neurological disease, which can be particularly expected in MS patients. The worsening of the motor capacities will restrain a significant number of these patients to a bed-ridden condition in which the advantages of

onabotA injections may no longer be perceived. One should remember that the regulatory studies excluded patients wheel-chair bound or bed-ridden. In addition, a significant number of SCI patients had bladder augmentation or urinary diversion during the period of analysis.

Three studies were identified that assessed the effect of repeated injections of onabotA and abobotA in NDO patients. A cohort of 199 patients with spinal cord lesions treated with abobotA 500 U to 1000 U was analysed retrospectively, after 8 years of repeated injections. The intervals of between injections remained constant. Urodynamic improvements, patients' satisfaction with treatment and number of pads or other protective devices was also constant after treatments [Del Popolo et al., 2008]. Intervals exceeded 12 months in 19.5% of the patients, ranged between 10 and 12 months in 40.2%, was < 10 months in 30.5% and < 6 months in only 10% of the patients [Del Popolo et al., 2008].

In another study, 20 consecutive NDO (SCI 18, MS 2) patients received at least five intradetrusor injections of onabotA 300 U in 30 sites above the trigone. Intervals between injections remained constant, between 193 and 199 days. Clinical continence improved significantly after the first injection and then remained constant after repeat injections. The median reflex volume increased from a 200 ml at baseline to values between 440 and 500 ml at follow-up studies. The presence of NDO decreased by 60–75%. Maximum cystometric capacity increased more than 2 folds and maximum detrusor pressure from a median of 70 cm H₂O to values of about 20 cmH₂O [Reitz et al., 2007].

In a MS cohort with 137 patients who underwent detrusor onabot 300 U, 99 (72%) returned for a second treatment, and 47, 25, 14 and 5 returned for re-treatments 3 to 6, respectively. The median interval for 1st, 2nd, 3rd, 4th, and 5th re-injections ranged between 12 and 13 months. The outcome in terms of continence did not differ among treatments [Khan et al., 2011].

8.1.1.7 Repeated Injections in IDO/OAB

The median time to request a retreatment in the Chapple et al. [2013] and Nitti et al. [2013] RCTs was 24 weeks following treatment with onabotA implicates that repeated injections are necessary if treatment is required.

Patients participating in the two phase 3 studies were invited to participate in a long-term, 3-year extension study to determine the efficacy and safety of repeated onabotA 100 U injections for the management of OAB. This is the largest cohort with the longest follow-up available until now. Treatments were requested by participants upon reappearance of OAB symptoms and once eligible, patients were re-injected with a similar 100 U dose of onabotA. An interim analysis after 5 treatment cycles showed that the decrease from baseline of UUI episodes remained stable,

around 3 episodes per day and the proportion of patients reporting a high satisfaction rate remained high, ranging from 70% to 90%. The duration of the effect remained stable or even increased in subsequent treatments. However, for reasons that are unclear patients that received up to 5 treatments were a minority when compared with those that requested only 1 or 2 injections. These results were up-dated recently by Nitti et al. [2016]. From the initial 839 patients enrolled, a total of 829 received one or more

treatments and 430 (51.3%) completed the 3.5-year study period. At baseline the mean

episodes of UI per day was 5.6 and the I-QOL total score was low. The decrease of UI episodes ranged between -3.1 and -3.8 episodes per day whether patients received 1 to 6 treatments. The median duration of effect, calculated as the time to requalify to a retreatment was 7.6 months. The median duration of effect was 6 months or less in 34.2% of the participants, between 6 to 12 months in 37.2% and greater than 12 months in 28.5% [Nitti et al., 2016]. The overall incidence of toxin neutralizing antibody formation was 0.4% [Nitti et al., 2016].

Real-life studies offer contradictory results concerning persistence on an onabotA program. Malde et al. [2014] reported that in a group of 100 patients with refractory OAB 90% would return to the program in the future and 93% would recommend the treatment to a friend. Moreover, 81% accepted the treatment as life-long. On the other hand, Mohee et al. [2013] found that 66.3% of patients discontinued therapy at 36 months. The main reasons for abandonment were UTIs and the need for CIC. In a single-centre retrospective study [Marcelissen et al., 2016] the persistence on treatment of a total of 128 women with at least 5-year follow-up after their first injection and a mean follow-up 97 (60-125) months was investigated. Of all patients, 30% were still on BoNT-A treatment at the last follow-up visit. Of the 70% that discontinued treatment, 27% had insufficient effect and 43% had tolerability issues. Most patients discontinued treatment after the first (79%) and second (19%) injections. Only 2% of patients discontinued treatment after more than two injections during follow-up. In these last two studies [Mohee et al., 2013; Marcelissen et al., 2016] the majority of patients were treated with onabotA 200 U. A high rate of adverse events related with the high dose used may have, therefore, contributed to the low persistence in treatment.

Other 4 studies were identified that analysed repeated injections in IDO patients. In general, longer duration of BoNT/A effect and a relatively higher rate of treatment drop out is seen among IDO patients. A cohort of 34 IDO patients treated with onabotA 200 U [Sahai et al., 2010] was updated with 100 patients [Dowson et al., 2012]. A statistically significant reduction in frequency, urgency, and urge urinary incontinence were seen following onabotA 200 U injection compared to baseline. Such improvement was again

maintained after repeated injections. The mean inter-injection interval was 322 days. Interestingly, 37% of the patients stopped treatment after the first two injections, dropouts being rare thereafter. The most common reason for discontinuing treatment was poor efficacy (13%). CIC related issues was pointed out by 11% of patients despite the incidence of CIC after the first injection being 35% [Dowson et al., 2012].

In a prospective, observational study after 1 single onabotA 100 U injection, 26 patients were followed up for 2 years. One patients did not respond (primary failure), 3 were lost to follow-up, and 11 patients had a repeated injection at 5–26 months. At 2 years 7 of the remaining 11 patients were recommended repeated injection or another treatment, and four required no other treatment.

Schmid et al. [2008] reported on 25 women and 5 men that received repeated (2) injections of onabotA for treatment of IDO. The interval between two subsequent treatments ranged between 4 and 26 months (mean 12 months). Improvement of OAB symptoms, quality of life and urodynamic parameters were observed after reinjection.

8.1.1.8 Cost-effectiveness of BoNT/A

Economic aspects of BoNT/A are a concern due to the price of the drug and the need for repeated cystoscopies, very often performed under general anaesthesia and under close monitoring to detect and treat eventual episodes of autonomic dysreflexia. Nevertheless, In UK, in a cohort of 101 patients with detrusor overactivity, 63 of whom of neurogenic origin, BoNT/A treatment was shown to be cost-effective in both NDO and IDO cases [Kalsi et al, 2006]. Costs were based on the resources used by typical patients in UK and in the cost-effectiveness of 200-300 U BoNT/A (Botox) compared with standard care [Kalsi et al., 2006]. In Germany, a multicenter cost analysis showed that BoNT/A (onabotA) treatment halved costs for incontinence aids and for urinary tract infection treatment in 214 NDO patients. In patients using incontinence aids, mean costs per patient decreased from €2 to €1 per day, whereas the mean cost of drugs to treat UTIs per patient decreased from €163 to €8 per year [Wefer et al., 2009].

Also in NDO patients, break-even point for BoNT/A and augmentation cystoplasty costs may be reached at five years. However, BoNT/A may be substantially more cost-effective if the duration of effect of each injection is superior to 5 months or if the complications associated with augmentation cystoplasty overtake 40% of the patients [Padmanabhan et al., 2011].

For OAB/IDO, an assessment of costs, from a US payer perspective, extending up to 3 years, was made for 3 interventions, sacral neuromodulation, BoNTA, and augmentation cystoplasty in patients refractory to antimuscarinics. The initial treatment cost was \$22,226, \$1,313, and \$10,252 for sacral neuromodulation, BoNTA, and augmentation cystoplasty respectively. Three years after initiating treatment,

the cumulative cost was \$26,269, \$7651, and \$14,337 respectively. Sensitivity analyses revealed that sacral neuromodulation persisted as the most costly intervention [Watanabe et al., 2010].

Visco et al. [2016] analysed cost and effectiveness data from participants in the Anticholinergic versus Botox Comparison randomized trial of daily anticholinergic medication versus 100 U of intradetrusor Botox injection. They concluded that Botox and anticholinergic medications have similar costs and effectiveness in the first 6 months of UUI treatment. If costs and outcomes are considered through 9 months, Botox may have significantly lower costs but similar symptom control as anticholinergics.

8.1.1.9 Clinical Comparisons and Switch Between Different BoNT/A Brands

Different brands of botulinum toxin type A cannot be used interchangeably. The molecular weights are different. OnabotA is a 900 kDa molecule, abobotulinumtoxinA is approximately 500 kDa and incobotA, is a 150 kDa molecule [Cruz, 2014]. In addition, potency of these brands is impossible to compare due to the distinct tests used to evaluate it. While onabotA's potency is determined by the EC50 (amount of toxin required to provoke a response halfway between the baseline and the maximum response) of cleaved synaptosomal associated protein of 25 kDa (cSNAP-25) in differentiated neuroblastoma cells, abobotA potency is determined by the mouse LD50 (amount of toxin that kills 50% of the mice) [Cruz, 2014]. Despite the fact that they are not licenced both abobotA and incobotA are however being used in real-life clinical practice to treat NDO and OAB. As doses for these brands were never established by appropriate dose finding studies in the lower urinary tract, empiric conversion ratios are applied with unknown consequences for the comparison of the outcomes. Mangera et al. [2011] in a systematic review identified good-quality studies that evaluated onabotA for all the indications in adults. However, that was not the case with abobotA. Although this does not imply that onabotA is more effective than abobotA, it should be a consideration when counselling patients on the use of botulinum toxin in urologic applications., either in terms of predicting outcomes or in determining doses to be used.

A study compared two different brands of BoNT/A, onabot A 200 or 300 U against the Chinese BoNT/A Presigne in the same dosage. Improvement in MCC was significantly greater with onabotA Botox versus Presigne (+103.3% vs. +42.2%; P = 0.019). Continence was achieved by week 12 in 16 onabotA recipients (76.2%) and in 10 Presigne recipients (47.6%; P = 0.057) [Gomes et al., 2010]. Future studies seems, therefore, justified to assess the relative potencies of the different brands of BoNT/A.

A few studies have examined the consequences of changing botulinum toxin type A brands to treat bladder dysfunction. Ravindra et al. [2013] initially treated OAB patients with onabotA with a standard dose of

200 U. Then, they switched to abobotA with a standard dose of 500 U based on an empiric conversion ratio of 1:2.5 between the two toxins. The onabotA (n = 101) and the abobotA cohorts (n = 106) had similar reductions in frequency, nocturia and daily incontinence episodes. No difference in the duration of the effect was observed. However, the abobotA group had almost twice the rate of symptomatic urinary retention requiring CIC (42% versus 23%).

Peyronnet et al. [2016] assessed the results of onabotA detrusor injections when abobotA detrusor injection failed. Twenty-six patients with SCI (n=14), MS (n=9), myelomeningocele (n=2) and myelitis (n=1) in whom a first injection of 750 U abobotA in 20 sites failed in treating NDO received onabotA 300 U in 30 sites. The reasons for the failure of first treatment were not clear and in no case a second injection of abobotA was attempted. OnabotA injections brought continence to 65.4% and detrusor overactivity was relieved in 57.7% of the patients.

In another study Peyronnet et al. [2015] reviewed the charts of 58 NDO patients who received either onabotA or abobotA for the management of NDO. A toxin switch was carried out in 29 patients, whereas the other 29 patients received a reinjection of the same toxin at the same dose. The success rate was higher in patients who switched toxin (51.7% vs 24.1%, P = 0.03). Patients treated with a switch from abobotA to onabotA and those treated with a switch from onabotA to abobotA had similar success rates (52.9% vs 50%)

Switch between brands is currently clearly being made on empiric grounds. In particular the lack of effect of a treatment with a particular brand should not be seen as a compulsory reason for switching to another brand. In a recent sub-analysis of the NDO patients included in the onabotA pivotal studies whom experienced <50% reduction in urinary incontinence episodes following the first onabotA treatment, about 1/3 had a positive response in subsequent injections [Denys et al., 2015]. Even in patients with an initial response below 25%, marked improvements were found in subsequent treatments. As a matter of fact, in 10 of the 23 patients with <25% reduction at the first treatment, mean urinary incontinence reduction was ≥50% in all subsequent injections. Thus, an initial low response does not necessarily predict a permanent low response to subsequent treatments.

Reasons for the lack of response to botulinum toxin A injection in the bladder wall cannot be attributed neither to the lack of SNAP-25, an indispensable membrane protein nor to the formation of antibodies against the toxin which is a rare event. Rather, inappropriate storage the vials, incorrect toxin reconstitution, or incorrect technique of administration, including the type of needle used, should be more obvious reasons for treatment failure [Karsenty et al., 2014]. A large variation of the number of bladder neurons expressing cleaved SNAP-25, the end-product of botulinum toxin A activity, after 1 injection of a fixed dose

of onabotA was recently shown in experiments conducted in rodent bladder. The amount of cleaved protein after onabotA injection reached a 5-fold variation between experiments [Oliveira et al., 2015].

8.1.1.10 Comparison Between BoNT/A and Other Treatments

BonT/A has been compared to other OAB treatments only rarely as it is assumed that its introduction should follow the failure of first line oral pharmacotherapy, antimuscarinics and the beta3 agonist mirabegron. However, given the frequently suboptimal efficacy and long-term compliance of anticholinergic medications, researchers must assess whether BONT/A has a role as first line therapy for women with OAB. The Anticholinergic Versus Botulinum Toxin A Comparison Trial (ABC trial) [Visco et al., 2012] randomization of 249 women with OAB who had 5 or more episodes of urgency urinary incontinence in a 3-day bladder diary. For a 6-month participants were randomly assigned to one intradetrusor injection of 100 U of onabotA plus daily oral placebo daily or oral anticholinergic medication (solifenacin, 5 mg initially, with possible escalation to 10 mg and, if necessary, subsequent switch to trospium XR, 60 mg) plus one intradetrusor injection of saline. The primary outcome was the reduction from baseline in mean episodes of urgency urinary incontinence per day recorded in 3-day diaries over the 6-month [Visco et al., 2012]. The mean reduction in episodes of urgency urinary incontinence per day, from a baseline average of 5.0 per day, was 3.3 in the onabotA group and 3.4 in the anticholinergic group (P = 0.81). Complete continence was reported by more commonly in the onabotA than in the anticholinergic group, 27% vs 13% (P = 0.003), respectively. The toxin group had higher rates of catheter use at 2 months (5% vs. 0%, P = 0.01) and UTI (33% vs. 13%, P<0.001) than the anticholinergic group. The latter on the other hand had a higher rate of dry mouth (46% vs. 31%, P =0.02) [Visco et al., 2012].

In a similar study researchers randomised patients with OAB and urinary incontinence to receive double placebo (n = 60), onabotA 100 U injection plus placebo (n = 145), or oral solifenacin plus placebo injection (n = 151) for 12 weeks. Co-primary endpoints were change from baseline in urinary incontinence episodes/day and the proportion of patients with 100% reduction in urinary episodes at week 12 after injection. Overall, patients had 4.9 urinary incontinence episodes per day. At week 12, mean reduction from baseline in urinary incontinence episodes/day was significantly greater with either onabotA (-3.2) or solifenacin (-2.6) versus placebo (-1.3; P < .001 for both). Reduction in urinary incontinence episodes/day was significantly greater with onabotA than solifenacin (post-hoc analysis; P = .022). The proportion of patients with 100% reduction in urinary incontinence episodes at week 12 was significantly better for onabotA (33.8%) and solifenacin (24.5%) compared with placebo (11.7%) [Everaert et al., 2016]

The Rosetta study compared onabotA 200 U bladder injections against SNM (interStim) in refractory OAB patients [Amundsen et al., 2014]. The proportion of randomised patients suitable for SNM implant was identical in the two arms. At baseline the onabotA group (n=190) had 5.4 and the SNM (n=174) had 5.2 episodes of urinary incontinence per day. OnabotA 200 U resulted in a significantly greater mean daily reduction in UUI episodes over 6 months, which averaged one episode/day. A significantly greater number of patients experienced a complete resolution (20% vs 4%) or 75% reduction of UUI episodes (46% vs 26%) with OnabotA 200 U treatment than with SNM InterStim.

In addition, a survey in 50 OAB patients, with a mean age of 61 years, 74% prefer onabotA and only 26 % chose SNM as first treatment option. In those who preferred onabotA, 54 % disliked the thought of a foreign body in the back, 45.9 % made the option due to a short waiting list and 43.24 % made the choice based on the quicker onset of benefit. In the SNM group 61.5 % were averse to the potential need for repeated injections and 46.1 % chose SNM to avoid the risk of urinary retention associated with the toxin [Balchandra and Rogerson, 2014].

Although the outcomes of SNM (interStim) seem worse than those of onabotA it should be noticed that SNM may be useful in non-responders to onabotA. In a small cohort with 20 patients 17 (85%) had discontinued onabotA because of lack of efficacy and 3 had been treated successfully with BoNT/A but requested a more permanent solution. In 14 patients (70%) the test stimulation was successful and they received a definitive implant. Of the 14 patients 5 even showed a decrease of greater than 90% in leakage episodes. One year after implantation 11 patients (79%) were satisfied with SNM [Smits et al., 2013]. This study suggests therefore that half of patients non-responders to onabotA may still have a chance of long term improvement with SNM.

8.1.1.11 BONT/A in IC/PBS

BoNT/A significantly inhibits the noxious sensory input from the bladder [Vemulakonda et al., 2005; Rapp et al., 2006; Lucioni et al., 2008]. Moreover, BoNT/A decreases the urinary levels of NGF and BDNF which may contribute to decrease the bladder allodynia observed in these patients [Pinto et al., 2010; 2014]. Therefore, several pilot studies were carried out in the last few years. None is placebo controlled, a fact that limits the scientific value of the observations. On the other hand, different techniques of administration have been assessed. These two facts may explain some heterogeneity of results.

The first pilot study with 13 females observed that, 9 (69%) had subjective improvement after onabotA 100 or 200 U injected in the trigone and above the trigone. Mean scores in the Interstitial Cystitis Symptom Index and the Interstitial Cystitis Problem Index improved by 71% and 69%, respectively. Daytime frequency, nocturia, and pain measured by a Visual Analogue

Scale (VAS) decreased by 44%, 45%, and 79%, respectively. Symptom improvement lasted a mean of 3.7 months (range 1 to 8) [Smith and Chancellor, 2004]. In another pilot study with 15 patients, Giannantoni et al. [2006; 2008] reported similar observations after bladder injection of onabotA 200 U (150U above the trigone, 50 U in the trigone). Subjective improvement at 1- and 3-month follow-up occurred in 86% of the patients but at 5-month only persisted in 26.6%. Importantly, 9 patients experienced moderate to severe voiding difficulties [Giannantoni et al., 2006; 2008] A third study could not demonstrate any effect of onabotA in 13 IC/PBS patients treated with onabotA 100–300 U in the bladder [Davies et al., 2006].

Three other studies, which added substantial modifications to the above protocol, reported, on the contrary, considerable improvement in clinical and urodynamic outcomes after BoNT/A administration.

A prospective, randomized study enrolled 67 patients with refractory IC/PBS. Of these, 44 patients received suburothelial injection of onabotA 200 U (15) or 100 U (29) followed by cystoscopic hydrodistention 2 weeks later. The control group (23 patients) only received hydrodistention. The IC/PBS symptom score significantly decreased in all three groups, but VAS pain reduction and urodynamic improvement were only observed at 3 months in the arms that received onabotA, without any relevant differences between the two doses. A successful result at 12 and 24 months was reported in 55% and 30% of onabotA treated patients, respectively, compared with only 26% and 17% in the control group. The validity of these positive long-term results should however be interpreted with caution since all patients remained on baseline pentosan polysulphate throughout the study [Kuo and Chancellor, 2009].

Taking in consideration that most of the bladder nociceptors course in the trigone, Pinto et al. [2010] restricted 100 U onabotA injections to the trigone, in 10 sites (10 U/ 1 ml each). Twenty-six women with positive findings at cystoscopy and biopsy were enrolled. All patients reported subjective improvement at 1- and 3-month follow-up in pain, daytime and nighttime voiding frequency, O'Leary-Sant score and QoL. Bladder volume to first pain and maximal cystometric capacity more than doubled. Treatment remained effective in >50% of the patients for 9 months. Retreatment was equally effective in all cases, with similar duration of the effect up to four consecutive treatments (Pinto et al., 2013). No cases of dysfunctional voiding were reported after trigonal injections of onabotA 100 U. Also, PVR at urodynamics and bladder contractility index were not impaired [Pinto et al., 2010; Pinto et al., 2013]. Interestingly trigonal injections of onabotA 100 U were equally effective in patients with and without Hunner's lesions [Pinto et al., 2014].

The third was a small placebo controlled trial comparing periurethral injections of onabotA 50U (n=9) versus saline (n=11). The rationale was to investigate

the participation of periurethral somatic afferents to pain. The solution, 2 ml, was injected in the region of the bladder neck, at the 3 o'clock and 9 o'clock positions. Unfortunately, there was no differences between the onabotA and the at 3-month follow-up in terms of symptoms.

8.1.2 BoNT/B

Some humans repeatedly injected with BoNT/A may develop resistance to the toxin, possibly due to antibody formation. Although this event seems very rare in the case of bladder injections, a minimum interval of 3 months between two BoNT/A injections is generally recommended to decrease its occurrence. If resistance appears, recent reports [Dykstra et al., 2003; Pistolesi et al., 2004; Reitz et al., 2004] investigated the replacement of BoNT/A serotype by BoNT/B. At this moment empiric doses of BoNT/B are being used as there is no clear potency equivalents for the two serotypes and between BoNT/B brands.

In 3 patients with spinal NDO, bladder injection of 5000 U [Pistolesi et al., 2004] or 7500 U [Reitz and Schurch, 2004] of BoNT/B (Neurobloc®) restored bladder function for 6 months [Reitz and Schurch, 2004]. Interestingly, one patient experienced dry mouth and dry eyes that resolved within 20 days. As this side effect was not reported after bladder BoNT/A application, it is possible that different toxin serotypes have some different degrees of organ affinity. Dykstra et al. [2003] carried on a dose escalation study with BoNT/B (rimabotB) in 15 female patients with OAB. They used doses of 2500, 3750, 5000, 10,000, and 15,000 U injected at 10 sites. Only one patient failed to respond and a clear dose-dependent effect, was observed, with the longest response seen in those injected with 15,000 U. Two patients, both injected with 15,000 U, experienced dry mouth and general malaise. In another study involving IDO and NDO patients, in which rimabotB 5000 U were used, Hirst and coworkers [2007] observed a limited duration of action, with most of the symptomatic beneficial effects wearing off by 10 weeks in most of the patients. The short duration of action for BoNT/B at safe doses may, therefore, limit the clinic usefulness of this serotype.

BoNT is effective for treatment of both NDO and IDO and has an acceptable adverse effect profile (Table 2).

8.2. Capsaicin and Resiniferatoxin (RTX)

8.2.1 Rationale for Intravesical Vanilloids

The rationale for intravesical vanilloid application in patients with detrusor overactivity (DO) was offered by the demonstration that capsaicin, following bladder C-fiber desensitization, suppresses involuntary detrusor contractions dependent upon a sacral micturition reflex [de Groat, 1997]. The C-fiber micturition reflex is usually inactive but it was shown that it is enhanced in patients with chronic spinal-cord lesions above sacral segments [de Groat, 1997] in those with

chronic bladder outlet obstruction [Chai et al., 1998] and in those with IDO [Silva et al., 2002]. In the bladders of NDO patients, the enhancement of the micturition reflex is accompanied by an increase in the number of sub-urothelial C-fibers expressing TRPV1 [Brady et al., 2004]. Curiously, NDO patients who responded better to intravesical RTX exhibited a significant decrease in the density of TRPV1 immunoreactive fibers, whereas non-responders experience a non-significant variation [Brady et al., 2004]. A decrease in TRPV1 expression in urothelial cells of NDO patients was also demonstrated after intravesical application of RTX [Apostolidis et al., 2005; 2006].

Changes in sub-urothelial C-fiber innervation expressing neuropeptides [Smet et al. 1997] or TRPV1 [Liu and Kuo, 2007] were also reported in patients with and sensory urgency. In IDO patients, responders to intravesical RTX are closely associated with the over-expression of the receptor in the bladder mucosa [Liu and Kuo, 2007]. In women with sensory urgency, TRPV1 mRNA expressed in trigonal mucosa was not only increased but also inversely correlated with the bladder volume at first sensation of filling during cystometry further indicating that TRPV1 play a role in premature bladder sensation [Liu et al., 2007].

8.2.2 Intravesical Capsaicin

Intravesical capsaicin for NDO was studied in 6 non-controlled [Fowler et al., 1992; Fowler et al., 1994; Geirsson et al., 1995; Das et al., 1996; Cruz et al., 1997; De Ridder et al., 1997] and one controlled clinical trial [de Seze et al., 1998]. Capsaicin was dissolved in 30% alcohol and 100-125 ml (or half of the bladder capacity if lower than that volume) of 1-2 mM solutions were instilled into the bladder and left in contact with the mucosa for 30 minutes. Best clinical results were found among patients with incomplete spinal cord lesions, in whom clinical improvement could be observed in up to 70-90% the patients [Fowler et al., 1994, Cruz et al., 1997; De Ridder et al., 1997]. In patients with complete spinal cord lesions the success rate was much lower [Geirsson et al., 1995].

Only one small randomized controlled study compared capsaicin against 30% ethanol, the vehicle solution. Ten patients received capsaicin and found a significant regression of the incontinence and urge sensation. In contrast, only 1 among the 10 patients that received ethanol had clinical improvement [de Seze et al., 1998].

The pungency of alcoholic capsaicin solutions has prevented the widespread use of this compound. The possibility of triggering autonomic dysreflexia with capsaicin, especially in patients with higher spinal cord lesions has progressively restrained its use. The relevance of capsaicin might however be back with a recent observation by de Séze et al. [2006] with a new capsaicin formulation. They conducted a double-blind placebo controlled study with a glucidic solution of capsaicin in 33 NDO patients. The glucidic-capsaicin

treated group showed improvement both in symptoms and urodynamic parameters above the comparator arm. The global tolerance of this new capsaicin formulation was excellent [de Sèze et al., 2006].

8.2.3 RTX in NDO

Resiniferatoxin (RTX) has the advantage over capsaicin in being much less pungent [Cruz et al., 1997]. Intravesical RTX application in NDO patients was evaluated in five small open-label studies (Cruz et al., 1997; Lazzeri et al., 1997; 1998; Silva et al., 2000; Kuo, 2003). Different RTX concentrations, 10 nM, 50 nM, 100 nM and 10 μ M were tested. RTX brought a rapid improvement or disappearance of urinary incontinence in up to 80% of the selected patients and a 30% decrease in their daily urinary frequency. Furthermore, RTX also increased the volume to first detrusor contraction and maximal cystometric capacity. In general, in patients receiving 50-100 nM RTX the effect was long-lasting, with a duration of more than 6 month being reported. In patients treated with 10 μ M doses, transient urinary retention may occur [Lazzeri et al., 1998].

In a recent placebo-controlled study, the urodynamic effects of RTX in NDO patients was specifically evaluated. Only in the RTX arm a significant increase in first detrusor contraction and maximal cystometric capacity was found [Silva et al., 2005]. RTX also caused a significant improvement in urinary frequency and incontinence [Silva et al., 2005].

RTX, 600 nM was compared against BONT/A (Botox, 300U) in a study involving 25 patients with NDO due to chronic spinal cord injury [Giannantoni et al., 2004]. Both neurotoxins were capable of significantly reducing the number of daily incontinence episodes and improving maximum bladder capacity, although BONT/A turned out to be more effective.

8.2.4 RTX in IDO

The first study with intravesical RTX in IDO patients was designed as a proof-of-concept study and involved 13 patients. Intravesical RTX 50 nmol/L was associated with an improvement in volume to FDC from 170 ± 109 mL to 440 ± 153 mL at 30 days, and to 391 ± 165 mL at 90 days. An increase in mean MCC from 291 ± 160 mL to 472 ± 139 mL at 30 days and to 413 ± 153 mL at 90 days was also observed. These improvements were accompanied by a decrease in episodes of urgency incontinence and of daily frequency [Silva et al., 2002]. Subsequent small open label studies confirmed these observations using either a single high (50-100 nM) or multiple low (10 nM) dose approaches [Kuo, 2003; Dinis et al, 2004b; Kuo et al., 2005a].

The effect of RTX on refractory IDO was evaluated in two randomized clinical trials [Kuo et al., 2006; Rios et al., 2007]. Kuo et al. [2006] randomised 54 patients to receive 4 weekly instillations of a low concentration RTX solutions (10 nmol/L) or the vehicle solution, 10% ethanol in saline [Kuo et al., 2006] Three months

after completing the 4 intravesical treatments, the RTX treated group had 42.3% and 19.2% of patients feeling much better or improved, respectively. This was significantly more than in the placebo group, 14.2% and 7.1% respectively. At 6 months, treatment remained effective in 50% patients in the RTX group but only in 11% in the placebo group [Kuo et al., 2006]. Such clinical and urodynamic findings could not be reproduced in another study in which patients were randomly assigned to receive a single intravesical dose of 100 ml of either RTX 50 nM or placebo. Patients were followed-up only for 4 weeks. During this period a single 50 nM intravesical dose of RTX was not better than placebo for the treatment of women with IDO and urgency incontinence [Rios et al., 2007].

8.2.5 RTX and Urgency

The involvement of bladder C-fibers in IDO has led some investigators to explore the role of these sensory afferents to the genesis of urgency. In a non-controlled study involving 12 male patients with LUTS associated with BPH, mean IPSS halved following intravesical administration of RTX (50 nmol/L). The decrease in IPSS was largely due to improvements in scores related to urgency, in addition to improvement in nocturia and frequency [Dinis et al., 2005]. In another open-label study 15 patients with intractable urgency and frequency, with or without urgency incontinence or bladder pain/discomfort, and without urodynamic evidence of DO received one single 50 nM RTX solution. A trend towards an improvement of urgency was noticed [Apostolidis et al., 2006].

In a quasi-randomised study, 23 OAB patients with refractory urgency entered a 30-day run-in period in which medications influencing the bladder function were interrupted. At the end of this period patients filled a 7-day bladder diary. Then, patients were instilled with 100 ml of 10% ethanol in saline (vehicle solution) and 30 days later a second 7-day diary was collected. Finally, patients were instilled with 100 ml of 50 nM RTX in 10% ethanol in saline and additional bladder diaries were collected at 1 and 3 months. After vehicle instillation, the mean number of episodes of urgency per week was 56 ± 11 . At 1 and 3 months after RTX instillation the number of episodes of urgency decreased to 39 ± 9 ($p = 0.002$) and 37 ± 6 ($p = 0.02$), respectively [Silva et al., 2007].

8.2.6 Intravesical RTX and IC/PBS

TRPV1 involvement in pain has stimulated the investigation of RTX as a treatment for bladder pain in IC/PBS. After desensitization of bladder C-fibers, RTX reduces the spinal expression of c-fos, a pain evoked gene, in animal models of cystitis [Dinis et al., 2004a]. TRPV1 knock-out mice, which do not express the receptor in the bladder, do not experience an increase in the frequency of bladder reflex contractions or in the expression of c-fos in the spinal cord during cystitis [Charrua et al., 2007]. Patients with IC/PBS have more TRPV1 expressing sensory fibers in their

bladder mucosa than normal individuals [Mukerji et al., 2006].

In a placebo-controlled study of 18 patients with IC/PBS, Lazzeri et al. [2000] reported an improvement in pain and urinary frequency after administration of intravesical RTX in 10 nmol/L concentration. This effect was short-lasting, eventually due to the use of a low dose of RTX. Chen and co-workers conducted a dose-escalating study and concluded that the most commonly reported adverse event with RTX was pain during instillation. However, at 10 or 5 nM RTX was safe and could improve bladder pain [Chen et al., 2005]. Additionally, 3 non-controlled studies have also reported bladder pain improvement after intravesical RTX [Lazzeri et al., 2004; Apostolidis et al., 2006; Peng and Kuo, 2007]. A randomized, double-blind study in 163 patients with IC/PBS, in which several doses of intravesical RTX (10 nmol/L, 50 nmol/L, and 100 nmol/L) were compared with placebo, failed, however, to show any advantage for the neurotoxin over placebo in terms of overall symptoms, pain, urgency, frequency, nocturia, or average voided volume during 12 weeks of follow up [Payne et al., 2005].

9. OTHER DRUGS

9.1. Baclofen

Gamma-amino-butyric acid (GABA) is a ubiquitous inhibitory neurotransmitter in the CNS that can inhibit the micturition reflex in several points along its central pathway [de Groat, 1997; Pehrson et al., 2002]. Experimental data suggest the GABAergic system as an interesting target for bladder dysfunction therapy. Baclofen intrathecally attenuated oxyhemoglobin induced detrusor overactivity, suggesting that the inhibitory actions of GABA(B) receptor agonists in the spinal cord may be useful for controlling micturition disorders caused by C-fiber activation in the urothelium and/or suburothelium [Pehrson et al., 2002]. In spinal intact rats, intrathecal application of bicuculline induced detrusor-sphincter dyssynergia (DSD)-like changes whereas intrathecal application of baclofen induced urethral relaxation during isovolumetric bladder contractions [Miyazato et al., 2009]. After spinal cord injury (SCI), Miyazato et al. [2009] found signs of hypofunction of the GABAergic system (glutamate decarboxylase 67 mRNA levels in the spinal cord and dorsal root ganglia were decreased), and showed that activation of GABA(A) and GABA(B) receptors in the spinal cord inhibited DO as evidenced by a reduction in non-voiding contractions. GABA(B) receptor activation preferentially reduced DO prior to inhibiting voiding contractions while GABA(A) receptor activation inhibited DO and voiding contraction at the same concentration.

As a GABA agonist on GABA(B) receptors, *baclofen* was used orally in IDO patients. However, its efficacy was poor, eventually dictated by the fact that baclofen does not cross the blood-brain barrier [Taylor and

Bates, 1979]. ADX71441 is a selective positive allosteric modulator of the GABA_B receptor (GABA_B PAM), which is orally available and showed promising effects in animal models of micturition disturbances [Kalinichev et al., 2014]. Further studies of this agent would be of interest.

Baclofen is one of the most effective drugs for the treatment of spasticity following spinal cord injury, traumatic or hypoxic brain injury, and cerebral palsy [Ochs, 1993], and *intrathecal* baclofen was shown to be useful in some patients with spasticity and bladder dysfunction [Bushman et al., 1993]. Baldo et al. [2000] found a rapid (24 hours) and persistent increment in the volume to first detrusor contraction and of the maximal cystometric whereas maximal detrusor pressure decreased. At ten days, the volume to first detrusor contraction had increased from 143 ml to 486 ml. In selected patients with spasticity and bladder dysfunction, intrathecal baclofen seems to be an effective therapy.

10. COMBINATIONS

10.1. α_1 -AR Antagonists with Antimuscarinics or β_3 -AR Agonists

Traditionally, male lower urinary tract symptoms (LUTS) were thought to result from benign prostatic obstruction (BPO) secondary to benign prostatic enlargement (BPE). However, male LUTS may arise from prostatic pathology, bladder dysfunction, or both. Thus, diagnosis and appropriate treatment of men with overactive bladder (OAB) symptoms are complex and difficult. α_1 -AR antagonists remain the most widely used pharmacologic agents for relief of bladder outflow resistance as they relax prostatic and urethral smooth muscle tone, which is the dynamic component of BPO. In contrast, antimuscarinics, which function by competitively blocking muscarinic receptors, are the first-line pharmacologic treatment for OAB. Given the prevalence of combined voiding and OAB symptoms, as well as the finding that the quality of life (QoL) of these patients is affected primarily by the symptoms of OAB, it is logical for this category of patients to be given antimuscarinic drugs.

A number of studies have demonstrated the superior efficacy of combination treatment with an α_1 -AR antagonist and an antimuscarinic for alleviating symptoms of benign prostatic hyperplasia (BPH) and concomitant OAB compared to either monotherapy [Saito, et al., 1999; Athanasopoulos et al., 2003; Lee et al., 2005; Ruggieri et al., 2005; Kaplan et al., 2006; MacDiarmid et al., 2006; Kaplan et al., 2013a; van Kerrebroeck et al., 2013a; b Van Kerrebroeck et al., 2013]. The combination treatment is now recommended treatment for men with moderate-to-severe LUTS in those with predominant storage symptoms by AUA, EAU, and NICE.

The therapeutic benefits of combining an antimuscarinic agent (propiverine) with α_1 -AR antagonists

(tamsulosin) compared to α_1 -AR antagonists alone were reported by Saito and colleagues [Saito et al., 1999]. The rates of improvement in daytime frequency, incontinence, and urgency were greater in the combination group than the α_1 -AR antagonist-alone group. The post-void residual (PVR) was unchanged in both groups, and there was one case (1.5%) of acute urinary retention (AUR) with the combined treatment. Subsequently, Lee et al. [2005] compared the efficacy and safety of combination therapy using propiverine and doxazosin in 211 men with urodynamically confirmed bladder outlet obstruction (BOO) and OAB symptoms for 8 weeks. Compared with doxazosin monotherapy, patients in the combination therapy group showed greater improvement in urinary frequency, average micturition volume, and storage and urgency scores of international prostate symptom score (IPSS). Patient satisfaction was significantly higher in the combination group. There was also a significant increase in PVR (+20.7 mL) in the combination group, but no case of urinary retention was reported.

A large-scale, multicenter, randomized, double-blind, placebo-controlled trial (TIMES study) demonstrated the efficacy and safety of tolterodine extended release (ER) alone, tamsulosin alone, and the combination of both in 879 men with OAB and BPO [Kaplan et al. 2006]. In their primary efficacy analysis, 172 men (80%) receiving tolterodine ER plus tamsulosin reported treatment benefits by week 12 ($p < 0.001$ vs. placebo; $p = 0.001$ vs. tolterodine ER; $p = 0.03$ vs. tamsulosin). In their secondary efficacy analysis, patients receiving tolterodine ER plus tamsulosin compared with placebo experienced small but significant reductions in urgency incontinence, urgency episodes, daytime frequency, and nocturia. However, there were no significant differences between tamsulosin monotherapy and placebo for any dietary variables at week 12. Patients receiving tolterodine ER plus tamsulosin demonstrated significant improvements in total IPSS (-8.02 vs. placebo, -6.19, $p = 0.003$) and QoL (-1.61 vs. -1.17, $p = 0.003$). Although there were significant improvements in total IPSS among patients who received tamsulosin alone, the differences in total IPSS among patients that received tolterodine ER versus placebo were not significant. A subanalysis [Rovner et al., 2008] of data from the TIMES study focused on the urgency perception scale and concluded that the group of 217 men who received tolterodine plus tamsulosin showed significantly improved urgency variables and patient-reported outcomes. Moreover, this group of patients reported increased satisfaction with the treatment as well as a greater willingness to continue the treatment. Another subanalysis [Kaplan et al., 2008b] of data from the TIMES study examined the effects of the drugs on urinary symptoms as assessed by the IPSS. Based on this subanalysis, the authors concluded that tolterodine ER plus tamsulosin was significantly more effective than placebo in treating storage LUTS, including OAB symptoms.

Maruyama et al. [2006] reported different results in their prospective, randomized, controlled study in which naftopidil (25-75 mg/day), an α_{1d} -AR antagonist, was administered alone or in combination with propiverine hydrochloride (10-20 mg/day) or oxybutynin hydrochloride (2-6 mg/day) for 12 weeks to 101 BPH patients. In their study, the IPSS and QoL indexes improved significantly in both groups, with no marked differences between groups. Maximum flow rate (Qmax) and PVR showed an improvement trend in both groups, again with no differences between groups. However, the median post-therapeutic PVR was significantly higher in the combination group (45.0 mL) than in the monotherapy group (13.5 mL, $p = 0.021$). There were significantly more patients with increased residual urine volume relative to unchanged residuals in the combination therapy (22.9%) group versus the monotherapy group (5.0%, $p = 0.038$). The authors concluded that combination therapy with a low-dose antimuscarinic agent was not more effective than monotherapy. Moreover, although they did not encounter any cases of urinary retention, the percentage of patients with increased residual urine volume was significantly greater in the combination therapy group than in the monotherapy group.

In caution of increased PVR or voiding symptoms, low-dose antimuscarinic therapy was studied in men with OAB and BPO. Kang et al. [2009] evaluated the efficacy and safety of combined treatment with tamsulosin 0.2 mg and propiverine hydrochloride (10 mg) compared with tamsulosin monotherapy. After 3 months, both groups showed significant improvements in IPSS, QoL, voided volume, Qmax, and PVR, but only the QoL index was significantly different between the groups in favor of the combination group. No cases of AUR were recorded in this low-dose study.

The efficacy and safety of solifenacin in combination with tamsulosin were assessed in several large-scale RCTs, including the VICTOR [Kaplan et al., 2013] and SATURN [Van Kerrebroeck et al., 2013b] trials. The VICTOR trial [Kaplan et al., 2013] was a randomized, placebo-controlled study assessing solifenacin 5 mg as an add-on therapy to α_1 -AR antagonists treatment in men with residual OAB symptoms. Significant reductions in daytime frequency, the primary outcome of the study, were achieved in both solifenacin (and tamsulosin) and placebo (and tamsulosin) trials compared to baseline, but the difference between the two drug groups was not significant. Solifenacin add-on significantly reduced daily urgency episodes compared to placebo, but this was the only significant efficacy difference between solifenacin and placebo. Seven patients (3%) in the solifenacin group developed retention problems, with three requiring catheterisation, versus none in the placebo group. The SATURN study was a randomized, placebo-controlled trial evaluating the combination of different doses of solifenacin (3, 6, and 9 mg/day) with tamsulosin versus tamsulosin alone in men with voiding and storage LUTS [Van Kerrebroeck et al., 2013].

Decreases in micturition frequency and total urgency and frequency scores and increases in void volume per micturition were significantly greater with increasing solifenacin dosage in the combination groups versus with tamsulosin monotherapy. In a post-hoc analysis, patients with at least two urgency episodes and at least eight micturitions per 24 h at baseline showed clear improvements in storage and QoL parameters with combination treatment over tamsulosin alone. The subgroup of patients with fewer storage symptoms experienced little or no additional benefit from combination therapy compared with tamsulosin monotherapy. Combination therapy was well tolerated, and adverse events were consistent with the safety profiles of each individual compound. Mean PVR volume increased with increasing solifenacin dose, but the changes were not clinically relevant and were not accompanied by an increase in the incidence of retention.

A meta-analysis compared the efficacy and safety of treatment with α -blockers and anticholinergics to α -blocker monotherapy among men with storage urinary symptoms related to benign prostatic hyperplasia (BPH) [Filson et al., 2013]. Combination therapy produced a significantly greater reduction in IPSS storage subscore (Δ -0.73, 95% CI -1.09 - -0.37) and voiding frequency (Δ -0.69 voids, 95% CI -0.97 - -0.41) than monotherapy. There was also a greater reduction in Qmax (Δ -0.59 ml/sec, 95% CI -1.04 - -0.14) and an increase in PVR (Δ 11.60 ml, 95% CI 8.50-14.70) with combination therapy. The number of patients needed to be treated with combination therapy to cause 1 acute urinary retention episode was 101.

More recently, the efficacy and safety of a fixed-dose combination (FDC) tablet containing solifenacin 6 mg plus an oral controlled absorption system (OCAS™) formulation of tamsulosin (TOCAS) 0.4 mg has been studied in a phase III trial (NEPTUNE). NEPTUNE, which included 1,334 men with LUTS/BPH who had moderate-to-severe storage symptoms and voiding symptoms, showed that an FDC of solifenacin 6 mg plus TOCAS improved storage symptoms and QoL compared with TOCAS alone [van Kerrebroeck et al., 2013]. FDC treatment was also well tolerated and exhibited an adverse event profile similar to those reported for the individual monotherapies. Consequently, a once-daily FDC tablet of solifenacin 6 mg plus TOCAS 0.4 mg aimed at treating both storage and voiding symptoms in men with LUTS/BPH is licensed and available in several countries, including the UK. NEPTUNE and NEPTUNE II open-label extension studies further evaluated long-term (up to 52 wk) safety and efficacy of flexible dosing of two FDC of solifenacin plus TOCAS (Soli 6 mg plus TOCAS 0.4 mg or Soli 9 mg plus TOCAS 0.4mg) in men with moderate to severe storage and voiding symptoms [Drake et al., 2015]. Reductions in total IPSS and total urgency and frequency score (TUFS) during NEPTUNE were maintained for up to 52 wk of FDC treatment, with mean reductions of 9.0 (standard deviation [SD]: 5.7) and 10.1 (SD: 9.2), respectively,

from baseline to end of treatment. Urinary retention occurred in 13 of 1208 (1.1%) patients receiving one or more FDCs in NEPTUNE and/or NEPTUNE II; 8 (0.7%) required catheterization. Responder and health-related QoL (HRQoL) analyses of the NEPTUNE study reported that men treated with an FDC of solifenacin 6 mg plus TOCAS consistently had significantly improved outcomes compared with both the placebo and TOCAS [Drake et al., 2016]. There was a significant correlation between the reduction in total urgency frequency score and the improvement in HRQoL defined by the IPSS QoL score, the OAB-q symptom bother score, the overall patient global impression bladder symptoms, and the general health of the patient. Sokol et al. expected that the positive HRQoL data for FDC of solifenacin 6 mg plus TOCAS are likely to translate into improved persistence of treatment and possibly increased confidence to prescribe combined therapy as the initial treatment for moderate-to-severe LUTS/BPH.

Ichihara et al. [2015] evaluated the efficacy and safety of add-on treatment with mirabegron for overactive bladder symptoms remaining after α 1-blocker (tamsulosin) treatment in men with benign prostatic obstruction. The change in post-void residual urine volume was significantly greater in the combination group. Six patients (out of 76) experienced adverse events in the combination group, and urinary retention was observed in 1 patient. Nevertheless, the authors concluded that combination was effective and safe in these patients.

10.2. Combined Antimuscarinics

Although antimuscarinic agents are the first choice of treatment for patients with OAB symptoms, these drugs do not always lead to the desired effects of detrusor stability and continence, especially for patients with spinal cord injury or neurologic diseases such as multiple sclerosis or meningocele. When antimuscarinic treatments fail, invasive procedures such as the injection of botulinum toxin, electrical nerve stimulation, or augmentation cystoplasty are necessary. In patients who failed to respond or showed suboptimal response to antimuscarinic drugs but tolerated the treatment well, it was shown that increasing the daily dose may lead to significant improvements of OAB symptoms. A significant decrease of incontinence episodes was observed after doubling the recommended daily doses of trospium chloride and tolterodine to 90 and 8 mg, respectively, in patients with persistent neurogenic detrusor overactivity (NDO) [Horstmann et al., 2006]. Another non-invasive approach in patients with refractory NDO or OAB is the combination of two different antimuscarinic drugs; this has been demonstrated as effective and safe in several clinical studies including patients with either NDO [Amend et al., 2008; Nardulli et al., 2012] or OAB [Bolduc et al., 2009; Kosilov et al., 2014a; b] (Table 3).

Positive results were speculated to be due to 1) synergistic activation of different muscarinic receptors or

interactions of receptors on different parts of the bladder wall, 2) undiscovered faster metabolism of antimuscarinics requiring an increased dosage of differ-

ent antimuscarinic drugs, 3) down-regulation of subdivisions of antimuscarinic receptors under monotherapy that may lead to better susceptibility of other subdivisions when treated by the second drug.

Study	Patients (n)	Initial antimuscarinics	Combined antimuscarinics	Efficacy results
Amend et al. (Amend, Hennenlotter et al. 2008)	NDO (27)	Oxybutynin 30mg/day Tolterodine 2x8mg/day Trospium 3x30 mg	+trospium 45–90 mg +oxybutynin 15–30 mg +tolterodine 4–8 mg	UI episodes decreased: 8.6±2.7 to 1.3±0.9 7.0±1.5 to 0.6±0.7 7.5±2.7 to 2.0±1.5
Nardulli et al. (Nardulli, Losavio et al. 2012)	NDO (12)	Oxybutynin 15mg/day Oxybutynin 15mg/day	+trospium 80 mg +solifenacin 10 mg	UI episodes decreased: 5.3±SD to 0.8±SD 4.5±SD to 1.0±SD
Bolduc et al. (Bolduc, Moore et al. 2009)	NDO (19) OAB (14)	Tolterodine 4mg	+solifenacin 5 mg +solifenacin 10 mg	UI episodes decreased: 100% in 17 pts > 90% in 14 pts 50–89% in 2 pts
Kosilov et al. (Kosilov, Loparev et al. 2014a)	OAB (313)	Trospium 60mg + solifenacin 20mg (198) or Placebo (115)		Significant decrease in UI episodes compared to placebo
Kosilov et al. (Kosilov, Loparev et al. 2014b)	OAB (341)	Trospium 60 mg/day + solifenacin 20 (58) Trospium 30 mg/day + solifenacin 10 (55) Trospium 30 mg/day + solifenacin 10 (62)		Cyclic therapy with high-dose combination showed the most successful treatment without increase in side effects
Kosilov et al. (Kosilov, Loparev et al. 2016)	OAB & BPH (338)	solifenacin 5 mg + trospium 5 mg + tamsulosin 0.4 mg vs. tamsulosin 0.4 mg		UI episodes decreased: 3.4(0.8) to 0.9(0.7)

Table 3. Clinical studies of combined antimuscarinic treatments

A combined antimuscarinic regimen using tolterodine, oxybutynin, and trospium was evaluated as a non-invasive alternative by Amend and colleagues [Amend et al., 2008] for patients who had neurogenic bladder dysfunction with incontinence, reduced bladder capacity, and increased intravesical pressure. They added secondary antimuscarinics to the existing double-dosed antimuscarinics for patients who previously demonstrated unsatisfactory outcomes with double-dosed antimuscarinic monotherapy. After a 4-week combined regimen, incontinence episodes decreased, and reflex volume, maximal bladder capacity, and detrusor compliance increased. Side-effects were comparable to those seen with normal-dose antimuscarinics.

Kosilov and colleagues evaluated the effectiveness of cyclic therapy of combined high-dosed trospium and solifenacin depending on severity of OAB symptoms in elderly men and women. They found that cyclic therapy of high-dose solifenacin and trospium in elderly patients with moderate or severe symptoms of

OAB enabled patients to maintain a longer therapeutic effect with an acceptable level of side effects [Kosilov et al., 2014a].

They conducted another study to evaluate the efficiency of treatment for severe symptoms of OAB with cyclic therapy of combined antimuscarinic drugs in elderly men and women and determined that cyclic therapy with combined antimuscarinics appeared to be effective for controlling severe OAB in elderly patients, increasing the compliance level (76–84%). However, continuous therapy with standard doses of trospium and solifenacin results in low adherence and high rates of treatment withdrawal (≥ 66%) despite satisfactory clinical and urodynamic results.

The effectiveness of combination therapy with two different antimuscarinics was also evaluated in patients with severe symptoms of OAB and BPH [Kosilov et al., 2015b; Kosilov et al., 2016]. Patients in the experimental group for 2 months received treatment with a daily combination of solifenacin 5 mg and trospium 5

mg simultaneous with tamsulosin 0.4 mg. Patients in the control group were treated only with tamsulosin. In the experimental group, the number of episodes of incontinence reduced from a moderate level of 3.4 (0.8) per day to 0.9 (0.7) per day, and most urodynamic indices normalized significantly.

In the control group, changes in urodynamic indices were not significant. The quantity of side effects did not exceed the level that is commonly found in patients receiving antimuscarinic monotherapy. The authors concluded that combination of tospium and solifenacin in standard doses is an efficient and safe method for managing severe symptoms of OAB over the course of treatment with tamsulosin in patients with OAB/BPH [Kosilov et al., 2016]. However, in patients with OAB/BPH, the efficacy and side effects of combination therapy using different antimuscarinics should be further evaluated.

10.3. Antimuscarinics and 5 α -Reductase Inhibitors

The standard first-line medical therapy for men with moderate-to-severe LUTS is an α_1 -AR antagonist, a 5 α -reductase inhibitor, or combination therapy with both drugs. Both α_1 -AR antagonist and 5 α -reductase inhibitors alleviate LUTS in men by reducing bladder outlet resistance α_1 -AR antagonists decrease smooth muscle tone in the prostate and bladder neck, while 5 α -reductase inhibitors reduce prostate volume. Several trials have demonstrated the efficacy and safety of combination therapy with antimuscarinics and α_1 -AR antagonist for patients with OAB and coexisting BPO. However, post hoc analyses of the TIMES study [Kaplan et al., 2006] suggested that men with smaller prostates benefit more from antimuscarinic therapy than those with larger prostates [Roehrborn et al., 2008; Roehrborn et al., 2009]. Chung and co-workers conducted an open-label, fixed-dose study to assess the efficacy and safety of tolterodine ER in combination with dutasteride in men with large prostates (≥ 30 g) and persistent OAB symptoms after α_1 -AR antagonist therapy who had been unsuccessfully treated with dutasteride alone [Chung et al., 2010]. At the start of the study, all patients had been on dutasteride 0.5 mg daily for at least 6 months, and α_1 -AR antagonist therapy had failed. All patients were given 4 mg tolterodine ER daily for 12 weeks and had discontinued α_1 -AR antagonist before the start of the study. At 12 weeks, the frequency (-3.2/24hrs, $p < 0.02$), urgency (19.2%, $p < 0.03$), number of severe OAB episodes (71.4%, $p < 0.05$), and incidence of nighttime voiding (-0.9, $p < 0.003$) were found to have decreased significantly from baseline. IPSS decreased with dutasteride treatment (from 19.3 to 14.3) and further decreased with the addition of tolterodine to 7.1 ($p < 0.001$). Storage symptoms decreased from 9.8 to 4.5 ($p < 0.001$). Dry mouth occurred in four (7.5%) subjects, constipation in one (2%), and decreased sexual function in two (3.9%). PVR increased by 4.2 mL, Qmax decreased by 0.2 mL/s, and no patients went into retention. The authors concluded that the combination of tolterodine

and dutasteride was effective, safe, and well-tolerated in men with large prostates with persistent OAB symptoms and LUTS secondary to BPO. Their results indicate that antimuscarinics are safe and effective in select patients with OAB and BPO when used in combination with 5 α -reductase inhibitors. Further studies are required to verify the efficacy of antimuscarinics combined with 5 α -reductase inhibitors in patients with persistent OAB symptoms and LUTS secondary to BPO.

Dutasteride was evaluated in terms of OAB symptoms and bladder ischemia in men with BPE [Wada et al., 2015]. Twenty-four weeks after dutasteride treatment, bladder vascular resistive index (RI) significantly decreased, and urgency score of IPSS was significantly improved from 2.3 ± 1.9 to 1.4 ± 1.4 ($P < 0.01$). In 20 patients with persistent urgency after dutasteride, RI was less improved than in an additional 10 patients without urgency. Post-treatment bladder outlet obstruction index (BOOI) and PdetQmax in patients with persistent urgency were significantly higher than in those without urgency after dutasteride. The authors suggested that reduction of obstruction and improvement of bladder ischemia might play important roles in the beneficial impact of dutasteride on OAB symptoms.

10.4. α_1 -AR Antagonists with 5 α -Reductase Inhibitors

The Medical Therapy of Prostatic Symptoms Study (MTOPS) and Combination of Avodart® and Tamsulosin study (CombAT) have demonstrated that superiority of combinations of α_1 -AR antagonists with 5 α -reductase inhibitors over monotherapy for improving clinical outcomes and preventing symptomatic progression, risk of AUR, and BPH-related surgery [McConnell et al., 2003; Roehrborn et al., 2010]. Currently, a combination of α_1 -AR antagonist with a 5 α -reductase inhibitor is recommended by the American Urological Association (AUA) and European Association of Urology (EAU) for men with bothersome moderate to severe LUTS, high risk of disease progression-enlarged prostate (prostate volume > 40 mL), and higher PSA [McVary et al., 2011; Oelke et al., 2013]. The possible disadvantage of combinations of α_1 -AR antagonists with 5 α -reductase inhibitors is the increased incidence of adverse events, since there are concomitant effects of both classes of drugs [Fullhase et al., 2013; La Torre et al., 2016]. Potential side effects (e.g., ejaculation dysfunction with α_1 -AR antagonists or loss of libido with 5 α -reductase inhibitors) might be additive and may negatively affect patient quality of life and, especially, sexual function.

10.5. Antimuscarinic with β_3 -Adrenoceptor Agonists

Since the mechanism of action of β_3 -adrenoceptor agonists is different from that of antimuscarinics, it might prove to be a useful treatment in patients experiencing adverse events to antimuscarinics or insufficient symptom improvement. In addition, combining

β_3 -AR agonist with an antimuscarinic may potentially improve efficacy in the treatment of OAB. Several clinical trials have demonstrated the efficacy and safety of the combination therapy of antimuscarinics and β_3 -AR agonists. Abrams et al. reported results of a phase II trial (Symphony) of combination treatment with mirabegron and solifenacin in patients with OAB [Abrams et al., 2015]. A total of 1306 patients were randomly assigned to 12 groups: placebo, 6 combination groups (solifenacin 2.5, 5, or 10 mg plus mirabegron 25 or 50 mg), and 5 monotherapy groups (solifenacin 2.5, 5, or 10 mg, or mirabegron 25 or 50 mg) for a 12-week treatment period. The primary endpoint was change from baseline to end of treatment in mean volume voided per micturition (MVV). All combinations with solifenacin 5 or 10 mg improved MVV significantly comparing to solifenacin 5 mg monotherapy, and a decreasing trend in the mean number of micturitions per 24 hours was observed with increasing solifenacin and mirabegron doses. The three drug

combinations (solifenacin 5 mg plus mirabegron 50 mg, solifenacin 10 mg plus mirabegron 25 mg, and solifenacin 10 mg plus mirabegron 50 mg) demonstrated significant improvements compared to both solifenacin 5 mg and placebo.

No severe adverse events were reported, and treatment was generally well tolerated. In Japan, Yamaguchi et al. conducted a multicenter, open-label, phase IV study (MILAI study) to assess the safety and efficacy of mirabegron in combination with solifenacin in OAB patients who were being treated with solifenacin 2.5 mg or 5 mg once daily for at least 4 weeks [Yamaguchi et al., 2015]. A total of 223 patients were randomly assigned to one of 4 groups: solifenacin 2.5 mg plus mirabegron 25 mg (n=35), solifenacin 2.5 mg plus mirabegron 50 mg (n=37), solifenacin 5 mg plus mirabegron 25 mg (n=58), or solifenacin 5 mg plus mirabegron 50 mg (n=93) for a 16-week treatment period.

Table 4. Current status of possible future drugs/targets

Negative proof of concept
Potassium channel openers
Prostaglandin receptor antagonists
Positive proof of concept
Neurokinin receptor antagonists
Vitamin D3 receptor agonists
Monoamine reuptake inhibitors
Opioid receptor agonists
Cox inhibitors
Promising based on animal data
Rho- kinase - inhibitors
Drugs acting on GABA receptors
Purinergic system – P2X3 receptor antagonists
Cannabinoid system – exocannabinoids; FAAH inhibitors
TRP channel family – TRP channel antagonists

The overall incidence of drug-related TEAEs was 23.3%, and all TEAEs were mild or moderate. All treatments showed significant improvements in OABSS total score, overactive bladder questionnaire short form (OAB-q SF) score (symptom bother and total HRQL score), mean number of micturitions/24 h, mean number of urgency episodes/24 h, mean number of UI episodes/24 h, mean number of urgency UI episodes/24 h, mean volume voided/micturition, and mean number of nocturia episodes/night.

Recently, a phase IIIB trial (BESIDE) in incontinent OAB patients was carried out in Europe [Drake et al., 2016]. A total of 2174 patients with OAB who remained incontinent despite solifenacin 5 mg once

daily during 4-wk single-blind run-in were randomized 1:1:1 to a double-blind daily combination (n=727), solifenacin 5 mg (n=728), or 10 mg (n=719) for 12 wk. The primary efficacy end-point was change in mean number of incontinence episodes per 24 h. Key secondary efficacy end points were change in mean number of micturitions per 24 h and the number of incontinence episodes noted in the 3-d voiding diary. All combinations significantly improved daily incontinence episodes (p=0.001), daily micturitions (p<0.001), and incontinence noted in a 3-d voiding diary (p=0.014) compared to solifenacin 5 mg monotherapy. The combination of drugs was not inferior to solifenacin 10 mg for key secondary end points and was superior to solifenacin 10 mg for improving daily

micturitions. All treatments were well tolerated. These results suggest that combination therapy of mirabegron 50 mg with solifenacin 5 mg may be an alternative to dose escalation of solifenacin in patients with insufficient response to solifenacin 5 mg monotherapy.

11. FUTURE POSSIBILITIES

Much nonclinical and clinical research is ongoing, both involving modifications of existing options and directed at identifying novel pharmacological principles involved in LUTS/OAB pathophysiology, and this has been extensively discussed in several reviews [Yeo et al., 2013; Zacche et al 2014; Sacco and Bientinesi, 2015; Bechis et al. 2015, Andersson, 2015; 2016]. Details on some of the drugs under discussion are given below as is a critical summary of the current situation (Table 4).

11.1. Peripherally Acting Drugs

11.1.1 P2X₃-Receptors and P2X₃ Receptor Antagonists

During bladder filling the urothelium is stretched and ATP is released from the umbrella cells, thereby activating mechanotransduction pathways via stimulation of purinergic receptors on suburothelial sensory nerves to initiate the voiding reflex and to mediate the sensation of bladder filling and urgency [Burnstock, 2013; 2014]. P2X receptors are ligand-gated ion channels (Figure 19), and seven P2X receptor subunits have been identified from molecular studies and characterized functionally and pharmacologically [North and Surprenant, 2000; Gever et al., 2006; Ford and Cockayne, 2011]. Sensory nerve fibers expressing P2X₃ immunoreactivity have been found projecting into the lamina propria, urothelium and detrusor smooth muscle (Ford and Cockayne, 2011), where this and several other P2X receptors are functionally expressed (Ford and Cockayne 2011; Shabir et al., 2013). As mentioned, ATP is released from the urothelium in response to bladder filling [Ferguson et al., 2007; Vlaskovska et al., 2001; Wang et al., 2005a], and studies using an isolated rodent bladder-pelvic nerve preparation have shown that bladder distension leads to increased afferent nerve activity that is mimicked by ATP and/or α,β -meATP [Namasivayam et al., 2009; Vlaskovska et al., 2001; Rong et al., 2002]. Intravesical infusion of ATP or α,β -meATP can directly stimulate bladder overactivity in conscious rats, in a manner that is concentration-dependent and sensitive to the ATP receptor antagonist, TNP-ATP [Pandita and Andersson, 2002]. Thus, P2X₃ and P2X_{2/3} receptors may be important in sensing volume changes during normal bladder filling, and may participate in lowering the threshold for C-fiber activation under pathophysiological conditions.

Purinergic signaling in the bladder may be changed in different LUT disorders [Burnstock, 2014]. Thus,

bladder inflammation can sensitize and enhance P2X receptor function on pelvic visceral and hypogastric splanchnic afferents in the lumbosacral and thoracolumbar DRG [Dang et al., 2005]. In bladder urothelial cells from patients with bladder pain syndrome/interstitial cystitis (BPS/IC), P2X₃ receptor expression appears to be abnormally up-regulated in response to stretch [Sun and Chai, 2004; Sun et al., 2009].

An increased density of P2X₃ and TRPV1-expressing nerve fibers has been observed in the bladders of patients with neurogenic detrusor overactivity, and following treatment with resiniferatoxin, patients responding to treatment showed diminished levels of both TRPV1 and P2X₃ immunoreactivity [Brady et al., 2004].

P2X receptors, and in particular P2X₃ receptors, have been of interest for treatment of LUT disorders for a long time [Ford et al., 2006; Ford and Cockayne, 2011; Ford, 2012; North and Jarvis, 2013]. Selective P2X₃ antagonists, such as A-317491, were shown to effectively reduce the signs of cyclophosphamide-induced cystitis [Ito et al., 2008], and to improve bladder function in a rat spinal cord injury (SCI) model [Lu et al., 2007]. A-317491 produced a dose-dependent inhibition of non-micturition contractions, increased

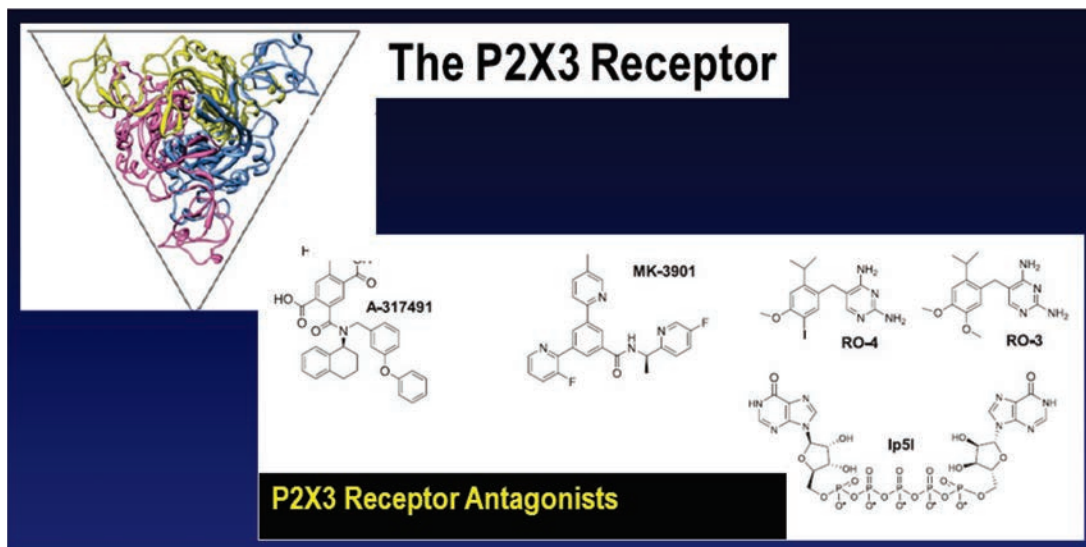

Figure 19: During bladder filling the urothelium is stretched and ATP is released from the umbrella cells, thereby activating mechanotransduction pathways via stimulation of purinergic receptors on suburothelial sensory nerves to initiate the voiding reflex and to mediate the sensation of bladder filling and urgency. Selective P2X3 antagonists have been shown to decrease signs of bladder overactivity in different animal models without affecting bladder contraction amplitude.

inter-micturition intervals, and bladder capacity, without influencing the amplitude of voiding contractions. Munoz et al. [2012] showed that SCI rats had significantly higher frequencies for field potentials and non-voiding contractions than normal rats. Intravesical ATP increased field potential frequency in control but not SCI rats, while systemic administration of the P2X3/P2X2/3 antagonist, AF-353 [Gever et al., 2010], significantly reduced this parameter in both groups. AF-353 also reduced the inter-contraction interval in control but not in SCI rats; however, the frequency of non-voiding contractions in SCI rats was significantly reduced. AF-353 was also studied in a closed cystometric model (“refill VIBC”) in a urethane anesthetized rat model. A dose-dependent increase in volume threshold by up to 50–70%, with slightly reduced frequency, but no appreciable change in amplitude was demonstrated [Ford and Cockayne, 2011]. As AF-353 penetrates the blood–brain barrier [Gever et al., 2010], it was not clear whether these effects resulted from P2X3 antagonism at peripheral terminals within the bladder wall, or alternatively at central terminals in the spinal cord dorsal horn. It has been suggested that ATP can be released and act on spinal P2X3 and P2X2/3 receptors to affect afferent signals originating from the bladder [Ford, 2012]. Spinal ATP may then constitute an endogenous central presynaptic purinergic mechanism to regulate visceral sensory transmission. Further characterization of this spinal purinergic control in visceral activities may help the development of P2X3 and P2X2/3 antagonists to treat urological dysfunction, such as overactive bladder [Ford, 2012].

11.1.2 TRP Channel Antagonists

The transient receptor potential (TRP) channel superfamily has been shown to be involved in nociception and mechanosensory transduction in various organ systems, and studies of the LUT have indicated that several TRP channels, including TRPV1, TRPV2, TRPV4, TRPM8, and TRPA1, are expressed in the bladder, and may act as sensors of stretch and/or chemical irritation [Araki et al., 2008; Everaerts et al., 2008; Andersson et al., 2010; Skryma et al., 2011; Avelino et al., 2013; Deruyver et al., 2014; Franken et al., 2014]. TRPV1 and TRPV4 channels have been found to be expressed in the urinary bladder [Tomimaga et al., 1998; Birder et al., 2001; Gevaert et al., 2007]. TRPV1 is present and active both in the urothelium and in the nerve fibers of several species including humans [Ji et al., 2002; Charrua et al., 2009a]. TRPV4 was initially described in the urothelium of rodents and humans [Janssen et al., 2011]. Co-expression of the two receptors was observed in 20% of rat urothelial cells [Kullmann et al., 2009]. Recent observations indicate, however, that TRPV4 may also be expressed in bladder afferents. In fact, about 30% of L6 dorsal root ganglia neurons that project to the urinary bladder co-express TRPV1 and TRPV4 [Cao et al., 2009; Charrua et al., 2012a]. The physiological meaning of this observation is unclear.

TRPV1 KO mice have a normal or quasi-normal phenotype. In awake animals, the only change detected in TRPV1 KO mice was a smaller volume per void when compared with wild type (WT) controls [Birder et al., 2001]. In cystometries performed under anaesthesia, the TRPV1 KO mice phenotype seems also

very benign. Some studies reported that this animals have totally normal cystometric traces [Charrua et al., 2007]. However, other studies showed that TRPV1 KO mice develop a few non-voiding contractions preceding the voiding contraction [Birder et al., 2001; Frias et al., 2012]. Accordingly, TRPV1 antagonists (GRC 6211) did not show any relevant effect on bladder activity of intact rodents [Charrua et al., 2009b]. In contrast with TRPV1 KO mice, the micturition phenotype of TRPV4 KO animals is clearly abnormal. TRPV4 KO mice are incontinent, most probably due to incomplete bladder emptying [Gevaert et al., 2007]. Cystometric studies carried out under physiological conditions revealed that TRPV4 KO mice have an marked increase in the inter-contraction interval when compared to wild-type (WT) littermates. [Gevaert et al., 2007; Birder et al. 2002]. Likewise, TRPV4 antagonists (HC-067047) decreased the frequency of bladder contractions and increased the inter-contraction interval [Everaerts et al, 2010]. These observations indicated that TRPV4 has a role in the control of normal micturition reflex.

Indisputably, TRPV1 or TRPV4 have a role in the increase of micturition frequency associated with cystitis [Charrua et al., 2007; Everaerts et al., 2010]. While inflamed WT mice exhibit bladder hyperactivity and intense spinal Fos expression after different forms of bladder inflammation, including acetic acid or bacterial extracts, TRPV1 KO mice have normal cystometries and normal spinal c-fos expression [Charrua et al., 2007]. The same holds true for TRPV4. In fact, TRPV4 KO mice exhibit significantly lower voiding frequencies and larger voided volumes than WT after inflammation with cyclophosphamide [Everaerts et al., 2010].

The blockade of TRPV1 and TRPV4 with specific antagonist confirm the observations carried out in knock-out animals. As a matter of fact, the TRPV1 antagonist GRC 6211 or the TRPV4 antagonist HC-067047 both abolish the increase of micturition frequency associated with chemical cystitis [Everaerts et al., 2010; Charrua et al., 2009b]. Recently, it was shown that the systemic co-administration of TRPV1 and TRPV4 antagonist was more effective in treating the cystitis-induced increase of micturition frequency than the individual application of each antagonist [Charrua et al., 2012b]. The effect could be observed at very low doses of the TRPV1 and TRPV4 antagonists, which had no effect when given isolated. This observed effect might be the answer to overcome the eventual adverse events related with the application of some of these antagonists [Planells-Cases et al., 2011]. Just to mention a few, TRPV1 antagonists are associated with hyperthermia and increased risk of cardiac ischemia [Avelino et al., 2012] while TRPV4 antagonists may eventually precipitate urinary retention and overflow incontinence [Gevaert et al., 2007].

It is known for long that TRPV1 is involved in the emergence of neurogenic detrusor overactivity following spinal cord transection [Avelino & Cruz, 2006]. A TRPV1 antagonist GRC 6211 has been shown to

decrease reflex detrusor overactivity in rats after chronic spinal cord transection. With increasing doses, it was possible to obtain a total suppression of bladder activity [Santos-Silva et al., 2012]. Kitagawa et al. [2013] evaluated the effects of the selective TRPV1 antagonist JTS-653 evaluated the effects of JTS-653 on the increased pelvic nerve discharge and intravesical pressure induced by intravesical infusion of capsaicin, in anesthetized rats. The drug significantly suppressed both parameters (Figure 20). The clinical relevance of this finding will be certainly further investigated in the future. Interestingly, Uvin et al. [2015] found evidence for involvement of TRPM8 in rat and mouse models of acute cold-induced urinary urgency.

There seem to be several links between activation of different members of the TRP superfamily and LUTS/DO/OAB, and further exploration of the involvement these channels in LUT function, normally and in dysfunction, may be rewarding. However, proof of concept studies in humans are still lacking.

11.1.3 Vitamin D₃ Receptor Analogues

It is well known that vitamin D affects skeletal muscle strength and functional efficiency, and vitamin D insufficiency has been associated with notable muscle weakness. The levator ani and coccygeus skeletal muscles are critical components of the pelvic floor and may be affected by vitamin D nutritional status. Weakened pelvic floor musculature is thought to be associated with the development of urinary incontinence and fecal incontinence symptoms. Aging women are at increased risk for both pelvic floor dysfunction as well as vitamin D insufficiency [Kilic et al., 2016], and to date only case reports and observational studies have shown an association between insufficient vitamin D and pelvic floor dysfunction symptom severity (Parker-Autry et al., 2012). Rat and human bladders were shown to express receptors for vitamin D [Crescioli et al., 2005], which makes it conceivable that the bladder may also be a target for vitamin D. Analogues of vitamin D₃ have also been shown to inhibit benign prostatic hyperplasia (BPH) cell proliferation and to counteract the mitogenic activity of potent growth factors for BPH cells [Crescioli et al., 2002; 2003; 2004]. Experiments in rats with bladder outflow obstruction, Schröder et al. [2006] showed that a vitamin D analogue, BXL-628 m (elocalcitol), at non-hypercalcemic doses, did not prevent bladder hypertrophy, but reduced the decrease in contractility of the bladder smooth muscle which occurred with increasing bladder weight [Schröder et al., 2006]. The mechanism of action for the effects has not been clarified. However, elocalcitol was shown to have an inhibitory effect on the RhoA/Rho kinase pathway [Morelli et al., 2007]. Upregulation of his pathway has been associated with bladder changes associated with diabetes, outflow obstruction, and DO [Peters et al., 2006; Christ and Anderson, 2007]. In rats with outflow obstruction, previous elocalcitol-treatment improved the effects of tolterodine on bladder compliance [Streng et al., 2012]. It

was suggested that in rats elocalcitol exerted additional beneficial actions on outflow obstruction-induced functional changes during the filling phase of micturition, which may support combined therapy in BPH-related LUTS. If valid in humans, combined therapy with the drug would be of value.

The effect of elocalcitol on prostate volume was evaluated in patients with BPH, and it was found that the drug was able to arrest prostate growth within 12 weeks in men aged >or=50 years with prostatic volume > or = 40 ml [Colli et al., 2006]. In an RCT enrolling 120 female patients with OAB, where the primary endpoint was an increase in the mean volume voided, a significant increase vs placebo (22% vs 11%) was demonstrated [Colli et al., 2007]. Whether or not vitamin D receptor agonism (monotherapy or in combination) will be a useful alternative for the treatment of LUTS/OAB, requires further RCTs. However, currently, the development of the drug seems to be stopped [Tiwari, 2009].

11.1.4 Prostanoid Receptor Agonists/Antagonists

Recent developments in the field of prostanoid receptors may open new possibilities to use selective prostanoid receptor antagonists for DO/OAB treatment [Aoki et al., 2009; Jones et al., 2009; Rahnama'i et al., 2012; Dobrek and Thor, 2015]. There is evidence suggesting that PGE2 contributes to the pathophysiology of DO/OAB: PGE2 infused into the bladder induces DO in humans and animals, increases PGE2 production in DO models and there

are high concentrations of PGE2 in the urine of patients with OAB [McCafferty et al., 2008]. PGE2 is an agonist at EP receptors 1 to 4, all G-protein coupled, which mediate its physiological effects. Based on studies using knockout (KO) mice and EP1 receptor antagonists, it was suggested that the effects of PGE2 on bladder function were mediated through EP1 receptors (Schroder et al., 2004). EP receptors can be found on urothelium/urothelium, in detrusor smooth muscle and in intramural ganglia [Rahnama'i et al., 2010; Rahnama'i et al., 2011]. Functionally, it has been proposed that modulation of bladder activity exerted via EP1 receptors occurs via an afferent mechanism. Schröder et al. [2004] found no difference in urodynamic parameters between unobstructed EP1 receptor KO and WT mice. However, EP1 receptor KO mice did not respond to intravesical PGE2 instillation, while WT mice developed DO. The lack of EP1 receptor did not prevent bladder hypertrophy due to partial bladder outflow obstruction but after obstruction WT mice had pronounced DO, while this was negligible in EP1 receptor KO mice.

Lee et al. [2008] found that in normal rats, a selective EP receptor antagonist significantly increased bladder capacity, micturition volume and micturition intervals. The antagonist significantly decreased the stimulatory effects of PGE2, and decreased the frequency and amplitude of nonvoiding contractions in animals with BOO. More recently it has been shown that also EP3 receptor KO mice have a diminished response to bladder infusion of PGE2, and demonstrate an enhanced bladder capacity

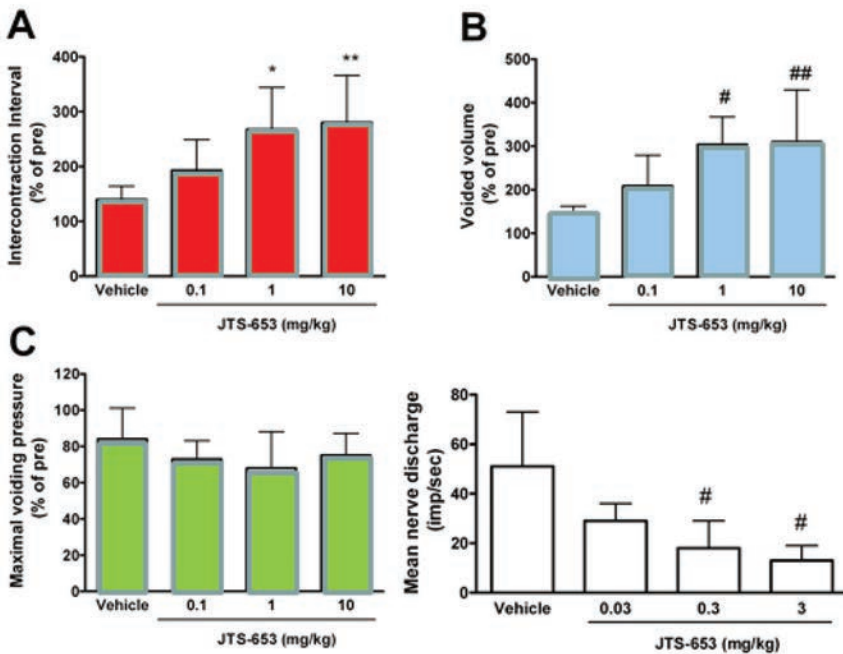

Figure 20: Effect of the selective TRPV1 antagonist JTS-653 given intravenously on capsaicin induced increase in pelvic nerve firing frequency (A) and IVP (B) in anesthetized rats. Modified from Kitagawa et al., *J Urol.* 2013 Mar;189(3):1137-46.

under basal conditions [Jones et al., 2009]. This findings suggest an important contribution for EP3 receptors in the modulation of bladder function under physiological conditions as well as under conditions of enhanced PGE2 production evoking DO. Thus, EP1 and EP3 receptors may have a role in PGE2 mediated DO.

Interestingly, activation of EP3 receptors evoked diuresis and EP3 receptor antagonism was found to induce an antidiuretic effect [Jugus et al., 2009]. Thus, to modulate bladder activity, it appears that the EP3 receptor has a role in regulating urine production. Both effects may be useful for treatment of DO/OAB. It cannot be denied that EP1/EP3 receptors constitute interesting and promising targets for drugs aimed at DO/OAB treatment. However, a randomised, double-blind, placebo-controlled phase II study to investigate the efficacy and safety of the EP-1 receptor antagonist, ONO-8539, in patients with the overactive bladder syndrome suggests that the role of EP1 receptor antagonism in the management of OAB syndrome is minimal [Chapple et al., 2011].

11.1.5 Cannabinoids

There is increasing evidence that cannabinoids can influence micturition in animals as well as in humans, both normally and in bladder dysfunction [Ruggieri, 2011; Hedlund, 2014; Hedlund and Gratzke, 2016]. The effects of the cannabinoids are exerted via two types of well defined receptors, CB1 and CB2, distributed widely in the body. However, additional receptor subtypes cannot be excluded [Pertwee et al., 2010; Ruggieri, 2011]. Both in the CNS and in peripheral tissues, CB1 and CB2 receptors have been identified; centrally CB1 and peripherally CB2 receptors seem to be predominant [Pertwee et al., 2010; Ruggieri, 2011] CB1 as well as CB2 receptors have been identified in all layers of the human bladder [Merriam et al., 2008; Gratzke et al., 2009; Tyagi et al., 2009; Walczak et al., 2009]; their expression in the urothelium was found to be significantly higher than in the detrusor, and the expression of CB1 was higher than that of CB2 [Tyagi et al., 2009]. Gratzke et al. [2009] found higher expression of CB2 receptors, but not CB1 receptors, in the mucosa than in the detrusor. Compared to the detrusor, larger amounts of CB2receptor containing nerves that also expressed TRPV1 or CGRP were observed in the suburothelium. Nerve fibers containing CB2 receptors and VACHT (cholinergic neurons) were located in the detrusor. In general, activation of CB1 peripherally has been associated with vasodilation and motility changes via suppression of release of neurotransmitters, whereas activation of CB2 appears to induce anti-inflammatory, antinociceptive, and immunosuppressive actions [Pertwee et al., 2010; Ruggieri, 2011]. Several animal studies have suggested a modulatory role of CB2 receptors in both afferent signalling and cholinergic nerve activity [Gratzke et al., 2009; 2010; 2011]. Thus, in vivo the selective CB2 receptor agonist, cannabino, increased micturition intervals and volumes, and increased threshold and

flow pressures, suggesting that peripheral CB2 receptors may be involved in sensory functions. In rats with partial urethral obstruction treated daily for 14 days with cannabino, bladder weight was lower, the ability to empty the bladder was preserved and non-voiding contraction frequency was low compared to those in controls.

The key enzyme for the degradation of anandamide and other endogenous cannabinoids, is fatty acid amide hydrolase (FAAH). FAAH was found to be expressed in rat and human urothelium and was coexpressed with CB2 receptors. In rats, a FAAH inhibitor altered urodynamic parameters that reflect sensory functions, suggesting a role for the endocannabinoid system in bladder mechanoafferent functions [Strittmatter et al., 2011]. Aizawa et al. [2016] found that URB937, a peripherally restricted FAAH inhibitor, reduced BO and C-fibre hyperactivity in the rat bladder provoked by PGE2, suggesting an important role of the peripheral endocannabinoid system in bladder overactivity and hypersensitivity. Charrua et al. [2016] showed that URB937 in LPS induced cystitis decreased voiding contactions on a dose dependent manner in low to mederate doses. In high doses the FAAH inhibitor did the opposite effect, increasing voiding frequency. Moreover, in the same model of cystitis URB937 in the doses that decreased bladder overactivity decreased the levels of anandamide and increase the levels of palmitoylethanolamide in the bladder tissue. Therefore, more studies are necessary in this field to clearly understand the dynamic of endocannabinoids in peripheral tissues. In addition, there seem to be no clinical studies assessing the effects of FAAH inhibitors on LUTS or on LUT visceral functions in humans [Hedlund and Gratzke, 2016].

It has not been established whether the effects of the cannabinoids are exerted in the CNS (brain, spinal cord) or peripherally. In a preliminaray report Blywert et al. [2003] demonstrated an effect of combined CB1/CB2 receptor activation on detrusor overactivity in rats with spinal cord transection, which seemed to exclude the brain as a main site of action.

The clinical experiences the cannabinoid treatment of micturition disturbances inclung LUTS are limited [Ruggieri, 2011], but both open-label and placebo-controlled studies have demonstrated that orally administered cannabinoid modulators may alleviate neurogenic overactive bladder (OAB) symptoms refractory to first-line treatment [Brady et al., 2004b; Freeman et al., 2006; Kavia et al., 2010]. Brady et al. [2004b] evaluated the efficacy of 2 whole plant extracts (δ^9 -tetrahydrocannabinol and cannabidiol) of *Cannabis sativa* in patients with advanced MS and refractory LUTS. Urinary urgency, the number and volume of incontinence episodes, frequency and nocturia decreased significantly following treatment. Freeman et al. [2006] tested in a subanalysis of a multicenter trial (the CAMS study) whether cannabinoids could decrease urge incontinence episodes without affecting voiding in patients with MS. The CAMS study randomized 630 patients to receive oral

administration of the cannabis extract δ 9-tetrahydrocannabinol or matched placebo. Based on incontinence diaries a significant decrease in incontinence episodes was demonstrated.

Kavia et al. [2010] assessed the efficacy, tolerability and safety of Sativex® (nabiximols) as an add-on therapy in alleviating bladder symptoms in patients with MS. They performed a 10-week, double-blind, randomized, placebo-controlled, parallel-group trial on 135 randomized subjects with MS and overactive bladder (OAB). The primary endpoint, reduction in daily number of urinary incontinence episodes from baseline to end of treatment (8 weeks), showed little difference between Sativex and placebo. However, four out of seven secondary endpoints were significantly in favour of Sativex, including number of episodes of nocturia, number of voids/day, and number of daytime voids. The improvement in I-QOL was in favour of Sativex, but did not reach statistical significance.

Systemic cannabinoids have effects on the lower urinary tract that may have a therapeutic potential; local delivery (intravesical, spinal) may be possible, but more information is needed. The mechanisms of cannabinoid receptors in control of the human LUT is incompletely known, and further research is necessary for the development of novel cannabinoid drugs for treatment of LUT disorders. In a recent review, Hedlund and Gratzke [2016] concluded that currently "the endocannabinoid system can be considered as a potential drug target for pharmacological management of LUTS, with a more favourable adverse event profile than antimuscarinic agents".

11.1.6 Intraprostatic Injections of Drugs.

Intraprostatic injection therapy is probably the oldest minimally invasive surgical therapy for BPH and has been investigated for over 100 years with renewed interest recently. There are different injectables and various routes of administration, transperineal, transrectal and transurethral (Andersson, 2015).

11.1.7 Ethanol

Ethanol injection is one of the most investigated intraprostatic therapies and have been investigated for more than a decade [Goya et al., 1999]. However, the mechanism of action, patient selection and application of ethanol (the number of injection sites and the injection volume) have not been well investigated and long-term results are scarce. It seems that ethanol causes inflammation, coagulative necrosis with protein denaturation and cell membrane lysis, and, finally, sloughing of prostatic tissue resulting in cavity formation [Plante et al., 2003]. The majority of trials demonstrated a significant reduction in symptoms and post-void residual volume as well as a significant improvement in Qmax and QoL and prostate volume also decreased significantly in the majority of studies [Goya et al., 2004; Grise et al., 2004; Plante et al.,

2007; Sakr et al., 2009]. The durability of clinical effects beyond 1 year seems poor. One trial with a mean follow-up of 3 years showed a retreatment rate of 41% [Goya et al., 2004].

11.1.8 BoNT/A

BoNT-A investigation for the treatment of benign prostatic enlargement (BPE) due to benign prostatic hyperplasia (BPH) started in 2003 [Maria et al., 2003] after the experimental study by Doggweiler et al. [1998] demonstrating prostatic atrophy in the rat after intraprostatic injection of the neurotoxin. In an exploratory study, which involved injection of 200 U of onabotA in moderate to large prostate glands, a rapid prostate volume decrease was induced and still present at 12 months [Maria et al., 2003]. Following this study, Kuo [2005] reported similar findings when injecting prostate glands of 50 ml or larger. BoNT/A injection in smaller prostate glands caused a much lesser reduction in prostate volume, but a 15% reduction was still observed [Chuang et al., 2005; Chuang et al., 2006c]. Independent of the extent of prostate volume reduction, improvement of LUTS and flow were consistently reported [Maria et al., 2003; Kuo, 2005; Chuang et al., 2005; Chuang et al., 2006c], while a decrease in total serum PSA were observed only in some studies [Maria et al., 2003; Guercini et al., 2005]. In a multicenter, double-blind, randomized phase II clinical trial of 100 and 300 unit doses of onabotA to treat the lower urinary tract symptoms of BPH, Crawford and coworkers concluded that intraprostatic injection of 100 or 300 units of onabotA passed predetermined criteria for treatment efficacy and safety (30% improvement from baseline to 3 months in American Urological Association symptom index and/or maximum urinary flow rate and safety). The ideal dose was not found, but it seemed that the 100 U dose may be preferable due to similar efficacy with reduced costs and adverse effects [Crawford et al., 2011]. Some serious adverse events were reported, including 3 cases of urosepsis related to the onabotA injection. Other minor adverse events reported were urinary tract infection, pelvic pain, urinary retention, macroscopic hematuria and hematospermia [Crawford et al., 2011].

Silva et al. [2008], selected a particular group of patients with high co-morbidity in which more invasive treatments were contraindicated. Intraprostatic BoNT/A injection was carried out transrectally, under ultrasound guidance. Twenty-one men with large BPE, 70 ± 10 ml, on chronic indwelling catheter for at least 3 mo who were not candidates for surgery because of poor general condition received 200 U BoNT/A in the transition zone. Baseline prostate volume of decreased to 57 ± 10 ml at 1mo and to 47 ± 7 ml at 3 months. At 1 month, 16 patients (76%) could resume voiding with a mean Qmax of 9.0 ± 1.2 ml/s. At 3 months, 17 patients (81%) voided with a mean Qmax of 10.3 ± 1.4 ml/s. Residual urine was not significant and mean serum total PSA showed a slight decrease [Silva et al. 2008]. The analysis of 11 patients

of the initial cohort showed that the duration of prostate atrophy after the single injection of 200U of BoNT/A was found to be about 18 months [Silva et al., 2009b].

Intraprostatic injection of BoNT/A seems devoid of sexual adverse events. Sixteen sexually active men aged > 60 years with BPH/benign prostatic enlargement (BPE) refractory to standard medical therapy received 200U of BoNT/A by transrectal route. Erectile function was evaluated using the International Index of Erectile Function – Short Form (IIEF-5) questionnaire. Orgasmic/ejaculatory function and libido were evaluated using questions 9, 10, 11 and 12 of the IIEF – Long Form. Intraprostatic injection of BoNT/A did not cause deterioration of any domain of sexual function [Silva et al., 2011].

Although necrosis of the gland at the places of BoNT/A injection could explain the rapid volume reduction, transrectal ultrasound examination of the glands, performed in these or in previous studies [Maria et al., 2003; Kuo 2005; Chuang et al., 2005; Silva et al., 2008, was unable to detect signs of cavitation that indirectly could suggest the presence of necrosis. Therefore, the reason for the decreased prostate volume should be more appropriately related to the widespread apoptosis detected in the gland after BoNT/A administration. Apoptosis was reported in rats, dogs, and humans, and affected both the epithelial and stromal components [Dogweiler et al., 1998; Chuang et al., 2005; Chuang et al., 2006b; Chuang et al., 2006d, Silva et al., 2009a].

Although until now, no important side-effects have been reported after intraprostatic injection of the neurotoxin in doses ranging between 100 and 300 U, a multicenter, double-blind, randomized phase II clinical trial of 100 and 300 unit doses of onabotA to treat the lower urinary tract symptoms of benign prostatic hyperplasia, was recently published [Crawford et al., 2011]. OnabotA prostatic injection met the two safety criteria proposed, (a dose failed if: 1- a life threatening, disabling or fatal event was determined to be related to the onabotA injection, or 2- 40% or more of the participants reported a moderate or severe side effect related to the botulinum toxin injection). Nonetheless, some serious AEs were reported, including 3 cases of urosepsis related to the onabotA injection and the remaining events were judged not related to the injection. Other minor AEs reported were urinary tract infection, pelvic pain, urinary retention, macroscopic hematuria and hematospermia [Crawford et al., 2011].

These findings were not reproduced, however, in two recent, large RCTs. One enrolled patients with IPSS > 12 and a peak flow rate (Qmax) between 5-15 ml/s [Marberger et al., 2012]. A total of 380 men met the inclusion/exclusion criteria, were randomized (ITT population), and received treatment via the transperineal (n = 63) or transrectal (n = 311) routes with either placebo (n = 94) or onabotA 100 U (n = 95), 200 U (n = 94), or 300 U (n = 97). The other [McVary et

al., 2014] enrolled 427 men with IPSS score > 14 and Q max between 4 to 15 ml/s. All received initially a sham procedure to exclude cases with a high placebo response during the run-in phase. Then a total of 315 patients were randomized 1:1 to receive a single intraprostatic treatment of onabotA 200U or placebo. Although in both studies a substantial decrease in IPSS score and increase in Qmax occurred in the onabotA 200 U groups, the changes were not significantly different from those observed in the saline arm, indicating that they arose from a considerable placebo effect associated with the injection procedure.

The population enrolled in the Marberger and McVary trials may vary from those usually referred to minimal invasive BPH procedures. As a matter of fact, 51% of the men enrolled in the Marberger study, although having moderate to severe LUTS had never received treatment with licensed drugs for BPH/LUTS. In the McVary study [2014], 78.3% of the patients were not on α -AR antagonists or 5 ARI when they were enrolled in the study. From a total of 313 patients only 68 (21.7%) were on treatment, while all the others had meanwhile abandoned oral pharmacotherapy. Interestingly, patients unsatisfied with medical treatment for their BPH/LUTS seem to respond more positively to onabotA injection in the prostate. In the Marberger trial, an exploratory post hoc analysis of the subgroup of patients who had received α -AR antagonists showed a significant reduction from baseline in IPSS in the onabotA 200-U group versus placebo. A sub analysis of the population on concurrent BPH therapy in the McVary study showed an improvement in Qmax that was significantly greater in the onabotA than in the placebo arm.

Recently, a non-inferiority randomized clinical trial compared in BPH patients dissatisfied with oral pharmacotherapy prostatic injection of onabotA 200 U against optimized medical therapy [Robert et al., 2015]. Patients on optimized drug therapy received any possible drug combination for treatment of BPH/LUTS. The group submitted to toxin injection stopped oral medication 30 days after the procedure. Total IPSS at the end of treatment was similar in the two arms, allowing the conclusion that onabotA is not inferior to optimized medical therapy, in men with BPH/LUTS refractory to initial oral pharmacotherapy. Interestingly, in the onabotA group only 1 episode of acute urinary retention occurred. In contrast, 6 cases were observed in the optimized medical treatment group.

11.1.9 NX-1207

NX-1207 is a new drug under investigation for the treatment of LUTS associated with BPH [Kunit and Lusuardi, 2014]. It is a new therapeutic protein of proprietary composition with selective pro-apoptotic properties [Shore, 2011]. The drug is injected directly into the directly into the transitional zone of the prostate as a single administration to induce focal cell loss in prostate tissue through apoptosis, leading to non-regressive prostate shrinkage and both short- and

long-term symptomatic improvement. Information about the drugs is scarce and mostly published in abstract form and not yet in the peer-reviewed literature. Two US Phase II trials have been performed [Shore, 2011]. One of them was a multicenter, randomized, non-inferiority study involving 32 clinical sites with 85 subjects and two dose ranges (2.5 and 0.125 mg) and an active open-label comparator (finasteride). Subjects and investigators on NX-1207 were double-blind as to dosage. The primary endpoint was change in AUASI at 90 and 180 days for a single injection of NX-1207 as compared to finasteride on a non-inferiority basis. Inclusion criteria included an AUA Symptom Score \geq 15, diminished peak urine flow ($<$ 15 ml/s) and a prostate size of $>$ 30 and $<$ 70 mg. The mean AUA Symptom Score improvement after 90 days in the intent-to-treat group was 9.71 points for 2.5 mg NX-1207 (n = 48) versus 4.13 points for finasteride (n = 24) (p = 0.001) and 4.29 for 0.125 mg NX-1207 (n = 7) (p = 0.034). The 180-day results also were positive (NX-1207 2.5 mg non-inferior to open-label finasteride).

No significant changes in serum testosterone or serum PSA levels in the NX-1207 cohorts. There were no reported adverse effects on sexual function. Two US multicenter, double-blind, placebo-controlled Phase III studies are currently underway. The results of such studies are needed to assess whether or not this therapeutic principle is a useful addition to the current treatment alternatives.

Recently, the clinical development of this drug was suspended and clinical trials going on in Europe suspended due to the release of negative data coming from a phase III trial run in the US.

11.1.10 PRX302

PRX302 is a modified form of proaerolysin, a highly toxic bacterial pore-forming protoxin that requires proteolytic processing by prostate-specific antigen (PSA). [Singh et al., 2007]. The safety and efficacy of PRX302 was evaluated in men with moderate to severe BPH [Denmeade et al., 2010]. The patients were refractory, intolerant, or unwilling to undergo medical therapies for BPH and had an IPSS $>$ 12, a quality of life (QoL) score $>$ 3, and prostate volumes between 30 and 80 g. Fifteen patients were enrolled in phase 1 studies, and 18 patients entered phase 2 studies. Subjects received intraprostatic injection of PRX302 into the right and left transition zone via a transperineal approach in an office-based setting. Phase 1 subjects received increasing concentrations of PRX302 at a fixed volume; phase 2 subjects received increasing volumes per deposit at a fixed concentration. IPSS, QoL, prostate volume, Qmax, IIEF, serum PSA levels, pharmacokinetics, and adverse events were recorded at 30, 60, 90, 180, 270, and 360 days after treatment. Sixty percent of men in the phase 1 study and 64% of men in the phase 2 study treated with PRX302 had $>$ 30% improvement compared to baseline in IPSS out to day 360. Patients also experienced improvement in QoL and reduction

in prostate volume out to day 360. Patients receiving $>$ 1 ml of PRX302 per deposit had the best response overall. There were no deleterious effects on erectile function. Adverse events were mild to moderate and transient in nature. The major study limitation was the small sample size. The promising safety profile and evidence of efficacy in the majority of treated subjects in these phase 1 and 2 studies supports further development of PRX302 as a minimally invasive, targeted treatment for BPH.

To overcome these limitations, a phase IIb study was carried out recently [Elhilali et al., 2013]. A total of 92 men with an IPSS \geq 15, Q_{max} \leq 12 ml/s and prostate volume between 30 and 100 ml were randomized 2:1 to a single ultrasound guided prostatic injection of PRX302 (0.6 mg per g prostate) or placebo. Benign prostatic hyperplasia medications were prohibited. The toxin decreased IPSS score by approximately 9-point and increase Q_{max} by 3 ml/s, both changes being statistically significant when compared to vehicle. Efficacy was sustained for 12 months. PRX302 apparent toxicity was mild, transient, and limited to local discomfort/pain and irritative urinary symptoms occurring in the first few days, with no effect on erectile function. Further developments are therefore awaited.

11.2. Centrally Acting Drugs

Many parts of the brain seem to be activated during storage and voiding [see, Griffiths 2007; Fowler et al., 2008; Griffiths and Tadic, 2008], and there is increasing interest in drugs modulating the micturition reflex by a central action [Andersson and Pehrson, 2003; Yoshimura et al., 2014]. Several drugs used for pain treatment also affect micturition; morphine and some antiepileptic drugs being a few examples (Figure 21). However, central nervous mechanisms have so far not been preferred targets for drugs aimed to treat OAB, since selective actions may be difficult to obtain. Holstege [2005], reviewing some of the central mechanisms involved in micturition, including the periaqueductal gray (PAG) and the pontine micturition center (PMC), suggested that "the problem in OAB or urgency-incontinence is at the level of the PAG or PMC and their connections, and possible treatments for this condition should target the micturition pathways at that level."

11.2.1 Gonadotropin-releasing Hormone Antagonists

The beneficial effects of the 5α -reductase inhibitors, finasteride and dutasteride in the treatment of male LUTS are well documented. The efficacy of other hormonal treatments, for example, antiandrogens or gonadotropin-releasing hormone (GnRH; also known as luteinizing hormone-releasing hormone: LHRH) agonists is either poor or at the expense of unacceptable side effects such as medical castration associated with hot flushes, decrease of potency and libido, and negative effects on bone density following long-term androgen ablation [Schroeder et al., 1986; Peters et al., 1987; Bosch et al., 1989; Eri and Tveter, 1993]. With GnRH antagonists submaximal, non-castrating blockade of the androgen testosterone and consequently of dihydrotestosterone (DHT) can be achieved, thus avoiding medical castration. Several GnRH antagonists – such as cetrorelix, ozarelix and teverelix - have been tested in Phase IIA/IIB clinical trials for their ability to improve LUTS in patients with BPH [Colli and Tanko, 2011].

Debruyne et al. [2008] demonstrated in a phase 2 RCT that the LHRH antagonist cetrorelix, given subcutaneously weekly for 20 weeks to 140 men with LUTS (IPSS ≥ 13 , peak urinary flow rates 5-13 ml/s), rapidly caused a significant improvement in the mean IPSS: the peak decrease was -5.4 to -5.9 vs -2.8 for placebo. All dosage regimens tested were well tolerated, and the authors concluded that the drug offered a safe and effective treatment of male LUTS.

Due to these results, two phase III studies were conducted in the United States and Europe [Aeterna Zentaris]; in the US study, 637 men were randomized to receive either two doses of placebo or cetrorelix on

weeks 2 and 26. The drug showed no statistically significant benefit in improving IPSS. In addition, cetrorelix did not have a significant effect on peak flow rate or prostate volume versus placebo. It is difficult to reconcile this lack of efficacy given favorable prior results. A subsequent multicenter European trial also failed to show any treatment-related efficacy of cetrorelix. The experience with cetrorelix highlights the importance of randomized, placebo-controlled trials that are appropriately powered to show clinical benefit and safety.

11.2.2 Gabapentin

Gabapentin is one of the new first-generation antiepileptic drugs that expanded its use into a broad range of neurologic and psychiatric disorders [Striano and Striano, 2008]. It was originally designed as an anti-convulsant GABA (γ -aminobutyric acid) mimetic capable of crossing the blood-brain barrier [Maneuf et al., 2003]. The effects of gabapentin, however, do not appear to be mediated through interaction with GABA receptors, and its mechanism of action remains controversial [Maneuf et al., 2003]. It has been suggested that it acts by binding to a subunit of the $\alpha_2\delta$ unit of voltage dependent calcium channels [Gee et al., 1996; Striano and Striano, 2008]. Gabapentin is also widely used not only for seizures and neuropathic pain, but for many other indications, such as anxiety and sleep disorders, because of its apparent lack of toxicity.

Carbone et al. [2006] reported on the effect of gabapentin on neurogenic DO. They found a positive effect on symptoms and significant improvement in urodynamic parameters, and suggested that the effects of the drug should be explored in further controlled studies in both neurogenic and non-

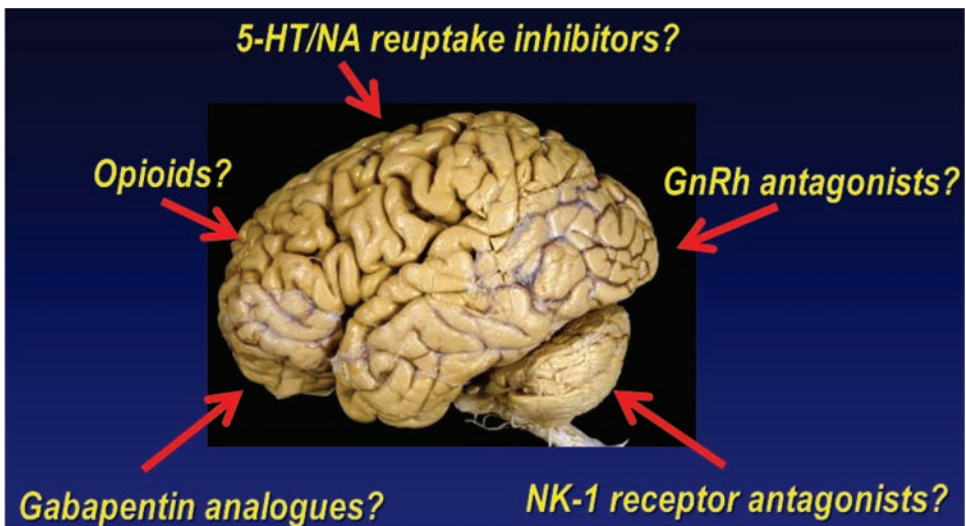

Figure 21: OAB drugs with a central mode of action. Several principles seem to work, but currently used drugs have low efficacy and/or unacceptable side effects. However, there is great potential for further developments

neurogenic DO. Kim et al. [2004] studied the effects of gabapentin in patients with OAB and nocturia not responding to antimuscarinics. They found that 14 out of 31 patients improved with oral gabapentin. The drug was generally well tolerated, and the authors suggested that it can be considered in selective patients when conventional modalities have failed. It is possible that gabapentin and other $\alpha_2\delta$ ligands (e.g., pregabalin and analogs) will offer new therapeutic alternatives, but convincing RTC are still lacking.

11.2.3 Tramadol

Tramadol is a well-known analgesic drug [Grond and Sablotzski, 2004]. By itself, it is a weak μ -receptor agonist, but it is metabolized to several different compounds, some of them almost as effective as morphine at the μ -receptor. However, the drug (metabolites) also inhibits serotonin (5-HT) and noradrenaline reuptake [Grond and Sablotzski, 2004]. This profile is of particular interest, since both μ -receptor agonism and amine reuptake inhibition may be useful principles for treatment of LUTS/OAB/DO, as shown in a placebo controlled study with duloxetine [Steers et al., 2007].

In rats, tramadol abolished experimentally induced DO caused by cerebral infarction [Pehrson et al., 2003]. Tramadol also inhibited DO induced by apomorphine in rats [Pehrson and Andersson, 2003] – a crude model of bladder dysfunction in Parkinson’s disease. Singh et al. [2008] gave tramadol epidurally and found the drug to increase bladder capacity and compliance, and to delay filling sensations without adverse effects on voiding. Safarinejad and Hosseini [2006] evaluated in a double-blind, placebo-controlled, randomized study, the efficacy and safety of tramadol in patients with idiopathic DO. A total of 76 patients 18 years or older were given 100 mg tramadol sustained release every 12 h for 12 weeks. Clinical evaluation was performed at baseline and every two weeks during treatment. Tramadol significantly ($p<0.001$) reduced the number of incontinence periods per 24 hours from 3.2 \pm 3.3 to 1.6 \pm (2.8) and induced improvements in urodynamic parameters. The main adverse event was nausea. It was concluded that in patients with non-neurogenic DO, tramadol provided beneficial clinical and urodynamic effects. However, the study was later retracted due to unacceptable statistical errors [Safarinejad and Hosseini, 2006; retracted 2014].

NK1-Receptor Antagonists

The main endogenous tachykinins, substance P (SP), neurokinin A (NKA) and neurokinin B (NKB), and their preferred receptors, NK1, NK2, and NK3, respectively, have been demonstrated in various CNS regions, including those involved in micturition control [Lecci and Maggi, 2001; Saffroy et al., 2003; Covenas et al., 2003]. NK1 receptor expressing neurons in the dorsal horn of the spinal cord may play an important role in DO, and tachykinin involvement via NK1 receptors in the micturition reflex induced by

bladder filling has been demonstrated [Ishizuka et al., 1994] in normal, and more clearly, rats with bladder hypertrophy secondary to BOO. Capsaicin-induced detrusor overactivity was reduced by blocking NK1 receptor-expressing neurons in the spinal cord, using intrathecally administered substance P-saponin conjugate [Seki et al., 2002]. Furthermore, blockade of spinal NK1 receptor could suppress detrusor activity induced by dopamine receptor (L-DOPA) stimulation [Ishizuka et al., 1995].

In conscious rats undergoing continuous cystometry, antagonists of both NK1 and NK2 receptors inhibited micturition, decreasing micturition pressure and increasing bladder capacity at low doses, and inducing dribbling incontinence at high doses. This was most conspicuous in animals with outflow obstruction [Gu et al., 2000]. Intracerebroventricular administration of NK1 and NK2 receptor antagonists to awake rats suppressed detrusor activity induced by dopamine receptor (L-DOPA) stimulation [Ishizuka et al., 2000]. Taken together, available information suggests that spinal and supraspinal NK1 and NK2 receptors may be involved in micturition control.

Aprepitant, an NK-1 receptor antagonist used for treatment of chemotherapy-induced nausea and vomiting [Massaro and Lenz, 2005], significantly improved symptoms of OAB in postmenopausal women with a history of urgency incontinence or mixed incontinence (with predominantly urgency urinary incontinence), as shown in a well-designed pilot RCT [Green et al., 2006]. The primary end-point was percent change from baseline in average daily micturitions assessed by a voiding diary. Secondary end points included average daily total urinary incontinence and urgency incontinence episodes, and urgency episodes. Aprepitant significantly ($p<0.003$) decreased the average daily number of micturitions (-1.3 \pm 1.9) compared with placebo (-0.4 \pm 1.7) at 8 weeks. The average daily number of urgency episodes was also significantly ($p<0.047$) reduced (-23.2 \pm 32%) compared to placebo (-9.3 \pm 40%), and so were the average daily number of urgency incontinence and total urinary incontinence episodes, although the difference was not statistically significant. Aprepitant was generally well tolerated and the incidence of side effects, including dry mouth, was low. Since this initial proof of concept study suggested that NK-1 receptor antagonism hold promise as a potential treatment approach for OAB symptoms, a randomized, double-blind, multicenter trial enrolled 557 adults with overactive bladder (8 or more average daily micturitions and 1 or more daily urge incontinence episodes) [Frenkl et al., 2010]. After a 1-week placebo run-in the patients were randomized to treatment with 8 weeks of daily 0.25, 1 or 4 mg serlopitant, 4 mg tolterodine extended release or placebo. Patients kept 7-day voiding diaries. The primary end -point was change from baseline in micturitions per day. Secondary end points included urgency, total incontinence, urge incontinence episodes and incidence of dry mouth. Of the 557 patients randomized, 476 completed the trial and had valid efficacy data for analysis. Mean change

from baseline in daily micturitions was significantly greater for 0.25 (-1.1) and 4 mg (-1.1) serloptant, and for tolterodine (-1.5) than for placebo (-0.5), but not for 1 mg serloptant (-0.8). No serloptant dose response was demonstrated. Tolterodine was numerically superior to all doses of serloptant in mean micturitions per day and secondary end points. The incidence of dry mouth on serloptant (3.3%) was comparable to placebo (4.6%) and lower than tolterodine (8.8%). Serloptant was generally well tolerated. Haab et al. [2014] performed a phase II, multicenter, double-blind study in which adults with OAB symptoms >6 months were randomized to receive 1 of 3 doses of netupitant (50, 100, 200 mg) or placebo once daily for 8 weeks. The primary efficacy endpoint was percentage change from baseline in average number of daily micturitions at week 8. Urinary incontinence, urge urinary incontinence (UUI), and urgency episodes were also assessed. They found that the primary efficacy endpoint was similar in the treatment groups (-13.85 for placebo to -16.17 in the netupitant 200 mg group) with no statistically significant differences between netupitant and placebo.

NK-1 receptor antagonists may have a role in the treatment of overactive bladder, but at least the compounds tested so far do not offer advantages in efficacy compared to tolterodine.

A different approach, modulation of neuropeptide release rather than NK receptor blockade, was tested in a pilot study with cizolirline, which is a substance-P and CGRP release modulator at the spinal cord level. The modulation of substance-P and CGRP is probably related to the increase of extracellular levels of noradrenaline and serotonin. Cizolirline 200 and 400 mg were compared to placebo in 79 OAB patients. Although the decrease in key OAB symptoms was significantly higher in the active arms, adverse events were reported in 68% and 81% of the patients on cizolirline 200 and 400mg. More commonly reported side effects were gastro-intestinal in nature, including dry mouth and vomiting [Martinez-Garcia et al., 2008]. No further developments of this compound have been reported.

11.3. Critical Summary

Based on review of the literature on what is described as “emerging” or “innovative” drugs/targets for treatment of LUTS/OAB, a long list of “possible” or “promising” alternatives can be constructed (Table 4). However, a critical review of these alternatives reveals that although many agents may have theoretically interesting profiles, they do not seem to be in active development for different reasons. For several drugs, proof-of-concept studies are available revealing either no effect, insufficient effect, or disturbing side effects.

Negative proof of concept (Table 4). K⁺ channel openers have shown great promise in preclinical experiments [Petkov, 2011], but so far the K-channel openers studied clinically- have yielded disappointing results [Andersson et al., 2013]. PGE₂, acting via

EP1 receptors, stimulates bladder contractile activity by sensitization of afferent nerves, and is increased in urine from patients with LUTS [Rahnama'i et al., 2012]. Despite promising results in animal experiments, a double-blind, placebo-controlled phase II study in OAB patients concluded that the role of an EP1 receptor antagonist in the management of OAB syndrome is minimal [Chapple et al., 2014].

Positive proof of concept (Table 4) Several neurokinin receptor antagonists have shown clinical efficacy, but not sufficient for further development [Green et al., 2006; Frenkl et al., 2019; Haab et al., 2014]. The monoamine reuptake inhibitor, duloxetine showed good efficacy in a randomized controlled clinical trial [Steers et al., 2007], but had many side effects. Side effects also stopped development of different COX-inhibitors (2).

A positive proof-of-concept study was reported for the opioid receptor agonist, tramadol [Safarinejad et al. 2006]. However, the study was later retracted due to unacceptable statistical errors.

Promising based on animal data (Table 4). Up-regulation of the Rho-kinase pathway has been associated with bladder changes in diabetes, outflow obstruction, and idiopathic DO, making Rho-kinase inhibition a theoretically interesting principle for inhibition of bladder overactivity [Christ and Andersson, 2007]. The vitamin D₃ agonist, elocalcitol, was shown to have an inhibitory effect on the RhoA/Rho kinase pathway [Morelli et al., 2007; Penna et al., 2009], and showed some promising effects in female patients with OAB symptoms [Digesu et al., 2012]. However, whether or not vitamin D₃ receptor agonism (monotherapy or in combination) will be a useful alternative for the treatment of LUTS/OAB, requires further randomized controlled trials.

Several years ago Taylor and Bates performed a double-blind crossover trial of oral baclofen on patients with the “unstable bladder syndrome” with positive outcome [Taylor and Bates, 1979], but the principle of GABA_B receptor stimulation was not further developed until recently. ADX71441 is a selective positive allosteric modulator of the GABA_B receptor (GABA_B PAM), which is orally available and showed promising effects in animal models of micturition disturbances [Kalinichev et al., 2014]. Further studies of this agent would be of interest.

Other promising targets seem to be the purinergic [Ford and Cockayne, 2011; Ford and Udem., 2013; North and Jarvis., 2013; Andersson, 2015] and cannabinoid [Ruggieri. 2011; Hedlund, 2014; Hedlund and Gratzke 2016] systems, and different members of the TRP channel family [Everaerts et al., 2008; Andersson et al., 2010; Skryma et al., 2011; Avelino et al., 2013; Deruyver et al., 2014; Franken et al., 2014]. P2X₃-receptor antagonists are currently being developed for treatment of non-bladder diseases, but clinical experiences in bladder disorders have not yet been reported. Clinical studies with the use of exo-

cannabinoids on LUTS are scarce and essentially restricted to MS patients, and the results have so far not been convincing. However, amplification of the activity of endocannabinoids by fatty acid amino hydrolase (FAAH) inhibitors, inhibiting their degradation, may be an attractive approach (Hedlund and Gratzke., 2016), but again clinical proof of concept is lacking. Several TRP channels, including TRPV1, TRPV2, TRPV4, TRPM8, and TRPA1, are expressed in the bladder and urethra, and may act as sensors of stretch and/or chemical irritation [Everaerts et al., 2008; Andersson et al., 2010; Skryma et al., 2011; Avelino et al., 2013; Deruyver et al., 2014; Franken et al., 2014]. The therapeutic potential for TRPV1 channel agonists (capsaicin, resiniferatoxin) has been convincingly demonstrated. However, the adverse effect of hyperthermia of the first generation TRPV1 channel antagonists has delayed development. Nevertheless, TRP channels still may be one of the most exciting targets for future LUT drugs.

III. DRUGS USED FOR TREATMENT OF STRESS INCONTINENCE

1. STRESS INCONTINENCE IN WOMEN

Many factors seem to be involved in the pathogenesis of stress urinary incontinence (SUI) in women: urethral support and function, bladder neck support and function of the nerves and musculature of the bladder, urethra, and pelvic floor [Delancey, 1997; Mostwin et al., 2005; Koelbl et al., 2009; Chapple and Milsom, 2012]. Pure structural factors cannot be treated pharmacologically. However, SUI in women is generally thought to be characterized by decreases in urethral transmission pressure and, in most cases, resting urethral closure pressure [Henriksson et al., 1979; Hilton and Stanton, 1983; Koelbl et al., 2009]. It, therefore, seems logical that increasing urethral pressure should improve the condition.

Factors which may contribute to urethral closure include the tone of the urethral smooth and striated muscle (the rhabdosphincter) and the passive properties of the urethral lamina propria, in particular its vasculature. The relative contribution to intraurethral pressure of these factors is still subject to debate. However, there is ample pharmacological evidence that a substantial part of urethral tone is mediated through stimulation of α -ARs in the urethral smooth muscle by released noradrenaline [Andersson, 1993; Andersson and Wein, 2004; 2012]. A contributing factor to SUI, mainly in elderly women with lack of estrogen, may be lack of mucosal function. The pharmacological treatment of SUI aims at increasing intraurethral closure forces by increasing the tone in the

urethral smooth and striated musculature, either directly or through increased motorneuron activity. Several drugs may contribute to such an increase [Andersson and Wein, 2012], but relative lack of efficacy or/and side effects have limited their clinical use.

1.1. α -Adrenoceptor Agonists

Several drugs with agonistic effects on peripheral α -ARs have been used in the treatment of SUI (Table 5). Noradrenaline (NA) has a central role of in increasing the excitability of urethral rhabdosphincter motorneurons in the rat analogue of Onuf's nucleus, an effect due at least in part to α_1 -AR dependent depolarization. This could contribute to the mechanism by which NA reuptake inhibitors improve SUI [Yashiro et al., 2010]. Ephedrine and norephedrine (phenylpropanolamine; PPA) seem to have been the most widely used [Andersson and Wein, 2012]. The original United States Agency for Healthcare Policy and Research Guidelines [Agency for Healthcare Policy and Research, 1992] reported 8 randomized controlled trials with PPA, 50 mg twice daily for SUI in women. Percent cures (all figures refer to percent effect on drug minus percent effect on placebo) were listed as 0% to 14%, percent reduction in continence as 19% to 60%, and percent side effects and percent dropouts as 5% to 33% and 0% to 4.3% respectively. The most recent Cochrane review on the subject [Alhasso et al, 2005, reprinted virtually unchanged in 2008] assessed randomized or quasi-randomized controlled trials in adults with stress urinary incontinence which included an adrenergic agonist drug in at least one arm of the trial. There were no controlled studies reported on the use of such drugs in men. Twenty-two eligible trials were identified, 11 of which were crossover trials, which included 1099 women, 673 of whom received an adrenergic drug (PPA in 12, midrodrine in 2, norepinephrine in 3, clenbuterol in 3, terbutaline in 1, and RO 115-1240 in 1). The authors concluded, "there was weak evidence to suggest that use of an adrenergic agonist was better than placebo in reducing the number of pad changes and incontinence episodes, as well as, improving subjective symptoms". There was not enough evidence to evaluate the merits of an AR agonist compared with estrogen, whether used alone or in combination.

Regarding adverse events, the review reported similar numbers with adrenergic, placebo, or alternative drug treatment. Over 25% of subjects reported such effects, but when these consisted of effects due to AR stimulation, they caused discontinuation in only 4% of the total.

Ephedrine and PPA lack selectivity for urethral α -ARs and can increase blood pressure and cause sleep disturbances, headache, tremor, and palpitations [Andersson and Wein, 2012]. Kernan et al. [2000] reported the risk of hemorrhagic stroke to be 16 times higher in women less than 50 years of age who had been taking PPA as an appetite suppressant

(statistically significant) and 3 times higher in women who had been taking the drug for less than 24 hours as a cold remedy (not statistically significant).

There was no increased risk in men. PPA has been removed from the market in the United States. It is still allowed as a treatment for SUI in a few countries. Numerous case reports of adverse reactions due to ephedra alkaloids exist, and some [Bent et al., 2003] had suggested that sale of these compounds as a dietary supplement be restricted or banned. In December 2003, the Food and Drug Administration of the US decreed such a ban, a move which has survived legal appeal.

Midodrine and methoxamine stimulate α_1 -ARs with some degree of selectivity. According to the RCTs available, the effectiveness of these drugs is moderate at best, and the clinical usefulness seems to be limited by adverse effects [Alhasso et al., 2003; Radley et al., 2001; Weil et al., 1998].

Attempts continue to develop agonists with relative selectivity for the human urethra. Musselman et al. [2004] reported on a phase 2 randomized crossover study with RO 115-1240, a peripheral active selective $\alpha_{1A/1L}$ -AR partial agonist [Blue et al., 2004] in 37 women with mild to moderate SUI

A moderate, positive effect was demonstrated, but side effects have apparently curtailed further development of the drug. PF-3774076, a CNS penetrating partial α_{1A} -AR agonist, increased peak urethral pressure in dogs and was selective with respect to α_{1B} and α_{1D} receptors, but heart rate and blood pressure changes caused significant concern (Conlon et al., 2009). Furuta et al. [2009] reported that the α_2 -AR can inhibit the release of glutamate presynaptically in the spinal cord and proposed that α_2 -AR antagonists would be useful as a treatment for SUI. This hypothesis awaits testing

1.2. β -Adrenoceptor Agonists. Clenbuterol

β -AR stimulation is generally conceded to decrease urethral pressure [Andersson, 1993], but β_2 -AR agonists have been reported to increase the contractility of some fast contracting striated muscle fibers and suppress that of slow contracting fibers of others [Fellenius et al., 1980]. Some β -AR agonists also stimulate skeletal muscle hypertrophy – in fast twitch more so than slow twitch fibers [Kim et al., 1992]. Clenbuterol has been reported to potentiate the field stimulation induced contraction in rabbit isolated periurethral muscle preparations, an action which is suppressed by propanolol and greater than that produced by isoproterenol [Kishimoto et al, 1991]. These authors were the first to report an increase in urethral pressure with clinical use of Clenbuterol and to speculate on its potential for the treatment of SUI. Yaminishi et al. [1994] reported an inotropic effect of clenbuterol and terbutaline on the fatigued striated urethral sphincter of dogs, abolished by β -AR blockade.

Yasuda et al. [1993] described the results of a double-blind placebo controlled trial with this agent in 165 women with SUI. Positive statistical significance was achieved for subjective evaluation of incontinence frequency, pad usage per day, and overall global assessment. Pad weight decreased from 11.7 ± 17.9 g to 6.0 ± 12.3 g for drug and from 18.3 ± 29.0 g to 12.6 ± 24.7 g for placebo, raising questions about the comparability of the 2 groups.

The “significant” increase in MUCP was from 46.0 ± 18.2 cm H₂O to 49.3 ± 19.1 cm H₂O, versus a change of -1.5 cm H₂O in the placebo group. 56/77 patients in the clenbuterol group reported some degree of improvement versus 48/88 in the placebo group. The positive effects were suggested to be a result of an action on urethral striated muscle and/or the pelvic floor muscles.

Drug	Level of Evidence	Grade of Recommendation
Clenbuterol	3	C
Duloxetine	1	B
Ephedrine	3	D
Estrogen	2	D
Imipramine	3	D
Methoxamine	2	D
Midodrine	2	C
Norephedrine (phenylpropanolamine)	3	D

Table 5. Drugs used in the treatment of stress incontinence. Assessments according to the Oxford system (modified)

Ishiko et al. [2000] investigated the effects of clenbuterol on 61 female patients with stress incontinence

in a 12-week randomized study, comparing drug therapy to pelvic floor exercises. The frequency and volume of stress incontinence and the patient's own impression were used as the basis for the assessment of efficacy. The improvement of incontinence was 76.9%, 52.6%, and 89.5% in the respective groups. In an open study, Noguchi et al [1997] reported positive results with clenbuterol (20 mg b.i.d. for 1 month) in 9 of 14 patients with mild to moderate stress incontinence after radical prostatectomy. No subsequent published reports have appeared. Further well-designed RTCs investigating effects of clenbuterol are needed to adequately assess its potential as a treatment for stress incontinence.

There have been no recent reports of clinical trials with α_1 - or β -AR agonists or antagonists for SUI.

1.3. β -Adrenoceptor Antagonists

The theoretical basis for the use of β -AR antagonists in the treatment of stress incontinence is that blockade of urethral β -ARs may enhance the effects of noradrenaline on urethral α -ARs. Propranolol has been reported to have beneficial effects in the treatment of stress incontinence [Gleason et al., 1974; Kaisary, 1984] but there are no RCTs supporting such an action. In the Gleason et al. [1974] study, the beneficial effects become manifest only after 4 to 10 weeks of treatment, a difficult to explain phenomenon. Donker and Van der Sluis [1976] reported that β -AR blockade did not change UPP in normal women. Although suggested as an alternative to α -AR agonists in patients with SUI and hypertension, these agents may have major potential cardiac and pulmonary side effects of their own, related to their therapeutic β -AR blockade.

1.4. Imipramine

Imipramine, among several other pharmacological effects has classically been reported to inhibit the reuptake of noradrenaline and serotonin in adrenergic nerve endings. In the urethra this could be expected to enhance the contractile effects of noradrenaline on urethral smooth muscle. Gilja et al. [1984] reported in an open study on 30 women with stress incontinence that imipramine, 75 mg daily, produced subjective continence in 21 patients and increased mean maximal urethral closure pressure (MUCP) from 34 to 48 mm Hg. A 35% cure rate was reported by pad test and, in an additional 25%, a 50% or more improvement. Lin et al. [1999] assessed the efficacy of imipramine (25 mg imipramine three times a day for three months) as a treatment of genuine stress incontinence in 40 women. A 20-minute pad test, uroflowmetry, filling and voiding cystometry, and stress urethral pressure profile were performed before and after treatment. The efficacy of "successful treatment" was 60% (95% CI 11.8-75.2). There are no RCTs on the effects of imipramine on SUI. No subsequent published reports have appeared.

Interestingly, Gillman [2007] reported that clomipramine had far greater 5-HT reuptake inhibition than imipramine and roughly similar NA reuptake inhibition. Desipramine and reboxetine had greater NA reuptake inhibition (desipramine superior), with less effects than imipramine on 5-HT uptake (desipramine superior).

1.5. Duloxetine

Duloxetine hydrochloride is a combined norepinephrine and serotonin reuptake inhibitor, which has been shown to significantly increase sphincteric muscle activity during the filling/storage phase of micturition in the cat acetic acid model of irritated bladder function [Thor et al., 1995; Katofiasc et al., 2002]. Bladder capacity was also increased in this model, both effects mediated centrally through both motor efferent and sensory afferent modulation [Fraser et al., 2003]. The sphincteric effects were reversed by α_1 -AR (prazosin) and 5-HT₂ receptor (LY 53857) antagonism, while the bladder effects were mediated by temporal prolongation of the actions of serotonin and norepinephrine in the synaptic cleft [Fraser et al., 2003]. Duloxetine is lipophilic, well absorbed, and extensively metabolized (CYP2D6). Its plasma half-life is approximately 12 h [Sharma et al., 2000].

Thor et al. [2007] describe the mechanisms of action and the physiologic effects of duloxetine. 5-HT (serotonin) and NA terminals are dense in spinal areas associated with lower urinary tract functioning especially around the pudendal nerve neurons in Onuf's nucleus. These are projections from separate areas in the brain stem. Glutamate is the primary excitatory neurotransmitter in the spinal cord, activating the pudendal neurons in Onuf's nucleus causing contraction of the urethral rhabdosphincter (Figure 22).

The rhabdosphincter innervation is proposed as distinct from that of the levator ani [Thor and de Groat, 2010]. The responsiveness of the rhabdosphincter motor neurons to glutamate is modulated (facilitated) by 5-HT (through 5-HT₂ receptors) and NA (through α_1 -ARs). 5-HT and NA, however, only modulate, and, when micturition occurs, glutamate excitation and the rhabdosphincter contraction cease. Excitatory effects on urethral sphincter activity are shared to a lesser extent by receptors for 5HT_{1A} (indirect through a supraspinal stimulation), TRH, Vasopressin, NMDA and AMPA; inhibitory effects are similarly mediated by κ_2 opioid, α_1 ARs, GABA-A, GABA-B and glycine receptors [Thor and de Groat, 2010]. Some CNS penetrant selective 5-HT_{2C} agonists have been found to increase urethral muscle tone and inhibit micturition reflexes in animal models, and these are additional candidates for clinical development for the

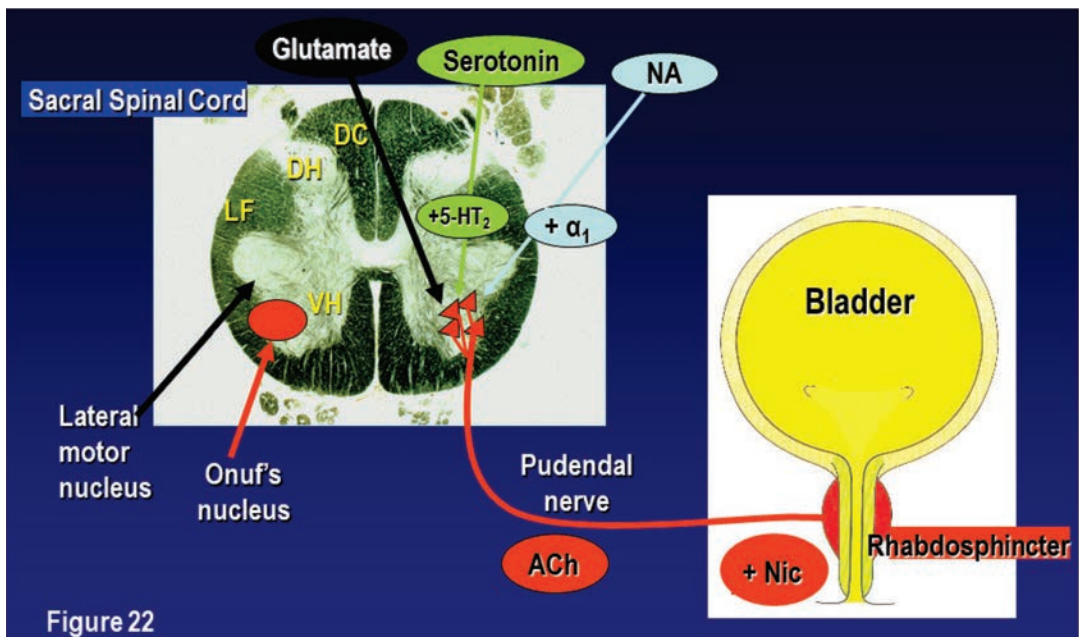

Figure 22: The striated urethral sphincter is innervated by the pudendal nerve, which contains the axons of motor neurons whose cell bodies are located in Onuf's nucleus. Glutamate exerts a tonic excitatory effect on these motor neurons, and this effect is enhanced by noradrenaline (NA) and serotonin (5-HT), acting on α_1 -adrenoceptors and 5-HT₂-receptors, respectively. By inhibition of the reuptake of noradrenaline and serotonin, duloxetine increases the contractile activity in the striated sphincter (nicotinic receptors: + Nic). DC = dorsal commissure; DH = dorsal horn; VH = ventral horn; LF = lateral funiculus; ACh = acetylcholine

treatment of SUI [Brennan et al., 2009, Andrews et al., 2011].

Several RTCs have documented the effect of duloxetine i SUI [Norton et al., 2002; Dmochowski et al, 2003; Millard et al., 2004; Van Kerrebroeck et al., 2004; Ghoneim et al., 2005]. A Cochrane review of the effects of duloxetine for stress urinary incontinence in women is available, the last substantive amendment listed as 25 May 2005 [Mariappan et al., 2005]. Fifteen reports were deemed eligible for analysis, 9 primary studies and 6 additional reports related to 1 or 2 of the primary references. An additional analysis "performed under the auspices of the Cochrane Incontinence Group" was performed on just the 9 primary trials comparing duloxetine and placebo, and published separately [Mariappan et al., 2007]. The results can be summarized as follows. Subjective "cure" in the duloxetine 80 mg daily (40 mg b.i.d.) was higher than in the placebo group (10.8% vs 7.7%, overall RR = 1.42; 95% CI, 1.02-1.98; p = 0.04). The estimated absolute size of effect was about 3 more patients cured of every 100 treated. Objective cure data, available from only 1 trial, showed no clear drug/placebo difference. Duloxetine showed greater improvement in I-QOL (WMD for 80 mg: 4.5; 95% CI 2.83-6.18, p<0.00001). Adverse effects in 6 trials were analysed. These were reported by 71% of drug subjects and 59% of those allocated to placebo. Nausea was the most common adverse event and the incidence ranged from 23-25% and was the main reason for discontinuation. Other side

effects reported were vomiting, constipation, dry mouth, fatigue, dizziness and insomnia, overall RR 1.30 (95% CI, 1.23-1.37). Across these 6 trials 17% in the drug group withdrew, 4% in the placebo arm. In the 2007 article, the authors conclude by saying that further research is needed as to whether management policies incorporating duloxetine are clinically effective and cost effective compared to other current minimally invasive and more invasive approaches in patients with varying severity of SUI, and that "longer term experience is now a priority to determine whether there is sustained efficacy during and after duloxetine use and to rule out complications".

Hurley et al. [2006] characterized the safety of duloxetine for treatment of SUI in women, using an integrated database generated from four published placebo-controlled clinical trials. The database included 1913 women randomized to duloxetine (N=958) or placebo (N=955), examining adverse events (AEs), serious adverse events (SAEs), vital signs, electrocardiograms, and laboratory analytes. AEs occurring initially or worsening during the double-blind treatment period were considered treatment-emergent (TEAE). Differences between duloxetine-treated and placebo-treated groups were compared statistically. Common TEAEs included: nausea (23.2%), dry mouth (13.4%), fatigue (12.7%), insomnia (12.6%), constipation (11.0%), headache (9.7%), dizziness (9.5%), somnolence (6.8%), and diarrhea (5.1%). Most TEAEs that emerged early were mild to moderate, rarely worsened, and resolved quickly. Overall

AE discontinuation rates were 20.5% for duloxetine and 3.9% for placebo ($P<.001$). Most discontinuations (83%) occurred within the first month of treatment. SAEs were uncommon and did not differ between treatments. Statistically significant, but clinically unimportant mean increases in heart rate (2.4 bpm) and systolic and diastolic blood pressure (≤ 2 mmHg) occurred. No arrhythmogenic potential was observed and any rare, transient, asymptomatic increases in hepatocellular enzymes normalized. The authors concluded that duloxetine was safe and tolerable, although transient AEs were not uncommon. Hashim and Abrams [2006] suggested, to reduce the risk of nausea, to begin with a dose of 20 mg twice daily for 2 weeks, then to increase to the recommended 40 mg b.i.d. dosage.

Ghoniem et al. [2005] randomized women with SUI to 1 of 4 treatment combinations: duloxetine alone (40 mg b.i.d.), pelvic floor muscle training, combination and placebo. Overall, drug with or without PFMT was superior to PFMT alone or placebo, while pad results and QOL data favored combination therapy to single treatment. Cardozo et al. [2004b] reported that 20% of women awaiting continence surgery changed their minds while taking duloxetine. Duckett et al. [2006], offered a 4-week course to women awaiting a TVT operation. Thirty-seven percent (of 73) declined. Excluding women for whom concomitant prolapse surgery was planned, 8/33 (24%) scheduled for incontinence surgery alone came off the list. Sixteen (48%) discontinued duloxetine because of AEs, 9 (27%) found the drug ineffective.

Bent et al. [2008], reported on the effects of 12 weeks of duloxetine (40 mg b.i.d.) vs placebo in a large group of women with MUI. For SUI episodes, the mean IEF (incontinence episode frequency) per week decreased 58.9% with drug (7.69 to 3.93) vs 43.3% for placebo (8.93 to 6.05). Interestingly, corresponding decreased for UUI episodes were 57.7% vs 39.6%. Both sets of values are statistically significant, but the baselines are different and the absolute change for SUI amounted to -3.76 episodes per week for drug, -2.87 for placebo. Nausea was reported by 18% of patients on drug, 4.5% on placebo. Corresponding percents for other AEs include, dry mouth (12 vs 2.8), dizziness (9.7 vs 2.4), constipation (8.3 vs 4.2), fatigue (6.7 vs 2.8). Nausea and dizziness were less common in a subgroup taking concurrent antidepressants. Women 65 years and older with SUI or stress predominant MUI (S-MUI) were given duloxetine (40 mg b.i.d. after a 2-week start on 20 mg b.i.d.) or placebo for 12 weeks by van Leeuwen et al. [2008]. They conclude, "this study supports the use of duloxetine in elderly women with SUI or S-MUI". The data show an absolute change in SUI + S-MUI episodes of -11.7 and -6.9 IEF/week (drug and placebo) and median percent changes of -52.5% vs -36.7% from 24h diaries, both significant at $p<0.001$. However, the changes for SUI alone were -53% vs -42% (NS) while for S-MUI alone they were -51.6% vs -32.7% ($p<0.001$). Nausea was less than in other trials (7.5% vs 3.1%), perhaps due to the lower starting dose.

Other AEs included fatigue (14.2% vs 5.4), constipation (10.4 vs 0.8), dizziness (9.0 vs 4.6), excess sweating (5.2 vs 0).

Schagen van Leeuwen et al. [2008] investigated efficacy and safety of duloxetine in elderly women with stress urinary incontinence or stress-predominant mixed urinary incontinence. Duloxetine-treated patients had a significantly greater decrease from baseline to endpoint in mean incontinence episode frequency/week than placebo-treated patients (-52.47% vs. -36.70%). The responder rate ($> \text{ or } =50\%$ reduction in incontinence episode frequency/week) was 57.1% in the duloxetine group and 35.2% in the placebo group ($P<0.001$). Significant benefits of duloxetine were also demonstrated for weekly continence pad usage, mean time between voids, incontinence quality of life questionnaire scores ($P<0.001$), and global impression of improvement ratings ($P<0.001$). Patients with depressive symptoms and cognitive impairments were few and changes were insignificant.

Persistence on duloxetine was studied by Vella et al. [2008] who found that only 31% of an original cohort of 228 were still taking drug beyond 4 weeks, 12% at 4 months, 10% at 6 months, and 9% at 1 year. Fifty-six percent of the discontinuations were attributed to side effects, 33% to lack of efficacy. Bump et al. [2008], however, reported that the positive effects of duloxetine were maintained in patients who continued treatment up to 30 months, but admitted that this subgroup was likely to include predominantly patients who had favorable responses. The number decreased from 1424 in this cohort at 3 months to 368 at 30 months

Shaban et al. [2010] concluded that duloxetine is "optional second line for women not willing or unfit for surgery after warning against side effects as recommended by NICE guidelines in the UK". Similar sentiments are expressed by Robinson and Cardozo [2010].

Duloxetine is licensed at 40 mg twice daily for the treatment of SUI in the European Union (European Medicines Agency, Scientific Discussion, 2005) in women with moderate to severe incontinence (defined as 15 or more episodes per week). It was withdrawn from the FDA consideration process in the United States for the treatment of SUI, but is approved for the treatment of major depressive disorder (20-30 mg b.i.d. initially, 60 mg once daily maintenance), diabetic peripheral neuropathic pain (60 mg once daily), generalized anxiety disorder (60 mg once daily, fibromyalgia (c0 mg once daily initially, 60b mg once daily maintenance) and chronic musculoskeletal pain (30 mg once daily initially, 60 mg once daily as maintenance. The product information contains a "black box" warning of "increased risk of suicidal thinking and behavior in children, adolescents and young adults taking antidepressants for major depressive disorder and other psychiatric disorders", noting also that "depression and certain other psychi-

atric disorders are themselves associated with increases in the risk of suicide” [Prescribing Information, revised September 2011, Eli Lilly and Company, Indianapolis, Indiana 46285]. Other warnings and precautions in the U.S. in the United States Product Information for psychiatric indications, not SUI, include hepatotoxicity (not to be used in patients with substantial alcohol use or chronic liver disease), orthostatic hypotension, serotonin syndrome (general statement regarding SSRIs and SNRIs), abrupt discontinuation (may result in dizziness, paresthesias, irritability and headache), inhibitors of CYP1A2 (such as ciprofloxacin), thioridazine (do not administer concomitantly) potent inhibitors of CYP2D6 (may increase concentration), and others. Adverse events for 6801 drug and 4487 placebo-treated patients reported in the US Product Information (treatment for the indications mentioned) are nausea (24% vs 8%), dry mouth (13 vs 5), fatigue (10 vs 5), somnolence (10 vs 3), insomnia (10 vs 6), constipation (10 vs 4), dizziness (10 vs 5).

2. STRESS URINARY INCONTINENCE IN MEN

Although a problem of significant magnitude, especially after radical prostatectomy (RP) for cancer, the pharmacologic treatment of male SUI is an area that has received relatively little attention.

Intrinsic sphincter function is the most important outlet factor maintaining continence in men. Urethral support is less important, and there is no entity similar to the hypermobility phenomenon in women. The proximal urethral sphincter extends from the bladder neck through the prostatic urethra. Its function is removed by radical prostatectomy. The distal urethral sphincter includes the rhabdosphincter, urethral smooth muscle and extrinsic paraurethral skeletal muscle, extending from the prostatic urethra below the verumontanum through the membranous urethra [Koelbl et al., 2009].

Tsakiris et al (2008) searched for articles on drug treatment of male SUI published between 1966 and June 2007 and did a generalized database search in addition. Nine trials were identified using α -AR agonists, β_2 -AR antagonists or SNRSs. Only one of these included a comparison arm (Filocamo et al, 2007), 40 mg b.i.d. duloxetine plus pelvic floor exercise (PFE) vs PFE with placebo. The results suggested a positive effect of drug, but were a bit confusing. Of those patients completing the 4-month trial (92/112) 78% of the drug treated patients vs 52% of those in the placebo group were “dry”. However, one month after the end of the study, the corresponding figures were 46% vs 73%, a shift still observed 2 months later. The authors of the review article suggested further larger and well designed studies on duloxetine for this potential usage.

Cornu et al. (2011) reported a series of post RP men with SUI or MUI (stress predominant) randomized to

duloxetine (15) and placebo (16) after a 2-week placebo run in. Dosage was 20 mg b.i.d. for 7d, 40 mg b.i.d. for 67d, 20 mg for 14d. Subjects were at least 1 year post surgery. Outcome measures included percent decrease in IEF, 1h pad test and various QOL measures. Statistical significance for IEF percent decrease occurred only at week 8 & 12 [(-) 52.2 ± 38.6% vs (+)19 ± 43.5%] but there was clearly a trend at 4 weeks. There was no statistical difference in 1h pad test weights but there was in various QOL scores. A 50-100% decrease in IEF was seen at 12 weeks in over half of the patients. Adverse events for drug and placebo included fatigue (50 vs 13%), insomnia (25 vs 7), libido loss (19 vs 7), constipation (13 vs 7), nausea (13 vs 7), diarrhea (13 vs 7), dry mouth (6 vs 0), anorexia (6 vs 0), and sweating (25 vs 20). Drawbacks and concerns are the small number (the original proposed sample size was 90) and the lack of any placebo effect on IEF and QOL. There were 4 men with MUI in the drug group, 5 in the placebo group. Results for SUI and UUI were not separated. One would logically not expect improvement to continue after drug withdrawal unless a permanent change occurred in behavior, anatomy or neuromuscular function. In an uncontrolled usage study on men with post RP SUI, Collado Serra et al. (2011) reported that the benefit remained in 85% after the drug was stopped. In that series, 25% of patients withdrew because of AEs and 33% because of lack of effect.

Usage of duloxetine for SUI in the male is universally off label. A drug for this indication would be welcome. Larger controlled and better designed studies are necessary to provide conclusive positive or negative data on this subject.

IV. DRUGS TO TREAT UNDERACTIVE BLADDER/DETRUSOR UNDERACTIVITY

The Underactive Bladder (UAB: symptom diagnosis) and Detrusor Underactivity (DUA: urodynamic diagnosis) have multifactorial pathophysiologies, which introduce obvious therapeutic problems [Andersson, 2014; Miyazato et al., 2014; Osman et al., 2014; Osman and Chapple, 2014]. Not only can the pathophysiologies vary between patients (Figure 23), but also in an individual patient several factors may contribute, and it is not always possible to identify “major” and “minor” players that can be targets for treatment. Since complete bladder emptying is dependent on an intact central nervous system (CNS) control, normal sensation and detrusor smooth muscle activity, coordinated bladder and urethral sphincter function, and voluntary initiation of voiding, incomplete bladder emptying and urinary retention can result from disturbances of any of these components. If there are irreversible changes at any level, e.g., in the bladder wall (loss of nerves, loss of muscle tissue, increased

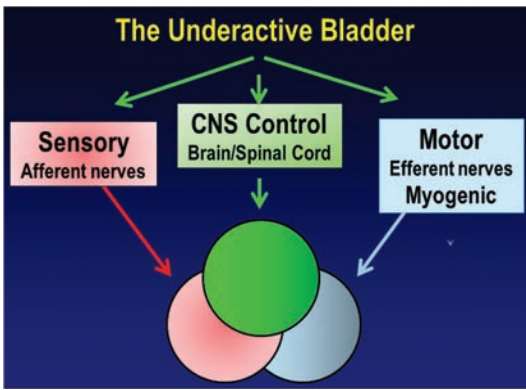

Figure 23: The Underactive Bladder have multifactorial pathophysiologyes. Since complete bladder emptying is dependent on an intact central nervous system (CNS) control, normal sensation and detrusor smooth muscle activity, coordinated bladder and urethral sphincter function, and voluntary initiation of voiding, incomplete bladder emptying and urinary retention can result from disturbances of any of these components. From Andersson, *Curr Opin Urol.* 2014 Jul;24(4):363-9.

collagen deposition), the possibilities of successful pharmacological treatment are reduced.

Detrusor Hyperactivity with Impaired Contractility [DHIC: Resnick and Yalla, 1987] is a diagnosis related to both overactive bladder (OAB)/detrusor overactivity (DO) and UAB/DUA, and the condition creates therapeutic problems. However, as pointed out by several investigators, UAB/DUA and OAB/DO may not be separate disease entities [Semins and Chancellor, 2004; Chancellor, 2014; Nomiya et al., 2014; Zhao et al., 2016]. Instead, chronic untreated or treatment-refractory OAB/DO, caused by neurologic diseases, diabetes, BOO, ischemic bladder dysfunction, or aging, may progress to DO with impaired contractility and eventually to UAB/DU. Progression of OAB/DO to UAB/DUA has been demonstrated in animal models [Nomiya et al., 2014; Zhao et al., 2016] and, if proven also in humans, suggests that early education, behavioral modification, and medical treatment may alter and/or prevent progression to UAB/DUA [Chancellor et al., 2014].

To what extent drug treatment of associated morbidities (e.g., diabetes, Parkinson's disease, multiple sclerosis) also can improve impaired bladder emptying has only been investigated to a limited extent.

1. PHARMACOLOGICAL PRINCIPLES USED FOR TREATMENT

To improve bladder emptying, agents that increase the contractile force of the detrusor, decrease outflow resistance, or improve detrusor contractility and decrease outflow resistance at the same time, would theoretically be useful [Wein, 2012]. In addition, agents that improve decreased sensation (increase

afferent activity and/or the perception of bladder filling) seem attractive [Smith, 2010]. However, in many cases the pathophysiology of UAB/DUA is complex, simultaneously involving several mechanisms [Andersson, 2014; Miyazato et al., 2014; Osman et al., 2014; Osman and Chapple, 2014]. This implies that targeting only one potentially important mechanism will not always have the desired effect.

1.1. Muscarinic Receptor Agonists and Cholinesterase Inhibitors

It is well established the acetylcholine is the main contractile transmitter in the detrusor muscle, and that release of this agent induced by activation of the parasympathetic outflow from the spinal cord leads to a co-ordinated bladder contraction and bladder emptying with simultaneous relaxation of the outflow region [Andersson and Arner, 2004]. Standard pharmacotherapy of impaired bladder emptying has for a long time included muscarinic receptor agonists, such as bethanechol and carbachol to directly stimulate muscarinic receptors on the detrusor muscle, or choline esterase inhibitors, like distigmine to reduce the degradation of acetylcholine. However, based on available information it has been considered that little, if any, beneficial effects can be obtained in preventing or treating UAB/DUA [Barendrecht et al., 2007; Andersson et al., 2013]. Why do not these drugs work? One of the reasons is that direct stimulation of detrusor muscarinic receptors will cause contraction (contracture) of the bladder without simultaneous relaxation of the outflow region. Activation of the cholinergic nerves of the outflow region by spinal parasympathetic outflow will not only release acetylcholine for bladder contraction, but also nitric oxide, relaxing the urethra. In addition, systemic administration of a muscarinic receptor agonist has no selectivity for the bladder which means that action on non-target sites will cause adverse effects. Another factor is that both bethanechol and carbachol have low oral bioavailability which makes it difficult to attain "active" blood concentrations.

Bethanechol seems to be the best investigated of the parasympathomimetic drugs. Even if beneficial effects have been reported, most studies have shown no significant effect vs placebo in the treatment of UAB/DUA [Barendrecht et al. 2007]. Attempts have been made to increase the usefulness of muscarinic agonist stimulation. Riedl et al. [2000] used electro-motive administration of intravesical bethanechol and could identify patients with an atonic bladder and adequate residual detrusor muscle function. They concluded that patients who do not respond to the electro-motive administration of bethanechol do not benefit from oral bethanechol and are candidates for catheterization. To combine bladder contraction and outflow relaxation,

Hindley et al. [2004], in a placebo-controlled study, treated 19 patients with DUA with a combination of intravesical PGE₂ and oral bethanechol. They concluded that there was evidence of a pharmacological

effect with a limited therapeutic efficacy compared with placebo. However, this treatment was not recommended as routine, but only for the occasional treatment of a patient with DUA. In summary, available information shows that the beneficial effects that can be obtained with carbachol and bethanechol in preventing or treating UAB/DUA are small or negligible [Barndrecht et al., 2007; Andersson et al., 2013].

A number of studies have tested the effect of distigmine bromide on voiding efficiency, but the results have been conflicting. In a double-blind study, Shah et al [1983] investigated the effect of distigmine bromide versus placebo on voiding after prostatectomy 93 patients. The results showed a trend towards improvement, but no statistically significant increase in post-operative flow rates, in reduction in bladder volume, and in the incidence of re-catheterisation in the patients treated with the drug. In a prospective randomized study on 100 patients undergoing vaginal surgery for genital prolapse, Savona Ventura et al [1991] compared distigmine bromide, phenoxybenzamine hydrochloride, and prostaglandin F_{2α}, to prevent urinary retention. They found that all agents appeared to increase the incidence of an elevated residual urinary volume by about three times. Even if the mechanisms behind these findings are difficult to explain, they clearly do not encourage the use of these agents on the indication.

Philp and Thomas [1980] gave distigmine bromide to 23 patients with paraplegia due to suprasacral spinal cord injury who retained a reflex micturition. There was a marked reduction of the residual urine volume in all patients whilst being on parenteral distigmine. The oral preparation of the drug proved less effective and this was attributed to poor absorption from the gut. Tanaka et al. [2001] found in 14 patients with poor detrusor contractility after transurethral prostatectomy (TURP) that oral administration of distigmine bromide (5 mg three times daily for 4 weeks) resulted in subjective as well as objective improvement; the International Prostate Symptom Score (IPSS) was reduced from a mean of 18.9 to a mean of <10 and the maximum flow increased from a mean of 8.9 ml/second to a mean of >12 ml/second. In addition, detrusor contractility tended to improve. Bougas et al. [2004] investigated 27 patients (11 men and 16 women) with poor detrusor function established using pressure-flow studies. They were treated with distigmine bromide for 4 weeks which resulted in a statistically significant reduction of residual volume (from a mean of 329.1 to a mean of 156.8 ml), obviating the need for intermittent self-catheterisation in 11 patients. In addition, maximum flow rate and detrusor pressure at maximum flow increased, although not significantly. The drug was generally well tolerated by the majority of patients.

It is obvious that the most positive effects of distigmine have been obtained in non-placebo controlled studies with small patient materials with various diagnoses. It cannot be excluded that in some selected patient categories distigmine may have a

positive effect, but the lack of adequately designed studies implies that a fair assessment of the drug as a general treatment of UAB/DUA is not possible.

In a recent pilot study on 19 patients with DUA, Sugimoto et al. [2015] studied the effects of acotiamide, a drug approved in Japan for treatment various gastrointestinal disorders [Doi et al., 2004]. Acotiamide “appears to exert an antagonistic effect on muscarinic M1, M2, and M3 receptors and thereby inhibit the negative feedback system by blocking muscarinic auto receptors that regulate acetylcholine release.” The main outcome parameter of the study was post-void residual (PVR) which after acotiamide changed from 161.4±90.0 mL at baseline to 116.3±63.1 mL at 2- weeks post-treatment. This may be statistically significant but is not very impressive. If the mechanism of action of the drug is increased acetylcholine release, it may not differ from other parasympathomimetic drugs.

For all parasympathomimetic drugs, well-designed, randomized controlled trials on well-defined patient materials are lacking, implying that these drugs cannot be recommended for general use, but may be utilized for personalized treatment of UAB/DUA.

1.2. α -Adrenoceptor Antagonists

The role of α -adrenoceptor (AR) antagonists in the treatment of voiding symptoms in men with bladder outflow obstruction (BOO) is well documented [Michel, 2010; Lepor et al., 2012]. Although most men with voiding symptoms do not necessarily have UAB/DUA, the drugs may improve bladder emptying in these patients. The use of α_1 -AR antagonists has repeatedly been shown to be beneficial in patients with acute urinary retention due to benign prostatic enlargement [McNeill et al., 2004; 2005; Fitzpatrick et al., 2012]. These drugs are believed to facilitate bladder emptying by relaxing tone at the bladder neck. Administration of alfuzosin 10 mg daily almost doubles the likelihood of a successful trial without a catheter, even in patients who are elderly with a PVR > 100 mL. Continued use of alfuzosin significantly reduced the risk of BPH surgery in the first 3 months; however, this effect was not significant after 6 months [Fitzpatrick and Kirby, 2006; Emberton et al., 2008a; b; Kalejaiye et al., 2009]. Thus, α_1 -AR antagonists provide rapid symptom relief from outlet obstruction caused by benign prostatic enlargement and delay the time to acute urinary retention; however, they do not decrease the overall risk of acute urinary retention or surgery [Emberton et al., 2008a;b; Edwards, 2008; Fitzpatrick et al., 2012].

Acute urinary retention may occur after surgery. Buckley and Lapitan [2010] reviewed drugs used for treatment of post-operative urinary retention either alone or in combination, assessing cholinergic agents, α_1 -AR blockers, sedatives and prostaglandins. A statistically significant association between intravesically administered prostaglandins and successful voiding was detected, but no such association was found for the other drugs

investigated. When cholinergic agents were combined with sedative there was an improved likelihood of spontaneous voiding compared with placebo.

Supporting this, α_1 -AR antagonists have been widely used in the conservative management of acute urinary retention caused by BOO as shown in systematic reviews of available data [Creta et al., 2015; Guan-Jun et al., 2015].

In patients with neurogenic bladder, reduction of urethral resistance during voiding by α -AR antagonists have been reported to be useful [Yamanishi et al., 1999; Sakakibara et al., 2000; Schulte-Baukloh et al 2002; Moon et al., 2015]. However, most of the studies have been performed on small patient materials with varying diagnoses and all studies have not been positive. In a study of 14 children from age 6 to 16 years with neurogenic bladder and LPP > 40 cm H₂O, Kroll et al. [2016] found no evident efficacy of doxazosin after 6-8 weeks of treatment. Yamanishi et al. [2004] reported in a prospective single-blind randomized study that the combination of a cholinergic drug (bethanechol) and a α_1 -AR antagonist (urapidil) was more effective than monotherapy in improving urination in patients with UAB/DUA. Theoretically, the approach of enhancing detrusor contractility and lowering urethral resistance simultaneously seems attractive. However, in the study by Yamanishi et al. [2004], monotherapy with bethanechol seemed to be marginal, and whether the combination therapy really is better than monotherapy with α -AR antagonist has to be confirmed in appropriately designed studies.

1.3. Prostanoids

Previous experimental studies have shown that e.g., prostaglandin (PG) E₂ can both increase detrusor contraction and relax the urethra in humans [Andersson and Wein, 2004]. PGE₂ does not only stimulate detrusor contraction directly, but may also enhance the efficacy of other contraction-mediating transmitters. In addition, PGE₂ can increase afferent activity both by stimulating the urothelial and myogenic pathways [Maggi et al., 1984; 1988].

Intravesical instillation of PGE₂ and other prostanoids has been reported (no controlled randomized trials) to stimulate bladder contractile activity acutely [Andersson et al., 1978; Wagner et al., 1985, Tammela et al., 1987, Schlussler, 1990], but not without side effects (e.g., uterine contraction). Experiences from patients with chronic bladder emptying difficulties [Delaere et al., 1981] or neurogenic bladder dysfunction [Vaidyanathan et al., 1981] have not been encouraging. The question is whether useful actions can be sorted out from the mixture of effects exerted by PGE₂. The effects of this prostanoid are produced through four types of EP-receptors (EP1-EP4), each mediating separate actions [Sugimoto and Narumiya, 2007]. EP1 and EP3 receptors seem to mediate the excitatory bladder effects of PGE₂ both on afferent activity and on smooth muscle, and EP2 receptors

are known to mediate bladder and urethral relaxation. Drugs stimulating both EP3 and EP2 receptors simultaneously would have an interesting profile, and provided that they show selectivity for the bladder over e.g., the uterus and the gastrointestinal tract, they should be interesting to test in patients with UAB. ONO-8055 is a highly potent and selective agonist for both EP2 and EP3 receptors on CHO cells [Sekido et al., 2016]. The compound contracted bladder strips and relaxed urethral strips. Awake cystometry in a model of neurogenic bladder (lumbar spinal stenosis) showed that ONO-8055 significantly decreased bladder capacity, residual urine, and voiding pressure. Compared with the vehicle, tamsulosin and ONO-8055 significantly decreased urethral pressure. The authors concluded that ONO-8055 had potential to ameliorate neurogenic UAB/DUA. However, to prove this controlled clinical trials are required.

1.4. Transient Receptor Potential (TRP) Channel Agonists

TRP channels are widely distributed in the LUT and stimulation and blockade of these channels may have a potential application for treatment of various voiding disturbances, including UAB/DUA [Everaerts et al., 2008; Andersson et al., 2010; Skryma et al., 2011; Avelino et al., 2013, Franken et al., 2014; Deruyver et al., 2015]. Agents such as capsaicin and resiniferatoxin stimulate bladder activity via activation of Transient Receptor Potential (TRP) channel V1 [Maggi et al., 1989] This should make small molecule TRPV1 agonists an interesting future option for treatment of UAB/DUA, provided that they do not desensitize the afferent nerves.

TRPM4 channels seem to regulate human detrusor smooth muscle excitability and contractility and are critical determinants of human urinary bladder function, actions that may be worthwhile exploring [Hristov et al., 2016].

Even if the pharmacological profile of some of the TRP channel active drugs (based on preclinical studies) seem promising for treatment of UAB/DUA, which agent (s) to choose for further development remains speculative since there are no published clinical experiences.

1.5. 5-Hydroxytryptamine (Serotonin)

Many preclinical studies have shown serotonin, acting on a variety of receptor subtypes both peripherally and on the central nervous system, to have diverse effects on micturition [Ramage, 2006]. If some of these effects were valid also for humans, they would have potential interest for the treatment of UAB/DUA [Ramage, 2006]. Serotonin has a well-established contractile effect on human bladder strips mediated by 5-HT₄ receptors via facilitation of cholinergic neuromuscular transmission [Tonini et al., 1994; Candura et al., 1996], and an occasional case report suggests efficacy in some cases of UAB/DUA with cisapride [Franceschetti et al., 1997], a 5-HT₄ agonist with 5-

HT₃ antagonist activity, widely used to promote gastrointestinal motility, but withdrawn because of cardiac (long QT) side effects [Quigley et al., 2011]. Whether or not analogues without this side effect would be useful can only be speculated on.

1.6. Botulinum Toxin

Kuo [2007] treated 27 patients with idiopathic low detrusor contractility with urethral injection of onabotA. It was found that patients with normal bladder sensation combined with a poor relaxation or hyperactive urethral sphincter were significantly more likely to recover normal detrusor function. Further studies on such patients would be desirable.

Conclusions

The current pharmacological possibilities to effectively treat UAB/DUA are limited. Dependent on the multifactorial pathophysiology of the condition, treatment with approved agents have to be personalised and to be successful therapy has to be directed to both the major mechanism involved and the associated morbidities.

V. HORMONAL TREATMENT OF URINARY INCONTINENCE

1. OESTROGENS

1.1. Oestrogens and the Continence Mechanism

The oestrogen sensitive tissues of the bladder, urethra and pelvic floor all play an important role in the continence mechanism. For women to remain continent the urethral pressure must exceed the intra-vesical pressure at all times except during micturition. The urethra has four oestrogen sensitive functional layers all of which have a role in the maintenance of a positive urethral pressure 1) epithelium, 2) vasculature, 3) connective tissue, 4) muscle.

Two types of oestrogen receptor, (α and β) have been identified in the trigone of the bladder, urethra and vagina as well as in the levator ani muscles and fascia and ligaments within the pelvic floor [Smith et al., 1990; Copas et al., 2001; Gebhardt et al., 2001]. After the menopause oestrogen receptor α has been shown to vary depending upon exogenous oestrogen therapy [Fu et al., 2003]. In addition, exogenous oestrogens affect the remodeling of collagen in the urogenital tissues resulting in a reduction of the total collagen concentration with a decrease in the cross linking of collagen in both continent and incontinent women [Falconer et al., 1998; Keane et al., 1997]. Studies in both animals and humans have shown that oestrogens also increase vascularity in the peri-urethral plexus which can be measured as vascular pulsations on urethral pressure profilometry [Robinson

et al., 1996; Endo et al., 2000; Versi and Cardozo, 1986].

1.2. Oestrogens for Stress Urinary Incontinence

The role of oestrogen in the treatment of stress urinary incontinence has been controversial despite a number of reported clinical trials [Hextall, 2000]. Some have given promising results but this may have been because they were small observational and not randomised, blinded or controlled. The situation is further complicated by the fact that a number of different types of oestrogen have been used with varying doses, routes of administration and duration of treatment.

Fantl et al. [1996] treated 83 hypo-oestrogenic women with urodynamic stress incontinence and/or detrusor overactivity with conjugated equine oestrogens 0.625 mg and medroxyprogesterone 10 mg cyclically for three months. Controls received placebo tablets. At the end of the study period the clinical and quality of life variables had not changed significantly in either group. Jackson et al. [1996] treated 57 postmenopausal women with urodynamic stress or mixed incontinence with Oestradiol 2 mg or placebo daily for six months. There was no significant change in objective outcome measures although both the active and placebo groups reported subjective benefit.

Two meta-analyses of early data have been performed. In the first, a report by the Hormones and Urogenital Therapy (HUT) committee the use of oestrogens to treat all causes of incontinence in postmenopausal women was examined [Fantl et al., 1994]. Of 166 articles identified, which were published in English between 1969 and 1992, only six were controlled trials and 17 uncontrolled series. The results showed that there was a significant subjective improvement for all patients and those with urodynamic stress incontinence. However, assessment of the objective parameters revealed that there was no change in the volume of urine lost, Maximum urethral closure pressure increased significantly but this result was influenced by only one study showing a large effect.

In the second meta-analysis Sultana and Walters [1990] reviewed eight controlled and 14 uncontrolled prospective trials and included all types of oestrogen treatment. They also found that oestrogen therapy was not an efficacious treatment for stress urinary incontinence but may be useful for the often associated symptoms of urgency and frequency. Oestrogen when given alone therefore does not appear to be an effective treatment for stress urinary incontinence.

Several studies have shown that oestrogen may have a role in combination with other therapies e.g. α -adrenoceptor agonists. However, phenylpropamalamine (the most widely used α -adrenoceptor agonist in clinical practice) has now been restricted or banned by the US Food and Drug Administration (FDA).

In a randomised trial Ishiko et al. [2001] compared the effects of the combination of pelvic floor exercise and oestriol (1 mg per day) in 66 patients with post menopausal stress urinary incontinence. Efficacy was evaluated every three months based on stress scores obtained from a questionnaire. They found a significant decrease in stress score in mild and moderate stress incontinent patients in both groups three months after the start of therapy and concluded that combination therapy with oestriol plus pelvic floor exercise was effective and could be used as first line treatment for mild stress urinary incontinence. A further study evaluating the effects of intravaginal oestriol and pelvic floor rehabilitation on urogenital aging in post menopausal women randomised 206 women with symptoms of urogenital aging into two groups of 103 women each. Subjects in the treatment group received intravaginal oestriol ovules 1 mg once daily for 2 weeks and then 2 ovules weekly for a total of six months together with pelvic floor rehabilitation. Subjects in the control group received only intravaginal oestriol. Prior to treatment 83 (80.6%) of the women in the treatment arm complained of stress urinary incontinence compared to 103 (100%) of the control women. At the end of the study only 22 (21.4%) of the treated patients suffered from stress urinary incontinence compared to 93 (90.3%) of the control group representing a significant improvement in stress incontinence as a result of this combination therapy [Capobianco et al., 2012]

Thus even prior to the more recently reported secondary analyses of the heart and oestrogens/progestogen replacement study (HERS) [Grady et al., 2001] and women's health initiative (WHI) [Hendrix et al., 2005] it was already recognised that systemic oestrogen therapy alone had little effect in the management of urodynamic stress incontinence [Al-Badr et al., 2003; Robinson and Cardozo, 2003].

1.3. Oestrogens for Urgency Urinary Incontinence and Overactive Bladder Symptoms.

Oestrogen has been used to treat post menopausal urgency and urge incontinence for many years but there have been few controlled trials to confirm that it is of benefit [Hextall, 2000]. A double blind multi centre study of 64 post menopausal women with "urge syndrome" failed to show efficacy [Cardozo et al., 1993]. All women underwent pre-treatment urodynamic investigation to ensure that they had either sensory urgency or detrusor overactivity. They were randomised to treatment with oral oestriol 3 mg daily or placebo for three months. Compliance with therapy was confirmed by a significant improvement in the maturation index of vaginal epithelial cells in the active but not the placebo group. Oestriol produced subjective and objective improvements in urinary symptoms but was not significantly better than placebo.

Another randomised controlled trial from the same group using 25 mg Oestradiol implants confirmed the

previous findings [Rufford et al., 2003], and furthermore found a higher complication rate in the Oestradiol treated patients (vaginal bleeding).

Symptoms of an overactive bladder increase in prevalence with increasing age and lower urinary tract symptoms and recurrent urinary tract infections are commonly associated with urogenital atrophy. Whilst the evidence supporting the use of oestrogens in lower urinary tract dysfunction remains controversial there are considerable data to support their use in urogenital atrophy and the vaginal route of administration correlates with better symptom relief by improving vaginal dryness, pruritis and dyspareunia, greater improvement in cytological findings and higher serum oestradiol levels [Cardozo et al., 1998]. Overall vaginal oestradiol has been found to be the most effective in reducing patient symptoms although conjugated oestrogens produced the most cytological change and the greatest increase in serum oestradiol and oestrone. The most recent meta analysis of intravaginal oestrogen treatment in the management of urogenital atrophy was reported by the Cochrane group in 2012 (Cody et al., 2012) Overall 34 trials including 19676 incontinent women of whom 9599 received oestrogen therapy (1464 involved in trials of local vaginal oestrogen administration). The trials used varying combinations of oestrogen, dose, duration of treatment and length of follow up. The combined result of six trials of systemic administration (oral oestrogen) resulted in worse incontinence than placebo. However, there was some evidence that oestrogen used locally as vaginal creams or pessaries improved incontinence. Overall there was less frequency and urgency in those women treated with local oestrogen.

Thus, theoretically there could be a role for combination treatment with an antimuscarinic agent and vaginal oestrogen in post menopausal women. However, the three clinical trials which have been reported to date differ in their outcome. Tseng et al. [2009] showed superior efficacy in terms of symptom improvement for the overactive bladder when Tolterodine was used with vaginal oestrogen cream as opposed to Tolterodine alone. However, Serati et al. [2009] found no difference between Tolterodine with or without topical oestrogen in women with symptomatic detrusor overactivity. A further study compared the efficacy and safety of solifenacin succinate versus solifenacin succinate with local oestrogen for the treatment of overactive bladder in 104 post menopausal women randomised to receive either solifenacin 5 mg daily plus Promestriene vaginal capsules or solifenacin alone. The primary outcome measure was changed from baseline to end of treatment in the mean number of voids per 24 hours, quality of life was assessed using international prostate symptom score and overactive bladder symptoms score questionnaires. The median decreases in number of voids in 24 hours in the two groups were 5.4 and 4.3 respectively which was not statistically different. The median decrease in urgency episodes was 2.0 and 2.5 respectively. In addition, the quality of life scores significantly changed in both groups (both the <0.05). The author

concluded that solifenacin with or without local oestrogen was effective and safe for overactive bladder treatment in post menopausal women. The addition of local oestrogen improved subjective feelings and quality of life [Jiang et al., 2016].

There has been one study comparing the oestradiol vaginal ring with oral oxybutynin for treatment of overactive bladder [Nelken et al., 2011]. Participants were randomised to receive either the ultra low dose oestradiol vaginal ring or oral oxybutynin for 12 weeks. The primary outcome was a decrease in the number of voids in 24 hours. Secondary outcomes were quality of life questionnaires, vaginal pH levels and vaginal maturation index. 59 women were enrolled, 31 were randomised to receive oxybutynin whereas 28 received oestradiol vaginal ring. Women who received oxybutynin had a mean decrease of 3.0 voids per day and women who received the vaginal ring had a mean decrease of 4.5 voids per day with no significant difference between the groups. There was a significant improvement in urogenital distress index and incontinence impact questionnaire scores in both groups with no significant difference in improvement between the two groups, thus ultra low dose oestradiol releasing vaginal ring and oral oxybutynin seemed to be similarly effective in decreasing the number of daily voids in post menopausal women with overactive bladder.

1.4. Evidence Regarding Oestrogens and Incontinence from Large Clinical Trials.

The HERS study included 763 post menopausal women under the age of 80 years with coronary heart disease and intact uteri [Grady et al., 2001]. It was designed to evaluate the use of oestrogen in secondary prevention of cardiac events. In a secondary analysis 1525 participants who reported at least one episode of incontinence per week at baseline were included. Participants were randomly assigned to 0.625 mg of conjugated oestrogens plus 2.5 mg of medroxyprogesterone acetate in one tablet (N=768) or placebo (N=757) and were followed for a mean of 4.1 years. Severity of incontinence was classified as improved, unchanged or worsened. The results showed that incontinence improved in 26% of the women assigned to placebo compared to 21% assigned to hormones whilst 27% of the placebo group worsened compared with 39% of the hormone group (P=0.001). This difference was evident by four months of treatment, for both urgency and stress urinary incontinence. The number of incontinence episodes per week increased an average of 0.7 in the hormone group and decreased by 0.1 in the placebo group (p< 0.001). The authors concluded that daily oral oestrogen plus progestogen therapy was associated with worsening urinary incontinence in older post menopausal women with weekly incontinence and did not recommend this therapy for treatment of incontinence. However, it is possible that the progestogen component may have had an influence on the results of this study.

The Women's Health Initiative (WHI) was a multi centre double blind placebo controlled randomised clinical trial of menopausal hormone therapy in 27347 postmenopausal women age 50-79 years enrolled between 1992 and 1998 for whom urinary incontinence symptoms were known in 23296 participants at baseline and one year [Hendrix et al., 2005]. The women were randomised based on hysterectomy status to active treatment or placebo. Those with a uterus were given 0.625 mg per day of conjugated equine oestrogen (CEE) plus 2.5 mg per day of medroxyprogesterone Acetate (CEE+MPA), whereas those who had undergone hysterectomy received oestrogen alone (CEE). At one year hormone therapy was shown to increase the incidence of all types of urinary incontinence among women who were continent at baseline. The risk was highest for stress urinary incontinence CEE+MPA: RR, 1.7 95% confidence interval CI (1.61-2.18); CEE alone RR 2.15 mg, 95% CI, 1.77-2.62, followed by mixed urinary incontinence CEE+MPA: RR 1.49 95% CI 1.10-2.01. On CEE alone RR was 1.79 95% CI, 1.26-2.53. The combination of CEE and MPA had no significant effect on developing urge urinary incontinence RR, 1.15; 95% CI, 0.99-1.34 but CEE alone increased the risk RR 1.32; 95% CI, 1.10-1.58. For those women experiencing urinary incontinence at baseline frequency worsened in both active groups CEE+MPA; RR, 1.38 95% CI 1.28-1.49; CEE alone: RR, 1.47 95% CI, 1.35-1.61. Quantity of urinary incontinence worsened at one year in both active groups, CEE+MPA: RR, 1.20 95% CI, 1.06-1.76; CEE alone: RR, 1.59 95% CI, 1.39-1.82. Those women receiving hormone therapy were more likely to report that urinary incontinence limited their daily activities CEE+MPA: RR 1.18 95% CI, 1.06-1.32. CEE alone: RR 1.29 95% CI, 1.15-1.45 at one year. Thus, based on this secondary analysis of data from a huge study conjugated equine oestrogen alone or in combination with Medroxyprogesterone Acetate was shown to increase the risk of urinary incontinence amongst continent women and worsen urinary incontinence amongst asymptomatic women after one year of therapy.

The Nurses Health Study [Grodstein et al., 2004] was a biennial postal questionnaire starting in 1976. In 1996 39436 post-menopausal women aged 50-75 years was reported no urinary leakage at the start of the study were followed up for four years to identify incident cases of urinary incontinence. 5060 cases of occasional and 2495 cases of frequent incontinence were identified. The risk of developing urinary incontinence was increased amongst post menopausal women taking hormones compared to women who had never taken hormones (oral oestrogen: RR1.54 95% CI 1.44, 1.65; transdermal oestrogen: RR1.68, 95% CI 1.41, 2.00; oral oestrogen with progestin: RR1.34, 95% CI 1.24, 1.44; transdermal oestrogen with progestin: RR1.46, 95% CI 1.16, 1.84). After cessation of hormone therapy there was a decreased risk of incontinence such that 10 years after stopping

hormones the risk was identical in women who had and who never had taken hormone therapy.

The most recent meta analysis of the effect of oestrogen therapy on the lower urinary tract has been performed by the Cochrane Group [Cody et al., 2012] and is notable as the conclusions are starkly different from those drawn from the previous review [Moehrer et al., 2003]. Overall 34 trials were identified including 19676 incontinent women (1464 involved in trials of local administration) of which 9599 received oestrogen therapy.

Systemic administration (of unopposed oral oestrogens – synthetic and conjugated equine oestrogens) resulted in worse incontinence than placebo (RR1.32; 95% CI: 1.17-1.48). Although this is heavily influenced by the size of the WHI study [Hendrix et al 2005]. When considering combination therapy there was a similar worsening effect on incontinence when compared to placebo (RR1.11; 95% CO: 1.04-1.08). There was some evidence suggesting that the use of local oestrogen therapy may improve incontinence (RR0.74; 95% CI: 0.64-0.86) and overall there were 1-2 fewer voids in 24 hours and less frequency and urgency.

The authors conclude that local oestrogen therapy for incontinence may be beneficial although there was little evidence of long term effect. The evidence would suggest that systemic hormone replacement using conjugated equine oestrogens may make incontinence worse. In addition they report that there are too few data to comment reliably on the dose type of oestrogen and route of administration.

2. GENITOURINARY SYNDROME OF MENOPAUSE

Following a consensus conference held in 2013 the Board of Directors of the International Society for the Study of Women's Sexual Health (ISSWSH) and the Board of Trustees of the North American Menopause Society (NAMS) acknowledged the need to review current terminology associated with genitourinary tract symptoms related to menopause [Portman et al., 2014]. They agreed on the new term Genitourinary Syndrome of Menopause (GSM) as a more accurate all encompassing and publically acceptable term than vulvo-vaginal atrophy. As well as genital symptoms this covers the urinary symptoms of urgency, dysuria and recurrent urinary tract infections. It has long been appreciated that these symptoms respond well to low dose local (intravaginal) oestrogen therapy given long term to post menopausal women [Baber et al., 2016]. The most recent Cochrane review included 16 trials with 2129 women and intravaginal oestrogen was found to be placebo in terms of efficacy although there were no differences between types of formulation. Fourteen trials compared safety between the different vaginal preparations and found a higher risk of endometrial stimulation with conjugated equine oestrogens as compared to oestradiol [Suckling et al.,

2003]. However, since then the traditional 25 microgram twice weekly dose of oestradiol vaginal tablets has been replaced by the ultra low dose 10 microgram twice weekly vaginal tablet [Simon & Mammari, 2013]. This has unfortunately led to reduced efficacy and does not appear to be adequate for the control of overactive bladder symptoms in post menopausal women, 50% of whom may suffer from genitourinary syndrome of the menopause if untreated.

3. OTHER HORMONES

Progesterone and progestogens are thought to increase the risk of urinary incontinence. Lower urinary tract symptoms especially stress urinary incontinence have been reported to increase in the progestogenic phase of the menstrual cycle [Hextall et al., 2001]. In similar studies, progesterone has been shown to increase beta adrenergic activity leading to a decrease in the urethral closure pressure in female dogs [Raz et al., 1973]. However, in the WHI there appeared to be no difference whether or not progestin was given in addition to oestrogen [Hendrix et al., 2005].

Selective oestrogen receptor modulators (SERMS) have been reported to have varying effects. Each of the SERMS has receptor ligand conformations that are unique and have both oestrogenic and anti oestrogenic effects. In the clinical trials of levormeloxifene there was a fourfold increase in the incidence of incontinence leading to cessation of the clinical trial [Hendrix et al., 2001]. However, raloxifene has not been shown to have any effect at all on urinary incontinence [Waetjen et al., 2004]. There are no reported clinical trials evaluating the effect of androgens, and in particular testosterone, on urinary incontinence in women.

Conclusions. Oestrogen has an important physiological effect on the female lower urinary tract and its deficiency is an aetiological factor in the pathogenesis of a number of conditions. However, the use of oestrogen either alone or in combination with progestogen has yielded poor results. The current level 1 evidence against the use of systemic oestrogen for the treatment of urinary incontinence comes from studies powered to assess their benefit in the prevention of cardiovascular events and therefore the secondary analyses have only been based on self reported symptoms of urinary leakage without any objective data. Despite this all of these large randomised controlled trials show a worsening of pre-existing urinary incontinence both stress and urgency and an increased new incidence of urinary incontinence with both oestrogen and oestrogen plus progestogen. However, the majority of subjects in all of these studies were taking combined equine oestrogen and this may not be representative of all oestrogens taken by all routes of administration.

In a systematic review of the effects of oestrogens for symptoms suggestive of an overactive bladder the

conclusion was that oestrogen therapy may be effective in alleviating OAB symptoms, and that local administration may be the most beneficial route of administration [Cardozo et al., 2004]. It is quite possible that the reason for this is that the symptoms of urinary urgency, frequency and urge incontinence may be a manifestation of genitourinary syndrome of menopause atrophy in older post menopausal women rather than a direct effect on the lower urinary tract [Robinson and Cardozo, 2003]. Whilst there is good evidence that the symptoms and cytological changes of urogenital atrophy may be reversed by low dose (local) vaginal oestrogen therapy there is currently no evidence that oestrogens with or without progestogens should be used in the treatment of urinary incontinence. The International Menopause Society (IMS) has produced new 2016 recommendations on women's midlife health and menopause hormone therapy (MHT) to help guide healthcare professionals in optimising their management of women in menopause transition and beyond. They have given a Grade A recommendation to the use of local oestrogens for urogenital symptoms and a Grade B recommendation for the long-term use of such treatment. They have also allocated a Grade B recommendation to the use of low dose local oestrogens in the management of recurrent lower urinary tract infection [Barber et al., 2016].

4. DESMOPRESSIN

The endogenous hormone vasopressin (also known as anti-diuretic hormone) has two main functions: it causes contraction of vascular smooth muscle and stimulates water reabsorption in the renal medulla. These functions are mediated by two specific vasopressin receptors of which there are two major subtypes, namely the V_1 and V_2 receptors. The V_2 subtype is particularly important for the anti-diuretic effects of vasopressin. A genetic or acquired defect in making and secreting vasopressin leads to central diabetes insipidus, and genetic defects in the gene encoding the V_2 receptor can cause nephrogenic diabetes insipidus [Insel et al., 2007]. Accordingly, decreased vasopressin levels are believed to be important in the pathophysiology of polyuria, specifically nocturnal polyuria, which can lead to symptoms such as nocturia [Matthiesen et al., 1996; Weiss et al., 2011a]. Nocturia is currently defined by the International Continence Society (ICS) as the complaint that an individual has to wake at night one or more times to void. It is, however, "an underreported, understudied, and infrequently recognized problem in adults" [Weiss et al., 2011b]. Nocturia leads to decreased quality of life [Kupelian et al., 2011], and has been associated with both increased morbidity and mortality [Nakagawa et al., 2010; Kupelian et al., 2012]. While it remains largely unknown in which fraction of patients nocturia can indeed be explained by too little vasopressin, the presence of nocturnal polyuria in the absence of behavioural factors explaining it (such as

excessive fluid intake) is usually considered as an indication that a (relative) lack of vasopressin may exist. While it remains largely unknown in what fraction of patients nocturia is explained by too little vasopressin, the presence of nocturnal polyuria in the absence of behavioral factors that can explain it (e.g. excessive fluid intake) is usually considered to indicate decreased vasopressin levels [Bosch and Weiss., 2011, Weiss et al., 2011b]. Based upon these considerations, vasopressin receptor agonists have been used to treat nocturia, both in children and in adults. Desmopressin is the most common vasopressin analogue used to treat nocturia. Desmopressin shows selectivity for anti-diuretic over vasopressor effects. It has a more powerful and longer-lasting antidiuretic action than vasopressin. It is available in formulations for oral, parenteral, and nasal administration. It has a fast onset of action, with urine production decreasing within 30 minutes of oral administration [Rittig et al., 1998]. Because of symptomatic hyponatremia with water intoxication which is the only serious adverse event reported in children, occurred after intranasal or intravenous administration of desmopressin [Thumfart et al., 2005; Robson et al., 2007; Van de Walle et al., 2010], the U.S. Food and Drug Administration (FDA) and the European Medicines Agency (EMA) removed the indication for the treatment of primary nocturnal enuresis from all intranasal preparations of desmopressin. An oral lyophilisate (MELT) formulation requiring no concomitant fluid intake is currently available. In a recent open-label, randomized, cross-over study, desmopressin MELT was shown to have similar levels of efficacy and safety at lower doses than the tablet formulation of desmopressin in children. A recent study confirmed the superior pharmacodynamic characteristics of desmopressin MELT to desmopressin tablets [De Guchtenaere et al., 2011].

The use of desmopressin in children with nocturnal enuresis was comprehensively reviewed by the Cochrane Collaboration in 2002 [Glazener et al., 2002]. These authors evaluated 47 randomized controlled trials involving 3448 children, of whom 2210 received desmopressin. According to their analysis, desmopressin was effective relative to placebo in reducing bed-wetting (e.g. a dose of 20 µg resulted in a reduction of 1.34 wets/night (95% CI 1.11; 1.57), and children were more likely to become dry with desmopressin (98%) than with placebo (81%). However, there was no difference between desmopressin and placebo after discontinuation of treatment, indicating that desmopressin suppresses symptom enuresis but does not cure the underlying cause. The Cochrane Group have reviewed a total of 40 randomised or quasi-randomised controlled trials of 1780 children who were enrolled receiving an active drug other than desmopressin or a tricyclic. Thirtyone different drugs or classes of drug were tested. For drugs versus placebo, when compared to placebo indomethacin, diazepam, mestorelone and atomoxetine appeared to reduce the number of children failing to

have 14 consecutive dry nights. Although indomethacin and diclofenac were better than placebo during treatment, they were not as effective as desmopressin and there was a higher chance of adverse effects [Desphande et al., 2012]. Additionally, not all children responded sufficiently to desmopressin monotherapy. The combination of desmopressin and an enuresis alarm resulted in a greatly improved short-term success rate and decreased relapse rates [Alloussi et al., 2011]. The combination of desmopressin and antimuscarinics resulted in better short- and long-term success rates as well as a lower relapse rate than desmopressin alone [Austin et al., 2008; Alloussi et al., 2009]. A recent Cochrane Review has shown that when Imipramine combined with Desmopressin was compared with Imipramine monotherapy there was no difference in outcomes. However, when imipramine plus desmopressin was compared with desmopressin monotherapy the combination was more effective with 15% not achieving 14 consecutive dry nights at the end of treatment for imipramine plus desmopressin versus 40% for desmopressin monotherapy [Caldwell et al., 2016]. For non-responders to desmopressin, replacement of desmopressin with other medications such as tricyclic antidepressants or loop diuretics could be of benefit, whereas muscarinic receptor antagonists may be ineffective in such children (De Guchtenaere et al., 2007; Neveus and Tullus, 2008). A study of enuresis patients thought to be resistant to desmopressin who were subsequently referred to a specialist centre showed that 1/3 of the children could become dry on desmopressin monotherapy under specialist care once their daytime symptoms had been addressed [Rittig et al., 2014]. This has led to recommendations for maximising the chances of treatment success in patients receiving desmopressin [Kamperis et al., 2016]

Other studies have explored a possible treatment role for desmopressin in the treatment of nocturia in adults. A search for these studies in Medline using the terms "desmopressin" and "nocturia" was performed and limited to clinical studies of *de novo* nocturia, i.e. those that excluded subjects in whom childhood enuresis persisted into adulthood. Several previous studies investigated the use of desmopressin for the treatment of nocturia in the context of multiple sclerosis [Eckford et al., 1994; 1995]. One study with single dose administration reported a reduction in nocturnal polyuria, but by design did not assess nocturia [Eckford et al., 1995]. Three placebo-controlled double-blind studies with a small patient number (16-33 patients total per study) reported a significant reduction in nocturia [Hilton et al., 1983; Eckford et al., 1994; Valiquette et al., 1996]. Other controlled studies of similar size, most with a crossover design, used micturition frequency within the first 6 h after desmopressin administration rather than nocturia as their primary endpoint. These studies consistently reported that desmopressin treatment for up to 2 weeks was efficacious [Kinn and Larsson, 1990; Fredrikson, 1996; Hoverd and Fowler, 1998]. While desmopres-

sin treatment was generally well tolerated, 4 of 17 patients in one study discontinued treatment due to asymptomatic or minimally symptomatic hyponatremia [Valiquette et al., 1996]. Accordingly, desmopressin is now registered for the treatment of nocturia in multiple sclerosis patients [Cvetkovic and Plosker, 2005]. In a small open-label study, desmopressin was also reported to reduce nocturnal polyuria in spinal cord injury patients [Zahariou, Karagiannis et al. 2007].

Further studies have explored the use of desmopressin in adults with nocturia in the apparent absence of neurological damage. The recruited patient populations were based upon different criteria, including having at least two nocturia episodes per night or having nocturnal polyuria. Earlier studies mostly used a desmopressin dose of 20 µg given either orally [Asplund et al., 1999] or intranasally [Hilton and Stanton, 1982; Cannon et al., 1999], and tended to be very small (≤25 patients). Later studies, as part of the NOCTUPUS program, were considerably larger, involving a total of 1003 screened patients, and higher oral doses (0.1-0.4 mg) were administered for a period of 3 weeks of double-blind treatment in adults [Mattiasson et al., 2002; Lose et al., 2003; van Kerrebroeck et al., 2007]. A total of 632 patients entered the dose-titration phase and 422 patients entering the double-blind phase of the three NOCTUPUS trials. To counter the argument that the study was performed in desmopressin responders after the dose titration phase, all patients in the NOCTUPUS trials were washed-out following the dose-titration phase and in order to be randomized, it was a requirement that the patients returned to baseline nocturnal diuresis before inclusion in the double-blind phase. The trials showed that oral desmopressin (0.1, 0.2 or 0.4 mg) is effective in both men and women aged ≥ 18 years with nocturia. The number of nocturnal voids decreased from 3 to 1.7 in the desmopressin group compared to 3.2 to 2.7 in the placebo group. In women, the number of nocturnal voids in the desmopressin group decreased from 2.92 to 1.61, whereas that in the placebo group decreased from 2.91 to 2.36. When clinical response was defined as ≥ 50% reduction in nocturnal voids from baseline, 34% of men experienced clinical response with desmopressin, compared with 3% of men who received placebo. In women, 46% of desmopressin-treated patients experienced a clinical response, compared with 7% of patients on placebo.

Weiss and colleagues reported outcomes on a four week multi centre randomised double blind placebo controlled trial to determine the efficacy of orally disintegrating sub-lingual Desmopressin i.e., "melt" formulation. The authors randomised patients to 10, 25, 50 and 100 micrograms. Approximately 90% of the subjects reported true nocturnal polyuria, 710 patients completed the study. A statistically significant difference in the number of nocturnal voids was seen for all patients with a 100 micrograms and 50 micrograms. Women responded to 25 micrograms as well, however for men there was only a statistically

significant difference with 100 micrograms. The proportion of patients with at least a 33% reduction in the number of nocturnal voids (primary outcome measure) increased with dosage for all patients but there was a stronger response seen in women at 25 micrograms. A total of 24 patients (3%) experienced hyponatremia which was a more likely occurrence in patients over the age of 65 years [Weiss et al., 2012].

The efficacy of desmopressin for the treatment of nocturia was confirmed in a long-term (10-12 months) open-label study involving 249 patients, which was an extension of the randomized studies in known desmopressin responders. However, a rebound effect was seen when treatment was withdrawn, confirming the association between continued treatment and response [Lose et al., 2004]. An open-label pilot study in a nursing home setting also reported that desmopressin had beneficial effects [Johnson et al., 2006].

Around 75% of community-dwelling men and women with nocturia (≥ 2 voids/night) have nocturnal polyuria (NP) [Rembratt et al., 2003; Swithinbank et al. 2004]. The key urological factors most relevant to nocturia are NP and OAB in women [Irwin et al., 2008], and NP and benign prostatic hyperplasia (BPH) in men. About 74% of women with OAB have nocturia and 62% of patients with OAB and nocturia have NP. Among men with nocturia, 83% have NP; 20% have NP alone, and 63% have NP in combination with another factor such as a small nocturnal bladder capacity or bladder outlet obstruction [Chang et al., 2006]. Therefore, desmopressin combination therapy with α_1 -adrenergic blockers and/or anticholinergics should be considered for patients with treatment-resistant nocturia. Seventy-three percent of α_1 -adrenergic blocker-resistant BPH patients experienced a $\geq 50\%$ reduction in nocturnal voids with oral desmopressin [Rembratt et al., 2003; Yoong et al., 2005]. A randomized, double-blind, placebo-controlled study evaluating the long-term (1, 3, 6, and 12 months) efficacy and safety of low dose (0.1 mg) oral desmopressin in elderly (≥ 65 years) patients reported that low dose oral desmopressin led to a significant reduction in the number of nocturnal voids and nocturnal urine volume in patients with BPH [Wang et al., 2011a].

Because nocturia can be caused by different factors, several studies have investigated whether desmopressin may be beneficial in patients with other symptoms in addition to nocturia. In a small, non-randomized pilot study of men believed to have BPH, desmopressin was reported to improve not only nocturia, but also to reduce the overall international prostate symptom score (IPSS) [Chancellor et al., 1999]. An exploratory, placebo-controlled double-blind study in women with daytime urinary incontinence reported that intranasal administration of 40 μg desmopressin increased the number of leakage-free episodes 4 hours after drug administration (Robinson et al., 2004). One double-blind, placebo-controlled pilot study in patients with OAB treated with 0.2 mg oral

desmopressin reported a reduction in voids along with an improvement in quality of life (QoL) [Hashim et al., 2009]. While these data indicate that desmopressin may be effective in treating voiding dysfunction not limited to nocturia, they are too sparse to allow treatment recommendations.

Desmopressin was well tolerated in all the studies and resulted in significant improvements compared to placebo in reducing nocturnal voids and increasing the hours of undisturbed sleep. There was also an improvement in QoL. However, one of the main clinically important side-effects of desmopressin usage is hyponatremia. Hyponatremia can lead to a variety of adverse events ranging from mild headache, anorexia, nausea, and vomiting to loss of consciousness, seizures, and death. Hyponatremia usually occurs soon after treatment is initiated. The risk of hyponatremia appears to increase with age, cardiac disease, and increasing 24-hour urine volume [Rembratt et al., 2003; 2006]. Based on a meta-analysis, the incidence is around 7.6% [Weatherall, 2004]. Increased age and female gender are well-known risk factors for the development of desmopressin-induced hyponatremia [Rembratt et al., 2006]. Bae et al. [2007] assessed the effects of long-term oral desmopressin on serum sodium and baseline antidiuretic hormone secretion in 15 elderly male patients with severe nocturia (greater than 3 voids nightly), who did not show hyponatremia within 7 days of administration of 0.2 mg desmopressin. Desmopressin (0.2 mg) was administered orally nightly for 1 year. Before and 1 month after the 1-year medication 24-hour circadian studies were performed to monitor changes in antidiuretic hormone. Every 3 months during the 1-year medication, serum changes and timed urine chemistry were monitored. The results showed that long-term desmopressin administration gradually decreased serum sodium and induced statistically, but not clinically significant, hyponatremia after 6 months of treatment. Administration of desmopressin for 1 year did not affect baseline antidiuretic hormone secretion. The authors recommended that for long-term desmopressin administration serum sodium should be assessed regularly, at least every 6 months.

There has been some research exploring gender differences in the antidiuretic response to desmopressin. Juul et al. [2011] found an increasing incidence of hyponatremia with increasing dose, and at the highest dose level of 100 μg decreases in serum sodium were approximately twofold greater in women over 50 yr of age than in men. A new dose recommendation stratified by gender was suggested in the treatment of nocturia: for men, 50- to 100 μg melt was suggested to be an efficacious and safe dose, while for women a dose of 25 μg melt was recommended as efficacious with no observed incidences of hyponatremia. Weiss and colleagues investigated the efficacy and safety of 50 and 75 micrograms Desmopressin orally disintegrating tablets in 385 men with nocturia. They showed that both doses increased the time to first void from baseline by approximately 40

1. ANTIMUSCARINIC AGENTS – EFFICACY AND TOLERABILITY

minutes compared to placebo. The response to Desmopressin was seen within a week of treatment and was sustained producing significant increases in health-related quality of life and sleep quality compared to placebo. Only 2 subjects aged 74 and 79 years respectively developed hyponatremia [Weiss et al., 2013]. A similar study carried out in women explored the efficacy and safety of 25 micrograms of desmopressin orally disintegrating tablets compared to placebo. 261 women with nocturia were randomised to either 25 micrograms of desmopressin or placebo. Desmopressin significantly reduced the mean number of nocturnal voids compared to placebo and increased the mean time to first nocturnal void by 49 minutes compared to placebo. Once again response was seen within the first week of treatment and sustained throughout the 3-month trial. Desmopressin was well tolerated with only three transient decreases in serum sodium level [Sand et al., 2013].

Initiation of desmopressin is currently not indicated for patients aged ≥ 65 years. The mechanisms behind desmopressin-induced hyponatraemia are well understood, and serum sodium monitoring at baseline and early during treatment of older patients for whom treatment with desmopressin is indicated can greatly reduce their risk of developing the condition. Other advice regarding treatment administration, such as restriction of evening fluid intake and adherence to recommended dosing, should be followed to minimize the risk of hyponatremia [Vande Walle et al., 2007].

Desmopressin is useful for patients with nocturia as well as for children with nocturnal enuresis. The drug has been proven to be well-tolerated and effective by several randomized, placebo-controlled trials and is recommended as a first-line treatment (either as monotherapy or in combination with other agents) for patients who have been appropriately evaluated and whose nocturia is related to NP, whether or not this is accompanied by BPH or OAB. For assessment, see Table 2.

VI. CONSIDERATIONS IN THE ELDERLY

The mainstay of pharmacological therapy for OAB in the elderly has been antimuscarinic agents. However, antimuscarinics may be associated with side effects that result in poor persistence and contribute to the anticholinergic burden of polypharmacie. Since antimuscarinics and β_3 -AR agonists (mirabegron) are similarly efficacious, and mirabegron has a more favorable tolerability profile than antimuscarinics amongst older patients, this drug was suggested to provide an improved benefit-to-risk ratio and therefore should be considered as an alternative to antimuscarinics for older patients [Wagg et al., 2016]. Until recently, few studies had specifically evaluated the efficacy and safety of antimuscarinics in the treatment of OAB symptoms in elderly patients.

The efficacy of antimuscarinic agents for treating symptoms of overactive bladder and urge urinary incontinence in older people is similar to that observed in younger and middle-aged adults. Age-related pooled results or sub-analyses from randomized controlled trials of tolterodine [Malone-Lee et al., 2001, Zinner et al., 2002], solifenacin [Wagg et al., 2006], darifenacin [Foote et al., 2007], fesoterodine [Kraus et al., 2010; Sand et al., 2012; see Wagg et al., 2015], and trospium chloride [Sand et al., 2011] indicate that reductions of 25-75% in urgency urinary incontinence episodes can be expected with use of these agents in older (65+) adults. Higher doses may be needed in those over age 75 [Kraus et al., 2010]. In a post-marketing surveillance study of darifenacin, Michel et al. [2010] found that increasing age was negatively associated with improvements in urgency episodes and incontinence, with a statistically significant, but non-clinically relevant effect (0.01 more urgency episodes per year of age). Older adults may derive greater benefit from use of a combined drug and behavioural therapy regime as compared to treatment with drug therapy alone [Burgio et al., 2000]. Dry mouth is the most frequently reported treatment-related adverse event, however overall tolerance has been reported as good to excellent with fewer treatment-motivated withdrawals in recent trials of older patients persisting on antimuscarinic therapy [Sand et al., 2012; Sand et al., 2011a;b]. Constipation is also common and may be particularly bothersome for older adults already suffering from chronic bowel dysmotility [Meek et al., 2011, Gallegos-Orozco et al., 2012].

However, the therapeutic effectiveness and tolerability of antimuscarinic agents in the elderly in the real-world practice setting may differ from the results obtained in randomized controlled trials for several reasons. First, research trials generally exclude individuals with concomitant consumption of other anticholinergic agents. In practice, older adults are a heterogeneous group, often consuming many medications that may augment, desensitize or alter the response to antimuscarinic therapy. As well, there is a higher prevalence of comorbidity among the elderly, which can further reduce treatment efficacy and heighten the potential for side effects to occur (see the Section on Incontinence in the Frail Elderly). Failure to acknowledge the multifactorial nature of urinary incontinence in the elderly often leads to sub-optimal treatment. Urgency symptoms may be exacerbated by consumption of caffeinated beverages, pelvic floor muscle weakness, diuretics or other functional and systemic dysfunctions. Treatment should therefore address all possible etiologies, and not be limited to a solitary intervention.

2. ANTIMUSCARINIC AGENTS – COGNITIVE SAFETY

A growing body of literature has emerged to address the concern that antimuscarinic agents used to treat symptoms of overactive bladder may cross the blood-brain barrier and provoke subtle or not so subtle cognitive impairment [Callegari et al., 2011; Jakobsen SM et al., 2011; Wagg et al., 2010; Pagoria et al., 2011; Gray et al., 2015]. Higher cumulative anticholinergic use seems to be associated with an increased risk for dementia [Gray et al., 2015]. Large randomized controlled trials were not designed to adequately measure central nervous system adverse events [Paquette et al., 2011]. As a result, evidence on the relative risk of different antimuscarinic agents for crossing the blood brain barrier and inducing changes in cognitive comes primarily from in-vitro studies and experimental studies using detailed neuropsychological testing.

Early studies suggested that administration of anticholinergic agents such as scopolamine could impair memory and attention in older adults, and possibly induce hallucinations and confusion [Flicker et al., 1992; Sperling et al., 2002]. Oxybutynin, in particular, due to its small molecular size and increased propensity to cross the blood-brain barrier, has consistently shown potential to elicit cognitive impairment in new users after a single high dose of this agent or at steady state, and should be avoided in the elderly [Donellan et al., 1997; Katz et al., 1998; Kay et al., 2008, Wesnes et al., 2009]. Katz et al. [1998] used a double-blind, placebo-controlled cross-over design to test a convenience sample of 12 healthy continent older adults, and revealed cognitive decrements on seven of fifteen cognitive measures resulting from oxybutynin use. Impairments were observed in verbal learning, memory, reaction time, attention, concentration and psychomotor speed. In a sleep study, oxybutynin was found to significantly alter EEG patterns compared to placebo [Todorova et al., 2001]. Oxybutynin was compared to darifenacin and placebo in a 3-week randomized multicentre double-blind parallel-group study in 150 healthy volunteers aged 60-83 [Kay et al., 2006]. Darifenacin produced no impairments compared to placebo at 3-weeks, but oxybutynin caused significant memory deterioration in delayed recall compared to the other two groups. Darifenacin was associated with significantly slower reaction times than placebo in the Divided Attention Test, but not in other tests of information processing speed. Oxybutynin also reduced accuracy scores for immediate recall in one of three tests. Wesnes et al. [2009] showed in a single-dose crossover study with 12 healthy older volunteers that oxybutynin IR 10 mg induced significant deficits in attention and memory compared to placebo, whereas solifenacin 10 mg did not.

Studies with the antimuscarinic agents solifenacin, trospium chloride ER and darifenacin suggest that

these agents confer significantly lower cognitive risk than oxybutynin. Administration of trospium chloride ER to 12 cognitively intact adults with overactive bladder aged 65-75 was found to have no effect on memory testing with the Hopkins Verbal Learning Test on day 10 post-administration compared to baseline, and was also found to be undetectable in the cerebral spinal fluid of participants [Staskin et al., 2010]. In a study of darifenacin among 129 older adults aged 65-84, no significant effects on cognition were observed (memory scanning sensitivity, speed of reaction time, and word recognition) compared with placebo [Lipton et al., 2005]. No data on fesoterodine and memory were found.

New onset delirium also does not appear to be a significant concern in patients taking antimuscarinic agents. Although several published case reports have documented the acute onset of delirium following initiation of tolterodine, in incontinent adults with and without dementia [Womack and Heilman, 2003; Salvatore et al., 2007; Williams et al., 2004; Tsao et al., 2003], these deficits resolved upon discontinuation or dose reduction of tolterodine. In a randomized controlled study of extended-release oxybutynin in nursing-home residents with mild to severe dementia, there was no incidence of delirium over the duration of the study [Lackner et al., 2008]. Furthermore, more recent evidence puts into question the traditionally held belief that new use of anticholinergic agents provokes incident delirium in hospitalized older patients [Campbell et al., 2011; Luukkanen et al., 2011].

Taken together, increasing evidence suggests that with the exception of oxybutynin, use of the other antimuscarinic agents poses little or no cognitive risk to otherwise healthy older adults with symptoms of overactive bladder [Esin et al., 2015]. However, two caveats apply. First, the integrity of the blood brain barrier may be compromised in many older adults with cerebrovascular disease, diabetes, or certain forms of dementia, with the results of studies in healthy older adults not generalizable to frailer individuals [Kay et al., 2005]. Second, long-term use of anticholinergic agents over months or years may yield more detrimental cognitive effects than single dose or short-term use. A number of large observational studies have linked chronic consumption of anticholinergic drugs with an increased risk of cognitive impairment, although most studies simultaneously examined the cumulative effect of drugs with any anticholinergic properties rather than each drug class alone [Ancelin et al., 2006; Campbell et al., 2009; Fox et al., 2011, Gray et al., 2015]. The Eugenia study of aging randomly recruited 372 adults 60 years and older from Montpellier, France, and showed that antimuscarinic drug users displayed significantly poorer reaction time, attention, immediate and delayed visuospatial memory, narrative recall, and verbal fluency than did non-drug users [Ancelin et al., 2006]. A 2-year longitudinal study of 13,000 participants enrolled in the Medical Research Council Cognitive Function and Ageing Study also showed that use of medication with anticholinergic effects was associated with a

0.33-point greater decline in the Folstein Mini Mental Status Exam score (95% confidence interval (CI)=0.03-0.64, $P=.03$) than not taking anticholinergics. Two-year mortality was also greater for those taking (OR=1.68; 95% CI=1.30-2.16; $P<.001$) anticholinergics. Many commonly prescribed medications in the elderly possess antimuscarinic properties [Chew et al., 2008], so the results may not be specific to bladder antimuscarinics. Other anticholinergic medication include, among others, amitriptyline, clozapine, olanzapine, paroxetine, furosemide, hydrocodone, lansoprazole, levofloxacin, and metformin.

Clinicians who remain wary of prescribing antimuscarinic agents for frail older adults with symptoms of overactive bladder are suggested to proceed with caution in prescribing these medications and fully weigh the risk-benefit ratio in light of other therapeutic options that can be equally effective for urgency and mixed incontinence in the elderly. If antimuscarinics are to be prescribed, a short cognitive screen (such as the Montreal Cognitive Assessment <http://www.mocatest.org>) or even a full neuropsychological test battery for those patients who are concerned or at risk, before and after initiating therapy might reveal whether subtle impairments have been induced. This is especially pertinent because patients are often unaware of their memory deficits [Kay et al., 2006]. A proxy informant, such as the patient's spouse or a relative, may be able to provide more reliable information on possible cognitive changes resulting from the drugs.

A frequently asked clinical question is whether antimuscarinic agents used to treat incontinence should be contraindicated in patients with dementia already taking cholinesterase inhibitors, as the mechanisms of these two medications are diametrically opposed. A number of small studies have shown that cholinesterase inhibitors used to improve cognition in Alzheimer's disease precipitate urinary incontinence [Hashimoto et al., 2000]. A Japanese study followed 94 patients with mild to moderate dementia treated with donepezil [Hashimoto et al., 2000]. Seven patients developed urinary incontinence, although the event was transient in most patients. In Scotland, among 216 patients with Alzheimer's disease initiating treatment with a cholinesterase inhibitor, incontinence was precipitated in 6.6%, and those with existing incontinence worsened [Starr, 2007]. Epidemiologic studies also show associations between cholinesterase inhibitors and incontinence [Gill et al., 2005; Roe et al., 2002]. In a large population-based cohort study of 44,884 adults with dementia carried out in Canada, those who were dispensed cholinesterase inhibitors were more likely to subsequently receive an antimuscarinic drug for incontinence compared to those not receiving cholinesterase inhibitors (hazard ratio 1.55, 95% confidence interval 1.39-1.72) [Gill et al., 2005]. This finding was confirmed by a separate study in the U.S. documenting a two-fold risk of taking oxybutynin in dementia patients treated with donepezil compared to those not treated with

donepezil [Roe et al., 2002]. A Japanese study examined the addition of a 3-month trial of propiverine 20 mg/day to donepezil in twenty-six cognitively impaired older adults, and found improved dryness rates with no deleterious effect on cognition [Sakakibara et al., 2009]. A 6-month study also compared the effects of trospium, galantamine, or trospium plus galantamine in 178 older adults with urge incontinence ($n=99$), dementia ($n=43$) or dementia and incontinence ($n=36$) respectively [Isik et al., 2009]. Treatment with 45-60 mg/day of trospium chloride and combined use of trospium with galantamine 24 mg/day was found to have no adverse effect on cognitive or physical function scores in this group of patients. A larger observational study of 3,563 long-term care residents with dementia also failed to document an increased rate of cognitive decline with combined use of a cholinesterase inhibitor and anticholinergic therapy (oxybutynin or tolterodine) compared to cholinesterase therapy alone [Sink et al., 2008]. However, a 50% faster rate of physical function decline was observed in higher-functioning participants on dual therapy compared to cholinesterase inhibitor therapy alone. This evidence suggests the competing mechanisms of the antimuscarinics and cholinesterase inhibitors may indeed have clinical consequences in some, but not all patients.

It has been stated that a dementia diagnosis does not preclude management of incontinence, but it was emphasized that treatment options may be more limited in those with advanced dementia who are unable to retain information and modify behaviors [Orme et al., 2015]

3. ANTIMUSCARINIC AGENTS – CARDIAC SAFETY

Another serious side effect of antimuscarinic drugs in the elderly is the risk of cardiac adverse effects and increased mortality, particularly due to increases in heart rate, prolongation of the QT interval, and induction of polymorphic ventricular tachycardia. These have been previously discussed, and it has been noted that studies specific to the elderly are lacking [Andersson et al., 2011]. Only one study prospectively examined the effect of anticholinergic drug use in 400 community-dwelling older people (aged 75-90 years) with stable cardiovascular disease in Helsinki, Finland [Uusvaara et al., 2011]. Bladder antimuscarinic agents were not examined individually, but were considered in a cumulative assessment of all drugs with anticholinergic properties being taken by the same individual. The unadjusted follow-up mortality was 20.7% and 9.5% among users and non-users of anticholinergic drugs, respectively ($p=0.010$). However, the use of drugs with anticholinergic properties was not a significant predictor of mortality in multivariate analysis after adjustment for age, sex and other comorbidities (hazard ratio 1.57; 95% CI 0.78, 3.15).

4. ANTIMUSCARINIC AGENTS – DRUG/DRUG INTERACTIONS IN THE ELDERLY

Rates of polypharmacy (> 5 drugs per patient) are high in the geriatric population, and cause potential for drug-drug interactions that increase toxicity or reduce the efficacy of antimuscarinic agents [Chancellor and Miguel, 2007]. The relationship between the number of drugs and potential drug-drug interactions in the elderly is alarming. Consumption of 5 to 7 and 8 to 10 drugs places older adults at a 4-fold and 8-fold increased risk of potentially serious drug-drug interactions respectively, compared with consumption of 2 to 4 drugs [Johnell and Klarin, 2007]. Drug drug interactions frequently involve isoenzymes of the hepatic cytochrome CYP450 system [Zakrzewski-Jakubiak et al., 2011]. Of the antimuscarinic drugs, tolterodine, darifenacin, solifenacin, and oxybutynin are extensively metabolized by CYP450 and are at greater risk of having altered drug metabolism due to hepatic-based drug-drug interactions. Trospium is eliminated renally as unchanged drug, suggesting that it has lower potential for CYP450 drug-drug interactions [Sand et al., 2011]. Trospium may therefore represent a safer treatment option in the context of polypharmacy in the elderly.

5. B₃-AR AGONISTS (MIRABEGRON)

Wagg et al. [2014] performed a prospective subanalysis of individual and pooled efficacy and tolerability data from three 12-week, randomised, Phase III trials, and of tolerability data from a 1-year safety trial in order to evaluate the efficacy and tolerability of mirabegron in subgroups of patients aged ≥ 65 and ≥ 75 years. Mirabegron 25 mg and 50 mg once-daily reduced the mean numbers of incontinence episodes and micturitions/24 h from baseline to final visit in patients aged ≥ 65 and ≥ 75 years. The drug was well tolerated. In both age groups, hypertension and urinary tract infection were among the most common adverse effects over 12 weeks and 1 year. The incidence of dry mouth, was up to sixfold higher among the older patients randomised to tolterodine than any dose of mirabegron.

Combined treatment for severe symptoms of OAB in elderly men and women with standard doses of solifenacin and mirabegron provided satisfactory therapeutic effect within short period of time without increasing the risk of side effects, and improved the quality of life and self-esteem of patients [Kosilov et al., 2015a]. In elderly men (≥ 65 years), combination of mirabegron as additional therapy to treatment with α -AR antagonists was effective, particularly if OAB was not controlled with $\alpha 1$ -AR-blocker monotherapy. Mirabegron did not have negative effects on voiding function [Matsuo et al., 2016]. The combination of mir-

abegron with tamsulosin did not seem to cause clinically relevant changes in cardiovascular safety or safety profiles [van Gelderen et al., 2014].

6. DESMOPRESSIN – EFFICACY AND SAFETY IN THE ELDERLY

Desmopressin (DDAVP) (0.1–0.2 mg) reduces nocturia in older persons [Rezakhaniha et al., 2011; Fu et al., 2011; Johnson et al., 2006], but has been associated with significant dose-related hyponatremia in 2–20% of older patients [Fu et al., 2011; Johnson et al., 2006; Weatherall, 2004]. Both female sex and increasing age are risk factors for the development of hyponatremia [Callreus et al., 2005; Rembratt et al., 2006; Juul et al., 2010]. A lower starting dose (0.025 mg) for the melt form has been suggested for older women [Juul et al., 2010] but requires further study. Caution is recommended for the initiation of desmopressin in adults aged 65 years and older at the current time.

7. BONT/A IN OLDER ADULTS

To date no studies have stratified the results of trials using BoNTA/A for the treatment of urinary incontinence in patients with neurogenic bladder according to age. The risk of catheterization due to high post-void residual urine volumes following treatment with botulinum toxin may be higher in older adults, as they are at higher risk of elevated residuals, but this requires systematic investigation.

8. OTHER

None of the other drug classes have undergone rigorous evaluation in the elderly, however a number of general guidelines apply. Use of α -AR agonists and tricyclic antidepressants are discouraged in the elderly due to blood pressure considerations. Uncontrolled systolic hypertension could occur with the former agents and orthostatic hypotension leading to falls with the latter. There is no evidence that hormonal agents are of benefit for urgency or stress incontinence in older women, although local estrogens may be indicated to treat symptomatic vaginal atrophy. Finally, removal of any offending agents that could be contributing to incontinence should be considered.

Thus, proper patient selection for antimuscarinic and any other drug treatment requires careful assessment of underlying physical status including cognitive function, mobility, and comorbidities.

REFERENCES

- Abrams P, Amarenco G, Bakke A et al. Tamsulosin: efficacy and safety in patients with neurogenic lower urinary tract dysfunction due to suprasacral spinal cord injury. *J Urol*, 2003;170(4 Pt 1):1242
- Abrams P, Andersson KE. Muscarinic receptor antagonists for overactive bladder. *BJU Int*. 2007 Nov;100(5):987
- Abrams P, Andersson K-E, Buccafusco JJ, et al. Muscarinic receptors: their distribution and function in body systems, and the implications for treating overactive bladder. *Br J Pharmacol* 2006;148:565
- Abrams P, Cardozo L, Chapple C et al. Comparison of the efficacy, safety, and tolerability of propiverine and oxybutynin for the treatment of overactive bladder syndrome. *Int J Urol*. 2006 Jun;13(6):692
- Abrams P, Cardozo L, Fall M. et al. The standardisation of terminology of lower urinary tract function: report from the Standardisation Subcommittee of the International Continence Society. *NeuroUrol Urodyn*, 2002;21(2):167
- Abrams P, Kaplan S, De Koning Gans HJ, Millard R. Safety and tolerability of tolterodine for the treatment of overactive bladder in men with bladder outlet obstruction. *J Urol*. 2006 Mar;175(3 Pt 1):999-1004
- Abrams P, Kelleher C, Huels J et al. Clinical relevance of health-related quality of life outcomes with darifenacin. *BJU Int*. 2008 Jul;102(2):208
- Abrams P, Kelleher C, Staskin D, et al. Combination treatment with mirabegron and solifenacin in patients with overactive bladder: efficacy and safety results from a randomised, double-blind, dose-ranging, phase 2 study (Symphony). *Eur Urol*. 2015 Mar;67(3):577-88.
- Abrams P, Swift S. Solifenacin is effective for the treatment of OAB dry patients: a pooled analysis. *Eur Urol*. 2005 Sep;48(3):483
- Agency for Healthcare Policy and Research. Urinary Incontinence Guideline Panel. Urinary Incontinence in Adults: Clinical Practice Guideline (AHCPR publication #92-0038). Rockville, MD, US Dept. of Health and Human Services, 1992.
- Aizawa N, Gandaglia G, Hedlund P, et al. URB937, a peripherally restricted inhibitor for fatty acid amide hydrolase, reduces prostaglandin E2 -induced bladder overactivity and hyperactivity of bladder mechano-afferent nerve fibres in rats. *BJU Int*. 2016 May;117(5):821-8.
- Aizawa N, Homma Y, Igawa Y. Effects of mirabegron, a novel β 3-adrenoceptor agonist, on primary bladder afferent activity and bladder microcontractions in rats compared with the effects of oxybutynin. *Eur Urol*. 2012 Dec;62(6):1165-73.
- Akbar M, Abel R, Seyler TM et al. Repeated botulinum-A toxin injections in the treatment of myelodysplastic children and patients with spinal cord injuries with neurogenic bladder dysfunction. *BJU Int*. 2007 Sep;100(3):639
- Al-Badr A, Ross S, Soroka D et al. What is the available evidence for hormone replacement therapy in women with stress urinary incontinence? *J Obstet Gynecol Can*, 2003;25(7):567
- Albayrak S, Solmaz V, Gencden Y, Firat F, Oran Demir M, Aksoy D, Tanik N, Tanik S, Erdemir F. Assessment of overactive bladder in women antidepressant users. *Int Urol Nephrol*. 2015 Sep;47(9):1479-84.
- Alhasso A, Glazener CMA, Pickard R et al. Adrenergic drugs for urinary incontinence in adults. *Cochrane Database Syst Rev*. 2003;(2):CD001842
- Alhasso A, Glazener CMA, Pickard R, N'Dow J: Adrenergic drugs for urinary incontinence in adults (Review). *Cochrane Database for Systematic Reviews* 2005, Issue 3, Art. No. CD001842. DOI: 10.1022/14651858. CD001842, pub 2. Reprinted in *The Cochrane Library* 2008, Issue 2.
- Alloussi S, Laval K-U, Eckert R. Trosipium chloride (Spasmolyt) in patients with motor urge syndrome (detrusor instability): a double-blind, randomised, multicentre, placebo-controlled study. *J Clin Res* 1998;1:439
- Alloussi SH, Mürtz G, Lang C, et al. Desmopressin treatment regimens in monosymptomatic and nonmonosymptomatic enuresis: A review from a clinical perspective. *J Pediatr Urol*. 2011 Feb;7(1):10-20.
- Alloussi SH, Mürtz G, Gitzhofer S, et al. Failure of monotherapy in primary monosymptomatic enuresis: a combined desmopressin and propiverine treatment regimen improves efficacy outcomes. *BJU Int*. 2009 Jun;103(12):1706-12.
- Altaweel W, Jednack R, Bilodeau C et al. Repeated intradetrusor botulinum toxin type A in children with neurogenic bladder due to myelomeningocele. *J Urol*. 2006 Mar;175(3 Pt 1):1102
- Altaweel W, Mokhtar A, Rabah DM. Prospective randomized trial of 100u vs 200u botox in the treatment of idiopathic overactive bladder. *Urol Ann*. 2011 May;3(2):66-70.
- Amarenco G, Marquis P, McCarthy C et al. Qualité de vie des femmes souffrant d'impériosité mictionnelle avec ou sans fuites: étude prospective après traitement par oxybutinine (1701 cas). *Presse Medicale*, 1998;27:5

- Amarenco G, Sutory M, Zachoal R, et al.. Solifenacin is effective and well tolerated in patients with neurogenic detrusor overactivity: Results from the double-blind, randomized, active- and placebo-controlled SONIC urodynamic study. *Neurourol Urodyn*. 2015 Dec 29. [Epub ahead of print]
- Amend B, Hennenlotter J, Schäfer T, et al. Effective treatment of neurogenic detrusor dysfunction by combined high-dosed antimuscarinics without increased side-effects. *Eur Urol*. 2008 May;53(5):1021-8.
- Amundsen CL, Richter HE, Menefee S, et al. The Refractory Overactive Bladder: Sacral NEuromodulation vs. BoTulinum Toxin Assessment: ROSETTA trial. *Contemp Clin Trials*. 2014 Mar;37(2):272-83.
- Ancelin ML, Artero S, Portet F et al. Non-degenerative mild cognitive impairment in elderly people and use of anticholinergic drugs: longitudinal cohort study. *BMJ* 2006;332:455
- Anderson RU, Mobley D, Blank B. et al. Once-daily controlled versus immediate-release oxybutynin chloride for urge urinary incontinence. OROS Oxybutynin Study Group. *J Urol* 1999;161:1809
- Andersson K-E: Current concepts in the treatment of disorders of micturition. *Drugs* 1988;35:477
- Andersson, K.-E. Pharmacology of lower urinary tract smooth muscles and penile erectile tissues. *Pharmacol Rev*, 45:253, 1993.
- Andersson K-E. Pathways for relaxation of detrusor smooth muscle. In: *Advances in Bladder Research*, ed by Baskin LS and Hayward SW, Kluwer Academic/Plenum Publishers, New York 1999, p 241
- Andersson KE. Bladder activation: afferent mechanisms. *Urology*. 2002a May;59(5 Suppl 1):43
- Andersson K-E. Potential benefits of muscarinic M3 receptor selectivity. *Eur Urol Suppl*, 2002b;1(4):23
- Andersson K-E. Alpha-adrenoceptors and benign prostatic hyperplasia: basic principles for treatment with alpha-adrenoceptor antagonists. *World J Urol* 2002c;19(6):390
- Andersson KE. Antimuscarinics for treatment of overactive bladder. *Lancet Neurol*. 2004 Jan;3(1):46
- Andersson KE. Treatment-resistant detrusor overactivity--underlying pharmacology and potential mechanisms. *Int J Clin Pract Suppl*. 2006 Dec;(151):8-16.
- Andersson KE. LUTS treatment: future treatment options. *Neurourol Urodyn*. 2007 Oct;26(6 Suppl):934-47.
- Andersson KE. Muscarinic acetylcholine receptors in the urinary tract. *Handb Exp Pharmacol*. 2011a;(202):319-44.
- Andersson KE. Antimuscarinic mechanisms and the overactive detrusor: an update. *Eur Urol*. 2011b Mar;59(3):377-86
- Andersson KE. Drugs and future candidates. *Can Urol Assoc J*. 2011c Oct;5(5 Suppl 2):S131-3.
- Andersson KE. Drug therapy of overactive bladder--what is coming next? *Korean J Urol*. 2015 Oct;56(10):673-9.
- Andersson KE. Intraprostatic injections for lower urinary tract symptoms treatment. *Curr Opin Urol*. 2015 Jan;25(1):12-8.
- Andersson KE. Purinergic signalling in the urinary bladder. *Auton Neurosci*. *Auton Neurosci*. 2015 Sep;191:78-81
- Andersson KE. The many faces of impaired bladder emptying. *Curr Opin Urol*. 2014 Jul;24(4):363-9.
- Andersson KE. Potential Future Pharmacological Treatment of Bladder Dysfunction. *Basic Clin Pharmacol Toxicol*. 2016 Mar 17. doi: 10.1111/bcpt.12577. [Epub ahead of print]
- Andersson KE, Appell R, Cardozo LD et al. The pharmacological treatment of urinary incontinence. *BJU Int* 1999 Dec;84(9):923
- Andersson KE, Arner A. Urinary bladder contraction and relaxation: physiology and pathophysiology. *Physiol Rev*. 2004 Jul;84(3):935-86.
- Andersson K-E, Chapple CR, Cardozo L, et al. Pharmacological treatment of urinary incontinence, in Abrams P, Khoury S, Wein A (Eds), *Incontinence, 4rd International Consultation on Incontinence*. Plymouth, Plymbridge Distributors Ltd, UK, Plymouth, p 633, 2009
- Andersson K-E, Chapple CR, Cardozo L et al. Pharmacological treatment of urinary incontinence, in Abrams P, Cardozo, Khoury S, Wein A (Eds), *Incontinence, 5th International Consultation on Incontinence*. ICUD-EAU pp 623-728, 2013
- Andersson KE, Campeau L, Olshansky B. Cardiac effects of muscarinic receptor antagonists used for voiding dysfunction. *Br J Clin Pharm* 2011;72:186-196.
- Andersson K-E, Chapple CR. Oxybutynin and the overactive bladder. *World J Urol* 2001;19(5):319
- Andersson KE, de Groat WC, McVary KT, et al. Tadalafil for the treatment of lower urinary tract symptoms secondary to benign prostatic hyperplasia: pathophysiology and mechanism(s) of action. *Neurourol Urodyn*. 2011 Mar;30(3):292-301
- Andersson K-E, Fullhase C, Soler R. Urothelial effects of oral antimuscarinic agents. *Current Urology Reports* 2008b Nov;9(6):459

- Andersson KE, Gratzke C. Pharmacology of alpha1-adrenoceptor antagonists in the lower urinary tract and central nervous system. *Nat Clin Pract Urol*. 2007 Jul;4(7):368-78.
- Andersson KE, Gratzke C, Hedlund P. The role of the transient receptor potential (TRP) superfamily of cation-selective channels in the management of the overactive bladder. *BJU Int*. 2010 Oct;106(8):1114-27.
- Andersson KE, Henriksson L, Ulmsten U. Effects of prostaglandin E2 applied locally on intravesical and intraurethral pressures in women. *Eur Urol*. 1978;4(5):366-9.
- Andersson K-E, Michel MC. *Urinary Tract. Handbook of Experimental Pharmacology*. Springer-Verlag. Berlin Heidelberg 2011
- Andersson KE, Pehrson R. CNS involvement in overactive bladder: pathophysiology and opportunities for pharmacological intervention. *Drugs*. 2003;63(23):2595
- Andersson KE, Olshansky B. Treating patients with overactive bladder syndrome with antimuscarinics: heart rate considerations. *BJU International* 2007;100:1007
- Andersson K-E, Persson K. The L-arginine/nitric oxide pathway and non-adrenergic, non-cholinergic relaxation of the lower urinary tract. 1993; *Gen Pharmacol* 24:833
- Andersson K-E, Uckert S, Stief C et al. Phosphodiesterases (PDEs) and PDE inhibitors for treatment of LUTS. *Neurourol Urodyn* 1997 Oct;26(6Suppl):928
- Andersson K-E, Wein AJ. Pharmacology of the lower urinary tract - basis for current and future treatments of urinary incontinence. *Pharmacol Rev* 2004 Dec; 56(4):581
- Andersson KE, Sarawate C, Kahler KH, et al. Cardiovascular morbidity, heart rates and use of antimuscarinics in patients with overactive bladder. *BJU Int*. 2010 Jul;106(2):268-74.
- Andersson K, Wein A. Pharmacologic management of lower urinary tract storage and emptying failure. In *Campbell-Walsh Urology* (Wein A, Kavoussi L, Novick A, Partin A, Peters C, eds), Elsevier Saunders, Philadelphia, 2012, pp1967-2002
- Andrews MD, Fish P v, Blagg J, et al. Pyrimido [4,5-d] azepines as potent and selective 5-HT_{2c} receptor agonists: design, synthesis and evaluation of PF-3246799 as a treatment for urinary incontinence. *Bioorg Med Chem Lett* 2011;21(9):2715-2720
- Aoki KR. Review of a proposed mechanism for the antinociceptive action of botulinum toxin type A. *Neurotoxicology*. 2005 Oct;26(5):785
- Aoki K, Hirayama A, Tanaka N, et al. A higher level of prostaglandin E2 in the urinary bladder in young boys and boys with lower urinary tract obstruction. *Biomed Res*. 2009 Dec;30(6):343-7.
- Apostolidis A, Brady CM, Yiangou Y, et al. Capsaicin receptor TRPV1 in urothelium of neurogenic human bladders and effect of intravesical resiniferatoxin. *Urology*. 2005 Feb;65(2):400-5.
- Apostolidis A, Dasgupta P, Denys P et al; European Consensus Panel. Recommendations on the use of botulinum toxin in the treatment of lower urinary tract disorders and pelvic floor dysfunctions: a European consensus report. *Eur Urol*. 2009 Jan;55(1):100-19.
- Apostolidis A, Gonzales GE, Fowler CJ, Effect of intravesical Resiniferatoxin (RTX) on lower urinary tract symptoms, urodynamic parameters, and quality of life of patients with urodynamic increased bladder sensation. *Eur Urol*. 2006 Dec;50(6):1299
- Apostolidis A, Jacques TS, Freeman A, et al. Histological changes in the urothelium and suburothelium of human overactive bladder following intradetrusor injections of botulinum neurotoxin type A for the treatment of neurogenic or idiopathic detrusor overactivity. *Eur Urol*. 2008 Jun;53(6):1245-53
- Apostolidis A, Kirana PS, Chiu G, et al. Gender and age differences in the perception of bother and health care seeking for lower urinary tract symptoms: results from the hospitalised and outpatients' profile and expectations study. *Eur Urol*. 2009 Dec;56(6):937-47.
- Apostolidis A, Popat R, Yiangou Y et al. Decreased sensory receptors P2X3 and TRPV1 in suburothelial nerve fibers following intradetrusor injections of botulinum toxin for human detrusor overactivity. *J Urol*. 2005 Sep;174(3):977
- Appell RA, Chancellor MB, Zobrist RH et al. Pharmacokinetics, metabolism, and saliva output during transdermal and extended-release oral oxybutynin administration in healthy subjects. *Mayo Clin Proc*, 2003;78(6):696, 2003.
- Appell RA, Sand P, Dmochowski R et al. Overactive bladder: judging effective control and treatment study group. Prospective randomized controlled trial of extended-release oxybutynin chloride and tolterodine tartrate in the treatment of overactive bladder: results of the OBJECT Study. *Mayo Clin Proc*, 2001;76(4):358
- Araki I. TRP channels in urinary bladder mechanosensation. *Adv Exp Med Biol*. 2011;704:861-79.
- Araki I, Du S, Kobayashi H, et al Roles of mechanosensitive ion channels in bladder sensory transduction and overactive bladder. *Int J Urol*. 2008 Aug;15(8):681-7.

- Arisco AM, Brantly EK, Kraus SR. Oxybutynin extended release for the management of overactive bladder: a clinical review. *Drug Des Devel Ther.* 2009 Sep 21;3:151-61.
- Asplund R, Sundberg B, Bengtsson P. Oral desmopressin for nocturnal polyuria in elderly subjects: a double-blind, placebo-controlled randomized exploratory study. *BJU Int* 1999;83:591
- Athanasopoulos A, Cruz F. The medical treatment of overactive bladder, including current and future treatments. *Expert Opin Pharmacother.* 2011 May;12(7):1041-55
- Athanasopoulos A, Gyftopoulos K, Giannitsas K et al. G. Combination treatment with an alpha-blocker plus an anticholinergic for bladder outlet obstruction: a prospective, randomized, controlled study. *J Urol* 2003; 169:2253
- Athwal BS, Berkley KJ, Hussain I. et al. Brain responses to changes in bladder volume and urge to void in healthy men. *Brain*, 2001;124(Pt 2):369
- Austin PF, Ferguson G, Yan Y, et al. Combination therapy with desmopressin and an anticholinergic medication for nonresponders to desmopressin for monosymptomatic nocturnal enuresis: a randomized, double-blind, placebo-controlled trial. *Pediatrics.* 2008 Nov;122(5):1027-32.
- Avelino A, Charrua A, Frias B, Cruz C, Boudes M, de Ridder D, Cruz F. Transient receptor potential channels in bladder function. *Acta Physiol (Oxf).* 2013 Jan;207(1):110-22
- Avelino A, Cruz F. TRPV1 (vanilloid receptor) in the urinary tract: expression, function and clinical applications. *Naunyn Schmiedeberg Arch Pharmacol.* 2006 Jul;373(4):287-99.
- Baber RJ, Panay N, Fenton A and the IMS Writing Group. 2016 IMS Recommendations on women's mid-life health and menopause hormone therapy. *Climacteric* 2016. Vol 19 No 2, 109-150
- Badawi JK, Seja T, Uecelehan H et al. Relaxation of human detrusor muscle by selective beta-2 and beta-3 agonists and endogenous catecholamines. *Urology.* 2007 Apr;69(4):785
- Bae JH, Oh MM, Shim KS et al. The effects of long-term administration of oral desmopressin on the baseline secretion of antidiuretic hormone and serum sodium concentration for the treatment of nocturia: a circadian study. *J. Urol* 2007;178(1):200
- Baigrie RJ, Kelleher JP, Fawcett DP et al. Oxybutynin: is it safe? *Br J Urol*, 1988;62:319
- Jonville AP, Dutertre JP, Autret E et al. Effets indésirables du chlorure d'oxybutynine (Ditropan®). *Thérapie* 1992;47:389
- Balchandra P, Rogerson L. Women's perspective: intra-detrusor botox versus sacral neuromodulation for overactive bladder symptoms after unsuccessful anticholinergic treatment. *Int Urogynecol J.* 2014 Aug;25(8):1059-64.
- Baldessarini KJ. Drugs in the treatment of psychiatric disorders. In: Gilman et al. (Eds.) *The pharmacological basis of therapeutics*, 7th ed., McMillan Publishing Co., p387, 1985
- Baldo A, Berger TH, Kofler M et al.: The influence of intrathecal baclofen on detrusor function. A urodynamic study. *NeuroUrol Urodyn*, 2000, 19, 444 (abstract 53).
- Banakhar MA, Al-Shaiji TF, Hassouna MM. Pathophysiology of overactive bladder. *Int Urogynecol J.* 2012 Aug;23(8):975-82.
- Barendrecht MM, Oelke M, Laguna MP et al. Is the use of parasympathomimetics for treating an underactive urinary bladder evidence-based? *BJU Int* 2007;99:749
- Basra RK, Wagg A, Chapple C et al. A review of adherence to drug therapy in patients with overactive bladder. *BJU Int* 2008; 102: 774 – 9
- Batista JE, Kölbl H, Herschorn Set al.; BEYOND study group. The efficacy and safety of mirabegron compared with solifenacin in overactive bladder patients dissatisfied with previous antimuscarinic treatment due to lack of efficacy: results of a noninferiority, randomized, phase IIIb trial. *Ther Adv Urol.* 2015 Aug;7(4):167-79.
- Bayliss M, Wu C, Newgreen D et al. A quantitative study of atropine-resistant contractile responses in human detrusor smooth muscle, from stable, unstable and obstructed bladders. *J Urol* 1999;162:1833
- Bechara A, Romano S, Casabe A et al. Comparative efficacy assessment of tamsulosin vs. tamsulosin plus tadalafil in the treatment of LUTS/BPH. Pilot study. *J Sex Med* 2008;5:2170-2178.
- Bechis SK, Kim MM, Wintner A, Kreydin, EI. Differential response to medical therapy for male lower urinary tract symptoms. *Curr Bladder Dysfunct Rep* 2015;10:177-85
- Beckel JM, Holstege G. Neuroanatomy of the lower urinary tract. *Handb Exp Pharmacol.* 2011;(202):99-116.
- Beckmann-Knopp S, Rietbrock S, Weyhenmeyer R et al. Inhibitory effects of trospium chloride on cytochrome P450 enzymes in human liver microsomes. *Pharmacol Toxicol*, 1999;(6):299
- Beermann B, Hellstrom K, Rosen A. On the metabolism of propantheline in man. *Clin Pharmacol Ther.* 1972; 13(2):212

- Behr-Roussel D, Oger S, Caisey S, et al. Vardenafil decreases bladder afferent nerve activity in unanesthetized, decerebrate, spinal cord-injured rats. *Eur Urol* 2010;59: 272-279.
- Bent A, Gousse A, Hendrix S. Duloxetine compared with placebo for the treatment of women with urinary incontinence. *Neurourol Urodyn* 2008;27(3):212-221
- Bent S, Tiedt TN, Odden MC, et al. The relative safety of ephedra compared with other herbal products. *Ann Intern Med.* 2003;138(6):468
- Berridge MJ. Smooth muscle cell calcium activation mechanisms. *J Physiol.* 2008 Nov 1;586(Pt 21):5047-61
- Bharucha AE, Seide B, Guan Z et al. Effect of tolterodine on gastrointestinal transit and bowel habits in healthy subjects. *Neurogastroenterol Motil.* 2008 Jun;20(6):643
- Biers SM, Reynard JM, Brading AF. The effects of a new selective beta3-adrenoceptor agonist (GW427353) on spontaneous activity and detrusor relaxation in human bladder. *BJU Int.* 2006 Dec;98(6):1310
- Bigger JT, Giardina EG, Perel JM et al. Cardiac antiarrhythmic effect of imipramine hydrochloride. *N Engl J Med* 1977;296:206
- Birder L, Andersson KE. Urothelial signaling. *Physiol Rev.* 2013 Apr;93(2):653-80
- Birder LA, de Groat WC. Mechanisms of disease: involvement of the urothelium in bladder dysfunction. *Nat Clin Pract Urol.* 2007 Jan;4(1):46-54.
- Birder LA, Kanai AJ, de Groat WC, et al. Vanilloid receptor expression suggests a sensory role for urinary bladder epithelial cells. *Proc Natl Acad Sci U S A.* 2001 Nov 6;98(23):13396-401.
- Birder LA, Nakamura Y, Kiss S, et al. Altered urinary bladder function in mice lacking the vanilloid receptor TRPV1. *Nat Neurosci.* 2002 Sep;5(9):856-60.
- Blaivas JG, Labib KB, Michalik J et al. Cystometric response to propantheline in detrusor hyperreflexia: therapeutic implications. *J Urol,* 1980;124:259
- Blok BF, Sturms LM, Holstege G. Brain activation during micturition in women. *Brain,* 1998;121 (Pt 11):2033
- Blue DR, Daniels DV, Gever JR et al. Pharmacological characteristics of Ro 115-1240, a selective? 1A-1L- adrenoceptor partial agonist: a potential therapy for stress urinary incontinence. *BJU Int* 2004;93(1):162
- Blyweert W, Van Der Aa F, De Ridder D. Cannabinoid therapy in detrusor overactivity: local versus systemic effect in a spinalised rat model. *Neurourol Urodyn* 2003;22:379–80.
- Bödeker RH, Madersbacher H, Neumeister C, Zellner M. Dose escalation improves therapeutic outcome: post hoc analysis of data from a 12-week, multicentre, double-blind, parallel-group trial of trosipium chloride in patients with urinary urge incontinence. *BMC Urol.* 2010 Sep 14;10:15.
- Bolduc S, Moore K, Lebel S, Lamontagne P, Hamel M. Double anticholinergic therapy for refractory overactive bladder. *J Urol.* 2009 Oct;182(4 Suppl):2033-8.
- Bolduc S, Moore K, Nadeau G, et al. Prospective open label study of solifenacin for overactive bladder in children. *J Urol.* 2010 Oct;184(4 Suppl):1668-73.
- Bosch R, J LH, Griffiths DJ, Blom JHM et al. Treatment of benign prostatic hyperplasia by androgen deprivation: effects on prostate size and urodynamic parameters. *J Urol* 1989;141:68
- Bosch JL, Weiss JP. The Prevalence and Causes of Nocturia. *J Urol* 2010;184(2): 440-446.
- Bougas DA, Mitsogiannis IC, Mitropoulos DN, et al. Clinical efficacy of distigmine bromide in the treatment of patients with underactive detrusor. *Int Urol Nephrol.* 2004;36(4):507-12.
- Boy S, Seif C, Braun PM et al. Retrospective Analysis of treatment outcomes and medical care of patients with neurogenic detrusor overactivity (NDO) receiving BOTOX therapy. *European Urology Supplements,* 2008;7 (3):212
- Brady CM, Apostolidis AN, Harper M et al. Parallel changes in bladder suburothelial vanilloid receptor TRPV1 and pan-neuronal marker PGP9.5 immunoreactivity in patients with neurogenic detrusor overactivity after intravesical resiniferatoxin treatment. *BJU Int.* 2004a Apr;93(6):770
- Brady CM, Apostolidis A, Yiangou Y, Baecker PA, Ford AP, Freeman A, Jacques TS, Fowler CJ, Anand P. P2X3-immunoreactive nerve fibres in neurogenic detrusor overactivity and the effect of intravesical resiniferatoxin. *Eur Urol.* 2004c Aug;46(2):247-53.
- Brady CM, DasGupta R, Dalton C, et al. An open-label pilot study of cannabis-based extracts for bladder dysfunction in advanced multiple sclerosis. *Mult Scler* 2004b;10:425–33.
- Braverman AS, Doumanian LR, Ruggieri MR, Sr. M2 and M3 muscarinic receptor activation of urinary bladder contractile signal transduction. II. Denervated rat bladder. *J Pharmacol Exp Ther,* 2006;316:875
- Braverman AS, Karlovsky M, Pontari MA et al. Aging and hypertrophy change the muscarinic receptor subtype mediating bladder contraction from M3 towards M2. *J Urol* 2002;167 Suppl.: Abstract #170.
- Braverman AS, Kohn IJ, Luthin GR et al. Prejunctional M1 facilitatory and M2 inhibitory muscarinic receptors mediate rat bladder contractility. *Am J Physiol* 1998a;274: R517

- Braverman AS, Luthin GR, Ruggieri MR. M2 muscarinic receptor contributes to contraction of the denervated rat urinary bladder. *Am J Physiol*, 1998b;275:R1654
- Braverman AS, Ruggieri MR, Sr. Hypertrophy changes the muscarinic receptor subtype mediating bladder contraction from M3 toward M2. *Am J Physiol*, 2003;285:R701
- Brennan PE, Whitlock GA, Ho DK, et al. Discovery of a novel azepine series of potent and selective 5-HT_{2c} agonists as potential treatments for urinary incontinence. *Bioorg Med Chem Lett*, 2009;19:4999-5003
- Bridgewater M, Brading AF. Evidence for a non-nitroergic inhibitory innervation in the pig urethra. *NeuroUrol Urodyn*, 1993;12:357
- Briggs KS, Castleden CM, Asher MJ. The effect of flavoxate on uninhibited detrusor contractions and urinary incontinence in the elderly. *J Urol*, 1980;123:665
- Brubaker L, FitzGerald MP. Nocturnal polyuria and nocturia relief in patients treated with solifenacin for overactive bladder symptoms. *Int Urogynecol J Pelvic Floor Dysfunct*. 2007 Jul;18(7):737
- Brubaker L, Richter HE, Visco A et al. Pelvic Floor Disorders Network, Refractory idiopathic urge urinary incontinence and botulinum A injection. *J Urol*. 2008 Jul;180(1):217
- Brynne N, Dalen P, Alvan G et al. Influence of CYP2D6 polymorphism on the pharmacokinetics and pharmacodynamics of tolterodine. *Clin Pharmacol Ther* 1998;63:529
- Brynne N, Stahl MMS, Hallén B et al. J. Pharmacokinetics and pharmacodynamics of tolterodine in man: a new drug for the treatment of urinary bladder overactivity. *Int J Clin Pharmacol Ther* 1997;35:287
- Bschleipfer T, Schukowski K, Weidner W, et al. Expression and distribution of cholinergic receptors in the human urothelium. *Life Sci* 2007;80:2303
- Buckley BS, Lapitan MC. Drugs for treatment of urinary retention after surgery in adults. *Cochrane Database Syst Rev*. 2010 Oct 6;(10):CD008023.
- Bump RC, Voss S, Beardsworth A et al. Long-term efficacy of duloxetine in women with stress urinary incontinence. *Br J Urol Int* 2008;102:214
- Burger M, Betz D, Hampel C, Vogel M. Efficacy and tolerability of solifenacin in men with overactive bladder: results of an observational study. *World J Urol*. 2014 Aug;32(4):1041-7
- Burgio KL, Locher JL, Goode PS. Combined behavioral and drug therapy for urge incontinence in older women. *J Am Geriatr Soc*. 2000;48:370-4.
- Burnstock G. Purinergic signalling in the urinary tract in health and disease. *Purinergic Signal*. 2014 Mar;10(1):103-55
- Burnstock G. Purinergic signalling in the lower urinary tract. *Acta Physiol (Oxf)*. 2013 Jan;207(1):40-52
- Bushman W, Steers WD, Meythaler JM, Voiding dysfunction in patients with spastic paraplegia: urodynamic evaluation and response to continuous intrathecal baclofen. *NeuroUrol Urodyn*. 1993;12(2):163
- Buser N, Ivic S, Kessler TM, Kessels AG, Bachmann LM. Efficacy and adverse events of antimuscarinics for treating overactive bladder: network meta-analyses. *Eur Urol*. 2012 Dec;62(6):1040-60.
- Caine M, Gin S, Pietra C et al. Antispasmodic effects of flavoxate, MFCA, and REC 15/2053 on smooth muscle of human prostate and urinary bladder. *Urology* 1991;37(4):390
- Caldwell PH, Sureshkumar P, Wong WC. Tricyclic and related drugs for nocturnal enuresis in children. *Cochrane Database Syst Rev* 2016 Jan; (1) CD002117.
- Caldwell PH, Sureshkumar P, Wong WC. Tricyclic and related drugs for nocturnal enuresis in children. *Cochrane Database Syst Rev* 2016 Jan; (1) CD002117.
- Callegari E, Malhotra B, Bungay PJ, et al. A comprehensive non-clinical evaluation of the CNS penetration potential of antimuscarinic agents for the treatment of overactive bladder. *Br J Clin Pharmacol* 2011;72:235-46.
- Callreus T, Ekman E, Andersen M. Hyponatremia in elderly patients treated with desmopressin for nocturia: a review of a case series. *Eur. J. Clin. Pharmacol* 2005;61(4):281
- Campbell N, Boustani M, Limbil T, et al. The cognitive impact of anticholinergics: a clinical review. *Clin Interv Aging*. 2009;4:225-33.
- Campbell N, Perkins A, Hui S, et al. Association between prescribing of anticholinergic medications and incident delirium: a cohort study. *J Am Geriatr Soc*. 2011;59 Suppl 2:S277-81.
- Candura SM, Messori E, Franceschetti GP, et al. Neural 5-HT₄ receptors in the human isolated detrusor muscle: effects of indole, benzimidazolone and substituted benzamide agonists and antagonists. *Br J Pharmacol*. 1996 Aug;118(8):1965-70.
- Cannon A, Carter PG, McConnell AA et al. Desmopressin in the treatment of nocturnal polyuria in the male. *BJU Int* 1999; 84:20
- Cao DS, Yu SQ, Premkumar LS. Modulation of transient receptor potential Vanilloid 4-mediated membrane currents and synaptic transmission by protein kinase C. *Mol Pain*. 2009 Feb 10;5:5.

- Capo JP, Lucente V, Forero-Schwanhaeuser S, He W. Efficacy and tolerability of solifenacin in patients aged ≥ 65 years with overactive bladder: post-hoc analysis of 2 open-label studies. *Postgrad Med*. 2011 Jan;123(1):94-104.
- Capobianco G, Donolo E, Borghero G, et al.. Effects of intravaginal oestriol and pelvic floor rehabilitation on urogenital aging in postmenopausal women. *Arch Gynecol Obstet* 2012. Feb 285(2) 397-403
- Carbone A, Palleschi G, Conte A et al. Gabapentin treatment of neurogenic overactive bladder. *Clin Neuropharmacol*. 2006 Jul-Aug;29(4):206
- Cardozo L, Amarengo G, Pushkar D, et al.; SUNRISE Study Group. Severity of overactive bladder symptoms and response to dose escalation in a randomized, double-blind trial of solifenacin (SUNRISE). *BJU Int*. 2013 May;111(5):804-10.
- Cardozo LD, Bachmann G, McClish D, et al. Meta-analysis of oestrogen therapy in the management of urogenital atrophy in postmenopausal women: Second report of the Hormones and Urogenital Therapy Committee. *Obstet Gynaecol* 1998; 92: 722-727
- Cardozo L, Castro-Diaz D, Gittelman M et al. Reductions in overactive bladder-related incontinence from pooled analysis of phase III trials evaluating treatment with solifenacin. *Int Urogynecol J Pelvic Floor Dysfunct*. 2006 Sep;17(5):512
- Cardozo L, Chapple CR, Toozs-Hobson P, et al. Efficacy of trospium chloride in patients with detrusor instability: a placebo-controlled, randomized, double-blind, multicentre clinical trial. *BJU Int* 2000;85(6):659
- Cardozo L, Dixon A. Increased warning time with darifenacin: a new concept in the management of urinary urgency. *J Urol*. 2005 Apr;173(4):1214
- Cardozo L, Drutz HP, Baygari SK, et al. Pharmacological treatment of women awaiting surgery for stress urinary incontinence. *Obstet Gynecol* 2004b;104(3):511-519
- Cardozo L, Hessdörfer E, Milani R, et al.; SUNRISE Study Group. Solifenacin in the treatment of urgency and other symptoms of overactive bladder: results from a randomized, double-blind, placebo-controlled, rising-dose trial. *BJU Int*. 2008 Nov;102(9):1120-7
- Cardozo L, Lisec M, Millard R et al. Randomized, double-blind placebo controlled trial of the once daily antimuscarinic agent solifenacin succinate in patients with overactive bladder. *J Urol*. 2004 Nov;172(5 Pt 1):1919
- Cardozo L, Lose G, McClish D et al. A systematic review of the effects of estrogens for symptoms suggestive of overactive bladder. *Acta Obstet Gynaecol Scand* 2004a;83:892
- Cardozo L, Rekers H, Tapp A et al. Oestriol in the treatment of postmenopausal urgency: a multicentre study. *Maturitas* 1993;18:47
- Cardozo LD, Stanton SL, Robinson H et al. Evaluation on flurbiprofen in detrusor instability. *Br Med J* 1980a;280:281
- Cardozo LD, Stanton SL. A comparison between bromocriptine and indomethacin in the treatment of detrusor instability. *J Urol* 1980b;123:39
- Caremel R, Oger-Roussel S, Behr-Roussel D et al. Nitric oxide/cyclic guanosine monophosphate signalling mediates an inhibitory action on sensory pathways of the micturition reflex in the rat. *Eur Urol* 2010;58:616-625.
- Cartwright R, Cardozo L. Transdermal oxybutynin: sticking to the facts. *Eur Urol*. 2007 Apr;51(4):907
- Cartwright R, Srikrishna S, Cardozo L, Robinson D. Patient-selected goals in overactive bladder: a placebo controlled randomized double-blind trial of transdermal oxybutynin for the treatment of urgency and urge incontinence. *BJU Int*. 2011 Jan;107(1):70-6.
- Castleden CM, Morgan B. The effect of β -adrenoceptor agonists on urinary incontinence in the elderly. *Br J Clin Pharmacol* 1980;10:619
- Catterall WA, Striessnig J, Snutch TP et al. International Union of Pharmacology. XL. Compendium of voltage-gated ion channels: calcium channels. *Pharmacol Rev* 2003;55:579
- Caulfield MP, Birdsall NJM. International Union of Pharmacology. XVII. Classification of muscarinic acetylcholine receptors. *Pharmacol Rev* 1998;50:279
- Cazzulani P, Pietra C, Abbiati GA et al. Pharmacological activities of the main metabolite of flavoxate 3-methylflavone-8-carboxylic acid. *Arzneimittelforschung*, 1988;38(3):379
- Cellek S, Cameron NE, Cotter MA, et al. Microvascular dysfunction and efficacy of PDE5 inhibitors in BPH-LUTS. *Nat Rev Urol*. 2014 Apr;11(4):231-41.
- Chai TC, Gray ML, Steers WD, The incidence of a positive ice water test in bladder outlet obstructed patients: evidence for bladder neural plasticity. *J Urol*. 1998 Jul;160(1):34
- Chancellor MB. The overactive bladder progression to underactive bladder hypothesis. *Int Urol Nephrol*. 2014 Sep;46 Suppl 1:S23-7
- Chancellor MB, Appell RA, Sathyan G et al. A comparison of the effects on saliva output of oxybutynin chloride and tolterodine tartrate. *Clin Ther* 2001;23(5):753
- Chancellor MB, Atan A, Rivas DA et al. Beneficial effect of intranasal desmopressin for men with benign prostatic hyperplasia and nocturia: preliminary results. *Tech Urol*, 1999;5:191

- Chancellor MB, de Miguel F. Treatment of overactive bladder: selective use of anticholinergic agents with low drug-drug interaction potential. *Geriatrics* 2007;62:15-24.
- Chancellor MB, Fowler CJ, Apostolidis A et al. Drug Insight: biological effects of botulinum toxin A in the lower urinary tract. *Nat Clin Pract Urol*. 2008b Jun;5(6):319
- Chancellor MB, Kaufman J. Case for pharmacotherapy development for underactive bladder *J Urol* 2008c;72(5):966-967
- Chancellor MB, Kianifard F, Beamer E et al. A comparison of the efficacy of darifenacin alone vs. darifenacin plus a Behavioural Modification Programme upon the symptoms of overactive bladder. *Int J Clin Pract*. 2008a Apr;62(4):606
- Chancellor MB, Oefelein MG, Vasavada S. Obesity is associated with a more severe overactive bladder disease state that is effectively treated with once-daily administration of trospium chloride extended release. *Neurourol Urodyn*. 2010 Apr;29(4):551-4.
- Chancellor MB, Patel V, Leng WW, et al. OnabotulinumtoxinA improves quality of life in patients with neurogenic detrusor overactivity. *Neurology*. 2013 Aug 27;81(9):841-8.
- Chancellor MB, Staskin DR, Kay GG, et al. Blood-brain barrier permeation and efflux exclusion of anticholinergics used in the treatment of overactive bladder. *Drugs Aging*. 2012 Apr 1;29(4):259-73.
- Chancellor MB, Yehoshua A, Waweru C, et al. Limitations of anticholinergic cycling in patients with overactive bladder (OAB) with urinary incontinence (UI): results from the CONsequences of Treatment Refractory Overactive bLadder (CONTROL) study. *Int Urol Nephrol*. 2016 Jul;48(7):1029-36.
- Chang SC, Lin AT, Chen KK, Chang LS. Multifactorial nature of male nocturia. *Urology*. 2006 Mar;67(3):541-4.
- Chapple CR, Abrams P, Andersson KE, et al. Phase II study on the efficacy and safety of the EP1 receptor antagonist ONO-8539 for nonneurogenic overactive bladder syndrome. *J Urol*. 2014 Jan;191(1):253-60.
- Chapple CR, Arano P, Bosch JL et al. Solifenacin appears effective and well tolerated in patients with symptomatic idiopathic detrusor overactivity in a placebo- and tolterodine-controlled phase 2 dose-finding study. 2004a;BJU Int, 93(1):71
- Chapple CR, Cardozo L, Steers WD et al. Solifenacin significantly improves all symptoms of overactive bladder syndrome. *Int J Clin Pract*. 2006 Aug;60(8):959
- Chapple CR, Cardozo L, Nitti VW, Siddiqui E, Michel MC. Mirabegron in overactive bladder: a review of efficacy, safety, and tolerability. *Neurourol Urodyn*. 2014 Jan;33(1):17-30.
- Chapple C, DuBeau C, Ebinger U et al. Long-term darifenacin treatment for overactive bladder in patients aged 65 years and older: analysis of results from a 2-year, open-label extension study. *Curr Med Res Opin*. 2007 Nov;23(11):2697
- Chapple CR, Fianu-Jonsson A, Indig M et al.; STAR study group. Treatment outcomes in the STAR study: a subanalysis of solifenacin 5 mg and tolterodine ER 4 mg. *Eur Urol*. 2007 Oct;52(4):1195
- Chapple CR, Kaplan SA, Mitcheson D, et al. Randomized double-blind, active-controlled phase 3 study to assess 12-month safety and efficacy of mirabegron, a $\beta(3)$ -adrenoceptor agonist, in overactive bladder. *Eur Urol*. 2013 Feb;63(2):296-305.
- Chapple C, Khullar V, Gabriel Z et al. The effects of antimuscarinic treatments in overactive bladder: a systematic review and meta-analysis. *Eur Urol* 2005;48:5
- Chapple CR, Khullar V, Gabriel Z et al. The effects of antimuscarinic treatments in overactive bladder: an update of a systematic review and meta-analysis. *Eur Urol*. 2008b Sep;54(3):543
- Chapple CR, Martinez-Garcia R, Selvaggi L et al. A comparison of the efficacy and tolerability of solifenacin succinate and extended release tolterodine at treating overactive bladder syndrome: results of the STAR trial. *Eur Urol*. 2005 Sep;48(3):464
- Chapple C, Milsom I. Urinary incontinence and pelvic prolapse: Epidemiology and pathophysiology. In Campbell-Walsh Urology (Wein A, Kavoussi L, Novick A, Partin A, Peters C, eds), Elsevier Saunders, Philadelphia, 2012, pp 1871-1908
- Chapple CR, Montorsi F, Tammela TLJ, et al. on behalf of the European Silodosin Study Group. Silodosin therapy for lower urinary tract symptoms in men with suspected benign prostatic hyperplasia: results of an international, randomized, double-blind, placebo- and active-controlled clinical trial performed in Europe. *Eur Urol*. 2011 Mar;59(3):342-52.
- Chapple CR, Parkhouse H, Gardener C et al. Double-blind, placebo-controlled, cross-over study of flavoxate in the treatment of idiopathic detrusor instability. *Br J Urol* 1990;66:491
- Chapple C, Patel A. Botulinum toxin--new mechanisms, new therapeutic directions? *Eur Urol*. 2006 Apr;49(4):606-8.
- Chapple CR, Patroneva A, Raines SR. Effect of an ATP-sensitive potassium channel opener in subjects with overactive bladder: a randomized, double-blind, placebo-controlled study (ZD09471L/0004). *Eur Urol* 2006; 49: 879

- Chapple CR, Rechberger T, Al-Shukri, S et al. YM-905 Study Group. Randomized, double-blind placebo- and tolterodine-controlled trial of the once-daily antimuscarinic agent solifenacin in patients with symptomatic overactive bladder. *BJU Int* 2004b;93(3):303
- Chapple C, Schneider T, Haab F, et al. Superiority of fesoterodine 8 mg vs 4 mg in reducing urgency urinary incontinence episodes in patients with overactive bladder: results of the randomised, double-blind, placebo-controlled EIGHT trial. *BJU Int*. 2014 Sep;114(3):418-26
- Chapple C, Sievert KD, MacDiarmid S, et al. OnabotulinumtoxinA 100 U significantly improves all idiopathic overactive bladder symptoms and quality of life in patients with overactive bladder and urinary incontinence: a randomised, double-blind, placebo-controlled trial. *Eur Urol*. 2013 Aug;64(2):249-56.
- Chapple C, Steers W, Norton P et al. A pooled analysis of three phase III studies to investigate the efficacy, tolerability and safety of darifenacin, a muscarinic M3 selective receptor antagonist, in the treatment of overactive bladder. *BJU Int*. 2005 May;95(7):993
- Chapple CR, Van Kerrebroeck PE, Jünemann KP et al. Comparison of fesoterodine and tolterodine in patients with overactive bladder. *BJU Int*. 2008c Jul 21. [Epub ahead of print]
- Chapple C, Van Kerrebroeck P, Tubaro A et al. Clinical efficacy, safety, and tolerability of once-daily fesoterodine in subjects with overactive bladder. *Eur Urol*. 2007 Oct;52(4):1204
- Chapple CR, Yamaguchi O, Ridder A et al. Clinical proof of concept study (Blossom) shows novel $\beta 3$ adrenoceptor agonist YM178 is effective and well tolerated in the treatment of symptoms of overactive bladder. *Eur Urol Suppl* 2008b;7(3):239 (abstract 674)
- Chapple C, Wyndaele JJ, van Kerrebroeck P, et al. Dose-ranging study of once-daily mirabegron (YM178), a novel selective $\beta 3$ adrenoceptor agonist, in patients with overactive bladder (OAB). *Eur Urol* 2010;(Suppl 9):249.
- Charrua A, Cruz CD, Cruz F, Avelino A. Transient receptor potential vanilloid subfamily 1 is essential for the generation of noxious bladder input and bladder overactivity in cystitis. *J Urol*. 2007 Apr;177(4):1537-41.
- Charrua A, Cruz CD, Narayanan S, et al. GRC-6211, a new oral specific TRPV1 antagonist, decreases bladder overactivity and noxious bladder input in cystitis animal models. *J Urol*. 2009b Jan;181(1):379-86.
- Charrua A, Reguenga C, Cordeiro JM, et al. Functional transient receptor potential vanilloid 1 is expressed in human urothelial cells. *J Urol*. 2009a Dec;182(6):2944-50.
- Charrua A., Boudes M., de Ridder D., et al. TRPV1 and TRPV4 expression in bladder neurons during normal condition and during cystitis. *European Urology Supplements*, Volume 11, Issue 1, February 2012a, Page e366
- Charrua A., Cruz CD., Cruz F. TRPV1 and TRPV4 antagonist have synergistic effect for treating bladder overactivity in rats. *European Urology Supplements*, Volume 11, Issue 1, February 2012b, Page e366
- Charrua A, Matos R, Marczylo T, Nagy I, Cruz F. Measurement of endocannabinoids levels during treatment of bladder hyperactivity induced by cystitis with FAAH inhibitors and evaluation of the cannabinoid receptor and TRPV1 roles. *European Urology Supplements* 15(3):e274-e274a · March 2016
- Chartier-Kastler E, Denys P, Kepenne V, et al. Efficacy and safety of onabotulinumtoxinA 100 U for treatment of urinary incontinence due to neurogenic detrusor overactivity in non-catheterising multiple sclerosis patients. Abstract 647 EAU Munich 2016
- Chen TY, Corcos J, Camel M, et al. Prospective, randomized, double-blind study of safety and tolerability of intravesical resiniferatoxin (RTX) in interstitial cystitis (IC). *Int Urogynecol J Pelvic Floor Dysfunct*. 2005 Jul-Aug;16(4):293-7.
- Chess-Williams R. Muscarinic receptors of the urinary bladder: detrusor, urothelial and prejunctional. *Auton Autacoid Pharmacol* 2002;22:133
- Chess-Williams R, Chapple CR, Yamanishi T et al. The minor population of M3-receptors mediate contraction of human detrusor muscle in vitro. *J Auton Pharmacol*, 2001;21:243
- Chew ML, Mulsant BH, Pollock BG et al. Anticholinergic activity of 107 medications commonly used by older adults. *J Am Geriatr Soc*. 2008 May 26. Epub ahead of publication.
- Choo MS, Doo CK, Lee KS. Satisfaction with tolterodine: assessing symptom-specific patient-reported goal achievement in the treatment of overactive bladder in female patients (STARGATE study). *Int J Clin Pract*. 2008 Feb;62(2):191
- Christ GJ, Andersson KE. Rho-kinase and effects of Rho-kinase inhibition on the lower urinary tract. *Neurourol Urodyn*. 2007 Oct;26(6 Suppl):948
- Christ GJ, Day NS, Day M, et al. Bladder injection of "naked" hSlo/pcDNA3 ameliorates detrusor hyperactivity in obstructed rats in vivo. *Am J Physiol Regul Integr Comp Physiol*. 2001 Nov;281(5):R1699-709.
- Christ T, Wettwer E, Wuest M, et al. Electrophysiological profile of propiverine--relationship to cardiac risk. *Naunyn Schmiedeberg Arch Pharmacol*. 2008 Feb;376(6):431-40.

- Chuang YC, Chiang PH, Huang CC, et al. Botulinum toxin type A improves benign prostatic hyperplasia symptoms in patients with small prostate. *Urology*. 2005;66: 775 – 779.
- Chuang YC, Tu CH, Huang CC, et al. Intraprostatic injection of botulinum toxin type-A relieves bladder outlet obstruction in human and induces prostate apoptosis in dogs. *BMC Urol*, 2006b; 6:12.
- Chuang YC, Chancellor MB. The application of botulinum toxin in the prostate. *J Urol*, 2006d;176: 2375 – 2382.
- Chuang YC, Chiang PH, Yoshimura N, et al. Sustained beneficial effects of intraprostatic botulinum toxin type A on lower urinary tract symptoms and quality of life in men with benign prostatic hyperplasia. *BJU Int*, 2006c;98: 1033 – 1037.
- Chuang YC, Thomas CA, Tyagi S, et al.: Human urine with solifenacin intake but not tolterodine or darifenacin intake blocks detrusor overactivity. *Int Urogynecol J Pelvic Floor Dysfunct* 2008 Oct;19(10):1353
- Chuang YC, Tyagi P, Huang CC, et al. Urodynamic and immunohistochemical evaluation of intravesical botulinum toxin A delivery using liposomes. *J Urol*. 2009 Aug;182(2):786-92.
- Chung DE, Te AE, Staskin DR, Kaplan SA. Efficacy and safety of tolterodine extended release and dutasteride in male overactive bladder patients with prostates >30 grams. *Urology*. 2010 May;75(5):1144-8.
- Citeri M, Spinelli M, Zanollo L et al. Botulinum toxin into the trigone in neurogenic overactive bladder non responder to detrusor injection. *Eur Urol Suppl*, 2008:7 (3):213
- Clemett D, Jarvis B. Tolterodine: a review of its use in the treatment of overactive bladder. *Drugs Aging*, 2001;18(4):277
- Cockayne DA, Hamilton SG, Zhu QM et al. Urinary bladder hyporeflexia and reduced pain-related behaviour in P2X3-deficient mice. *Nature*, 2000;407(6807):1011
- Cody JD, Jacobs ML, Richardson K, Moehrer B, Hextall A.. Oestrogen therapy for urinary incontinence in post-menopausal women. *Cochrane Database Syst Rev*. 2012 Oct 17;10:CD001405
- Coelho A, Dinis P, Pinto R, Gorgal et al. Distribution of the high-affinity binding site and intracellular target of botulinum toxin type A in the human bladder. *Eur Urol*. 2010 May;57(5):884-90.
- Coelho A, Cruz F, Cruz CD, Avelino A. Spread of OnabotulinumtoxinA After Bladder Injection. Experimental Study Using the Distribution of Cleaved SNAP-25 as the Marker of the Toxin Action. *Eur Urol*. 2012a Jun;61(6):1178-84.
- Coelho A, Cruz F, Cruz CD, Avelino A. Effect of onabotulinumtoxinA on intramural parasympathetic ganglia: an experimental study in the guinea pig bladder. *J Urol*. 2012b; 187(3):1121-6.
- Cohen BL, Barboglio P, Rodriguez D, Gousse AE. Preliminary results of a dose-finding study for botulinum toxin-A in patients with idiopathic overactive bladder: 100 versus 150 units. *Neurourol Urodyn*. 2009;28(3):205-8.
- Collado Serra A, Rubio-Briones J, Puyol Payás M, et al. Postprostatectomy established stress urinary incontinence treated with duloxetine. *Urology*. 2011 Aug;78(2):261-6.
- Collas D, Malone-Lee JG. The pharmacokinetic properties of rectal oxybutynin - a possible alternative to intravesical administration. *Neurourol Urodyn* 1997;16:346
- Colli E, Digesu GA, Olivieri L. Overactive bladder treatments in early phase clinical trials. *Expert Opin Investig Drugs*. 2007 Jul;16(7):999-1007.
- Colli E, Rigatti P, Montorsi F et al. BXL628, a novel vitamin D3 analog arrests prostate growth in patients with benign prostatic hyperplasia: a randomized clinical trial. *Eur Urol*. 2006 Jan;49(1):82
- Colli E, Tankó LB. Gonadotropin-Releasing Hormone Antagonists: From Basic Science to the Clinic in Patients With Benign Prostatic Hyperplasia and Lower Urinary Tract Symptoms. *UroToday Int J*. 2010 Oct;3(5) doi:10.3834/uij.1944-5784.2010.10.14
- Compérat E, Reitz A, Delcourt A et al. Histologic features in the urinary bladder wall affected from neurogenic overactivity--a comparison of inflammation, oedema and fibrosis with and without injection of botulinum toxin type A. *Eur Urol*. 2006 Nov;50(5):1058
- Conlon K, Christy C, Westbrook S, et al. Pharmacological properties of 2-((R-5-chloro-4-methoxymethyl-indan-1-yl)-1H-imidazole (PF-3774076), a novel and selective alpha_{1A}-adrenergic partial agonist, in vitro and in vivo models of urethral function. *J Pharmacol Exp Ther* 2009;330(3):892-901
- Connolly MJ, Astridge PS, White EG, Morley CA, Cowan JC. Torsades de pointes ventricular tachycardia and terodiline. *Lancet*. 1991 Aug 10;338(8763):344
- Copas PM, Bukovsky A, Asubyr B et al. Estrogen, progesterone and androgen receptor expression in levator ani muscle and fascia. *J Womens Health Gen Based Med* 2001;10(8):785
- Corcos J, Al-Taweel W, Pippi Salle J et al. The Treatment of detrusor hyperreflexia using botulinum A toxin in myelomeningocele patients unresponsive to anticholinergic International Continence Society Annual Meeting. 2002: Abstract 39

- Corcos J, Casey R, Patrick A et al. A double-blind randomized dose-response study comparing daily doses of 5, 10 and 15 mg controlled-release oxybutynin: balancing efficacy with severity of dry mouth. *BJU Int.* 2006 Mar;97(3):520
- Cornu J-N, Merlet B, Ciofu C, et al. Duloxetine for mild to moderate postprostatectomy incontinence: preliminary results of a randomized, placebo-controlled trial. *Eur Urol* 2011;59(1):148-154
- Covenas R, Martin F, Belda M et al. Mapping of neurokinin-like immunoreactivity in the human brainstem. *BMC Neurosci* Febr 4(1):3
- Coyne KS, Elinoff V, Gordon DA et al. Relationships between improvements in symptoms and patient assessments of bladder condition, symptom bother and health-related quality of life in patients with overactive bladder treated with tolterodine. *Int J Clin Pract.* 2008 Jun;62(6):925
- Crawford ED, Hirst K, Kusek JW, et al. Effects of 100 and 300 units of onabotulinum toxin A on lower urinary tract symptoms of benign prostatic hyperplasia: a phase II randomized clinical trial. *J Urol*, 2011;186: 965 – 970.
- Crescioli C, Ferruzzi P, Caporali A et al. Inhibition of spontaneous and androgen-induced prostate growth by a nonhypercalcemic calcitriol analog. *Endocrinology.* 2003 Jul;144(7):3046
- Crescioli C, Ferruzzi P, Caporali A et al. Inhibition of prostate cell growth by BXL-628, a calcitriol analogue selected for a phase II clinical trial in patients with benign prostate hyperplasia. *Eur J Endocrinol.* 2004 Apr;150(4):591
- Crescioli C, Morelli A, Adorini L, et al. Human bladder as a novel target for vitamin D receptor ligands. *J Clin Endocrinol Metab.* 2005 Feb;90(2):962-72.
- Crescioli C, Villari D, Forti G, et al. Des (1-3) IGF-I-stimulated growth of human stromal BPH cells is inhibited by a vitamin D3 analogue. *Mol Cell Endocrinol.* 2002 Dec 30;198(1-2):69-75.
- Creta M, Bottone F, Sannino S, et al. Effects of alpha1-blockers on urodynamic parameters of bladder outlet obstruction in patients with lower urinary tract symptoms suggestive of benign prostatic enlargement: a review. *Minerva Urol Nefrol.* 2015 Oct 27. [Epub ahead of print]
- Cruz F. Targets for botulinum toxin in the lower urinary tract. *NeuroUrol Urodyn.* 2014 Jan;33(1):31-8.
- Cruz F, Guimarães M, Silva C et al. Suppression of bladder hyperreflexia by intravesical resiniferatoxin. *Lancet.* 1997 Aug 30; 350 (9078):640
- Cruz F, Herschorn S, Aliotta P, et al. Efficacy and safety of onabotulinumtoxinA in patients with urinary incontinence due to neurogenic detrusor overactivity: a randomised, double-blind, placebo-controlled trial. *Eur Urol.* 2011 Oct;60(4):742-50.
- Cui Y, Zong H, Yang C, Yan H, Zhang Y. The efficacy and safety of mirabegron in treating OAB: a systematic review and meta-analysis of phase III trials. *Int Urol Nephrol.* 2014 Jan;46(1):275-84.
- Cvetkovic RS, Plosker GL. Desmopressin in adults with nocturia. *Drugs* 2005;65:99
- D'Agostino G, Barbieri A, Chiossa E et al. M4 muscarinic autoreceptor-mediated inhibition of [3H]acetylcholine release in the rat isolated urinary bladder. *J Pharmacol Exp Ther* 1997;283:750
- D'Agostino G, Condino AM, P. Involvement of β -adrenoceptors in the inhibitory control of cholinergic activity in human bladder: Direct evidence 3 by [H]-acetylcholine release experiments in the isolated detrusor. *Eur J Pharmacol* 2015; 758:115–122
- Dahm TL, Ostri P, Kristensen JK et al. Flavoxate treatment of micturition disorders accompanying benign prostatic hypertrophy: a double-blind placebo-controlled multicenter investigation. *Urol Int* 1955;55:205
- Dang K, Lamb K, Cohen M, Bielefeldt K, Gebhart GF. Cyclophosphamide-induced bladder inflammation sensitizes and enhances P2X receptor function in rat bladder sensory neurons. *J Neurophysiol.* 2008 Jan;99(1):49-59
- Das A, Chancellor MB, Watanabe T et al. Intravesical capsaicin in neurologic impaired patients with detrusor hyperreflexia. *J Spinal Cord Med.* 1996 Jul;19(3):190
- da Silva CM, Chancellor MB, Smith CP, Cruz F. Use of botulinum toxin for genitourinary conditions: What is the evidence? *Toxicon.* 2015 Dec 1;107(Pt A):141-7.
- Davies AM, Chahal R, Inman R, Urwin G. Intravesical botulinum A toxin (Botox) - does it have a role in the management of interstitial cystitis? *Eur Urol Suppl* 2006; 5(2):222.
- Davila GW, Daugherty CA, Sanders SW. A short-term, multicenter, randomized double-blind dose titration study of the efficacy and anticholinergic side effects of transdermal compared to immediate release oral oxybutynin treatment of patients with urge urinary incontinence. *J Urol* 2001;166(1):140
- Deaney C, Glickman S, Gluck T et al. Intravesical atropine suppression of detrusor hyperreflexia in multiple sclerosis. *J Neurol Neurosurg Psychiatry* 1998;65:957
- Debruyne F, Gres AA, Arustamov DL. Placebo-controlled dose-ranging phase 2 study of subcutaneously administered LHRH antagonist cetorelix in patients with symptomatic benign prostatic hyperplasia. *Eur Urol.* 2008 Jul;54(1):170
- de Groat WC, A neurologic basis for the overactive bladder. *Urology.* 1997 Dec; 50 (6A Suppl):36-52; discussion 53

- de Groat, WC, Booth AM, Yoshimura N. Neurophysiology of micturition and its modification in animal models of human disease. In: *The Autonomic Nervous System*. Vol. 6, Chapter 8, Nervous Control of the Urogenital System, ed. by C.A. Maggi. Harwood Academic Publishers, London, U.K., p. 227, 1993.
- de Groat WC, Downie JW, Levin RM et al. Basic neurophysiology and neuropharmacology, in Abrams P, Khoury S, Wein A (Eds), *Incontinence, 1st International Consultation on Incontinence*. Plymouth, United Kingdom, Plymbridge Distributors Ltd, p. 105, 1999.
- de Groat, W.C., and Yoshimura N. Pharmacology of the lower urinary tract. *Annu Rev Pharmacol Toxicol*, 41:691, 2001
- de Groat WC, Yoshimura N. Anatomy and physiology of the lower **urinary** tract. *Handb Clin Neurol*. 2015;130:61-108
- De Guchteneare A, Vande Walle C, Van Sintjan P et al. Desmopressin resistant nocturnal polyuria may benefit from furosemide therapy administered in the morning. *J Urol* 2007;178:2635
- De Guchteneare A, Van Herzeele C, Raes A, et al. Oral lyophilizate formulation of desmopressin: superior pharmacodynamics compared to tablet due to low food interaction. *J Urol*. 2011 Jun;185(6):2308-13
- Delaere KP, Thomas CM, Moonen WA, Debruyne FM. The value of intravesical prostaglandin E2 and F2 alpha in women with abnormalities of bladder emptying. *Br J Urol*. 1981 Aug;53(4):306-9.
- De Laet K, De Wachter S, Wyndaele JJ. Systemic oxybutynin decreases afferent activity of the pelvic nerve of the rat: new insights into the working mechanism of antimuscarinics. *Neurourol Urodyn*. 2006;25(2):156
- DeLancey JOL. The pathophysiology of stress urinary incontinence in women and its implications for surgical treatment. *World J Urol* 1997;15:268
- Dell'utri C, Digesu GA, Bhide A, Khullar V. Fesoterodine in randomised clinical trials: an updated systematic clinical review of efficacy and safety. *Int Urogynecol J*. 2012 Mar 13.
- Del Popolo G, Filocamo MT, Li Marzi V, et al. Neurogenic detrusor overactivity treated with english botulinum toxin a: 8-year experience of one single centre. *Eur Urol*. 2008 May;53(5):1013-19.
- Denmeade SR, Egerdie B, Steinhoff G, et al. Phase 1 and 2 studies demonstrate the safety and efficacy of intraprostatic injection of PRX302 for the targeted treatment of lower urinary tract symptoms secondary to benign prostatic hyperplasia. *Eur Urol*. 2011 May;59(5):747-54.
- de Mey C, Mateva L, Krastev Z, et al. Effects of hepatic dysfunction on the single-dose pharmacokinetics of fesoterodine. *J Clin Pharmacol*. 2011 Mar;51(3):397-405.
- de Paiva A, Meunier FA, Molgó J, et al. Functional repair of motor endplates after botulinum neurotoxin type A poisoning: biphasic switch of synaptic activity between nerve sprouts and their parent terminals. *Proc Natl Acad Sci U S A*. 1999 Mar 16;96(6):3200-5.
- Del Popolo G, Filocamo MT, Li Marzi V et al. Neurogenic detrusor overactivity treated with english botulinum toxin a: 8-year experience of one single centre. *Eur Urol*. 2008 May;53(5):1013
- Denys P, Del Popolo G, Amarenco G.; Dysport Study Group. Efficacy and safety of two administration modes of an intra-detrusor injection of 750 units dysport® (abobotulinumtoxinA) in patients suffering from refractory neurogenic detrusor overactivity (NDO): A randomised placebo-controlled phase IIa study. *Neurourol Urodyn*. 2016 Jan 12.
- Denys P, Le Normand L, Ghout I, et al.; VESITOX study group in France. Efficacy and safety of low doses of onabotulinumtoxinA for the treatment of refractory idiopathic overactive bladder: a multicentre, double-blind, randomised, placebo-controlled dose-ranging study. *Eur Urol*. 2012 Mar;61(3):520-9
- Denys, P., Dmochowski, R., Aliotta, P., et al. Positive response to first onabotulinumtoxinA treatment persists long-term with repeat treatments in patients with neuro-genic detrusor overactivity. *Eur. Urol*. 2015 Suppl. 14, e1092.
- De Ridder D, Chandiramani V, Dasgupta P et al. Intravesical capsaicin as a treatment for refractory detrusor hyperreflexia: a dual center study with long-term followup. *J Urol*. 1997 Dec;158(6):2087
- Deruyver Y, Hakim L, Franken J, De Ridder D. The use of imaging techniques in understanding lower urinary tract (dys)function. *Auton Neurosci*. 2016 Jul 25. pii: S1566-0702(16)30053-4.
- Deruyver Y, Voets T, De Ridder D, Everaerts W. Transient receptor potential channel modulators as pharmacological treatments for lower urinary tract symptoms (LUTS): myth or reality? *BJU Int*. 2015 May;115(5):686-97
- de Sèze M, Gallien P, Denys P et al. Intravesical glucidic capsaicin versus glucidic solvent in neurogenic detrusor overactivity: a double blind controlled randomized study. *Neurourol Urodyn*. 2006;25(7):752
- de Sèze M, Wiart L, Joseph PA et al. Capsaicin and neurogenic detrusor hyperreflexia: a double-blind placebo-controlled study in 20 patients with spinal cord lesions. *Neurourol Urodyn*. 1998;17(5):513

- De Wachter S. Afferent signaling from the bladder: species differences evident from extracellular recordings of pelvic and hypogastric nerves. *NeuroUrol Urodyn*. 2011 Jun;30(5):647-52.
- Desphande AV, Caldwell PH, Sureshkumar P. Drugs for nocturnal enuresis in children (other than Desmopressin and tricyclics). *Cochrane Database Syst Review* 2012 Dec 12:12 CD002238
- Diefenbach K, Jaeger K, Wollny A, et al. Effect of tolterodine on sleep structure modulated by CYP2D6 genotype. *Sleep Med* 2008Jul;9(5):579
- Digesu GA, Khullar V, Cardozo L, Salvatore S. Overactive bladder symptoms: do we need urodynamics? *NeuroUrol Urodyn*. 2003;22(2):105
- Digesu GA, Verdi E, Cardozo L, et al. Phase IIb, multicenter, double-blind, randomized, placebo-controlled, parallel-group study to determine effects of elocalcitol in women with overactive bladder and idiopathic detrusor overactivity. *Urology*. 2012 Jul;80(1):48-54.
- Dinis P, Charrua A, Avelino A, Cruz F. Intravesical resiniferatoxin decreases spinal c-fos expression and increases bladder volume to reflex micturition in rats with chronic inflamed urinary bladders. *BJU Int*. 2004a Jul;94(1):153-7.
- Dinis P, Charrua A, Avelino A, et al. The distribution of sensory fibers immunoreactive for the TRPV1 (capsaicin) receptor in the human prostate. *Eur Urol*. 2005 Jul;48(1):162-7.
- Dinis P, Silva J, Ribeiro MJ et al. Bladder C-fiber desensitization induces a long-lasting improvement of BPH-associated storage LUTS: a pilot study. *Eur Urol*. 2004b Jul;46(1):88
- Diokno AC. Medical management of urinary incontinence. *Gastroenterology*, 2004 Jan;126 (1Suppl 1):S77-81
- Diokno AC, Appell RA, Sand PK et al. Prospective, randomized, double-blind study of the efficacy and tolerability of the extended-release formulations of oxybutynin and tolterodine for overactive bladder: results of the OPERA trial. *Mayo Clin Proc* 2003;78(6):687
- Dmochowski R, Abrams P, Marschall-Kehrel D et al. Efficacy and tolerability of tolterodine extended release in male and female patients with overactive bladder. *Eur Urol*. 2007a Apr;51(4):1054
- Dmochowski RR, Davila GW, Zinner NR et al. Efficacy and safety of transdermal oxybutynin in patients with urge and mixed urinary incontinence. *J Urol* 2002;168(2):580
- Dmochowski R, Chapple C, Nitti VW, et al. Efficacy and safety of onabotulinumtoxinA for idiopathic overactive bladder: a double-blind, placebo controlled, randomized, dose ranging trial. *J Urol*. 2010c Dec;184(6):2416-22.
- Dmochowski R, Kreder K, MacDiarmid S et al. The clinical efficacy of tolterodine extended-release is maintained for 24 h in patients with overactive bladder. *BJU Int*. 2007b Jul;100(1):107
- Dmochowski RR, Miklos JR, Norton PA et al. Duloxetine vs. placebo in the treatment of North American women with stress urinary incontinence. *J Urol* 2003b;170:1259
- Dmochowski RR, Newman DK, Sand PK, et al. Pharmacokinetics of oxybutynin chloride topical gel: effects of application site, baths, sunscreen and person-to-person transference. *Clin Drug Investig*. 2011;31(8):559-71.
- Dmochowski RR, Nitti V, Staskin D et al. Transdermal oxybutynin in the treatment of adults with overactive bladder: combined results of two randomized clinical trials. *World J Urol*. 2005 Sep;23(4):263
- Dmochowski RR, Peters KM, Morrow JD, et al. Randomized, double-blind, placebo-controlled trial of flexible-dose fesoterodine in subjects with overactive bladder. *Urology*. 2010a Jan;75(1):62-8.
- Dmochowski R, Roehrborn C, Klise S et al. Urodynamic effects of once daily tadalafil in men with lower urinary tract symptoms secondary to clinical benign prostatic hyperplasia: a randomized, placebo controlled 12-week clinical trial. *J Urol* 2010b;183:1092-1097.
- Dmochowski RR, Sand PK, Zinner NR et al. Comparative efficacy and safety of transdermal oxybutynin and oral tolterodine versus placebo in previously treated patients with urge and mixed urinary incontinence. *Urology*, 2003a;62(2):237
- Dmochowski RR, Sand PK, Zinner NR et al. Trospium 60 mg once daily (QD) for overactive bladder syndrome: results from a placebo-controlled interventional study. *Urology* 2008 Mar;71(3):449
- Dmochowski R, Chapple C, Nitti VW, et al. Efficacy and safety of onabotulinumtoxinA for idiopathic overactive bladder: a double-blind, placebo controlled, randomized, dose ranging trial. *J Urol*. 2010d Dec;184(6):2416-22
- Dmochowski RR, Staskin DR, Duchin K, Paborji M, Tremblay TM. Clinical safety, tolerability and efficacy of combination tolterodine/pilocarpine in patients with overactive bladder. *Int J Clin Pract*. 2014 Aug;68(8):986-94
- Dobrek Ł, Thor PJ. The role of prostanoids in the urinary bladder function and a potential use of prostanoid-targeting pharmacological agents in bladder overactivity treatment. *Acta Pol Pharm*. 2015 Jan-Feb;72(1):13-9.
- Doggweiler R, Zermann DH, Ishigooka M, et al. Botox-induced prostatic involution. *Prostate*, 1998;37: 44 – 50.

- Doi Y, Murasaki O, Kaibara M, et al. Characterization of functional effects of Z-338, a novel gastroprokinetic agent, on the muscarinic M1, M2, and M3 receptors expressed in *Xenopus* oocytes. *Eur J Pharmacol*. 2004 Nov 28;505(1-3):31-5.
- Dolly JO, Lawrence GW. Chapter 3: Molecular basis for the therapeutic effectiveness of botulinum neurotoxin type A. *Neurourol Urodyn*. 2014 Jul;33 Suppl 3:S14-20.
- Donath F, Braeter M, Feustel C. The influence of propiverine hydrochloride on cardiac repolarization in healthy women and cardiac male patients. *Int J Clin Pharmacol Ther*. 2011 Jun;49(6):353-65.
- Dong M, Yeh F, Tepp WH et al. SV2 is the protein receptor for botulinum neurotoxin A. *Science*. 2006 Apr 28;312(5773):592
- Donker P, Van der Sluis C. Action of beta adrenergic blocking agents on the urethral pressure profile. *Urol Int*, 1976;31:6
- Donnellan CA, Fook L, McDonald P, et al. Oxybutynin and cognitive dysfunction. *BMJ*, 1997;315:1363
- Doroshenko O, Jetter A, Odenthal KP et al. Clinical pharmacokinetics of trospium chloride. *Clin Pharmacokinet*. 2005;44(7):701
- Dorschner W, Stolzenburg JU, Griebenow R et al. Efficacy and cardiac safety of propiverine in elderly patients - a double-blind, placebo-controlled clinical study. *Eur Urol*, 2000;37:702
- Douchamps J, Derenne F, Stockis A et al. The pharmacokinetics of oxybutynin in man. *Eur J Clin Pharmacol*, 1988;35:515
- Downie JW, Karmazyn M. Mechanical trauma to bladder epithelium liberates prostanoids which modulate neurotransmission in rabbit detrusor muscle. *J Pharmacol Exp Ther* 1984;230: 445
- Dowson C, Khan MS, Dasgupta P, Sahai A. Repeat botulinum toxin-A injections for treatment of adult detrusor overactivity. *Nat Rev Urol*. 2010 Dec;7(12):661-7
- Dowson C, Sahai A, Watkins J, et al. The safety and efficacy of botulinum toxin-A in the management of bladder oversensitivity: a randomised double-blind placebo-controlled trial. *Int J Clin Pract*. 2011 Jun;65(6):698-704.
- Dowson C, Watkins J, Khan MS, et al. Repeated botulinum toxin type A injections for refractory overactive bladder: medium-term outcomes, safety profile, and discontinuation rates. *Eur Urol*. 2012 Apr;61(4):834-9.
- Drake, M., Ginsberg, D., Gruenenfelder, J. Onabotulinumtoxin A improves the symptoms of urgency and incontinence and provides treatment benefit in patients with overactive bladder regardless of incontinence severity at baseline. *Eur. Urol. Suppl*. 14, e148.
- Drake MJ, Chapple C, Esen AA, et al. BESIDE study investigators, Efficacy and Safety of Mirabegron Add-on Therapy to Solifenacin in Incontinent Overactive Bladder Patients with an Inadequate Response to Initial 4-Week Solifenacin Monotherapy: A Randomised Double-blind Multicentre Phase 3B Study (BESIDE). *Eur Urol*. 2016 Jul;70(1):136-45.
- Drake MJ, Chapple C, Sokol R, et al NEPTUNE Study Group. Long-term safety and efficacy of single-tablet combinations of solifenacin and tamsulosin oral controlled absorption system in men with storage and voiding lower urinary tract symptoms: results from the NEPTUNE Study and NEPTUNE II open-label extension. *Eur Urol*. 2015 Feb;67(2):262-70.
- Drake MJ, Sokol R, Coyne K, et al; NEPTUNE study group. Responder and health-related quality of life analyses in men with lower urinary tract symptoms treated with a fixed-dose combination of solifenacin and tamsulosin oral-controlled absorption system: results from the NEPTUNE study. *BJU Int*. 2016 Jan;117(1):165-72.
- Dubeau CE, Kraus SR, Griebing TL, et al. Effect of fesoterodine in vulnerable elderly subjects with urgency incontinence: a double-blind, placebo controlled trial. *J Urol*. 2014 Feb;191(2):395-404.
- Duckett J, Aggarwal I, Patil A. Duloxetine treatment for women awaiting continence surgery. *Int Urogynecol J Pelvic Floor Dyfunct* 2006;17(6):563-565
- Duthie JB, Vincent M, Herbison GP, Wilson DI, Wilson D. Botulinum toxin injections for adults with overactive bladder syndrome. *Cochrane Database Syst Rev*. 2011 Dec 7;12:CD005493
- Dwyer P, Kelleher C, Young J et al. Long-term benefits of darifenacin treatment for patient quality of life: results from a 2-year extension study. *Neurourol Urodyn*. 2008;27(6):540
- Dwyer PL, Teele JS. Prazosin: a neglected cause of genuine stress incontinence. *Obstet Gynecol* 1992;79:117
- Dykstra D, Enriquez A, Valley M. Treatment of overactive bladder with botulinum toxin type B: a pilot study. *Int Urogynecol J Pelvic Floor Dysfunct*. 2003 Dec;14(6):424
- Eastham JE, Gillespie JI. The concept of peripheral modulation of bladder sensation. *Organogenesis*. 2013 Jul-Sep;9(3):224-33
- Eckford SD, Carter PG, Jackson SR et al. An open, in-patient incremental safety and efficacy study of desmopressin in women with multiple sclerosis and nocturia. *Br J Urol* 1995;76:459
- Eckford SD, Swami KS, Jackson SR et al. Desmopressin in the treatment of nocturia and enuresis in patients with multiple sclerosis. *Br J Urol* 1994;74:733

- Edmondson SD, Zhu C, Kar NF, et al. Discovery of Vibegron: A Potent and Selective β_3 Adrenergic Receptor Agonist for the Treatment of Overactive Bladder. *J Med Chem*. 2016 Jan 28;59(2):609-23
- Edwards KR, O'Connor JT. Risk of delirium with concomitant use of tolterodine and acetylcholinesterase inhibitors. *J Am Geriatr Soc* 2002;50:1165
- Ehlert FJ, Ahn S, Pak KJ, et al. Neuronally release acetylcholine acts on the M2 muscarinic receptor to oppose the relaxant effect of isoproterenol on cholinergic contractions in mouse urinary bladder. *J Pharmacol Exp Ther* 2007; 322:631
- Ehren I, Volz D, Farrelly E et al. Efficacy and impact of botulinum toxin A on quality of life in patients with neurogenic detrusor overactivity: a randomised, placebo-controlled, double-blind study. *Scand J Urol Nephrol*. 2007;41(4):335
- Ekström B, Andersson K-E, Mattiasson A. Urodynamic effects of intravesical instillation of atropine and phentolamine in patients with detrusor hyperactivity. *J Urol* 1992;149:155
- Elhilali MM, Pommerville P, Yocum RC, et al Prospective, randomized, double-blind, vehicle controlled, multicenter phase IIb clinical trial of the pore forming protein PRX302 for targeted treatment of symptomatic benign prostatic hyperplasia. *J Urol*. 2013 Apr;189(4):1421-6.
- Elinoff V, Bavendam T, Glasser DB et al. Symptom-specific efficacy of tolterodine extended release in patients with overactive bladder: the IMPACT trial. *Int J Clin Pract*. 2006 Jun;60(6):745
- Ellington DR, Szychowski JM, Malek JM, et al. Combined Tolterodine and Vaginal Estradiol Cream for Overactive Bladder Symptoms After Randomized Single-Therapy Treatment. *Female Pelvic Med Reconstr Surg*. 2016 Jul-Aug;22(4):254-60
- Emberton M, Cornel EB, Bassi PF, et al. Benign prostatic hyperplasia as a progressive disease: a guide to the risk factors and options for medical management. *Int J ClinPract*. 2008;62:1076-1086.
- Emberton M, Fitzpatrick J. The Reten-World survey of the management of acute urinary retention: preliminary results. *BJU Int* 2008;101(Suppl 3):27-32.
- Endo RM, Girao MJ, Sartori MG et al. Effect of estrogen-progestogen hormonal replacement therapy on periurethral and bladder vessels. *Int Urogynecol J Pelvic Floor Dysfunct* 2000;11(2):120
- Enskat R, Deaney CN, Glickman S. Systemic effects of intravesical atropine sulphate. *BJU Int* 2001;87:613
- Eri LM, Tveter KJ. A prospective, placebo-controlled study of the luteinizing hormone-releasing hormone agonist leuprolide as treatment for patients with benign prostatic hyperplasia. *J Urol* 1993;150:359
- Esin E, Ergen A, Cankurtaran M, et al. Influence of antimuscarinic therapy on cognitive functions and quality of life in geriatric patients treated for overactive bladder. *Aging Ment Health*. 2015;19(3):217-23.
- Everaerts W, Gevaert T, Nilius B, De Ridder D. On the origin of bladder sensing: Tr(i)ps in urology. *Neurourol Urodyn*. 2008;27(4):264-73.
- Everaert K, Sriram R, A. Kohan A, et al. The efficacy and safety of onabotulinumtoxinA and solifenacin compared to placebo in solifenacin-naïve patients with idiopathic overactive bladder: Results from a multicentre, randomised, double-blind, phase 3b trial. *European Urology Supplements, Volume 15, Issue 3, March 2016, Pages e877, e877*
- Everaerts W, Zhen X, Ghosh D, et al. Inhibition of the cation channel TRPV4 improves bladder function in mice and rats with cyclophosphamide-induced cystitis. *Proc Natl Acad Sci U S A*. 2010 Nov 2;107(44):19084-9.
- Fader M, Glickman S, Haggar V et al. Intravesical atropine compared to oral oxybutynin for neurogenic detrusor overactivity: a double-blind, randomized crossover trial. *J Urol* 2007 Jan;177(1)208
- Falconer C, Ekman-Ordeberg G, Blomgren B et al. Paraurethral connective tissue in stress incontinent women after menopause. *Acta Obstetr Gynaecol Scand* 1998;77(1)95
- Fall M, Lindstrom S, Mazieres L. A bladder-to-bladder cooling reflex in the cat. *J Physiol*, 1990;427:281
- Fantl JA, Bump RC, Robinson D et al. Efficacy of estrogen supplementation in the treatment of urinary incontinence. *Obstet Gynaecol* 1996;88:745
- Fantl JA, Cardozo L, McClish DK Estrogen therapy in the management of urinary incontinence in postmenopausal women: a meta-analysis. *Frist report of the Hormones and Urogenital Therapy Committee*. *Obstet Gynaecol* 1994;83:12
- Fellenius E, Hedberg R, Holmberg E et al. Functional and metabolic effects of terbutaline and propranolol in fast and slow contracting skeletal muscle in vitro. *Acta Physiol Scand*, 1980;109:89
- Ferguson DR, Kennedy I, Burton TJ. ATP is released from rabbit urinary bladder epithelial cells by hydrostatic pressure changes--a possible sensory mechanism? *J Physiol*. 1997 Dec 1;505 (Pt 2):503-11.
- Fernández-Salas E, Wang J, Molina Y, et al. Botulinum neurotoxin serotype A specific cell-based potency assay to replace the mouse bioassay. *PLoS One*. 2012;7(11):e49516.
- Fetscher C, Fleischman M, Schmidt M et al. M3 muscarinic receptors mediate contraction of human urinary bladder. *Br J Pharmacol* 2002; 136: 641

- Fibbi B, Morelli A, Vignozzi L et al. Characterization of phosphodiesterase type 5 expression and functional activity in the human male lower urinary tract. *J Sex Med* 2009; 7:59-69.
- Filocamo MT, LiMarzi V, Del Popoilo G et al. Pharmacologic treatment in postprostatectomy stress urinary incontinence. *Eur Urol* 2007;51:1559
- Filson CP, Hollingsworth JM, Clemens JQ, Wei JT. The efficacy and safety of combined therapy with α -blockers and anticholinergics for men with benign prostatic hyperplasia: a meta-analysis. *J Urol*. 2013 Dec;190(6):2153-60.
- Finney SM, Andersson KE, Gillespie JI, Stewart LH. Antimuscarinic drugs in detrusor overactivity and the overactive bladder syndrome: motor or sensory actions? *BJU Int*. 2006 Sep;98(3):503
- Fitzpatrick JM, Desgrandchamps F, Adjali K, et al; Reten-World Study Group. Management of acute urinary retention: a worldwide survey of 6074 men with benign prostatic hyperplasia. *BJU Int*. 2012 Jan;109(1):88-95.
- Fitzpatrick J, Kirby R. Management of acute urinary retention. *BJU Int* 2006;97(Suppl 2):16-20.
- Flicker C, Ferris SH, Serby M. Hypersensitivity to scopolamine in the elderly. *Psychopharmacol (Berl)* 1992;107:437
- Flynn MK, Amundsen CL, Pervich M, et al. Outcome of a randomized, double-blind, placebo controlled trial of botulinum A toxin for refractory overactive bladder. *J Urol*. 2009 Jun;181(6):2608-15
- Fonseca J, Martins da Silva C. The diagnosis and treatment of lower urinary tract symptoms due to benign prostatic hyperplasia with α -blockers: focus on silodosin. *Clin Drug Investig*. 2015 Feb;35 Suppl 1:7-18. doi: 10.1007/s40261-014-0257-3.
- Foote J, Glavind K, Kralidis G et al. Treatment of overactive bladder in the older patient: pooled analysis of three phase III studies of darifenacin, an M3 selective receptor antagonist. *Eur Urol*. 2005 Sep;48(3):471
- Ford AP. In pursuit of P2X3 antagonists: novel therapeutics for chronic pain and afferent sensitization. *Purinergic Signalling* 2012); 8 (Suppl 1):S3–S26
- Ford AP, Gever JR, Nunn PA et al. Purinoceptors as therapeutic targets for lower urinary tract dysfunction. *Br J Pharmacol*. 2006 Feb;147 Suppl 2:S132
- Ford AP, Cockayne DA. ATP and P2X purinoceptors in urinary tract disorders. *Handb Exp Pharmacol*. 2011;(202):485-526.
- Ford AP, Udem BJ. The therapeutic promise of ATP antagonism at P2X3 receptors in respiratory and urological disorders. *Front Cell Neurosci*. 2013 Dec 19;7:267.
- Fowler CJ, Beck RO, Gerrard S et al. Intravesical capsaicin for the treatment of detrusor hyperreflexia. *J Neurol Neurosurg Psychiatry* 1994;57:169
- Fowler CJ, Griffiths D, de Groat WC. The neural control of micturition. *Nat Rev Neurosci*. 2008 Jun;9(6):453-66
- Fowler CJ, Jewkes D, McDonald WI et al. Intravesical capsaicin for neurogenic bladder dysfunction. *Lancet*. 1992 May 16;339(8803):1239.
- Fox C, Richardson K, Maidment ID, et al. Anticholinergic medication use and cognitive impairment in the older population: the medical research council cognitive function and ageing study. *J Am Geriatr Soc*. 2011;59:1477-83.
- Franceschetti GP, Candura SM, Vicini D, Tonini M. Cisapride enhances detrusor contractility and improves micturition in a woman with lazy bladder. *Scand J Urol Nephrol*. 1997 Apr;31(2):209-10.
- Franken J, Uvin P, De Ridder D, Voets T. TRP channels in lower urinary tract dysfunction. *Br J Pharmacol*. 2014 May;171(10):2537-51
- Fraser MO, Chancellor MB: Neural control of the urethra and development of pharmacotherapy for stress urinary incontinence. *BJU Int* 2003;91(8):743
- Frazier EP, Braverman AS, Peters SLM et al. Does phospholipase C mediate muscarinic receptor-induced rat urinary bladder contraction? *J Pharmacol Exp Ther* 2007; 322: 998
- Frazier EP, Mathy MJ, Peters SL et al. Does cyclic AMP mediate rat urinary bladder relaxation by isoproterenol? *J Pharmacol Exp Ther*. 2005 Apr;313(1):260
- Frazier EP, Peters SLM, Braverman AS et al. Signal transduction underlying control of urinary bladder smooth muscle tone by muscarinic receptors and β -adrenoceptors. *Naunyn-Schmiedeberg's Arch Pharmacol* 2008;377: 449
- Fredrikson S. Nasal spray desmopressin in treatment of bladder dysfunction in patients with multiple sclerosis. *Acta Neurol Scand* 1996;94:31
- Freeman RM, Adekanmi O, Waterfield MR, et al. The effect of cannabis on urge incontinence in patients with multiple sclerosis: a multicentre, randomised placebo-controlled trial (CAMS-LUTS). *Int Urogynecol J Pelvic Floor Dysfunct* 2006;17:636–41.
- Freeman R, Hill S, Millard R et al. Tolterodine Study Group. Reduced perception of urgency in treatment of overactive bladder with extended-release tolterodine. *Obstet Gynecol* 2003;102(3):605
- Frenkl TL, Zhu H, Reiss T, et al. A multicenter, double-blind, randomized, placebo controlled trial of a neurokinin-1 receptor antagonist for overactive bladder. *J Urol*. 2010 Aug;184(2):616-22.

- Frew R, Lundy PM. A role for Q type Ca²⁺ channels in neurotransmission in the rat urinary bladder. *Br J Pharmacol* 1995;116:1595
- Frias B, Charrua A, Avelino A, et al. TRPV1 mediates NGF-induced bladder hyperactivity and noxious input. *BJU Int*. 2012 Oct;110(8 Pt B):E422-8.
- Fröhlich G, Burmeister S, Wiedemann A et al. Intravesical instillation of trospium chloride, oxybutynin and verapamil for relaxation of the bladder detrusor muscle. A placebo controlled, randomized clinical test. *Arzneimittelforschung*.1998;May;48(5):486. (German).
- Fu FG, Lavery HJ, Wu DL. Reducing nocturia in the elderly: a randomized placebo-controlled trial of staggered furosemide and desmopressin. *Neurourol Urodyn*, 2011;30:312-316.
- Fu X, Rezapour M, Wu X, et al. Expression of estrogen receptor alpha and beta in anterior vaginal walls of genuine stress incontinence women. *Int Urogynaecol J Pelvic Floor Dysfunc* 2003;14(4):276, discussion 281
- Fujimura T, Tamura K, Tsutsumi T et al. Expression and possible functional role of the beta3-adrenoceptor in human and rat detrusor muscle. *J Urol*. 1999 Feb;161(2):680
- Füllhase C, Chapple C, Cornu JN, et al. Systematic review of combination drug therapy for non-neurogenic male lower urinary tract symptoms. *Eur Urol*. 2013 Aug;64(2):228-43.
- Furuta A, Naruoka T, Suzuki Y, et al: α 2-Adrenoceptor as a new target for stress urinary incontinence. *LUTS* 2009;1:526-529
- Fusgen I, Hauri D. Trospium chloride: an effective option for medical treatment of bladder overactivity. *Int J Clin Pharmacol Ther*, 2000;38(5):223
- Gacci M, Andersson KE, Chapple C, et al. Latest Evidence on the Use of Phosphodiesterase Type 5 Inhibitors for the Treatment of Lower Urinary Tract Symptoms Secondary to Benign Prostatic Hyperplasia. *Eur Urol*. 2016 Jul;70(1):124-33.
- Gacci M, Carini M, Salvi M, et al. Management of benign prostatic hyperplasia: role of phosphodiesterase-5 inhibitors. *Drugs Aging*. 2014 Jun;31(6):425-39
- Gacci M, Vittori G, Tosi N, et al. A randomised, placebo-controlled study to assess safety and efficacy of vardenafil 10 mg and tamsulosin 0,4 mg versus tamsulosin 0,4 mg alone in the treatment of lower urinary tract symptoms secondary to benign prostatic hyperplasia. *J Sex Med*. 2011
- Gallegos-Orozco JF, Foxx-Orenstein AE, Sterler SM, Stoa JM. Chronic constipation in the elderly. *Am J Gastroenterol*. 2012 ;107:18-25.
- Gamé X, Castel-Lacanal E, Bentaleb Y, et al. Botulinum toxin A detrusor injections in patients with neurogenic detrusor overactivity significantly decrease the incidence of symptomatic urinary tract infections. *Eur Urol*. 2008 Mar;53(3):613-8.
- Garely AD, Kaufman JM, Sand PK et al. Symptom bother and health-related quality of life outcomes following solifenacin treatment for overactive bladder: the VESicare Open-Label Trial (VOLT). *Clin Ther*. 2006 Nov;28(11):1935
- Gebhardt J, Richard D, Barrett T. Expression of estrogen receptor isoforms alpha and beta messenger RNA in vaginal tissue of premenopausal and postmenopausal women. *Am J Obstetr Gynaecol* 2001;185:1325
- Gee NS, Brown JP, Dissanayake VU et al. The novel anticonvulsant drug, gabapentin (Neurontin), binds to the alpha2delta subunit of a calcium channel. *J Biol Chem*. 1996 Mar 8;271(10):5768
- Geirsson G, Fall M, Sullivan L. Clinical and urodynamic effects of intravesical capsaicin treatment in patients with chronic traumatic spinal detrusor hyperreflexia. *J Urol*. 1995 Nov;154(5):1825
- George J, Tharion G, Richar J et al. The effectiveness of intravesical oxybutynin, propantheline, and capsaicin in the management of neuropathic bladder following spinal cord injury. *ScientificWorldJournal*. 2007 Oct 22;7:1683
- Gevaert T, Vriens J, Segal A, et al. Deletion of the transient receptor potential cation channel TRPV4 impairs murine bladder voiding. *J Clin Invest*. 2007 Nov;117(11):3453-62.
- Gever JR, Cockayne DA, Dillon MP, Burnstock G, Ford AP. Pharmacology of P2X channels. *Pflugers Arch*. 2006 Aug;452(5):513-37
- Gever JR, Soto R, Henningsen RA, et al. AF-353, a novel, potent and orally bioavailable P2X3/P2X2/3 receptor antagonist. *Br J Pharmacol*. 2010 Jul;160(6):1387-98
- Geyer J, Gavrilova O, Petzinger E. The role of p-glycoprotein in limiting brain penetration of the peripherally acting anticholinergic overactive bladder drug trospium chloride. *Drug Metab Dispos*. 2009 Jul;37(7):1371-4.
- Ghoneim GM, Van Leeuwen JS, Elser DM et al. A randomized controlled trial of duloxetine alone, pelvic floor muscle training alone, combined treatment, and no treatment in women with stress urinary incontinence. *J Urol* 2005;173:1647
- Giannantoni A, Di Stasi SM, Nardicchi V et al. Botulinum-A toxin injections into the detrusor muscle decrease nerve growth factor bladder tissue levels in patients with neurogenic detrusor overactivity. *J Urol*. 2006 Jun;175(6):2341

- Giannantoni A, Di Stasi SM, Stephen RL et al. Intravesical resiniferatoxin versus botulinum-A toxin injections for neurogenic detrusor overactivity: a prospective randomized study. *J Urol* 2004;172:240
- Giannantoni A, Serva MR, Proietti S, et al. Six year follow-up of intradetrusorial injections of botulinum toxin type A in patients with refractory neurogenic detrusor overactivity: clinical and urodynamic results - Abstract 567. *Eur Urol Supplements*. 2008;7:212
- Giardina EG, Bigger JT. Jr, Glassman AH et al. The electrocardiographic and antiarrhythmic effects of imipramine hydrochloride at therapeutic plasma concentrations. *Circulation* 1979;60:1045
- Giemybcz MA. Life after PDE4: overcoming adverse events with dual-specificity phosphodiesterase inhibitors. *Curr Opin Pharmacol*. 2005 Jun;5(3):238
- Giglio D, Tobin G. Muscarinic receptor subtypes in the lower urinary tract. *Pharmacology*. 2009;83(5):259-69.
- Gilja I, Radej M, Kovacic M et al. Conservative treatment of female stress incontinence with imipramine. *J Urol* 1984;132:909
- Gill SS, Mamdani M, Naglie G et al. A prescribing cascade involving cholinesterase inhibitors and anticholinergic drugs. *Arch Intern Med* 2005;165:808
- Gillespie JI, Drake MJ. The actions of sodium nitroprusside and the phosphodiesterase inhibitor dipyridamole on phasic activity in the isolated guinea-pig bladder. *BJU Int* 2004;93:851-858.
- Gillespie JI, Palea S, Guilloteau V, et al. Modulation of non-voiding activity by the muscarinic antagonist tolterodine and the $\beta(3)$ -adrenoceptor agonist mirabegron in conscious rats with partial outflow obstruction. *BJU Int*. 2012 Jul;110(2 Pt 2):E132-42.
- Gillespie JI, Rouget C, Palea S, et al. Beta adrenergic modulation of spontaneous microcontractions and electrical field-stimulated contractions in isolated strips of rat urinary bladder from normal animals and animals with partial bladder outflow obstruction. *Naunyn Schmiedebergs Arch Pharmacol*. 2015a Jul;388(7):719-26
- Gillespie JI, Rouget C, Palea S, et al. The characteristics of intrinsic complex micro-contraction activity in isolated strips of the rat bladder. *Naunyn Schmiedebergs Arch Pharmacol*. 2015b Jul;388(7):709-18.
- Gillman P. Tricyclic antidepressant pharmacology and therapeutic drug interactions updated. *Br J of Pharmacol* 2007;151(6):737-748
- Ginsberg D, Cruz F, Herschorn S, et al. OnabotulinumtoxinA is effective in patients with urinary incontinence due to neurogenic detrusor overactivity [corrected] regardless of concomitant anticholinergic use or neurologic etiology. *Adv Ther*. 2013 Sep;30(9):819-33.
- Ginsberg D, Gousse A, Keppenne V, et al. Phase 3 efficacy and tolerability study of onabotulinumtoxinA for urinary incontinence from neurogenic detrusor overactivity. *J Urol*. 2012 Jun;187(6):2131-9.
- Ginsberg D, Schneider T, Kelleher C, et al. Efficacy of fesoterodine compared with extended-release tolterodine in men and women with overactive bladder. *BJU Int*. 2013 Aug;112(3):373-85.
- Gittelman M, Weiss H, Seidman L. A phase 2, randomized, double-blind, efficacy and safety study of oxybutynin vaginal ring for alleviation of overactive bladder symptoms in women. *J Urol*. 2014 Apr;191(4):1014-21.
- Giuliano F, Ückert S, Maggi M, et al. The mechanism of action of phosphodiesterase type 5 inhibitors in the treatment of lower urinary tract symptoms related to benign prostatic hyperplasia. *Eur Urol*. 2013 Mar;63(3):506-16.
- Glazener CMA, Evans JHC. Desmopressin for nocturnal enuresis in children. *Cochrane Database Syst Rev* 2002;3:CD002112. 2008.
- Glazener CM, Evans JH, Peto RE. Tricyclic and related drugs for nocturnal enuresis in children. *Cochrane Database Syst Rev*. 2003;(3):CD002117.
- Gleason JM, Daniels C, Williams K, et al. Single center experience with oxybutynin transdermal system (patch) for management of symptoms related to non-neuropathic overactive bladder in children: an attractive, well tolerated alternative form of administration. *J Pediatr Urol*. 2014 Aug;10(4):753-7
- Gleason DM, Reilly SA, Bottacini MR, et al. The urethral continence zone and its relation to stress incontinence. *J Urol* 1974;112:81
- Gleason DM, Susset J, White C et al. Evaluation of a new once-daily formulation of oxybutynin the treatment of urinary urge incontinence. The Ditropan XL Study Group. *Urology* 1999;54:420
- Glickman S, Tsokkos N, Shah PJ. Intravesical atropine and suppression of detrusor hypercontractility in the neuropathic bladder. A preliminary study. *Paraplegia* 1995;33:36
- Goldfischer ER, Sand PK, Thomas H, Peters-Gee J. Efficacy and safety of oxybutynin topical gel 3% in patients with urgency and/or mixed urinary incontinence: a randomized, double-blind, placebo-controlled study. *Neurourol Urodyn*. 2015 Jan;34(1):37-43.
- Gomes CM, Castro Filho JE, Rejowski RF, et al. Experience with different botulinum toxins for the treatment of refractory neurogenic detrusor overactivity. *Int Braz J Urol*. 2010 Jan-Feb;36(1):66-74.
- Gomes T, Juurlink DN, Mamdani MM. Comparative adherence to oxybutynin or tolterodine among older patients. *Eur J Clin Pharmacol*. 2012 Jan;68(1):97-9.

- Gopalakrishnan M, Shieh C-C. Potassium channel subtypes as molecular targets for overactive bladder and other urological disorders. *Expert Opin Ther Targets* 2004; 8: 437
- Gotoh M, Kamihira O, Kinikawa T, et al. Comparison of α_{1A} -selective adrenoceptor antagonist, tamsulosin, and α_{1D} -selective adrenoceptor antagonist, naftopidil, for efficacy and safety in the treatment of benign prostatic hyperplasia: a randomized controlled trial. *BJU Int.* 2005 Sep;96(4):581-6.
- Goya N, Ishikawa N, Ito F, et al. Ethanol injection therapy of the prostate for benign prostatic hyperplasia: preliminary report on application of a new technique. *J Urol*, 1999;162: 383 - 386.
- Goya N, Ishikawa N, Ito F, et al. Transurethral ethanol injection therapy for prostatic hyperplasia: 3-year results. *J Urol*, 2004;172: 1017 - 1020.
- Grady D, Brown JS, Vittinghoff E et al. Postmenopausal hormones and incontinence: the Heart and Estrogen/Progestin Replacement Study. *Obstet Gynaecol* 2001;97:116
- Granato C, Korstanje C, Guilloteau V, et al. Prostaglandin E2 excitatory effects on rat urinary bladder: a comparison between the β -adrenoceptor modulation of non-voiding activity in vivo and micro-contraction activity in vitro. *Naunyn Schmiedebergs Arch Pharmacol.* 2015 Jul;388(7):727-35.
- Gratzke C, Streng T, Park A, et al. Distribution and function of cannabinoid receptors 1 and 2 in the rat, monkey and human bladder. *J Urol* 2009;181:1939–48.
- Gratzke C, Streng T, Stief CG, et al. Cannabinor, a selective cannabinoid-2 receptor agonist, improves bladder emptying in rats with partial urethral obstruction. *J Urol* 2011;185:731–6.
- Gratzke C, Streng T, Stief CG, et al. Effects of cannabinor, a novel selective cannabinoid 2 receptor agonist, on bladder function in normal rats. *Eur Urol.* 2010 Jun;57(6):1093-100.
- Gray SL, Anderson ML, Dublin S, et al. Cumulative use of strong anticholinergics and incident dementia: a prospective cohort study. *JAMA Intern Med.* 2015 Mar;175(3):401-7.
- Griffiths D. Imaging bladder sensations. *Neurol Urodyn.* 2007 Oct;26(6 Suppl):899
- Griffiths D, Tadic SD. Bladder control, urgency, and urge incontinence: evidence from functional brain imaging. *Neurol Urodyn.* 2008;27(6):466
- Griffiths DJ. Use of functional imaging to monitor central control of voiding in humans. *Handb Exp Pharmacol.* 2011;(202):81-97
- Grigoleit U, Mürtz G, Laschke S, et al. Efficacy, tolerability and safety of propiverine hydrochloride in children and adolescents with congenital or traumatic neurogenic detrusor overactivity--a retrospective study. *Eur Urol.* 2006 Jun;49(6):1114-20; discussion 1120-1
- Grise P, Plante M, Palmer J, et al. Evaluation of the transurethral ethanol ablation of the prostate (TEAP) for symptomatic benign prostatic hyperplasia (BPH): a European multi-center evaluation. *Eur Urol*, 2004;46: 496 - 501.
- Grise P, Ruffion A, Denys P, et al. Efficacy and tolerability of botulinum toxin type A in patients with neurogenic detrusor overactivity and without concomitant anticholinergic therapy: comparison of two doses. *Eur Urol.* 2010 Nov;58(5):759-66.
- Green SA, Alon A, Ianus J et al. Efficacy and safety of a neurokinin-1 receptor antagonist in postmenopausal women with overactive bladder with urge urinary incontinence. *J Urol.* 2006 Dec;176(6 Pt 1):2535
- Grigoleit U, Mürtz G, Laschke S et al. Efficacy, tolerability and safety of propiverine hydrochloride in children and adolescents with congenital or traumatic neurogenic detrusor overactivity--a retrospective study. *Eur Urol.* 2006 Jun;49(6):1114
- Grise P, Ruffion A, Denys P, et al. Efficacy and tolerability of botulinum toxin type A in patients with neurogenic detrusor overactivity and without concomitant anticholinergic therapy: comparison of two doses. *Eur Urol.* 2010 Nov;58(5):759-66.
- Grodstein F, Lifford K, Resnick NM et al., Curham GC. Postmenopausal hormone therapy and risk of developing urinary incontinence. *Obstet Gynaecol* 2004;103(2):254
- Grond S, Sablotzki A. Clinical pharmacology of tramadol. *Clin Pharmacokinet.* 2004;43(13):879
- Grosse J, Kramer G, Stöhrer M. Success of repeat detrusor injections of botulinum a toxin in patients with severe neurogenic detrusor overactivity and incontinence. *Eur Urol.* 2005 May;47(5):653
- Grüneberger A. Treatment of motor urge incontinence with clenbuterol and flavoxate hydrochloride. *Br J Obstet Gynaecol* 1984;91:275
- Gu BJ, Ishizuka O, Igawa Y et al. Role of supraspinal tachykinins for micturition in conscious rats with and without bladder outlet obstruction. *Naunyn Schmiedebergs Arch Pharmacol.* 2000 May;361(5):543
- Guan-Jun D, Feng-Bin G, Xun-Bo J. α_1 -Blockers in the management of acute urinary retention secondary to benign prostatic hyperplasia: a systematic review and meta-analysis. *Ir J Med Sci.* 2015 Mar;184(1):23-30.

- Guercini, F, Giannantoni A, Bard RL et al. Intraprostatic botox - an injection in patients with severe benign prostatic hyperplasia. A multicenter study. *Eur Urol Suppl*, 2005;4: 150.
- Guarneri L, Robinson E, Testa R. A review of flavoxate: pharmacology and mechanism of action. *Drugs Today*, 1994;30:91
- Guay DR. Clinical pharmacokinetics of drugs used to treat urge incontinence. *Clin Pharmacokinet*. 2003;42(14):1243
- Guay DR. Darifenacin: another antimuscarinic for overactive bladder. *Consult Pharm*. 2005 May;20(5):424-31.
- Guerra LA, Moher D, Sampson M et al. Intravesical oxybutynin for children with poorly compliant neurogenic bladder: a systematic review. *J Urol*. 2008 Sep;180(3):1091
- Gutman GA, Chandy KG, Adelman JP, et al. International Union of Pharmacology. XLI. Compendium of voltage-gated ion channels: potassium channels. *Pharmacol Rev* 2003; 55: 583
- Haab F, Braticevici B, Krivoborodov G, et al. Efficacy and safety of repeated dosing of netupitant, a neurokinin-1 receptor antagonist, in treating overactive bladder. *NeuroUrol Urodyn*. 2014 Mar;33(3):335-40
- Haab F, Cardozo L, Chapple C et al. Solifenacin Study Group. Long-term open-label solifenacin treatment associated with persistence with therapy in patients with overactive bladder syndrome. *Eur Urol*. 2005 Mar;47(3):376
- Haab F, Corcos J, Siami P et al. Long-term treatment with darifenacin for overactive bladder: results of a 2-year, open-label extension study. *BJU Int*. 2006 Nov;98(5):1025
- Haab F, Stewart L, Dwyer P. Darifenacin, an M3 selective receptor antagonist, is an effective and well-tolerated oncedaily treatment for overactive bladder. *Eur Urol*, 2004;45(4):420
- Habler HJ, Janig W, Koltzenburg, M. Activation of unmyelinated afferent fibres by mechanical stimuli and inflammation of the urinary bladder in the cat. *J Physiol*, 1990;425:545
- Haferkamp A, Schurch B, Reitz A et al. Lack of ultrastructural detrusor changes following endoscopic injection of botulinum toxin type a in overactive neurogenic bladder. *Eur Urol*. 2004 Dec; 46(6): 784
- Halaska M, Ralph G, Wiedemann A et al. Controlled, double-blind, multicentre clinical trial to investigate long-term tolerability and efficacy of trospium chloride in patients with detrusor instability. 2003; *World J Urol* 20(6):392
- Hanna-Mitchell AT, Wolf-Johnston AS, Barrick SR, et al. Effect of botulinum toxin A on urothelial-release of ATP and expression of SNARE targets within the urothelium. *NeuroUrol Urodyn*. 2015 Jan;34(1):79-84.
- Harper M, Popat RB, Dasgupta R et al. A minimally invasive technique for outpatient local anaesthetic administration of intradetrusor botulinum toxin in intractable detrusor overactivity. *BJU Int*. 2003 Aug;92(3):325
- Haruno A. Inhibitory effects of propiverine hydrochloride on the agonist-induced or spontaneous contractions of various isolated muscle preparations. *Arzneim-Forsch /Drug Res* 1992;42:815
- Hashim H, Abrams P. Do symptoms of overactive bladder predict urodynamics detrusor overactivity? *NeuroUrol Urodyn* 2004;23(5/6):484
- Hashim H, Abrams P. Pharmacologic management of women with mixed urinary incontinence. *Drugs* 2006;66(5):591
- Hashim H, Malmberg L, Graugaard-Jensen C et al. Desmopressin, as a "designer-drug," in the treatment of overactive bladder syndrome. *NeuroUrol Urodyn*. 2009;28(1):40-6.
- Hashimoto M, Imamura T, Tanimukai S et al. Urinary incontinence: an unrecognised adverse effect with donepezil. *Lancet* 2000;356:568.
- Hashimoto S, Kigoshi S, Muramatsu I. Nitric oxidedependent and -independent neurogenic relaxation of isolated dog urethra. *Eur J Pharmacol* 1993;231: 209
- Hatanaka T, Ukai M, Watanabe M, et al. In vitro and in vivo pharmacological profile of the selective β_3 -adrenoceptor agonist mirabegron in rats. *Naunyn Schmiedebergs Arch Pharmacol*. 2013 Mar;386(3):247-53.
- Haustein KO, Huller G. On the pharmacokinetics and metabolism of propiverine in man. *Eur J Drug Metab Pharmacokinet* 1988;13(2):81
- Hawthorn MH, Chapple CR, Cock M et al. Urothelium-derived inhibitory factor(s) influences on detrusor muscle contractility in vitro. *Br J Pharmacol* 2000;129:416
- Hedlund P. Cannabinoids and the endocannabinoid system in lower urinary tract function and dysfunction. *NeuroUrol Urodyn*. 2014 Jan;33(1):46-53
- Hedlund P, Gratzke C. The endocannabinoid system - a target for the treatment of LUTS? *Nat Rev Urol*. 2016 Aug;13(8):463-70
- Hegde SS. Muscarinic receptors in the bladder: from basic research to therapeutics. *Br J Pharmacol* 2006;147:S80
- Hegde SS, Choppin A, Bonhaus D, et al. Functional role of M2 and M3 muscarinic receptors in the urinary bladder of rats in vitro and in vivo. *Br J Pharmacol* 1997;120: 1409

- Helfand BT, Evans RM, McVary KT. A comparison of the frequencies of medical therapies for overactive bladder in men and women: analysis of more than 7.2 million aging patients. *Eur Urol*. 2010 Apr;57(4):586-91
- Hendrix SL, Cochrane BB, Nygaard IE et al. Effects of estrogen with and without progestin on urinary incontinence. *JAMA* 2005;293(8):935
- Hendrix SL, McNeeley SG. Effect of selective estrogen receptor modulators on reproductive tissues other than endometrium. *Ann N Y Acad Sci* 2001;949:243
- Henriksson L, Andersson K-E, Ulmsten U. The urethral pressure profiles in continent and stress incontinent women. *Scand J Urol Nephrol* 1979;13:5
- Herbison P, Hay-Smith J, Ellis G et al. Effectiveness of anticholinergic drugs compared with placebo in the treatment of overactive bladder: systematic review. *Br Med J* 2003;326:841
- Herschorn S, Gajewski J, Ethans K, et al. Efficacy of botulinum toxin A injection for neurogenic detrusor overactivity and urinary incontinence: a randomized, double-blind trial. *J Urol*. 2011a Jun;185(6):2229-35.
- Herschorn S, Gajewski J, Schulz J, Corcos J. A population-based study of urinary symptoms and incontinence: the Canadian Urinary Bladder Survey. *BJU Int*. 2008 Jan;101(1):52
- Herschorn S, Pommerville P, Stothers L, et al. Tolerability of solifenacin and oxybutynin immediate release in older (> 65 years) and younger (≤ 65 years) patients with overactive bladder: sub-analysis from a Canadian, randomized, double-blind study. *Curr Med Res Opin*. 2011b Feb;27(2):375-82.
- Herschorn S, Swift S, Guan Z, et al. Comparison of fesoterodine and tolterodine extended release for the treatment of overactive bladder: a head-to-head placebo-controlled trial. *BJU Int*. 2010 Jan;105(1):58-66.
- Hextall A. Oestrogens and lower urinary tract function. *Maturitas* 2000;36:83
- Hextall A, Bidmead J, Cardozo L et al. The impact of the menstrual cycle on urinary symptoms and the results of urodynamic investigation. *BJOG* 2001;108(11):1193
- Hicks A, McCafferty GP, Riedel E et al. GW427353 (solabegron), a novel, selective beta3-adrenergic receptor agonist, evokes bladder relaxation and increases micturition reflex threshold in the dog. *J Pharmacol Exp Ther*. 2007 Oct;323(1):202
- Hill S, Khullar V, Wyndaele JJ et al. Dose response with darifenacin, a novel once-daily M3 selective receptor antagonist for the treatment of overactive bladder: results of a fixed dose study. *Int Urogynecol J Pelvic Floor Dysfunct*. 2006 May;17(3):239
- Hillelsohn JH, Rais-Bahrami S, Bagadiya N, et al. Use of desipramine for the treatment of overactive bladder refractory to antimuscarinic therapy. *Urol J*. 2014 Jan 4;10(4):1114-8.
- Hills CJ, Winter SA, Balfour JA. Tolterodine. *Drugs* 1998;55:813
- Hilton P, Hertogs K, Stanton SL. The use of desmopressin (DDAVP) for nocturia in women with multiple sclerosis. *J Neurol Neurosurg Psychiatry* 1983;46:854
- Hilton P, Stanton SL. The use of desmopressin (DDAVP) in nocturnal urinary frequency in the female. *Br J Urol* 1982;54:252
- Hilton P, Stanton SL. Urethral pressure measurement by microtransducer: the results in symptom free women and in those with genuine stress incontinence. *Br J Obstet Gynaecol* 1983 Oct;90(10):919-33.
- Hindley RG, Brierly RD, Thomas PJ. Prostaglandin E2 and bethanechol in combination for treating detrusor underactivity. *BJU Int*. 2004 Jan;93(1):89-92.
- Hirst GR, Watkins AJ, Guerrero K et al. MG, Botulinum toxin B is not an effective treatment of refractory overactive bladder. *Urology* 2007 Jan;69(1):69
- Hoebeke P, De Caestecker K, Vande Walle J, et al. The effect of botulinum-A toxin in incontinent children with therapy resistant overactive detrusor. *J Urol*. 2006 Jul;176(1):328-30
- Hoebeke P, De Pooter J, De Caestecker K, et al. Solifenacin for therapy resistant overactive bladder. *J Urol*. 2009 Oct;182(4 Suppl):2040-4.
- Hoebeke PB, Vande Walle J. The pharmacology of paediatric incontinence. *BJU Int*. 2000 Sep;86(5):581-9.
- Holmes DM, Montz FJ, Stanton SL. Oxybutynin versus propantheline in the management of detrusor instability. A patient regulated variable dose trial. *Br J Obstet Gynaecol* 1989;96: 607
- Homma Y, Yamaguchi T, Yamaguchi O. A randomized, double-blind, placebo-controlled phase II dose-finding study of the novel anti-muscarinic agent imidafenacin in Japanese patients with overactive bladder. *Int J Urol*. 2008a Sep;15(9):809-15.
- Homma Y, Yamaguchi O; Imidafenacin Study Group. A randomized, double-blind, placebo- and propiverine-controlled trial of the novel antimuscarinic agent imidafenacin in Japanese patients with overactive bladder. *Int J Urol*. 2009 May;16(5):499-506.

- Homma Y, Yamaguchi O. Long-term safety, tolerability, and efficacy of the novel anti-muscarinic agent imidafenacin in Japanese patients with overactive bladder. *Int J Urol*. 2008b Oct;15(11):986-91.
- Horstmann M, Schaefer T, Aguilar Y, Stenzl A, Sievert KD. Neurogenic bladder treatment by doubling the recommended antimuscarinic dosage. *Neurourol Urodyn*. 2006;25(5):441-5.
- Hoverd PA, Fowler CJ. Desmopressin in the treatment of daytime urinary frequency in patients with multiple sclerosis. *J Neurol Neurosurg Psychiatry* 1998;65:778
- Howe BB, Halterman TJ, Yochim CL, et al. Zeneca ZD6169: a novel KATP channel opener with in vivo selectivity for urinary bladder. *J Pharmacol Exp Ther* 1995; 274: 884
- Hristov KL, Smith AC, Parajuli SP, et al. Novel regulatory mechanism in human urinary bladder: central role of transient receptor potential melastatin 4 channels in detrusor smooth muscle function. *Am J Physiol Cell Physiol*. 2016 Apr 1;310(7):C600-11.
- Hruz P, Lövblad KO, Nirikko AC et al. Identification of brain structures involved in micturition with functional magnetic resonance imaging (fMRI). *J Neuroradiol*. 2008 Jul;35(3):144-9.
- Hsiao SM, Chang TC, Wu WY, et al. Comparisons of urodynamic effects, therapeutic efficacy and safety of solifenacin versus tolterodine for female overactive bladder syndrome. *J Obstet Gynaecol Res*. 2011 Aug;37(8):1084-91.
- Hu S, Kim HS. Modulation of ATP sensitive and large-conductance Ca²⁺-activated K⁺ channels by Zeneca ZD6169 in guinea pig bladder smooth muscle cells. *J Pharmacol Exp Ther* 1997;280:38
- Hudman D, Elliott RA, Norman RI. K(ATP) channels mediate the beta(2)-adrenoceptor agonist-induced relaxation of rat detrusor muscle. *Eur J Pharmacol*. 2000 May 26;397(1):169
- Hughes KM, Lang JCT, Lazare R et al. Measurement of oxybutynin and its N-desethyl metabolite in plasma, and its application to pharmacokinetic studies in young, elderly and frail elderly volunteers. *Xenobiotica*, 1992;22:859
- Humeau Y, Doussau F, Grant NJ et al. How botulinum and tetanus neurotoxins block neurotransmitter release. *Biochimie*. 2000 May;82(5):427
- Hunsballe JM, Djurhuus JC. Clinical options for imipramine in the management of urinary incontinence. *Urol Res* 2001;29:118
- Hurley DJ, Turner CL, Yalcin I et al. Duloxetine for the treatment of stress urinary incontinence: an integrated analysis of safety. *Eur J Obstet Gynecol Reprod Biol* 2006; 125:120
- Hussain RM, Hartigan-Go K, Thomas SHL et al. Effect of oxybutynin on the QTc interval in elderly patients with urinary incontinence. *Br J Clin Pharmacol* 1994;37:485P
- Huwyler M, Schurch B, Knapp PA, Reitz A. Can the ice-water test predict the outcome of intradetrusor injections of botulinum toxin in patients with neurogenic bladder dysfunction? *World J Urol*. 2007 Dec;25(6):613-7.
- Hyman MJ, Groutz A, Blaivas JG. Detrusor instability in men: correlation of lower urinary tract symptoms with urodynamic findings. *J Urol*. 2001 Aug;166(2):550
- Ichihara K, Masumori N, Fukuta F, et al. A randomized controlled study of the efficacy of tamsulosin monotherapy and its combination with mirabegron for overactive bladder induced by benign prostatic obstruction. *J Urol*. 2015 Mar;193(3):921-6.
- Igawa Y, Aizawa N, Homma Y. Beta3-adrenoceptor agonists: possible role in the treatment of overactive bladder. *Korean J Urol*. 2010 Dec;51(12):811-8.
- Igawa Y, Michel MC. Pharmacological profile of β3-adrenoceptor agonists in clinical development for the treatment of overactive bladder syndrome. *Naunyn Schmiedebergs Arch Pharmacol*. 2013 Mar;386(3):177-83.
- Igawa Y, Yamazaki Y, Takeda H et al. Functional and molecular biological evidence for a possible beta3-adrenoceptor in the human detrusor muscle. *Br J Pharmacol*. 1999 Feb;126(3):819
- Igawa Y, Yamazaki Y, Takeda H et al. Relaxant effects of isoproterenol and selective beta3-adrenoceptor agonists on normal, low compliant and hyperreflexic human bladders. *J Urol*. 2001 Jan;165(1):240
- Iijima K, De Wachter S, Wyndaele JJ. Effects of the M3 receptor selective muscarinic antagonist darifenacin on bladder afferent activity of the rat pelvic nerve. *Eur Urol*. 2007 Sep;52(3):842
- Ikeda Y, Zabbarova IV, Birder LA, et al. Botulinum Neurotoxin Serotype A Suppresses Neurotransmitter Release from Afferent as Well as Efferent Nerves in the Urinary Bladder. *Eur Urol*. 2012 Dec;62(6):1157-64.
- Ikemoto I, Kiyota H, Ohishi Y, et al. Usefulness of tamsulosin hydrochloride and naftopidil in patients with urinary disturbances caused by benign prostatic hyperplasia: a comparative, randomized, two-drug crossover study. *Int J Urol*. 2003 Nov;10(11):587-94.
- Insel PA, Tang C-M, Hahntow I et al. Impact of GPCRs in clinical medicine: genetic variants and drug targets. *Biochim Biophys Acta* 2007;1768:994
- Irwin DE, Abrams P, Milsom I, et al; EPIC Study Group. Understanding the elements of overactive bladder: questions raised by the EPIC study. *BJU Int*. 2008 Jun;101(11):1381-7.

- Irwin DE, Milsom I, Hunskaar S, et al. Population-based survey of urinary incontinence, overactive bladder, and other lower urinary tract symptoms in five countries: results of the EPIC study. *Eur Urol*. 2006 Dec;50(6):1306
- Ishiko O, Hirai K, Sumi T et al. Hormone replacement therapy plus pelvic floor muscle exercise for postmenopausal stress incontinence. A randomized controlled trial. *J Reprod Med* 2001;46:213
- Ishiko O, Ushiroyama T, Saji F et al. Beta(2)-Adrenergic agonists and pelvic floor exercises for female stress incontinence. *Int J Gynaecol Obstet* 2000;71:39
- Ishizuka O, Igawa Y, Lecci A et al. Role of intrathecal tachykinins for micturition in unanaesthetized rats with and without bladder outlet obstruction. *Br J Pharmacol*. 1994 Sep;113(1):111
- Ishizuka O, Igawa Y, Nishizawa O et al. Role of supraspinal tachykinins for volume- and L-dopa-induced bladder activity in normal conscious rats. *NeuroUrol Urodyn*. 2000;19(1):101
- Ishizuka O, Mattiasson A, Andersson KE. Effects of neurokinin receptor antagonists on L-dopa induced bladder hyperactivity in normal conscious rats. *J Urol*. 1995 Oct;154(4):1548
- Isik AT, Celik T, Bozoglu E, Doruk H. Tropicam and cognition in patients with late onset Alzheimer disease. *J Nutr Health Aging* 2009;13:672-676.
- Ito K, Iwami A, Katsura H, Ikeda M. Therapeutic effects of the putative P2X3/P2X2/3 antagonist A-317491 on cyclophosphamide-induced cystitis in rats. *Naunyn Schmiedeberg's Arch Pharmacol*. 2008 Jun;377(4-6):483-90.
- Jacky BP, Garay PE, Dupuy J, et al. Identification of fibroblast growth factor receptor 3 (FGFR3) as a protein receptor for botulinum neurotoxin serotype A (BoNT/A). *PLoS Pathog*. 2013;9(5):e1003369.
- Jacobsen SM, Kerstein H, Molden E. Evaluation of brain anticholinergic activities of urinary spasmolytic drugs using a high-throughput radio receptor bioassay. *J Am Geriatr Soc* 2011;59:501-505.
- Jackson S, Shepherd A, Abrams P. The effect of oestradiol on objective urinary leakage in postmenopausal stress incontinence: a double blind placebo controlled trial. *NeuroUrol Urodyn* 1996;15:322
- Janig W, Morrison JF. Functional properties of spinal visceral afferents supplying abdominal and pelvic organs, with special emphasis on visceral nociception. *Prog Brain Res*, 1986;67:87
- Janssen DA, Hoenderop JG, Jansen KC, et al. The mechanoreceptor TRPV4 is localized in adherence junctions of the human bladder urothelium: a morphological study. *J Urol*. 2011 Sep;186(3):1121-7.
- Jeremy JY, Tsang V, Mikhailidis DP et al. Eicosanoid synthesis by human urinary bladder mucosa: pathological implications. *Br J Urol* 1987;59:36
- Ji RR, Samad TA, Jin SX, et al. p38 MAPK activation by NGF in primary sensory neurons after inflammation increases TRPV1 levels and maintains heat hyperalgesia. *Neuron*. 2002 Sep 26;36(1):57-68.
- Jiang F, Zhu L, Xu T, et al. Efficacy and safety of solifenacin succinate tablets versus solifenacin succinate tablets with local oestrogen for the treatment of overactive bladder in postmenopausal women – a multicenter, randomised, open-label, controlled comparison study. *Menopause* 2016 Apr 23(4) 451-7
- Johnell K, Klarin I. The relationship between number of drugs and potential drug-drug interaction in the elderly. *Drug Safety* 2007;30:911-918.
- Johnson TMII, Miller M, Tang T et al. Oral ddAVP for nighttime urinary incontinence in characterized nursing home residents: a pilot study. *J Am Med Dir Assoc* 2006;7:6
- Jones, R.L., Giembycz, M.A., Woodward, D.F., 2009. Prostanoid receptor antagonists: development strategies and therapeutic applications. *Br J Pharmacol* 158, 104-145.
- Jonville AP, Dutertre JP, Autret E, Barbellion M. [Adverse effects of oxybutynin chloride (Ditropan). Evaluation of the official survey of Regional Pharmacovigilance Centers]. *Therapie*. 1992 Sep-Oct;47(5):389-92.
- Jugus MJ, Jaworski JP, Patra PB, et al. Dual modulation of urinary bladder activity and urine flow by prostanoid EP3 receptors in the conscious rat. *Br J Pharmacol* 2009;158: 372-381.
- Juul KV, Klein BM, Sandstrom R et al. Gender difference in antidiuretic response to desmopressin. *Am J Physiol Renal Physiol* 2011;300:F1116-F1122.
- Jünemann KP, Al-Shukri S. Efficacy and tolerability of trospium chloride and tolterodine in 234 patients with urge-syndrome: a double-blind, placebo-controlled multicentre clinical trial. *NeuroUrol Urodyn* 2000;19:488
- Jünemann KP, Halaska M, Rittstein T et al. Propiverine versus tolterodine: efficacy and tolerability in patients with overactive bladder. *Eur Urol*. 2005 Sep;48(3):478
- Jünemann KP, Hessdörfer E, Unamba-Oparah I, et al. Propiverine hydrochloride immediate and extended release: comparison of efficacy and tolerability in patients with overactive bladder. *Urol Int*. 2006;77(4):334
- Kachur JF, Peterson JS, Carter JP et al. R and S enantiomers of oxybutynin: pharmacological effects in guinea pig bladder and intestine. *J Pharmacol Exp Ther*, 1988;247: 867

- Kadekawa K, Onaga T, Shimabukuro S, et al. Effect of Imidafenacin before Sleeping on Nocturia. *Low Urin Tract Symptoms*. 2012 Sep;4(3):130-5.
- Kaidoh K, Igawa Y, Takeda H et al. Effects of selective beta2 and beta3-adrenoceptor agonists on detrusor hyperreflexia in conscious cerebral infarcted rats. *J Urol*. 2002 Sep;168(3):1247
- Kaiho Y, Nishiguchi J, Kwon DD et al. The effects of a type 4 phosphodiesterase inhibitor and the muscarinic cholinergic antagonist tolterodine tartrate on detrusor overactivity in female rats with bladder outlet obstruction. *BJU Int*. 2008 Mar;101(5):615
- Kaisary AV. Beta adrenoceptor blockade in the treatment of female stress urinary incontinence. *J d'Urol (Paris)* 1984;90:351
- Kajbafzadeh AM, Moosavi S, Tajik P et al. Intravesical injection of botulinum toxin type A: management of neuropathic bladder and bowel dysfunction in children with myelomeningocele. *Urology*, 2006 Nov; 68(5):1091
- Kajbafzadeh AM, Nikfarjam L, Mahboubi AH, Dianat S. Antibody formation following botulinum toxin type A (Dysport) injection in children with intractable bladder hyper-reflexia. *Urology*. 2010 Jul;76(1):233-7.
- Kajbafzadeh AM, Montaser-Kouhsari L, Ahmadi H, Sotoudeh M. Intravesical electromotive botulinum toxin type A administration: part I--Experimental study. *Urology*. 2011 Jun;77(6):1460-4.
- Kalder M, Pantazis K, Dinas K, et al. Discontinuation of treatment using anticholinergic medications in patients with urinary incontinence. *Obstet Gynecol*. 2014 Oct;124(4):794-800.
- Kalejaiye O, Speakman MJ. Management of acute and chronic retention in men. *Eur Urol* 2009;Suppl 8:523-9.
- Kalinichev M, Palea S, Haddouk H, et al. ADX71441, a novel, potent and selective positive allosteric modulator of the GABA(B) receptor, shows efficacy in rodent models of overactive bladder. *Br J Pharmacol*. 2014 Feb;171(4):995-1006.
- Kalsi V, Apostolidis A, Gonzales G et al. Early effect on the overactive bladder symptoms following botulinum neurotoxin type A injections for detrusor overactivity. *Eur Urol*. 2008 Jul;54(1):181
- Kalsi V, Gonzales G, Popat R et al. Botulinum injections for the treatment of bladder symptoms of multiple sclerosis. *Ann Neurol*. 2007 Nov;62(5):452
- Kalsi V, Popat RB, Apostolidis A et al. Cost-consequence analysis evaluating the use of botulinum neurotoxin-A in patients with detrusor overactivity based on clinical outcomes observed at a single UK centre. *Eur Urol*. 2006 Mar; 49(3):519
- Kamperis K, van Herzeele C, Rittig S, Walle JV. Optimising response to desmopressin in patients with monosymptomatic nocturnal enuresis. *Pediatr Nephrol*. 2016 Apr 12. [Epub ahead of print]
- Kanagarajah P, Ayyathurai R, Caruso DJ, et al. Role of botulinum toxin-A in refractory idiopathic overactive bladder patients without detrusor overactivity. *Int Urol Nephrol*. 2012 Feb;44(1):91-7.
- Kanai A, Andersson KE. Bladder afferent signaling: recent findings. *J Urol*. 2010 Apr;183(4):1288-95.
- Kanayama N, Kanari C, Masuda Y, et al. Drug-drug interactions in the metabolism of imidafenacin: role of the human cytochrome P450 enzymes and UDP-glucuronic acid transferases, and potential of imidafenacin to inhibit human cytochrome P450 enzymes. *Xenobiotica*. 2007 Feb;37(2):139-54.
- Kang I S, Sung ZH, et al. The efficacy and safety of combination therapy with alpha-blocker and low-dose propiverine hydrochloride for benign prostatic hyperplasia accompanied by overactive bladder symptoms. *Korean J Urol* 2009;50: 1078-82.
- Kaplan SA, Cardozo L, Herschorn S, et al. Assessment of Fesoterodine after Tolterodine ER (AFTER) Study Group. Efficacy and safety of fesoterodine 8 mg in subjects with overactive bladder after a suboptimal response to tolterodine ER. *Int J Clin Pract*. 2014 Sep;68(9):1065-73
- Kaplan SA, Goldfischer ER, Steers WD, et al. Solifenacin treatment in men with overactive bladder: effects on symptoms and patient-reported outcomes. *Aging Male*. 2010 Jun;13(2):100-7.
- Kaplan SA, Gonzalez RR, Te AE. Combination of alufosin and sildenafil is superior to monotherapy in treating lower urinary tract symptoms and erectile dysfunction. *Eur Urol* 2007;51:1717-1723.
- Kaplan SA, McCammon K, Fincher R, et al. Safety and tolerability of solifenacin add-on therapy to α -blocker treated men with residual urgency and frequency. *J Urol*. 2013 Jan;189(1 Suppl):S129-34.
- Kaplan SA, Roehrborn CG, Rovner ES et al. Tolterodine and tamsulosin for treatment of men with lower urinary tract symptoms and overactive bladder: a randomized controlled trial. *JAMA* 2006 Nov 15;296(19):2319
- Kaplan SA, Roehrborn CG, Chancellor M et al. Extended-release tolterodine with or without tamsulosin in men with lower urinary tract symptoms and overactive bladder: effects on urinary symptoms assessed by the International Prostate Symptom Score. *BJU Int*. 2008b Nov;102(9):1133-9.
- Kaplan SA, Schneider T, Foote JE, et al. Superior efficacy of fesoterodine over tolterodine extended release with rapid onset: a prospective, head-to-head, placebo-controlled trial. *BJU Int*. 2011 May;107(9):1432-40.

- Kaplan SA, Walmsley K, Te AE. Tolterodine extended release attenuates lower urinary tract symptoms in men with benign prostatic hyperplasia. *J Urol*. 2008a May;179(5 Suppl):S82
- Kaplan SA, He W, Koltun WD, et al. Solifenacin plus tamsulosin combination treatment in men with lower urinary tract symptoms and bladder outlet obstruction: a randomized controlled trial. *Eur Urol*. 2013 Jan;63(1):158-65
- Karmarkar R, Khullar V. Emerging drugs for overactive bladder. *Expert Opin Emerg Drugs*. 2015;20(4):613-24.
- Karsenty G, Boy S, Reitz A et al. Botulinum toxin A (BTA) in the treatment of neurogenic detrusor overactivity incontinence (NDOI)- a prospective randomized study to compare 30 vs 10 injections sites. *Neurourol Urodyn*. 2005; 24 (5/6): 547-548 (abstract 93).
- Karsenty G, Baverstock R, Carlson K P. et al. Technical aspects of botulinum toxin type A injection in the bladder to treat urinary incontinence: reviewing the procedure. *Int J Clin Pract*. 2014 Jun;68(6):731-42
- Karsenty G, Denys P, Amarenco G, et al.. Botulinum toxin A (Botox) intradetrusor injections in adults with neurogenic detrusor overactivity/neurogenic overactive bladder: a systematic literature review. *Eur Urol*. 2008 Feb;53(2):275
- Karsenty G, Elzayat E, Delapparent T et al. Botulinum toxin type A injections into the trigone to treat idiopathic overactive bladder do not induce vesicoureteral reflux. *J Urol*. 2007 Mar;177(3):1011
- Kasabian NG, Vlachiotis JD, Lais A et al. The use of intravesical oxybutynin chloride in patients with detrusor hypertonicity and detrusor hyperreflexia. *J Urol* 1994;151:944
- Katofiasc MA, Nissen J, Audia JE, et al: Comparison of the effects of serotonin selective norepinephrine selective, and dual serotonin and norepinephrine reuptake inhibitors on lower urinary tract function in cats. *Life Sci* 2002;71(11):1227
- Katz IR, Prouty Sands L, Bilker W et al. Identification of medications that cause cognitive impairment in older people: the case of oxybutynin chloride. *J Am Geriatr Soc* 1998;46:8
- Kavia R, De Ridder D, Constantinescu S, et al. Randomised controlled trial of Sativex to treat detrusor overactivity in multiple sclerosis. *Mult Scler* 2010;16:1349–59.
- Kawabe K, Yoshida M, Homma Y; Silodosin Clinical Study Group. Silodosin, a new alpha1A-adrenoceptor-selective antagonist for treating benign prostatic hyperplasia: results of a phase III randomized, placebo-controlled, double-blind study in Japanese men. *JU Int*. 2006 Nov;98(5):1019-24.
- Kay G, Crook T, Reveda L et al. Differential effects of the antimuscarinic agents darifenacin and oxybutynin ER on memory in older subjects. *Eur Urol*. 2006 Aug;50(2):317
- Kay GG, Ebinger U. Preserving cognitive function for patients with overactive bladder: evidence for a differential effect with darifenacin. *Int J Clin Pract*. 2008 Nov;62(11):1792-800.
- Kay GG, Wesnes KA. Pharmacodynamic effects of darifenacin, a muscarinic M selective receptor antagonist for the treatment of overactive bladder, in healthy volunteers. *BJU Int*. 2005 Nov;96(7):1055
- Keane DP, Sims TJ, Abrams P et al. Analysis of collagen status in premenopausal nulliparous women with genuine stress incontinence. *Br J Obstet and Gynaecol* 1997;104(9)994
- Kelleher CJ, Cardozo L, Chapple CR, Haab F, Ridder AM. Improved quality of life in patients with overactive bladder symptoms treated with solifenacin. *BJU Int* 2005; 95 : 81-5
- Kelleher C, Cardozo L, Kobashi K et al. Solifenacin: as effective in mixed urinary incontinence as in urge urinary incontinence. *Int Urogynecol J Pelvic Floor Dysfunct*. 2006 Jun;17(4):382
- Kelleher CJ, Dmochowski RR, Berriman S, et al. Sustained improvement in patient-reported outcomes during long-term fesoterodine treatment for overactive bladder symptoms: pooled analysis of two open-label extension studies. *BJU Int*. 2012 Aug;110(3):392-400.
- Kelleher CJ, Tubaro A, Wang JT et al. Impact of fesoterodine on quality of life: pooled data from two randomized trials. *BJU Int*. 2008 Jul;102(1):56
- Kennedy C, Tasker PN, Gallacher G et al. Identification of atropine- and P2X1 receptor antagonist-resistant, neurogenic contractions of the urinary bladder. *J Neurosci* 2007 Jan 24;27(4):845
- Kennelly M, Dmochowski R, Ethans K, et al. Long-term efficacy and safety of onabotulinumtoxinA in patients with urinary incontinence due to neurogenic detrusor overactivity: an interim analysis. *Urology*. 2013 Mar;81(3):491-7
- Kennelly M, Dmochowski R, Schulte-Baukloh H, et al.; 191622-094 Investigators. Efficacy and safety of onabotulinumtoxinA therapy are sustained over 4 years of treatment in patients with neurogenic detrusor overactivity: Final results of a long-term extension study. *Neurourol Urodyn*. 2015 Nov 24.
- Kerbusch T, Wahlby U, Milligan PA et al. M.O. Population pharmacokinetic modelling of darifenacin and its hydroxylated metabolite using pooled data, incorporating saturable first-pass metabolism, CYP2D6 genotype and formulation-dependent bioavailability. *Br J Clin Pharmacol* 2003;56(6):639

- Kernan WN, Viscoli CM, Brass LM, et al. Phenylpropanolamine and the risk of hemorrhagic stroke. *N Engl J Med* 200;343(25):1826
- Kessler TM, Bachmann LM, Minder C, et al. Adverse event assessment of antimuscarinics for treating overactive bladder: a network meta-analytic approach. *PLoS One*. 2011 Feb 23;6(2):e16718.
- Kessler TM, Khan S, Panicker JN, et al. In the human urothelium and suburothelium, intradetrusor botulinum neurotoxin type A does not induce apoptosis: preliminary results. *Eur Urol*. 2010 May;57(5):879-83.
- Kessler TM, Studer UE, Burkhard FC. The effect of terazosin on functional bladder outlet obstruction in women: a pilot study. *J Urol*. 2006 Oct;176(4 Pt 1):1487
- Khan S, Game X, Kalsi V, Gonzales et al. Long-term effect on quality of life of repeat detrusor injections of botulinum neurotoxin-A for detrusor overactivity in patients with multiple sclerosis. *J Urol*. 2011 Apr;185(4):1344-9.
- Khera M, Somogyi GT, Kiss S et al. Botulinum toxin A inhibits ATP release from bladder urothelium after chronic spinal cord injury. *Neurochem Int*. 2004 Dec;45(7):987
- Khullar V, Cambroner J, Ströberg P, et al. The efficacy and tolerability of mirabegron in patients with overactive bladder - results from a European-Australian Phase III trial. Presented at the 26th Annual Congress of the European Association of Urology, Vienna, Austria, 18-22 March 2011.
- Khullar V, Foote J, Seifu Y, Egermark M. Time-to-effect with darifenacin in overactive bladder: a pooled analysis. *Int Urogynecol J*. 2011 Dec;22(12):1573-80.
- Khullar V, Rovner ES, Dmochowski R et al. Fesoterodine dose response in subjects with overactive bladder syndrome. *Urology*. 2008 May;71(5):839
- Kilic MK, Kizilarlanoglu MC, Kara O, et al Hypovitaminosis D is an independent associated factor of overactive bladder in older adults. *Arch Gerontol Geriatr*. 2016 Jul-Aug;65:128-32.
- Kim YH, Bird ET, Priebe M et al. The role of oxybutynin in spinal cord injured patients with indwelling catheters. *J Urol* 1996;158:2083
- Kim TH, Lee SE, Lee HE, Lee KS. Safety and efficacy of fesoterodine fumarate in patients with overactive bladder: results of a post-marketing surveillance study in Korea. *Curr Med Res Opin*. 2016 Aug;32(8):1361-6.
- Kim YT, Kwon DD, Kim J et al. Gabapentin for overactive bladder and nocturia after anticholinergic failure. *Int Braz J Urol*. 2004 Jul-Aug;30(4):275
- Kim YS, Sainz RD. Beta adrenergic agonists and hypertrophy of skeletal muscles. *Life Sci* 1992;50:397
- Kim Y, Yoshimura N, Masuda H, de Miguel F, Chancellor MB. Antimuscarinic agents exhibit local inhibitory effects on muscarinic receptors in bladder afferent pathways. *Urology*. 2005 Feb;65(2):238-42.
- Kim Y, Yoshimura N, Masuda H et al.: Intravesical instillation of human urine after oral administration of tropsium, tolterodine and oxybutynin in a rat model of detrusor overactivity. *BJU Int* 2006, 97:400
- Kim TH, You HW, Park JH, et al. Persistence of solifenacin therapy in patients with overactive bladder in the clinical setting: a prospective, multicenter, observational study. *Int J Clin Pract*. 2016 Apr;70(4):351-7.
- Kinn AC, Larsson PO. Desmopressin: a new principle for symptomatic treatment of urgency and incontinence in patients with multiple sclerosis. *Scand J Urol Nephrol* 1990;24:109
- Kishimoto T, Morita T, Okamiya Y et al. Effect of clenbuterol on contractile response in periurethral striated muscle of rabbits. *Tohoku J Exp Med* 1991;165(3):243
- Kitagawa Y, Kuribayashi M, Narimoto K, et al. Immediate effect on overactive bladder symptoms following administration of imidafenacin. *Urol Int*. 2011;86(3):330-3
- Kitagawa Y, Wada M, Kanehisa T, et al. JTS-653 blocks afferent nerve firing and attenuates bladder overactivity without affecting normal voiding function. *J Urol*. 2013 Mar;189(3):1137-46.
- Klausner AP, Steers WD. Antimuscarinics for the treatment of overactive bladder: a review of central nervous system effects. *Curr Urol Rep*. 2007 Nov;8(6):441
- Klutke CG, Burgio KL, Wyman JF, et al. Combined effects of behavioral intervention and tolterodine in patients dissatisfied with overactive bladder medication. *J Urol*. 2009 Jun;181(6):2599-607.
- Kobayashi F, Yageta Y, Segawa M, Matsuzawa S. Effects of imidafenacin (KRP-197/ONO-8025), a new anti-cholinergic agent, on muscarinic acetylcholine receptors. High affinities for M3 and M1 receptor subtypes and selectivity for urinary bladder over salivary gland. *Arzneimittelforschung*. 2007a;57(2):92-100.
- Kobayashi F, Yageta Y, Yamazaki T, et al. Pharmacological effects of imidafenacin (KRP-197/ONO-8025), a new bladder selective anticholinergic agent, in rats. Comparison of effects on urinary bladder capacity and contraction, salivary secretion and performance in the Morris water maze task. *Arzneimittelforschung*. 2007b;57(3):147-54.
- Koelbl H, Nitti, V, Baessler K, et al. Pathophysiology of urinary incontinence, faecal incontinence and pelvic organ prolapse. In *Incontinence* (Abrams P, Cardozo L, Khoury S, Wein A, eds), Health Publication, Limited, Editions 21, Paris, 2009, pp 255-330

- Kojima Y, Sasaki S, Imura M, et al. Correlation between expression of alpha-adrenoceptor subtype mRNA and severity of lower urinary tract symptoms or bladder outlet obstruction in benign prostatic hyperplasia patients. *BJU Int.* 2010 Aug 26
- Kojima Y, Sasaki S, Kubota Y, et al. Expression of alpha1-adrenoceptor subtype mRNA as a predictor of the efficacy of subtype selective alpha1-adrenoceptor antagonists in the management of benign prostatic hyperplasia. *J Urol.* 2008 Mar;179(3):1040-6.
- Kok ET, Schouten BW, Bohnen AM et al. Risk factors for lower urinary tract symptoms suggestive of benign prostatic hyperplasia in a community based population of healthy aging men: the Krimpen Study. *J Urol* 2009;181:710-716.
- Komatsu, T, Gotoh M, Funahashi Y, et al. Efficacy of propiverine in improving symptoms and quality of life in female patients with wet overactive bladder. *LUTS* 2009;1:22-24
- Kories C, Czyborra C, Fetscher C et al. Gender comparison of muscarinic receptor expression and function in rat and human urinary bladder: differential regulation of M2 and M3? *Naunyn-Schmiedeberg's Arch Pharmacol* 2003;367:524
- Kosilov K, Loparev S, Ivanovskaya M, Kosilova L. A randomized, controlled trial of effectiveness and safety of management of OAB symptoms in elderly men and women with standard-dosed combination of solifenacin and mirabegron. *Arch Gerontol Geriatr.* 2015a Sep-Oct;61(2):212-6.
- Kosilov K, Loparev S, Ivanovskaya M, Kosilova L. Additional correction of OAB symptoms by two anti-muscarinics for men over 50 years old with residual symptoms of moderate prostatic obstruction after treatment with Tamsulosin. *Aging Male.* 2015b Mar;18(1):44-8.
- Kosilov K, Loparev S, Iwanowskaya M, Kosilova L. Effectiveness of combined high-dosed trospium and solifenacin depending on severity of OAB symptoms in elderly men and women under cyclic therapy. *Cent European J Urol.* 2014a;67(1):43-8.
- Kosilov KV, Loparev SA, Ivanovskaya MA, Kosilova LV Randomized controlled trial of cyclic and continuous therapy with trospium and solifenacin combination for severe overactive bladder in elderly patients with regard to patient compliance. *Ther Adv Urol.* 2014b Dec;6(6):215-23.
- Kosilov KV, Loparev SA, Ivanovskaya MA, Kosilova LV. Effectiveness of Solifenacin and Trospium for Managing of Severe Symptoms of Overactive Bladder in Patients With Benign Prostatic Hyperplasia. *Am J Mens Health.* 2016 Mar;10(2):157-63.
- La Torre A, Giupponi G, Duffy D, et al. Sexual Dysfunction Related to Drugs: a Critical Review. Part V: α -Blocker and 5-ARI Drugs. *Pharmacopsychiatry.* 2016 Jan;49(1):3-13.
- Kraus SR, Ruiz-Cerdá JL, Martire D, et al. Efficacy and tolerability of fesoterodine in older and younger-subjects with overactive bladder. *Urology* 2010;76:1350-7.
- Kroll P, Gajewska E, Zachwieja et al. An Evaluation of the Efficacy of Selective Alpha-Blockers in the Treatment of Children with Neurogenic Bladder Dysfunction--Preliminary Findings. *Int J Environ Res Public Health.* 2016 Mar 15;13(3). pii: E321
- Kuipers M, Tran D, Krauwinkel W et al. Absolute bioavailability of YM905 in healthy male volunteers. A single-dose randomized, two-period crossover study. Presented at the 32nd International Continence Society Annual Meeting, Heidelberg, Germany, August 2002
- Kullmann FA, Shah MA, Birder LA, de Groat WC. Functional TRP and ASIC-like channels in cultured urothelial cells from the rat. *Am J Physiol Renal Physiol.* 2009 Apr;296(4):F892-901.
- Kumar V, Cross RL, Chess-Williams R et al. Recent advances in basic science for overactive bladder. *Curr Opin Urol* 2005;15:222
- Kunit T, Lusuardi L. An evidence-based review of NX1207 and its potential in the treatment of benign prostatic hyperplasia. *Res Rep Urol.* 2014 Jul 12;6:67-70.
- Kuo HC. Effectiveness of intravesical resiniferatoxin in treating detrusor hyper-reflexia and external sphincter dyssynergia in patients with chronic spinal cord lesions. *BJU Int.* 2003 Oct;92(6):597
- Kuo HC. Urodynamic evidence of effectiveness of botulinum A toxin injection in treatment of detrusor overactivity refractory to anticholinergic agents. *Urology.* 2004 May;63(5):868-72.
- Kuo HC. Clinical effects of suburothelial injection of botulinum A toxin on patients with nonneurogenic detrusor overactivity refractory to anticholinergics. *Urology.* 2005b Jul;66(1):94
- Kuo HC. Multiple intravesical instillation of low-dose resiniferatoxin is effective in the treatment of detrusor overactivity refractory to anticholinergics. *BJU Int.* 2005a May;95(7):1023
- Kuo HC. Prostate botulinum A toxin injection – an alternative treatment for benign prostatic obstruction in poor surgical candidates. *Urology,* 2005c;65: 670 - 674.
- Kuo HC. Comparison of effectiveness of detrusor, suburothelial and bladder base injections of botulinum toxin a for idiopathic detrusor overactivity. *J Urol.* 2007a Oct;178(4 Pt 1):1359
- Kuo HC. Recovery of detrusor function after urethral botulinum A toxin injection in patients with idiopathic low detrusor contractility and voiding dysfunction. *Urology.* 2007b Jan;69(1):57-61

- Kuo HC, Chancellor MB. Comparison of intravesical botulinum toxin type A injections plus hydrodistention with hydrodistention alone for the treatment of refractory interstitial cystitis/painful bladder syndrome. *BJU Int.* 2009 Sep;104(5):657-61.
- Kuo HC, Liao CH, Chung SD. Adverse events of intravesical botulinum toxin a injections for idiopathic detrusor overactivity: risk factors and influence on treatment outcome. *Eur Urol.* 2010 Dec;58(6):919-26.
- Kuo HC, Liu HT, Yang WC. Therapeutic effect of multiple resiniferatoxin intravesical instillations in patients with refractory detrusor overactivity: a randomized, double-blind, placebo controlled study. *J Urol.* 2006 Aug;176(2):641
- Kuo HC, Liu HT, Chuang YC, et al. Pilot study of liposome-encapsulated onabotulinumtoxinA for patients with overactive bladder: a single-center study. *Eur Urol.* 2014 Jun;65(6):1117-24
- Kupelian V, Fitzgerald MP, Kaplan SA, et al. Association of Nocturia and Mortality. Results from the Third National Health and Nutrition Examination Survey. *J Urol* 2011;185 (2): 571-577
- Kupelian V, Wei J, O'Leary M, et al. Nocturia and Quality of Life: Results from the Boston Area Community Health Survey. *Eur Urol.* 2012 Jan;61(1):78-84.
- Kim TH, You HW, Park JH, et al. Persistence of solifenacin therapy in patients with overactive bladder in the clinical setting: a prospective, multicenter, observational study. *Int J Clin Pract.* 2016 Apr;70(4):351-7.
- Lackner TE, Wyman JF, McCarthy TC, et al. Randomized, placebo-controlled trial of the cognitive effect, safety, and tolerability of oral extended-release oxybutynin in cognitively impaired nursing home residents with urge urinary incontinence. *J Am Geriatr Soc* 2008;56:862-70.
- Larsen JJ. alpha And beta-adrenoceptors in the detrusor muscle and bladder base of the pig and beta-adrenoceptors in the detrusor muscle of man. *Br J Pharmacol* 1979;65(2):215
- Lazzeri M, Beneforti P, Spinelli M, et al. Intravesical resiniferatoxin for the treatment of hypersensitive disorder: a randomized placebo controlled study. *J Urol.* 2000 Sep;164(3 Pt 1):676-9.
- Lazzeri M, Beneforti P, Turini D, et al Urodynamic effects of intravesical resiniferatoxin in humans: preliminary results in stable and unstable detrusor. *J Urol* 1997 Dec;158(6):2093
- Lazzeri M, Spinelli M, Beneforti P et al. Intravesical resiniferatoxin for the treatment of detrusor hyperreflexia refractory to capsaicin in patients with chronic spinal cord diseases. *Scand J Urol Nephrol.* 1998 Sep;32(5):331
- Lazzeri M, Spinelli M, Beneforti P, et al. Intravesical infusion of resiniferatoxin by a temporary in situ drug delivery system to treat interstitial cystitis: a pilot study. *Eur Urol.* 2004 Jan;45(1):98-102.
- Lecci A, Maggi CA. Tachykinins as modulators of the micturition reflex in the central and peripheral nervous system. *Regul Pept.* 2001 Sep 15;101(1-3):1-18.
- Lee T, Andersson K-E, Strenng T, Hedlund P. Simultaneous registration of intraabdominal and intravesical pressures during cystometry in conscious rats--effects of bladder outlet obstruction and intravesical PGE2. *Neurourol Urodyn* 2008;27:88-95.
- Lee KS, Choo MS, Kim DY et al. Combination treatment with propiverine hydrochloride plus doxazosin controlled release gastrointestinal therapeutic system formulation for overactive bladder and coexisting benign prostatic obstruction: a prospective, randomized, controlled multicenter study. *J Urol.* 2005 Oct;174(4 Pt 1):1334
- Lee YS, Choo MS, Lee JY, Oh SJ, Lee KS. Symptom change after discontinuation of successful antimuscarinic treatment in patients with overactive bladder symptoms: a randomised, multicentre trial. *Int J Clin Pract.* 2011a Sep;65(9):997-1004.
- Lee SH, Chung BH, Kim SJ. Initial combined treatment with anticholinergics and α -blockers for men with lower urinary tract symptoms related to BPH and overactive bladder: a prospective, randomized, multicenter, double-blind, placebo-controlled study. *Prostate Cancer Prostatic Dis.* 2011b Dec;14(4):320-5
- Lee JY, Kim HW, Lee SJ et al. Comparison of doxazosin with or without tolterodine in men with symptomatic bladder outlet obstruction and an overactive bladder. *BJU Int.* 2004 Oct;94(6):817
- Lee KS, Lee HW, Choo MS, et al. Urinary urgency outcomes after propiverine treatment for an overactive bladder: the 'Propiverine study on overactive bladder including urgency data'. *BJU Int.* 2010 Jun;105(11):1565-70.
- Lee KS, Park B, Kim JH, Kim HG, Seo JT, Lee JG, Jang Y, Choo MS. A randomised, double-blind, parallel design, multi-institutional, non-inferiority phase IV trial of imidafenacin versus fesoterodine for overactive bladder. *Int J Clin Pract.* 2013 Dec;67(12):1317-26.
- Leng J, Liao L, Wan B, Du C, Li W, Xie K, Shen Z, Xu Z, Wu S, Fang Z, Ma L, Han S, Results of a randomized, double-blind, active-controlled clinical trial with propiverine ER 30 mg in patients with overactive bladder. Feustel C, Yang Y, Madersbacher H. *BJU Int.* 2016 Apr 18.. [Epub ahead of print]
- Leitner L, Sammer U, Walter M et al. Bacteruria in patients undergoing intradetrusor onabotulinumtoxinA injections for refractory neurogenic detrusor overactivity: do we need antibiotic prophylaxis? *J Urol.* 2016; 195: e189-e190. abstract

- Leon LA, Hoffman BE, Gardner SD, et al. Effects of the beta 3-adrenergic receptor agonist disodium 5-[(2R)-2-[[[(2R)-2-(3-chlorophenyl)-2-hydroxyethyl]amino]propyl]-1,3-benzodioxole-2,2-dicarboxylate (CL-316243) on bladder micturition reflex in spontaneously hypertensive rats. *J Pharmacol Exp Ther.* 2008 Jul;326(1):178-85
- Lepor H, Hill LA. Silodosin for the treatment of benign prostatic hyperplasia: pharmacology and cardiovascular tolerability. *Pharmacotherapy.* 2010 Dec;30(12):1303-12.
- Lepor H, Kazzazi A, Djavan B. α -Blockers for benign prostatic hyperplasia: the new era. *Curr Opin Urol.* 2012 Jan;22(1):7-15.
- Leslie CA, Pavlakis AJ, Wheeler JS Jr et al. Release of arachidonate cascade products by the rabbit bladder: neurophysiological significance? *J Urol* 1984;132:376
- Leung FP, Yung LM, Yao X, et al. Store-operated calcium entry in vascular smooth muscle. *Br J Pharmacol.* 2008 Mar;153(5):846-57.
- Liguori G, Trombetta C, De Giorgi G. et al. Efficacy and safety of combined oral therapy with tadalafil and alfuzosin: an integrated approach to the management of patients with lower urinary tract symptoms and erectile dysfunction. Preliminary report. *J Sex Med* 2009;6:544-552.
- Lin HH, Sheu BC, Lo MC et al. Comparison of treatment outcomes for imipramine for female genuine stress incontinence. *Br J Obstet Gynaecol* 1999;106:1089
- Lincoln J, Burnstock G. Autonomic innervation of the urinary bladder and urethra. In *The Autonomic Nervous System. Vol. 6, Chapter 2, Nervous Control of the Urogenital System*, ed. CA Maggi, London: Harwood Academic Publisher, p. 33, 1993.
- Lipton RB, Kolodner K, Wesnes K. Assessment of cognitive function of the elderly population: effects of darifenacin. *J Urol* 2005;173:493-498.
- Liu HT, Chancellor MB, Kuo HC. Urinary nerve growth factor levels are elevated in patients with detrusor overactivity and decreased in responders to detrusor botulinum toxin-A injection. *Eur Urol.* 2009 Oct;56(4):700-6
- Liu HT, Kuo HC. Increased expression of transient receptor potential vanilloid subfamily 1 in the bladder predicts the response to intravesical instillations of resiniferatoxin in patients with refractory idiopathic detrusor overactivity. *BJU Int.* 2007 Nov;100(5):1086
- Liu L, Mansfield KJ, Kristiana I, et al. The molecular basis of urgency: regional difference of vanilloid receptor expression in the human urinary bladder. *NeuroUrol Urodyn.* 2007;26(3):433-8
- Lecci A, Maggi CA. Tachykinins as modulators of the micturition reflex in the central and peripheral nervous system. *Regul Pept.* 2001 Sep 15;101(1-3):1
- Leon LA, Hoffman BE, Gardner SD et al. Effects of the beta 3-adrenergic receptor agonist disodium 5-[(2R)-2-[[[(2R)-2-(3-chlorophenyl)-2-hydroxyethyl]amino]propyl]-1,3-benzodioxole-2,2-dicarboxylate (CL-316243) on bladder micturition reflex in spontaneously hypertensive rats. *J Pharmacol Exp Ther.* 2008 Jul;326(1):178
- Leung FP, Yung LM, Yao X et al. Store-operated calcium entry in vascular smooth muscle. *Br J Pharmacol* 2008; 153: 846
- Lindholm P, Lose G. Terbutaline (Bricanyl) in the treatment of female urge incontinence. *Urol Int* 1986;41(2):158
- Lipton RB, Kolodner K, Wesnes K. Assessment of cognitive function of the elderly population: effects of darifenacin. *J Urol.* 2005 Feb;173(2):493
- Longhurst PA, Briscoe JA, Rosenberg DJ et al. The role of cyclic nucleotides in guinea-pig bladder contractility. *Br J Pharmacol.* 1997 Aug;121(8):1665
- Lose G, Jorgensen L, Thunborg P. Doxepin in the treatment of female detrusor overactivity: A randomized double-blind crossover study. *J Urol* 1989;142:1024
- Lose G, Lalos O, Freeman RM et al. Efficacy of desmopressin (Minirin) in the treatment of nocturia: a double-blind placebo-controlled study in women. *Am J Obstet Gynecol* 2003;189:1106
- Lose G, Mattiasson A, Walter S et al. Clinical experience with desmopressin for long-term treatment of nocturia. *J Urol* 2004;172:1021
- Lose G, Norgaard JP. Intravesical oxybutynin for treating incontinence resulting from an overactive detrusor. *BJU Int* 2001;87:767
- Low BY, Liang ML, Yuen KH et al. Terazosin therapy for patients with female lower urinary tract symptoms: A randomized, double-blind, placebo controlled trial. *J Urol.* 2008 Apr;179(4):1461
- Lowenstein L, Kenton K, Mueller ER, et al. Solifenacin objectively decreases urinary sensation in women with overactive bladder syndrome. *Int Urol Nephrol.* 2012 Apr;44(2):425-9.
- Lu SH, Groat WC, Lin AT, Chen KK, Chang LS. Evaluation of purinergic mechanism for the treatment of voiding dysfunction: a study in conscious spinal cord-injured rats. *J Chin Med Assoc.* 2007 Oct;70(10):439-44.
- Lucioni A, Bales GT, Lotan TL et al. Botulinum toxin type A inhibits sensory neuropeptide release in rat bladder models of acute injury and chronic inflammation. *BJU Int.* 2008 Feb;101(3):366 .
- Luo D, Liu L, Han P, Wei Q, Shen H. Solifenacin for overactive bladder: a systematic review and meta-analysis. *Int Urogynecol J.* 2012 Aug;23(8):983-91.

- Luukkanen MJ, Uusvaara J, Laurila JV, et al. Anticholinergic drugs and their effects on delirium and mortality in the elderly. *Dement Geriatr Cogn Dis Extra*. 2011;1(1):43-50.
- MacDiarmid SA, Ellsworth PI, Ginsberg DA, et al. Safety and efficacy of once-daily trospium chloride extended-release in male patients with overactive bladder. *Urology*. 2011 Jan;77(1):24-9.
- Madersbacher H, Halaska M, Voigt R et al. A placebo-controlled, multicentre study comparing the tolerability and efficacy of propiverine and oxybutynin in patients with urgency and urge incontinence. *BJU Int* 1999;84:646
- Madersbacher H, Mürz G. Efficacy, tolerability and safety profile of propiverine in the treatment of the overactive bladder (non-neurogenic and neurogenic). *World J Urol*, 2001;19:324
- Madersbacher H, Stohrer M, Richter R ET AL. Trospium chloride versus oxybutynin: a randomized, double-blind, multicentre trial in the treatment of detrusor hyper-reflexia. *Br J Urol* 1995;75(4):452
- Madhuvrata P, Cody JD, Ellis G, et al. Which anticholinergic drug for overactive bladder symptoms in adults. *Cochrane Database Syst Rev*. 2012 Jan 18;1:CD005429.
- Maggi CA, Barbanti G, Santicioli P, et al. Cystometric evidence that capsaicin-sensitive nerves modulate the afferent branch of micturition reflex in humans. *J Urol*. 1989 Jul;142(1):150-4.
- Maggi CA, Borsini F, Lecci A et al. The effect of acute and chronic administration of imipramine on spinal and supraspinal micturition reflexes in rats. *J Pharmacol Exp Ther*, 1989;248:278
- Maggi CA, Evangelista S, Grimaldi G, et al. Evidence for the involvement of arachidonic acid metabolites in spontaneous and drug-induced contractions of rat urinary bladder. *J Pharmacol Exp Ther*. 1984 Aug;230(2):500-13.
- Maggi CA, Giuliani S, Conte B, et al. Prostanoids modulate reflex micturition by acting through capsaicin-sensitive afferents. *Eur J Pharmacol*. 1988 Jan 12;145(2):105-12.
- Makovey I, Davis T, Guralnick ML, O'Connor RC. Botulinum toxin outcomes for idiopathic overactive bladder stratified by indication: lack of anticholinergic efficacy versus intolerability. *Neurol Urodyn*. 2011 Nov;30(8):1538-40
- Malde S, Dowson C, Fraser O, et al. Patient experience and satisfaction with Onabotulinumtoxin A for refractory overactive bladder. *BJU Int*. 2015 Sep;116(3):443-9.
- Malhotra BK, Glue P, Sweeney K et al. Thorough QT study with recommended and supratherapeutic doses of tolterodine. *Clin Pharmacol Ther*. 2007 Mar;81(3):377
- Malhotra B, Gandelman K, Sachse R, et al. The design and development of fesoterodine as a prodrug of 5-hydroxymethyl tolterodine (5-HMT), the active metabolite of tolterodine. *Curr Med Chem*. 2009a;16(33):4481-9.
- Malhotra B, Sachse R, Wood N. Influence of food on the pharmacokinetic profile of fesoterodine. *Int J Clin Pharmacol Ther*. 2009b Jun;47(6):384-90.
- Malhotra B, Gandelman K, Sachse R, Wood N. Assessment of the effects of renal impairment on the pharmacokinetic profile of fesoterodine. *J Clin Pharmacol*. 2009c Apr;49(4):477-82.
- Malhotra B, Guan Z, Wood N, Gandelman K. Pharmacokinetic profile of fesoterodine. *Int J Clin Pharmacol Ther*. 2008 Nov;46(11):556-63.
- Malhotra B, Wood N, Sachse R, Gandelman K. Thorough QT study of the effect of fesoterodine on cardiac repolarization. *Int J Clin Pharmacol Ther*. 2010 May;48(5):309-18.
- Malone-Lee JG, Walsh JB, Maugourd MF et al. Tolterodine: a safe and effective treatment for older patients with overactive bladder. *J Am Geriatr Soc* 2001;49:700
- Maneuf YP, Gonzalez MI, Sutton KS et al. Cellular and molecular action of the putative GABA-mimetic, gabapentin. *Cell Mol Life Sci*. 2003 Apr;60(4):742
- Manecksha RP, Cullen IM, Ahmad S, et al. Prospective Randomised Controlled Trial Comparing Trigone-Sparing versus Trigone-Including Intradetrusor Injection of AbobotulinumtoxinA for Refractory Idiopathic Detrusor Overactivity. *Eur Urol*. 2012 May;61(5):928-35.
- Mangera A, Andersson KE, Apostolidis A, et al. Contemporary management of lower urinary tract disease with botulinum toxin A: a systematic review of botox (onabotulinumtoxinA) and dysport (abobotulinumtoxinA). *Eur Urol*. 2011 Oct;60(4):784-95.
- Mangera A, Apostolidis A, Andersson KE, et al. An updated systematic review and statistical comparison of standardised mean outcomes for the use of botulinum toxin in the management of lower urinary tract disorders. *Eur Urol*. 2014 May;65(5):981-90.
- Maniscalco M, Singh-Franco D, Wolowich WR et al. Solifenacin succinate for the treatment of symptoms of overactive bladder. *Clin Ther*. 2006 Sep;28(9):1247
- Mansfield KJ, Liu L, Mitchelson FJ et al. Muscarinic receptor subtypes in human bladder detrusor and mucosa, studied by radioligand binding and quantitative competitive RT-PCR: changes in ageing. *Br J Pharmacol* 2005;144:1089
- Marberger M, Chartier-Kastler E, Egerdie B, et al. A randomized double-blind placebo-controlled phase 2 dose-ranging study of onabotulinumtoxinA in men with benign prostatic hyperplasia. *Eur Urol*. 2013 Mar;63(3):496-503.

- Marcelissen TA, Rahnama'i MS, Snijkers A, Schurch B, De Vries P. Long-term follow-up of intravesical botulinum toxin-A injections in women with idiopathic overactive bladder symptoms. *World J Urol.* 2016 Jun 7. [Epub ahead of print]
- Marencak J, Cossons NH, Darekar A, Mills IW. Investigation of the clinical efficacy and safety of pregabalin alone or combined with tolterodine in female subjects with idiopathic overactive bladder. *Neurourol Urodyn.* 2011 Jan;30(1):75-82.
- Maria G, Brisinda G, Civello IM, et al. Relief by botulinum toxin of voiding dysfunction due to benign prostatic hyperplasia: results of a randomized, placebo-controlled study. *Urology.* 2003;62: 259 – 264.
- Mariappan P, Ballantyne Z, N'Dow JMO et al: Serotonin and noradrenaline reuptake inhibitors (SNRI) for stress urinary incontinence in adults (review). *Cochrane Database of Systemic Reviews* 2005, Issue 3, Art. No: CD 004742. DOI: 10.1002/14651858. CD 0043742. pub 2. Also published in *The Cochrane Library* 2007, issue 3
- Marks LS, Gittelman MC, Hill LA, Volinn W, Hoel G. Rapid efficacy of the highly selective $\alpha 1A$ -adrenoceptor antagonist silodosin in men with signs and symptoms of benign prostatic hyperplasia: pooled results of 2 phase 3 studies. *J Urol* 2009a;181:2634–40.
- Marks LS, Gittelman MC, Hill LA, Volinn W, Hoel G. Silodosin in the treatment of the signs and symptoms of benign prostatic hyperplasia: a 9-month, open-label extension study. *Urology* 2009b; 6:1318–22.
- Marschall-Kehrel D, Feustel C, Persson de Geeter C, et al. Treatment with propiverine in children suffering from nonneurogenic overactive bladder and urinary incontinence: results of a randomized placebo-controlled phase 3 clinical trial. *Eur Urol.* 2009 Mar;55(3):729-36.
- Marte A, Borrelli M, Sabatino MD, et al. Effectiveness of botulinum-A toxin for the treatment of refractory overactive bladder in children. *Eur J Pediatr Surg.* 2010 May;20(3):153-7.
- Martin SW, Radley SC, Chess-Williams R et al. Relaxant effects of potassium-channel openers on normal and hyper-reflexic detrusor muscle. *Br J Urol* 1997; 80: 405
- Martin MR, Schiff AA. Fluphenazine/nortriptyline in the irritative bladder syndrome: a double-blind placebo-controlled study. *Br J Urol* 1984;56:178
- Martínez-García R, Abadías M, Arañó P, et al. Cizolirtine citrate, an effective treatment for symptomatic patients with urinary incontinence secondary to overactive bladder: a pilot dose-finding study. *Eur Urol.* 2009 Jul;56(1):184-90.
- Maruyama O, Kawachi Y, Hanazawa K, et al. Naftopidil monotherapy vs naftopidil and an anticholinergic agent combined therapy for storage symptoms associated with benign prostatic hyperplasia: A prospective randomized controlled study. *Int J Urol.* 2006 Oct;13(10):1280-5.
- Mascarenhas F, Cocuzza M, Gomes CM et al. Trigonal injection of botulinum toxin-A does not cause vesicoureteral reflux in neurogenic patients. *Neurourol Urodyn.* 2008;27(4):311
- Massaro AM, Lenz KL. Aprepitant: a novel antiemetic for chemotherapy-induced nausea and vomiting. *Ann Pharmacother.* 2005 Jan;39(1):77
- Masumori N, Miyamoto S, Tsukamoto T, et al. The efficacy and safety of propiverine hydrochloride in patients with overactive bladder symptoms who poorly responded to previous anticholinergic agents. *Adv Urol.* 2011;2011:714978.
- Matsukawa Y, Gotoh M, Komatsu T, et al. Efficacy of silodosin for relieving benign prostatic obstruction: prospective pressure flow study. *J Urol* 2009;182:2831-2835.
- Mattiasson A, Abrams P, van Kerrebroeck P et al. Efficacy of desmopressin in the treatment of nocturia: a double-blind placebo-controlled study in men. *BJU Int* 2002;89:855
- Mattiasson A, Blaakaer J, Hoyer K et al. Tolterodine Scandinavian Study Group. Simplified bladder training augments the effectiveness of tolterodine in patients with an overactive bladder. *BJU Int* 2003;91(1):54
- Matsui M, Griffin MT, Shehnaz D et al. Increased relaxant action of forskolin and isoproterenol against muscarinic agonist-induced contractions in smooth muscle from M2 receptor knockout mice. *J Pharmacol Exp Ther* 2003; 305:106
- Matsui M, Motomura D, Fujikawa T, et al. Mice lacking M2 and M3 muscarinic acetylcholine receptors are devoid of cholinergic smooth muscle contractions but still viable. *J Neurosci* 2002; 22:10627
- Matsui M, Motomura D, Karasawa H, et al. Multiple functional defects in peripheral autonomic organs in mice lacking muscarinic acetylcholine receptor gene for the M3 subtype. *Proc Natl Acad Sci U S A.* 2000 Aug 15;97(17):9579-84.
- Matsuo T, Miyata Y, Kakoki K, et al. The efficacy of mirabegron additional therapy for lower urinary tract symptoms after treatment with $\alpha 1$ -adrenergic receptor blocker monotherapy: prospective analysis of elderly men. *BMC Urol.* 2016 Jul 29;16(1):45.
- Matthiesen TB, Rittig S, Norgaard JP et al. Nocturnal polyuria and natriuresis in male patients with nocturia and lower urinary tract symptoms. *J Urol* 1996;156:1292

- Mauseth SA, Skurtveit S, Spigset O. Adherence, persistence and switch rates for anticholinergic drugs used for overactive bladder in women: data from the Norwegian Prescription Database. *Acta Obstet Gynecol Scand.* 2013 Oct;92(10):1208-15
- May K, Westphal K, Giessmann T et al. Disposition and antimuscarinic effects of the urinary bladder spasmolytics propiverine: influence of dosage forms and circadian-time rhythms. *J Clin Pharmacol.* 2008 May;48(5):570
- McCafferty GP, Misajet BA, Laping NJ, et al. Enhanced bladder capacity and reduced prostaglandin E2-mediated bladder hyperactivity in EP3 receptor knockout mice. *Am J Physiol Renal Physiol* 2008;295: F507-514
- McConnell JD, Roehrborn CG, Bautista OM et al. Medical Therapy of Prostatic Symptoms (MTOPS) Research Group. The long-term effect of doxazosin, finasteride, and combination therapy on the clinical progression of benign prostatic hyperplasia. *N Engl J Med.* 2003 Dec 18;349(25):2387
- McCrery RJ, Appell RA. Oxybutynin: an overview of the available formulations. *Ther Clin Risk Manag.* 2006 Mar;2(1):19
- McDowell DT, Noone D, Tareen F, Waldron M, Quinn F. Urinary incontinence in children: botulinum toxin is a safe and effective treatment option. *Pediatr Surg Int.* 2012 Mar;28(3):315-20.
- McNeill SA, Hargreave TB. Alfuzosin once daily facilitates return to voiding in patients in acute urinary retention. *J Urol* 2004;171:2316
- McNeill SA, Hargreave TB, Roehrborn CG. Alfuzosin 10 mg once daily in the management of acute urinary retention: results of a double-blind placebo-controlled study. *Urology* 2005;65:83
- McVary KT, Monnig W, Camps JL Jr et al. Sildenafil citrate improves erectile function and urinary symptoms in men with erectile dysfunction and lower urinary tract symptoms associated with benign prostatic hyperplasia: a randomized, double-blind trial. *J Urol.* 2007b Mar;177(3):1071
- McVary KT, Roehrborn CG, Avins AL, et al. Update on AUA guideline on the management of benign prostatic hyperplasia. *J Urol.* 2011 May;185(5):1793-803
- McVary KT, Roehrborn CG, Kaminetsky JC et al. Tadalafil relieves lower urinary tract symptoms secondary to benign prostatic hyperplasia. *J Urol.* 2007a Apr;177(4):1401
- McVary KT, Roehrborn CG, Avins AL, et al. Update on AUA guideline on the management of benign prostatic hyperplasia. *J Urol* 2011;185:1793-1803.
- McVary KT, Roehrborn CG, Chartier-Kastler E, et al. A multicenter, randomized, double-blind, placebo controlled study of onabotulinumtoxinA 200 U to treat lower urinary tract symptoms in men with benign prostatic hyperplasia. *J Urol.* 2014 Jul;192(1):150-6.
- Meek PD, Evang SD, Tadrous M, Roux-Lirange D, Triller DM, Gumustop B. Overactive bladder drugs and constipation: a meta-analysis of randomized, placebo-controlled trials. *Dig Dis Sci.* 2011;56:7-18.
- Mehnert U, Birzele J, Reuter K, Schurch B. The effect of botulinum toxin type a on overactive bladder symptoms in patients with multiple sclerosis: a pilot study. *J Urol.* 2010 Sep;184(3):1011-6.
- Mehnert U, Boy S, Schmid M, et al. A morphological evaluation of botulinum neurotoxin A injections into the detrusor muscle using magnetic resonance imaging. *World J Urol.* 2009 Jun;27(3):397-403.
- Mehnert U, Boy S, Svensson J et al. Brain activation in response to bladder filling and simultaneous stimulation of the dorsal clitoral nerve - an fMRI study in healthy women. *Neuroimage* 2008 Jul 1;41(3):682-9.
- Menarini M, Del Popolo G, Di Benedetto P et al. Trospium chloride in patients with neurogenic detrusor overactivity: is dose titration of benefit to the patients? *Int J Clin Pharmacol Ther.* 2006 Dec;44(12):623
- Meng E, Lin WY, Lee WC, Chuang YC. Pathophysiology of Overactive Bladder. *Low Urin Tract Symptoms.* 2012 Mar;4 Suppl 1:48-55
- Meng J, Wang J, Lawrence G et al. Synaptobrevin I mediates exocytosis of CGRP from sensory neurons and inhibition by botulinum toxins reflects their antinociceptive potential *J Cell Sci.* 2007 Aug 15;120(Pt 16):2864
- Merriam FV, Wang ZY, Guerios SD, Bjorling DE. Cannabinoid receptor2 is increased in acutely and chronically inflamed bladder of rats. *Neurosci Lett* 2008;445:130-4.
- Michel MC. Fesoterodine: a novel muscarinic receptor antagonist for the treatment of overactive bladder syndrome. *Expert Opin Pharmacother.* 2008a Jul;9(10):1787
- Michel MC, Barendrecht MM. Physiological and pathological regulation of the autonomic control of urinary bladder contractility. *Pharmacol Ther* 2008b;117:297
- Michel MC, Hegde SS. Treatment of the overactive bladder syndrome with muscarinic receptor antagonists: a matter of metabolites? *Naunyn Schmiedebergs Arch Pharmacol.* 2006 Nov;374(2):79
- Michel MC, Igawa Y. Therapeutic targets for overactive bladder other than smooth muscle. *Expert Opin Ther Targets.* 2015 May;19(5):687-705
- Michel MC, Vrydag W. Alpha1-, alpha2- and beta-adrenoceptors in the urinary bladder, urethra and prostate. *Br J Pharmacol.* 2006 Feb;147 Suppl 2:S88

- Michel MC, Wetterauer U, Vogel M et al. Cardiovascular safety and overall tolerability of solifenacin in routine clinical use: a 12-week, open-label, post-marketing surveillance study. *Drug Saf.* 2008;31(6):505
- Milani R, Scalabrino S, Milia R et al. Double-blind crossover comparison of flavoxate and oxybutynin in women affected by urinary urge syndrome. *Int Urogynecol J*, 1993;4:3 Millard RJ. Asia Pacific Tolterodine Study Group. Clinical efficacy of tolterodine with or without a simplified pelvic floor exercise regimen. *Neurourol Urodyn* 2004;23(1):48
- Millard RJ, Moore K, Rencken R et al. Duloxetine versus placebo in the treatment of stress urinary incontinence: a four continent randomized clinical trial. *BJU Int* 2004;93:311
- Miller DW, Hinton M, Chen F. Evaluation of drug efflux transporter liabilities of darifenacin in cell culture models of the blood-brain and blood-ocular barriers. *Neurourol Urodyn.* 2011 Nov;30(8):1633-8.
- Miyazato M, Sasatomi K, Hiragata S, et al. GABA receptor activation in the lumbosacral spinal cord decreases detrusor overactivity in spinal cord injured rats. *J Urol.* 2008 Mar;179(3):1178-83.
- Miyazato M, Yoshimura N, Chancellor MB. The other bladder syndrome: underactive bladder. *Rev Urol.* 2013;15(1):11-22.
- Moehrer B, Hextall A, Jackson S. Oestrogens for urinary incontinence in women. *Cochrane Database Syst Rev.* 2003;(2):CD001405. Review. Update in: *Cochrane Database Syst Rev.* 2009;(4):CD001405.
- Mohee A, Khan A, Harris N, Eardley I. Long-term outcome of the use of intravesical botulinum toxin for the treatment of overactive bladder (OAB). *BJU Int.* 2013 Jan;111(1):106-13.
- Montorsi F, Gandaglia G, Chapple C, Cruz F, Desgrandchamps F, Llorente C. Effectiveness and safety of silodosin in the treatment of lower urinary tract symptoms in patients with benign prostatic hyperplasia: A European phase IV clinical study (SiRE study). *Int J Urol.* 2016 Jul;23(7):572-9.
- Montreal Cognitive Assessment homepage. Accessed at <http://www.mocatest.org> on June 4, 2011.
- Moon KH, Park CH, Jung HC, et al. A 12-Week, Open Label, Multi-Center Study to Evaluate the Clinical Efficacy and Safety of Silodosin on Voiding Dysfunction in Patients with Neurogenic Bladder. *Low Urin Tract Symptoms.* 2015 Jan;7(1):27-31.
- Morelli A, Filippi S, Comeglio P et al. Acute vardenafil administration improves bladder oxygenation in spontaneously hypertensive rats. *J Sex Med* 2009a;7:107-120.
- Morelli A, Filippi S, Sandner P et al. Vardenafil modulates bladder contractility through cGMP-mediated inhibition of RhoA/Rho kinase signaling pathway in spontaneously hypertensive rats. *J Sex Med* 2009b;6:1594-1608.
- Morelli A, Sarchielli E, Comeglio P et al. Phosphodiesterase type 5 expression in human and rat lower urinary tract tissues and the effect of tadalafil on prostate gland oxygenation in spontaneously hypertensive rats. *J Sex Med* 2011;8:2746-2760
- Morelli A, Vignozzi L, Filippi S et al. BXL-628, a vitamin D receptor agonist effective in benign prostatic hyperplasia treatment, prevents RhoA activation and inhibits RhoA/Rho kinase signaling in rat and human bladder. *Prostate.* 2007 Feb 15;67(3):234
- Morenilla-Palao C, Planells-Cases R, García-Sanz N et al. Regulated exocytosis contributes to protein kinase C potentiation of vanilloid receptor activity. *Biol Chem.* 2004 Jun 11;279(24):25665
- Morganroth J, Lepor H, Hill LA, et al. Effects of the selective α_{1A} -adrenoceptor antagonist silodosin on ECGs of healthy men in a randomized, double blind, placebo-moxifloxacin-controlled study. *Clin Pharmacol Ther* 2010;87:609–13.
- Morita T, Ando M, Kihara K, et al. Effects of prostaglandins E1, E2 and F2alpha on contractility and cAMP and cGMP contents in lower urinary tract smooth muscle. *Urol Int* 1994;52:200
- Morita T, Iizuka H, Iwata T et al. Function and distribution of beta3-adrenoceptors in rat, rabbit and human urinary bladder and external urethral sphincter. *J Smooth Muscle Res.* 2000 Feb;36(1):21
- Mostwin J, Bourcier A, Haab F et al. Pathophysiology of urinary incontinence, fecal incontinence and pelvic organ prolapse. In, Abrams P, Cardozo L, Khoury S, Wein A (eds): *Incontinence.* Plymouth, UK, Health Publications, pp 423, 2005
- Mukerji G, Yiangou Y, Agarwal SK, Anand P. Transient receptor potential vanilloid receptor subtype 1 in painful bladder syndrome and its correlation with pain. *J Urol.* 2006 Aug;176(2):797-801.
- Muller C, Siegmund W, Huupponen R et al. Kinetics of propiverine as assessed by radioreceptor assay in poor and extensive metabolizers of debrisoquine. *Eur J Drug Metab Pharmacokinet* 1993;18(3):265
- Munoz A, Somogyi GT, Boone TB, Ford AP, Smith CP. Modulation of bladder afferent signals in normal and spinal cord-injured rats by purinergic P2X3 and P2X2/3 receptors. *BJU Int.* 2012 Oct;110(8 Pt B):E409-14.
- Murakami S, Chapple CR, Akino H et al. The role of the urothelium in mediating bladder responses to isoprenaline. *BJU Int.* 2007 Mar;99(3):669
- Murakami S, Yoshida M, Iwashita H, et al. Pharmacological effects of KRP-197 on the human isolated urinary bladder. *Urol Int.* 2003;71(3):290-8.
- Muskat Y, Bukovsky I, Schneider D et al. The use of scopolamine in the treatment of detrusor instability. 1996; *J Urol* 156:1989

- Musselman DM, Ford AP, Gennevois DJ, et al. A randomized crossover study to evaluate Ro 115-1240, a selective alpha 1 A/1L-adrenoceptor partial agonist in women with stress urinary incontinence. *BJU Int* 2004;93(1):78
- Nadeau G, Schröder A, Moore K, et al. Long-term use of solifenacin in pediatric patients with overactive bladder: Extension of a prospective open-label study. *Can Urol Assoc J*. 2014 Mar;8(3-4):118-23
- Nagle G, Radomski SB, Brymer C et al. A randomized, double-blind, placebo controlled crossover trial of nimodipine in older persons with detrusor instability and urge incontinence. *J Urol* 2002;167:586
- Naglo AS, Nergardh A, Boreus LO. Influence of atropine and isoprenaline on detrusor hyperactivity in children with neurogenic bladder. *Scand J Urol Nephrol* 1981;15(2):97
- Nakagawa H, Niu K, Hozawa A, et al. Impact of nocturia on bone fractures and mortality in older people: A Japanese longitudinal cohort study. *J Urol* 2010;184: 1413-1418.
- Namasivayam S, Eardley I, Morrison JF. Purinergic sensory neurotransmission in the urinary bladder: an in vitro study in the rat. *BJU Int*. 1999 Nov;84(7):854-60.
- Nardulli R, Losavio E, Ranieri M, et al. Combined antimuscarinics for treatment of neurogenic overactive bladder. *Int J Immunopathol Pharmacol*. 2012 Jan-Mar;25(1 Suppl):35S-41S.
- Natalin R, Reis LO, Alpendre C et al. Triple therapy in refractory detrusor overactivity: a preliminary study. *World J Urol* 2009;28:79-85.
- Nelken RS, Ozel BZ, Leegant AR, et al. Randomized trial of estradiol vaginal ring versus oral oxybutynin for the treatment of overactive bladder. *Menopause*. 2011 Sep;18(9):962-6.
- Nergardh A, Boreus LO, Naglo AS. Characterization of the adrenergic beta-receptor in the urinary bladder of man and cat. *Acta Pharmacol Toxicol (Copenh)* 1977;40(1):14
- Neveus T, Tullus K. Tolterodine and imipramine in refractory enuresis: a placebo-controlled crossover study. *Pediatr Nephrol* 2008;23:263
- Ney P, Pandita RK, Newgreen DT et al. Pharmacological characterization of a novel investigational antimuscarinic drug, fesoterodine, in vitro and in vivo. *BJU Int*. 2008 Apr;101(8):1036
- Nilvebrant L, Andersson K-E, Gillberg PG. Tolterodine—a new bladder-selective antimuscarinic agent. *Eur J Pharmacol*, 1997b;327(2-3):195
- Nilvebrant L, Gillberg PG, Sparf B. Antimuscarinic potency and bladder selectivity of PNU-200577, a major metabolite of tolterodine. *Pharmacol Toxicol*, 1997a;81(4):16
- Nilvebrant L, Sparf B. Dicyclomine, benzhexol and oxybutynin distinguish between subclasses of muscarinic binding sites. *Eur J Pharmacol* 1986;123:133
- Nilvebrant L, Sparf B. Receptor binding profiles of some selective muscarinic antagonists. *Eur J Pharmacol*. 1988 Jun 22;151(1):83-96.
- Nishiguchi J, Kwon DD, Kaiho Y, et al. Suppression of detrusor overactivity in rats with bladder outlet obstruction by a type 4 phosphodiesterase inhibitor. *BJU Int*. 2007 Mar;99(3):680
- Nitti VW. Botulinum toxin for the treatment of idiopathic and neurogenic overactive bladder: state of the art *Rev Urol*. 2006 Fall;8(4):198
- Nitti VW, Dmochowski R, Sand PK, et al. Efficacy, safety and tolerability of fesoterodine for overactive bladder syndrome. *J Urol*. 2007 Dec;178(6):2488-94.
- Nitti VW, Dmochowski R, Herschorn S, et al.; EMBARK Study Group. OnabotulinumtoxinA for the treatment of patients with overactive bladder and urinary incontinence: results of a phase 3, randomized, placebo controlled trial. *J Urol*. 2013 Jun;189(6):2186-93.
- Nitti VW, Ginsberg D, Sievert KD; 191622-096 Investigators. Durable Efficacy and Safety of Long-Term OnabotulinumtoxinA Treatment in Patients with Overactive Bladder Syndrome: Final Results of a 3.5-Year Study. *J Urol*. 2016 Sep;196(3):791-800.
- Nitti V, Herschorn S, Auerbach S, et al. The efficacy and safety of mirabegron in patients with overactive bladder syndrome - results from a North-American Phase III trial. Presented at the 26th Annual Congress of the European Association of Urology, Vienna, Austria, 18-22 March 2011.
- Nitti VW, Rovner ES, Bavendam T. Response to fesoterodine in patients with an overactive bladder and urgency urinary incontinence is independent of the urodynamic finding of detrusor overactivity. *BJU Int*. 2010 May;105(9):1268-75.
- Noguchi M, Eguchi Y, Ichiki J, et al. Therapeutic efficacy of clenbuterol for urinary incontinence after radical prostatectomy. *Int J Urol* 1997;4:480
- Nomiya M, Yamaguchi O. A quantitative analysis of mRNA expression of alpha 1 and beta-adrenoceptor subtypes and their functional roles in human normal and obstructed bladders. *J Urol*. 2003 Aug;170(2 Pt 1):649
- Nomiya M, Burmeister DM, Sawada N, et al. Prophylactic effect of tadalafil on bladder function in a rat model of chronic bladder ischemia. *J Urol*. 2013 Feb;189(2):754-61
- Nomiya M, Yamaguchi O, Akaihata H, et al. Progressive vascular damage may lead to bladder underactivity in rats. *J Urol*. 2014 May;191(5):1462-9.

- Norhona-Blob L, Kachur JF. Enantiomers of oxybutynin: in vitro pharmacological characterization at M1, M2 and M3 muscarinic receptors and in vivo effects on urinary bladder contraction, mydriasis and salivary secretion in guinea pigs. *J Pharmacol Exp Ther* 1991;256:562
- North RA, Jarvis MF. P2X receptors as drug targets. *Mol Pharmacol*. 2013 Apr;83(4):759-69.
- North RA, Surprenant A. Pharmacology of cloned P2X receptors. *Annu Rev Pharmacol Toxicol*. 2000;40:563-80
- Norton PA, Zinner NR, Yalcin I et al. Duloxetine versus placebo in the treatment of stress urinary incontinence. *Am J Obstet Gynecol* 2002;187:40
- Nour S, Svarer C, Kristensen JK, Paulson OB, Law I. Cerebral activation during micturition in normal men. *Brain*. 2000 Apr;123 (Pt 4):781-9.
- Novara G, Galfano A, Secco S et al. Systematic review and meta-analysis of randomized controlled trials with antimuscarinic drugs for overactive bladder. *Eur Urol*. 2008 Oct;54(4):740-63.
- Novara G, Chapple CR, Montorsi F. A pooled analysis of individual patient data from registrational trials of silodosin in the treatment of non-neurogenic male lower urinary tract symptoms (LUTS) suggestive of benign prostatic hyperplasia (BPH). *BJU Int*. 2014 Sep;114(3):427-33.
- Ochs GA. Intrathecal baclofen. *Baillieres Clin Neurol*. 1993 Apr;2(1):73-86.
- Oelke M, Bachmann A, Descazeaud A, et al. European Association of Urology. EAU guidelines on the treatment and follow-up of non-neurogenic male lower urinary tract symptoms including benign prostatic obstruction. *Eur Urol*. 2013 Jul;64(1):118-40.
- Oger S, Behr-Roussel D, Gorny D, et al. Combination of alfuzosin and tadalafil exerts in vitro an additive relaxant effect on human corpus cavernosum. *J Sex Med* 2008;5:935-945.
- Oger S, Behr-Roussel D, Gorny D, et al. Signalling pathways involved in sildenafil-induced relaxation of human bladder dome smooth muscle. *Br J Pharmacol* 2010;160:1135-1143.
- Ohlstein EH, von Keitz A, Michel MC (2012) A multicenter, double-blind, randomized, placebo-controlled trial of the β_3 -adrenoceptor agonist solabegron for overactive bladder. *Eur Urol* 62(5):834–840
- Ohmori S, Miura M, Toriumi C, et al. Absorption, metabolism, and excretion of [14 C]imidafenacin, a new compound for treatment of overactive bladder, after oral administration to healthy male subjects. *Drug Metab Dispos*. 2007 Sep;35(9):1624-33.
- Ohno T, Nakade S, Nakayama K, et al. Absolute bioavailability of imidafenacin after oral administration to healthy subjects. *Br J Clin Pharmacol*. 2008 Feb;65(2):197-202.
- Oka M, Kimura, Y, Itoh Y et al. Brain pertussis toxin-sensitive G proteins are involved in the flavoxate hydrochloride-induced suppression of the micturition reflex in rats. *Brain Res* 1996;727(1-2):91
- Oliveira R, Coelho A, Charrua A, Avelino A, Cruz F. Expression of cleaved
- SNAP-25 after bladder wall injection of onabotulinumtoxinA or abobotulinumtoxinA: A comparative study in the mice. *NeuroUrol Urodyn*. 2015 Oct 16
- Olshansky B, Ebinger U, Brum J et al. Differential pharmacological effects of antimuscarinic drugs on heart rate: A randomized, placebo-controlled, double-blind, crossover study with tolterodine and darifenacin in healthy participants ≥ 50 Years. *J Cardiovasc Pharmacol Ther*. 2008 Dec;13(4):241-51.
- Orme S, Morris V, Gibson W, Wagg A. Managing Urinary Incontinence in Patients with Dementia: Pharmacological Treatment Options and Considerations. *Drugs Aging*. 2015 Jul;32(7):559-67.
- Osman NI, Chapple CR. Contemporary concepts in the aetiopathogenesis of detrusor underactivity. *Nat Rev Urol*. 2014 Nov;11(11):639-48.
- Osman NI, Chapple CR, Abrams P, et al. Detrusor underactivity and the underactive bladder: a new clinical entity? A review of current terminology, definitions, epidemiology, aetiology, and diagnosis. *Eur Urol*. 2014 Feb;65(2):389-98.
- Otsuka A, Shinbo H, Matsumoto R et al. Expression and functional role of beta-adrenoceptors in the human urinary bladder urothelium. *Naunyn Schmiedebergs Arch Pharmacol*. 2008 Jun;377(4-6):473
- Otsuki H, Kosaka T, Nakamura K, et al. β_3 -Adrenoceptor agonist mirabegron is effective for overactive bladder that is unresponsive to antimuscarinic treatment or is related to benign prostatic hyperplasia in men. *Int Urol Nephrol*. 2013 Feb;45(1):53-60.
- Ouslander JG. Management of overactive bladder. *New Engl J Med*, 350:786, 2004.
- Ouslander JG, Blaustein J, Connor A et al. Pharmacokinetics and clinical effects of oxybutynin in geriatric patients. *J Urol* 1988;140:47
- Ouslander JG, Schnelle JF, Uman G et al. Does oxybutynin add to the effectiveness of prompted voiding for urinary incontinence among nursing home residents? A placebo-controlled trial. *J Am Geriatr Soc* 1995;43:610
- Padmanabhan P, Scarpero HM, Milam DF, et al. Five-year cost analysis of intra-detrusor injection of botulinum toxin type A and augmentation cystoplasty for refractory neurogenic detrusor overactivity. *World J Urol*. 2011 Feb;29(1):51-7.

- Pagoria D, O'Connor RC, Guralnick ML. Antimuscarinic drugs: review of the cognitive impact when used to treat overactive bladder in elderly patients. *Curr Urol Rep* 2011;12:351-357.
- Palea S, Artibani, W, Ostardo, E et al. Evidence for purinergic neurotransmission in human urinary bladder affected by interstitial cystitis. *J Urol*, 1993;150(6):2007
- Palmer J. Report of a double-blind crossover study of flurbiprofen and placebo in detrusor instability. *J Int Med Res* 1983;11 Supplement 2:11
- Palmer LS, Zebold K, Firlit CF et al. Complications of intravesical oxybutynin chloride therapy in the pediatric myelomeningocele population. *J Urol* 1997;157:638
- Pandita RK, Andersson KE. Intravesical adenosine triphosphate stimulates the micturition reflex in awake, freely moving rats. *J Urol*. 2002 Sep;168(3):1230-4.
- Parker-Autry CY, Burgio KL, Richter HE. Vitamin D status: a review with implications for the pelvic floor. *Int Urogynecol J*. 2012 Nov;23(11):1517-26
- Park C, Park J, Choo MS, et al. A randomised, prospective double-blind, propiverine-controlled trial of imidafenacin in patients with overactive bladder. *Int J Clin Pract*. 2014 Feb;68(2):188-96.
- Patel AK, Patterson JM, Chapple CR. Botulinum toxin injections for neurogenic and idiopathic detrusor overactivity: A critical analysis of results. *Eur Urol*. 2006 Oct;50(4):684
- Paquette A, Gou P, Tannenbaum C. Systematic review and meta-analysis: do clinical trials testing anti-muscarinic agents for overactive bladder adequately measure central nervous system adverse events? *J Am Geriatr Soc* 2011;59:1332-9.
- Payne CK, Mosbaugh PG, Forrest JB, et al., ICOS RTX Study Group (Resiniferatoxin Treatment for Interstitial Cystitis). Intravesical resiniferatoxin for the treatment of interstitial cystitis: a randomized, double-blind, placebo controlled trial. *J Urol*. 2005 May;173(5):1590-4.
- Pehrson R, Andersson KE. Tramadol inhibits rat detrusor overactivity caused by dopamine receptor stimulation. *J Urol*. 2003 Jul;170(1):272
- Pehrson R, Andersson KE. Effects of tiagabine, a gamma-aminobutyric acid re-uptake inhibitor, on normal rat bladder function. *J Urol*. 2002 May;167(5):2241
- Pehrson R, Stenman E, Andersson KE. Effects of tramadol on rat detrusor overactivity induced by experimental cerebral infarction. *Eur Urol*. 2003 Oct;44(4):495
- Peng CH, Kuo HC. Multiple intravesical instillations of low-dose resiniferatoxin in the treatment of refractory interstitial cystitis. *Urol Int*. 2007;78(1):78-81.
- Penna G, Fibbi B, Amuchastegui S, et al. The vitamin D receptor agonist elocalcitol inhibits IL-8-dependent benign prostatic hyperplasia stromal cell proliferation and inflammatory response by targeting the Rho/Rho kinase and NF-kappaB pathways. *Prostate*. 2009 Apr 1;69(5):480-93.
- Pertwee RG, Howlett AC, Abood ME, et al. International Union of Basic and Clinical Pharmacology. LXXIX. Cannabinoid receptors and their ligands: beyond CB1 and CB2. *Pharmacol Rev* 2010;62: 588–631.
- Peters SL, Schmidt M, Michel MC. Rho kinase: a target for treating urinary bladder dysfunction? *Trends Pharmacol Sci*. 2006 Sep;27(9):492
- Peters CA, Walsh PC. The effect of nafarelin acetate, a luteinizing-hormone-releasing hormone agonist, on benign prostatic hyperplasia. *N Engl J Med* 1987;317:599.
- Petkov GV. Role of potassium ion channels in detrusor smooth muscle function and dysfunction. *Nat Rev Urol*. 2011 Dec 13;9(1):30-40.
- Petkov GV. Central role of the BK channel in urinary bladder smooth muscle physiology and pathophysiology. *Am J Physiol Regul Integr Comp Physiol*. 2014 Sep 15;307(6):R571-84
- Peyronnet B, Castel-Lacanal E, Manunta A, et al. Failure of botulinum toxin injection for neurogenic detrusor overactivity: Switch of toxin versus second injection of the same toxin. *Int J Urol*. 2015 Dec;22(12):1160-5.
- Peyronnet B, Roumiguié M, Castel-Lacanal E, et al. Efficacy and safety of the first and repeated intradetrusor injections of abobotulinum toxin A 750 U for treating neurological detrusor overactivity. *World J Urol*. 2016 May;34(5):755-61.
- Peyronnet B, Castel-Lacanal E, Roumiguié M, et al. Intradetrusor injections of onabotulinum toxin A (Botox®) 300 U or 200 U versus abobotulinum toxin A (Dysport®) 750 U in the management of neurogenic detrusor overactivity: A case control study. *Neurourol Urodyn*. 2016 Mar 31
- Philp NH, Thomas DG. The effect of distigmine bromide on voiding in male paraplegic patients with reflex micturition. *Br J Urol*. 1980 Dec;52(6):492-6.
- Pinggera GM, Frauscher F, Paduch DA, et al. Effect of Tadalafil Once Daily on Prostate Blood Flow and Perfusion in Men With Lower Urinary Tract Symptoms Secondary to Benign Prostatic Hyperplasia: A Randomized, Double-blind, Multicenter, Placebo-controlled Trial. *Urology*. 2014 Aug;84(2):412-9.
- Pinggera GM, Mitterberger M, Pallwein L, et al. alpha-Blockers improve chronic ischaemia of the lower urinary tract in patients with lower urinary tract symptoms. *BJU Int*. 2008 Feb;101(3):319-24.

- Pinto R, Lopes T, Frias B, et al. Trigonal injection of botulinum toxin A in patients with refractory bladder pain syndrome/interstitial cystitis. *Eur Urol*. 2010 Sep;58(3):360-5.
- Pinto R, Lopes T, Silva J, Silva C, Dinis P, Cruz F. Persistent therapeutic effect of repeated injections of onabotulinum toxin a in refractory bladder pain syndrome/interstitial cystitis. *J Urol*. 2013 Feb;189(2):548-53.
- Pinto R, Lopes T, Costa D, et al. Ulcerative and nonulcerative forms of bladder pain syndrome/interstitial cystitis do not differ in symptom intensity or response to onabotulinum toxin A. *Urology*. 2014 May;83(5):1030-4
- Pistolesi D, Selli C, Rossi B et al. Botulinum toxin type B for type A resistant bladder spasticity. *J Urol*. 2004 Feb;171(2 Pt 1):802
- Planells-Cases R, Valente P, Ferrer-Montiel A, et al. Complex regulation of TRPV1 and related thermo-TRPs: implications for therapeutic intervention. *Adv Exp Med Biol*. 2011;704:491-515
- Plante MK, Gross AL, Kliment J, et al. Intraprostatic ethanol chemoablation via transurethral and transperineal injection. *BJU Int*, 2003;91: 94 - 98.
- Plante MK, Marks LS, Anderson R, et al. Phase I/II examination of transurethral ethanol ablation of the prostate for the treatment of symptomatic benign prostatic hyperplasia. *J Urol*, 2007;177: 1030 - 1035.
- Pontari MA, Braverman AS, Ruggieri MR, Sr. The M2 muscarinic receptor mediates in vitro bladder contractions from patients with neurogenic bladder dysfunction. *Am J Physiol* 2004;286:R874
- Porst H, Kim ED, Casabe AR et al. Efficacy and safety of tadalafil once daily in the treatment of men with lower urinary tract symptoms suggestive of benign prostatic hyperplasia: results of an international randomized, double-blind, placebo-controlled trial. *Eur Urol* 2011;60:1105-1113.
- Porst H, McVary KT, Montorsi F et al. Effects of once-daily tadalafil on erectile function in men with erectile dysfunction and signs and symptoms of benign prostatic hyperplasia. *Eur Urol* 2009;56:727-735.
- Portman DJ, Margery LS, Gass MD. Genitourinary syndrome of menopause: new terminology for vulvovaginal atrophy from the International Society for the Study of Women's Sexual Health and The North American Menopause Society. *Menopause: The Journal of the North American Menopause Society* 2014. Vol 21 10: 1-6
- Purkiss J, Welch M, Doward S et al. Capsaicin-stimulated release of substance P from cultured dorsal root ganglion neurons: involvement of two distinct mechanisms. *Biochem Pharmacol*. 2000 Jun 1;59(11):1403
- Quigley EM. Cisapride: what can we learn from the rise and fall of a prokinetic? *J Dig Dis*. 2011 Jun;12(3):147-56.
- Radley SC, Chapple CR, Bryan NP et al. Effect of methoxamine on maximum urethral pressure in women with genuine stress incontinence: a placebo-controlled, double-blind crossover study. *Neurourol Urodyn* 2001;20(1):43
- Rahnama'i MS, de Wachter SG, van Koeveringe GA, et al. The relationship between prostaglandin E receptor 1 and cyclooxygenase I expression in guinea pig bladder interstitial cells: proposition of a signal propagation system. *J Urol*. 2011 Jan;185(1):315-22.
- Rahnama'i MS, van Kerrebroeck PE, de Wachter SG, van Koeveringe GA. The role of prostanoids in urinary bladder physiology. *Nat Rev Urol*. 2012 Mar 13;9(5):283-90
- Rahnama'i MS, van Koeveringe GA, Essers PB, et al. Prostaglandin receptor EP1 and EP2 site in guinea pig bladder urothelium and lamina propria. *J Urol*. 2010 Mar;183(3):1241-7.
- Ramage AG. The role of central 5-hydroxytryptamine (5-HT, serotonin) receptors in the control of micturition. *Br J Pharmacol*. 2006 Feb;147 Suppl 2:S120-31
- Rapp DE, Lucioni A, Katz EE et al. Use of botulinum-A toxin for the treatment of refractory overactive bladder symptoms: an initial experience. *Urology*. 2004 Jun;63(6):1071
- Rapp DE, Lyon MB, Bales GT et al. A role for the P2X receptor in urinary tract physiology and in the pathophysiology of urinary dysfunction. *Eur Urol* 2005;48:303
- Rapp DE, Turk KW, Bales GT et al. Botulinum toxin type a inhibits calcitonin gene-related peptide release from isolated rat bladder. *J Urol*. 2006 Mar;175(3 Pt 1):1138
- Ravindra P, Jackson BL, Parkinson RJ. Botulinum toxin type A for the treatment of non-neurogenic overactive bladder: does using onabotulinumtoxinA (Botox®) or abobotulinumtoxinA (Dysport®) make a difference? *BJU Int*. 2013 Jul;112(1):94-9.
- Raz S, Zeigler M, Caine M. The effect of progesterone on the adrenergic receptors of the urethra. *Br J Urol* 1973;45(2)131
- Reitz A, Denys P, Fermanian C et al. Do repeat intradetrusor botulinum toxin type a injections yield valuable results? Clinical and urodynamic results after five injections in patients with neurogenic detrusor overactivity. *Eur Urol*. 2007 Dec;52(6):1729
- Reitz A, Schurch B., Botulinum toxin type B injection for management of type A resistant neurogenic detrusor overactivity. *J Urol*. 2004 Feb;171(2 Pt 1):804

- Reitz A, Stöhrer M, Kramer G et al. European experience of 200 cases treated with botulinum-A toxin injections into the detrusor muscle for urinary incontinence due to neurogenic detrusor overactivity. *Eur Urol.* 2004 Apr;45(4):510
- Rembratt A, Norgaard JP, Andersson KE. Desmopressin in elderly patients with nocturia: short-term safety and effects on urine output, sleep and voiding patterns. *BJU Int.* 2003;91(7), 642
- Rembratt A, Riis A, Norgaard JP. Desmopressin treatment in nocturia; an analysis of risk factors for hyponatremia. *Neurourol Urodyn* 2006;25(2):105
- Resnick NM, Yalla SV. Detrusor hyperactivity with impaired contractile function. An unrecognized but common cause of incontinence in elderly patients. *JAMA.* 1987 Jun 12;257(22):3076-81.
- Rezakhaniha B, Arianpour N, Siroosbakhat S. Efficacy of desmopressin in treatment of nocturia in elderly men. *J Res Med Sci* 2011;16:516-23.
- Riccabona M, Koen M, Schindler M, et al. Botulinum-A toxin injection into the detrusor: a safe alternative in the treatment of children with myelomeningocele with detrusor hyperreflexia. *J Urol.* 2004 Feb;171(2 Pt 1):845-8;
- Riedl CR, Stephen RL, Daha LK, et al. Electromotive administration of intravesical bethanechol and the clinical impact on acontractile detrusor management: introduction of a new test. *J Urol.* 2000 Dec;164(6):2108-11.
- Rios LA, Panhoca R, Mattos D Jr et al. Intravesical resiniferatoxin for the treatment of women with idiopathic detrusor overactivity and urgency incontinence: A single dose, 4 weeks, double-blind, randomized, placebo controlled trial. *Neurourol Urodyn* 2007;26(6):773
- Rittig S, Jensen AR, Jensen KT, Pedersen EB. Effect of food intake on the pharmacokinetics and antidiuretic activity of oral desmopressin (DDAVP) in hydrated normal subjects. *Clin Endocrinol (Oxf).* 1998 Feb;48(2):235-41.
- Rittig N, Hagstroem S, Mahler B, et al. Outcome of a standardized approach to childhood urinary symptoms – long term follow-up of 720 patients. *Neurourol Urodyn.* 2014 Jun;33(5):475-81
- Robinson D, Cardozo L. The role of estrogens in female lower urinary tract dysfunction. *Urology* 2003;62(4 Suppl 1):45
- Robinson D, Cardozo L. New drug treatments for urinary incontinence. *Maturitas* 2010;65(4):340-347
- Robinson D, Cardozo L, Akesson M et al. Antidiuresis: a new concept in managing female daytime urinary incontinence. *BJU Int* 2004;93:996
- Robinson D, Cardozo L, Terpstra G et al. A randomized double-blind placebo-controlled multicentre study to explore the efficacy and safety of tamsulosin and tolterodine in women with overactive bladder syndrome. *BJU Int.* 2007 Oct;100(4):840
- Robinson D, Rainer RO, Washburn SA et al. Effects of estrogen and progestin replacement on the urogenital tract of the ovariectomized cynomolgus monkey. *Neurourol Urodyn* 1996;15(3):215
- Robert G, Delongchamps NB, Descazeaud A et al. Efficacité et tolérance des injections intra-prostatique de toxine botulique dans le traitement de l'hyperplasie bénigne de prostate symptomatique : PHRC national PROTOX. *Prog Urol.* 2015 Nov;25(13):853-4.
- Robson WL, Leung AK, Norgaard JP. The comparative safety of oral versus intranasal desmopressin for the treatment of children with nocturnal enuresis. *J Urol.* 2007 Jul;178(1):24-30.
- Roe CM, Anderson MJ, Spivack B. Use of anticholinergic medications by older adults with dementia. *J Am Geriatr Soc* 2002;50:836
- Roehrborn CG, Kaplan SA, Kraus SR, et al. Effects of serum PSA on efficacy of tolterodine extended release with or without tamsulosin in men with LUTS, including OAB. *Urology.* 2008 Nov;72(5):1061-7;
- Roehrborn CG, Kaplan SA, Jones JS et al. Tolterodine extended release with or without tamsulosin in men with lower urinary tract symptoms including overactive bladder symptoms: effects of prostate size. *Eur Urol.* 2009 Feb;55(2):472-9
- Roehrborn CG, McVary KT, Elion-Mboussa A, Viktrup, L. Tadalafil administered once daily for lower urinary tract symptoms secondary to benign prostatic hyperplasia: a dose finding study. *J Urol* 2008;180:1228-1234.
- Roehrborn CG, Siami P, Barkin J, et al. CombAT Study Group. The effects of combination therapy with dutasteride and tamsulosin on clinical outcomes in men with symptomatic benign prostatic hyperplasia: 4-year results from the CombAT study. *Eur Urol.* 2010 Jan;57(1):123-31.
- Rogers R, Bachmann G, Jumadilova Z et al. Efficacy of tolterodine on overactive bladder symptoms and sexual and emotional quality of life in sexually active women. *Int Urogynecol J Pelvic Floor Dysfunct.* 2008 Nov;19(11):1551
- Rong W, Spyer KM, Burnstock G. Activation and sensitisation of low and high threshold afferent fibres mediated by P2X receptors in the mouse urinary bladder. *J Physiol.* 2002 Jun 1;541(Pt 2):591-600.
- Roosen A, Datta SN, Chowdhury RA, et al. Suburothelial myofibroblasts in the human overactive bladder and the effect of botulinum neurotoxin type A treatment. *Eur Urol.* 2009 Jun;55(6):1440-8.

- Rossanese M, Novara G, Challacombe B, Iannetti A, Dasgupta P, Ficarra V. Critical analysis of phase II and III randomised control trials (RCTs) evaluating efficacy and tolerability of a β 3-adrenoceptor agonist (Mirabegron) for overactive bladder (OAB). *BJU Int*. 2015 Jan;115(1):32-40.
- Rouget C, Rekek M, Camparo P, et al. Modulation of nerve-evoked contractions by β 3-adrenoceptor agonism in human and rat isolated urinary bladder. *Pharmacol Res*. 2014 Feb;80:14-20.
- Rovner E, Kennelly M, Schulte-Baukloh H, et al. Urodynamic results and clinical outcomes with intradetrusor injections of onabotulinumtoxinA in a randomized, placebo-controlled dose-finding study in idiopathic overactive bladder. *Neurourol Urodyn*. 2011 Apr;30(4):556-62
- Rovner E, Kohan A, Chartier-Kastler E, et al. Long-Term Efficacy and Safety of OnabotulinumtoxinA in Patients with Neurogenic Detrusor Overactivity Who Completed 4 Years of Treatment. *J Urol*. 2016 Sep;196(3):801-8.
- Rovner ES, Kreder K, Sussman DO et al. Effect of tolterodine extended release with or without tamsulosin on measures of urgency and patient reported outcomes in men with lower urinary tract symptoms. *J Urol*. 2008a Sep;180(3):1034
- Rovner ES, Rackley R, Nitti VW et al. Tolterodine extended release is efficacious in continent and incontinent subjects with overactive bladder. *Urology*. 2008b sept;72(3):488
- Rudy D, Cline K, Harris R et al. Multicenter phase III trial studying tiroprium chloride in patients with overactive bladder. *Urology* 2006 Feb;67(2):275
- Rufford J, Hextall A, Cardozo L et al. A double blind placebo controlled trial on the effects of 25 mg estradiol implants on the urge syndrome in postmenopausal women. *Int Urogynecol J Pelvic Floor Dysfunct* 2003;14(2):78
- Ruffmann R. A review of flavoxate hydrochloride in the treatment of urge incontinence. *J Int Med Res* 1988;16:317
- Ruggieri MR Sr. Mechanisms of disease: role of purinergic signaling in the pathophysiology of bladder dysfunction. *Nat Clin Pract Urol*. 2006 Apr;3(4):206
- Ruggieri MR Sr. Cannabinoids: potential targets for bladder dysfunction. *Handb Exp Pharmacol*. 2011;(202):425-51.
- Ruggieri MR Sr, Braverman AS, Pontari MA. Combined use of alpha-adrenergic and muscarinic antagonists for the treatment of voiding dysfunction. *J Urol*. 2005 Nov;174(5):1743
- Sacco E, Bientinesi R. Innovative pharmacotherapies for women with overactive bladder: where are we now and what is in the pipeline? *Int Urogynecol J* 2015;26:629-40.
- Sadananda P, Chess-Williams R, Burcher E. Contractile properties of the pig bladder mucosa in response to neurokinin A: a role for myofibroblasts? *Br J Pharmacol* 2008; 153:1465
- Safarinejad MR, Hosseini SY. Safety and efficacy of tramadol in the treatment of idiopathic detrusor overactivity: a double-blind, placebo-controlled, randomized study. *Br J Clin Pharmacol*. 2006 Apr;61(4):456-63. Retraction in: *Br J Clin Pharmacol*. 2014 Jan;77(1):216.
- Saffroy M, Torrens Y, Glowinski J et al. Autoradiographic distribution of tachykinin NK2 binding sites in the rat brain: comparison with NK1 and NK3 binding sites. *Neuroscience*. 2003;116(3):761
- Sahai A, Dowson C, Khan MS, Dasgupta P. Improvement in quality of life after botulinum toxin-A injections for idiopathic detrusor overactivity: results from a randomized double-blind placebo-controlled trial. *BJU Int*. 2009 Jun;103(11):1509-15.
- Sahai A, Khan MS, Dasgupta P, Efficacy of botulinum toxin-A for treating idiopathic detrusor overactivity: results from a single center, randomized, double-blind, placebo controlled trial *J Urol*. 2007 Jun;177(6):2231
- Sahai A, Mallina R, Dowson C et al. Evolution of transdermal oxybutynin in the treatment of overactive bladder. *Int J Clin Pract*. 2008 Jan;62(1):167
- Sairam K, Kulinskaya E, McNicholas TA et al. Sildenafil influences lower urinary tract symptoms. *BJU Int*. 2002 Dec;90(9):836
- Saito H, T, Yamada T, et al. A comparative study of the efficacy and safety of tamsulosin hydrochloride alone and combination of propiverine hydrochloride and tamsulosin hydrochloride in the benign prostatic hypertrophy with pollakisuria and/or urinary incontinence. *Jpn J Urol Surg* 1999;12: 525-36.
- Sakai H, Igawa T, Onita T, et al. Efficacy of naftopidil in patients with overactive bladder associated with benign prostatic hyperplasia: prospective randomized controlled study to compare differences in efficacy between morning and evening medication. *Hinyokika Kiyo*. 2011 Jan;57(1):7-13. Japanese.
- Sakakibara R, Hamano H, Yagi H. Cognitive Safety and Overall Tolerability of Imidafenacin in Clinical Use: A Long-Term, Open-Label, Post-Marketing Surveillance Study. *Low Urin Tract Symptoms*. 2014 Sep;6(3):138-44.
- Sakakibara R, Ito T, Uchiyama T et al. Effects of milnacipran and paroxetine on overactive bladder due to neurologic diseases: a urodynamic assessment. *Urol Int* 2008;81:335-339.

- Sakakibara R, Ogata T, Uchiyama T, et al. How to manage overactive bladder in elderly individuals with dementia? Combined use of donepezil, a central acetylcholinesterase inhibitor, and propiverine, a peripheral muscarine receptor antagonist. *J Am Geriatr Soc* 2009;57:1515-1517
- Sakakibara R, Hattori T, Uchiyama T, et al. Are alpha-blockers involved in lower urinary tract dysfunction in multiple system atrophy? A comparison of prazosin and miosislyte. *J Auton Nerv Syst*. 2000 Mar 15;79(2-3):191-5.
- Sakr M, Eid A, Shoukry M, et al. Transurethral ethanol injection therapy of benign prostatic hyperplasia: four-year follow-up. *Int J Urol*, 2009;16: 196 - 201.
- Salvatore S, Serati M, Cardozo L et al. Cognitive dysfunction with tolterodine use. *Am J Obstet Gynecol* 2007;197:e8.
- Salvatore S, Serati M, Bolis P. Tolterodine for the treatment of overactive bladder. *Expert Opin Pharmacother*. 2008 May;9(7):1249
- Sand PK, Davila GW, Lucente VR, et al. Efficacy and safety of oxybutynin chloride topical gel for women with overactive bladder syndrome. *Am J Obstet Gynecol*. 2012 Feb;206(2):168.e1-6
- Sand PK, Johnson Li TM, Rovner ES, et al. Trosipium chloride once-daily extended release is efficacious and tolerated in elderly subjects (aged \geq 75 years) with overactive bladder syndrome. *BJU Int* 2011a;107:612-20.
- Sand PK, Rovner ES, Watanabe JH, Oefelein MG. Once-daily trospium chloride 60 mg extended release in subjects with overactive bladder syndrome who use multiple concomitant medications: Post hoc analysis of pooled data from two randomized, placebo-controlled trials. *Drugs Aging*. 2011b;28(2):151-60.
- Sand PK, Heesakkers J, Kraus SR, et al. Long-term safety, tolerability and efficacy of fesoterodine in subjects with overactive bladder symptoms stratified by age: pooled analysis of two open-label extension studies. *Drugs Aging* 2012;29:119-31.
- Sand PK, Dmochowski RR, Reddy J, van der Meulen EA. Efficacy and safety of low dose desmopressin orally disintegrating tablet in women with nocturia: results of a multicenter, randomized, double-blind, placebo controlled, parallel group study. *J Urol*. 2013 Sep;190(3):958-64.
- Santos-Silva A, Charrua A, Cruz CD, et al. Rat detrusor overactivity induced by chronic spinalization can be abolished by a transient receptor potential vanilloid 1 (TRPV1) antagonist. *Auton Neurosci*. 2012 Jan 26;166(1-2):35-8.
- Savona-Ventura C, Grech ES, Saliba I. Pharmacological measures to prevent post-operative urinary retention; a prospective randomized study. *Eur J Obstet Gynecol Reprod Biol*. 1991 Oct 8;41(3):225-9.
- Sawant SD, Lakshma Reddy G, Dar MI, et al. Discovery of novel pyrazolopyrimidinone analogs as potent inhibitors of phosphodiesterase type-5. *Bioorg Med Chem*. 2015 May 1;23(9):2121-8
- Schagen van Leeuwen JH, Lange RR, Jonasson AF et al. Efficacy and safety of duloxetine in elderly women with stress urinary incontinence or stress-predominant mixed urinary incontinence. *Maturitas*. 2008 Jun 20;60(2):138
- Schmid DM, Sauermann P, Werner M et al. Experience with 100 cases treated with botulinum-A toxin injections in the detrusor muscle for idiopathic overactive bladder syndrome refractory to anticholinergics. *J Urol*. 2006 Jul;176(1):177
- Schneider T, Fetscher C, Kregge S et al. Signal transduction underlying carbachol-induced contraction of human urinary bladder. *J Pharmacol Exp Ther* 2004a; 309:1148
- Schneider T, Hein P, Bai J et al. A role for muscarinic receptors or rho-kinase in hypertension associated rat bladder dysfunction? *J Urol* 2005b;173:2178
- Schneider T, Hein P, Michel MC. Signal transduction underlying carbachol-induced contraction of rat urinary bladder. I. Phospholipases and Ca²⁺ sources. *J Pharmacol Exp Ther* 2004b; 308:47
- Schneider T, Hein P, Michel-Reher M et al. Effects of ageing on muscarinic receptor subtypes and function in rat urinary bladder. *Naunyn-Schmiedeberg's Arch Pharmacol* 2005a;372:71
- Schröder A, Colli E, Maggi M et al. Effects of a vitamin D3 analogue in a rat model of bladder outflow obstruction. *BJU Int* 2006; 98:637
- Schroder, A., Newgreen, D., Andersson, K.E., 2004. Detrusor responses to prostaglandin E2 and bladder outlet obstruction in wild-type and Ep1 receptor knockout mice. *J Urol* 172, 1166-1170.
- Schroeder FH, Westerhof M, Bosch RJJLH, Kurth KH. Benign prostatic hyperplasia treated by castration or the LH-RH analogue buserelin: a report on 6 cases. *Eur Urol* 1986;12:318
- Schulte-Baukloh H, Michael T, Miller K, Knispel HH. Alfuzosin in the treatment of high leak-point pressure in children with neurogenic bladder. *BJU Int*. 2002 Nov;90(7):716-20.
- Schulte-Baukloh H, Knispel HH, Stolze T et al. Repeated botulinum-A toxin injections in treatment of children with neurogenic detrusor overactivity. *Urology*. 2005 Oct;66(4):865
- Schulte-Baukloh H, Michael T, Schobert J, Stolze T, Knispel HH. Efficacy of botulinum-a toxin in children with detrusor hyperreflexia due to myelomeningocele: preliminary results. *Urology*. 2002 Mar;59(3):325-7;

- Schulte-Baukloh H, Michael T, Stürzebecher B, Knispel HH. Botulinum-a toxin detrusor injection as a novel approach in the treatment of bladder spasticity in children with neurogenic bladder. *Eur Urol.* 2003 Jul;44(1):139-43.
- Schulte-Baukloh H, Mürtz G, Henne T et al. Urodynamic effects of propiverine hydrochloride in children with neurogenic detrusor overactivity: a prospective analysis. *BJU Int.* 2006 Feb;97(2):355
- Schulte-Baukloh H, Zurawski TH, Knispel HH et al. Persistence of the synaptosomal-associated protein-25 cleavage product after intradetrusor botulinum toxin A injections in patients with myelomeningocele showing an inadequate response to treatment. *BJU Int.* 2007 Nov;100(5):1075
- Schurch B, Denys P, Kozma CM et al. Botulinum toxin A improves the quality of life of patients with neurogenic urinary incontinence. *Eur Urol.* 2007 Sep;52(3):850
- Schurch B, de Sèze M, Denys P et al. Botulinum toxin type a is a safe and effective treatment for neurogenic urinary incontinence: results of a single treatment, randomized, placebo controlled 6-month study. *J Urol.* 2005 Jul;174(1):196
- Schurch B, Schmid DM, Stöhrer M. Treatment of neurogenic incontinence with botulinum toxin A. *N Engl J Med.* 2000a Mar 2;342(9):665
- Schurch B, Stöhrer M, Kramer G et al. Botulinum-A toxin for treating detrusor hyperreflexia in spinal cord injured patients: a new alternative to anticholinergic drugs? Preliminary results. *J Urol.* 2000b Sep;164(3 Pt 1):692
- Schüssler B. Comparison of the mode of action of prostaglandin E2 (PGE2) and sulprostone, a PGE2-derivative, on the lower urinary tract in healthy women. A urodynamic study. *Urol Res.* 1990;18(5):349-52.
- Schwinn DA, Price DT, Narayan P. alpha1-Adrenoceptor subtype selectivity and lower urinary tract symptoms. *Mayo Clin Proc.* 2004 Nov;79(11):1423-34.
- Schwinn DA, Roehrborn CG. Alpha1-adrenoceptor subtypes and lower urinary tract symptoms. *Int J Urol.* 2008 Mar;15(3):193-9.
- Sears CL, Lewis C, Noel K, Albright TS, Fischer JR. Overactive bladder medication adherence when medication is free to patients. *J Urol* 2010;183:1077 – 81
- Seki S, Erickson KA, Seki M et al. Elimination of rat spinal neurons expressing neurokinin 1 receptors reduces bladder overactivity and spinal c-fos expression induced by bladder irritation. *Am J Physiol Renal Physiol.* 2005 Mar;288(3):F466
- Sekido N, Kida J, Mashimo H, Promising Effects of a Novel EP2 and EP3 Receptor Dual Agonist, ONO-8055, on Neurogenic Underactive Bladder in a Rat Lumbar Canal Stenosis Model. *J Urol.* 2016 Aug;196(2):609-16.
- Sellers DJ, Chess-Williams R. Muscarinic agonists and antagonists: effects on the urinary bladder. *Handb Exp Pharmacol.* 2012;(208):375-400.
- Semins MJ, Chancellor MB. Diagnosis and management of patients with overactive bladder syndrome and abnormal detrusor activity. *Nat Clin Pract Urol.* 2004 Dec;1(2):78-84; quiz 109.
- Serati M, Salvatore S, Uccella S, et al. Is there a synergistic effect of topical oestrogens when administered with antimuscarinics in the treatment of symptomatic detrusor overactivity? *Eur Urol.* 2009 Mar;55(3):713-9.
- Serels SR, Toglia MR, Forero-Schwanhaeuser S, He W. Impact of solifenacin on diary-recorded and patient-reported urgency in patients with severe overactive bladder (OAB) symptoms. *Curr Med Res Opin.* 2010 Oct;26(10):2277-85.
- Serati M, Braga A, Sorice P, Siesto G, Salvatore S, Ghezzi F. Solifenacin in women with de novo overactive bladder after tension-free obturator vaginal tape--is it effective? *J Urol.* 2014 May;191(5):1322-6.
- Serra DB, Afrime MB, Bedigian MP et al. QT and QTc interval with standard and supratherapeutic doses of darifenacin, a muscarinic M3 selective receptor antagonist for the treatment of overactive bladder. *J Clin Pharmacol.* 2005 Sep;45(9):1038
- Shaban A, Drake M, Hashim H. The medical management of urinary incontinence. *Autonomic Neuroscience: Basic and Clinical* 2010;152(1-2):4-10
- Shabir S, Cross W, Kirkwood LA, et al. Functional expression of purinergic P2 receptors and transient receptor potential channels by the human urothelium. *Am J Physiol Renal Physiol.* 2013 Aug 1;305(3):F396-406
- Shah PJ, Abrams PH, Choa RG, et al. Distigmine bromide and post-prostatectomy voiding. *Br J Urol.* 1983 Apr;55(2):229-32.
- Shamliyan TA, Kane RL, Wyman J et al. Systematic review: randomized, controlled trials of nonsurgical treatments for urinary incontinence in women. *Ann Int Med* 2008;148:459
- Sharma A, Goldberg MJ, Cerimele BJ: Pharmacokinetics and safety of duloxetine, a dual-serotonin and norepinephrine reuptake inhibitor. *J Clin Pharmacol* 2000;40(2):161
- Sheldon JH, Norton NW, Argentieri TM. Inhibition of guinea pig detrusor contraction by NS-1619 is associated with activation of BKCa and inhibition of calcium currents. *J Pharmacol Exp Ther* 1997; 283: 1193

- Sheu MT, Yeh GC, Ke WT et al. Development of a high-performance liquid chromatographic method for bioequivalence study of flavoxate tablets. *J Chromatogr B Biomed Sci Appl* 2001;751(1):79
- Shieh C-C, Brune ME, Buckner SA, et al. Characterization of a novel ATP-sensitive K⁺ channel opener, A-251179, on urinary bladder relaxation and cystometric parameters. *Br J Pharmacol* 2007; 151: 467
- Shimizu T, Shibata M, Toriumi H, et al Reduction of TRPV1 expression in the trigeminal system by botulinum neurotoxin type-A. *Neurobiol Dis.* 2012 Dec;48(3):367-78.
- Shore N. NX-1207: a novel investigational drug for the treatment of benign prostatic hyperplasia. *Expert Opin Investig Drugs.* 2010 Feb;19(2):305-10
- Sellers DJ, Chess-Williams R. Muscarinic agonists and antagonists: effects on the urinary bladder. *Handb Exp Pharmacol.* 2012;(208):375-400.
- Siddiqui MA, Perry CM, Scott LJ. Oxybutynin extended- release: a review of its use in the management of overactive bladder. *Drugs,* 2004;64(8):885
- Sievert KD, Chapple C, Herschorn S, et al. OnabotulinumtoxinA 100U provides significant improvements in overactive bladder symptoms in patients with urinary incontinence regardless of the number of anticholinergic therapies used or reason for inadequate management of overactive bladder. *Int J Clin Pract.* 2014 Oct;68(10):1246-56.12443.
- Sievert K.D., Heesakkers J., Ginsberg D., et al. Efficacy of onabotulinumtoxinA in neurogenic detrusor overactivity is independent of concomitant anticholinergic use. *Eur Urol; Suppl.* 2012;11:e461
- Silva J, Pinto R, Carvallho T, et al. Mechanisms of Prostate atrophy after glandular botulinum neurotoxin type A Injection: An experimental study in the rat. *Eur Urol,* 2009a;56: 134 – 141.
- Silva J, Pinto R, Carvalho T, et al. Intraprostatic Botulinum Toxin Type A injection in patients with benign prostatic enlargement: duration of the effect of a single treatment. *BMC Urol,* 2009b;15; 9: 9.
- Silva J, Pinto R, Carvalho T, et al. Intraprostatic botulinum toxin type A administration: evaluation of the effects on sexual function. *BJU Int,* 2011;107: 1950 – 1954.
- Silva C, Ribeiro MJ, Cruz F. The effect of intravesical resiniferatoxin in patients with idiopathic detrusor instability suggests that involuntary detrusor contractions are triggered by C-fiber input. *J Urol.* 2002 Aug;168(2):575
- Silva C, Rio ME, Cruz F, Desensitization of bladder sensory fibers by intravesical resiniferatoxin, a capsaicin analog: long-term results for the treatment of detrusor hyperreflexia. *Eur Urol.* 2000 Oct;38(4):444
- Silva C, Silva J, Castro H et al. Bladder sensory desensitization decreases urinary urgency. *BMC Urol.* 2007 Jun;11(7):9
- Silva C, Silva J, Ribeiro MJ et al. Urodynamic effect of intravesical resiniferatoxin in patients with neurogenic detrusor overactivity of spinal origin: results of a double-blind randomized placebo-controlled trial. *Eur Urol.* 2005 Oct; 48 (4):650
- Silva J, Silva C, Saraiva L, et al. Intraprostatic botulinum toxin type a injection in patients unfit for surgery presenting with refractory urinary retention and benign prostatic enlargement. Effect on prostate volume and micturition resumption. *Eur Urol,* 2008;53: 153 – 159.
- Silver N, Sandage B, Sabounjian L, et al Pharmacokinetics of once-daily tiroprium chloride 60 mg extended release and twice-daily tiroprium chloride 20 mg in healthy adults. *J Clin Pharmacol.* 2010 Feb;50(2):143-50.
- Simon JA, Maamari RV. Ultra low dose vaginal oestrogen tablets for the treatment of postmenopausal vaginal atrophy. *Climacteric* 2013 Aug; 16 Suppl 1:37-43
- Singh SK, Agarwal MM, Batra YK, et al. Effect of lumbar-epidural administration of tramadol on lower urinary tract function. *Neurourol Urodyn.* 2008;27(1):65
- Singh R, Browning JL, Abi-Habib R, et al.. Recombinant prostate-specific antigen proaerolysin shows selective protease sensitivity and cell cytotoxicity. *Anti-cancer Drugs.* 2007 Aug;18(7):809-16.
- Sink KM, Thomas J, Xu H, Craig B, Kritchevsky S, Sands LP. Dual use of bladder anticholinergics and cholinesterase inhibitors: long-term functional and cognitive outcomes. *J Am Geriatr Soc* 2008;56:847-853.
- Sjögren C, Andersson K-E, Husted S et al. Atropine resistance of the transmurally stimulated isolated human bladder. *J Urol* 1982;128:1368
- Skerjanec A. The clinical pharmacokinetics of darifenacin. *Clin Pharmacokinet.* 2006;45(4):325
- Skryma R, Prevarskaya N, Gkika D, Shuba Y. From urgency to frequency: facts and controversies of TRPs in the lower urinary tract. *Nat Rev Urol.* 2011 Oct 4;8(11):617-30
- Smet PJ, Moore KH, Jonavicius J. Distribution and colocalization of calcitonin gene-related peptide, tachykinins, and vasoactive intestinal peptide in normal and idiopathic unstable human urinary bladder. *Lab Invest.* 1997 Jul;77(1):37

- Smith PP, Chalmers DJ, Feinn RS. Does defective volume sensation contribute to detrusor underactivity? *Neurourol Urodyn*. 2015 Nov;34(8):752-6
- Smith CP, Chancellor MB. Emerging role of botulinum toxin in the management of voiding dysfunction. *J Urol*. 2004 Jun;171(6 Pt 1):2128-37
- Smith PH, Cook JB, Prasad EW. The effect of ubretid on bladder function after recent complete spinal cord injury. *Br J Urol*. 1974 Apr;46(2):187
- Smith CP, Gangitano DA, Munoz A et al. Botulinum toxin type A normalizes alterations in urothelial ATP and NO release induced by chronic spinal cord injury. *Neurochem Int*. 2008 May;52(6):1068
- Smith N, Grimes I, Ridge S et al. YM905 is effective and safe as treatment of overactive bladder in women and men: Results from phase II study. *ICS Proceedings*. Heidelberg, Germany: 138 (abstract 222), 2002
- Smith P, Heimer G, Norgren A et al. Steroid hormone receptors in pelvic muscles and ligaments in women. *Gynecol Obstet Investig* 1990;30(1):27
- Smits MA, Oerlemans D, Marcelissen TA, et al. Sacral neuromodulation in patients with idiopathic overactive bladder after initial botulinum toxin therapy. *J Urol*. 2013 Dec;190(6):2148-52.
- Smulders RA, Krauwinkel WJ, Swart PJ et al. Pharmacokinetics and safety of solifenacin succinate in healthy young men. *J Clin Pharmacol*. 2004 Sep;44(9):1023
- Smulders R, Tan H, Krauwinkel W et al. A placebo-controlled, dose –rising study in healthy male volunteers to evaluate safety, tolerability, pharmacokinetics and pharmacodynamics of single oral doses of YM905. Presented at the 32nd International Continence Society Annual Meeting, Heidelberg, Germany, August 2002
- Song C, Park JT, Heo KO et al. Effects of bladder training and/or tolterodine in female patients with overactive bladder syndrome: a prospective, randomized study. *J Korean Med Sci*. 2006 Dec;21(6):1060
- Sperling R, Greve D, Dale A et al. Functional MRI detection of pharmacologically induced memory impairment. *Proc Natl Acad Sci USA* 2002;99:455
- Stahl MM, Ekstrom B, Sparf B et al. Urodynamic and other effects of tolterodine: a novel antimuscarinic drug for the treatment of detrusor overactivity. *Neurourol Urodyn*, 1995;14(6):647
- Stanton SL. A comparison of emepronium bromide and flavoxate hydrochloride in the treatment of urinary incontinence. *J Urol* 1973;110:529
- Starr JM. Cholinesterase inhibitor treatment and urinary incontinence in Alzheimer's disease. *J Am Geriatr Soc* 2007;55:800
- Staskin DR, Dmochowski RR, Sand PK, et al. Efficacy and safety of oxybutynin chloride topical gel for overactive bladder: a randomized, double-blind, placebo controlled, multicenter study. *J Urol*. 2009 Apr;181(4):1764-72.
- Staskin D, Kay G, Tannenbaum C, et al. Trospium chloride has no effect on memory testing and is assay undetectable in the central nervous system of older patients with overactive bladder. *Int J Clin Pract*. 2010;64(9):1294-1300.
- Staskin DR, Robinson D. Oxybutynin chloride topical gel: a new formulation of an established antimuscarinic therapy for overactive bladder. *Expert Opin Pharmacother*. 2009 Dec;10(18):3103-11.
- Staskin DR, Rosenberg MT, Sand PK, et al. Trospium chloride once-daily extended release is effective and well tolerated for the treatment of overactive bladder syndrome: an integrated analysis of two randomised, phase III trials. *Int J Clin Pract*. 2009 Dec;63(12):1715-23.
- Staskin DR, Salvatore S. Oxybutynin topical and transdermal formulations: an update. *Drugs Today (Barc)*. 2010 Jun;46(6):417-25
- Staskin D, Sand P, Zinner N et al. Trospium Study Group. Once daily trospium chloride is effective and well tolerated for the treatment of overactive bladder: results from a multicenter phase III trial. *J Urol* 2007 Sep;178(3 Pt 1):978
- Staskin DR, Te AE. Short- and long-term efficacy of solifenacin treatment in patients with symptoms of mixed urinary incontinence. *BJU Int*. 2006 Jun;97(6):1256
- Steers W, Corcos J, Foote J et al. An investigation of dose titration with darifenacin, an M3-selective receptor antagonist. *BJU Int*. 2005 Mar;95(4):580
- Steers WD, Herschorn S, Kreder KJ et al. Duloxetine compared with placebo for treating women with symptoms of overactive bladder. *BJU Int*. 2007 Aug;100(2):337
- Stengel PW, Yamada M, Wess J et al. M3-receptor knockout mice: muscarinic receptor function in atria, stomach fundus, urinary bladder, and trachea. *Am J Physiol Regul Integr Comp Physiol* 2002; 282: R1443
- Stevens LA, Chapple CR, Chess-Williams R. Human idiopathic and neurogenic overactive bladders and the role of M2 muscarinic receptors in contraction. *Eur Urol*. 2007 Aug;52(2):531-8.
- Stewart DA, Taylor J, Ghosh S et al. Terodiline causes polymorphic ventricular tachycardia due to reduced heart rate and prolongation of QT interval. *Eur J Clin Pharmacol*. 1992;42(6):577
- Stief CG, Porst H, Neuser D et al. A randomised, placebo-controlled study to assess the efficacy of twice-daily vardenafil in the treatment of lower urinary tract symptoms secondary to benign prostatic hyperplasia. *Eur Urol*. 2008 Jun;53(6):1236

- Stöhrer M, Bauer P, Giannetti BM et al. Effect of trospium chloride on urodynamic parameters in patients with detrusor hyperreflexia due to spinal cord injuries: a multicentre placebo controlled double-blind trial. *Urol Int* 1991;47:138
- Stöhrer, M., Madersbacher, H., Richter, R. et al. Efficacy and safety of propiverine in SCI-patients suffering from detrusor hyperreflexia—a double-blind, placebo-controlled clinical trial. *Spinal Cord* 1999;37:196
- Stöhrer M, Mürtz G, Kramer G et al. Propiverine compared to oxybutynin in neurogenic detrusor overactivity—results of a randomized, double-blind, multicenter clinical study. *Eur Urol*. 2007 Jan;51(1):235
- Stöhrer M, Mürtz G, Kramer G, et al. Efficacy and tolerability of propiverine hydrochloride extended-release compared with immediate-release in patients with neurogenic detrusor overactivity. *m Spinal Cord*. 2013 May;51(5):419-23
- Streng T, Christoph T, Andersson K-E. Urodynamic effects of the K⁺ channel (KCNQ) opener retigabine in freely moving, conscious rats. *J Urol* 2004; 172: 2054
- Streng T, Andersson KE, Hedlund P, et al. Effects on bladder function of combining elocalcitol and tolterodine in rats with outflow obstruction. *BJU Int*. 2012 Jul;110(2 Pt 2):E125-31
- Striano P, Striano S. Gabapentin: a Ca²⁺ channel alpha 2-delta ligand far beyond epilepsy therapy. *Drugs Today (Barc)*. 2008 May;44(5):353
- Strittmatter F, Gandaglia G, Benigni F, et al. Expression of fatty acid amide hydrolase (FAAH) in human, mouse, and rat urinary bladder and effects by FAAH inhibition on bladder function in awake rats. *Eur Urol* 2012;61:98–106.
- Suarez O, Osborn D, Kaufman M, Reynolds WS, Dmochowski R. Mirabegron for male lower urinary tract symptoms. *Curr Urol Rep*. 2013 Dec;14(6):580-4
- Suckling J, Lethaby An, Kennedy R. Local oestrogen for vaginal atrophy in postmenopausal women. *Cochrane Database Syst Rev* 2003; (4) CD001500
- Sugimoto K, Akiyama T, Shimizu N, et al. A pilot study of acotiamide hydrochloride hydrate in patients with detrusor underactivity. *Res Rep Urol*. 2015 May 8;7:81-3
- Sugimoto Y, Narumiya S. Prostaglandin E receptors. *J Biol Chem*. 2007 Apr 20;282(16):11613-7.
- Sugiyama Y, Yoshida M, Masunaga K et al. Pharmacological effects of propiverine and its active metabolite, M-1, on isolated human urinary bladder smooth muscle, and on bladder contraction in rats. *Int J Urol*. 2008 Jan;15(1):76
- Sultana CJ, Walters MD. Estrogen and urinary incontinence in women. *Maturitas* 1990;20:129
- Sun Y, Chai TC. Up-regulation of P2X3 receptor during stretch of bladder urothelial cells from patients with interstitial cystitis. *J Urol*. 2004 Jan;171(1):448-52.
- Sun Y, Keay S, Lehrfeld TJ, Chai TC. Changes in adenosine triphosphate-stimulated ATP release suggest association between cytokine and purinergic signaling in bladder urothelial cells. *Urology*. 2009 Nov;74(5):1163-8
- Sussman D, Garely A. Treatment of overactive bladder with once-daily extended-release tolterodine or oxybutynin: the antimuscarinic clinical effectiveness trial (ACET). *Curr Med Res Opin* 2002;18 (4):177
- Swart PJ, Krauwinkel WJ, Smulders RA et al. Pharmacokinetic effect of ketoconazole on solifenacin in healthy volunteers. *Basic Clin Pharmacol Toxicol*. 2006 Jul;99(1):33.
- Swithbank LV, Vestey S, Abrams P. Nocturnal polyuria in community-dwelling women. *BJU Int*. 2004 Mar;93(4):523-7.
- Szonyi G, Collas DM, Ding YY et al. Oxybutynin with bladder retraining for detrusor instability in elderly people: a randomized controlled trial. *Age Aging*, 1995;24:287
- Szollar SM, Lee SM. Intravesical oxybutynin for spinal cord injury patients. *Spinal Cord*, 1996;34:284
- Tack J, Wyndaele JJ, Ligozio G, Egermark M. A review and additional post-hoc analyses of the incidence and impact of constipation observed in darifenacin clinical trials. *Drug Healthc Patient Saf*. 2012;4:127-39.
- Tadic SD, Griffiths D, Schaefer W et al. Abnormal connections in the supraspinal bladder control network in women with urge urinary incontinence. *Neuroimage* 2008 Feb 15;39(4):1647-53.
- Takasu T, Ukai M, Sato S et al. Effect of (R)-2-(2-aminothiazol-4-yl)-4'-{2-[(2-hydroxy-2-phenylethyl)amino]ethyl} acetanilide (YM178), a novel selective beta3-adrenoceptor agonist, on bladder function. *J Pharmacol Exp Ther*. 2007 May;321(2):642
- Takao T, Tsujimura A, Yamamoto K, et al. Solifenacin may improve sleep quality in patients with overactive bladder and sleep disturbance. *Urology*. 2011 Sep;78(3):648-52. Epub 2011 Jun 15.
- Take H, Shibata K, Awaji T, et al. Vascular alpha1-adrenoceptor subtype selectivity and alpha1-blocker-induced orthostatic hypotension. *Jpn J Pharmacol*. 1998 May;77(1):61-70
- Takeda M, Obara K, Mizusawa T et al. Evidence for beta3-adrenoceptor subtypes in relaxation of the human urinary bladder detrusor: analysis by molecular biological and pharmacological methods. *J Pharmacol Exp Ther*. 1999 Mar;288(3):1367

- Takeda H, Yamazaki Y, Igawa Y et al. Effects of beta(3)-adrenoceptor stimulation on prostaglandin E(2)-induced bladder hyperactivity and on the cardiovascular system in conscious rats. *Neurourol Urodyn.* 2002;21(6):558
- Takusagawa S, van Lier JJ, Suzuki K, Nagata M. Absorption, Metabolism and Excretion of [¹⁴C]Mirabegron (YM178), a Potent and Selective β₃-Adrenoceptor Agonist, after Oral Administration to Healthy Male Volunteers. *Drug Metab Dispos.* 2012 Jan 23. [Epub ahead of print]
- Tamimi NA, Mincik I, Haughie S. et al. A placebo-controlled study investigating the efficacy and safety of the phosphodiesterase type 5 inhibitor UK-369,003 for the treatment of men with lower urinary tract symptoms associated with clinical benign prostatic hyperplasia. *BJU Int* 2010;106:674-680.
- Tammela T, Kontturi M, Käär K, Lukkarinen O. Intravesical prostaglandin F₂ for promoting bladder emptying after surgery for female stress incontinence. *Br J Urol.* 1987 Jul;60(1):43-6.
- Tanaka Y, Masumori N, Itoh N, et al. Symptomatic and urodynamic improvement by oral distigmine bromide in poor voiders after transurethral resection of the prostate. *Urology.* 2001 Feb;57(2):270-4.
- Tanaka Y, Masumori N, Tsukamoto T. Urodynamic effects of solifenacin in untreated female patients with symptomatic overactive bladder. *Int J Urol.* 2010 Sep;17(9):796-800.
- Tanaka M, Sasaki Y, Kimura Y et al. A novel pyrrole derivative, NS-8, suppresses the rat micturition reflex by inhibiting afferent pelvic nerve activity. *BJU Int* 2003; 92: 1031
- Tatemichi S, Tomiyama Y, Maruyama I, et al. Uroselectivity in male dogs of silodosin (KMD-3213), a novel drug for the obstructive component of benign prostatic hyperplasia. *Neurourol Urodyn.* 2006;25(7):792-9;
- Tatemichi S, Akiyama K, Kobayashi M, et al. A selective alpha_{1A}-adrenoceptor antagonist inhibits detrusor overactivity in a rat model of benign prostatic hyperplasia. *J Urol.* 2006 Sep;176(3):1236-41.
- Taylor MC, Bates CP, A double-blind crossover trial of baclofen--a new treatment for the unstable bladder syndrome. *Br J Urol.* 1979 Dec;51(6):504
- The Montreal Cognitive Assessment homepage. Accessed at <http://www.mocatest.org> on June 4, 2008
- Thiagamoorthy G, Giarenis I, Cardozo L. Early investigational β₃ adreno-receptor agonists for the management of the overactive bladder syndrome. *Expert Opin Investig Drugs.* 2015;24(10):1299-306.
- Thor KB, de Groat WC. Neural control of the female urethral and rhabdosphincteris and pelvic floor muscles. *Am J Physiol Regul Integr Comp Physiol* 2010;299(2):R416-438
- Thor K, Katofiasc MA. Effects of duloxetine, a combined serotonin and norepinephrine reuptake inhibitor, on central neural control of lower urinary tract function in the chloralose-anesthetized female cat. *J Pharmacol Exp Ther* 1995;274(2):1014
- Thor K, Kirby M, Viktrup L. Serotonin and noradrenaline involvement in urinary incontinence, depression and pain: scientific basis for overlapping clinical efficacy from a single drug. *Int J Clinical Practice* 2007;61(8):1349-1355
- Thumfart J, Roehr CC, Kapelari K, et al. Desmopresin associated symptomatic hyponatremic hypervolemia in children. Are there predictive factors? *J Urol.* 2005 Jul;174(1):294-8; discussion 298.
- Thüroff JW, Bunke B, Ebner A et al. Randomized, double-blind, multicenter trial on treatment of frequency, urgency and incontinence related to detrusor hyperactivity: oxybutynin versus propantheline vesus placebo. *J Urol,* 1991;145:813
- Thüroff JW, Chartier-Kastler E, Corcus J, et al. Medical treatment and medical side effects in urinary incontinence in the elderly. *World J Urol.* 1998;16 Suppl 1:S48-61.
- Tincello DG, Kenyon S, Abrams KR, et al. Botulinum Toxin A Versus Placebo for Refractory Detrusor Overactivity in Women: A Randomised Blinded Placebo-Controlled Trial of 240 Women (the RELAX Study). *Eur Urol.* 2012 Sep;62(3):507-14.
- Tiwari A.. Elocalcitol, a vitamin D3 analog for the potential treatment of benign prostatic hyperplasia, overactive bladder and male infertility. *IDrugs.* 2009 Jun;12(6):381-93.
- Todorova A, Vonderheid-Guth B, Dimpfel W. Effects of tolterodine, trospium chloride, and oxybutynin on the central nervous system. *J Clin Pharmacol* 2001;41(6):636
- Toglia MR, Serels SR, Laramée C, et al. Solifenacin for overactive bladder: patient-reported outcomes from a large placebo-controlled trial. *Postgrad Med.* 2009 Sep;121(5):151-8.
- Tokuno H, Chowdhury JU, Tomita T. Inhibitory effects of propiverine on rat and guinea-pig urinary bladder muscle. *Naunyn-Schmiedeberg's Arch Pharmacol,* 1993;348:659
- Tominaga M, Caterina MJ, Malmberg AB, et al. The cloned capsaicin receptor integrates multiple pain-producing stimuli. *Neuron.* 1998 Sep;21(3):531-43.
- Tonini M, Messori E, Franceschetti GP, et al. Characterization of the 5-HT receptor potentiating neuromuscular cholinergic transmission in strips of human isolated detrusor muscle. *Br J Pharmacol.* 1994 Sep;113(1):1-2.

- Truss MC, Stief CG, Uckert S et al. Initial clinical experience with the selective phosphodiesterase-I isoenzyme inhibitor vinpocetine in the treatment of urge incontinence and low compliance bladder. *World J Urol* 2000;18:439
- Truss MC, Stief CG, Uckert S et al. Phosphodiesterase 1 inhibition in the treatment of lower urinary tract dysfunction: from bench to bedside. *World J Urol* 2001;19:344
- Tsakiris P, de la Rosette JJ, Michel M et al. Pharmacologic treatment of male stress urinary incontinence: systemic review of the literature and levels of evidence. *European Urology* 2008;53:53-59
- Tsao JW, Heilman KM. Transient memory impairment and hallucinations associated with tolterodine use. *N Engl J Med* 2003;349:2274
- Tseng LH, Wang AC, Chang YL, et al. Randomised comparison of tolterodine with vaginal oestrogen cream versus tolterodine alone for the treatment of postmenopausal women with overactive bladder syndrome. *Neurourol Urodyn* 2009 28 (1) 47-51
- Tuncel A, Nalcacioglu V, Ener K et al. Sildenafil citrate and tamsulosin combination is not superior to monotherapy in treating lower urinary tract symptoms and erectile dysfunction. *World J Urol* 2010;28:17-22.
- Tyagi V, Philips BJ, Su R, et al. Differential expression of functional cannabinoid receptors in human bladder detrusor and urothelium. *J Urol* 2009;181:1932-8.
- Uchida H, Shishido K, Nomiya M et al. Involvement of cyclic AMP-dependent and -independent mechanisms in the relaxation of rat detrusor muscle via beta-adrenoceptors. *Eur J Pharmacol.* 2005 Aug 22;518(2-3):195
- Uckert S, Hedlund P, Andersson KE, et al. Update on phosphodiesterase (PDE) isoenzymes as pharmacologic targets in urology: present and future. *Eur Urol.* 2006 Dec;50(6):1194-207
- Uckert S, Kuthe A, Jonas U et al. Characterization and functional relevance of cyclic nucleotide phosphodiesterase isoenzymes of the human prostate. *J Urol* 2001;166:2484
- Uckert S, Stief CG, Odenthal KP et al. Responses of isolated normal human detrusor muscle to various spasmolytic drugs commonly used in the treatment of the overactive bladder. *Arzneimittelforschung,* 2000;50(5):456
- Uusvaara J, Pitkala KH, Kautiainen H, et al. Association of anticholinergic drugs with hospitalization and mortality among older cardiovascular patients: A prospective study. *Drugs Aging* 2011;28:131-8.
- Uvin P, Franken J, Pinto S, et al. Essential role of transient receptor potential M8 (TRPM8) in a model of acute cold-induced urinary urgency. *Eur Urol.* 2015 Oct;68(4):655-61. doi: 10.1016/j.eururo.2015.03.037. Epub 2015 Apr 3.
- Valiquette G, Herbert J, Maede-D'Alisera P. Desmopressin in the management of nocturia in patients with multiple sclerosis. A double-blind, crossover trial. *Arch Neurol* 1996;53:1270
- Vande Walle J, Stockner M, Raes A, Nørgaard JP. Desmopressin 30 years in clinical use: a safety review. *Curr Drug Saf.* 2007 Sep;2(3):232-8.
- Van de Walle J, Van Herzeele C, Raes A. Is there still a role for desmopressin in children with primary monosymptomatic nocturnal enuresis?: a focus on safety issues. *Drug Saf.* 2010 Apr 1;33(4):261-71.
- van Gelderen EM, Li Q, Meijer J, et al. An exploratory comparison of the single dose pharmacokinetics of the beta3-adrenoceptor agonist mirabegron in healthy CYP2D6 poor and extensive metabolizers. *Clin Pharmacol Ther.* 2009;85:S88.
- van Gelderen M, Tretter R, Meijer J, et al. Absence of clinically relevant cardiovascular interaction upon add-on of mirabegron or tamsulosin to an established tamsulosin or mirabegron treatment in healthy middle-aged to elderly men. *Int J Clin Pharmacol Ther.* 2014 Aug;52(8):693-701.
- Van Kerrebroeck P, Abrams P, Lange R et al. Duloxetine vs. placebo in the treatment of European and Canadian women with stress urinary incontinence. *Br J Obstet Gynaecol* 2004;111:249
- Van Kerrebroeck P, Chapple C, Drogendijk T, NEPTUNE Study Group. Combination therapy with solifenacin and tamsulosin oral controlled absorption system in a single tablet for lower urinary tract symptoms in men: efficacy and safety results from the randomised controlled NEPTUNE trial. *Eur Urol.* 2013 Dec;64(6):1003-12
- Van Kerrebroeck P, Haab F, Angulo JC, (2013). Efficacy and safety of solifenacin plus tamsulosin OCAS in men with voiding and storage lower urinary tract symptoms: results from a phase 2, dose-finding study (SATURN). *Eur Urol* 2013;64(3): 398-407.
- Van Kerrebroeck P, Kreder K, Jonas U et al. Tolterodine once-daily: superior efficacy and tolerability in the treatment of the overactive bladder. *Urology,* 2001;57(3):414
- van Kerrebroeck P, Rezapour M, Cortesse A et al. Desmopressin in the treatment of nocturia: a double-blind, placebo-controlled study. *Eur Urol,* 2007;52:221
- van Leeuwen J, Lange R, Jonasson A, et al. Efficacy & safety in elderly women with stress urinary incontinence or stress predominant mixed urinary incontinence. *Maturitas* 2008;60(2):138-147
- van Rey F, Heesakkers J. Solifenacin in multiple sclerosis patients with overactive bladder: a prospective study. *Adv Urol,* 2011;2011:834753. Epub 2011 May 5.

- Vardy MD, Mitcheson HD, Samuels TA, et al. Effects of solifenacin on overactive bladder symptoms, symptom bother and other patient-reported outcomes: results from VIBRANT - a double-blind, placebo-controlled trial. *Int J Clin Pract*. 2009 Dec;63(12):1702-14.
- Vaughan CP, Johnson TM 2nd, Ala-Lipasti MA, et al. The prevalence of clinically meaningful overactive bladder: bother and quality of life results from the population-based FINNO study. *Eur Urol*. 2011 Apr;59(4):629-36.
- Vaidyanathan S, Rao MS, Mapa MK, et al. Study of intravesical instillation of 15(S)-15 methyl prostaglandin F2-alpha in patients with neurogenic bladder dysfunction. *J Urol*. 1981 Jul;126(1):81-5.
- Veenboer PW, Bosch JL. Long-term adherence to antimuscarinic therapy in everyday practice: a systematic review. *J Urol*. 2014 Apr;191(4):1003-8.
- Vella M, Duckett J, Basu M. Duloxetine 1 year on: the long term outcome of a cohort of women prescribed duloxetine. *Int Urogynecol J Pelvic Floor Dysfunct* 2008;19(7):961-964
- Vemulakonda VM, Somogyi GT, Kiss S, et al. Inhibitory effect of intravesically applied botulinum toxin A in chronic bladder inflammation. *J Urol*. 2005 Feb;173(2):621-4.
- Versi E, Appell R, Mobley D et al. Dry mouth with conventional and controlled-release oxybutynin in urinary incontinence. The Ditropan XL Study Group. *Obstet Gynecol*, 2000;95(5):718-721
- Versi E, Cardozo LD. Urethral instability: diagnosis based on variations in the maximum urethral pressure in normal climacteric women. *Neurourol Urodynamics* 1986;5(6):535
- Vijaya G, Digesu GA, Derpapas A, et al. Antimuscarinic effects on current perception threshold: a prospective placebo control study. *Neurourol Urodyn*. 2012 Jan;31(1):75-9.
- Visco AG, Brubaker L, Richter HE, et al.; Pelvic Floor Disorders Network. Anticholinergic versus botulinum toxin A comparison trial for the treatment of bothersome urge urinary incontinence: ABC trial. *Contemp Clin Trials*. 2012 Jan;33(1):184-96.
- Visco AG, Zyczynski H, Brubaker L, et al. Cost-Effectiveness Analysis of Anticholinergics Versus Botox for Urgency Urinary Incontinence: Results From the Anticholinergic Versus Botox Comparison Randomized Trial. *Female Pelvic Med Reconstr Surg*. 2016 Sep-Oct;22(5):311-6
- Vlaskovska M, Kasakov L, Rong W, Bodin P, Bardini M, Cockayne DA, Ford AP, Burnstock G. P2X3 knock-out mice reveal a major sensory role for urothelially released ATP. *J Neurosci*. 2001 Aug 1;21(15):5670-7.
- Wada N, Matsumoto S, Kita M, Hashizume K, Kazizaki H. Improvement of Overactive Bladder Symptoms and Bladder Ischemia with Dutasteride in Patients with Benign Prostatic Enlargement. *Low Urin Tract Symptoms*. 2015 Jan;7(1):37-41.
- Wada N, Watanabe M, Kita M, et al. Efficacy and safety of propiverine and solifenacin for the treatment of female patients with overactive bladder: a crossover study. *LUTS* 2011;3:36-42
- Wada N, Watanabe M, Kita M, et al. Effect of imidafenacin on nocturia and sleep disorder in patients with overactive bladder. *Urol Int*. 2012;89(2):215-21.
- Waetjen LE, Brown JS, Modelska K et al. Effect of raloxifene on urinary incontinence: a randomized controlled trial. *Obstet Gynaecol* 2004;103(2)261
- Wagg A, Compion G, Fahey A, Siddiqui E. Persistence with prescribed antimuscarinic therapy for overactive bladder: a UK experience. *BJU Int*. 2012 Dec;110(11):1767-74.
- Wagg A, Cardozo L, Nitti VW, Castro-Diaz D, Auerbach S, Blauwet MB, Siddiqui E.
- The efficacy and tolerability of the β 3-adrenoceptor agonist mirabegron for the treatment of symptoms of overactive bladder in older patients. *Age Ageing*. 2014 Sep;43(5):666-75.
- Wagg A, Dale M, Tretter R, et al. Randomised, multi-centre, placebo-controlled, double-blind crossover study investigating the effect of solifenacin and oxybutynin in elderly people with mild cognitive impairment: the SENIOR study. *Eur Urol*. 2013 Jul;64(1):74-81.
- Wagg A, Khullar V, Marschall-Kehrel D, et al. Flexible-dose fesoterodine in elderly adults with overactive bladder: results of the randomized, double-blind, placebo-controlled study of fesoterodine in an aging population trial. *J Am Geriatr Soc*. 2013 Feb;61(2):185-93.
- Wagg A, Khullar V, Michel MC, et al. Long-term safety, tolerability and efficacy of flexible-dose fesoterodine in elderly patients with overactive bladder: open-label extension of the SOFIA trial. *Neurourol Urodyn*. 2014 Jan;33(1):106-14
- Wagg A, Nitti VW, Kelleher C, Castro-Diaz D, Siddiqui E, Berner T. Oral pharmacotherapy for overactive bladder in older patients: mirabegron as a potential alternative to antimuscarinics. *Curr Med Res Opin*. 2016;32(4):621-38
- Wagg A, Oelke M, Angulo JC, Scholfield D, Arumi D. Review of the efficacy and safety of fesoterodine for treating overactive bladder and urgency urinary incontinence in elderly patients. *Drugs Aging*. 2015 Feb;32(2):103-25.
- Wagg A, Verdejo C, Molander U. Review of cognitive impairment with antimuscarinic agents in elderly patients with overactive bladder. *Int J Clin Pract* 2010;64:1279-1286.

- Wagg A, Wyndaele JJ, Sieber P. Efficacy and tolerability of solifenacin in elderly subjects with overactive bladder syndrome: a pooled analysis. *Am J Geriatr Pharmacother.* 2006 Mar;4(1):14
- Wagner G, Husslein P,ENZELSBERGER H. Is prostaglandin E2 really of therapeutic value for postoperative urinary retention? Results of a prospectively randomized double-blind study. *Am J Obstet Gynecol.* 1985 Feb 1;151(3):375-9.
- Walczak JS, Cervero F. Local activation of cannabinoid CB1 receptors in the urinary bladder reduces the inflammation-induced sensitization of bladder afferents. *Mol Pain* 2011;7:31–42.
- Waldeck K, Larsson B, Andersson K-E. Comparison of oxybutynin and its active metabolite, N-desethyl-oxybutynin, in the human detrusor and parotid gland. *J Urol.* 1997;157:1093
- Walter P, Grosse J, Bihl AM et al. Bioavailability of trospium chloride after intravesical instillation in patients with neurogenic lower urinary tract dysfunction: A pilot study. *Neurourol Urodyn.* 1999;18(5):447-53.
- Walter R, Ullmann C, Thummler et al. Influence of propiverine on hepatic microsomal cytochrome p450 enzymes in male rats. *Drug Metab Dispos* 2003;31(6):714
- Wammack R, Weihe E, Dienes H-P, Hohenfellner R. Die Neurogene Blase in vitro. *Akt Urol.* 1995;26:16
- Wang EC, Lee JM, Ruiz WG, Balestreire EM, von Bodungen M, Barrick S, Cockayne DA, Birder LA, Apodaca G. ATP and purinergic receptor-dependent membrane traffic in bladder umbrella cells. *Clin Invest.* 2005 Sep;115(9):2412-22.
- Wang CJ, Lin YN, Huang SW, Chang CH.. Low dose oral desmopressin for nocturnal polyuria in patients with benign prostatic hyperplasia: a double-blind, placebo controlled, randomized study. *J Urol.* 2011a Jan;185(1):219-23.
- Wang J, Zurawski TH, Meng J, et al. A dileucine in the protease of botulinum toxin A underlies its long-lived neuroparalysis: transfer of longevity to a novel potential therapeutic. *J Biol Chem.* 2011b Feb 25;286(8):6375-85.
- Watanabe JH, Campbell JD, Ravelo A, et al. Cost analysis of interventions for antimuscarinic refractory patients with overactive bladder. *Urology.* 2010 Oct;76(4):835-40.
- Weatherall M. The risk of hyponatremia in older adults using desmopressin for nocturia: a systematic review and meta-analysis. *Neurourol Urodyn* 2004;23(4):302
- Wefer B, Ehlik B, Bremer J, et al. Treatment outcomes and resource use of patients with neurogenic detrusor overactivity receiving botulinum toxin A (BOTOX) therapy in Germany. *World J Urol.* 2010 Jun;28(3):385-90.
- Wegener JW, Schulla V, Lee T-S, et al. An essential role of CaV1.2 L-type calcium channel for urinary bladder function. *FASEB J* 2004; 18: 1159
- Wehnert J, Sage S. Comparative investigations to the action of Mictonorm (propiverin hydrochloride) and Spasuret (flavoxat hydrochloride) on detrusor vesicae. *Z Urol Nephrol.* 1989;82:259
- Wehnert J, Sage S. Therapie der Blaseninstabilität und Urge-Inkontinenz mit Propiverin hydrochlorid (Mictonorm®) und Oxybutynin chlorid (Dridase®) - eine randomisierte Crossover- Vergleichsstudie. *Akt Urol.* 1992;23:7
- Weil EH, Eerdmans PH, Dijkman GA et al. Randomized double-blind placebo controlled multicenter evaluation of efficacy and dose finding of midodrine hydrochloride in women with mild to moderate stress urinary incontinence: a phase II study. *Int Urogynecol J Pelvic Floor Dysfunct* 1998;9(3):145
- Wein AJ. Pathophysiology and classification of lower urinary tract dysfunction. In, Wein, AJ, Kavoussi LR, Novick AC, Partin AW, Peters CA (eds): *Campbell-Walsh Urology*, tenth Edition, volume 3, Elsevier Saunders, pp. 1834-1846, 2012
- Wein AJ, Dmochoski RR. Neuromuscular dysfunction of the lower urinary tract. In, Wein, AJ, Kavoussi LR, Novick AC, Partin AW, Peters CA (eds): *Campbell-Walsh Urology*, tenth Edition, volume 3, Elsevier Saunders, pp 1909-1946, 2012
- Weiss JP, Blaivas J, Bliwise D, et al. The Evaluation and Treatment of Nocturia: A Consensus Statement. *BJU Int* 2011a;108(1):6-21
- Weiss JP, Herschorn S, Albei CD, van der Meulen EA. Efficacy and safety of low dose desmopressin orally disintegrating tablet in men with nocturia: results of a multicenter, randomized, double-blind, placebo controlled, parallel group study. *J Urol.* 2013 Sep;190(3):965-72.
- Weiss JP, Zinner NR, Klein BM et al: Desmopressin orally disintegrating tablet effectively reduces nocturia: results of a randomised double-blind placebo-controlled trial. *Neurourol Urodyn.* 2012 Apr;31(4):441-7
- Weiss JP, van Kerrebroeck PE, Klein BM, Nørgaard JP. Excessive nocturnal urine production is a major contributing factor to the etiology of nocturia. *J Urol.* 2011b Oct;186(4):1358-63.
- Weiss JP, Jumadilova Z, Johnson TM 2nd, et al. Efficacy and safety of flexible dose fesoterodine in men and women with overactive bladder symptoms including nocturnal urinary urgency. *J Urol.* 2013 Apr;189(4):1396-401.
- Werkström V, Persson K, Ny L et al. Factors involved in the relaxation of female pig urethra evoked by electrical field stimulation. *Br J Pharmacol* 1995;116:1599

- Werkström V, Svensson A, Andersson KE et al. Phosphodiesterase 5 in the female pig and human urethra: morphological and functional aspects. *BJU Int.* 2006 Aug;98(2):414
- Wesnes KA, Edgar C, Tretter RN, Bolodeoku J. Exploratory pilot study assessing the risk of cognitive impairment or sedation in the elderly following single doses of solifenacin 10 mg. *Expert Opin Drug Saf.* 2009;8(6):615-626.
- White WM, Pickens RB, Doggweiler R, Klein FA. Short-term efficacy of botulinum toxin a for refractory overactive bladder in the elderly population. *J Urol.* 2008 Dec;180(6):2522-6.
- Wiedemann A, Füsgen I, Hauri D. New aspects of therapy with trospium chloride for urge incontinence. *Eur J Geriatrics* 2002;3:41
- Williams SG, Staudenmeier J. Hallucinations with tolterodine. *Psychiatr Serv* 2004;55:1318
- Wiseman OJ, Fowler CJ, Landon DN. The role of the human bladder lamina propria myofibroblast. *BJU Int.* 2003 Jan;91(1):89-93.
- Womack KB, Heilman KM. Tolterodine and memory: dry but forgetful. *Arch Neurol* 2003;60:771
- Woods M, Carson N, Norton NW et al. Efficacy of the beta3-adrenergic receptor agonist CL-316243 on experimental bladder hyperreflexia and detrusor instability in the rat. *J Urol.* 2001 Sep;166(3):1142
- Wuest M, Hiller N, Braeter M et al. Contribution of Ca²⁺ influx to carbachol-induced detrusor contraction is different in human urinary bladder compared to pig and mouse. *Eur J Pharmacol* 2007; 565: 180
- Wuest M, Kaden S, Hakenberg OW et al. Effect of rilimakalim on detrusor contraction in the presence and absence of urothelium. *Naunyn-Schmiedeberg's Arch Pharmacol* 2005; 372:203.
- Wuest M, Weiss A, Waelbroeck M et al. Propiverine and metabolites: differences in binding to muscarinic receptors and in functional models of detrusor contraction. *Naunyn Schmiedebergs Arch Pharmacol.* 2006 Nov;374(2):87
- Wyndaele JJ, Goldfischer ER, Morrow JD, et al. Effects of flexible-dose fesoterodine on overactive bladder symptoms and treatment satisfaction: an open-label study. *Int J Clin Pract.* 2009 Apr;63(4):560-7.
- Wyndaele JJ, Van Dromme SA, Muscular weakness as side effect of botulinum toxin injection for neurogenic detrusor overactivity. *Spinal Cord.* 2002 Nov;40(11):599
- Xin W, Li N, Cheng Q, Petkov GV. BK channel-mediated relaxation of urinary bladder smooth muscle: a novel paradigm for phosphodiesterase type 4 regulation of bladder function. *J Pharmacol Exp Ther.* 2014 Apr;349(1):56-65.
- Yamada S, Seki M, Ogoda M, et al. Selective binding of bladder muscarinic receptors in relation to the pharmacokinetics of a novel antimuscarinic agent, imidafenacin, to treat overactive bladder. *J Pharmacol Exp Ther.* 2011 Feb;336(2):365-71.
- Wada N, Matsumoto S, Kita M, Hashizume K, Kakizaki H. Improvement of Overactive Bladder Symptoms and Bladder Ischemia with Dutasteride in Patients with Benign Prostatic Enlargement. *Low Urin Tract Symptoms.* 2015 Jan;7(1):37-41.
- Wada N, Matsumoto S, Kita M, Hashizume K, Kakizaki H. Improvement of Overactive Bladder Symptoms and Bladder Ischemia with Dutasteride in Patients with Benign Prostatic Enlargement. *Low Urin Tract Symptoms.* 2015 Jan;7(1):37-41.
- Yamaguchi O, Marui E, Kakizaki H et al. Randomized, double-blind, placebo- and propiverine-controlled trial of the once-daily antimuscarinic agent solifenacin in Japanese patients with overactive bladder. *BJU Int.* 2007 Sep;100(3):579
- Yamaguchi O, Uchida E, Higo N, et al.; Oxybutynin Patch Study Group. Efficacy and safety of once-daily oxybutynin patch versus placebo and propiverine in Japanese patients with overactive bladder: A randomized double-blind trial. *Int J Urol.* 2014 Jun;21(6):586-93.
- Yamanishi T, Mizuno T, Tatsumiya K, et al. 2009. Urodynamic effects of silodosin, a new alpha 1A-adrenoceptor selective antagonist, for the treatment of benign prostatic hyperplasia. *Neurourol Urodyn* 2009;29: 558-562
- Yaminishi T, Yasuda K, Tojo M et al. Effects of beta-2 stimulants on contractility and fatigue of canine urethral sphincter. *J Urol,* 1994;151:1073.
- Yamanishi T, Yasuda K, Homma Y, et al. A multicenter placebo-controlled, double-blind trial of urapidil, an alpha-blocker, on neurogenic bladder dysfunction. *Eur Urol.* 1999 Jan;35(1):45-51.
- Yamanishi T, Yasuda K, Kamai T, et al. Combination of a cholinergic drug and an alpha-blocker is more effective than monotherapy for the treatment of voiding difficulty in patients with underactive detrusor. *Int J Urol.* 2004 Feb;11(2):88-96.
- Yarker YE, Goa KL, Fitton A. Oxybutynin - A review of its pharmacodynamic and pharmacokinetic properties, and its therapeutic use in detrusor instability. *Drugs Aging,* 1995;6:243
- Yashiro K, Thor K, Burgard E. Properties of urethral rhabdosphincter motoneurons and their regulation by noradrenaline. *J Physiol* 2010;588(Pt 24);4951-4967
- Yasuda K, Kawabe K, Takimoto Y et al. A double blind clinical trial of a beta-2 adrenergic agonist in stress incontinence. *Int. Urogynecol J,* 1993;4:146

- Yeo EK, Hashim H, Abrams P. New therapies in the treatment of overactive bladder. *Expert Opin Emerg Drugs* 2013;18:319- 37
- Yokoyama T, Uematsu K, Watanabe T, et al. Naftopidil and propiverine hydrochloride for treatment of male lower urinary tract symptoms suggestive of benign prostatic hyperplasia and concomitant overactive bladder: a prospective randomized controlled study. *Scand J Urol Nephrol* 2009;43:307-314.
- Yokoyama O, Hiro S, Hotta S, et al. Efficacy of fesoterodine on nocturia and quality of sleep in Asian patients with overactive bladder. *Urology* 2014 Apr;83(4):750-5
- Yokoyama O, Homma Y, Yamaguchi O. Imidafenacin, an antimuscarinic agent, improves nocturia and reduces nocturnal urine volume. *Urology* 2013 Sep;82(3):515-20.
- Yokoyama T, Koide T, Hara R, et al. Long-term safety and efficacy of two different antimuscarinics, imidafenacin and solifenacin, for treatment of overactive bladder: a prospective randomized controlled study. *Urol Int.* 2013;90(2):161-7.
- Yokoyama O, Yamaguchi O, Kakizaki H, et al. Efficacy of solifenacin on nocturia in Japanese patients with overactive bladder: impact on sleep evaluated by bladder diary. *J Urol.* 2011 Jul;186(1):170-4.
- Yoo DS, Han JY, Lee KS, Choo MS. Prescription pattern of oxybutynin ER in patients with overactive bladder in real life practice: a multicentre, open-label, prospective observational study. *Int J Clin Pract.* 2012 Feb;66(2):132-8.
- Young JS, Matharu R, Carew MA, Fry CH. Inhibition of stretching-evoked ATP release from bladder mucosa by anticholinergic agents. *BJU Int.* 2012 Oct;110(8 Pt B):E397-401
- Yoshida M, Homma Y, Inadome A, et al. Age-related changes in cholinergic and purinergic neurotransmission in human isolated bladder smooth muscles. *Exp Gerontol* 2001;36(1):99
- Yoshida M, Homma Y, Kawabe K. Silodosin, a novel selective alpha 1A-adrenoceptor selective antagonist for the treatment of benign prostatic hyperplasia. *Expert Opin Investig Drugs.* 2007 Dec;16(12):1955-65.
- Yoshida M, Inadome A, Maeda Y et al. Non-neuronal cholinergic system in human bladder urothelium. *Urology.* 2006 Feb;67(2):425
- Yoshida M, Masunaga K, Satoji Y et al. Basic and clinical aspects of non-neuronal acetylcholine: expression of non-neuronal acetylcholine in urothelium and its clinical significance. *J Pharmacol Sci.* 2008 Feb;106(2):193
- Yoshida M, Miyamae K, Iwashita H, et al. Management of detrusor dysfunction in the elderly: changes in acetylcholine and adenosine triphosphate release during aging. *Urology.* 2004 Mar;63(3 Suppl 1):17
- Yoshida M, Kudoh J, Homma Y, Kawabe K. Safety and efficacy of silodosin for the treatment of benign prostatic hyperplasia. *Clin Interv Aging.* 2011;6:161-72.
- Yoshimura N, Miyazato M, Kitta T, Yoshikawa S. Central nervous targets for the treatment of bladder dysfunction. *Neurourol Urodyn.* 2014 Jan;33(1):59-66.
- Yossepowitch O, Gillon G, Baniel J et al. The effect of cholinergic enhancement during filling cystometry: can edrophonium chloride be used as a provocative test for overactive bladder? *J Urol.* 2001 May;165(5):1441
- Yoong HF, Sundaram MB, Aida Z. Prevalence of nocturnal polyuria in patients with benign prostatic hyperplasia. *Med J Malaysia.* 2005 Aug;60(3):294-6.
- Zacche MM, Giarenis I, Cardozo L. Phase II drugs that target cholinergic receptors for the treatment of overactive bladder. *Expert Opin Investig Drugs* 2014;23:1365-74.
- Zahariou A, Karagiannis G, Papaionnou P et al. The use of desmopressin in the management of nocturnal enuresis in patients with spinal cord injury. *Eura Medicophys* 2007;43:333
- Zaitzu M, Mikami K, Ishida N, Takeuchi T. Comparative Evaluation of the Safety and Efficacy of Long-Term Use of Imidafenacin and Solifenacin in Patients with Overactive Bladder: A Prospective, Open, Randomized, Parallel-Group Trial (the LIST Study). *Adv Urol.* 2011;2011:854697.
- Zakrzewski-Jakubiak H, Doan J, Lamoureux P, et al. Detection and prevention of drug-drug interactions in the hospitalized elderly: utility of new cytochrome p450-based software. *Am J Geriatr Pharmacother* 2011;9(6):461-70.
- Zarghooni S, Wunsch J, Bodenbenner M, et al. Expression of muscarinic and nicotinic acetylcholine receptors in the mouse urothelium. *Life Sci,* 2007;80:2308.
- Zhao Z, Azad R, Yang JH, Siroky MB, Azadzo KM. Progressive changes in detrusor function and micturition patterns with chronic bladder ischemia. *Investig Clin Urol.* 2016 Jul;57(4):249-59.
- Zhu HL, Brain KL, Aishima M et al. Actions of two main metabolites of propiverine (M-1 and M-2) on voltage-dependent L-type Ca²⁺ currents and Ca²⁺ transients in murine urinary bladder myocytes. *J Pharmacol Exp Ther.* 2008 Jan;324(1):118

Zinner N. Darifenacin: a muscarinic M3-selective receptor antagonist for the treatment of overactive bladder. *Expert Opin Pharmacother.* 2007 Mar;8(4):511-23

Zinner NR, Dmochowski RR, Staskin DR, et al. Once-daily trospium chloride 60 mg extended-release provides effective, long-term relief of overactive bladder syndrome symptoms. *Neurourol Urodyn.* 2011 Sep;30(7):1214-9.

Zinner N, Gittelman M, Harris R et al. Trospium Study Group. Trospium chloride improves overactive bladder symptoms: a multicenter phase III trial. *J Urol* 2004a;171(6 Pt 1):2311

Zinner NR, Mattiasson A, Stanton SL. Efficacy, safety, and tolerability of extended-release once-daily tolterodine treatment for overactive bladder in older versus younger patients. *J Am Geriatr Soc.* 2002 May;50(5):799-807.

Zinner N, Susset J, Gittelman M et al. Efficacy, tolerability and safety of darifenacin, an M₃ selective receptor antagonist: an investigation of warning time in patients with OAB. *Int J Clin Pract.* 2006 Jan;60(1): 119

DIAGNOSIS AND MANAGEMENT OF URINARY INCONTINENCE IN CHILDHOOD

Chair

Rien Nijman (THE NETHERLANDS)

Members

Serdar Tekgul (TURKEY)

Janet Chase (AUSTRALIA)

An Bael (BELGIUM)

Dan Wood (UK)

Doug Canning (USA)

Paul Austin (USA)

Erik van Laeke (Belgium)

Johan van der Walle (Belgium)

Giovanni Mosiello (Italy)

Alexander von Gontard (GERMANY)

CONTENTS

I.	INTRODUCTION	962	5.	Principles of non-pharmacological treatment of all different states	999
2.	Normal values	963	6.	Pharmacological treatment	1006
II.	EVALUATION IN CHILDREN WHO WET	965	V.	NEUROGENIC DETRUSOR-SPHINCTER DYSFUNCTION	1010
1.	History taking	965	1.	Introduction	1010
2.	Physical examination	965	2.	Presentation of neurogenic detrusor-sphincter dysfunction in children	1011
3.	Urinalysis	966	3.	Classification: pattern recognition	1012
4.	Non-invasive techniques	966	4.	Prenatal diagnosis and fetal surgery	1012
5.	Quantification of urine loss	967	5.	Management	1013
6.	Scoring systems	967	VI.	SURGICAL MANAGEMENT OF URINARY INCONTINENCE IN CHILDREN	1016
7.	Urinary flow	967	1.	Introduction	1016
8.	Ultrasound imaging of upper and lower urinary tract	970	2.	Indications for surgical procedures to correct urinary incontinence	1018
9.	Invasive diagnostic techniques	971	3.	Bladder reservoir construction	1018
III.	CHILDREN WITH NIGHT TIME INCONTINENCE	974	4.	Bladder outlet surgery	1022
1.	Definition	974	5.	Complications of continence surgery in children	1026
2.	Severity	974	VII.	PSYCHOLOGICAL ASPECTS OF URINARY INCONTINENCE, ENURESIS AND FAECAL INCONTINENCE	1031
3.	Prevalence	974	1.	Introduction	1031
4.	Inheritance	975	2.	Clinical behavioural disorders	1032
5.	Sex and monosymptomatic NE	975	3.	CLINICAL BEHAVIOURAL DISORDERS IN CHILDREN WITH NOCTURNAL ENURESIS AND DAYTIME URINARY INCONTINENCE	1033
6.	Classification	975	4.	CLINICAL BEHAVIOURAL DISORDERS IN CHILDREN WITH FAECAL INCONTINENCE	1035
7.	Pathophysiology of Monosymptomatic NE	976	5.	Children with special needs	1037
8.	Management of nocturnal enuresis	980	6.	GENERAL PRINCIPLES: ASSESSMENT	1037
9.	Therapy	983	VIII.	URINARY INCONTINENCE IN CHILDREN WITH SPECIAL NEEDS	1043
10.	Refractory MNE:	989	1.	Introduction	1043
IV.	CHILDREN WITH BOTH DAY AND NIGHT TIME INCONTINENCE	991			
1.	Prevalence	992			
2.	Introduction to clinical assessment	993			
3.	Confounding factors: Lower urinary tract dysfunction, recurrent urinary tract infection and vesicoureteric reflux (VUR)	993			
4.	Classification	994			

2.	Children with special needs: general information	1043
3.	Lower Urinary Tract Symptoms in children with special needs: prevalence	1044
4.	Pathophysiology of LUTS in children with special needs	1044
5.	Comorbidity	1045
6.	Evaluation of the special need child suffering LUTS	1046
7.	Treatment of urinary incontinence in children with special needs.....	1046
8.	Pharmacological treatment	1047
9.	Surgery	1047
10.	Clean intermittent catheterisation (CIC)	1047
11.	Conclusion	1047
	REFERENCES	1049
I.	INTRODUCTION	1049
II.	EVALUATION IN CHILDREN WHO WET	1050
III.	CHILDREN WITH NIGHT TIME INCONTINENCE	1053
IV.	CHILDREN WITH BOTH DAY AND NIGHT TIME INCONTINENCE	1063
V.	NEUROGENIC DETRUSOR-SPHINCTER DYSFUNCTION	1071
VI.	SURGICAL MANAGEMENT OF URINARY INCONTINENCE IN CHILDREN	1075
VII.	PSYCHOLOGICAL ASPECTS OF URINARY INCONTINENCE, ENURESIS AND FAECAL INCONTINENCE	1086
VIII.	URINARY INCONTINENCE IN CHILDREN WITH SPECIAL NEEDS	1090

DIAGNOSIS AND MANAGEMENT OF URINARY INCONTINENCE IN CHILDHOOD

RIEN NIJMAN (THE NETHERLANDS)

SERDAR TEK GUL (TURKEY), JANET CHASE (AUSTRALIA), AN BAEL (BELGIUM), DAN WOOD (UK), DOUG CANNING (USA), PAUL AUSTIN (USA), ERIK VAN LAEKE (BELGIUM), JOHAN VAN DER WALLE (BELGIUM), GIOVANNI MOSIELLO (ITALY), ALEXANDER VON GONTARD (GERMANY)

I. INTRODUCTION

In this chapter the diagnostic and treatment modalities of urinary incontinence in childhood will be discussed. In order to understand the pathophysiology of the most frequently encountered problems in children, we shall also consider the normal development of bladder and sphincter.

Underlying pathophysiology will be outlined and the specific investigations for children will be covered but for general information on epidemiology and urodynamic investigations their respective chapters should be consulted.

1.1. Normal development of bladder and sphincter control

Normal bladder storage and voiding involve low-pressure and adequate bladder volume filling followed by a continuous detrusor contraction that results in bladder emptying, associated with adequate relaxation of the sphincter complex. This process requires normal sensation and normal bladder outlet resistance. The neurophysiological mechanisms involved in normal bladder storage and evacuation include a complex integration of sympathetic, parasympathetic and somatic innervation which is ultimately controlled by a complex interaction between spinal cord, brain stem, midbrain and higher cortical structures (1,2).

Achievement of urinary control is equally complex and as yet not fully understood: various developmental stages have been observed (2,3).

In new-borns, the bladder has been traditionally described as "uninhibited", and it has been assumed that micturition occurs automatically by a simple spinal cord reflex, with little or no mediation by the higher neural centres. However, studies have indicated that even in full-term fetuses and new-borns, micturition is modulated by higher centres and the previous notion

that voiding is spontaneous and mediated by a simple spinal reflex is an oversimplification (4). Fetal micturition seems to be a behavioural state-dependent event: intrauterine micturition is not randomly distributed between sleep and arousal, but occurs almost exclusively while the fetus is awake (4).

During the last trimester the intra-uterine urine production is much higher than in the postnatal period (30ml/hr) and the voiding frequency is approximately 30 times every 24 hours (5).

Immediately after birth voiding is very infrequent during the first few days of life. The first void may only take place after 12 to 24 hours. After the first week frequency increases rapidly and peaks at the age of 2 to 4 weeks to an average of once per hour. It then decreases and remains stable after 6 months to about 10 to 15 times per day. After the first year it decreases to 8 to 10 times per day, while voided volumes increase by three-to-fourfold.

During the postnatal period, micturition control mechanisms undergo further changes and extensive modulation. Using ambulatory bladder monitoring techniques in conjunction with polysomnographic recordings it has been shown that even in new-borns the bladder is normally quiescent and micturition does not occur during sleep (6).

This inhibition (or lack of facilitation) of detrusor contractions during sleep is also observed in infants with neurogenic bladder dysfunction who have marked detrusor overactivity while they are awake. In response to bladder distension during sleep, an infant nearly always exhibits clear electro-encephalographic evidence of cortical arousal, facial grimaces or limb movements, or actual awakening. Sleeping infants are always seen to wake up before the bladder contracts and voiding occurs. This arousal period may be transient and the infant may cry and move for a brief period before micturition and then shortly af-

terward go back to sleep. Because this waking response is already well established in new-borns, it follows that the control of micturition probably involves more complicated neural pathways and higher centres than has been appreciated. There is also strong evidence that a pronounced reorganisation of pre-existing synaptic connections and neural pathways involved in bladder control occurs during the early post-natal period.

In new-borns micturition occurs at frequent intervals and may have an intermittent pattern although bladder emptying efficiency is usually good. In over 80 percent of voids the bladder empties completely (7).

During infancy voiding pressures are much higher than in adults. It has also been noted that these pressures are higher in boys than in girls (mean pdet max of 118 vs. 75 cm H₂O, respectively) (8,9).

These higher detrusor pressures decrease progressively with increasing age. In up to 70 percent of infants (up to the age of 3 years) with normal lower urinary tracts, intermittent patterns of voiding were observed. They tend to disappear with increasing age, and are thought to represent variations between individual infants in the maturation of detrusor and sphincteric co-ordination during the first 1 to 2 years of life. Videourodynamic studies have confirmed these findings (6,8-11).

Between the age of 1 and 2, conscious sensation of bladder filling develops. The ability to void or inhibit voiding voluntarily at any degree of bladder filling commonly develops in the second and third years of life. Central inhibition is crucial to obtain continence.

During the second and third year of life, there is progressive development towards a socially conscious continence and a more voluntary type of micturition control develops. The child becomes more aware of the sensation of bladder distension and the need to urinate, as well as social norms and embarrassment associated with urinary incontinence. Through an active learning process, the child acquires the ability to voluntarily inhibit and delay voiding until a socially convenient time, then actively initiate urination even when the bladder is not completely full, and allows urination to proceed to completion. During the first years of life, gradual development to an adult type of voluntary micturition control that conforms to the social norms depends on an intact nervous system, in addition to at least three other events occurring concomitantly:

- a) a progressive increase in functional storage capacity,
- b) maturation of function and control over the external urinary sphincter,
- c) and most importantly, achievement of volitional control over the bladder-sphincteric unit so that the child can voluntarily initiate or inhibit a micturition reflex (12).

The final steps are usually achieved at the age of 3 to 4 years when most children have developed the adult pattern of urinary control and are dry both day and night. The child has learned to inhibit a micturition reflex and postpone voiding and voluntarily initiate micturition at socially acceptable and convenient times and places. This development is also dependent on behavioural learning and can be influenced by toilet training, which in turn depends on cognitive perception of the maturing urinary tract.

It is understandable that this series of complex events is highly susceptible to malfunction. Various functional derangements of the bladder-sphincter-perineal complex may occur during this sophisticated course of early development of normal micturition control mechanisms. These acquired "functional" disorders overlap with other types of bladder functional disturbances that may have a more organic underlying pathophysiological basis.

2. NORMAL VALUES

2.1. Normal bladder capacity

Bladder capacity increases during the first 8 years of life roughly with 30 ml per year, so with an average capacity of 30 ml in the neonatal period, a child's bladder volume can be calculated as $Y = 30 + 30 X$, where $Y =$ capacity in ml and $X =$ age in years (Fig 1) (13).

Hjälms described a linear correlation that could be used up to 12 years of age: in boys, $Y = 24.8 X + 31.6$, in girls $Y = 22.6 X + 37.4$, where Y is capacity in ml, and X is age in years (14).

It should be noted that these data were obtained during cystometric investigations. Cystometric capacity is generally less than normal bladder volumes. Obviously, the relation between age and bladder capacity is not linear for all ages, nor is the relation between body weight and bladder capacity (15).

Another formula to calculate bladder capacity in infants is: bladder capacity (ml) = $38 + (2.5 \times \text{age (mo)})$ (11).

Kaefer and co-workers demonstrated that a non-linear model was the most accurate for the relation between age and bladder capacity, and they determined two practical linear equations:

$Y = 2 X + 2$ for children less than 2 years old, and $Y = X/2 + 6$ for those 2 years old or older; $Y =$ capacity in ounces, $X =$ age in years (Fig. 2) (16).

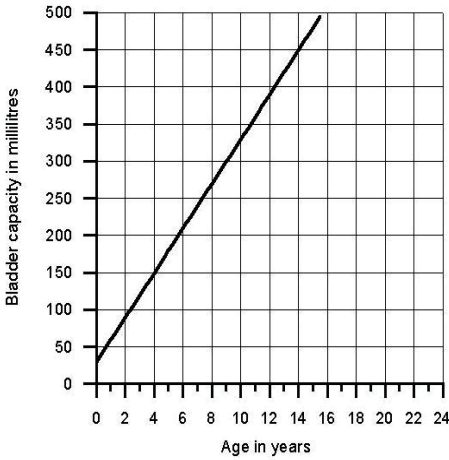

Fig 1. Bladder capacity using the formula

$$Y = 30 + 30 X$$

(Y = capacity in ml, X = age in years)

None of these formulae have been acquired from a population based study and do not reflect normal bladder capacity. Normal bladder capacity should be regarded as the maximum voided volume of urine and shows huge variation. Recent work of Rittig et al looked at Maximum Voided Volumes (MVV). The Koff Formula showed a reasonably good correlation with 2836 daytime voids, if first morning voids were neglected (17).

Girls were found to have a larger capacity than boys, but the rate of increase with age was not significantly

Normal urinary flow rates

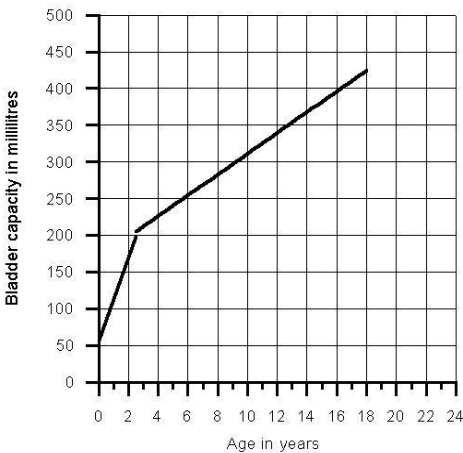

Fig 2. Bladder capacity using the formula

$$Y = (2 X + 2) \times 28.35 \text{ ml} < 2 \text{ years}$$

$$Y = (X/2+6) \times 28.35 \text{ ml} > 2 \text{ years}$$

(Y = capacity in ml, X is age in years)

different between them. Data on 'normal' bladder capacity have been obtained in continent children undergoing cystography, with retrograde filling of the bladder.

Data obtained from the International Reflux Study indicate that there is not a linear relation between age and capacity and that there is a huge variability. (Fig. 3) (18).

2.2. Normal voiding

The micturition frequency of the fetus during the last trimester is approximately 30 per 24 hours. It decreases to 12 during the first year of life, and after that it is gradually reduced to an average of 5 ± 1 voidings per day (11, 16). The normal range for the micturition frequency at age seven is 3 to 7 (19).

By age 12, the daily pattern of voiding includes 4-6 voids per day (20). Mattson and Lindström emphasize the enormous variability of voiding frequencies in children: also in individual children, the weight-corrected diuresis could vary up to 10-fold (21).

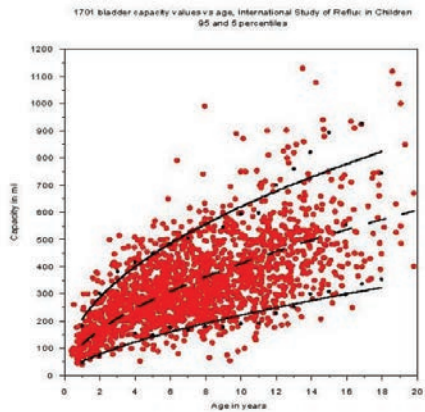

Fig 3. Bladder capacities determined by VCUG in the International Reflux Study

2.3. Normal voiding pressures

Bladder dynamics in children have demonstrated developmental changes with age. Detrusor pressures at voiding in children after the age of 2 years are similar to adults, with a mean maximum pressure of 66 cm H₂O in boys, and 57 cm H₂O in girls (22).

These pressures are lower than those reported in infancy by Yeung et al, who found boys having pressures of 118 cm H₂O and girls 75 cm H₂O (6).

2.4. Normal urinary flow rates

Urinary flow rates in normal children have been only minimally described. Szabo et al published nomograms for flow rates vs. age in normal children (23).

As in adults, flow rates are clearly dependent upon voided volume, and normal values can only be applied to flow rates that have been registered when

voiding at a bladder volume approximating the normal capacity for age (21,24).

II. EVALUATION IN CHILDREN WHO WET

Even with clear definitions, the approach to history-taking and physical examination should be structured. The child's complaints at presentation are not synonymous with the signs and symptoms that have to be checked to arrive at a diagnosis. Also, sociocultural aspects and psychomotor development will distort the presentation. The International Children's Continence Society has provided two standardisation documents on the diagnostic evaluation of children with daytime incontinence as well as on the evaluation of and treatment for monosymptomatic enuresis (1,2). Standardisation reports on urodynamic studies of the lower urinary and on initial diagnostic evaluation, follow-up and therapeutic intervention in congenital neurogenic bladder and bowel dysfunction in children are available (3,4).

Validated questionnaires are very helpful in structuring the history-taking; they at least provide checklists (5). With a structured approach the diagnosis of monosymptomatic nocturnal enuresis can be made with confidence.

When ultrasound imaging of kidneys and bladder, recording of urinary flow, and measurement of post-void residual are added to history and physical examination, the clinical entities caused by functional disturbances of the bladder and sphincter mechanism (non-neurogenic detrusor and pelvic floor dysfunction) can be diagnosed accurately in the majority of cases, and a high level of suspicion can be maintained towards incomplete bladder emptying in both neurogenic pelvic floor dysfunction and structurally caused incontinence. This is important in view of the potential these conditions have to cause irreversible loss of kidney function.

In a minority of incontinent children the non-invasive assessment yields equivocal results, or results suggesting gross deviations from normal function. Only in these situations is there an indication for invasive investigations, such as:

- Voiding cystourethrography.
- Invasive urodynamics (cystometry, pressure/flow/EMG studies, videocystometry).
- Renal scans or intravenous urography.
- Cystourethroscopy.

1. HISTORY TAKING

For the paediatric age group, where the history is jointly obtained from parents and child, and where the failure to develop bladder control generates specific

problems, a structured approach with a questionnaire is recommended (5,6).

Level of evidence: 3

Grade of recommendation: B

Many signs and symptoms related to voiding and wetting are new to the parents, and they should be specifically asked for, using the questionnaire as checklist. If possible the child should be addressed as the patient and questioned directly, as the symptoms prompting the parents to seek consultation may be different from those are problematic for the child.

A voiding diary is mandatory to determine the child's voiding frequency and voided volumes. Checklists and frequency volume chart can be filled out at home, and checked at the first visit to the clinic. History-taking should also include assessment of bowel function; a similar proactive process using a questionnaire should be followed for defaecation and faecal soiling (7).

The general history-taking should include questions relevant to familial disorders, neurological and congenital abnormalities, as well as information on previous urinary infections, behavioural problems, relevant surgery and menstrual and sexual function (in pubertal and older children). Information should be obtained on medication with known or possible effects on the lower urinary tract.

The ICCS recommends to screen all children with incontinence with validated questionnaire forms such as CBCL (Achenbach) or Strengths and Difficulties Questionnaire (SDQ) (8,9).

A short screening instrument for psychological problems in enuresis (SSIPPE) and a disease specific quality of life questionnaire for children with LUTD called PinQ are also validated tools available to the clinician (10,11). If a clinically relevant behavioural or emotional disorder is suspected, a full child psychological or psychiatric assessment is recommended (8).

Sexual abuse can be signalled first by symptoms of the lower urinary or gastrointestinal tract (12). However, other more specific symptoms of abuse predominate (13).

Level of evidence: 4

Grade of recommendation: C

2. PHYSICAL EXAMINATION

Apart from a general paediatric examination, the physical examination should include the assessment of perineal sensation, the perineal reflexes supplied by the sacral segments S1-S4 (standing on toes, bulbocavernosus) and anal sphincter tone and control. Special attention should be paid to inspection of the male or female genital region, and of the urethral meatus. Asymmetry of buttocks, legs or feet, as well

as other signs of occult neurospinal dysraphism in the lumbosacral area (subcutaneous lipoma, skin discoloration, hair growth and abnormal gait) should be specifically looked for (14).

In examining the abdomen for the presence of a full bladder, a full sigmoid or descending colon is a significant finding with a history of constipation.

Detailed questioning of the parents' observation of the child's voiding habits is essential as is direct observation of the voiding, if possible. Children may have their voiding dysfunction ameliorated or even eliminated by correcting anomalies of body position detected when observing the child's micturition. Children may void in awkward positions, e.g. with their legs crossed or balancing on the toilet without proper support of the legs, thereby preventing the pelvic floor relaxation and obstructing the free flow of urine (15) (Fig. 4).

Level of evidence: 4

Grade of recommendation: D

3. URINALYSIS

In order to be comprehensive, physical examination should include urinalysis to identify patients with urinary tract infection, diabetes mellitus, diabetes insipidus and hypercalcaemia if indicated (16).

4. NON-INVASIVE TECHNIQUES

The frequency/volume chart is a detailed diary recording each void by time and urine output over 24-hour periods. The chart gives objective information on the number of voidings, the distribution of day and night voids, along with the voided volumes and episodes of urgency and leakage, or dribbling. In order to obtain a complete picture, defaecation frequency and/or soiling are often also recorded: this becomes termed as bladder-bowel diary due to its complexity.

For a complete picture of the child's elimination habits, a 14-day defaecation diary that includes frequency, soiling and stool consistency based on the Bristol Stool Form scale and Rome III criteria should be documented (17).



Fig 4. Improper position for voiding: the feet are not supported (unbalanced position) and the boy is bent forward. Support of the feet will correct this and will allow the pelvic floor muscles to relax properly.

The frequency volume chart provides the maximum storage capacity as the largest voided volume, exclusive of the first morning micturition which reflects overnight urine production and capacity, and is termed maximum voided volume (MVV) (18). MVV should be referenced during cystometry to prevent overfilling. Whenever possible, filling out the chart is the responsibility of the child: the parents provide assistance and support. Ideally the chart should cover 3 complete days, but in reality completion over a weekend restricts the record to 2 days (19). The frequency volume chart is a reliable non-invasive measure of maximum bladder storage capacity and can be used as an outcome measure in children with bladder dysfunction if care is taken to minimise confounding factors and sources of error during chart completion (19). The amount of urine voided by a non-supervised child during the day varies considerably since the child's voidings are dictated more by social circumstances and/or bladder activity rather than by bladder capacity. Children with bladder symptoms void smaller volumes of urine than may be expected from traditional estimates (19). This is unrelated to either gender, type of presenting incontinence or a positive family history of bladder dysfunction. The only significant influence upon voided volumes recorded on a frequency volume chart is the age effect, and voided volumes, even in incontinent children, increase incrementally with age. The frequency volume chart is useful when comparing the mean voided volume and standard deviation by a child's age (20,21).

Validation and test/retest data on frequency/volume charts whilst scarce indicate that voiding interval is the most variable parameter. Data in normal children and in children with different categories of incontinence are available for comparison (19,22,23).

In order to obtain a complete picture it is better to ask for a bladder diary: fluid intake as well as voiding frequency, voided volumes, incontinence episodes and defaecation frequency and/or soiling are recorded.

Test/retest evaluation is not available; trend analyses of frequency/volume charts can be extracted from currently available data.

Level of evidence: 3

Grade of recommendation: B

5. QUANTIFICATION OF URINE LOSS

Subjective grading of incontinence may not indicate reliably the degree of dysfunction. For objective grading, 12-hour pad test and frequency/volume charts are validated instruments (23-25). One should be aware that children tend to do their utmost best when filling out diaries and doing pad tests: underestimation is more the case than overestimation (26).

In children, the 12-hour pad test should also give information about fluid intake. The pad test is complementary to the bladder diary, which denotes more the frequency of incontinence and the distribution of wetting episodes than the quantities of urine lost.

The amount of urine lost during sleep can be determined by weighing diapers or absorbent pads, before and after sleep. To obtain a measure of the total nocturnal urine output, the volume of the early-morning voiding should be added to the amount lost during sleep.

6. SCORING SYSTEMS

At present three scoring systems, based on validated questionnaires have been described. Specific scores correlated with lower urinary tract dysfunction with a specificity and sensitivity of about 90% (27-29).

The value of these scoring systems to determine the cause of incontinence seems to be of limited value to the individual patient, but can be very useful in studies to determine and compare treatment outcome.

Level of evidence: 3

Grade of recommendation: C

6.1. Quantification of constipation

Scoring a plain X-ray of the abdomen (Barr score) yields inconsistent results in grading constipation. (17,30-32) Reproducibility seems to be best using the method described by Leech (33-35). A better way to match clues from the medical history with signs and symptoms is the measurement of colonic transit time. As many children with an overactive bladder habitually use their pelvic floor as an "emergency brake", anomalous defaecation frequency and constipation have a high prevalence in this group.

Diagnosing constipation is important: we recommend using the Rome III criteria listed in the table below (36).

The Rome III paediatric criteria for functional constipation

Functional constipation

Must include ≥ 2 of the following in a child with a developmental age of ≥ 4 years with insufficient criteria for diagnosis of IBS:

- ≤ 2 defaecations per week
- ≥ 1 episode of faecal incontinence per week
- History of retentive posturing or excessive volitional stool retention
- History of painful or hard bowel movements
- Presence of a large faecal mass in the rectum
- History of large diameter stools that obstruct the toilet

For a complete picture of the child's elimination habits, a 14-day defaecation diary that includes frequency, soiling and stool consistency based on the Bristol Stool Form scale and Rome III criteria is documented (17).

A non-invasive way to determine faecal retention is the estimation of rectal diameter on ultrasound. In children without constipation the mean diameter was 2, 2.1 and 2.4 cm in three different studies respectively (37-39). In children with constipation the rectal diameter was on average 3.4 cm in the first, 4.9 in the second and 4.2 cm in the third study, significantly different from the non-constipated children. Joensson et al. also re-measured constipated children 4 weeks after treatment with laxatives finding the rectal diameters in the constipation group were significantly reduced ($p < 0.001$) (40).

Finding a dilated and filled rectum on ultrasound while the child feels no need to defaecate probably can replace a digital rectal examination and a distended rectum in ultrasound of 35 mm or more may be one of the signs indicative of constipation.

Overt constipation should be dealt with before embarking on treatment of incontinence or bladder and pelvic floor dysfunction (41,42).

Level of evidence 3

Grade of recommendation: B

7. URINARY FLOW

Voiding should be analysed in detail in all incontinent children, with the exception of monosymptomatic bedwetting, where voiding, as far as we know, is normal. Graphic registration of the urinary flow rate during voiding is a standard office procedure. Flow patterns and rates should be repeated to allow for evaluation, and several recordings are needed to obtain consistency. Afterwards, parents are asked if their child's flowmetry pattern was representative of their voiding.

Approximately 1% of school children have a voiding that can be labelled abnormal with flattened or intermittent flow curves. The remaining 99% have a bell-shaped flow curve (43). It should be noted that a normal flow does not exclude a voiding disturbance, nor does an abnormal flow pattern automatically mean a bladder or voiding dysfunction, as in asymptomatic normal schoolchildren abnormal patterns were also found (44,45).

Flow recordings with a voided volume of less than 50% of the functional capacity are not consistent: they represent voiding on command, and many children will try to comply by using abdominal pressure. On the other hand, overdistension of the bladder can result in abnormal uroflow recordings also (46).

A helpful tool in this respect is the use of trans-abdominal ultrasound (e.g. bladder scan) before micturition in order to assess the bladder volume (47,48). If the bladder is still nearly empty the child should be asked to drink some water until the bladder is full enough for a reliable flow. Urinary flow may be described in terms of rate and pattern and may be continuous, intermittent (in fractions), or staccato (fluctuating). An intermittent flow pattern shows a interrupted flow, whereas in staccato voiding the flow does not stop completely, but fluctuates due to incomplete relaxation of the sphincter.

Measurement of urinary flow is performed as a solitary procedure, with bladder filling by diuresis (spontaneous or forced), or as part of a pressure/flow study, with bladder filling by catheter. Patterns and rates should be consistent to allow for evaluation, and several recordings are needed to obtain consistency (49,50).

The same parameters used to characterise continuous flow may be applicable, if care is exercised, in children with intermittent, or staccato flow patterns (Fig. 2 - 5). In measuring flow time, the time intervals between flow episodes are disregarded. Voiding time is total duration of micturition, including interruptions. (Figures 5 – 8)

Sonographic estimation of Post Void Residual volume completes the assessment. In children >6 years, a repetitive PVR of >20 ml or >10% bladder capacity is considered elevated. In children > 7 years, repetitive PVR>10ml or 6% bladder capacity is regarded as elevated (51). Ideally 3 uroflows are representative but 2 will suffice as this maintains accuracy and consistency.

First morning uroflows should be avoided as they may exceed normal voided volumes

Level of evidence: 3

Grade of recommendation: B

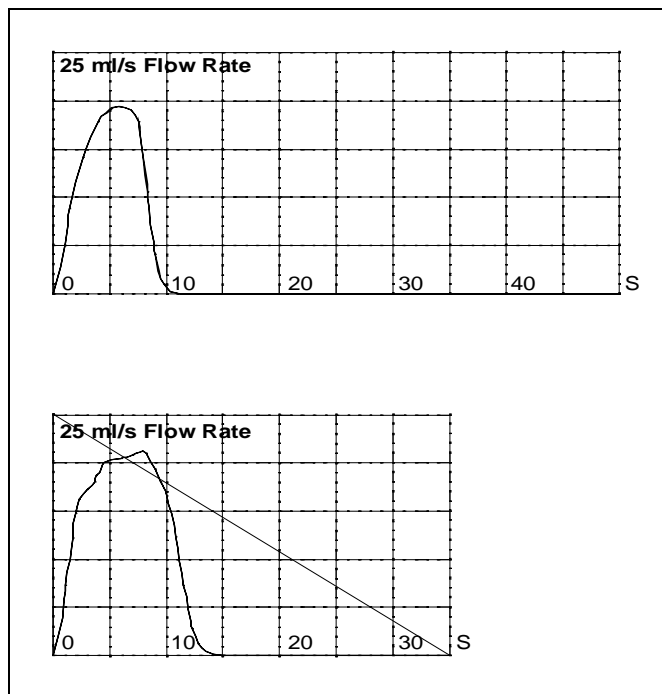

Figure 5. Normal urinary flow curves of 2 children.

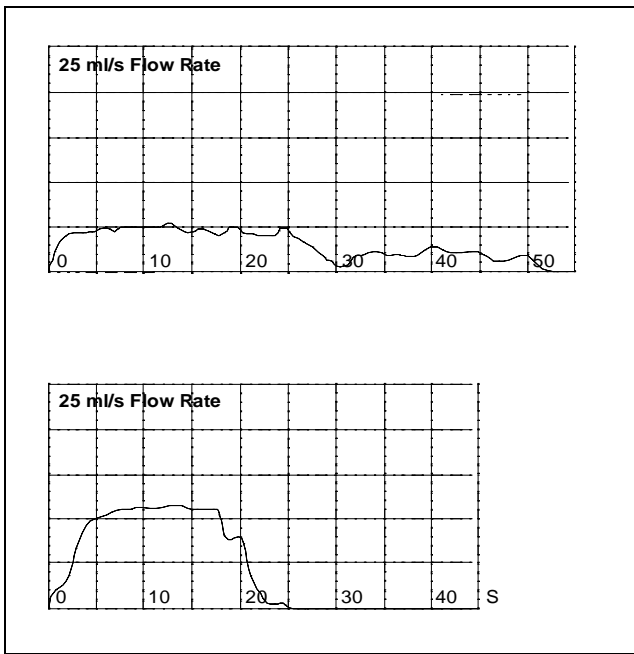

Figure 6: flow curves of 2 children with a static, anatomic obstruction; the curve is continuous but the flow is lower than normal and extended in time.

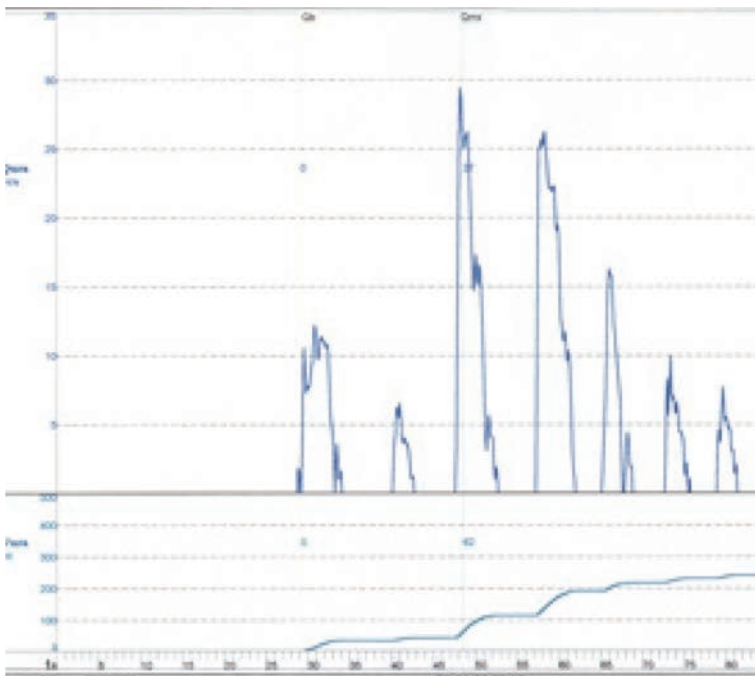

Figure 7: Figure 4: intermittent flow curve in a child voiding with abdominal straining

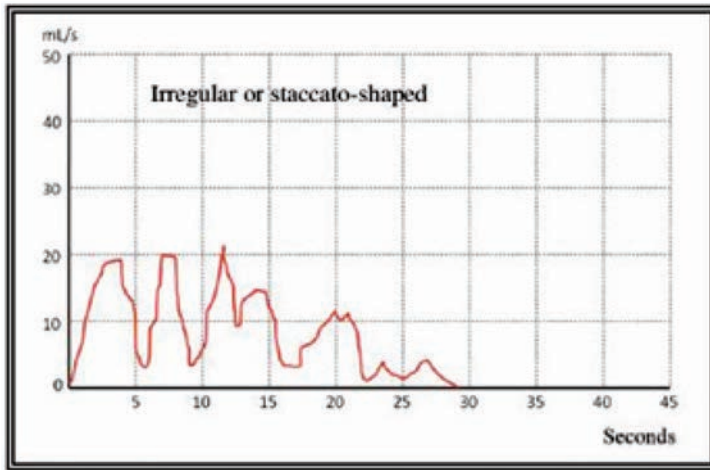

Figure 8: Staccato voiding in a child

8. ULTRASOUND IMAGING OF UPPER AND LOWER URINARY TRACT

In most clinical settings, ultrasound-imaging techniques are routinely used in children with incontinence. Upper tract abnormalities such as duplex kidney, dilatation of the collecting system, and gross reflux nephropathy can be readily detected, but detection of the more subtle expressions of these abnormalities requires urological expertise on the part of the ultrasound operator (52).

Lower urinary tract abnormalities are even more difficult to assess for the inexperienced, aside from bladder wall thickness: a bladder wall cross-section of more than 3-4 millimetres, measured at 50% of expected bladder capacity, is suspicious of detrusor overactivity (53,54). Because only a few studies have been conducted to compare bladder wall thickness in normal children without complaints and in children with lower urinary tract dysfunction, more studies need to be performed to validate these non-invasive techniques (55,56).

Another possibility is to assess bladder volume and bladder wall thickness to calculate the Bladder Volume / Bladder Wall Thickness index. In children with nocturnal enuresis this index correlated well with response to treatment (57).

8.1. Post-void residual volume

Except in small infants, the normal bladder will empty completely at every micturition (58).

The identification or exclusion of post-void residual is therefore an integral part of the study of micturition. However, an uneasy child voiding in unfamiliar surroundings may yield unrepresentative results, as may voiding on command with a partially filled or overfilled

bladder. When estimating residual urine, voided volume and the time interval between voiding and estimation of post-void residual should be recorded. This is of particular importance if the patient is in a diuretic phase. In patients with gross vesicoureteral reflux, urine from the ureters may enter the bladder immediately after micturition and may falsely be interpreted as residual urine. The absence of residual urine is an observation of clinical value, but does not exclude bladder outlet obstruction or sphincter / pelvic floor overactivity with absolute certainty. An isolated finding of residual urine requires confirmation before being considered significant, especially in infants and young children.

8.2. Ultrasound-flow-ultrasound

This combination of imaging and non-invasive urodynamics is a standardised procedure used to obtain representative data on flow rate and flow pattern, as well as post-void residual volumes. With ultrasound, bladder filling is assessed and when the bladder capacity is equal to the functional or expected bladder capacity for age, the child is asked to void into the flowmeter. After recording the flow, post-void residual is assessed again.

This procedure avoids the registration of flow rates at unrealistic bladder volumes.

Alternatively, children can be asked to use a flowmeter at home: a special flowmeter has been designed to use at home (59). For those children who have difficulty voiding in a strange environment, this option can be useful.

9. INVASIVE DIAGNOSTIC TECHNIQUES

The important question (for the incontinent child) "whether invasive diagnostic procedures are necessary" is decided by the results of the non-invasive procedures.

At present, there are no studies indicating that a videocystourethrogram (VCUG) is useful in children with incontinence, but without urinary tract infections.

In general urodynamic studies will only be done if the outcome will alter the management, and this will also depend on whether the possible treatments being considered are invasive. The diagnostic information needed is that which is necessary to find the correct treatment. Indicators include, straining or manual expression during voiding, a weak urinary stream, previous febrile urinary tract infection, continuous dribbling incontinence or pronounced apparent stress incontinence, or previously identified dilating vesicoureteral reflux.

The finding of genitourinary abnormalities or signs of occult spinal dysraphism at physical examination also indicate the need for further diagnostics. Urinary flow registration will detect the plateau-shaped flow curve typical for structural bladder outlet obstruction, and an intermittent flow suggesting detrusor-sphincter-pelvic floor dys-coordination (48).

A clinically significant post-void residual on repeated occasions clearly points to incomplete bladder emptying. The pad test will detect the cases with obvious stress and urgency incontinence, or continuous dribbling. Ultrasound imaging will raise suspicion of an ectopic ureter.

In short, invasive diagnostics are indicated when the non-invasive testing raises suspicion of neurogenic detrusor-sphincter dysfunction (occult spinal dysraphism), obstruction (especially posterior urethral valves), genitourinary abnormalities (e.g. epispadias), advanced non-neurogenic detrusor-sphincter-pelvic floor dysfunction (as in children with vesicoureteral reflux and upper tract dilatation and/or febrile urinary tract infections), or significant post void residuals.

To diagnose the complex of non-neurogenic detrusor-sphincter dysfunction, recurrent urinary tract infections and vesicoureteral reflux, urodynamic studies are needed in only a minority of all children.

9.1. Technique of VCUG in children

Cleanse and rinse the external genitalia with lukewarm water: do not use detergents. Use a feeding tube with side holes and a rounded tip (Ch 06-08) or balloon catheter to catheterise the bladder; check the urine for infection. Empty the bladder completely before filling. Use a radio-opaque dye of maximum 30%

concentration, at body temperature, and fill the bladder by slow-drip infusion, with a hydrostatic pressure of not more than 40 cm H₂O. Note the volume of the contrast medium instilled. Use fluoroscopy during filling at regular intervals.

Take spot-films (70mm or 90mm camera) with the child in supine position, with partial filling and at the end of filling, in AP projection, of the complete urinary tract. Upper and lower tract should be visible.

When voiding is imminent, change the position of the child so that spot films of bladder and urethra in 3/4 projection can be taken during voiding. Also take a spot film of the upper urinary tract during voiding, as the degree of vesicoureteral reflux (VUR) may change with the pressure generated by the detrusor muscle during voiding. Post-void residual volumes vary very considerably with VCUG. The voiding phase is critically important to VCUG, both for reflux detection and for assessment of voiding dynamics. Without a voiding phase the VCUG is incomplete.

Prophylactic antibiotics are indicated in all children, to minimise the risk for post-VCUG urinary tract infection especially in children with an anatomic abnormality.

9.1.1 Indications for VCUG

A VCUG is an invasive procedure and should only be done if the outcome will influence the management. It is indicated in children with recurrent urinary tract infections to detect reflux, in children with a dilated system on ultrasound and in children with an abnormal flow pattern to detect bladder outlet abnormalities (like valves, strictures or a syringocoele).

In children with incontinence the lateral projection during voiding is the most important part of the study. Especially in children with stress incontinence or a neurogenic bladder the position and configuration of the bladder neck during filling and voiding should be noted.

In children with non-neurogenic detrusor-sphincter-pelvic floor dysfunction as well as in children with neurogenic detrusor-sphincter dyssynergia, the proximal urethra may show the so-called 'spinning top' configuration, during filling and during voiding. With detrusor and pelvic floor muscles contracting at the same time, the force of the detrusor contraction will dilate the proximal urethra down to the level of the forcefully closed striated external sphincter. The resulting 'spinning top' configuration used to be seen as a sure sign of distal urethral stenosis, a concept held responsible for recurrent urinary tract infections in girls, with urethral dilatation or blind urethrotomy as the obvious therapy. However, urodynamics made it clear that the 'spinning top' will only appear when detrusor and pelvic floor contract synchronously, which makes it a functional anomaly, not an anatomical one (60,61).

Women often recall their experience with VCUG as young girls in terms bordering on abuse. The use of

VCUG in children should be limited to the absolutely necessary.

9.1.2 (Video)-Urodynamics

In children urodynamic investigations should only be performed if the outcome will have consequences for treatment (62-64). Furthermore like VCUG it may be considered when invasive or surgical interventions are planned. The main question is whether the urodynamic study will provide new information that cannot be obtained otherwise and will influence the further management. From the few studies that have addressed this issue it can be concluded that urodynamic studies in the majority of cases do not provide significant additional information to justify this type of investigation as a routine procedure in children (65-67).

Both children and parents need careful preparation and adequate information before the study is done. It is an invasive procedure and artefacts may occur. Because of the invasiveness of the investigations all children are anxious and this may be reflected in the outcome of the study. Especially during the first filling cycle, when the child does not know what to expect, detrusor overactivity may be seen and the voiding phase can be incomplete due to contraction or incomplete relaxation of the pelvic floor muscles during voiding. Once the child knows that filling and voiding are not painful a subsequent filling and voiding cycle may show a completely different pattern. The study should be repeated at least 2 or 3 times. Only if during the first filling cycle, no detrusor contractions are seen and also the voiding phase is in accordance with history and uroflow, it is probably sufficient to do only one complete filling and voiding cycle (68).

Still the results may not always be reproducible and it should be stressed that the primary objective is to treat the child and not a "urodynamic abnormality" *per se*.

Special attention should be given to a pleasant surrounding for the child: one or both parents should be present and young children may be given a bottle. Older children may be distracted by watching a video movie. The child should be awake, non-anaesthetised and neither sedated nor taking any drugs that affect bladder function. Intranasal midazolam may be administered in certain situations where high anxiety levels cannot be mollified, as this drug appears to be innocuous regarding outcome of the study (69).

During the study the investigator has the opportunity to observe the child and discuss various findings and correlate them to what the child feels and/or normally would do in such circumstances.

Because UDS is an invasive procedure artifacts may influence accurate interpretation of results (70)

In children, the transition from filling phase to voiding phase is not as marked as in adults. To avoid missing this important transition, cystometry and pressure-flow/EMG measurements are performed as one continuous study in paediatric urodynamics.

Electromyography of the pelvic floor muscles is assumed to evaluate the activity of the striated urethral sphincter, in the filling phase and in the voiding phase. Surface skin electrodes are usually used to record the EMG. In children the pelvic floor EMG is probably of much more importance than in adults as it helps to differentiate the different voiding disorders.

Filling the bladder can be achieved by diuresis (natural fill cystometry) or retrograde by catheter. For retrograde filling by catheter, saline 0.9% or contrast medium at body temperature is recommended in children. Especially in young children some urodynamic parameters, such as capacity and detrusor activity are influenced by the temperature of the filling fluid. Although the clinical relevance is as yet unknown, it is recommended to fill the bladder with fluid of body temperature (71).

When filling by catheter, slow fill cystometry (5 – 10 percent of expected bladder capacity per minute (based on the voiding diary), or < 10ml/min) is recommended in children.

Involuntary detrusor contractions may be provoked by rapid filling, alterations of posture, coughing, walking, jumping, and other triggering procedures.

The presence of these contractions does not necessarily imply a neurological disorder. In infants, detrusor contractions often occur throughout the filling phase (Figure 9).

Bladder sensation is difficult to evaluate in children. Only in toilet-trained cooperative children is it a relevant parameter. Normal desire to void is not relevant in the infant, but can be used as a guideline in children of 4 years and older. Normal desire to void should be considered the volume at which some unrest is noted, e.g. wriggling the toes; this usually indicates voiding is imminent. In the older child, the volume may be small with the first cystometry, for fear of discomfort. Also involuntary detrusor contractions occur more often during the first filling cycle (71). This is the reason that in paediatric urodynamics at least two cycles of filling are recommended.

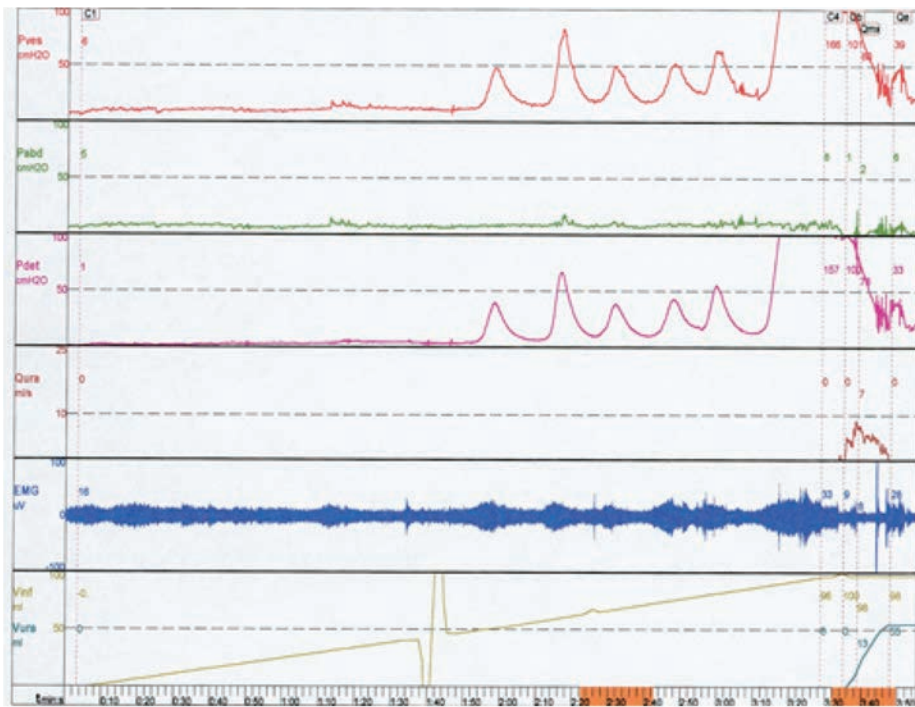

Fig. 9. Urodynamic study illustrating involuntary detrusor contractions, counter action of pelvic floor muscles (guarding reflex) and incomplete pelvic floor relaxation during voiding resulting in post void residual urine (detrusor overactivity + dysfunctional voiding) (72).

Maximum cystometric capacity (MCC) is the volume in the bladder at which the infant or child starts voiding. The value for maximum cystometric capacity is derived from volume voided plus residual volume. Values for MCC should be interpreted in relation to normal values for age.

Compliance indicates the change in volume for a change in pressure. For children with neurogenic detrusor-sphincter dysfunction, data are available relating poor compliance to the risk of upper urinary tract damage (73).

The usual notation for compliance is a single value, but a full characterisation of compliance may be helpful, as some children have varying compliance factors throughout filling (74). This variability depends on several factors: rate of filling, which part of the curve is used for compliance calculation, shape (configuration) of the bladder, thickness, and mechanical properties of the bladder wall, contractility, relaxability of the detrusor, and degree of bladder outlet resistance (68).

The urethral closure mechanism during storage may be normal or incompetent. The normal urethral closure mechanism maintains a positive urethral closure pressure during filling, even in the presence of increased abdominal pressure or during detrusor overactivity (guarding reflex) (72). An incompetent closure mechanism is defined as one that allows leakage of urine in the absence of a detrusor contraction.

In urodynamic stress incontinence, leakage occurs when Pves exceeds Purethra (intraurethral resistance) as a result of an increase in intraabdominal pressure, often in conjunction with low Purethra (72). Although common in multiparous females, it is exceedingly rare in paediatrics but may be noted in athletically active teenage girls (77). Immediately prior to micturition the normal closure pressure decreases to allow flow.

Bladder outlet obstruction, recorded with a pressure / flow study, may be anatomical or functional in nature. An anatomical obstruction may be present at the bladder neck or in the urethra as a stenosis or a stricture when there is a small and fixed urethral diameter that does not dilate during voiding. As a result, the flow pattern is plateau shaped, with a low and constant maximum flow rate, despite high detrusor pressure and complete relaxation of the urethral sphincter. In a functional obstruction, it is the active contraction of the urethral sphincter or pelvic floor during passage of urine, that creates the narrow urethral segment as a constant or intermittent obstruction. To differentiate anatomical from functional obstruction, information is needed about the activity of the urethral sphincter during voiding. This information can be obtained, and recorded together with pressure and flow, by monitoring the urethral pressure at the level of the urethral sphincter, or by recording a continuous electromyogram of the pelvic floor, as in clinical practice the urethral sphincter is not readily accessible, and the electromyogram of the external anal sphincter is

often used to monitor activity of the striated urethral sphincter. This corresponds to activity of the pelvic floor muscles. Also the use of video urodynamics can be very helpful in this respect, as contractions of the pelvic floor muscles can actually be seen during the voiding phase (Fig 5 and 6).

In infants and small children, pelvic floor muscle over-activity during voiding (with post-void residuals) is not uncommon: in all probability, it is a normal developmental feature (75,76).

9.1.3 Cystoscopy

In the majority of children cystoscopy is not indicated. In boys with therapy resistant incontinence, an abnormal flow pattern, especially in combination with a history of (recurrent) urinary tract infection is suspicious of infra-vesical obstruction such as bladder neck obstruction, urethral valves, syringocele etc. A VCUG may not always show these abnormalities and pressure flow curves may be equivocal (78).

In girls the flow may be directed upward, indicating an abnormal meatal position or stenosis. A dorsal meatotomy generally solves this problem. It has been postulated that in girls the abnormal direction of the stream triggers the bulbocavernosus reflex resulting in dysfunctional voiding (79).

III. CHILDREN WITH NIGHT TIME INCONTINENCE

Nocturnal enuresis is a complex disorder, with multiple pathogenetic factors, treated by multiple disciplines but seldom in a multidisciplinary setting, leading to confusing terminology. To avoid further confusion, this is an update to previous ICI-papers, largely keeping the same definitions and structure [1], integrating with recent ICCS standardisation papers [2].

1. DEFINITION

Nocturnal enuresis (NE) is involuntary voiding of urine during sleep a week, in children over 5 years of age in the absence of congenital or acquired defects of the central nervous system [3]. Parental concern and child distress affect the clinical significance of the problem [4], and is to some extent country and culture dependent. Most children who wet at night after age five should be considered as patients with enuresis, although decision to start diagnostic and therapeutic approach must take in account that several factors including the child's development level play a role. The age criterion of five is not only epidemiology driven, but reflects the natural course of achieving bladder control [5-7], as well the maturation of the circadian rhythm of diuresis. Epidemiology demonstrates that girls acquire earlier continence than boys, a gender difference that disappears after the age of 10 years

[5,8,9]. Research on pathophysiology has demonstrated that both diuresis-rate and bladder dysfunction might play a role in this sex difference.

NE is bedwetting without daytime symptoms. Non-monosymptomatic or polysymptomatic NE describes children with both day and night-time wetting [10], but further finetuned by including also patients with other daytime symptoms (LUTS) than incontinence [2,11].

This subtyping is essential for appropriate diagnostic and therapeutic approach in first line, but there is a large overlap in pathogenesis between both groups. Where all patients with NMNE have underlying bladder dysfunction

2. SEVERITY

Nocturnal enuretics vary in wetting frequency. Although fifteen percent wet each night, most children wet less frequently [2, 12]. In a population survey of nearly 1,800 Irish children aged 4 –14 years, Devlin found the frequency of wetting as follows: less than once per week in 33 percent, once per week in 11 percent and 2 to 4 times per month in 25 percent [13]. Some children and parents are concerned about an occasional wet bed, while others accept regular wetting.

Various definitions have complicated the literature and research. Applying the criteria set forth by the DSM-5 and ICD-10, enuresis and daytime urinary incontinence is a significant condition if it occurs >1 episode per month and a frequency of 3 episodes over 3 months. We propose in the future to follow the ICCS definition to qualify the significance of enuresis as frequent (>4 per week) or infrequent (<4 per week), to homogenise literature and future studies [2]. Severe bedwetters at the age of 5 years have a poor prognosis, with a spontaneous regression-rate of only 50-60% [9].

3. PREVALENCE

Bedwetting is common. In the United Kingdom, estimates approximately 750,000 children and young people over 7 years regularly wet the bed. In the United States 5 to 7 million children regularly experience primary NE [14-16]. The prevalence of bedwetting might vary regionally, although self-reporting might underestimate the real problem, because of the taboo in several cultures. In China, where parents take children out of diapers earlier, bedwetting seems to resolve more quickly. For example, in a large survey from Shandon, the proportion of children attaining nocturnal urinary control before age 2 was 7.7%; by age 3, this had increased to 53.1%, and by age 5 to 93%. The overall prevalence of NE was 4.3%, with a significantly higher prevalence in boys than girls. There was no additional decrease in the prevalence of enuresis between 6 and 16 years [17]. This can suggest that structured awakening and toileting is effective treatment for monosymptomatic NE, even in

small children, although the observation of CK Yeung suggests that in Hong Kong a progressive increase of self-reported enuresis rate could be explained by increased awareness and less taboo, but probably also because of changing lifestyle and nutritional habits [8, 9, 18].

Bedwetting becomes less common with advancing age. In the West, 15 per cent of children each year develop nocturnal bladder control [3]. By adulthood, bedwetting is rare. Hirasing *et al* sampled over 13,000 adults [18-64 years] and found only two decades ago an overall prevalence rate of NE at 0.5% [19]. Of these, 12 percent of men and 29 percent of women had daytime incontinence. Despite persistence of wetting into adulthood, 50 percent of men and 35 percent of the women never seek help for their problem. The enuresis prevalence of 0.5% in otherwise healthy adults in Hirasing's study refers to a largely untreated population. Fifty percent of the men had primary enuresis and had never been consistently dry at night. Assuming a prevalence of enuresis of 8 percent in 7-year-old boys, the risk for an enuretic boy to remain so for the rest of his life is 3 percent. CK Yeung documented that the severe cases had only a spontaneous regression-rate of 50-60 % [18].

Adults with enuresis represent a "hard core" group with worse symptoms. These individuals are likely to have associated LUTS during daytime%. Goessaert documented that in patients with long-term follow up 1/3 patients persisted to have symptoms into adulthood, especially in a subgroup with nocturia ($p < 0.01$) [22].

4. INHERITANCE

Bedwetting runs in the family of many children who suffer from bedwetting. In one study, A positive family history was found in 94 families (23%) of 411 probands with PNE, including 49% of fathers, 9% of mothers, 6% of both parents, 6% of the siblings and 30% of grandfathers or (and) mothers. Among the probands the ratio of male to female was 1.3:1 excluding sex-linked inheritance. Family studies indicated autosomal dominant inheritance in 15%, and autosomal recessive inheritance consistent in 1.46% of families. Thus, the mode of inheritance is usually autosomal dominant; if both parents were nocturnal enuretics as children, the risk for their children is from 65 to 85 % [3,23]. If only one parent has NE the risk is about 45 percent [24].

Molecular studies have clearly shown that NE is a complex disease with locus heterogeneity and no clear genotype-phenotype association.

Linkage studies to determine the location of the genetic changes have suggested foci on several genes. Linkage studies to markers on chromosomes 4p, 8q, 12q and 13q and 22s demonstrate both clinical, as well as genetic heterogeneity in nocturnal enuresis [25-29]. So far, there has been no reported association of the genotype with a phenotype of enuresis

[29]. The weak indications from genetic studies might indicate only autosomal monogenetic inheritance in a minority of cases, where in many families the predisposition might be multifactorial.

5. SEX AND MONOSYMPOMATIC NE

Boys suffer nocturnal enuresis more frequently. In a population survey in London of 706 families, a higher prevalence was found for boys than girls, at age 3 years, with 56 percent of boys and 40 percent of girls being wet at night more than once a week [30]. More recent studies are consistent [31]. Surveys of monosymptomatic NE undertaken in Great Britain, Holland, New Zealand and Ireland suggest that the prevalence for boys is 13-19% at 5 years, 15-22% at 7 years, 9-13% at 9 years and 1-2% at 16 years. For girls, the prevalence rates are about half: 9-16% at 5 years, 7-15% at 7 years, 5-10% at 9 years and 1- 2% in the late teenage years [5, 6, 13]. Although monosymptomatic NE is more common in young boys, by adolescence the incidence in males is the same as in females [9, 32]. This might be explained by gender difference in maturation of the bladder, but also in renal sensitivity to vasopressin, not only in the elderly but also in children [33,34,35,36].

6. CLASSIFICATION

6.1. Primary versus secondary nocturnal enuresis

Children who have never been free of bedwetting for 6 months have primary NE. Secondary NE is the re-emergence of wetting after a period of being dry for at least six months. A birth cohort of 1265 New Zealand children studied over 10 years by Fergusson *et al* found an increased risk of secondary nocturnal enuresis with age [37]. The proportion of children who developed secondary enuresis was 3.3 percent at 5 years, 4.7 percent at 6 years, 6.2 percent at 7 years, 7.0 percent at 8 years, 7.5 percent at 9 years and 7.9 percent at 10 years. But all studies failed to document how many patients with secondary enuresis, were totally symptom free, including absence of LUTS during daytime and nocturia. In the past, major attention was given to the psychological comorbidities: Secondary NE is associated with a higher incidence of stressful events particularly parental separation, disharmony between parents, birth of a sibling, early separation of the child from parents and psychiatric disturbance in a parent [24, 37, 38]. Von Gontard and colleagues found children with secondary enuresis had significantly more emotional difficulties compared to those with primary NE. Their evidence also suggests children with secondary enuresis, compared to those with primary enuresis, are more likely to have behavioural problems, a finding which corresponds to that of McGee *et al* [1, 39, 40].

Both Jarvelin and Fergusson *et al* argue that primary and secondary enuretics are similar [37, 41]. They believe the two share a common organic aetiological basis. The rate the child acquires primary control influences his or her risk of secondary enuresis. The primary form is the consequence of a delay in maturation of the physiological mechanisms. The child's capacity to sustain and maintain nocturnal bladder control is manifest in the rate at which he or she acquires control. On the other hand, this capacity determines the child's susceptibility to lapsing back to night wetting when exposed to stress. Psychological factors should be considered as comorbidities.

Other sources of secondary enuresis must be excluded prior to proceeding with treatment for enuresis. These include sleep apnoea from obstructive airway disease, obesity, constipation and infrequent or dysfunctional voiding. Treatment of sleep apnoea from an obstructed airway has been shown to improve or eliminate NE in some children following surgery or medical management [42, 43]. Obesity has been associated with nocturnal enuresis both independently [44-47] and in the context of sleep apnoea [48-51].

6.2. Mono-symptomatic versus non-mono-symptomatic NE

Mono-symptomatic NE refers to those children who report no other bladder or voiding problems associated with wetting. Non-mono-symptomatic NE refers to bedwetting, that is associated with overt detrusor overactivity or voiding problems such as urgency, frequency and bladder holding during the day [52, 53].

This classification becomes important when considering the most appropriate treatment intervention. Many parents are unaware of daytime symptoms when seeking help for bedwetting and when identified these symptoms should be treated prior to intervention for the NE. Between 10-28% of children with NE have associated daytime wetting, and were considered according to the old ICCS standardisation [54] as NMNE. If so, these children should be considered day and night incontinent. In these cases, night time incontinence is not any longer an isolated phenomenon but part of the symptomatology of day and night time incontinence. These children are more resistant to treatment and more vulnerable to relapse [55]. These boys and girls are more appropriately managed in the context of the primary bladder problem.

7. PATHOPHYSIOLOGY OF MONOSYMPOMATIC NE

NE stems from a mismatch of functional bladder volume overnight and, nocturnal urine output and the ability for the child to arouse during sleep. Night wetting is considered normal/ acceptable until age 5. Delayed maturation in one or more of the following systems results in NE: overactive bladder (OAB), or de-

creased arginine vasopressin (AVP) release are considered to play a major role. In desmopressin refractory nocturnal polyuria, more complex pathogenetic mechanisms are involved, such as abnormal circadian rhythm of different renal functions resulting in a relative increased solute excretion during the night [56-60]. The third parameter is an inability to wake from sleep to full bladder sensations [61, 62]. Combinations of all three problems may be present.

A unifying and simplistic concept with important clinical implications, is that NE is caused by a mismatch between nocturnal bladder capacity and the amount of urine produced during the night, combined with delayed or incomplete arousal response to the afferent neurological stimulus of the full bladder (Figure 1 and 2).

7.1. Increased nocturnal urine output

In normal children, the circadian rhythm of urine production results in a nocturnal reduction in diuresis to approximately 50% of daytime levels [63, 64]. In children, this is the result of nocturnal release of hormones that regulate free water excretion (arginine vasopressin, (AVP) [65, 66] or solute excretion (angiotensin II and aldosterone) as well [67, 68] as haemodynamic homeostasis [69] and may result from circadian changes in glomerular filtration [70-72]. In the normal child, this results in increased urine concentration and reduced urine volume during sleep, in presence of decreased osmotic excretion. Therefore, children who are not enuretic sleep through the night without being wet and do not need to rise to void.

Two thirds of patients with mono-symptomatic NE [2] have been found to have a lack of circadian rhythm of vasopressin, resulting in high nocturnal urine production, which exceeds bladder capacity [65, 73, 74]. Rittig *et al* and Norgaard *et al* demonstrated abnormalities in the circadian rhythm of AVP secretion resulting in increased nocturnal urine output that exceeded bladder capacity in children with nocturnal enuresis [65] [66, 73]. These children make more urine at night, and often overcome their bladder capacity and wet early in the night. Abnormalities can also be intrinsic, related to reduced nocturnal circadian changes in glomerular filtration rate (GFR) [70, 72] or in sodium and calcium excretion [59, 75-78].

Detection of low plasma vasopressin levels, GFR assessments or specific sodium and calcium excretion are too difficult to measure as first line investigation. Instead, we look for clinical signs of low vasopressin during the assessment interview. Weighing the diapers and adding the first morning void provides the total nocturnal urine output. If this total exceeds the child's functional bladder capacity this may indicate nocturnal polyuria. Nocturnal polyuria is defined as nocturnal diuresis >130% of expected bladder capacity for age, this is based on expert opinion [79]. If we would indicate the diuresis volume that might predict desmopressin response, >100%EBV seems to be more appropriate [80]. Nocturnal urine output varies appreciably from night to night [36, 81], but seems

larger in children with NE who respond best to desmopressin (dDAVP) [82].

By the time the child becomes an adolescent, the circadian rhythm is less prominent. In adolescents and adults with nocturnal enuresis, there is no diurnal rhythm of plasma vasopressin concentration. The changes in urine production at night occur from a decrease in the urinary sodium excretion that is not due to differences in concentration of AVP but due to a lack of sensitivity to AVP [64, 83] [84] with resultant increased urine output [56, 85].

There may be a small sub-group of children with impaired renal sensitivity to vasopressin or desmopressin [57, 81, 86]. Recent work by Devitt *et al* suggests that 18 percent of children have 'normal' levels of plasma vasopressin release but remain enuretic [74, 87]. These children all failed to respond to a therapeutic dosage of desmopressin. This finding could indicate renal insensitivity to vasopressin but could also be indicative of detrusor overactivity or a small functional bladder capacity. Total urine output during the night could be helpful in differentiating between the two conditions. The archetype of patients with NE and increased nocturnal urine output generally has a normal functional bladder capacity and a favourable response to dDAVP [88] [11, 80, 82], while the archetype of patients with OAB, will reduce fluid intake as compensatory mechanism, and have low diuresis volumes overnight, but the combination exists.

7.2. Detrusor overactivity during the night

The detrusor, to function appropriately, needs to be relaxed during filling and allow an appropriate functional capacity. Detrusor overactivity usually causes small voided volumes resulting in a decreased functional bladder capacity [89].

Watanabe and his colleagues, employing EEG and cystometry recording during sleep, discovered that 32 percent of children with NE had involuntary detrusor contractions that resulted in enuresis [90-93]. These children had smaller functional bladder capacities at the point of wetting, than children with enuresis who did not have detrusor overactivity. Functional bladder capacity – defined as the largest daytime void on a frequency-volume (F/V) chart, after excluding the first morning void, may give a reasonably accurate assessment of daytime functional bladder capacity (FBC). Reduced functional bladder capacity, when below 70% of predicted FBC for age, is likely to result in poor response to dDAVP treatment [80, 94]. Daytime bladder capacity is smaller than night time capacity in children without NE [95].

The pattern may be different at night. Yeung *et al* reported that 44 percent of treatment failures [with desmopressin or the enuresis alarm] have normal daytime bladder function but marked detrusor overactivity during sleep resulting in enuresis [96]. Almost none of these children had nocturnal polyuria. Ultrasound studies of the bladder furthermore revealed an

increased bladder wall thickness in these children [97] [98].

When further segregated prior to treatment, increased bladder wall thickness and bladder volume predicted the response to therapy in children with their primary nocturnal enuresis (more than three nights weekly). In one study, Yeung, *et al*. [97], correlated ultrasound measured parameters and urodynamic findings. Of 35 children with frequent NE, bladder wall thickness index was normal in only eight patients. It was less than 70% of predicted in 24, and more than 130% in three. When bladder volume and wall thickness index was correlated with ultrasound, 87% of the patients with a normal index exhibited a normal bladder pattern on imaging and 96% of patients with an index less than 70 exhibited detrusor over activity on ultrasound. All the children with a normal index either had a complete or good response to conventional treatment for nocturnal enuresis, whereas 62% of those with an index less than 70 % did not respond to treatment. With longer follow-up, bladder dysfunction had resolved in 38% of the children with an initial index of less than 30, all of whom had a good response to treatment. The bladder dysfunction persisted in the 63% of children who had partial or no response to treatment. What this means is that ultrasound measured bladder parameters may segregate children, prior to management of primary nocturnal enuresis, into groups that have a favourable outcome and those that do not, following conventional treatment. These studies will become more and more important in helping to predict response of various treatment regiments in the future.

This approach may be even more important in adults with refractory monosymptomatic nocturnal enuresis. Bower, *et al*. [99] found that in 56 consecutive adolescents and adults compared with 293 normal adults, there were significantly higher childhood scores of urgency, frequency, urgency incontinence, infrequent voiding and small volume voids than their normal non-enuretic counterparts. This suggests that adolescents and adults with persistent nocturnal enuresis may have a more significant bladder component, particularly since the majority of patients with adult type nocturnal enuresis do not seem to exhibit the nocturnal polyuria problem seen more commonly in the smaller children.

7.3. Lack of arousal

The fundamental mechanism resulting in nocturia or NE is that the bladder fills to its capacity during sleep and needs to empty (Figure 1). Bladder fullness is due to nocturnal polyuria and/or a reduction of the bladder capacity due to detrusor overactivity during sleep. The arousability differentiates patients with diuresis/ bladder volume mismatch into enuresis versus nocturia, but does not reflect underlying / associated sleep disturbances neither CNS dysfunction.

From an adult patient point of view, these factors do not fully explain why the enuretic child does not wake

up during the night to the sensation of a full or contracting bladder. Regardless of whether the child has detrusor overactivity or nocturnal polyuria, the enuresis event results from the child's inability to awaken

from sleep to empty prior to the wetting episode. However, we must admit that the majority of children become dry, without nocturia, what might indicate that nocturia is a defence against diuresis/mismatch only present in children with high arousability.

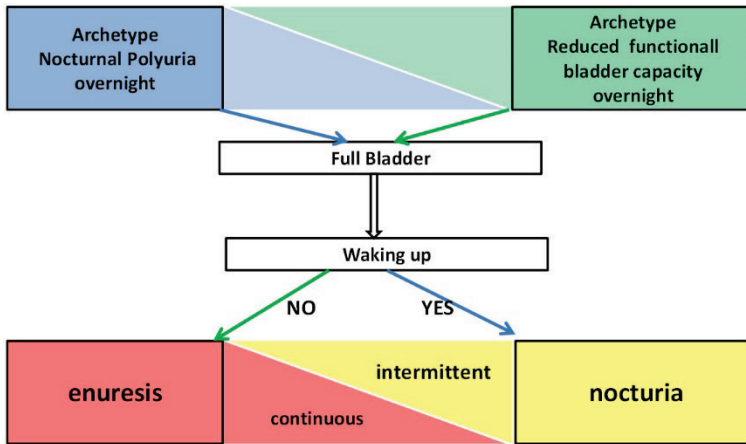

Figure 1: Basic pathophysiology of NE or nocturia. When the bladder is full because of (relative) polyuria and/or a reduced bladder capacity, the child either wakes up to void (nocturia) or voids while sleeping (NE). The two archetypes nocturnal polyuria and overactive bladder are well defined, but combination of both factors might be present. In additional it should be stressed that the enuresis and/or nocturia might be continuous or intermittent.

Recent findings suggest that the issue of decreased arousability is not the same as deep sleep.

There is a widely-held belief amongst parents and some clinicians that enuretics are deep sleepers. This is logical, since many of the children exposed to alarm therapy sleep through the alarm while family members awaken. Nevéus reviewed by questionnaire 1413 schoolchildren between the ages of six and ten and noted that enuresis was associated with subjectively high threshold arousal and significant confusion upon awakening from sleep [100]. Wolfish, in a study of 15 enuretic and 18 control boys and girls found that enuretics wet most frequently during the first two-thirds of the night and that arousal attempts were less successful in enuretics than in normals [101, 102]. This might explain why the most heavily endorsed view of both children and parents, regarding the aetiology of NE is a belief in deep sleep [103]. The recent findings of Dhont and Van Herzele favour a disrupted sleep, with increased arousals, rather than a deep sleep [104-110].

Enuretic episodes occur during all stages of sleep in proportion to the amount of time spent in that stage and appear to occur independent of sleep stage but occur when the bladder is at a volume equivalent to the maximal daytime functional capacity [111-114]. Bedwetting children sleep normally but are unable to suppress nocturnal detrusor contractions or awaken in response to them or to bladder fullness.

Waking becomes easier as the night progresses. However, several authors have found that children with NE are also more likely to wet in the first third of

the night, often in the first two hours following sleep [101, 102, 113, 115-119]. Thus, the point of bladder fullness for most enuretic children coincides with a time of night where they find it most difficult to wake from sleep, and not always when there is already an apparent diuresis / bladder mismatch: maybe diuresis-rate is more important than absolute volume, or OAB overnight is unidentified [120].

7.4. Comorbidities

There is increasing interest in comorbidities, not only coinciding with enuresis, but with common pathways in pathogenesis and/or interfering with therapy response.

7.4.1 Sleep disturbance

There is increasing evidence that sleep disturbance alone, or in combination with disrupted homeostasis play a role in the pathogenesis of nocturnal enuresis.

Recently it was documented that enuretic children did not exhibit deep sleep, but rather a disturbed sleep with increased PLMS, cortical arousals, and awakenings [104, 107-110], both in patients with refractory enuresis and in children with monosymptomatic + nocturnal polyuria. Polysomnography studies documented a significant difference in PLMS index, arousal index, and awakening index compared with healthy control subjects. The presence of sleep fragmentation does not exclude a high sleep pressure or high arousal threshold. The role of sleep fragmentation in children with NE was earlier emphasised using sleep actigraphy [121]. Obstructive airway syndrome

(OSAS) causes nocturnal polyuria in both children and adults, eventually resulting in enuresis. The prevalence of this NE subtype in patients primarily consulting for enuresis is not known, but the anti-enuretic response to OSAS therapy suggests that in refractory cases this might be considered [48-51].

In conclusion, albeit there is little doubt that sleep and/or arousal plays a role in the pathophysiology of NE the clinical relevance and possible implications are still unclear and, so far, sleep investigation is not part of routine evaluation of enuretic children.

Dhont and van Herzele published evidence that the superficial sleep, was coinciding with neurocognitive dysfunctions, thereby undermining earlier opinions that sleep patterns of children with NE are no different from control children [107, 110]. These neurocognitive dysfunctions were already documented in the past. In patients with enuresis, treatment of the enuresis resulted in amelioration of sleep quality and neurocognitive functioning [110].

7.4.2 Neurocognitive comorbidities.

Several neurocognitive comorbidities, coincide with nocturnal enuresis and might play a role, not only in pathogenesis but certainly in therapy resistance, such as psychological / behavioural problems; and attention deficit, neurocognitive dysfunction.

Psychological comorbidity among children with functional urinary incontinence is high: 20-30% of children with nocturnal enuresis (NE), 20-40% of children with daytime urinary incontinence (DUI), and 30-50% of children with faecal incontinence (FI) have clinically relevant comorbid disorders [1, 122-134]. Both internalising and externalising characteristics are represented [131, 135-137]. The best documented comorbidity conditions are attention deficit/hyperactivity disorder (ADHD) and oppositional defiant disorder (ODD). Attention deficit disorders coincide with higher prevalence of enuresis (both MNE and NMNE), where the prevalence of ADHD in the enuresis population is up to 4 times higher than the background population. The association of abnormal prepulse inhibition (Startle reflex) in both ADHD and enuresis patients, might suggest a common central nervous pathogenic pathway but this is far from fully understood [138-141].

Frietag *et al* studied brainstem evoked potentials in 37 children with nocturnal enuresis and compared these aged 8 to 14 years, with 40 controls, mean age 10 years, and found that interpeak latencies of the brainstem evoked potentials were increased in children with nocturnal enuresis, suggesting that a maturational deficit of the brainstem was present in children with nocturnal enuresis. Differences in visually evoked potential latencies might point to a reason behind functional cortical differences in children with family history of nocturnal enuresis [142].

Frietag's study would suggest that a maturational effect is present [143]; however, overnight studies in

enuretic children with simultaneous sleep electroencephalographic and cystometry have revealed marked detrusor overactivity, only occurring after sleep at night and not during wakeful periods during the day [143]. Because this pattern has not been observed in normal non-enuretic subjects, even during the new-born period, one may hypothesize that this could be due to a small neurologic lesion affecting a tiny area near the pontine micturition centre, the posterior hypothalamus (responsible for secretion of antidiuretic hormone) or the locus coeruleus which may be the cortical arousal centre [144] [145].

Another interesting study by Baeyens *et al.* [138] showed a convincingly significant difference between children with enuresis and control groups, and the startled eye blink reflex which improved with maturation but did not seem to correlate with resolution of enuresis. Clearly there is considerable work that is required to further unravel the mechanisms behind perceived differences in arousal between enuretic and non-enuretic children.

7.4.3 Constipation

The coexistence of LUT symptoms and functional constipation and/or faecal incontinence in children is not uncommon and was previously identified as Dysfunctional Elimination Syndrome' [146-148] and more recently as 'Bladder and Bowel Dysfunction' (BBD) [147].

Although the association with dysfunctional voiding, decreased voiding frequency and underactivity is obvious, there is also a clear comorbidity between bladder overactivity (urgency), increased voiding frequency, bladder underactivity and constipation. It is a well-established clinical experience that treatment of defecation problems in children with BBD enhances successful management of lower urinary tract disturbances such as daytime urinary incontinence (DUI), enuresis, and urinary tract infections (UTIs) [40, 147, 149, 150]. Treatment of the bowel dysfunction gives amelioration of the voiding disorder and should be first line treatment [151].

7.4.4 Mentally and motor disabled

It is evident that many of these children have underlying or associated bladder-dysfunctions. These children may also suffer from typical enuresis nocturna, but we should consider their maturation level, and, if this is delayed, initiate appropriate therapy which takes this into account [152].

Children who do wake up but are afraid to go to the bathroom [63], and therefore wet their bed should be identified as their treatment, for obvious reasons, is completely different [153].

8. MANAGEMENT OF NOCTURNAL ENURESIS

The age at which the child and his or her parent begins to be concerned about bedwetting varies. Hjalmas *et al.* noted that, “for successful treatment of nocturnal enuresis, the child must be brought to the physician by the parents who are concerned and the physician must have the necessary knowledge about the condition and be motivated to start treatment [63]. To fulfil these requirements, parents, teachers, and nurses in primary care need to understand nocturnal enuresis and be ready to treat the child, regardless of age according EBM based guidelines, against “Dr. Google” directed information. There remains a big task for demystification not only for patients/parents but also care givers in primary care.

Nocturnal enuresis is thought of as a social problem and less of a medical problem; therefore, since most children stop wetting as they mature and since no ill health follows bedwetting in most cases, there is a tendency for many practitioners to take a “wait and see” approach despite the fact that the family and the child in many cases are quite disturbed. In one study, 3803 French school children aged between five and ten years noted the prevalence of primary nocturnal enuresis to be 9.2%. The majority of the children noted that bedwetting bothered them and hoped that a doctor could help them. In this survey, a questionnaire was addressed to mothers of enuretic children, 100 school teachers and 100 school doctors. The mothers had a relatively tolerant attitude but two-thirds had consulted a doctor. Most of the doctors had proposed no solution or a “wait and see” attitude or treatment with a drug rather than an alarm. From this study, we may conclude that considerable work needs to be done to help educate not only parents but teachers and even physicians about the importance of treatment of nocturnal enuresis as well as supportive care [154].

The actual timing of treatment for nocturnal enuresis may vary depending on the needs of the child and the

parent. Toilet training age may be different in different societies [155]. For example, toileting in Asia may begin earlier than in North America or other parts of the world [61, 154, 156, 157]. Toilet training should be started when both the child and parents are ready. Most studies appear to show that children start training between 24 and 36 months of age with a current trend toward later completion than in previous generations. This is markedly different than noted in some Asian cultures where training appears to begin much earlier. Toilet training should occur in an environment that is comfortable for the child. Unfortunately, toilets in most household bathrooms are adult sized, making it difficult for the child who needs to climb to the top of the toilet to relax. In these cases, a potty chair to toilet train the child, and once the child is old enough, he or she should be transitioned to an over-the-toilet seat with a footstool to allow optimal posture for voiding. Parents should encourage children to relax and take time to completely empty the bladder [63].

It is essential that both the child and his or her parents understand bedwetting pathophysiology and treatment philosophy. The clinician should give the child general advice such as what to eat and drink and to void regularly during the day, abstain from drinking too much during the late afternoon and evening and have relaxed routines at bedtime. The clinician should stress that NE is common and usually represents a delay in maturation without any psychopathological undertone. Up to 19 percent of children will become dry within the next 8 weeks without any further treatment besides good counselling [63, 156, 158].

8.1. Evaluation / intake

Over past decades several attempts have been made to standardise qualitative intake of patients, although still limited translated into primary care. Hjalmas recommended a careful history which will be summarised in these next few paragraphs. (Figure 2, table 1). This approach, which has been recommended by the International Children’s Continence Society, provides an excellent guide toward the taking of a history for a child with nocturnal enuresis, with a few adaptations over time [11, 63, 159-161].

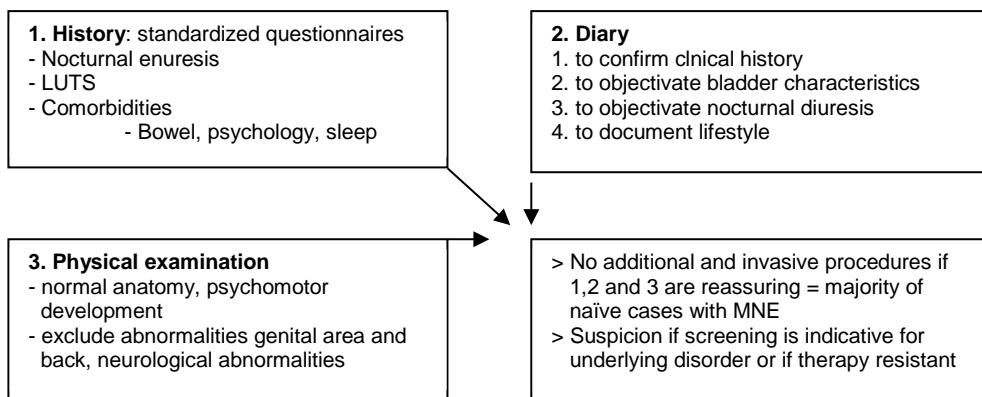

Figure 2: Schematic work-up in patients presenting with night-time wetting

8.2. frequency volume chart (FVC).

Parents are asked to record a two-day three-night record. This includes recording the child's fluid intake and urine output, frequency of micturition and the frequency and pattern of voiding. The largest single micturition is considered the functional bladder capacity. This chart can be performed beginning on a Friday evening and concluding on Sunday on any weekend [11].

Symptoms of nocturnal enuresis [11, 53, 161]. A careful history should include questions about the age of onset of nocturnal enuresis, length and circumstances of dry spells, number and time of episodes of nocturnal enuresis or nocturia, presence of daytime voiding symptoms or urinary tract infection, posture while voiding, daytime and evening fluid intake, sleep habits, frequency and consistency of bowel movements and psychosocial situation. One must establish whether, or not, symptoms represent primary or secondary nocturnal enuresis. It is critical to search for new psychological problems that might cause secondary nocturnal enuresis, particularly when the child presents with nocturnal enuresis after a prolonged period of dryness. The personality of the child, family situation, school environment, and presence of alternative caregivers might have an appreciable impact

on voiding habits and will influence management options (43). Children may drink large volumes of fluid in the hours before sleep and this may result in nocturnal enuresis or nocturia.

It is helpful to determine the number of hours of sleep and to compare this to standard charts of average duration of sleep by age. Morning fatigue may be the result of obstructive sleep apnoea or restless legs syndrome. Other symptoms of sleep apnoea include mouth breathing, snoring, and restless sleep [11, 63]. More attention should be given to sleep hygiene: is the child drinking, eating prior to sleep? Is the child voiding just before bedtime? Is the light turned off immediately after going to bed?

It is important to rule out symptoms of anatomical or physiological urological conditions that may lead to nocturnal enuresis. Many of these conditions are covered in other parts of this section, and include a failure to store urine or failure to empty urine. Storage symptoms include increased frequency, urgency, and urgency incontinence including squatting behaviour, daytime incontinence and the sensation to need to void again. The clinician must carefully assess daytime wetting, particularly in older children. In many cases, the child may hide these symptoms from the clinician and the family.

Table 1, simple overview of items to be investigated in children with enuresis.

	history	diary
Enuresis nocturna		
night time episodes only	Y/N n = /w	Y/N n = /w
nocturia	Y/N n = /w	Y/N n = /w
Exclusion daytime symptoms		
Daytime incontinence: timing before or after void? Very wet pants? Frequency of leakage, Intermittent versus continuous leakage	Y/N Y/N Y/N Y/N n = /w Interm /cont.	Y/N Y/N Y/N Y/N n = /w Interm /cont.
Urgency	Y/N	
Frequency >8 or < 3 x/day	Y/N Y/N	Y/N Y/N
Voiding postponement	Y/N	Y/N
Interrupted stream	Y/N	Y/N
Urinary tract infections	Y/N	Y/N
History uropathy	Y/N	Y/N
Comorbidities		
Sleep disorders: restless legs, arousals, sleepwalking, snoring	Y/N	Y/N
Psychological comorbidity	Y/N	
ADHD, ADD, autism	Y/N	

	history	diary
Mentally and motoric disabled	Y/N	
Constipation, soiling	Y/N	Y/N
Lifestyle		
Sleep hygiene: Hours + timing of sleep + waking up Voiding prior to bedtime Once in bed immediately sleeping	/ Y/N Y/N	/ Y/N Y/N
Fluid intake Enough, spread over the day No drinking before sleeping time or overnight	Y/N Y/N Y/N	Y/N Y/N Y/N

Children void four to seven times a day or about every two to three hours [11, 80, 162]. If the child is voiding significantly more frequently than eight or more times a day, this may suggest incomplete emptying or overactive bladder. Urgency is present in many children and posturing, including squeezing or crossing the legs, squirming while standing or sitting, or physically compressing the genital area with a hand is all suggestive of overactive bladder due to detrusor overactivity which may or may not be associated with dysfunctional voiding. Other causes include urinary tract infection, polyuria from diabetes mellitus or diabetes insipidus, which can also cause more frequent voiding [63]. Treatment for these symptoms is covered in other sections within this chapter.

Additional symptoms during the daytime include continuous dribbling between voids that can come from an ectopic ureter bypassing sphincter mechanisms, from failing to empty the bladder or from sphincter incompetence. Also, continuous leakage can result from neurological causes or anatomical causes such as epispadias, or a closed bladder exstrophy or urogenital sinus.

Lastly, children may have incomplete emptying from true dysfunctional voiding which results from the sphincter or pelvic floor contracting at the same time as the detrusor contracts during micturition. In addition, detrusor underactivity may result from neuropathy from diabetes mellitus and in some cases conditions such as the prune belly syndrome will result in detrusor underactivity. Lastly, urethral strictures may result in incontinence due to detrusor overactivity with poor bladder emptying. Boys with posterior urethral valves or Cobb's collar may also have incomplete emptying. Lastly, the clinician should be alert for symptoms of constipation and faecal incontinence [163]. It is a common misconception that if a child is stooling once per day then he or she is not constipated. In fact, the best symptom of constipation is the infrequent or painful passage of hard small pellet-like stools. Faecal incontinence may also be present, the principal sign of this being faecal material in the underwear. Excessive stool retention may result in bladder dysfunction. In these cases [164], this may result in increased urethral sphincter and pelvic floor activity

and explain the association of voiding dysfunction with incomplete voiding. Treatment of constipation may result in improvement in enuresis [151].

8.3. Physical examination

Anatomical and behavioural causes for enuresis may be identified through a careful physical examination. Evidence of improper gait, spinal deformities, and foot abnormalities including asymmetry, high-arched feet, or hammer toes are signs of sacral neuropathy. Physical signs of occult spinal abnormalities such as dimples, tufts of hair, skin discoloration, lipoma, asymmetrical buttocks and gluteal clefts are also important. A careful abdominal examination with emphasis on the left lower quadrant may identify the colon full of firm stool. In most cases, a rectal examination is not performed but in some cases this may also be indicated. Occult faecal impaction, poor perineal sensation and reduced anal sphincter tone can be indicative of neuropathy.

In boys, marked narrowing of the urethral meatus (when the meatal lips are separated and no mucosa is seen), must be identified and carefully noted. If these signs are present, the boy should be asked to void so the clinician can witness and record the flow rate and residual urine. Narrowed or displaced urinary stream is suggestive of meatal stenosis.

In girls, the introitus should be identified for the position of the urethra. Evidence of wetting or irritation of the labia or vagina should be identified, as this could be suggestive of post-void dribbling or incomplete emptying with incontinence due to either detrusor overactivity or sphincter weakness [2, 146].

8.4. Laboratory examination

There is very little laboratory examination that is required in patients with nocturnal enuresis other than a urinalysis to rule out UTI and evidence of glycosuria and a urine culture if the urinalysis is suggestive of infection [63].

Urodynamics and imaging have no place in the initial intake and therapeutic approach of a child with monosymptomatic nocturnal enuresis. If there is any suggestion, however, that daytime wetting is occurring,

and then a full evaluation of the daytime problem should precede the evaluation for nocturnal enuresis.

9. THERAPY

The management of NE depends on:

- the child's motivation to participate in treatment
- exclusion of confounding psychosocial factors
- providing information and instruction about daily habits, underlining the importance of having regular fluid intake, regular voidings, and relaxed routines at bedtime
- regular review of the new intervention

The therapist should convey a sense of understanding and compassion to both the child and the family. Education about the problem and a realistic discussion about the prognosis will help instil competence in the treatment offered which may improve both compliance and outcome [82, 165-167].

9.1. Evidence based recommendations for treatment.

First line treatment and preliminary steps: primary and secondary forms of nocturnal enuresis are treated the same. If faecal incontinence, constipation or daytime wetting is present, these should be treated first [146, 151, 164].

All guidelines advocate urotherapy as first line therapy, although the evidence in children with NMNE is low, and efficacy is questioned [161, 168]. However, it is rational to initially normalise lifestyle and to give first urotherapy-advice.

However, treatment modalities like lifting, fluid restriction, dry-bed training, retention control training, psychotherapy, acupuncture, and hypnosis all have insufficient data in the literature to recommend any of them. However, non-invasive behavioural modifications such as resisting over-hydration in the evening are appropriate recommendations at the initiation of therapy. Normal fluid intake, but spread over the day should be advocated, to reduce osmotic excretion overnight [59]. The child must void before bed. Excessive protein or sodium intake should be avoided in the evening, since it will result in osmotic diuresis [59, 75, 76, 78]. During the day, the child should be instructed to void regularly, not to hold urine until the last minute, and to relax and take time to completely empty. If deemed important by the parents, a letter should be sent to the school to explain this.

Timing of treatment for the child who wets is dependent on the family's desire and the child's desire. As a good rule of thumb, children should be six to eight years of age. Some children, however, may want to wait until later. Others may be ready closer to age six. It is important for the parents to know that relapses can occur. The successful treatment of children with

nocturnal enuresis has a foundation of realistic expectations and a motivated family [63].

Before starting treatment, a "baseline" meeting with counselling, provision of information, positive reinforcement, reassurance that 15% of children with mild enuresis (<4/7d) resolve each year, and increasing motivation should occur first. Children are asked to fill out a calendar or chart depicting the wet and dry nights. Children became significantly drier in two non-randomised trials associated with fewer wet nights simply by focusing them more on record keeping and true reward charts [121].

It is also important to be realistic about parental expectations, including the next steps of EBM, the alarm and desmopressin, where success-rates after 1 year do not exceed 60%, relapse free.

9.2. Enuresis alarm

The underlying mechanism of action of the alarm remains uncertain [169], and interpretation of the data in the literature when using the new ICCS definitions, unknown, since almost all studies have been performed with poor differentiation of MNE from NMNE, according to the new standards [2, 54, 63, 79, 170].

In unselected or poorly subtyped patients with enuresis, the enuresis alarm is the most effective means of facilitating arousal from sleep and remains the most effective way to treat NE [171-174]. There is an average success rate of nearly 68% with efficacy increasing with the duration of therapy. Relapse rates in the 6 months following treatment are in the order of 15 - 30 %, significantly lower than for desmopressin in unselected populations. Alarm therapy has been shown in a meta-analysis to have a 43% lasting cure rate [175-178].

Better results occur with optimal motivation of the child and family and higher frequency of wet nights. Reduced efficacy is associated with the lack of concern shown by the child, lack of supervision, inconsistent use, family stress, abnormal scores on behaviour system checklists, psychiatric disorder of the child, failure to awaken in response to the alarm, unsatisfactory housing conditions and more than one wetting episode per night. Enuresis alarms require several months of continuous use and are, therefore, unsuitable for some families [11, 179, 180].

For optimal results, alarm therapy should be individualised; it requires a motivated family and child with significant commitment to time and effort. The impact on other family members should be considered. In some families, alarm therapy may wake other members of the family and may increase parental annoyance and place a child at increased risk for physical or emotional abuse. Be aware of the burden, if the alarm is activated early in the night or several times per night, especially because these are predictive of resistance. Close follow-up is important to sustain motivation, troubleshoot technical problems, monitor the therapy [63], and identify the burden. The exact

mechanisms of action for alarm treatment are unknown. The effects are not due to classical conditioning, as stimulus awakening occurs after and not before wetting. Instead it is clearly an operant type of behavioural approach, i.e. a learning programme with positive reinforcement that includes aversive elements. Dryness is reached either by waking up leading to “nocturia” in 35% of children or by sleeping through the night with a full bladder in 65%. Body worn (vibrating) alarms are at least as effective as bedside alarms [121].

The family should continue alarm therapy for at least 14 consecutive dry nights – or a maximum of 16 weeks before discarding it as ineffective [11]. Compliance remains a problem: dropout rates are rarely disclosed in reported studies. Proper guidance and instructions are mandatory.

The key to success is not the stimulus intensity of the alarm triggering, but the child’s preparedness to awake and respond to the signal. Comparison of the different types of alarm did not show significant outcomes.

In general, alarm treatment is more effective than other forms of treatment and the lasting cure rate about twice as high.

Level of evidence 1

Grade of recommendation A

In some cases, alarm therapy can be enhanced using the alarm in addition to other behavioural components. Overlearning (giving extra fluids at bedtime after successfully becoming dry using an alarm) and avoiding penalties may further reduce the relapse rate [171].

9.3. Dry bed training

This is a package of behavioural procedures used in conjunction with the enuresis alarm first described by Azrin *et al* [181, 182]. It incorporates:

- the enuresis alarm
- cleanliness training (encouraging the child to take responsibility for removing of wet night clothes and sheets, re-making the bed and resetting the alarm),
- waking schedules – to ease arousability from sleep as described above and involving:
 - for the first night, waking the child each hour, praising a dry bed, encouraging the child to decide at the toilet door whether he or she needs to void, and on returning to bed the child is encouraged to have a further drink
 - On the second night, the child is awakened and taken to the toilet 3 hours after going to sleep. For each dry night, the waking time is advanced by 30 minutes. If the child is wet on any night, the waking time stays at the time of the previous evening. The waking

schedule is restarted if the child begins wetting twice or more in any week, stating again 3 hours after sleep.

High success rates and low drop out have been reported although relapse rates are no different than enuresis alarm treatment alone. Modifications are advocated to remove some of the more punitive elements of the programme but at best, it is a complex, time consuming and a demanding technique [171, 183, 184].

Hirasing *et al* found 80 % success with group administered dry bed training. Girls responded better than boys [185]. Most parents were satisfied with the programme but opinions of the children were divided. Factors related to failure were the child’s age, bed-wetting frequency, secondary enuresis or family history. In another study, they found a positive effect on behavioural problems [186].

An important component analysis by Bollard & Nettelbeck found that the enuresis alarm accounted for most of the success achieved through dry bed training. They believe that a large proportion of the components of the procedure can be eliminated without sacrificing much of its overall effectiveness and that the waking schedule coupled with the enuresis alarm is as effective as the complete dry bed-training programme [187, 188].

Level of evidence: 2

Grade of recommendation D (no more effective than alarm treatment alone)

9.4. Arousal training

Arousal training entails reinforcing appropriate behaviour [waking and toileting] in response to alarm triggering. The aim is to reinforce the child’s rapid response to the alarm triggering, not on ‘learning to keep the bed dry’.

The instructions involve: setting up the alarm before sleep

- when the alarm is triggered the child must respond by turning it off within 3 minutes
- the child completes voiding in the toilet, returns to bed and re-sets the alarm
- when the child reacts in this fashion he is rewarded with 2 stickers
- when the child fails to respond in this way the child pays back one sticker

Van Londen *et al* first described this procedure with a group of 41 children, aged 6-12 years, with predominantly primary enuresis [189]. They reported 98 percent success [14 consecutive dry nights] compared to 73 percent success with alarm monotherapy. The difference was significant [p<0.001]. Ninety-two per cent remained dry after 2 ½ years: a very low relapse rate. An extraordinary aspect of this study was the lack of

contact between therapist and parents. All those included were parents who had ordered an alarm from a rental agency and were given the instructions with the alarm. The authors conclude that arousal training is 'definitely the treatment of choice for enuretic children between 6 and 12 years'. Compared with other studies, and considering experience of daily practice, one may question the very high success rate in this group of patients.

Level of evidence: 3

Recommendation: grade C

9.5. Pharmacological treatment

Based on the three main causes of enuresis, namely nocturnal polyuria, detrusor overactivity, and disorder of arousal, the pharmacological treatment is designed to address these three areas. Table 2 shows rates of efficacy.

9.5.1 Desmopressin therapy [190-198]

Arginine vasopressin (AVP) or antidiuretic hormone (ADH) is normally produced in the hypothalamus and released in the pituitary in response to hyperosmolality or hypovolaemic conditions. Vasopressin acts on the collecting ducts and distal tubules to enhance water absorption. AVP, by virtue of an independent vasoconstrictor effect, is also a potent vasopressor. Desmopressin (or dDAVP) is an analogue of vasopressin created by deaminating the cystine residue at position 1 and substituted D-arginine for L-arginine at position 8. These changes result in significantly increased antidiuretic activity but loss of vasopressor activity. The half-life of Desmopressin is 1.5 to 3.5 hours. In a larger portion of children with monosymptomatic nocturnal enuresis, the normal circadian variation in urine production with nocturnal rise of vasopressin is absent. In these cases, dDAVP would seem to be particularly appropriate. Desmopressin is easy to administer and the clinical effects appear within 1 hour.

Several formulations are on the market: rhinyl nasal solution, desmopressin nasal spray, desmopressin oral tablet and the desmopressin oral lyophilisate (sublingual), all characterized by rather low bioavailability, with large intra-individual variability (0.08-0.16% in adults); only the last 2 formulations have a licence for enuresis in children [196, 197]. The intranasal form is no longer recommended for nocturnal enuresis, because of concern about water-intoxication, because of unpredictable nasal reabsorption in children.

The low bioavailability is largely related to the peptide structure, making oral /intestinal reabsorption very difficult, although pharmacodynamic effects remains very predictable, and when used *lege artis*, is rarely associated with serious adverse effects. It is available as a tablet (dosage, 0.2–0.6 mg) or a fast-melting oral lyophilisate (Melt; dosage, 120–240 µg). The latter is a recommended formulation for all children and is preferred by children under 12 years [197, 199-201].

It is not affected by nasal congestion or gastrointestinal transit and does not require fluid intake. Since tablets require up to 200 ml of fluid intake, which is ~25% of a 7-year-old's bladder capacity, the Melt formulation is more suited to the antidiuretic indication of desmopressin. Good pharmacodynamic data are available for the Melt and its dosing in children with enuresis [197, 202] [58].

Some patients have a delayed response and a small group of children who do not respond to desmopressin in ordinary dosage will become dry when the dose is increased, but this off-label use should be restricted to expert centres [203, 204]. Desmopressin may be particularly beneficial in the child with limited numbers of wet episodes per week. Often advice is given to use it as added security on special nights such as a sleepover. There is no sound medical evidence for this advice as intermittent regimens have never been proven to be beneficial [80].

Nocturnal polyuria is a characteristic of children that respond the best to desmopressin [56, 80, 205]. ICCS defines nocturnal polyuria >130% of expected bladder capacity for age, but the DRIP study showed that diuresis lower than 60%EBV is likely desmopressin resistant, where diuresis>100% has a 60% response-rate.

The efficacy of desmopressin in the treatment of enuresis is well documented [57, 192, 193, 206]. In a Cochrane Library, meta-analysis 17 controlled trials all showed superiority of desmopressin compared to placebo regardless of the route of administration [194, 207]. An estimated 70% of the enuresis population has full or partial response to the drug [110] and the response to desmopressin is highly dependent on factors such as nocturnal urine production and bladder capacity. The few studies that have tried to compare different doses of the drug reveal comparable efficacies [191, 208-210]. Several key issues should be taken into consideration, when the drug is prescribed. 200 to 400 mg tablets are considered bioequivalent to 120-240 µg Melt and are the therapeutic range for children with MNE between 7 - 18 years. The recently documented size relationship could mean that higher dosages might be needed in some of the larger children [200].

Medication should be taken 1 h before the last void before bedtime to allow timely enhanced concentration of urine to occur. Fluid intake should be reduced from 1 h before desmopressin administration and for 8 h subsequently to encourage optimal concentrating capacity and treatment response, as well as to reduce the risk of dilutional hyponatraemia/ water intoxication [82, 194, 197, 199].

Desmopressin is only effective on the night of administration; therefore, it must be taken daily. Full adherence is required to avoid wet nights. Desmopressin acts immediately, but in our expert opinion, the initial duration of treatment should be for 2–6 weeks, to ascertain its anti-enuretic effect [11]. If a sufficient degree of improvement is experienced, then treatment

can be continued for an additional 3 months—where appropriate. Country-specific regulations regarding treatment breaks should be followed. If patients are dry on treatment after this initial period, breaks are recommended to ascertain whether the problem has resolved and therapy is no longer necessary. If the child does not achieve complete dryness, or if wetting resumes once treatment is withdrawn, it should be continued or resumed. There is some evidence that structured withdrawal of medication may reduce relapse rates following its discontinuation [211,212]. Desmopressin is well tolerated, but clinicians should be aware that it is a potent antidiuretic and families must be educated regarding the rare possibility of patients developing hyponatraemia/water intoxication with symptoms including headache, nausea, and vomiting [196]. Self-titration of medication should be avoided (opinion).

Adherence to the drug is important. It is estimated that ~30% of non-responders are not taking medication correctly [166, 167, 213]. Non-adherence to recommendations regarding timing of medication, voiding before bed time, and limitation of evening fluids can increase treatment success [214]. Moreover, compliance is often overestimated, both by patients and clinicians; therefore, it should be documented in a diary. Regular contacts between caregiver and patient are necessary to keep up compliance. Patients who appear treatment-resistant should be advised of the importance of full adherence and asked if they have had any difficulty with complying with recommendations. We may also neglect that in divorced families, information must be given to both parents, so that the treatment is appropriately given on daily basis

Desmopressin has higher success rates in children with large bladder and nocturnal polyuria [35, 80, 215]. The response rate of the initial studies of >70% have been decreasing in more recent studies to 20-30%, since the prevalence of occult OAB patients with small bladder volume and low nocturnal diuresis volume was high in these populations [216]. There are several unanswered questions regarding desmopressin therapy. It is still unclear whether desmopressin treatment leads to better long-term outcome than the spontaneous cure rate. The long-term cure rate of 15- 30% annually is higher than the spontaneous cure rate [193, 206, 217]. Long-term follow up showed persistent LUTs symptoms in the patients with NMNE and not in the MNE patients [22]. The suggestion that tapering of the dose and the structured withdrawal programme should be beneficial is still unproven [211, 218].

Desmopressin: Tolerability and Safety

Considering the worldwide prescription-rate, desmopressin, is an extremely safe product, if correctly dosed and fluid intake is withheld after administration. There are no reports of water-intoxication with the melt or the tablet, at correct doses, since the spray was withdrawn. On the other hand, we cannot stress

enough that the drug should be correctly administered, since every year there are reports of children taking it in the morning.

We reinforce the ICI-advice that a rigid regimen of water restriction must be enforced for two hours prior to bedtime and to allow one eight-ounce (300 ml) glass of water at dinner and nothing for two hours prior to bedtime. In a survey on hyponatraemia in patients with nocturnal enuresis, by Robson and Noorgard in 1996, it was found that in most children water intoxication was due to considerable intake of water during the time the child was taking the desmopressin [219-221].

The results of numerous clinical trials have shown that desmopressin is well tolerated even during long-term treatment and associated with a low risk of adverse events. In the SWEET study, only six of 242 children (2.5%) withdrew during the long-term treatment because of very mild adverse events following the administration of intranasal desmopressin.

Predictors of Response:

Translating results from historical studies with no, or old ICCS standardisation of enuresis-patients remains difficult. The SWEET study found that those who improved or became dry during desmopressin were older (greater than 8 years), had fewer wet nights during baseline, and had only one wet episode during the week and responded initially to the smallest dose of desmopressin used in the study [52, 206, 208, 222, 223]. The DRIP study documented that the highest response rate was in older children, with less severe bedwetting, nocturnal polyuria and larger functional bladder volumes. A low diuresis-volume, <60% of EBV overnight, is highly predictive of desmopressin resistance; this is logical, since low diuresis-volume coincides with already presence of maximal concentrating activity of the kidney, where desmopressin cannot have additional value [80, 201].

There is considerable evidence that desmopressin works better than placebo. In one study, patients on desmopressin were 4.6 times more likely to achieve 14 consecutive dry nights compared with placebo [207]. However, relapse after short-term treatment is common. Sixty-one percent of 399 patients six to 12 years of age recruited from a primary care in one study responded to desmopressin initially [206]. Using intention to treat analysis 19% (77 of the 399) remained dry off medication and 18% were dry while still on desmopressin, thus not significantly better than the spontaneous cure rate. This suggests that desmopressin, by reducing the urine output overnight, reduces nocturnal enuresis but does not significantly affect the resolution rate over time above the spontaneous rate.

Although several studies have shown that dDAVP is a well-tolerated and safe drug, even during long-term usage, one must be aware that dDAVP is a potent antidiuretic drug and that there have been reports of

severe water retention with hyponatraemia and convulsions, but these are infrequent [204, 208, 219, 220, 224-231].

Level of evidence: 1

Grade of recommendation: A

9.5.2 Combined treatment with alarm and desmopressin

Combined treatment may be superior to use of the alarm alone, especially for non-responders of each individual treatment. In this approach, treatments are started at the same time: the rapid action of dDAVP is believed to facilitate the child's adaptation to the alarm [232-237]. After 6 weeks, the dDAVP is discontinued while the alarm treatment is continued until the child becomes completely dry. Compared with either therapy alone, the combination is particularly effective in children with high wetting frequencies and behavioural problems. Combination with full-spectrum therapy may even yield higher success rates [232, 238].

van Kampen *et al* reported their results of 'full-spectrum' therapy in 60 patients: they were treated for 6 months with a combination of alarm, bladder training, motivational therapy and pelvic floor muscle training: 52 patients became dry. The combination of alarm with six weeks of 40ug Desmopressin intranasally was better than alarm treatment alone, especially with high micturition frequency and comorbid behavioural symptoms [239]. In a Chinese study comparing alarm, desmopressin and a combined therapy, the latter had the highest rate of sustained response (40.6%). However, there was a high relapse rate after discontinuing medication [240].

In another randomised-controlled, double blind study, the addition of 3 weeks of 40ug and 3 weeks of 20ug Desmopressin to alarm use, lead to temporary, short-term reduction of wet nights compared to controls on alarm and placebo [237]. The long-term success rate did not differ between the two groups and were low (36% and 37%, respectively). In the subgroup of Desmopressin non-responders, the combination of alarm plus Desmopressin was not more successful (51.5% remission) than alarm plus placebo (48.1% remission), so that this cannot be recommended as a routine strategy [241].

Theoretically, the combination of alarm and desmopressin makes little sense: alarm treatment is an operant type of behavioural therapy that requires a certain number of wet nights to be effective: by reducing the number of wet nights through desmopressin, the child will have less opportunity to 'practice' and 'learn' continence by the alarm therapy.

9.5.3 Antimuscarinic drugs for OAB

Antimuscarinic drugs should not theoretically be efficacious in children with monosymptomatic nocturnal enuresis. However, because there is considerable

misdiagnosis of monosymptomatic nocturnal enuresis, some children with mild daytime symptoms of overactive bladder may have symptoms of overactive bladder at night. Moreover, it has been shown that on urodynamics, 73% of adults with primary nocturnal enuresis have some form of functional bladder outlet outflow obstruction classified as (1) "primary bladder neck dysfunction" or "detrusor sphincter dyssynergia" [242]. That would suggest then that antimuscarinic drugs might be a useful alternative in some children who are unresponsive to DDAVP. Antimuscarinic therapy is also indicated in combined day and night-time incontinence [86, 243, 244].

In general, antimuscarinic drugs are well tolerated but there are some side effects, namely vasodilation, dryness of the mouth, constipation and vertigo (rare), and symptoms of hyperactivity and concentration disorders, especially in a population of children with ADHD. These side-effects are more predominant with oxybutynin, than with the newer anticholinergics. Constipation can also pose a problem since the development of constipation may aggravate detrusor overactivity and thus counteract the beneficial effects of the drug. Antimuscarinics may also result in increased residual volumes which may make it difficult for the child to empty prior to bedtime. Antimuscarinic treatment in conjunction with desmopressin may have a role in cases with suspected day and night time detrusor overactivity.

The combination of alarm and anticholinergics should be considered if overactive bladder is suspected. If the alarm is set off several times per night, indicative of overactive bladder, this combination has been proven to be successful. For example, 5 mg of oxybutynin in the evening, combined with an alarm could be tried in these cases. If higher levels of anticholinergics are required, several doses should be given over the day. Other programmes such as 'full spectrum treatment' remain treatment forms that are reserved for therapy-resistant cases.

Level of evidence: 2

Grade of recommendation: B.

In those children who have NE due to detrusor overactivity during the night, treatment with an antimuscarinic drug should be considered [245, 246]. Because it is difficult to perform a night time cystometry in these children, it may be tried in children who have more than 2 wetting episodes per night and who do not respond to dDAVP or be given in combination with alarm or dDAVP [244] [247]. At present, no studies have been performed to demonstrate its efficacy in this circumstance.

Level of evidence: 3

Grade of recommendation: C

9.5.4 Tricyclic antidepressants

Although tricyclic antidepressant drugs, particularly imipramine, have worked in many children, most of

the studies that recommend this drug are relatively old. The major drawbacks to imipramine therapy are cardiotoxic side effects, in some cases even with therapeutic doses, and the possibility of death with overdose.

Because imipramine and other drugs of the same family have potential cardiotoxic side effects they cannot be generally recommended for treatment of this non-lethal disorder [248]. Although treatment with tricyclic drugs is associated with a decrease of one wet night per week, the lasting cure rate of only 17 percent restricts the use of these drugs [249].

Only in selected cases (like adolescent boys with Attention Deficit Hyperactivity Disorder and persistent NE) or refractory cases should it be considered [250], and use restricted to expert centres. The need to perform an *a priori* ECG remains open for discussion, but obtaining a clinical history to exclude familial sudden death in adolescents and adults is mandatory.

Level of evidence: 1

Grade of recommendation: C (due to potential cardiotoxicity)

Table 2: Response and cure rates of different treatment modalities. Full response (while on medication) and Cure rates (6 months after cessation of treatment) of Nocturnal Enuresis

	Full response	Cure
Alarm treatment	65%	43%
Desmopressin	31%	22%
Dry-bed training	40%	18%
Imipramine		17%

9.5.5 Alternative regimens:

Several other drugs, such as carbamazepine and NSAIDs (indomethacin, ibuprofen) have also been investigated: based on study design as well as study outcomes, these drugs are not recommended [251-256].

Acupuncture, laser acupuncture and neurostimulation have also been suggested, but none has demonstrated a convincing positive effect in primary care enuresis patients [257-262].

In one randomised controlled trial that examined acupuncture, 40 children were allocated either to dDAVP or acupuncture, 75% of children were dry after 6 months of therapy (while still on medication), while 65% of patients were completely dry after a mean of 12 sessions. The evidence from these alternatives is too weak to recommend them as a first line approach. It is concluded that as an alternative, cost-effective and short-term therapy, acupuncture should remain among available treatment options. Another meta-analysis provides some evidence for the efficacy of acupuncture for the treatment of childhood nocturnal enuresis. Comparison of treatment outcome and cure rates is difficult because of the inconsistent use of definitions, the inclusion of children with daytime symptoms, and the variable follow-up periods in most studies. For a pragmatic approach, see Figure 3.

Level of evidence: 4

Recommendation: grade D

9.6. Conclusion

Based on current evidence, the enuresis alarm remains the most effective means of facilitating arousal from sleep in unselected patients. The key to success is not the stimulus intensity of the alarm triggering, but the child's preparedness to awake and respond to the signal. As an adjunct programme, arousal treatment is easy to perform and effective. But this evidence is obtained from meta-analysis comparing the use of alarm and desmopressin in poorly characterised enuresis populations, mixing up MNE with non-MNE, if we use the recent ICCS standardisation criteria.

A second therapy regimen involves individualising the treatment to the characteristics of nocturnal diuresis and functional bladder volume overnight.

The ideal therapy regimen for children with a large bladder volume, a high diuresis volume with low urinary osmolality overnight will most likely be desmopressin responsive, and would only respond to the alarm by acquiring nocturia.

The 2nd archetype is children with a small bladder volume, low diuresis volume, with already maximal concentrating capacity who are likely to be desmopressin resistant, and where the alarm is the first choice. But there are many patients who overlap between these two types, where combination therapy will be necessary, even with associated anticholinergics.

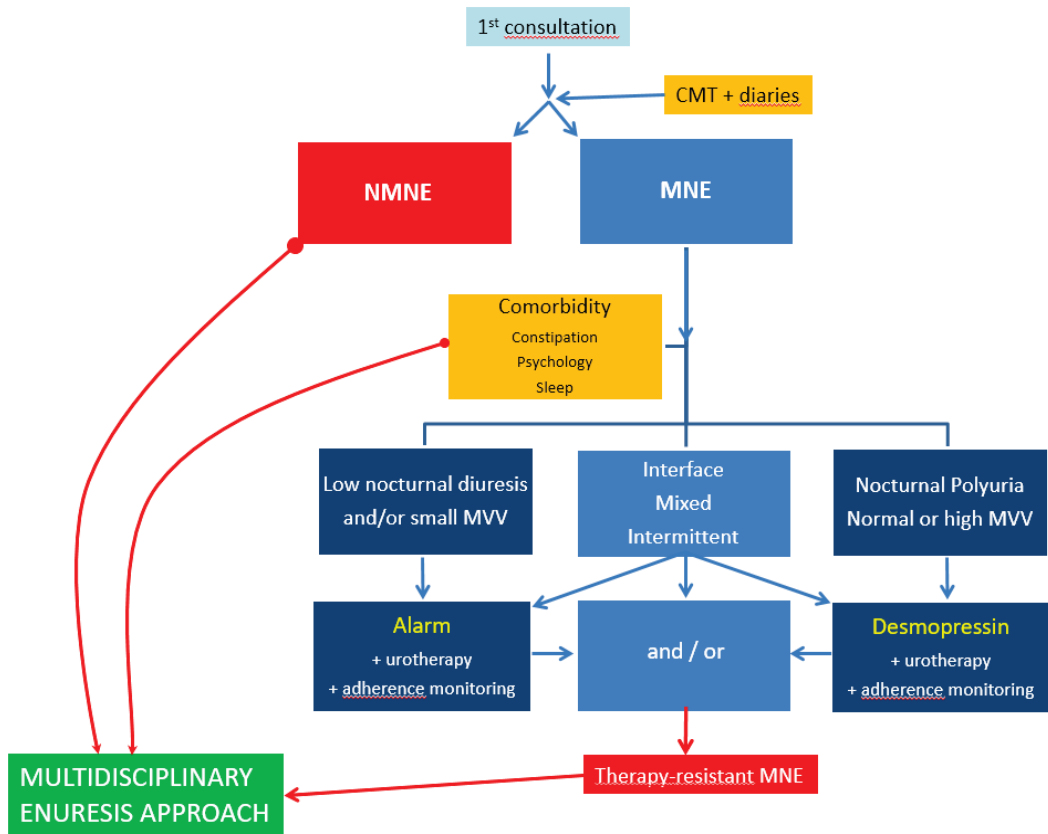

Figure 3: Treatment algorithm for enuresis.

10. REFRACTORY MNE:

About one third of children do not respond to treatment with alarm and/or dDAVP. The majority of these children are likely to have a small nocturnal bladder capacity and suffer from “detrusor dependent NE”.

Most patients with MNE who are non- or partial responders are likely to have underlying bladder dysfunction, missed during the initial assessment, because 1) it was not performed appropriately, or 2) patients were classified according to the old ICCS standardisation, when according to the new ICCS standardisation they should be considered as NME. The full screening should be redone, with history of incontinence diurna (ID), diurnal symptoms after the age of 3,5 years, high / low frequency, postponing during normalised fluid intake as well as small enuresis volumes early in the night are very suggestive for bladder dysfunction. Spontaneous low fluid intake is suggestive of a defence mechanism, and may mask OAB symptoms. These symptoms are often not mentioned by parents, and deserve repeated questioning or documentation in a bladder diary during standardized fluid intake 1,5ml/1.73m²/day: this can give addi-

tional information. Uroflow and bladder ultrasonography may also be useful. These children benefit from a multidisciplinary approach and should not be treated in a primary care [264, 265].

But, in the absence of any bladder dysfunction we should concentrate on the desmopressin effect in differentiating different pathophysiological characteristics that may be involved 1) anti-enuretic effect = number of wet nights, 2) the anti-diuretic effect (= nocturnal diuresis rate 3) concentrating capacity (= urinary osmolality). Partial response to desmopressin in MNE (anti-enuretic effect) is related to persistent nocturnal polyuria on the wet nights [81].

Poor compliance should be excluded [167], including not taking the drug (consider letting the patient fill out a drug-diary and register the number of prescriptions /compliance):

1. the child forgets to void before going to bed, and already starts the night with a filled bladder
2. exclude drinking overnight, because fluid intake overnight or even the hour before desmopressin administration reduces both maximum and duration of anti-diuretic effect and concentrating capacity significantly.

3. intermittent polyuria might as well be related to the PK/PD characteristics of desmopressin [82, 199-202, 213]:

a. The 3 formulations (tablet, melt and spray) have poor bioavailability, ranging respectively 0.2 - 2% - 4%, but with a rather large SD = intra-individual variability. Only for the melt are dose-response-data and proper pharmacodynamic and kinetic data in children available. The melt showed superior PK and PD profile, better compliance and some indication of higher response rates. Before considering desmopressin resistance, a switch to the melt should be considered.

b. The child takes the drug just before sleeping time (the time to reach maximum concentrating capacity and anti-diuretic effect is 1-3 hours, and therefore the drug should be taken at least one hour before the last void before sleeping). Interference with nutrition (the tablet should be given on an empty stomach (= at least 2 hours after the last meal [85, 199, 200, 266].

But 2 hours after the last meal, and 1 hour before sleep is not realistic in most children: a consideration that favours the melt above the tablet.

c. The melt study has demonstrated that, even in the therapeutic range of 120-240µg there is a large variation in maximal concentrating capacity and antidiuresis, as well as duration of action. Better understanding of these PK/PD dynamics, can lead to more personalised medicine, with individualised dosing. The PK/PD data demonstrate that at least 25% of patients might benefit from higher doses, patients that can be identified by a pharmacodynamics test in an ambulatory setting in the individual patient (24h concentration-profile), especially in the older patients. Increasing the dose without this test is indefensible, because of the risk for toxicity.

In desmopressin refractory nocturnal polyuria with low urinary osmolality, diabetes insipidus should be excluded. X-linked DI in boys does not present as enuresis, but female carriers might have a more *forme fruste* pattern with enuresis as major symptom. Many renal diseases (CKD, tubulopathies, renal dysplasia, uropathy) present with enuresis. Hypertension, and especially night time hypertension, coincides with nocturnal polyuria, and should be considered in refractory patients. Although there might be some anti-diuretic effect of desmopressin, these patients never reach maximum concentrating capacity. A desmopressin / vasopressin concentration test may be helpful if conventional diagnostic tests (ultrasound, lab) fail. It should be noted that the majority of studies on desmopressin in children with MNE demonstrate that up to 25% of patients do not reach >850 mOsm/L after desmopressin therapy. Although these patients do not fulfil the criteria of DI, there is an increased prevalence of patients at the lower end of the normal range of concentrating capacity in these children. A 20% decrease in concentrating capacity will result in

20% increase in diuresis, and this may be the difference between continence and enuresis in many patients.

Desmopressin resistant nocturnal polyuria, with high urinary osmolality overnight might be associated / correlated with high urinary osmolality overnight. This can be caused by an increased solute load only in the evening or during 24 h [59, 60]. Sodium is the major osmotic agent [59, 72, 76, 267]. Although nutritional intake plays a major role, abnormalities of several circadian rhythms like prostaglandins [268-270], GFR [70, 72], blood pressure [69] and sleep pattern [104, 105, 108] have a significant impact in selected tertiary care patient populations. Extrapolation of these findings to primary care enuresis patients is premature. But these findings offer indications of future treatment options. Some pilot studies have promising results, such as sodium restricted diet, diuretics (Furosemide) [76, 251, 271, 272], NSAID, and treatment of sleep disturbances, (OSAS and melatonin) [48, 50, 273-276]. In the past much attention was put on the role of calcium, and a calcium restricted diet might be effective [77, 78, 277], but hypercalciuria might be a secondary phenomenon due to differences in diet [75, 84, 278].

Symptoms resistant to conventional therapy cannot only be related to underlying bladder dysfunction and renal response to desmopressin, but also to associated comorbidities. Identifying these, and addressing them if possible might increase the response rate. Constipation and faecal incontinence should be treated before the treatment of MNE but are often underestimated and underreported. Psychological comorbidities, as well internalising as externalising are more frequent in enuresis-patients. Attention deficit disorders, and autism are well studied and seem to have common pathways. A structured therapeutic approach is mandatory. Renal dysfunction, hypertension, diabetes mellitus and sleep disturbances should be treated appropriately. Many drugs interfere with the circadian rhythm of biorhythms, including diuretics, steroids, cyclosporine A, and neurotropic drugs and may be a possible trigger to offset enuresis in a sub-set of children: this is largely speculative, as good studies are lacking.

Conclusion [11, 82]

In children with MNE two first-line treatment options are available - desmopressin and the enuresis alarm. Without further individualised treatment, success rates of monotherapy may not exceed 30%, with a relapse rate up to 50%.

Optimally;

1. the initial treatment selection should be guided by the family's level of motivation and their preference.
2. and be based on the information from diaries: this will identify subtypes of MNE allowing further fine-tuning of treatment according to the child's characteristics and family motivation.

- Children with a normal urine output during the night and normal bladder capacity can be given either the alarm or desmopressin.
- Children with smaller than expected bladder capacity for age will likely be desmopressin-resistant and more sensitive to the alarm.
- Children with NP and normal bladder volume will be more sensitive to desmopressin.
- Children with both excessive urine output and reduced bladder capacity may find combined therapy of alarm and desmopressin to be successful. This strategy lessens the burden of alarm treatment as the alarm is triggered several times per night.

Despite best efforts, up to 30% of enuretics will be therapy resistant. We advocate to individualize therapy based upon the identification of the most likely pathophysiological mechanisms, bladder, kidney; sleep and comorbidities, in a multidisciplinary setting.

IV. CHILDREN WITH BOTH DAY AND NIGHT TIME INCONTINENCE

Urinary incontinence in children may be caused by a congenital anatomical or neurologic abnormality, such as ectopic ureter, bladder exstrophy or myelomeningocele (MMC). In many children, however, there is no such obvious cause for the incontinence and they are referred to as having “functional incontinence.”

Becoming continent is a complicated process: there is a progressive development towards normal storage and emptying of the bladder at a socially accepted place and time, mostly achieved by age 3-4.

Bladder control is believed to be under the influence of the central nervous system. The pontine region is considered to be responsible for detrusor sphincter coordination while the cortical area is responsible for inhibition of the micturition reflex and voluntary initiation of micturition (detrusor overactivity control). Formerly it was believed that bladder maturation followed maturation of cortical inhibition processes. However, recent work of CK Yeung suggests bi-directional maturation of both the coordinating influence on the bladder and the pons may be implicated. This implies that a condition such as detrusor overactivity would be the result of loss of cortical control or of deficiency in cortical control, while dysfunctional voiding would be the result of non maturation of the coordination.

With the emergence of functional MRI, future studies will be able to illuminate this enigma.[1,2] This opens an era of corticocentric thinking on lower urinary tract dysfunction, moving away from the current trend of vesicocentric thinking. Detrusor overactivity may be a symptom of a centrally located dysfunction affecting bladder, bowel, sexual function and even mood and behaviour.[3] Indeed many studies indicate that there

exists a link between lower urinary tract dysfunction and behavioural disorders such as ADHD (attention deficit / hyperactivity disorder) [4-5].

The desire to void is a sensation which, in the developing child, is incorporated into daily life so that voiding takes place at an appropriate time and place. Problems with training or psychological difficulties possibly have a great impact on the results of training: some parents send their child to the toilet many times, though his/her bladder may be empty [6,7]. Voiding in these circumstances can only be achieved by abdominal straining. The positive reinforcement that the child receives by voiding even a small amount may lead to the development of an abnormal voiding pattern. The same is true when children receive negative feedback related to voiding [8-10]. At present no evidence exists to prove these assumptions.

Urinary incontinence in children may be due to disturbances of the filling phase, the voiding phase or a combination of both. In the ICCS terminology document, these conditions are termed functional bladder disorders or Lower Urinary tract (LUT) conditions. They are divided into either overactive bladder (OAB) or dysfunctional voiding [11]. While the former condition is a filling disorder the latter is considered an emptying disorder. They can of course coincide and one may even be causative of the other. No evidence exists however for this last assumption. It has been postulated that detrusor overactivity may eventually lead to poor bladder emptying due to underactivity of the detrusor or severe dyscoordination between detrusor, sphincter and pelvic floor. However, the natural history of many of these children does not confirm this hypothesis, nor the early onset of severe pathology in some of them. Hoebeke et al found no evidence for this dysfunctional voiding sequence: children with functional incontinence have different primary diseases, but all have a common risk of incontinence, UTI, VUR [15%] and constipation [17%] [12].

Detrusor overactivity may lead to disturbances in the filling phase characterized by urgency, frequency and at times urgency incontinence. Girls present with OAB symptoms more often than boys. In addition to the urinary symptoms, children with functional urinary incontinence may also have recurrent urinary tract infections (UTI) and constipation.

Incomplete relaxation or tightening of the sphincteric mechanism and pelvic floor muscles during voiding results in an interrupted or staccato voiding pattern, that may be associated with elevated bladder pressures and post-void residuals. Such individuals with dysfunctional voiding are also prone to constipation and recurrent UTIs [13]. Bladder function during the filling phase in these children may be essentially normal, alternatively OAB may be present. In children with an underactive detrusor, voiding occurs with reduced or minimal detrusor contractions with post-void residuals, and incontinence is a characteristic symptom.

1. PREVALENCE

For more detailed information on the prevalence of daytime incontinence the Chapter on Epidemiology should be consulted. The main problem is that it is impossible to draw any conclusions from the presented data as different studies have used different definitions and criteria. Furthermore, it is virtually impossible to identify the prevalence of detrusor overactivity or dysfunctional voiding as the studies tended to look primarily at daytime versus night-time incontinence and made no effort to evaluate the type of daytime incontinence.

Daytime or combined daytime and night-time incontinence at least once a week seems to occur in about 2-4 percent of 7-year old children and is more common in girls than in boys [14]. Overall the rates of prevalence vary from 1 to 10 percent, but in general for 6 to 7-year-old children the prevalence is somewhere between 2 and 4 percent, and rapidly decreases during the following years [15-19]. Suresh Kumar et al in a population based survey of over 2000 new entrant primary school children [age 4-6 years] in Sydney, Australia noted an over-all prevalence of daytime wetting of 19.2% defined as at least one daytime wetting episode in the prior 6 months with 16.5% having experienced more than one wetting episode and only 0.7% experiencing wetting on a daily basis [20]. Multivariate analysis showed that recent stress, a history of daytime wetting along the paternal line, and a history of wetting among male siblings were independent risk factors for moderate to severe daytime wetting. Because this was a cross-sectional study recall bias may have resulted in an overestimate of risk of daytime wetting being caused by such factors as emotional stress and family history. In addition, urine cultures were not obtained so occult UTIs could not be identified. Chung comes to the same percentage of OAB (16.6%) in 19,240 Korean children. In this study OAB was differentiated in 'dry' OAB and 'wet' OAB: children with OAB do not always have incontinence (21).

In a questionnaire based study, supplemented by telephone calls, Hellstrom assessed the prevalence of urinary incontinence in 7 year old Swedish school entrants [22]. Diurnal incontinence was more frequent in girls than boys, 6.7% vs 3.8%, respectively. Wetting every week was reported in 3.1% girls and 2.1% of boys. The majority of children with diurnal incontinence had concomitant symptoms: urgency was reported in 4.7% girls and 1.3% boys. Nocturnal incontinence combined with daytime wetting was equally common in males versus females, 2.2% versus 2%, respectively. At the age of 17 years daytime wetting, at least once a week, was found in 0.2 % of boys and 0.7% of girls. A limitation of this study is its dependency on recall. Children with daytime or mixed wetting were found to suffer from urgency in 50.7 %, with 79.1 % wetting themselves at least once in 10 days [23]. Urgency symptoms seem to peak at age 6-9 years and diminish towards puberty, with an assumed

spontaneous cure rate for daytime wetting of about 14% per year [24].

In a, cross sectional sample of 594 individuals 4 to 26 years old Kyrklund describes in 2012 4% of respondents with frequent UI, most < 12 years. Prevalence decreases enormously with age (25).

Most children are toilet-trained by the age of 3 years, although the mean age may range from 0.75 to 5.25 years, with girls being trained earlier [2.25 years] than boys (2.56 years) [26]. A 2008 Turkish study reported day dryness at a mean age of 28 months (27). This is confirmed by a 2015 Turkish study in 1500 children whose mean age of dryness was 29 months (28). The age of commencing toilet training has increased [29]. This is thought to be associated with higher education levels in parents and the popularity of the child-oriented approach rather than parent-initiated methods [26]. Children who exhibited elimination signals for voiding became dry sooner than those who did not show such signs. There is huge social and cultural variation in toilet training practices with some of the implicated issues being, availability of inside toilet, washable versus disposable diapers, working or home-based mothers, rural or urban location and use or not of punishment methods (22). It appeared that initiating toilet training after 24 months of age may be associated with problems attaining and maintaining bladder control and that early training is not associated with bladder dysfunction (29,30). A prospective study in 112 patients published in 2014 however showed problems in early training (<2 years) and in late training (>3 years) alike (31). Da Fonseca found no association between children with combined bladder and bowel dysfunction and the time of toilet training compared to healthy children (32).

Swithinbank et al found a prevalence of day wetting [including also "occasional" wetting] in 12.5% in children age 10-11 years which decreases to 3.0% at age 15-16 years [33]. Based on these findings, it seems that the prevalence of all kinds of daytime incontinence diminishes by 1-2% per year from age 10-11 to age 15-16 years, while daytime incontinence, at least once a week, seems to diminish by 0.2% per year from age 7 to age 17 years. Because of treatment interventions the studies may not recount the true natural history.

A cohort study of all school children in the first and fourth grades in the city of Eskilstuna (Sweden), published in 2004, daytime urinary incontinence (at least once a month) was reported in 6.3% of the first graders and 4.3% of the fourth graders, while bedwetting (at least once a month) was reported in 7.1% and 2.7% and faecal incontinence in 9.8% and 5.6%, respectively. This study demonstrates that soiling and daytime urinary incontinence often coexist [34].

The natural history of detrusor overactivity in children is not well understood. It is no longer held that detrusor overactivity in children is idiopathic or due to a maturational delay but more likely to be associated with feed forward loops from the generation of a high

pressure system during voiding or filling. Both the interplay of neural drive with motor control and the dynamic nature of the growing bladder could be causative. This is in contrast to the adult population, where detrusor overactivity is considered a chronic condition whose origin is unrelated to functional use. There is no long-term data to determine if childhood detrusor overactivity predicts detrusor overactivity as an adult. There is evidence that genetic influences affect adult urinary symptoms and that suffering lower urinary tract conditions in childhood increases the risk for these conditions in adult women (35-39). Recent research points to a link between deficits in the brain and functional urinary problems (5).

By the age of 5 years, unless organic causes are present, the child is normally able to void at will and to postpone voiding in a socially acceptable manner. After this age, night-time and daytime involuntary wetting become a social problem and a cause for therapeutic intervention. In children who present with a change in voiding habits, such as a new onset of voiding dysfunction, one should consider the possibility of child sexual abuse [37]. A more recent study found no significant differences in the presence of lower urinary tract symptoms between children and adolescents who had experienced sexual abuse and controls [31]. Nevertheless this should be kept in mind, especially when invasive diagnostic and therapeutic procedures are contemplated. One may want to simply ask the parent or caregiver if there were any precipitating events or concerns that they feel may have led to the changes in the child's voiding habits. The appropriate individuals should be contacted if there is a high index of suspicion. Of adult women with complex urinary symptoms, a significant proportion report sexual abuse as a child.

2. INTRODUCTION TO CLINICAL ASSESSMENT

The International Children's Continence Society has published standardisation documents on the diagnostic evaluation of children with daytime incontinence as well as on the management of daytime urinary incontinence in general and dysfunctional voiding in children. They also assessed psychological and psychiatric issues in urinary and faecal incontinence (39-41).

The evaluation of daytime wetting is based on the medical and voiding history, a physical examination, a urinalysis, bladder diaries and uroflowmetry with post void residual. The upper urinary tract should be evaluated in children with recurrent infections and dysfunctional voiding. Uroflowmetry can be combined with pelvic floor electromyography to demonstrate overactivity of the pelvic floor muscles. Urodynamic studies are usually reserved for patients with therapy resistant dysfunctional voiding and those not responding to treatment who are being considered for invasive treatment [42-46].

Treatment is usually a combination of 'standard therapy' (see below), behaviour therapy, bladder training, physiotherapy and medical treatment. Surgery is rarely needed for the management of daytime wetting in the absence of a structural abnormality. The roles of neurostimulation, botulinum toxin and intravesical therapies in the management of paediatric urinary incontinence are less well-defined. Clean intermittent self-catheterisation is sometimes necessary in children with poor bladder emptying, due to underactivity of the detrusor and subsequent large residuals, who do not respond to a more conservative approach.

The importance of treatment during childhood was pointed out in a general population study of 1333 adult women. Fifty percent reported symptoms of stress incontinence and 22 percent reported symptoms of urgency incontinence. Eight percent noted severe symptoms. Women who at age six years had wet episodes during the day or were wet several nights per week, were more likely to suffer from severe incontinence and report urgency symptoms: occasional bedwetting was not associated with an increased risk in adult life [47].

3. CONFOUNDING FACTORS: LOWER URINARY TRACT DYSFUNCTION, RECURRENT URINARY TRACT INFECTION AND VESICoureTERIC REFLUX (VUR)

The relationship between detrusor dysfunction and VUR associated with a urodynamic anomaly was first described by Allen and Koff and has been confirmed by several authors [48-51]. Koff demonstrated that treatment of detrusor overactivity reduced the incidence of infection and resulted in a 3 fold increase in the rate of reflux resolution. In a study by Sillen of children with gross bilateral reflux, extreme detrusor overactivity without signs of bladder outlet obstruction was found in boys. Infant girls with gross bilateral reflux did not show the same degree of detrusor overactivity [51]. Other investigators assessing high grade VUR in new-borns noted similar findings. Van Gool et al noted that 40% of 93 girls and boys evaluated for urgency incontinence and recurrent UTIs had reflux [52].

These studies in infants and the association of combined bladder and bowel dysfunction with reflux and infection in older children support the suggestion that, in some individuals, vesicoureteral reflux is a secondary disorder related more to abnormal detrusor function than to a primary anatomical defect at the ureterovesical junction. It has been shown that increased intravesical pressure, without reflux, may be detrimental for the upper tracts: renal scarring without reflux was recently described by Vega et al [53].

In support of this concept is the common finding of vesicoureteral reflux in children with neuro-pathic bladders and detrusor-sphincter dyssynergia. In such children, the institution of clean intermittent catheterisation and anticholinergic therapy leads to the resolution of VUR in a large number of cases. It is believed that the decrease of detrusor overactivity and restoration of functional capacity in combination with regular and complete emptying of the bladder are the responsible co-factors [54]

Koff et al. evaluated the effects of antimuscarinic therapy in 62 children with a history of recurrent UTIs, VUR and detrusor overactivity, and compared these children with an age-matched control group with a normal urodynamic study [55]. The overall small sample size and the small number of compliant patients limit the study, however, it did demonstrate a statistically significant difference in the resolution rate of VUR between the treated group and the control group. The overall infection rate was lower in the treated group [16%] compared to the non-medically treated group [63%] and the age-matched control group [71%]. Several authors have documented the relationship between detrusor overactivity and dysfunctional voiding with recurrent UTIs .

Proposed aetiologies for the increased incidence of UTIs in these patient populations include a milk back phenomenon whereby bacteria in the proximal urethra are “milked back” into the bladder during contraction of the pelvic floor muscles. Alternatively, decreased blood flow and relative hypoxia during periods of increased detrusor pressure such as during involuntary detrusor contractions and voiding against functional obstruction, may induce transient bladder mucosal injury.

Constipation is prevalent among children with bladder symptoms, but often poorly identified by parents [56]. It is a risk factor for recurrent UTIs. Contrary to expectations, findings from the European Bladder Dysfunction Study suggested that symptoms of disordered defaecation did not influence the cure rate of treatment for bladder symptoms [57]. In a prospective non-randomised clinical series of day wetting children, a strong correlation was found between recurrent urinary tract infections, detrusor overactivity and detrusor-sphincter dysfunction [58]. In a study by Hansson et al, symptoms of detrusor overactivity, such as urgency and daytime incontinence were found in a high percentage of girls with asymptomatic bacteriuria [59].

In the majority of children with dysfunctional voiding the recurrent infections disappeared following successful treatment of the voiding dysfunction. This finding confirms the hypothesis that dysfunctional voiding is the main factor responsible for the infections [and to a lesser extent vice versa] [60,61]. Additionally, since such children typically have coexistent constipation, attempts at restoring normal bowel habits will also contribute to decreasing the risk of UTIs.

At present, current opinion is that vesicoureteral reflux as such does not predispose to UTI: however it may facilitate renal involvement [causing pyelonephritis] once bacteriuria has been established in the bladder. This concept has not been scientifically validated and the incidence of renal scars as a consequence of pyelonephritis is reportedly the same, regardless of whether reflux has been documented or not [62]. Those children with VUR in association with detrusor overactivity and/or voiding dysfunction may be at increased risk for upper tract damage given their increased risk of developing UTIs. With this in mind, aggressive treatment of the underlying filling/voiding disorder, the addition of prophylactic antibiotics, and attention to their bowel habits should be given in an effort to decrease the risk of UTIs in this higher risk group [63-66].

In a recent study evaluating retrospectively a large group of children with LUT conditions it was shown that in patients who had urinary tract infection the presence of reflux increased the rate of renal cortical abnormalities. [67].

4. CLASSIFICATION

Numerous classifications have been used for children who present with varying degrees of ‘functional’ urinary symptoms, unrelated to apparent disease, injury or congenital malformation. In 2016, the International Children’s Continence Society (ICCS) released a standardised terminology to provide guidelines for the classification and communication about LUTS in children [11].

Symptoms are classified according to their relation to the voiding and or storage phase of bladder function.

In addition to gaining a comprehensive history, observing micturition and examining the child forms the basis of assessment: the information derived from a 48 hour bladder diary, stool record, voiding uroflowmetry and lower urinary tract ultrasonography is also essential in making the initial diagnostic classification (39,68).

Screening for psychological symptoms with questionnaires is recommended, as 30-40% of children with daytime urinary incontinence are affected by comorbid emotional or behavioural disorders [69].

Urodynamic investigations elucidate the basis of clinical findings but are first line evaluation techniques only in tertiary referral centres where children have not responded to previous treatment or have symptoms suggestive of neural involvement or anatomical anomalies.

The ICCS has classified daytime LUT conditions into groups that currently align with understanding of underlying pathophysiology. The groups commonly overlap and allocation is based on the 4 symptoms of urinary incontinence, frequency of volitional voiding, micturition volumes and fluid intake.

- Over active bladder (OAB) including urgency incontinence
- Dysfunctional voiding
- Underactive bladder

The symptom-specific conditions of

- Voiding postponement
- Vaginal reflux
- Giggle incontinence
- Extraordinary daytime urinary frequency
- Elimination syndrome

The term 'non-neurogenic dysfunction' is commonly encountered in the literature and describes the whole spectrum, from simple bladder overactivity to severe cases with deterioration of the upper tracts. The fact that a neurologic deficit is not demonstrated at the time of evaluation, does not, however exclude the possibility that a neurological abnormality was present at the onset of the problem. It has been postulated that detrusor overactivity may eventually lead to poor bladder emptying due to underactivity of the detrusor or severe dyscoordination between detrusor, sphincter and pelvic floor. However, the natural history of many of these children does not confirm this hypothesis, nor the early onset of severe pathology in some of them. Hoebeker et al found no evidence for this dysfunctional voiding sequence: children with functional incontinence have different primary diseases, but all have a common risk of incontinence, UTI, VUR [15%] and constipation [17%] [12].

4.1. Overactive bladder in children

The term bladder overactivity is used to describe the symptom complex of urgency, which may or may not be associated with urgency incontinence and is not a direct result of known neurological damage. Recent suggestions describe OAB as a symptom of corticocentral dysfunction that affects multiple systems rather than a dysfunction isolated to the urinary bladder [70]. Urgency syndrome is characterised clinically by frequent episodes of an urgent need to void, countered by contraction of the pelvic floor muscles (guarding reflex) and holding manoeuvres, such as squatting and the Vincent curtsy sign. The term urgency refers to a sudden compelling desire to void that is often difficult to defer, unlike the need to void which is experienced by all individuals and may be intense if one holds one's urine for a prolonged period. The symptoms are thought to arise from detrusor overactivity during the filling phase, causing urgency. These detrusor contractions are countered by voluntary contraction of the pelvic floor muscles to postpone voiding and minimise wetting. Where present, the detrusor contractions can be demonstrated urodynamically, as can the increased activity of the pelvic floor muscles during each contraction.

The voiding phase is essentially normal, but detrusor contraction during voiding may be extremely powerful. The flow rate reaches its maximum quickly and may level off ('tower shape'). Such strong bladder and pelvic floor muscle contractions have been postulated to result in damage to the bladder mucosa increasing the risk of UTIs. In addition, these children may note suprapubic or perineal pain. A cohort of patients presenting with night-time pain syndromes based on pelvic floor spasms was described by Hoebeker et al. Good response to pelvic floor relaxation biofeedback is described in this study [71].

Overactive bladder (OAB) should also be considered in "continent" children with recurrent UTI and vesicoureteral reflux. Depending on fluid intake and urine production, the complaints of incontinence become worse towards the end of the day, due to loss of concentration and fatigue and may also occur during the night. Children usually diminish their fluid intake to minimise wetting, and therefore incontinence may not be the main complaint or symptom, but on careful questioning urgency becomes apparent.

Frequent voluntary contractions of the pelvic floor muscles may also lead to postponement of defaecation. Constipation and faecal incontinence (soiling) are often found in children with detrusor overactivity [72]. The constipation is aggravated by the decreased fluid intake. Constipation contributes to an increased risk of UTIs and may exacerbate the detrusor overactivity. An investigation of the natural history of combined emptying dysfunction of bladder and bowel, using an elimination score in women with and without urogynaecological problems, demonstrated that childhood lower urinary tract dysfunction may have a negative impact on bladder and bowel function in later life [73]. Urinary symptoms and faecal problems often go hand in hand, epidemiological data show that urinary continence is found more often in girls, where defaecation problems are more often found in boys. A clear explanation is not yet found.

A careful history, physical examination and scrutiny of the child's bladder diary will identify symptoms of detrusor overactivity. Urine flow rate registration and post-void residual urine measurement help to identify co-existing dysfunctional voiding. Thus, in most children, invasive studies such as urodynamic studies are not indicated as part of the initial evaluation. Such studies are reserved for those children with a question of an underlying neurological defect and those who fail to improve with medical and behavioural therapy, if invasive therapies are being considered. Those children with a history of recurrent UTIs should undergo assessment with a renal/bladder ultrasound and depending on the age of the child, and the severity of the UTI(s), a voiding cystourethrogram (VCUG) to assess reflux is occasionally performed [74,75]. By adopting a structured approach to history and physical examination, the diagnosis can be made in most children without the need for invasive diagnostic procedures.

Treatment:

Treatment involves a multimodal approach, involving strategies such as behavioural modification, antimuscarinic medication and neurostimulation. Underlying and potentially complicating conditions such as constipation and UTI are managed prior to intervention.

Level of evidence: 3

Grade of recommendation: C

4.2. Dysfunctional voiding

Dysfunctional voiding refers to an inability to fully relax the urinary sphincter or pelvic floor muscles during voiding. There is no identified underlying neurologic abnormality. Children with dysfunctional voiding usually present with incontinence, urinary tract infections and constipation and demonstrate an intermittent, or fluctuating pattern referred to as staccato flow (by ICCS definition) during repeated uroflowmetry.

No clear data are available on the possible causes of dysfunctional voiding. It may be that detrusor overactivity eventually leads to overactivity of the pelvic floor muscles, with subsequent insufficient relaxation during voiding [75]. Alternatively, poor relaxation of the pelvic floor muscles during voiding may be a learned condition during the toilet training years, adopted following episodes of dysuria due to UTI, or constipation or occurring secondary to sexual abuse [77]. The child's environment, in particular toilet conditions and privacy issues, can trigger or exacerbate voiding anomalies [78]. In some girls, anatomical anomalies of the external urethral meatus seem to be associated with a higher incidence of dysfunctional voiding. The urine stream may be deflected anteriorly and cause stimulation of the clitoris with subsequent reflex activity of the bulbocavernosus muscle causing intermittent voiding [78]. Since no true structural obstruction can be identified the intermittent in-complete pelvic floor relaxation that occurs during abnormal voiding is termed a functional disorder.

Abnormal flow patterns seen in children with dysfunctional voiding:

- Fluctuating (Staccato) voiding: continuous urine flow with periodic reductions in flow rate precipitated by bursts of pelvic floor activity. Voids are commonly prolonged and incomplete.
- Interrupted voiding: characterized by unsustained detrusor contractions resulting in infrequent and incomplete voiding, with micturition in separate fractions. Bladder volume is usually larger than age-expected capacity. Residual urine is often present. Detrusor overactivity may be seen but it may also be absent [61, 73, 80]

Sustained alteration of voiding is associated with subsequent filling phase anomalies such as phasic detrusor overactivity and inappropriate urethral relaxation [81]. Urinary tract infections and kidney damage are common sequelae [82]. Over time, routine incomplete bladder emptying may possibly progress to

detrusor over-distension associated with chronic urinary retention and poor bladder emptying due to detrusor underactivity.

Urinary symptoms associated with dysfunctional voiding range from urgency to complex incontinence patterns during the day and night [78]. Children with dysfunctional voiding have a higher rate of recurrent urinary tract infections than children with no voiding abnormality and demonstrate increased incidence of higher grades of VUR [67, 84]. Symptoms are significantly more common in children with Attention Deficit Disorder than in 'normal' children [85].

Signs of dysfunctional voiding reflect initial "compensatory" overactivity of the detrusor along with poor emptying ability. They may include small bladder capacity, increased detrusor thickness, decreased detrusor contractility, impaired relaxation of the external urinary sphincter/ pelvic floor during voiding, weak or interrupted urinary stream and large post-void residual volumes of urine. There may also be ultrasound abnormalities, secondary vesicoureteric reflux, faecal incontinence or constipation [67, 86,87].

Treatment:

Symptoms are often refractory to standard therapy of hydration, bowel management, timed voiding and basic relaxed voiding education. Effective intervention requires combination therapy, generally with a sizeable investment of time over a long period. Treatment is aimed at optimising bladder emptying and inducing full relaxation of the urinary sphincter or pelvic floor prior to and during voiding.

Specific goals are:

- consistent relaxation of the pelvic floor throughout voiding,
- normal flow pattern,
- no residual urine and
- resolution of both storage and voiding symptoms.

Strategies to achieve these goals include pelvic floor muscle awareness and timing training, repeated sessions of biofeedback visualisation of uroflow curves and/or pelvic floor activity and relaxation, clean intermittent self-catheterisation for large post-void residual volumes of urine, and antimuscarinic drug therapy if detrusor overactivity is present. If the bladder neck is implicated in increased resistance to voiding, alpha-blocker drugs may be introduced. Recurrent urinary infections and constipation should be treated and prevented during the treatment period.

Treatment efficacy can be evaluated by improvement in bladder emptying and resolution of associated symptoms [88]. Controlled studies of the various interventions are needed. As with detrusor overactivity, the natural history of untreated dysfunctional voiding is not well delineated and optimum duration of therapy is poorly described.

Level of evidence: 4

Grade of recommendation: C

4.3. Detrusor underactivity

Children with detrusor underactivity may demonstrate low voiding frequency and an inability to void to completion using detrusor pressure alone. Voiding is of long duration, low pressure, intermittent and often augmented with abdominal straining.

Children with this condition usually present with urinary tract infections and incontinence. Urodynamically, the bladder has a larger than normal capacity, a normal compliance and reduced or no detrusor contraction during voiding. Abdominal pressure is the driving force for voiding. The previously used term 'lazy bladder' is incorrect and is no longer used.

A correct diagnosis can only be made by urodynamic evaluation. Renal function studies, renal ultrasound and VCUG should be performed to assess the extent of renal damage and reflux. Long-standing overactivity of the pelvic floor may in some children be responsible for decompensation of the detrusor, leading to an acontractile detrusor. However, no data are available to support this theory.

Treatment:

Treatment is aimed at optimising bladder emptying after each void. Clean intermittent (self) catheterisation is the procedure of choice to promote complete bladder emptying, in combination with treatment of infections and constipation [which may be extreme in these patients]. Intravesical electrostimulation has been described, but now it is still not recommended as a routine procedure for children.

Level of evidence 4

Grade of recommendation C

4.4. Voiding postponement

Voiding postponement is a condition in which children habitually postpone imminent micturition until overwhelmed by urgency, resulting in urgency incontinence [88]. A study comparing children with typical OAB to those with voiding postponement revealed a significantly higher frequency of clinically relevant behavioural symptoms in postponers than in children with OAB, suggesting that voiding postponement is an acquired or behavioural disorder [88]. The rates of Oppositional Defiant Disorder (ODD) are especially high. Some children with voiding postponement have abnormal uroflow patterns (90).

Voiding postponement can develop out of previous OAB, but can represent a separate disorder. Also, voiding postponement can induce OAB. Therefore, different aetiologies need to be considered.

Only 20% exhibit a fluctuating voiding pattern. It remains to be determined whether voiding postponement can develop in the setting of a perfectly normal

urinary tract or whether OAB is a necessary precursor.

Level of evidence 4

Grade of recommendation C

4.5. Giggle incontinence

In some children giggling can trigger partial to complete bladder emptying well into their teenage years, and intermittently into adulthood [91,92]. The condition occurs in girls and occasionally in boys and is generally self-limiting. The aetiology of giggle incontinence is not defined. Urodynamic studies fail to demonstrate any abnormalities, there is no anatomic dysfunction, the upper tracts appear normal on ultrasound, the urinalysis is normal and there are no neurological abnormalities [86,87]. It is postulated that laughter induces a generalised hypotonic state with urethral relaxation, thus predisposing an individual to incontinence, however the effect has not been demonstrated on either smooth or skeletal muscle. It has also been suggested that giggle incontinence is due to laughter triggering the micturition reflex and overriding central inhibitory mechanisms. One small study hinted at an association with cataplexy (associated involuntary truncal body movements) and narcolepsy (a state of excessive daytime sleepiness), suggesting involvement of central nervous structures, however with only 7 subjects further evidence is needed [94]. Since the aetiology of giggle incontinence is not known it is difficult to determine the appropriate form of treatment. Positive results have been reported with conditioning training, methylphenidate and imipramine [92- 98]. Others have tried antimuscarinic agents and alpha-sympathomimetics. There is no acceptable evidence that any form of treatment is superior to no intervention.

Level of evidence 3

Grade of recommendation D

4.6. Vesicovaginal entrapment

Urinary leakage that occurs in girls a short time after voiding to completion, that is not associated with any strong desire to void, may be the result of vesicovaginal reflux

[98]. Urine may become entrapped in the vagina during voiding due to labial adhesions, a funnel shaped hymen, or an inappropriate position on the toilet. The classic presentation is that of a girl who does not spread her legs apart during voiding and who is not sitting all the way back on the toilet seat, but who is rather sitting near the end of the toilet seat tilting forward. Obesity may be an associated risk factor. Changes in voiding position and treatment of labial adhesions will lead usually to resolution of the urine leakage.

Level of evidence 4

Grade of recommendation C

4.7. Bladder and bowel disorder

This is a term used to describe the association of any bowel and/or bladder disorder (11).

The genitourinary tract and the gastrointestinal system are interdependent, sharing the same embryologic origin, pelvic region and sacral innervation. Although children with voiding disturbances often present with bowel dysfunction, until recently this co-existence was considered coincidental. However, it is now accepted that dysfunction of both systems, in the absence of anatomical abnormality or neurological disease, is inter-related. The common neural pathways, or the mutual passage through the pelvic floor musculature, may provide a theoretical basis for this relationship, as may the acquisition of environmental and developmental learning. The latter can be influenced by episodes of urinary tract infection, constipation, anal pain or trauma, childhood stressors, reluctance to toilet and poor toilet facilities [69,78,100].

There is also evidence to suggest that in severe cases symptoms may have a neurological basis.

BBD is seen more frequently in girls than boys and is significantly associated with the presence of both VUR and UTI [101]. VUR is slower to resolve and breakthrough urinary tract infections are significantly more common in children with ES when compared to those without the diagnosis. Infections do not ameliorate with antibacterial prophylaxis. Age of first febrile UTI does not appear to be an aetiological factor [91], however, recurrence of UTI in children older than 5 years is associated with the presence of BBD [102-104].

Abnormal recruitment of the external anal sphincter during defecation or at call to stool is considered causative, in that it elicits concomitant urethral sphincter and pelvic floor co-contractions. Thus, in both systems a functional obstruction to emptying is generated. In the case of the urinary system, high pressures generated by the detrusor muscle to overcome a decrease in urethral diameter can stimulate detrusor hypertrophy, detrusor overactivity, and lead to incompetence of the vesicoureteric junctions. In the early stages of defaecation disorders, bowel emptying is incomplete, infrequent and poorly executed. As the dysfunction progresses stool quality becomes abnormal, the child develops distension of the rectum and descending colon, seems to lose normal sensation and develops faecal retentive incontinence. If constipation was not present as a predisposing factor, it rapidly develops [101].

Children with BBD commonly complain of daytime urinary incontinence, non-monosymptomatic nocturnal enuresis, recurrent urinary tract infections, imperative urgency to void (OAB) and exceptionally urinary frequency. On investigation, they are often noted to have poor voiding efficiency, vesicoureteric reflux, constipation, faecal incontinence, no regular bowel

routine and infrequent toileting. The incidence of children with elimination syndrome and sub-clinical signs and symptoms is unknown.

It is important to differentiate between functional constipation and non-retentive faecal incontinence, as the treatment differs. The ICCS has provided documents for both disorders (105,106).

Assessment follows the same process as for other aspects of paediatric bladder dysfunction, with the addition of a 2-week bowel diary and relevant symptom score. The inclusion of an ultrasound rectal diameter measure when assessing the bladder, has been shown to be discriminative for children with elimination syndrome. Urinary flow curve, perineal EMG and post void residual urine estimate, when considered in isolation, are not conclusive for the diagnosis of elimination syndrome. There is no evidence to suggest that anorectal manometry is warranted as a first line investigation in these children. Recently a symptom scale for BBD has been developed providing objective assessment for diagnosis and quantification of severity [107].

Treatment:

Treatment aims at assisting a child to become clean and dry in the short term, by retraining appropriate bladder and bowel awareness and teaching optimal toileting skills. As bowel dysfunction is more socially isolating than urinary incontinence, and in the light of evidence that amelioration of underlying constipation can relieve bladder symptoms, most clinicians begin with treatment of the bowel. Strategies include disimpaction [if needed], prevention of stool reaccumulation, and post-prandial efforts to empty the bowel while maintaining optimal defaecation dynamics (106). Once stools are being passed regularly, treatment focuses on teaching awareness of age appropriate fullness in the bladder, and training unopposed emptying (without straining or pelvic floor muscle recruitment), at pre-scheduled times. Pelvic floor awareness training and biofeedback therapy are integral.

There are few studies of the efficacy of treatment in children with BBD. Several authors have evaluated the outcome of constipation management on bladder symptoms, however the baseline characteristics of subjects were not described adequately enough to allow clear diagnosis of BBD [72, 107]

A review on the effectiveness of biofeedback for dysfunctional BBD reports that 80% of children benefited from biofeedback but that the level of evidence was low due to poor study designs (106, 109).

Level of evidence 4

Grade of recommendation C

5. PRINCIPLES OF NON-PHARMACOLOGICAL TREATMENT OF ALL DIFFERENT STATES

Treatment of the overactive bladder focuses on both the involuntary detrusor contractions and the child's awareness to these. The initial treatment of this and all other daytime urinary incontinence subtypes involves a behavioural and cognitive approach. Urotherapy is the umbrella term for all non-surgical and non-pharmacological interventions. The child and parent[s]/caregiver(s) are educated about normal bladder function and responses to urgency. Voiding regimens are instituted and UTIs and any constipation are managed. Additional treatment involves pharmacotherapy, pelvic floor muscle relaxation techniques and biofeedback, either alone or in combination.

Although there are many studies reported in the literature assessing the effects of various forms of therapy on daytime incontinence and urinary symptoms, many of these are case series rather than being randomised or controlled trials. The paucity of studies evaluating basic standard therapy initiatives has precluded double-blinded trials of novel and multimodal interventions. Whilst clinically important benefits are commonly described, patient numbers, objective outcome measures and length of follow-up are sub-optimal.

The main objectives of treatment are to normalise the micturition pattern, normalise bladder and pelvic floor overactivity and cure the incontinence, infections and constipation. Traditional therapy for day-wetting children is cognitive and behavioural. Children learn to recognise the desire to void and to suppress this by normal central inhibition instead of resorting to holding manoeuvres [i.e. immediate voiding without postponement] to generate urethral compression. Children with dysfunctional voiding learn to initiate voiding with a completely relaxed pelvic floor and to pass urine in association with a detrusor contraction rather than via generation of abdominal pressure. Dietary changes and bowel regimens are used to treat the constipation [108]. Antibiotic prophylaxis may prevent recurrent UTIs, however, data to support this is limited.

Some authors contend that in less severely affected children a thorough explanation of the underlying causes and the expected progress of resolution is sufficient treatment [52]. More active conventional management involves a combination of cognitive, behavioural, physical and pharmacological therapy. Common modes of treatment include parent and child reassurance, bladder retraining (including timed toileting), pharmacotherapy, pelvic floor muscle relaxation and the use of biofeedback to inhibit rises in detrusor pressure associated with urinary incontinence [33, 110-112]. Further treatment options include sug-

gestive or hypnotic therapy and acupuncture. A combination of bladder training programmes and pharmacological treatment, aimed specifically at reducing detrusor contractions, is often useful and sometimes necessary.

5.1. Bladder rehabilitation and urotherapy

Initial intervention for OAB, voiding postponement and dysfunctional voiding uses a non-pharmacological approach. Despite the use of urotherapy for many years there is no set format and many clinical studies utilise differing combinations of therapies, which makes it difficult to evaluate the results [111,112]. The aim of urotherapy is to normalise the micturition pattern and to prevent further functional disturbances. This is achieved through a combination of patient education, cognitive, behavioural and physical therapy methods.

A Danish report of the outcome of standard urotherapy in 240 children with daytime incontinence noted achievement of dryness in 126 children (55%). Alarm therapy has traditionally been used for the treatment of nocturnal enuresis but was recently used in management of daytime wetting. When a time watch was utilised as a reminder to void at regular intervals 70% of children became dry. An earlier study of a contingent alarm [which sounded when the child wets] versus a noncontingent alarm system (which sounded at intermittent intervals to remind the child to void) over 3 months in 45 children [113] was equally successful for the achievement of continence. Predictors for dryness included a low voiding frequency, larger volumes voided in relation to age-expected storage and fewer incontinent episodes per week [114].

There is evidence that for children who are therapy-resistant, timed voiding assisted by a timer watch added to urotherapy is effective (115).

Following a 3-month training programme, 42.8% of day wetting children were cured at 1 month, 61.9% by 6 months, and 71.4% by 1 year (116). Allen et al [117] reported that urotherapy patients with good compliance with timed voiding were significantly more likely to improve their continence than those with poor compliance. It has recently been highlighted however, that there is frequently conflict between school rules, routines and toilet facilities and the urotherapy programme components. Adaptive coping techniques added to urotherapy training may enhanced gains in dryness.

In children with OAB and dysfunctional voiding the pelvic floor muscles relaxation is impaired during voiding. Physiotherapy is concerned with re-training of specific muscle groups. Adjunctive physiotherapeutic input offers children different strategies to achieve pelvic floor relaxation during micturition.

Several centres offer intensive urotherapy called voiding schools or even inpatient rehabilitation. A prospective evaluation of 38 Belgian children who underwent this approach showed improvement in 90% of the children with 42% becoming dry, whilst no child

on the waiting list improved during the 6 months (118). Long-term follow-up of 75 incontinent children who underwent intensive urotherapy 16-22 years later showed a good result in 84% and the authors concluded that if the original outcomes of paediatric intensive inpatient urotherapy were good, they tend to remain so over time in most patients (119).

Level of evidence 3

Grade of recommendation C

5.2. Adjunctive biofeedback

Biofeedback is a technique in which physiological activity is monitored, amplified and conveyed to the patient as visual or acoustic signals, thereby providing the patient with information about unconscious physiological processes. Biofeedback is mainly utilized for the management of voiding phase (dysfunctional voiding due to pelvic floor muscle overactivity) abnormalities (120)

Biofeedback can help children to identify how to relax their pelvic floor muscles or recognize involuntary detrusor contractions.

Training with biofeedback can be used as a single treatment [121,122], or in conjunction with a comprehensive rehabilitation program [123,124]. It may be performed by a cystometrogram during which the child is taught to recognize and inhibit involuntary detrusor contractions by watching the pressure curve during cystometry. This is invasive and a time-consuming process with limited application as a routine treatment.

More commonly pelvic floor muscle relaxation is taught using EMG biofeedback and/or real-time uroflow. The child sits on a toilet with a flow transducer, watching both the flow curve and EMG on a computer display, and attempts to empty completely in one relaxed void. Ultrasound may be used to determine the post void residual and demonstrate complete emptying. Interactive computer games are commonly used to make biofeedback training more attractive to children [125,126], however care should be taken that posture and muscle recruitment approximates that of the voiding position. Home training can be performed with success using pure EMG-biofeedback.

The results of biofeedback are commonly reported as case series rather than RCTs. Results are generally positive but overall may not be superior to high quality standard urotherapy. The group receiving adjunctive biofeedback in the Vasconcelos study [116] did not achieve greater continence rates at the study end point, although a greater proportion of subjects achieved earlier dryness. Furthermore, the post void residual volumes were significantly reduced in the biofeedback group compared to the standard therapy only group.

Long duration follow-up, whilst desirable, confounds results of intervention in children who are continually

growing and maturing. Hellstrom *et al* report results of a 6-week bladder rehabilitation programme inclusive of biofeedback [111] and note that at 3 years, 71% of the children with detrusor overactivity, 70% of those with dysfunctional voiding and 73% of those with a combined disturbance had a normal micturition pattern. The potential for bias from intercurrent events and interventions precludes statements about the efficacy of biofeedback alone.

Level of evidence: 3

Grade of recommendation C

5.3. Clean intermittent (self) catheterisation

In children with an underactive detrusor, bladder emptying can be achieved with timed and double voiding. If this does not adequately empty the bladder clean intermittent self-catheterisation (CISC) may be tried [127-129]. This requires careful guidance for both the child and the parents. Sometimes it is necessary to give the child a suprapubic catheter for a while and gradually prepare him/her to accept CISC. Once the infections have cleared and the child is continent it will become easier for both the parents and the child to accept. The frequency of CISC depends on the severity of the problem and may vary between four times a day and once a day before going to bed.

Level of evidence 4

Grade of recommendation C

5.4. Neurostimulation

Neurostimulation has been used in adults for a variety of lower urinary tract symptoms and has been applied in children. The main indication is OAB or urge incontinence with good success rates. The use of transcutaneous stimulation with surface electrodes stimulating the sacral root (S3) has shown promising results, especially when tested as part of a randomised controlled trial [130]. Transcutaneous and percutaneous neurostimulation delivered over either the sacral outflow or peroneal region of the ankle at a frequency between 10-25 Hz, has proven a useful adjunctive treatment in children with detrusor overactivity. Intravesical stimulation is rarely indicated and can affect the function of an underactive detrusor and potentially improve detrusor contractile function and enhance bladder emptying [131,132]).

Electrical current directly affects the central nervous system by activating CNS centres facilitating both neural plasticity and normative afferent and efferent activity of the lower urinary tract. For children with structural abnormalities, for example imperforate anus, electrostimulation is one method of facilitating strength gains in the skeletal muscle and its fascial attachments. Treatment is particularly useful in patients with very little pelvic floor awareness to stimulate muscle recruitment. Once neural efficiency has improved, training is augmented by active pelvic floor contractions.

In 2011 three papers were published reviewing the use of neurostimulation in children (133-135). This highlights the level of interest in this modality for treating LUTD and bowel dysfunction. A literature search revealed 27 reports of the use of neurostimulation in children with non-neurogenic bladder dysfunction. Only five of these studies were randomised controlled or randomised cross-over studies whilst the rest were case series. However, parasacral Tens has been shown to be more effective than sham in randomised trials in treating OAB. Use of neurostimulation in children with neurogenic LUT dysfunction has been reported in 12 studies, 5 of which were randomised controlled trials.

Previously most studies have looked at the use of electrical neurostimulation in children whose symptoms have been refractory to all other interventions, whereas it is becoming apparent that sacral neurostimulation, especially TENS as first-line treatment is beneficial.

A recent prospective study in 69 children where neurostimulation was used as first-line treatment, a complete resolution of symptoms was seen in more than half of them (55,1%), after 20 sessions (136).

Also, studies using intravesical, transcutaneous and implantable electrodes have noted improved bowel function. One randomised placebo-controlled trial using interferential current transcutaneously showed significant improvements in colonic transit times, decreased soiling and abdominal pain and increased quality of life in children with severe constipation (137). Following up on these children for an average of 3.5 years has shown that these improvements were maintained (145).

From Table 1 and 2 different modes of application have been trialled in mostly small series of children. There is minimal standardisation of populations, application parameters or outcome measures. Thus, evidence is largely drawn from low quality studies. Clearly neurostimulation in children warrants larger, controlled and randomised studies, including its use as first-line intervention and in children with combined bladder and bowel dysfunction. Despite the slow pace of research the reviewers of the articles mentioned above agree that there is a positive role for neurostimulation in children with LUTD, and that it is adjunctive to other interventions, with no known predictors of efficacy now, but also rare and minor adverse events. Neurostimulation of the bowel shows promise.

Reported changes on bladder function with neurostimulation include: significantly increased bladder capacity, decreased severity of urgency, improved continence, and decreased frequency of urinary tract infection. Significant improvement in urodynamic parameters of bladder compliance, number of involuntary contractions, and bladder volume at first detrusor contraction have also been noted.

Tables 1 and 2: Study parameters in paediatric neurostimulation trials

Author and year of publication	Population	Design	N	Mode of application	Outcome measure
Guys 2004	Neurogenic (Spina bifida)	RCT	42	Sacral implant	n/s difference from controls for continence
Marshall 1997	Neurogenic (MMC)	RCT	50	Transcutaneous	n/s difference from controls for continence
Johnston 2005	Neurogenic (spinal cord injury)	Series	2	FES implant	Suppression of detrusor overactivity in 1 pt
Han 2004	Neurogenic (MMC)	Series	24	Intravesical	Significant ↓ in faecal incontinence
De Gennaro 2004	Neurogenic and Non neurogenic	Series	6 17	Percutaneous tibial nerve	n/s difference in neuropathic pts 5/9 with incontinence cured
Gladh 2003	Neurogenic and Non neurogenic	Series	20 24	Intravesical	40% cure neurogenic 83% cure non neurogenic
Hagerty 2007	Neurogenic	series	405	IVES	61% gained sensation >UD bladder capacity 77%
Balcolm 1997	Neurogenic	series	29	Transcutaneous	Sensation improved >bladder capacity (p<0.05)
Kajbafzadeh 2009	Neurogenic	series	30	Transcutaneous IFT	MMDP, PVR, and DSD improved to sham (p <0 .05) Also frequency and enuresis (p<0.05)

Table 2

Author and year of publication	Population	Design	N	Mode of application	Outcome measure
Tanagho 1992	Non neurogenic	Series	6	Sacral implant	Resolution 4/6
Trsinar 1996	Non neurogenic	Controlled trial (sham)	73	Anal plug	+ve gains in active group
Bower 2001	Non neurogenic	Series	17	Transcutaneous sacral	73% improved continence

Author and year of publication	Population	Design	N	Mode of application	Outcome measure
Gladh 2001	Non neurogenic (DI diagnosis)	Series	48	Anal plug	18/48 cured
Hoebeke 2001	Non neurogenic	Series	41	Transcutaneous sacral	56% cured after 1 year
Hoebeke 2002	Non neurogenic	Series	32	Percutaneous tibial nerve	25% cured, 35% improved UD>MVV
Gladh 2003	Non neurogenic	Series	24	Intravesical	Normalized voiding 83%
Lee 2005	Non neurogenic (infrequent voiding)	Series	12	Intravesical	Signif <input type="checkbox"/> max flow rate, signif <input type="checkbox"/> PVR
Barroso 2006	Non neurogenic (urge syndrome)	Series	36	Transcutaneous sacral	12/19 "complete" improvement
Humphreys 2006	Non neurogenic (severe DES)	Series	23	Sacral implant	Improvements: Day 83% Urgency 75% Freq'y 73% Bowel 80% Retent'n 60%
Malm-Buatsi 2007	Non neurogenic	Series	18	Transcutaneous sacral	13 cured
Roth 2008	Non Neurogenic (DES)	Series	20	Sacral implant	Resolution constipation in 71%
Hagstroem 2008	Non neurogenic	RCT (sham)	25	Transcutaneous sacral	8/13 partial response
Lordelo 2009	Non neurogenic	Series	49	Transcutaneous sacral	2yr later 73% cured
Capitanucci 2009	Non neurogenic	Series	33	Percutaneous tibial nerve	Complete /partial response 78% 2 yrs later
Lordelo 2010	Non neurogenic	RCT (sham)	21 (test) 16(control)	Transcutaneous sacral	62% cured test group. None in control (p<0.001)
Haddad 2010 (139)	Non neurogenic	RCT crossover	33	Sacral implant	Effective (p<0.001) Improvements: 75% for urinary 81% bowel
Lordelo 2010	Non neurogenic (NMNE)	Series	19	Transcutaneous sacral	42% resolved

Author and year of publication	Population	Design	N	Mode of application	Outcome measure
					21% improved
Groen 2012 (138)	Non neurogenic	Series	18	16 invasive SNM 7 pudendal stimulation	78% response 40% full response at end of study
Dwyer 2014 (141)	Non neurogenic	Series	105	Sacral implant	88% UI improvement
Sillen 2014 (140)	Non neurogenic	RCT	62	Transcutaneous sacral	No significance vs standard
Patidari 2015 (142)	Non Neurogenic	Series	40	Percutaneous tibial nerve	71,4% improvement
Veiga 2016 (135)	Non Neurogenic	Series	60	Transcutaneous sacral	89% improvement
Barroso 2013 (143)	Non-neurogenic OAB First line treatment	Series comparing PTNS to sacral Tens.	59 22PTNS 37 sacral Tens	PTNS x 1/week for 12 weeks Sacral Tens 20 mins, 3/week for 20 sessions	PTNS 9% full response Tens 70% full response
De Oliveira 2013	Non neurogenic Primary nocturnal enuresis	RCT behaviour therapy vs behaviour therapy plus sacral Tens	45 18 control 27 Tens group	Sacral Tens 3/weekly 10 sessions	Overall improvement 37.3% controls: 61.8% Tens (p=0.003) Controls : Tens Response 6%:15% Partial R 33%;56% No R 61%;30%
Tugtepe 2015	Refractory urinary incontinence –OAB and DV	Series	27 TENS	Tens over S3 dermatome 20 minutes daily for 3 months	70% complete response rate
Leong 2011	Children with slow transit constipation	3.5 year follow up following RCT using interferential electrical stimulation (IFT)	30	IFT 3/week -1-2 months	Improvement in 73% lasting more than 2 years in 30%. Recurrence in 30% after 6 months
Yik 2012 (144)	Children with slow transit constipation	Series	29	Home based IFT 1 hour /daily for 3-6 months	Sign. Reduction defaecation freq. and soiling,overall improvement pain / consistence
Sulkowsky 2015 (146)	Constipation, urinary and fecal incontinence , OAB	series	29	invasive SNM	55% voluntary bowel movements 91% suspended anticholinergics

Author and year of publication	Population	Design	N	Mode of application	Outcome measure
Rahem 2013 (145)	MNE	RCT sham	28	14 PTNS, 14 sham	78,6% partial/full response
Kajbafzadeh 2014	Neurogenic	RCT sham	30	Perineal electrical stimulation 15 minutes 15 sessions Sham –intensity not increased	Daily incontinence improved in treatment group (P<0.02).
Boudaoud 2015 (147)	Non neurogenic	RCT	20	11 TCPNS vs 9 sham	Urodynamics improves in PPTNS group, clinical results the same
Choi 2013	Neurogenic	Retrospec-tive study	88	Intravesical stimulation (IVES)	Bladder capacity increased DSD resolved in 55.6%

More recently the first reports on sacral nerve stimulation with implantable electrodes have been published. In a group of 20 patients between 8 and 17 years old followed prospectively, urinary incontinence, urgency and frequency, nocturnal enuresis and constipation were improved or resolved in 88% (14 of 16), 69% (9 of 13), 89% (8 of 9), 69% (11 of 16) and 71% (12 of 17) of subjects, respectively. Complications were seen in 20% of patients [138]. Different neuroanatomical pathways have been described as targets for invasive sacral neurostimulation. The third sacral (S3) nerve root remains the main access point used for neurostimulation treatment. A retrospective study of Luitzen-Albert Groen et al included 18 patients, of which 5 with neurogenic bladder showed a good short term (78%) and long term (73%) response (73%) (139). These results are similar to those of Hadad (140).

General limits of the evaluation of results for invasive SNS are the small number of patients in all series, the general absence of RCT, the different way to evaluate results and different clinical protocols, including implant techniques, furthermore in some countries as in the United States, SNS and PTNS have been approved by FDA for the treatment of urology diseases but SNS is not approved in children younger than 16 yrs. In Europe, the age limit is not so strictly defined as in the USA but the majority of experiences are mainly referred to postpuberal patients. Implantations of very young patient are generally avoided for a risk of electrode dislocation with statural growth during time, reduced collaboration and limitation for MRI studies. For all these reasons SNM in children still needs further studies (controlled and randomised). Evaluating SNM as first-line treatment in children with combined bladder and bowel dysfunction also depends on defining the criteria for optimal indications and predicting efficacy (149).

Due to the uncontrolled design the level of evidence is low. Experience from adults offered this treatment modality suggests future positive development in children to be likely.

Level of evidence: 3

Grade of recommendation C

5.5. Alarm therapy

Alarm therapy has traditionally been used for the treatment of nocturnal enuresis and has rarely been used for daytime wetting. Only one randomised clinical trial has been published to establish the efficacy of this form of treatment. Halliday *et al* compared a contingent alarm which sounded when the child wets with a noncontingent alarm system (which sounded at intermittent intervals to remind the child to void) [113]. Forty-four children participated in the study, 50% were assigned to each form of therapy for a 3-month period. Success was measured as 6 consecutive weeks without daytime wetting. Nine children in the non-contingent group and 6 children in the contingent group had persistent wetting. Although the risk

of persistent wetting with the contingent alarm was 67% of the risk of persistent wetting with the noncontingent alarm, the difference in the reduction in wetting between the groups was not significant (RR 0.67, 95% CI 0.29 to 1.56). In a retrospective review by Van Laecke et al, a cure rate of 35% after the use of a daytime alarm was described [150]. Due to the retrospective design of the study the level of evidence is low.

Level of evidence: 3

Grade of recommendation C

5.6. Group training

Group training programmes have been developed for children with treatment-resistant incontinence. The program includes provision of information, coaching regarding drinking and voiding habits, relaxation and stress-reduction techniques, as well as cognitive-behavioural therapy (CBT). The training proved to be effective in pre-post analyses (151).

5.7. Conclusion

Many clinical studies describe combinations of therapies rather than single interventions, which makes it difficult to evaluate the results. Physiotherapy and biofeedback both focus on the pelvic floor. Relaxation of the pelvic floor during voiding is essential for normal voiding and most of these patients are unable to relax their pelvic floor muscles. Biofeedback is important for showing the children the effect of their relaxation efforts. Most studies only state the clinical responses, and do not provide information on urodynamic parameters before and after treatment. A 'normal' flow curve may not mean normal voiding if no information is provided on post-void residual urine. In most papers the inclusion and exclusion criteria are not clearly documented, and it may very well be that the more difficult patients with both storage and voiding dysfunction were included in the study population. Furthermore, different series may describe different groups of patients due to poor definitions and an inadequate classification system. In children with a suspected bladder outlet obstruction, endoscopic investigations should be performed. Most often the anatomic abnormality causing obstruction can be treated at the same time. In girls, a meatal web may cause a deflection of the stream upwards [causing stimulation of the clitoris and bulbocavernosus reflex]. A meotomy may cure this problem, though no information on the long-term effects is available [79].

6. PHARMACOLOGICAL TREATMENT

6.1. Antimuscarinic therapy

Antimuscarinic therapy remains one of the common forms of therapy for overactive bladder / detrusor overactivity. Its use is predicated on the concept that parasympathetic mediated stimulation of muscarinic

receptors in the bladder causes detrusor overactivity, which is responsible for the symptoms of detrusor overactivity. Antimuscarinic agents have been demonstrated to increase bladder capacity, increase bladder compliance and decrease detrusor contractions in neurogenic detrusor overactivity. Detrusor overactivity is believed to play a role in many children with functional incontinence, vesicoureteral reflux and urinary tract infections [152]. More commonly, pharmacotherapy is instituted when behavioural therapy has failed to achieve a satisfactory outcome. Some clinicians use pharmacological therapy as first line in children with moderate to severe daytime incontinence [66].

Despite the frequent use of anticholinergic therapy, often in conjunction with a behavioural therapy regimen, the outcome of pharmacological therapy for daytime urinary incontinence is “unpredictable and inconsistent” and there are few randomised studies available to assess drug safety and efficacy.

The following antimuscarinics are briefly discussed:

Oxybutynin: approved for use in children FDA EMA

Propiverine: approved for use in children EMA

Tolterodine: tested phase 3 clinical trials, not approved for use in children

Solifenacin: tested phase 3 clinical trials, awaiting approval for use in children

Terodiline: investigated in a randomised placebo controlled trial, withdrawn because of serious cardiac side effects.

Trospium chloride: used in small series in children

Fesoterodine: used in small series in children

Oxybutynin

Currently the pharmacological therapy most widely used in children with detrusor overactivity is oxybutynin [153]. In 2002, a long-acting formulation, Oxbutynin-XL, has been approved by the FDA for use in children [154]. Historically, oxybutynin use has been limited by its adverse effect profile with such side effects as dry mouth, constipation, facial flushing and CNS effects. The incidence of side effects seems to be dose-related, both for oral and intravesical administration [155]. The CNS effects are related to the ability for oxybutynin to cross the blood brain barrier. Oxybutynin-XL utilises a novel delivery system, which results in absorption in the large intestine, thereby bypassing the first pass metabolism in the liver. This leads to a decrease in the amount of active metabolite [produced in the liver]: resulting in a more favourable tolerability profile. The delivery system requires an intact tablet and thus it cannot be cut or crushed to facilitate swallowing. Another method of delivery of oxybutynin is intravesical therapy. This method of delivery also avoids the first pass effect and leads to increased amounts of oxybutynin available compared to immediate release oxybutynin. Its

use in the neurologically intact patient is limited by the need for catheterisation [155].

There are only a few studies and only one randomised and double blinded, assessing the efficacy of oxybutynin in detrusor overactivity in children. In the European Bladder Dysfunction study, 97 children with DO on cystometrogram, received oxybutynin or placebo: the placebo effect of 45% was equal to the effect of oxybutynin chloride (156).

Curran *et al*, in a retrospective review of 60 patients assessed the efficacy of several agents, primarily oxybutynin in children with non-neurogenic detrusor overactivity, confirmed by urodynamics, who were refractory to behavioural therapy. Some children were treated with combination therapy. Eighty percent had complete resolution or a significant improvement in their urinary symptoms. The authors noted an average time to resolution of symptoms of 2.7 years [range 0.2 to 6.6], however patients were not followed frequently [157]. In a study by Van Hoeck *et al*, holding exercises with and without oxybutynin showed no beneficial effect on bladder volume. [158].

Level of evidence: 3

Grade of recommendation C

Propiverine

Propiverine is the second antimuscarinic drug approved by the EMA for use in children. A randomised, double-blind, placebo-controlled phase 3 trial with propiverine in children aged 5-10 yr. was reported in 2008. Of 171 randomised children, 87 were treated with propiverine and 84 with placebo. The primary efficacy outcome, decrease in voiding frequency, was -2.0 episodes for propiverine versus -1.2 for placebo; $p=0.0007$. Superiority could also be demonstrated for increase in voided volume (31.4 vs. 5.1ml; $p<0.0001$) and reduction in incontinence episodes (-0.5 vs. -0.2 episodes per d; $p=0.0005$). This clinical trial showed superior efficacy of propiverine over placebo and good tolerability for the treatment of children suffering from DO and urinary incontinence. [159,160] This is the first study with level of evidence 1 that shows beneficial effect of anticholinergic therapy.

A retrospective study published in 2012 on 68 children with OAB, reports a response rate of 86.8% (161).

Level of evidence: 1

Grade of recommendation B/C (only single study)

The following antimuscarinics are not approved for use in children, and may only be used off-label.

Tolterodine

Tolterodine, a non-selective antimuscarinic used for the treatment of overactive bladder and detrusor overactivity in adults. It is the first antimuscarinic agent designed specifically for use in detrusor overactivity and is felt to be “bladder selective”. Its affinity for the bladder compared to other organ systems

leads to an improved tolerability profile. The chemical nature of tolterodine makes it less likely to penetrate the blood brain barrier, which is supported by EEG studies [162]. The delivery system of the long acting preparation is such that the capsule may be cracked and "sprinkled" on food. Tolterodine has not been approved for use in children but there are several studies, which evaluate its safety and efficacy in children with detrusor overactivity. Hjalmas reported the results of an open label, dose escalation study using immediate release tolterodine in 33 children [163]. Doses ranged from 0.5 mg po BID to 2 mg po BID for 14 days. The results demonstrated a 21% (23% with 2 mg po BID) mean decrease from baseline in micturition frequency and a 44% mean decrease from baseline for the number of incontinence episodes in children treated with 1 mg and 2 mg po BID. Bolduc *et al* reported on a prospective crossover study of 34 children followed for > 1 year who were crossed over from oxybutynin to tolterodine because of adverse effects with oxybutynin [164]. Detrusor overactivity was confirmed in 19/20 who had urodynamic studies performed prior to therapy. Children received either 1 mg or 2 mg po BID and the median treatment period was 11.5 months. Efficacy was assessed by a questionnaire and was comparable for oxybutynin and tolterodine. Sixty-eight percent noted a > 90% reduction in wetting episodes at 1 year and an additional 15% noted a > 50% reduction in wetting episodes. Fifty nine percent reported no side effects with tolterodine and 18% reported the same side effect as with oxybutynin, but felt it was less severe. Eight patients [24%] discontinued tolterodine.

Munding *et al* reported on the use of tolterodine in children with "dysfunctional voiding" manifested as daytime wetting, frequency or urgency [165]. There was no documentation of uroflow studies to make the diagnosis of "dysfunctional voiding" and from the symptoms these children appeared to have detrusor overactivity. Children were started on behavioural modification for 4-6 weeks and pharmacological therapy was instituted if they failed or had only slight improvement with behavioural therapy. A minimum of 1 month's follow-up was needed for inclusion, but the mean follow-up was only 5.2 months. Doses ranged from 1 mg po BID to 4 mg po BID. Assessment of results was made by telephone survey. Thirty three percent had > 90% reduction in daytime and nighttime wetting episodes and 60% had > 50% reduction. Four patients [13.3%] had side effects, constipation in 2, dry mouth in 1 and diarrhoea in 1.

Reinberg *et al* performed an open label parallel group retrospective study of the efficacy and safety of immediate release and long acting tolterodine and extended release oxybutynin [166]. Children started out with the lowest possible dose, 2 mg tolterodine and 5 mg oxybutynin and titrated up according to response and side effects. Children were arbitrarily assigned to therapy based on the formulary restrictions of the health plan and there was an uneven distribution of patients in the treatment groups. Final dose and duration of treatment were not noted. Study nurses

asked about side effects and a voiding diary was used to assess efficacy. The authors concluded that extended release tolterodine [$p < 0.05$] and oxybutynin [$p < 0.01$] were more effective than immediate release tolterodine in improving urinary incontinence symptoms and that extended release oxybutynin was more effective than extended release tolterodine in resolving diurnal incontinence ($p < 0.05$) Long term tolerability of tolterodine extended release in a large paediatric population has been shown. [167]

Level of evidence: 3

Grade of recommendation C

Solifenacin

Solifenacin is an antimuscarinic agent used in children with OAB: Hoebeke *et al* published results on 139 children with therapy resistant OAB, with favourable results, and few side effects, in 2009 (168).

Bolduc *et al* conducted a prospective, open label study, and published their results in 2009: 72 children enrolled, 45 with non-neurogenic DO. Continence improved in all patients, including 24 who were dry, and 42 and 6 who were significantly and moderately improved, respectively (169).

Long term use showed that high subjective and objective success rates were maintained over a longer follow-up (170).

Phase 3 clinical studies in neurogenic children as well as in non- neurogenic children are being conducted.

Level of evidence: 2

Grade of recommendation 3

Terodiline

One of the drugs which has been investigated in a randomised placebo controlled trial was terodiline [171,172]. Because of serious cardiac side effects terodiline has been withdrawn from the market and is of only historical interest.

Trospium chloride

Trospium chloride has been used in small series in children. It is currently available in a twice a day dosing formulation. In the adult population, there is a 16% intra-individual variability in bioavailability and 36% inter-individual variability. Absorption is affected by food intake. Trospium's chemical structure make it unlikely to penetrate the blood brain barrier as supported by EEG studies. Lopez Periera *et al* evaluated the use of trospium in 62 children with documented detrusor overactivity and absence of 'detrusor sphincter dyssynergia' [173]. Children were randomly assigned to 10, 15, 20 or 25 mg of trospium administered in 2 divided doses or placebo. Fifty-eight children were evaluated. Response rates were assessed by incontinence episodes and urodynamic parameters. Overall, 32% had an excellent response, 42% a good response and 8% a fair response. Detrusor

overactivity completely resolved in 35%. Four children had medication related adverse effects including headache, dizziness, abdominal cramps and dry mouth.

Level of evidence: 3

Grade of recommendation C

Fesoterodine

Fesoterodine is approved for adults, and is reportedly safe and effective. A post marketing surveillance study with 2978 adults with OAB scored on efficacy in Korea showed amelioration in 91% (174)

Comparison with solifenacin showed no difference in efficacy, but more side effects with fesoterodine (175).

Expert opinion is that fesoterodine has a similar tolerability and side effect profile to other antimuscarinics and is, therefore, unlikely to revolutionise the treatment of the overactive bladder (176).

In children, the only study done is a Dose-escalating study of the pharmacokinetics and tolerability, showing steady-state plasma 5-hydroxy-methyltolterodine exposures similar to those in adults. The doses given were well tolerated. Only 10 children with non-neurogenic bladder and OAB were included (177).

Darifenacin

Darifenacin is approved for use in adults too. Although already mentioned in 2004 to be promising, in children, up to date no studies have published (178).

Some authors try combinations of anticholinergics for refractory OAB: Bolduc *et al* treated 33 children with a combination of oxybutynin and solifenacin or tolterodine with good success (179, 180).

Fahmy *et al* enrolled 72 children in a prospective study where trospium chloride was added to oxybutynin in refractory OAB: 68% showed improvement, 22,2% was completely dry (181).

6.2. Beta3-adrenoceptor agonists

Mirabegron is the first of a new class of drugs for the treatment of OAB. Stimulation of β_3 -adrenoreceptors results in relaxation of the detrusor smooth muscle and improves bladder compliance and bladder capacity. Randomised controlled trials in adults show that mirabegron decreased the number of micturitions and incontinence episodes in a 24-hour period compared with placebo. Mirabegron is approved for use in adults (182,183).

There is only one study published in children. A prospective off-label study in 58 children with refractory OAB or with significant side effects with at least two different antimuscarinic agents were recruited. Continence improved in 52 of 58, with 13 being completely dry. Eight patients reported mild or moderate side effects. Absence of a placebo group is a limitation of the study (184).

Phase 3 studies with mirabegron are currently running in children with neurogenic bladder, but not yet in neurologically normal children.

6.3. Botulinum Toxin

Botulinum toxin is used in children, mainly with neurogenic detrusor overactivity. Initial results are promising, but more studies need to be done. In children 100-200 Units on average, are injected in 30-40 spots [185]. The trigone should not be injected, as there is an increased risk of vesico-ureteric reflux. The results last about 6-9 months. Botulinum toxin is not registered for injection in the detrusor or the sphincter in children. It is used off-label and further prospective studies are needed before a general recommendation can be made (186).

One prospective uncontrolled study by Hoebeke *et al* in 21 children shows beneficial effects of botulinum toxin in 70% of children with therapy resistant detrusor overactivity [187].

Urodynamic assessment proves amelioration after botulinum toxin A in detrusor contractions and bladder capacity in a prospective study with 13 children included (188). Leon *et al* published an even smaller prospective uncontrolled series in 2014 on 8 children with favourable results (189). Other published studies are all retrospective: A retrospective study in 30 patients by Blackburn *et al* published in 2013 and a retrospective study in 57 patients by Mc Dowell published in 2012 demonstrates good response (190, 191). Injection of botulinum toxin into the external sphincter is also possible, but the results are more variable and last only 3-4 months [192]. Radojici *et al* describe excellent results in the treatment of dysfunctional voiding. In 20 children, good results are described for 17 patients [193]. In a retrospective study by Franco *et al*, similar results are described in 16 children, however using a higher dosage [194].

These results are confirmed by 't Hoen *et al*, and by Vricella *et al*, but the effect in their series is longer: they report safe and persistent satisfactory results during an average of 13-months in 18 of 20 patients and 15 months in 8 of 12 patients respectively with therapy-refractory dysfunctional voiding (195,196).

Less invasively, botulinum toxin can be administered electromotively: a small study in 15 children shows the administration is feasible, safe, and results in considerable improvement on urinary incontinence (197).

Level of evidence: 3

Grade of recommendation C

6.4. Alpha-adrenergic blockers

Treatment of the overactive pelvic floor and sphincter is much more difficult. Treatment with alpha-adrenergic blockade seems promising, but from the presented studies it is difficult to draw firm conclusions:

as most series are small, not randomised and describe a mixed patient population [198-200].

In a more recent uncontrolled study by Donohoe *et al* a total of 26 patients with Primary Bladder Neck Dysfunction (20 males, 6 females, mean age 12.8 years) were treated with alpha-blockers. Mean average and maximum uroflow rates improved from 5.5 to 12.6 cc per second and from 10.3 to 19.7 cc per second, respectively, while mean EMG lag time decreased from 24.4 to 5.7 seconds and post-void residual urine volume from 98.9 to 8.9 cc (all $p < 0.001$). Mean follow-up was 31 months and no major adverse side effects were observed [201]. Further randomised controlled studies are needed to define the place of alpha-blockers.

Level of evidence: 3

Grade of recommendation C

Because there is much variability in presenting symptoms as well as the underlying pathology an individual approach is advisable: a step by step algorithm has been developed by Marschall-Kehrel, which seems to deal with many of these variables [202].

Level of evidence 3.

Grade of recommendation B/C

The limited number of identified randomised controlled trials does not allow a reliable assessment of the benefits and harms of different methods of management in children. Further work is required in this difficult clinical area. The establishment of outcome measures is needed, to facilitate randomised controlled trials of routine therapy. Interventions that would benefit from further investigations include: bladder and voiding education, bladder retention training, bowel management, hypnotherapy and alternative therapies, psychology, prophylactic antibiotic medication, neuromodulation, biofeedback therapy and pelvic floor muscle awareness and specific relaxation. Only then can the efficacy of new interventions be measured in children with detrusor overactivity or dysfunctional voiding.

6.5. Conclusion

A wide therapeutic choice available to clinicians, many of the commonly used treatments are of dubious value and have not been rigorously evaluated in careful clinical trials with an appropriate study design. Children who suffer this distressing condition, and their families, and those who care for them clinically, need clear guidance as to which treatments are of proven value. They need access to treatments which work, and they need protection from treatments which do not work.

Children who present with urinary symptoms may have been victims of sexual abuse. In these cases, the use of invasive diagnostic procedures (VCUG and urodynamic studies) must be regarded as contraindicated, as must the use of invasive intra-anal treatment devices. Development of less invasive methods

of diagnosis and treatment should therefore be encouraged.

V. NEUROGENIC DETRUSOR-SPHINCTER DYSFUNCTION

1. INTRODUCTION

Neurogenic detrusor-sphincter dysfunction (NDSD) can develop because of a lesion at any level in the nervous system. This condition contributes to various forms of lower urinary tract dysfunction which may lead to incontinence, urinary tract infections (UTIs), vesicoureteral reflux (VUR), and renal scarring. Surgery may be required to establish adequate bladder drainage, and potentially, if not managed properly, NDSD can cause renal failure, requiring dialysis or transplantation.

Management of neurogenic detrusor sphincter dysfunction in children has undergone major changes over the years. While the use of diapers, permanent catheters, external appliances and various forms of urinary diversion were acceptable treatment modalities; these are now reserved for only a small number of resistant patients (1). Initially, long-term renal preservation was the only aim of therapy and early diversion had the best long term results for preserving renal function. Despite some of the complications of ileal conduits and cutaneous urostomies requiring secondary surgery, this form of treatment offered the best outcome for renal preservation with socially acceptable continence (2).

Introduction of clean (self) intermittent catheterisation revolutionised the management of children with NDSD. It, not only made conservative management a very successful treatment option, but also made surgical creation of continent reservoirs a very effective alternative with a good quality of life (3).

The causes and presentation of a neurogenic bladder in a child is different from adult forms. In most cases, the paediatric neurologic bladder is caused by congenital problems, and many investigators differentiate between a neurologic and a neuropathic bladder. A neurogenic bladder is one from a true neurologic deficit like spina bifida (SB), and a neuropathic bladder is one that acts like a neurogenic bladder but is not caused by an innervation problem like valve bladder syndrome. Acquired forms caused by trauma, infection, or behavioural issues are more comparable with adult clinical pictures (4).

The most common cause of NDSD in children is neurospinal dysraphism and this condition presents with various patterns of detrusor-sphincter dysfunction within a wide range of severity. About 15 % of neonates with myelodysplasia have no signs of lower urinary tract dysfunction (LUTD) when initially studied (5). However, there is a high risk of progressive changes in the dynamics of the neurological lesion in

time and even babies with normal LUT function at birth have a 1 in 3 risk of developing either detrusor sphincter dyssynergia or acontractile detrusors by the time they reach puberty (6). Nearly 60 % of the neonates with neurospinal dysraphism may develop upper tract deterioration due to increased detrusor filling pressures and infections, with or without reflux (7,8).

As our understanding of urodynamic studies has evolved it allowed us to understand the nature and severity of the problems and administer management in a more rational manner differing according to the functional characteristics of each detrusor sphincter unit. Although the last quarter century has witnessed a remarkable progress in understanding pathophysiology, pathogenesis and the management of these children, the main goals of treatment remained the same i.e. the prevention of urinary tract deterioration and the achievement of continence at an appropriate age.

2. PRESENTATION OF NEUROGENIC DETRUSOR-SPHINCTER DYSFUNCTION IN CHILDREN

Neurogenic detrusor sphincter dysfunction can develop because of a lesion at any level in the nervous system, including the cerebral cortex, spinal cord or the peripheral nervous system. The level of the defect on the spine is strongly associated with survival and the development of cognitive and motor skills, with cervico-thoracic levels performing significantly lower in comparison with lumbosacral defects.

The type and degree of detrusor sphincter dysfunction is poorly correlated with the type and spinal level of the neurological lesion.

The closure of spinal canal in utero takes place in caudad direction from cephalic end and is completed at around 35 days of gestation. The failure of mesodermal in-growth over the developing spinal canal results in an open lesion most commonly seen in the lumbosacral area. The degree of this closure deficiency contributes to a variable presentation of neural injury with varying degrees of LUTD and lower extremity problems.

Myelodysplasia, also commonly known as **spina bifida (SB)**, is a general term that describes incomplete closure of the vertebral column and malformation of the embryonic neural tube. This term includes a group of lesions like spina bifida occulta, meningocele, lipomyelomeningocele, or myelomeningocele. Myelomeningocele is by far the most common defect seen and the most detrimental. Traumatic and neoplastic spinal lesions of the cord are less frequent in children (9).

In **meningocele**, the meninges protrude through a vertebral canal defect

but the neural elements of the cord remain confined within the canal.

In **myelomeningocele**, the neural roots or segments of the spinal cord herniate through the incompletely closed vertebrae.

The neurological lesions produced by myelodysplasia are variable and contingent on the neural elements that protrude within the meningocele sac. The bony vertebral level correlates poorly with the neurologic lesions produced. Additionally, different growth rates between the vertebral bodies and the elongating spinal cord can introduce a dynamic factor to the lesion, and scar tissue surrounding the cord at the site of meningocele closure can tether the cord during growth (11).

In **occult myelodysplasia**, the lesions are not overt and often with no obvious signs of neurological lesion. The diagnosis of this condition has increased since the advent of spinal ultrasonography and magnetic resonance imaging. Yet, in nearly 90% of patients, a cutaneous abnormality overlies the lower spine and this condition can easily be suspected by simple inspection of the lower back. These cutaneous lesions can vary from a dimple or a skin tag to a tuft of hair, a dermal vascular malformation, or an obvious subdermal lipoma. (9) Alterations may be found in the arrangement or configuration of the toes, along with discrepancies in lower extremity muscle size and strength with weakness or abnormal gait. Back pain and an absence of perineal sensation are common symptoms in older children. Incidence of abnormal lower urinary tract function in patients with spina bifida occulta is as high as 40%. Occult lesions may also become manifest with tethering of the cord later in life. This can lead to changes in bowel, bladder, sexual and lower extremity function.

Sacral agenesis is a rare congenital anomaly that involves absence of part or all of one or more sacral vertebrae. Perineal sensation is usually intact and lower extremity function is usually normal and the diagnosis is made when a flattened buttock and a short gluteal cleft is seen on physical examination. This lesion may produce variable degrees and patterns of LUTD.

Cerebral palsy patients may also present with varying degrees of LUTD usually in the form of overactive detrusor and wetting.

Imperforate anus is a rare anomaly and presents with a closed rectum that does not open onto anal skin verge. These children may present with accompanying spinal cord pathology. This is more common when the rectum ends above the pelvic floor muscles and they should undergo a MR imaging for detection. Early detection of this problem in imperforate anus patients is important to improve the child's chance of maintaining healthy kidneys and becoming continent.

3. CLASSIFICATION: PATTERN RECOGNITION

The purpose of any classification system is to facilitate the understanding and management of the underlying pathology. There are various systems of classification of the neurogenic bladder.

Most systems of classification were formulated primarily to describe those types of dysfunction secondary to neurologic disease or injury. Such systems are based on the localisation of the neurological lesion and findings of the neuro-urologic examination. These classifications have been of more value in adults as neurogenic lesions are usually due to trauma and more readily identified.

In children, the spinal level and extent of congenital lesion is poorly correlated with the clinical outcome. Indeed, severe detrusor sphincter dysfunction has been associated with minimal bony defects. Various possible neuropathological lesions of the spinal cord including syringomyelia, hydromyelia, tethering of the cord and dysplasia of the spinal cord are the causes of these disparities and they may extend several segments above and below the actual site of the myelomeningocele. Therefore, urodynamic and functional classifications have been more practical for defining the extent of the pathology and planning treatment in children.

The detrusor and sphincter are two units working in harmony to make a single functional unit. The initial approach should be to evaluate the state of each unit and define the pattern of bladder and sphincter dysfunction. Determined by the nature of the neurologic deficit, they may be either in an overactive or in an inactive state. The detrusor may be overactive with increased contractions during filling, with a diminished bladder capacity and compliance or be underactive with no effective contractions during voiding; the bladder outlet (urethra and sphincter) may be independently overactive causing functional obstruction or paralysed with no resistance to urinary flow leading stress incontinence.

These conditions may exist in any combination (10-15).

Urodynamic evaluation (preferably in combination with fluoroscopy) makes pattern recognition possible. Four major types are usually used to describe the detrusor-sphincter dysfunction:

1. Detrusor overactivity with overactivity of the sphincter (mostly dyssynergia),
2. Detrusor overactivity with normal or underactivity of the sphincter,
3. Detrusor underactivity with sphincter overactivity and
4. Detrusor underactivity with sphincter underactivity.

Besides these 4 patterns, one can use the ICS classification: overactive detrusor, underactive detrusor, overactive sphincter and underactive sphincter. Sometimes this is more helpful, as the detrusor may be overactive during filling, but underactive during 'voiding'.

The urodynamic investigation is considered normal when there is suitable age appropriate capacity, good compliant bladder with no overactivity and normal innervation of the sphincter with normal sacral reflexes and an increase in pelvic floor activity during filling and no activity during voiding. Presence of detrusor overactivity during filling with or without decreased capacity and compliance, is usually seen when there is upper motor neuron lesion and this is usually accompanied by overactivity of the sphincter and failure to relax during voiding. A lower motor neuron lesion is considered when the voiding detrusor contractions are weak or lost and the sphincter is underactive. Urodynamic investigations make it possible to establish a management plan for each individual patient.

Level of evidence: 3

Grade of recommendation B

For the very young child the combination of an overactive detrusor and sphincter is potentially dangerous because of the high intravesical filling pressures, which will put the upper tract at risk (vesicoureteral reflux and hydronephrosis), whereas an underactive detrusor and a paralysed sphincter is relatively safe, providing a low-pressure reservoir (16-19).

Level of evidence: 2

4. PRENATAL DIAGNOSIS AND FETAL SURGERY

In utero intervention holds the promise of reversing some of the sequelae and improving outcome in SB patients. To prospectively evaluate the value of intrauterine surgery, a randomised controlled trial was established in 3 centres. The endpoints of this Management of Myelomeningocele Study (MOMS) included fetal and infant mortality, the need for a ventriculoperitoneal shunt at 1 year of age, and the evaluation of mental and motor development at 30 months of age. There were no maternal deaths and the rates of adverse neonatal outcomes were generally similar between the two groups (20). Long-term (5-year) follow-up has occurred in this cohort of patients. Previous reports have documented decreased incidence of ventriculoperitoneal shunting and neuromotor functioning, showing improved outcomes (less trabeculation and open bladder neck) compared with historical controls (21). The evidence to suggest prenatal surgery is still low and it should only be done in designated centres.

5. MANAGEMENT

The main aim in management of NDSD in children is to ensure and maintain a reservoir with normal age-matched capacity and good compliance that can be emptied completely at low pressures and at regular intervals. Urological care is initiated soon after a child with SB is born and is maintained throughout childhood. In the first years of life, the kidneys are highly susceptible to backpressure and infection. Bladder drainage is essential during and after the closure of the spinal defect in early in life. Following the closure within a few weeks emphasis will be on documenting the pattern of neurogenic detrusor- sphincter dysfunction and assessing the potential for functional obstruction and whether there is vesicoureteral reflux (19,22). Ultrasound studies and a VCUG or video-urodynamics to exclude reflux must be performed soon after birth. Measurement of residual urine during both ultrasound and cystography should also be done. These studies provide a baseline for the appearance of the upper and lower urinary tracts, can facilitate the diagnosis of hydronephrosis or vesicoureteral reflux and can help identify children at risk for upper urinary tract deterioration and impairment of renal function.

Concerning the bladder function, 2 general scenarios are common. One group of patients will have an overactive sphincter and develop high detrusor leak point pressures greater than 40 cm H₂O and are, therefore, at risk for upper tract damage. The other group will have underactive sphincter resulting in free urine flow at low pressures into the diaper with little risk to the upper tract. A urodynamic evaluation can be done after some weeks and needs to be repeated at regular intervals, in combination with evaluation of the upper tracts (22).

Level of evidence 3

Grade of recommendation: B

Overwhelming experience gained over the years with early management of neurogenic bladder in infants has led to a consensus that children do not develop upper tract deterioration when managed early with CIC and antimuscarinic medication (22-25). Therefore, initial treatment should consist of oral or intravesical antimuscarinic drugs in combination with clean intermittent catheterisation, to start soon after birth in all babies and especially in those with signs of possible outlet obstruction (26-30). The volume of urine collected with CIC and severity of urine leakage in between CIC will provide more information about the characteristics of bladder storage and drainage.

Level of evidence 2

Grade of recommendation: B

The early initiation of intermittent catheterisation in the new-born period, makes it easier for parents to master it and for children to accept it as they grow

older (31,32). With early management, not only are upper tract changes fewer, but also bladders are better protected and incontinence rates are much lower.

It has been suggested that increased bladder pressures due to detrusor-sphincter dyssynergia cause secondary changes to the bladder wall. These fibroproliferative changes may cause loss of elasticity resulting in a small non-compliant bladder with progressively elevated pressures. It is believed that early institution of intermittent catheterisation and anticholinergic drugs may prevent this in some patients (33-35).

Level of evidence 3

Retrospective evaluation of patients has also shown that significantly fewer bladder augmentations were required in patients with early start of CIC (30,31).

Level of evidence 4

The main disadvantage of CIC is bacteriuria which is found in 60% of the patients, but symptomatic UTI are less common (20%) with CIC when compared to the group without CIC (40%). Since the risk of reflux is similarly low with CIC, the renal scar rates are lower. CIC alone, when begun in infancy can achieve continence at a rate of 60 %. When combined with newer and more potent antimuscarinic drugs continence rates approach 75-80%. (36-39)

Due to high risk of latex sensitivity in the NDSD population, non-latex catheters are recommended. Hydrophilic-coated catheters have become more popular as they are more practical to use and are associated with less pain in use. In a randomised trial comparing hydrophilic-coated catheters to uncoated catheters, there was a reduction in microscopic haematuria and better overall satisfaction with the hydrophilic-coated catheters (40).

A Cochrane review examined sterile versus clean catheterisation technique, coated (pre-lubricated) versus uncoated (separate lubricant) catheters, single (sterile) or multiple use (clean) catheters, self-catheterisation versus catheterisation by others, and any other strategies designed to reduce UTIs with respect to incidence of symptomatic UTI, haematuria, other infections, and user preference, in adults and children using CIC (41). This review found a lack of evidence to state that the incidence of UTI is affected by any parameter. Another recent review failed to show that single use hydrophilic-coated catheters decrease the incidence of symptomatic urinary tract infection, when compared to clean multiple use polyvinylchloride catheters (42). The evidence to suggest one specific catheter type, technique, or strategy is weak and choice of catheters and regimens should be made on an individual basis.

Level of evidence 3

At present oxybutynin, tolterodine, trospium, propiverine and solifenacin are the most frequently used anticholinergic drugs to treat detrusor overactivity in children.

The clinical efficacy and side effects from anticholinergics is related to the receptor subtype present in the target organ. There are several muscarinic receptor subtypes throughout the body named as M1, M2, M3, M4, and M5. The predominant muscarinic subtype in the bladder is the M2 receptor (66%); however, it is the M3 receptor subtype (33%) that is more important for detrusor activity (43).

Some clinical studies are available, but not many randomised placebo controlled studies have been performed (35,44-46).

Oxybutynin is the first anticholinergic agent which has undergone a broad investigation in children with NDS. It is the only FDA approved anticholinergic for paediatric use in NDS. The dosing of oral and intravesical oxybutynin is 0.2 mg/kg/dose every 8 hr. Despite its high efficacy, oxybutynin has major side effects, which include: dry mouth, constipation, blurred vision, headache, somnolence, learning disability, flushing, constipation and dry itchy skin.

If children are unable to tolerate oral oxybutynin, other modes of delivery can help reduce side effects. The intravesical route does not rely on gastrointestinal absorption and therefore largely avoids hepatic metabolite, N-desethyloxybutynin, that is generated. It is an active metabolite with similar pharmacological properties to oxybutynin, increasing the potential for adverse effects. A meta-analysis involving intravesical oxybutynin in children with NBD supports its efficacy in lowering the mean maximum detrusor pressure while increasing bladder capacity, but side effects are nevertheless present, although fewer than with oral oxybutynin. Incontinence has been shown to be improved significantly in most studies, with "dry and improved" rates ranging from 61% to 83% (47,48). The transdermal route is an alternative route with similar benefits as intravesical treatment as it circumvents the production of N-desethyloxybutynin (49). The main limitations with transdermal delivery are local skin site irritation and the necessity for continual skin adherence.

A prospective controlled trial evaluating trospium in children reports that trospium is effective and safe in correcting detrusor overactivity in children but this study did not include patients with a neurogenic bladder (50). Tolterodine has undergone a trial in children with NDS by the FDA. Study design limitations, however, prevent therapeutic labelling for tolterodine in the treatment of children with NDS. In small case studies two different forms of tolterodine have been investigated in children. Tolterodine has similar efficacy and tolerability to oxybutynin in children with NDS and the extended release formulation of tolterodine was as efficient as the instant release form with the advantages of being a single dose and less expensive (51,52).

In a randomised, controlled trial once-daily solifenacin oral suspension in children with overactive bladder was superior to placebo for mean voided volume

(primary efficacy endpoint) and was well tolerated (53).

Mirabegron added to solifenacin was also shown to be a safe alternative for children with refractory overactive bladder. Dual therapy is well tolerated and adjusted dose regimen appears safe in this first paediatric study (54).

Based on the data available in children with neurogenic bladder over activity use of anticholinergic drugs is the mainstay of medical treatment. There is high level of evidence to suggest use of anticholinergic drugs in children with NDS to reduce storage pressures and increase voided volume.

Level of evidence 2

Grade of recommendation: B (side effects)

Use of medication in children with neurogenic bladder to facilitate emptying has not been studied well in the literature. Few studies investigating the use of alpha-adrenergic blockade in children with neurogenic bladder report good response rates but they are non-controlled studies and long-term follow-up is lacking (55-57). A recent study with selective α 1-blockers (doxazosin) in children with NDS and increased leak point pressure (LPP) did not show any evident efficacy (58).

Level of evidence 4

In neurogenic bladders that are refractory to antimuscarinics and remain in a low capacity and high-pressure state, injection of onabotulinumtoxinA (BTX) into the detrusor has been introduced as a new treatment alternative (59-60). Initial promising results in adults have initiated its use in children. So far paediatric studies have been open-label and prospective controlled trials are lacking (61-63). In a recent systematic review examining 12 series (all non-randomised and only 2 with control group) injection of BTX A in therapy resistant bladders causes a significant improvement in terms of continence, maximum detrusor pressure, maximum cystometric capacity, and bladder compliance. This treatment seems to be more effective in bladders with evidence of detrusor overactivity, while non-compliant bladders without obvious detrusor contractions are unlikely to respond to this treatment (64).

Level of evidence 2

Grade of recommendation B

Dosage in children should be determined by body weight, with caution regarding total dose if also being used for treatment of spasticity, and minimum age (65- 68). In most published studies, the dose of BTX-A is 10 U/kg up to a maximal dose of 300 U involving 30 trigone sparing injections of 10 U/kg/ml in the detrusor. BTX-A seems to reach efficacy levels at 2 weeks and maximum effects within a month. Duration of the BTX-A effect ranges from 3 to 8 months depending on short-term versus long-term repeated in-

jections (69-70). Few adverse events have been reported in children, but the need for CIC after injection is an important consideration and is higher when high doses are used (71).

BTX-A injection into the urethral sphincter has been shown to be effective in decreasing urethral resistance and to improve voiding (72). A meta-analysis of BTX-A injection (in mainly adults with spinal cord injury) to the sphincter has shown its effectiveness in reducing postvoid residual urine and demonstrating a statistically significant reduction in detrusor pressure and urethral pressure 1 month postinjection (73). Current evidence is insufficient to recommend its routine use in decreasing outlet resistance, but it could be considered as an alternative in refractory cases (74, 75).

Level of evidence 3

Grade of recommendation B

Intravesical electrical stimulation of the bladder was introduced more than four decades ago and it has been tested in some open clinical trials in children since 1984 (76). Its practice is limited to a few centres who have reported varying results.

The only randomised controlled trial looking at this mode of therapy has failed to show efficacy (77).

The nature of this type of treatment (time consuming and very dedicated personnel) renders it unattractive for most treatment centres.

Level of evidence 2

Grade of recommendation C

Nerve stimulation via the sacral or transcutaneous route has been also studied in the treatment of patients with a non-neuropathic bladder.

Although transcutaneous nerve stimulation has been found to be effective in treating overactive bladder disorders in chronic pelvic pain/painful bladder syndrome and in children with non-neurogenic lower urinary tract disorders; its effectiveness has not been established for children with NDS (78).

In a report of a prospective study, sacral nerve modulation conducted in children with NDS, comparison of urodynamic variables revealed no statistically significant difference except that functional bladder capacity was better in the oxybutynin group and leak point pressure was better in the sacral neuromodulation group (79).

Although nerve stimulation has good evidence for its efficacy in non-neurogenic bladder overactivity, both in children and adults, there is no evidence for its effectiveness in neurogenic overactivity. Its use remains investigational (80).

Children with neurogenic bladder also have disturbances of bowel function. Faecal incontinence in these children is frequently unpredictable; it is related to the loss of lower bowel sensation and function, altered

reflex activity of the external sphincter and the consequent failure to fully empty the rectum (81).

Most children with a neurogenic bladder also have constipation and this is managed most commonly with laxatives, such as mineral oil, combined with enemas to facilitate removal of bowel contents. A regular and efficient bowel emptying regimen is often necessary to maintain faecal continence and this may have to be started even at a very young age. With antegrade or retrograde enemas, most of these children's constipation can be managed and they may attain some degree of faecal continence (82-86).

With availability of retrograde enemas devices with a balloon on the rectal catheter to prevent leakage of solution, retrograde enemas have become more efficient and more popular in comparison to antegrade enemas (87).

Level of evidence 3.

Grade of recommendation C

Biofeedback training programmes to strengthen the external anal sphincter have not been shown to be more effective than a conventional bowel management programme in achieving faecal continence (88). Electrostimulation of the bowel may also offer a variable improvement in some patients (89).

Level of evidence 3

Grade of recommendation D

Urinary tract infections are common in children with neurogenic bladders. In the absence of reflux, patients with urinary tract infections should be treated if symptomatic. There is strong evidence not to prescribe antibiotics to patients with asymptomatic bacteriuria (90-93). Bacteriuria is seen in more than half of the children using clean intermittent catheterisation (CIC), but this is not an indication for treatment.

Level of evidence 3

Grade of recommendation B

Patients with vesicoureteral reflux and frequent urinary tract infection require prophylactic antibiotics to reduce the incidence of pyelonephritis, which can potentially lead to renal damage (94).

Sexuality, while not an issue in early childhood, becomes progressively more important as the patient ages. This issue has historically been overlooked. Patients with myelodysplasia have sexual encounters, and studies indicate that at least 15-20% of males are capable of fathering children and 70% of females can conceive and carry a pregnancy to term. Therefore, counselling patients regarding sexual development is important in early adolescence.

Children with a good response to antimuscarinic treatment and an overactive sphincter may be continent between catheterisations. Bladder pressure and (normal) development of the upper tracts will determine whether additional treatment is necessary.

Children with therapy resistant overactivity of the detrusor, or small bladder capacity and poor compliance will usually need additional surgical treatment such as bladder augmentation.

Children with detrusor overactivity but with underactive sphincters will be in a better shape in terms of protecting their upper tracts, but they may be severely handicapped because of their incontinence. Initial treatment will be intermittent catheterisation (as it may reduce the degree of incontinence and offers a much better control over urinary infections) in combination with antimuscarinic drugs. At a later age the outlet resistance must be increased to render them continent (95). There is no medical treatment of proven efficacy that increases bladder outlet resistance. Alpha-receptor stimulation of the bladder neck has not been very effective. Surgical procedures need to be considered for maintaining continence (96-98).

It is important to establish adequate bowel emptying before attempting to correct bladder dysfunction surgically or medically.

Patients with a neurogenic bladder require lifelong supervision; monitoring of renal function is extremely important. Periodic investigation for upper tract changes, renal function and bladder status is mandatory. Therefore, repeat urodynamic studies are needed more frequently at younger ages and less frequently as time progresses. A repeat urodynamic study is warranted when the patient has a change in symptoms or undergoes any neurosurgical procedure. In case of any apparent changes both in the upper and lower urinary tract or any changes of neurological symptoms, a more detailed examination including urodynamics and MRI of the spine is indicated. Renal failure usually progresses slowly but may occur with startling rapidity.

VI. SURGICAL MANAGEMENT OF URINARY INCONTINENCE IN CHILDREN

1. INTRODUCTION

The core of current NDSD management is non-surgical. Intermittent catheterisation and drug therapy are usually sufficient in most cases for maintaining continence and preserving upper tracts. Surgical procedures should be considered if conservative measures fail to achieve continence between catheterisations or preserve upper tracts.

There is no particular surgical procedure which is suitable for everyone. Surgical management must be tailored to each individual case, based on careful consideration of urodynamic findings, medical history, age and presence of other disability.

Surgical intervention is required for congenital and acquired diseases interfering with the function of the storage function of the bladder, the sphincter mechanisms or which bypass normal sphincter mechanisms. A plethora of different surgical procedures has been proposed to maintain continence by using different mechanisms. Various procedures using different mechanisms for maintaining continence may be used in the same patient.

In many cases measures such as intermittent catheterisation and drug therapy are needed in addition to surgery since most of the surgical procedures can achieve 'dryness', but rarely restore normal voiding.

Patients with bladder neck incompetence pose a real challenge and require a different approach. All surgical procedures to "reconstruct" the bladder neck have one thing in common; an obstruction is created to enhance bladder outlet resistance. Even if successful, normal spontaneous voiding with low pressures without external help is not possible in most patients. Considering the long-term outcome, it may be better not to void spontaneously when bladder outlet resistance is increased because longstanding outlet resistance may cause secondary changes of the bladder wall.

The rarity and complexity of the conditions associated with congenital incontinence in children precludes the establishment of higher levels of evidence because of the rarity and spectrum of the pathology. Choice of surgical treatment depends on the need of each patient and there is never one surgical protocol that is good for everyone. The results are highly dependent on the skills and experience of the individual surgeon. Therefore, graded recommendations for specific procedures cannot be provided. There are no randomised controlled trials (level 1 and 2 evidence). Based on the available literature most studies have a level of evidence 3-4 and grade of recommendation C or D.

1.1. Abnormalities of storage

Bladder Exstrophy: The incidence of bladder exstrophy is 1 per 30,000 live births. (male to female ratio 2:3.1-6.1). Closure of the bladder is generally performed within the first days of life; pelvic osteotomies facilitate reconstruction of the abdominal wall and may improve ultimate continence (1,2,3). Some children will develop more or less normal capacities. Even after successful closure there will be some children who end up with poorly compliant small bladders, requiring later bladder enlargement or urinary diversion (ureterosigmoidostomy) (4,5,6,7). Patients with a good bladder template who develop sufficient bladder capacity after successful primary closure and epispadias repair can achieve acceptable continence without bladder augmentation and intermittent catheterisation (8,9,10).

Reconstruction of the bladder neck can either be done at the time of bladder closure or at a later stage. Early reconstruction may facilitate normal bladder

function, but should be attempted only at centres experienced with such surgery (11,12). Continence rates vary from centre to centre and may range between 43 to 87% (13,14).

Cloacal Exstrophy: The incidence of cloacal exstrophy is 1 per 200,000 live births. This is a much more complex deformity that requires an individual approach. Most of these children have anomalies of the nervous system, upper urinary tract and gastrointestinal tract that can adversely affect urinary tract reconstruction. Before reconstructive procedures are considered, an extensive evaluation must be carried out.

Agensis and duplication of the bladder are both extremely rare. Agensis is rarely compatible with life. In bladder duplication, other associated congenital anomalies are often observed such as duplication of external genitalia or lower gastrointestinal tract.

Abnormal storage function in combination with other anomalies is usually caused by a neurological deficit or is secondary to bladder outlet obstruction. Sacral anomalies are frequently seen with cloacal malformations and imperforate anus (15, 16, 17,18).

Posterior urethral valves may cause severe hypertrophy of the detrusor with a small poorly compliant bladder (19,20). Unfortunately, following valve ablation, these bladders may not return to normal function (21,22).

1.2. Abnormalities of sphincteric function

Epispadias (without exstrophy): incidence 1 in 60,000 live births, male to female ratio: 3-5:1. All patients with bladder exstrophy also have complete epispadias.

In male patients with complete epispadias and in all females, the sphincteric mechanism is deficient and the child has complete incontinence. Reconstruction of the bladder neck is either performed at the time of epispadias repair or at a later stage. The bladder function may or may not be normal in these patients (23,24).

Malformation of the Urogenital Sinus occurs exclusively in phenotypic females. The incidence is 1 in 50,000 live births. In patients with classical urogenital sinus or cloaca, the sphincteric mechanism is insufficient and due to associated neurological abnormalities the bladder function may be abnormal.

Ectopic ureteroceles protruding into the urethra may be responsible for a partial defect of the bladder neck. In these rare cases, sphincteric incontinence may be the result.

Sphincter abnormalities secondary to spina bifida and other neurological disorders are of importance. The sphincter may be overactive (like in detrusor-sphincter dyssynergia) or underactive. Overactivity of the sphincter causes secondary changes of the bladder wall (increased collagen type III with decreased elasticity and compliance). Continence is usually achieved with antimuscarinic drug treatment

or bladder augmentation (using the overactivity of the sphincter for continence). In cases of incompetence of the sphincter, different types of surgical intervention are possible to enhance the sphincteric mechanism. In general, all patients with a neurogenic bladder need Clean Intermittent Catheterisation (CIC). In patients reliant upon wheelchair mobility a suprapubic channel can be created (Mitrofanoff) to facilitate CIC.

Bypass of sphincteric mechanism

Ectopic Ureter is an abnormally located terminal portion of the ureter. Instead of the ureter opening in the bladder, it opens in the urethra, vagina, or uterus. Ectopic ureters occur more frequently in girls and are commonly part of a duplex system: in girls, the ectopic orifice of the upper pole moiety drains into the urethra below sphincteric level or vaginal vestibule, thus causing incontinence (25).

When the ectopic ureter represents a single system, the trigone is usually asymmetrical and not well developed. These children may suffer from continuous incontinence as well as a deficient sphincteric mechanism: this is particularly true in bilateral ectopia of single systems. In these patients, the trigone and bladder neck are functionally abnormal and treatment includes surgical reconstruction of the bladder neck. When the upper pole ureter opens in the mid or distal female urethra or outside the urinary tract (i.e. vulva or vagina) incontinence results. Upper pole nephrectomy or ipsilateral uretero-ureterostomy solves the problem.

A rare and a challenging condition is when there are bilateral ectopic ureters. Since the bladder is hypoplastic, in these children achieving normal bladder capacity and function may require additional procedures to ureteric reimplantation (26,27,28).

Urethral duplication. Most patients with urethral duplication will leak urine from the abnormal meatus during voiding. In rare cases, when the urethra bypasses the sphincteric mechanisms, continuous leakage may be present (29).

Vesicovaginal fistulae. Acquired fistulae may be traumatic or iatrogenic, following procedures on the bladder neck.

1.3. Evaluation and diagnosis

A detailed history and physical examination in combination with imaging studies and urodynamic evaluation are the corner stones for successful management. Imaging studies are essential to define the anatomical abnormalities responsible for and associated with incontinence. Ultrasonography of bladder and kidneys as well as a voiding cystourethrogram are the basic studies. In infants and small children sacral ultrasonography can demonstrate normal position and mobility of the spinal cord. The scout film of the contrast voiding cystourethrogram (VCUG) assesses the lower spine and sacrum, intersymphysal distance, and faecal retention. The contrast films will show bladder configuration, presence of

vesicoureteral reflux, incomplete voiding, bladder neck competence, urethral anatomy, and vaginal reflux. Occasionally, an intravenous urogram will provide the clearest assessment of the urinary tract. MRI and CT scanning can be helpful in defining spinal abnormalities as well as congenital abnormalities in the urinary tract.

In addition to imaging studies, urodynamic studies (cystometrography, and when needed, electromyography of the sphincters and urinary flow studies) are useful for all patients with neurogenic incontinence, and after surgery in some cases of bladder exstrophy and after posterior urethral valves resection to help define the mechanism of any continued incontinence. However, in many patients much useful information on the function of the lower urinary tract can be obtained with very basic studies including ultrasound and cystometry.

2. INDICATIONS FOR SURGICAL PROCEDURES TO CORRECT URINARY INCONTINENCE

2.1. Storage function

Reduced bladder capacity is the main indication for simple bladder augmentation. Reduced capacity can be congenital (bilateral single ectopic ureters, bladder exstrophy) or caused by previous surgery e.g. bladder neck reconstruction in exstrophy patients, where a part of the bladder is used to create an outlet resistance. Other indications are low functional bladder capacity as it may be present in neurogenic detrusor overactivity, or poor bladder compliance (meningo-myelocele), or bladder scarring from previous surgery or obstruction. Bladder scarring from bilharzia remains common in areas where this is endemic and is increasingly common with immigration to the developed world. In all such cases surgery is indicated when conservative treatment has failed.

Several studies suggest that aggressive early intervention with CIC and anticholinergic therapy improves bladder compliance and may protect children from augmentation surgery (30,31).

A survey has reported that there has been no change in augmentation rates during the last 5 years: rates demonstrate significant inter-institutional variability (32).

2.2. Sphincter function during storage

Most of the diseases in childhood requiring surgical repair for incontinence not only have an influence on bladder capacity but also on sphincter function. Conservative measures to improve sphincter function have limited value and surgery is required in many cases. There are different surgical options; either to increase outlet resistance or to create or implant a new sphincter mechanism. In neurologically normal

patients such as classic exstrophy patients, early anatomic reconstruction may allow 'normal' bladder and sphincter function. Sling procedures are indicated when the residual sphincter function is not sufficient to avoid incontinence. This may be the case in patients with neurogenic bladder disturbances and urethral incontinence. If there is no residual sphincter function or outlet resistance, an autologous tape or colposuspension in girls, and an artificial sphincter in boys, may be required. Primary urinary diversion (rectal reservoirs / continent stoma) offers an alternative solution to this problem.

2.3. Procedures to bypass the sphincter

If bladder outlet surgery fails or urethral catheterisation is not possible, a continent stoma may be constructed. Some patients prefer catheterising through a continent stoma rather than through the sensate urethra. The continent stoma (Mitrofanoff principle) may be combined with bladder augmentation and/or bladder neck reconstruction or closure. An alternative to such procedures would be the use of the anal sphincter for urinary continence with the use of colon as the storage reservoir

3. BLADDER RESERVOIR CONSTRUCTION

3.1. Ureterosigmoidostomy

This type of continent urinary reconstruction may be utilised in reconstruction for bladder exstrophy, an incontinent urogenital sinus or the traumatic loss of the urethral sphincter. As this reconstruction is totally dependent on the normal function of the anal sphincter, contraindications include incompetence of the anal sphincter, anal prolapse, previous anal surgery, and irradiation. Because of the potential for electrolyte resorption, renal insufficiency is also a contraindication.

Low pressure rectal reservoirs are superior to simple ureterosigmoidostomy because the augmented or reconfigured rectal bladder achieves lower pressure storage and accordingly, enhances continence.

There are two techniques which have been utilised:

a) The augmented rectal bladder in which the rectosigmoid is opened on its antimesenteric border and augmented by an ileal segment. The sigmoid may be invaginated to form a nipple valve to avoid reflux of urine into the descending colon and thus to minimise metabolic complications.

b) The sigma-rectum pouch (Mainz pouch II) in which there is an antimesenteric opening of the recto-sigmoid and a side to side detubularisation anastomosis. Ureteral reimplantation of normal sized ureters is by a standard submucosal tunnel (Goodwin, Leadbetter). If the ureter is dilated the technique utilizing a serosa lined extramural tunnel may be more appropriate (33,34).

As reported by D'elia et al, the results of these low-pressure rectal reservoirs are excellent with day and night continence better than 95% and complications related to the surgical procedure range from 0 -10% with the sigma-rectum pouch to 34% for the augmented rectal bladder (35). Late complications for the sigma-rectum pouch range from 6-12.5% and the late complications for the augmented rectal bladder are 17%. Early complications include pouch leakage while late complications are mainly related to the ureteral implantation into the bowel and pyelonephritis. Metabolic acidosis also occurs (69% of the patients had a capillary base excess of -2.5 mmol/L and used oral alkalinizing drugs to prevent hyperchloraemic acidosis).

Periodic follow-up is important to check the upper urinary tract and prevent metabolic acidosis. Due to the risk of malignancy at the ureterointestinal anastomosis, colonoscopy should be performed annually beginning at postoperative year 10 (30,36,37,38,39).

Level of evidence: 3

Grade of recommendation: B

3.2. Bladder augmentation, bladder replacement and continent urinary diversion, using intestine

The indication for bladder augmentation, replacement of the bladder, or the creation of a continent urinary diversion, is either the morphological or functional loss of normal bladder function. The main goal of this surgery is to relieve high pressure and low capacity of the urinary bladder and create a new reservoir with low storage pressures that can be emptied periodically. It is particularly important that the patients understand that spontaneous voiding will not be possible after such surgery and lifelong intermittent catheterisation will be required.

Before deciding on what type of procedure can be performed some significant factors must be addressed. These are

3. Physical and mental capacity of the patient to do intermittent catheterisation.
4. Previous surgery (on urinary tract and bowel)
5. Renal function status (including acid base state)
6. Absence or presence of reflux
7. Outlet resistance
8. The need for a catheterisable channel

The different technical approaches to bladder augmentation or replacement are dependent on the clinical presentation of the patient:

- a simple bladder augmentation using intestine may be carried out if there is any bladder tissue, a competent sphincter and/or bladder neck, and a catheterisable urethra,

- an augmentation with additional bladder outlet procedures such as bladder neck reconstruction or other forms of urethral reconstruction are required when both the bladder and outlet are deficient. This occurs most commonly in spina bifida or bladder exstrophy. It must be appreciated that bladder outlet procedures may complicate transurethral catheterisation.
- augmentation with surgical closure of the bladder neck may be required primarily, or as a secondary procedure in certain rare clinical situations. In this situation, a continent stoma will be required. However, most urologists prefer to leave the bladder neck and urethra patent as a safety precaution: when the bladder is very full leakage will occur and it allows transurethral manipulations such as catheterisation if the continent reservoir cannot be emptied through the suprapubic catheterisable channel.
- an augmentation with formation of an additional continent stoma is utilised primarily following failure of previous bladder outlet surgery. It is advisable also when an inability to catheterise transurethral can be anticipated. An abdominal wall continent stoma may be particularly beneficial to the wheelchair bound spina bifida patient who often can have difficulty with urethral catheterisation or who is dependent on others to catheterise the bladder. For continence with augmentation and an abdominal wall stoma, it is essential that there be an adequate bladder outlet mechanism to maintain continence.
- total bladder replacement in anticipation of normal voiding in children is very rare, as there are infrequent indications for a total cystectomy, with preservation of the bladder outlet and a competent urethral sphincter. This type of bladder replacement is much more common in adult urological reconstruction.

The main contraindications are the inability of the patient to be catheterised, or perform CIC him or herself and the anticipation of poor patient compliance. When there is reduced renal function generally with a creatinine above 2 mg/dl or a creatinine clearance below 40 ml./min/1.73 m², there is a relative contraindication to the use of ileum or colon because of metabolic acidosis secondary to resorption. The stomach with its excretion of acid may be used with a low creatinine clearance possibly in preparation for transplantation. It is, however, not wise to use stomach in any voiding patient or one with any questions of an incompetent bladder outlet because of the severe skin irritation that the acid urine may produce (haematuria-dysuria syndrome).

3.3. Which intestinal segment should be utilized?

a) Stomach

Stomach has limited indications primarily because of the complications that have been seen. It is the only intestinal segment suitable in patients with significantly reduced renal function (40,41,42).

Additionally, when no other bowel may be available, such as after irradiation or in the presence of a short bowel syndrome, as in cloacal exstrophy, this may be the only remaining alternative.

b) Ileum / Colon

Clinically these two intestinal segments appear to be equally useful. In children, sigmoid colon is widely used except in those who have been treated for imperforate anus. Use of the ileocaecal region can be associated with transient and sometimes prolonged diarrhoea. Use of this segment should be avoided in patients with a neurogenic bowel such as in myelomeningocele or who have been subject to previous pelvic irradiation. If the ileocaecal valve must be used, it can easily be reconstructed at the time of performing the ileo-colonic anastomosis. The ileum can be satisfactorily used for bladder augmentation: however, because of its smaller diameter a longer segment of ileum is required to create a comparable reservoir to that created from colon. Colon has greater flexibility for ureteral implantation and construction of a continent catheterisable channel.

c) General principles

There are several important principles for bladder augmentation and replacement that should be respected:

- use the minimal amount of bowel and, if available, use hindgut segments or conduits from previous surgical procedures,
- a low-pressure large capacity reservoir is essential. This requires detubularisation of any intestinal segment used.
- for colonic reservoirs, a sigmoid segment of 20-30 cm is generally satisfactory. A slightly longer segment of ileum is generally used. The length of the segments can be scaled down in smaller children. Care should be taken not to use more than 50 to 60 cm of ileum in adolescents and comparable lengths in younger children because of reduction of the intestinal resorptive surface.
- the jejunum is contraindicated in intestinal reconstruction of the urinary tract because of its metabolic consequences (hyponatraemia, hypercalcaemia, and acidosis).
- it is wise to strive to achieve an anti-reflux ureteral anastomosis into the reservoir to avoid the potential for reflux and consequently ascending infection: in high pressure bladders with reflux the reflux usually disappears spontaneously following augmentation (43,44).
- a reliable continence mechanism (continent urinary outlet) must be assured.

- because of the risk of stone formation only re-sorbable sutures and staples should be used in bladder augmentation and reservoir construction.

d) Bladder augmentation techniques

1. In gastric augmentation, a 10-15 cm wedge-shaped segment of stomach is resected. Most commonly this is based on the right gastroepiploic artery but can be based on the left artery as an alternative. The segment is brought down to the bladder easily in the retroperitoneal space along the great vessels.
2. When using large or small bowel the segment to be utilised is opened on the antimesenteric border and detubularised prior to anastomosis to the bladder remnant. The anastomosis of the intestinal segment to the bladder remnant and to itself is usually carried out in one running layer of inverting absorbable sutures.
3. The techniques for urinary diversion with continent stoma (Mainz pouch, Indiana pouch, Kock pouch) are covered in the chapter on urinary diversion in adults (45,46,47).

Currently, augmentation cystoplasty is the standard treatment for low capacity and/or low compliance bladders secondary to neurogenic, congenital and inflammatory disorders. Due to the relatively high morbidity of conventional augmentation there is renewed interest in alternative methods (48, 49,50,51,52,53). These alternative techniques try to avoid the contact between urine and intestinal mucosa and include gastrocystoplasty, bladder auto-augmentation, seromuscular augmentation, alloplastic or biodegradable scaffolds grafted with autologous urothelium developed in cell culture, and ureterocystoplasty.

e) Auto-augmentation

The principle of auto-augmentation of the bladder is the excision of a great portion of the detrusor while leaving the urothelium intact, creating a large diverticulum for the storage of urine at lower pressures. This urine stored at a low pressure can be drained by intermittent catheterisation. The theoretical advantages of this procedure are the low complication rates of the surgery, reduced operative morbidity with shorter stay in the hospital, absence of urine salt resorption, less mucus production in the urine and possibly absence of potential carcinogenesis. Although some series showed good results with this procedure (54,55,56,57), most authors have been unable to achieve the early reported rates of success (58). Long-term results have been rather disappointing: MacNeily et al concluded that of 17 patients with neurogenic bladder following auto-augmentation, 71% were clinical failures and 14 out of 15 were urodynamic failures (59). Similar findings have been reported by others (60,61). The inability of this procedure to achieve long-term good results may be due to the regeneration of nerve fibres divided during the

surgery as well as the ischaemic atrophy of the mucosa.

Although there are many potential advantages to this approach to a small poorly compliant bladder the inconsistency of success make it a less favourable option. It is generally felt that pressures can be lowered but that capacity remains unchanged.

More recently, some authors have proposed the laparoscopic auto-augmentation as a minimally invasive procedure for the treatment of a low capacity/low compliance bladder. (62,63). Despite the indifferent results, some still suggest its consideration before a standard augmentation because of the reasons listed above (64,65,66).

Level of evidence 4

Grade of recommendation C

f) Seromuscular patch

To overcome one of the major disadvantages of a conventional augmentation, that is mucus formation, several techniques have been developed to use intestinal segments free of mucosa. The first attempts resulted in viable seromuscular segments covered with urothelial mucosa (67,68). The intense inflammatory response and shrinkage observed in the intestinal segment discouraged its use in humans (69). Further attempts consisted of using the association between demucosalised intestinal segments and auto-augmentation. In the initial model using sheep, the animals tolerated the procedure poorly, reflected by inflamed, haemorrhagic colonic segments in the animals sacrificed within one month. In addition, colonic mucosa regrowth occurred in one third of the animals (70). Follow-up studies in a dog model with previously reduced bladder capacity suggested that the contraction of the intestinal patch in seromuscular enterocystoplasty can be avoided by the preservation of both the bladder urothelium and lamina propria, together with the submucosa and muscularis mucosa of the intestinal patch (71,72). This form of bladder augmentation was shown to prevent absorption of toxic substances like ammonium chloride (73). Other authors using the same technique to line de-epithelialised gastric patches in the mini-pig model found it useless due to the fibrotic changes and decreased surface of the patch (74).

The initial experience in treating humans with colcystoplasty lined with urothelium were reported by Gonzales and Lima who independently developed a slightly different technique (75,76). Bladder capacity increased significantly while bladder pressures decreased. Biopsies demonstrated urothelium covering the augmented portion of the bladder in the majority of cases. Longer term follow-up is now available and although the results are very encouraging, they seem to be highly operator dependent and the way in which the mucosa is removed seems to be crucial. Lima *et al* no longer preserve the bladder urothelium and use a silicone balloon to prevent the augmented segment from contracting (they remove the balloon after 2

weeks: urine is diverted using ureteral stents): in 123 patients, no ruptures were found and only 10% were regarded as failures (77).

Gonzalez *et al* found seromuscular colcystoplasty in combination with an artificial urinary sphincter successful in 89% of their patients and that it effectively achieved continence with no upper tract deterioration, they concluded that this is their preferred method of augmentation when adverse bladder changes occur after implanting the AUS (78).

Although more authors have now reported their results this procedure remains a more complex form of augmenting the bladder and has not received general acceptance among the paediatric urological community. It is being done in some designated centres (79,80,81,82). A recent comparison of the long-term outcome of this technique with standard intestincystoplasty has indicated that most of the risks and benefits of augmentation cystoplasty performed using intestine and seromuscular patch appear similar.

Level of evidence 3

Grade of recommendation C

g) Ureteral bladder augmentation

Another alternative to avoid the morbidity of intestinal bladder augmentation is the use of ureteral segments to improve bladder capacity and/or compliance. Megaureters associated with poorly or non-functioning kidneys provide an excellent augmentation material with urothelium and muscular backing, free of potential electrolyte and acid base disturbance, and mucus production (83,84).

An alternative in patients with ureteral dilation and good ipsilateral renal function, is to combine transureteroureterostomy with ureterocystoplasty (85). An additional option in patients with bilateral dilated ureters with preserved renal function is bilateral reimplantation and the use of the distal ends for detubularised bladder augmentation (86,87).

Bladder augmentation with ureter may be effective in a small sub group of patients with ureteral dilation and poor bladder capacity. Overall long-term results are good and remain so over a longer period (88,89,90,91,92,93).

In a recent evaluation of the long term functional outcome of this technique, ureterocystoplasty provided durable functional urodynamic improvement, yet some patients (4 out of 17 in this series) eventually needed a standard intestinal cystoplasty (94).

Level of evidence 3

Grade of recommendation B

This type of augmentation can also be employed in children who require a kidney transplantation (95,96,97).

h) Experimental Methods

The artificial bladder has been the topic of speculation and experiment that remains outside the bounds of clinical application. Somewhat nearer to clinical application may be engineered autologous urothelium and bladder muscle cells. These cells may be grown on biodegradable scaffolds—both naturally derived and synthetic—for the temporary support of growing tissues which can then be used for augmenting the bladder. Several synthetic materials and natural matrices have been used in experimental and clinical settings and major improvement has been made in techniques of cell harvest, culture, and expansion as well as polymer design.

A range of applications of engineered bladder tissues are at different stages of development. There have been a few in preclinical trials, recent progress suggests that engineered bladder tissues may have an expanded clinical applicability in the future. Clinical trials with these methods are not far away (98-110). Although this field of research may represent the future of bladder reconstructive surgery, currently only experimental studies are available and it may be some time before clinical use becomes a practical reality. We strongly encourage further research in this field.

4. BLADDER OUTLET SURGERY

4.1. Urethral enhancement

In those children where sphincteric incompetence is the only cause of incontinence or plays a major role in association with decreased bladder capacity or compliance, surgical procedures to enhance outlet resistance should be considered. In many cases bladder outlet surgery needs to be combined with other procedures aimed at creating a large low pressure storage reservoir.

4.2. Bulking agents

The injection of bulking substances in the tissues around the urethra and bladder neck to increase outlet resistance in children dates to at least 1985. However, concern about distant migration of the injected substance and risk of granuloma formation prevented this technique from gaining widespread acceptance (111,112).

The search for safer, biocompatible substances to create periurethral compression has first led to the use of cross-linked bovine collagen, with initially reported success in about 20-50% of children (113,114,115). Collagen injection appeared to effectively improve urethral resistance, but this did not always translate into satisfactory dryness, besides, the effect of the injection is of short duration and repeated injections were often necessary (116,117). Because of this collagen is no longer recommended for this indication.

Currently, the following substances are available and have been tested in children with incontinence: dextranomer / hyaluronic acid copolymer (a nontoxic, nonimmunogenic, non-migrant synthetic substance) and polydimethylsiloxane.

Usually the substance is injected endoscopically in the bladder neck area (finding the best spot is often the most difficult part of the procedure): more than one procedure may be necessary. On average 2.8 – 3.9 ml is injected. More than 50% of patients need more than one injection. Initial results of 75% success have been reported, but after 7 years there is a gradual decrease and only 40% remained dry (118,119,120). Others have reported success rates of 0 - 70% (121-128). Despite limited success bulking agents remain an option for all patients who are poor surgical candidates and those who want to avoid extensive bladder neck reconstruction. An alternative route may be the injection around the urethra using laparoscopy (129).

Level of evidence: 3

Grade of recommendation C

4.3. Artificial urinary sphincter (AUS)

Since its introduction in 1973, the AUS has undergone major transformations over the years. Different devices are currently in use: one of the most frequently used devices is the AS800-T that has been in use for almost 20 years (130). It consists of an inflatable cuff, a pressure regulating balloon and a unit containing a pump and control mechanisms. The inflatable cuff can only be implanted around the bladder neck in females and pre-pubertal males. In post-pubertal males, bulbar urethral placement is possible but not recommended for patients either requiring a wheelchair or those who perform intermittent catheterisation (131). In patients who have had extensive urethral surgery (exstrophy and epispadias) placement may not be technically feasible.

Implantation of an AUS requires special training and difficulties may be encountered in the dissection of the space around the bladder neck in obese, post-pubertal males or in patients with a history of previous bladder neck procedures. A 61-70 cm H₂O pressure balloon is used exclusively when the cuff is around the bladder neck and a lower pressure balloon when it is around the bulbous urethra. Although high in cost, the artificial sphincter remains the most effective means or increasing urethral resistance and preserving the potential for voiding. The ideal candidate for AUS implantation is a patient with pure sphincteric incompetence who voids spontaneously and has good bladder capacity and compliance. Unfortunately, only a small proportion of children with sphincteric incontinence meet these criteria. The AUS may also be used in those dependent on clean intermittent catheterisation. The compatibility of the AUS with intermittent catheterisation and enterocystoplasty is well documented (132,133,134).

The ability to empty the bladder spontaneously or by Valsalva manoeuvre may be preserved after AUS implantation. In series reporting children with AUS, the majority having neurogenic incontinence, 25% void spontaneously (135). When the AUS is implanted before puberty, the ability to void spontaneously may be lost after puberty. Overall, 40 to 50% of neurogenic patients require a bladder augmentation concomitantly or subsequently to the AUS implantation (133,136,137,138). The continence rate ranges from 63 to 97% (139-146). Herndon et al reported a success rate of 86% (of 134 patients): 22% voided, 11% had to perform CIC after voiding, 48% only performed CIC through the urethra, 16% performed CIC through a continent channel and 3% used diversion (147). Mechanical problems occurred in 30% of patients who had an 800-model implanted (versus 64% in the old model). Revisions (in 16%) were significantly less in the 800 model. Erosion occurred in both groups (16%). A major complication was perforation of the augmented bladder in this group (occurring in 10 patients). In 28% a secondary bladder augmentation was necessary.

Another interesting aspect of the AUS is that in some children the device is either deactivated or no longer functions but they remain dry: others have reported that placing a cuff only without activation is all that is required to make them dry (148).

The complications most commonly encountered in patients with AUS are mechanical failures. The longevity of the present devices is expected to exceed 10 years, although Spiess et al reported a mean lifetime of only 4.7 years (149). The second most common problem is the development of reduced bladder compliance with time. This may result from an error in the preoperative evaluation or the reaction of the detrusor to obstruction (a reaction noted in some patients with spina bifida). These changes can be seen after many years of follow-up. The results of decreased capacity and compliance may be incontinence, upper tract deterioration, or the development of vesicoureteral reflux. Therefore, long term follow-up with ultrasound, renal scintigraphy and if indicated urodynamics is mandatory in all patients with an AUS.

Infection of the prosthesis should occur in no more than 15% of all cases. Erosions of the tissues in contact with the prosthesis are rather infrequent. Bladder neck erosions are practically non-existent when the sphincter is implanted around a "virgin" bladder neck. When the AUS is used as a salvage procedure following bladder neck reconstruction, the erosion rate may be as high as 30% (137). Despite the high complication and revision rate, AUS results show that acceptable continence rates can be achieved in the long-term. For this reason, AUS implantation may be better considered as the initial treatment in selected cases (150).

4.4. Fascial slings.

Fascial slings constructed with the fascia of the anterior rectus muscle have been used to increase outlet

resistance in incontinent children, particularly those with neurogenic dysfunction since 1982 (151). The sling is used to elevate and compress the bladder neck and proximal urethra. The dissection around the urethra may be facilitated by a combined vaginal and abdominal approach, however, this option is limited to post-pubertal females (152). Several technical variations of the sling have been reported. The fascial strip may be a graft or a flap based on the rectus sheath on one side. The fascial strip can be crossed anteriorly or wrapped around the bladder neck to enhance urethral compression. Although the short-term success rate reported by most authors is encouraging, there are no series reporting detailed results at 5 years (153-154). Most authors report a greater success when fascial slings are used in conjunction with bladder augmentation and success seems more likely in females than in males (155-158). In patients with neurogenic incontinence postoperative CIC is recommended.

The pubovaginal sling in girls may also be placed through the vagina: in 24 girls with spina bifida this procedure was successful in 19, while another 3 became dry following additional injections with bulking agent around the bladder neck via a suprapubic needle introduction. CIC was possible in all patients. One patient developed a vesicovaginal fistula (159). Complications of sling procedures include difficulties with intermittent transurethral catheterisation, erosion of the urethra and persistent incontinence. Overall, the increase in outlet resistance provided by slings seems less than that provided by the artificial sphincter. Experience with these procedures suggests an overall success between 50 and 80% in females. Numerous alternatives are now being used; small intestinal submucosa has been used in 20 children and showed equivalent rates of continence. The advantage being that it is available off-the-shelf. Results were better in girls than in boys (85 vs 43% being dry) (160,161,162).

When combining bladder augmentation with a Gore-Tex sling in 19 children the results were poor: because of erosion the sling had to be removed in 14 patients, all except in one who also had a bladder stone. In this respect, this type of sling should not be used (163).

From the data published it presently seems that the AUS provides more consistent results in boys and for girls capable of spontaneous voiding who have not had previous bladder neck surgery. Bladder neck slings may be used for the enhancement of bladder outlet resistance in most patients with neurogenic bladder who need augmentation cystoplasty and whom we do not expect will be capable of voiding spontaneously. Sling procedures are probably equally effective for girls, dependant on intermittent catheterisation and in conjunction with bladder augmentation. At present, given the cost and lack of effectiveness of injection procedures, their use does not appear justified in incontinent children. The cost of the AUS may restrict its use.

Level of evidence 2.

Grade of recommendation B

It is important that one should know these patients who undergo bladder outlet surgery need long-term follow-up not only because of the complications but also, because their bladder behaviour may undergo unexpected clinically asymptomatic changes that could impair their upper tracts if augmentation is not performed at the same time (164).

4.5. Bladder neck closure

In 'desperate' cases the bladder neck may be closed, the indication for this being persistent leakage despite several attempts to enhance outlet resistance by bulking agents or other surgical procedures. Although initial results are acceptable, long-term results are usually disappointing: persistent urinary leakage, stomal stenosis and leakage or stone formation (in up to 40%) (165,166). One of the most important factors seems to be compliance with intermittent catheterisation and bladder irrigation.

4.6. Bladder outlet reconstruction

Surgical procedures to achieve urinary continence are dictated by functional and anatomical deficiencies and by the goal of either continence (with normal voiding) or dryness (dependent on intermittent catheterisation).

Construction of a functional urethra for continence usually implies an anatomical defect without a neurogenic component (epispadias / exstrophy) and includes urethral and bladder neck narrowing and urethral lengthening (167-172).

Such procedures may initially require intermittent catheterisation or occasional post voiding catheterisation, but bladder emptying by voiding is anticipated.

Urethral reconstruction for dryness, however, mandates intermittent catheterisation. The goal in surgery to achieve dryness is to create a urethra suited to catheterisation, which has closure such that intraluminal pressures always exceed intravesical pressure. The most dependable procedures for dryness utilise a flap valve or tunnel to achieve urethral closure, although urethral slings, wraps and injections have also been used (173).

Level of evidence 3

Grade of recommendation C

Reconstruction to achieve continence is based on the principle that proximal reduction of the calibre of the urethra supports the inherent proximal sphincteric mechanism of the bladder neck and proximal urethra. The narrowing must be dynamic to permit closure for continence and yet permit opening with funnelling during voiding. Several techniques have been described to achieve this goal (3, 166-176). Young (1922) performed a "double sphincter technique" that

involved the excision of a wedge of tissue at the anterior bladder neck, as well as removal of a wedge of tissue just proximal to the epispadiac meatus (external sphincter). Dees (1949) added the concept of lengthening the urethral tube to that of narrowing. In his procedure, parallel incisions were made through the existing bladder neck area which created a posterior urethral plate from what had previously been the trigone of the bladder. This is tubularised to give added length to the proximal urethra. The added length provides increased potential for urethral closure and moves the bladder neck and proximal urethra into the abdominal cavity. Leadbetter (1964) modified the Young-Dees procedure by creating muscular flaps from the area of the bladder neck and proximal urethra which were used to wrap the newly created proximal tube. This procedure was popularized by Jeffs (1983) who applied it to a staged repair of exstrophy. He supported a lengthened urethra by a suspension. They report their long-term continence rate with this procedure as greater than 80%, without the need for CIC or augmentation (177).

Presently, this represents the gold standard for reconstruction for continence, however, modifications of the technique have reported similar or improved results. Most urethral lengthening procedures utilising the posterior urethra and bladder neck require ureteral reimplantation and preservation of the posterior urethral plate. Because part of the bladder is used to create the functional lengthening of the urethra, bladder capacity decreases following the procedure. It also remains to be seen whether the created urethra is actually a functioning urethra: in many patients fibrosis around the urethra prevent it from being really 'functional': in these patients, it may act as an anatomical obstruction and long-term follow-up is necessary to follow not only the bladder but also the upper tracts.

In a study examining the long-term outcome of urethral lengthening procedures (Kropp and Salle procedures) nearly 80% dryness was achieved at 4 hourly intervals and 90% at 3-hourly intervals, but the need for additional procedures were high (catheterisable channel: 54%, delayed augmentation: 47%) (178).

Surgery for dryness is dependent on the effectiveness of intermittent catheterisation and is usually reserved for patients with neurogenic dysfunction or multiple previous surgeries. Procedures to achieve dryness usually create a urethral closure pressure that exceeds bladder pressure.

A flap valve can be constructed by using an anterior or posterior bladder flap (full thickness) to construct a tube that is placed in a submucosal tunnel (171,175,176).

The major disadvantage of these procedures (flap valves) is that the valve will not allow leakage with high intravesical pressures, potentiating renal damage. Therefore, these procedures can be dangerous to the patient who is not totally committed to follow catheterisation recommendations.

Bladder outlet procedures without augmentation cystoplasty remain controversial. It is generally advised to combine it with augmentation cystoplasty to avoid upper tract changes and continued incontinence. In a review of 109 patients who underwent bladder outlet procedures without augmentation cystoplasty the need of augmentation cystoplasty was 30% and additional continence procedures was 70%. There were upper tract changes in more than 50% and chronic kidney disease 20% in a cumulative 10-year follow-up (179-181).

Unfortunately, the ideal procedure for surgical reconstruction of the bladder neck does not exist. The surgical approach to urinary incontinence in the child must be multifaceted because of the inherent complex and varied nature of the problem.

Recent data support the concept that very early reconstruction in the exstrophy / epispadias group may result in physiological bladder cycling which facilitates normal bladder and urethral development. This results in higher potential for continence without the need for bladder augmentation and bladder neck reconstruction (Level 3). More work and clinical experience in this area is strongly recommended.

Grade of recommendation A

4.7. Alternative continence channels

In the surgical treatment of incontinence in children every effort must be made to preserve the natural upper and lower urinary tract. The bladder is the best urinary reservoir, the urethra the best outlet and the urethral sphincters the best control mechanism. If the bladder is partly or wholly unusable it may be augmented or replaced by a variety of techniques.

Urethral failure may occur either because the sphincters are incompetent or because it is overactive and does not allow spontaneous voiding. It would be preferable for the former to be treated by one of the techniques described above and the latter by intermittent catheterisation (CIC). If these fail, continent supra pubic diversion is indicated.

a) The Mitrofanoff principle.

Mitrofanoff's name is given to the technique of burying a narrow tube within the wall of the bladder or urinary reservoir whose distal end is brought to the abdominal wall to form a catheterisable stoma suitable for intermittent catheterisation (182). The technique is simple and familiar to all urologists who are accustomed to re-implanting ureters. Several narrow tubes are available for the Mitrofanoff conduit (183,184). In the original description, the appendix was used. However, even if the appendix is still present, it may be unusable in 31% of patients (184).

If no suitable tube is found, a good tube can be formed by tailoring ileum transversely so that only 2-3cm of ileum can be made into a 7-8 cm conduit. This modification was originally described by Yang in humans and by Monti in experimental animals

(185,186). It is increasingly used though great care must be taken in its construction to avoid an internal fistula (187). The ureter may be used but there may be some difficulty in achieving sufficient calibre with a previously normal ureter. Earlier reports that the Fallopian tube could be used have not stood the test of time.

The Mitrofanoff system achieves reliable continence, which is maintained in long-term follow-up, for a high proportion of patients. Long-term follow-up data show that in the original series of Paul Mitrofanoff of 23 patients after a mean follow-up of 20 years, 1 patient had died, but in the other 22 patients no metabolic changes were noted. The bladder neck was closed in 21 patients. Secondary bladder augmentation had to be performed in 8, while in 4 children a non-continent diversion was created. With time the need for additional surgery decreased and after 20 years 16 patients had a good and stable continent diversion (189). The pressure generated within the lumen of the conduit is 2 to 3 times higher than that within the reservoir so that continence is preserved even when the intra-abdominal pressure is raised by straining. Conversely, the pressure in the lumen of a Kock nipple is only slightly higher than that in the reservoir so that continence is less reliable (189,190). The conduit may be buried either between the mucosal and muscle layers of the reservoir, or may be completely embroccated in the full thickness of the reservoir wall. Any well supported tunnel of about 2- 4 cm will suffice. The choice depends both on the nature of the reservoir and on the conduit (192). Continence rates of 90-100% with the Mitrofanoff Principle are reported, regardless of diagnosis, reservoir or conduit type (192,193). Follow-up for at least ten years has shown that the system is resilient (194-196). Retrospective review of short and long-term outcomes of patients with the Mitrofanoff procedure reveal that stoma stenosis and leakage are the most frequent complications (within wide ranges of 10 – 60 % each) and occur early during the first two years after creation. After the initial peak of complications, there is a relatively complication-free period. Yet late complications occur in long-term evaluations, probably because of wear and tear of the channels and to anatomical modifications at adolescence with commonly associated obesity (197-201).

A modified technique of vesicostomy is described using a gastrostomy button, which could be used as a continent urinary stoma in children with incomplete voiding. Button vesicostomy is a useful addition to the options available for a catheterisable continent urinary stoma in children in the short or medium term (202). Although perfect continence seems attractive, it may not be in the child's best interests. A 'pop-off' valve may be in the interest of the child if catheterisation is impossible or forgotten.

b) The ileo-caecal valve.

The ileo-caecal valve is an obvious sphincter to combine with cecum and ascending colon as the reservoir

and the terminal ileum as the conduit. The early continence rate of 94% was not sustained because of high pressures in the tubular reservoir and weakness of the valve (203-205). The Indiana system is based on the competence of the ileo-caecal valve but with a detubularised reservoir (206). The valve itself is reinforced with non-absorbable plicating sutures and the terminal ileum which forms the conduit is tailored. The best reported continence rate is 96% with a 2% rate of catheterisation difficulties.

In the complete Mainz I pouch a length of terminal ileum is intussuscepted through the ileo-caecal valve as a Kock nipple (207). It is impossible to say whether the nipple or the ileocecal valve (or both) produce the continence which is reported in 96% of patients. Both of these systems work well as complete reconstructions and are widely used as bladder replacements in children. The sacrifice of the ileo-caecal valve may cause gastro-intestinal complications.

c) Kock pouch

The first workable continent diversion was the Kock pouch (42). The reservoir is made from 40cm ileum reconfigured to reduce the intrinsic pressure. The continence mechanism is formed by intussusception of 12cm of ileum. In a complete form it requires 72cm of ileum which may be more than can be spared from the gastro-intestinal tract. Although first described as a mechanism for a continent ileostomy in children the Kock pouch is not commonly used in children because of the problem with large amount of bowel needed, stone formation and mediocre success with dryness of the catheterisable stoma (208,209).

d) Artificial Sphincter

As a last resort, the AUS may be considered to give continence to a reconstructed outlet. Experimental evidence suggests that AUS cuffs can be placed safely around intestine providing the cuff pressure is low (210). The AUS has been used successfully around large bowel, in three of four children with follow-up to 11 years (211).

e) Where to place the cutaneous stoma

In patients with spina bifida, particularly those unable to walk, the site must be chosen with care. The natural tendency is for the spine to collapse with time so that the lower half of the abdomen becomes more pendulous and beyond the range of vision. A low site may seem appropriate in the child, but will become unusable in the adult. It is best to use a high, midline site, preferably hidden in the umbilicus. The site should be determined in a sitting position and marked before surgery because in the supine position the position will change dramatically. In some patients, the best position may not be in the midline at all: special care must be taken that the patient can manage bladder emptying and irrigation him/herself.

For most other patients, the site of the stoma should be chosen by cosmetic criteria. The umbilicus can be made into a very discrete stoma; the risk of stenosis

is low and it is a readily identifiable landmark. Otherwise, the stoma should be as low on the abdominal wall as possible and certainly below the top of the underpants. However, many surgeons find the best results by placing the catheterisable stoma in the umbilicus.

The problem of stomal stenosis remains ever present. It can occur at any time so that only follow up of many years could determine whether any system of anastomosis to the skin is better than any other. The published rate of stomal stenosis is between 10 and 20%. The multi-flap V.Q.Z. stoma is claimed to have the lowest rate but follow up is short and it may well not pass the test of time (212).

5. COMPLICATIONS OF CONTINENCE SURGERY IN CHILDREN

5.1. Storage and emptying complications

In the short term, continent diversions can store urine and can be emptied by clean intermittent catheterisation (CIC). It is apparent that there is a constant need for review and surgical revision. This observation mirrors the late complications of augmentation cystoplasty for neuropathic bladder where the median time to revision surgery is as long as ten years (213,214).

In general, once continent, they remain continent, although there are occasional reports of late development of incontinence. The problem lies more in difficulties with catheterisation, particularly stenosis and false passages which may occur in up to 34% of patients (192). In a recent retrospective evaluation of 500 augmentations over 25 years with a median follow-up of 13.3 years, the cumulative risk of further surgery at the bladder level was 0.04 operations per patient per year of augmentation and 34% of the patients needed further surgery for complications. Bladder perforation occurred in 43 patients (8.6%) with a total of 53 events and 125 surgeries done for bladder stones in 75 cases (215). The principal complications arise because the reservoir is usually made from intestine. Ideally, urothelium should be used and preservation of the bladder epithelium gives fewer complications than enterocystoplasty (216). Combinations of detrusor myectomy and augmentation with de-mucosalised colon have given promising results in the short term. The surgery is difficult as the bladder epithelium must not be damaged and the intestinal mucosa must be removed completely. When achieved there are no metabolic problems and many patients can void (216).

When augmentation can be done with a dilated ureter, the results are good and the complication rate low even in children with compromised renal function or transplantation (217). All intestinal reservoirs produce mucus. The amount is difficult to measure and most

estimates are subjective. No regime has been shown to dependably reduce mucus production (218).

5.2. Reservoir rupture

The most morbid and disastrous complication following bladder augmentation is perforation, which may lead to peritonitis, sepsis, and even death. Reported rates of bladder perforation following augmentation range between 6 and 13 % (219-222).

There may be delay in diagnosis although the history of sudden abdominal pain and diminished or absent urine drainage should make it obvious. The patient rapidly becomes very ill with symptoms of generalized peritonitis (223,224). A 'pouchogram' may not be sensitive enough to demonstrate a leak. Diagnosis is best made by history, physical examination, ultrasonography and a CT cystogram. If diagnosed early, catheterisation and broad spectrum antibiotics may sometimes lead to recovery. If the patient fails to respond within 12 hours on this regime or if the patient is ill, laparotomy should be performed at once. If there is any instability of the patient laparotomy should be considered as an immediate necessity as bladder rupture in this clinical situation can be lethal.

Level of evidence 2.

Grade of recommendation A

Figures are not available on the incidence of this complication in reservoirs made only of bowel but come from patients with intestinal segments in the urinary tract. Most papers report small numbers. In a multi-centre review from Scandinavia an incidence of 1.5% was noted. There were eight patients with neurogenic bladder which was said to be disproportionately high (223). In a series of 264 children with any sort of bowel reservoir or enterocystoplasty, 23 perforations occurred in 18 patients with one death (224). Therefore, as this complication is more common in children it becomes a very important consideration (222). A review of 500 bladder augmentation procedures performed during the preceding 25 years, spontaneous perforations occurred in 43 patients (8.6%), for a total of 54 events. The calculated risk was 0.0066 perforations per augmentation-year (225).

Patients and their families should be warned of this possible complication and advised to return to hospital at once for any symptoms of acute abdomen, especially if the reservoir stops draining its usual volume of urine. All young patients with urinary reconstructions including intestincystoplasty should carry suitable information to warn attending physicians of their urinary diversion in case of emergency.

5.3. Metabolic complications

Because enteric tissue, although incorporated into the bladder, retains its absorptive and secretory properties, there are potential serious consequences, especially for children with an expected longer life span than adults (226,227). Metabolic changes are common when urine is stored in intestinal reservoirs and

must be carefully monitored. It is uncertain whether they are commoner in children or whether they just live longer and are more closely monitored. Nurse *et al* found that all patients absorbed sodium and potassium from the reservoirs but the extent was variable (228). A third of patients (but 50% of those with an ileocecal reservoir) had hyperchloraemia. All patients had abnormal blood gases, the majority having metabolic acidosis with respiratory compensation. The findings were unrelated to renal function or the time since the reservoir was constructed. In 183 patients of all ages at St Peter's Hospitals who had any form of enterocystoplasty, hyperchloraemic acidosis was found in 25 (14%) and borderline hyperchloraemic acidosis in an additional 40 (22%) patients. The incidence was lower in reservoirs with ileum as the only bowel segment compared to those containing some colon (9% v 16%). When arterial blood gases were measured in 29 of these children a consistent pattern was not found (229). In a series of 23 patients, Dittono *et al* found that 52% of patients with a reservoir of right colon had hyperchloraemic acidosis (230). In ileal reservoirs, Poulsen *et al* found mild acidosis but no patients with bicarbonate results outside the reference range (231). Many authors do not distinguish between patients with normal and abnormal renal function. All of 12 patients in one series with a pre-operative serum creatinine above 2.0mg% developed hyperchloraemic acidosis within 6 months of enterocystoplasty (232). It is prudent to monitor patients for metabolic abnormalities, especially hyperchloraemic acidosis, and to treat them when found (233).

With increasing experience, it has become clear that there is a risk of developing vitamin B12 deficiency, sometimes after many years of follow up. It is likely that resection of ileum in children leads to an incomplete absorption defect. Stores of B12 may last for several years before the serum level becomes abnormal. At a mean follow up of six years, low levels of B12 have been found in 14% of children. There was a corresponding rise in the serum methyl malonic acid which accumulates in B12 deficiency, suggesting that the finding was clinically significant. Similarly, in adults, 18.7% have B12 deficiency at five years. In the adults, the mean B12 level was significantly lower when the ileo-caecal segment as opposed to ileum alone had been used (413 ng/ml compared to 257 ng/ml) (234,235). To avoid the serious neurological complications, regular monitoring of B12 levels is essential. In a review of 500 augmentations starting at 7 years postoperatively, 6 of 29 patients (21%) had low B12 values, while 12 of 29 (41%) had low-normal values (236). Paediatric patients who have undergone ileal enterocystoplasty are at risk for development of vitamin B12 deficiency. These patients are at the highest risk beginning at 7 years postoperatively, and the risk increases with time. An annual serum B12 value in children beginning at 5 years following bladder augmentation is recommended.

Level of evidence 2

Grade of recommendation B

The stomach has had a chequered career as a urinary reservoir. Its non-absorptive role in the gastro-intestinal tract has made it particularly useful in reconstruction of children with inadequate intestine, such as those with cloacal exstrophy. There is little effect on gastrointestinal function. Metabolically, the acid production leading to hyperchloraemic alkalosis may be positively beneficial in children with renal failure. It produces no mucus and the acidic urine is less easily infected and seldom grows stones. However, about a third of children have had serious long term complications, often multiple. The quite severe dysuria / haematuria and the skin complications from the acid urine, particularly, have limited its use (237,238).

5.4. Effects on the gastrointestinal tract

Little attention has been paid to the effects on gastro intestinal motility of removing segments of ileum or cecum for urinary reconstruction in children. In adults, disturbance of intestinal function has been found to be more frequent and more debilitating than might be expected. Disturbance of bowel habit does not mean diarrhoea alone. It also includes urgency, leakage and nocturnal bowel actions. Quality of life may be seriously undermined by changes in bowel habit (239). It is known that the bowel has a considerable ability to adapt, especially in young animals, when parts are removed. Nonetheless, reconstruction should be undertaken with the smallest length of bowel possible. Care should be taken in children with neurological abnormality in whom rectal control is already poor. Poorly controlled faecal incontinence may occur in a third of patients (240,241).

5.5. Renal function

Obstruction and high pressures in the bladder during storage have devastating effects on the upper urinary tract. Bladder augmentation eliminates these high pressures. Urinary diversion with recurrent urinary tract infections and stone formation also may have deleterious effects on renal function. It is therefore of utmost importance to evaluate renal function in young children who have undergone undiversion or continent diversion. In the follow-up so far available, these procedures do not seem to affect renal function. When function has improved after such surgery it is likely to be the result of eliminating obstruction or high bladder storage pressure. In rats with near complete nephrectomy the rate of progression of renal failure is no worse in those with ileocystoplasty compared to those with normal bladder (242). This suggests, experimentally, that storage of urine in small intestine is not, on its own, harmful to renal function.

Clinically, in the longer term, renal deterioration has been related to obstruction, reflux and stone formation. In one long-term study of Kock pouch patients, these complications occurred at the same rate as that found in patients with ileal conduits: 29% at five to 11 years (243). Similarly, in a prospective follow-up to a minimum of 10 years, it was found that the deterioration in glomerular filtration rate (GFR),

that was found in 10 of 53 patients, was due to a 'surgical' cause in all but one (244).

Although a more complicated procedure, a renal transplant can be anastomosed to an intestinal reservoir with similar long term results as those using an ileal conduit (245,246).

5.6. Infections and stones

The incidence of bladder reservoir stones varies between 12 and 25%. This is higher in children compared to adults. Palmer *et al* reported an incidence of 52.5% during a follow-up of four years (247). Renal stones are uncommon, occurring in about 1.6% of patients, an incidence which would be expected in a group with congenital urinary tract anomalies.

In a series comparing the Kock pouch with the Indiana pouch (which does not have staples), 43.1% of 72 Kock reservoirs formed stones compared to 12.9% of 54 Indiana reservoirs (248). Furthermore, no patient with an Indiana pouch formed a stone after 4 years, but patients with Kock pouches continued to do so at a steady rate up to eight years.

Apart from the presence of a foreign body, several factors have been blamed for the high stone risk. Almost all reservoir stones are triple phosphate on analysis, though Terai *et al* found carbonate apatite, urate and calcium oxalate in up to 50% of stones from patients with an Indiana pouch (249). This suggests that infection rendering the urine alkaline is a key factor. Micro-organisms that produce urease and split urea to form ammonia are the main culprits. The incidence of infection in reservoirs is high, 95% in one series, and yet the majority of patients do not form stones, suggesting that there are predisposing factors other than infection and the anatomical abnormality of the urine reservoirs (250). It has been suggested that the immobility associated with spina bifida may be responsible, but this seems to have been in series with a predominance of such patients and was not confirmed in other studies (251). In intestinal augmentation, mucus formation is especially troublesome as it tends to block catheters and requires regular irrigation, and may predispose to stone formation. The finding of a spectrum of stone formation from mucus, through calcification to frank stone lends some support to this aetiology. However, it could be a secondary event, with mucus becoming adherent to a stone that has already formed. Many surgeons encourage patients to wash out their reservoirs vigorously with water two or three times a week. There seem to be fewer stones in those that claim to practice regular washing. In a prospective study a regime of weekly washouts did not improve the incidence of stones in 30 children compared to historical controls (252). Mathoera *et al* found an incidence of 16% during a follow-up of 4.9 years in 90 patients: girls were more frequently affected than boys and concomitant bladder neck reconstruction, recurrent infections and difficulties with CIC were other risk factors identified, while the frequency of irrigation did not appear to be a risk factor (253).

Mucins are an important component of the epithelial barrier and protect the epithelium from mechanical and chemical erosion. Mucins are known to act as important adhesion molecules for bacteria. Mucins may also enhance the formation of crystals (254). Mucin expression changes after incorporating the intestinal segment in the bladder. Upregulation of MUC1 and MUC4 expression occurs in transposed ileal segments resembling normal epithelium, whereas ileal segments in enterocystoplasty showed an upregulation of MUC2,3,4 and 5AC expression towards the site of anastomosis with the ileal segment. These changes which may be due to exposure to urine coincide with a change from ileal sialomucins to colonic sulfomucins by a change in glycosylation. The mucins bind calcium and may form a template resembling the crystal structure on which crystals are formed and grow. From these studies, it is concluded that inhibition of bacterial adhesion (by using different irrigation fluids based on sugars) could be of eminent importance in the prevention of certain types of infection stones. An interesting comparison has been made between children with a native bladder alone and those with an augmentation, all of whom were emptying by self-catheterisation. There was no significant difference in the incidence of stones with or without an augmentation (255).

Stones are associated with inadequate drainage in the sense that CIC through the urethra, the most dependent possible drainage, has the lowest stone rate. Patients with the most 'uphill' drainage, that is with a Mitrofanoff channel entering the upper part of an orthotopic reservoir have a higher incidence of stones (254). Kronner *et al* made the observation, that the incidence of stones was statistically associated with abdominal wall stomas and a bladder outlet tightening procedure (21.1% compared to 6% in patients with augmentation alone) (250). Once a bladder stone has been diagnosed it has to be removed: several methods are available, but ESWL should be avoided as it is difficult to remove all fragments (and small particles may get trapped in mucus and the pouch wall), which may form the focus of a new calculus. Because of the recurrent nature of these stones the least invasive method should be recommended (256,257). Because of the high incidence of stones following enterocystoplasty several measures should be recommended to the patients and their parents. Regular CIC under hygienic circumstances with adequate fluid intake and irrigation seem to be the most important (258). It is unclear whether prophylactic antibiotics are useful, but a clinical infection should be treated adequately. Maybe in the future different types of irrigation fluid may prove helpful.

5.7. Growth

The suggestion that enterocystoplasty delayed growth in height seems to have been ill founded. In a group of 60 children reported in 1992 it was stated that 20% had delayed growth (259). Current follow up of the same group has shown that all have caught up

and achieved their final predicted height. Furthermore, measurements in a group of 123 children from the same unit have shown no significant delay in linear growth (260). Enterocystoplasty may have an effect on bone metabolism even if growth is not impaired. At least in rats with enterocystoplasty there is significant loss of bone mineral density especially in the cortical compartment where there is endosteal resorption. These changes are not associated with HCA and are lessened by continuous antibiotic administration (261,262). More recent follow-up data shows either no effect on growth or a decreased linear growth (263-266).

5.8. Pregnancy

When reconstructing girls it is essential to have a future pregnancy in mind. The reservoir and pedicles should be fixed on one side to allow enlargement of the uterus on the other. Pregnancy may be complicated and requires the joint care of obstetrician and urologist (267). Problems include upper tract obstruction and changes in continence as the uterus enlarges. Pregnancy with an orthotopic reconstruction appears to have a good outcome but chronic urinary infection is almost inevitable and occasionally an indwelling catheter is needed in the third trimester (268). With a suprapubic diversion, catheter drainage for incontinence or retention may be needed in the third trimester (269). Except in patients with an artificial urethral sphincter and extensive bladder outlet reconstruction, vaginal delivery is usual and caesarean section should generally be reserved for purely obstetric indications (distorted pelvis in spina bifida patients). During the delivery, the bladder reservoir should be empty and an artificial sphincter deactivated. The urologist should be present during Caesarean section to ensure protection for the reservoir, the continent channel and its pedicles.

5.9. Malignancy

The risk of malignancy in enteric augmentations has been reported to be higher than expected, and the risk increases with length of follow-up. Malignancy occurs in 0.6-2.8% of patients during median follow-up of 13-21 years. In a study including 153 patients with a median follow-up time of 28 years, malignancy was found in 4.5% (270). Animal data suggest that faecal and urinary streams must be mixed in bowel for neoplasia to occur. However, if it is chronic mixed bacterial infection, rather than the faeces *per se*, then all bowel urinary reservoirs are at risk. The malignancy seemed to be associated with coexisting carcinogenic stimuli or with the inherent risk present with bladder exstrophy. In patients with colonic and ileal cystoplasties high levels of nitrosamines have been found in the urine of most of the patients examined (271). Clinically significant levels probably only occur in chronically infected reservoirs (272). Biopsies of the ileal and colonic segments showed changes like those that have been found in ileal and colonic conduits and in ureterosigmoidostomies. More severe

histological changes and higher levels of nitrosamines correlated with heavy mixed bacterial growth on urine culture (273). In a review by Filmer *et al*, 14 cases of pouch neoplasm were identified (274). Special features could be found in nearly all the cases. Ten patients had been reconstructed for tuberculosis; four tumours were not adenocarcinomas; one patient had a pre-existing carcinoma; six patients were over 50 years old. Cancer was found in bowel reservoirs at a mean of 18 years from formation. This is a few years earlier than the mean time at which malignant neoplasms are seen in ureterosigmoidostomies. In a review of 260 patients with a follow-up of more than 10 years, Soergel *et al* found 3 malignancies (all transitional cell carcinoma): 2 following ileocecal and 1 after caecal augmentation. The age at augmentation was 8, 20 and 24 years respectively: the tumours were found when they were 29, 37 and 44 years old. All had metastatic disease and died. The incidence of malignancy in this group was 1.2%: considering that the development of tumours usually takes 20-25 years the probable incidence of malignancy following enterocystoplasty may be as high as 3.8 % (275). Hussmann *et al* studied a group of 153 patients with a mean follow-up of 27 years (10-52 yrs.) after augmentation cystoplasty. In those with a neurogenic bladder (n=97) they found 2 patients with transitional cell carcinoma (both smokers), in 38 patients with bladder exstrophy 3 multifocal adenocarcinomas in the augmented segment were found and in 2 of 18 patients with urethral valves an adenocarcinoma was discovered. The overall risk of cancer was 4.5% after a median period of 32 years. Of the 7 patients 5 died suggesting that these tumours are very aggressive and metastasised early (270). This level of carcinogenesis was also confirmed by Sung (276).

Patients who undergo bladder augmentation with a gastric remnant are at increased risk for malignancy, probably similar to that in patients with enterocystoplasty. In a review of 119 patients underwent augmentation cystoplasty with stomach in 2 institutions, three patients had gastric adenocarcinoma, while the other had poorly differentiated transitional cell carcinoma. Each case progressed to malignancy more than 10 years after augmentation (277-279). It has also been shown that patients with neurogenic bladder managed solely with clean intermittent catheterisation have an increased risk of bladder cancer, and this risk may be increased following bladder augmentation (280). If cancer is going to be a common problem, there will be some difficulty in monitoring the patients at risk (281). Endoscopy with a small instrument through a stoma may not be sufficient. Ultrasound may not be able to distinguish between tumours and folds of mucosa. Three-dimensional reconstruction of computerised tomography may be helpful, though the equipment is expensive and not widely available at present (282). Although many advise to perform an annual endoscopic evaluation in all patients following enterocystoplasty starting 10 years after surgery,

some argue that yearly endoscopy is not cost-effective and the potential morbidity makes it an ineffective screening procedure (283).

5.10. Psychological consequences and quality of life

The main justification for performing a bladder reconstruction or continent diversion is to improve the individual's Quality of Life (QoL). It would seem logical that continent urinary diversion would be better than a bag. This is not always the case. In adults, the only sure advantage is cosmetic. Validated QoL surveys in children have not been reported, primarily because of the lack of suitable instruments (284). Our prejudice is that reconstruction does, indeed, improve the lives of children although supporting evidence is very thin and based on experience in adults.

The ileal conduit has been a standard part of urological surgery for over 50 years. It has well known complications but few would seriously suggest that they were more troublesome than those of the complex operations for bladder replacement. In an early investigation into quality of life issues, Boyd *et al* investigated 200 patients, half with an ileal conduit and half with a Kock pouch: there was little difference between the groups except that those with a Kock pouch engaged in more physical and sexual contact. The only patients that were consistently 'happier' were those who had had a conduit and subsequently were converted to a Kock pouch (285).

In a recent QoL survey in adults, a wide range of complications were considered to be acceptable, although an ordinary urological clinic would be full of patients trying to get rid of such symptoms: mild incontinence (50%), nocturia (37%), bladder stones (12%), urinary infections (9%), hydronephrosis (5%). Nonetheless, their QOL was judged to be good, primarily because 70% had experienced no adverse effect on their normal daily lives (286).

Quality of life does not mean absence of disease or a level of complications acceptable to the reviewing clinician. It is a difficult concept to measure because lack of validated instruments, difficulties in translating from one culture or language to another, and the difficulties in selecting control groups and variations in clinical situations. Gerharz *et al* have constructed their own 102 item instrument and compared 61 patients with a continent diversion and 131 with an ileal conduit. Patients with a continent diversion did better in all stoma related items indicating that containment of urine within the body and voluntary emptying is of major importance. In addition, they had better physical strength, mental capacity, social competence and used their leisure time more actively. There was little difference in satisfaction with professional life, financial circumstances and in all interactions within the family including sexual activity (287).

Consensus statement on surgical treatment of urinary incontinence in children

Forms of urinary incontinence in children are diverse, however, a detailed history, physical examination and voiding diary obviate the need for further studies for the majority. This should identify that limited group that may require surgery. Many patients in this group will have obvious severe congenital abnormalities.

Because of the spectrum of problems, specific treatment is usually dictated by the expertise and training of the treating physician. The rarity of many of these problems precludes the likelihood of any surgeon having expertise in all areas. Furthermore, nuances in surgical procedures develop gradually and are often never systematically evaluated.

Nevertheless, it may be that newer forms of very early aggressive surgical approaches to severe complex anomalies such as exstrophy, myelodysplasia and urethral valves may provide a successful model for significant impact on the ultimate continence in such patients. Ultimately these may provide a basis for randomised studies to determine the most specific and effective mode of therapy.

The committee would encourage vigorous research on the molecular basis of bladder development and support the development of surgical and treatment strategies which would utilise the natural ability of the bladder to transform in the early months of development and immediately after birth.

Furthermore, efforts to promote bladder healing, and to protect and achieve normal bladder function should be supported. Such studies and research may lead to earlier and more aggressive treatment of many of the complex anomalies now treated by the surgical procedures outlined in this report.

VII. PSYCHOLOGICAL ASPECTS OF URINARY INCONTINENCE, ENURESIS AND FAECAL INCONTINENCE

List of abbreviations used in this section

ADHD	Attention-Deficit/Hyperactivity Disorder
CBCL	Child Behaviour Checklist
DSM-5	Diagnostic and Statistical Manual of Mental Disorders – 5
DUI	Daytime urinary incontinence
HKD	Hyperkinetic Disorder
FI	Faecal incontinence
ID	Intellectual Disability
ICD-10	International Classification of Diseases – 10

LUTS	Lower urinary tract symptoms
NE	Nocturnal enuresis
ODD	Oppositional Defiant Disorder

Since the publication of the 4th ICI report in 2009 (1) an increasing body of reviews has been published on psychological factors of incontinence in children (2-5). A new focus of research and clinical practice is on children with special needs, who have higher rates of incontinence and behavioural problems (6). This chapter includes an update based on the recent literature and especially the ICCS standardisation document on psychological aspects in urinary and faecal incontinence (7), as well as other ICCS documents.

1. INTRODUCTION

Children with urinary incontinence, enuresis and faecal incontinence carry a higher risk for manifest behavioural disorders, as well as for subclinical emotional and behavioural symptoms. It is important to assess and integrate psychological factors in treatment for two reasons:

1. As can be seen in table 1, the rate of comorbid behavioural and emotional disorders is much higher than possible organic causes (7). The same care used to exclude organic causes should be applied to the assessment of behavioural aspects. Therefore, paediatricians and urologists should have a basic understanding of psychological principles to treat their young patients adequately.

2. In functional or non-organic incontinence, provision of information, cognitive therapy and behavioural modification are the most effective, first-line approaches to treatment. Medication can be helpful in many cases, but are usually not the mainstay of treatment. Surgery is rarely indicated. As most of the techniques used in “urotherapy” are based on cognitive-behavioural psychotherapy, it is essential to be acquainted with the basic psychological principles.

Table 1: Organic causes and comorbidity of clinically relevant psychological disorders or symptom scores*

Nocturnal enuresis	
Organic causes	< 1%
Behavioural comorbidity*	20-30%
Urinary incontinence	
Organic causes	<10%
Behavioural comorbidity*	20-40%
Faecal incontinence with constipation	
Organic causes	< 5%
Behavioural comorbidity*	30-50%
Faecal incontinence without constipation	

Nocturnal enuresis	
Organic causes	< 1%
Behavioural comorbidity*	30-50%

* **Comparable population norms: 10%**

This chapter provides information on comorbid manifest clinical disorders, as well as symptoms which might be emotionally distressing for children and parents, but do fulfil the criteria for a disorder. Often, these will resolve upon attaining continence, while manifest disorders usually do not. In addition, children with psychological disorders are less compliant, and this explains why the failure rate of children's incontinence treatment is much higher. It is recommended that both incontinence and any comorbid psychological disorder are treated separately to ensure effective therapy.

The relevance of psychological factors for the different subtypes of incontinence will be considered. The terminology of the ICCS for enuresis and urinary incontinence as well as of the Rome-IV classification for faecal incontinence will be used (8,9).

2. CLINICAL BEHAVIOURAL DISORDERS

Worldwide, approximately 10 to 20% of children are affected by clinically relevant mental health disorder according to ICD-10 (10) or DSM-5 (11) criteria (12). Even under most conservative estimates, 15% of children and adolescents have psychological disturbances with daily incapacitation. But are these disorders increasing? Bor *et al.* tackled this question in their very carefully conducted review and found that for toddlers and children, there was no major increase of psychological disorders (13). However, adolescents show an increasing risk for internalising disorders such as anxiety and depression, especially girls. The rate of comorbid behavioural disorders is increased in children with all types of incontinence. Comorbidity denotes the co-occurrence of two or more disorders at the same time (concurrent comorbidity) or in sequence (sequential comorbidity). The focus on comorbidity allows a descriptive approach without referring to possible causal associations. Basically, four combinations are possible:

- A behavioural disorder can be a consequence of the wetting problem,
- A behavioural disorder can precede and induce a relapse when a genetic disposition for enuresis is present, for example in secondary nocturnal enuresis,
- Wetting and a behavioural disorder can both be due to a common neurobiological dysfunction (such as in nocturnal enuresis and ADHD),

- With such common disorders, no causal relationship can be present and the two may co-exist by chance.

A psychological disorder (synonyms: psychiatric, psychic, mental disorder) "is a syndrome characterised by clinically significant disturbance in an individual's cognition, emotion regulation, or behaviour that reflects a dysfunction in the psychological, biological, or developmental processes underlying mental functioning. Mental disorders are usually associated with significant distress or disability in social, occupational, or other important activities" (DSM-5) (11).

Clinically relevant disorders can be assessed by two basic methods: the categorical and the dimensional approach. The categorical method is based on a detailed diagnostic process (including history, observation, exploration, mental state examination, questionnaires, testing, physical examination and other procedures) and are professional diagnoses according to standardised classification schemes: ICD-10 (10) or DSM-5 (11). Dimensional assessment is based on symptom scores by questionnaires, but do not represent diagnoses. Cut-offs are defined to delineate a clinical (and sub-clinical) range.

One can differentiate three broad categories:

1. Externalising or behavioural disorders with outwardly-directed, visible behaviour (examples: conduct disorders and ADHD),
2. Internalising, i.e. inwardly-directed, intrapsychic disorders such as emotional disorders (examples: separation anxiety, social anxiety, phobias, sibling rivalry and depressive disorders),
3. Other disorders that do not fit into the two categories, such as anorexia nervosa, tic disorders and autism spectrum disorders.

Five of the most important disorders occurring in children and adolescents with NE, DUI and FI are summarised below:

Major depression has a prevalence of 2-5%. The aetiology is multifactorial with a 40-50% contribution of genetic factors. Symptoms include sadness, unhappiness, loss of enjoyment, lack of energy and interest, negative thinking, sleep and appetite problems. Treatment includes counselling, cognitive-behavioural, interpersonal and psychodynamic psychotherapy which can be combined with antidepressant medication. A population-based study of 2079 6-year old children has shown that depressive and anxious symptoms are more common in children with NE and DUI, and especially high in FI (14).

Anxiety disorders affect 5% of children. Again, aetiology is multifactorial, including family, temperament and to 40% genetic factors. Four subtypes predominate: separation anxiety disorder, characterised by fears associated with separation; generalised anxiety disorder with the main symptom of worrying; in social phobia avoidance of social situations is typical and in

phobia a fear of objects. Treatment consists of counselling, cognitive-behavioural therapy, relaxation, exposure and skills-based techniques, psychodynamic psychotherapy and medication in severe cases (antidepressants). Studies on anxiety in children with incontinence are still rare; exceptions are the study by Equit *et al.* (14).

Attention-deficit/hyperactivity disorder (ADHD) has a prevalence of 6% and a predominantly genetic aetiology (70-80%). The main symptoms are inattention, hyperactivity and impulsivity. Treatment includes counselling, parent training and cognitive-behavioural therapy. Medication plays a major role (mainly stimulants). In one population-based study of 1391 6-year old children, children with DUI had the highest rates of ADHD (15). Many studies have been conducted on the associations of ADHD and incontinence, which have been summarised in the systematic review of von Gontard and Equit (5).

Oppositional Defiant Disorder (ODD) is characterised by persistent hostile, provocative and noncompliant behaviour and affects 2-5% of children. The aetiology is best explained by a gene-environment interaction, including a genetic disposition and dysfunctional parenting practices. Treatment consists of counselling, parent training, cognitive-behavioural therapy, school-based interventions, but usually not medication. One population-based study on 718 6-year-old children showed a high rate of ODD, especially in children with DUI (16); and another study of 1676 6-year old children, especially those with FI were affected by ODD, ADHD or both (17).

Autism Spectrum Disorder (ASD) is a neurodevelopmental disorder, defined by persistent deficits in social communication and social interaction and restricted, repetitive patterns of behaviour, interests and activities (DSM-5) (11). These disorders are pre-

sent from the early developmental period, cause clinically significant impairment and are associated with intellectual and language impairment, other disorders. The prevalence of ASD is 0.6-1%. The aetiology is mainly genetic, with up to 90% of the variance being due to genetic factors. 15% of ASD are syndromal forms, with the Fragile-X Syndrome, Tuberous Sclerosis being the most important syndromes. The diagnosis is based on a full child psychiatric, paediatric and genetic assessment. Treatment consists of parent training and counselling, autism-specific training programmes and behavioural therapy. Medication includes neuroleptics, stimulants, antidepressants (SSRI), which are not given routinely, but only when indicated. In a recent systematic review, the associations of ASD and incontinence were summarised, as well as the many open research questions (18).

3. CLINICAL BEHAVIOURAL DISORDERS IN CHILDREN WITH NOCTURNAL ENURESIS AND DAYTIME URINARY INCONTINENCE

Children with urinary incontinence show a higher rate of comorbid behavioural and emotional problems (16.5% to 51.9%) than non-wetting children (7.8% to 10.2%), in both epidemiological and in clinical studies. The overall relative risk is 1.4 – 4.5 times higher, based on early population-based studies (7). Epidemiological studies have the advantage of revealing representative associations. They often cannot differentiate well between subgroups. To date, the largest and best population-based studies are those of Joinson *et al.*, based on the British ALSPAC birth cohort (19, 20, 21) (see table 2).

Table 2: Epidemiological, population-based studies: Percentage of children with clinically relevant behavioural problems in comparison to controls and their relative risk*

Study	Age (yrs)	N	Type of wetting	Incontinent children	Controls	Odd's ratio
Joinson 2007 (19)	7 ½ years	8242	NW	Separation anxiety: 8.0%	6.4%	1.3
				Social anxiety: 7.0%	4.6%	1.5
				Specific phobia: 14.1%	11.5%	1.2
				Generalised anxiety: 10.5%	7.7%	1.4
				Depression: 14.2%	10.9%	1.3
				ODD: 8.8%	4.7%	1.9
				Conduct disorders: 8.5%	5.7%	1.5
				ADHD: 17.6%	11.9%	1.5
Joinson 2006 (20)	7-9	8213	DW	Separation anxiety: 11.4%	6.8%	1.8
				Attention/activity: 24.8%	13.8%	2.1

				Oppositional behaviour: 10.9%	5.8%	2.0
				Conduct problems: 11.8%	6.2%	2.0
Joinson 2006 (21)	7-8	8242	FI	Separation anxiety: 4.3%	0.8%	5.4
				Specific phobia: 4.3%	1.0%	4.3
				Generalised anxiety: 3.4%	0.4%	8.5
				ADHD: 9.2%	1.9%	4.8
				ODD: 11.9%	1.9%	6.3

*DUI = Daytime urinary incontinence

*FI = Faecal incontinence

*NE = Nocturnal enuresis

3.1. Nocturnal enuresis

The ICCS differentiates between primary (never dry) and secondary NE (relapse after a dry period of 6 months); and monosymptomatic (no lower urinary tract symptoms - LUTS) and non-monosymptomatic NE (with LUTS). Therefore, four subgroups of nocturnal enuresis can be differentiated:

- Primary monosymptomatic nocturnal enuresis
- Primary non-monosymptomatic nocturnal enuresis
- Secondary monosymptomatic nocturnal enuresis
- Secondary non-monosymptomatic nocturnal enuresis

Epidemiological studies show clearly that, depending on definitions and instruments used, 20-30% of all nocturnal enuretic children show clinically relevant behavioural problems, 2 to 4 times higher than non-wetting children (7).

In the British population-based ALSPAC-study of 8242 children at the age of 7 ½ years, children with NE were affected by: separation anxiety (8.0%), social anxiety (7.0%), specific phobia (14.1%), generalised anxiety (10.5%), depression (14.2%), ODD (8.8%), conduct disorders (8.5%) and ADHD (17.6%) (table 2) (19).

Children with primary nocturnal enuresis were not different from controls in epidemiological studies (22). Secondary nocturnal enuresis was preceded by a higher rate of weighted life-events (23) and was significantly associated with a higher rate of psychiatric disorders, which can persist into adolescence (22). By adolescence, the attainment of dryness after the age of 10 years increased the risk for behavioural problems, independently of the primary or secondary status (24).

The only epidemiological study addressing monosymptomatic nocturnal enuresis included 8242 children aged 7 ½ years (25). Though not adhering to the ICCS criteria, children with monosymptomatic nocturnal enuresis showed fewer behavioural symptoms than those with daytime problems (i.e. the non-monosymptomatic forms), although the differences did not reach significance.

Regarding the types of behavioural and emotional disorders, externalising disorders such as ADHD and ODD predominate (5, 15,16,17, 26).

In a retrospective study of patients with ADHD, 20.9% wetted at night and 6.5% during the day. The odds-ratios were 2.7 and 4.5 times higher, respectively, which means that there is a nonspecific association of ADHD and both night and daytime wetting (27). 25% of 140 children with ADHD were affected by nocturnal enuresis compared to 10.8% of 120 controls (28). The highest comorbidity rates of 40% for ADHD and nocturnal enuresis were reported by Baeyens *et al.* (29), possibly due to selection bias: 15% had a combined, 22.5% an inattentive and only 2.5% a hyperactive type of ADHD. In a community based sample, the prevalence rate was much lower. ADHD continued to be present in 72.5% of children in a two-year follow-up indicating a high stability (37). Children with ADHD continued to wet at follow-up much more often (65%) than controls (37%) (Odds-ratio 3.17). At a 4-year follow-up, 64% still had ADHD: of these, 42% continued to wet at night (compared to 37% of the controls) (30).

In clinical practice, children with ADHD are more difficult to treat. In a retrospective study, 113 children with ADHD and nocturnal enuresis had a worse outcome on alarm treatment than controls (with nocturnal enuresis only): 43% (vs. 69%) were dry at 6 months and 19% (vs. 66%) at 12 months. There was no difference if they were treated with medication, which does not require active cooperation. Non-compliance was reported in 38% of children with ADHD, but only in 22% of the controls (31). This means that

children with both enuresis and ADHD require special attention – and both need to be treated separately.

3.2. Daytime urinary incontinence

Daytime wetting has been neglected in epidemiological research. The most important study is based on a cohort of 8213 children aged 7 ½ to 9 years (20). Children with daytime wetting had significantly increased rates of psychological problems, especially separation anxiety (11.4%), attention deficit (24.8%), oppositional behaviour (10.9%) and conduct problems (11.8%). Externalising disorders predominate in daytime wetting children, which, in turn, will interfere with treatment. In the same cohort, 10,000 children aged 4 to 9 years were analysed. Delayed development, difficult temperament and maternal depression / anxiety were associated with daytime wetting and soiling (32). In another population-based study, 36.7% of children with urinary incontinence had ADHD symptoms, in comparison to 3.4% of dry children (15).

ADHD is a common problem among day wetting children, as well. Compared to controls, children with ADHD had more symptoms of incontinence, constipation, infrequent voiding and dysuria (33). With ADHD, treatment outcome is worse. In a retrospective analysis, 68% of day wetting children with ADHD became dry compared to 91% of controls. Non-compliance was much higher for timed voiding (31).

Daytime wetting is a heterogeneous group of disorders. According to the ICCS terminology, following subgroups can be differentiated (8):

- Over-active bladder including urgency incontinence
- Voiding postponement
- Underactive detrusor
- Dysfunctional voiding
- Obstructive voiding
- Stress urinary incontinence
- Vaginal reflux
- Giggle incontinence
- Extraordinary daytime urinary frequency

Only some of these subgroups have been studied regarding comorbid psychological disorders.

Children with urgency incontinence have fewer behavioural problems than those with other types of DUI. 29 % of children with urgency incontinence had an ICD-10 diagnosis and 14% had an internalising disorder. 13.5 % had a clinical total problem score in the CBCL, again mainly internalising problems (34, 35). The children are distressed by their wetting and family functioning is intact. In another study, 35% of children with urgency incontinence fulfilled the criteria for an ICD-10 diagnosis (36). Children with urgency incontinence have lower rates of comorbid disorders than those with voiding postponement (36% vs.

59%), but higher than controls (9%). Children with urgency incontinence predominantly have emotional, introversive disorders. In summary, children with urgency incontinence have only a slightly increased rate of comorbid psychiatric disorders. If they are affected, emotional, introversive symptoms predominate.

Children with voiding postponement, on the other hand, fall into two groups: in some it represents an acquired habit, in others, it is associated with externalising psychological disorders, especially oppositional defiant disorder (ODD). In a systematic study of children with voiding postponement in a paediatric and child psychiatric setting, 53.8 % fulfilled the criteria for at least one ICD-10 diagnosis (34). These were mainly externalising disorders in a third children such as Oppositional Defiant Disorder (ODD). Also, 37.3 % of children had a CBCL total score in the clinical range, again, with externalising symptoms predominating. In addition, family functioning was impaired (34,35). In another sample, 53% of children with voiding postponement had at least one ICD-10 diagnosis (37). In summary, children with voiding postponement have highly increased psychiatric risks. Voiding postponement as one of the most important subgroups of DUI was the topic of a recent review (38).

Studies on comorbid behavioural problems in children with underactive bladder have not been performed. Systematic investigations of psychological aspects of dysfunctional voiding are rare. In some children, it represents an acquired habit, in others severe psychological disturbances are present (39). Dysfunctional voiding following severe sexual abuse and deprivation as well as other familial stressors such as migration has been described in case reports (40). There have been no systematic investigations of children with giggle incontinence. From clinical experience, they are highly distressed by the symptom and try to avoid situations in which they might be forced to laugh. Social withdrawal, not going to parties and meeting with friends has been observed. It is not known if the rate of behavioural disorders is increased. Regarding the other subtypes of urinary incontinence, not even anecdotal data are available.

4. CLINICAL BEHAVIOURAL DISORDERS IN CHILDREN WITH FAECAL INCONTINENCE

According to the Rome-IV classification, two subtypes of faecal incontinence can be differentiated (9):

- Functional constipation (with or without incontinence)
- Non-retentive faecal incontinence.

4.1. Epidemiological Studies

In the large ALSPAC study of 8242 children aged 7-8 years, children with faecal incontinence had significantly increased rates of separation anxiety, specific phobias, generalised anxiety, ADHD and ODD (see table 2) (21). In other words, soiling children show a completely heterogeneous pattern of both internalising and externalising disorders. Again, these will require assessment in the individual child, as they will interfere with treatment of the incontinence.

In clinical studies, 35% to 50% of all children with faecal incontinence had a total behavioural score in the clinical range in this parental questionnaire. Compared to the normative population (10%), 3.5 to 5 times more children with faecal incontinence have total behaviour scores in the clinical range (7). Children with behavioural maladjustment are less compliant than children without psychological disorders (71% vs. 38% non-compliant) – so if these behavioural problems are not addressed treatment will be less successful (41).

Children with faecal incontinence and constipation have the same rate of behavioural scores in the clinical range as children without constipation (39% vs. 44%, (42) and 37% vs. 39%, (43)). This means that the two major types of faecal incontinence cannot be differentiated according to the behavioural comorbidity. More importantly, regarding the aetiology, there is no evidence that one type (i.e. with constipation) has more somatic aetiology, while the other type (i.e. without constipation) has a more psychogenic aetiology. There is no specific psychopathology typical for faecal incontinence: all types of behavioural and emotional disorders can co-exist.

4.2. Subclinical signs and symptoms

Subclinical behavioural signs and symptoms are common, understandable, adequate reactions towards the wetting problem and not disorders. Many studies have addressed the impact of wetting on children.

a) Impact on children

Most children are distressed by enuresis. For example, 35% said that they felt unhappy, 25% even very unhappy about wetting at night in one study (40 children aged 5-15 years) (44). In a Finnish population-based study, 156 day and night wetting children (from 3375 7-year olds) showed significant differences compared to 170 controls regarding following personality traits (45): they were more fitful (vs. peaceful), more fearful (vs. courageous), more impatient (vs. calm), more anxious (vs. does not worry) and had more inferiority feelings (vs. feels equal). In a large population-based British study of 8209 children aged 9 years, 36.7% of children consider bed-wetting to be “really difficult” – ranking 8th behind other stressful life-events (46).

One construct of special importance is that of self-esteem. In one study, lower self-esteem in children with

enuresis disappeared upon attaining dryness (47). In another, global self-esteem was significantly lower in children with nocturnal enuresis than in controls (48) and in yet another, the self-esteem total score was higher among enuretics than norms (49). Therefore, it was concluded that there is no clear evidence that bedwetting leads to lower self-esteem (50) – but there can be no doubt that self-esteem can improve upon attaining dryness (49). Self-esteem increases even if treatment of enuresis is not successful (51), showing that care and “good doctoring” for children and parents is of great help – regardless of outcome. Recently, a focus has been on quality of life, which is reduced in children with urinary incontinence (52). Questionnaires to assess quality of life will be presented later.

Children with faecal incontinence tend to feel less in control of positive life events and had a lower sense of self-esteem than children with other chronic conditions (53). However, in a more recent study, self-esteem did not differ between children with faecal incontinence and controls (54).

b) Impact on parents

Enuresis and urinary incontinence may be just as distressing for parents as for children. Generally, parents are very concerned about the welfare of their child. In a population based study, 17% worried a great deal and 46% some or a little (55). In one study, the greatest maternal concerns were: emotional impact, social relationships, smell, extra washing and financial aspects (56). Mothers of children with nocturnal enuresis had a reduced quality of life scores (bodily pain and emotional role) and more depressive symptoms (57).

Parents also believe that their child should be dry at a very early age, which can induce anxiety and stress: the mean anticipated age of dryness was 3.18 years in one study (58) and 2.75 years in another (59). Also, many parents think that emotional factors are the cause of nocturnal enuresis and forget that they might be the effect of the wetting problem instead (58,59).

A minority of parents show an attitude that was described as “maternal intolerance” by Butler et al (60). Convinced that their child is wetting on purpose, the risk for punishment is increased. In some cultures, punishment is very more common: 42% of Turkish children were spanked and 13% beaten (61). Chinese parents show a high level of parenting stress associated with externalising behavioural problems or their child (62). These parental attributions and experiences must be considered in all treatment plans for enuresis, as they can decisively influence the outcome.

Parents of children with faecal incontinence are also stressed and worried about the problem (63). In one study, children with faecal incontinence had family environments with less expressiveness and poorer organisation than controls (54). In another study of 104 families, nearly half (51%) had no unusual family

problems; 23 had severe and widespread difficulties including sexual abuse; 11 families described moderate difficulties and 18 a single traumatic event (64). In other words, the atmosphere was warm and supportive without major difficulties in at least half of the families.

5. CHILDREN WITH SPECIAL NEEDS

Special needs is an umbrella term referring to individuals who require additional medical, psychiatric, psychological and educational assistance (6). Those with special needs comprise heterogeneous groups of physical and intellectual disability, as well as a wide variety of neurodevelopmental disorders. These disorders and disabilities continue to affect adults, i.e. they are life-long conditions. Incontinence is major, but often neglected disorder in people with special needs.

Studies have shown repeatedly that all types of incontinence are more common in children with special needs than in normally developing children, i.e. nocturnal enuresis (NE), daytime urinary incontinence (DUI) and faecal incontinence (FI). Also, incontinence has a higher likelihood of persisting into adolescence and adulthood, i.e. becoming a chronic condition. Incontinence can have an additive negative effect on the emotional state, self-esteem and quality of life of the child with special needs – and can affect his/her own daily school and family functioning.

Many children with intellectual disability have special needs. Intellectual disability (ID) is defined by an IQ < 70. Mild ID (IQ 50-69) and severe ID (IQ < 50) are the two broad categories. Many different syndromes and disorders are associated with ID, most with prenatal, genetic causes. Overall, incontinence is more common in children, adolescent and young adults with ID (65). Also, there is an inverse relationship between IQ and incontinence, i.e. the lower the IQ is, the more often incontinence occurs.

Incontinence has been studied only in some of the specific syndromes of ID, such as Fragile-X, Williams, Down and Angelman syndromes (66-69). In addition to the IQ-level, syndrome-specific risk factors for incontinence have been identified, such as . epilepsy in Angelman syndrome and behavioural factors in other syndromes.

As many children with special needs do not receive standard assessment and adequate treatment. Professionals working with children with special needs should realise that incontinence is a major and common problem in their patients and should actively offer effective treatment based of incontinence, the underlying condition and associated, comorbid disorders. Daily distress will be reduced for patients, as well as parents and caregivers.

6. GENERAL PRINCIPLES: ASSESSMENT

6.1. Screening Questionnaires

Due to the high rate of comorbid behavioural disorders, the ICCS recommends screening with a broad-band, validated questionnaire (7,8). Broad-band means that a wide range of psychological symptoms are assessed. Narrow-band questionnaires are less useful as screening instruments, but are valuable in the diagnosis of specific disorders. Narrow-band questionnaires include those for depression, anxiety, ADHD, obsessive-compulsive behaviour, tics and autism spectrum disorders. If a manifest psychological disorder is suspected by history, clinical observation, exploration and broad-band questionnaires, a child psychological or psychiatric assessment is recommended. Short, medium and long screening questionnaires are available.

a) Short broad-band screening questionnaires

The 'Parental Questionnaire – Enuresis/Urinary Incontinence (PQ-EnU)', a parental questionnaire which has been used widely in clinical care and research, has recently been validated (3, 70). It contains yes/no questions regarding nocturnal enuresis (NE) (12 items), daytime urinary incontinence (DUI) (10 items), voiding and stool habits (19 items), as well as behavioural problems (10 items). In the validation sample of 496 patients, a high correlation of .723 to .778 with diagnoses of incontinence (NE, DUI and faecal incontinence -FI) could be demonstrated. A factor analysis of the Behavioural Problem Scale (BP) revealed three factors: "attention and school deficits" (Cronbach's $\alpha = .665$), "impulsive-aggressive behaviour" (Cronbach's $\alpha = .731$) and "internalising problems" (Cronbach's $\alpha = .409$). These factors showed significant correlations with Child Behaviour Checklist (CBCL – see below) total, internalising and externalising scales (.351 to .608). In summary, the PQ-EnU is a valid questionnaire to examine children with incontinence and can be used as a screening for psychological symptoms. It can be downloaded without charge (3).

The 'Short Screening Instrument for Psychological Problems in Enuresis (SSIPPE)' is a comparable instrument available in appendix of Van Hoecke et al. (71). It is a validated parental questionnaire, based on the Child Behaviour Checklist (CBCL) (72). It has three scales including 7 items for emotional problems, 3 items for attention symptoms and 3 items for hyperactivity/impulsivity symptoms. The authors recommend that if more than two yes answers are given for any of the 3 problem areas (emotional, attention, hyperactivity/impulsivity), this should be followed by a more detailed questionnaire such as the CBCL. If the CBCL T-scores are in clinical range (or many problem items are answered with a "2"), then a detailed child psychiatric assessment should follow.

b) Medium-length broad-band screening questionnaire

The Strengths and Difficulties Questionnaire (SDQ) is a medium-length behavioural screening questionnaire about 3-17 year olds (73). Parent and teacher versions are available, as well as self-reports for 11-17-year-old children and adolescents. It exists in several versions to meet the needs of researchers, clinicians and educationalists. In addition to the standard version, one version additionally assesses impact and incapacitation, while another version is useful for follow-up. Official translations are available in 77 languages.

All versions of the SDQ ask about 25 attributes, some positive and others negative. The items are scored on a three-point scale: not, somewhat and certainly true. The 25 items are divided between 5 scales: emotional symptoms (5 items), conduct problems (5 items), hyperactivity/inattention (5 items) and peer relationship problems (5 items) – these 4 scales form the total difficulties score. A fifth scale measures prosocial behaviour (5 items).

The Strengths and Difficulties Questionnaires, whether in English or in translation, are copyrighted documents that may not be modified in any way. Paper versions may be downloaded and subsequently photocopied without charge by individuals or non-profit organizations provided they are not making any charge to families. The questionnaires, scoring instructions, norms and related articles can be downloaded free of charge at following website: www.sdqinfo.org

c) Long broad-band screening questionnaires

The family of Achenbach questionnaires covers the age groups from 1 1/2 years to 30 years – with self-informant-, parent- and teacher versions (72). The parental Child Behaviour Checklist (CBCL/6-18) is one of the most widely used questionnaires world-

wide with translations in many different languages (over 90) and with national norms.

As the name implies, the CBCL/6-18 is a parental questionnaire for the age groups of 6 to 18 years. It consists of a 113 problem items, which are scored on a three-point scale: 0= not true; 1= somewhat or sometimes true; 2= very true or often true. Three composite scales can be calculated (total score, internalizing, externalising behaviour). For these composite scales, the clinical cut-off is at the 90th percentile and the borderline cut-off at the 85th percentile. In addition, 8 other syndrome scales can offer valuable information.

The CBCL is one of many questionnaires within the Achenbach family of instruments: these aim at the pre-schoolers (1 ½ - 5 years), school age children (6-18 years), young adults (18-30 years), adults (18-59 years) and older adults (60-90 years). Self-report, parent and teacher versions exist, so that behaviour can be assessed in different contexts. All Achenbach questionnaires (such as the CBCL), manuals and related materials can be ordered under: www.aseba.org

In the ICCS documents, a general screening for emotional and behavioural problems in all settings (paediatric, urologic, child psychiatric, etc.) with a validated and standardised parental behavioural questionnaire is recommended because of the high rate of comorbid disorders in 30-50% of children (8). This can be done in two steps: using a short screening questionnaire first, followed by a long questionnaire; or in one step: using a validated, medium of long questionnaires. If many problem items are checked, a child psychological or psychiatric assessment should follow. If comorbid disorders are present, counselling or treatment, if necessary, is recommended (see figure 1).

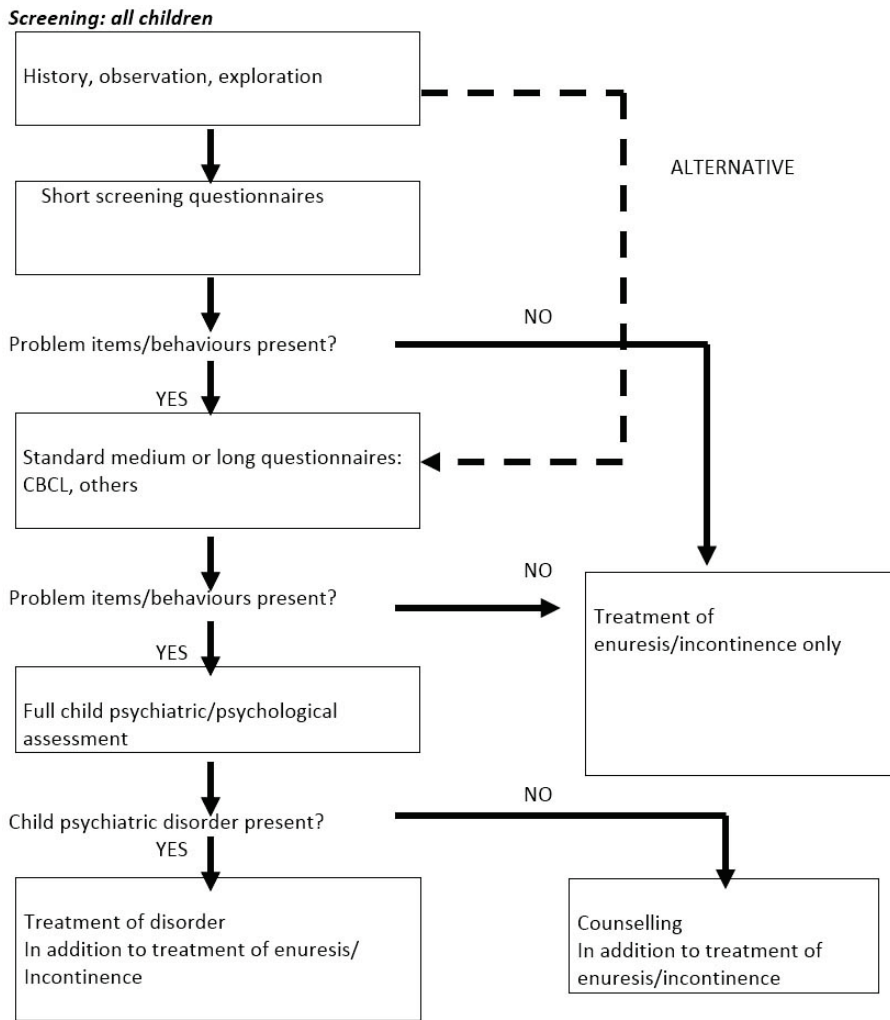

Figure 1: Flow chart for assessment of psychological symptoms (subclinical) or disorders (clinical). The specific treatment for enuresis / incontinence is the same for all children including those with symptoms requiring counselling, and those with disorders needing treatment (7)

One construct of special interest in children with incontinence is that of health-related quality of life (HQoL). In their standardisation document, the ICCS recommends to screen for changes of health-related quality of life (HrQoL) and specifically recommends using the PinQ-questionnaire, which is by far the best condition-specific HrQoL for children with incontinence (8, 74).

Generic HrQoL questionnaires can be useful in research in comparison with healthy controls and with children affected by other chronic medical conditions (75-77). Self-report versions for different age-groups, as well as proxy-report versions exist. The youngest age for self-report is 4 to 6 years, with reliable results available from 8 years onwards. The most commonly used proxy report is by parents, but caregivers, nurses and doctors can fill out these questionnaires,

as well. Parental and child appraisal of HrQoL can differ. In research, comparison of child and own parental QoL can be interesting (77,78), but is usually not feasible in clinical practice.

In general, as HrQoL is a multidimensional construct, different aspects are assessed such as physical functioning, psychological well-being, social relationships, everyday life activities, satisfaction, discomfort, etc. These questionnaires can also be useful in monitoring the effects of therapy – in research, as well as in clinical practice. HrQoL-questionnaires are not useful in screening for psychological disorders, i.e. the information is not sufficient to decide if a disorder could be present or not.

6.2. Child psychiatric assessment

A child psychiatric assessment is a professional procedure with the goal of coming to a categorical decision: to see if a diagnosis, according to the standardised classification schemes (ICD-10 or DSM-15) is present in the child or not (10,11).

The first step is a detailed developmental, behavioural and family history in much greater detail than provided in the outline in the appendix. The next step is to observe the child as well as the parent-child-interaction, followed by an active exploration of the child. The information gained from history, observation and exploration forms the basis of the mental state examination. This is a descriptive, phenomenological assessment of mental and behavioural signs and symptoms (for example: CASCAP-D) (79).

Questionnaires are always an essential part of child psychiatric assessment. They are a time-efficient way to gather information from different informants. They can contribute towards but do not provide a diagnosis. Behavioural questionnaires can again be divided into general and specific questionnaires. The best known, most widely used general parental questionnaire is the Child Behaviour Check List, which has been translated into many languages (CBCL/6-18)(72). In the meantime, Achenbach and co-workers have produced a whole "family" of questionnaires for different age groups (infants, children – adolescents, young adults) and different informants (parents, teachers and for children themselves starting from age 11). In addition, other specific questionnaires address circumscribed areas such as depressive symptoms or ADHD problems.

An intelligence test is not routinely indicated in the assessment of children with elimination disorders, as the IQ is in the normal range for most children with wetting, as well as soiling problems. However, the rate of elimination disorders is clearly increased in children with general developmental disorders, including those with mental and physical handicap (6). If a lower intelligence is suspected, one-dimensional tests (such as the CFT or CPM/SPM tests) or multidimensional tests such as the Kaufman or the Wechsler tests can be performed. If specific developmental disorders such as dyslexia or dyscalculia are suspected, specific tests for these circumscribed disorders are indicated. Disorders of speech or language (such as articulation, expressive and receptive speech disorders) require a detailed assessment by an audiologist and speech therapist. Motor disorders can be assessed clinically by including soft neurological signs in the physical examination of children.

After the diagnostic process has been completed, the child's disorder is diagnosed according to standardised classification schemes. The two standard classification systems are the ICD-10 (10), which is widely used in Europe and in other parts of the world and the DSM-5 (11) employed in the United States.

In child psychiatry, a multi-axial classification is used. Six different axes denoting different domains are used, including:

1. Axis: clinical psychiatric diagnosis (such as anorexia nervosa, depressive episodes, etc.)
2. Axis: specific developmental disorders (such as dyslexia)
3. Axis: intelligence (such as dyslexia, speech and motor disorders)
4. Axis: somatic diagnosis (such as epilepsy and other paediatric diagnoses)
5. Axis: psychosocial risks occurring within the last six months (such as distorted intra-familial interaction, isolated family and other stressful life events)
6. Axis: the global severity of a disorder (ranging from mild incapacitation to disorders requiring constant supervision and guidance)

Only after the diagnostic process has been completed and discussed with parents and children, should therapeutic interventions be planned.

6.3. General principles: treatment of psychological disorder

For most children with elimination disorders, a symptom-orientated approach is sufficient. If, however, another, co-occurring child psychiatric disorder is present, additional types of treatment will be necessary. In these cases, a differential indication for therapy is mandatory. The question is: which treatment is most effective for this child in this family at this moment?

For some disorders (such as ADHD), medication plays a major role. For most others, psycho-therapeutic interventions are the first-line treatment. There can be no doubt that psychotherapy in children is effective. In one of the best and largest meta-analysis of 150 studies, Weisz et al. (80) conclude that "psychotherapy with young people produces positive effects of respectable magnitude "(i.e. effect sizes in the medium to large range - 0.5 to 0.8). It has been estimated that over 500 different types of psychotherapies exist in the USA for children and adolescents alone (81). Of those which have been evaluated, four basic schools of psychotherapy can be differentiated:

1. Depth psychology (or psycho-analysis), which addresses and works with unconscious aspects of the psyche;
2. Client- (or child-) centred-psychotherapy, which focuses on the current conscious experience of the child and the healing aspects of their therapeutic relationship;
3. Family therapy, which focuses on the interaction between family members but not the individual person;

4. Cognitive-behavioural therapy, focusing on cognitions and observable behaviour.

Before initiating any psychotherapy, a differential indication for therapy as to be made. The first basic question should be: is treatment needed at all? In many cases counselling of parents and child is all that is required. In other cases, changes in the child's environment (such as changing school) or help from social services can be more useful than psychological treatment in the narrower sense.

The modality should be considered. Although parents are nearly always included, the focus can be on an individual, group or family therapy. The intensity and duration should be addressed: is a short focal therapy focused on one specific problem needed, or a longer more general treatment? The age of the patient plays an important role: while older children and adolescents can be reached verbally, younger children require play or other non-verbal media in their therapy.

Psychotherapies can be combined with other methods, such as pharmacotherapy, but also by using speech, occupational, physiotherapy, music and other types of therapies – if indicated. The decision should no longer be based on personal inclinations. Instead, empirically based “practice parameters” or “guidelines” have been developed in many countries. These interventions are usually performed on an out-patient basis. Day clinic treatment can be indicated in more severe disorders, which require a more intense approach and management. Finally, in-patient child psychiatric treatment is indicated in severe disorders, in which a more intense type of treatment is possible.

6.4. General principles

a) Urotherapy

A major part of therapy of incontinence in children is non-pharmacological and non-surgical. The term urotherapy is used in some countries. It is an umbrella term which has been defined as a “type of training which makes use of cortical control of the bladder, teaching children to recognise and employ conscious command over their lower urinary tract. Its main ingredients are information about normal lower urinary tract function and the specific dysfunction in the child, instruction about what to do about it and support and encouragement to go through with the training programme (82).

Although not a psychotherapy in a narrow sense, it employs many psycho-therapeutic techniques borrowed especially from counselling and cognitive-behavioural therapies. As these approaches have been shown to be most effective, basic principles and findings shall be outlined.

b) Non-specific approaches

The first step in any diagnostic and therapeutic process is to create a good relationship with both the child and the parent. One should enquire and talk about all relevant facts, signs and symptoms openly.

It is also important to ask about the subjective meanings and connotations. Next, the provision of information is essential, because many facts are not known. It is often forgotten that not only parents but each child needs information, as well. This should be provided in words and concepts that a child understands and in a format that is attractive. Increasing motivation and alleviation of stress and guilt feelings are also part of all patient contacts.

c) Counselling

Counselling is already part of the treatment process, which has been defined as the provision of assistance and guidance in resolving personal, social, or psychological difficulties. For many children, even with psychological disorders, counselling is, in fact, sufficient. Sometimes, it can be helpful to enhance the verbal counselling by other techniques. One simple technique is that of “demonstration”, e.g. actively showing how an alarm works. In “coaching”, parents and children take an even more active role, e.g. they set and activate an alarm themselves. They can be observed and corrected. Other techniques might include “modelling” and “role-playing”. The learning effect is much greater in these active forms of teaching than in solely verbal counselling.

d) Cognitive-behavioural therapy

Cognitive-behavioural therapy (CBT) is a subtype of psychotherapy that has shown to be effective for many disorders. Cognitive therapy focuses on irrational, dysfunctional conditions, thoughts and beliefs. Cognitive therapy encompasses a whole variety of techniques such as “self-monitoring” (observation and registration), “activity scheduling” (organisation of activities) and “labelling” (using positive suggestive statements). Behavioural therapy concentrates on observable behaviour, which it aims to modify with a variety of techniques. These include “classical conditioning” and “operant conditioning”, which basically means learning by success, which can be achieved by different strategies using positive or negative reinforcement.

e) Baseline and observation

Baseline and observation are effective techniques used in cognitive-behavioural therapy. Children (and parents) are advised to observe a defined symptom. Different parameters such as frequency (how often it occurs), severity (how marked it is), symptomatology (in what form it occurs) and in which situation (associated factors) can be registered, e.g. in an observation chart. The mere observation and registration has a therapeutic effect and many symptoms diminish if they are simply observed.

In nocturnal enuresis, children are asked to fill out a calendar or chart depicting the wet and the dry nights symbolically for two to four weeks (3). These non-specific measures have been shown to be successful and are associated with fewer wet nights (3). In one clinical trial, for example, 18% became dry after an 8-week baseline (83).

In urgency incontinence, the cognitive aspects are stressed in treatment: children are asked to register feelings of urgency, refrain from using holding manoeuvres, to void and register the voiding (or any wetting) in a chart (3). For children with voiding postponement, timed voiding 7 times a day and registration in a chart is recommended (3,38).

For all children with faecal incontinence, stool regulation is an essential part of treatment. Children are asked to sit on the toilet three times a day after mealtimes in a relaxed mode for five to ten minutes (4). This is documented in a chart and can be reinforced positively. If constipation is present and a large amount of faecal mass has accumulated, disimpaction has to be performed at the beginning of treatment. Oral disimpaction is the preferred method. To avoid re-accumulation of faecal masses, maintenance therapy with oral laxatives, such as polyethyleneglycol (PEG) is recommended for at least six, and up to twenty-four months (84). The preferred oral laxatives are osmotic laxatives such as PEG.

f) Biofeedback

Biofeedback has been shown to be effective in some elimination disorders such as dysfunctional voiding (85). It is defined as a variety of techniques, by which physiological activity is registered, enhanced and presented to the patient in real time by visual and acoustical signals). In faecal incontinence, biofeedback is no more effective than standard behavioural techniques in faecal incontinence both with (86) and without constipation (87).

g) Alarm treatment

Alarm treatment for nocturnal enuresis is also a type of cognitive behavioural therapy. It works by positive reinforcement, as well as aversive, negative experiences and has been shown to be highly effective and was introduced by Mowrer and Mowrer (88).

It is the most effective form of treatment of nocturnal enuresis with the best long-term results (grade I level of evidence according to reviews and meta-analyses). Houts et al. (89) compiled a systematic review and meta-analysis on 78 randomised studies on nocturnal enuresis. 62% were dry at the end of treatment and 47% at follow-up. The authors conclude that "urine alarm treatments should not only be considered the treatment of choice, but the evidence from this review suggests that cure rather than management is a realistic goal for the majority of children suffering from nocturnal enuresis". Therefore, when indicated, alarm has been endorsed as a first line curative treatment by various guidelines and by the ICCS (90).

The effect of alarm treatment can be enhanced by adding additional behavioural components to the treatment. Programmes that include alarm in addition to other behavioural components showed following general effects: 72% of children became dry at the end of treatment, and 56% remained so at follow-up (meta-analysis) (89).

These specific programmes including alarm are all essentially cognitive-behavioural techniques. Arousal training is a simply and easily performed (91,92). Children are instructed to turn off the alarm within three minutes, go to the toilet and reset the alarm. This goal is reinforced positively with two tokens. If the goal is not reached, one token has to be returned. The initial success rate (89 %) and the rate of dryness after 2 ½ years (92 %) were higher than with alarm treatment alone (73 % and 72 % respectively).

Finally, alarm treatment can be combined with pharmacotherapy, although the evidence for combination treatment is conflicting. The combination of desmopressin and alarm treatment has been reported in several studies (92,93). The combination with anticholinergics plays an important part in clinical practice, but has not been investigated systematically. However, when alarm treatment fails, the ICCS recommends switching to desmopressin alone (90).

6.5. Conclusion and summary

This review summarised the most important psychological aspects in children with enuresis, urinary incontinence and faecal incontinence.

The rate of comorbid clinical behavioural disorders is increased. Children with DUI are more affected than those with NE. Children with secondary and non-monosymptomatic NE have especially high rates of comorbid psychological disorders. The most common single diagnosis is ADHD, but other disorders such as depression, anxiety disorders and autism spectrum disorders can exist and must be considered.

Children with DUI have mainly externalising behavioural disorders. Children with urgency incontinence have a low comorbidity, those with voiding postponement are characterised by oppositional behaviour. Children with FI have the highest rate of associated disorders – both internalising and externalising.

These disorders will not disappear upon attaining dryness. They must be addressed, as they will interfere with the incontinence therapy due to low compliance. Even if comorbid disorders are not present, children and parents are highly stressed by the incontinence. These subclinical symptoms will often recede upon successful treatment. Children with special needs, especially those with ID, have very high rates of incontinence. Assessment and treatment of incontinence should be offered to all affected children.

Questionnaires are useful as screening instruments in the assessment process. It is recommended that questionnaires are used as a general screening procedure for emotional and behavioural problems routinely in all settings. If a psychological disorder is suspected, a full child psychiatric assessment and subsequent treatment is needed. The basic principles, including those of psychotherapy, are outlined. Psychotherapeutic techniques are used in urotherapy, especially cognitive-behavioural elements. Non-pharmacological and non-surgical techniques are most effective.

tive for most forms of incontinence. Therefore, it is important that psychological aspects are integrated into the treatment of children with incontinence problems.

VIII. URINARY INCONTINENCE IN CHILDREN WITH SPECIAL NEEDS

1. INTRODUCTION

Children with special needs, i.e. intellectually and / or motor disabled, suffer lower urinary tract symptoms (LUTS) than the normal population. Several studies have shown that nocturnal enuresis, daytime urinary incontinence and faecal incontinence are more frequent in children with special needs. Moreover, incontinence has a higher likelihood to persist during adolescence and adulthood. Although LUTS are associated with poor quality of life and health status, they are often less important to parents and physicians who are mainly focusing on physical rehabilitation. Literature on this topic is limited, but illustrates that adequate treatment improves quality of life significantly.

2. CHILDREN WITH SPECIAL NEEDS: GENERAL INFORMATION

2.1. Intellectual disability

Intellectual disability, the former mental retardation, is defined by the American Association on Mental Retardation (AAMR) as a disability characterised by significant limitations both in intellectual functioning and in adaptive behaviour as expressed in conceptual, social and practical adaptive skills. The disability originates before 18 years of age. Limitations in intellectual ability correspond to an IQ less than 70 to 75.

According to DSM -V (Diagnostic and Statistical Manual of Mental Disorders 5th edition. American Psychiatric Association (2013) Washington, DC) intellectual disability involves impairments of general mental abilities that impact adaptive functioning in three domains, or areas. These domains determine how well an individual copes with everyday tasks:

- The conceptual domain includes skills in language, reading, writing, math, reasoning, knowledge, and memory.
- The social domain refers to empathy, social judgement, interpersonal communication skills, the ability to make and retain friendships, and similar capacities.
- The practical domain centres on self-management in areas such as personal care, job responsibilities, money management, recreation, and organizing school and work tasks.

In DSM-V intellectual disability is two standard deviations or more below the population mean, which equals an IQ score of 70.

Severity was defined in the DSM-IV (Diagnostic and Statistical Manual of Mental Disorders 4th edition. American Psychiatric Association (2000) Washington, DC) based on IQ ranges:

- Mild: 50-55 to 70
- Moderate: 35-40 to 50-55
- Severe: 20-25 to 35-40
- Profound: < 20-25

2.2. Motor disability:

Motor disabilities affect a person's ability to learn motor tasks such as walking, running, skipping, sitting, handwriting and others. To be considered a disability, the problem must cause a person to have motor coordination that is significantly below what would be expected for age, and the problem must interfere with activities of learning and daily living.

Although Intellectual disabilities and motor disabilities can stand on their own, in a considerable number of patients, a combination of both is diagnosed.

Intellectual disability is a common problem. Up to 10% of the school-aged children are learning impaired and as many as 3% of children in the US manifest some degree of mental retardation. The prevalence of mild mental retardation is about 1/77 (1.2%) and that of severe mental retardation is 1/300 (0.33%). For the clear majority of individuals with mental retardation (45-63%) no aetiology is identifiable. More than 800 syndromes are associated with mental retardation, of which Trisomy 21 or Down syndrome is the best known. In addition, environmental factors, such as Foetal Alcohol Syndrome and perinatal and postnatal conditions, such as CMV, rubella and hypo-ischemic encephalopathy, may also be responsible for mental retardation.

The second most important cause of developmental disability is cerebral palsy (CP). Cerebral palsy encompasses a group of disorders of the development of movement and posture, causing activity limitation, which are attributed to non-progressive disturbances occurring in the developing fetal or infant brain. [1] Often disturbances of sensation, cognition, communication, perception and/or behaviour, and/or seizure disorders accompany the motor disorders. CP is a non-progressive injury of the brain occurring in the perinatal period and persisting through the lifespan.

The incidence of cerebral palsy is about 1.5 per 1000 births.

Twenty percent of the intellectually disabled individuals suffer cerebral palsy and 50% of the cerebral palsy patients are intellectually disabled.

3. LOWER URINARY TRACT SYMPTOMS IN CHILDREN WITH SPECIAL NEEDS: PREVALENCE

Von Wendt *et al.* published that 7-year-old children with mild intellectual disability differ relatively little from healthy children with respect to enuresis, (11.1% versus 9.8%), but suffered significantly more daytime urinary incontinence (16.7%) than the normal population (3.4%). The more severe the intellectual disability the higher the risk of persisting enuresis and daytime urinary incontinence. [2]

In children with CP 55.5% suffer LUTS, of which urinary incontinence is the most frequent with a prevalence rate ranging between 20% and 94%. Urgency and frequency, with a respective prevalence of 38.5% and 22.5%, are also very common in CP patients. Urinary incontinence, urgency and frequency are significantly more common in children with CP compared to a healthy population.

Storage symptoms are more prevalent than voiding symptoms, with a prevalence of hesitancy in children with CP of 16.5%. Urinary tract infections (UTI), with a prevalence rate of 8.5%, are also more common in CP children than in the normal population. [3]

Patients with Down's syndrome also show an impaired ability to become continent. Several studies have illustrated that children with Down's syndrome have a delay in toilet training and are more prone to incontinence afterward. One fifth of the children with Down's syndrome are not toilet trained at the age of five and nearly 50% of the toilet trained children will have incontinence, that even can persist into adulthood. [4]

LUTS are also more common in children with Down's syndrome, with a prevalence around 27%. The LUTS are more common in male (42.8%) than in female (19.6%) patients. These LUTS decrease with age, and patients with Down's syndrome older than 10 years have a five times lower chance of LUTS compared to those who are ten years or younger. [5] Kitamura *et al.* found LUTS to be very common in children with Down's syndrome, but remarkably neither the children nor their environment seemed to be aware of it. [6]

Von Gontard reviewed the association of nocturnal enuresis, daytime urinary incontinence and faecal incontinence in children with intellectual disability in general and in patients with specific syndromes of intellectual disability including Rett's, Angelman's, Fragile-X, Prader Willi, Noonan's and Williams' syndrome. He concluded that people with profound intellectual disability have the highest rate of incontinence, whereas syndromes with mild intellectual disability have much lower rates. [7-12]

Not only intellectual capacity, but also the motor capacity is correlated with the development of continence. The more immobile the higher the prevalence of urinary incontinence. Motor disability, especially the degree of mobility, rather than intellectual disability seems to be the dominant factor determining urinary continence. [13]

4. PATHOPHYSIOLOGY OF LUTS IN CHILDREN WITH SPECIAL NEEDS

a) Urodynamics findings

Samijn *et al.* found in their review on LUTS and Urodynamic Findings in CP patients that 84.5% had an abnormal videourodynamic study. Neurogenic detrusor overactivity (NDO) is the most common urodynamic abnormality, with an average prevalence rate of 59% [3]. The finding of NDO on urodynamics is not synonymous for the prevalence of LUTS. Several authors found pathological urodynamic findings in both symptomatic and non-symptomatic children with CP and *vice versa* [14-17]. Therefore some authors stress on the need for urodynamic examination in this population to discover silent bladder dysfunction or risk factors for upper urinary tract dysfunction (UUTD).

Abnormal uroflow patterns, especially staccato pattern, were found in 36.5% to 66% of CP patients [13, 18, 19]. Van Laecke *et al.* could not establish a correlation between uroflow pattern and urinary incontinence, whereas Silva *et al.* reported a significant correlation between abnormal uroflow patterns and the presence of LUTS [13, 18].

The average prevalence rate of detrusor sphincter dyssynergia (DSD) is 11% [3].

Comparing urodynamic studies with uroflowmetry showed more pathological findings on urodynamics than on uroflow, which can be explained by the fact that uroflowmetry only measures the voiding phase.

The high prevalence of NDO can be explained by the fact that CP is caused by a cerebral insult, with lesions in the suprapontine circuitry, disturbing the inhibitory control over the pontine micturition centre [20]. Overactivity of the pelvic floor and the urethral sphincter is not expected in patients with a cerebral lesion, and may suggest a lesion of the lumbosacral cord. Severe hypoxia might be the cause of this in CP patients [20-22].

In children with CP, hesitancy is more prevalent than DSD, which may indicate that other factors than DSD contribute to overactivity of the pelvic floor. Mayo *et al.* suggested that hypertonia is the cause of the inability to relax the pelvic floor muscles during micturition, resulting in an increased rate of hesitancy [23]. One might conclude that children with spasticity may suffer pelvic floor overactivity as a voluntary reaction to an overactive bladder.

Kitamura *et al.* found in their study that a significant lower number of children with Down's syndrome had a normal bell-shaped uroflow pattern (18%) than age-matched control children (60%). They concluded that the non-bell-shaped uroflow patterns are due to functional and not to anatomical or organic abnormalities [6].

b) Bladder capacity:

Reduced bladder capacity is a major factor in the pathophysiology of urinary incontinence in children with special needs. Several studies illustrated that 73.5% of the CP subjects have a too small bladder capacity compared to the expected bladder capacity for age (EBC). Mean bladder capacity is 58.5% of the EBC [3]. Bladder capacity can be negatively influenced by uninhibited bladder contractions, characteristic for NDO, inadequate fluid intake due to swallowing problems and inadequate hydration [13, 24-27]. Constipation, which can be due to restricted fluid intake, can negatively influence reduced bladder capacity [28].

c) Inadequate fluid intake

Van Laecke *et al.* found that only 9.9% of the children with a special need included in their study had a normal fluid intake. Although some of these children suffer swallowing problems, the major problem was found to be inadequate drinking. Increasing the fluid intake to a normal level of 1500ml/m² resulted in a significant increase in continence and maximum voided volume [13, 27].

d) Post-void residual

In CP patients, according to the low prevalence of DSD and hesitancy, prevalence of pathologically increased post-void residual is limited [14, 18, 19, 29, 30]. In Down's syndrome patients post-void residual was demonstrated in 7% [6].

e) Intellectual disability and motor dysfunction.

LUTS are less influenced by intellectual disability than by moderate to severe motor dysfunction [13, 31, 32]. Concerning children with CP, continence is less often achieved in subjects with low intellectual capacity combined with spastic quadriplegia than in subjects with high intellectual capacity combined with hemi- or diplegia [33]. The combination of both intellectual disability and spasticity has a bigger influence than both factors independently. Bross *et al.* concluded that urinary symptoms and pathological urodynamic findings increase along with the degree of motor function impairment [14].

Involuntary spasticity of the pelvic floor, which may be part of a general spasticity, may cause LUT dysfunction [25, 28]. This can also explain the vulnerability to acquire pelvic floor hyperactivity in reaction to NDO in children with spasticity [14, 23].

In subjects with quadriplegia LUTS and abnormal urodynamic findings are found more often than in patients with diplegia, illustrating that not only lower limb

impairment, but also upper limb impairment plays a role in achieving continence [33]. The plasticity of the central nervous system enables the unaffected side to assume more control over the bladder during development. This could explain the lower prevalence of LUTS and disturbed urodynamic findings in children with hemiplegia [32].

Poor mobility is an important factor in achieving continence. Inability to reach the toilet, to get adequate on the toilet and to drink enough will influence both urinary incontinence and constipation. Moderate to severe functional impairment (GMFCS III or higher) and the spastic subtype with quadriplegic distribution will negatively influence the ability to become continent [3].

5. COMORBIDITY

a) Constipation and faecal incontinence

Constipation is an important comorbidity in the process of urinary incontinence in children with special needs. There is a proven correlation between constipation and urinary incontinence, detrusor overactivity, dysfunctional voiding and UTI [34]. Intellectual disabled children are more prone to constipation and faecal incontinence. Up to 70% of these children suffer constipation [35]. Up to 90% of the children with CP suffer constipation and 47% faecal incontinence, though most of them to a minor degree [36].

b) Neuropsychiatric disorders

ADHD and autism are more frequent in intellectually disabled children and there is a proven correlation between ADHD and urinary incontinence [37, 38].

c) Sleep disorders

There is increasingly more evidence that there is a relationship between nocturnal enuresis and sleep disorders in otherwise healthy children [39-41]. Sleep is a complex neurological function. In children with brain damage, the autonomous nervous system, which is involved in pineal melatonin secretion and sleep regulation might be affected [42]. Sleep is also vulnerable to several other factors common in CP. Muscle spasms, decreased ability to change body position during sleep, epilepsy and glossoptosis, which can induce sleep disorder breathing, may be the cause of disturbed sleep in these children [43, 44]. Sleep disorders like delayed insomnia, disrupted sleep, early awake or a combination of these are frequently reported in patients with CP. Newman *et al.* found that 44% of the patients presented at least one clinically significant sleep disorder. Nearly 50% of the children with CP have some kind of sleep problem. These problems are more reported in non-walkers (72%) than in walkers (36%) [45]. Also in patients with Down's syndrome sleep disturbances are more common [4].

6. EVALUATION OF THE SPECIAL NEED CHILD SUFFERING LUTS

a) History

History taking in children with special needs is often challenging, and mainly relies on hetero-anamnestic data. Important is that not only parental information but also information from the care givers should be considered, as many of these patients spend a lot of their time in specialised institutions. The questions should include items on nocturnal enuresis, urinary incontinence, lower urinary tract symptoms and bowel function. Attention should also be paid to intellectual and motor development, family disorders, the child's psychosocial and familial situation, neurological and congenital anomalies, urinary tract infections, relevant medication and surgery. Special emphasis should be given to fluid intake and food habits

A voiding and drinking diary, and a dry-wet calendar are essential to determine the child's voiding frequency and voided volumes, to evaluate the number of enuresis and incontinence episodes, to determine the nocturnal diuresis and to evaluate the quantity and quality of fluid intake. The same should be done for stool, registering defaecation frequency, stool consistency and soiling.

b) Physical examination

Theoretically, physical examination should include the assessment of perineal sensation, the perineal reflexes supplied by the sacral segments S1-S4 and anal sphincter tone and control. Practically, as this is confronting for the child, this part of the physical examination is restricted to those where there is a suspicion of neuropathy.

Special attention should be paid to signs of neuropathy such as: spine deformity, abnormal gait, abnormal deep tendon reflexes, asymmetrical atrophy of the feet, high plantar arches, hammer toes, and signs of occult dysraphism, i.e. skin discolouration, dimples, hairy tufts, subcutaneous lipoma, asymmetrical buttock, legs or feet and oblique gluteal cleft [46]. The abdomen should be palpated to assess a full bladder, full sigmoid or descending colon and flank masses. The external genital region must be inspected for vaginitis and vulvitis, meatal web and a hymen that covers nearly the complete vaginal introitus in girls and for penile anomalies and meatal stenosis in boys. In motor disabled children the locomotor system has to be evaluated according to muscle power, mobility, stability and spasticity. In intellectual disabled children the IQ and the functional autonomy has to be estimated.

c) Laboratory tests

Urine analysis to exclude pyuria, proteinuria, glycosuria, haematuria, calciuria and bacteriuria should be done at the first office visit. Urine osmolality and elec-

trolytes should be determined in case of monosymptomatic enuresis with persistent therapy resistant polyuria.

d) Uroflowmetry

Uroflowmetry in children with special needs is often a problem. Intellectual disabled children are often too anxious to perform a uroflowmetry and motor disabled children are often incapable to perform a non-disturbed micturition because of their instable position on the flow chair. Therefore uroflowmetry, especially in moderate and severe patients, should be preferably performed in their own environment on their personal adapted toilet chair.

e) Ultrasound

Ultrasound is used to evaluate the upper and lower urinary tract in children with LUTS especially when they are suffering UTI. It can also be used to measure the post-void residual.

f) (Video-) Urodynamic examination

These urodynamic investigations are invasive, especially in children with special needs who often lack the intellectual capacity to understand what is going to happen, or are physically unable to undergo the examination in a comfortable way. Although some authors are convinced that urodynamics should be performed in the majority of moderate and severe patients to rule out the silent bladder dysfunction or risk factors for UUTD, this examination should be reserved for those patients suffering therapy resistant urinary incontinence and/or recurrent UTI or when obstructive lower urinary tract problems are suspected.

7. TREATMENT OF URINARY INCONTINENCE IN CHILDREN WITH SPECIAL NEEDS

a) Urotherapy

Urotherapy in children with special needs does not differ fundamentally from that used in normally developing children. The aim is also to achieve normalisation of the micturition pattern by a combination of patient education and cognitive, behavioural and physical therapy methods.

The first cornerstone of this therapy is patience. Treating these children will certainly take more efforts and time, but even in severe patients it may lead to an important amelioration or cure of urinary incontinence.

The second is adequate fluid intake. Although often time-consuming, the results are remarkably positive as illustrated in the study of Van Laecke *et al.* [27]. Fluid intake does not only positively influence maximum voided volume and continence, but also contributes to an important amelioration of constipation.

The third cornerstone of urotherapy is correct toilet position. Adequate relaxation of the pelvic floor can only be achieved when sitting in a stable position. In many children with CP this can only be the case when using a personal adapted toilet chair.

b) Treatment of Bowel Dysfunction

Constipation and faecal incontinence are common comorbidities in children with special needs. LUT dysfunction and bowel dysfunction often occur concomitant and have been labeled as BBD (Bladder and Bowel Disturbance) by the ICCS [47]. Adequate management of both constipation and faecal incontinence is essential for successful treatment of urinary incontinence in these patients.

Prevention and treatment of milder forms exist of optimisation of food and fluid intake (qualitative and quantitative) and of toilet habits (regular toileting after meals). In case of functional constipation stool masses need to be evacuated with laxatives or enemas. Afterwards laxatives should be continued together with behavioural therapy and dietary interventions for months or even years [48].

c) Alarm treatment

Just like in normally developing children, alarm therapy can be used to treat either nocturnal enuresis or daytime urinary incontinence in children with special needs [49-51]. In the treatment of daytime incontinence, it can be used to achieve active continence, but in some therapy resistant cases it can also be used to achieve passive continence by introducing timed voiding [52]. Again one should be aware of the fact that using an alarm in this population will be more challenging and time consuming.

8. PHARMACOLOGICAL TREATMENT

a) Antimuscarinics

If standard urotherapy fails to achieve urinary continence antimuscarinics are the mainstay of treatment in patients with overactive bladder (OAB). Oxybutynin remains the only FDA approved antimuscarinic for the treatment in children. The major problem with oxybutynin are the side effects; dry mouth, constipation, blurred vision, psychologic and personality changes are common side effects, causing up to 10% of the children to stop their treatment [53]. Especially in children with special needs these side effects are more problematic as tooth decay, constipation, mood disturbances and intellectual delay, which are already relatively common in this population, can get even worse. Therefore, newer, more bladder specific antimuscarinics, only approved for adults, like solifenacin and tolterodine are used off-label in these patients. Propiverine, which is suggested to be better tolerated than oxybutynin, has been approved in some coun-

tries for the use in children [54]. When using antimuscarinics strict follow-up, with special attention for side effects and post void residual is necessary.

b) Desmopressin

In case of monosymptomatic enuresis with proven nocturnal polyuria, as in normally developing children, desmopressin is the first line treatment [55]. This treatment should be used with care as excessive fluid intake shortly before or quickly after administration of desmopressin can cause a life threatening water intoxication with hyponatraemia and convulsions.

c) Botulinum toxin

Botulinum toxin has been used off-label successfully for the treatment of children with neuropathic bladder and non-neurogenic bladder dysfunction [50, 56-58]. In accordance with treatment in normally developing children, also in children with special needs it can only be considered in patients suffering OAB or urinary incontinence in whom other treatment options have failed.

9. SURGERY

Children with Down's syndrome have a significantly increased risk of anterior urethral obstruction and posterior urethral valves [59]. In Down's syndrome children, where there is suspicion of obstruction of the LUT, cystoscopy under general anaesthesia with possible incision of the obstructive element should be performed. In those patients with a neuropathic bladder, refractory to conventional therapy, bladder augmentation, i.e. ileocystoplasty with or without continent catheterisable stoma (Appendicovesicostomy, Monty) can offer the final, non-reversible, solution to achieve continence and to protect the upper urinary tract.

10. CLEAN INTERMITTENT CATHETERISATION (CIC)

Some children do need intermittent catheterisation, especially those undergoing a bladder augmentation. Children with cerebral palsy treated with continuous Baclofen can also suffer urinary retention needing intermittent catheterisation. The problem with some of these children with special needs is that they have a normal genital sensation that makes catheterisation uncomfortable, or even painful. Combined with the reduced intellectual capacities of some this makes CIC nearly impossible. Therefore, incontinent stoma is sometimes the only solution.

11. CONCLUSION

Although often thought to be a minor problem urinary incontinence remains an important issue for every special needs child. Urinary incontinence can lead to limited self-esteem and independence, and may be

challenging health. Often it is a multifactorial problem, but with adequate therapy these children are amenable to continence rehabilitation. The majority can become continent, but some will only achieve a passive form of continence.

REFERENCES

I. INTRODUCTION

1. Steers WD. Physiology and pharmacology of the bladder and urethra. In Walsh PC, Retol AB, Vaughan ED, Wein AJ (eds): *Campbell's Urology*, 7th ed. Philadelphia, WB Saunders, 1997; 870-916
2. de Groat WC, Griffiths D, Yoshimura N. Neural control of the lower urinary tract. *Compr Physiol*. 2015 Jan;5(1):327-96.
3. Muellner SR: Development of urinary control in children, some aspects of the cause and treatment of primary enuresis. *JAMA* 1960;172: 1256-61
4. Franco I: Detrusor overactivity in children. Part 1: Pathophysiology. *J Urol*, 2007. 178: 761-8; discussion 768
5. Ohel G, Haddad S, Samueloff A: Fetal urine production and micturition and fetal behavioral state. *Am J Perinatol* 1995;12:91-92
6. Goellner MH, Ziegler EE, Fomon SJ: Urination during the first 3 years of life. *Nephron* 1981;28:174-8
7. Yeung CK, Godley ML, Ho CKW, Ransley P, Duffy PG, Chen CN, Li AKC: Some new insights into bladder function in infancy. *Br J Urol* 1995;6:235-40
8. Yeung CK, Godley ML, Duffy PG, Ransley PG: Natural filling cystometry in infants and children. *Br J Urol* 1995;75: 531-7
9. Yeung CK, Godley ML, Dhillon HK, Duffy PG, Ransley PG: Urodynamic patterns in infants with normal lower urinary tracts or primary vesico-ureteric reflux. *Br J Urol* 1998; 81: 461-7
10. Bachelard M, Sillen U, Hansson S, Hermansson G, Jodal U, Jacobsson B: Urodynamic pattern in asymptomatic infants: siblings of children with vesico-ureteric reflux. *J Urol*. 1999; 162: 1733-7
11. Sillen U, Solsnes E, Hellstrom AI, Sandberg K: The voiding pattern of healthy preterm neonates. *J Urol*. 2000; 163:278-81
12. Holmdahl G, Hansson E, Hansson M, Hellstrom A-L, Hjälmås, Sillen U: Four hour voiding observation in healthy infants. *J Urol*. 1996; 156: 1809-12
13. Yeates WK: Bladder function in normal micturition. In Kolvin I, MacKeith RC, Meadow SR (eds): *Bladder Control and Enuresis*. London, W Heinemann Medical, 1973;28-365
14. Koff SA: Estimating bladder capacity in children. *Urology* 1983;21:248-51
15. Hjälmås K: Micturition in infants and children with normal lower urinary tract: a urodynamic study. *Scand J Urol Nephrol* 1976;37:9-17
16. Zerlin JM, Chen E, Ritchey ML, Bloom DA: Bladder capacity as measured at voiding cystourethrography in children-relationship in toilet training and frequency of micturition. *Radiology* 1993;187: 803-6
17. Kaefer M, Zurakowsky D, Bauer SB, Retik AB, Peters CA, Atala A, Treves ST: Estimating normal bladder capacity in children. *J Urol*. 1997;158:2261-4
18. Rittig S, Kamperis K, Siggaard C, Hagstroem S, Djurhuus JC: Age Related Nocturnal Urine Volume and Maximum Voided Volume in Healthy Children: Reappraisal of International Children's Continence Society Definitions. *J Urol* 2010; 183:1561-67
19. Bael An M, Lax H, Hirche H, Hjälmås K†, Tamminen-Möbius T, Van Hoeck KM, Van Gool J. Reference ranges for cystographic bladder capacity in children—with special attention to vesicoureteral reflux. *J Urol* 2006;
20. Berk LB, Friman PC: Epidemiological aspects of toilet training. *Clin Paediatrics* 1990; 29:278-82
21. Hellström A.L, Hanson E, Hansson S, Hjälmås K and Jodal U: Micturition habits and incontinence in 7-year old Swedish school entrants. *Eur J Paediatr* 1990; 149:434-7
22. Mattsson S, Lindström S: Diuresis and voiding pattern in healthy schoolchildren. *Br. J. Urol*. 1995;76: 783-89
23. Wen JG, Tong EC: Cystometry in infants and children with no apparent voiding symptoms. *Br. J. Urol*. 1998; 81: 468-73
24. Szabo L, Fegyvernski S: Maximum and average urine flow rates in normal children- the Miskolc nomograms. *Br J Urol* 1995;76:16-20
25. Mattson S , Spangberg A: Urinary flow in healthy school children. *Neurourol Urodyn* 1994;13: 281-96

II. EVALUATION IN CHILDREN WHO WET

1. Bauer SB, Austin PF, Rawashdeh YF, de Jong TP, Franco I, Siggard C, Jorgensen TM; International Children's Continence Society. International Children's Continence Society's recommendations for initial diagnostic evaluation and follow-up in congenital neuropathic bladder and bowel dysfunction in children. *Neurourol Urodyn.* 2012 Jun;31(5):610-4
2. Franco I, von Gontard A, De Gennaro M; International Children's Continence Society. Evaluation and treatment of nonmonosymptomatic nocturnal enuresis: a standardization document from the International Children's Continence Society. *J Pediatr Urol.* 2013 Apr;9(2):234-43
3. Rawashdeh YF1, Austin P, Siggaard C, Bauer SB, Franco I, de Jong TP, Jorgensen TM; International Children's Continence Society. International Children's Continence Society's recommendations for therapeutic intervention in congenital neuropathic bladder and bowel dysfunction in children. *Neurourol Urodyn.* 2012 Jun;31(5):615-20
4. Bauer SB, Nijman RJ, Drzewiecki BA, Sillen U, Hoebeke P; International Children's Continence Society Standardization Subcommittee. International Children's Continence Society standardization report on urodynamic studies of the lower urinary tract in children. *Neurourol Urodyn.* 2015 Sep;34(7):640-7.
5. Van Gool JD, Hjälmås K, Tamminen-Möbius T and Olbing H. Historical clues to the complex of dysfunctional voiding, urinary tract infection and vesicoureteral reflux—the International Reflux Study in Children. *J Urol* 1992;148:1699-1702
6. Sureshkumar P, Craig JC, Roy LP, Knight JF. A reproducible pediatric daytime urinary incontinence questionnaire. *J Urol.* 2001;165:569-73
7. Benninga MA, Büller HA, Staalman CR, Gubler FM, Bossuyt PM, Plas RN van der, and Tamminiau JAJM. Defecation disorders in children, colonic transit time versus the Barr-score. *Eur J Pediatr* 1995;154:277-84
8. von Gontard A, Baeyens D, Van Hoecke E, Warzak W, Bachmann C: Psychological and psychiatric issues in urinary and fecal incontinence. *J Urol* 2011;185, 1432-1437
9. Achenbach TM. Manual for the child behavior checklist 4-18 and 1991 profile. Burlington, Vt: University of Vermont, 1991
10. Van Hoecke E.; *J. Urol* 2007; 178: 2611-2615
11. Bower WF, *Neurourology and Urodynamics* 2006; 25: 221-7
12. Bloom D A. Sexual abuse and voiding dysfunction [editorial]. *J Urol* 1995;153:777
13. Mellon, M.W., Whiteside, S.P., Friedrich, W.N.: The relevance of fecal soiling as an indicator of child sexual abuse. *Journal of Developmental and Behavioral Pediatrics* 27, 25-32, 2006
14. Martinez-Lage JF, Niguez BF, Perez-Espejo MA, Almagro MJ, Maeztu C. *Midline Childs Nerv Syst.* 2006;22:623-7
15. Wennergren HM, Öberg BE and Sandstedt P: The importance of leg support for relaxation of the pelvic floor muscles. A surface electromyography study in healthy girls. *Scand J Urol Nephrol* 1991; 25:205-13
16. Biyikli NK, Alpay H, Guran T. Hypercalciuria and recurrent urinary tract infections: incidence and symptoms in children over 5 years of age. *Pediatr Nephrol.* 2005;20:1435-8
17. Burgers RE, Mugie SM, Chase J, et al. Management of functional constipation in children with lower urinary tract symptoms: report from the Standardisation Committee of the International Children's Continence Society. *J Urol* 2013;190:29–36.
18. Rittig S, Kamperis K, Siggaard C, et al. Age related nocturnal urine volume and maximum voided volume in healthy children: Reappraisal of international children's continence society definitions. *J Urol* 2010;183:1561–7.
19. Bower WF, Moore KH, Adams RD, Shepherd R. Frequency volume chart data from 3222 incontinent children. *Br J Urol.*1997; 80:658-62
20. Koff SA. Estimating bladder capacity in children. *Urology* 1983;21:248-51
21. Rittig S, Kamperis K, Siggaard C, Hagstroem S, Djurhuus JC. Age Related Nocturnal Urine Volume and Maximum Voided Volume in Healthy Children: Reappraisal of International Children's Continence Society Definitions. *J. Urol.* 2010; 183: 1561-67
22. Mattson S. Voiding frequency, volumes and intervals in healthy schoolchildren. *Scand J Urol Nephrol* 1994;28:1-11
23. Kirk J, Rasmussen PV, Rittig S and Djurhuus JC. Micturition habits and bladder capacity in normal children and in patients with desmopressin-resistant enuresis. In: Nørgaard JP, Djurhuus JC, Hjälmås K, Hellström A.-L and Jørgensen TM (eds.). *Proceedings, Second International Workshop, International Enuresis Research Center, Aarhus.* *Scand J Urol Nephrol* 1 995;173:49-50

24. Hellström A-L, Andersson K, Hjälmås K and Jodal U. Pad tests in children with incontinence. *Scand J Urol Nephrol* 1986;20:47-50
25. Imada N, Kawauchi A, Tanaka Y, Watanabe H. The objective assessment of urinary incontinence in children. *Br.J Urol.* 1998;81:107-8
26. Bael An M, Lax, Hirche H H, Gäbel E, Winkler P, Hellström AL, van Zon R, Jahnsen E, Güntek S, Renon C, van Gool JD (on behalf of the European Bladder Dysfunction Study EU BHM1-CT94-1006). Self-reported urinary incontinence, voiding frequency, voided volume, and pad-test results- variables in a prospective study in children. *BJU Int.* 2007;100:651-6
27. Akbal C, Genc Y, Burgu B, Ozden E, Tekgul S. Dysfunctional voiding and incontinence scoring system: quantitative evaluation of incontinence symptoms in pediatric population. *J Urol.* 2005;173:969-73
28. Farhat W, Bagli DJ, Capolicchio G, O'Reilly S, Merguerian PA, Khoury A, McLorie GA. The dysfunctional voiding scoring system: quantitative standardization of dysfunctional voiding symptoms in children. *J Urol.* 2000;164:1011-15
29. Afshar K, Mirbagheri A, Scott H, MacNeily AE. Development of a symptom score for dysfunctional elimination syndrome. *J Urol.* 2009;182:1939-43
30. Barr RG, Levine MD, Wilkinson RH and Mulvihill, D. Chronic and occult stool retention—a clinical tool for its evaluation in school-aged children. *Clin Pediatr* 1979;18:674-6
31. Blethyn AJ, Verrier Jones K, Newcombe R, Roberts GM and Jenkins HR. Radiological assessment of constipation. *Arch Dis Child* 1995;3:532-3
32. Rockney RM, McQuade WH and Days AL. The plain abdominal roentgenogram in the management of encopresis. *Arch Pediatr Adolesc Med* 1995;149:623-7
33. van den Bosch M, Graafmans D, Nievelstein R, Beek E. Systematic assessment of constipation on plain abdominal radiographs in children. *Pediatr Radiol.* 2006;36:224-6
34. Baker SS, Liptak GS, Colleti RB, Croffie JM, Di Lorenzo C, Ector W, Nurko S. Constipation in infants and children: evaluation and treatment. A medical position statement of the North American Society for pediatric gastroenterology and Nutrition. *J Pediatr Gastroenterol Nutr* 1999;29:612-26
35. Reuchlin-Vroklage LM, Bierma-Zeinstra S, Benninga MA, Berger MY. Diagnostic value of abdominal radiography in constipated children: a systematic review. *Arch Pediatr Adolesc Med.* 2005;159(7):671-8
36. Rasquin A, Di Lorenzo C, Forbes D, et al. Childhood functional gastrointestinal disorders:child/adolescent. *Gastroenterology* 2006; 130: 1527-37
37. Singh SJ, Gibbons NJ, Vincent MV, Sithole J, Nwokoma NJ, Alagarswami KV. Use of pelvic ultrasound in the diagnosis of megarectum in children with constipation.*J.Pediatr.Surg.* 2005;40:1941-44
38. Klijn AJ, Asselman M, Vijverberg MA, Dik P, De Jong TP. The diameter of the rectum on ultrasonography as a diagnostic tool for constipation in children with dysfunctional voiding. *J Urol* 2004;172:1986-88
39. Berger MY, Tabbers MM, Kurver MJ, Boluyt N, Benninga MA. Value of abdominal radiography, colonic transit time, and rectal ultrasound scanning in the diagnosis of idiopathic constipation in children: a systematic review. *J Pediatr.* 2012;161:44-50
40. Joensson IM, Siggaard C., Rittig S., Hagstroem S, Djurhuus J C. Transabdominal Ultrasound of Rectum as a Diagnostic Tool in Childhood Constipation. *J Urol,* 2008; 179: 1997-2002
41. van der Plas RN, Benninga MA, Buller HA, Bos-suyt PM, Akkermans LM, Redekop WK and Taminiau JA. Biofeedback training in treatment of childhood constipation: a randomised controlled study. *Lancet* 1996;348:776-80
42. Biggs WS, Dery WH. Evaluation and treatment of constipation in infants and children. *Am Fam physician.* 2006;73:469-77
43. Mattson S , Spangberg A. Urinary flow in healthy school children. *NeuroUrol Urodyn* 1994; 13: 281-96
44. Bartkowski DP, Doubrava RG. Ability of a normal dysfunctional voiding symptom score to predict uroflowmetry and external urinary sphincter electromyography patterns in children. *J Urol.* 2004;172:1980-85
45. Bower WF, Kwok B, Yeung CK. Variability in normative urine flow rates. *J Urol.* 2004;171:2657-59
46. Yang SS, Chang SJ. The effects of bladder overdistention on voiding function in kindergartens. *J Urol.* 2008;180:2177-82; discussion 2182
47. Dudley NJ, Kirkland M, Lovett J, Watson AR. Clinical agreement between automated and calculated ultrasound measurements of bladder volume. *Br J Radiol.* 2003;76:832-4

48. Austin PF, Bauer SB, Bower W, Chase J, Franco I, Hoebeke P, Rittig S, Walle JV, von Gontard A, Wright A, Yang SS, Nevéus T. The standardization of terminology of lower urinary tract function in children and adolescents: Update report from the standardization committee of the International Children's Continence Society. *NeuroUrol Urodyn*. 2016 Apr;35(4):471-81
49. Hannson S, Hellström A-L, Hermansson G and Hjälhmås K. Standardisation of urinary flow patterns in children. In: Nørgaard JP, Djurhuus JC, Hjälhmås K, Hellström A-L and Jørgensen TM, eds. *Proceedings of the Third International Children's Continence Symposium*. Royal Tunbridge Wells: Wells Medical 1996;159-61
50. Kanematsu A, Johnin K, Yoshimura K, Okubo K, Aoki K, Watanabe M, Yoshino K, Tanaka S, Tanikaze S, Ogawa O. Objective patterning of uroflowmetry curves in children with daytime and nighttime wetting. *J Urol*. 2010;184:1674-9
51. Chang SJ, Chiang IN, Hseih CH, et al. Age and gender specific nomograms for single and dual post void residual urine in healthy children. *NeuroUrol Urodyn*. 2013;32:1014-8.
52. Kuzmic AC, Brkljacic B. Color Doppler ultrasonography in the assessment of vesicoureteric reflux in children with bladder dysfunction. *Pediatr Surg Int*. 2002;18:135-9
53. Müller L, Bergström T, Hellström, Svensson E, Jacobsson B. Standardised ultrasound method for assessing detrusor muscle thickness in children. *J Urol* 2000; 164: 134-8
54. Cvitkovic-Kuzmic A, Brkljacic B, Ivankovic D, Grga A. Ultrasound assessment of detrusor muscle thickness in children with non-neuropathic bladder/sphincter dysfunction. *Eur Urol*. 2002;41:214-8
55. Dogan HS, Akpınar B, Gurocak S, Akata D, Bakkaloglu M, Tekgul S. Non-invasive evaluation of voiding function in asymptomatic primary school children. *J Urol*. 2008;179:1564-7
56. Yeung CK, Sreedhar B, Leung VT, Metreweli C. Ultrasound bladder measurements in patients with primary nocturnal enuresis: a urodynamic and treatment outcome correlation. *J Urol*. 2004;171:2589-94
57. Sreedhar B, Yeung CK, Leung VY, Chu CW. Ultrasound bladder measurements in children with severe primary nocturnal enuresis: pre-treatment and post treatment evaluation and its correlation with treatment outcome. *J Urol*. 2008 Mar;179:1122-6
58. Roberts DS and Rendell B. Postmicturition residual bladder volumes in healthy babies. *Arch Dis Child* 1989; 64:825-8
59. Yang SS, Wang CC, Chen YT. Home uroflowmetry for the evaluation of boys with urinary incontinence. *J Urol*. 2003;169:1505-7
60. Lyon RP and Smith DR. Distal urethral stenosis. *J Urol* 1963;89:414-21
61. Saxton HM, Borzyskowski M and Robinson LB. Nonobstructive posterior urethral widening (spinning top urethra) in boys with bladder instability. *Radiology* 1992;182:81-5
62. Szabo L, Lombay B, Borbas E, Bajusz I. Videourodynamics in the diagnosis of urinary tract abnormalities in a single center. *Pediatr Nephrol*. 2004;19:326-31
63. Bauer SB. Pediatric urodynamics: lower tract. In: O'Donnell B, Koff SA, eds. *Pediatric urology*. Oxford: Butterworth-Heinemann, 1998:125-151
64. Drzewiecki B, Bauer S. Urodynamic testing in children: indications, technique, interpretation and significance. *J Urol* 2011; 186: 1190-97
65. Kaufman MR, DeMarco RT, Pope JC 4th, Scarpero HM, Adams MC, Trusler LA, Brock JW 3rd. High yield of urodynamics performed for refractory nonneurogenic dysfunctional voiding in the pediatric population. *J Urol*. 2006;176:1835-7
66. Soygur T, Arikan N, Tokatli Z, Karaboga R. The role of video-urodynamic studies in managing nonneurogenic voiding dysfunction in children. *BJU Int*. 2004;93:841- 3
67. Hoebeke P, Van Laecke E, Van Camp C, Raes A, Van De Walle J. One thousand video-urodynamic studies in children with non-neurogenic bladder sphincter dysfunction. *BJU Int*. 2001;87:575-80
68. Chin-Peuckert L, Komlos M, Rennick JE, Jednak R, Capolicchio JP, Salle JL. What is the variability between 2 consecutive cystometries in the same child? *J Urol*. 2003;170:1614-7
69. Bozkurt P, Kilic N, Kaya G, et al. The effects of intranasal midazolam on urodynamic studies in children. *Br J Urol* 1996;78:282-6.
70. Nijman RJM. Pitfalls in urodynamic investigations in children. *Acta Urol Belg* 1995;63:99-103.
71. Chin-Peuckert L, Rennick JE, Jednak R, Capolicchio JP, Salle JL. Should warm infusion solution be used for urodynamic studies in children? A prospective randomised study.. *J Urol*. 2004;172:1653-6
72. Park JM and Bloom DA. The guarding reflex revisited. *Br J Urol* 1997; 80:940-5

73. McGuire EJ, Woodside JR, Borden TA and Weiss RM. Prognostic value of urodynamic testing in myelodysplastic patients. *J Urol* 1981;126:205-9
74. Gilmour RF, Churchill BM, Steckler RE, et al. A new technique for dynamic analysis of bladder compliance. *J Urol* 1993;150:1200-3.
75. Yeung CK, Godley ML, Ho CKW, Ransley P, Duffy PG, Chen CN, Li AKC. Some new insights into bladder function in infancy. *Br J Urol* 1995;6:235-40
76. Yeung CK, Godley ML, Dhillon HK, Duffy PG, Ransley PG. Urodynamic patterns in infants with normal lower urinary tracts or primary vesico-ureteric reflux. *Br J Urol* 1998;81: 461-7
77. Vasquez E, Cendron M, Chow J, et al. Is Pelvic floor laxity a cause for daytime urinary incontinence in young girls? Abstract presented the Pediatric Urology Fall Congress, Miami, Fl. Oct. 24, 2014.
78. de Kort LM, Uiterwaal CS, Beek EJ, Jan Nievelstein RA, Klijn AJ, de Jong TP. Reliability of voiding cystourethrography to detect urethral obstruction in boys. *Urology*. 2004;63:967-71
79. Hoebeke P, Van Laecke E, Raes A, Van Gool JD, Vande Walle J. Anomalies of the external urethral meatus in girls with non-neurogenic bladder sphincter dysfunction. *BJU Int*. 1999;83:294-8
6. Verhulst, F.C., et al., The prevalence of nocturnal enuresis: do DSM III criteria need to be changed? A brief research report. *J Child Psychol Psychiatry*, 1985. 26(6): 989-93.
7. [Proposal of the terminological adaptation to Spanish of the ICCS standardization of terminology of lower urinary tract function in children and adolescents]. *Actas urologicas espanolas*, 2008. 32(4):371-89.
8. Yeung, C.K., Nocturnal enuresis in Hong Kong: different Chinese phenotypes. *Scand J Urol Nephrol Suppl*, 1997. 183:17-21.
9. Yeung, C.K., et al., Characteristics of primary nocturnal enuresis in adults: an epidemiological study. *BJU Int*, 2004. 93(3): 341-5.
10. van Gool, J.D., et al., Subtypes in monosymptomatic nocturnal enuresis. II. *Scand J Urol Nephrol Suppl*, 1999. 202: 8-11.
11. Vande Walle, J., et al., Practical consensus guidelines for the management of enuresis. *Eur J Pediatr*, 2012. 171(6): 971-83.
12. Foxman, B., R.B. Valdez, and R.H. Brook, Childhood enuresis: prevalence, perceived impact, and prescribed treatments. *Pediatrics*, 1986. 77(4):482-7.
13. Devlin, J.B., Prevalence and risk factors for childhood nocturnal enuresis, *Irish medical Journal*, . 1991;84:118, .
14. Warzak, W.J., Psychosocial implications of nocturnal enuresis. *Clin Pediatr (Phila)*, 1993. Spec No:38-40.
15. Miller, K., Concomitant nonpharmacologic therapy in the treatment of primary nocturnal enuresis. *Clin Pediatr (Phila)*, 1993. Spec No:32-7.
16. Houts, A.C., Nocturnal enuresis as a biobehavioral problem. *Beh. Ther* 1991. 22.
17. Liu, X., et al., Attaining nocturnal urinary control, nocturnal enuresis, and behavioral problems in Chinese children aged 6 through 16 years. *J Am Acad Child Adolesc Psychiatry*, 2000. 39(12):1557-64.
18. Yeung, C.K., et al., Differences in characteristics of nocturnal enuresis between children and adolescents: a critical appraisal from a large epidemiological study. *BJU Int*, 2006. 97(5):1069-73.
19. Hirasing, R.A., Bedwetting in adults. *Paris*, p84, 1997.
20. Forsythe, W.I. and A. Redmond, Enuresis and spontaneous cure rate. Study of 1129 enuretics. *Arch Dis Child*, 1974. 49(4):259-63.
21. Moilanen, I., et al., A follow-up of enuresis from childhood to adolescence. *Br J Urol*, 1998. 81 Suppl 3:94-7.

III. CHILDREN WITH NIGHT TIME INCONTINENCE

1. Tekgul, S., et al., Diagnosis and management of urinary incontinence in childhood. Report from the 4th International Consultation on Incontinence. 2009: Health Publication Ltd.
2. Austin, P.F., et al., The standardization of terminology of lower urinary tract function in children and adolescents: update report from the Standardization Committee of the International Children's Continence Society. *J Urol*, 2014. 191(6): 1863-1865.
3. Forsythe, W.I. and R.J. Butler, Fifty years of enuretic alarms. *Arch Dis Child*, 1989. 64(6): 879-85.
4. Butler, R.J., et al., Nocturnal enuresis: a survey of parental coping strategies at 7 1/2 years. *Child Care Health Dev*, 2005. 31(6): 659-67.
5. Verhulst, F.C., et al., [Prevalence of enuresis in 4-to-16-year-old children: an epidemiological study]. *Ned Tijdschr Geneesk*, 1985. 129(47): 2260-3.

22. Goessaert, A.S., et al., Long-term followup of children with nocturnal enuresis: increased frequency of nocturia in adulthood. *J Urol*, 2014. 191(6):1866-70.
23. Bailey, J.N., et al., Transmission of primary nocturnal enuresis and attention deficit hyperactivity disorder.[see comment]. *Acta Paediatrica*, 1999. 88(12): 1364-8.
24. von Gontard, A., et al., Clinical enuresis phenotypes in familial nocturnal enuresis. *Scand J Urol Nephrol Suppl*, 1997. 183:11-6.
25. von Gontard, A., et al., Genetic heterogeneity in nocturnal enuresis. *Am J Psychiatry*, 1997. 154(6):885.
26. von Gontard, A., et al., Clinical enuresis phenotypes in familial nocturnal enuresis. *Scandinavian journal of urology and nephrology. Suppl*, 1997. 183:11-6.
27. Eiberg, H., et al., Linkage study of a large Danish 4-generation family with urge incontinence and nocturnal enuresis. *The Journal of urology*, 2001. 166(6):2401-3.
28. Arnell, H., et al., The genetics of primary nocturnal enuresis: inheritance and suggestion of a second major gene on chromosome 12q. *J Med Genet*, 1997. 34(5):360-5.
29. Loeys, B., et al., Does monosymptomatic enuresis exist? A molecular genetic exploration of 32 families with enuresis/incontinence. *BJU international*, 2002. 90(1): 76-83.
30. Weir, K., Night and day wetting among a population of three-year-olds. *Dev Med Child Neurol*, 1982. 24(4):479-84.
31. Tai, H.L., et al., The epidemiology and factors associated with nocturnal enuresis and its severity in primary school children in Taiwan. *Acta Paediatr*, 2007. 96(2): 242-5.
32. Moore, K.H., D.H. Richmond, and B.T. Parys, Sex distribution of adult idiopathic detrusor instability in relation to childhood bedwetting. *Br J Urol*, 1991. 68(5): 479-82.
33. Mahler, B., et al., Puberty alters renal water handling. *Am J Physiol Renal Physiol*, 2013. 305(12):F1728-35.
34. Graugaard-Jensen, C., S. Rittig, and J.C. Djurhuus, Nocturia and circadian blood pressure profile in healthy elderly male volunteers. *J Urol*, 2006. 176(3):1034-9; discussion 1039.
35. Hvistendahl, G.M., et al., The relationship between desmopressin treatment and voiding pattern in children. *BJU Int*, 2002. 89(9): 917-22.
36. Hansen, M.N., et al., Intra-individual variability in nighttime urine production and functional bladder capacity estimated by home recordings in patients with nocturnal enuresis. *The Journal of urology*, 2001. 166(6): 2452-5.
37. Fergusson, D.M., L.J. Horwood, and F.T. Shannon, Secondary enuresis in a birth cohort of New Zealand children. *Paediatr Perinat Epidemiol*, 1990. 4(1): 53-63.
38. Jarvelin, M.R., et al., Life changes and protective capacities in enuretic and non-enuretic children. *J Child Psychol Psychiatry*, 1990. 31(5):763-74.
39. McGee, R., et al., A longitudinal study of enuresis from five to nine years. *Aust Paediatr J*, 1984. 20(1):39-42.
40. Burgers, R.E., et al., Management of functional constipation in children with lower urinary tract symptoms: report from the Standardization Committee of the International Children's Continence Society. *J Urol*, 2013. 190(1):29-36.
41. Jarvelin, M.R., et al., Aetiological and precipitating factors for childhood enuresis. *Acta Paediatr Scand*, 1991. 80(3): 361-9.
42. Weissbach, A., et al., Adenotonsillectomy improves enuresis in children with obstructive sleep apnea syndrome. *International Journal of Pediatric Otorhinolaryngology*, 2006. 70(8):1351-6.
43. Basha, S., et al., Effectiveness of adenotonsillectomy in the resolution of nocturnal enuresis secondary to obstructive sleep apnea. *Laryngoscope*, 2005. 115(6):1101-3.
44. Slyper, A.H., Childhood obesity, adipose tissue distribution, and the pediatric practitioner. *Pediatrics*, 1998. 102(1):e4.
45. Guven, A., K. Giramonti, and B.A. Kogan, The effect of obesity on treatment efficacy in children with nocturnal enuresis and voiding dysfunction. *J Urol*, 2007. 178(4 Pt 1):1458-62.
46. Weintraub, Y., et al., Enuresis--an unattended comorbidity of childhood obesity. *Int J Obes (Lond)*, 2013. 37(1):75-8.
47. Wagner, C., et al., Obesity, overweight, and eating problems in children with incontinence. *J Pediatr Urol*, 2015. 11(4):202-7.
48. Kovacevic, L., et al., Enuretic children with obstructive sleep apnea syndrome: should they see otolaryngology first? *J Pediatr Urol*, 2013. 9(2):145-50.
49. Kovacevic, L., et al., Why does adenotonsillectomy not correct enuresis in all children with sleep disordered breathing? *J Urol*, 2014. 191(5 Suppl):1592-6.

50. Kovacevic, L., et al., Adenotonsillectomy Normalizes Hormones and Urinary Electrolytes in Children With Nocturnal Enuresis and Sleep-Disordered Breathing. *Urology*, 2015. 86(1):158-61.
51. Kovacevic, L., et al., Adenotonsillectomy improves quality of life in children with sleep-disordered breathing regardless of nocturnal enuresis outcome. *J Pediatr Urol*, 2015. 11(5): 269 e1-5.
52. Norgaard, J.P., S. Rittig, and J.C. Djurhuus, Nocturnal enuresis: an approach to treatment based on pathogenesis. *J Pediatr*, 1989. 114(4 Pt 2):705-10.
53. Austin, P.F., et al., The standardization of terminology of lower urinary tract function in children and adolescents: Update report from the standardization committee of the International Children's Continence Society. *Neurourol Urodyn*, 2015.
54. Norgaard, J.P., et al., Standardization and definitions in lower urinary tract dysfunction in children. *International Children's Continence Society. Br J Urol*, 1998. 81 Suppl 3:1-16.
55. Fielding, D., The response of day and night wetting children and children who wet only at night to retention control training and the enuresis alarm. *Behav Res Ther*, 1980. 18(4):305-17.
56. Rittig, S., et al., The circadian defect in plasma vasopressin and urine output is related to desmopressin response and enuresis status in children with nocturnal enuresis. *The Journal of urology*, 2008. 179(6):2389-95.
57. Norgaard, J.P., et al., A pharmacodynamic study of desmopressin in patients with nocturnal enuresis. *J Urol*, 1995. 153(6): 1984-6.
58. Kamperis, K., et al., Nocturnal polyuria in monosymptomatic nocturnal enuresis refractory to desmopressin treatment. *Am J Physiol Renal Physiol*, 2006. 291(6): F1232-40.
59. Dehoorne, J.L., et al., Desmopressin resistant nocturnal polyuria secondary to increased nocturnal osmotic excretion. *J Urol*, 2006. 176(2):749-53.
60. Vande Walle, J., et al., Nocturnal polyuria is related to 24-hour diuresis and osmotic excretion in an enuresis population referred to a tertiary center. *J Urol*, 2007. 178(6):2630-4.
61. Butler, R.J. and P. Holland, The three systems: a conceptual way of understanding nocturnal enuresis. *Scandinavian Journal of Urology & Nephrology*, 2000. 34(4):270-7.
62. Neveus, T., et al., Depth of sleep and sleep habits among enuretic and incontinent children. *Acta Paediatrica*, 1999. 88(7):748-52.
63. Hjalmas, K., et al., Nocturnal enuresis: an international evidence based management strategy. *J Urol*, 2004. 171(6 Pt 2):2545-61.
64. Rittig, S., et al., Age-related changes in the circadian control of urine output. *Scand J Urol Nephrol Suppl*, 1995. 173:71-4; discussion 74-5.
65. Rittig, S., et al., Abnormal diurnal rhythm of plasma vasopressin and urinary output in patients with enuresis. *Am J Physiol*, 1989. 256(4 Pt 2):F664-71.
66. Rittig, S., et al., The circadian defect in plasma vasopressin and urine output is related to desmopressin response and enuresis status in children with nocturnal enuresis. *J Urol*, 2008. 179(6):2389-95.
67. Rittig, S., et al., Diurnal variation of plasma atrial natriuretic peptide in normals and patients with enuresis nocturna. *Scandinavian journal of clinical and laboratory investigation*, 1991. 51(2):209-17.
68. Rittig, S., et al., Adult enuresis. The role of vasopressin and atrial natriuretic peptide. *Scand J Urol Nephrol Suppl*, 1989. 125:79-86.
69. Kruse, A., et al., Increased nocturnal blood pressure in enuretic children with polyuria. *The Journal of urology*, 2009. 182(4 Suppl):1954-60.
70. De Guchtenaere, A., et al., Nocturnal polyuria is related to absent circadian rhythm of glomerular filtration rate. *J Urology*, 2007. 178(6): 2626-9.
71. Dossche, L., J.V. Walle, and C. Van Herzele, The pathophysiology of monosymptomatic nocturnal enuresis with special emphasis on the circadian rhythm of renal physiology. *Eur J Pediatr*, 2016. 175(6):747-54.
72. Dossche, L., et al., Circadian Rhythm of Glomerular Filtration and Solute Handling Related to Nocturnal Enuresis. *J Urol*, 2016. 195(1):162-7.
73. Norgaard, J.P., E.B. Pedersen, and J.C. Djurhuus, Diurnal Anti-Diuretic-Hormone Levels in Enuretics. *Journal of Urology*, 1985. 134(5):1029-1031.
74. Devitt, H., et al., Plasma vasopressin and response to treatment in primary nocturnal enuresis. *Arch Dis Child*, 1999. 80(5): 448-51.
75. Raes, A., et al., Abnormal circadian rhythm of diuresis or nocturnal polyuria in a subgroup of children with enuresis and hypercalciuria is related to increased sodium retention during daytime. *The Journal of urology*, 2006. 176(3):1147-51.

76. De Guchteneare, A., et al., Desmopressin resistant nocturnal polyuria may benefit from furosemide therapy administered in the morning. *The Journal of urology*, 2007. 178(6):2635-9; discussion 2639.
77. Valenti, G., et al., Urinary aquaporin 2 and calciuria correlate with the severity of enuresis in children. *Journal of the American Society of Nephrology : JASN*, 2000. 11(10):1873-81.
78. Valenti, G., et al., Low-calcium diet in hypercalciuric enuretic children restores AQP2 excretion and improves clinical symptoms. *American journal of physiology. Renal physiology*, 2002. 283(5): F895-903.
79. Neveus, T., et al., The standardization of terminology of lower urinary tract function in children and adolescents: report from the Standardisation Committee of the International Children's Continence Society. *J Urol*, 2006. 176(1):314-24.
80. Van Herzele, C., et al., Predictive parameters of response to desmopressin in primary nocturnal enuresis. *J Pediatr Urol*, 2015. 11(4):200 e1-8.
81. Raes, A., et al., Partial response to intranasal desmopressin in children with monosymptomatic nocturnal enuresis is related to persistent nocturnal polyuria on wet nights. *J Urol*, 2007. 178(3 Pt 1):1048-51; discussion 1051-2.
82. Kamperis, K., et al., Optimizing response to desmopressin in patients with monosymptomatic nocturnal enuresis. *Pediatr Nephrol*, 2017. 32(2):217-226.
83. Rittig, S., et al., Sodium regulating hormones in enuresis. *Scandinavian journal of urology and nephrology. Supplementum*, 1999. 202: 45-6.
84. Kamperis, K., et al., Urinary calcium excretion in healthy children and children with primary monosymptomatic nocturnal enuresis. *The Journal of urology*, 2006. 176(2):770-3.
85. De Guchteneare, A., et al., Evidence of partial anti-enuretic response related to poor pharmacodynamic effects of desmopressin nasal spray. *J Urol*, 2009. 181(1):302-9; discussion 309.
86. Medel, R., et al., Monosymptomatic primary enuresis: differences between patients responding or not responding to oral desmopressin. *Br J Urol*, 1998. 81 Suppl 3:46-9.
87. Butler, R., et al., The effectiveness of desmopressin in the treatment of childhood nocturnal enuresis: predicting response using pretreatment variables. *Br J Urol*, 1998. 81 Suppl 3:29-36.
88. Neveus, T., et al., Bladder capacity and renal concentrating ability in enuresis: pathogenic implications. *J Urol*, 2001. 165(6 Pt 1):2022-5.
89. Kruse, S., A.L. Hellstrom, and K. Hjalmas, Day-time bladder dysfunction in therapy-resistant nocturnal enuresis. A pilot study in urotherapy. *Scand J Urol Nephrol*, 1999. 33(1):49-52.
90. Watanabe, H., Sleep patterns in children with nocturnal enuresis. *Scand J Urol Nephrol Suppl*, 1995. 173:55-6; discussion 56-7.
91. Kawauchi, A., et al., Changes in the structure of sleep spindles and delta waves on electroencephalography in patients with nocturnal enuresis. *Br J Urol*, 1998. 81 Suppl 3:72-5.
92. Watanabe, H. and A. Kawauchi, Is small bladder capacity a cause of enuresis? *Scand J Urol Nephrol Suppl*, 1995. 173: 37-41.
93. Watanabe, H., et al., Physiological background of enuresis type I. A preliminary report. *Scand J Urol Nephrol Suppl*, 1997. 183:7-9; discussion 9-10.
94. Eller, D.A., et al., Daytime functional bladder capacity as a predictor of response to desmopressin in monosymptomatic nocturnal enuresis. *Eur Urol*, 1998. 33 Suppl 3:25-9.
95. Kawauchi, A., et al., Relationships among nocturnal urinary volume, bladder capacity, and nocturia with and without water load in nonenuretic children. *Urology*, 2002. 59(3):433-7.
96. Yeung, C.K., H.N. Chiu, and F.K. Sit, Bladder dysfunction in children with refractory monosymptomatic primary nocturnal enuresis. *J Urol*, 1999. 162(3 Pt 2):1049-54; discussion 1054-5.
97. Sreedhar, B., et al., Ultrasound bladder measurements in children with severe primary nocturnal enuresis: pretreatment and posttreatment evaluation and its correlation with treatment outcome. *J Urol*, 2008. 179(4):1568-72; discussion 1572.
98. Yeung, C.K., et al., Ultrasound bladder measurements in patients with primary nocturnal enuresis: a urodynamic and treatment outcome correlation. *J Urol*, 2004. 171(6 Pt 2):2589-94.
99. Bower, W.F., F.K. Sit, and C.K. Yeung, Nocturnal enuresis in adolescents and adults is associated with childhood elimination symptoms. *J Urol*, 2006. 176(4 Pt 2):1771-5.
100. Neveus, T., et al., Depth of sleep and sleep habits among enuretic and incontinent children. *Acta Paediatr*, 1999. 88(7):748-52.
101. Wolfish, N.M., Sleep/Arousal and enuresis subtypes. *J Urol*, 2001. 166(6):2444-7.

102. Wolfish, N.M., Enuresis: A maturational lag. *Paediatr Child Health*, 2002. 7(8): 521-3.
103. Bower, W.F., et al., The epidemiology of childhood enuresis in Australia. *Br J Urol*, 1996. 78(4):602-6.
104. Dhondt, K., et al., Abnormal sleep architecture and refractory nocturnal enuresis. *The Journal of urology*, 2009. 182(4 Suppl): 1961-5.
105. Dhondt, K., et al., Sleep fragmentation and increased periodic limb movements are more common in children with nocturnal enuresis. *Acta Paediatr*, 2014. 103(6):268-72.
106. Van Herzeele, C., et al., Periodic limb movements during sleep are associated with a lower quality of life in children with monosymptomatic nocturnal enuresis. *Eur J Pediatr*, 2015.
107. Van Herzeele, C., et al., Neuropsychological functioning related to specific characteristics of nocturnal enuresis. *J Pediatr Urol*, 2015. 11(4):208 e1-6.
108. Dhondt, K., et al., Sleep fragmentation and periodic limb movements in children with monosymptomatic nocturnal enuresis and polyuria. *Pediatr Nephrol*, 2015. 30(7):1157-62.
109. Van Herzeele, C., et al., Periodic limb movements during sleep are associated with a lower quality of life in children with monosymptomatic nocturnal enuresis. *Eur J Pediatr*, 2015. 174(7):897-902.
110. Van Herzeele, C., et al., Desmopressin (melt) therapy in children with monosymptomatic nocturnal enuresis and nocturnal polyuria results in improved neuropsychological functioning and sleep. *Pediatr Nephrol*, 2016. 31(9):1477-84.
111. Norgaard, J.P., et al., Simultaneous Registration of Sleep-Stages and Bladder Activity in Enuresis. *Urology*, 1985. 26(3): 316-319.
112. Norgaard, J.P., Pathophysiology of nocturnal enuresis. *Scand J Urol Nephrol Suppl*, 1991. 140:1-35.
113. Mikkelsen, E.J., et al., Childhood enuresis. I. Sleep patterns and psychopathology. *Arch Gen Psychiatry*, 1980. 37(10):1139-44.
114. Mikkelsen, E.J. and J.L. Rapoport, Enuresis: psychopathology, sleep stage, and drug response. *Urol Clin North Am*, 1980. 7(2):361-77.
115. Djurhuus, J.C., J.P. Norgaard, and S. Rittig, Monosymptomatic bedwetting. *Scand J Urol Nephrol Suppl*, 1992. 141:7-17; discussion 18-9.
116. Norgaard, J.P. and J.C. Djurhuus, The pathophysiology of enuresis in children and young adults. *Clin Pediatr (Phila)*, 1993. Spec No:5-9.
117. Hunsballe, J.M., S. Rittig, and J.C. Djurhuus, Sleep and arousal in adolescents and adults with nocturnal enuresis. *Scandinavian journal of urology and nephrology. Supplementum*, 1995. 173:59-60; discussion 60-1.
118. Hunsballe, J.M., Increased delta component in computerized sleep electroencephalographic analysis suggests abnormally deep sleep in primary monosymptomatic nocturnal enuresis. *Scand J Urol Nephrol*, 2000. 34(5):294-302.
119. Neveus, T., The role of sleep and arousal in nocturnal enuresis. *Acta Paediatr*, 2003. 92(10):1118-23.
120. Tauris, L.H., et al., Tailoring treatment of monosymptomatic nocturnal enuresis: the role of maximum voided capacity. *J Urol*, 2012. 187(2): 664-9.
121. Glazener, C.M. and J.H. Evans, Simple behavioural and physical interventions for nocturnal enuresis in children. *Cochrane Database Syst Rev*, 2004(2): CD003637.
122. Niemczyk, J., et al., Incontinence in children with treated attention-deficit/hyperactivity disorder. *J Pediatr Urol*, 2015. 11(3):141 e1-6.
123. Niemczyk, J., et al., Prevalence of incontinence, attention deficit/hyperactivity disorder and oppositional defiant disorder in preschool children. *Eur Child Adolesc Psychiatry*, 2015. 24(7):837-43.
124. Niemczyk, J., et al., Incontinence in persons with Noonan Syndrome. *J Pediatr Urol*, 2015. 11(4): 201 e1-5.
125. Niemczyk, J., et al., Incontinence and psychological symptoms in individuals with Mowat-Wilson Syndrome. *Res Dev Disabil*, 2017. 62:230-237.
126. von Gontard, A., et al., Psychological and psychiatric issues in urinary and fecal incontinence. *J Urol*, 2011. 185(4):1432-6.
127. von Gontard, A., et al., Incontinence in children with autism spectrum disorder. *J Pediatr Urol*, 2015. 11(5): 264 :1-7.
128. von Gontard, A., et al., Specific behavioral comorbidity in a large sample of children with functional incontinence: Report of 1,001 cases. *Neurourol Urodyn*, 2015. 34(8):763-8.
129. von Gontard, A., et al., Incontinence and parent-reported oppositional defiant disorder symptoms in young children--a population-based study. *Pediatr Nephrol*, 2015. 30(7):1147-55.
130. Equit, M., et al., Elimination disorders in persons with Prader-Willi and Fragile-X syndromes. *Neurourol Urodyn*, 2013. 32(7):986-92.

131. von Gontard, A., et al., Psychological and psychiatric issues in urinary and fecal incontinence. *The Journal of urology*, 2011. 185(4):1432-6.
132. von Gontard, A., et al., Association of attention deficit and elimination disorders at school entry: a population based study. *J Urol*, 2011. 186(5):2027-32.
133. Von Gontard, A., et al., Central nervous system involvement in nocturnal enuresis: evidence of general neuromotor delay and specific brainstem dysfunction. *J Urol*, 2001. 166(6): 2448-51.
134. Baeyens, D., et al., Attention deficit/hyperactivity disorder in children with nocturnal enuresis. *J Urol*, 2004. 171(6 Pt 2):2576-9.
135. Van Hoecke, E., et al., An assessment of internalizing problems in children with enuresis. *J Urol*, 2004. 171(6 Pt 2):2580-3.
136. Van Hoecke, E., et al., Enuresis and daytime wetting as a biopsychosocial problem: a review. Expert review of pharmacoeconomics & outcomes research, 2007. 7(6):633-40.
137. Van Hoecke, E., et al., Internalizing and externalizing problem behavior in children with nocturnal and diurnal enuresis: a five-factor model perspective. *J Pediatr Psychol*, 2006. 31(5):460-8.
138. Baeyens, D., et al., The impact of maturation of brainstem inhibition on enuresis: a startle eye blink modification study with 2-year followup. *The Journal of urology*, 2007. 178(6): 2621-5.
139. Ornitz, E.M., et al., Prepulse inhibition of startle and the neurobiology of primary nocturnal enuresis. *Biol Psychiatry*, 1999. 45(11):1455-66.
140. Ornitz, E.M., et al., Prepulse inhibition of startle, intelligence and familial primary nocturnal enuresis. *Acta Paediatr*, 2000. 89(4):475-81.
141. Ornitz, E.M., G.L. Hanna, and J. de Traversay, Prestimulation-induced startle modulation in attention-deficit hyperactivity disorder and nocturnal enuresis. *Psychophysiology*, 1992. 29(4):437-51.
142. Freitag, C.M., et al., Neurophysiology of nocturnal enuresis: evoked potentials and prepulse inhibition of the startle reflex. *Developmental Medicine & Child Neurology*, 2006. 48(4):278-84.
143. Freitag, C.M., et al., Neurophysiology of nocturnal enuresis: evoked potentials and prepulse inhibition of the startle reflex. *Dev Med Child Neurol*, 2006. 48(4): 278-84.
144. Yeung, C.K., M. Diao, and B. Sreedhar, Cortical arousal in children with severe enuresis. *N Engl J Med*, 2008. 358(22):2414-5.
145. Watanabe, H. and A. Kawauchi, Locus coeruleus function in enuresis. *Scand J Urol Nephrol Suppl*, 1999. 202:14-7; discussion 18-9.
146. Chase, J., et al., The management of dysfunctional voiding in children: a report from the Standardisation Committee of the International Children's Continence Society. *The Journal of urology*, 2010. 183(4):1296-302.
147. Burgers RE, Mugie SM, Chase J, Cooper CS, von Gontard A, Siggard Rittig C, Homsy Y, Benninga M: Management of functional bowel disorders in children: Report from the standardisation committee of the international Children's Continence Society. *J Urology*, 2013: 190; 29-36
148. Joensson, I.M., et al., Transabdominal ultrasound of rectum as a diagnostic tool in childhood constipation. *J Urol*, 2008. 179(5): 1997-2002.
149. De Paepe, H., et al., Pelvic-floor therapy in girls with recurrent urinary tract infections and dysfunctional voiding. *Br J Urol*, 1998. 81 Suppl 3:109-13.
150. Hellstrom, A., et al., Association between urinary symptoms at 7 years old and previous urinary tract infection. *Arch Dis Child*, 1991. 66(2):232-4.
151. Borch, L., et al., Bladder and bowel dysfunction and the resolution of urinary incontinence with successful management of bowel symptoms in children. *Acta Paediatr*, 2013. 102(5):215-20.
152. Van Laecke, E., et al., Adequate fluid intake, urinary incontinence, and physical and/or intellectual disability. *The Journal of urology*, 2009. 182(4 Suppl):2079-84.
153. Niemczyk, J., et al., Toilet refusal syndrome in preschool children: do different subtypes exist? *J Pediatr Gastroenterol Nutr*, 2014. 58(3):303-6.
154. Lottmann, H., Enuresis treatment in France. *Scand J Urol Nephrol Suppl*, 1999. 202:66-9.
155. Hellstrom, A.L., et al., Micturition habits and incontinence in 7-year-old Swedish school entrants. *Eur J Pediatr*, 1990. 149(6): 434-7.
156. Butler, R.J., et al., Investigating the three systems approach to complex childhood nocturnal enuresis--medical treatment interventions. *Scand J Urol Nephrol*, 2004. 38(2):117-21.
157. Kaerts, N., et al., Toilet training in daycare centers in Flanders, Belgium. *Eur J Pediatr*, 2012. 171(6): 955-61.
158. Devlin, J.B. and C. O'Cathain, Predicting treatment outcome in nocturnal enuresis. *Arch Dis Child*, 1990. 65(10): 1158-61.

159. Neveus, T., et al., Enuresis--background and treatment. *Scand J Urol Nephrol Suppl*, 2000(206): 1-44.
160. Neveus, T., Nocturnal enuresis-theoretic background and practical guidelines. *Pediatr Nephrol*, 2011. 26(8):1207-14.
161. Neveus, T., et al., Evaluation of and treatment for monosymptomatic enuresis: a standardization document from the International Children's Continence Society. *J Urol*, 2010. 183(2):441-7.
162. Zerlin, J.M., et al., Bladder capacity as measured at voiding cystourethrography in children: relationship to toilet training and frequency of micturition. *Radiology*, 1993. 187(3):803-6.
163. Loening-Baucke, V., Assessment, diagnosis, and treatment of constipation in childhood. *J Wound Ostomy Continence Nurs*, 1994. 21(2):49-58.
164. Loening-Baucke, V., Urinary incontinence and urinary tract infection and their resolution with treatment of chronic constipation of childhood. *Pediatrics*, 1997. 100(2 Pt 1): 228-32.
165. Longstaffe, S., M.E. Moffatt, and J.C. Whalen, Behavioral and self-concept changes after six months of enuresis treatment: a randomized, controlled trial. *Pediatrics*, 2000. 105(4 Pt 2): 935-40.
166. Baeyens, D., et al., Adherence in children with nocturnal enuresis. *Journal of pediatric urology*, 2009. 5(2): 105-9.
167. Van Herzeele, C., et al., Poor compliance with primary nocturnal enuresis therapy may contribute to insufficient desmopressin response. *The Journal of urology*, 2009. 182(4 Suppl): 2045-9.
168. Cederblad, M., et al., Infrequent enuresis, the uninvestigated majority comparisons between children with enuresis of varying severity. *J Pediatr Urol*, 2014.
169. Goel, K.M., et al., Evaluation of nine different types of enuresis alarms. *Arch Dis Child*, 1984. 59(8): 748-52.
170. Bauer, S.B., et al., Standardizing terminology in pediatric urology. *Journal of pediatric urology*, 2007. 3(2):163.
171. Glazener, C.M. and J.H. Evans, Alarm interventions for nocturnal enuresis in children. *Cochrane database of systematic reviews*, 2001(1): CD002911.
172. Glazener, C.M., J.H. Evans, and R.E. Peto, Treating nocturnal enuresis in children: review of evidence. *Journal of wound, ostomy, and continence nursing* : official publication of The Wound, Ostomy and Continence Nurses Society / WOCN, 2004. 31(4):223-34.
173. Glazener, C.M., J.H. Evans, and R.E. Peto, Alarm interventions for nocturnal enuresis in children. *Cochrane Database Syst Rev*, 2005(2): CD002911.
174. Neveus, T., et al., Evaluation of and treatment for monosymptomatic enuresis: a standardization document from the International Children's Continence Society. *The Journal of urology*, 2010. 183(2): 441-7.
175. Butler, R.J. and J.C. Robinson, Alarm treatment for childhood nocturnal enuresis: an investigation of within-treatment variables. *Scand J Urol Nephrol*, 2002. 36(4): 268-72.
176. Houts, A.C., J.S. Berman, and H. Abramson, Effectiveness of psychological and pharmacological treatments for nocturnal enuresis. *J Consult Clin Psychol*, 1994. 62(4): 737-45.
177. Kwak, K.W., K.H. Park, and M. Baek, The efficacy of enuresis alarm treatment in pharmacotherapy-resistant nocturnal enuresis. *Urology*, 2011. 77(1)200-4.
178. Van Hoeck, K.J., et al., Improving the cure rate of alarm treatment for monosymptomatic nocturnal enuresis by increasing bladder capacity--a randomized controlled trial in children. *J Urol*, 2008. 179(3): 1122-6; discussion 1126-7.
179. Evans, J.H., Evidence based management of nocturnal enuresis. *BMJ*, 2001. 323(7322):1167-9.
180. Lettgen, B., Differential diagnoses for nocturnal enuresis. *Scand J Urol Nephrol Suppl*, 1997. 183:47-8; discussion 48-9.
181. Azrin, N.H., T.J. Sneed, and R.M. Foxx, Dry-bed training: rapid elimination of childhood enuresis. *Behav Res Ther*, 1974. 12(3):147-56.
182. Azrin, N.H., T.J. Sneed, and R.M. Foxx, Dry bed: a rapid method of eliminating bedwetting (enuresis) of the retarded. *Behav Res Ther*, 1973. 11(4): 427-34.
183. Glazener, C.M. and J.H. Evans, Simple behavioural and physical interventions for nocturnal enuresis in children. *Cochrane database of systematic reviews*, 2002(2): CD003637.
184. Glazener, C.M., J.H. Evans, and R.E. Peto, Complex behavioural and educational interventions for nocturnal enuresis in children. *Cochrane database of systematic reviews*, 2004(1): CD004668.

185. Hirasing, R.A., L. Bolk-Bennink, and H. Reus, Dry bed training by parents: results of a group instruction program. *J Urol*, 1996. 156(6):2044-6.
186. HiraSing, R.A., et al., Effect of dry bed training on behavioural problems in enuretic children. *Acta Paediatr*, 2002. 91(8):960-4.
187. Bollard, R.J. and P. Woodroffe, The effect of parent-administered Dry-Bed training on nocturnal enuresis in children. *Behav Res Ther*, 1977. 15(2):159-65.
188. Bollard, J. and T. Nettelbeck, A component analysis of dry-bed training for treatment for bedwetting. *Behav Res Ther*, 1982. 20(4):383-90.
189. van Londen, A., et al., Arousal training for children suffering from nocturnal enuresis: a 2 1/2 year follow-up. *Behav Res Ther*, 1993. 31(6): 613-5.
190. Meadow, S.R. and J.H. Evans, Desmopressin for enuresis. *BMJ*, 1989. 298(6688):1596-7.
191. Janknegt, R.A. and A.J. Smans, Treatment with desmopressin in severe nocturnal enuresis in childhood. *Br J Urol*, 1990. 66(5): 535-7.
192. Knudsen, U.B., et al., Long-term treatment of nocturnal enuresis with desmopressin. A follow-up study. *Urol Res*, 1991. 19(4): p. 237-40.
193. Lackgren, G., et al., Desmopressin in the treatment of severe nocturnal enuresis in adolescents--a 7-year follow-up study. *Br J Urol*, 1998. 81 Suppl 3: 17-23.
194. Glazener, C.M. and J.H. Evans, Desmopressin for nocturnal enuresis in children. *Cochrane Database Syst Rev*, 2002(3): CD002112.
195. Van de Walle, J., C. Van Herzeele, and A. Raes, Is there still a role for desmopressin in children with primary monosymptomatic nocturnal enuresis?: a focus on safety issues. *Drug safety : an international journal of medical toxicology and drug experience*, 2010. 33(4): 261-71.
196. Vande Walle, J., et al., Desmopressin 30 years in clinical use: a safety review. *Curr Drug Saf*, 2007. 2(3): 232-8.
197. Vande Walle, J.G., et al., A new fast-melting oral formulation of desmopressin: a pharmacodynamic study in children with primary nocturnal enuresis. *BJU Int*, 2006. 97(3): 603-9.
198. Robson, W.L., Clinical practice. Evaluation and management of enuresis. *N Engl J Med*, 2009. 360(14):1429-36.
199. De Guchteneere, A., et al., Oral lyophilizate formulation of desmopressin: superior pharmacodynamics compared to tablet due to low food interaction. *The Journal of urology*, 2011. 185(6):2308-13.
200. De Bruyne, P., et al., Pharmacokinetics of desmopressin administered as tablet and oral lyophilisate formulation in children with monosymptomatic nocturnal enuresis. *Eur J Pediatr*, 2014. 173(2):223-8.
201. Lottmann, H., et al., A randomised comparison of oral desmopressin lyophilisate (MELT) and tablet formulations in children and adolescents with primary nocturnal enuresis. *Int J Clin Pract*, 2007. 61(9):1454-60.
202. Osterberg, O., et al., Pharmacokinetics of desmopressin administered as an oral lyophilisate dosage form in children with primary nocturnal enuresis and healthy adults. *J Clin Pharmacol*, 2006. 46(10):1204-11.
203. Neveus, T., et al., Desmopressin resistant enuresis: pathogenetic and therapeutic considerations. *J Urol*, 1999. 162(6):2136-40.
204. Dehoorne, J.L., et al., Desmopressin toxicity due to prolonged half-life in 18 patients with nocturnal enuresis. *The Journal of urology*, 2006. 176(2): 754-7; discussion 757-8.
205. Hunsballe, J.M., et al., The efficacy of DDAVP is related to the circadian rhythm of urine output in patients with persisting nocturnal enuresis. *Clin Endocrinol (Oxf)*, 1998. 49(6):793-801.
206. Hjalmas, K., et al., Long-term treatment with desmopressin in children with primary monosymptomatic nocturnal enuresis: an open multicentre study. *Swedish Enuresis Trial (SWEET) Group. Br J Urol*, 1998. 82(5): 704-9.
207. Glazener, C.M. and J.H. Evans, Desmopressin for nocturnal enuresis in children. *Cochrane database of systematic reviews*, 2000(2):CD002112.
208. Tullus, K., et al., Efficacy and safety during long-term treatment of primary monosymptomatic nocturnal enuresis with desmopressin. *Swedish Enuresis Trial Group. Acta Paediatr*, 1999. 88(11):1274-8.
209. Hjalmas, K. and B. Bengtsson, Efficacy, safety, and dosing of desmopressin for nocturnal enuresis in Europe. *Clin Pediatr (Phila)*, 1993. Spec No:19-24.
210. Kjoller, S.S., M. Hejl, and P.S. Pedersen, [Enuresis treated with minurin (DDAVP). A controlled clinical study]. *Ugeskr Laeger*, 1984. 146(43):3281-2.

211. Butler, R.J., P. Holland, and J. Robinson, Examination of the structured withdrawal program to prevent relapse of nocturnal enuresis. *J Urol*, 2001. 166(6):2463-6.
212. De Bruyne, E., et al., Problem behavior, parental stress and enuresis. *The Journal of urology*, 2009. 182(4 Suppl): 2015-20.
213. Juul, K.V., et al., Desmopressin melt improves response and compliance compared with tablet in treatment of primary monosymptomatic nocturnal enuresis. *Eur J Pediatr*, 2013. 172(9):1235-42.
214. Rushton, H.G., et al., Predictors of response to desmopressin in children and adolescents with monosymptomatic nocturnal enuresis. *Scand J Urol Nephrol Suppl*, 1995. 173:109-10; discussion 110-1.
215. Rushton, H.G., et al., The influence of small functional bladder capacity and other predictors on the response to desmopressin in the management of monosymptomatic nocturnal enuresis. *J Urol*, 1996. 156(2 Pt 2):651-5.
216. Lottmann, H., et al., Long-term desmopressin response in primary nocturnal enuresis: open-label, multinational study. *International journal of clinical practice*, 2009. 63(1):35-45.
217. Rittig, S., U.B. Knudsen, and S. Sorensen, Longterm doubleblind crossover study of DDAVP intranasal spray in the management of nocturnal enuresis., in *Desmopresin in nocturnal enuresis*. 1989, Horus Medical Publications.
218. Marschall-Kehrel, D., T.W. Harms, and G. Enuresis Algorithm of Marschall Survey, Structured desmopressin withdrawal improves response and treatment outcome for monosymptomatic enuretic children. *J Urol*, 2009. 182(4 Suppl): 2022-6.
219. Robson, W.L. and A.K. Leung, Hyponatraemia following desmopressin. *BMJ*, 1993. 307(6895): 64-5.
220. Robson, W.L. and A.K. Leung, Hyponatremia in children treated with desmopressin. *Arch Pediatr Adolesc Med*, 1998. 152(9):930-1.
221. Robson, W.L., Water intoxication in patients treated with desmopressin. *Pharmacotherapy*, 1996. 16(5):969-70.
222. Hjalmas, K., SWEET, the Swedish Enuresis Trial. *Scand J Urol Nephrol Suppl*, 1995. 173:89-92; discussion 93.
223. Kruse, S., et al., Treatment of primary monosymptomatic nocturnal enuresis with desmopressin: predictive factors. *BJU Int*, 2001. 88(6):572-6.
224. Wolfish, N.M., et al., The Canadian Enuresis Study and Evaluation--short- and long-term safety and efficacy of an oral desmopressin preparation. *Scand J Urol Nephrol*, 2003. 37(1): 22-7.
225. Lebl, J., et al., Cerebral oedema in enuretic children during low-dose desmopressin treatment: a preventable complication. *Eur J Pediatr*, 2001. 160(3): 159-62.
226. Odeh, M. and A. Oliven, Coma and seizures due to severe hyponatremia and water intoxication in an adult with intranasal desmopressin therapy for nocturnal enuresis. *J Clin Pharmacol*, 2001. 41(5): 582-4.
227. Apakama, D.C. and A. Bleetman, Hyponatraemic convulsion secondary to desmopressin treatment for primary enuresis. *J Accid Emerg Med*, 1999. 16(3): 229-30.
228. Sharma, R. and D. Stein, Hyponatremia after desmopressin (DDAVP) use in pediatric patients with bleeding disorders undergoing surgeries. *J Pediatr Hematol Oncol*, 2014. 36(6):371-5.
229. Yaouyanc, G., et al., Seizure with hyponatremia in a child prescribed desmopressin for nocturnal enuresis. *J Toxicol Clin Toxicol*, 1992. 30(4):637-41.
230. Kallio, J., et al., Severe hyponatremia caused by intranasal desmopressin for nocturnal enuresis. *Acta Paediatr*, 1993. 82(10): 881-2.
231. Lucchini, B., et al., Severe signs of hyponatremia secondary to desmopressin treatment for enuresis: a systematic review. *J Pediatr Urol*, 2013. 9(6 Pt B): 1049-53.
232. Van Kampen, M., et al., Long-term efficacy and predictive factors of full spectrum therapy for nocturnal enuresis. *J Urol*, 2004. 171(6 Pt 2): 2599-602; discussion 2602.
233. Bradbury, M.G. and S.R. Meadow, Combined treatment with enuresis alarm and desmopressin for nocturnal enuresis. *Acta Paediatr*, 1995. 84(9):1014-8.
234. Kamperis, K., et al., Combination of the enuresis alarm and desmopressin: second line treatment for nocturnal enuresis. *The Journal of urology*, 2008. 179(3):1128-31.
235. Sukhai, R.N., J. Mol, and A.S. Harris, Combined therapy of enuresis alarm and desmopressin in the treatment of nocturnal enuresis. *Eur J Pediatr*, 1989. 148(5): 465-7.
236. Onol, F.F., et al., Comparison of long-term efficacy of desmopressin lyophilisate and enuretic alarm for monosymptomatic enuresis and assessment of predictive factors for success: a randomized prospective trial. *J Urol*, 2015. 193(2): 655-61.

237. Leebeek-Groenewegen, A., et al., Efficacy of desmopressin combined with alarm therapy for monosymptomatic nocturnal enuresis. *J Urol*, 2001. 166(6):2456-8.
238. Van Kampen, M., et al., High initial efficacy of full-spectrum therapy for nocturnal enuresis in children and adolescents. *BJU Int*, 2002. 90(1): 84-7.
239. Bradbury, M., Combination therapy for nocturnal enuresis with desmopressin and an alarm device. *Scand J Urol Nephrol Suppl*, 1997. 183: 61-3.
240. Fai-Ngo Ng, C., S.N. Wong, and G. Hong Kong Childhood Enuresis Study, Comparing alarms, desmopressin, and combined treatment in Chinese enuretic children. *Pediatr Nephrol*, 2005. 20(2):163-9.
241. Gibb, S., et al., Evidence against a synergistic effect of desmopressin with conditioning in the treatment of nocturnal enuresis. *J Pediatr*, 2004. 144(3):351-7.
242. Yeung, C.K., et al., Urodynamic findings in adults with primary nocturnal enuresis. *J Urol*, 2004. 171(6 Pt 2): 2595-8.
243. Neveus, T., Oxybutynin, desmopressin and enuresis. *J Urol*, 2001. 166(6): 2459-62.
244. Kosar, A., N. Arıkan, and C. Dıncel, Effectiveness of oxybutynin hydrochloride in the treatment of enuresis nocturna--a clinical and urodynamic study. *Scand J Urol Nephrol*, 1999. 33(2): 115-8.
245. Nijman, R.J., Role of antimuscarinics in the treatment of nonneurogenic daytime urinary incontinence in children. *Urology*, 2004. 63(3 Suppl 1): 45-50.
246. Nijman, R.J., Paediatric voiding dysfunction and enuresis. *Curr Opin Urol*, 2000. 10(5): 365-70.
247. Tahmaz, L., et al., Combination therapy of imipramine with oxybutynin in children with enuresis nocturna. *Urol Int*, 2000. 65(3): 135-9.
248. Geller, B., et al., Critical review of tricyclic antidepressant use in children and adolescents. *J Am Acad Child Adolesc Psychiatry*, 1999. 38(5): 513-6.
249. Glazener, C.M. and J.H. Evans, Tricyclic and related drugs for nocturnal enuresis in children. *Cochrane database of systematic reviews*, 2000(3): CD002117.
250. Gepertz, S. and T. Neveus, Imipramine for therapy resistant enuresis: a retrospective evaluation. *J Urol*, 2004. 171(6 Pt 2):2607-10; discussion 2609-10.
251. Glazener, C.M. and J.H. Evans, Drugs for nocturnal enuresis in children (other than desmopressin and tricyclics). *Cochrane database of systematic reviews*, 2000(3): CD002238.
252. Al-Waili, N.S., Diclofenac sodium in the treatment of primary nocturnal enuresis: double-blind crossover study. *Clin Exp Pharmacol Physiol*, 1986. 13(2): 139-42.
253. al-Waili, N.S., Indomethacin suppository to treat primary nocturnal enuresis: double-blind study. *J Urol*, 1989. 142(5): 1290-2.
254. Al-Waili, N.S., Carbamazepine to treat primary nocturnal enuresis: double-blind study. *Eur J Med Res*, 2000. 5(1): 40-4.
255. Al-Waili, N.S., Increased urinary nitrite excretion in primary enuresis: effects of indomethacin treatment on urinary and serum osmolality and electrolytes, urinary volumes and nitrite excretion. *BJU Int*, 2002. 90(3): 294-301.
256. Al-Waili, N.S., et al., Effect of carbamazepine on urinary volume and osmolality, water clearance, and serum osmolality in patients with primary enuresis. *Eur Urol*, 2006. 50(4): 844-9; discussion 849-50.
257. Yuksek, M.S., et al., Acupressure versus oxybutynin in the treatment of enuresis. *J Int Med Res*, 2003. 31(6): 552-6.
258. Bower, W.F., et al., Acupuncture for nocturnal enuresis in children: a systematic review and exploration of rationale. *Neurourol Urodyn*, 2005. 24(3): 267-72.
259. Glazener, C.M., J.H. Evans, and D.K. Cheuk, Complementary and miscellaneous interventions for nocturnal enuresis in children. *Cochrane database of systematic reviews*, 2005(2): CD005230.
260. Libonate, J., S. Evans, and J.C. Tsao, Efficacy of acupuncture for health conditions in children: a review. *TheScientificWorldJournal*, 2008. 8: 670-82.
261. Bower, W.F. and M. Diao, Acupuncture as a treatment for nocturnal enuresis. *Auton Neurosci*, 2010. 157(1-2): 63-7.
262. Radvanska, E., et al., Effect of laser acupuncture for monosymptomatic nocturnal enuresis on bladder reservoir function and nocturnal urine output. *J Urology*, 2011. 185(5): p. 1857-61.
263. Vande Walle, J. and S. Rittig, Voiding disorders. *Pediatric Kidney Disease Editors: Geary, Denis F, Schaefer, Franz (Eds.)*, 2016.
264. Neveus, T., The dilemmas of refractory nocturnal enuresis. *J Urol*, 2008. 179(3): 817-8.

265. Aubert, D., et al., [Isolated primary nocturnal enuresis: international evidence based management. Consensus recommendations by French expert group]. *Prog Urol*, 2010. 20(5): 343-9.
266. Rittig, S., et al., Effect of food intake on the pharmacokinetics and antidiuretic activity of oral desmopressin (DDAVP) in hydrated normal subjects. *Clin Endocrinol (Oxf)*, 1998. 48(2): 235-41.
267. Kamperis, K., et al., Effect of indomethacin on desmopressin resistant nocturnal polyuria and nocturnal enuresis. *J Urol*, 2012. 188(5): 1915-22.
268. Kamperis, K., et al., Combination treatment of nocturnal enuresis with desmopressin and indomethacin. *Pediatr Nephrol*, 2017. 32(4): 627-633.
269. Kamperis, K., et al., The effect of desmopressin on renal water and solute handling in desmopressin resistant monosymptomatic nocturnal enuresis. *The Journal of urology*, 2008. 180(2): 707-13; discussion 713-4.
270. Kamperis, K., et al., The circadian rhythm of urine production, and urinary vasopressin and prostaglandin E2 excretion in healthy children. *J Urol*, 2004. 171(6 Pt 2): 2571-5.
271. Neveus, T., E. Johansson, and S. Hansson, Diuretic treatment of nocturnal enuresis: preliminary results of an open pilot study. *J Urol*, 2004. 171(6 Pt 2): 2584-5.
272. Neveus, T., et al., Diuretic treatment of nocturnal enuresis. *Scand J Urol Nephrol*, 2005. 39(6): 474-8.
273. Merks, B.T., et al., Melatonin treatment in children with therapy-resistant monosymptomatic nocturnal enuresis. *J Pediatr Urol*, 2012. 8(4): 416-20.
274. Thottam, P.J., et al., Sleep architecture parameters that predict postoperative resolution of nocturnal enuresis in children with obstructive sleep apnea. *Ann Otol Rhinol Laryngol*, 2013. 122(11): 690-4.
275. Neveus, T., et al., Respiration during sleep in children with therapy-resistant enuresis. *Acta Paediatr*, 2014. 103(3): 300-4.
276. Neveus, T., et al., Orthodontic widening of the palate may provide a cure for selected children with therapy-resistant enuresis. *Acta Paediatr*, 2014.
277. Aceto, G., et al., Enuresis subtypes based on nocturnal hypercalciuria: a multicenter study. *J Urol*, 2003. 170(4 Pt 2): 1670-3.
278. Raes, A., et al., Hypercalciuria is related to osmolar excretion in children with nocturnal enuresis. *The Journal of urology*, 2010. 183(1): 297-301.

IV. CHILDREN WITH BOTH DAY AND NIGHT TIME INCONTINENCE

1. DasGupta R, Kavaria RB, Fowler CJ. Cerebral mechanisms and voiding function. *BJU Int*. 2007 Apr;99(4):731-4
2. de Groat WC, Griffiths D, Yoshimura N. Neural control of the lower urinary tract. *Compr Physiol*. 2015 Jan;5(1):327-96.
3. Franco, I., Detrusor overactivity in children. Part 1: Pathophysiology. *J Urol*, 2007 178(3 Pt 1): 761-8; discussion 768.
4. Niemczyk J, Equit M, Hoffmann L, von Gontard AJ. Incontinence in children with treated attention-deficit/hyperactivity disorder. *Pediatr Urol*. 2015 Jun;11(3):141. 1-6
5. von Gontard A, Equit M. Comorbidity of ADHD and incontinence in children. *Eur Child Adolesc Psychiatry*. 2015 Feb;24(2):127-40.
6. Franco I. New ideas in the cause of bladder dysfunction in children. *Curr Op Urol*. 2011; 21: 334-338
7. Jeffcoate, T.N. and W.J. Francis, Urgency incontinence in the female. *Am J Obstet Gynecol*, 1966. 94(5): 604-18.
8. Straub, L.R., H.S. Ripley, and S. Wolf, Disturbances of bladder function associated with emotional states. *J Am Med Assoc*, 1949. 141(16): 1139-43.
9. Kiddoo DA. Toilet training children: when to start and how to train. *CMAJ*. 2012 Mar 20;184(5):511-2
10. Bakker E, Van Gool JD, Van Sprundel M, Van Der Auwera C, Wyndaele JJ. Results of a questionnaire evaluating the effects of different methods of toilet training on achieving bladder control. *BJU Int*. 2002 Sep;90(4):456-61
11. Austin PF, Bauer SB, Bower W, Chase J, Franco I, Hoebeke P, Rittig S, Walle JV, von Gontard A, Wright A, Yang SS, Nevéus T. The standardization of terminology of lower urinary tract function in children and adolescents: Update report from the standardization committee of the International Children's Continence Society. *Neurourol Urodyn*. 2016 Apr;35(4):471-81
12. Hoebeke, P., et al., One thousand video-urodynamic studies in children with non-neurogenic bladder sphincter dysfunction. *BJU Int*, 2001. 87(6): 575-80.

13. Hjalmas, K., P.B. Hoebeke, and H. de Paepe, Lower urinary tract dysfunction and urodynamics in children. *Eur Urol*, 2000. 38(5): 655-65.
14. Jarvelin, M.R., et al., Enuresis in seven-year-old children. *Acta Paediatr Scand*, 1988. 77(1): 148-53.
15. Bower, W.F., et al., The epidemiology of childhood enuresis in Australia. *Br J Urol*, 1996. 78(4): 602-6.
16. Bloom, D.A., et al., Toilet habits and continence in children: an opportunity sampling in search of normal parameters. *J Urol*, 1993. 149(5): 1087-90.
17. Mattsson, S., Urinary incontinence and nocturia in healthy schoolchildren. *Acta Paediatr*, 1994. 83(9): 950-4.
18. Vaz GT, Vasconcelos MM, Oliveira EA, Ferreira AL, Magalhães PG, Silva FM, et al. Prevalence of lower urinary tract symptoms in school-age children. *Pediatr Nephrol*. 2011
19. Sureshkumar, P., et al., Daytime urinary incontinence in primary school children: a population-based survey. *J Pediatr*, 2000. 137(6): 814-8.
20. Sureshkumar P, Jones M, Cumming R, Craig J. A population based study of 2,856 school-age children with urinary incontinence. *J Urol* 2009; 181: 808-815; discussion 815-816
21. Chung JM, Lee SD, Kang DI, Kwon DD, Kim KS, Kim SY, Kim HG, Moon du G, Park KH, Park YH, Pai KS, Suh HJ, Lee JW, Cho WY, Ha TS, Han SW; Korean Enuresis Association. Prevalence and associated factors of overactive bladder in Korean children 5-13 years old: a nationwide multicenter study. *Urology*. 2009;73(1): 63-7; discussion 68-9
22. Hellstrom, A.L., et al., Micturition habits and incontinence in 7-year-old Swedish school entrants. *Eur J Pediatr*, 1990. 149(6): 434-7.
23. Himsl, K.K. and R.S. Hurwitz, Pediatric urinary incontinence. *Urol Clin North Am*, 1991. 18(2): 283-93.
24. Rugolotto, S., et al., Toilet training started during the first year of life: a report on elimination signals, stool toileting refusal and completion age. *Minerva Pediatr*, 2008. 60(1): 27-35.
25. Kyrklund K, Taskinen S, Rintala RJ, Pakarinen MP. Lower urinary tract symptoms from childhood to adulthood: a population based study of 594 Finnish individuals 4 to 26 years old. *J Urol*. 2012 Aug;188(2):588-93
26. Mota, D.M. and A.J. Barros, Toilet training: methods, parental expectations and associated dysfunctions. *J Pediatr (Rio J)*, 2008. 84(1): 9-17.
27. Koc, I., et al., Toilet training in Turkey: the factors that affect timing and duration in different sociocultural groups. *Child Care Health Dev*, 2008.
28. Tarhan H, Çakmak Ö, Akarken İ, Ekin RG, Ün S, Uzelli D, Helvacı M, Aksu N, Yavaşcan Ö, Mutlubaş Özsan F, Cun S, Koç F, Özkarakaş Ö, İlbey YÖ, Zorlu F. Toilet training age and influencing factors: a multicenter study. *Turk J Pediatr*. 2015 Mar-Apr;57(2):172-6.
29. Joinson C, Heron J, von Gontard A, Butler U, Emond A, Golding J. A prospective study of age at initiation of toilet training and subsequent daytime bladder control in school-age children. *J Dev Behav Pediatr*. 2009;30(5): 385-93.
30. Yang SS, Zhao LL, Chang SJ. Early initiation of toilet training for urine was associated with early urinary continence and does not appear to be associated with bladder dysfunction. *Neurourol Urodyn*. 2011; 30(7): 1253-7
31. Hodges SJ, Richards KA, Gorbachinsky I, Krane LS. The association of age of toilet training and dysfunctional voiding. *Res Rep Urol*. 2014 Oct 3;6:127-30.
32. Da Fonseca EM, Santana PG, Gomes FA, Bastos MD. Dysfunction elimination syndrome: Is age at toilet training a determinant? *J Pediatr Urol*. 2011; 7(3):332-5.
33. Swithinbank, L.V., et al., The natural history of urinary symptoms during adolescence. *Br J Urol*, 1998. 81 Suppl 3: 90-3.
34. Soderstrom, U., et al., Urinary and faecal incontinence: a population-based study. *Acta Paediatr*, 2004. 93(3): 386-9.
35. Bower WF et al: Nocturnal enuresis in adolescents and adults is associated with childhood elimination symptoms. *J Urol* 2006; 176(4 Pt 2):1771-5.
36. Bower, W.F., S.K. Yip, and C.K. Yeung, Dysfunctional elimination symptoms in childhood and adulthood. *J Urol*, 2005. 174(4 Pt 2): 1623-7; discussion 1627-8.
37. Minassian VA et al: Effect of childhood dysfunctional voiding on urinary incontinence in adult women. *Obstetrics & Gynaecology* 2006; 107(6): 1247- 51.
38. Yildirim A, Uluocak N, Atilgan D, Ozcetin M, Erdemir F, Boztepe O. Evaluation of lower urinary tract symptoms in children exposed to sexual abuse. *Urol J*. 2011;8(1):38-42.
39. P. Hoebeke, W. Bower, A. Combs, T. De Jong, S. Yang. Diagnostic evaluation of children with daytime incontinence. *J Urol* 2010; 183: 699-703.

40. Chang SJ, Van Laecke E, Bauer SB, von Gontard A, Bagli D, Bower WF, Renson C, Kawachi A, Yang SS. Treatment of daytime urinary incontinence: A standardization document from the International Children's Continence Society. *Neurourol Urodyn*. 2015 Oct 16:183(4), 1296-1302.
41. von Gontard A, Baeyens D, Van Hoecke E, Warzak WJ, Bachmann C. Psychological and psychiatric issues in urinary and fecal incontinence. *J Urol*. 2011; 185(4):1432-6
42. Pfister, C., et al., The usefulness of a minimal urodynamic evaluation and pelvic floor biofeedback in children with chronic voiding dysfunction. *BJU Int*, 1999. 84(9): 1054-7.
43. Parekh, D.J., et al., The use of radiography, urodynamic studies and cystoscopy in the evaluation of voiding dysfunction. *J Urol*, 2001. 165(1): 215-8.
44. Schewe, J., F.H. Brands, and J. Pannek, Voiding dysfunction in children: role of urodynamic studies. *Urol Int*, 2002. 69(4): 297-301.
45. Soygur, T., et al., The role of vide-urodynamic studies in managing non-neurogenic voiding dysfunction in children. *BJU Int*, 2004. 93(6): 841-3.
46. Bauer SB, Nijman RJ, Drzewiecki BA, Sillen U, Hoebeke P; International Children's Continence Society Standardization Subcommittee. International Children's Continence Society standardization report on urodynamic studies of the lower urinary tract in children. *Neurourol Urodyn*. 2015 Sep;34(7):640-7.
47. Kuh, D., L. Cardozo, and R. Hardy, Urinary incontinence in middle aged women: childhood enuresis and other lifetime risk factors in a British prospective cohort. *J Epidemiol Community Health*, 1999. 53(8): 453-8.
48. Koff, S.A., J. Lapedes, and D.H. Piazza, Association of urinary tract infection and reflux with uninhibited bladder contractions and voluntary sphincteric obstruction. *J Urol*, 1979. 122(3): 373-6.
49. Scholtmeijer, R.J. and D.J. Griffiths, The role of videourodynamic studies in diagnosis and treatment of vesicoureteral reflux. *J Pediatr Surg*, 1990. 25(6): 669-71.
50. Soygur, T., et al., Relationship among pediatric voiding dysfunction and vesicoureteral reflux and renal scars. *Urology*, 1999. 54(5): 905-8.
51. Sillen, U., et al., Pronounced detrusor hypercontractility in infants with gross bilateral reflux. *J Urol*, 1992. 148(2 Pt 2): 598-9.
52. van Gool, J.D. and G.A. de Jonge, Urge syndrome and urge incontinence. *Arch Dis Child*, 1989. 64(11): 1629-34.
53. Vega, P.J. and L.A. Pascual, High-pressure bladder: an underlying factor mediating renal damage in the absence of reflux? *BJU Int*, 2001. 87(6): 581-4.
54. Lindehall, B., et al., Effect of clean intermittent catheterisation on radiological appearance of the upper urinary tract in children with myelomeningocele. *Br J Urol*, 1991. 67(4): 415-9.
55. Koff, S.A., T.T. Wagner, and V.R. Jayanthi, The relationship among dysfunctional elimination syndromes, primary vesicoureteral reflux and urinary tract infections in children. *J Urol*, 1998. 160(3 Pt 2): 1019-22.
56. McGrath, K.H., P.H. Caldwell, and M.P. Jones, The frequency of constipation in children with nocturnal enuresis: a comparison with parental reporting. *J Paediatr Child Health*, 2008. 44(1-2): 19-27.
57. Bael, A.M., et al., Functional urinary and fecal incontinence in neurologically normal children: symptoms of one 'functional elimination disorder'? *BJU Int*, 2007. 99(2): 407-12.
58. van Gool, J.D., M.A. Vijverberg, and T.P. de Jong, Functional daytime incontinence: clinical and urodynamic assessment. *Scand J Urol Nephrol Suppl*, 1992. 141: 58-69.
59. Hansson, S., et al., Lower urinary tract dysfunction in girls with untreated asymptomatic or covert bacteriuria. *J Urol*, 1990. 143(2): 333-5.
60. van Gool, J.D., et al., Bladder-sphincter dysfunction, urinary infection and vesico-ureteral reflux with special reference to cognitive bladder training. *Contrib Nephrol*, 1984. 39: 190-210.
61. Bachelard, M., et al., Urodynamic pattern in infants with urinary tract infection. *J Urol*, 1998. 160(2): 522-6.
62. Rushton, H.G. and M. Majd, Dimercaptosuccinic acid renal scintigraphy for the evaluation of pyelonephritis and scarring: a review of experimental and clinical studies. *J Urol*, 1992. 148(5 Pt 2): 1726-32.
63. Wennergren, H.M., B.E. Oberg, and P. Sandstedt, The importance of leg support for relaxation of the pelvic floor muscles. A surface electromyograph study in healthy girls. *Scand J Urol Nephrol*, 1991. 25(3): 205-13.
64. Varlam, D.E. and J. Dippell, Non-neurogenic bladder and chronic renal insufficiency in childhood. *Pediatr Nephrol*, 1995. 9(1): 1-5.
65. van Gool, J.D., et al., Functional daytime incontinence: non-pharmacological treatment. *Scand J Urol Nephrol Suppl*, 1992. 141: 93-103.

66. Hjalmas, K., G. Passerini-Glazel, and M.L. Chiozza, Functional daytime incontinence: pharmacological treatment. *Scand J Urol Nephrol Suppl*, 1992. 141:108-14.
67. Ural, Z., I. Ulman, and A. Avanoğlu, Bladder dynamics and vesicoureteral reflux: factors associated with idiopathic lower urinary tract dysfunction in children. *J Urol*, 2008. 179(4): 1564-7.
68. Lopes I, Veiga ML, Braga AA, Brasil CA, Hoffmann A, Barroso U Jr. A two- day bladder diary for children: Is it enough? *J Pediatr Urol*. 2015 Dec;11(6):348,1-4
69. von Gontard A, Niemczyk J, Weber M, Equit M. Specific behavioral comorbidity in a large sample of children with functional incontinence: Report of 1,001 cases. *Neurourol Urodyn*. 2015 Nov;34(8):763-8.
70. Franco, I., Pediatric detrusor overactivity syndrome: pathophysiology and management. *Paediatr Drugs*, 2007. 9(6): 379-90.
71. Hoebeke, P., et al., Pelvic floor spasms in children: an unknown condition responding well to pelvic floor therapy. *Eur Urol*, 2004. 46(5): 651-4; discussion 654.
72. Loening-Baucke, V., Urinary incontinence and urinary tract infection and their resolution with treatment of chronic constipation of childhood. *Pediatrics*, 1997. 100(2 Pt 1): 228-32.
73. Bower, W.F., S.K. Yip, and C.K. Yeung, Dysfunctional elimination symptoms in childhood and adulthood. *J Urol*, 2005. 174(4 Pt 2): 1623-7.
74. van Gool, J.D., et al., Historical clues to the complex of dysfunctional voiding, urinary tract infection and vesicoureteral reflux. The International Reflux Study in Children. *J Urol*, 1992. 148(5 Pt 2): 1699-702.
75. Koff, S.A., Relationship between dysfunctional voiding and reflux. *J Urol*, 1992.148(5 Pt 2): 1703-5.
76. Abidari, J.M. and L.M. Shortliffe, Urinary incontinence in girls. *Urol Clin North Am*, 2002. 29(3): 661-75.
77. Ellsworth, P.I., P.A. Merguerian, and M.E. Copening, Sexual abuse: another causative factor in dysfunctional voiding. *J Urol*, 1995. 153(3 Pt 1): 773-6.
78. Cooper, C.S., et al., Do public schools teach voiding dysfunction? Results of an elementary school teacher survey. *J Urol*, 2003. 170(3): 956-8.
79. Hoebeke, P., et al., Anomalies of the external urethral meatus in girls with non-neurogenic bladder sphincter dysfunction. *BJU Int*, 1999. 83(3): 294-8.
80. Glazier, D.B., et al., Evaluation of the utility of video-urodynamics in children with urinary tract infection and voiding dysfunction. *Br J Urol*, 1997. 80(5): 806-8.
81. Vereecken, R.L. and W. Proesmans, Urethral instability as an important element of dysfunctional voiding. *J Urol*, 2000. 163(2): 585-8.
82. Everaert, K., et al., Urodynamic assessment of voiding dysfunction and dysfunctional voiding in girls and women. *Int Urogynecol J Pelvic Floor Dysfunct*, 2000. 11(4): 254-64.
83. Chiozza, M.L., Dysfunctional voiding. *Pediatr Med Chir*, 2002. 24(2): p. 137- 40.
84. Benoit, R.M., et al., The effect of dysfunctional voiding on the costs of treating vesicoureteral reflux: a computer model. *J Urol*, 2002. 168(5): 2173-6; discussion 2176.
85. Duel, B.P., et al., A survey of voiding dysfunction in children with attention deficit-hyperactivity disorder. *J Urol*, 2003. 170(4 Pt 2): 1521-3; discussion 1523-4.
86. Hellerstein, S. and J.S. Linebarger, Voiding dysfunction in pediatric patients. *Clin Pediatr (Phila)*, 2003. 42(1): 43-9.
87. Mazzola, B.L., et al., Behavioral and functional abnormalities linked with recurrent urinary tract infections in girls. *J Nephrol*, 2003. 16(1): 133-8.
88. Upadhyay, J., et al., Use of the dysfunctional voiding symptom score to predict resolution of vesicoureteral reflux in children with voiding dysfunction. *J Urol*, 2003. 169(5): 1842-6; discussion 1846; author reply 1846.
89. Lettgen, B., et al., Urge incontinence and voiding postponement in children: somatic and psychosocial factors. *Acta Paediatr*, 2002. 91(9): 978-84.
90. von Gontard A, Niemczyk J, Wagner C, Equit (2106b). Voiding postponement in children – a systematic review. *Eur Child Adolesc Psychiatry*. 2016 Aug;25(8):809-20.
91. Maizels, M., et al., Diagnosis and treatment for children who cannot control urination. *Curr Probl Pediatr*, 1993. 23(10): 402-50.
92. Arena, M.G., et al., "Enuresis risoria": evaluation and management. *Funct Neurol*, 1987. 2(4): 579-82.
93. Glahn, B.E., Giggle incontinence (enuresis risoria). A study and an aetiological hypothesis. *Br J Urol*, 1979. 51(5): 363-6.

94. Sher, P.K. and Y. Reinberg, Successful treatment of giggle incontinence with methylphenidate. *J Urol*, 1996. 156(2 Pt 2): 656-8.
95. Richardson I, Palmer S. Successful treatment for giggle incontinence with biofeedback, *J Urol* 2009; 182, 2062-2066
96. Berry AK, Zderic S, Carr M. Methylphenidate for giggle incontinence. *J Urol*. 2009;182(4 Suppl): 2028-32.
97. Elzinga-Plomp, A., et al., Treatment of enuresis risoria in children by self-administered electric and imaginary shock. *Br J Urol*, 1995. 76(6): 775-8.
98. Chandra, M., et al., Giggle incontinence in children: a manifestation of detrusor instability. *J Urol*, 2002. 168(5): p. 2184-7.
99. Mattsson, S. and G. Gladh, Urethrovaginal reflux--a common cause of daytime incontinence in girls. *Pediatrics*, 2003. 111(1): 136-9.
100. Chase, J.W., et al., Functional constipation in children. *J Urol*, 2004. 171: 2641-3.
101. Chen, J.J., et al., A multivariate analysis of dysfunctional elimination syndrome, and its relationships with gender, urinary tract infection and vesicoureteral reflux in children. *J Urol*, 2004. 17(5): 1907-10.
102. Shaikh, N., et al., Dysfunctional elimination syndrome: is it related to urinary tract infection or vesicoureteral reflux diagnosed early in life? *Pediatrics*, 2003. 112(5): 1134-7.
103. Mingin, G.C., et al., Children with a febrile urinary tract infection and a negative radiologic workup: factors predictive of recurrence. *Urology*, 2004. 63(3): 562-5.
104. Sampaio C, Sousa AS, Fraga LG, Veiga ML, Bastos Netto JM, Barroso U Jr. Constipation and Lower Urinary Tract Dysfunction in Children and Adolescents: A Population-Based Study. *Front Pediatr*. 2016 Oct 3;4:101
105. Burgers RE, Mugie SM, Chase J, Cooper CS, von Gontard A, Siggard Rittig C, Homsy Y, Benninga M: Management of functional bowel disorders in children: Report from the standardisation committee of the international Children's Continence Society. *Journal of Urology*, 190, 29-36, 2013
106. Koppen IJH, von Gontard A, Chase J, Cooper CS, Rittig CS, Bauer SB, Homsy Y, Yang SS, Benninga MA. Management of functional non-retentive fecal incontinence in children; Report from the Standardization Committee of the International Children's Continence Society. *J Ped Urol*, 2016; 12(1): 56-64
107. Tokgoz, H., et al., Assessment of urinary symptoms in children with dysfunctional elimination syndrome. *Int Urol Nephrol*, 2007. 39(2): 425-36.
108. Erickson, B.A., et al., Polyethylene glycol 3350 for constipation in children with dysfunctional elimination. *J Urol*, 2003. 170(4 Pt 2): 1518-20.
109. Desantis DJ, Leonard MP, Preston MA, Barrowman NJ, Guerra LA. Effectiveness of biofeedback for dysfunctional elimination syndrome in pediatrics: A systematic review. *J Pediatr Urol*. 2011; 7(3): 342-8
110. Cigna, R.M., et al., [Enuresis in children. Diagnostic assessment and treatment]. *Minerva Pediatr*, 1989. 41(7): 371-3.
111. Hellstrom, A.L., K. Hjalmas, and U. Jodal, Rehabilitation of the dysfunctional bladder in children: method and 3-year followup. *J Urol*, 1987. 138(4): 847-9.
112. Hinman, F., Urinary tract damage in children who wet. *Pediatrics*, 1974. 54(2): 143-50.
113. Halliday, S., S.R. Meadow, and I. Berg, Successful management of daytime enuresis using alarm procedures: a randomly controlled trial. *Arch Dis Child*, 1987. 62(2): 132-7.
114. Hagstroem, S., et al., Treatment outcome of day-time urinary incontinence in children. *Scand J Urol Nephrol*, 2008: 1-6.
115. Hagstroem, S., Rittig, S., Kamperis, K., & Djurhuus, J. C. Timer watch assisted urotherapy in children: a randomised controlled trial. *J Urology*, 184(4), 1482-88
116. Vasconcelos, M., et al., Voiding dysfunction in children. Pelvic-floor exercises or biofeedback therapy: a randomised study. *Pediatr Nephrol*, 2006. 21(12):1858-64.
117. Allen, H.A., et al., Initial trial of timed voiding is warranted for all children with daytime incontinence. *Urology*, 2007. 69(5): 962-5.
118. Hoebeke P, Renon C, De Schryver M, De Schrijver L, Leenaerts E, Schoenaers A, et al. Prospective evaluation of clinical voiding reeducation or voiding school for lower urinary tract conditions in children. *J Urol*. 2011;186: 648-54.
119. Vijverberg, M. A., Stortelder, E., de Kort, L. M., Kok, E. T., & de Jong, T. P. Long-term Follow-up of Incontinence and Urge Complaints After Intensive Urotherapy in Childhood (75 Patients Followed Up for 16.2-21.8 Years). *Urology*, 78: 1391-1396.

120. Chase J, Austin P, Hoebeke P, McKenna P. The management of dysfunctional voiding in children: a report from the standardisation committee of the International Children's Continence Society. *J Urol*. 2010; 183: 1296-1302.
121. Maizels, M., L.R. King, and C.F. Firlit, Urodynamic biofeedback: a new approach to treat vesical sphincter dyssynergia. *J Urol*, 1979. 122(2): 205-9.
122. Norgaard, J.P. and J.C. Djurhuus, Treatment of detrusor-sphincter dyssynergia by bio-feedback. *Urol Int*, 1982. 37(4): 236-9.
123. Vijverberg, M.A., et al., Bladder rehabilitation, the effect of a cognitive training programme on urge incontinence. *Eur Urol*, 1997. 31(1): 68-72.
124. Hoebeke, P., et al., Outpatient pelvic-floor therapy in girls with daytime incontinence and dysfunctional voiding. *Urology*, 1996. 48(6): 923-7.
125. McKenna, P.H., et al., Pelvic floor muscle re-training for pediatric voiding dysfunction using interactive computer games. *J Urol*, 1999. 162(3 Pt 2):1056-62.
126. Herndon, C.D., M. Decambre, and P.H. McKenna, Interactive computer games for treatment of pelvic floor dysfunction. *J Urol*, 2001. 166(5): 1893-8.
127. Senior, J., Clean intermittent self-catheterisation and children. *Br J Community Nurs*, 2001. 6(8): 381-6.
128. Fishwick, J. and A. Gormley, Intermittent catheterisation in school: a collaborative agreement. *Prof Nurse*, 2004. 19(9): 519-22.
129. Pohl, H.G., et al., The outcome of voiding dysfunction managed with clean intermittent catheterisation in neurologically and anatomically normal children. *BJU Int*, 2002. 89(9): 923-7.
130. Klingler, H.C., et al., Use of peripheral neuromodulation of the S3 region for treatment of detrusor overactivity: a urodynamic-based study. *Urology*, 2000. 56(5): 766-71.
131. Primus, G., G. Kramer, and K. Pummer, Restoration of micturition in patients with acontractile and hypocontractile detrusor by transurethral electrical bladder stimulation. *Neurourol Urodyn*, 1996. 15(5): 489-97.
132. Jonas, U., et al., Efficacy of sacral nerve stimulation for urinary retention: results 18 months after implantation. *J Urol*, 2001. 165(1): 15-9.
133. Barroso, U., Jr., Tourinho, R., Lordelo, P., Hoebeke, P., & Chase, J. (2011). Electrical stimulation for lower urinary tract dysfunction in children: A systematic review of the literature. *Neurourology and Urodynamics* (in press).
134. De Gennaro, M., Capitanucci, M., Mosiello, G., & Zaccara, A. (2011). Current State of Nerve Stimulation Technique for Lower Urinary Tract Dysfunction in Children *J Urology*, 185, 1571-1577.
135. Barroso, U., Jr., Hoebeke, P., Van Laeke, E., De Gennaro, M., Fox, J., & Chase, J. (2011). Electrical Stimulation for Lower Urinary Tract Dysfunction. *Dialogues in Pediatric Urology*, 2011:32(4)
136. Veiga ML, Queiroz AP, Carvalho MC, Braga AA, Sousa AS, Barroso U Jr. Parasacral transcutaneous electrical stimulation for overactive bladder in children: An assessment per session. *J Pediatr Urol*. 2016; 12:396.e1-396
137. Clarke MC, Chase JW, Gibb S et al: Decreased colonic transit time after transcutaneous interferential electrical stimulation in children with slow transit constipation. *J Pediatr Surg* 2009; 44: 408.
138. Roth, T.J., et al., Sacral neuromodulation for the dysfunctional elimination syndrome: a single center experience with 20 children. *J Urol*, 2008. 180(1): 306-11.
139. L.A. Groen, P. Hoebeke, N. Loret, et al. Sacral neuromodulation with an implantable pulse generator in children with lower urinary tract symptoms: 15-year experience *J Urol*, 188 (4) (2012), 1313–1317
140. Haddad M, Besson R, Aubert D, Ravasse P, Lemelle J, El Ghoneimi A, Moscovici J, Hameury F, Baumstarck-Barrau K, Hery G, Guys JM. Sacral neuromodulation in children with urinary and fecal incontinence: a multicenter, open label, randomised, crossover study. *J Urol*. 2010 Aug;184(2):696-701.
141. Sillén U, Arwidsson C, Doroszkiewicz M, Antonsson H, Jansson I, Stålkjint M, Abrahamsson K, Sjöström S. Effects of transcutaneous neuromodulation (TENS) on overactive bladder symptoms in children: a randomised controlled trial. *J Pediatr Urol*. 2014 Dec;10(6):1100-5.
142. Dwyer ME, Vandersteen DR, Hollatz P, et al. Sacral neuromodulation for the dysfunctional elimination syndrome: a 10-year single-center experience with 105 consecutive children *Urology*, 84 (4) (2014), pp. 911–917
143. Patidari N, Mittal V, Kumar M Transcutaneous posterior tibial nerve stimulation in pediatric overactive bladder, a preliminary report. *J Ped Urol* 2015, 11, 1-6
144. Barroso U Jr., W. Viterbo W, Bittencourt J, Farias T, Lordelo P. Posterior tibial nerve stimulation vs parasacral transcutaneous neuromodulation for overactive bladder in children *J Urol*, 190 (2) (2013 Aug), pp. 673–677

145. Yik YI, Leong LC, Hutson JM, Southwell BR. The impact of transcutaneous electrical stimulation therapy on appendicostomy operation rates for children with chronic constipation--a single-institution experience. *J Pediatr Surg.* 2012 Jul;47(7):1421-6.
146. A.A. Raheem, Y. Farahat, O. El-Gamal, M. Ragab, M. Radwan, A.H. El-Bahnasy, et al. Role of posterior tibial nerve stimulation in the treatment of refractory monosymptomatic nocturnal enuresis: a pilot study *J Urol*, 189 (4) (2013 Apr), 1514–1518J
147. P. Sulkowski, K.M. Nacion, K.J. Deans, P.C. Minneci, M.A. Levitt, H.M. Mousa, et al. Sacral nerve stimulation: a promising therapy for fecal and urinary incontinence and constipation in children *J Pediatr Surg*, 50 (10) (2015 Oct), 1644–1647
148. Boudaoud N, Binet A, Line A. Et al Management of refractory overactive bladder in children by transcutaneous posterior tibial nerve stimulation . a controlled study . *J Ped Urol* 2015,138:1-10
149. Mason MD, Stephany HA, Casella DP, Clayton DB, Tanaka ST, Thomas JC, Adams MC, Brock JW 3rd, Pope JC 4th. Prospective Evaluation of Sacral Neuromodulation in Children: Outcomes and Urodynamic Predictors of Success. *J Urol.* 2016 Apr;195(4 Pt 2):1239-44.
150. Van Laecke, E., et al., The daytime alarm: a useful device for the treatment of children with daytime incontinence. *J Urol*, 2006. 176(1): 325-7.
151. Equit, M., Sambach, H., Niemczyk, J., von Gontard, A. (2015). Urinary and fecal incontinence – a training program for children and adolescents. Boston/Göttingen: Hogrefe Publishing
152. Nijman, R.J., Role of antimuscarinics in the treatment of nonneurogenic daytime urinary incontinence in children. *Urology*, 2004. 63(3 Suppl 1): 45-50.
153. Diokno, A.C. and J. Lapidus, Oxybutynin: a new drug with analgesic and anticholinergic properties. *J Urol*, 1972. 108(2): 307-9.
154. Youdim, K. and B.A. Kogan, Preliminary study of the safety and efficacy of extended-release oxybutynin in children. *Urology*, 2002. 59(3): 428-32.
155. Kaplinsky, R., et al., Expanded followup of intravesical oxybutynin chloride use in children with neurogenic bladder. *J Urol*, 1996. 156(2 Pt 2): 753-6.
156. van Gool JD, de Jong TP, Winkler-Seinstra P, Tamminen-Möbius T, Lax H, Hirche H, Nijman RJ, Hjälmås K, Jodal U, Bachmann H, Hoebeke P, Walle JV, Misselwitz J, John U, Bael A; European Bladder Dysfunction Study (EU BMH1-CT94-1006). Multi-center randomised controlled trial of cognitive treatment, placebo, oxybutynin, bladder training, and pelvic floor training in children with functional urinary incontinence. *Neurourol Urodyn.* 2014 Jun;33(5):482-7
157. Curran, M.J., et al., The detrusor overactivity in childhood: long-term results with conservative management. *J Urol*, 2000. 163(2): 574-7.
158. Van Hoeck, K.J., et al., Do holding exercises or antimuscarinics increase maximum voided volume in monosymptomatic nocturnal enuresis? A randomised controlled trial in children. *J Urol*, 2007. 178(5): 2132-6.
159. Marschall-Kehrel, D., et al., Treatment with Propiverine in Children Suffering from Nonneurogenic Detrusor overactivity and Urinary Incontinence: Results of a Randomised Placebo-Controlled Phase 3 Clinical Trial. *Eur Urol*, 2008.
160. Marschall-Kehrel D, Feustel C, Persson de Geeter C, Stehr M, Radmayr C, Sillén U, Strugala G. Treatment with propiverine in children suffering from nonneurogenic overactive bladder and urinary incontinence: results of a randomised placebo-controlled phase 3 clinical trial. *Eur Urol.* 2009;55(3):729-36.
161. Kim WJ, Lee DG, Lee SW, Lee YK, Lee JS, Park KH, Baek MKorean. Efficacy and safety of propiverine in children with overactive bladder. *J Urol.* 2012 Apr;53(4):275-9
162. Todorova, A., B. Vonderheid-Guth, and W. Dimpfel, Effects of tolterodine, trospium chloride, and oxybutynin on the central nervous system. *J Clin Pharmacol*, 2001. 41(6): 636-44.
163. Hjalmas, K., et al., The detrusor overactivity in children: a potential future indication for tolterodine. *BJU Int*, 2001. 87(6): 569-74.
164. Bolduc, S., et al., The use of tolterodine in children after oxybutynin failure. *BJU Int*, 2003. 91(4): 398-401.
165. Munding, M., et al., Use of tolterodine in children with dysfunctional voiding: an initial report. *J Urol*, 2001. 165(3): 926-8.
166. Reinberg, Y., et al., Therapeutic efficacy of extended release oxybutynin chloride, and immediate release and long acting tolterodine tartrate in children with diurnal urinary incontinence. *J Urol*, 2003. 169(1): 317-9.

167. Nijman, R.J., et al., Long-term tolerability of tolterodine extended release in children 5-11 years of age: results from a 12-month, open-label study. *Eur Urol*, 2007. 52(5): 1511-6.
168. Hoebeke P, De Pooter J, De Caestecker K, Raes A, Dehoorne J, Van Laecke E, Vande Walle J. Solifenacin for therapy resistant overactive bladder. *J Urol*. 2009;182(4 Suppl):2040-4.
169. Bolduc S, Moore K, Nadeau G, Lebel S, Lamontagne P, Hamel M. Prospective open label study of solifenacin for overactive bladder in children. *J Urol*. 2010 Oct;184(4 Suppl):1668-73.
170. Nadeau G, Schröder A, Moore K, Genois L, Lamontagne P, Hamel M, Pellerin E, Bolduc S. Long-term use of solifenacin in pediatric patients with overactive bladder: Extension of a prospective open-label study. *Can Urol Assoc J*. 2014 Mar;8(3-4):118-23
171. Hellstrom, A.L., K. Hjalmas, and U. Jodal, Terodiline in the treatment of children with unstable bladders. *Br J Urol*, 1989. 63(4): 358-62.
172. Elmer, M., et al., Terodiline in the treatment of diurnal enuresis in children. *Scand J Prim Health Care*, 1988. 6(2): 119-24.
173. Lopez Pereira, P., et al., Trosipium chloride for the treatment of detrusor instability in children. *J Urol*, 2003. 170(5): 1978-81.
174. Kim TH, Lee SE, Lee HE, Lee KS. Safety and efficacy of fesoterodine fumarate in patients with overactive bladder: results of a post-marketing surveillance study in Korea. *Curr Med Res Opin*. 2016 Aug;32(8):1361-6
175. Ercan Ö, Köstü B, Bakacak M, Aytaç-Tohma Y, Çoşkun B, Avcı F, Efe E. Comparison of solifenacin and fesoterodine in treatment of overactive bladder. *Saudi Med J*. 2015 Oct;36(10):1181-5
176. Vella M, Cardozo L. Review of fesoterodine. *Expert Opin Drug Saf*. 2011 Sep;10(5):805-8.
177. Malhotra B, El-Tahtawy A, Wang EQ, Darekar A, Cossons N, Crook TJ, Scholfield D, Reddy P. Dose-escalating study of the pharmacokinetics and tolerability of fesoterodine in children with overactive bladder. *J Pediatr Urol*. 2012 Aug;8(4):336-42.
178. Nijman RJ . Role of antimuscarinics in the treatment of nonneurogenic daytime urinary incontinence in children. *Urology*. 2004 Mar;63(3 Suppl 1):45-50.
179. Bolduc S, Moore K, Lebel S, Lamontagne P, Hamel M. Double anticholinergic therapy for refractory overactive bladder. *J Urol*. 2009;182(4 Suppl):2033-8.
180. Nadeau G, Schröder A, Moore K, Genois L, Lamontagne P, Hamel M, Pellerin E, Bolduc S. Double anticholinergic therapy for refractory neurogenic and nonneurogenic detrusor overactivity in children: Long-term results of a prospective open-label study. *Can Urol Assoc J*. 2014 May;8(5-6):175-80.
181. Fahmy A, Youssif M, Rhashad H, Mokhless I, Mahfouz W. Combined low-dose antimuscarinics for refractory detrusor overactivity in children. *J Pediatr Urol*. 2016 May 24
182. Andersson KE, Martin N, Nitti V. Selective β 3-adrenoreceptor agonist for the treatment of overactive bladder. *J. Urol* 2013;190:1173
183. Rossanese M, Novara G, Challacombe B, Iannetti A, Dasgupta P, Ficarra V. Critical analysis of phase II and III randomised controlled trials (RCTs) evaluating efficacy and tolerability of a β 3-adrenoreceptor agonist (Mirabegron) for overactive bladder (OAB). *BJU Int* 2015 Jan;115:32-40
184. Blais AS, Nadeau G, Moore K, Genois L, Bolduc S. Prospective Pilot Study of Mirabegron in Pediatric Patients with Overactive Bladder. *Eur Urol*. 2016 Jul;70(1):9-13
185. Kuo, H.C., Botulinum A toxin urethral injection for the treatment of lower urinary tract dysfunction. *J Urol*, 2003. 170(5): 1908-12.
186. Apostolidis A, Dasgupta P, Denys P, Elneil S, Fowler CJ, Giannantoni A, Karsenty G, Schulte-Baukloh H, Schurch B, Wyndaele JJ; European consensus panel. Recommendations on the use of botulinum toxin in the treatment of lower urinary tract disorders and pelvic floor dysfunctions: a european consensus report. *Eur urol*. 2009;55(1):100-19.
187. Hoebeke, P., et al., The effect of botulinum-A toxin in incontinent children with therapy resistant overactive detrusor. *J Urol*, 2006. 176(1): 328-30
188. Lahdes-Vasama TT Anttila A, Wahl E, Taskinen S. Urodynamic assessment of children treated with botulinum toxin A injections for urge incontinence: a pilot study. *Scand J Urol Nephrol*. 2011 Dec;45(6):397-400.
189. Léon P, Jolly C, Binet A, Fiquet C, Vilette C, Lefebvre F, Bouché-Pillon-Persyn MA, Poli-Mérol ML. Botulinum toxin injections in the management of non-neurogenic overactive bladders in children. *J Pediatr Surg*. 2014 Sep;49(9):1424-8.
190. Blackburn SC, Jones C, Bedoya S, Steinbrecher HA, Malone PS, Griffin SJ. Intravesical botulinum type-A toxin (Dysport®) in the treatment of idiopathic detrusor overactivity in children. *J Pediatr Urol*. 2013 Dec;9(6 Pt A):750-3.

V. NEUROGENIC DETRUSOR-SPHINCTER DYSFUNCTION

191. McDowell DT, Noone D, Tareen F, Waldron M, Quinn F. Urinary incontinence in children: botulinum toxin is a safe and effective treatment option. *Pediatr Surg Int.* 2012 Mar;28(3):315-20.
 192. Kuo, H.C., Effect of botulinum a toxin in the treatment of voiding dysfunction due to detrusor underactivity. *Urology*, 2003. 61(3): 550-4.
 193. Radojicic, Z.I., S.V. Perovic, and N.M. Milic, Is it reasonable to treat refractory voiding dysfunction in children with botulinum-A toxin? *J Urol*, 2006. 176(1): 332-6
 194. Franco, I., et al., The use of botulinum toxin A injection for the management of external sphincter dyssynergia in neurologically normal children. *J Urol*, 2007. 178(4): 1775-9
 195. t Hoen LA, van den Hoek J, Wolffenbuttel KP, van der Toorn F, Scheepe JR. Breaking the vicious circle: Onabotulinum toxin A in children with therapy-refractory dysfunctional voiding. *J Pediatr Urol.* 2015 Jun;11(3):119.e1-6
 196. Vricella GJ, Campigotto M, Coplen DE, Traxel EJ, Austin PF. Long-term efficacy and durability of botulinum-A toxin for refractory dysfunctional voiding in children. *J Urol.* 2014 May;191(5 Suppl):1586-91.
 197. Kajbafzadeh AM, Ahadi H, Montaser-Kouhsari L, Sharifi-Rad L, Nejat F, Bazargan-Hejazi S. Intravesical electromotive botulinum toxin type A administration--part II: Clinical application. *Urology.* 2011;77(2):439-45.
 198. Austin, P.F., et al., alpha-Adrenergic blockade in children with neuropathic and nonneuropathic voiding dysfunction. *J Urol*, 1999. 162(3 Pt 2): 1064-7.
 199. Cain, M.P., et al., Alpha blocker therapy for children with dysfunctional voiding and urinary retention. *J Urol*, 2003. 170(4 Pt 2): p. 1514-5; discussion 1516-7.
 200. Yang, S.S., C.C. Wang, and Y.T. Chen, Effectiveness of alpha1-adrenergic blockers in boys with low urinary flow rate and urinary incontinence. *J Formos Med Assoc*, 2003. 102(8): 551-5.
 201. Donohoe, J.M., A.J. Combs, and K.I. Glassberg, Primary bladder neck dysfunction in children and adolescents--part II: results of treatment with alpha-adrenergic antagonists. *J Urol*, 2005. 173(1): 212-6.
 202. Marschall-Kehrel, A.D., et al., An empirical treatment algorithm for incontinent children. *J Urol*, 2004. 171(6 Pt 2): 2667-71.
1. Bauer SB. The management of the myelodysplastic child: a paradigm shift. *BJU Int.* 2003; 92: 23-8
 2. Retik AB, Perlmutter AD, Gross RE. Cutaneous uretero-ileostomy in children. *N Eng J Med* 1967; 277:217-22
 3. Lapidus J, Diokno AC, Silber SJ, Lowe BS. Clean intermittent self-catheterisation in the treatment of urinary tract disease. *J Urol* 1972;107:458-62
 4. Frimberger D, Cheng E, Kropp BP. The current management of the neurogenic bladder in children with spina bifida. *Pediatr Clin North Am.* 2012; 59(4):757-67
 5. Bauer SB: The management of spina bifida from birth onwards. In Whitaker RH, Woodard JR (eds): *Paediatric Urology*. London, Butterworths, 1985, pp 87–112
 6. Bauer SB: Early evaluation and management of children with spina bifida. In King LR [ed]: *Urologic Surgery in Neonates and Young Infants*. Philadelphia, WB Saunders, 1988, pp 252–264
 7. Wilcock AR, Emery JL: Deformities of the renal tract in children with myelomeningocele and hydrocephalus, compared with those children showing no such deformities. *Br J Urol* 42:152-9, 1970
 8. Hunt GM, Whitaker RH: The pattern of congenital renal anomalies associated with neural tube defects. *Dev Med and Child Neurol* 29:91-5, 1987
 9. Pierre-Kahn A, Zerah M, Renier D, Cinalli G, Sainte-Rose C, Lellouch-Tubiana A, Brunelle F, Le Merrer M, Giudicelli Y, Pichon J, Kleinknecht B, Nataf F. Congenital lumbosacral lipomas. *Childs Nerv Syst.* 1997 Jun;13(6):298-334; discussion 335. Review.
 10. Tanikaze S, Sugita Y. Cystometric examination for neurogenic bladder of neonates and infants. *Hinyokika Kyo* 1991;37:1403-5
 11. Zoller G, Schoner W, Ringert RH. Pre-and postoperative findings in children with tethered spinal cord syndrome. *Eur Urol* 1991;19:139-41.;
 12. Ghoniem GM, Roach MB, Lewis VH, Harmon EP. The value of leak pressure and bladder;144-1440-2
 13. Ghoneim GM, Shoukry MS, Hassouna ME. Detrusor properties in myelomeningocele patients: in vitro study. *J Urol* 1998;159:2193-6

14. Zermann DH, Lindner H, Huschke T, Schubert J. Diagnostic value of natural fill cystometry in neurogenic bladder in children. *Eur Urol* 1997;32:223-8
15. Webb RJ, Griffiths CJ, Ramsden PD, Neal DE. Measurement of voiding pressures on ambulatory monitoring: comparison with conventional cystometry. *Br J Urol* 1990;65:152-4
16. Palmer LS, Richards I, Kaplan WE. Age related bladder capacity and bladder capacity growth in children with myelomeningocele. *J. Urol.* 1997; 158:1261-4
17. Agarwal SK, McLorie GA, Grewal D, Joyner BD, Bagli DJ, Khoury AE. Urodynamic correlates or resolution of reflux in meningomyelocele patients. *J Urol* 1997; 158:580-2
18. McGuire EJ et al: Prognostic value of urodynamic testing in myelodysplastic patients. *J Urol* 1981;126:205-9
19. Sillén U, Hansson E, Hermansson G, Hjälmås, Jacobsson B, Jodal U: Development of the urodynamic pattern in infants with myelomeningocele. *Br J Urol* 1996;78: 596-601
20. Adzick NS, Thom EA, Spong CY, et al. A randomised trial of prenatal versus postnatal repair of myelomeningocele. *N Engl J Med* 2011;364:993-1004
21. Brock JW 3rd, Carr MC, Adzick NS, Burrows PK, Thomas JC, Thom EA, Howell LJ, Farrell JA, Dabrowiak ME, Farmer DL, Cheng EY, Kropp BP, Caldamone AA, Bulas DI, Tolvaisa S, Baskin LS; MOMS Investigators.. Bladder Function After Fetal Surgery for Myelomeningocele. *Pediatrics.* 2015; 136(4): 906-13
22. Tarcan T, Bauer S, Olmedo E, Koshbin S, Kelly M, Darbey M. Long-term follow-up of newborns with myelodysplasia and normal urodynamic findings: Is follow-up necessary? *J Urol* 2001; 165:564-7
23. Kasabian NG et al. The prophylactic value of clean intermittent catheterisation and anticholinergic medication in newborns and infants with myelodysplasia at risk of developing urinary tract deterioration. *Am J Dis Child,* 1992;146:480-7
24. Wang SC et al. Urethral dilatation in the management of urological complications of myelodysplasia. *J Urol* 1989; 142:1054-5
25. Lin-Dyken DC, Wolraich ML, Hawtrey CE, Doja MS. Follow-up of clean intermittent catheterisation for children with neurogenic bladders. *Urology* 1992;40:525-9
26. Kaufman AM, Ritchey ML, Roberts AC, Rudy DC, McGuire EJ. Decreased bladder compliance in patients with myelomeningocele treated with radiological observation. *J Urol* 1996;156:2031-3
27. Wu HY, Baskin LS, Kogan BA. Neurogenic bladder dysfunction due to myelomeningocele: neonatal versus childhood treatment. *J Urol* 1997;157:2295-7
28. Kaefer M, Pabby A, Kelly M, Darbey M, Bauer SB. Improved bladder function after prophylactic treatment of the high risk neurogenic bladder in newborns with myelomeningocele. *J Urol* 1999;162:1068-71
29. van Gool JD, Dik P, de Jong TP. Bladder-sphincter dysfunction in myelomeningocele. *Eur J Pediatr* 2001; 160:414-20
30. Bauer SB. The argument for early assessment and treatment of infants with spina bifida. *Dialogues in Pediatric Urology* 2000;23 Nr 11:2-3
31. Park JM. Early reduction of mechanical load of the bladder improves compliance: Experimental and clinical observations. *Dialogues in Pediatric Urology* 2000;23 Nr 11:6-7
32. Lindehall B, Moller A, Hjalmas K, Jodal U. Long-term intermittent catheterisation: the experience of teenagers and young adults with myelomeningocele. *J Urol* 1994;152:187-9
33. Joseph DB, Bauer SB, Colodny AH, et al: Clean intermittent catheterisation in infants with neurogenic bladder. *Pediatrics* 1989;84:78-83
34. Park JM. Early reduction of mechanical load of the bladder improves compliance: Experimental and clinical observations. *Dialogues in Pediatric Urology* 2000;23 Nr 11:6-7
35. Kasabian NG, Bauer SB, Dyro FM, et al: The prophylactic value of clean intermittent catheterisation and anticholinergic medication in newborns and infants with myelodysplasia at risk of developing urinary tract deterioration. *Am J Dis Child* 1992;146:840-4
36. Baskin LS, Kogan BA, Benard F. Treatment of infants with neurogenic bladder dysfunction using anticholinergic drugs and intermittent catheterisation. *Br J Urol* 1990;66:532-4
37. Hopps CV, Kropp KA. Preservation of renal function in children with myelomeningocele managed with basic newborn evaluation and close followup. *J Urol.* 2003 Jan;169(1):305-8.
38. Edelstein RA, Bauer SB, Kelly MD, Darbey MM, Peters CA, Atala A, Mandell J, Colodny AH, Retik AB. The long-term urological response of neonates with myelodysplasia treated proactively with intermittent catheterisation and anticholinergic therapy. *J Urol.* 1995 Oct;154(4):1500-4.

39. Geraniotis E, Koff SA, Enrile B. The prophylactic use of clean intermittent catheterisation in the treatment of infants and young children with myelomeningocele and neurogenic bladder dysfunction. *J Urol.* 1988 Jan;139(1):85-6.
40. Stensballe J, Looms D, Nielsen PN, et al. Hydrophilic-coated catheters for intermittent catheterisation reduce urethral micro trauma: A prospective, randomised, participant-blinded, crossover study of three different types of catheters. *Eur Urol* 2005;48:978–83
41. Moore KN, Fader M, Getliffe K. Long-term bladder management by intermittent catheterisation in adults and children. *Cochrane Database Syst Rev.* 2007;2:CD006008.
42. Lucas EJ, Baxter C, Singh C, Mohamed AZ, Li B, Zhang J, Jayanthi VR, Koff SA, VanderBrink B, Justice SS. Comparison of the microbiological milieu of patients randomised to either hydrophilic or conventional PVC catheters for clean intermittent catheterisation. *J Pediatr Urol.* 2016;12:172: 1-8
43. Abrams P, Andersson KE, Buccafusco JJ, et al. Muscarinic receptors: Their distribution and function in body systems, and the implications for treating overactive bladder. *Br J Pharmacol* 2006;148:565–78
44. Goessel C, Knispel HH, Fiedler U, Harle B, Steffen-Wilke K, Miller K. Urodynamic effects of oral oxybutynin chloride in children with myelomeningocele and detrusor hyperreflexia. *Urology* 1998;51:94-8
45. Haferkamp A, Staehler G, Gerner HJ, Dorsam J. Dosage escalation of intravesical oxybutynin in the treatment of neurogenic bladder patients. *Spinal Cord* 2000;38:250-4
46. Ferrara P, D'Aleo CM, Tarquini E, Salvatore S, Salvaggio E. Side effects of oral or intravesical oxybutynin chloride in children with spina bifida. *BJU Int* 2001; 87:674-8
47. Guerra LA, Moher D, Sampson M, Barrowman N, Pike J, Leonard M. Intravesical oxybutynin for children with poorly compliant neurogenic bladder: A systematic review. *J Urol* 2008;180:1091–7.
48. Connor JP, Betrus G, Fleming P, Perlmutter AD, Reitelman C. Early cystometrograms can predict the response to intravesical instillation of oxybutynin chloride in myelomeningocele patients. *J Urol* 1994;151:1045-7
49. Cartwright PC, Coplen DE, Kogan BA, et al. Efficacy and safety of transdermal and oral oxybutynin in children with neurogenic detrusor overactivity. *J Urol* 2009;182:1548–54.
50. Lopez Pereira P, Miguelez C, Caffarati J, Estornell F, Anguera A J. Trospium chloride for the treatment of detrusor instability in children. *Urol.* 2003;170:1978-81
51. Ellsworth PI, Borgstein NG, Nijman RJ, Reddy PP. Use of tolterodine in children with neurogenic detrusor overactivity: relationship between dose and urodynamic response. *J Urol.* 2005 Oct;174(4 Pt 2):1647-51
52. Mahanta K, Medhi B, Kaur B, Narasimhan KL. Comparative efficacy and safety of extended-release and instant-release tolterodine in children with neural tube defects having cystometric abnormalities. *J Pediatr Urol.* 2008 Apr;4(2):118-23.
53. Newgreen D, Bosman B, Hollestein-Havelaar A, Dahler E, Besuyen R, Sawyer W, Bolduc S, Rittig S. Solifenacin in Children and Adolescents with Overactive Bladder: Results of a Phase 3 Randomised Clinical Trial. *Eur Urol.* 2017 Mar;71(3):483-490.
54. Morin F, Blais AS, Nadeau G, Moore K, Genois L, Bolduc S. Dual Therapy for Refractory Overactive Bladder in Children: A Prospective Open-Label Study. *J Urol.* 2016: S0022-5347(16)31880-8
55. Austin PF, Homsy YL, Masel JL, Cain MP, Casale AJ, Rink RC. Alpha- adrenergic blockade in children with neuropathic and non-neuropathic voiding dysfunction. *J Urol* 1999;162:1064-7
56. Bogaert G, Beckers G, Lombaerts R. The use and rationale of selective alpha blockade in children with non-neurogenic neurogenic bladder dysfunction. *Int Braz J Urol.* 2004 Mar-Apr;30(2):128-34.
57. Kakizaki H, Ameda K, Kobayashi S, Tanaka H, Shibata T, Koyanagi T. Urodynamic effects of alpha1-blocker tamsulosin on voiding dysfunction in patients with neurogenic bladder. *Int J Urol.* 2003 Nov;10(11):576-81.
58. Kroll P, Gajewska E, Zachwieja J, Sobieska M, Mańkowski P. An Evaluation of the Efficacy of Selective Alpha-Blockers in the Treatment of Children with Neurogenic Bladder Dysfunction- Preliminary Findings. *Int J Environ Res Public Health.* 2016 Mar 15;13: 321
59. Smith CP, Somogyi GT, Chancellor MB. Emerging role of botulinum toxin in the treatment of neurogenic and non-neurogenic voiding dysfunction. *Curr Urol Rep.* 2002; 3: 382-7
60. Leippold T, Reitz A, Schurch B. Botulinum toxin as a new therapy option for voiding disorders: current state of The art. *Eur Urol.* 2003 ; 44: 165-74

61. Schulte-Baukloh H, Knispel HH, Michael T. Botulinum-A toxin in the treatment of neurogenic bladder in children. *Pediatrics*. 2002; 110: 420-1
62. Lusuardi L, Nader A, Koen M, Schrey A, Schindler M, Riccabona M Minimally invasive, safe treatment of the neurogenic bladder with botulinum- A-toxin in children with myelomeningocele. *Aktuelle Urol*. 2004;35:49-53
63. Neel KF, Soliman S, Salem M, Seida M, Al-Hazmi H, Khatab A. Botulinum-A toxin: solo treatment for neuropathic noncompliant bladder. *J Urol*. 2007 Dec;178(6):2593-7
64. Hascoet J, Manunta A, Brochard C, Arnaud A, Dampousse M, Menard H, Kerdraon J, Journel H, Bonan I, Odent S, Fremont B, Siproudhis L, Gamé X, Peyronnet B; French Referral Network of Spina Bifida.. Outcomes of intra- detrusor injections of botulinum toxin in patients with spina bifida: A systematic review. *Neurourol Urodyn*. 2016 May 17. doi: 10.1002/nau.23025
65. Apostolidis A, Dasgupta P, Denys P, Elneil S, Fowler CJ, Giannantoni A, Karsenty G, Schulte-Baukloh H, Schurch B, Wyndaele JJ. Recommendations on the Use of Botulinum Toxin in the Treatment of Lower Urinary Tract Disorders and Pelvic Floor Dysfunctions: A European Consensus Report. *Eur Urol*. 2008 Sep 17.
66. Hoebeke P, De Caestecker K, Vande Walle J, Dehoorne J, Raes A, Verleyen P, Van Laecke E. The effect of botulinum-A toxin in incontinent children with therapy resistant overactive detrusor. *J Urol*. 2006 Jul;176(1):328-30
67. Kajbafzadeh AM, Moosavi S, Tajik P, Arshadi H, Payabvash S, Salmasi AH, Akbari HR, Nejat F. Intravesical injection of botulinum toxin type A: management of neuropathic bladder and bowel dysfunction in children with myelomeningocele. *Urology*. 2006 Nov;68(5):1091-6;
68. Akbar M, Abel R, Seyler TM, Bedke J, Haferkamp A, Gerner HJ, Möhring K. Repeated botulinum-A toxin injections in the treatment of myelodysplastic children and patients with spinal cord injuries with neurogenic bladder dysfunction. *BJU Int*. 2007 Sep;100(3):639-45. Erratum in: *BJU Int*. 2007 Sep;100(3):719
69. Game X, Mouracade P, Chartier-Kastler E, et al. Botulinum toxin-A (Botox) intradetrusor injections in children with neurogenic detrusor overactivity/ neurogenic overactive bladder: A systematic literature review. *J Pediatr Urol* 2009;5:156–64.
70. Scheepe JR, Blok BF, 't Hoen LA. Applicability of botulinum toxin type A in paediatric neurogenic bladder management. *Curr Opin Urol*. 2017 Jan;27(1):14-19.
71. Fowler CJ. Systematic review of therapy for neurogenic detrusor overactivity. *Can Urol Assoc J*. 2011 Oct;5(5 Suppl 2):S146-8.
72. Mokhless I, Gaafar S, Fouda K, Shafik M, Assem A. Botulinum A toxin urethral sphincter injection in children with nonneurogenic neurogenic bladder. *J Urol*. 2006 Oct;176(4 Pt 2):1767-70
73. Mehta S, Hill D, Foley N, Hsieh J, Ethans K, Potter P, Baverstock R, Teasell. Greer T, Abbott J, Breytenbach W, McGuane D, Barker A, Khosa J, Samnakay N. Ten years of experience with intravesical and intrasphincteric onabotulinumtoxinA in children. *J Pediatr Urol*. 2016 Apr;12(2):94.e1-6.
74. RW, Wolfe D; Spinal Cord Injury Rehabilitation Evidence Research Team.. A meta-analysis of botulinum toxin sphincteric injections in the treatment of incomplete voiding after spinal cord injury. *Arch Phys Med Rehabil*. 2012 Apr;93(4):597-603.
75. Hagerty JA, Richards I, Kaplan WE. Intravesical electrotherapy for neurogenic bladder dysfunction: a 22-year experience. *J Urol*. 2007 Oct;178(4 Pt 2):1680-3
76. Boone TB, Roehrborn CG, Hurt G. Transurethral intravesical electrotherapy for neurogenic bladder dysfunction in children with myelodysplasia: A prospective, randomised clinical trial. *J Urol* 1992;148:550–4.
77. Gaziev G, Topazio L, Iacovelli V, Asimakopoulos A, Di Santo A, De Nunzio C, Finazzi-Agrò E. Percutaneous Tibial Nerve Stimulation (PTNS) efficacy in the treatment of lower urinary tract dysfunctions: a systematic review. *BMC Urol*. 2013 Nov 25;13:61. doi: 10.1186/1471-2490-13-61. Review.
78. Guys JM, Haddad M, Planche D, Torre M, Louis-Borrione C, Breaud J. Sacral neuromodulation for neurogenic bladder dysfunction in children. *J Urol*. 2004 Oct;172(4 Pt 2):1673-6.
79. Lay AH, Das AK. The role of neuromodulation in patients with neurogenic overactive bladder. *Curr Urol Rep*. 2012 Oct;13(5):343-7.
80. Younoszai MK: Stooling problems in patients with myelomeningocele. *South Med J* 1992;85:718.)
81. Squire R, Kiely EM, Carr B, et al: The clinical application of the Malone antegrade colon colonic enema. *J Pediatr Surg* 1993;28:1012–15

82. Whitehead WE, Wald A, Norton NJ. Treatment options for fecal incontinence. *Dis Colon Rectum* 2001; 44:131-42
83. Krogh K, Kvitzau B, Jorgensen TM, Laurberg S. Treatment of anal incontinence and constipation with transanal irrigation. *Ugeskr Laeger* 1999;161:253-6
84. Van Savege JG, Yohannes P. Laparoscopic antegrade continence enema in situ appendix procedure for refractory constipation and overflow fecal incontinence in children with spina bifida. *J Urol* 2000; 164:1084-7
85. Aksnes G, Diseth TH, Helseth A, Edwin B, Stange M, Aafos G, Emblem R. Appendicostomy for antegrade enemas: effects on somatic and psychosocial functioning in children with myelomeningocele. *Pediatrics* 2002; 109:484-9
86. Matsuno D, Yamazaki Y, Shiroyanagi Y, Ueda N, Suzuki M, Nishi M, Hagiwara A, Ichiroku T. The role of the retrograde colonic enema in children with spina bifida: is it inferior to the antegrade continence enema? *Pediatr Surg Int*. 2010 May;26(5):529-33.
87. Loening-Baucke V, Deach L, Wolraich M: Bio-feedback training for patients with myelomeningocele and fecal incontinence. *Dev Med Child Neurol* 1988;30:781-6
88. Marshall DF, Boston VE Altered bladder and bowel function following cutaneous electrical field stimulation in children with spina bifida: Interim results of a randomised double-blind placebo-controlled trial. *Eur J Pediatr Surg* 1997;7:41-43
89. Hansson S, Caugant D, Jodal U, Svanborg-Eden C. Untreated asymptomatic bacteriuria in girls: I. Stability of urinary isolates. *BMJ* 1989;298:853-5
90. Hansson S, Jodal U, Lincoln K, Svanborg-Eden C. Untreated asymptomatic bacteriuria in girls: II. Effect of phenoxymethylpenicillin and erythromycin given for intercurrent infections. *BMJ* 1989;298:856-9
91. Hansson S, Jodal U, Noren L, Bjure J. Untreated bacteriuria in asymptomatic girls with renal scarring. *Pediatrics* 1989; 84:964-8
92. Johnson HW, Anderson JD, Chambers GK, Arnold WJ, Irwin WJ, Brinton JR. A short-term study of nitrofurantoin prophylaxis in children managed with clean intermittent catheterisation. *Pediatrics* 1994;93:752-5
93. Schlager TA, Anderson S, Trudell J, hendley JO. Nitrofurantoin prophylaxis for bacteriuria and urinary tract infection in children with neurogenic bladder on intermittent catheterisation. *J Pediatr* 1998;132:704-8
94. Austin PF, Westney OL, Leng WW, McGuire EJ, Ritchey ML: Advantages of rectus fascial slings for urinary incontinence in children with neuropathic bladder. *J Urol* 2001;165: 2369-71
95. Guys JM, Fakhro A, Louis-Borrione C, Prost J, Hautier A: Endoscopic treatment of urinary incontinence: long-term evaluation of the results. *J Urol* 2001;165: 2389-91
96. Kassouf W, Capolicchio G, Bernardinucci G, Corcos J: Collagen injection for treatment of urinary incontinence in children. *J Urol* 2001;165: 1666-8
97. Kryger JV, Leverson G, Gonzalez R: Long-term results of artificial urinary sphincters in children are independent of age at implantation. *J Urol* 2001;165: 2377-79.

VI. SURGICAL MANAGEMENT OF URINARY INCONTINENCE IN CHILDREN

1. Ben-Chaim J, Docimo SG, Jeffs RD, Gearhart JP. Bladder exstrophy from childhood into adult life. *JR Soc Med* 1996;89:39-46
2. Hollowell JG, Hill PD, Duffy PG, Ransley PG. Evaluation and treatment of incontinence after bladder neck reconstruction in exstrophy and epispadias. *Br J Urol* 1993;71:743-9
3. Mollard P, Mouriquand PE, Buttin X. Urinary continence after reconstruction of classical bladder exstroph6 (73 cases). *Br J Urol* 1994;73:298-302
4. Hollowell JG, Ransley PG. Surgical management of incontinence in bladder exstrophy. *Br J Urol* 1991;68:543-8
5. Canning DA. Bladder exstrophy: the case for primary bladder reconstruction. *Urology* 1996; 48:831-4
6. Stein R, Stockle M, Fisch M, Nakai H, Muller SC, Hohenfellner R. The fate of the adult exstrophy patient. *J Urol* 1994;52:1413-16
7. Hohenfellner R, Stein R. Primary urinary diversion in patients with bladder exstrophy. *Urology* 1996;48:828-30
8. Baird AD, Nelson CP, Gearhart JP. Modern staged repair of bladder exstrophy: A contemporary series. *J Pediatr Urol*. 2007 Aug;3(4):311-315.
9. Purves JT, Baird AD, Gearhart JP. The modern staged repair of bladder exstrophy in the female: a contemporary series. *J Pediatr Urol*. 2008 Apr;4(2):150-3.

10. Gearhart JP, Baird A, Nelson CP. Results of bladder neck reconstruction after newborn complete primary repair of exstrophy. *J Urol*. 2007 Oct;178(4 Pt 2):1619-22;
11. Shapiro E, Jeffs RD, Gearhart JP, Lepor H. Muscarinic cholinergic receptors in bladder exstrophy: insights into surgical management. *J Urol* 1985;134:308-10
12. Lee BR, Perlman EJ, Partin AW, Jeffs RD, Gearhart JP. Evaluation of smooth muscle and collagen subtypes in normal newborns and those with bladder exstrophy. *J Urol* 1996;156:2034-36
13. Cervellione RM, Bianchi A, Fishwick J, Gaskell SL, Dickson AP. Salvage procedures to achieve continence after failed bladder exstrophy repair. *J Urol*. 2008 Jan;179(1):304-6
14. DeCambre M, Casale P, Grady R, Swartz M, Mitchell M. Modified bladder neck reconstruction in patients with incontinence after staged exstrophy/epispadias closures. *J Urol*. 2006 Jul;176(1):288-91.
15. Sheldon CA, Gilbert A, Lewis AG, Aiken J, Ziegler MM. Surgical implications of genitourinary tract anomalies in patients with imperforate anus. *J Urol* 1994;152:196-9
16. Boemers TML, Bax KMA, Rovekamp, MH, Van Gool JD. The effect of posterior sagittal anorectoplasty and its variants on lower urinary tract function in children with anorectal malformations. *J Urol* 1995;153:1919
17. Boemers TML, Van Gool JD, de Jong TPVM, Bax KMA. Urodynamic evaluation of children with caudal regression syndrome (caudal dysplasia sequence). *J Urol* 1994;151:1038-42
18. Sheldon C, Cormier M, Crone K, Wacksman J. Occult neurovesical dysfunction in children with imperforate anus and its variants. *J. Pediatr Surg* 1991; 22:26:49-54
19. Kim YH, Horowitz M, Combs AJ, Nitti vw, Borer J, Glassberg KI. Management of posterior urethral valves on the basis of urodynamic findings. *J Urol* 1997;158:1011-16
20. Podesta ML, Ruarte A, Gargiulo C, Medel R, Castera R. Urodynamic findings in boys with posterior urethral valves after treatment with primary valve ablation or vesicostomy and delayed ablation. *J Urol* 2000;164:139-44
21. Podesta ML, Ruarte A, Gargiulo C, Medel R, Castera R, Herrera. Bladder function associated with posterior urethral valves after primary valve ablation or proximal urinary diversion in children and adolescents. *J Urol* 2002;1830-5
22. Ghanem MA, Wolffenbuttel KP, De Vylder A, Nijman RJM. Long-term bladder dysfunction and renal function in boys with posterior urethral valves based on urodynamic findings. *J Urol* 2004; 2409-12
23. Gearhar JP, Peppas DS, Jeffs RD. Complete genitourinary reconstruction in female epispadias. *J Urol* 1993;149:1110-13
24. Ben-chaim J, Peppas DS, Jeffs RD, Gearhart JP. Complete male epispadias: genital reconstruction and achieving continence. *J Urol* 1995;153:1665-7
25. Ahmed S, Morris LL, Byard RW. Ectopic ureter with complete ureteric duplication in the female child. *J Ped Surg* 1992;27:1455-60
26. Johnin K, Narita M, Kim CJ, Wakabayashi Y, Yoshiki T, Okada Y. Bilateral single ectopic ureters with hypoplastic bladder: How should we treat these challenging entities? *J Pediatr Urol*. 2007 Jun;3(3):243-6.
27. Heuser M, Zöller G, Seseke F, Zappel H, Ringert RH. Bladder dysfunction in children with bilateral single ectopic ureters. *J Pediatr Surg*. 2002 May;37(5):E15.
28. Podestà E, Scarsi PL, Di Rovasenda E, Ferretti S, Magillo P, Doderò P. Vesical continence in bilateral ectopic single ureters. *J Urol*. 2001 Jun;165(6 Pt 2):2363-5.
29. Psihramis KE, Colodny AH, Lebowitz RL, Retik AB, Bauer S. Complete duplication of the urethra. *J Urol* 1986;139:63-7
30. Wu HY, Baskin LS, Kogan BA. Neurogenic bladder dysfunction due to myelomeningocele: neonatal versus childhood treatment. *J Urol* 1997;157:2295-7
31. Kaefer M, Pabby A, Kelly M, Darbey M, Bauer SB. Improved bladder function after prophylactic treatment of the high risk neurogenic bladder in newborns with myelomeningocele. *J Urol* 1999;162:1068-71
32. Lendvay TS, Cowan CA, Mitchell MM, Joyner BD, Grady RW. Augmentation cystoplasty rates at children's hospitals in the United States: a pediatric health information system database study. *J Urol*. 2006 Oct;176(4 Pt 2):1716-20.
33. Pahernik S, Beetz R, Schede J, Stein R, Thürhoff JW. Rectosigmoid pouch (Mainz Pouch II) in children. *J Urol*. 2006 Jan;175(1):284-7.
34. Rösch WH, Ebert AK. [Development of treatment for extrophy-epispadias in Germany] *Urologe A*. 2007 Dec;46(12):1691-6.
35. D'elia, Pahernik S, Fisch M, Hohenfellner R, Thuroff JW. Mainz Pouch II technique: 10 years' experience. *BJU Int* 2004;93:1037-42

36. Smeulders N, Sudhakaran N, Wilcox DT, Ransley PG. Adenocarcinoma at the ureterosigmoidostomy site in a 16-year-old demonstrates the importance of screening in children. *J Pediatr Urol*. 2008 Jun;4(3):234-5.
37. Georgacopulo P, Tataranni G, Franchella A, Gilli P. Ureterosigmoidostomy and cancer of the colon. Report of a case. *Z Kinderchir Grenzgeb*. 1980 Jul;30(3):280-3.
38. Giannini O, Friedli A, Schärli AF. Sigmoid adenocarcinoma complicating ureterosigmoidostomy. *Pediatr Surg Int*. 1998 Nov;14(1-2):124-6.
39. Kliment J, Lupták J, Lofaj M, Horáková M, Beseda A. Carcinoma of the colon after ureterosigmoidostomy and trigonosigmoidostomy for exstrophy of the bladder. *Int Urol Nephrol*. 1993;25(4):339-43.
40. Leong CH, Ong GB. Gastrocystoplasty in dogs. *Aust NZ J. Surg* 1972;41:272-9
41. Nguyen DH, Mitchell ME. Gastric bladder reconstruction. *Urol Clin North Am* 1991;18:649-57
42. Zugor V, Schreiber M, Klein P, Schott GE. [Urinary bladder augmentation using the stomach in patients with compensate renal insufficiency] *Urologe A*. 2007 Jun;46(6):667-70.
43. Soylet Y, Emir H, Ilce Z, Yesildag E, Buyukunal SN, Danismend N. Quo vadis? Ureteric reimplantation or ignoring reflux during augmentation cystoplasty. *BJU Int*. 2004;94:379-80
44. Lopez Pereira P, Martinez Urrutia MJ, Lobato Romera R, Jaureguizar E. Should we treat vesicoureteral reflux in patients who simultaneously undergo bladder augmentation for neurogenic bladder? *J Urol* 2001;165:2259-61
45. Kock NG, Nilson AE, Nilsson LO, Norlen LJ, Philipson BM. Urinary diversion via a continent ileal reservoir: clinical results in 12 patients. *J Urol* 1982;128:469-75
46. Rowland RG, Mitchell ME, Bihrl R. The cecoileal continent urinary reservoir. *World J Urol* 1985;3:185-190
47. Thuroff JW, Alken P, Engelmann U, Riedmiller H, Jacobi GH, Hohenfellner R. The MAINZ pouch (mixed augmentation ileum and zoeum) for bladder augmentation and continent urinary diversion. *Eur Urol* 1985;11:152-60
48. McDougal WS. Complications of urinary intestinal diversion. *AUA Update series*, 1992; vol XI:37
49. Rowland RG. Complications of continent cutaneous reservoirs and neobladders – series using contemporary techniques. *AUA Update series*, 1995; Vol XIV:25
50. Medel R, Ruarte AC, Herrera M, Castera R, Podesta ML. Urinary continence outcome after augmentation ileocystoplasty as a single surgical procedure in patients with myelodysplasia. *J Urol* 2002 ;168:1849-52
51. Shekarriz B, Upadhyay J, Demirbilek S, Barthold JS, Gonzalez R. Surgical complications of bladder augmentation: comparison between various enterocystoplasties in 133 patients. *Urology* 2000;55:123-8
52. Chadwick Plaire J, Snodgrass WT, Grady RW, Mitchell ME. Long-term follow-up of the hematuria-dysuria syndrome. *J Urol* 2000;164:921-3
53. Leonard MP, Dharamsi N, Williot PE Outcome of gastrocystoplasty in tertiary pediatric urology practice. *J Urol* 2000;164:947-50
54. Duel BP, Gonzales R, Barthold JS. Alternative techniques for augmentation cystoplasty. *J Urol* 1998;159:998-1005
55. Kennely MJ, Gormley MA, McGuire EJ. Early clinical experience with adult auto-augmentation. *J Urol* 1994;152:303-6
56. Stoher M, Kramer A, Goepel M, Lochner, Ernst D, Kruse D, Rubben H. Bladder auto-augmentation – an alternative for enterocystoplasty: preliminary results. *Neurourol Urodyn* 1995;14:11-23
57. Dik P, Tsachouridis GD, Klijn AJ, Uiterwaal CS, de Jong TP. Detrusorectomy for neuropathic bladder in patients with spinal dysraphism. *J Urol* 2003;170:1351-4
58. Usui A, Inoue K, Nakamoto T, Kadena H, Usui T. Usefulness of bladder auto-augmentation in neurogenic bladder. *Nippon Nihyokika Gakkai Zasshi* 1006;87:802-5
59. MacNeily AE, Afshar K, Coleman GU, Johnson HW. Auto-augmentation by detrusor myotomy: its lack of effectiveness in the management of congenital neuropathic bladder. *J Urol* 2003;170:1643-46
60. Marte A, Di Meglio D, Cotrufo AM, Di Iorio G, De Pasquale M. A longterm followup of auto-augmentation in myelodysplastic children. *J Urol* 2003;169:1602-3
61. Lindley RM, Mackinnon AE, Shipstone D, Tophill PR. Long-term outcome in bladder detrusorectomy augmentation. *Eur J Pediatr Surg* 2003;7:12
62. Ehrlich RM, Gershman A. Laparoscopic seromyotomy (auto-augmentation) for non-neurogenic bladder in a child: initial case report.
63. Chung SY, Meldrum K, Docimo SG. Laparoscopic assisted reconstructive surgery: a 7-year experience. *J Urol* 2004;171:372-5

64. McDougall EM, Clayman RV, Figenshau RS, Pearl MS. Laparoscopic retropubic augmentation of the bladder. *J Urol* 1995;153:123-6
65. Poppas DP, Uzzo RG, Britanisky RG, Mininberg DT. Laparoscopic laser assisted auto-augmentation of the pediatric neurogenic bladder: early experience with urodynamic follow-up. *J Urol* 1996;155:1057-60
66. Gonzales R. Laparoscopic laser assisted auto-augmentation of the pediatric neurogenic bladder: early experience with urodynamic follow-up. *J Urol* 1996; 156:1783-6
67. Koontz WW, Jr. Prout GR, Jr. Mackler MA. Bladder regeneration following serosal colocolocystoplasty. *Invest Urol* 1970;8:170-6
68. DeBadiola F, Manivel JC, Gonzalez R. Seromuscular enterocolocystoplasty in rats. *J Urol* 1991;146:559-62
69. Salle JL, Fraga JC, Luvib A, Lampertz M, Jobim G, Putten A. Seromuscular enterocolocystoplasty in dogs. *J Urol* 1990;144:454-6
70. Dewan PA, Lorenz C, Stefanek W, Byard RW. Urothelial lined colocolocystoplasty in a sheep model. *Eur Urol* 1004;26:240-6
71. Buson H, Manivel JC, Dayanc M, Long R, Gonzales R. Seromuscular colocolocystoplasty lined with urothelium: experimental study. *Urology* 1994;44:743-8
72. Garibay JT, Manivel JS, Gonzales R. Effect of seromuscular colocolocystoplasty lined with urothelium and partial detrusorectomy on a new canine model of reduced bladder capacity. *J Urol* 1996;154:903-6
73. Denes ED, Vates TS, Freedman AL, Gonzales R. Seromuscular colocolocystoplasty lined with urothelium protects dogs from acidosis during ammonium chloride loading. *J Urol* 1997;158:1075-80
74. Frey P, Lutz N, Leuba AL. Augmentation cystoplasty using pedicled and de-epithelialized gastric patches in the mini-pig model. *J Urol* 1996;156:608-13
75. Gonzales R, Buson H, Reid C, Reinberg Y. Seromuscular colocolocystoplasty lined with urothelium: experience with 16 patients. *Urology* 1995;45:124-9
76. Lima SV, Araujo LA, Vilar FO, Kummer CL, Lima EC. Nonsecretory sigmoid cystoplasty: experimental and clinical results. *J Urol* 153:1651-1654, 1995.
77. Lima SV, Araujo LA, Vilar FO. Nonsecretory intestincystoplasty : a 10 year experience. *J Urol* 2004;165:2636-40
78. Gonzalez R, Jednak R, Franc-Guimond J, Schimke CM. Treating neuropathic incontinence in children with seromuscular colocolocystoplasty and an artificial urinary sphincter. *BJU Int* 2002;90:909-11
79. Oge O, Tekgul S, Ergen A, Kendi S. Urothelium-preserving augmentation cystoplasty covered with peritoneal flap. *BJU Int* 2000;85:802-5
80. Arikan N, Turkolmez K, Budak M, Gogus O. Outcome of augmentation sigmoidocolocystoplasty in children neurogenic bladder. *Urol Int* 2000;64:82-5
81. Jednak R, Schimke CM, Barroso U JR, Barthold JS, Gonzalez R. Further experience with seromuscular colocolocystoplasty lined with urothelium. *J Urol* 2000;164:2045-9
82. De Badiola F, Ruiz E, Puigdevall J, Lobos P, Moldes J, Lopez Raffo M, Gallo A. Sigmoid cystoplasty with argon beam without mucosa. *J Urol* 2001;165:2253-5
83. Churchill BM, Aliabadi H, Landau EH, McLorie GA, Steckler RE, McKenna, PH, Khoury AE. Ureteral bladder augmentation. *J Urol* 1993;150:716-20
84. Dewan PA, Nicholls EA, Goh DW. Ureterocolocystoplasty: an extraperitoneal, urothelial bladder autmentation technique. *Eur Urol* 1994;26:85-9
85. Gosalbez R, Jr, Kim CO, Jr. Ureterocolocystoplasty with preservation of ipsilateral renal function. *J Ped surg* 1996;31:970-5
86. Ben-Chaim, J, Partin AW, Jeffs RD. Ureteral bladder augmentation using the lower pole ureter of a duplicated system. *Urology* 1996;47:135-7
87. Denes FT, Nahas WC, Borrelli M, Rocha FT, Mitre AI, Gianini PTR, Apexatto M, Arap S. Ureterocolocystoplasty *J Bras Urol* 1997;23 (supl Espec):170-90
88. Husmann DA, Snodgrass WT, Koyle MA, Furness PD 3rd, Kropp BP, Cheng EY, Kaplan WE, Kramer SA. Ureterocolocystoplasty: indications for a successful augmentation. *J Urol*. 2004;171:376-80
89. Ahmed S, De Castro R, Farhoud RA, El Traifi A. Augmentation ureterocolocystoplasty in bladder exstrophy: 5-year follow-up in two cases. *Eur Urol* 2002 ;42:631-4
90. Perovic SV, Vukadinovic VM, Djordjevic ML. Augmentation ureterocolocystoplasty could be performed more frequently. *J Urol* 2000;164:924-7
91. Tekgul S, Oge O, Bal K, Erkan I, Bakkaloglu M. Ureterocolocystoplasty: an alternative reconstructive procedure to enterocolocystoplasty in suitable cases. *J Pediatr Surg* 2000;35:577-9

92. Carneiro PM, Binyamini J, Sofer M, Ben-Chaim J. Augmentation ureterocystoplasty: is it the preferred choice? *East Afr Med J*. 2005 May;82(5):247-9.
93. Youssif M, Badawy H, Saad A, Hanno A, Mokhlless I. Augmentation ureterocystoplasty in boys with valve bladder syndrome. *J Pediatr Urol*. 2007 Dec;3(6):433-7.
94. Johal NS, Hamid R, Aslam Z, Carr B, Cuckow PM, Duffy PG. Ureterocystoplasty: long-term functional results. *J Urol*. 2008 Jun;179(6):2373-5; discussion 2376.
95. Nahas WC, Lucon M, Mazzucchi E, Antonopoulos IM, Piovesan AC, Neto ED, Ianhez LE, Arap S. Clinical and urodynamic evaluation after ureterocystoplasty and kidney transplantation. *J Urol* 2004;171:1428-31
96. Talic RF. Augmentation ureterocystoplasty with ipsilateral renal preservation in the management of patients with compromised renal secondary to dysfunctional voiding. *Int Urol Nephrol* 1999;31:463-70
97. Taghizadeh A, Mahdavi R, Mirsadraee S, Ghorbani HR, Patel HR. Ureterocystoplasty is safe and effective in patients awaiting renal transplantation. *Urology*. 2007 Nov;70(5):861-3.
98. Atala A, Vacanti JP, Peters CA, Mandell J, Retik AB, Freeman MR. Formation of urothelial structures in vivo from dissociated cells attached to biodegradable polymer scaffolds in vitro. *J Urol* 1992;148:658-62
99. Hutton KA, Trejdosiewicz LK, Thomas DF, Southgate J. Urothelial tissue culture for bladder reconstruction: an experimental study. *J Urol* 1993;150:721-5
100. Atala A, Freeman MR, Vacanti JP, Shepard J, Retik AB. Implantation in vivo and retrieval of artificial structures consisting of rabbit and human urothelium and human bladder muscle. *J Urol* 1993;150:608-12
101. Hakim S, Merguerian PA, Chavez D. Use of biodegradable mesh as a transport for a cultured uroepithelial graft: an improved method using collagen gel. *Urology* 1994;44:139-42
102. Scriven SD, Booth C, Thomas DF, Trejdosiewicz LK, Southgate J. Reconstruction of human urothelium from monolayers culture. *J Urol* 1997;158:1147-52
103. Magnan M, Berthod F, Champigny MF, Soucy F, Bolduc S. In vitro reconstruction of a tissue-engineered endothelialized bladder from a single porcine biopsy. *J Pediatr Urol*. 2006 Aug;2(4):261-70.
104. Moriya K, Kakizaki H, Murakumo M, Watanabe S, Chen Q, Nonomura K, Koyanagi T. Creation of luminal tissue covered with urothelium by implantation of cultured urothelial cells into the peritoneal cavity. *J Urol*. 2003 Dec;170(6 Pt 1):2480-5.
105. Zhang Y, Lin HK, Frimberger D, Epstein RB, Kropp BP. Growth of bone marrow stromal cells on small intestinal submucosa: an alternative cell source for tissue engineered bladder. *BJU Int*. 2005 Nov;96(7):1120-5.
106. Nakanishi Y, Chen G, Komuro H, Ushida T, Kaneko S, Tateishi T, Kaneko M. Tissue-engineered urinary bladder wall using PLGA mesh-collagen hybrid scaffolds: a comparison study of collagen sponge and gel as a scaffold. *J Pediatr Surg*. 2003 Dec;38(12):1781-4.
107. Hafez AT, Afshar K, Bägli DJ, Bahoric A, Aitken K, Smith CR, Khoury AE. Aerosol transfer of bladder urothelial and smooth muscle cells onto demucosalized colonic segments for porcine bladder augmentation in vivo: a 6-week experimental study. *J Urol*. 2005 Oct;174(4 Pt 2):1663-7; discussion 1667-8.
108. Zhang Y, Kropp BP, Moore P, Cowan R, Furness PD 3rd, Kolligian ME, Frey P, Cheng EY. Coculture of bladder urothelial and smooth muscle cells on small intestinal submucosa: potential applications for tissue engineering technology. *J Urol*. 2000 Sep;164(3 Pt 2):928-34; discussion 934-5.
109. Drewa T, Sir J, Czajkowski R, Wozniak A. Scaffold seeded with cells is essential in urothelium regeneration and tissue remodeling in vivo after bladder augmentation using in vitro engineered graft. *Transplant Proc*. 2006 Jan-Feb;38(1):133-5.
110. Atala A, Bauer SB, Soker S, Yoo JJ, Retik AB. Tissue-engineered autologous bladders for patients needing cystoplasty. *Lancet*. 2006 Apr 15;367(9518):1241-6.
111. Vorstman B, Lockhart J, Kaufman MR, Politano V. Polytetrafluoroethylene injection for urinary incontinence in children. *J Urol* 1985;133:248-50
112. Malizia AA, Jr, Reiman HM, Myers RP, Sande JR, Bahrman SS, Benson RC, Jr, Dewanjee MK, Utz WJ. Migration and granulomatous reaction after periurethral injection of polytef (Teflon). *JAMA* 1984;251:3277-81
113. Bomalski MD, Bloom DA, McGuire EJ, Panzi A. Glutaraldehyde cross-linked collagen in the treatment of urinary incontinence in children. *J Urol* 1996;155:699-702

114. Chernoff A, Horowitz M, Combs A, Libretti D, Nitti V, Glassberg KL. Periurethral collagen injection for the treatment of urinary incontinence in children. *J Urol* 1997;157:2303-5
115. Capozza N, Caione P, DeGennaro M, Nappo S, Patricola M. Endoscopic treatment of vesicoureteral reflux and urinary incontinence. Technical problems in the pediatric patient. *Br J Urol* 1995;75:538-42
116. Sundaram CP, Reinberg Y, Aliabadi HA. Failure to obtain durable results with collagen implantation in children with urinary incontinence. *J Urol* 1997;157:2306-7
117. Block CA, Cooper CS, Hawtrey CE. Long-term efficacy of periurethral collagen injection for the treatment of urinary incontinence secondary to myelomeningocele. *J Urol* 2003;169:327-9
118. Caione P, Capozza N. Endoscopic treatment of urinary incontinence in pediatric patients: a 2-year experience with dextranomer / hyaluronic acid copolymer. *J Urol* 2002;168:1868-71
119. Lottmann HB, Margaryan M, Bernuy M, Rouffet MJ, Bau MO, El-Ghoneimi A, Aigrain Y, Stenberg A, Lackgren G. The effect of endoscopic injections of dextranomer based implants on continence and bladder capacity: a prospective study of 31 patients. *J Urol* 2002;168:1863-7
120. Lottmann HB, Margaryan M, Lortat-Jacob S, Bernuy M, Läckgren G. Long-term effects of dextranomer endoscopic injections for the treatment of urinary incontinence: an update of a prospective study of 61 patients. *J Urol*. 2006 Oct;176(4 Pt 2):1762-6.
121. Guys JM, Simeoni-Alias J, Fakhro A, Delarue A. Use of polydimethylsiloxane for endoscopic treatment of urinary incontinence in children. *J Urol* 1999;162:2133-5
122. Guys JM, Fakhro A, Louis-Borrione C, Prost J, Hautier A. Endoscopic treatment of urinary incontinence: long-term evaluation of the results. *J Urol* 2001;165: 2389-91
123. Halachmi S, Farhat W, Metcalfe P, Bagli DJ, McLorie GA, Khoury AE. Efficacy of polydimethylsiloxane injection to the bladder neck and leaking diverting stoma for urinary continence. *J Urol* 2004;171:1287-90
124. Guys JM, Breaud J, Hery G, Camerlo A, Le Hors H, De Lagausie P. Endoscopic injection with polydimethylsiloxane for the treatment of pediatric urinary incontinence in the neurogenic bladder: long-term results. *J Urol*. 2006 Mar;175(3 Pt 1):1106-10.
125. Dyer L, Franco I, Firlit CF, Reda EF, Levitt SB, Palmer LS. Endoscopic injection of bulking agents in children with incontinence: dextranomer/hyaluronic acid copolymer versus polytetrafluoroethylene. *J Urol*. 2007 Oct;178(4 Pt 2):1628-31.
126. Kitchens DM, Minevich E, DeFoor WR, Reddy PP, Wacksman J, Koyle MA, Sheldon CA. Incontinence following bladder neck reconstruction--is there a role for endoscopic management? *J Urol*. 2007 Jan;177(1):302-5; discussion 305-6.
127. Dean GE, Kirsch AJ, Packer MG, Scherz HC, Zaontz MR. Antegrade and retrograde endoscopic dextranomer/hyaluronic Acid bladder neck bulking for pediatric incontinence. *J Urol*. 2007 Aug;178(2):652-5.
128. Misseri R, Casale AJ, Cain MP, Rink RC. Alternative uses of dextranomer/hyaluronic acid copolymer: the efficacy of bladder neck injection for urinary incontinence. *J Urol*. 2005 Oct;174(4 Pt 2):1691-3; discussion 1693-4.
129. Lund L, Yeung CK. Periurethral injection therapy for urinary incontinence using a laparoscopic port. *J Endourol* 2003;17:253-4
130. Scott FB, Bradley W W, Timm GW. Treatment of urinary incontinence by implantable prosthetic sphincter. *Urology* 1973;1:252-9
131. Diokno AC, Sonda P. Compatibility of genitourinary prosthesis and intermittent self catheterisation. *J Urol* 1981;125:659-60
132. Gonzalez R, Nguyen DH, Koilelat N, Sidi AA. Compatibility of enterocystoplasty and the artificial urinary sphincter. *J Urol* 1989;142:502-4
133. Strawbridge LR, Kramer SA, Castillo OA, Barrett DM. Augmentation cystoplasty and the artificial genitourinary sphincter. *J Urol* 1989;142:297-301
134. Holmes NM, Kogan BA, Baskin LS. Placement of artificial urinary sphincter in children and simultaneous gastrocystoplasty. *J Urol* 2001;165:2366-8
135. Gonzalez R, Merino FG, Vaughn M. Long term results of the artificial urinary sphincter in male patients with neurogenic bladder. *J Urol* 1995;154:769-70
136. Levesque PE, Bauer SB, Atala A, Zurakowski D, Colodny A, Peters C, Retik AB. Ten year experience with the artificial sphincter in children. *J Urol* 1996;156:625-8
137. Singh G, Thomas DG. Artificial urinary sphincter in patients with neurogenic bladder dysfunction. *Br J Urol* 1996;77:252-5

138. Simeoni J. Artificial urinary sphincter for neurogenic bladder: A multi-institutional study in 107 children. *Br J Urol* 1996;78:287-93
139. Castera R, Podesta ML, Ruarte A, Herrera M, Medel R. 10-Year experience with artificial urinary sphincter in children and adolescents. *J Urol* 2001;165:2373-76
140. Kryger JV, Levenson G, Gonzalez R. Long-term results of artificial urinary sphincters in children are independent of age at implantation. *J Urol* 2001;165:2377-9
141. Nurse DE, Mundy AR. One hundred artificial sphincters. *Br J Urol* 1988;61:318-25
142. Barrett DM, Parulkar BG, Kramer SA. Experience with AS800 artificial sphincter in pediatric and young adult patients. *J Urol* 1993;42:431-6
143. Hafez AT, McLorie G, Bagli D, Houry A. A single-centre long-term outcome analysis of artificial urinary sphincter placement in children. *BJU Int* 2002;89:82-5
144. Albouy B, Grise P, Sambuis C, Pfister C, Mitrofanoff P, Liard A. Pediatric urinary incontinence: evaluation of bladder wall wraparound sling procedure. *J Urol.* 2007 Feb;177(2):716-9.
145. Lopez Pereira P, Somoza Ariba I, Mart nez Urrutia MJ, Lobato Romero R, Jaureguizar Monroe E. Artificial urinary sphincter: 11-year experience in adolescents with congenital neuropathic bladder. *Eur Urol.* 2006 Nov;50(5):1096-101; discussion 1101.
146. Rod o JS, C ceres FA, Lerena JR, Rossy E. Bladder augmentation and artificial sphincter implantation: urodynamic behavior and effects on continence. *J Pediatr Urol.* 2008 Feb;4(1):8-13.
147. Herndon CD, Rink RC, Shaw MB, Simmons GR, Cain MP, Kaefer M, Casale AJ. The Indiana experience with artificial urinary sphincters in children and young adults. *J Urol* 2003;169:650-4
148. Herndon CD, Rink RC, Shaw MB, Cain MP, Casale AJ. Experience with non-cycled artificial urinary sphincters. *BJU Int* 2004;93:1049-52
149. Spiess PE, Capolicchio JP, Kiruluta G, Salle JP, Berardinucci G, Corcos J. Is an artificial sphincter the best choice for incontinent boys with Spina Bifida? Review of our long term experience with the AS-800 artificial sphincter. *Can J Urol* 2002;9:1486-91
150. Aliabadi H, Gonzalez R. Success of the artificial sphincter after failed surgery for incontinence. *J Urol* 1996;143:987-91
151. Woodside JR, Borden TA. Pubovaginal sling procedure or the management of urinary incontinence in a myelodysplastic girl. *J Urol* 1986;78:808-9
152. Gormley EA, Bloom DA, McGuire EJ, Ritchey ML. Pubovaginal slings for the management of urinary incontinence in female adolescents. *J Urol* 1994;152:822-5
153. Kakizaki H, Shibata T, Kobayashi S, Matsumara K, Koyanagi T. Fascial sling for the management of incontinence due to sphincter incompetence. *J Urol* 1995;153:644-7
154. Elder JS. Periurethral and puboprostatic sling repair for incontinence in patients with myelodysplasia. *J Urol* 1990;144:434-7
155. Decter RM. Use of fascial sling for neurogenic incontinence: Lessons learned. *J Urol* 1993;150:683-6
156. Raz S, Ehrlich RM, Zeidman EJ, Alarcon A, McLaughlin S. Surgical treatment of the incontinent female patient with myelomeningocele. *J Urol* 1988;139:524-6
157. Bauer SB, Peters CA, Colodny AH, Mandell J, Retik AB. The use of rectus fascia to manage urinary incontinence. *J Urol* 1989;142:516-9
158. Perez LM, Smith EA, Broecker BH, Massad CA, Parrott TS, Woodard JR. Outcome of sling cystourethropexy in the pediatric population: A critical review. *J Urol* 1996;156:642-6
159. Dik P, Klijn AJ, van Gool JD, de Jong TP. Transvaginal sling suspension of bladder neck in female patients with neurogenic sphincter incontinence. *J Urol* 2003;170:580-1
160. Colvert JR 3rd, Kropp BP, Cheng EY, Pope JC 4th, Brock JW 3rd, Adams MC, Austin P, Furness PD 3rd, Koyle MA. The use of small intestinal submucosa as an off-the-shelf urethral sling material for pediatric urinary incontinence. *J Urol* 2002 ;168:1872-5
161. Bugg CE Jr, Joseph DB. Bladder neck cinch for pediatric neurogenic outlet deficiency. *J Urol* 2003;170:1501-3
162. Misseri R, Cain MP, Casale AJ, Kaefer M, Meldrum KK, Rink RC. Small intestinal submucosa bladder neck slings for incontinence associated with neuropathic bladder. *J Urol.* 2005 Oct;174(4 Pt 2):1680-2; discussion 1682.
163. Godbole P, Mackinnon AE. Expanded PTFE bladder neck slings for incontinence in children: the long-term outcome. *BJU Int.* 2004;93:139-41

164. Dave S, Pippi Salle JL, Lorenzo AJ, Braga LH, Peralta-Del Valle MH, Bägli D, Khoury AE. Is long-term bladder deterioration inevitable following successful isolated bladder outlet procedures in children with neuropathic bladder dysfunction? *J Urol*. 2008 May;179(5):1991-6; discussion 1996.
165. Nguyen HT, Baskin LS. The outcome of bladder neck closure in children with severe urinary incontinence. *J Urol* 2003;169: 1114-16
166. Hoebeke P, De Kuyper P, Goeminne H, Van Laecke E, Everaert K. Bladder neck closure for treating pediatric incontinence. *Eur Urol* 2000;38:453-6
167. Young HH. An operation for incontinence associated with epispadias. *J Urol* 1922;7:1-32
168. Dees J. Congenital epispadias with incontinence. *J Urol* 1949;62:513-22
169. Leadbetter GW. Surgical correction of total urinary incontinence. *J Urol* 1964;91:261-6
170. Mollard P. Bladder reconstruction in exstrophy. *J. Urol* 1980;124 :525-9
171. Jones JA, Mitchell ME, Rink RC. Improved results using a modification of the Young-Dees-Leadbetter bladder neck repair. *Br J Urol* 1993;71:555-61
172. Salle JL. Urethral lengthening with anterior bladder wall flap (Pippi Salle procedure): modifications and extended indications of the technique. *J Urol* 1997;158:586-90
173. Hendren WH. Congenital female epispadias with incontinence. *J Urol* 1981;125:558-64
174. Lepor H and Jeffs RD. Primary bladder closure and bladder neck reconstruction in classical bladder exstrophy. *J Urol* 1983;123:1142-5
175. Kropp KA and Angwafo FF. Urethral lengthening and reimplantation for neurogenic incontinence in children. *J. Urol* 1986;135:533-6
176. Snodgrass W. A simplified Kropp procedure for incontinence. *J Urol* 1997;158:1049-52
177. Surer I, Baker LA, Jeffs RD, Gearhart JP. Modified Young-Dees-Leadbetter bladder neck reconstruction in patients with successful primary bladder closure elsewhere: a single institution experience. *J Urol* 2001;165:2438-40.
178. Szymanski KM, Rink RC, Whittam B, Ring JD, Misseri R, Kaefer M, Cain MP. Long-term outcomes of the Kropp and Salle urethral lengthening bladder neck reconstruction procedures. *J Pediatr Urol*. 2016 Dec;12(6):403.e1-403.e7.
179. Grimsby GM, Menon V, Schlomer BJ, Baker LA, Adams R, Gargollo PC, Jacobs MA. Long-Term Outcomes of Bladder Neck Reconstruction without Augmentation Cystoplasty in Children. *J Urol*. 2016 Jan;195(1):155-61.
180. Snodgrass W, Villanueva C, Gargollo P et al: New hydronephrosis and/or vesicoureteral reflux after bladder outlet surgery without augmentation in 75 children with neurogenic bladder. *J Pediatr Urol* 2014; 10: 906.
181. Whittam B, Szymanski K, Misseri R, Carroll A, Kaefer M, Rink R, Cain M. Long-term fate of the bladder after isolated bladder neck procedure. *J Pediatr Urol*. 2014 Oct;10(5):886-91.
182. Mitrofanoff P. Cystostomie continente trans-appendiculaire dans le traitement de vessies neurologique. *Chirurgae Paediatrica* 1980;621:297-305
183. Duckett JW, Snyder HM. Continent urinary diversion: variations on the Mitrofanoff principle. *J Urol* 1986;136:58-62
184. Woodhouse CRJ, MacNeilly AE. The Mitrofanoff principle: expanding on a versatile theme. *Br J Urol* 1994;74:447-53
185. Leibovitch I, Avigad I, Nativ O, Goldwasser B. The frequency of histopathological abnormalities in incidental appendectomy in urological patients: the implications for incorporation of the appendix in urinary tract reconstructions. *J Urol* 1992;148:41-3
186. Yang WH. Yang needle tunneling technique in creating antireflux and continence mechanisms. *J Urol* 1993;150:830-4
187. Monti PR, Lara RC, Dutra MA, Rezende de Carvalho R. New techniques for construction of efferent conduits based on the Mitrofanoff principle. *Urology* 1997;49:112-5
188. Gerharz EW, Tassadaq T, Pickard RS, Shah PJR, Woodhouse CRJ. Transverse retubularised ileum: early clinical experience with a new second line Mitrofanoff tube. *J Urol* 1998;159:525-8
189. Liard A, Segulier-Lipszyc E, Mathiot A, Mitrofanoff P. The Mitrofanoff procedure: 20 years later. *J Urol* 2001;165:2394-8.
190. Malone PR, d'Cruz VT, Worth PHL, Woodhouse CRJ. Why are continent diversions continent? *J Urol* 1989;141:303-6
191. Riedmiller H, Burger R, Muller SC, Thuroff J, Hohenfellner R. Continent appendix stoma: a modification of the Mainz pouch technique. *J Urol* 1990;143:1115-7
192. Woodhouse CRJ. The Mitrofanoff principle for continent urinary diversion. *World J Urology* 1996;14:99-104

193. Duckett JW, Lofti A-H. Appendicovesicostomy (and variations) in bladder reconstruction. *J Urol* 1993;149:567-9
194. Fishwick J, Gough DCS, O'Flynn KJ. The Mitrofanoff: does it last? *British Journal of Urology International* 2000;85:496-7
195. Cain MP, Casale AJ, King SJ, Rink RC. Appendicovesicostomy and newer alternatives for the Mitrofanoff procedure: results in the last 100 patients at Riley Children's Hospital. *J Urol*. 1999;162:1749-52
196. Piaggio L, Myers S, Figueroa TE, Barthold JS, González R. Influence of type of conduit and site of implantation on the outcome of continent catheterizable channels. *J Pediatr Urol*. 2007 Jun;3(3):230-4.
197. Thomas JC, Dietrich MS, Trusler L, et al. Continent catheterizable channels and the timing of their complications. *J Urol* 2006;176:1816–20.
198. Harris CF, Cooper CS, Hutcheson JC, et al. Appendicovesicostomy: the Mitrofanoff procedure – a 15-year perspective. *J Urol* 2000;163:1922–6.
199. Narayanaswamy B, Wilcox DT, Cuckow PM, et al. The Yang-Monti ileovesicostomy: a problematic channel? *BJU Int* 2001;87:861–5.
200. Leslie B, Lorenzo AJ, Moore K, et al. Long-term follow-up and time to event outcome analysis of continent catheterizable channels. *J Urol* 2011;185:2298–302
201. Faure A, Cooksey R, Bouty A, Woodward A, Hutson J, O'Brien M, Heloury Y. Bladder continent catheterizable conduit (the Mitrofanoff procedure): Long- term issues that should not be underestimated. *J Pediatr Surg*. 2017 Mar;52(3):469-472.
202. Hitchcock RJ, Sadiq MJ. Button vesicostomy: A continent urinary stoma. *J Pediatr Urol*. 2007 Apr;3(2):104-8.
203. Gilchrist RK, Merricks JW, Hamlin HH, Rieger IT. Construction of substitute bladder and urethra. *Surgery, Gynecology and Obstetrics* 1950;90:752-60
204. Harper JGM, Berman MH, Herzberg AD, Lerman F, Brendler H. Observations on the use of cecum as a substitute bladder. *J Urol* 1954;71:600-2
205. Rowland RG, Mitchell ME, Bihrlle R, Kahnoski PJ, Piser JE. Indiana continent urinary reservoir. *J Urol* 1987;137:1136-9
206. Rowland RG, Webster G, Goldwasser B, editors. *Urinary diversion*. 1 ed. Oxford: Isis Medical Media; 1995; 22, Right colon reservoir using plicated tapered ileal outlet. p. 229-35
207. Thuroff J, Alken P, Reidmiller H, Jakobi GH, Hohenfellner R. 100 cases of Mainz pouch: continuing experience and evolution. *J Urol* 1988;140:283-8
208. Robertson GN, King L. Bladder substitution in children. *Urol Clin North America* 1986;13:333-44
209. Skinner EC, Lieskovsky G, Boyd JD, et al. Hendry WF, editors. *Recent advances in urology/andrology*. 5 ed. Edinburgh: Churchill Livingstone; 1991; 9, Continent cutaneous diversion and total bladder replacement using the Kock principles. p. 135-48
210. Engelmann UH, Felderman TP, Scott FB. The use of the AMS AS800 artificial sphincter for continent urinary diversion 1. investigations including pressure flow studies using rabbit intestinal loops. *J Urol* 1985;134-83
211. Light KK. Long term clinical results using the artificial sphincter around bowel. *Br J Urol* 1989;64:56-60
212. Mor Y, Quinn FMJ, Carr B, Mouriquand PD, Duffy PG, Ransley PG. Combined Mitrofanoff and antegrade continence enema procedures for urinary and fecal incontinence. *J Urol* 1997;158:192-5
213. Herschorn S, Hewitt RJ. Patient perspective of long term outcome of augmentation cystoplasty for neurogenic bladder. *Urology* 1998;52:672-8
214. Leng WW, Balock HJ, Fredricksson WH, English SF, McGuire EG. Enterocystoplasty or detrusor myomectomy: comparison of indications and outcomes for bladder augmentation. *J Urol* 1999;161:758-63
215. Metcalfe PD, Cain MP, Kaefer M, Gilley DA, Meldrum KK, Misseri R, King SJ, Casale AJ, Rink RC. What is the need for additional bladder surgery after bladder augmentation in childhood? *J Urol*. 2006 Oct;176(4 Pt 2):1801-5; discussion 1805.
216. Dayanc M, Kilciler M, Tan O, Gokalp A, Goktas S, Peker AF. A new approach to bladder augmentation in children: seromuscular enterocystoplasty. *BJU Int* 1999;84:103-7
217. Landau EH, Jayanthi VR, McIlorie GA, Churchill BM, Khoury AE. Renal transplantation in children following augmentation ureterocystoplasty. *Urology* 1997;50:260-2
218. N'Dow J, Robson CN, Matthews JNS, Neal DE, Pearson JP. Reducing mucus production after urinary reconstruction: prospective randomised trial. *J Urol* 2001;165:1433-40
219. Flood HD, Malhotra SJ, O'Connell HE, et al. Long-term results and complications using augmentation cystoplasty in reconstructive urology. *Neurourol Urodyn*. 1995;14(4):297–309.

220. Bertschy C, Bawab F, Liard A, et al. Enterocystoplasty complications in children. A study of 30 cases. *Eur J Pediatr Surg.* 2000;10(1):30-4.
221. Shekarriz B, Upadhyay J, Demirbilek S, et al. Surgical complications of bladder augmentation: comparison between various enterocystoplasties in 133 patients. *Urology.* 2000;55(1):123-8.
222. DeFoor W, Tackett L, Minevich E, et al. Risk factors for spontaneous bladder perforation after augmentation cystoplasty. *Urology.* 2003;62(4):737-41
223. Mansson W, Bakke A, Bergman B. Perforation of continent urinary reservoirs. *Scandinavian Journal of Urology and Nephrology* 1997;31:529-32
224. Rink RC, Hollensbe DW, Adams MC, Keating MA. Is sigmoid enterocystoplasty at greatest risk or perforation? Observations and etiology in 23 bladder perforations in 264 patients. *Scandinavian Journal of Urology and Nephrology* 1992;142(Supplement):179-83
225. Metcalfe PD, Casale AJ, Kaefer MA, Misseri R, Dussinger AM, Meldrum KK, Cain MP, Rink RC. Spontaneous bladder perforations: a report of 500 augmentations in children and analysis of risk. *J Urol.* 2006 Apr;175(4):1466-70; discussion 1470-1.
226. Scales CD, Jr., Wiener JS. Evaluating outcomes of enterocystoplasty inpatients with spina bifida: A review of the literature. *J Urol* 2008;180:2323.
227. Rawashdeh YF, Austin P, Siggaard C, Bauer SB, Franco I, de Jong TP, Jorgensen TM; International Children's Continence Society.. International Children's Continence Society's recommendations for therapeutic intervention in congenital neuropathic bladder and bowel dysfunction in children. *Neurourol Urodyn.* 2012 Jun;31(5):615-20.
228. Nurse DE, Mundy AR. Metabolic complications of cystoplasty. *Br J Urol* 1989;63:165-70
229. Wagstaff KE, Woodhouse CRJ, Rose GA, Duffy PG, Ransley PG. Blood and urine analysis in patients with intestinal bladders. *Br J Urol* 1991;68:311-6
230. Ditunno P, Battaglia M, Ricapito V, Saracino GA, Selvaggi FP. Metabolic acidosis and urinary tract infections in ileocolic orthotopic reservoirs with an afferent ileal loop. *Scandinavian Journal of Urology and Nephrology* 1992;142:134-5
231. Poulsen AL, Thode J, Steven K. Acid base metabolism following urinary diversion with the ileal Kock reservoir. *Scandinavian Journal of Urology and Nephrology;* 1992;142(Supplement):135-6
232. Mitchell ME, Piser JA. Intestincystoplasty and total bladder replacement in children and young adults: follow up in 129 cases. *J Urol* 1987;138:579-84
233. Mingin GC, Nguyen HT, Mathias RS, Shepherd JA, Glidden D, Baskin LS. Growth and metabolic consequences of bladder augmentation in children with myelomeningocele and bladder exstrophy. *Pediatrics* 2002;110:1193- 8
234. Kalloo NB, Jeffs RD, Gearhart JP. Long term nutritional consequences of bowel segment use for lower urinary tract reconstruction in pediatric patients. *Urology* 1997;50:967-71
235. Racioppi M, D'Addessi A, Fanasca E. Vitamin B12 and folic acid plasma levels after ileocaecal and ileal neobladder reconstruction. *Urology* 1997;50:888-92
236. Rosenbaum DH, Cain MP, Kaefer M, Meldrum KK, King SJ, Misseri R, Rink RC. Ileal enterocystoplasty and B12 deficiency in pediatric patients. *J Urol.* 2008 Apr;179(4):1544-7; discussion 1547-8.
237. Kurzrock EA, Baskin LS, Kogan BA. Gastrocystoplasty: long term follow up. *J Urol* 1998;160:2182-6
238. Mingin GC, Stock JA, Hanna MK. Gastrocystoplasty: long term complications in 22 patients. *J Urol* 1999;162:1122-5
239. N'Dow J, Leung HY, Marshall C, Neal DE. Bowel dysfunction after bladder reconstruction. *J Urol* 1998;159:1470-5
240. Singh G, Thomas DG. Bowel problems after enterocystoplasty. *BJU* 1997;79:328-32
241. Husmann OA, Cain MP. Fecal and urinary continence after ileal cecal cystoplasty for the neurogenic bladder. *J Urol* 2001;165:922-96
242. Vordemark JS, Irby PB, Shehata BM, Brown RF. The effects of ileocystoplasty on the development of renal failure in a rat model 5/6th nephrectomy. *J Urol* 1992;148:566-70
243. Akerlund S, Delin K, Kock NG. Renal function and upper urinary tract configuration following urinary diversion to a continent ileal reservoir (Kock pouch): a prospective 5-11 year follow-up after reservoir construction. *J Urol* 1989;142:1193-8
244. Fontaine E, Leaver R, Woodhouse CRJ. The effect of intestinal urinary reservoirs on renal function: a ten year follow up study. *BJU Int* 2000;86:195-8

245. Crowe A, Cairns HS, Wood S, Rudge CR, Woodhouse CRJ, Neild GH. Renal transplantation following renal failure due to urological disorders. *Nephrology, Dialysis and Transplantation* 1998;13:2065-9
246. Riedmiller H, Gerharz EW, Kohl U, Weingartner K. Continent urinary diversion in preparation for renal transplantation: a staged approach. *Transplantation* 2000;70:1713-7
247. Palmer LS, Franco I, Kogan S, Reda E, Bhagwant G, Levitt S. Urolithiasis in children following augmentation cystoplasty. *J Urol* 1993;150:726-9
248. Ginsberg D, Huffman JL, Lieskovsky G, Boyd SD, Skinner DG. Urinary tract stones: a complication of the Kock pouch urinary diversion. *J Urol* 1991;145:956-9
249. Terai A, Ueda T, Kakehi Y, Terachi T, Arai Y, Okada Y, Yoshida O. Urinary calculi as a late complication of the Indiana continent urinary diversion: comparison with the Kock pouch procedure. *J Urol* 1996;155:66-8
250. Kronner KM, Casale AJ, Cain MP, Zerlin MJ, Keating MA, Rink RC. Bladder calculi in the pediatric augmented bladder. *J Urol* 1998;160:1096-8
251. Woodhouse CRJ, Lennon GN. Management and aetiology of stones in intestinal urinary reservoirs in adolescents. *Eur Urol* 2001;39:253-9
252. Brough RJ, O'Flynn KJ, Fishwick J, Gough DCS. Bladder washout and stone formation in paediatric enterocystoplasty. *Eur Urol* 1998;33:500-2
253. Mathoera RB, Kok DJ, Nijman RJ. Bladder calculi in augmentation cystoplasty in children. *Urology* 2000;56:482-7
254. Mathoera RB, Kok DJ, Verduin CM, Nijman RJM. Pathological and therapeutic significance of cellular invasion by *Proteus Mirabilis* in an enterocystoplasty infection stone model. *Infec. Immun* 2002;70: 7022-32
255. Barroso U, Jednak R, Fleming P, Barthold JS, Gonzalez R. Bladder calculi in children who perform clean intermittent catheterisation. *BJU Int* 2000;85:879-84
256. Cain MP, Casale AJ, Kaefer M, Yerkes E, Rink RC. Percutaneous cystolithotomy in the pediatric augmented bladder. *J Urol* 2002;168:1881-2
257. Roberts WW, Gearhart JP, Mathews RI. Time to recurrent stone formation in patients with bladder or continent reservoir reconstruction: fragmentation versus intact extraction. *J Urol* 2004;172: 1706-9
258. Hensle TW, Bingham J, Lam J, Shabsigh A. Preventing reservoir calculi after augmentation cystoplasty and continent urinary diversion: the influence of an irrigation protocol. *BJU Int* 2004;93:585-7
259. Wagstaff KE, Woodhouse CRJ, Duffy PG, Ransley PG. Delayed linear growth in children after enterocystoplasty. *Br J Urol* 1992;69:314-7
260. Gerharz EW, Woodhouse CRJ, Ransley PG. Growth failure revisited: a second look at the metabolic consequences of enterocystoplasty in childhood. *J Urol* 2001;165:106-9
261. McDougal WS, Koch MO, Shands C, Price RR. Boney demineralisation following urinary intestinal diversion. *J Urol* 1988;140:853-5
262. Gerharz EW, Mosekilde L, Thomsen JS, Gasser J, Ransley PG, Reidmiller H, Woodhouse CRJ. Biomechanical consequences of bone loss following urinary diversion through intestinal segments. *J Urol* 1999;161:67
263. Feng AH, Kaar S, Elder JS. Influence of enterocystoplasty on linear growth in children with exstrophy. *J Urol* 2002;167:2552-5
264. Gros DA, Dodson JL, Lopatin UA, Gearhart JP, Silver RI, Docimo SG. Decreased linear growth associated with intestinal bladder augmentation in children with bladder exstrophy. *J Urol* 2000;164:917-20
265. Hafez AT, McLorie G, Gilday D, Laudenberg B, Upadhyay J, Bagli D, Khoury AE. Long-term evaluation of metabolic profile and bone mineral density after ileocystoplasty in children. *J Urol* 2003;170:1639-41
266. Taskinen S, Mäkitie O, Fagerholm R. Intestinal bladder augmentation at school age has no adverse effects on growth. *J Pediatr Urol*. 2008 Feb;4(1):40-2.
267. Hill DE, Kramer SA. Pregnancy after augmentation cystoplasty. *J Urol* 1989;144:457-9
268. Creagh TA, McInerney PD, Thomas PJ, Mundy AR. Pregnancy after lower urinary tract reconstruction in women. *J Urol* 1995;154:1323-4
269. Hatch TR, Steinberg RW, Davis LE. Successful term delivery by cesarean section in a patient with a continent ileocecal urinary reservoir. *J Urol* 1991;146:1111-2
270. Husmann DA, Rathbun SR. Long-term follow up of enteric bladder augmentations: The risk for malignancy. *Journal of Pediatric Urology* 2008; 4:381-5
271. Groschel J, Riedasch G, Kalble T, Tricker AR. Nitrosamine excretion in patients with continent ileal reservoirs for urinary diversion. *J Urol* 1992;147:1013-6

272. Creagh TA, Picramenos D, Smalley ET, Walters CL, Mundy AR. The source of nitrosamines in patients with enterocystoplasties. *Br J Urol* 1997;79:28-31
273. Nurse DE, Mundy AR. Assessment of the malignant potential of cystoplasty. *Br J Urol* 1989;64:489-92
274. Filmer RB, Bruce JR. Malignancies in bladder augmentations and intestinal conduits. *J Urol* 1990;143:671-8
275. Soergel TM, Cain MP, Misseri R, Gardner TA, Koch MO, Rink RC. Transitional cell carcinoma of the bladder following augmentation cystoplasty for the neuropathic bladder. *J Urol* 2004;172:1649-52
276. Sung M-T, Zhang S, Lopez-Beltran A, Montironi R, Wang M, Davidson D D, Koch M O, Cain M P, Rink R C & Cheng L. Urothelial carcinoma following augmentation cystoplasty: an aggressive variant with distinct clinicopathological characteristics and molecular genetic alterations. *Histopathology* 2009; 55: 161–173
277. Castellan M, Gosalbez R, Perez-Brayfield M, Healey P, McDonald R, Labbie A, Lendvay T. Tumor in bladder reservoir after gastrocystoplasty. *J Urol*. 2007 Oct;178(4 Pt 2):1771-4; discussion 1774.
278. Vemulakonda VM, Lendvay TS, Shnorhavorian M, Joyner BD, Kaplan H, Mitchell ME, Grady RW. Metastatic adenocarcinoma after augmentation gastrocystoplasty. *J Urol*. 2008 Mar;179(3):1094-6; discussion 1097.
279. Balachandra B, Swanson PE, Upton MP, Yeh MM. Adenocarcinoma arising in a gastrocystoplasty. *J Clin Pathol*. 2007 Jan;60(1):85-7.
280. Higuchi TT, Granberg CF, Fox JA, et al. Augmentation cystoplasty and risk of neoplasia: fact, fiction and controversy. *J Urol*. 2010;184(6):2492– 6.
281. Shaw J, Lewis MA. Bladder augmentation surgery--what about the malignant risk? *Eur J Pediatr Surg* 1999 ;9:39-40
282. Stenzl A, Frank R, Eder R. 3-dimensional computerised tomography and virtual reality endoscopy of the reconstructed lower urinary tract. *J Urol* 1998;159:741-6
283. Higuchi TT, Fox JA, Husmann DA. Annual endoscopy and urine cytology for the surveillance of bladder tumors after enterocystoplasty for congenital bladder anomalies. *J Urol*. 2011;186(5):1791–5.
284. Eiser C. Need for a distinctive child quality of life measure. *Dialogues in Pediatric Urology* 1997;20:3-4
285. Boyd SD, Feinberg SM, Skinner DG. Quality of life survey of urinary diversion patients. *J Urol* 1987;138:1386-9
286. Sullivan LD, Chow VDW, Ko DSC, Wright JE, McLoughlin MG. An evaluation of quality of life in patients with continent urinary diversions after cystectomy. *Br J Urol* 1998;81:699-704
287. Gerharz EW, Weingartner K, Dopatke T. Quality of life after cystectomy and urinary diversion: results of a retrospective interdisciplinary study. *J Urol* 1998;158:778-85.

VII. PSYCHOLOGICAL ASPECTS OF URINARY INCONTINENCE, ENURESIS AND FAECAL INCONTINENCE

1. Tekgul S, Nijman RJM, Hoebecke P, Canning D, Bower W, von Gontard A. Diagnosis and management of urinary incontinence in children. In: Abrams P, Cardozo L, Khoury S, Wein A (eds.): *Incontinence* (4th. edition). Paris, Health Publication Ltd., 2009: 701-792
2. Franco I, Austin P, Bauer S, von Gontard A, Homsy Y (editors) (2015). *Pediatric Incontinence: Evaluation and Clinical Management*. Oxford and Hoboken: Wiley-Blackwell.
3. von Gontard A: Enuresis (2012a). In: J Rey (ed.): *IACAPAP Textbook of Child and Adolescent Mental Health*, online, 2012; <http://iacapap.org/iacapap-textbook-of-child-and-adolescent-mental-health>
4. von Gontard A (2012b). Encopresis. In: J. Rey (ed.): *IACAPAP Textbook of Child and Adolescent Mental Health*, online, 2012, <http://iacapap.org/iacapap-textbook-of-child-and-adolescent-mental-health>
5. von Gontard A, Equit M. Comorbidity of ADHD and incontinence in children – a review. *European Child and Adolescent Psychiatry*, 2015; 24: 127-140
6. von Gontard, A. Urinary and faecal incontinence in children with special needs. *Nature Reviews of Urology* , 2013; 10, 667-674
7. von Gontard A, Baeyens D, Van Hoecke E, Warzak W, Bachmann C. Psychological and psychiatric issues in urinary and fecal incontinence. *J Urol*. 2011;185: 1432-37

8. Austin PF, Bauer S, Bower W, Chase J, Franco I, Hoebeke P, Rittig S, Vande Walle J, von Gontard A, Wright A, Yang A, Nevéus T. The Standardization of Terminology of Bladder Function in Children and Adolescents: Update Report from the Standardization Committee of the International Children's Continence Society (ICCS). *J Urol.* 2014; 191, 1863-1865
9. Hyams JS, Di Lorenzo CD, Saps M, Schulman R, Staiano A, van Tilburg M. Childhood functional gastrointestinal disorders: child/adolescent. *Gastroenterology*, 2015 150: 1456-1468
10. World Health Organisation. The ICD-10 classification of mental and behavioural disorders - diagnostic criteria for research. Geneva, 1993
11. American Psychiatric Association. Diagnostic and statistical manual of mental disorders (DSM-5). Washington, D.C. 2013
12. Fuchs M, Bösch A, Hausmann A, Steiner H. „The child is father or man“ – Review von relevanten Studien zur Epidemiologie in der Kinder- und Jugendpsychiatrie. *Zeitschrift für Kinder und Jugendpsychiatrie und Psychotherapie*, 2013; 41, 45-57
13. Bor W, Dean AJ, Najman J, Hayatbaksh R. Are child and adolescent mental health problems increasing in the 21st century? *Australian & New Zealand Journal of Psychiatry*, 2014; 48: 606-616
14. Equit M, Klein A, Braun-Bither K, Gräber S, von Gontard A. Elimination disorder and anxious-depressed symptoms in preschool children – a population-based study. *European Child and Adolescent Psychiatry*, 2014; 23: 417-423
15. von Gontard A, Moritz AM, Thome-Granz S., Freitag C. Association of attention deficit and elimination disorders at school entry – a population-based study. *J Urol*, 2011; 186, 2027-2032
16. von Gontard A, Niemczyk J, Thomé-Granz S, Nowack J, Moritz A, MD, Equit M. Incontinence and parent reported oppositional defiant disorder symptoms in young children – a population-based study. *Pediatric Nephrology*, 2015; 30, 1147-1155.
17. Niemczyk J, Equit M, Braun-Bither K, Klein AM, von Gontard A. Prevalence of incontinence, attention deficit/hyperactivity disorder and oppositional defiant disorder in preschool children. *Eur Child Adolesc Psychiatry*, 2015; 24: 837-843
18. Niemczyk J, Wagner C, von Gontard A (2017). Incontinence in Autism Spectrum Disorder – A systematic review. *Eur Child Adolesc Psychiatry*, under review
19. Joinson C, Heron J, Emond A, Butler R. Psychological problems in children with bedwetting and combined (day and night) wetting: A UK population-based study. *Pediatr Psychol* 2007;32:605-616
20. Joinson C, Heron J, von Gontard A and the ALSPAC study team. Psychological problems in children with daytime wetting. *Pediatrics*, 2006; 118: 1985-93
21. Joinson C, Heron J, Butler U, von Gontard A. and the ALSPAC study team: Psychological differences between children with and without soiling problems. *Pediatrics*, 2006; 117: 1575-84
22. Feehan M, Mc Gee R, Stanton W, Silva PA. A 6 year follow-up of childhood enuresis: prevalence in adolescence and consequences for mental health. *Journal of Paediatric Child Health*, 1990; 26: 75-79
23. Järvelin MR, Moilanen I, Vikeväinen-Tervonen L, Huttunen NP. Life changes and protective capacities in enuretic and non-enuretic children. *Journal of Child Psychology and Psychiatry*, 1990; 31: 763-74
24. Fergusson DM, Horwood LJ. Nocturnal enuresis and behavioral problems in adolescence: a 15-year longitudinal study. *Pediatrics*, 1994; 94: 662-68
25. Butler R, Heron J, Alspac Study Team. Exploring the differences between mono- and polysymptomatic nocturnal enuresis. *Scandinavian Journal of Urology and Nephrology*, 2006;40: 313-19
26. von Gontard A, Plück J, Berner W, Lehmkuhl G. Clinical behavioral problems in day and night wetting children, *Pediatric Nephrology*, 1999; 13: 662-67
27. Robson WL, Jackson HP, Blackhurst D, Leung AK. Enuresis in children with attention-deficit hyperactivity disorder. *Southern Medical Journal*, 1997; 90: 503-5
28. Biederman J, Santagelo SL, Faraone SV, Kiely K, Guite J, Mick E, Reed ED, Kraus I, Jellinek M, Perrin J. Clinical correlates of enuresis and ADHD and non-ADHD children. *Journal of Child Psychology and Psychiatry*, 1995; 36: 865-877
29. Baeyens D. The relationship between attention-deficit/hyperactivity disorder (ADHD) and enuresis in children. PhD thesis, Gent, Belgium, 2005

30. Baeyens D, Roeyers, H, Van Erdeghem S, Hoebecke P, Vande Walle J. The prevalence of attention deficit/hyperactivity disorder in children with nonmonosymptomatic nocturnal enuresis: a 4-year followup study. *J Urol.* 2007; 178: 2616-20
31. Crimmins CR, Rathburn SR, Husman DA. Management of urinary incontinence and nocturnal enuresis in attention-deficit hyperactivity disorder. *J Urol.* 2003;170: 1347-50
32. Joinson C, Heron J, von Gontard A, Butler R, Golding J, Emond A. Early childhood risk factors associated with daytime wetting and soiling in school-age children. *Pediatr Psychol.* 2008;33:739-50
33. Duel BP, Steinberg-Epstein R, Hill M, Lerner M. A survey of voiding dysfunction in children with attention deficit-hyperactivity disorder. *J Urol.* 2003; 170: 1521-24
34. von Gontard A, Lettgen B, Gaebel E, Heiken-Löwenau C, Schmitz I, Olbing H. Day wetting children with urge incontinence and voiding postponement - a comparison of a pediatric and child psychiatric sample - behavioural factors. *BJU.* 1998; 81: Suppl. 3, 100-106
35. Lettgen B, von Gontard A, Heiken-Löwenau C, Gaebel C, Schmitz I, Olbing H. Urge incontinence and voiding postponement in children: somatic and psycho-social factors. *Acta Paediatrica.* 2002; 91: 978-84
36. Kuhn S, Natale N, Siemer S, Stöckle M, von Gontard A. Clinical differences in subtypes of daytime wetting - urge incontinence and voiding postponement. *J Urology* 2009;182:1967-1972
37. Zink S, Freitag CM, von Gontard A. Behavioral comorbidity differs in subtypes of enuresis and urinary incontinence. *J Urol,* 2008; 179: 295-98
38. von Gontard A, Niemczyk J, Wagner C, Equit (2106). Voiding postponement in children – a systematic review. *European Child and Adolescent Psychiatry,* 25:809-20
39. Hinman F, Baumann FW. Vesical and ureteral damage from voiding dysfunction in boys without neurologic or obstructive disease. *J Urol.* 1073; 109: 727-32
40. Varlam DE, Dippel J. Non-neurogenic bladder an chronic renal insufficiency in childhood. *Pediatric Nephrology,* 1995; 9: 1-5
41. Nolan T, Debelle G, Oberklaid F, Coffey C. Randomised trial of laxatives in treatment of childhood faecal incontinence. *Lancet,* 1991;338: 523-27
42. Bannina MA, Buller HA, Heymans HS, Tytgat GN, Taminiou JA. Is faecal incontinence always the result of constipation? *Archives of Disease in Childhood,* 1994; 71: 186-93
43. Bannina MA, Voskuilj WP, Akkerhuis GW, Taminiou JA, Buller HA. Colonic transit times and behaviour profiles in children with defecation disorders. *Archives of Disease in Childhood,* 2004; 89: 13-16
44. Morrison MJ, Tappin D, Staines H. 'You feel helpless, that's exactly it': parents' and young people's beliefs about bed-wetting and the implications for practice. *Journal of Advanced Nursing,* 2000; 31: 1216-27
45. Moilanen I, Järvelin M, Vikeväinen-Torvonen L, Huttunen N.-P. Personality and family characteristics of enuretic children. *Psychiatria Fennica,* 1987; 18: 53-61
46. Butler R, Heron J. An exploration of children's views of bed-wetting at 9 years. *Child: Care, Health and Development,* 2007; 34: 65-70
47. Hägglöf B, Andren O, Bergström E, Marklund L, Wendelius M. Self-esteem before and after treatment in children with nocturnal enuresis and urinary incontinence. *Scand J Urol Nephrol.* 1996; 31: Suppl. 183, 79-82
48. Theunis M, Van Hoecke E, Paesbrugge S, Hoebecke P, Vande Walle J. Self-image and performance in children with nocturnal enuresis. *Eur Urol.* 2002; 41: 660-667
49. Moffat EKM, Kato C, Pless IB. Improvements in self-concept after treatment of nocturnal enuresis: randomised controlled trial. *Journal of Pediatrics,* 1987; 110: 647-652
50. Redsell SA, Collier J. Bedwetting, behaviour and self-esteem: a review of the literature. *Child: Care, health and Development,* 2000; 27: 149-162
51. Longstaffe S, Moffat M, Whalen J. Behavioral and self-concept changes after six months of enuresis treatment: a randomised, controlled trial. *Pediatrics,* 2000; 105: 935-940
52. Gladh G, Eldh M, Mattsson S. Quality of life in neurologically healthy children with urinary incontinence. *Acta Paediatrica* 1648-1652, 2006
53. Landman GB, Rappaport L, Fenton T, Levine M. Locus of control and self-esteem in children with faecal incontinence. *Developmental and Behavioral Pediatrics,* 1986; 7: 111-113
54. Cox DJ, Morris JB, Borrowitz SM, Sutphen JL. Psychological differences between children with and without chronic faecal incontinence. *Journal of Pediatric Psychology,* 2002; 27: 585-591

55. Foxman B, Valdez B, Brook RH. Childhood enuresis: prevalence, perceived impact, and prescribed treatment. *Pediatrics*, 1986; 77: 482-487
56. Butler RJ. Maternal attributions and tolerance for nocturnal enuresis. *Behav Res Ther*. 1986; 24: 307-312
57. Egemen A, Akil I, CAnda E, Ozyurt BC, Eser E. An evaluation of quality of life of mothers of children with enuresis nocturna. *Pediatric Nephrology*, 2008; 23: 93-98
58. Haque M, Ellerstein NS, Gundy JH, Shelov SP, Weiss JC, Mc Intire MS, Olness KN, Jones DJ, Heagarty MC, Starfield BH. Parental Perceptions of Enuresis. *American Journal of Disease in Children*, 1981; 135: 809-811
59. Shelov SP, Gundy I, Weiss JC, Mc Intire MS, Olness K, Staub HP, Jones DJ, Haque M, Ellerstein NS, Heagarty MC, Starfield B. Enuresis: a contrast of attitudes of parents and physicians. *Pediatrics*, 1981; 67: 707-710
60. Butler RJ. *Nocturnal enuresis: Psychological perspectives*. Wright, Bristol, 1987
61. Can G, Topbas M, Okten A, Kizil M. Child abuse as a result of enuresis. *Pediatrics International*, 2004; 46: 64-66
62. Chang SS, Ng CFN, Wong, SN. Behavioural problems in children and parenting stress associated with primary nocturnal enuresis in Hong Kong. *Acta Paediatrica*, 2002; 91: 475-479
63. Bernard-Bonnin AC, Haliy N, Belanger S, Nadeau D. Parental ant patient perceptions about faecal incontinence and ist treatment *Journal of Developmental and Behavioral Pediatrics*, 1993; 14: 397- 400
64. Silver E. Family therapy and soiling. *Journal of Family Therapy*, 1996; 18: 415-432
65. Von Wendt L, Similä S, Niskanen P, Järvelin M-R. Development of bowel and bladder control in the mentally retarded. *Developmental Medicine and Child Neurology*, 1990; 32: 515-518
66. Niemczyk J, von Gontard A, Equit M, Bauer K, Naumann T, Wagner C, Curfs L (2016). Detailed assessment of incontinence in boys with fragile-X syndrome in a home setting. *Eur J Pediatr* 175: 1325-1334
67. von Gontard A, Niemczyk J, Borggreffe-Mousavian S, Wagner C, Curfs L, Equit M (2016). Incontinence in children, adolescents and adults with Williams syndrome. *Neurourology and Urodynamics* 35: 1000-1005
68. Niemczyk J, von Gontard A, Equit M, Medoff D, Wagner C, Curfs L. (2016). Incontinence in persons with Down Syndrome. *Neuroroul Urodyn*, e-published
69. Wagner C, Niemczyk J, Equit M, Curfs L, von Gontard A (2016). Incontinence in persons with Angelman syndrome. *Eur J Pediatr*, e-published
70. Niemczyk J, Schäfer S, Becker N, Equit M, Wagner C, von Gontard A (2016). Evaluation of the 'Parental Questionnaire: Enuresis/Urinary Incontinence'. ICCS Conference Kyoto, 30.6.-2.7.2016, manuscript ready for publication
71. Van Hoecke E, Baeyens D, Vanden Bossche H, Hoebeke P, Braet C, Vande Walle J. Early detection of psychological problems in a population of children with enuresis: construction and validation of the short screening instrument for psychological problems in enuresis. *J Urol*. 2007; 178: 2611-15
72. Achenbach TM. *Manual for the child behavior checklist 4-18 and 1991 profile*. Burlington, Vt: University of Vermont, 1991
73. Goodman R (1997) The Strengths and Difficulties Questionnaire: A Research Note. *Journal of Child Psychology and Psychiatry*, 38, 581-586.
74. Bower WF, Wong EM, Yeung CK Development of a validated quality of life tool specific to children with bladder dysfunction. *Neurourology and Urodynamics*, 2006; 25: 221-227
75. Matza LS, Swensen AR, Flood EM, Secnik K, Leidy NK: Assessment of health-related quality of life in children: a review of conceptual, methodological, and regulatory issues. *Value in Health*, 2004; 7: 79-92
76. Bachmann C, Lehr D, Janhsen E, Steuber C, Gäbel E, von Gontard A, Bachmann H (2009). German version of the Pediatric Questionnaire for Urinary Incontinence Health related Quality of Life. *Journal of Urology*, 182, 1993-1999
77. Equit M, Hill J, Hübner A, von Gontard A (2014). Health-related quality of life and treatment effects on children with functional incontinence and their parents. *Journal of Pediatric Urology* 10, 922-928
78. Naitoh Y, Kawauchi A, Soh J, Kamoi K, Miki T (2012). Health related quality of life for mono-symptomatic enuretic children and their mothers. *J Urol* 188, 1910-1914

79. Döpfner M, Berner W, Flechtner H, Lehmkuhl G, Steinhausen HC. Psychopathologische Befund-Dokumentation für Kinder und Jugendliche (CASCAP-D): Befundbogen, Glossar und Explorationsleitfaden. Göttingen: Hogrefe, 1999
80. Weisz JR, Weiss B, Han SS, Granger DA, Morton T. Effects of psychotherapy with children and adolescents revisited: a meta-analysis of treatment outcome studies. *Psychological Bulletin*, 1995; 117: 450-468
81. Kazdin A. Psychotherapy for children and adolescents – directions for research and practice. New York/ Oxford: Oxford University Press, 2000
82. Hellström A-L, Hjalmas K, Jodal V. Rehabilitation of the dysfunctional bladder in children: method and 3-year follow-up. *J Urol*. 1987; 138: 847-849
83. Devlin JB, O' Cathain C. Predicting treatment outcome in nocturnal enuresis. *Archives of Disease in Childhood*, 1990; 65: 1158-61
84. Felt B, Wise CG, Olsen A, Kochhar P, Marcus S, Coran A. Guideline for the management of pediatric idiopathic constipation and soiling. *Archives of Pediatric and Adolescent Medicine*, 1999; 153: 380-385
85. Chase J, Austin P, Hoebeke P, McKenna P (2010). The management of dysfunctional voiding in children: a report from the standardisation committee of the International Children's Continence Society. *Journal of Urology* 183: 1296-1302.
86. Cox DJ, Sutphen J, Ling W, Quillian W, Borowitz S. Additive benefits of laxative, toilet training, and biofeedback therapies in the treatment of pediatric faecal incontinence. *Journal of Pediatric Psychology*, 1996; 21: 659 – 670
87. Van Ginkel R, Benninga MA, Blommart JE, van der Plas R, Boeckstaens GE, Büller HA, Taminiau J. Lack of benefit of laxatives as an adjunctive therapy for functional nonretentive fecal soiling in children. *Journal of Pediatrics*, 2000;137: 808-813
88. Mowrer OH, Mowrer WM. Enuresis: a method für its study and treatment. *American Journal of Orthopsychiatry*, 1938; 8: 436-459
89. Houts AC, Berman JS, Abramson H. Effectiveness of psychological and pharmacological treatments for nocturnal enuresis. *Journal of Consulting and Clinical Psychology*, 1994; 62: 737-745
90. Neveus T, Eggert P, Macedo A, Rittig S, Tekgül S, Vande Walle J, Yeung CK, Robsen L. Evaluation of and treatment for monosymptomatic enuresis: A standardization document from the International Children's Continence Society. *Journal of Urology* 183, 441-447, 2010
91. van Londen A, van Londen-Barensten M, van Son M, Mulder G. Arousal training for children suffering from nocturnal enuresis: a 2 1/2 year follow-up. *Behavior Research and Therapy*, 1993; 31: 613-615
92. van Londen A, van Londen-Barensten M, van Son M, Mulder G. Relapse rate and parental reaction after successful treatment of children suffering from nocturnal enuresis: a 2 ½ year follow-up of bibliotherapy. *Behavior Research and Therapy*, 1995; 33: 309-311
93. Leebeek-Groenewegen A, Blom J, Sukhai R, van der Heijden B. Efficacy of desmopressin combined with alarm therapy for monosymptomatic nocturnal enuresis. *J Urol*. 2001; 166: 2456-58
94. Gibb S, Nolan T, South M, Noad L, Bates G, Vidmar S. Evidence against a synergistic effect of desmopressin with conditioning in the treatment of nocturnal enuresis. *Journal of Pediatrics*, 2004; 144: 351-357

VIII. URINARY INCONTINENCE IN CHILDREN WITH SPECIAL NEEDS

1. Bax, M.C., D.P. Smyth, and A.P. Thomas, Health care of physically handicapped young adults. *Br Med J (Clin Res Ed)*, 1988. 296(6630): p. 1153-5.
2. von Wendt, L., et al., Development of bowel and bladder control in the mentally retarded. *Dev Med Child Neurol*, 1990. 32(6): p. 515-8.
3. Samijn, B., et al., Lower urinary tract symptoms and urodynamic findings in children and adults with cerebral palsy: A systematic review. *Neurological Urodyn*.
4. Powers, M.K., et al., Trends in Toilet Training and Voiding Habits among Children with Down Syndrome. *J Urol*. 194(3): p. 783-7.
5. de Carvalho Mard, F.C., et al., Prevalence of lower urinary tract symptoms in individuals with Down syndrome. *J Pediatr Urol*. 10(5): p. 844-9.
6. Kitamura, A., et al., Assessment of lower urinary tract function in children with Down syndrome. *Pediatr Int*. 56(6): p. 902-8.

7. von Gontard, A., et al., Do we manage incontinence in children and adults with special needs adequately? ICI-RS 2014. *Neurourol Urodyn*. 35(2): p. 304-6.
8. Von Gontard, A., et al., Urinary incontinence in persons with Prader-Willi Syndrome. *BJU Int*. 106(11): p. 1758-62.
9. Niemczyk, J., et al., Incontinence in persons with Noonan Syndrome. *J Pediatr Urol*. 11(4): p. 201 e1-5.
10. von Gontard, A., et al., Incontinence in children, adolescents and adults with Williams syndrome. *Neurourol Urodyn*.
11. Giesbers, S., et al., Incontinence in Individuals with Rett Syndrome: A Comparative Study. *J Dev Phys Disabil*. 24(3): p. 287-300.
12. Radstaake, M., et al., Incontinence in individuals with Angelman syndrome: a comparative study. *Res Dev Disabil*. 34(11): p. 4184-93.
13. Van Laecke, E., et al., Voiding disorders in severely mentally and motor disabled children. *J Urol*, 2001. 166(6): p. 2404-6.
14. Bross, S., et al., Correlation between motor function and lower urinary tract dysfunction in patients with infantile cerebral palsy. *Neurourol Urodyn*, 2007. 26(2): p. 222-7.
15. Chiu, P.K., et al., Does selective dorsal rhizotomy improve bladder function in children with cerebral palsy? *Int Urol Nephrol*, 2014. 46(10): p. 1929-33.
16. Delialioglu, S.U., et al., Evaluation of lower urinary system symptoms and neurogenic bladder in children with cerebral palsy: relationships with the severity of cerebral palsy and mental status. *Turkish Journal of Medical Sciences*, 2009. 39(4): p. 571-578.
17. Houle, A.M., et al., Bladder function before and after selective dorsal rhizotomy in children with cerebral palsy. *J Urol*, 1998. 160(3 Pt 2): p. 1088-91.
18. Fernandes Silva, J.A., F. Borges Carreterre, and R. Damiao, Uroflowmetry in the management of lower urinary tract symptoms of children and adolescents with cerebral palsy. *J Pediatr Urol*, 2014. 10(3): p. 413-7.
19. Ersoz, M., et al., Noninvasive evaluation of lower urinary tract function in children with cerebral palsy. *Am J Phys Med Rehabil*, 2009. 88(9): p. 735-41.
20. Fowler, C.J., D. Griffiths, and W.C. de Groat, The neural control of micturition. *Nat Rev Neurosci*, 2008. 9(6): p. 453-66.
21. Decter, R.M., et al., Urodynamic assessment of children with cerebral palsy. *J Urol*, 1987. 138(4 Pt 2): p. 1110-2.
22. Azzarelli, B. and U. Roessmann, Diffuse "anoxic" myelopathy. *Neurology*, 1977. 27(11): p. 1049-52.
23. Mayo, M.E., Lower urinary tract dysfunction in cerebral palsy. *J Urol*, 1992. 147(2): p. 419-20.
24. Allen, H.A., et al., Initial trial of timed voiding is warranted for all children with daytime incontinence. *Urology*, 2007. 69(5): p. 962-5.
25. Drigo, P., et al., Neurogenic vesico-urethral dysfunction in children with cerebral palsy. *Ital J Neurol Sci*, 1988. 9(2): p. 151-4.
26. Reid, C.J. and M. Borzyskowski, Lower urinary tract dysfunction in cerebral palsy. *Arch Dis Child*, 1993. 68(6): p. 739-42.
27. Van Laecke, E., et al., Adequate fluid intake, urinary incontinence, and physical and/or intellectual disability. *J Urol*, 2009. 182(4 Suppl): p. 2079-84.
28. Gundogdu, G., et al., Relationship of bladder dysfunction with upper urinary tract deterioration in cerebral palsy. *J Pediatr Urol*, 2013. 9(5): p. 659-64.
29. Fernandes Silva, J.A., et al., Lower urinary tract dysfunction in children with cerebral palsy. *Neurourol Urodyn*, 2009. 28(8): p. 959-63.
30. Karaman, M.I., et al., Urodynamic findings in children with cerebral palsy. *Int J Urol*, 2005. 12(8): p. 717-20.
31. Anigilaje, E.A. and T.T. Bitto, Prevalence and Predictors of Urinary Tract Infections among Children with Cerebral Palsy in Makurdi, Nigeria. *Int J Nephrol*, 2013. 2013: p. 937268.
32. Murphy, K.P., S.A. Boutin, and K.R. Ide, Cerebral palsy, neurogenic bladder, and outcomes of lifetime care. *Dev Med Child Neurol*, 2012. 54(10): p. 945-50.
33. Roijen, L.E., et al., Development of bladder control in children and adolescents with cerebral palsy. *Dev Med Child Neurol*, 2001. 43(2): p. 103-7.
34. Chase, J.W., et al., Functional constipation in children. *J Urol*, 2004. 171(6 Pt 2): p. 2641-3.
35. Bohmer, C.J., et al., The prevalence of constipation in institutionalized people with intellectual disability. *J Intellect Disabil Res*, 2001. 45(Pt 3): p. 212-8.
36. Krogh, K., P. Christensen, and S. Laurberg, Colorectal symptoms in patients with neurological diseases. *Acta Neurol Scand*, 2001. 103(6): p. 335-43.

37. Szymanski, L. and B.H. King, Practice parameters for the assessment and treatment of children, adolescents, and adults with mental retardation and comorbid mental disorders. American Academy of Child and Adolescent Psychiatry Working Group on Quality Issues. *J Am Acad Child Adolesc Psychiatry*, 1999. 38(12 Suppl): p. 5S-31S.
38. von Gontard, A. and M. Equit, Comorbidity of ADHD and incontinence in children. *Eur Child Adolesc Psychiatry*. 24(2): p. 127-40.
39. Dhondt, K., et al., Sleep fragmentation and increased periodic limb movements are more common in children with nocturnal enuresis. *Acta Paediatr*. 103(6): p. e268-72.
40. Dhondt, K., et al., Abnormal sleep architecture and refractory nocturnal enuresis. *J Urol*, 2009. 182(4 Suppl): p. 1961-5.
41. Dhondt, K., et al., Sleep fragmentation and periodic limb movements in children with monosymptomatic nocturnal enuresis and polyuria. *Pediatr Nephrol*. 30(7): p. 1157-62.
42. Jan, J.E. and R.D. Freeman, Melatonin therapy for circadian rhythm sleep disorders in children with multiple disabilities: what have we learned in the last decade? *Dev Med Child Neurol*, 2004. 46(11): p. 776-82.
43. Newman, C.J., M. O'Regan, and O. Hensey, Sleep disorders in children with cerebral palsy. *Dev Med Child Neurol*, 2006. 48(7): p. 564-8.
44. Kotagal, S., V.P. Gibbons, and J.A. Stith, Sleep abnormalities in patients with severe cerebral palsy. *Dev Med Child Neurol*, 1994. 36(4): p. 304-11.
45. Svedberg, L.E., et al., Parental perception of cold extremities and other accompanying symptoms in children with cerebral palsy. *Eur J Paediatr Neurol*, 2008. 12(2): p. 89-96.
46. Martinez-Lage, J.F., et al., Midline cutaneous lumbosacral lesions: not always a sign of occult spinal dysraphism. *Childs Nerv Syst*, 2006. 22(6): p. 623-7.
47. Austin, P.F., et al., The standardization of terminology of lower urinary tract function in children and adolescents: update report from the Standardization Committee of the International Children's Continence Society. *J Urol*. 191(6): p. 1863-1865 e13.
48. Burgers, R.E., et al., Management of functional constipation in children with lower urinary tract symptoms: report from the Standardization Committee of the International Children's Continence Society. *J Urol*. 190(1): p. 29-36.
49. Franco, I., A. von Gontard, and M. De Gennaro, Evaluation and treatment of nonmonosymptomatic nocturnal enuresis: a standardization document from the International Children's Continence Society. *J Pediatr Urol*. 9(2): p. 234-43.
50. Chang, S.J., et al., Treatment of daytime urinary incontinence: A standardization document from the International Children's Continence Society. *Neurourol Urodyn*.
51. Van Laecke, E., et al., The daytime alarm: a useful device for the treatment of children with daytime incontinence. *J Urol*, 2006. 176(1): p. 325-7.
52. Lancioni, G.E., I. Van Bergen, and F. Furniss, Urine alarms and prompts for fostering daytime urinary continence in a student with multiple disabilities: a replication study. *Percept Mot Skills*, 2002. 94(3 Pt 1): p. 867-70.
53. Nijman, R.J., Role of antimuscarinics in the treatment of nonneurogenic daytime urinary incontinence in children. *Urology*, 2004. 63(3 Suppl 1): p. 45-50.
54. McKeage, K., Propiverine: a review of its use in the treatment of adults and children with overactive bladder associated with idiopathic or neurogenic detrusor overactivity, and in men with lower urinary tract symptoms. *Clin Drug Investig*. 33(1): p. 71-91.
55. Neveus, T., et al., Evaluation of and treatment for monosymptomatic enuresis: a standardization document from the International Children's Continence Society. *J Urol*. 183(2): p. 441-7.
56. Game, X., et al., Botulinum toxin-A (Botox) intradetrusor injections in children with neurogenic detrusor overactivity/neurogenic overactive bladder: a systematic literature review. *J Pediatr Urol*, 2009. 5(3): p. 156-64.
57. Hoebeke, P., et al., The effect of botulinum-A toxin in incontinent children with therapy resistant overactive detrusor. *J Urol*, 2006. 176(1): p. 328-30; discussion 330-1.
58. Rawashdeh, Y.F., et al., International Children's Continence Society's recommendations for therapeutic intervention in congenital neuropathic bladder and bowel dysfunction in children. *Neurourol Urodyn*. 31(5): p. 615-20.
59. Kupferman, J.C., C.M. Druschel, and G.S. Kupchik, Increased prevalence of renal and urinary tract anomalies in children with Down syndrome. *Pediatrics*, 2009. 124(4): p. e615-21.

NEUROLOGIC URINARY AND FAECAL INCONTINENCE

Chairman

A. Apostolidis (Greece)

Co-Chairman

M.J. Drake (U.K.)

Members

A. Emmanuel (U.K.),
J. Gajewski (Canada),
R. Hamid (UK),
J. Heesackers (Netherlands),
T. Kessler (Switzerland),
H. Madersbacher (Austria),
A. Mangera (UK),
J. Panicker (U.K.),
P. Radziszewski (Poland),
R. Sakakibara (Japan),
K.-D. Sievert (Germany),
J.-J. Wyndaele (Belgium)

CONTENTS

LIST OF ABBREVIATIONS	1095	7. Meningitis-retention syndrome	1200
I. INTRODUCTION	1096	8. Acute disseminated encephalomyelitis (ADEM)	1202
1. The evidence base	1097	9. Spinal canal stenosis	1203
II. PATHOPHYSIOLOGY	1098	10. Cauda Equina Syndrome	1204
1. Suprapontine lesions	1098	11. Transverse myelitis	1205
2. Pontine lesions	1099	12. Neuropathies and muscle disorders.	1207
3. Suprasacral spinal cord lesions	1099	13. Familial Amyloid Polyneuropathy	1209
4. Sacral and subsacral lesions	1101	14. Familial Dysautonomia	1209
III. NEUROLOGICAL URINARY INCONTINENCE	1102	15. Charcot-Marie-Tooth disease	1209
1. Epidemiology (Introduction)	1102	16. Autonomic Neuropathies	1210
2. Specific diagnostics	1103	17. Disorders of the neuromuscular junction	1210
3. Conservative treatment	1115	18. Muscle Disorders	1210
4. Pharmacotherapy	1121	19. Peripheral neuropathy due to iatrogenic lesions (focal neuropathy)	1211
5. Minimally invasive treatments	1128	20. Multiple Sclerosis	1213
6. Surgical treatment of urinary incontinence	1142	21. Spinal cord lesions	1216
IV. NEUROLOGICAL FAECAL INCONTINENCE	1178	22. Spina bifida	1231
1. Epidemiology	1178	23. Diabetes Mellitus	1234
2. Pathophysiology	1178	24. Systemic and other conditions	1237
3. Assessment	1178	REFERENCES	1240
4. Conservative treatment	1178	I. INTRODUCTION	1240
5. Surgical treatment	1179	II. PATHOPHYSIOLOGY	1240
V. SPECIFIC NEUROLOGICAL DISEASES	1180	III. NEUROLOGICAL URINARY INCONTINENCE	1242
1. Dementias	1180	IV. NEUROLOGICAL FAECAL INCONTINENCE	1279
2. Constipation and Faecal Incontinence in dementia	1185	V. SPECIFIC NEUROLOGICAL DISEASES	1280
3. Normal pressure hydrocephalus	1186		
4. Multiple system atrophy	1187		
5. Parkinson's disease	1192		
6. Cerebral lesions and cerebrovascular accidents	1196		

NEUROLOGIC URINARY AND FAECAL INCONTINENCE

A. APOSTOLIDIS (GREECE)

M.J. DRAKE (U.K.), A. EMMANUEL (U.K.), J. GAJEWSKI (CANADA), R. HAMID (UK), J. HEESAKKERS (NETHERLANDS), T. KESSLER (SWITZERLAND), H. MADERSBACHER (AUSTRIA), A. MANGERA (UK), J. PANICKER (U.K.), P. RADZISZEWSKI (POLAND), R. SAKAKIBARA (JAPAN), K.-D. SIEVERT (GERMANY), J.-J. WYNDAELE (BELGIUM)

LIST OF ABBREVIATIONS

Most abbreviations used in the text are given here. Others may be given within the front of the section in which they are used.

Ach	acetylcholine	DRS	digital rectal stimulation
AChE	acetylcholinesterase	DSD	detrusor sphincter dyssynergia
AD	autonomic dysreflexia	ES	electrical stimulation
ADL	activities of daily living	EAS	external anal sphincter
ALD	Alzheimer's disease	EMG	electromyography
AS	anal sphincter	EPT	electric perception threshold
AUS	artificial urethral sphincter	FI	faecal incontinence
BBB	Blood-brain barrier	FTD	fronto-temporal dementia
BCR	bulbocavernosus reflex	GBS	Guillain-Barre Syndrome
BST	bethanechol supersensitivity test	ID	indwelling catheter
CC	cystometric capacity	IC	intermittent catheterization
CIC	clean intermittent catheterization	IVES	intravesical electrical stimulation
CMG	cystometrogram	IWT	ice water test
CPG	clinical practice guideline	LGIT	lower gastrointestinal tract
CPT	current perception threshold	LMNL	lower motor neuron lesion
CT	computer tomography	LOE	level of evidence
CTT	colonic transit time	LS	lumbosacral
CUM	continuous urodynamic monitoring	LUT	lower urinary tract
CVA	cerebro-vascular accident	LUTD	lower urinary tract dysfunction
CVC	conventional cystometry	LUTS	lower urinary tract symptoms
DI	double incontinence	Pdet max	maximum detrusor pressure
DLB	dementia with Lewy bodies	MMC	meningomyelocoele
DOA	detrusor overactivity	MUP	motor unit potential
		MRI	magnetic resonance imaging
		MS	multiple sclerosis
		MSA	multiple system atrophy
		NBo	neurogenic bowel
		NBoD	neurogenic bowel dysfunction

NDO	neurogenic detrusor overactivity
NLUTD	neurological lower urinary tract dysfunction
NUI	neurogenic urinary incontinence
NFC	natural fill cystometry
OR	odds ratio
PD	Parkinson's disease
PF	pelvic floor
PFD	pelvic floor dysfunction
PSP	progressive supranuclear palsy
Psym	parasympathetic
PVR	post void residual
QoL	quality of life
RCT	randomised controlled trial
SARS	sacral anterior root stimulation
SCI	spinal cord injury
SCL	spinal cord lesion
SDAF	sacral deafferentation
SIC	sterile intermittent catheterization
SLE	systemic lupus erythematosus
SNS	sacral nerve stimulation
SOM	somatic
SPC	suprapubic catheter
SSEP	somatosensory evoked potentials
SSR	sympathetic skin response
SUI	stress urinary incontinence
Sym	sympathetic
TBI	traumatic brain injury
TRI	transrectal irrigation
TURS	transurethral sphincterotomy
UFM	uroflowmetry
UI	urinary incontinence
UMN	upper motor neuron
US	urethral sphincter
U/S	ultrasound
UTI	urinary tract infection
UUT	upper urinary tract
VCUG	voiding cystourethrogram
VSD	vesicosphincteric disorders
VUR	vesicoureteric reflux

WBC white blood cells

I. INTRODUCTION

This chapter deals with neurologic urinary and faecal incontinence; it draws on previous ICI reports, and complements information in other ICI chapters. In developing the content, literature searches were undertaken with the keywords; "neurologic", "neurogenic", "bladder", "bowel", "lower urinary tract", "anorectal", "incontinence", "continence", "urinary", "faecal", "paralysis", "dysfunction", "retention", "constipation". Searches for specific neurologic diseases (section E) were undertaken, looking into selected neurological diseases of particular relevance to neurourology, comprising the more prevalent or more challenging in terms of incontinence diagnosis and treatment.

Continence relates to reservoir functions of the bladder and rectum, and closure of their respective outlets by contraction of smooth muscle (bladder neck and internal bowel sphincter) and striated muscle urethral and anal sphincters. Expulsion requires relaxation of these latter structures, and contraction of the musculature of the respective reservoirs, to permit a physiological reflex evacuation of urine or faeces.

The lower urinary tract (LUT) and the lower bowel tract (LBT) are interrelated structures. Embryologically, bladder and rectum originate from the same basic structure, the cloaca [1]. Anatomically both viscera lie in close proximity to each other, and to the muscular structures of the pelvic floor. Both are innervated by autonomic and somatic nerves (**table 1**), and have similar principles of central control [2, 3]. The LBT differs from the bladder in having an enteric nervous system [4]. Interactions between the two organ systems are increasingly recognised, and their activity is co-ordinated. Voiding can occur without defecation [5], and the initiation of micturition often precedes that of defecation, even if both organs are considered equally full [6]. The filling status of the bladder influences sensation in the rectum and vice versa [7], and the potential for mutual influence in pathology is emerging [8]. Nonetheless, little information is available on co-ordination of both functions in patients with neurological pathology.

Table 1: Overview of function of the abdominal sympathetic, the pelvic parasympathetic and somatic nerves in the LUT and LBT.

	Sympathetic T10-L1	Parasympathetic S2-4	Somatic S3-5
Bladder	-	+	
Bladder neck	+	-	
External urethral sphincter	exp	exp	+
Bowel		+	
Internal anal sphincter	+	-	
External anal sphincter	exp	exp	+
Pelvic floor			+

Exp= only suggested in animal experiments, no definite clinical evidence.

1. THE EVIDENCE BASE

Neurogenic lower urinary tract dysfunction (NLUTD) is a term that applies to an extraordinarily diverse spectrum of clinical conditions. This heterogeneity can be appreciated by considering the different challenges faced by the infant born with myelomeningo-coele and the elderly patient with dementia-associated incontinence. Some order can be imposed by grouping conditions based on their cause and site of impact on the neuraxis (see table 2) [9].

Historical data demonstrates that the management of NLUTD has made huge advances over the last century, largely based on a trial and error approach and

the dissemination of expert opinion [10]. Improved outcomes for patients were the result of the development of a urodynamic-based understanding of pathophysiology, the introduction of effective treatments to allow safe and reliable urine storage and intermittent catheterisation, the advent of more effective antibiotics and the development of better catheters and appliances. However, the historical approach is accompanied by significant problems. Dangerous or ineffective treatments can be trialled out-with an appropriate ethical framework and successful therapies can be slow to be introduced because their proponents may not convince their peers of the merits of the new treatment.

Table 2: categorisation of neurological lesions according to time of onset, clinical course and CNS location, with example conditions.

	Congenital and perinatal lesions	Acquired, stable conditions	Acquired, progressive conditions
Brain and brainstem	Cerebral palsy	Stroke, Head injury	Multiple sclerosis,* Parkinson's disease, Dementia, Multiple System Atrophy*
Suprasacral spinal cord	Hereditary spastic paraparesis, Spinal dysraphism*	Trauma	Multiple sclerosis*, Spondylosis with myelopathy
Sacral spinal cord	Spinal dysraphism, Sacral agenesis, Ano-rectal anomaly	Conus injury	Tumour
Subsacral	Spinal dysraphism, Familial dysautonomia	Cauda equina injury, Pelvic nerve injury	Tumour, Peripheral neuropathy (e.g. diabetic)

***Conditions that can arise in more than one region of the CNS.**

There is an inherent risk when an area of clinical practice has not been accompanied by a culture of high quality scientific research, and where the data which

is available is used uncritically. For example, there has long been concern that management of NLUTD by indwelling catheter drainage results in excessive

morbidity and, at first glance, published data on complication rates between different bladder management systems would appear to confirm that catheters are damaging to upper urinary tract function. However, this is based on cross-sectional data; such studies do not effectively take into account the preceding bladder management methods, the inability to randomise to different management approaches, and that catheters are typically used as a last resort in patients who have already developed problems with their urinary tracts [11]. Prospective longitudinal evaluation accounting for antecedent bladder management actually indicates that indwelling catheterisation is protective for the upper urinary tract [12].

The extensive evidence base concerning NLUTD is clearly demonstrated by the content of this chapter, but much of the evidence is contained in reports of studies which fail to meet contemporary standards for high quality evidence. How then should the clinical community respond to the challenge of improving the scientific foundations of our care for patients with NLUTD?

There are many aspects of modern management of NLUTD which will never be tested in definitive clinical trials because they appear to be of self-evident value. As a result, no trial could be conducted because the hypothesis that was to be tested would lack equipoise. For example, it would be impossible to conduct a trial that randomised spinal cord-injured patients between urodynamic-led and clinical-led treatment planning. However, that does not preclude the need to question these standard approaches. For example, such a study could be conducted in the context of multiple sclerosis where different approaches have been advocated [13, 14].

Despite the difficulties of conducting high quality trials in the field of NLUTD, there are an increasing number of studies that demonstrate the feasibility of such studies. Large, industry-sponsored studies have been conducted and are capable of providing near-definitive data on important clinical questions [15, 16]. However, even where high-quality data exists for some patient groups, there may be little or no data for others; spinal cord-injured and multiple sclerosis patients have been shown to respond to intra-detrusor injections of botulinum neurotoxin A but there is a dearth of data on patients with neurogenic detrusor overactivity (DO) due to intracranial conditions. Extrapolation from one condition to another is inevitably going to be needed but would be aided by even small, well-conceived trials that looked at patients with less common conditions.

There are a large number of interventions that have only been assessed by low quality methodologies, typically uncontrolled case-series. In some cases, such as that of the artificial urinary sphincter, there is sufficient data on which to base an evaluation, whereas other procedures still await a more complete assessment; the majority of alternative operations

used to treat neurogenic stress incontinence fall in this category.

Finally, there is the question of how to evaluate new investigative and treatment techniques. Drug therapies are tightly controlled by regulatory authorities but it is common for drugs to be extensively investigated in the non-neurogenic population but not in patients with NLUTD. It is to be hoped that tighter regulation and the demonstration that NLUTD trials are feasible will encourage drug evaluation in this patient group. For devices and surgical procedures, regulation is less tight and it is therefore for the clinical body to resist the premature introduction of techniques that lack an appropriate evidence base. There is a need for multi-centre cooperation in clinical trials that are designed to look, not only at short-term clinical efficacy, but also at long term results, complications and cost-effectiveness of new interventions.

II. PATHOPHYSIOLOGY

With a neurologic lesion the type of dysfunction that follows in LUT (and LBT) will depend on the site, the extent and the evolution of the deficit. Traditionally neuro-urological pathology has been divided into the upper motor neuron lesions (UMNL), comprising suprapontine (cerebral) and suprasacral (brainstem, and spinal cord); and lower motor neuron lesions (LMNL), comprising sacral and subsacral (cauda equina and peripheral nerve). Brainstem lesions are rarely compatible with more than short-term survival, so they are only infrequently encountered in neuro-urological practice.

Very recently Powell proposed a new step in classification of the neurogenic bladder: SALE (Stratify by Anatomic Location and Etiology). The classification is based on seven categories, each having a neurologic defect in a distinct anatomic location. In addition, the presence or absence of bowel dysfunction and autonomic dysreflexia is reported. In the future, as more definite prognostic information can be gleaned from biomarkers, urinary nerve growth factor (NGF) and urinary brain-derived neurotrophic factor (BDNF) levels can be added to the classification. The SALE system should efficiently describe a patient suffering from NGB and simultaneously inform the most appropriate treatment, follow-up regimen, and long-term prognosis. [1]

1. SUPRAPONTINE LESIONS

In suprapontine lesions a neurologic LUTD may be a direct consequence of the neurologic lesion, but may also be due to or changed by other conditions: e.g. motor and cognitive dysfunctions may lead to “functional” incontinence.

There is growing knowledge about how cerebral suprapontine regions are related to the LUT function. The location and extent of a suprapontine lesion will

determine the resulting symptoms and if they are reversible or not. While historically a close clinical observation, post-mortem or surgical evaluation were the main link between LUTD and brain lesions, the modern functional neuroimaging has illustrated such interaction better and has permitted to highlight smaller lesions. [2]

The current model of central LUT control consists of a network of interconnected brain regions involved in the switch between storage and voiding. A recent overview accepts functional roles of the supplementary motor area, dorsal anterior cingulate cortex, lateral prefrontal cortex, thalamus, insula. [3] It is important that there is laterality of cerebral control networks, which can influence the dysfunction in unilateral pathology. Speculations have been made regarding the role of neural circuits but, what is still lacking is a full understanding of connectivity of cerebral control networks.

The cerebral control of the urethral sphincter will depend on voluntary and involuntary control by different parts of the brain. [4]

Supra-Pontine neurologic lesions differ from other neurologic insults because they lead to loss of tonic inhibition of the pontine micturition center (PMC). This can lead to spontaneous involuntary DO, which is different from DO that occurs after supra-sacral SCI. The supra-pontine lesions are overall characterized by storage dysfunction. Normal uroflow and normal post voiding residual (PVR) can often be expected. In some cases detrusor underactivity (DU) has been reported, as well as DO with impaired contraction (DOIC). So it is important to acknowledge that DO is not the only finding in supra-pontine injury. [5] Moreover there may be loss of one or more of the cerebral activities, such as volitional control over timing of emptying, inhibition of bladder, conscious filling and emptying sensations and some integration functions with other organ systems and activities of daily life. One should not overlook the importance of the loss of mobility and of initiative /cognition. This is not seldom the case in such brain lesions as stroke or head injury, which mostly continue to have a synergic LUT function. In many cases there will be OAB syndrome, the patients may purposely increase sphincter activity during an overactive detrusor contraction to prevent urinary incontinence which would otherwise occur. [6] This has been termed "pseudo-dyssynergia" because it is difficult to distinguish from true detrusor sphincter dyssynergia (DSD) on an urodynamic record.

New knowledge is developing. The CNS, once considered to be an immune-privileged area may instead be an active surveillance site, with bidirectional communication with the immune system. This finding has led to a significant interest in neuroimmunological interactions and investigation into the role of the immune system in the pathology of various neurological disorders. The proposal has been made that the relationship between peripheral immune cells, the brain, and the urologic system

should be considered as an additional possible mechanism in urologic diseases, and that immunotherapy might be an alternative therapeutic strategy in treating neurogenic bladder dysfunction. [7] [8]

A growing body of evidence suggests that 5-hydroxytryptamine (5-HT; serotonin) has both physiological and pathological functions in the LUT. In the central pathways controlling the micturition reflex, 5-HT1A, 5-HT2A, and 5-HT7 are involved in regulation of bladder and urethral sphincter activities. Their functions, especially that of 5-HT1A, vary in a species- and site (spinal or supraspinal)- dependent manner. [9]

A similar relationship between the bladder and mitochondrial function in the regulation of cellular energetics and metabolism was described as in heart failure. Though there are currently no pharmacologic agents that directly affect mitochondrial biogenesis in organ failure, current advances in the development of therapy including mitochondrial biogenesis, mitochondrial oxidative stress and mitochondrial pore transition proteins might become important in the future. [10]

2. PONTINE LESIONS

The dorsal pontine tegmentum has been established as the seat of the micturition centre. Lesions at that level are rare, but may lead to DO and DSD. This can occur in multiple system atrophy (MSA; formerly known as Shy-Drager syndrome). In view of the crucial role of the pons in key homeostatic and physiological functions, only a limited extent of pontine dysfunction is compatible with life.

3. SUPRASACRAL SPINAL CORD LESIONS

3.1. Complete suprasacral lesions

A lesion resulting in a completely transected spinal cord which occurs above the level of the conus medullaris (L1/L2), leads to a cranial cord segment and a caudal cord segment which cease to communicate (Fig 1). The caudal segment therefore becomes autonomous and is known as the **distal autonomous cord**. This leads to an upper motor neurone picture in the affected limbs with hypertonicity, spasticity, absent sensation and hyperreflexia. Occasionally, a lesion above the conus medullaris may extend into the lumbar and sacral segments of the conus and lead to lower motor neurone effects in the affected limbs. The

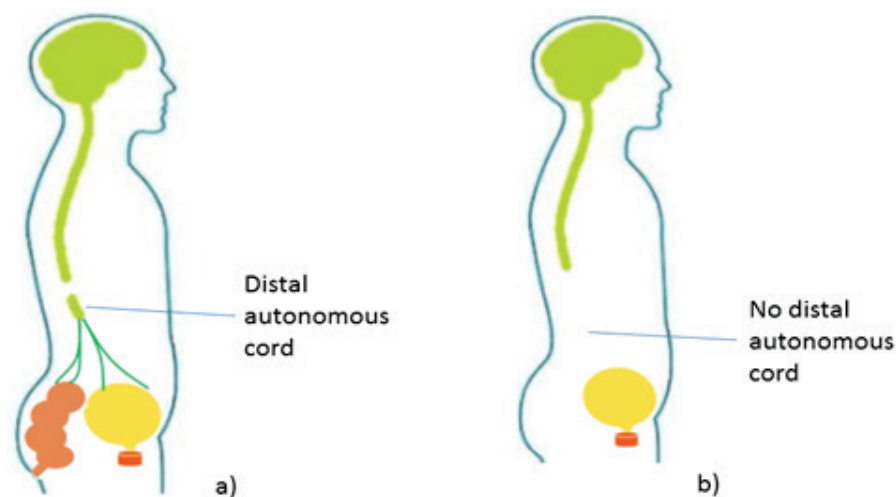

Figure 1: Diagrammatic representation of complete spinal cord injury with a) distal autonomous cord present leads to spasticity, hypertonicity and hyperreflexia in limbs and reflex activity and DSD for the bladder and sphincter respectively, b) No distal autonomous cord/ sacral lesion leads to flaccidity and areflexia in limbs and an areflexic bladder with a flaccid sphincter.

resulting LUT dysfunction in this case will follow a sacral pattern rather than a suprasacral pattern. Therefore it is not just the level of injury which is important but the extent of injury and whether it leads to a distal autonomous cord (Fig 1).

With complete suprasacral injury, micturition, which was once controlled by the pontine micturition centre becomes essentially an unmodulated spinal reflex. Previously quiescent, C fibre afferents become activated and the patient develops a **reflex bladder**. As the bladder fills and pressure rises it contracts automatically leading to involuntary urination, seen as neurogenic detrusor overactivity on an urodynamic study. The guarding reflex (which contracts the urethral sphincter on urine entering the bladder neck) is no longer synchronised with voiding (as this is co-ordinated by the pons). This leads to detrusor sphincter dyssynergia (DSD) i.e. concomitant contraction of the urethral sphincter during bladder contraction. [11]

Incontinence is caused by detrusor overactivity when the bladder pressure overcomes the sphincteric resistance or when the sphincter fatigues. The bladder also may not empty to completion as it is reliant on the neurogenic detrusor overactivity (reflex contractions) to empty and is impeded by the DSD.

Another feature of the distal autonomous cord is **autonomic dysreflexia**. This can be potentially life threatening. This occurs due to a painful stimulus occurring in the distal autonomous cord which is above T6. The effect is vasoconstriction, piloerection and sweating in the region supplied by the distal autonomous cord. This leads to the dumping of blood from the areas supplied by this region into the circulation of the regions above the spinal lesion resulting in significant hypertension. The body's response is to precipitate a reflex bradycardia and vasodilatation which

can only occur in the areas under suprapontine control i.e. those above the lesion. [12] This results in the visibly characteristic vasoconstriction in the skin below the level of SCI and vasodilation above.

A complete suprasacral cord injury results in a reflex bladder with DSD. The important aspects worth considering are that: [1] bladder contraction involves different afferent fibres (experiments in cats indicate that the relevant afferents are the C-fibres) [13] [2] bladder contractions are poorly sustained, [3] the urethra and bladder become dyssynergic, and [4] previously irrelevant stimuli influence the bladder and/or external sphincter activity. Also voluntary inhibition of the micturition reflex is lost, though some consciousness of bladder sensation may still be present.

Of 489 patients assessed by Kaplan et al. it was shown that all those with suprasacral cord lesions without sacral cord signs (complete SCI) had detrusor overactivity and DSD and in those with sacral cord signs (incomplete injury) 84% had an areflexic bladder. [14] Another study by Weld and Dmochowski of 196 veterans with suprasacral injuries revealed 95% had NDO and/or DSD. [15] Six patients (3%) all with lumbar injuries had bladder areflexia and fit the subsacral pattern described below.

DSD may cause incomplete emptying and with prolonged detrusor contractions structural bladder changes may occur resulting in bladder fibrosis and poor compliance with vesico-ureteric reflux. When combined with recurrent urinary tract infections, renal failure may result. This is more common with continuous than intermittent DSD although both require long term follow-up. [16] More than half of men develop urological complications and are considered to be at high risk of upper tract damage.

3.2. Incomplete suprasacral lesions

Incomplete suprasacral injuries can take many forms but four common patterns of injury have been described. **Anterior cord syndrome**, usually occurs due to disruption of the anterior spinal artery leading to reduced or absent motor activity and pain/ temperature sensation but proprioception is retained. In contradistinction, **posterior cord syndrome** for example due to tabes dorsalis affects only proprioception. **Lateral cord syndrome** also known as Brown Sequard leads to ipsilateral loss of power and proprioception and contralateral loss of pain and temperature sensation. The most common pattern however, is seen due to traumatic neck hyperextension during a fall and is termed **central cord syndrome**. [17] Due to lamination in the spinal cord, the upper limbs are more affected than lower limbs (as they lie closer to the central canal) and the former are more likely to show lower motor neurone features compared to the latter which demonstrate spasticity. Sensation also disproportionately affects the upper limbs. Recovery is also more likely in the less affected lower limb. [18]

Incomplete suprasacral lesions lead to variable bladder and sphincteric function. Anterior cord injury leads to detrusor overactivity in the majority of patients, and DSD is also a possibility dependent on how extensive the injury is and which parts of the cord are affected. The pathways co-ordinating the bladder and sphincter are located mostly in the lateral columns and if these are affected DSD may occur. [19] If the dorsal columns are unaffected, bladder sensation is spared. [20] The risk of upper tract injury is based on the individual circumstances.

A urodynamic study of 22 veterans with central cord syndrome revealed normal findings in three men, detrusor areflexia in four, DSD in 11, detrusor overactivity without DSD in one and detrusor underactivity in one, also two men had BOO due to BPH. [21] Therefore it is clear that the LUT function in central cord syndrome will be variable and the risk of upper tract damage due to DSD or poor compliance needs to be considered but is not common and also sensation is reported to be preserved. [22]

With Brown Sequard syndrome, urodynamic studies in eight patients revealed detrusor overactivity in four, an areflexic detrusor in three and DSD in four patients. [23] In a study of 269 patients with spinal cord lesions, those with unimpaired sensation and younger age were most likely to recover acceptable bladder function. [24] Brown Sequard and central cord syndromes carried the best prognosis for recovery of bladder function.

4. SACRAL AND SUBSACRAL LESIONS

Lesions of the conus medullaris and cauda equina are characterized by motor and sensory symptoms in the lower limbs, buttocks, perineum accompanying

the dysfunctions of bladder, bowel and sexual activity: the "cauda equina syndrome". [25] As the axons with roots from cauda equina extend into the spinal cord, dysfunctions caused by a lesion of conus or cauda are similar thus making distinction between them on clinical grounds difficult. [26]

4.1. Sacral (conus medullaris) lesions

The intermediolateral nucleus contains the motor nuclei of the autonomic nervous system. In the sacral spinal cord, this region is parasympathetic, and damage to the nucleus renders the detrusor areflexic. Resulting retention of urine can cause incontinence (formerly termed overflow incontinence). Onuf's nucleus, located medially in the ventral horn of the sacral spinal cord, is a mixed autonomic/ somatic nucleus containing the motor nuclei for the LUT and LBT outlets. Damage to this structure affects sphincters (and some pelvic floor musculature), and thus stress incontinence may result. If the pudendal nerve is also impaired, there is an increased risk for incontinence.

The functioning of a sacral or areflexic bladder depends on the sphincteric resistance (detrusor leak point pressure). The bladder will fill up to the detrusor leak point pressure and empty by over flow. There will be no detrusor contraction. The bladder may develop poor compliance and pose some risk to the upper tracts. The symptoms can be acute with motor and sensory changes as when central large lumbar disc herniation occurs. Chronic symptoms may occur when degenerative disc disease and osteoarthritis of the spine create gradually narrowing of the spinal canal and/or foramina.

4.2. Subsacral lesions (cauda equina or peripheral nerves)

The same effects as seen with lesions of the conus medullaris can result from lesions of the subsacral nerves (the cauda equina, or the peripheral nerves including the pudendal nerves). The main function of peripheral nerves is the communication between the CNS and peripheral effector organs. Lesions at that level can occur by different causes as infections (cytomegalovirus, herpes), fractures, surgery, radiotherapy and many more. Peripheral neuropathies are found in a long list of conditions as diabetes, alcohol abuse, Guillain-Barré et al. [27] [28] Both parasympathetic and somatic motor function will potentially be impaired; the detrusor can be underactive or areflexic and the external sphincter can be paralyzed. These lesions can also cause a variety of sensory deficits. Some pain and/or filling sensation can be retained because of intact sympathetic hypogastric nerves, which enter the spinal cord in thoracic roots. The bladder neck is predominantly innervated by sympathetic pathways, and so it can retain some function in sacral injury. If there is extensive autonomic damage, the bladder neck remains open. [29]

Iatrogenic causes of focal pelvic nerve lesions have been described with abdominoperineal resection,

III. NEUROLOGICAL URINARY INCONTINENCE

1. EPIDEMIOLOGY (INTRODUCTION)

though these are probably less frequent with intraoperative neuro-monitoring. It has been studied in hysterectomy, where nerve sparing techniques offer a better outcome. [30] [31] Also in radical prostatectomy enhanced attention to the innervation at the time of surgery may result in improved preservation. [32] Complete lesions of all local innervation, are followed by a silent, painless distension of the bladder. Urinary retention follows, leading to incontinence by overfilling, though if the external urethral sphincter is also denervated stress urinary incontinence (SUI) and even continuous urine leakage may occur. When lesions are partial, sensory symptoms may predominate. But patients, especially women, can report “spontaneous voiding” with Valsalva. In patients with a presumed isolated PNS involvement (as in Guillain-Barré syndrome), DO with or without DSD has been described. [33] [34]

In patients with a complete cauda equina or a lower conus lesion, a sensory input from the bladder can be preserved and is possibly transferred through the intact hypogastric plexus to the thoracolumbar segments of the spinal cord. [35]

Conclusions (LOE = 1)

- With a neurologic lesion the type of dysfunction that follows in LUT (and LBT) will depend on the site, the extent and the evolution of the deficit.
- Distinction is made between suprapontine, pontine, sacral and subsacral lesions.

Recommendations (grade A)

- It seems worthwhile to further evaluate the classification of the neurogenic bladder: stratified by Anatomic Location and Etiology (SALE). Beside classifying into seven categories, each corresponding with a neurologic defect in a distinct anatomic location, the presence or absence of bowel dysfunction and autonomic dysreflexia is reported.
- In the future, if further evaluation confirms their importance, prognostic information as from biomarkers, NGF and BDNF, can be added to the classification and will be an important avenue for further research.
- As such the classification describes a patient suffering from NGB and simultaneously informs about the most appropriate treatment, follow-up regimen, and long-term prognosis

NLUTD may be caused by a variety of neurological diseases and/or events affecting the various parts of the nervous systems controlling the LUT. The resultant dysfunction depends grossly on the location, extent, and nature of the causative neurological lesion or lesions. Overall prevalence estimates for NLUTD in the general population are scarce, but data are available on the prevalence of the underlying conditions and, in some cases, the relative risk for the development of NLUTD. It is important to realise that most of these data show a very wide range of prevalence figures, due to low level of evidence in most published data and smaller sample sizes.

Nevertheless, worldwide estimates of the prevalence of spinal cord injury (SCI) are at over 2.5 million, multiple sclerosis (MS) considerably greater than 1.5 million and Parkinson's disease (PD) approximately 3 million [1-3]. Spinal cord injuries are common, with an estimated 50 people per million sustaining a traumatic spinal injury every year in the Western world [4]. Non-traumatic injury (vascular, infection, tumour) is more common, and cancer alone is estimated to cause more SCI than trauma [5]. Traumatic injury mostly affects young men, and advances in rehabilitation medicine mean that the longevity of paraplegics is similar to the general population while that of tetraplegics is 10 years shorter [9]. The prevalence of MS is approximately 1 per 1 000 [2].

Mobility, pain and bladder dysfunction in neurological patients has been relatively well studied, while the bowel and pelvic floor dysfunction has been neglected by comparison. With rapid advances in rehabilitation medicine resulting in increased survival of patients, these individuals are experiencing bladder and bowel symptoms for ever-longer periods.

As in previous International Consultations on Incontinence reports published data on epidemiology were reported both in a separate section and in each specific neurological condition, it seemed more appropriate for the 2016 ICI report to present updates of epidemiology only with each specific neurological condition. The general conclusions and recommendations on epidemiology of the previous ICI report remain unchanged.

Conclusions

- Dysfunction of the LUT occurs in patients with a variety of neurologic diseases but precise epidemiological data is seldom available

- Common manifestations of NLUTD include urinary incontinence, voiding difficulties, and urinary retention.
- Because neurological disease is often present in elderly populations, it is frequently difficult to discriminate if LUTS are due to aging alone, or due to the presence of neurological disease. This difficulty is reflected in widely varying prevalence estimates.

Recommendations

- Patients with neurologic disease known to be associated with NLUTD should be evaluated for the presence of lower urinary tract symptoms.
- In certain neurologic disease states, NLUTD may be relatively asymptomatic, yet represent a risk of upper urinary tract impairment.
- In the appropriate clinical setting, a neurological evaluation may be recommended in a patient with unexplained LUTS and no known neurological disturbance. This is particularly true in the case of a young patient with idiopathic severe LUTS after proper office evaluation for common etiologies.
- Prevalence estimates of NLUTD would be improved by multicenter co-operative studies from large tertiary centers utilizing established outcomes and evaluation tools.

known. Lifestyle factors such as smoking, alcohol, or addictive drug use should be assessed as well as an evaluation of Quality of Life. Social impact and the degree of disability have to be taken into consideration. Patients with a spinal cord lesion above Th6 may develop autonomic dysreflexia, so a history of severe headaches should be explored.

The signs and symptoms that bring the patient to consultation must be documented. Symptoms related to storage and voiding, continence and /or retention, as well as onset and nature of the NLUTD (acute or insidious) should be determined. If appropriate this information should be compared with the patient's condition before the NLUTD developed. Bladder sensation and mode and type of voiding (catheterization) should be considered. Validated questionnaires are useful for recording symptoms, their frequency, severity and bother, and the impact of LUTS on QoL. Some instruments were not validated in NLUTD or are impossible to implement because of sensory or motor deficiency in NLUTD. An excellent review of available tools for neurological disease and urinary-specific instruments used to assess QOL associated to bladder symptoms has been written by Clark and Welk [3]. Results are summarized in Table 3 at the end of this paragraph. Warning signs and symptoms that warrant early further investigation include; fever, pain, hematuria, catheterization problems, clinical infections and signs of autonomic dysreflexia. Individuals with NLUTD may not be accurate at determining whether they have a UTI based on their symptoms [4]. UTI management is not standardised and clinical practice suffers from a weak evidence base [5].

2. SPECIFIC DIAGNOSTICS

Before any functional investigation is planned, all "basic" data should be gathered and used for further interpretation of the NLUTD [1,2]. Relevant investigations include; history and physical examination, questionnaires, urine tests, voiding diary, urodynamic studies (cystometry, electromyography (EMG), video-urodynamics, uroflowmetry, pressure-flow study), diagnostic imaging with voiding cystourethrography and ultrasonography. In this chapter are highlighted some data specially related to NLUTD. Some tests developed for the diagnosis of neurologic dysfunction are considered specifically; the bethanechol supersensitivity test, and the ice water or bladder cooling test. Neurophysiologic studies are discussed in the chapter "Clinical Neurophysiological testing", and only some data for NLUTD is given here.

2.1. History

The *general history* aims at gathering information on the neurological and congenital abnormalities, previous urinary complications or treatments. The use of medication with known or possible effects on the LUT, menstrual, sexual and bowel function, and obstetric history are also important. Hereditary or familial risk factors, metabolic diseases and other must be

Table 3: Disease- and urinary-specific instruments used to assess QOL associated to bladder symptoms (adapted from [3])

Scale	Population	Original purpose	Item generation	Internal validity	Reliability	External validity	Responsiveness and MDC*
Qualiveen [6]	SCI/MS	Cross-sectional and longitudinal examination of SCI patients	Patient interview and expert review	$\alpha > 0.80$	ICC: 0.85–0.92	Consistent with predicted correlations with SQLP	SRM > 0.75 (in patients with MS) [7] MDC: 32
SCI-SCS [8]	SCI	Cross-sectional and longitudinal examination of SCI patients	Adapted from the SCQ	$\alpha > 0.76$	ICC: 0.56–0.80	R: 0.31–0.64 between total score and 6 SF-12 domains	SRM: NE MDC: NC
SCI-QOL bladder management difficulties bank [9]	SCI	Cross-sectional and longitudinal examination of SCI patients	Adapted items from Neuro-QOL with patient interview and expert opinion	$\alpha: 0.74$	ICC: 0.74	Study in progress	SRM: NE MDC: 12
SCI-FI [10,11]	SCI	Cross-sectional and longitudinal examination of SCI patients	Interviews with patients, literature review and expert consensus	$\alpha: 0.85–0.95$	ICC: 0.90–0.99	Not evaluated	SRM: NE MDC: NC
I-QOL [12]	SUI/SCI/MS	Cross-sectional and longitudinal examination of SCI patients	Patient interview and expert review	$\alpha > 0.79$	ICC: 0.89–0.99 [13]	R: 0.36–0.59 for SF-36 mental health, social functioning and vitality domains	SRM: NE MDC: NC MID: 11 with medium effect size estimation
NBSS [14]	SCI/MS/SB	Cross-sectional and longitudinal examination of SCI and MS patients	Interviews with patients, literature review and expert consensus	$\alpha: 0.89$	ICC: 0.91	R: 0.52–0.59 with AUASS, ICIQ-UI, GBA and SF-Qualiveen total	SRM: NE MDC: 9
MSQOL-54 [15]	MS	Cross-sectional and longitudinal examination of MS patients	Adapted from SF-36 with literature and expert review	$\alpha > 0.75$	ICC: 0.66–0.96	Varying degrees of correlation with SF-36, MOS, and faces scale	SRM: 0.71 for physical health SRM: 0.57 for mental health [16] MDC: 67

Scale	Population	Original purpose	Item generation	Internal validity	Reliability	External validity	Responsiveness and MDC*
MSIS-29 [17]	MS	Cross-sectional and longitudinal examination of MS patients	Interviews with patients, literature review and expert consensus	$\alpha > 0.91$	ICC: 0.65–0.90	Consistent with predicted correlations with SF-36, FAMS, EQ-5D, GHQ-12, postal Barthel Index	Effect size: 0.66 (psychological scale), 0.82 (physical scale) MDC: 2
FAMS [18]	MS	Cross-sectional and longitudinal examination of MS patients	Interviews with patients, literature review and expert consensus	$\alpha > 0.82$	ICC: 0.85–0.91	Consistent with predicted correlations with SF-36, HADS, MDI, PSR and MCSDS	SRM: 0.58 [9] MDC: 29
HAQUAMS [19]	MS	Cross-sectional and longitudinal examination of MS patients	Items adapted from FAMS and SF-36 and expert opinion	$\alpha > 0.68$	ICC: 0.75–0.94	Consistent with predicted correlations with EDSS, T8, SDMT, 9HPT, FAMS, HADS	SRM: –0.55 in worsening patient SRM: 0.30 and 0.59 in patient undergoing intervention [20] MDC: 2
MSQLI [21]	MS	Cross-sectional and longitudinal examination of MS patients	Conglomeration of 10 scales [22]	$\alpha > 0.70$	ICC: 0.83–0.92 (for bladder scale)	R: 0.45–0.58 (for bladder scale)	SRM: NE MDC: NC
ABSST/SF [23,24]	MS	Cross-sectional and longitudinal examination of MS patients	Interviews with patients, literature review and expert consensus	$\alpha: 0.85–0.90$	ICC: 0.80	Long form R ≥ 0.782 with OAB-q SF and HRQOL scores	SRM: NE MDC: 12
QOLSB [25]	SB	Cross-sectional and longitudinal examination of children with SB	Interviews with patients/parents, literature review and expert consensus	$\alpha: 0.93–0.94$	ICC: 0.37–0.63	R: 0.26 (children) and 0.89 (adolescent) with Piers-Harris Children's Self-Concept Scale	SRM: NE MDC: NC
IIQ-7 [26]	UI			$\alpha > 0.88$	ICC > 0.8		SRM: NE

Scale	Population	Original purpose	Item generation	Internal validity	Reliability	External validity	Responsiveness and MDC*
		Cross-sectional and longitudinal examination of adults with UI	Adapted from the IIQ			Consistent with predicted correlations with EORTC QLQC30	MDC: NC
KHQ-LUTS [27]	UI	Cross-sectional and longitudinal examination of adults with UI	Adapted from the KHQ	$\alpha > 0.72$	ICC: 0.93 [28]	Consistent with predicted correlations with SF-36 [29]	SRM: NE MDC: 39
ICIQ-OAB [30]	OAB	Cross-sectional and longitudinal examination of adults with over active bladder	Interviews with patients/parents, literature review and expert consensus	$\alpha > 0.86$	ICC: 0.91–0.95 [31]	Consistent with predicted correlations with SF-36	SRM: 0.6 [32] MDC: NC

Table 3 abbreviations: QOL, quality of life; MDC*, $1.96 * [SD * \sqrt{(1-ICC)}] * \sqrt{2}$; SCI, spinal cord injury; MS, multiple sclerosis; α , Cronbach's alpha; ICC, interclass correlation coefficient; SQLP, Subjective Quality of Life Profile; SRM, standardized response mean; MDC, minimally detectable change; SCI-SCS, Spinal Cord Injury Secondary Conditions Scale; SCQ, Seekins Secondary Conditions Scale; R, Spearman correlational coefficient; NE, not established; NC, not calculable; SCI-QOL, Spinal Cord Injury Quality of Life; Neuro-QOL, Quality of Life in Neurological Disorders Measurement System; SCI-FI, Spinal Cord Injury Functional Index; I-QOL, Incontinence Quality of Life; SUI, stress urinary incontinence; SF-36, Short Form 36 Health Survey; MID, minimally important difference; NBSS, neurogenic bladder symptom score; SB, spina bifida; AUASS, American Urological Association Symptom Score; ICIQ-UI, International Consultation on Incontinence-Urinary Incontinence; GBA, Global Bladder Assessment; MSQOL-54, Multiple Sclerosis Quality of Life 54-item scale; MOS, medical outcomes study health distress measure; MSIS-29, Multiple Sclerosis Impact Scale 29-item; GHQ-12, General Health Questionnaire; FAMS, Functional Assessment of Multiple Sclerosis; MDI, multiscale depression inventory; PSR, Eastern cooperative oncology group performance status rating; MCSDS, Marlow Crowne social desirability scale; HAQUAMS, Hamburg Quality of Life Questionnaire in MS; EDSS, expanded disability status scale; T8, timed 8-minute walk; SDMT, symbol digit modalities test; 9HPT, nine hole peck test; HADS, hospital anxiety and depression scale; MSQLI, Multiple Sclerosis Quality of Life Index; ABSST, Actionable Bladder Symptom Screening Tool; SF, short form; OAB-q SF, Over Active Bladder Questionnaire; HRQOL, health related quality of life; QOLSB, Quality of Life in Spina Bifida scale; IIQ-7, Incontinence Impact Questionnaire 7-item; UI, urinary incontinence; IIQ, Incontinence Impact Questionnaire; EORTC QLQC30, EORTC Quality of Life Questionnaire; KHQ-LUTS, King's Health Questionnaire Lower Urinary Tract; ICIQ-OAB, International Consultation on Incontinence Questionnaire Overactive Bladder.

A *urinary diary* can be used to capture information on the number of voids (frequency and nocturia), the sensation at each void, volumes voided, incontinence, and volume/ time of fluid intake. Little information is available on optimal diary duration in NLUTD, considering information captured balanced against inconvenience to the patient [33]. However general recommendation is to do it at least for 3 days [34]. Some information could be difficult or impossible to collect because of sensory or motor deficiency in NLUTD. Nonetheless, such diaries deliver useful assessment for evaluating treatment outcomes [35].

A Urinary diary can be subdivided into:

1. Micturition Time Chart: this records only the times of micturitions, day and night, for at least 24 hours.
2. Frequency Volume Chart (FVC): It records the volumes voided as well as the time of each micturition, day and night, for at least 24 hours.

Bladder Diary: it records the times of micturitions and voided volumes, incontinence episodes, pad usage and other information such as fluid intake, the degree of urgency and the degree of incontinence.

2.2. Physical examination

A general impression of patient's physical and mental possibilities is relevant to the choice of investigations and treatment. Severely impaired mobility, extreme spasticity, severe mental disorder and general weakness are all important in this respect. The physical examination evaluates the lower abdomen, external genital organs and perineal skin. Palpation per vagina or per rectum is done in search of pelvic organ descent, or cervix-uterus/ prostate disease. The strength of the pelvic floor muscles should be assessed. Cardiovascular function should be considered. Patients with very high neurological lesions may suffer from a significant drop in blood pressure when changing position.

Specific examination of the lumbo-sacral innervation includes: sensation of fine touch and pin-prick in the different perineal dermatomes (Figure 2), evaluation of bulbocavernosus/ anal/ cremaster reflexes, tone of anal sphincter and voluntary contraction of the anal sphincter / pelvic floor muscles (Figure 3). Clinical neurological findings correlate well with NLUTD in some types of neuropathy such as single level traumatic spinal cord lesions [36] but less in other types like meningomyelocele or combined traumatic spinal cord lesions [37,38]. Urinary symptoms and pathological urodynamic findings increase along with the degree of motor function impairment in infantile cerebral palsy [39] The levels of vertebra lesions does not correspond to the level of nerve damage (Figure 4) [40]

2.3. Urine tests

Tests for bacteria or pyuria do not establish a diagnosis of urinary tract infection (UTI), but are helpful in

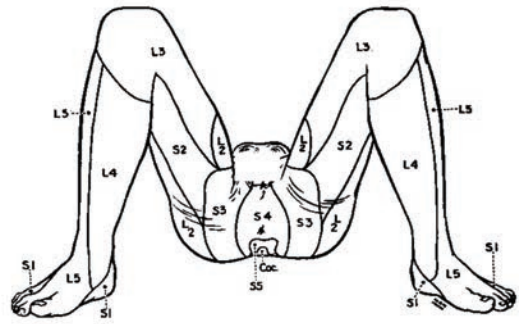

Figure 2: Dermatomes of spinal cord levels L2-S4

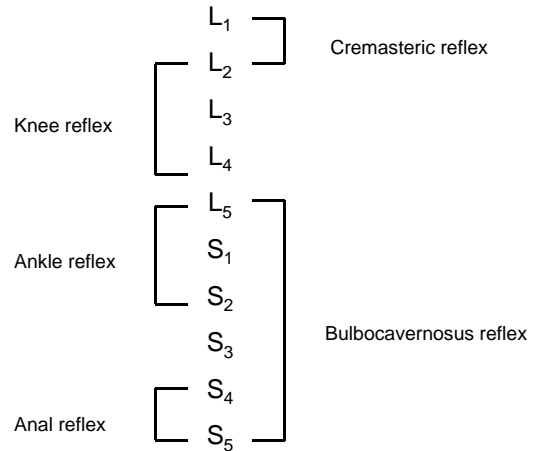

Figure 3: Urogenital and other reflexes in lower spinal cord

the context when symptoms are present. The urine sample should be collected with sterile catheter and taken to the laboratory immediately. Colony forming units $\geq 10^5$ cfu/L in an intermittent catheter specimen with symptoms present, represents sufficient diagnosis of UTI's. In clean-voided specimens from catheter-free men using condom catheters, $\geq 10^7$ (cfu/L) is a sufficient level [41]. There is however lack of other high level evidence to define UTI's in patients with NLUTD.

2.4. Urodynamic tests

Urodynamic techniques evaluate multiple functional parameters in NLUTD [42]. The International Urodynamic Basic Spinal Cord Injury (SCI) Data Set sets out data to be included in the urodynamic evaluation of patients with SCI. Variables included are; bladder sensation during filling cystometry, detrusor function

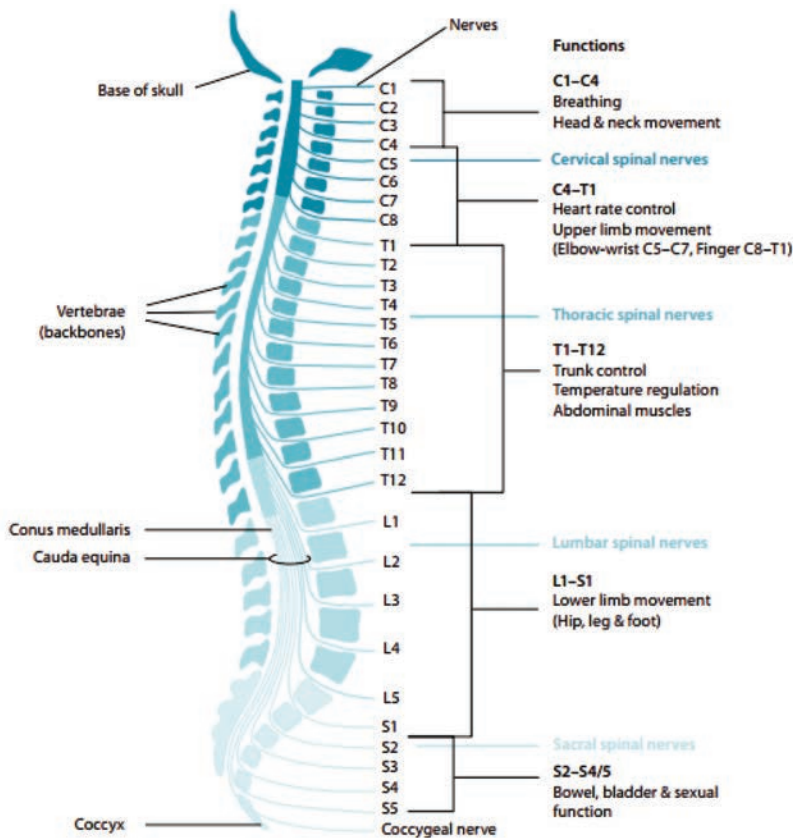

Figure 4. Levels of spinal cord injury

and compliance during filling cystometry, detrusor function during voiding, detrusor leak point pressure, maximum detrusor pressure, cystometric bladder capacity and post-void residual [16]. If the study is undertaken with video control then one has to look for reflux, bladder trabeculations and sphincter dyssynergia.

Often, the nature of NLUTD is impossible to anticipate from clinical assessment alone, exemplified by CNS tumours in children [43]. Likewise, severity of NLUTD does not necessarily correspond with severity of neurological lesion.

Electromyography (EMG) during cystogram and pressure flow studies

The basis of EMG has long been a question of debate [44, 45]. Sundin and Petersen [46] used cystometry (EMG) investigation in NLUTD for patients with an active detrusor contraction associated with impaired bladder emptying. A voluntary control of external urethral sphincter relaxation was found in most of the healthy volunteers, and cystometry-EMG gave reliable information on DSD in patients. On the other hand Kirby et al showed that perineal surface patch EMG did not measure expected pelvic floor and urethral sphincter relaxation during voiding [47]. De et al

found significant disagreement between needle EMG and VCUG for a positive diagnosis of DESD and suggested a combination of EMG and VCUG for diagnosis of DESD [48]. Perakash [49] found rhythmic detrusor contractions on cystomanometry with associated marked increase in EMG activity on attempted voiding to be relevant characteristics of patients with DSD. Rodriguez et al. [50] used EMG-gas cystometrogram to select SCI patients for removal of a Foley catheter. Important factors governing success were the amplitude of the detrusor contraction, the presence of detrusor-sphincter synergy and the presence of a flaccid sphincter. Mayo and Kiviat [51] used multichannel urodynamic studies in patients with incomplete bladder emptying secondary to suprasacral spinal cord lesions. They found that bladder pressure and sphincter EMG measurement during voiding, combined with fluoroscopy, are ideal methods to identify the factors responsible for incomplete emptying in problem cases. Perlow and Diokno [52] and Koyanagi et al. [53] found cystometry-EMG informative in SCI patients.

Blaivas et al. [54] described three types of dyssynergia. Type 1 had a crescendo increase in EMG activity that reached a maximum at the peak of the detrusor contraction, type 2 had clonic sphincter contractions

interspersed throughout the detrusor contraction and type 3 was characterized by a sustained sphincter contraction that coincided with the detrusor contraction. There was no correlation between the clinical neurologic level and the type of dyssynergia. In DSD, Rudy et al. observed clinically that increases in EMG activity and external urethral sphincter pressure were associated clearly with a positive slope of the intravesical pressure trace, whereas decreases in both parameters were associated with a negative slope [55].

Simultaneous recording of intravesical pressure, sphincter electromyography and uroflowmetry was compared by Aoki et al. [56] with cystometry EMG. They found some influence of the catheter in the urethra. Micturition pressure and opening pressure were larger with cystometry EMG, and incidence of DSD was greater. The authors also found that the Credé manoeuvre exaggerated the DSD. Urodynamics with needle electrode EMG permitted Kirby [57] to differentiate between patients with pelvic nerve injury, distal autonomic neuropathy, progressive autonomic failure - multiple system atrophy, and idiopathic Parkinson's disease. This influenced the selection of patients for transurethral surgery. Pavlakis et al. [58] studied cystometry concomitant with perineal floor and rectus abdominis EMG and were able to improve the recognition of intravesical pressure elevation owing to voluntary contraction of the abdominal musculature. EAS motor unit potential (MUP) analysis and EMG cystometry were used to differentiate multiple system atrophy (MSA) from Parkinson's disease in the first five years after disease onset. It showed that involvement of Onuf's nucleus in MSA is time-dependent; before the fifth year of illness, the prevalence of neurogenic change does not seem to be high, so a negative result cannot exclude the diagnosis of MSA [59]. Rapidi et al. used combined urodynamic and electrophysiological study in diabetic cystopathy [60].

Filling parameters

The importance of detrusor pressure has been acknowledged for many years. Filling rate is important in NLUTD, and slow filling is recommended by the International Continence Society to minimise artefactually affecting compliance [61].

Bruschini et al. [62] undertook clinical, urodynamic and imaging evaluation of the upper and lower urinary tract in inadequately managed myelomeningocele patients. The urodynamic data correlated with the status of the upper urinary tract (UUT). The cystometry showed detrusor overactivity (DO), poor compliance, increased bladder capacity and normal cystometry in 48, 49, 2 and 1% of the patients, respectively. Detrusor leak point pressure (DLPP) over 40 cm H₂O was associated with UUT damage. Patients with decrease of functional bladder capacity (FBC) had more renal scars than their counterparts. Incomplete SCI patients with neurogenic DO should be evaluated with the same caution as complete SCI patients, as

there can be little difference in cystometric capacity and leak point pressure between complete and incomplete spinal cord injury patients [63].

The importance of urodynamic tests for diagnosis and follow up was demonstrated in the study by Abrahamsson et al. [64] on urodynamic changes with untethering in myelomeningocele children. After untethering, 35% experienced improved bladder function and 5% deteriorated. All of the patients who deteriorated before untethering improved afterward, and 90% of those who were stable preoperatively continued to be stable postoperatively. Regular evaluation of bladder function in children with myelomeningocele is recommended. Kang et al. [65] used urodynamic tests to determine prognostic factors affecting urological outcome after untethering surgery for lumbosacral lipoma.

Perkash and Friedland [66] found simultaneous transrectal ultrasonography helpful. They recommended not to irritate the bladder when introducing the urodynamic catheter, and to examine the entire curve of the CMG, not simply the initial rise [67].

Filling technique

In SCI patients with neurogenic LUT dysfunction, Ko et al. [68] determined whether cystometry performed by filling using diuretics (FMCG) reveals different findings compared with conventional CMG. Significant differences between the two techniques were found in pressures and compliance in neurogenic DO, but not in hyporeflexic or areflexic bladders. Natural filling by the production of urine can change the results of cystometry considerably, and should be considered when performing urodynamic investigations and interpreting the results.

De Gennaro et al. [69] performed continuous urodynamic monitoring over six hours in children and compared this with standard urodynamics. They found continuous monitoring feasible, permitting a better diagnosis than standard cystometry in some cases. Zermann et al. [70] investigated the diagnostic value of natural fill cystometry (NFC) in children with neurologic bladder in comparison to conventional videocystometry. In 45%, NFC detected additional findings. The extra value of ambulatory urodynamics as compared to conventional urodynamics in spinal cord injury patients was investigated by Martens et al. They concluded that ambulatory urodynamics do not seem necessary for diagnosis and risk assessment in SCI patients suspected for DO when conventional urodynamics are done properly [71].

The outlet during voiding

Pressure-flow study can demonstrate an obstructive pattern (high pressure voiding) in neurologic patients due to urethral relaxation failure [72,73]. Videourodynamics (VUUDS) offers visualisation of bladder neck and urethral sphincter activity during filling and voiding [74,75]. Accordingly, VUUDS is a test that can determine the site of obstruction. Zerlin et al. [76] found

that the urographic position of the bladder neck in relation to the pubic symphysis was correlated with lower motor neuron (LMN) denervation of the urethral sphincter as detected with electromyography in infants and children with myelodysplasia. They concluded that, although not as precise as urodynamic testing, significant descent of the bladder neck is a reliable urographic finding of complete LMN denervation of the external urethral sphincter in infants and children with myelodysplasia. In men with SCI, some cystometric variables and detrusor overactivity may remain consistent over sequential studies [77].

Bladder sensation

In a large cohort study it was shown that impaired perception of bladder filling during CMG is a sign of neuropathy [78]. Nonetheless, despite spinal abnormality, patients can experience bladder filling sensation, signifying the presence of afferent pathways joining the spinal cord at higher levels. In 52 SCI patients, 26 % of those with a supposed complete lesion had sensation of bladder filling during cystometry [79]. In 41 patients with myelodysplasia the perception of bladder filling was present in a majority [80]. In a study of 26 SCI patients, bladder sensation was reported by 73% of patients in daily life. However, only 41% of patients had analyzable bladder sensation concomitant with detrusor overactivity during ambulatory Urodynamics [81].

Ersoz and Akyuz [82] investigated bladder filling sensation in 73 SCI patients with complete lesions above T11 and below T10 and with incomplete lesions. Bladder filling sensation was present to some degree in all incomplete SCI patients, in 82.4% of the patients with complete lesions below T10, and in 38.9% of the patients with complete lesions above T11. Bladder-filling sensation investigations were reproducible in terms of bladder filling sensation category in 36 SCI patients who had a second CMG. The authors concluded that presence of bladder-filling sensation in many SCI patients reveal the potential for sensation-dependent bladder emptying, especially in the ones with complete lesions below T10 and the ones with incomplete lesions. The safe use of sensation-dependent bladder emptying was shown to be dependent on the urodynamic situation [83].

The amplitude of the first overactive contraction and the maximal detrusor contraction were found to be statistically greater in female patients with multiple sclerosis and neurogenic detrusor overactivity compared to women with idiopathic overactivity. The threshold volume for detrusor overactivity was greater, likely secondary to the elevated post void residual urine volume in the MS patients. In this study using a cut off value of 30 cm H₂O for amplitude of the first overactive contraction achieved a positive predictive value of 88% for identifying multiple sclerosis [84].

Complications of urodynamic testing

Complications of cystometry include hematuria due to the urethral catheter, the development of oedema in the urinary bladder wall and urinary bladder spasm as a result of catheter irritation. One case report of twist and knot formation in the double lumen urethral catheter after cystometry of a patient with a hypocompliant bladder has been published [85]. Another case report describes bladder rupture during filling cystometry many years after bladder augmentation in a girl with meningomyelocoele [86].

Symptomatic urinary tract infections after cystometry are not infrequent and antibiotic prophylaxis has been advocated [87]. Randomised controlled trials (RCTs) comparing effectiveness of prophylactic antibiotics with placebo or nothing in reducing bacteriologically proven UTI after invasive cystometry have been done for all patients, including NLUTD [88]. The use of prophylactic antibiotics in urodynamics reduced the risk of significant bacteriuria but there was not enough evidence to suggest that this effect reduced symptomatic urinary tract infections [89].

Conclusions

- Findings of Urodynamic tests can be difficult to anticipate from clinical assessment alone in NLUTD (LOE 2)
- A combination with EMG and/or imaging adds to the diagnostic possibilities (LOE 2)
- Filling rate can influence the outcome of several urodynamic parameters (LOE 2)
- Pressure development in the bladder is one of the important parameters to be studied and high leak point pressure is a risk factor for renal deterioration (LOE 2)
- Sensation of filling may be preserved despite spinal abnormality (LOE 2)
- Complications of urodynamic testing are rare, but antibiotic prophylaxis in NLUTD can be considered (LOE 1)

Recommendations

- There is currently inadequate data (LOE3-4) to support recommendations for the use of urodynamics in each specific neurological condition. However, the use of invasive urodynamics is recommended in neurological conditions associated with 'high-pressure bladders' which may place renal function at risk (A), as opposed to 'urodynamically safe' bladder conditions (C)
- Methods of Urodynamic testing in NLUTD should follow International Continence Society recommendations (A)

2.5. Special tests

Bladder-cooling reflex; the ice water test (IWT)

The ice water test (IWT) is a C-fiber mediated reflex, first described as a way to differentiate upper from lower motor neuron lesions. It is based on the principle that mucosal temperature receptors can elicit a spinal reflex contraction of the detrusor, a reflex that is normally inhibited by supraspinal centers. An upper motor neuron lesion interrupts these inhibitory pathways, resulting in manifestation of the reflex, whereas a lower motor neuron lesion does not. A positive test should therefore theoretically occur in patients with upper motor neuron lesions, whereas those with lower motor neuron lesions and neurologically normal patients should have a negative test. Simultaneous measurement of intravesical pressure with cold fluid instillation enables evaluation of the response. Patients without neurogenic disease have a greater perception of cold during the IWT than neurogenic patients; this must be considered when evaluating test results [90]. The bladder cooling reflex was blocked in 16 out of 17 neurogenic patients when 30 mg intravesical oxybutinin was instilled [91].

There is a significant correlation between a positive IWT with abnormal sensation of bladder filling and inability to inhibit micturition voluntarily. A negative IWT also corresponded with the occurrence of phasic detrusor contractions during cystometry. The IWT may be useful for functional subdivision of overactive bladders. In patients with voiding dysfunction in the absence of LUT inflammation, a positive test is an indicator of a silent or overt neurological disorder. Geirsson [92] reported positive or a false negative IWT in a large cohort study. Geirsson and Fall [93] used the IWT in patients suspected of DSD (cystometry and needle EMG). A positive test with a high detrusor pressure was stated to indicate DSD, whereas the contrary applies to the negative test. All patients who responded to cold stimulation with detrusor contraction but without fluid leakage (called positive non-leakage IWT), manifested DSD on EMG. The authors concluded that the simpler IWT could substitute for a needle EMG study.

Ishigooka et al. [94] evaluated urinary bladder sensation to ice water instillation in patients with diabetes mellitus. There was no apparent relationship between prevalence of peripheral neuropathy and that of negative sensation of IWT. Impairment of ice water perception was less frequent than that of mechanoreceptor sensation in patients with diabetic cystopathy.

Ronzoni et al. [95] studied the IWT in 148 patients with neurologic bladder dysfunction resulting from a traumatic lesion and in 130 patients with neurologic bladder dysfunction and multiple pathogenic disorders. IWT was positive in 95% of patients affected by complete and in 86% of patients with incomplete medullary lesions. The IWT in patients with lower motor neuron medullary lesions was always negative. The test was used diagnostically in patients with lower

motor neuron lesions. In those with upper motor lesions it was used as a rehabilitation method during the medullary-shock phase to accelerate the appearance of the micturition reflex. In 9% of patients it was used to induce micturition during cystography. The authors consider IWT as a useful complement to urodynamic examinations in patients with neurological bladder disease. By contrast, Chancellor et al. [96] found lack of sensitivity and specificity of the IWT in SCI patients and concluded it did not contribute to their management. Autonomic dysreflexia can occur during evaluation. Since the IWT is an unphysiological investigation that might significantly bias subsequent urodynamics, Kozomara et al. suggest that the IWT should not precede more physiological standard urodynamic investigation [97].

Repeating the IWT has been shown to increase its positivity [98]. Combining the IWT and electrical perception threshold (EPT) testing will reinforce the results of both tests and can indicate more clearly the possibility of an unsuspected neurologic pathologic finding in patients with idiopathic DO. In multiple sclerosis it may have pathophysiological value, indicating a spinal rather than cerebral mechanism of overactive bladder, and diagnostic value, indicating multifocal demyelination [99].

Conclusions:

- The majority of published studies show value of the IWT in the diagnosis of NLUTD and in the differentiation between reflexic and areflexic neurologic bladder (LOE 2)

Recommendation:

- The ice water test is an optional test which should be interpreted in the context of all data from the diagnostic evaluation, but should not precede regular UDS (B)

Bethanechol supersensitivity test (BST)

Bethanechol is a muscarinic agonist which may improve bladder emptying in some non neurologic patients, and correspondingly increase bladder sensitivity [100]. The BST was developed by Lapidet et al. in 1962 [101] to try to distinguish between a neurologic and a myogenic aetiology in an acontractile bladder. It is based on the observation that after an organ is deprived of its nerve supply, it develops hypersensitivity to the normal excitatory neurotransmitters. A neurologically intact bladder should have a pressure increase of less than 15 cm H₂O above the control value, whereas a denervated bladder shows a response greater than 15 cm H₂O. The clinical utility has not been studied in detail recently.

The test is considered unreliable by some [102]. Penders [103] considered the test reliable when the indications are good (large capacity, hypotonic bladder, clinical suspicion of lower neuron lesion) and when the interpretation is based on a right under-

standing of its mechanism. Pavlakis et al. [104] suggest that the BST is more sensitive and more specific than perineal floor electromyography in corroborating bladder neuropathy. Sidi et al. [105] studied patients with neurologic or non-neurologic detrusor areflexia with the BST, EMG of the urethral rhabdosphincter and bulbocavernosus reflex latency and found the sensitivity of these tests in detecting neurologic mechanisms to be 90, 87.5 and 78.1%, and the specificity 96, 76 and 80%, respectively. When all three tests were performed together, the combined accuracy approached 100 %. They conclude that these combined tests are useful in the diagnosis of patients with equivocal bladder neurologic conditions and in those with subtle neurological lesions. Denervation supersensitivity to bethanechol was demonstrated in acute idiopathic autonomic neuropathy [106] .

Wheeler et al. [107] found the positive BST not diagnostic of neurologic detrusor areflexia because of the many variables that can influence the test. In a later study, the same group [108] suggested that flow rate, surface electromyography, and bethanechol supersensitivity test cannot help differentiate neurologic from non-neurologic detrusor failure. Although no test can accurately differentiate neurologic from non-neurologic female urinary retention, careful neurourologic evaluation will help guide to more appropriate management.

Conclusion:

- The literature on the value of the bethanechol test for the diagnosis of neurologic pathology is contradictory. The test may contribute to overall evaluation of neurologic LUT dysfunction. (LOE 2)

Recommendation:

- The bethanechol supersensitivity test has limitations, and results should be interpreted in conjunction with established diagnostic results. (B)

Electrodiagnostic tests

EMG of the urethral sphincter

EMG of the urethral sphincter has been used for decades in the diagnosis of NLUTD; its value in practice remains uncertain. Use of needle or surface electrodes is debated. Urethral concentric needle electrodes were found to be superior to surface patch electrodes for evaluating relaxation of the muscle during voiding in neurologically intact women [109]. Nordling and Meyhoff [110] used cystometry in combination with urethral and anal sphincter EMG in patients with suspected NLUTD and found anal sphincter EMG to be highly unreliable. Koyanagi et al. [111] also found discordant activities between the anal and the external urethral sphincters in 39 % of male patients with SCI. The degree of bladder dysfunction was related more to the degree of dyssynergia of the urethral than the anal sphincter. Nevertheless, Podnar states that anal sphincter EMG is the most useful

diagnostic test, particularly for focal sacral lesions, and atypical Parkinsonism [112]. Fowler et al. [113] introduced a technique of recording EMG activity of striated muscle in the urethral sphincter by using a concentric needle electrode and an oscilloscope with a delay line and trigger. Individual motor units were isolated and measured. Vodusek also studied individual motor units [114]. Both conclude that quantitative EMG may be a helpful technique in the investigation of patients with disorders of micturition.

Ziemann and Reimers [115] found the sphincter EMG the most sensitive technique in the diagnosis of chronic pudendal lesions. However, pure afferent lesions cannot be detected by the sphincter EMG. In this case, the BCR, using unilateral stimulation of the dorsal nerves of the penis, provides the opportunity to distinguish between afferent and efferent lesions of the sacral innervation. Fowler [116] concluded that sphincter electromyography (EMG) is valuable for identifying patients with Parkinsonism who have multiple system atrophy. Tests which examine aspects of nerve conduction velocity have proved to be of lesser value both because such investigations test conduction of nerve fibres rather than levels of innervation. Furthermore, they examine large myelinated fibre conduction, rather than the unmyelinated fibres which comprise the autonomic innervation. Sphincter EMG is a diagnostic test of Fowler's syndrome in young women with urinary retention [117]. Sphincter EMG can be used in gauging timing of stimulation for suppressing DO [118].

De E J et al. [119] found a significant disagreement between needle EMG and voiding cystourethrogram (VCUG) for diagnosis of DSD. A combination of EMG and VCUG may identify more cases of DSD than either modality alone and underscores the need for more strict criteria when defining this entity from a urodynamic standpoint.

Anal sphincter EMG as well as external urethral sphincter EMG can be used to detect the onset of detrusor contractions in patients with both neurogenic detrusor overactivity (NDO) and detrusor sphincter dyssynergia (DSD) opening a door for the use of triggered devices to inhibit unwanted contractions through continuous electrical stimulation of sensory nerves [120,121]. Light et al. [122] found in patients with detrusor areflexia and a high spinal cord lesion, EMG of the pelvic floor muscles is the neurophysiological test which best predicts detrusor contractility.

EMG of the urethral sphincter has been used to investigate retention in multiple-system atrophy [123], LUT function in Machado-Joseph disease [124], the impact of pregnancy and delivery on vesico-urethral disorders in patients with multiple sclerosis [125] and children with cerebral palsy [126].

ICS Guidelines on urodynamic equipment standardization recommend that EMG during urodynamics should have high input impedance greater than 100 MOhms, a common-mode rejection (CMRR) greater

than 80, and a filtering program to best produce a consistent EMG during testing [127].

EMG of Detrusor muscle

Detrusor EMG has not been widely studied in neurologic patients. La Joie et al. [128] recorded simultaneous EMG recordings from the bladder detrusor muscle and the inferior rectus abdominis muscle in 6 normal subjects, in 4 patients with LMN bladder disease and in 2 patients with an UMN type of bladder lesion. The bladder electrodes did not appear to record muscle activity remote from the abdominal muscles so that any increased detrusor electrical activity with abdominal contraction must have some other explanation. Kaplan and Nanninga [129] analysed detrusor EMG in upper motor neuron type NLUTD. Kinder et al. did not advocate detrusor EMG [130]. Recent data are lacking and so the technique cannot be considered a standard diagnostic test.

Conclusion

- Sphincter EMG can be valuable in the diagnosis of patients with neurologic bladder dysfunction (LOE 2).
- Detrusor EMG is not established as a diagnostic test

Recommendation:

- EMG of the urethral sphincter can be considered as a specialized diagnostic method in patients with neurologic LUT dysfunction and neurologic urinary incontinence (B B)

Dynamic Bulbocavernosus reflex (BCR)

Walter et al. [131] studied dynamic BCR during micturition induced by using periodic dorsal penile nerve stimulation; the evoked reflex response was recorded with an anal sphincter pressure sensing balloon. Results indicate that an enhanced BCR is a factor contributing to increased urethral resistance during micturition.

Kaiho et al. [132] recorded the evoked potential of the BCR (BCR-EP) with a concentric needle electrode at the periurethral striated muscle. They found BCR-EP was suppressed during voluntary voiding in normal subjects, but it was insufficiently suppressed in the patients with NLUTD. It was suggested that the measurement of BCR-EP could distinguish involuntary voiding caused by pathological urethral sphincter relaxation from voluntary voiding. The same group [133] investigated the change of sacral reflex activity of the striated urethral sphincter in the urine storage phase with BCR-EP in normal male subjects and male patients with NLUTD due to suprasacral spinal cord injury. Sacral reflex activity was accelerated by bladder filling in both the normal subjects and SCI patients, particularly in the latter. In addition to the conventional evaluation of the integrity of sacral reflex arc by BCR examination, the observation of changes of

BCR affected by bladder filling may provide information on the continuity of sacral segment and supraspinal micturition centre. Niu et al. showed that in 8% of patients with SCI and in 70% of patients with peripheral nerve lesions the BCR was abnormal [134].

Motor evoked potentials

Motor evoked potentials (MEP) has been used to assess neurogenic lesions affecting the urethral compressive musculature with simultaneous recording of evoked pressure curves [135]. MEP recording is an accurate and easily applicable test for the diagnosis of lumbosacral spinal cord lesions [136].

Nerve conduction studies

In patients with diabetes mellitus, conduction velocities are decreased [137]. Vereecken et al. [138] found urethral and anal responses produced by electrical stimulation of penis, bladder neck and anus were delayed and the duration reduced. Carbone et al. [139] assessed the effect of urinary bladder filling on the excitability of somatic spinal motor neurones in patients affected by neurogenic and non-neurogenic DO and proposed that H-reflex modulation may be considered a tool in the differential diagnosis of voiding dysfunctions.

Somatosensory evoked potentials

In the committee's literature search, no recent publications were found on somatosensory evoked potentials (SSEP). Badr et al. [140] described techniques of recording evoked potentials in humans in response to stimulation of the urinary bladder. Galloway et al. [141] described a method of sacral evoked response to measure the integrity and function of the lower sacral segments by stimulation at the urethral and anal sphincters.

Mochida et al. [142] studied evoked spinal cord potentials (ESCP) in surgical patients with cervical myelopathy. The presence of NLUTD was closely correlated with severe limb symptoms and with relatively slow ESCP velocity. However, for 47% of the patients with urinary complaints, findings of urodynamic examinations were negative; these patients may have had pathologic or psychosomatic factors other than neurogenic bladder due to cervical myelopathy.

Curt et al. [143] studied the significance of SSEP recordings in predicting the recovery of bladder function in acute, traumatic spinal cord injury (SCI). They found a good correlation with the recovery of the external urethral sphincter function, but not with the urodynamic impairment. SSEP in response to stimulation of the tibial nerve have been studied in patients with hyperactive urinary bladder to clarify their role in prognosis of tibial neuromodulation efficacy [144].

Afferent nerve recording on sacral roots

Afferent nerve activity from the sacral dermatome, bladder and rectum can be recorded using cuff elec-

trodes placed on the extradural S3 sacral root in humans, but improvements in recording quality and sophisticated signal processing methods are needed for chronic application. The applicability in clinical practice is very limited [145, 146].

Conclusions:

- Detrusor EMG, BCR-EP and MEP are techniques of experimental interest, but with insufficient basis for use as standard clinical diagnostic tests.
- There are some arguments that nerve conduction studies can be useful in the further differentiation of the nerve deficits in cases of neurologic pathology of the bladder (C)
- Direct measurement of sacral afferent nerve activity is still experimental

Recommendation

- Somatosensory evoked potentials can be of use in the further diagnosis of nervous deficits related to LUT dysfunction (C).

Electrosensation in the LUT

Measurement of the sensory threshold of the LUT towards electrical stimulation was attempted as early as 1899 [147]. After re-introduction of the technique by Markland et al. [148] several authors have studied its value in neurologic bladder dysfunction. Kieswetter [149], and Powell and Feneley [150] demonstrated abnormal electrosensation in patients with NLUTD. Frimodt-Møller [151] described pathological electrosensation in patients with Parkinson's disease, multiple sclerosis and meningomyelocele. He also found abnormal electrosensation in half of patients with diabetes and generalized sensory neuropathy, but only in 10% of the diabetic patients with a neurologic bladder. Electro sensation was present in many meningomyelocele patients with absent skin sensation and absent reflexes, and in many patients with suspected complete spinal cord injury on clinical evaluation [78,79].

Wyndaele [152] determined the threshold of sensitivity to electrical stimulation in several parts of the LUT in 436 consecutive patients. In the groups with different patterns of disturbed sensation a higher incidence of neuropathy was found than in the group with a normal sensation. Further neurological investigation revealed abnormal innervation in 29% of patients who lacked electrosensitivity in one or more parts of the LUT but who had no previous evidence of neuropathy.

Standardization is necessary to develop the technique and achieve reproducible results [153]. While it is a constructive concept to be able to determine threshold of different fibre types selectively [154], so far no such fibre selectivity has been demonstrated in the bladder [155]. In the committee's literature search, no recent publications were found.

Conclusion:

- To determine the electrosensation in the LUT might be valuable to evaluate the afferent innervation in cases of neurologic bladder.
- Absent electrosensitivity might guide further neurologic tests in patients with LUT dysfunction (LOE 2)
- Further development and standardisation is needed for the use of electrosensation test to become established as a clinical test.

Functional Magnetic Resonance Imaging (fMRI)

fMRI has been used as a research tool in patients with overactive bladder [156-158].but only a single study has been conducted in SCI patients with neurogenic LUTD [159]

Neuroimaging-positron emission tomography (PET) and single-photon emission computerized tomography (SPECT).

Novel functional brain imaging study (PET) showed evidence for the existence of abnormal interaction between brainstem and cortical centers in women with urinary retention [160]. There are however only limited reports on using these studies in NLUTD, mainly in Parkinson's disease [161-165]. A report on using SPECT brain imaging with special reference of bladder function, performed in eight multiple system atrophy (MSA) patients suggested that the decrease in tracer activity in the cerebellar vermis during urinary storage and micturition is contributing to the micturitional disturbance in this disorder [161].

Conclusion

- These tests are still restricted to specialized centres and are considered as a research tool rather than diagnostic test.

Sympathetic skin response

Schurch et al. [166] assessed the descending sympathetic spinal tract and correlated these findings with bladder neck function in SCI patients. Evidence was presented that the integrity of the descending sympathetic spinal tract is necessary for a synergic function of the vesicourethral complex and that sympathetic skin responses (SSR) are of value in the diagnosis of bladder neck dyssynergia. SSR's are absent in case of bladder neck dyssynergia. For lesions below the T12 level, other investigative methods to exclude bladder neck dyssynergia are necessary. Rodic et al. [167] found that recording the perineal SSR in addition to that of the hand and foot represents a sensitive diagnostic tool for assessing sympathetic nerve function within the thoracolumbar spinal cord, representing a reliable and accurate diagnostic tool for assessing bladder neck competence and incompetence.

Emad et al. showed abnormal suprapubic, palmar, and plantar SSR in urinary incontinence patients due to incomplete SCI. They considered an abnormal SSR from the suprapubic area as another way to show bladder sympathetic system involvement [168].

SSR recordings above a spinal lesion level after urethral electrostimulation might provide a useful and technically simple objective diagnostic tool to assess integrity of autonomic (visceral) afferent nerves from the LUT. Somatosensory deficits are not always paralleled by viscerosensory loss and vice versa. SSR may be superior to visceral sensory evoked potentials, which are more difficult to record. The clinical utility needs to be further studied.

Conclusion

- Sympathetic skin responses may help evaluate the integrity of LUT-related sympathetic function, including bladder neck competence and synergia (LOE 2)

3. CONSERVATIVE TREATMENT

Therapeutic principles in different patterns of NLUTD depend on the underlying processes: dysfunction of the detrusor, dysfunction of the sphincter or a combination of both. Neurogenic detrusor overactivity leads to “reflex-incontinence”, detrusor acontractility with incontinence due to retention (overflow incontinence). An acontractile (incompetent) sphincter causes neurogenic stress-incontinence, an overactive sphincter overflow-incontinence. Quite often detrusor and sphincter are affected simultaneously by the neurogenic lesion. In most patients the storage problem, leading to incontinence, is associated with an emptying problem; therefore both aspects have to be considered at the same time. Therapy of neurogenic incontinence is primarily a conservative one. Timed bladder emptying, by whatever means, controlled fluid-intake and avoidance of urinary tract infections are the prerequisites for successful treatment.

If incontinence persists, and if operative procedures are not indicated or possible, containment products will be needed. The indwelling catheter remains an option for conservative therapy, and can offer acceptable quality of life outcomes [1]. However, most experts regard indwelling catheterisation as being associated with significant problems [3]. While suprapubic catheters are generally preferred over urethral, there is little evidence on which to base practice [4]. Urethral leakage can persist despite continuous drainage with a SPC either due to persisting detrusor overactivity (DO), induced or aggravated by UTI, then pharmacological inhibition of DO as well as UTI treatment/prophylaxis need to be considered. Bladder neck closure is rarely indicated [5].

3.1. Overview according to type of lesion

The aim of neurogenic bladder management is to preserve kidney function and to control incontinence resp. to restore continence.

Supraspinal lesions (previously included in upper motor neuron lesions)

In supraspinal lesions, neurogenic DO is mostly combined with normal sphincter function; overactivity incontinence is the main symptom and behavioural treatment together with antimuscarinic therapy is the method of choice, especially in patients with cognitive impairment. Antimuscarinics are able to increase the bladder capacity but are not able to change the underlying pathophysiology.

Spinal lesions

They mostly cause simultaneous dysfunction of the detrusor and the sphincter.

Suprasacral spinal lesions (previously included in upper motor neuron lesions)

In suprasacral lesions, the spinal reflex bladder manifests the combination of DO with an overactive/ dys-synergic sphincter. For these patients, spontaneous reflex voiding may be possible. However, detrusor contractions may be inadequate and detrusor striated sphincter dyssynergia present, both potentially leading to inefficient voiding. Triggered reflex voiding is recommended only if it is urodynamically safe and reflex incontinence is manageable; accordingly, careful support is needed to achieve adequate symptom control [6] and long-term renal safety [2]. The method of choice nowadays is – at least in complete lesions – to circumvent the spastic sphincter by intermittent catheterisation. Treatment to lower tone and spasticity of the urethral sphincter can be used to aid emptying, especially in incomplete lesions using sphincterotomy [7], stenting [8] or repeated botulinum toxin injections into the sphincter [9]. Any unit managing patients with SCI should be appropriately set up to manage acute autonomic dysreflexia. Sphincterotomy may help in reducing episodes of autonomic dysreflexia [11].

The mainstay of treatment in current practice is intermittent catheterization (IC) [12], undertaken by the patient or carer. However, to achieve low pressure LUT urine storage and continence between catheterisations, additional pharmacotherapy may be necessary. If bladder inhibitory agents fail or are not tolerable, electrotherapy is an alternative in incomplete lesions: ano-genital electrostimulation (penile, clitoral, vaginal and anal) can inhibit neurogenic detrusor overactivity by stimulating pudendal nerve afferents (see Electrical neuromodulation section).

Sacral/subsacral spinal cord lesions (previously called lower motor neuron lesions)

For complete conus lesions, acontractility of the detrusor with acontractility of the sphincter is character-

istic. Sphincter incompetence causes neurogenic urinary stress incontinence and may be combined with dribbling incontinence if adequate emptying is not achieved. Conservative treatment to achieve continence is often unsuccessful. Bladder expression is potentially dangerous, and pharmacotherapy is not helpful in this situation. Accordingly, appliances and condom catheters are often necessary, and consideration of suitability of surgery may be needed [9].

Acontractility of the detrusor combined with overactivity of the sphincter may occur in epiconal lesions. This pattern may also result from decompensation of a neurogenic overactive bladder after chronic urinary retention. With this combination, overflow incontinence can be controlled by intermittent catheterization- mostly without adjunctive additional pharmacotherapy. If intermittent catheterization is not possible, an indwelling catheter, preferably suprapubic (expert opinion), may be needed. If overactivity of the detrusor is combined with acontractility of the sphincter, reflex incontinence is combined with neurogenic stress incontinence. This pattern is sometimes found in epiconal lesions, especially in myelomeningoceles. Agents inhibiting abnormal bladder pathways may diminish neurogenic detrusor overactivity. In incomplete lesions, electrical stimulation of the pelvic floor musculature may improve sphincter function. However, with this type of neurogenic LUT dysfunction, conservative treatment alone is generally unable to restore continence; therefore either appliances or operative treatment must be considered.

Cauda equina and peripheral nerve lesions are often incomplete. Hypoactivity or acontractility of the detrusor may also be combined with a normally functioning external striated sphincter, a combination which can be seen after intrapelvic surgery, when the pudendal nerves remain intact. Conversely, pudendal nerve lesions in which the pelvic plexus remains intact, a combination of a normally functioning detrusor with a hypo- or acontractile external sphincter may be present. If there is DO, pharmacotherapy is the first choice treatment. For some lesions, intravesical electrotherapy has been reported to increase detrusor contractility [13]. Repeated injection of botulinum toxin in the striated sphincter is a potential treatment option, not well accepted as retreatment may be necessary maybe already after three months.

3.2. Specific interventions

During the acute period of spinal or cerebral shock, bladder management comprises proper bladder drainage. For the post shock period, or for non-acute neurogenic dysfunctions, several conservative treatments are in use [14, 15]:

- a. Behavioral therapy
 - a.1 Triggered reflex voiding
 - a.2 Bladder expression (Crédé and Valsalva maneuver)
 - a.3 Toileting assistance

- b. Catheters and appliances
 - b.1 Intermittent catheterization
 - b.2 Indwelling catheterization
 - b.3 Condom catheter and external appliances
- c. Pharmacotherapy

Triggered reflex voiding

“Automatic” or spinal “reflex” bladder behaviour can occur following recovery from spinal shock in suprasacral spinal cord lesions. This can be used as a means to empty the bladder, using voluntary approaches to provoking a bladder contraction by stimulation of the sacral and lumbar dermatomes. The most commonly used manoeuvres are suprapubic “tapping”, thigh scratching and anal/rectal manipulation. A quadriplegic patient who is unable to perform ISC or has nobody who can do it for him may choose this option, however, mostly incontinence aids are necessary and post-void residual urine is present (see below).

If the efferent branches of the pelvic nerve are impaired, reflex emptying is much less complete, and considerable voluntary straining is additionally required to empty the bladder to a satisfactory degree. Integrity of the sacral reflexes predicts the potential to use this approach.

The aims of regular triggered reflex voiding are to achieve “balanced voiding”, decreasing incontinence but ensuring safe (low pressure) urodynamic function. The possibility of collecting the urine in a socially acceptable way and a reasonable time period for bladder emptying are needed. Frequency of emptying has to be specified for each patient. Whether bladder outlet obstruction is present also has to be considered; this is not often considered in published literature. To improve emptying, control autonomic dysreflexia related to bladder filling and contraction, and avoid upper tract damage, the effect of alpha-blockers is still discussed controversially, botulinum toxin sphincteric injections have to be repeated periodically. Sphincterotomy and/or bladder neck incision may sometimes be needed. Regular follow-up is essential, though the frequency of check-up appointments is not validated.

Triggered voiding should not be recommended as first line management; in current practice, IC is the accepted standard for continence, upper urinary tract protection and improvement of quality of life.

Conclusions

- Reflex voiding is based on an unphysiological sacral reflex. It is potentially dangerous and has a limited role in managing the reflex bladder (LOE3).
- Costs of appliances and of adjuvant therapies (pharmacotherapy, surgery, urethral prosthesis etc) have to be evaluated (LOE 2).

- Treatment of co-existing sphincteric spasticity/ bladder neck obstruction and co-morbidity should be taken into consideration (LOE 1 and 2)

Recommendations

- Triggered voiding could be recommended only for patients whose situation has proven to be urodynamically safe and stable, and who can manage reflex incontinence.
- Triggered voiding can be considered for patients after sphincterotomy and/or bladder neck incision and/or alpha-blockers and/or intrasphincteric botulinum toxin injections, in order to improve spontaneous reflex voiding (C).
- Reflex voiding can be recommended only if an adequate follow-up is guaranteed (C)
- Any unit managing patients with SCI should be appropriately set up to manage acute autonomic dysreflexia.

Bladder expression (Crédé and Valsalva)

Bladder expression comprises various techniques aimed at increasing intravesical pressure in order to facilitate bladder emptying. The most commonly used are the Valsalva (abdominal straining) and the Crédé (manual compression of the lower abdomen). It has been recommended for a long time for patients with a combination of an acontractile detrusor with an acontractile sphincter or with an incompetent urethral closure mechanism of other origin (e.g. after sphincterotomy). Difficulties in emptying the bladder by expression may either be due to an inability to open the bladder neck or due to compression of the membranous urethra on its way through the pelvic floor even if it is flaccid during these manoeuvres. Therefore, especially in men, these techniques may induce a functional obstruction at the level of the membranous urethra despite complete paralysis of the musculature of the pelvic floor. Over time, patients may manifest problems such as reflux into the prostate and seminal vesicles, or epididymo-orchitis. Moreover, the high pressures could cause reflux into the upper urinary tract. The stress to the pelvic floor with these techniques several times a day also can make incontinence worse, and causes additional genital-rectal prolapse and haemorrhoids.

Adjunctive therapy to decrease outflow assistance includes alpha-blockers, sphincterotomy or botulinum toxin injections. If effective, they usually cause or increase neurogenic urinary stress incontinence. Expression of the bladder for voiding by Crédé and Valsalva can be effective. To empty the bladder, the pressures measured may be high and potentially dangerous for the upper urinary tract. Bladder expression is often not safe. Sphincter-hyperreflexia and detrusor-sphincter dyssynergia are contra-indications for bladder expression.

Conclusions

- Bladder expression by Valsalva or Crédé is potentially hazardous for the urinary tract due to functional obstruction at the level of the pelvic floor (LOE 3).
- It is contraindicated if it creates a high intravesical pressure, particularly in association with reflux into the ureters or seminal vesicles. Hernias, pelvic organ prolapse, haemorrhoids and urethral pathology (strictures) are relative contraindications (LOE 3).
- Bladder expression may adversely affect a flaccid pelvic floor, potentially exacerbating incontinence (LOE 3).
- Alpha-blockers, sphincterotomy or botulinum toxin may reduce the outflow resistance, but may also induce or increase urinary stress incontinence (LOE 3).

Recommendations

- Before recommending bladder expression by Valsalva or Crédé, it must be proven that the LUT is urodynamically safe. (B)
- Exclude contraindications, such as vesico-ureteric reflux, pelvic organ prolapse, hernias, urethral pathology and symptomatic UTIs before recommending this type of bladder emptying. (B)
- In general, bladder expression should be replaced by CIC in most patients with neurogenic bladder-sphincter dysfunction. (B)
- Adjunctive therapy of outflow obstruction can be considered. (B).

Toileting assistance: timed voiding, habit re-training, prompted voiding

See also the chapters on adult conservative treatment and frail elderly.

Adaptation of the drinking and voiding regimen requires education and can be implemented by the patient and/or caregivers. The aim of the behavioural process in adults is to re-establish the control of urinary continence. The goals include correcting faulty habit patterns of frequent urination, improving ability to control bladder urgency, prolonging voiding intervals, increasing bladder capacity, reducing incontinent episodes, and building a patient's confidence in controlling his/her bladder. In dependent patients all these techniques can be proposed and tried, provided that caregivers (physiotherapist, nurse, family members, etc.) are supportive.

Timed voiding is characterized by a fixed interval between toileting, e.g. every two hours. It is a passive toileting assistance program, initiated and maintained by caregivers. It is considered appropriate for patients who cannot participate in independent toileting. It has

been used where incontinence is associated with cognitive and/or motor deficits. Its aim is more to avoid incontinence than to restore a normal bladder function. For neurologic patients it has also been considered as an adjunct to tapping and/or Cr  de manoeuvre and/or intermittent catheterisation. Timed voiding can also be recommended in the management of patients with excessive bladder volumes, exemplified by diabetic patients with impaired bladder filling sensation. With habit retraining the intervals between toileting are based individually on the voiding diary. As with timed voiding also the aim of habit retraining is to help patients to avoid incontinence by decreasing voiding intervals. Prompted voiding is used to teach people to initiate their own toileting through requests for help and positive reinforcement from caregivers. These techniques are more suited to patients with brain diseases than spinal cord diseases, and for patients with cognitive and/or motor deficits. Such a program is very useful for institutionalised patients, there are no specific evaluations on neurologic patients in the literature.

Conclusions

- Behavioural techniques should be used in conjunction with other therapies (pharmacological treatment, catheterisation) (LOE 2)
- When appropriate, toileting assistance should be used to improve continence of neurologic impaired patients (LOE 3)
- Timed voiding, habit retraining and prompted voiding may be able to decrease incontinence episodes. Patients likely to benefit from the technique are those with less cognitive impairment and higher dependency (LOE 2/3)

Recommendations

- Behavioural techniques are a suitable component of the rehabilitation program for each individual. (C)
- There are no guidelines or consensus on suitable intervals for bladder emptying. They should ideally be derived from the voiding diary and other related factors (bladder volume, fluid intake, post-void residual urine volume, urodynamic parameters). (C)
- The mental status of a patient must be taken into consideration, and a rehabilitation program realistically tailored to the patient's possibilities. (B/C).

Intermittent catheterization

Intermittent catheterization (IC), including intermittent self-catheterization (ISC), aims to resume normal bladder storage and regularly complete urine evacuation. They avoid some of the complications of indwelling catheterization (IDC). IC can improve incontinence, or make patients with neurogenic bladder

continent, if; bladder capacity is sufficient, bladder pressure is kept low, urethral resistance is adequate, and fluid intake is balanced with frequency of catheterization. In children with SCI, IC used with anticholinergic drugs appears to minimise upper urinary tract deterioration, improve continence and decrease infections; safe increase in capacity appears to increase with growth [16, 17]. Post-void residual signifying the need to institute IC remains to be clarified. However, Dromerick et al. [18] (LOE 2) demonstrated in a series of stroke patients that a post-void residual greater than 150 ml is an independent risk factor for development of UTI.

Most appropriate technique and catheter depend on individual anatomic, social and economic possibilities [19] (LOE 1). Two main techniques have been adopted, aseptic IC (IC) and clean IC (CIC). The aseptic non-touch technique involves the use of sterile materials each time and insertion of the catheter "out of the sheath" without touching it directly ("non-touch technique"). In an intensive care unit, some advocate wearing a mask and a sterile gown as well [20]. De Ridder et al. [21] compared SpeediCath hydrophilic-coated catheters versus uncoated polyvinyl chloride (PVC) catheters, in SCI patients. This 1-year, prospective, open, parallel, comparative, randomised, multi centre study included 123 male patients injured within the preceding 6 months. Primary endpoints were occurrence of symptomatic UTI and hematuria. Secondary endpoints were development of urethral strictures and convenience of use. The results indicate a beneficial effect regarding UTI when using hydrophilic-coated catheters. Bjerklund-Johansen et al. evaluated patient willingness to change and satisfaction with catheters for IC in neurogenic bladder dysfunction. They also compared patient response to conventional catheters and a packaged hydrophilic catheter: LoFric Primo [22]. 409 neurogenic patients were recruited and 378 (283 males, 95 females; mean age 43.5 years) completed a short-term trial. Patient satisfaction was expressed on a Visual Analogue Scale for seven topics covering use and general satisfaction. Differences regarding satisfaction, handling, time spent, and ability to cope with daily life were reported. Kovindah and Madersbacher investigated whether a silicone catheter reused over years for clean IC was safe for men with SCI [23]. Reused silicone catheter appeared to function as well as disposable. However, to reuse urinary catheters, one should consider the increased risk of infection. The authors suggest that for SCI patients in developing countries, CIC with a reusable silicone catheter may be a suitable and safe choice if one cleans and applies it. In the same way, Getliffe performed a systematic Cochrane review summarizing current evidence on the relationship between sterile single-use catheters or clean reused catheters and the incidence of UTIs [24]. 13 trials met the inclusion criteria. There was considerable variation in length of follow-up, definitions of UTI, and numbers of subjects. Attrition was a problem for several studies, and all were underpowered. Several studies were more than 10 years old,

and outcome measures were imprecise, making it difficult to draw conclusions on the benefit of one catheterization method over another. They concluded that there are no definitive studies illustrating that incidence of UTIs is affected by sterile single-use or coated catheters compared to clean reused catheters. However the current research base is weak and design issues are significant. Based on the current data, it is not possible to state that one catheter method is better than another and further research is needed (LOE1). Research to evaluate clean vs. sterile PVC catheter use, and coated vs. uncoated catheter use (both sterile and reused), is needed. It seems that single or multiple use silicone catheters are becoming more popular especially in Asian countries, studies are available only from the Japanese silicone catheter [25].

Frequency of catheterization depends on many factors, e.g. bladder volume, fluid intake, post void residual, and urodynamic parameters (compliance, detrusor pressure). Usually it is recommended to catheterize 4 – 6 times a day during the early stage after spinal cord lesion. Some will need to keep this frequency if IC is the only way of bladder emptying. Others will catheterize 1 – 3 times a day to check and evacuate residual urine after voiding. To overcome high detrusor pressure, adjunctive therapy with antimuscarinic drugs or other bladder relaxants can be indicated. For those who develop a low compliance bladder, upper tract deterioration or severe incontinence, injection of Botulinum toxin in the bladder wall or surgery, such as bladder augmentation, may be necessary.

If catheterization is begun by patients with recurrent or chronic UTI and urinary retention, the incidence of infection usually decreases. If symptomatic infections occur, improper CIC or misuse should be considered. Chronic infection persists if the cause of the chronicity remains. Treatment of UTI is necessary if the infection becomes symptomatic. Lindehall et al. evaluated the rate of complications associated with catheterization and the risk of urethral lesions in myelomeningocele treated with clean IC for a minimum of 10 years. They found that there were remarkably few problems [26]. The incidence of major urethral lesions did not increase during puberty. Larger catheters seemed to be protective against major lesions [27] (LOE3). In contrast, Chen et al. found that the incidence of urethral strictures increases with a longer follow-up, and bladder stone formation is associated with long-term use of CIC in SCI patients [28] (LOE3).

Oh et al. evaluated health-related quality of life (HRQOL) with IC in neurogenic bladder. They conducted a prospective trial involving 132 patients (81 men and 51 women, mean age 41.8 years, range 18 to 80 years) with SCI and 150 age and sex-matched controls [29]. Patients using IC have a reduced quality of life in all health domains, as assessed by the SF-36 (LOE2). In another prospective, cross-sectional study involving 102 SCI patients and 110 controls, the same group of researchers found that the

risk for depression was 4.6-fold higher in patients unable to perform CIC (LOE2) [30].

Conclusions

- IC in the neurogenic bladder is effective and safe in short- and long- term use. (LOE 1)
- Complications such as UTI are regularly seen and seem to be related to both, the catheterization itself (technique and materials) and the pre-existing LUT condition (LOE 2)
- Urethral and bladder complications seem to increase in the long- term (LOE 3)
- In order to reduce and prevent complications, appropriate materials and correct techniques should be taught, performed and controlled (LOE 3)
- Adequate frequency of IC, a non-traumatizing technique and suitable materials are the key factors for a successful outcome (LOE 2)

Recommendations

- IC is the first choice treatment for those with inability to empty the bladder adequately and safely in neurogenic voiding dysfunction. It is a valuable tool for achieving continence. (A)
- Proper education and teaching are necessary to achieve a good outcome. (B)
- To prevent and reduce complications, a non-traumatizing technique (external lubricant or lubricant coated catheters) with adequate frequency of catheterization and complete emptying should be achieved. (B)
- Annual follow-up is needed. (B/C)
- Due to the poor quality of studies it is currently not possible to state whether any IC method or catheter type is advantageous (Grade D) and further research on the topic is strongly recommended.

Indwelling Catheter (IDC)

The Foley catheter was developed in the early 20th century. After the World War I, most SCI and other neurologic patients were treated with indwelling urethral catheterization (IDUC) or suprapubic catheterization (SPC) due to difficulty in voiding or urinary incontinence. While IC is nowadays recommended for neurologic patients, many still choose IDC due to difficulty in performing IC, or persistent leakage between catheterizations. In developing countries, IDC can still be the method of choice for those with urinary retention or incontinence.

IDUC placement requires meticulous technique. More frequent catheter changes may be needed in patients with recurrent UTIs. IDUC can cause various complications, such as; urethral trauma and bleeding,

urethritis, bladder stones, cystitis, acute and chronic UTI, bladder neck incompetence, meatus and urethral sphincter erosion, and bladder carcinoma. Fistulas can result from pressure effects, caused by improper catheter size and inadequate securing technique, particularly with long-term use. Therefore many experts advocate removal of an IDUC as soon as possible, and usage of other methods such as IC or SPC. Nowadays the complications of IDUC seem less, presumed due to better materials, judicious size selection and a proper technique of securing the catheter. For CIC wet patients, overnight IDUC self-placement seems to decrease risk of febrile episode due to UTI, as compared to CIC alone [31]. In the morning, the catheter was removed, washed with tap water and stored in disinfectant (LOE3).

The study by Pannek (LOE 3) reported an incidence 0.11% for bladder cancer in catheterised SCI individuals (48 out of 43,561 patients), similar to that observed in the general population [32]. However, more than 60% of the patients with SCI initially presented with muscle-infiltrating bladder cancer. Hypothetically, the expression of inducible nitric oxide synthase with IDUC [33] might predispose to formation of potentially carcinogenic nitrosamines in the bladder. Hamid et al. [34] did not find bladder cancer on bladder biopsies in patients with SCI and a mean IDUC use of 12.1 years. Literature remains conflicting as in a recent series of 129 consecutive patients suffering from NLUTD for at least 5 years, investigation with bladder washing cytology and urethrocystoscopy identified a range of relevant histological findings (bladder melanosis, nephrogenic adenoma, keratinizing squamous metaplasia, intestinal metaplasia, and muscle-invasive adenocarcinoma) in 5% of them [35]. Nevertheless, both general guidelines on bladder cancer (EAU)[36] and more specific spinal cord medicine guidelines [37] recommend urethrocystoscopy and/or cytology as part of routine follow-up for patients with NLUTD.

Routine antibiotic prophylaxis for patients with IDC is not recommended. Attempts at eliminating bacteriuria associated with indwelling or intermittent catheters are generally unsuccessful [38, 39] (LOE 4). For prevention of UTI, general cleanliness and local hygiene should be encouraged. In symptomatic UTI, it is important to consider catheter blockage and problems such as urinary stones. Symptomatic UTIs have to be treated with the most specific, narrowest spectrum antibiotics available for the shortest possible time. Guidelines for selecting antimicrobial agents in SCI patients are similar to guidelines for the treatment of complicated UTIs in the general population. Characteristics of the quinolones make them well suited for treating UTI in SCI patients [40] (LOE 4). Recommendations of the local microbiology department should be sought.

The benefit and risks of SPC are similar to IDUC, including the risk for UTI, stone formation and maintenance cost of catheter and bag. Advantages include:

minimized risk of urethral trauma and pain- in neurologically impaired women with even relatively short-term IDUC, urethral destruction is a significant risk. The key disadvantage is that SPC placement requires a minor 'surgical' procedure to insert the suprapubic catheter, with potential to injure nearby organs [41]. In this respect, if the SPC is displaced, unless replaced promptly, reinsertion may be a problem through the same tract. While most centres favour SPC use, complications are well-recognised and literature is limited. Most publications are old, there are no prospective studies and no RCTs on SPC.

Conclusions:

- Long-term IDUC use in neurologic patients can predispose to complications. (LOE 2)
- Catheters should have as large a lumen as possible to maximise time to blockage by encrustation (12-14 Fr silicone catheters in men and 14-16 Fr silicone catheters for women), and 5-10 ml self-retaining balloons to minimise the pressure effect on the bladder neck. (LOE 4)
- Closed drainage systems are associated with lower infection risk. (LOE 1)
- Frequency of change largely depends on time to blockage, which is influenced by catheter materials and lumen, patient factors and infection. (LOE 3)
- SPC is a reasonable alternative to IDUC, but IC is the first line intervention (LOE 3).
- SPC is a safe and effective short-term management of urinary retention. (LOE 3)

Recommendations:

- Silicone or hydrogel-coated catheters are preferable. (A/B)
- Use sterile materials and aseptic technique, and routine catheter care in the context of a closed drainage system. (C/D)
- Catheters should be changed regularly, to try to pre-empt obstruction or infection. (C/D)
- Bladder irrigation and antibiotic prophylaxis are not recommended as a routine infection-control measure. Symptomatic UTI should be treated with narrowest spectrum antibiotic possible, according to local microbiology practice. (B)
- Patient education on daily cleanliness (meatus) and hygiene care are mandatory. (C)
- Short-term IDC during the acute phase of neurological injury is a safe management for neurologic patients. (B)
- Long-term IDC should be the last resort and may be safe only if a careful check-up of urodynamic,

renal function, and upper and lower tract imaging are performed. (B)

- Bladder screening for bladder cancer is strongly recommended, especially those with IDC more than 5-10 years. (C) Annual bladder washing cytology is recommended after the 5th year, which should be combined with urethrocytoscopy after year 10 (B)
- Annual cystoscopy and biopsy may be necessary for those with gross hematuria, or chronic symptomatic UTI refractory to therapy. (C)
- Consider the use of antimuscarinic drugs in individuals with suprasacral lesions using chronic indwelling catheters. (C)
- Patient comfort, convenience, sexuality and quality of life need to be considered. (C)

Condom catheters and external appliances

Male patients with neurogenic bladder and chronic urinary incontinence can be candidates for a condom catheter connected to a collection bag. However, some men have difficulty in applying condom catheters, e.g. due to obesity, penile atrophy or retraction.

Conclusions

- Condom catheters facilitate urinary containment in neurologic male patients (LOE 3)
- Long-term use does not increase the risk of UTI when compared to other methods of bladder management. (LOE 3)
- Complications may be less if technique, hygiene, replacement and maintenance of low bladder pressures are optimised. (LOE 3)
- Due to possible Latex allergy especially in children with congenital NBD silicone condom catheters are to be preferred.

Recommendations

- Size selection should consider control of leakage, and prevention of penile compressive effects. (B)
- Regular bladder emptying with low bladder pressures and low post void residual should be confirmed (B)

4. PHARMACOTHERAPY

This chapter deals primarily with specific issues of continence pharmacotherapy in neurologic patients. For a fuller description of the drugs in use, see chapter 8. The principal causes of urinary incontinence in this subpopulation are neurogenic DO and/or incompetence of urethral closing function. Accordingly,

treatment aims to decrease storage-phase detrusor activity, increase bladder capacity and/or increase bladder outlet resistance. This picture is blurred by the occurrence of DSD, which can be present concomitantly with DO. Pharmacologic therapy alone is particularly helpful in relatively mild degrees of neurogenic bladder dysfunction. Patients with more profound neurogenic bladder disturbances may require pharmacologic treatment to improve results of other forms of management, such as IC.

In 2013 Madersbacher et. al published a review on efficacy, tolerability and safety of oral antimuscarinics in patients with neurogenic detrusor overactivity, based on thirty studies, thereof 16 randomized controlled trials, enrolling 1479 patients.

The following conclusions were made: Only oxybutynin, propiverine and trospium were evaluated in large-placebo controlled studies, demonstrating a decrease in the maximum detrusor pressure by 30 - 40 % and an increase of maximum cystometric bladder capacity 30 - 40 %. Antimuscarinics were able to normalize the intravesical pressure and to increase cystometric bladder capacity. Self selected dosing of AM, exceeding the recommended doses, improve efficacy and tolerability.

However other important parameters were not adequately investigated so far as e.g. achievement of continence inbetween catheterizations in patients on IC, also long-term data were not assessed, despite the fact that most patients with NDO are on antimuscarinic medication life-long.

Therefore the authors proposed that any further study should aim at incorporating not only urodynamic, but also crucial clinical parameters as achievement of continence and long-term results.

In 2016, three years later, an integrative review of standardized clinical evaluation tool utilization in anticholinergic drug trials for neurogenic lower urinary tract dysfunction published by Stothers et al. identified infrequent use of standardized clinical evaluation tools and reporting measures state, that data from future trials evaluating therapies for neurogenic bladder would likely be more applicable to specific patient groups, if current standardized classification and descriptors are used consistently.[1] Still the "ideal" studies are not yet available.

Also between 2013 and 2016 only a comparatively small number of relevant papers were published: 6 with Oxybutynin (Oxy.), 4 of them dealing with children, 3 with Solifenacin, 1 with each Fesoterodine, Propiverine, Imidafenacin and 1 with the "newcomer" Mirabegron. There was no study published during these years with Trospium (only in a study in combination with Oxybutynin [2] and no study with Tolterodine, only in one study with Solifenacin as active control [3].

4.1. Drugs for neurogenic storage dysfunction

Oral bladder relaxants

Antimuscarinics

General indications of pharmacological treatment in neurogenic DO are to improve reflex incontinence, decrease high intravesical storage and voiding pressures and support other interventions e.g. IC and IDC. Antimuscarinic therapy is a symptomatic treatment. In neurogenic DO, antimuscarinics may increase post void residual urine.

The evidence base for the use of antimuscarinics in patients with a neurogenic bladder is limited. In fact, in a recent Cochrane review performed on all current literature regarding anticholinergic therapy for MS-related incontinence, only five usable studies were found, and no conclusion supporting benefit could be drawn from the analysis [4].

Oxybutynin

Oxybutynin hydrochloride is a moderately potent antimuscarinic agent with a pronounced muscle relaxant activity and local anesthetic activity as well- the clinical relevance of the latter is debatable. In a prospective, 12-week dose titration trial of controlled release oxybutynin (OXY-XL), Bennett et al. [5] evaluated the efficacy and tolerability of higher dose oxybutynin chloride in patients with neurogenic bladder and multiple sclerosis, spinal cord injury or Parkinson's disease. A 7-day washout period was used before initiation of the starting dose of 10 mg OXY-XL. Doses of OXY-XL were increased by 5 mg at weekly intervals to a maximum dose of 30 mg per day guided by patient perception of efficacy versus side effect. At the end of the study statistically significant decreases in the number of voids in 24 hours, episodes of nocturia and incontinence episodes were observed. Residual urine remained unchanged. No patient experienced serious adverse events (LOE2). In a prospective, open label trial of 3 formulations of oxybutynin (tablets, syrup and extended release tablets), Franco et al. [6] evaluated the efficacy and safety of oxybutynin in children with neurogenic DO. The effect of treatment on average urine volume per catheterization and on secondary urodynamic outcomes was evaluated. Maximal cystometric capacities increased, and mean detrusor and intravesical pressures were significantly decreased at week 24. Improvements in bladder function were consistent across all oxybutynin formulations (LOE 2). Gajewski et al. demonstrated in a prospective randomized study that oxybutynin was more effective than propantheline in the treatment of DO in patients with multiple sclerosis (LOE 1) [7].

More recently two Oxybutynin papers deal with intravesical application (0,1%), one in adults, one in children (see topic Antimuscarinics Intravesical Bladder Relaxants).

Lee et.al (2014) published a retrospective, multi-centre, observational study with Oxybutynin in paediatric neurogenic bladder due to spinal dysraphism: of 121 patients 41 (34 %) received OXY. at less than 5 years of age. During a mean observation time of 19 months (range 0,3 to 111 months) there was a significant improvement of both primary efficacy outcomes, MCC increased about 8 %, mean EFP was reduced from 33 to 21 cm H₂O. No serious AEs were reported; constipation and fascial flushing consisted of the major AEs. (LOE3) [8].

Propiverine

In a randomized, double-blind, prospective multicenter clinical study, Stöhrer et al. [9] compared the efficacy and tolerability of propiverine and oxybutynin in patients with neurogenic detrusor overactivity. Propiverine and oxybutynin were equally effective in increasing bladder capacity and lowering bladder pressure. The trend for better tolerability of propiverine compared to oxybutynin achieved significance for dryness of the mouth (LOE1). Propiverine hydrochloride has also been shown to be effective in neurogenic detrusor overactivity in children and adolescents, even in some of those cases unresponsive to other anticholinergics [10, 11]. The low incidence rate of adverse events evidenced a favourable risk-benefit profile of propiverine hydrochloride (LOE3).

In 2013 a review on Propiverine, of its use in the treatment of adults and children with overactive bladder associated with idiopathic or neurogenic detrusor overactivity, as well as in men with lower urinary tract symptoms was published by McKeage [12].

Propiverine is now also produced in an extended release (ER) formulation. Comparing patients with neurogenic detrusor overactivity in a double-blind randomized multi-centre study, comprising 66 patients with proven NDO Stöhrer et. al (2013) demonstrated, that both galenic formulations are equi-effective, However following propiverine ER 45 mg s.i.d higher continence rates compared with propiverine ER 15 mg t.i.d were achieved, indicating most probably more balanced plasma-levels with the ER formulation [13]. A slight tendency for superior tolerability outcome with ER compared with IR was demonstrated; however it did not reach statistical significance. (LOE2)

Trospium

Trospium is a quaternary ammonium derivative with mainly antimuscarinic actions. Trospium has been shown to significantly reduce the number of urinations, increase cystometric capacity and mean effective volume of the bladder, and reduce the incidence of urgent voids in neurogenic patients [14, 15] (LOE1). It is the only antimuscarinic which does not pass the healthy blood-brain-barrier as proved by Staskin et al. (2010) comparing the trospium levels in the blood and the CNF after trospium treatment in a group of healthy elderly people [16]. Since 2013 no further study with trospium in NDO was published.

Tolterodine

Tolterodine is a competitive muscarinic receptor antagonist. Tolterodine has a high selectivity *in vitro* and exhibits selectivity for the urinary bladder over the salivary glands *in vivo*. Several phase II studies have demonstrated the efficacy and safety of tolterodine in patients with overactive bladder [17]. Ethans conducted a prospective, randomized, double-blind, crossover trial plus open-label comparative stage, aiming at comparing tolterodine with oxybutynin and placebo in people with neurogenic DO. Tolterodine, when used at self-selected doses (SSDs) was comparable with oxybutynin at SSDs in enhancing bladder volume and improving continence, but with less dry mouth. It seems that larger doses of tolterodine are needed to achieve best effect on neurogenic bladder [18, 19] (LOE3). Since 2013 no study with tolterodine in NDO was published.

Solifenacin succinate

Solifenacin has been extensively studied in OAB [20, 21] (LOE1). In a prospective, open-label study of solifenacin for the treatment of OAB in MS patients, van Rey et al. demonstrated a significant improvement in number of micturitions, number of pads used per day and severity of urgency compared to baseline following eight weeks of treatment [22] (LOE 2).

Three studies were published between 2013 and 2016 using Solifenacin. Krebs and Pannek (2013) report on the effects of solifenacin in patients with neurogenic detrusor overactivity as a result of spinal cord lesion. In this retrospective analysis of case histories and urodynamic data (35 SCI patients) solifenacin (dosage unknown) resulted in significant improvements in bladder capacity, decrease in maximum detrusor pressure (median -7 cm H₂O), reflex volume (median + 62, 5 ml) and detrusor compliance (median +25.0 ml/cmH₂O). The findings indicate that solifenacin significantly improves bladder capacity, detrusor compliance, reflex volume and maximum detrusor pressure. Res. two patients discontinued Solifenacin treatment due to insufficient efficacy or intolerable adverse event. [23] (LOE3)

The second study is a double-blind, randomized, active- and placebo-controlled urodynamic study (SONIC), in which 189 patients with neurogenic detrusor overactivity-NDO due to multiple sclerosis (MS) or spinal cord injury (SCI) were randomized to placebo or active treatment (solifenacin 5 mg, 10 mg and oxybutynin 15 mg) for four weeks [3]. In the primary analysis solifenacin significantly improved mean change from baseline MCC vs. placebo and was associated with improvements in bladder volume at first contraction and at first leak as well as detrusor pressure at first leak. Similar results were obtained for oxybutynin versus placebo. However the study was not powered for the comparison of Solifenacin with oxybutynin. Solifenacin 10 mg was more effective than solifenacin 5 mg in most of the parameters. (LOE1)

The third trial with solifenacin is a double-blind, randomized, placebo-controlled, 3-site study with an open label extension phase to determine the efficacy of Solifenacin in idiopathic PD patients with OAB (Zesiewicz et al., 2015). The primary outcome measure was the change in the mean number of micturitions per 24 h period, secondary outcome measures included the change in the mean number of urinary incontinence episodes. In this pilot trial Solifenacin treatment led to an improvement in urinary incontinence, despite persistence in other OAB symptoms. Adverse events included constipations and xerostomia, central nervous system side effects are not mentioned, however in a study on patients with cerebral diseases the tolerability and safety of antimuscarinics should include systemic evaluation of central nervous system side effects. [24] A good example how to do it, is the paper of Sakakibara et al. (2013), with Imidafenacin (see below) [25]. (LOE2)

Darifenacin

Darifenacin has a higher relative selectivity for the M₃ receptor compared with other anticholinergics. Darifenacin has been extensively studied in OAB, but not in neurogenic bladder dysfunction.

Fesoterodine

Fesoterodine acts functionally as a prodrug, hydrolysed by nonspecific esterases to 5-hydroxymethyl tolterodine (5-HMT). This active metabolite, responsible for the antimuscarinic activity of fesoterodine is also an active metabolite of tolterodine. Phase 3 trials have evaluated fesoterodine in OAB. There is one dose-escalating study on the pharmacokinetics and tolerability of Fesoterodine in children with overactive bladder. Of 21 children enrolled, 11 had neurogenic detrusor overactivity. Treatment-related adverse events (all mild or moderate) including 1 event each of dry mouth, constipation, dry eyes and blurred vision, and 2 events each of nausea and increased post-void residual volume. Moreover, oral administration of Fesoterodine in children produced steady-state plasma 5-hydroxy-methyltolterodine exposures similar to those in adults. [26] (LOE3)

Imidafenacin

A study by Sakakibara et. al with 62 patients, mean age 70 years (25-86) with OAB due to neurologic diseases investigated the urinary symptoms survey, moreover cognitive tests (MMSE, FAB, ADAS-cog) were performed in all patients. Urodynamics were conducted in 35 patients and real-time near-infrared spectroscopy (NIRS)-urodynamics in eight patients before and after Imidafenacin for 3 months at 0,2 mg/day. [25]

Imidafenacin significantly ameliorated urinary urgency, night-time urinary frequency, and quality of life and - most important - the three cognitive measures did not change significantly. Urodynamics showed increased bladder capacity, but detrusor overactivity did not change significantly. NIRS showed changes

in the bilateral prefrontal area but without statistical significance. It is concluded, that imidafenacin effects on bladder and brain function, ameliorated bladder sensation without cognitive worsening, with a trend of prefrontal activation. Imidafenacin seems safe in treating OAB patients with or due to neurological diseases.

The long term results of double anticholinergic therapy for refractory neurogenic and non-neurogenic detrusor overactivity were reported in a paper by Nadeau et.al. (2014) in a prospective open-label study. Results showed that with DO or NDO refractory to anticholinergic monotherapy double anticholinergic therapy is feasible and efficient approach. Side effects were reported by half of the patients (28/56) light by 20, moderate by 8 and severe in 2 with withdrawal from the study. [27]

Dual therapy with antimuscarinics

Dual therapy (between combinations of oxybutynin, tolterodine and trospium) has been shown to be effective and well tolerated in a few patients with neurogenic bladder dysfunction [28] (LOE 2).

Hadiji et.al (2014) evaluated efficacy of anticholinergic agents in the treatment of neurogenic overactive bladder and neurogenic detrusor overactivity in spinal cord injury patients on clean intermittent catheterization. Neither the monotherapy nor a combination of Oxybutynin with Trospium was not always satisfactory in terms of control of NDO and rarely allowed full continence. [2]

Antimuscarinics in neurological patients with cognitive impairment

In the cognitively impaired, antimuscarinics should be prescribed with a warning about possible deterioration in memory or the onset of confusion. It would appear sensible to recommend the use of antimuscarinics that are likely to have less impact on cognition, either by lower propensity to cross the blood–brain barrier (e.g. trospium chloride) or by relative selectivity for the M3 receptor (e.g. darifenacin) which is not known to be involved in cognition; evidence affirming these considerations is limited. Only one study by Sakakibara et al. (2009) with results on the management of overactive bladder in elderly individuals with dementia, the combined used of donepezil (a central acetylcholinesterase inhibitor) and propiverine (a peripheral muscarinic receptor antagonist) showed by evaluated MMSE and mean ADHS-coc that there was no significant change in these parameters when propiverine was added to cholinesterase inhibitor therapy. The authors conclude that this combination of therapy - acetylcholinesterase inhibitor plus propiverine could become an option in patients who suffer from dementia and OAB together.[29] In a randomised, double-blind, parallel group, multicentre study of 3 weeks treatment with darifenacin in the healthy elderly, no significant effects on memory compared to placebo was observed, in comparison to

oxybutynin ER which caused significant memory deterioration [30] (LOE 1). In a single-centre, non-comparative, pre-post dose intervention phase IV study of healthy elderly that was primarily designed to evaluate CSF trospium levels after orally dosed trospium, no decline in performance on tests of learning and memory was observed following ten days [31] (LOE 2).

Recommendations

- The evidence demonstrating the efficacy of oral pharmacotherapy in the management of storage NLUTD symptoms concerns mainly the older antimuscarinics. More large-scale randomised controlled studies are needed to evaluate this further.

Beta-3-Andrenoceptor agonists – Mirabegron

Only one study is so far published reporting the initial experience with the treatment of neurogenic detrusor overactivity with the β -3 agonist Mirabegron as monotherapy in patients with spinal cord injury in a retrospective chart analysis comprising 15 patients with NDO during a period of at least 6 weeks. There was a significant reduction of the frequency of bladder evacuation per 24h (8,1 vs 6,4, $P = 0,003$) and incontinence episodes per 24h (2,9 vs. 1,3, $P=0,027$). Furthermore there was an improvement in bladder capacity (from 365 to 419, of compliance and of detrusor pressure during storage phase (45,8 vs. 30 cm H₂O). However, due to the limited number of patients and the retrospective nature of the study, prospective, placebo-controlled studies are needed. In regards to tolerability it is mentioned, that NDO treatment with Mirabegron in patients with NLUTD due to SCI is feasible and well tolerated, without giving any further details on tolerability and safety. [32]

The different working mechanisms of antimuscarinics and the beta-3-adrenoceptor agonist Mirabegron let us assume that a combination of both could have synergistic effect. In a study by Wada et. al (2015, phase IV study, article in Japanese) efficacy and safety of Mirabegron in patients with neurogenic bladder, who had detrusor overactivity or a low compliance bladder despite taking anticholinergic medications are reported. Mirabegron was added to the anticholinergic medication (Solifenacin 5 mg, 10 mg and Tolterodine 4 mg). After 7 months of the combination with Mirabegron (50 mg, once daily) together with the anticholinergics, incontinence improved in all patients, bladder deformity improved as well, VUR disappeared in all 3 patients. The authors conclude that combination therapy of Mirabegron with anticholinergics is effective and beneficial for neurogenic bladder resistant to anticholinergic monotherapy. [33]

Based on these however limited results Mirabegron is an alternative in NDO if antimuscarinics are contraindicated, not effective or cause intolerable side effects. Cognitive impairment should not occur. Beta-3-

receptors are also in the brain, however, their functions is unknown.

Oral cannabinoid agonists

The cannabinoid system comprises exocannabinoids and endocannabinoids. Both anecdotal reports of MS patients [34] and clinical trials [35-37] suggest that cannabis and cannabis-based medicinal extracts (CBME) improve skeletal muscle spasticity as well as bladder and bowel dysfunction. An open-label (LOE3) study using sublingual spray of extracts containing delta-9-tetrahydrocannabinol (THC) and/or cannabidiol (CBD) in patients with advanced MS and NLUTD concluded that both extracts significantly reduced urinary urgency, the number of incontinence episodes, daytime frequency, nocturia, daily total voided and catheterized urine volumes as well as incontinence pad weights [35]. *Freeman et al.* (2006) investigated the effect of a CBME (Δ^9 -THC) on urgency incontinence in a large multi-center, randomized, placebo controlled trial (the CAMS-LUTS study) involving 647 patients with MS. The study demonstrated a significant effect of CBME on incontinence episodes compared to placebo (LOE1)[36]. Another multicentre double-blind, placebo-controlled trial specifically studying LUTS in 135 patients with advanced MS used an endocannabinoid modulator comprising THC and CBD in a 1:1 ratio (Sativex). The active treatment improved daytime frequency, nocturia, and Patient's Global Impression of Change significantly more than placebo (LOE1)[37]. Improvements in urgency and urgency incontinence episodes did not reach statistical significance over placebo.

With regards to endocannabinoids, Strittmatter et al. (2012) investigated the distribution of fatty acid amide hydrolase (FAAH; cannabinoid degrading enzyme) immunoreactivity in the human urothelium [38]. Aizawa et al. (2014) demonstrated in a rat experiment that inhibition of peripheral FAAH suppresses the A-delta and C-fiber activity of primary bladder afferents via CB1 and CB2 receptors, a promising finding for further research [39].

Intravesical bladder relaxants

Antimuscarinics

Since the first use of the intravesical application by Brendler et al. in 1989 [40], there have been several articles reporting successes of intravesical oxybutynin to treat OAB and neurogenic DO. The main findings were, at least at short term follow up; improved LUTS, fewer incontinence episodes, an increase of maximum bladder capacity and decreased DO. George et al. 2007 compared the therapeutic response of intravesical oxybutynin, propantheline, and capsaicin in the treatment of neurogenic DO [41]. Oxybutynin 5 mg in solution or propantheline 15 mg in solution and capsaicin were instilled intravesically in each patient. Urodynamic studies were done before and after the intravesical instillation of each drug. There was a significant difference in therapeutic re-

sponse between intravesical oxybutynin, propantheline, and capsaicin in the treatment of detrusor overactivity for leak volume (LV) and leak frequency at 2nd week. When comparing responses of oxybutynin and propantheline, more subjects demonstrated improvement with intravesical propantheline than oxybutynin for reflex volume, detrusor leak point pressure, clean intermittent catheterization volume, and LV (LOE3). However, there is no standard instillation protocol concerning the use of intravesical oxybutynin; doses used range between 5-30 mg, diluted in 30-40 ml saline [41, 42]. Also the instillation frequency is not standardized and varies between 1 to 3 times /d. Small case series report on long-term success of intravesical oxybutynin (up to 3 years in adults, up to one year in children with NDO (LOE4) [43, 44]. Despite favourable results on urodynamic parameters, there is also a low level of evidence for the use of intravesical oxybutynin in low-compliance neurogenic bladders [45]. Modulation of the ice-water test and suppression of the electrical perception threshold by oxybutynin has been studied [46]. An animal experiment suggested that early administration of oxybutynin might have a protective effect on structural bladder alterations, at least in obstructed animals [47].

Fader et al. 2007 [48] tested the efficacy and side effect profiles of intravesical atropine compared to oxybutynin immediate release (IR) in MS. They performed a study to determine the most effective dose of atropine. Eight participants used increasing doses of intravesical atropine (2 to 6 mg in 20 ml saline) during a 12-day period. Bladder diary data showed that the instillation of 6 mg atropine 4 times daily was most effective for increasing bladder capacity (voided/catheter volumes). Afterwards they performed a randomized, double-blind crossover trial. Participants received 14 days of treatment with oral oxybutynin IR 5 mg twice daily (range 2.5 twice to 5 mg 4 times daily) or with intravesical atropine, followed by 14 days of alternative treatment. Participants recorded a bladder diary and rated side effects and quality of life. The primary outcome variable was bladder capacity. 57 participants with MS completed the study. Average change in bladder capacity was higher in the atropine arm. Changes in incontinence events and voiding frequency were not statistically different between the arms. Changes in total side effect and dry mouth scores were significantly better in the atropine treatment arm. These findings suggest that intravesical atropine is as effective as oxybutynin IR for increasing bladder capacity and has less antimuscarinic side effects (LOE2). However, no further results of clinical trials with intravesical atropine have been published since. Since 2013 two papers deal with intravesical application of oxybutynin (0,1 %), one in children and one in adults:

In the paediatric long-term study with evaluation 15 ± 1 years after the switch from oral to intravesical, bladder compliance shows a statistically significant increase; pyélonéphritic episodes decreased, from 10

during the 2 years on oral to 3 over 15 years with intravesical oxybutynin indicating that intravesical oxybutynin provided more than adequate suppression of detrusor activity without side effects for a period of 15 years [49] (LOE3).

The adult study is a randomized, prospective, controlled multi-centre trial comparing intravesical 0,1 %, oxybutynin 3 times per day with a group on oral oxybutynin 5 mg, 3 times a day, each for a period of 28 days: There was a statistically significant increase in maximum bladder capacity with intravesical application compared to oral oxybutynin ADR were reported by 55,6 % with intravesical and 82,5 % with oral administration. Significant differences in favour of intravesical application were observed in ADR affecting vision, gastrointestinal tract, nervous system, skin and subcutis [50]. ADR from the nervous systems are reported 2/10 with intravesical vs 8/14 with oral OXY. But also in this study as in others (exception a study of Sakakibara on Imidafenacin [25]) no systematic evaluation of CNS effects using relevant cognitive tests was undertaken. (LOE 2)

Nociceptin/orphanin FQ (N/OFQ)

Nociceptin is a peptide that exerts several physiologic actions at both the central and the peripheral level by activating a specific G-protein-coupled receptor named nociceptin orphan peptide (NOP) receptor. Animal studies have demonstrated that N/OFQ inhibits the micturition reflex in the rat [51]. Lazzeri et al. recently studied the feasibility, safety and efficacy of daily intravesical instillation of 1 mg of the endogenous peptide N/OFQ in a selected group of patients who performed CIC for neurogenic DO [52]. A total of 18 patients were randomized to receive 1 mg nociceptin/orphanin FQ in 10 ml saline or placebo (saline) at the first catheterization for 10 days. Mean daily urine leakage episodes significantly decreased from 2.18 at baseline to 0.94 during nociceptin/orphanin FQ treatment, while no significant changes were reported in the placebo group. The bladder capacity significantly increased in patients receiving nociceptin/orphanin FQ. The urodynamic parameters showed an increase in cystometric capacity and a decrease in maximum bladder pressure. Although these findings supported the use of nociceptin/orphanin FQ peptide receptor agonist as an alternative approach for controlling NDO incontinence (LOE2), no further study results have been published since 2006.

Compounds acting via the transient receptor potential (TRP) channels

The vanilloids, capsaicin (CAP) and resiniferatoxin (RTX), desensitize afferent nerves by binding TRPV1 receptors. CAP has been the subject of small, short-lasting placebo-controlled trials in patients with SCI or MS [53] (LOE1-2). Thus, the use of CAP is still largely experimental and limited by the fact of prolonged and painful excitation of the sensory c-fibers. The alcoholic solvent may be a major factor in the poor tolerability of alcoholic CAP instillation, as suggested by the result of one placebo controlled study

showing that side effects appeared to be the same after intravesical instillation of CAP diluted in 30% ethanol as after instillation of ethanol alone (LOE2).

RTX acts without the potent neuronal excitatory effect of capsaicin, and therefore elicits less discomfort. The difference in tolerability of the 2 vanilloids (CAP vs. RTX) was usually attributed to the differential pungency of the 2 agents. Nevertheless, because we know the role of the solvent in the irritative effect on bladder mucosa, it is reasonable to assume that differential effects could be related to the use of different vectors. From a technical point of view the choice of the solvent is limited because of the poor hydrosolubility of CAP, imposing the use of an alcoholic, lipidic or glucidic vector. The safety of the lipidic solution could be imperfect because of difficulty of achieving complete elimination of lipidic solution from the bladder. On the contrary, a glucidic solution may represent a safe and valuable alternative to the alcoholic vector. De Seze et al. [54] compared the efficacy and tolerance of intravesical instillations of CAP and RTX using a glucidic solvent for CAP and the 10% ethanol solvent for RTX in a controlled randomized, double blind study in patients with severe urinary incontinence due to spinal cord injury. On day 30, improvement was found clinically and urodynamically in 78% and 83% respectively of patients treated with CAP vs. 80% and 60% treated with RTX. No significant difference between the 2 groups was observed. The benefit remained in two-thirds of the 2 groups on day 90. There were no differences in regard to incidence, nature or duration of side effects in CAP vs. RTX treated patients. These results once more strongly argue for the importance of accounting for the role of vanilloid solute when interpreting efficacy and tolerance of vesical vanilloid instillation in neurogenic DO cases. They suggest that a glucidic solution is a valuable solvent for CAP instillation (LOE2).

RTX seems to have a beneficial effect on neurogenic DO (LOE 2). However, good randomized controlled studies are needed to determine its place in the treatment of NDO. Also the optimum doses (concentration) as well as the inter treatment intervals need to be determined. Moreover, the long-term safety of vanilloid agents, particularly concerning mutagenic and carcinogenic effects on the bladder wall is not perfectly known. RTX belongs to the family of tumor promoting phorbol esters, strengthening the need to ensure the safety of RTX before extending its therapeutic applications.

Initial interest in RTX has declined following the introduction of intradetrusor Botulinum toxin injections in the treatment of intractable neurogenic DO. In a randomized trial comparing onabotulinumtoxinA injection to resiniferatoxin intravesical instillation in 25 patients with spinal neurogenic DO [55] there was a significant decrease in catheterization and incontinence episodes for both treatments at 6, 12, and 18-months of follow-up. However, onabotulinumA injections provided superior clinical and urodynamic benefits as compared to intravesical resiniferatoxin, although

RTX did not necessitate subsequent intermittent catheterisation (LOE1-2).

Transient receptor potential channels are being increasingly investigated as targets for the treatment of detrusor overactivity. Piperine, a novel vanilloid compound, was found to have both acute and prolonged in vitro effects [56]. In an animal model of chronic spinal NDO, systemic administration of GRC-6211, a novel TRPV1 antagonist, could abolish DO [57]. An antagonist of another TRP channel, the ankyrin-repeat transient receptor potential 1 channel (TRPA1), could decrease the number and amplitude of non-voiding bladder contractions in SCI rats [58]. Finally, nitro-oleic acid, an electrophilic fatty acid nitroalkene derivative which modulates gene transcription and protein function via post-translational protein modification demonstrated TRP-agonist actions affecting both the TRPV1 and the TRPA1 receptors in rat bladders [59].

For both vanilloids no clinical studies were published between 2013 and 2016.

Potential intravesical treatments with Cannabinoid modulators

While orally administered cannabinoid modulators appear to improve neurogenic OAB symptoms, particularly in MS patients [60], the identification of functional cannabinoid receptors (CBs) in the human bladder urothelium [61, 62] has intensified research in intravesical cannabinoid agonists for bladder dysfunctions. To date, only preclinical studies exist, and in non-neurogenic bladder models. Cannabinor, a selective CB2 receptor agonist, was found to affect bladder function in both normal rats as well as rats with bladder outlet obstruction, by increasing intervals between bladder contractions as well as flow pressures [63, 64]. In rats, but not humans, a *Cannabis sativa* extract enriched in cannabidiol drug substance reduced cholinergic-mediated bladder contractility in vitro [65]. Intravesical application of a non-selective cannabinoid agonist suppressed afferent activity via activation of CB1 receptors [66]. Finally, intravesical administration of the fatty acid amide hydrolase, the enzyme responsible for the degradation of the endocannabinoid anandamide, altered afferent-related urodynamic parameters in normal rats [67]. In a single study using a spinal cord injury model, systemic administration of a CB2-selective agonist could improve spontaneous voiding, possibly via a positive effect on inflammatory responses in the spinal cord [68].

4.2. Drugs for sphincter deficiency

Several drugs, including alpha-adrenergic agonists, estrogens, beta-adrenergic agonists and tricyclic antidepressants, and duloxetine have been used in an effort to increase outlet resistance. No adequately designed controlled studies of any of these drugs for treating neurogenic sphincter deficiency have been published.

4.3. Drugs for treating voiding dysfunction

Alpha-adrenergic antagonists (alpha-blockers)

Alpha-adrenoceptors are present in the bladder base, posterior urethra and prostate. Alpha-blockers have been already reported to be useful in neurogenic bladder by decreasing urethral resistance during voiding. Tamsulosin has been shown to improve bladder storage and emptying in MS and SCI [69]. Abrams et al. [70] evaluated the efficacy and safety of tamsulosin in patients with neurogenic lower urinary tract dysfunction secondary to suprasacral spinal cord lesions in a 4-week randomized controlled trial (RCT) followed by a 1-year, open label, long-term study. A total of 263 patients were randomized to 4-week double-blind therapy with placebo, or 0.4 or 0.8 mg tamsulosin once daily. The primary efficacy parameter was maximum urethral pressure (MUP). In the long-term study, but not in the RCT trial, there was a statistically significant mean decrease in MUP from baseline to end point. In the long-term study tamsulosin also improved several cystometry parameters related to bladder storage and emptying, e.g. decreased maximum urethral closure pressure. It also increased mean voided volume based on the micturition diary. There was statistically significant improvement for the International Prostate Symptom Score Quality of Life. Both doses were effective and well tolerated. (LOE1).

The value of alpha blockers with neurogenic LUT dysfunction is still discussed controversially. The efficacy of selected alpha-blockers in the treatment of children with neurogenic bladder dysfunction is investigated by Kroll et.al. (2016). The aim was to assess the usefulness of selective alpha-1-blockers in children with neurogenic urinary tract dysfunctions and increased leak point pressure (LPP). 14 children from age 6 to 16 years with LPP higher than 40 cm H₂O were enrolled in the study. All patients received the selective α 1-blocker doxazosin for 6-8 weeks (initial dosage 0,03 mg/kg). The differences both in LPP and LPV before and after treatment were not statistically significant. This observation is consistent with the conclusions from other studies and showed no evident efficacy of doxazosin in children with neurogenic bladder. [71]

Conclusions

- Antimuscarinic drugs improve storage function (LOE 1).
- Antimuscarinic drugs have a high incidence of side effects (dry mouth, constipation, urinary retention, etc.). Tolterodine, propiverine, trospium and controlled-release oxybutynin have significantly less side effects compared to immediate-release oxybutynin (LOE 1).
- High doses of oxybutynin have been used to treat patients with neurogenic bladder dysfunction (LOE 3)

- Intravesical instillation of oxybutynin may be an alternative route of administration (LOE 4).
- An alternative to antimuscarinics is the beta-3-agonist Mirabegron, however, only one study was published so far. The advantages in regards to side effects compared to antimuscarinics are evident.
- There is LOE1 data to support a beneficial effect of oral cannabinoid agonists on neurogenic lower urinary tract dysfunction in patients with MS
- Intravesical instillation of capsaicin/resiniferatoxin has been reported to improve spinal reflex incontinence. Resiniferatoxin is preferable (LOE 3). Recent results supporting their use are lacking.
- Long-term alpha adrenergic antagonists are effective and well tolerated in patients with MS and suprasacral spinal cord lesion with neurogenic lower urinary tract dysfunction (LOE1)
- There is no adequately designed controlled study of any drug for neurogenic sphincter deficiency.

Recommendations

- Antimuscarinic drugs should be recommended for the treatment of neurogenic detrusor overactivity (A). Titration of the dosage of these drugs individually should be done to optimal balance of therapeutic and adverse effects. If one drug is not tolerated, another drug should be tried (C/D).
- The use of oral cannabis-based medicinal extracts can be recommended for MS patients with NLUTD, currently in specialized research centres (C). Further research is needed on oral and intravesical cannabinoids in patients with NLUTD
- Vanilloid intravesical therapy still remains experimental and therefore is not recommended except within clinical trials (C/D)
- For decreasing outlet resistance in neurogenic bladder α -adrenergic antagonists may be used (B/C).
- For neurogenic sphincter deficiency, no effective drugs are available up to now; further research is needed (D).
- For detrusor acontractility no effective drugs are available up to now; further research is needed

5. MINIMALLY INVASIVE TREATMENTS

5.1. Botulinum neurotoxin type A injections

Botulinum neurotoxin type A for neurogenic incontinence

Efficacy. Botulinum neurotoxin type A (BoNT/A) intradetrusor injections has become the newest approved treatment for urinary incontinence in adult neurological patients with inadequate response to (or reduced tolerance of) an anticholinergic medication (U.S. Food and Drug Administration approval) in the OnabotulinumtoxinA (BOTOX®) format. Similar approval has been granted in European countries. Several systematic reviews [1-4] [5, 6], meta-analyses [7] and randomized, controlled trials (LOE1) [8-14], an active comparator-controlled trial (LOE1-2)[15], four LOE2 studies [16-19], as well as numerous LOE3 studies have confirmed the efficacy of BoNT/A in the treatment of refractory neurogenic DO incontinence. Clinical improvement is accompanied by significant ameliorations in bladder function, as urodynamic parameters that matter in the management of NDO, namely maximum cystometric capacity, maximum detrusor pressure and reflex volume, appear to gain substantial benefits [1-3, 20]. Almost all studies have published on two BoNT/A preparations, onabotulinumtoxinA (Botox®) and abobotulinumtoxinA (Dysport®)[3, 5]. The two formats are not interchangeable and there are no direct comparisons for dose, efficacy and safety, at least in urological indications. Although both products appear to be efficacious in NDO, onabotulinumtoxinA has been more comprehensively studied than abobotulinumtoxinA [3]. Two LOE1 studies have been published reporting abobotulinumtoxinA [14, 17]. An LOE3 study suggests that onabotulinumtoxinA may be more efficacious than a novel BoNT/A preparation, Prosigne, in the treatment of refractory NDO [21].

The mean duration of efficacy of a single injection is 6-16 months for onabotulinumtoxinA and 5-12 months for abobotulinumtoxinA [3]. The FDA regulatory trials (275 and 416 patients, respectively) demonstrated a mean duration of effect of 37-42 weeks for onabotulinumtoxinA compared to 13 weeks for placebo [10, 12]. Complete continence was achieved in 36-38% and 40-41% respectively with the 200U and 300U doses of onabotulinumtoxinA as opposed to 7.6-10% with placebo. Interestingly, significantly higher post-treatment continence rates have been reported in single-centre studies with both preparations (a mean 71% with onabotulinumtoxinA and 65% with abobotulinumtoxinA) [3]. Similarly, reduction in the number of daily leaks was significantly superior in LOE3 compared to LOE1&2 studies (80% vs 63%, $p=0.01$) [5], but the majority of LOE3 studies had used 300U onabotulinumtoxinA. The concomitant use of anticholinergics does not appear to provide additional benefit [22], although this needs to be

confirmed in specifically-designed studies. In those taking anticholinergics, onabotulinumtoxinA initially reduces the dose of anticholinergics needed, but this tends to increase again at longer follow-ups [23] [24]. A single real-life study has investigated the effect of switching from the earlier used 300U to the newly approved 200U onabotulinumtoxinA [25]. Although 94% of patients continued to experience symptomatic improvement, 25% reverted back to the original 300U dose. Somewhat greater reductions in daytime frequency and nocturia were recorded with 200U vs. 300U (87.5% and 81.3% respectively vs. 75% and 75%) but lesser urgency improvements (75% vs 81). At three year follow-up, 82% of patients who had switched to the lower dose were happy and keen to continue receiving 200IU OnabotulinumtoxinA. Several retrospective studies [19, 26-36] and a single prospective trial [37] now attest to the sustained efficacy of repeat treatment sessions with either of the two formulations. In prospectively followed-up patients opting for repeat injections, the median duration of effect was ≥ 9 months, with one in four patients enjoying an even more lasting effect of at least one year [37].

Reported failure rates are 5-25% for onabotulinumtoxinA and 10-32% for abobotulinumtoxinA [3] [39]. Clinical predictors of success/failure in NDO have little been studied. A study of spinal cord injured patients proposed that the level of injury may be important as patients with thoracic and lumbar injury had better clinical and urodynamic outcomes compared to cervical injury patients [38]. A longer duration of MS has been proposed as a predicting factor for treatment failure [9] (LOE3). To date there is no robust evidence to link treatment failure with the formation of neutralizing BoNT/A antibodies, but a wide range of antibody formation rates following treatment has been reported (0-35%) [40-43] and its clinical significance needs further investigation. A small, mid-term, controlled study in children (LOE1-2) found no association between antibody formation and treatment failure, but reported an increased rate of antibody formation in those receiving repeat versus single injections (71% vs. 38%) [44] up to 4 months post treatment. In the long-term, antibody titers returned to control levels. Patient-related factors also affect adherence to treatment; in a long-term study with a mean 12-year follow-up, 21% of patients discontinued treatment due to inadequate efficacy, but another 19% opted for other treatments (antimuscarinics, sacral neuromodulation) despite the toxin's efficacy [36]. In another study, only 59.3% of spinal cord injured patients were satisfied with repeat treatments and only 20% continued after a fourth injection, with 33.9% reporting inadequate efficacy and 6.8% discontinuing due to adverse events [35]. Nevertheless, in treatment failures toxin switch could be more effective than re-injection with the same toxin (51.7% vs. 24.1%). Patients treated with a switch from abobotulinumtoxinA to onabotulinumtoxinA and those treated with a switch from onabotulinumtoxinA to abobotulinumtoxinA had similar success rates (52.9% vs. 50%)[45].

Patient populations. The majority of the studies involved participants with neurogenic bladder due to SCI or MS, often mixed, while only small case series investigated efficacy in patients with Parkinson's disease, multiple system atrophy or cerebrovascular accident (CVA) [46-49]. Comparisons of efficacy between neurological subpopulations are generally lacking, although a small LOE3 study suggested better continence outcomes and more significant improvements in maximum detrusor pressures in SCI patients compared to those with CVA [49]. The largest RCTs which involved MS and SCI patients conclude that the toxin is highly efficacious in both subpopulations [10, 12]. A lower placebo effect in the SCI subpopulation could be noted, although the studies were not designed for head-to-head comparisons.

Doses. The FDA registration studies demonstrated a similar efficacy and adverse event profile for the 200U and 300U onabotulinumtoxinA (BOTOX) doses, suggesting a plateau in the efficacy of the toxin. Similar conclusions were drawn by a smaller randomized study [19]. Providing the best benefit/risk ratio, the 200U onabotulinumtoxinA dose was recommended for the treatment of refractory NDO incontinence [10] [12]. A LOE2 study suggested a trend towards better clinical and urodynamic improvements with 750U as opposed to 500U abobotulinumtoxinA [46]. Other, non-randomized and inadequately powered studies (LOE3)[16, 17, 50] could not identify a clear dose-response for higher doses of abobotulinumtoxinA, although 1000U abobotulinumtoxinA might produce a beneficial effect of greater duration than that with 500U[17].

Little data exists on lower doses. A pilot LOE3-4 study suggests that 100U onabotulinumtoxinA could be effective in MS patients and minimize unfavourable side-effects, particularly the need for IC [51], while a LOE1 dose-response study confirms a more significant clinical benefit of the 200U dose as opposed to the 50U and 100U doses of onabotulinumtoxinA in patients with SCI [13].

Effect on quality of life (QOL). Both preparations have been shown to improve patients' QOL in RCTs. The I-QOL questionnaire has been used in the majority of LOE1 studies. Patients with NDO-associated incontinence receiving a single injection of 500 units abobotulinumtoxinA, diluted in 25 ml saline and injected into 25 injection sites, had a more significant change in clinical, QOL and urodynamic parameters when compared to placebo at 26 weeks, in addition to reduced use of anticholinergics [9]. Similarly, 200U and 300U onabotulinumtoxinA administered into 30 injection sites improved QOL scores significantly more than placebo in all LOE1 studies [10-12, 52][53, 54]. Moreover, OnabotulinumtoxinA-treated patients achieve their treatment goals at significantly higher proportion than placebo-treated patients (LOE1) [55]. Fully published data on QOL following repeat treatments is sparse; in a 3-year extension study of the registration trials, QOL improvement was sustained

with repeat injections (up to six) in parallel with clinical benefits [56].

Administration technique. A large variance in the number and volume of injections has been described. However, in the majority of studies onabotulinumtoxinA was given at 30 injection sites (range 10–40) at a dilution of 10U/1ml per injection site (total volume of 30 ml, range 3–30 ml), as described in the original publication by Schurch et al. [57]. The same dilution and number of injection sites was used when administering either 300U or 200U onabotulinumA in the regulatory trials. Administration of abobotulinumtoxinA is less standardized (10–30 injection sites, total volume of 5–30 ml), but a total 30 ml given at 30 injection sites appears to be the most common again [3]. The effect of these variables on outcomes has little been studied. A recent LOE1 study compared 15 to 30 injection sites (Dysport 750 U or the equivalent placebo) and concluded that a reduction of injection sites does not affect efficacy [14]. Urodynamic results were more robust than the clinical ones, the small sample size possibly affecting the statistics. A randomised, non-controlled study on OnabotulinumtoxinA only exists in short report format [58]. Comparing 10 to 30 injection sites (300 U Botox), *Karsenty et al.* found no significant difference in number of incontinence episodes or cystometric capacity, but a significant reduction in post-procedure pain was noted in the 10 injection-sites group.

The vast majority of studies reported injections into the detrusor muscle sparing the trigone, as in the original technique [57]. There is, however, LOE2 evidence to suggest that trigonal injections may produce better continence rates than detrusor injections alone; urodynamic parameters were affected to a lesser extent, as only reflex volume was improved more significantly in patients who received trigonal injections [18]. There is also LOE1-2 evidence suggesting that submucosal injections are comparable in efficacy to intradetrusor injections, with the exception of voided volume [59] and detrusor compliance [60]. An impressive difference was found, however, in patient satisfaction favouring the suburothelial injections (88.8% vs. 64.3% of patients satisfied) [60].

Alternative delivery techniques are being investigated including intravesical instillation of BoNT/A encapsulated in liposomes [61] or via electromotive drug administration (EMDA) [62]. The former has only been tested in non-neurogenic patients in small, short-term, placebo-controlled trials [63, 64] (LOE1-2) with inconclusive results. In the largest trial (n=62 patients), intravesical instillation of liposomal onabotulinumtoxinA (200U) improved micturition frequency and urgency severity scores over placebo at 4 weeks, but not urgency episodes or urgency incontinence [64]. No urinary retention episodes were reported though. The EMDA method has been tested in a pilot LOE3-4 study in children with myelomeningocele. Significant improvements were reported in maximum cystometric capacity, detrusor pressure, urinary in-

continence, vesicoureteric reflux and even fecal incontinence [65], but results need to be confirmed in controlled trials.

Safety. The treatment appears to be overall safe in currently used doses and techniques. The most common adverse event is the significant increase in post-void residual in patients not using CIC prior to treatment. In onabotulinumtoxinA placebo-controlled trials, 12-22%, 30-47%, and 42-49% of patients in the placebo, 200U, and 300U groups, respectively, initiated CIC post-treatment [10] [12]. Rates of de novo CIC appear to be reduced after repeat treatments: in a 4-year study with up to six onabotulinumtoxinA injections, de novo CIC rates were 29.5, 3.4, and 6.0% (200U), and 43.0, 15.0, and 4.8% (300U) for treatments 1-3, respectively; de novo CIC rates were 0% for treatments 4-6 [56].

Although earlier studies had reported a reduced incidence of UTIs in NDO patients treated with BoNT/A [31, 66, 67], recent large RCTs [10][12] as well as systematic reviews [6] and meta-analyses [7] suggest a higher incidence of UTIs in those treated with onabotulinumtoxinA as opposed to placebo-treated patients. This might be associated with the increased rate of *de novo* CIC in the Botox®-treated population. In prospective, long-term, follow-up trials UTIs remained the most common adverse event, but with no increased incidence over time [37, 56]. Long-term controlled trials could clarify these apparent discrepancies.

Haematuria, constipation and flu-like symptoms have also been described [3, 10, 12], while inclusion of trigonal injections does not appear to produce vesicoureteral reflux (LOE2-3) [18][68][69]. A study in SCI male patients found a post-treatment decrease in the volume of ejaculate accompanied by improvements in semen quality, sperm mobility and vitality, as well as semen culture [70]. Further research is needed to confirm these results and explore whether they are due to local re-organization of autonomic function which also affects the reproductive system.

The most serious adverse event is generalized paraparesis/ fatigue, which has been described in 0.005% of patients receiving onabotulinumtoxinA and in 0.026% of patients receiving abobotulinumtoxinA [3]. The effect resolves spontaneously after 4-6 weeks and appears to be dose-related, with most cases reported in those patients injected with 750-1000U abobotulinumtoxinA or 300U onabotulinumtoxinA [12, 29, 71].

As BoNT/A studies in skeletal muscles have identified autonomic, histological and other secondary effects [72, 73], further investigation is needed on safety issues, especially after repeat injections [2]. Preclinical studies provided evidence for transport of the toxin from the bladder to the CNS and vice versa [74, 75]. A single study to-date prospectively examined distant effects post-BoNT/A bladder injection using single-fibre EMG; one-third of the patients had findings of neuromuscular jitter post-treatment, but there was no

placebo arm or pre-treatment data for comparison [76] (LOE3). Frequency and severity of autonomic dysreflexia episodes were reported to be reduced following onabotulinumtoxinA bladder injections (LOE3)[77]. Other studies produced histological evidence of reduced or no additional fibrosis after one or multiple injections, including in children [78-80].

Future research should highlight the gaps in our knowledge of long-term treatment with focus on patient-reported outcomes and satisfaction, safety and tolerability issues as well as technical aspects such as alternative techniques of application, ways to minimize post-treatment voiding dysfunction in patients who void freely and larger studies in select patient populations.

Botulinum neurotoxin type A for neurogenic voiding dysfunction

Sphincter injections were historically the first application of BoNT/A in the lower urinary tract [81], but there is still inadequate evidence to support its use. The most commonly injected volume is 4ml of either the onabotulinumtoxinA or the abobotulinumtoxinA preparations. Usually 100U onabotulinumtoxinA or 150U abobotulinumtoxinA have been delivered transperineally or transurethrally [82, 83]. No direct comparison of injection techniques exists; there is low evidence (LOE4) to suggest the two delivery approaches are equally effective [82].

In a LOE1 study, the effects on DSD of botulinum toxin versus placebo was studied in 86 multiple sclerosis (MS) patients [84]. The study employed a single transperineal injection of onabotulinumtoxinA, 100 U in 4 ml normal saline, or placebo, into the striated sphincter with EMG guidance. The primary endpoint was post void residual volume at 30 days. The secondary endpoints included voiding and urodynamic variables. OnabotulinumtoxinA failed to decrease post-void residual volume in this group of MS patients, although it increased voided volume and reduced pre-voiding and maximum detrusor pressures. These findings differ from those in patients with spinal cord injury and may be due to lower detrusor pressures in MS patients. A small LOE1-2 study (n=13 patients) showed a superior effect of onabotulinumtoxinA over lidocaine 0.5% injected in the urethral sphincter in MS patients [83]. Another small (n=21 patients), controlled study (LOE1-2) in CVA patients with urethral sphincter pseudodyssynergia reported superior clinical efficacy in the active treatment group (91% response rate and higher improvements in QOL and symptom scores with 100U OnabotulinumtoxinA) despite highly significant urodynamic benefits noted in the control group (reduction in voiding pressures and increase in maximum flow rates) [85]. In MS patients there is also LOE3 to suggest that a combination of detrusor and sphincter injections may facilitate bladder emptying [86]. In children with NDO and DSD due to myelomeningocele there is LOE1-2 from a single study to suggest that sphincter injections additional to the detrusor injections accomplish significant

improvements in post-void residuals, as well as more significant benefits in urinary incontinence, constipation, vesicoureteral reflux and creatinine levels [87].

Since the last ICI update (2012) there has been a single LOE3 study in SCI patients with NDO and DSD comparing urethral injections of 100U onabotulinumtoxinA to detrusor injections of 200U onabotulinumtoxinA depending on the main symptoms (voiding dysfunction vs. NDO-associated incontinence) and found less patient satisfaction in the urethral injection group (60.6% vs. 77.3% in the detrusor injections group) as well as greater improvements in the UDI-6 and IIQ-7 scores in the detrusor injection group, despite significant urodynamic benefits in both groups [88]. Not unexpectedly, patients in the urethral injection group were dissatisfied due to increased degree of post-Botox incontinence whereas the detrusor injection group suffered higher rates of post-treatment voiding difficulty.

Overall, randomized controlled trials (RCTs) or quasi-RCTs investigating the use of BoNT/A in patients with neurogenic DSD in comparison to placebo or active comparators were reviewed by the Cochrane database. Published data were found to be of limited quality due to the small sample sizes, the heterogeneity in the protocols, and with a high risk of bias. Nevertheless, the authors conclude that intraurethral BoNT/A injections improve some urodynamic parameters at 30 days post-injection and propose future high-quality research to address the optimal dose and mode of injection for neurogenic DSD [89].

Conclusions

- Botulinum neurotoxin A (BoNT/A) injection into the detrusor muscle improves clinical and urodynamic parameters (LOE1) as well as the quality of life (LOE1), and has been approved as second-line treatment for urinary incontinence associated with neurogenic detrusor overactivity in patients with inadequate response to or intolerance of an anticholinergic.
- Both the OnabotulinumtoxinA and the AbobotulinumtoxinA formats are effective (LOE1), but the vast majority of currently published data concerns OnabotulinumtoxinA
- Repeat intradetrusor injections of BoNT/A provide sustained clinical benefits (LOE3)
- Published LOE1 data almost exclusively concern intra-detrusor injection administration, but there is limited LOE2 data to favour trigonal and submucosal over detrusor injections
- Treatment with intradetrusor BoNT/A is considered overall safe, with increased post-void residual and need for post-treatment CIC being the most common adverse event (LOE1). A higher incidence of UTIs in those treated with the toxin has become apparent in LOE1 studies.

- Antibody formation is not associated with treatment failure, but may be increased after repeat injections (children)(LOE1-2)
- BoNT/A is probably safe and effective for the treatment of DSD in spinal cord injury patients (LOE2). However, on the basis of one LOE1 study,
- BoNT/A does not provide significant benefit for the treatment of DSD in MS patients.

Recommendations

- BoNT/A should be offered as a treatment option for incontinence associated with neurogenic detrusor overactivity (A).
- Further research is needed on long-term outcomes and safety, administration techniques, the bio-equivalence of the various preparations, the concomitant use of anticholinergic drugs or β 3-agonists, mechanisms of action, and wider effects (A)
- BoNT/A may be considered for DSD in spinal cord injury patients (B)

5.2. Electrical Neuromodulation

In the last decade, sacral nerve neuromodulation (SNM) has been established as a treatment option for patients with OAB. The success with SNM has increased the interest in other neuromodulation techniques. Additional methods include: (a) anogenital stimulation (b) pudendal nerve stimulation, (c) dorsal genital nerve stimulation (d) percutaneous tibial nerve stimulation, (e) magnetic stimulation and (f) deep brain stimulation. It is not really known how neuromodulation works, but there is evidence that sites of action are spinal and supraspinal [90]. Firstly the non-surgical ways of neuromodulation will be presented, followed by the surgical techniques.

Anogenital Stimulation

This has been applied in children with OAB complaints. Gladh et al. found a response for anogenital stimulation in 53% of the children [91]. Trsinar and Kralj used an endoanal electrode and reported a complete or partial response to the treatment in 75% of the patients [92]. In a control group of patients who had the endoanal electrode introduced but not activated, no patient had the symptoms resolved completely. No recent publications could be found.

Pudendal Nerve Stimulation

Pudendal nerve stimulation and electrode positioning can be carried out under neurophysiological monitoring (using a St. Mark's electrode) in order to guide the electrode in Alcock's Canal as close as possible to the pudendal nerve [93]. Electrode implantation can

also be carried out by a rear approach under local anesthesia according to the method described by the same team [94, 95]. On the other hand, an anatomical study demonstrated that the technique for implanting electrodes at the pudendal level may carry some risk [96].

Direct pudendal nerve stimulation has beneficial effects on numerous pelvic floor function impairments such as urinary and/or fecal incontinence, retention, and constipation. In preceding literature the implant technique required a fairly complex and invasive procedure, although recent advances with percutaneous placement of the lead through an introducer have made the procedure much less invasive. Electrical stimulation of pudendal nerve afferents can inhibit bladder contractions in patients with SCI, and bladder capacity can be increased [97] (LOE3). Implants such as the InterStim system have made this treatment modality commercially available (see sacral nerve stimulation). Common to these implantable systems is that they use continuous stimulation. Detrusor inhibition is in principal only necessary during an involuntary contraction and, thus, stimulation could be turned off between contractions (i.e. conditional stimulation) [98]. Such a stimulation scheme could have a number of advantages. Power consumption may be decreased and, thus, extend battery lifetime. Furthermore, continuous stimulation of a reflex may lead to habituation, which would be minimized or prevented by conditional stimulation. Hansen et al. [99] examined the effect of the automatic, event driven electrical stimulation of pudendal nerve afferents on bladder capacity in patients with SCI. The study included two women and 14 men older than 18 years with NDO, bladder capacity below 500 ml and complete or incomplete suprasacral SCI. Detrusor pressure (P_{det}) was recorded during natural bladder filling. In a similar subsequent recording P_{det} was used to trigger electrical stimulation when pressure exceeded 10 cm H₂O. Of the 16 patients enrolled in this study, 13 had increased bladder capacity and reduced storage pressure decrease achieved by event-driven electrical stimulation. During stimulated filling, P_{det} never exceeded 55 cm H₂O. An average bladder capacity increase of 53% was achieved (LOE 3). Ohlson et al. treated eight patients with NDO in whom vaginal/rectal stimulation failed, with acute pudendal nerve stimulation. Five achieved a decrease in urinary frequency and four had an increase in cystometric capacity [100].

Spinelli et al. [94] performed a staged procedure similar to that of sacral neuromodulation (SNM) to place a tined lead near the pudendal nerve, using neurophysiological guidance. They named this approach chronic pudendal nerve stimulation (CPNS). Fifteen neurogenic patients (eight male, seven female) with urgency incontinence underwent CPNS. All patients had complete neurophysiological and urodynamic evaluation at baseline and follow-up and were asked to complete a voiding and bowel diary for 7 days. During screening, the average number of incontinent episodes per day decreased from 7+/-3.3 to 2.6+/-3.3

($P < 0.02$, paired t-test). Eight patients became continent, two improved by more than 88% (from 9 to 1 daily incontinence episodes) and two patients reduced the number of incontinence episodes by 50%. The implantable pulse generator (IPG) was subsequently implanted in those 12 patients. Three patients without improvement did not continue to second stage. In implanted patients with 6 months follow-up, urodynamic evaluation showed an objective improvement in the maximum cystometric capacity which increased from 153.3 ± 49.9 to 331.4 ± 110.7 ml ($P < 0.01$, paired t-test). The maximum pressure decreased from 66 ± 24.3 to 36.8 ± 35.9 cmH₂O ($P = 0.059$, paired t-test). Eight patients reported significant improvement in bowel function (LOE3).

Another elegant way to approach the pudendal nerve is the laparoscopic one as described by Possover et al. [101].

Only recently in 2016 an experimental study with electrical stimulation of dog pudendal nerve is showing that stimulation of the pudendal nerve trunk is a promising method to modulate bladder function. It can well be that in medium term sacral neuromodulation could be replaced by pudendal nerve stimulation, a method which was described already in 1986 by Vodusek et al. [102] and more recently, also Spinelli et al. (2006) reported success with pudendal nerve stimulation by a minimally invasive procedure in 15 patients with failed previous SNM [103].

Dorsal Genital Nerve (DGN) stimulation

DGN stimulation can be continuous or conditional. Goldman et al. used continuous stimulation for one week [104]. They found a 55% increase in cystometric capacity. In 47% there was >50% reduction in incontinence episodes, and in 81% there was >50% reduction in number of urgency events. Increases in cystometric capacity vary significantly between studies using continuous stimulation (range 11-177%) and also conditional stimulation (range 37-144%). Horvath et al. and Oppisso et al. showed that DO was suppressed conditionally, with a subsequent increase in bladder volume and postponement of incontinence [105, 106]. Martens et al. found with conditional stimulation that an increase in stimulation current results in a more pronounced detrusor inhibition [107]. Besides DO suppression, increases of the pressure at the bladder neck and the urethral sphincter contribute to continence [108]. In general, patients tolerate conditional stimulation well and they adapt to the sensation in long-term use [109]. Stimulation effectively suppresses urgency and decreases urgency episodes. Suppression of urgency during stimulation might contribute to tolerance of stimulation. This might enable stimulation at higher current to increase effectiveness when stimulation is applied conditionally.

Posterior tibial nerve stimulation

Percutaneous posterior tibial nerve stimulation (PTNS) was described 20 years ago as a minimally

invasive treatment for urge incontinence due to neurogenic detrusor overactivity (NDO) in spinal cord injury (SCI) patients. Interestingly, the location where the tibial nerve is stimulated is in the same area as the Sanyinjiao (SP6) point used in Chinese acupuncture to treat pelvic floor organ dysfunctions. The PTN is derived from the L4-S3 nerve roots and therefore shares common roots with those serving bladder functions. SCI and Parkinson patients with neurogenic DO have been treated with PTNS. PTN seems to increase cystometric bladder capacity and bladder volume at which DO and associated leakage occurs [110, 111] (LOE3). Gobbit et al. looked at the effect in 21 MS patients. Eighty-nine percent of patients reported a treatment satisfaction of 70%. Significant improvement in QoL was seen in most domains of the King's Health QoL questionnaire [112]. Kabay et al. looked at the clinical and urodynamic effects in MS and Parkinson's disease [113, 114]. They found significant clinical and urodynamic improvements, although it was impossible to completely suppress DO. De Seze et al. looked at transcutaneous PTNS in 70 MS patients [115]. With daily stimulation sessions, they showed clinical improvement in urgency and frequency in more than 80% of patients at three months. They also observed an initial acute cystometric response in > 50% of the patients without correlation with clinical efficiency. There still is debate about the possibilities to really influence voiding behavior via the posterior tibial nerve [116]. PTNS is a stimulation technique that allows for sham comparison. It should therefore be tested in this fashion.

As in SNM, the literature reports of PTNS in the neurogenic bladder population is complicated by limited number of studies, small sample sizes, non-standard treatment plans, poor descriptions of the extent and severity of neurologic disease, and heterogeneous patient populations. A recent meta-analysis by Gaziev et al. (2013) including MS and Parkinson's disease showed mixed findings on success rate ranging from approximately 40 % to 100 % for neurogenic overactive bladder or urinary retention [117] (LOE3). In 2015 Kabay et al. published the results of a retrospective case-controlled study with 34 patients enrolled to PTNS treatment. 21 patients completed the one year PTNS treatment with controls at 6, 9 and 12 months of therapy. After 12 weeks of therapy, PTNS was applied at 14-day intervals for 3 months, then 21-day intervals for 3 months, and in the end for another 3 months with 28-day intervals. The improvements for all voiding diary parameters were significant at each control when compared to the baseline. Day-time frequency decreased by 5.4 voids daily, urgency incontinence decreased by 3.4 episodes daily, urgency episodes decreased by 7.4 episodes daily, nocturia decreased by 2.6 voids, and voided volume improved by a mean of 72.1 cc. The reported results demonstrate an excellent durability of PTNS over 12 months [118] (LOE3).

Repetitive transcranial magnetic stimulation

Repetitive transcranial magnetic stimulation (rTMS) of the motor cortex induces a long-lasting modulation of spinal cord excitability [119]. Thus, it represents a potentially useful tool for the treatment of neurogenic urinary disturbances. Centonze et al. [120] investigated the effects of low frequency (5 Hz) excitatory rTMS over the motor cortex on LUT dysfunction in 10 MS patients complaining of urinary symptoms. All but one of the patients reported an improvement of voiding phase LUT symptoms and a significant reduction of post void residual volume. In patients with pure detrusor underactivity, there was increase of $P_{det}Q_{max}$ and Q_{max} . In patients with DSD, on the other hand, rTMS produced negligible effects, although the observation of a reduction of $P_{det}Q_{max}$ in this context seems to suggest a better relaxation of the urethral sphincter (LOE3). Brusa et al. also observed positive effects lasting 2 weeks after rTMS in 8 patients [121].

Deep brain stimulation

Subthalamic nucleus deep brain stimulation (STMN-DBS)

A large proportion of patients suffering from Parkinson's disease present with urinary dysfunction including urgency, increased frequency or incontinence [122]. Deep brain stimulation (DBS) of the subthalamic nucleus (STN) has been established as a surgical treatment of motor symptoms in Parkinson's disease patients [123]. However, data from experimental urodynamic measures in men [124] and animal models [125] have also demonstrated a significant influence of STN-DBS on urinary bladder function. In these studies, the main effect of STN-DBS appeared to be a normalization of urodynamic parameters in the storage phase with a delayed first desire to void and an increased bladder capacity. Herzog et al. investigated the effect of STN-DBS on the neural mechanisms underlying cerebral bladder control. Using PET to measure changes in regional cerebral blood flow (rCBF), 11 patients with bilateral STN-DBS were studied during urodynamic bladder filling in STN-DBS ON and OFF condition. A filled bladder led to a significant increase of rCBF in the anterior cingulate cortex, which was further enhanced during STN-DBS OFF. A significant interaction between bladder state and STN-DBS was observed in lateral frontal cortex with increased rCBF when the bladder was filled during STN-DBS OFF [126, 127] (LOE3).

Thalamic deep brain stimulation

The precise mechanisms underlying cerebral regulation of lower urinary tract function are still poorly understood. Essential tremor (ET) is not known to induce lower urinary tract symptoms (LUTS) or neurophysiological changes in the thalamus. Consequently, DBS in patients with ET offers the unique opportunity to investigate the role of the thalamic ventral intermediate nucleus (VIM) nucleus in lower urinary tract function. Kessler et al. [128] evaluated the effect of thalamic DBS on urodynamic parameters in patients

with ET. Seven patients were examined (two females, five males) with ET 15–85 months after implantation of DBS leads into the VIM. They compared urodynamic parameters during thalamic DBS (ON state) and 30 min after turning the stimulator off (OFF state). In the ON compared with the OFF state, there was a significant decrease in bladder volume at first desire to void (median, 218 ml vs. 365 ml, $p = 0.031$), at strong desire to void (median, 305 ml vs. 435 ml, $p = 0.031$), and at maximum cystometric capacity (median, 345 ml vs. 460 ml, $p = 0.016$). No significant differences between the ON and OFF state were detected for changes in detrusor pressure during filling cystometry, bladder compliance, maximum detrusor pressure, detrusor pressure at maximum flow rate, maximum flow rate, voided volume, and postvoid residual (LOE3).

Conclusions

- Electrical neuromodulation is not first line treatment for neurogenic DO. There are some limited reports showing that it may be beneficial (LOE 3).
- Automatic, event-driven electrical stimulation in the treatment of neurogenic DO is feasible (LOE 3).
- Chronic pudendal nerve stimulation is feasible. Neurophysiological guidance seems to be mandatory to place the lead near the pudendal nerve (LOE3).
- Percutaneous Tibial Nerve Stimulation gives improved clinical and urodynamic parameters. (LOE3), but its role is not established.
- Enhancing corticospinal tract excitability by rTMS might be useful to ameliorate detrusor contraction and/or urethral sphincter relaxation in MS patients with bladder dysfunction (LOE3).
- Thalamic deep brain stimulation resulted in an earlier desire to void and decreased bladder capacity, suggesting a regulatory role of the thalamus in lower urinary tract function (LOE3).
- STN-DBS appeared to tend to normalization of urodynamic parameters in the storage phase, with a delayed first desire to void and an increased bladder capacity (LOE3).

Recommendations

- If pharmacotherapy fails to relax the overactive detrusor, electrical neuromodulation may be optional in patients with neurogenic DO (C/D)
- Although the setup for conditional, event-driven electrical stimulation is not suitable in a clinical setting, the treatment modality is promising and it warrants further investigation (D).
- Further studies on chronic pudendal nerve stimulation must be carried out to identify the best

stimulation parameters and to verify the long term results (D)

- The thalamus may be a promising target for the development of new therapies for lower urinary tract dysfunction. Further investigation on this matter is needed before its potential role can be elaborated.

5.3. Electrical stimulation of the pelvic floor musculature

The aim of electrical stimulation in patients with neurogenic urinary stress incontinence is to improve key functions, namely the strength and/or timing of the pelvic floor muscle contraction. Electrical stimulation is provided nowadays mostly by portable battery powered stimulation, offering a wide combination of wave forms, frequencies, intensities, electrode placements etc.

In patients with incomplete denervation of the pelvic floor muscle and of the striated sphincter, electrical stimulation via anal or vaginal plugs performed over months, may improve pelvic floor function, and may thus improve incontinence. The incompleteness of the lesion should be as such that the patient is able to contract voluntarily the pelvic floor to some extent, even if such contraction is weak.

Conclusions

- There is no study published which deals with electrical stimulation via anal or vaginal plugs could be able to improve the strength of pelvic floor musculature (LOE 4)

Recommendations

- In patients with incomplete denervation and some voluntary contraction of the pelvic floor muscle and the striated sphincter, electrical stimulation may be an option to improve pelvic floor function, thus improve incontinence (C/D)

5.4. Intravesical electrical stimulation (IVES)

The technique involves a catheter with a stimulation electrode, introduced into the bladder and connected to the stimulator. Saline (0.9 %) is used as the current leading medium within the bladder. The neutral electrode is attached to the skin in an area with preserved sensation, usually in the lower upper abdomen. The afferent stimuli induced by IVES travel along afferent pathways from the LUT to the corresponding CNS structures. This “vegetative afferentation” results in sensation of bladder filling/urge to void, with subsequent enhancement of active contractions, and possibly also in voluntary control over the detrusor. Feedback training is mediated by enabling the patient to observe the change of the detrusor pressure on a water manometer, which enables the patient to notice when a detrusor contraction takes place. This also facilitates voluntary control.

Intravesical electrical stimulation of the bladder (IVES) is still not established as a therapy for patients with neurogenic detrusor dysfunction. IVES may help to verify function of afferent pathways, proper indication is crucial and this type of therapy should only be applied in those with afferent fibers between the bladder and the cortex, proved by the evaluation of viscerosensory cortical evoked potentials. Intravesical electrotherapy may be able to improve neurogenic bladder dysfunction. Studies about IVES were reviewed in previous consultations [129].

Conclusions

- Basic research during the last decade supports the underlying working concept of IVES (LOE 3)
- The results reported in the literature are controversial, mainly because of varied inclusion and exclusion criteria (LOE 3).
- In the only sham-controlled study the treatment period was short and the inclusion and exclusion criteria were not fully defined (LOE 3).

Recommendations

- Intravesical electrotherapy may improve neurogenic bladder dysfunction, inducing bladder sensation and the urge to void (B/C)
- IVES is the only available option to induce/improve bladder sensation and to enhance the micturition reflex in patients with incomplete central or peripheral nerve damage, but corroborating controlled evidence is needed (B)
- Selection of patients is crucial and IVES should be applied only if afferent fibers between the bladder and the cortex are still intact and if the detrusor muscle is still able to contract (B)
- The ideal indication is the neurogenic hyposensitive and hypocontractile detrusor (C)

5.5. Sacral neuromodulation

Two indications for neuromodulation are clearly valid in urology: overactivity/ urgency urinary incontinence and chronic urinary retention (aside from vesicosphincteric dyssynergia) [130], as discussed elsewhere in the consultation. This section focuses on the possible application of sacral neuromodulation in patients with neurological bladder dysfunction. The literature survey was undertaken with the key words: neurogenic bladder; spinal cord injury; spina bifida; meningomyelocele; multiple sclerosis, sacral neuromodulation

Hypotheses on the modes of action of neuro-modulation

The first effects of electricity on the bladder were reported during electro stimulation treatment of pelvic floor muscles (with the aid of electrodes situated in the anus, the vagina, on the penis...) during urinary

incontinence reeducation [131-134]. Inhibition of bladder contractions by electrostimulation was seen. Tanagho and Schmidt, the pioneers of neuromodulation, attributed the benefits of neuromodulation in urinary incontinence to a hypertrophy of the pelvic muscles, allowing better control [135]. Voluntary contractions of the pelvic floor muscles can cause reflex relaxation of the bladder. However, the most widely held hypothesis currently is that neuromodulation allows a restoration of normal vesical reflexes [136-138] (LOE4). This hypothesis explains that the stimulation can inhibit the guarding reflex pathway and restore normal urination or turn off supraspinally mediated overactivity by blocking ascending sensory pathways. The role of cortico-subcortical structures was recently emphasized in studies of patients with incontinence [139, 140] (LOE4) or retention [141] (LOE4). Somatic afferents as the vectors for neuromodulation mechanism of action is supported by the observation that visceral nerve fibers are not activated by the parameters normally used [142] (LOE4). Despite data obtained in animals [143] (LOE4), it seems that neuromodulation cannot be effective in patients with a non functional peripheral nerve circuit.

Treatment of neurogenic detrusor overactivity incontinence

Prior to 2010 the literature examining the use of sacral neuromodulation (SNM) in the neurogenic population was scarce and limited by heterogeneous patient populations including multiple neurologic diagnoses, lack of randomized controlled trials, small sample sizes, and short-term follow-up. Many studies even recorded results for incontinence and for retention at the same time, without always separating the results. Since the technique's first stages, Vodusek [134, 135] (LOE4) reported that non-muscular electrical stimulation of the sacral somatic afferents can induce bladder inhibition in patients who present with DO secondary to a medullary lesion, be it due to trauma or to multiple sclerosis (MS). The data on SNM in the neurogenic population is more or less limited to patients with stroke, Parkinson's disease, MS and incomplete spinal cord injury. In recent years, however, the literature has shifted somewhat to separate studies based on individual neurologic diagnoses, moreover, one randomized trial to this effect is underway (Knüpfner et al. 2014, [144]) (LOE3). With these limitations in mind, the current literature is generally positive and indicates that SNM demonstrates similar efficacy among the neurogenic and the non-neurogenic populations in terms of successful test phase, device implantation, clinical outcomes and urodynamic outcomes.

Two points must be kept in mind when treating patients with neurological bladder:

- The disappearance of wettings between catheterizations can be considered a success by itself in patients using IC. In contrast, in able-bodied patients, treating retention with IC is most often considered a failure

- On the other hand (contrasting, for example with botulinum toxin injections), neuromodulation does not systematically require the use of IC. Furthermore, reversibility of neuromodulation is a strong point that must be considered when devising a therapeutic plan.

The main published series are summarized in **Table 4**. Author definitions for neurological pathology differed widely: some authors considered a history of pelvic surgery as a possible etiology while others included only patients with medullary neurological lesions. Despite this, several points considering the neurological etiology of the bladder dysfunction can be discussed;

- MS is not a contra-indication for neuromodulation [139, 145, 146] (LOE3-4). However, it seems important to propose this treatment only in patients who present with a stabilized form of multiple sclerosis. In addition, patients must be clearly informed that the results of neuromodulation may be altered by the evolution of their underlying illness.
- Patients with incomplete medullary lesions, whether of traumatic or other origins, may benefit from neuromodulation [139, 147-152] (LOE3-4). On the other hand, all authors agree on excluding patients with complete medullary lesions. Clinical data, especially from the Hohenfellner series [149] (LOE3), support among others those reported by Schurch et al. in 2003 [153] (LOE4). These authors published a study in which they recorded external anal sphincter (EAS) electromyographic activity caused by stimulation of the S3 sacral root during a percutaneous needle evaluation (PNE) test in three patients who presented with neurogenic DO and DSD secondary to a complete traumatic medullary lesion. They describe a reflex response with early and late latency in the three patients. They also demonstrated that the EAS contraction observed during the PNE represented an indirect motor response mediated by the afferent nerves towards the spinal cord. Despite the recording of an EAS motor response in the three patients, they did not obtain any urodynamic or clinical benefit. This suggests the participation of supraspinal neuronal centers—presumptively a spino-bulbar spinal pathway—in the SNM mode of action. However, these data are contradicted by an experimental study using bilateral neuromodulation in the cat [154] (LOE4).
- Guys et al. [155] demonstrated significant but limited urodynamic differences in children (LOE3). However, the clinical translation of these modifications has not been reported. It must be emphasized that, in the absence of electrodes adapted to paediatric sizes, the study was carried out without the usual percutaneous evaluation phase.

- Encouraging short term results in neurological bladder dysfunction do not necessarily translate into long-term efficacy [149] (LOE2). Despite a positive test in about half of the patients tested, long term (54 months) results were poor in almost all patients (1/12 had neuromodulation efficacy).
- Sievert et al. [156] performed acute bilateral sacral S3 nerve stimulation in 10 patients with complete spinal cord lesions (SCLs) during the spinal shock phase, with six patients as controls. After a mean follow-up of 26 months, the cystometric capacity increased and IDC were abolished in the stimulation group. Further studies should look into this technique and question the ideas about the working mechanism in sacral nerve stimulation since afferent stimulation effects are unlikely in complete SCI.
- One of the largest and latest series is from Chaabane et al. [157]. They looked at the results of PNE testing and SNM implants with a mean follow-up of 4.3 years in 62 patients (34 with DO, 28 with chronic urinary retention). DSD was present in nine cases. 41 patients (66.1%) had more than 50% improvement on urodynamic evaluation and bladder diary with PNE, and 37 were implanted. At follow-up results remained similar to the evaluation phase in 28 cases (75.7%). In six cases (16.2%), clinical response had been lost; in these six cases, neuromodulation failed on average 12.0 months after implantation.

Particular attention has been given to the outcomes of SNM in the MS population. These patients present unique challenges given the heterogeneity of neurologic lesions and the ability of the disease to progress over time. Engeler et al. (2015) performed a single center prospective series for the treatment of neurogenic lower urinary tract dysfunction (NLUTD) caused by Multiple Sclerosis. Out of seventeen patients (13 women, 4 men) treated with SNM for refractory NLUTD, enrolled 2007–2011, 94 % had a positive test phase with a >70 % improvement. After implantation of the pulse generator the improvement in voiding variables persisted. At 3 years, the median voided volume had improved from 125 to 265 ml, the post void residual from 170 to 25 ml, micturition frequency from 12 to 7, and number of incontinence episodes from 3 to 0. Only two patients developed lack of benefit. No major complications are reported. These results are based on a careful patient selection, patients had to have stable disease and confirmed neurogenic lower urinary tract dysfunction [158]. (LOE2). These results correlate with those reported in a review article which was carried out up to December 2014 by Puccini et al. (2016). Based on two prospective studies the authors conclude “SNM seems to be a safe and effective treatment for LUTS in MS patients. Fur-

ther and larger studies as well as randomized controlled trials are needed to confirm its clinical role in patients with MS.” [159] (LOE3)

In a prospective neuromodulation database study, Peters et al. (2013) enrolled patients with mixed etiology [160]: stroke (n=17), multiple sclerosis (n=13), Parkinson's disease (n=10), incomplete spinal cord injury (n=4), cerebral palsy (n=1) and some others. 63 of 71 (88,7%) had a positive test phase and received the implantable pulse generator. This group of patients was compared with the group of patients with non-neurogenic bladders. Most patients (> 50 %) in both groups reported moderate and marked improvement in overall bladder symptoms of two years, and the patients with neurogenic bladder dysfunction experienced benefits after neuromodulation similar to the benefits experienced by those without coexisting neurologic condition. These results are encouraging, however, there are still some issues which need to be solved, e.g. unilateral vs. bilateral implantation especially in patients with a neurogenic underactive detrusor. Life time of the implanted generator (battery) of course depends very much on how much electricity is necessary. Moreover, also the issue of performing MRI needs to be discussed with the patient and his neurologist as MRI might damage the implant (according to the producing company). (LOE3)

Scheepens et al. [150] reported two prognostic factors for poor response (the study population was six incomplete medullary injuries, five patients with cauda equina syndrome, six with multiple sclerosis, and one with myelomeningocele) (LOE3): duration of the symptoms (more than seven months in this study) and the existence of a neurological cause for bladder dysfunction. Neurological patients with a very localized and incomplete nervous condition were the most successful. Patients with herniated disc surgery had a greater chance of good response. Patients with complete medullary or large sacral lesions were poor neuromodulation candidates.

Clinical results of neuromodulation do not necessarily correlate to urodynamic results. Bosch indicated in his series [147] that almost half of the patients considered to have had a good outcome clinically in reality retained some overactivity. One publication reported correspondence between urodynamic test data and clinical data [139] (LOE4). In 2001 Chartier-Kastler [161] et al. published the results of a prospective study concerning the evolution of urodynamic parameters during the acute phase of the PNE test in 14 patients with neurogenic DO. The authors concluded that the acute phase of PNE was accompanied by a significant change in urodynamic parameters in more than 2/3 of the patients, and that this should be a possible means for selecting patients.

Sacral neuromodulation for urinary retention in neurological bladder dysfunction

Only two studies reported specific results for neurogenic urinary retention. The first is by Hohenfellner et al. [149] (LOE3), reporting on 11 patients. Of these

patients, three were implanted with temporarily satisfactory results in only two.

Lombardi et al. in 2014 evaluated 95 incomplete SCI patients suffering from chronic, neurogenic non-obstructive urinary retention. Only 41 % were suitable for implant after the test phase. The implant was done unilaterally. After three years 25 of all patients (29%) were considered to be successful, 11 (19%) were failures. The majority of them with the unilateral implant had success when the contralateral L3 sacral root was stimulated. The authors conclude that SCI patients with neurogenic, non-obstructive urinary retention are good candidates for SNM in the medium follow-up. [162] (LOE2)

Due to the limited available data and the rather low success rate, SNM currently holds a marginal place in neurogenic retention patients. Patients need to be clearly informed of the high risk of failure. In this respect the bladder contractility test could be helpful in order to predict a successful outcome of sacral nerve stimulation in acontractile neurogenic bladders [163]. It is also necessary to be especially prudent in patients with cauda equina problems, who may have the illusion of recovering urination, but actually may be enhancing abdominal straining to evacuate their bladder. In reflex incontinence, patients with complete spinal cord or cauda equina lesions are poor candidates (LOE4). While a few studies have reported on SNM in specific contexts [164-167], patients should be informed that IC is the first-line therapeutic option for neurogenic urinary retention.

Recommendations

- Sacral neuromodulation can have an inhibitory effect on neurogenic DO (C)
- While sacral neuromodulation has a place in the care of neurological urinary incontinence or neurological urinary retention, the proportion of patients whose condition is improved is much less than in non-neurological pathologies (B).
- Indications for sacral neuromodulation in the care of DSD in neurological urinary dysfunction are still not established (D).

Table 4: Results of sacral neuromodulation (test and implantation) in neurogenic patients.

Author	LOE	n (neurogenic bladder)	Follow-up (months)	Neurological Pathology	Type of dysfunction	Number of patients tested	Test success Criteria	Number of implantations	Success criteria after the implantation	Number or percentage of success after the implantation at the end of the study
Bosch et al. 1996 [146]	4	5(5)	6	MS 5	Incontinence	NA	>50%	5	>50%	4/5
Bosch et al. 1998 [147]	4	6(6)	24	MS 5 Incomplete SCI 1	Incontinence	NA	>50%	6	>50%	5/6
Chartier-Kastler et al. 2000 [139]	4	9(9)	43,6	MS 5 Myelitis 1 Vascular myelitis 1 SCI 2	Incontinence	23	>50%	9/26	>75%	7/9
Spinelli et al. 2001 [148]	4	196(10)	12	Discal hernia 5 MS 1 Incomplete SCI 2 Cerebral lesion 1	Incontinence Retention	NA	>50%	196(10)	>50%	Retention: 66% Incontinence: 50%
Hohenfellner et al. 2001 [149]	3	27(27)	54	SCI 9 Myelitis 5 Cerebral lesions 2 Discal hernia 7 Pelvic surgery 4	Incontinence Retention	27	>50%	12	>50%	1/12
Scheepens et al. 2002 [150]	4	211(24)	NA	Incomplete SCI 9 Caudal syndrome 5 Stroke 3 MS 6 Spina 1	Incontinence	211	>50%	NA	NA	NA
Bross et al. 2003 [153]	3	24	NA	Pelvic surgery 5 Ependymoma A Cerebral tumours 7 Discal hernia 5 Polyradiculoneuritis 6 Spina bifida 1	Retention	24	>50%	8/24	NP	NP
Guys et al. 2004 [155]	2	21	12	Spina bifida 13	Incontinence	NA	NA	21	>50%	NP

Author	LOE	n (neurogenic bladder)	Follow-up (months)	Neurological Pathology	Type of dysfunction	Number of patients tested	Test success Criteria	Number of implantations	Success criteria after the implantation	Number or percentage of success after the implantation at the end of the study
				Partial sacral agenesis 2 SCI 2 Tumour 2 Various 2						
Spinelli et al. 2005 [152]	3	15(15)	6	SCI incomplete 7 Various Medullar lesions 8	Incontinence	15	>50%	12/15	NP	NP
Wallace et al. 2007 [145]	3	33(33)	12,4	MS 16 Parkinson 6 Spina bifida 2 Stroke 2 Other 6	Incontinence Retention	33	>50%	28/33	>50%	NP (3 neuromodulators removed)
Chaabane et al. 2011 [157]	3	62	51	MS 13 Incomplete SCI 13 Peripheral neuropathy 8 Parkinson 4 Myelitis 4 Stroke 4 Other 16	Incontinence retention	62	>50%	41/62	>50%	76%
Knüpfer et al. 2014 [144] (only a protocol proposal for a randomized, placebo-controlled, double-blind clinical trial)										
Lombardi et al. 2014 [162]	3	85	NP	SCI incomplete	Neurogenic non-obstructive	85	NP	36	Significant improvement 0.01 to 0.05	23/34 full responders 11/34 inconstant responders

Author	LOE	n (neurogenic bladder)	Follow-up (months)	Neurological Pathology	Type of dysfunction	Number of patients tested	Test success Criteria	Number of implantations	Success criteria after the implantation	Number or percentage of success after the implantation at the end of the study
					urinary retention					
Peters et al. 2013 [160]	3	71	NP	Stroke 17 MS 13 Parkinson 10 Incomplete 4 Cerebral palsy 1 Others 26	Storage and voiding symptoms	Statistical significance	88,7%		Statistical significance	>50 %
Puccini et al. 2013 [159] (Literature research on two prospective and four retrospective studies – all patients with MS)	3	228	Up to 7 years	MS 79 Neurological disease 149	NP	NP	NP	159	Objective success often unclear, subjective cure rate 45%, patients reported satisfaction 85% Results stable over time	

NP: Not precisely stated, NA: Not applicable; LOE: Level of evidence MS: Multiple sclerosis.

6. SURGICAL TREATMENT OF URINARY INCONTINENCE

6.1. Denervation procedures for treating reflex urinary incontinence due to detrusor overactivity

Peripheral bladder denervation

The best known bladder denervation technique was developed by Ingelman-Sundberg [1,2]. The technique comprises resection of the inferior hypogastric plexus in contact with the bladder through an inverted U-shaped vaginal incision, dissecting the bladder laterally and posteriorly, as widely as possible. In the most recent paper [2], the authors report up to 54% recovery over a mean follow-up of about three years. Each published series is from the same group, is retrospective and reports only a small sample size (LOE4). It has only occasionally been used in neurogenic DO.

Isolated rhizotomy of ventral and/or dorsal sacral roots

Historically, attempts at sacral root surgery first focused on cutting the motor (ventral) sacral roots in order to abolish detrusor reflex contractions. It was soon clear that this method failed within six months. With a different objective, Brindley [3] developed a technique involving stimulation of ventral sacral roots to obtain controlled and complete bladder voiding in cases of SCI. He realised that patients only acquired continence if the stimuli causing reflex bladder contraction could be blocked [4]. Early techniques consisted in selective destruction of the dorsal sacral roots that evoke detrusor contractions. These selective rhizotomies did not, however, give the best results. Only after complete de-afferentation of the sacral micturition centre by intradural rhizotomy were better results obtained [5-8] (LOE2-3).

The technique of "selective" dorsal sacral rhizotomy has been studied more extensively but since 1988 no publications can be found anymore. It involves making an extra-dural approach to the sacral roots (S2-5), isolating and stimulating the dorsal (sensory) contingent whilst monitoring changes in urodynamic pressure within the bladder in order to cut only those fibres responsible that do not show evoked overactivity. This implies that only the sensory nerves are cut and the motor nerves are preserved. To retain reflex erection, S2 must be preserved, at least on one side. This treatment may be proposed for patients with neurogenic DO, and also those with urgency incontinence. The most recent article from 1988 by Lucas *et al.* [9] is about 22 patients (LOE3). At the mean follow-up of 4 years, 39% of patients retained a urodynamically stable bladder with satisfactory clinical response. The authors ascribe these improved results to a more extensive rhizotomy. However, it should be noted that there was a marked heterogeneity of patients in this series, three out of the eight, considered

to be "successes", were IDC patients with leakage due to DO.

Mertens *et al.* [10] applied a technique previously used for limb spasticity, namely microsurgical DREZotomy, the aim of which is to destroy the dorsal root entry zone (DREZ). This zone, first defined in 1972 by Sindou [11], is a functional anatomical entity that groups together the proximal portion of the dorsal root, the medial portion of the dorso-lateral tract and the superficial layers of the dorsal horn. The technique involves making a micro-surgical lesion (by micro-coagulation) on the ventro-lateral portion of the entry zone, near the apex of the dorsal zone. The effect of DREZotomy is to selectively block nociceptive afferents, and their relays, and myotatic afferents. The benefit of the limited lesion is to avoid complete abolition of tactile and proprioceptive sensitivity and to prevent the development of deafferentation phenomena. To treat neurogenic DO, the lesion must be made on both sides from S2 to S3, or even S4. The results from the first series concerned 38 patients treated for incapacitating lower limb spasticity, treated by extended DREZotomy from L2 to S1. 58% of these patients were permanently catheterized. At six months, DO had disappeared in 82%, with 63% having significantly improved bladder capacity. At 18 months post-surgery, leakage had disappeared in 89% of cases. Since 2003, no publications on DREZotomy for neurogenic LUT disorders were found, although the technique is still applied to alleviate pain.

Percutaneous sacral root block

Sacral root block is an old technique, since Dogliotti [12] proposed it as early as 1931 to relieve vertebral cancer pain by chemically sectioning several dorsal roots. An injection of alcohol causes denervation due to the fragmentation of myelin in the endoneurium. In the 1950s, Bors [13] applied the technique to the bladder, standardized the procedure and described preliminary results. Later authors reported on a few series (LOE3) [14, 15], but always with the same result; the benefit disappeared after a few months. Phenol, considered to be "selective" for C fibers was then tried but the results were no better [16-18]. Chemical destruction of the sacral nerve roots has proved ineffective and is accompanied by a high rate of minor complications (pain), resulting in significant discomfort and prolonged hospitalization (LOE3) [14, 15]. Mulcahy *et al.* [19] proposed sacral rhizotomy by percutaneous radiofrequency for neurogenic bladder (LOE4). A recent study was published by Ferreire *et al.* [20]. In 8 SCI patients they performed a bilateral block of S3 with bupivacaine. These 8 responders had an increased bladder capacity and for 3 out of 4 patients autonomic dysreflexia (AD) improved.

Rhizotomy of posterior sacral roots and stimulation of the anterior sacral roots

Electrostimulation to improve micturition in patients with spinal cord injury has been extensively re-

searched since 1954. Direct stimulation of the detrusor, the spinal cone, the splanchnic and sacral nerves have not produced reliable results. Since 1969, Giles Brindley developed a set of electrodes for stimulating the spinal roots in the *cauda equina*. The technique, first tested in baboons, led to the development of an implanted stimulator to induce micturition in paraplegic patients. Sacral rhizotomy performed during implant surgery makes it possible to control bladder hyperactivity and ensure continence. The energy source and the electronics for adjusting the stimulation parameters are not implanted. The transmitter transforms the electric current from the energy source into electromagnetic waves, which are picked up by the implanted receptor and re-transformed into an electric current that circulates to the electrodes in contact with the nerve. Depending on the surgeon's decision, the implant is placed within the membranes (intradurally) of the dura mater or outside them (extradurally), so as to stimulate the sacral roots from S2 to S4. At the same time, it is essential to perform posterior rhizotomy from S2 to S4 to remove any detrusor overactivity, though this is difficult to perform, especially extradurally [21] (LOE4). This technique can only be performed in those with spinal damage who are para- or tetraplegic. The sacral reflex arc must be preserved.

Micturition is not continuous: the detrusor cannot be stimulated without also stimulating the sphincter. The parasympathetic fibers and the fibers destined for striated muscles are stimulated together. The response of detrusor smooth muscle fibers causes a gradual increase in pressure, which continues after stimulation has ceased. The "on-off" response to stimulation of striated muscle fibers is different. When stimulation stops, the striated sphincter immediately relaxes, whilst the detrusor continues to contract. A new wave of stimulation increases and maintains sufficient detrusor pressure to cause micturition after stimulation stops. The careful selection of stimulation and stopping times results in a discontinuous, but satisfactory, micturition. Sphincter fatigue due to electrical stimulations, blocking of pudendal nerve motor fibers [22] (LOE4) or use of specific detrusor stimulation by performing an anodal block [23] (LOE 4) have been reported, together with poor efficacy.

Stimulation can also help defecation and erection and it resolves to some extent autonomic dysreflexia and also spasm of the lower part of the body, but it should be remembered that the principal object of sacral nerve stimulation combined with posterior rhizotomy is to achieve urine continence and bladder voiding. Induced erection is a secondary benefit but not an indication for the procedure, and men should be warned that they would lose reflex erection after posterior rhizotomy.

The results of the intervention are summarized in Table 5. Briefly, the outcome with regard to continence and bladder voiding are good (LOE 2-3). Failures result from incomplete rhizotomy, where bladder hyperactivity persists, or from sphincter insufficiency which

may be treated by additional placement of an artificial sphincter [7, 8] (LOE3). Incomplete rhizotomy can be surgically completed [7, 8, 24] (LOE 2-3). In all reported series, mean bladder capacity increased significantly (LOE 2-3). Micturition was obtained by electrostimulation with a post-voiding residue (PVR) of ≤ 50 ml in 69 to 100% of patients. All series reported decreased incidence of urinary infection, but the defining criteria were too varied to allow conclusions to be drawn. Posterior sacral rhizotomy probably protects the upper urinary tract from detrusor overactivity. It can resolve the problem of pre-operative reflux [24, 25] (LOE4). However, posterior sacral rhizotomy should be complete. Indeed, in a series of 500 patients, Brindley [24] (LOE3) reported twelve cases of upper urinary tract impairment, ranging from grade I reflux to upper urinary tract dilation.

Martens et al. looked at patients in the Netherlands who underwent a Finetech-Brindley procedure [26]. They investigated the effects on quality of life in a group of 46 patients that still used the implant. They also looked at the presumed beneficial effects of the rhizotomy only, comparing with a group of 70 matched controlled patients that had optimised standard care. The patients had a significant better Specific Impact of Urinary Problems score, general QoL index (Qualiveen), and continence rate, and less urinary tract infections compared to the Control Group. If the stimulator was not used anymore, patients still benefited from the rhizotomy with regard to QoL and continence rate. The subscales of the SF-36 had better scores for the patients who used their stimulator as compared to those who did not use the stimulator and compared to the Control Group. The conclusion was that the active group had a better QoL than the rhizotomy group, and both groups had advantages over optimized standard care. Schurch [27] focused on the specific problem of dysreflexia and recorded its persistence during stimulation in all patients who had suffered prior to surgery, but with marked improvement in symptoms.

Krasmik reported on the outcome of 137 retrospective analysed patients. After a mean follow-up time of 14.8 years elevated detrusor pressure was reduced from 65/137 to 2/137 patients, whereas low detrusor compliance changed from 62/137 to 13/137 patients. Mean bladder capacity significantly ($P < 0.001$) improved from 272.4 ± 143.0 to 475.0 ± 82.7 ml. The mean number of symptomatic UTI also decreased significantly ($P < 0.001$) from 6.2 ± 4.5 to 2.5 ± 2.6 per year. The number of patients suffering from incontinence had significantly ($P < 0.001$) decreased from 70/137 to 44/137. At the last follow-up visit, 107 (78.1%) patients were still using the stimulator. A total of 84 complications requiring surgical revision were observed. Defects of the stimulator cables or the receiver plate were the most common events ($n=38$) [28].

Castano-Botero et al reported on a retrospective analysis of 104 SCI patients who underwent an extradural implant procedure. Incontinence resolved in

86% of cases whereas UTI's went down from 91% to 16% [29].

Moreover the effect on bowel emptying can also be very rewarding as was published by Rasmussen et al. They reported that 73% of the 586 responding patients used the device for defecation and were very happy with it [30].

Table 5: Results of series on Sacral anterior root stimulation technique + Sacral deafferentation

	Patient numbers	Sex ratio (M/F)	LOE	Mean follow-up (extremes)	Pre-op. continence (%)	Post-op. Continence (%)	Pre-op. bladder capacity (ml)	Post-op. bladder capacity (ml)	% complete micturition (PVR < 50 ml)	Pre-op. dysreflexia (%)	Post-op. dysreflexia (%)	Pre-op. UTIs (%)	Post-op. UTIs (%)
Brindley <i>et al.</i> (1994) [24]	500	271/229	3	4 years	-	-	-	-	82	-	-	-	
Barat <i>et al.</i> (1992) [32]	40	26/14	3	2 ½ years	2,5	90	210 (50-500)	463 (200-600)	82	-	-	100	30
Van Kerrebroeck <i>et al.</i> (1996) [31]	52	29/23	3	3.5 years		81	285	592	87	14	4	4.2/year	1.4/year
Schurch <i>et al.</i> (1997) [27]	10	3/7	3	3.4 years	0	80	160	> 500 ml	100	60	60	80	30
Egon <i>et al.</i> (1998) [7]	96	68/28	3	5.5 years (0.5-14)	1	88	200 (40-600)	565 (300-600)	89	22	0	100	32
Van der Aa <i>et al.</i> (1999) [25]	37	33/4	3	(0.4-12)	-	84	75% < 400 ml	95% > 400 ml	91	-	-	-	-
Creasey <i>et al.</i> (2001) [733]	23	16/7	3	> 1 year	65	87	243 (30-450)	> 400 ml	69	35	7	82	78
Bauchet <i>et al.</i> (2001) [6]	20	6/14	3	4.5 years (1-8.5)	0	90	190 (40-600)	460 (350-800)	90	15	0	100	-
Vignes <i>et al.</i> (2001) [34]	32	-	3	8 years (4-11)	0	90	220 (50-600)	550 (350-600)	80	18	2	100	30
Kutzenberger (2005) [8]	464	244/220	2	6.6 (6-17)	-	83	173	470	81	-	-	6.3/yr	1.2/yr
Martens (2011) [26]	46	36/10	3	13(1-19)	-	52	-	-	-	-	-	-	50 (>1 yr)
Krasmik (2014) [28]	137	81/56	3	15(0-25)	51	32	272	475	-	61	2	88	51
Castano-Botero (2015) [29]	104	95/9	3	-	0	86	-	263 (SD 108)	91	66	6	91	16

Conclusion

- Bladder denervation is mainly reserved for those suffering complete spinal cord injuries.

Recommendations

- No peripheral bladder denervation technique has passed the test of time (D)
- Injections of neurolytic products to treat detrusor overactivity should be abandoned, since they are ineffective in the medium and long term and expose patients to morbidity (A)
- Sacral dorsal rhizotomies need to be quite extensive to treat successfully neurogenic DO. So they may be performed only in patients with lower limb neurological impairment (B)
- In certain situations, dorsal rhizotomies can be undertaken in association with ventral root stimulators (Brindley's technique) or even with continent cystostomy (B)
- Electrostimulation of the anterior sacral roots is a valid option for managing neurogenic bladder in patients with spinal lesion, with long-term follow-up (B)
- It must be combined with destruction of all or part of the posterior sacral nerves, and cannot therefore be performed in patients with conserved lower limb motility(B)
- The reflex arc must be intact(B)
- Posterior rhizotomy exposes men to loss of reflex erection and women to a loss in reflex vaginal lubrication(B)
- It is vital to assess the patient carefully before implantation so as to determine whether he/she will be able to mount a toilet or grasp a urinal handrail (B)

6.2. Surgery for Incontinence associated with poor bladder emptying

Incontinence in neurological patients can be aggravated by deficient bladder emptying and retention. Two mechanisms can be involved: detrusor sphincter dyssynergia (DSD) or detrusor underactivity.

6.3. Surgical treatment of detrusor external sphincter dyssynergia (DSD)

DSD is a characteristic feature of suprasacral and inrapontine lesions and can be treated with sphincterotomy. The aim of sphincterotomy is to produce reflex micturition into a condom catheter which acts as a pressure relieve valve, thus protecting the upper urinary tract. For the last thirty years, endoscopic sphincterotomy has been the technique of choice for patients who cannot or do not want to do IC. It is invasive, irreversible and the patient has no adaptation

period [35, 36] (LOE3). Prosthetic sphincterotomy using a urethral endoprosthesis (or stent) is an alternative.

Sphincterotomy recommendation supposes a diagnosis of a neurological cause of DSD that is complicated by hydronephrosis, vesicoureteral reflux, autonomic dysreflexia or repeated urinary infections secondary to poor bladder voiding. Patients should have failed or refused IC. Main contra-indications are [37, 38]:

- Impossibility to retain a condom catheter. All sphincterotomy techniques, including stenting, are contra-indicated for men who cannot retain a condom catheter (hence also for women). A semi-rigid penile prosthesis can be placed to help retain the condom catheter [39] (LOE3). However, patients must be informed that there is a 20% to 30% risk of erosion and infection of the penile prosthesis for those with SCI, as opposed to only 2.7% in the general population [40, 41] (LOE3).
- Detrusor acontractility or hypocontractility. Patients with spinal cord injury and no reflex detrusor contraction during urodynamic tests are poor candidates for the various techniques of sphincterotomy.
- Patients who wish to father children and are candidates for vibro/electro-ejaculation and an artificial insemination program.

Endoscopic sphincterotomy

Emmett [42] first described endoscopic sphincterotomy in 1948. He performed cervico-prostatic incisions in patients with SCI, but later realized that the problem lay in the striated sphincter. External sphincterotomy was performed in 1958 by Ross *et al.* [43]. They carried out cold-blade surgery and placed a catheter (Ch 22-26) for tamponade, since nearly all patients required transfusion (one of the ten patients in the series died after surgery). A few attempts at surgical sphincterotomy via the perineal and subpubic myotomy routes were tried later. Complexity and frequent serious complications explains why these approaches were abandoned [44, 45]. Sphincterotomy with electrocoagulation was finally found to be the best technique.

Endoscopic sphincterotomy morbidity includes hematuria, which can be abundant and sometimes difficult to control, requiring transfusion in 2-13% of patients (LOE2-3). Incision at the twelve o' clock position seems to offer the lowest risk of hemorrhage, with three and nine o' clock sphincterotomies entailing the highest risk [46] (LOE4).

Post-operative impotence is also a common complication. Rates of up to 56% were reported in early series [47-50] (LOE3). More recent series (Table 6, LOE 2-3), most using a median, or slightly deviated incision, have not affected sexual function. However, it should be noted that the population concerned may

have many other reasons (neurological, psychological, etc.) for suffering from erectile dysfunction. When sphincterotomy is accompanied by complete incontinence there are obvious reasons for psychological difficulties during intercourse. This issue must be discussed with the patient before surgery. The fear of this sequel sometimes causes the patient to decide against surgery; use of an incontinent prosthesis as first-line therapy can enable the patient to gain insight into this potential consequence of endoscopic sphincterotomy.

If striated sphincter section fails, the possibility of bladder neck stenosis should be investigated. This is seen in from 2 to 21% of patients (LOE 2-3). Section of the bladder neck may then improve voiding, but will result in permanent incontinence. Before surgery, the surgeon must make sure that the patient accepts this situation and can use a condom catheter.

Results of endoscopic sphincterotomy are summarized in 6 (LOE2-3). Any analysis is made difficult by the absence of unequivocal criteria of success. Some patients are improved by sphincterotomy, even with a 200 ml residue. Most authors use indirect urodynamic criteria to evaluate success (decrease in bladder pressure during micturition, decrease in PVR). The most obvious result is the improvement in autonomic dysreflexia observed in tetraplegic patients. It also appears that the intervention reduces the rate of symptomatic UTIs. However, chronic bacteriuria is not improved [51]. The reported results concerning resolution of hydronephrosis and vesicorenal reflux differ, and in each series, there are very few patients. Another essential point, well known in practice but rarely reported, is the recurrence of neurogenic DSD in many patients [36, 52, 53] (LOE3). Riccotone *et al.* (LOE3) [53] reported 82% recurrence of symptoms after ten years of follow-up. Juma *et al.* [36] (LOE3) report similar results after eleven years, with patients undergoing an average of 1.7 sphincterotomies. Pan *et al.* reported a mean duration of benefit of almost seven years, which could be sustained with a repeat procedure [54]. A single study has tried to address predictive factors for a successful sphincterotomy. In this retrospective study, although detrusor leak point pressure and retrograde perfusion pressure were found to be superior to residual urine volume in predicting sphincterotomy success, results were not statistically significant [55]. 30-68% of patients eventually develop some impairment of the upper urinary tract [36, 54]. Patients who have undergone this surgery must therefore be regularly monitored to detect any distension of their upper urinary tract.

The group from Ginsberg published their long term data on 97 patients who underwent bladder neck incision with external sphincterotomy (BNI/ES) over a period of 40 years. During the period reviewed, a solitary redo BNI/ES was done in 46 patients, a second redo BNI/ES was done in 23 patients, and a third redo BNI/ES was done in 7 patients with success rates of 50%, 68.2%, and 85.7%, respectively. All patients had a normal serum creatinine level at the end of the

follow-up. Mean elapsed follow-up after the last redo BNI/ES was 119 months (range, 6-408 months) for all patients evaluated. Mean durability of successful redo BNI/ES was 109.1 months. [56]

Table 6: Results of endoscopic sphincterotomy

	Number patients	LOE	Mean Follow-up (months)	Success criteria
Chancellor <i>et al.</i> 1999 [51]	26	2	24	- PVR decrease - Hydronephrosis, VR reflux decrease (100%, 100%) - Improved micturition comfort (80%) - Improved autonomous hyperreflexia (100%)
Catz <i>et al.</i> 1997 [90]	32	3	NP	- Significant decrease in PVR - Decrease in infections (74%) - Decrease in hydronephrosis, reflux (66%, 40%) - Improved autonomous hyperreflexia (100%)
Perkash <i>et al.</i> 1998 [95]	37	2	9	NK
Fontaine <i>et al.</i> 1996 [91]	92	2	20.6	- Decrease in hydronephrosis, reflux (100%, 90%) - Significant decrease in PVR, micturition pressure - Decrease in infections (74%) - Improved micturition comfort (73%) - Improved autonomous hyperreflexia (93%)
Noll <i>et al.</i> (1995) [35]	105	3	59	No statistical study, but: - Improved autonomous hyperreflexia (42 to 17%) - Decrease in mean PVR (180 to 70 ml) - Decrease in micturition pressure (from 97 to 37 cm H ₂ O) - Decrease in frequency of symptomatic urinary infections (8.1 to 3.6 per year)
Rivas <i>et al.</i> 1995 [96]	22	2	12	- Improved autonomous hyperreflexia (44%) - Significant decrease in PVR, micturition pressure - Decrease in hydronephrosis (40%)
Juma <i>et al.</i> 1995 [77]	63	3	132	- Renal function (creatinine): normal in 97% of patients - on X-ray, 30% of patients showed upper urinary tract impairment. - 2/3 patients had more than one sphincterotomy
Vapnek <i>et al.</i> 1994 [52]	16	3	39	- 31% required repeated sphincterotomy - 50% failure rate (sub-pubic catheter placed)
Namiki 1984 [92]	9	4	3	- PVR < 50 (100%)
Ruutu <i>et al.</i> 1982 [93]	11	4	NS	- Subjective improvement in micturition comfort (56%) - Improved autonomous hyperreflexia (100%)
Carrion <i>et al.</i> 1979 [94]	60	3	12	- Reflux disappeared (86%) - Significant decrease in reflux: 75%

LOE: Level of evidence; NK: Not known; PVR: Post-Void Residue

Prosthetic sphincterotomy

In 1990, Shaw *et al.* proposed using a wire mesh stent (Urolume) to treat patients with spinal injury presenting with DSD [58] (LOE3). Since then, various stents have been used.

7 lists the types of stent used for DSD, according to classification criteria [59, 60]. They can be placed in various sections of the urinary tract: prostatic urethra, through the striated sphincter or more distal in the sub-sphincteric urethra. Our review is limited to placement through the striated sphincter.

Table 7: Urethral stents used in neurogenic DSD

Temporary stents					
Stent	Expansion method	Size		Material	Maximal duration (months)
		Caliber (F)	Length (mm)		
Not specific to the striated sphincter					
First-generation					
Urospiral [97]	Non expandable	21	40-80	Stainless steel	<12
IUC [98]	Non expandable	16-18	25-80	Polyurethane	<6
Second-generation					
Memokath [99]	Heat	22/34	30-70	Nitinol	<36
Specific to the striated sphincter					
Diabolo [61]	Self-expansion	18	38	Medical steel	>12
Permanent stents					
Stent	Expansion method	Size		Material	
		Caliber (F)	Length (mm)		
Urolume Wallstent [100]	Self-expansion	42	20-40	Steel alloy	
Titan [101]	Balloon	43	19-58	Titanium	
Memotherm [102]	Heat	42	20-80	Nitinol	
Ultraflex [103]	Self-expansion	42	20-50	Nitinol	

Temporary prosthetic sphincterotomy

Temporary stents make it possible to carry out a therapeutic test to check the feasibility of condom catheter use, check that placing a foreign body in the urethra does not induce autonomic dysreflexia and ensure the patient accepts the mode of micturition. Moreover, during this trial period, it is possible to study how the bladder empties in the seated position, and assess the necessity of additional treatment for smooth muscle sphincter dyssynergia at the level of the bladder neck. As this treatment is simple and reversible, it is possible to propose it very early to the patients, rendering the patient autonomous with regard to carer-assisted catheterization, if this were the prior mode of micturition and leaving the possibility to discuss any fertility and sexual issues, and considering the possibilities of preserving sperm. For patients with SCI, early temporary stent placement (within six months of trauma) theoretically has the added advantage of waiting for recovery of upper limb motility to enable IC. After using a temporary stent, the patient may choose his mode of micturition; i.e. return to his

former state, change to another temporary stent, replace it by a permanent stent, or choose surgical sphincterotomy.

By definition, temporary stents should be self-retaining, easy to remove and must not epithelialize. Only the temporary stent Diabolo [61] is specific for the external urethral sphincter. The results of two types of temporary stenting (test) for incontinence have been published in the same series [62] (LOE3). In a retrospective study of 147 patients, the authors demonstrated a significant effect on incontinence throughout the mean ten month test period, with very low morbidity (15%). The temporary stents were removed easily from all patients without sequelae. After this period, 62.6% of patients chose permanent sphincterotomy, usually by means of a permanent stent. Memokath is another device that has been studied in neurological patients [63-68] (LOE3-4). Several authors report complications (32-100%) using this stent, which seems to induce a lot of bladder stones and to be quite difficult to remove, especially if it is left longer than 18 months. When used as second-line treatment following failed sphincterotomy, Memokath success-

fully reduced post-void residuals, but failed to improve urodynamic parameters including bladder capacity, detrusor leak point pressure, bladder compliance, and maximum detrusor pressure [63].

Permanent prosthetic sphincterotomy

Permanent stents are designed to integrate with the urethral wall [69]. They resist the striated sphincter and prevent its closing during reflex contraction. They can be removed if necessary, or at the patient's request, with recovery of striated sphincter contraction [70, 71]. Permanent stents are made of biocompatible materials such as nitinol (a nickel and titanium alloy) and titanium. They usually consist of a mesh comprising a single thread (e.g. Urolume) or several threads (e.g. Ultraflex). None of the stents are specifically adapted for the urethral striated sphincter. Three have been reported for treating neurological patients with DSD: Urolume, Memotherm and Ultraflex. All can be placed under local anesthesia. Table 8 summarizes the principal series published on these devices. Only Urolume was studied according to strict prospective criteria [51] (LOE1-2). Using stringent clinical and statistical methods, they classified the stent as LOE 1 for effectiveness and morbidity in DSD with a 5-year follow-up. 160 patients with SCI (mean age 36.3 years) in 15 North American centres, were treated prospectively with Urolume for DSD. Urodynamic parameters for micturition pressure, PVR and functional bladder capacity were measured before treatment and then annually up to 5 years afterwards. Mean micturition pressure, the primary criterion, was significantly lower 5 years after stenting. PVR decreased significantly and was maintained after 5 years. Mean bladder capacity remained constant. Hydronephrosis, suffered by 28 patients before surgery, disappeared in 22 (78.6%) and was improved in the others. Autonomic dysreflexia resolved in 70% of cases. The indwelling catheters of 63 of the 86 (84.9%) patients catheterized before surgery could be removed. The percentage of positive urine cultures remained unchanged after stenting. No cases of peri- or post-operative bleeding, soft tissue erosion or bladder lithiasis were observed during the study. One case of prosthetic encrustation occurred during the first year; three during the second year; three during the third year; two during the fourth year and five in the fifth year. Urothelial reaction was reported in 44.4% of cases, but 93.3% of these were mild and none required treatment. No erectile dysfunction was reported. Stents had to be removed from 24 patients (15%), four of whom received new implants. 80% of the patients considered their situation improved by stenting, and 84% of physicians considered the treatment effective. 47 patients required supplementary treatment on the bladder neck (endoscopic section in 20 cases). In the mid-term, prosthetic sphincterotomy using a Urolume stent appears to be satisfactory. However, the situation is not so clear over the longer-term. It is not always easy to remove the stent, especially from patients who have not been monitored regularly. Some teams report highly complex surgery for stent removal, especially in the event of associated

urethral stenosis [72-75] (LOE3). A small study (n=12) following patients up to twenty years after insertion, suggests a high rate of complications, as 5/6 patients who completed the 20-year follow-up developed bladder neck dyssynergia requiring incision, 2 patients developed obstructive encrustations within the first year of insertion and another patient developed bladder cancer [76]. However, in those patients who completed the 20-year follow-up, sustained significant improvements in maximum detrusor pressure and duration of detrusor contraction were recorded.

Table 8: Results of the main series on sphincterotomy using urethral stents

	Stent	Year	LOE	n	Efficacy (%)	Mean follow-up (Months)	Migration (%)	Complications
Pannek et al. 2011 [63]	Memokath	2011	3	22	78	10	18	32
Mehta et al. [66]	Memokath	2006	3	29	89	21	23	42
Hamid [104]	Memokath	2003	3	25	89	20	28	48
Vaidyanathan et al. 2002 [68]	Memokath	2002	4	10	90	20	10	100
Low et al. 1998 [65]	Memokath	1998	3	24	54	16	33	38
Shah et al. 1997 [195]	Memokath	1997	3	14	78	24	NA	NA
Game et al. 2007 [62]	Nissenkorn/Diabolo	2007	3	147	NR	10	29	30
Denys et al. 2004 [103]	Ultraflex	2004	3	47	81	19	22	15
Juan Garcia et al. 1999 [102]	Memotherm	1999	3	24	100	15	16	17
Rivas et al. 1994 [78]	Urolume/ vs sphincterotomy	1994	2	46	79	16	15	0
Chancellor et al. 1999 [51]	Urolume	1999	2	160	84	60	28	20
Chancellor et al. 1999 [80]	Urolume/ vs sphincterotomy	1999	1	54	81	24	9	0
Hamid et al. 2003 [64]	Urolume	2003	3	12	77	144	NR	16
Abdul-Rahman et al. 2010 [76]	Urolume	2010	3	12	80	144	0	80

Whether patients should be offered prosthetic or endoscopic sphincterotomy is not yet agreed. Endoscopic sphincterotomy is the preferred standard treatment for DSD, where IC cannot be performed. Two prospective studies carried out in the US in 1994 indicated that prosthetic sphincterotomy was at least as effective as standard sphincterotomy in patients with SCI, and offered advantages in terms of morbidity, duration of hospitalization and cost [77, 78]. The two studies were not randomized. Follow-up was short (mean 15 months), with a potential risk of bias, since the conclusion that external sphincter balloon dilatation is as effective as endoscopic and prosthetic sphincterotomy is not borne out by long-term outcomes [79].

A prospective, multicenter, randomized study comparing endoscopic sphincterotomy with prosthetic sphincterotomy was published in 1999 by Chancellor and Rivas, using the Urolume stent [80]. Fifty-seven patients in three specialist spinal cord injury centers were included. The study concluded that prosthetic sphincterotomy was as effective as endoscopic sphincterotomy and required shorter hospitalization. Polguer et al published their experience with the Ultraflex (n=11) and Memotherm (n=11) during 56 months in patients with DSD. Complementary procedures after stenting included: five stent prolongation or displacement (mean interval 7.6 months), six bladder neck incisions (12.2 months), three urethrotomy (42 months), ten obstruction treated by laser (47.3 months). Eight patients had a change of their urinary pattern: four underwent ileal conduit diversion, one had a continent urinary diversion, one chose self-intermittent catheterization, two were under indwelling catheterization waiting for another treatment. Stent retrieval was either harmful or impossible for four of them. Three patients were free of complementary procedures. They conclude that nitinol urethral stent was an effective treatment initially. However after years urethral stenosis and hypertrophic growth of the urethral mucosa usually require extra endoscopic procedures (0.31 per patient per year). They recommend yearly endoscopic follow-up. [81]

6.4. Bladder neck incision (BNI) for detrusor-bladder neck dyssynergia (DBND)

The rationale to use BNI was that sympathetic overactivity might inhibit detrusor contraction and transurethral incision of bladder neck might interrupt the inhibitory reflex arc and result in restoration of detrusor contractility. In a single retrospective study BNI was performed in 22 patients with high-level SCI and DBND demonstrated upon video-urodynamics, who were previously managed by either IC or indwelling catheter [82]. Voiding symptoms were complicated by autonomic dysreflexia in 17/22 patients. Deep incisions were carried out at the 5 and 7 o'clock positions, sparing the external urethral sphincter. A satisfactory surgical outcome was recorded in 86.4% of the patients 3 months post-op (LOE3). While all patients additionally suffered from DSD preoperatively, an open

urethral sphincter during voiding was reported in 86.4% of them following BNI, and autonomic dysreflexia became less severe or resolved in 88.2% of sufferers. The authors hypothesized the presence of a urethra-to-bladder neck reflex pathway to explain additional improvements in DSD

Recommendations

- Where clean intermittent catheterization is not possible, the use of a urethral stent is possible (B).
- Whatever type of sphincterotomy is chosen (surgical or prosthetic):
- Patients must think carefully about the different modes of micturition possible for them (A).
- The few studies reporting long-term results of sphincterotomy demonstrate the vital importance of regular patient monitoring for the recurrence of DSD or blockage (B).
- This mode of micturition is contraindicated in women, and in men with difficulty in maintaining a condom catheter (B).
- Men who wish to have children should be warned of the risk of ejaculatory duct obstruction (B).
- For patients who have chosen surgical sphincterotomy:
- The reference technique involves an elective 11, 12 or 1 o'clock incision of the urethral sphincter (B).
- Although surgical sphincterotomy is the accepted reference treatment for neurogenic DSD, analysis of the literature highlights the lack of reliable efficacy and reproducibility criteria for the technique (B).
- For patients who have chosen prosthetic sphincterotomy:
- Different types of stent are used, depending on whether sphincterotomy is temporary or permanent. Stents are complementary, and different designs can be used for different situations (B).
- Surgical complications depend as much on the surgeon's competence as on the material and may be reduced by experience (C).
- Clinical studies have demonstrated that neurogenic patients prefer prosthetic sphincterotomy because it is reversible, even when permanent stents are placed (C).
- Careful follow-up, using yearly cystourethroscopy is mandatory when leaving a permanent urethral stent (B).
- Published data is inadequate to support a recommendation on the use of bladder neck incision in patients with inadequate bladder emptying due

to detrusor-bladder neck dyssynergia, either as a first-line procedure or as a complementary approach to DBND recognised following permanent urethral stenting. Further studies are needed.

6.5. Surgery to increase detrusor strength

For some patients, the cause of detrusor underactivity lies in the bladder wall. In this case, the control circuit functions but the bladder muscle is too weak. At present there is no medical treatment for this situation. The general objective is to reduce peripheral resistances as much as possible and where this fails, to propose IC. However, some teams have suggested placing rolled strips of muscle around the bladder. Some authors have also suggested a strip of *rectus abdominis* muscle. This is easier to perform and may be used essentially for reconstructive surgery, such as in bladder exstrophy [83-85] (LOE4). The only team to have published results on detrusor underactivity in man is that of Ninkovic *et al.* [86] (LOE2). They reported interesting results from 20 patients suffering from neurogenic detrusor underactivity and requiring self-catheterization. They reported a technique that they had designed in animal experiments [87,88] (LOE4) and which consisted of transferring a free strip of latissimus dorsi muscle, which was anastomosed to the epigastric vessels and the lowest branch of the intercostal nerve. Out of 20 patients, with a mean follow-up of 44 months, 60% no longer required IC, with PVR below 100 ml. After complementary surgery on the bladder neck, there was a 90% success rate that was stable over time. The authors reported no heavy morbidity, particularly with regard to the donor site. These promising results were largely confirmed in a multicentre trial involving 24 patients with a median follow-up time of 46 months [89]. Complete spontaneous voiding (mean PVR 25ml) was restored in 71% of the patients, while frequency of CIC was reduced in another 13%. Recurrent UTIs ceased in 91% of patients. A critical increase in bladder contractility index may be required to achieve complete bladder emptying, but the number of patients was too small for safe conclusions. Future development could use tissue-engineering techniques to construct vascularized and contractile strips implanted around the bladder with the same procedure.

Recommendations:

- Latissimus dorsi myoplasty on the bladder is a promising technique that needs to be validated further (C).

6.6. Stress urinary incontinence (SUI) due to sphincteric incompetence

Some patients with neurogenic lower urinary tract dysfunction will suffer from incontinence due to sphincter weakness. In general, patients with lesions affecting the brain or suprasacral spinal cord will not

suffer from this problem, as the sacral sphincter guarding reflexes will be intact. However, patients with lesions of the conus medullaris, the cauda equina or peripheral sacral nerves are at risk of developing neurogenic stress incontinence. Patients with neurological disease may also suffer from stress incontinence due to direct sphincter injury from urethral catheter trauma or as a result of previous interventions such as sphincterotomy or dorsal rhizotomy. In women, SUI may be present for non-neurogenic reasons such as urethral hypermobility due to previous pregnancy and childbirth.

People with neurogenic lower urinary tract dysfunction and SUI may also have impaired bladder storage function. If this is the case, a surgical procedure that treats the stress incontinence in isolation might put the patient at risk of upper urinary tract deterioration (as the upper tracts become exposed to the full force of the bladder dysfunction, having lost the "safety valve" effect of a weak sphincter) or of persisting incontinence. Pre-operative urodynamic evaluation of bladder function is therefore mandatory before undertaking surgery for neurogenic SUI.

The question as to when it is safe to treat neurogenic SUI while leaving bladder dysfunction uncorrected has been studied most intensively in the paediatric age group. Most series relate to children with spinal dysraphism/myelomeningocele and, typically, authors report the necessity to proceed to bladder augmentation in at least a third of patients. Even with a thorough urodynamic and radiologic preoperative evaluation, some patients will have late bladder compliance deterioration [106-123]. However, the issue continues to generate debate and studies have not reached total consensus; for example, Snodgrass *et al.* [124] (LOE3) published a retrospective analysis of 30 children (mean age: 8.6 years) who had a bladder neck sling procedure and appendico-vesicostomy without augmentation. At 22 month of mean follow-up, only one patient had had to undergo a bladder augmentation. In a subset of 16 patients who had urodynamics at 24 months, 13/16 had an increase of their maximum bladder capacity. However, 67% of the patients required anticholinergic therapy. In contrast, Dave *et al.* [125] (LOE3) strongly advocate the case for simultaneous bladder augmentation. The authors report a series of 15 children followed for at least five years after an isolated bladder outlet procedure (5 Pippi-Salle, 5 slings and 5 artificial urinary sphincter). At a mean follow-up of 11.25 years, all the patients underwent surgery to increase bladder capacity, either for recurrent incontinence or for upper urinary tract deterioration. At present, no definitive conclusions can be drawn as to advisability of routine prophylactic bladder augmentation, but many authors recommend a concomitant bladder augmentation when performing a bladder outlet procedure [126] (LOE4). The option of using detrusor injections of botulinum toxin in children offers a further therapeutic approach in circumstances where there is uncertainty.

A further important consideration when contemplating neurogenic SUI surgery is the means of bladder emptying following treatment of the sphincter weakness. In particular, patients who are emptying their bladders using an element of straining will not be able to empty in this way post-operatively. Patients will therefore need to consider how they will empty their bladder once continence is achieved. The options available to patients will include: IC (either via the urethra or a continent catheterisable abdominal conduit) or the use of a suprapubic catheter (either on free drainage or with a catheter valve). There will be some patients, who have only limited neurological damage, who will continue to be able to empty their bladder using voluntary voiding post-operatively but, even in this group, it is necessary to warn patients of the possible need for post-operative IC and to make sure that they are capable of using the technique before embarking on treatment.

Farag et al performed a systematic review on the treatment of stress urinary incontinence in neurogenic patients published from 1992 to 2013. Thirty studies were identified with Level 3 evidence. The quality of reporting was 43-81%, with significantly higher quality noted in studies published after 2002. None of the studies followed a randomized controlled trial (RCT) design. Three primary surgical procedures were used in 29 of 30 studies: artificial urinary sphincter (AUS), urethral slings, and urethral bulking agents. One study used a ProACT device. AUS was considered more successful than urethral bulking agents (77 ± 15% vs. 27 ± 20%, P = 0.002). Urethral bulking agents reported higher failures than urethral sling procedures (49 ± 16% vs. 21 ± 19%, P = 0.016) and AUS (21 ± 19% vs. 10 ± 11%, P < 0.002). They concluded that the quality of evidence obtained from non-RCTs is modest. Surgeries for NSUI have relatively high success rates but also high complication rates. [127]

6.7. Bulking agents

There have been some studies reporting on the use of bulking agents in neuropathic patients (**Table 9**). Most of the published series relate to the use of periurethral injections in children. Various agents have been used. Polytetrafluoroethylen (TEFLON) was one of the first [128, 129]. It was once popular for treating vesico-ureteric reflux, but it has been abandoned after several authors reported possible particle migration and granulomatous reaction to this product [130, 131] (LOE2). Collagen has also been used, but is no longer available. Collagen lysis was found to lead to the loss of the bulking effect over time [129, 132-139]. Other synthetic products that have been used include polymethylsiloxane (MACROPLASTIQUE) and dextranomer hyaluronic acid copolymer (ZUIDEX) [128, 140-146]. Henly et al. [188] demonstrated that distant migration of particulate silicone was observed in animals after periurethral injection with polymethylsiloxane (LOE4). One of the main advantages of periurethral injections of bulking agents is that they are minimally invasive and can

even be carried out as an outpatient procedure. The product is usually injected in the region of the bladder neck using a retrograde endoscopic approach. The bulking agent is injected at up to four sites with the aim of achieving urethral coaptation. Dean et al. [146] have suggested using an antegrade approach whereby the bladder neck is accessed using a percutaneous puncture into the bladder.

The results of periurethral injection surgery are summarized in Table 9. There are difficulties in comparing results from different series, because patient populations and definitions of treatment success differ. In particular, the criteria for defining "improvement" and "social continence" vary. Therefore, it seems appropriate to consider the proportion of "dry patients" as defining clear-cut success (even if some authors add to this result a notion of "dryness for some hours" between voiding or catheterization). Using this definition, 0 to 36% of the patients are considered to be cured using bulking agents (LOE2-3).

Most results are observed after a mean follow up that rarely exceeds 2 years (LOE2-3), although one series has reported long-term improvement up to 7 years after the last injection [148].

There are other important considerations to be made when interpreting the results of periurethral bulking agents. The first is that the studies in children generally contain patients with two types of problems: congenital urinary tract malformations (epispadias, bladder exstrophy) and neurogenic lower urinary tract dysfunction (mainly myelomeningocele). This is of importance because there is some indication that, in children, bulking agents work slightly better in patients with malformations than in those with neurological problems [128, 135, 143, 148]. The global results of the series are therefore probably more optimistic than the results that might be observed in a population of only neurological patients. A second point is that these children have frequently already undergone various surgical procedures, which could modify the results of the injection procedure. Although a high proportion of the patients in these studies use IC, some have satisfactory outcomes while continuing to void spontaneously.

Although the use of bulking agents does not appear to cause any severe complications, there is the suggestion that the presence of deposits of inert material might lead to greater difficulty in performing future bladder neck surgery [143, 148]. It is also important to acknowledge that the failure to correct incontinence is in itself a complication of the operation [126]. Gender and previous bladder/sphincter surgery do not seem to be reliable prognostic factors regarding the success of the injections

Table 9: Results of bulking agent injection in patients with neurological bladder dysfunction

	n	LOE	Neurogenic bladder number of patients	Bulking agent	Age (years)	Male/female	Follow up (years)	Dry (%)	Improved (%)
Leonard et al. [137]	18	3	10/18	Collagen	10.5	12/6	1.3	36	28
Perez et al. [136]	32	3	25/32	Collagen	9	23/9	0.9	20	28
Bomalaski et al. [135]	40	2	25/40	Collagen	12.1	28/12	2.1	22	54
Caione et al. [144]	16	2	3/16	DHAC	10.1	9/7	1	18.7	56.3
Sundaram et al. [133]	20	3	12/20	Collagen	9.5	12/8	1.3	5	25
Kassouf et al. [139]	20	3	20/20	Collagen	13.3	15/5	4.2	5	15
Chernoff et al. [138]	11	3	8/11	Collagen	10.6	6/5	1.2	36	18
Block et al. [134]	25	3	25/25	Collagen	11.7-21.9	15/10	2.9-4.7	4	44
Hamid et al. [421]	14	3	14/14	PDS	41	14/0	2.9	36	21
Godbole et al. [129]	15	3	14/15	PTFE, collagen, PDS	10.2	10/5	2.33	20	53
Halachmi et al. [140]	28	3	10/28	PDS	12.5	22/6	1	0	42
Misseri et al. [145]	16	3	12/16	DHAC	4 to 18	6/10	0.8	19	31
Lottmann et al. [148]	61	2	27/61	DHAC	10.3	41/20	3	26	26
Guys et al. [143]	49	3	49/49	PDS	14	21/28	6.1	33	14
Dean et al. [146]	34	3	28/34	DHAC	11.7	18/16	0.3	NS	71
Dyer et al. [128]	34	3	12/34	PTFE, DHAC	2.7 (PTFE)/14 (DHAC)	NS	NS	6	12
DeVocht et al. []	89	3	27/27	DHAC, PDS	Children	14/13	8	7	17
Renard et al 2016	5	3	5/5	PDMS elastomer	48	3/2	1	40	80

DHAC (Dextranomer Hyaluronic Acid Copolymer) PDS (polydimethylsiloxane), PTFE (Polytetrafluoroethylene), NS (Not stated), LOE (Level of evidence)

6.8. Autologous Sling Procedures

In women with neurogenic lower urinary tract dysfunction, the use of an autologous fascial sling to support the urethra (usually close to the bladder neck) has been widely used to treat stress incontinence. A sling can either be used in isolation or in conjunction with other procedures such as bladder augmentation. **Table 10** summarises the results of published case series. Complete continence is observed in 83 to 89% of the patients (LOE3). Once again it should be emphasised that many patients will be dependent on bladder emptying using IC or an SPC, because the patient's neurological dysfunction may preclude voluntary voiding and because the sling may have to be inserted under tension in order to provide sufficient outflow resistance in the face of neurogenic intrinsic sphincter deficiency. All of the series report a low morbidity rate from the procedure. In particular, the risk of urethral erosion is very low when fascial slings are used. Synthetic sling materials have generally not been advocated when significant sling tension is required because of the risk of secondary urethral erosion [129,] (LOE3). However, there is a lack of studies that compare the use of autologous tissue and synthetic material. Bladder neck slings appear to be capable of providing good results in children. Some series suggest that girls have better outcomes [124,149-151].

The group from McGuire published retrospectively about 33 women with neurogenic SUI treated with an autologous fascial sling. The mean follow-up time was 52 months, while the mean age of the patients was 37 years. Causes of neuropathic bladder were myelomeningocele in 21 and spinal cord injury in 12 patients. A total of 30 patients were successfully treated and satisfied with the outcome of the operation (91%). Twenty-five patients (76%) were totally dry, while 5 patients (15%) had markedly improved but still required one pad per day. The complication rate was 15 %. [152]

Table 10: Results of bladder neck sling procedures in patients with neurological bladder dysfunction

	n	LOE	Neurogenic bladder number of patients	Age (years)	Male/ female	Bladder augment. surgery (%)	Follow up (years)	Continence rate (%)
Snodgrass et al, 2007 [124]	30	3	30/30	8.6		0	1.9	57
Karsenty et al, 2007 [149]	11	3	11/11	42	0/11	100	3.6	72
Albouy et al, 2007 [151]	14	2	14/14	14	7/7	100	5	79
Castellan et al, 2005 [150]	58	3	58/58	11.4	15/43	100	4.2	88
Austin et al, 2001 [196]	18	3	18/18	14	8/10	33	1.8	87
Barthold et al, 1999 [197]	27	3	26/27	NP	7/20	81	2,1/3,6	28(sling)/50(wrap)
Gosalbez et al, 1998 [108]	30	3	28/30	10	6/24	97	3,1	93
Kakizaki et al, 1995 [109]	13	3	11/13	13	10/3	69	3	76
Gormley et al, 1994 [177]	15	3	15/15	NS	0/15	13	NK (0.5-8.5)	85
Elder et al, 1990 [178]	14	3	14/14	12.6	4/10	7	1	86
Athanasopoulos et al 2012 [152]	33	3	33	37	33/0	NS	4.3	91

(LOE: level of evidence, NS not stated)

6.9. Suburethral tapes

Midurethral tape operations, such as the tension-free vaginal tape procedure, have taken a major role in the management of stress incontinence in the non-neuropathic population but have not been adopted for the treatment of neurogenic stress incontinence; concerns about the risk of urethral erosion have been discussed already. Furthermore, intrinsic sphincter deficiency represents the usual pathophysiology in neurogenic SUI, contrasting with urethral hypermobility in non-neuropathic women.

There is very little published data available on the efficacy of midurethral tension-free tape operations in adult women with neurogenic LUTD. In a retrospective series of 12 women treated by TVT [153] with a mean follow up of 10 years, 9 patients were available for assessment of which 7 were dry and 2 were improved. The authors did not report any urethral erosions on follow up.

For male patients with post-prostatectomy incontinence, the use of synthetic tapes is increasing but, there is very little data for patients with a neurological cause to their incontinence, other than case reports. The use of this type of device in patients with underlying neurological illness should clearly be very cautious until further data emerges from clinical trials (LOE4).

6.10. Artificial urinary sphincter (AUS)

The AUS is recognized as one of the most effective treatments for urinary incontinence. It has the inherent advantage that it provides an adequate urethral closure pressure during the urine storage phase of the micturition cycle but then allows voiding to take place in the face of a low bladder outlet resistance. In patients with SUI, it is able to deliver either complete or "social" continence in 75 to 87% with satisfaction rates ranging between 85 and 95%. These rates are provided by published case series that contain a majority of patients with post-prostatectomy stress incontinence (PPI), along with some neuropathic patients. However, outcomes are probably similar for patients with neuropathic stress incontinence and a low-pressure bladder reservoir (LOE4) [154]. It should be noted that most of the published data on the use of the AUS in neurogenic SUI relates to men, although the device is also used in female patients with neurological disease as was published by Phe et al [155].

Before using the AUS in neurogenic SUI, several factors must be considered:

- Firstly, the risk of implant infection and erosion is probably higher than in the PPI population. It is generally recommended that patients undergo pre-operative urine culture and sterilisation of the urine before surgery [156] (LOE4).
- Manual dexterity must be sufficient to allow the patient to use the AUS pump- either to open the cuff to urinate, or to allow IC [154]. They must also accept the need for IC should the bladder

have reduced contractility. However, some studies seem to indicate that the cycling activation of the pump could be avoided in patients performing IC (LOE3) [157, 158]. Bersch et al. [157] have described a modified technique.

- The cuff implantation site in adult patients with a neurologic bladder dysfunction is debated. The cuff can be implanted via a retropubic approach at the level of the bladder neck or around the prostatic apex. Alternatively the cuff can be implanted around the bulbar urethra using a perineal incision. Proponents of the retropubic approach argue that perineal incisions may cause cicatrization problems for patients in wheelchairs. Moreover, traumatic catheterization is a well-known risk factor of urethral erosion in the non-neurological population undergoing an AUS [118] (1 to 5.5% in contemporary series) and, although it is recognized that IC is possible in AUS implanted patients [159], the risk of traumatic catheterization and subsequent cuff erosion might be higher when the bulbar urethral site is used. On the other hand, inserting an AUS cuff around the bladder neck is technically more difficult in adults in comparison with peri-bulbar implantation (LOE4). Some investigators are now exploring the possibility of using a laparoscopic technique for sphincter implantation [160].
- It is necessary to know the ejaculatory status of males in order to discuss the possible impact of the device on ejaculatory function. Cuff implantation around the bladder neck may allow patients to achieve antegrade ejaculation [161] (LOE4).

As previously stated, a thorough urodynamic evaluation of the bladder is mandatory in order to evaluate the potential impact of bladder compliance following AUS implantation. This has been reported in several retrospective series (LOE3) [108-123]. The reasons for this change in bladder behaviour are not known, and it has been observed particularly in populations of patients with myelomeningocele [115, 117, 119, 120, 122]. In the event of any doubt about the quality of the bladder reservoir, bladder augmentation should be performed. The main results of published series are summarized in **table 11**. The continence rate is high, especially when a bladder augmentation has been performed (59 to 100% of the patients). The older series include some patients with the previous version of the AMS 800 (AMS 792). Therefore, it is possible that the long-term outcomes for patients being implanted today may be better than those seen in the past as a result of technical modifications of the device. Device infection, cuff erosion into the urethra and loss of fluid from the implant are the main causes of loss of an AUS. Infection and erosion typically occur in the early months after implant but late erosions are seen [114] (LOE3). The majority of the authors consider AUS to be the "gold standard" procedure to treat neurogenic sphincter deficiency in men.

Table 11: Results of artificial urinary sphincter in patients with neurological bladder dysfunction

	n	LOE	Neurogenic bladder number of patients	Age (years)	Male/female	Bladder augment surgery (%)	Follow up (years)	Continence rate (%)	Cuff Implantation Site	Complication/revision rate (%)
Phe et al 2016 [155]	26	3	26	49.2	0/26	0	7.5	58	Bladder neck	9/35
Bersh et al. 2009 [111]	51	3	51/51	38.7	37/14	19.6 (sacral root surgery)	8	70.6% (total) /90.2% (social continence)	Bladder neck	7.8/35.3
Lai et al. [118]	218	3	11/218	46.3	215/3	NP	2.4	69	Peri-bulbar	18.2/36.4
Lopez Pereira et al. [120]	35	3	35/35	14.4	22/13	20/35	5.5	91.4	Bladder neck	11.4/20
Patki et al. [121]	9	4	9/9	38.2	9/0	NP	5,9	77	Peri-bulbar	22/43
Murphy et al. [179]	30	3	13/30	54	29/1	NP	NP	23	Peri-bulbar	33/70
Herndon et al. [116]	134	3	107/134	10	94/41	85/134	7.5	86%	Bladder neck (122), peri-bulbar (12)	16/41
Castera et al. [112]	49	3	38/49	14	39/10	9/49	7.5	67	Bladder neck (37), peri-bulbar (12)	20/12
Shankar et al. [180]	45	4	NP	11	45/0	NP	7	89	Bladder neck	4.4/6.7
Kryger et al. [117]**	32	3	28/32	6.7/14.5	25/7	9/32	15.4	100/	Bladderneck	41/95
Elliott et al. [113]	323	3	10/323	Global: 60.4	313/10	NP	5.7	NP	Bladder neck/peri bulbar	Global: 26.2/28.6
Fulford et al. [114]	61	3	34/61	26	43/18	7/34	10 to 15	88	Bladder neck (female)/peri-bulbar (male)	29.4/91.2
Levesque et al. [119]	54	3	49/54	10/12	34/20	23/54	NS (>10)	59.3	Bladder neck	24/67
Singh et al. [123]	90	3	90/90	26	75/15		4	92	Bladder neck/peri-bulbar	16.7/28

	n	LOE	Neurogenic bladder number of patients	Age (years)	Male/female	Bladder augment surgery (%)	Follow up (years)	Continence rate (%)	Cuff Implantation Site	Complication/revision rate (%)
Simeoni et al. [122]	107	3	107/107	13.7	74/33	22/107	5	76.6	Bladder neck(98)/peribulbar(9)	22.3/19.6
Gonzales et al. [115]	19	3	19/19	8.4	19/0	7/19	8	84.2	Bladder neck	5/100
Belloli et al. [110]	37	3	37/37	13-19	35/2	2/37	4.5	59	Bladder neck(33)/peribulbar(4)	10.8/38

** AUS modified**AUS modified and two groups of patients depending of their age at AUS implantation*

6.11. Surgery of the bladder neck

Three main procedures have been described. Historically, the technique of Young [162], later modified by Dees [163] and Leadbetter [164] came into use, essentially for reconstruction in cases of exstrophy and epispadias. The principle was to mobilise the trigone (after ureteric reimplantation) in order to resect bladder neck tissue, so as to reconstruct the trigone around a small catheter. Although some authors [165, 166] described its use in neurogenic patients, the procedure has rarely been used in this patient group. The Kropp procedure [167] involves the use of a tubularised flap of the anterior bladder wall, which is used to extend the bladder neck and create an intravesical conduit. The tube is secured to the posterior bladder wall between the ureteric orifices. In the initial technique, the tube was tunnelled submucosally, but this manoeuvre was thought to increase the risk of tube stenosis [168, 169] (LOE3).

A third technique is that described by Pippi-Salle [170]. It is considered to be a variant of the Kropp procedure (also called a Kropp-onlay), with an anterior bladder wall flap that is not tubularised. Initial descriptions involved routine ureteric reimplantation but this was abandoned in later patients as long as there was an absence of reflux [171, 172] (LOE3). In a systematic review, Kryger et al. [126] (LOE4) stated that only data on 83 patients for the Kropp technique and 25 with the Pippi-Salle procedure have been published. Since that review there has been a lack of further significant data concerning the outcomes of these procedures. The continence results are good (50-69% for the Pippi-Salle procedure, 78-81% for the Kropp procedure) [168, 169]. However, several problems exist with the two techniques. Firstly, the techniques do not allow easy endoscopic access to the bladder. This is a major problem because it prevents or limits future endoscopic procedures (especially ureteroscopy, botulinum toxin injections and litholopaxy). Secondly, 28-45% of patients (especially male) report catheterisation difficulties following a Kropp procedure. For the Pippi-Salle procedure, continence rates are lower than for the Kropp procedure, but fewer cases of catheterisation difficulty have been reported [126]. However, a revision procedure is necessary in significant numbers, and it has rarely been used in male patients.

6.12. Complete bladder neck or urethral closure

Closure of the bladder outlet may be required if alternative approaches to managing stress incontinence are inappropriate or have failed. In women, closure can be achieved either via a vaginal or an abdominal approach while in men, either the bladder neck or the bulbar urethra can be the site of closure. Bladder drainage is maintained using a continent catheterisable abdominal conduit (e.g. using the Mitrofanoff principle), an SPC or (rarely) an ileo-vesicostomy.

Colli published a single surgeon experience in 35 patients with 4-13 years follow-up. BNC was paired with

suprapubic catheter diversion. Indications for BNC included severe urethral erosion in 80%, decubitus ulcer exacerbated by urinary incontinence in 34%, urethrocutaneous fistula in 11%, and other indications in 9%. The overall complication rate was 17%. All but two patients were continent at follow-up. [173]

Bladder neck or urethral closure can be technically difficult and a secondary operation to close a persistent fistula may be needed in some cases [174]. Interposing vascularised tissue between the bladder neck suture line and the urethral or vaginal closure is a well-described aid to the avoidance of closure failure; a flap of rectus abdominis can be used for this purpose. Bladder neck closure has also been used in children where other means of correcting SUI have failed or are felt to have a limited chance of success. The published series of cases provided some reassurance that children with closed bladder necks do not suffer from excessive complications in the form of renal deterioration, bladder rupture or stone formation.

As a general principle, urethral closure should not be undertaken in cases where it is possible to maintain urethral patency using alternative approaches to treat SUI. For example, patients with neurogenic lower urinary tract dysfunction are at high risk of stone formation in the bladder or upper tracts and it is desirable to maintain easy endoscopic access to the bladder in order to allow potential endoscopic treatment. Finally, preserving the natural urethra may constitute a safety measure if high bladder storage pressures are present or in the event of any complication with bladder access via a continent catheterisable abdominal conduit or suprapubic catheter [175].

Recommendations:

- Patients with stress incontinence in association with neurogenic lower urinary tract dysfunction require careful assessment in order to plan appropriate management. Video-urodynamic study must be used to evaluate both bladder and sphincter function (C).
- The clinical assessment must also evaluate the degree of patient handicap in order to determine whether they can perform self-catheterization, or whether an alternative means of emptying the bladder will be required. (D).
- Patients require careful preoperative counselling with respect to the benefits and risks of different operative approaches
- Autologous slings can be used to treat neurogenic stress incontinence. (B).
- Due to the limited evidence base, possible sphincter deficiency, perceived risk of complications and potential consequences on future management options, the Committee is unable to recommend routine use of synthetic slings and

tapes to treat stress urinary incontinence in neurogenic patients (D). Synthetic tapes could be recommended in older women with stable neurological conditions and SUI due to urethral hypermobility (C) as opposed to younger patients (e.g. myelomeningocele) with neurogenic ISD (negative recommendation).

- Artificial urinary sphincter can be used to treat neurogenic stress incontinence (A).
- Bladder neck reconstruction can be used to treat neurogenic stress incontinence (D).
- Bulking agents can be used to treat neurogenic stress incontinence when there is a demand for a minimally invasive treatment (D). The patient should be aware that the technique has a low success rate.
- Bladder neck closure should be offered to patients who have persistent neurogenic stress incontinence where alternative treatments have either failed or are likely to fail (B).

6.13. Surgical alternatives excluding denervation procedures to treat reflex incontinence due to neurogenic detrusor overactivity

Keywords; neurogenic bladder; spinal cord injury; spina bifida; myelomeningocele; multiple sclerosis; bladder augmentation; enterocystoplasty; gastrocystoplasty; sigmoidocystoplasty; colcystoplasty; ureterocystoplasty; autoaugmentation; detrusorectomy

6.14. Bladder augmentation using intestinal segments

The aim of bladder augmentation is to provide long-term protection to the upper urinary tract by reducing the risk of impairment due to high bladder pressure, as well as to improve storage function [181]. First performed in man by Von Mickulicz [182] who used a segment of small intestine, the technique has regained popularity since the 1970s after the introduction of IC [183]. Unlike complete bladder replacement, enterocystoplasty preserves the integrity of the trigone of the bladder with the urethra and ureters, and reimplantation is not necessary. A segment of the gastrointestinal tract is taken out of continuity from the rest of the gut, and sutured onto the bladder. Various augmentation techniques using different segments of the gastrointestinal tract (caecum, colon, and ileum) have been described. Bladder augmentation is indicated wherever bladder capacity and compliance is reduced, or in the event of detrusor overactivity, when all conservative treatments (medical treatments, detrusor injections of botulinum toxin and/or neuromodulation of the posterior sacral roots) have failed [181, 184].

Before performing bladder augmentation, it is essential to ensure that:

- There is no malignant disease or lithiasis in the bladder.
- Renal function is normal and the upper urinary tract is unimpaired (screen particularly for lithiasis).
- There is no gastrointestinal tract disease (Crohn's disease, hemorrhagic proctocolitis, short gut syndrome, etc.).
- The patient is willing and capable of self-catheterization. This can be combined with continent cystostomy.

Technical principles:

There are two stages to the surgical procedure: first bladder preparation and then augmentation. Usually open surgery is performed, but recently laparoscopy has been reported [185, 186] (LOE3). At present, except for technical articles on laparoscopy, there are no publications comparing this technique with open surgery.

The bladder can be prepared either by clam cystoplasty or by supratrigonal cystectomy. The preferred preparation depends on the quality of the detrusor, and more particularly on whether the bladder has retained its visco-elastic properties. Where the detrusor is very fibrous and thick, supratrigonal cystectomy should be envisaged, since otherwise exclusion of the ileal patch may occur.

Clam cystoplasty

Clam cystoplasty involves freeing the anterior/posterior surfaces and dome of the bladder. The bladder can be opened either in the transverse plane or sagittal plane, the incision starting and ending about 2 cm above the bladder neck. If the lateral surfaces are not mobilised, the vesical arteries can be preserved to maintain vascularization of the bladder dome. Robot-assisted laparoscopic augmentation cystoplasty has been recently introduced. Preliminary results have been reported in children with spina bifida [187].

Supratrigonal cystectomy

Supratrigonal cystectomy involves resection of the body of the bladder, but retaining the trigone. The bladder is freed under the peritoneum and the superior vesical arteries ligated and sectioned. The bladder pedicles are ligated and sectioned laterally up to the trigone, which is preserved. The body of the bladder is excised 1-2 above the trigone. During the bladder dissection, care must be taken to spare the ureteric vascularization.

Ureteric reimplantation

Ureteric reimplantation must be carefully discussed in the event of vesicoureteric reflux (VUR). Several authors have reported that improved bladder compliance precludes the need for reimplantation (LOE 3)

[188-191]. They have reported a resolution rate of about 85% for VUR, classified below grade IV. For grade V reflux, improvement was observed in 2/3 of patients. Except for the work of Simforoosh [188], these results were obtained in small heterogeneous series of children (neurogenic bladders and congenital anomalies), and after relatively short mean follow-up times (1 to 5 years).

Hayashi et al. [192] reported on 22 patients treated by ureteric reimplantation during bladder augmentation (LOE 3). Their work was original in that it gave detailed account of renal function after long-term follow-up (mean 12 years). Ureteric reimplantation during bladder augmentation did not result in greater morbidity and 97% of patients recovered. Renal function was preserved and satisfactory. The case for ureteric reimplantation during augmentation cystoplasty was supported by a small non-randomised study (LOE2-3), where Wang *et al.* demonstrated that lack of ureteric reimplantation during cystoplasty in children with neurogenic bladder was a risk factor for residual high-grade reflux, which, in turn, was a risk factor for febrile UTIs [193]. A larger non-comparative non-randomised study (LOE3-4) reported equal success rates for the two methods, but ureteric reimplantation had been mostly reserved for the higher grade reflux cases [194]. These results were presented as part of a literature review which was inconclusive as to the superiority of the results of either method [194]. Accordingly, the need for ureteral reimplantation during bladder augmentation should still be considered, especially for cases of grade V reflux. However, improved bladder compliance will reduce some VUR.

Intestinal segments

The choice of intestinal segment depends on patient's history and the local conditions. All segments of the gastrointestinal tract may be used, except the jejunum because of the risk of water-electrolyte disorders. The most frequently used segment in adults is the ileum, because it is easy to remove, is close to the bladder and may be shaped easily into a reservoir. Colon segments are used more often in children. The removed intestinal segment must always be debulgarized to reduce peristalsis to a minimum and to obtain a reservoir with low pressure. The segment is then placed and sutured onto the bladder in the form of a patch. For supratrigonal cystectomy, the intestinal segment needs to be longer and fashioned into a neo-bladder [184].

Technical variations aim to reduce mucus secretion and reduce the reabsorption of urine by the intestinal mucosa that leads to metabolic acidosis. A number of variant techniques have been proposed but not developed extensively. Seromuscular colocolocystoplasty lined with urothelium involves removing the detrusor, leaving the bladder mucosa intact, and then covering it with a demucosalized sigmoid patch [195]. Seromuscular enterocystoplasty necessitates removing

the mucosal membrane of the intestinal segment surgically, or destroying it by argon beam [196], before placing it onto the prepared bladder [197].

A third technique uses an appendicular-based cecal flap, aiming for a less invasive form of augmentation cystoplasty [198]. The technique involves isolation of a 10-12 x 3 to 5-cm cecal flap on the base of the appendicular pedicle, by which the bladder was augmented and the appendix was brought out through the abdominal wall for catheterization. Without any bowel anastomosis, the cecal anterior wall was repaired.

An experimental technique tested only pre-clinically is the reversed seromuscular ileocystoplasty, where the seromuscular layer of the ileal loop from its antimesenteric aspect was sutured to the bladder mucosa of the previously bivalved bladder. Complete epithelialization of the ileum's serosal surface with transitional epithelium was confirmed 4 weeks post-operatively [199].

Results of enterocystoplasty

The main published series for patients undergoing surgery for neurogenic bladder are summarized in **Table 12**. Peri-operative mortality is estimated between 0 and 3.2% (LOE 2-3). The most frequently reported early morbidity (LOE 2-3) is prolonged post-operative ileus in up to 11.7% [200-203]. A nasogastric catheter is no more justified in neurological patients than in the general population (LOE3) [204]. Other common complications include episodes of febrile UTI (4.8-9%), urinary fistula (0.4-4%), that usually resolve, and thrombo-embolic complications (1-3%). When the pelvis has been irradiated, the patient must be warned of the increased risk of entero- or colovesical fistula. Stoma revisions (up to 50% in a small series) and wound infections have also been reported [203].

Chronic bacteriuria always occurs with IC and should not be considered a complication [203] (LOE4). Cases of late urosepsis have, however, been reported [255]. The risk of calculus in the enlarged reservoir ranges from 10-50% [205-209] (LOE 2-3). There may be a higher risk of developing upper urinary tract lithiasis than in the general population [210-212] (LOE3).

After bladder augmentation, intestinal transit disorders are frequent and probably underestimated (0-30% [213-215]). Several explanations have been proposed (ileocecal valve not preserved, biliary salt malabsorption, etc.). Somani et al. conducted a cohort study (LOE2) focusing on this particular problem [266]. They report a high rate of intestinal transit disorders, affecting almost 50% of patients treated for neurogenic bladder. These complications distressed patients and nearly 10% regretted having undergone surgery. Although transit disorders cannot be attributed to surgery alone (patients with neurogenic

bladder may have intestinal transit disorders unrelated to surgery), patients should be informed of this risk.

Since the gastrointestinal tract mucosa resorbs urine, water-electrolyte disorders may occur. Hyperchloremic acidosis is reported in up to 15% of cases (LOE 2-3). These water-electrolyte disorders may be accompanied by anomalies of calcium metabolism that do not appear to have any significant long-term effect, for example on growth in childhood, but the subject is still under debate (LOE 3) [217-220]. However, care must be taken when treating patients with a marked decrease in creatinine clearance, since metabolic acidosis is no longer compensated [184] (LOE4).

In theory, diversions performed using the ileocaecal junction and the end segment of the ileum would expose patients to a risk of vitamin B12 deficiency (with possible onset of megaloblastic anemia). The fact that the intestinal segments measure less than 50 cm would explain why few patients suffer clinically overt vitamin B12 deficiency.

The risk of cancer development of the newly formed reservoir is particularly important, since neuro-urological surgery is often indicated in patients with long life expectancy, many being children. The general consensus today is that patients with a bladder reservoir are at higher risk of developing a tumour than are the general population, but this risk has not as yet been clearly defined. The rates for the risk of tumour development range from 1 to 4.6% [221-224] (LOE 3-4). Most of the published cases concern adenocarcinoma at the junction of the intestinal mucosa with the urothelium. These usually developed long after the initial surgery (over 10 years in most cases). Some patients developed urothelial tumours with the typical risk factors. Two facts should be emphasised with regard to neurogenic bladder (augmented or not):

- The sensitivity and specificity of the routine bladder tumour diagnostic and monitoring tools (urinary cytology, BTA test, simple cystoscopy, etc.) may be reduced. Patient monitoring can only be envisaged by regular cystoscopy with biopsy of suspect areas.
- Monitoring is essential, since many patients develop tumours without symptoms and may not be diagnosed until late.

Monitoring frequency needs further investigation. A review of a series of cystoplasties performed in patients with congenital abnormalities including neurogenic bladder found comparable risk of bladder cancer, compared to control patients managed only by IC (4.6% vs 2.6%, $p=0.54$) [224]. In addition, a projected cost-analysis based on post-augmentation malignancy and cost estimates from published reports or US government sources concludes that annual screening with cytology and cystoscopy of children with spina bifida subjected to augmentation cystoplasty is unlikely to be cost effective at commonly accepted willingness-to-pay thresholds, but would be

justified if the annual rate of cancer development were more than 0.26% (12.8% lifetime risk) or there were a greater than 50% increase in screening effectiveness and cancer risk after augmentation [225].

The most serious and possibly life-threatening complication is cystoplasty perforation (LOE3). This can happen whichever gastrointestinal segment is used, but occurs more often after ileocystoplasty [226] (LOE3). It is estimated to occur in 5-13% of cases [230] (LOE3). Perforation usually occurs on the graft or at the junction of the bladder with the enterocystoplasty, and often results from high pressure within the enterocystoplasty, or more rarely from traumatic catheterization or urodynamic investigations [227] (LOE4).

Functional outcome

The functional outcome of bladder augmentation by enterocystoplasty is given in Table 12. Only series of patients undergoing bladder augmentation for neurogenic bladder were retained in our analysis. Given the wide range of indications, surgical techniques and enteric segments used, and retrospective nature of studies, it is difficult to draw any clear conclusions. Nonetheless, all authors reported an improvement in bladder capacity and compliance (LOE2-3). More than 90% of patients achieved nocturnal continence, and 91-100% achieved diurnal continence (LOE2-3).

Two quality-of-life studies (LOE2) reported improvement rates exceeding 90% [202, 231]. A 92% satisfaction rate was reported by a long-term follow-up study (mean 14.7 years) and patients would recommend the treatment to a friend [205]. However, a potential bias might arise due to the heterogeneous population analysed in some of these studies, including a mixture of patients with neurogenic and idiopathic DO.

If the bladder compliance defect persists, exclusion or ischemia of the intestinal patch must be investigated [222, 230]. Sometimes urinary leakage is related to sphincter deficiency and may be treated by an AUS [233] or other means of urethral pressure reinforcement [222, 232]. However, most authors consider that this type of adjunctive treatment should not be performed routinely since most patients have a good functional outcome after bladder augmentation, and only those with marked sphincter deficiency prior to surgery require these measures.

Possible alternatives to enterocystoplasty

Gastrocystoplasty and ureterocystoplasty

The use of a pedicled segment of stomach (gastrocystoplasty) or ureter (ureterocystoplasty) as an alternative to enterocystoplasty has been reported mainly for children with a neurogenic bladder. In theory, its advantage lies in the absence of metabolic acidosis, but in adults this is very theoretical. Moreover, both these intestinal segments secrete less mucus than the small and large intestines [234-238]. Abdel-Azim *et al.* [236] reported gastrocystoplasty in adults

(LOE3). In the light of their experience with children, they decided to use this technique in a set of young adults (mean age: 23 years, range: 4-32 years). Their paper records that the short-term results (3 years mean follow-up) of gastrocystoplasty were satisfactory, with increased functional bladder capacity and no impairment of the upper urinary tract (LOE3). However, two disadvantages are reported. First, a hematuria-dysuria syndrome requiring occasional use of antacids sometimes accompanied gastrocystoplasty. Second, the maximum bladder capacity was lower than that observed with enterocystoplasty. This may have a benefit for easier bladder voiding, but if the bladder were to lose some capacity, further surgery would potentially be required. The outcome in the very long-term for patients who have undergone this procedure remains unknown.

Table 12: Gastro-intestinal bladder augmentation in neurological patients with bladder dysfunction

Authors	LOE	Total number of patients (neurological patients)	Type of bladder augmentation	Max BC pre-op	Max BC post-op	DP pre-op	DP post-op	Mean Follow-up (months)	Increased compliance (% patients)	Post-op continence status	Results for quality of life
Gurung et al. [205]	3	19	Ileum	TBC	TBC	TBC	TBC	176.4	NP	92%	92% satisfied
Gundetii et al [187]	3	6	Ileum	TBC	250-450	NP	NP	18	NP	100%	NP
Chen et al. [282]	3	40 (34)	Ileum	115	513	NP	NP	93.6	NP	90%	NP
Shakeri et al. [198]	3	10	Cecum	171.4	263.7	62.2	13	23.8	100	90%	
Blaivas et al. [232]	3	76 (41)	Ileum, cecum	166	572	53	14	108	NP	Cured 70%/ Improved: 18%	NP
Mor et al. [233]	3	11(11)	Ileum	NP	NP	NP	NP	115	NP	Cured/improved: 82%	NP
Quek et al. [283]	3	26(26)	Ileum	201	615	81	20	96	92	Cured: 69%/Improved: 27%	NP
De Foor et al [226, 237]	3	105 (47)	Stomach, ileum, colon	NP	NP	NP	NP	88,8	NP	Cured/improved: 92%	NP
Medel et al. [284]	3	26(26)	Stomach, ileum, colon	NA	NA	NA	NA	45.6	100	Cured: 84.6% Improved: 5.4%	NP
Nomura et al. [285]	3	21(21)	Ileum	149	396	>60	NP	66	100	Cured/improved: 95%	NP
Shekarriz et al. [200]	3	133(100)	Ileum, sigmoid, autoaugmentation	NP	NP	NP	NP	64	NP	Cured/improved: 95%	NP
Arikan et al. [286]	3	18(18)	Sigmoid	86	370	NP	NP	40	NP	Cured/improved: 95%	NP
Chartier-Kastler et al. [201]	2	17	Ileum	174.1	508	65.5	18.3	75.6	100	Cured/improved: 88.5%	NP
Venn et al. [287]	3	267 (152)	Ileum	NP	NP	NP	NP	36	NP	Cured/improved: 86.6%	NP
Herschorn et al. [231]	2	59(59)	Ileum, cecum, sigmoid	220	531	48.9	15.8	72.6	100	Cured: 67% Improved: 28.8%	Excellent: 69.5%

Authors	LOE	Total number of patients (neurological patients)	Type of bladder augmentation	Max BC pre-op	Max BC post-op	DP pre-op	DP post-op	Mean Follow-up (months)	Increased compliance (% patients)	Post-op continence status	Results for quality of life
											Good: 20.3%
Flood et al. [228]	2	122 (59)	Ileum, sigmoid	NP	NP	NP	NP	37	95	Cured: 75% Improved: 20%	NP
Hasan et al. [202]	2	48 (13)	Ileum	307	588	NP	NP	38	69	Cured/improved: 92%	Good: 83% Moderate: 15%
Mast et al. [288]	3	28(24)	Ileum	235	511	72	46	30	95	Cured/improved: 95%	NP
McInerney et al. [230]	3	100(50)	Ileum	196	867	NP	NP	24	92	NA	NP
Singh & Thomas [229]	3	78	Ileum, cecum, sigmoid	NP	NP	NP	NP	100	NP	Cured/improved: 93.6%	NP
Khoury et al. [289]	3	100	Ileum, cecum, sigmoid	NP	NP	NP	NP	37	NP	Cured/improved: 91.7%	NP
Luangkhot et al. [290]	3	21(21)	Ileum, cecum	185	595	53	16	37	100	Cured/improved: 95%	NP
Nasrallah et al. [166]	3	14(14)	Sigmoid	101	383	61	NP	25	NP	Cured/improved: 86%	NP
Robertson et al. [291]	3	25(19)	Ileum, cecum	122	659	23	7	14		Cured/improved: 40%	NP
Hendren et al. [292]	3	129	Ileum, stomach, sigmoid	NP	NP	NP	NP	NP	NP	Cured/improved: 94%	NP
Sidi et al. [293]	3	12(12)	Cecum, sigmoid	134	562	NP	<30	1.3	NP	Cured/improved: 100%	NP
Lockhart et al. [294]	3	15(15)	Ileum, cecum, sigmoid	<150	330-480	>40	18-38	NP	NP	Cured/improved: 86%	NP

(Max BC: Maximal Bladder capacity, DP: Detrusor pressure at the maximal bladder capacity)

Kidney transplantation and augmentation cystoplasty

The general notion is that augmentation cystoplasty should be beneficial in patients with chronic renal failure and performed prior to transplantation, as a low-pressure reservoir might delay the native kidney's death and optimize graft survival rates. However, published studies suggest otherwise. In a small series (n=11) of neurogenic bladder patients, augmentation cystoplasty did not affect progression to end-stage renal disease (LOE2-3) [239]. More strikingly, prior cystoplasty was found to be associated with higher risk of graft rejection compared to non-cystoplasty transplants, up to 7 years post-operatively (LOE2-3). Although the authors suggest this may be due to higher rates of febrile UTIs and chronic rejection, it might also be due to a more severe underlying pathophysiology which resulted in the necessity of a cystoplasty in those children [240]. The same group of authors conclude that the timing of augmentation cystoplasty in relation to the transplant surgery (before or after) has no significant effect on the outcome of the transplantation, with respect to graft acute rejection, graft survival (up to 7 years) and incidence of febrile UTIs (LOE2-3) [241]. In terms of serious complications, patients with augmented bladders and a history of renal transplant on chronic immunosuppression were found to have a significantly higher incidence of bladder cancer compared to patients who were not immunosuppressed (15% vs 2.8%) [224] (LOE3).

Autoaugmentation by detrusor myotomy

Bladder autoaugmentation without any associated gastrointestinal tract surgery as an alternative to enterocystoplasty was proposed as early as 1972 by Mahony and Laferte [242] who performed detrusorotomies (detrusor incision without resection) to increase bladder capacity and reduce incontinence. With Cartwright and Snow [243], the technique then evolved to detrusorectomy (myectomy). This involves excising a thick segment of muscle from the dome of the bladder, leaving only the mucosal membrane in place. Bladder pressure gradually dilates the "demonularized" area resulting in bladder augmentation. The intervention, initially described by extra-peritoneal laparotomy, can be performed by video-assisted surgery [244, 245] or by robot-assisted surgery [246] (LOE4). The detrusor can be dissected by laser [247] (LOE3). The area around the detrusorectomy can be protected using the omentum [248] or a striated muscle [249] (rectus abdominis muscle) to prevent perforation and retraction (LOE4).

Techniques using free-graft or pedicled de-epithelialized gastric patches [250, 251] require gastrointestinal tract surgery and were therefore not included in the present work. Furthermore, most of the previously published studies concerned children. All the studies are retrospective and with few patients. For children, most authors [248, 253-256] report poor results after surgery, both symptomatic and urodynamic, together

with a risk of upper urinary tract impairment (LOE4). Two authors recently reported better results with certain technical adjustments, namely an extensive detrusorectomy [257] (LOE4) and rectus muscle hitch and backing [249] (LOE4). The last technique supposes a large dissection of the rectus muscle. Urothelium is then sutured to this muscle in the theoretical objective to prevent its retraction and shrinkage.

Only three retrospective series are available for adults. The first, published by Stöhrer et al. in 1997 [205] (LOE3), reports interesting results for efficacy, with increased functional bladder capacity. However, the authors did not report mean follow-up and described a mixed population with 39 patients with neurogenic bladder and 11 patients without. The two other published series concerning adults [252, 253] did not confirm these findings but did confirm the marked superiority of enterocystoplasty with respect to both urinary symptoms and upper urinary tract impairment (LOE3). Detrusor myectomy achieves better results for idiopathic DO; nearly all patients (5 of 6) with neurogenic DO were not improved, with a mean follow-up of 79 months [252] (LOE3).

There is little information on specific complications, but detrusorectomy is simpler and seems to present less risk than enterocystoplasty. A comparative retrospective study (LOE4) reported 20% complications for enterocystoplasty (infectious, digestive and parietal complications) against only 3% for detrusorectomy [253]. The rate of secondary rupture and/or perforation is poorly documented. An experimental animal study concluded that the bladder rupture pressure was slightly lower after detrusorectomy than after enterocystoplasty, thus potentially exposing the patient to an increased risk of rupture [259] (LOE4).

Bladder augmentation using biomaterials

Research interest in the role of tissue engineering in bladder reconstruction is growing. This research appears to evolve along three axes [260]:

- a. use of acellular natural or synthetic biomaterials: an acellular biomaterial graft is used as a tissue implant which becomes incorporated through the ingrowth of cells of the native host bladder
- b. use of biomaterial scaffolds which have been pre-incubated with autologous cultured human urothelial and smooth muscle cells
- c. composite cystoplasty, which combines the use of autologous cultured urothelial cells with a host pedicled and de-epithelialised smooth muscle segment.

Most publications concern preclinical studies [261-265] (LOE4). Several biomaterials have been used which can be grouped in 3 categories: (a) decellularized natural matrices produced from a variety of tissues; (b) matrices produced from natural extracted polymers (e.g., collagen, alginate, chitosan and hyaluronan); and (c) synthetic polymers including polyglycolic acid (PGA) and poly-caprolactone (PCL) (see

reviews [260, 266]). These biomaterials can only be used after performing clam cystotomy since the area to be colonized should not be too large. It also appears that the use of biomaterials is associated with higher incidence of bladder lithiasis. The best studied natural materials are porcine intestinal submucosa (SIS, Cook) and bladder-derived acellular matrix [267, 277-282].

Results from only two pilot human studies have been fully published to-date [280, 281]. The former reported on neurological patients, the latter on non-neurogenic OAB patients. In a small prospective study of 7 young myelomeningocele patients (LOE 2-3), Atala [281] describes his technique, which consists of seeding patient's urothelial and muscle cells on a biodegradable scaffold. After 7 weeks, this engineered artificial bladder could be implanted in patients. Although the small number of patients doesn't allow definitive conclusions, a trend towards an improved bladder capacity and compliance was observed. It was also implied that patients who received cell-seeded collagen-coated PGA scaffolds wrapped in omentum as a vascular bed had the best outcomes. Encouraging results were also reported in 12 women with intractable non-neurogenic OAB who were submitted to bladder augmentation using an acellular matrix of porcine dermal collagen and elastin fibres (Pelvicol, Bard) [280] (LOE4). Significantly improved or cured incontinence was achieved in 67% of them at a 12-month follow-up. Finally, a recent review article [276] claims results in short report form from two small Phase II trials on patients with neurogenic bladders due to either spina bifida (paediatric patients) or SCI (adults). Success rates of 60% and 67% are reported for up to 2-year follow-ups, depicting patients with preoperative 'normal bladder cycles' as the best candidates for bladder augmentation with a tissue-engineered scaffold. Further studies, including larger trials are necessary to evaluate routine use of biomaterials.

Recommendations

- Any segment of the gastrointestinal tract may be used for bladder augmentation, but the ileum seems to give the best results in terms of ease of use, risk of complications and efficacy (B). Few data are available concerning gastrocystoplasty and ureterocystoplasty in adults (D)
- When the bladder suffers a significant compliance defect, supratrigonal cystectomy and reconstruction is preferable to clam cystoplasty (B).
- Bladder augmentation may solve low-grade vesicoureteric reflux. In the event of grade IV or V reflux, ureteric reimplantation may be necessary (C).
- Patients should be informed that the most frequent and serious complications are bladder calculi and perforation at the bladder/bowel junction, usually caused by over-pressure (B).

- Bladder augmentation may have sequelae such as intestinal transit disorder, and patients should be informed of this before surgery (C).
- The body of evidence concerning detrusor myectomy in neurological patients is controversial. Therefore, detrusor myectomy should not be recommended in these patients with impaired bladder function (D)
- Bladder augmentation using biomaterials or tissue engineering is promising, but the preliminary results need to be confirmed by larger studies (D)
- Due to risk of complications, regular follow up is needed (B)

Cutaneous continent urinary diversion

Keywords; Continent urinary diversion; vesicostomy; cystostomy; neurogenic bladder; spinal cord injury; spina bifida; myelomeningocele; multiple sclerosis

For certain patients, urethral catheterization can be or become, unacceptable or even impossible. The following list is not exhaustive, but describes the more frequent reasons:

- Functional limitations of the upper limbs (tetraplegia [295] unilateral or bilateral plexus problems, musculoskeletal trauma problems)
- Cognitive disorders (forgetfulness, lack of comprehension, refusal)
- Difficulties in terms of mobility and/or undressing (spasticity, upper SCI resulting in difficulty in maintaining the equilibrium of the trunk and/or limited control of the upper limbs, obesity).
- Failure to reach the urethra independently (more common in women, compounded by the tilted pelvis and all other factors that cause mobility difficulties.)
- Urethral injuries (stenosis, fistulas, hyperesthesia), urethral pain.

In these situations, management requires careful consideration; in some, a continent cystostomy may be an option. The general principle is to permit the emptying of a full bladder, independently and easily, by IC through an efferent tube attached to the wall of the lower half of the abdomen. The absence of any leakage from the cystostomy is controlled by its own watertight system, associated with the return process of a capacitive and compliant reservoir. This will require careful selection of patient candidates, especially when there is any function impairment of the upper limbs (trauma to the spinal cord) [296-298] (LOE3).

Assessment is essential, and must include the motivation of the patient, capabilities for dressing and undressing, capability of catheterization in the planned stomal area, and tolerance for the time and potential

discomfort involved. In the case of cognitive difficulties that are too significant, if a severe upper limb dysfunction exists [295], or if compliance of the patient remains an impossible obstacle, continent diversion is not indicated. Impaired renal function can also be a contraindication [299].

In neuro-urology, techniques for heterotopic continent neo-reservoir (e.g. Koch pouch, Benchekroun, Mainz, Miami pouches) are seldom used initially. They can be offered to patients with VUR, with incontinence through the native urethra despite bladder enlargement, or when closure of the bladder neck will be needed (e.g. uretero-vaginal fistula).

Results of the different types of cystostomy:

The series are mainly retrospective (LOE 3) and frequently combine several techniques. This makes the analysis of the results difficult, but some major facts can be gleaned from them. The catheterizable tube must be able to penetrate the intact or enlarged bladder and it must be able to reach the abdominal wall through a direct pathway with easy access for the patient that has already been predetermined by pre-operative research. The pathway of the tube must be direct in order to facilitate self-catheterization. Techniques can be grouped in two major categories: simple tubes implanted with an anti-reflux system and intestinal loop invaginations.

a) Simple tubes: virtually any anatomical structure that is tubular or that can be tubularized and that is vascularized can be used to make a continent catheterizable tube [299] (LOE4). The two structures that are the simplest to use are:

- The appendix: Trans-appendicular cystostomy according to Mitrofanoff's procedure [300] has long been the most used technique (LOE3). Different modifications have been proposed, especially to gain more length by removing a cecal cuff.
- A short, remodeled intestinal segment (small intestine, less frequently the sigmoid or right colon). Yang and Monti simple [301] (LOE3) or double technique and the Yang-Monti technique modified according to Casale in order to gain length by avoiding a double tube [302] (LOE3).

Other structures have been used in a more anecdotal manner, primarily in children: cecum and appendix monobloc [303] (LOE4), bladder [304] (LOE4), stomach [305] (LOE4), distal ureter [306] (LOE4), Meckel's diverticulum [296, 307] (LOE4), or the preputial or clitoral skin [308] (LOE4).

For most authors, continence of the tube was achieved by implantation in the native bladder or in the augmentation via a submucosal path similar to that used in ureteral reimplantation for VUR. (LOE4). The submucosal path length must be at least 2cm, and is adapted to the bore of the tube (two to three times the diameter) [298] (LOE4). A posterior or pos-

terolateral bladder flap (kept in case of a supratrigonal cystectomy) should allow a more solid implantation of the tube in the bladder [309] (LOE2). Direct implantation into the cystoplasty has also been reported. The cutaneous anastomosis is made in the lower half of the abdomen, at the umbilicus, or in the right or left iliac fossa. It seems essential that the site of the stoma would be determined preoperatively in patients with functional limitations of the upper limbs. The site is chosen based on the patient's capabilities and the position during self-catheterization (seated in a chair, supine, other). The surgical technique used in this particular case must allow access to any point on the lower half of the abdominal wall [310-312]. Most authors recommend the interposition of a skin flap in the distal end of the tube in order to minimize stenosis of the circular orifice scars. Several techniques have been proposed: flap in V, VQZ [313] (LOE3), and VR [314] (LOE3). However, at present, the results published do not confirm that the risk of stenosis is avoided by any of the techniques.

Table 13 summarizes the results in terms of stoma continence and complications, specifically pertaining to the continent stoma. The necessity of reservoir augmentation (80% of published cases) and techniques allowing reinforcement of ureteral continence are addressed elsewhere. Continent stomas are obtained overall in 75 to 100% of cases (LOE3). Seven studies indicate significant improvement in quality of life after the procedure related to improved autonomy in bladder evacuation, to continence, and to improved sex life [297, 309, 311, 312, 315-317] (LOE2-3).

Table 13: Results for continent reconstructive surgery

Team	Year	LOE	n (neurogenic bladder)	Mean follow-up (months)	Technique	Functional continent cystostomy (%)	Stoma complication (%)	New procedure on the stoma
Wille et al. [332]	2011	3	? 11	20 (median)	Mitrofanoff (robot-assisted)	100 (initial 91)	27	3
Spahn et al. [331]	2010	3	6 (out of 17)	68	Mitrofanoff 8 Ileal intussusception valve 9	100 (initial 82)	23	7
Nguyen et al. [251]	2009	4	? out of 10	14.2 (median)	Mitrofanoff (9 robot-assisted)	100 (initial 70)	30	2
Vian et al. [333]	2009	3	32	21.6	Mitrofanoff 17	86	33	11
Welk et al. [334]	2008	3	67 (?)	28	Mitrofanoff 54 Ileovesicostomy 13	94	26	13
Mhiri et al. [335]	2007	3	20(28)	53	Mitrofanoff	100	13	3
Karsenty et al. [309]	2007	2	13(13)	44	Mitrofanoff 7 Yang-Monti 6	100	0	0
Touma et al. [317]	2007	3	12(12)	33	Casale	100	17	0
Franc-Guimond et al. [314]	2006	3	12(12)	18	Mitrofanoff	100	8	8
Thomas et al. [318]	2006	3	78 (62)	28,4	Mitrofanoff:33 Yang-Monti: 30 Bladder: 16	98	23	8
Castellan et al. [307]	2005	3	135 (100)	38	Mitrofanoff 74 Yang-Monti 45 Gastric tube 8 Bladder tube 2 Meckel tube 1	NP	23,5	8
Blaivas et al. [326]	2005	3	98(15)	108	NP	87	42	16
Chulamorkodt et al. [336]	2004	3	54 (48)	30	Mitrofanoff 47 Yang-Monti 7	95	16	NP
Barqawi et al. [337]	2004	3	109 (60)	46	Mitrofanoff 114 Yang-Monti ileac 21 Ureter 11 Others 5	92	36	NP

Team	Year	LOE	n (neurogenic bladder)	Mean follow-up (months)	Technique	Functional continent cystostomy (%)	Stoma complication (%)	New procedure on the stoma
Lemelle et al. [338]	2004	3	46(32)	64	Mitrofanoff 23 Yang-Monti 18	96	46	NP
Walsh et al. [311]	2004	4	6(6)	44	Mitrofanoff 3 Hemi Kock 2	NP		NP
Zommick et al. [297]	2003	3	21(21)	59	Mitrofanoff 7 Hemi Kock 2 Kock 6 Indiana 2	70	11	NP
De Ganck et al. [321]	2002	3	53(45)	32	Mitrofanoff 45 Yang-Monti 8	90	36	NP
Cain et al. [304]	2002	3	31 (15)	41	Bladder	100	45	NP
Tekant et al. [315]	2001	4	46(11)	28	Mitrofanoff 38 Yang Monti 6	86	19,5	NP
Kochakarn et al. [339]	2001	4	12(12)	12	Mitrofanoff 10 Yang Monti 2	100	NP	NP
Narayanaswamy et al. [320]	2001	4	92 (21)	30	Mitrofanoff 69 Yang Monti 25 (17 double, 8 simple)	NP	Appendix 26 Yang Monti 60	NP
Liard et al. [319]	2001	4	23(22)	240	Mitrofanoff 20 Bladder flap 2 Ureter 1	75	39	65
Harris et al. [340]	2000	4	31/50	51	Mitrofanoff	96	16	16
Cain et al. [341]	1999	4	69/100	48	Mitrofanoff 57 Yang Monti 22 Bladder tube 21	98	20	Appendix 21 Yang Monti 10 Bladder tube 29
Mollard et al. [296]	1997	4	56(46)	120	Mitrofanoff 48 Distal ureter 8	92	16	NP
Sylora et al. [310]	1997	4	7(7)	NP	Mitrofanoff 5 Yang-Monti Ileac 2	86	14	NP

The rate of stoma complications (16-60%) is dominated by the risk of stenosis, which is most often treatable by a simple dilation [318] (LOE3). Many authors emphasize the fact that this complication occurs most often in the year following surgery. However, Lizard et al. [319] (LOE3) reported an elevated (65%) intervention rate at 20 years of monitoring. For most authors the rate of complications related to the tube continence was lower when the segment used was the appendix or intestines remodeled according to Yang-Monti (LOE3). However, these two plasties seem to have equivalent complication rates. Only Narayanaswamy et al. [320] (LOE3) reported higher rates for catheterization difficulty and reintervention with the Yang-Monti tube in comparison to the appendix. The Monti tubes in this study were double tubes in 68% (17/25) of cases, and the majority of the complications were related to the junction area for the two hemi-tubes and not to stoma stenosis. Therefore it seems that this lengthening method should be used with caution. If there is a problem with tube length, the method proposed by Casale [302] (LOE4) has the theoretical advantage of avoiding an anastomosis on the tube or a bent pathway at the junction of the two tubes.

The umbilical anastomosis site for the stoma may be related to an increased frequency of stoma stenosis [304, 321] (LOE3). The poorer vascularization of the umbilicus has been proposed as an explanation [321]. However, results on this point are contradictory with more recent studies [309].

b) Other types of continent urinary stoma:

Techniques are extremely varied. Two technical approaches can be broadly outlined here:

- Invaginated valves (Koch pocket, Benckroun, Mainz), in which the continence mechanism is tied to the flattening of the invaginated valve by urine accumulated in the neo-reservoir;
- Ileal-caecal reservoirs, in which a portion of the ileum and the ileal-caecal valve are used as a continence mechanism (Indiana pouch, Charleston pouch, Miami pouch).
- A new technique using a pedicled cutaneous flap which is surgically elevated from a hairless area on the abdomen, tubularized and passed through the anterior abdominal wall directly into the bladder (The Daoud technique) [322].

Data in the literature do not allow a determination to be made as to the superiority of one type of stoma over the others. However, the catheterization difficulties seem to be lower with stomas that use the appendix, and the risk of lithiasis seems to be higher with the stomas constructed using metal staples [323] (LOE4). Several authors have also specifically reported results in neurological patients [312, 322, 324-329] (LOE3). Continence rates for the stoma vary between 63 and 100%. Complication rates for the stoma are between 10 and 23%.

Bladder outlet management; although prospective studies are missing, evidence from retrospective analyses (LOE2-3) suggest that continent diversion combined with bladder neck closure is superior in terms of functional outcomes to continent diversion with an open bladder neck, whilst having similar morbidity [330]. Another series reports primary continence rate following bladder neck closure and continent vesicostomy of 82% [331]. Both series report however on a mixed patient population.

Recommendations:

- Indication for cystostomy presumes a multidisciplinary evaluation involving the urologist and a neurologist or a reeducation doctor, as well as stomatherapy nurses or occupational therapists for estimating patient catheterization capabilities (A)
- Use of the appendix to carry out continent cystostomy is the standard method in children, but few long term data are available in adults (C). The appendix may have a short mesentery, so a reconfigured ileal segment is often needed.
- If the patient has undergone an appendectomy, the use of a segment of the small intestine can be proposed, with slightly poorer short term results (C)
- Long term follow up of after continent cystostomy is needed to have a better idea of the long term results of the various procedures (C).

6.15. Non-continent cutaneous urinary diversion

Keywords; neurogenic bladder; spinal cord injury; spina bifida; myelomeningocele; multiple sclerosis; urinary diversion; ileovesicostomy; Bricker; ureterosomy; vesicostomy; ileal conduit

Non-continent cutaneous diversion refers to all methods used to divert urine, and where incontinence remains or where a system of extra-physiological continence is created, i.e. urine flow is continuous and requires a means of collecting urine attached to the skin. In the context of neurogenic bladder, these diversions make it possible to obtain low bladder pressure and to preserve the upper urinary tract. This type of surgery is a last resort for the many complications related to neurogenic bladder (and congenital anomalies of the lower urinary tract), in patients for whom other therapies have failed to help. Urinary diversion techniques, however, have been largely replaced by augmentation cystoplasty in the treatment of refractory neurogenic bladder, at least in some groups of neurological patients. The analysis of the US national database of patients with spina bifida between 1998-2005 demonstrated that 3,403 patients were submitted to augmentation cystoplasty as opposed to 772 treated with urinary diversion. Moreover, patients undergoing urinary diversion required more healthcare resources, with significantly longer hospital stays,

higher total charges and more use of home health care after discharge home [342].

Four techniques are described for non-continent urinary diversions for patients with neurological vesico-sphincter disorders. In order of frequency these are: ileal conduit urinary diversion, ileovesicostomy, cystostomy and cutaneous ureterostomy.

Ileal conduit urinary diversion

Ileal conduit urinary diversion is the type of diversion most frequently performed on neurological patients with bladder dysfunction. Pre-operative location of the intended stoma site is crucial and must be adapted to the patient's main position (wheelchair or bed); the stoma site must be easy to access for management. The ileal segment must be as short as possible to prevent stasis [343] (LOE3). There is a variant to this technique whereby a segment of jejunal loop is removed and a stoma made on the left hemi-abdomen. This technique can be proposed after irradiation of the pelvis minor, if the ileum has been impaired and a short loop must be used (about 10 cm) to avoid metabolic disorder (jejunal conduit syndrome: hyperkalaemia, hyponatraemia, hypochloreaemia, acidosis) [344] (LOE3).

In neurological patients, ileal conduit urinary diversion by laparoscopy and by robot-assisted laparoscopy has been described [345-349] (LOE4). Patients seem to benefit from the procedure, though this remains to be confirmed in the medium and long-term [350] (LOE 2). Uretero-ureterostomy on conduit diversion has also been described in neurological transplant recipients in whom the donor ureter is too short to achieve a tension-free ureteroileal anastomosis [351]. Graft survival rates at mean 5.3 years follow-up was 83%.

Some series of neurological patients were evaluated to determine the onset of early and late complications [350, 352-357] (LOE2-3). The first study to use the recently introduced Clavien system reported on a series of multiple sclerosis patients (n=53), of whom 43% developed minor complications (Clavien grades I-II) and 11% major complications (Grades III-IV) [358]. Early series of children can be evaluated to determine the morphology of the upper urinary tract and renal function after urinary diversion over a long period (up to 20 years) [359-364] (LOE3). Despite complications, significant improvements in patients' quality of life were recorded, in both retrospective [359] and prospective studies [350]. The latter, however, noted that only aspects of QOL associated with the limitations and constraints induced by urinary problems were improved, not the overall QOL.

Mortality is estimated between 0 and 3.4% (LOE2-3). The commonest early complication is intestinal obstruction (4 to 12.6%), usually reversible after prolonged intestinal drainage [350, 352, 353, 355-357] (LOE2-3). The risk of gastrointestinal fistula should also be taken into account (0 to 3.3%). As for entero-

cystoplasty, the current trend is to try to reduce nasogastric tube drainage time to a few hours [365] (LOE3). The most frequent medical complications encountered (3 to 8%) are febrile urinary infections and thrombo-embolism (2 to 3%; LOE2-3). Other major complications include: urinary fistula in 0.3 to 3.4% of patients which may be prevented by placing a ureteric catheter for about ten days (LOE3). This complication could be a risk factor for later uretero-ileal anastomosis stricture (LOE4).

The risk of long-term intestinal obstruction ranges between 5% and 7% (LOE3). Even when a short intestinal segment is used, some patients can experience transient constipation or diarrhoea, which could adversely affect their quality of life [366] (LOE2).

Complications affecting the bladder left in situ. For the particular indication of neurological patients with bladder dysfunction, several authors have proposed not carrying out cystectomy so as to avoid potentially morbid surgery. At present, this is debatable for several reasons:

- There is a risk of pyocystis formation in the unused bladder (21-50%) [352, 353, 357, 367] (LOE3). Even where conservative treatments have been attempted (combining vesicular irrigation with antibiotherapy) [368] (LOE3), secondary cystectomy is then necessary in a high proportion [353, 359, 361]. For women, a surgical alternative is vaginovesicostomy, which appears to be effective [354, 361] (LOE4).
- The unused bladder frequently becomes infected and may become an "irritative thorn", especially in patients with spinal injury or multiple sclerosis (LOE 4) [353, 369].
- The risk of bladder neoplasia is higher in neurogenic patients, the principal risk factors being long-term indwelling catheterization (more than 8 years), bladder calculi and smoking [370-372] (LOE3). Moreover, screening by cystoscopy-biopsy is not effective [373, 374] (LOE3).
- Improvement of the cystectomy technique (noticeably laparoscopic cystectomy) has considerably reduced related morbidity [350, 375] (LOE2-3). Supratrigonal cystectomy can be performed in men, preserving the prostate and preventing any genital and sexual sequelae.

Upper urinary tract complications. Stenosis of the uretero-ileal anastomosis may occur in the medium and long term. This is very damaging to the upper urinary tract and requires regular monitoring. In contemporary series, it occurs in 2 to 7.8% of cases within 10 years [352-357] (LOE3). For cases followed for more than 10 years, the finding of 16.5 to 50% stenosis is essentially that of early paediatric series [359-364] (LOE3). Impairment of the upper urinary tract and renal function seems to be correlated mainly with stenosis of the uretero-ileal anastomosis, but also

with a long ileal graft and stomal stenosis leading to poor voiding and pyelonephritis [360] (LOE4). In the event of poor functioning of the uretero-ileal anastomosis, some authors suggest endoscopic dilation before further surgical repair of the anastomosis (LOE3) [356, 376-378]. Surgery however remains the reference treatment [378] (LOE3).

The risk of upper urinary tract lithiasis (3 to 31%) is always present in these patients (even without stenosis of the uretero-ileal anastomosis) [352, 353, 356, 357] (LOE3). Patient monitoring should include regular screening of the upper urinary tract to detect any lithiasis and to implement timely treatment (LOE 4). Chronic bacteriuria is frequent but should not be treated if asymptomatic. Both patients and attending physicians must be informed so as to avoid the administration of unnecessary antibiotics. However, the risk of febrile infection persists over the long term and may be predisposed by uretero-ileal stenosis (12 to 34%) [352, 353, 356, 357].

Stoma complications. These are relatively frequent (18.6 to 30%) and varied [353, 356, 357]. The risk of peristomal herniation is the most frequently reported (between 7.7 and 10%). Stomal stenosis may also occur. Stoma complications appear to occur more often in obese patients (LOE3) [379].

Some patients, usually adults who underwent surgery as children and who subsequently to recover a continent system, or who have had complications with their non-continent urinary diversion could ask for undiversion [380-384] (LOE3-4).

Ileovesicostomy

This technique was first described by Cordonnier in 1957 for treatment of three children suffering from myelomeningocele [385, 386](LOE4). Its theoretical advantages are relative simplicity, the absence of dissection and suture of the ureter, thus preventing ureteral complications and the potential of restoring the integrity of the bladder (only one case described) [387] (LOE4). The surgery consists in removing a 10 cm ileal segment from about 15 to 20 cm above the ileocecal valve. One side of the segment is anastomosed to the dome of the bladder and the other to the skin halfway between the iliac spine and the umbilicus. A partial cystectomy is performed to reduce reservoir volume and possible urine stagnation. Surgical variants have been described with simple partial detubularization of the ileum before vesico-ileal suture [388], or the creation of a modified Boari flap on the bladder associated with partial detubularization of the ileum [387, 390-393] (LOE3). These improve drainage by reducing the ileal segment. Laparoscopic ileovesicostomy seems to be feasible [389, 394] (LOE4), and robotic ileovesicostomy has been described. A small, retrospective comparative study (LOE3) reported similar results in terms of continence and complications with the open surgery group, although a trend for less blood loss and shorter hospital stays was noted in the robotic group [395, 396].

One of the problems with ileovesicostomy, particularly in women, is the need for further surgery to prevent residual urinary leakage. All authors agree that this significantly prolongs surgery time. This further surgery may consist in closing the bladder neck or placing a suburethral tape [436, 438,443, 448, 449] (LOE3). Some authors propose performing this surgery later, where necessary [388] (LOE3).

Early complications are related to the underlying condition of these patients, which is often poor. No case of post-operative mortality has been reported in the published series [385, 387, 388, 390-393, 395-400] (LOE3). Other early complications were related to poor results of the surgery performed to render patients continent (4). Patients with this type of problem are the most likely to resort to cystectomy with ileal diversion (3 to 6%) [387, 397] (LOE3).

Late complications are summarized in Table 14

Only one series to date has more than five years of follow-up [400]. It should be noted that, despite reduction in complication rates, particularly those related to chronic upper tract infections and stone formation, none of the patients in this series remained complication-free [399]. The largest series to-date also report high complication rates (up to 74%), albeit reduced in comparison with preoperative rates [397]. The most frequent new adverse events appear to be poor emptying related to stenosis of the stoma or the ileovesical anastomosis. Only one group of authors specifically mention problems related to stoma equipment that occur in about 38% of patients [397] (LOE3). The incidence of renal or vesicular lithiasis can be as high as 25% in some series, and several authors report that affected patients had a history of lithiasis [399].

Renal function appears to be preserved with this procedure at least with a mean follow-up of five years (LOE 3) [387, 388, 390-393, 397, 398, 401]. No case of impaired renal function, or even post-operative uretero-hydronephrosis was reported. Two patients in a series with long-term follow-up developed a bladder tumour [393] (LOE4).

Table 14: results for contemporary series of ileovesicostomy

	LOE	n	Mean follow-up (months)	Re operation following primary surgery (%)	Stomal problems (%)	Kidney lithiasis (%)	Bladder lithiasis (%)	Continent (%)	Post-op hydronephrosis (%)	Symptomatic urinary infection (%)
Zimmerman et al., 2011 [400]	4	7	26	40	0	0	0	60	0	16
Hellenthal, 2009 [399]	3	12	66	42	17	17	25	92	0	67
Tan et al., 2008 [397]	3	50	26,3	54	38	2	6	72	0	10
Gauthier & Winters, 2003 [398]	4	7	37,4	NP	14	14	0	NP	0/7	1/7
Atan et al., 1999 [390]	3	15	23,2	NP	16	33	20	67	0	20
Gudziak et al., 1999 [392]	3	13	23	23	8	8	0	92	0	8
Leng et al., 1999 [393]	3	38	52	NP	13	10	5	NP	3	3
Mutchnik et al., 1997 [388]	4	6	12	1/6	1/6	0	0	6/6	0/6	0
Rivas et al., 1995 [391]	3	11	24	NP	NP	NP	NP	100	0	0
Schwartz et al., 1994 [387]	3	23	45	NP	21	0	0	NP	0	NP

Vesicostomy

Vesicostomy was described by Blocksom in 1957 [402] and detailed subsequently by Lapidès [403, 404]. The technique consists in constructing a bladder tube anastomosed to the skin by making a transverse suprapubic incision to reach the space of Retzius. The stoma is located half way between the umbilicus and the incision. The principal benefits simplicity and reversibility, particularly in children [405-411], making it possible to envisage temporary surgery to treat an acute urological problem. In pediatric series, an improvement in the symptoms of infection was reported, with 6 to 20% of patients suffering bladder calculi and 6 to 18% stomal stenosis. Hydro-nephrosis improved or stabilized in most cases. The rate of end-stage renal failure varied between 6 and 18% for mean follow-ups of 6-7 years.

Nowadays, it is rare to conserve a vesicostomy long term. The long-term results of Lapidès [404] (LOE3) are therefore all the more interesting. At two years of follow-up, there was no urinary infection, 16% poor drainage, 12% calculi, and renal function was preserved. At 10 years, however, end-stage renal failure, mainly due to calculi and repeated infection of the upper urinary tract, and mortality were reported [404, 412] (LOE3). Follow up at intervals ranging up to 20 years, showed the rate of chronic renal failure is around 16.6% [402-413] (LOE3).

Recently, percutaneous button vesicostomy placement under endoscopic control was proposed as a temporary continent alternative to Mitrofanoff in a series of 10 children with neurogenic bladders. The authors only discuss the feasibility of the procedure, not its efficacy [414].

Cutaneous ureterostomy

Cutaneous ureterostomy was first performed in the 1960s, to treat children with spina bifida and severe upper urinary tract impairment [415, 416]. The technique was also developed to treat malformative uropathies (exstrophy of the bladder and the posterior urethral valves) [416-419]. During this procedure, the ureters are anastomosed direct to the skin without using intervening gastrointestinal tract tissue. It is only feasible in the context of significant ureteric dilatation, and even then chronic stenting is often needed. The absence of gastrointestinal resection/ anastomosis avoids a major source of morbidity and mortality, but successfully achieving urine containment with appliances can cause considerable problems. In the absence of cystectomy, two short lateral incisions are made in the iliac fossa, at approximately 3-4 cm from the anterosuperior iliac spine. Direct retroperitoneal access is made and the two ureters located on the internal border of the psoas muscle or above the iliac vessels. It is important that the peri-ureteral region be spared and the ureter sectioned as low as possible. The ureter is then catheterized and raised to the skin. The stoma is formed by attaching the ureter to the skin, or by spatulating the sutured ureter on a V-shaped cutaneous incision (separate sutures with

fine resorbable thread). Variants are described so as to obtain only one stoma: Y-transuretero-ureterostomy, implantation of both ureters in a single stoma, and implantation of a single ureter (ureter of the less functional kidney ligated, or even nephrectomy). The use of cutaneous plasties may remove the need for ureteral catheterization [420].

The main inconveniences are: cutaneous stenosis if the stoma is left unstented, upper urinary tract infections, and calcification around catheters. Moreover, it is frequently necessary to construct a double stoma. It is used in adults, usually in the context of palliative urinary diversion for those with obstructive pelvic cancer (bladder, uterus, rectum), and rarely in neurological patients [416-421]. Long-term results with a mean follow-up of 8 years are given hereafter: rates of stenosis between 8.7 to 11%, infections from 6.6 to 10% and calculi from 10 to 15.5% [419, 421] (LOE3). Renal function was preserved for short follow-up times, but fatal end-stage renal failure occurred in up to 26.6% of children during long-term follow-up [418] (LOE3).

This technique is almost never used for neurological patients with bladder dysfunction anymore because conservative treatments (intermittent catheterization, urological endoscopy) have improved and the number of children suffering from spina bifida or presenting with complex malformation of the lower urinary tract has gradually lowered. Moreover, new urinary diversion techniques have been developed.

Recommendations:

- Non-continent urinary diversion is the last resort for patients with neurogenic bladder (A).
- Bladder should be removed during the procedure because of the risk of later complications at this site (B)
- It may be indicated for urological dysfunction or in the event of a motor handicap that prevents other modes of micturition (C).
- Ileal conduit urinary diversion has the best long-term results for non-continent diversion, if the following pre- and peri-operative precautions are taken (B):
- Pre-operative identification of optimal location for the stoma site, with wheelchair test, if necessary.
- Utilization of a short intestinal segment (10 cm maximum).
- Minimal dissection of the ureters.
- There are several reports of good results for ileovesicostomy, but the medium-term results need to be confirmed in the long term. Quality-of-life studies should also be performed (C)
- Vesicostomy may be a useful temporary solution, particularly for children (D)

- Cutaneous ureterostomy shouldn't be used for non continent urinary diversion in adult patients because of the rate of long term complications (B).

IV. NEUROLOGICAL FAECAL INCONTINENCE

1. EPIDEMIOLOGY

Central nervous system (CNS) disorders are common, and patients with these disorders frequently experience bowel symptoms.[1][2] In those individuals, bowel symptoms are associated with significant impairment of quality of life. [2][3] Chronic constipation is the commonest symptom of bowel dysfunction seen in the majority of individuals in spinal cord injury, and over one-third of patients with Parkinson's disease (PD) and multiple sclerosis (MS).

2. PATHOPHYSIOLOGY

The digestive and excretory functions of the gastrointestinal tract are dependent on the interrelated physiological phenomena of gut transit and rectal evacuation. [4] Transit is under the complex regulatory interplay of the enteric nervous system and extrinsic autonomic innervation, whilst rectal evacuation depends on an interplay between conscious perception of rectal sensori-motor function and the internal and external anal sphincters. Excessively rapid transit and/or failure of the anorectal control mechanism can result in faecal incontinence, and it is easy to see how CNS disorders can result in bowel symptoms.

The level and extent of injury are the most important factors in determining bowel symptoms in both SCI and MS. Supraconal lesions (above the conus medullaris, where inhibitory input is lost) - slow whole gut transit and there is hypertonia (with consequent reduced rectal compliance) and hyperreflexia of the hindgut (i.e. distal to the splenic flexure).[5] The latter two abnormalities predispose to reflex defaecation and incontinence. By contrast, lesions within the conus or in the cauda equina (where excitatory sacral parasympathetic supply is lost) have rectal hypotonia and hyporeflexia predisposing to rectal impaction and overflow incontinence. [6]

In terms of extent of injury, since the striated external anal sphincter is under voluntary control from Onuf's nucleus in the ventral horn of the sacral spinal cord, complete SCI results in loss of voluntary control of the anal sphincter is lost. Complete SCI has been shown to result in the most severe degree of bowel dysfunction. [5]

The pathophysiology of bowel dysfunction in patients with Parkinson's disease is quite different. Dystonia of the striated muscles of the pelvic floor and external anal sphincter explains the defecatory dysfunction [6] which is associated with delayed colonic transit time secondary to central and peripheral neurodegeneration. [7]

3. ASSESSMENT

Current bowel symptomatology is assessed, regarding bowel frequency, stool consistency, faecal incontinence and manoeuvres needed to achieve bowel management. This information is usually gathered from standard patient and carer history. Use of diaries is especially valuable to reflect the chronic burden of these symptoms. [8] This can be supplemented by questionnaires, whether generic (Cleveland Constipation score, St Mark's incontinence score or condition specific score has been developed for neurologic patients, the Neurogenic Bowel Dysfunction (NBD) Score.[9]

Digital rectal examination allows assessment of rectal filling, resting anal tone, ability to generate a voluntary contraction and also gives a crude assessment of anal sensitivity. The place of more interventional physiological or radiological transit investigations is not established, but may be appropriate if there is any co-morbidity (prior anal surgery, obstetric history, pelvic organ prolapse). Plainly, patients with alarm symptoms should have necessary colonic imaging performed. Alarm symptoms in this patient group are more difficult to recognise, but any worsening of established bowel dysfunction, weight or blood loss warrants investigation.

4. CONSERVATIVE TREATMENT

The primary aims of bowel care are twofold: firstly to achieve bowel evacuation without excessive toileting time and secondly to avoid fecal incontinence. The first step requires optimizing stool consistency with adequate fluid and fibre intake, and stimulating evacuation of stool on a regularly scheduled basis with digital rectal stimulation. A range of other non-invasive interventions may supplement this: Valsalva or manually-generated external pressure, oral medications – stool softeners, stimulant laxatives and prokinetic agents; diet modification; biofeedback – a re-education strategy to inform change in bowel function; electrical stimulation and functional magnetic stimulations. The key to successful bowel management is intensive patient education and training. If conservative bowel management fails, surgical management may be necessary.

4.1. Bowel program/bowel care [9]

Initial management for all subjects is medication review (especially bladder drugs such as antimusca-

rinics, baclofen, ditropan, codeine analgesia, non-steroidal anti-inflammatory drugs (NSAIDs) and antibiotics) and addressing any unusual dietary habits. In general, scheduled defecation should be attempted once a day or on alternate days. However, knowledge of bowel frequency prior to injury is important in deciding on the bowel program.

4.2. Specific techniques

Establishing a regular diet to optimize bowel motility is important and in general reducing fibre intake is helpful in improving the bloating and flatulence caused by slow whole-gut transit. Conversely, a higher fibre diet helps improve stool consistency and therefore prevent fecal soiling. Excessive quantities of caffeine, alcohol and foodstuffs containing the sweetener sorbitol can cause the stools to become looser and hence more difficult to manage.

Promoting a sense of privacy and comfort while exploiting gravity to achieve a successful bowel regime, is advised. Digital rectal stimulation (DRS) can be used to invoke a reflex contraction of the colon and rectum, and hence a bowel action, although caution is advised as it may cause local trauma and induce autonomic dysreflexia (AD) in SCI individuals. Finally, manual extraction of stool can be used and combined with a Valsalva maneuver to improve effectiveness. [8]

Chemical stimulants such as suppositories and enemas may supplement the above by causing a reflex contraction of the rectum. Implicitly, there is little point in using these agents when the rectum is empty on digital checking. Stimulants range in potency, from glycerine suppositories, through micro-enemas, to larger volume stimulant enemas.

4.3. Assistive techniques for defecation [10]

Abdominal massage with the heel of the palm, in a circular motion from right to left may help increase bowel transit and movement of content towards the rectum. In small controlled trials, positive effects were seen in patients with multiple sclerosis and with spinal cord injury. Anal stimulation with pulsed water irrigation to break up stool impactions and to stimulate peristalsis is a safe and effective method for individuals with SCI who develop impactions, or do not have an effective bowel routine.

Several studies have been published on transanal irrigation (TAI), with efficacy demonstrated in a variety of neurological diseases. [11] Long-term efficacy has been demonstrated, with associated health economic benefit. [12] Amongst factors correlating with positive outcome were neurogenic bowel, low rectal volume at urge to defecate, low maximal rectal capacity, and low anal squeeze pressure increment. A perforation rate of 1 in 500,000 has been suggested in long-term safety studies.[13]

4.4. Appliance/assistive techniques for faecal incontinence

Anal plugs are one option although previous studies have yielded conflicting results. Whilst anal plugs may provide a benefit to the majority of patients, it does not suit all eligible patients, with *in situ* plug retention being a problem for some.

Neuromodulation, electrostimulation or magnetic stimulation are techniques that offer an alternative intervention option for neurogenic bowel dysfunction in children and adults.

5. SURGICAL TREATMENT

The mainstay of current treatment in neurogenic faecal incontinence is adopting a conservative approach towards reversing the systemic effects and optimizing the mechanics of defecation through the use of laxatives and irrigation approaches. Surgery should be normally reserved for patients who have failed conservative therapy. This section focuses on specific aspects of faecal incontinence surgery in neurogenic patients. Options for surgical treatment of neurogenic bowel dysfunction are limited consisting of; 1) sacral nerve stimulation, 2) antegrade continent enema procedure, 3) dynamic graciloplasty, 4) artificial anal sphincter, 5) elective colostomy, 6) postanal repair.

Outcomes with these techniques are limited to uncontrolled studies. [14] Sacral nerve stimulation has been reported to restore continence in patients with intact muscle structure. The overview of the studies shows that electrical nerve stimulation is effective in *partial* spinal cord injury, however, there are no reports for complete spinal cord lesions. A 17-year experience with sacral deafferentation (SDAF) and implantation of sacral anterior root stimulator (SARS) showed improved continence in over 80% of individuals. [15]

The original antegrade continent enema procedure was developed by Malone et al. who reported successful results in five children with intractable faecal incontinence. [16] This procedure has been applied mainly to the paediatric population with neuropathic bowel dysfunction and anorectal anomaly, and successful outcome was achieved in 70-100 %. Modifications have been reported including application among adult neurogenic patients with faecal incontinence, and similar success rates (83-100 %) were reported. [17]

There are other more intrusive surgical procedures that have been applied to small numbers of patients with neurogenic faecal incontinence – defunct ones (such as dynamic graciloplasty) or extant ones like artificial anal sphincter. Definitive studies are not available in this population, and given the nature of referral practice are unlikely to ever be performed.

Retrospectively reported series on the effect of colostomy or ileostomy formation in SCI patients have shown significant improvements in average time

spent on bowel care per week and quality of life. [18]The early and long-term complication rates are seen in the minority of patients, most frequently related to mucus discharge per rectum and diversion colitis, respectively. The decision about type of surgery depends on a multitude of factors related to manual dexterity, co-morbidity, carer availability and toilet set-up: as such careful patient counselling in individuals who have failed conservative therapies is the key to success. [17]

Conclusions

- In reflex bowel, digital rectal stimulation relaxes the external anal sphincter and increases peristaltic contractions by facilitating an excitatory anorectal (ano-colonic) reflex, and enhances bowel movement and evacuation
- Abdominal massage has beneficial effects on neurogenic bowel dysfunction, including defecation function and fecal incontinence
- Transanal irrigation is a safe method to improve constipation and faecal incontinence in individuals with neurogenic bowel dysfunction
- An anal plug can help control fecal incontinence in selected neurologic patients
- Different forms of electrical stimulation seem promising for fecal incontinence and defecation management in neurologic patients
- To increase adherence rate with bowel care program/clinical practice guideline, implementation strategies should be addressed to care providers
- SNS is a minimally invasive procedure, and seems to be an option for faecal incontinence and constipation due to functional deficit of the anal sphincter without structural defect in incomplete neurogenic lesions
- Antegrade continence enema stomas are effective for controlling faecal incontinence and constipation associated with neurogenic bowel dysfunction especially in neuropathic children
- Elective stoma formation is an option for some SCI patients with medically refractory symptoms.

Recommendations

- Multi-faceted programs are the first approach to neurogenic bowel management and are supported by lower levels of evidence. They may consist of toileting, rectal stimulation (digital or with water stream), manual feces extraction, transanal irrigation and other assistive techniques
- Diet can help but multi fibre is not necessarily indicated in patients with upper motor neuron lesion

- Autonomic dysreflexia when using mechanical stimulation and assistive techniques can occur in neurologic patients with a high spinal cord lesion
- Studies on larger series with long term follow-up are needed to determine the role of SNS in the treatment of faecal incontinence associated with neurological lesions and identify those patients most likely to benefit

V. SPECIFIC NEUROLOGICAL DISEASES

1. DEMENTIAS

Methods. Using MEDLINE we identified English-language journal articles and reviews up to the date of the current Consultation, which were added to literature obtained for previous Consultations, looking for the keywords Alzheimer's disease, vascular dementia, dementia with Lewy bodies, frontotemporal dementia, urinary incontinence, bladder dysfunction, management.

The dementias can be categorized according to clinical presentation, neuropathology and/or aetiology into four major dementia groupings, (I) the Alzheimer's group (Alzheimer's disease, AD); (II) the vascular group (including large and small vessel disease, particularly white matter disease); (III) the Parkinson's group (including Parkinson's disease dementia complex (PDD, being regarded as identical to DLB), and dementia with Lewy bodies (DLB), both being connoted as Lewy Body diseases); (IV) the frontotemporal group (including Pick's disease and Semantic dementia) [1]. Normal pressure hydrocephalus (NPH) is a less common pathology, but nonetheless important.

1.1. Alzheimer's disease

Epidemiology and prevalence

Alzheimer's disease (AD) is the most common type of dementia in clinical and autopsy surveys. AD affects mostly elderly people. The symptoms include worsening of the memory, impairment of language and other cognitive functions (analytical thinking, abstract reasoning). Ultimately, there is loss of self-hygiene, eating, dressing and ambulatory abilities, incontinence and motor dysfunction. The onset of incontinence usually correlates with the disease progression (LOE 3) [2]. In other words, urinary incontinence inevitably occurs in the advanced stage of disease, while urinary incontinence is not common in the early stage of AD. This is in contrast with early occurrence of urinary urgency and incontinence in vascular dementia and dementia with Lewy bodies. The prevalence of incontinence in AD is between 23 % and 48 % (LOE 3) [3, 4]. However, most previous studies did

not mention the type of dementia concerning 'frequency of urinary incontinence in dementia'. The prevalence of incontinence in dementia ranges from 10% (of out-patients) to more than 90% (of advanced, institutionalized individuals) (LOE 3) [5].

Pathology and disease-specific urinary tract problems

AD at the outset was identified by its unique pathology, the amyloid plaques and neurofibrillary tangles containing phosphorylated tau that Alzheimer referred to as "a clotting of fibrils.... in addition an extraordinary number of peculiar patches disseminated throughout the entire cortex." Amyloid and tau can now be measured *in vivo* by positron emission tomography and/or examination of the cerebrospinal fluid (CSF). There is a familial occurrence of AD [3]. In such cases, mutations in the genes encoding amyloid precursor protein (APP); presenilin 1 (PSEN1), or presenilin 2 (PSEN2) are reported.

The clinical hallmark of AD is memory impairment. A sense of memory failure, detected by the patient or a close relative, is usually the presenting symptom. Motor and sensory symptoms are absent until late in the course of the disease. However, other cognitive domains, such as language, praxis and recognition skills, are affected even early in the presentation. AD has a gradual and progressive course, and duration is typically 10 years from diagnosis to death. The advent of central cholinesterase inhibitors and glutamate receptor antagonists has had a positive effect on the memory symptoms of AD [6-8].

In early stages of AD the prevalence of urgency incontinence is lower than in dementia with Lewy bodies [9, 10]. During stage III (advanced) AD, urinary and faecal incontinence occur due to loss of sphincter control [10]. In a study by Del Ser et al. (LOE 3) urinary incontinence was associated with severe cognitive decline in pure AD but usually preceded severe mental failure in patients with dementia due to diffuse Lewy body disease [10]. Nobili et al. (LOE 3) performed quantitative EEG in AD patients, finding that incontinence was predicted by alpha power in the right side [11]. In another study by Nobili et al. (LOE 3) the value of regional cerebral blood flow from a posterior temporal-inferior parietal area in each hemisphere predicted development of incontinence [12]. A brain computer tomography study done by Sugiyama et al. (LOE 3) in AD patients showed that the degree of brain atrophy was more severe in those with detrusor overactivity (DO) than those without it [13]. DO was found in 40-61 % of their patients [13] (LOE 3). The incidence of DO in AD patients is low as compared with vascular dementia and dementia with Lewy bodies [9]. Haddad et al. (LOE 3) described two patients with vesicoureteral reflux, one of them showing buccosalivary, gastroesophageal, vesicoureteral, urethroprostatic and urethrovesical reflux as a consequence of the neurologic dysfunction [14]. In a study of 144 patients with AD reporting urinary incontinence, the most common type of urinary incontinence

was urgency urinary incontinence. Clinical Dementia Rating and Barthel's Activities of Daily Living predicted the severity of detrusor overactivity in urodynamics [15].

Diagnosis and treatment

Franssen et al. (LOE 2) examined the occurrence of the following developmental reflexes: the tactile suck reflex, the palmar and plantar grasp reflexes, and the plantar extensor reflex in healthy elderly, cognitively and functionally mildly impaired patients, and patients with AD [16]. Prevalence of all five reflexes was more than 6 times higher for those categories that comprised doubly incontinent patients compared to continent individuals. The frequency of developmental reflexes rose sharply with the onset of progressive incontinence, suggesting its cortical origin. As demonstrated above, the development of incontinence in AD patients is associated with cognitive impairment and brain degeneration, suggesting its CNS origin. Therefore behavioural therapy, toilet training and prompted voiding would be appropriate treatment modalities for this type of incontinence.

Hutchinson et al. (LOE 3) suggested that caregivers of patients with AD should study the toileting behaviours. This would permit them to provide physical and cognitive assistance while attempting to avoid accidents and "catastrophic events" [6]. Tariot (LOE 4) stressed the necessity for taking into account different factors (like mobility, cognitive functions, general medical conditions), when planning treatment (also for incontinence) in AD patients [7]. Lancioni et al. reported three AD patients who could learn to use urine alarms [17] (LOE 4). Again the general guidelines should apply for choosing the best management of incontinence in AD patients. The treatment should be tailored to individual patient needs and disease status. There is insufficient evidence to support non-pharmacological and non-surgical conservative interventions, for the prevention or management of incontinence in community dwelling people with dementia [18] (LOE 1).

There is still some controversy that the central acetylcholinesterase (AChE)- inhibitors given by the neurologist might exacerbate urinary incontinence in those patients. Donepezil hydrochloride is a selective central AChE inhibitor, which decreases degradation of acetylcholine in the brain, then increasing the concentration of acetylcholine in the synaptic cleft [19]. This drug is widely used to ameliorate cognitive decline in patients with AD [20, 21] which is thought to be due to a decrease in cholinergic innervation of the cerebral cortex and the basal forebrain [22]. Since the bladder is innervated by the parasympathetic cholinergic nerves, neurogenic lower urinary tract (LUT) dysfunction occurs in a subset of patients with AD [5, 13].

Although donepezil may facilitate cholinergic neurotransmission in the CNS, common adverse effects of donepezil, such as nausea and abdominal discomfort, have been attributed to effects on the peripheral

nervous system (PNS) [20]. This peripheral influence may contribute to altered bladder function. However, according to Sakakibara et al. (2005) the patients with AD showed a slight increase in the bladder capacity, which cannot be explained by the PNS effects alone [23] (LOE 3). Although it is unknown to what extent central cholinergic circuits may participate in the regulation of micturition, recent experimental studies showed that lesions in the nucleus basalis Meynert in the basal forebrain (central cholinergic nucleus projecting fibres to the frontoparietal cortex) give rise to decreased bladder capacity) [24]. In addition, improved cognitive status and alertness may well lead to proper initiative to hold urine. Central AChE inhibitors including donepezil hydrochloride, therefore, may have complex effects on the LUT function. It seems possible that donepezil could ameliorate cognitive function without serious adverse effects on the LUT function in patients with AD. This should be true also for other selective central AChE inhibitors. A large crossover cohort study used the Dutch PHARMO Record Linkage System, with 10 years of data on drug dispensing for over two million people. It suggested no firm association between AChE inhibitor treatment and risk of UI could be shown, except possibly during the first month of treatment [25] (LOE2).

Many elderly patients and their caregivers seek medical care for dementia and overactive bladder (OAB) together. In order to answer this, recent clinical trials of a combination therapy of central AChE inhibitors and peripheral anti-cholinergics for ameliorating both cognition and incontinence are available. In 26 older individuals who had both cognitive problems and overactive bladder (AD in 8, vascular dementia in 5, a combination of AD and multiple cerebral infarction in 8, and others), Sakakibara et al. reported that addition of 20 mg/day propiverine, an anticholinergic agent, to 5 mg/day donepezil improved OAB without any cognitive change [26] (LOE 3). Sink and colleagues retrospectively studied 3536 nursing home residents who were taking central AChE inhibitors, in whom 10.6% were prescribed anticholinergics together [27]. They found no differences in cognitive function between groups of AChE inhibitors alone and AChE inhibitors with anticholinergics (LOE 3). Isik et al. demonstrated that patients with advanced Alzheimer's Disease tolerated Trosipium chloride without significant changes in MMSE (Mini-Mental Status Examination) scores [28] (LOE 3). The combined use of a 'central' AChE inhibitor and a 'peripheral' muscarinic receptor antagonist remains a matter of controversy and the Dementia Working group of the International Continence Society has put forward a recommendation that antimuscarinics that do not easily cross the blood brain barrier or are more selective for the M2/M3 receptors should only be used in patients with dementia reporting incontinence [29] (LOE 3). There is a study indicating that this combination would be pharmacologically sound as a site-directed therapy [30].

Guidance for further research

There is still no cure for AD, which is progressive and a type of dementia-associated disease. We are still lacking studies evaluating LUT disorders in AD. No systematic review has been performed regarding the possibilities of medical management (both pharmacological and behavioural) of incontinence. An open issue also remains the question of aggressive surgery for LUT problems in these patients. Whether we should offer surgical therapy for incontinence in patients with stress incontinence and progressive AD is so far unanswered.

Conclusions

- Detrusor overactivity seems to be the most common cause of incontinence in Alzheimer's disease (AD) patients (LOE 3), while the incidence is low as compared with vascular dementia and dementia with Lewy bodies
- The degree of functional incontinence is associated with cognitive impairment and brain degeneration (LOE 3)
- EEG studies, occurrence of developmental reflexes and regional blood flow studies can predict the development of incontinence in AD patients (LOE 3)
- Selective central AChE inhibitors ameliorate cognitive function without serious adverse effects on LUT functions in patients with AD (LOE 3)
- A combination therapy of central AChE inhibitors and peripheral anticholinergics for ameliorating both cognition and incontinence awaits further studies (LOE 3)

Recommendations

- The extensive and aggressive therapy of incontinence in AD patients should be reserved for those with good general status and ambulation (C)
- In the case of ambulatory patients, prompted voiding, behavioural therapy and oral anticholinergics seem to be the treatment of choice (C)

1.2. Vascular dementia

Epidemiology and prevalence

Vascular dementia is the second most common form of dementia after Alzheimer's disease (AD) among the elderly. Pooled prevalence from eight European countries was 1.6% for vascular dementia in subjects older than 65, compared to a prevalence of 4.4% for AD (LOE 3) [31]. A meta-analysis of the European studies on the incidence of dementia showed vascular dementia constituted 17.6% of all incident dementia (LOE 3) [32].

Population-based MRI studies suggest that moderate white matter disease (WMD, a major cause of vascular dementia) affects around 10% (7.6–24%) of the general population of persons over 55 years of age [33], comparable to type 2 diabetes. WMD develops into three different geriatric syndromes; 1) vascular dementia (usually mild in the Mini-Mental State Examination and other general cognitive function), 2) vascular parkinsonism, and 3) so-called vascular incontinence, i.e. urinary frequency/urgency with or without incontinence [34]. Among these three syndromes, urinary and gait disorders are more prominent than dementia, and usually precede dementia. Comorbidity of Alzheimer's disease (a degenerative disease) and WMD (a vascular disease) is not uncommon.

Vascular dementia may be the result of a single strategic infarct, particularly involving the thalamus and left angular gyrus, or multiple cortical or subcortical infarcts that produce WMD. There is an elevated risk for subsequent dementia in patients who have had a stroke in comparison to controls without any evidence of a stroke (LOE 2) [35]. Diabetes and hypertension are stronger risk factors for vascular dementia than for Alzheimer's disease (LOE 3) [36]. The apolipoprotein e4 genotype is a risk factor for vascular dementia as well as AD (LOE 3) [37].

Pathology and disease-specific urinary tract problems

In patients with WMD, diffuse abnormalities are seen in the small deep perforating vessels of the hemispheric white matter, basal ganglia and brain stem. Pathological changes range from lipohyalinosis to fibrinoid necrosis and disintegration of small vessels. Disruption of the blood brain barrier is likely to precipitate or worsen progression of WMD [38] (LOE 3). Positron emission tomography imaging with 18F-fluoromisonidazole showed higher susceptibility to ischemia of white matter than gray matter in stroke cases [39]. Cortical WMD in MRI looks diffuse. However, within the brain, detailed pathology studies confirmed that the frontal lobe is most severely affected [40]. This is in line with documented frontal lobe atrophy on MRI volumetry, where glucose metabolism was also most severely reduced [41] (LOE 3). Corresponding to this, brain perfusion is most reduced in the frontal lobe of subjects with WMD [42] (LOE 3), a finding that remains to be fully explained. In patients with WMD reporting incontinence ("vascular incontinence"), performance on the frontal assessment battery suggests that performance on an inhibitory control task is decreased in patients with detrusor overactivity [43] (LOE 3).

The frontal cortex is an important higher center for micturition: damage to the prefrontal cortex, medial superior/middle frontal gyri, anterior cingulate cortex, supplemental motor area and insula result in marked lower urinary tract dysfunction in humans [44] (LOE 3), corroborated by functional neuroimaging [45, 46] (LOE 3). Altered spinobulbospinal micturition reflex

control may contribute to DO emergence in brain lesions [47] (LOE 3). Functional neuroimaging studies showed that the prefrontal cortex was deactivated in elderly subjects with urinary frequency/urgency [48] (LOE 3). Jirovec et al. (LOE 3) found that cognitive ability and mobility differ significantly between continent and incontinent patients [49]. When the variables were examined together, mobility emerged as the best predictor of the patient's urine control, followed by cognitive impairment.

The prevalence of DO in WMD cases is reported as 70–91% of patients. In Sakakibara's study, urodynamic studies in 33 subjects found DO more commonly in grade 1–4 white-matter lesions (82%) than grade 0 white-matter lesions (9%). Yoshimura et al. (LOE 3) found a 47% prevalence of DO which correlated with the presence of dementia [50].

Disease specific diagnosis and treatment

No specific diagnostic tests to evaluate dementia-related incontinence have been described. Since patients with dementia and incontinence usually have one or more concomitant diseases, the evaluation of the LUT functions should follow standard principles, bearing in mind that this is a population of frail elderly people. The treatment should start with modification of behaviour, and general rehabilitation targeted at making the patient more ambulatory. No other specific treatment in dementia has been described, however certain issues like prompted voiding, anticholinergic drugs and intermittent catheterization have been studied.

In a review of trials where prompted voiding was implemented, Eustice et al. (LOE 1) found that prompting increased self-initiated voiding and decreased incontinence episodes in the short-term [51]. A single small trial suggested that adding oxybutinin, reduced the number of incontinent episodes in the short-term. Suzuki et al. (LOE 3) found best results with the use of a portable chamber pot and induced urination in ambulatory patients; no improvement was seen in bedridden patients treated with anticholinergics [52]. Sugiyama et al. (LOE 3) studied the effects of anticholinergic therapy in patients aged 65 years or older, with and without dementia [53]. Urodynamic studies demonstrated significant increase of maximum bladder capacity in the dementia group and the non-dementia group. There was no significant difference in rate of objective improvement between both groups. On the other hand, rate of subjective improvement was significantly higher in the non-dementia group (40%) than in the dementia group (15%). Improvement of functional bladder parameters was not associated with better subjective symptoms in the dementia patients.

In voiding failure, intermittent catheterization (IC) is often feasible. Lieu et al. (LOE 3) found that carer-assisted clean IC is an effective and safe treatment option for persistent urinary retention in elderly female patients with cognitive impairment and other disabilities [31]. 54% of the patients were able to void

spontaneously and were continent after a median period of 6 weeks with a range of 1 to 40 weeks. 27% had significant improvement in the symptoms of urinary incontinence and the residual urine volumes became progressively smaller. 19% failed this treatment modality. The recovery of spontaneous voiding was influenced by the age of the patient, the carer performing the IC and the development of catheter-related UTI. 25% developed symptomatic UTI, leading to delay in the recovery of spontaneous voiding. UTI development was associated with the presence of pre-existing diabetes mellitus and predisposing common medical conditions, the person doing the catheterization, and the presence of dementia.

Ayonou et al. (LOE 3) studied a group of 13 patients with dementia who underwent transurethral resection of the prostate (TURP) [54]. Six patients reported good urination, 3 reported some improvement in urination but requiring IC, and 1 developed incontinence. No specific study addressing the issue of incontinence surgery in woman with dementia has been reported. However, it seems that incontinence surgery in patients with dementia should be reserved only for the cases with good ambulation and without concomitant functional disorders of micturition (overactive bladder, hypocontractile detrusor).

Recommendations for further research

Since dementia is not a homogeneous disease, a population study specifically reviewing disorders of lower urinary tract function is needed. A study evaluating different treatment modalities in patients with dementia (especially anticholinergic treatment for overactive bladder and surgical treatment for stress incontinence) is lacking.

Conclusions

- Incontinence occurs in 30-100 % of patients with dementia (LOE 3).
- The degree of incontinence is strongly associated with the patient's general status and ambulation (LOE 3)
- There is no one major cause for incontinence in these patients; however overactive bladder is responsible for a significant proportion of incontinence (LOE 3)

Recommendations

- Interventional therapy of incontinence in dementia should be reserved for patients with good general status and ambulation (C)
- In case of ambulatory patients, prompted voiding, rehabilitation and oral anticholinergics can be employed (C)
- Where there is a significant post-void residual, intermittent catheterization is the treatment of choice (B)

1.3. Dementia with Lewy bodies

Epidemiology and prevalence

Dementia with Lewy bodies (DLB) is thought to be the third most common type of dementia in the elderly, accounting for 10 – 15% of cases at autopsy. In population-based studies of subjects aged 65 and older, the prevalence of DLB was found to be 0.7% [55]. The epidemiology of DLB is sparse; age and gender distribution, and potential risk factors have yet to be defined.

Pathology and disease-specific urinary tract problems

DLB primarily affects the basal ganglia (as in Parkinson's disease) and the cerebral cortex. Lewy bodies and Lewy neuritis are pathologic aggregations of alpha-synuclein (SNCA), a ubiquitously-expressed synaptic protein that has been implicated in vesicle production [56]. Lewy bodies also contain chaperone proteins and elements of the ubiquitin-proteasome system. Immunohistochemical staining for alpha-synuclein is the most sensitive and specific method for detecting Lewy bodies and can be used in a semi-quantitative grading of severity of Lewy-related pathology [57]. Alpha-synuclein can now be measured *in vivo* by positron emission tomography and/or in the cerebrospinal fluid.

Many patients with DLB also have Alzheimer's disease pathology, which alters the clinical presentation. DLB patients who also have numerous neurofibrillary tangles display more core clinical features of AD [58]. Conversely, Lewy bodies also occur in more than half of patients with sporadic and early-onset AD [59]. The essential feature for a diagnosis of DLB is progressive cognitive decline of sufficient magnitude to interfere with normal social or occupational function. Fluctuations (waxing and waning of cognition, functional abilities and arousal, from almost normal to markedly confused or hypersomnolent) are a core feature of dementia with Lewy bodies. In DLB, autonomic dysfunctions occur and are included as a supportive feature for clinical diagnosis [60].

Horimoto et al. (LOE 3) found 97% incidence of urinary incontinence amongst patients with DLB. From the urological point of view, patients with DLB tend to develop urgency and urgency incontinence more often than do patients with Parkinson's disease (PD) or AD. Similar bladder capacity, detrusor pressure at maximum voiding, maximum urine flow, mean voided volume and post-void residual volume were found in each disease; DO was more prevalent in DLB than in PD and in AD [9]. Urinary symptoms were recorded in 35 % of patients with DLB, compared to 70 % in MSA and 25 % in PD patients. No detrusor-sphincter-dyssynergia was observed. DLB patients with DO had significantly higher Hoehn and Yahr scores than did those without. Since the prevalence of frequency, urgency, urge incontinence and DO is markedly lower in AD than in DLB, LUTS may contribute to the differential diagnosis of these two entities.

Disease specific diagnosis and treatment

Since patients with Lewy Body disease and incontinence usually have one or more concomitant diseases, the evaluation of the LUT functions should follow the general rules, bearing in mind that this is most often a population of frail elderly people.

1.4. Frontotemporal dementia (FTD)

Epidemiology and prevalence

Prevalence studies of FTD give ranges of 3.6-15.0 per 100,000 [61]. There is a high familial occurrence of FTD [62]. In such cases, a combination with parkinsonism, and rarely amyotrophic lateral sclerosis, also occurs. The distribution of FTD is equal between men and women. The mean duration of illness from onset to death is 4-6 years, with a range of 2-20 years.

Pathology and disease-specific urinary tract problems

Frontotemporal dementia (FTD), also known as Pick's disease, encompasses a diverse group of clinical and pathological disorders. There are several distinct clinical presentations, most commonly behavioral changes, but a language disorder, usually in the form of a progressive non-fluent aphasia, can be the main presenting sign. The most common clinical presentation of FTD is characterized by profound changes in personality and social conduct, including a decline in manners and social skills that are incongruent with the patient's premorbid behaviour. Affected patients lack emotional warmth, empathy and sympathy and are indifferent to others.

MRI of patients with FTD often shows atrophy in the frontal and temporal lobes (LOE 2), which may be asymmetric [63]. At autopsy, markedly gross atrophy of the frontal and temporal lobes is seen in FTD. On histologic examination the salient features include neuronal loss, micro-vacuolization and astrocytes gliosis centred on cortical layer II. Molecular pathology of FTD has identified four subtypes:

- classical Pick's disease (Pick body with accumulation of 3-repeat tau);
- mutations in the MAPT (microtubule-associated protein tau) gene;
- accumulation of TDP-43 (TAR DNA binding protein-43) with mutations in the PGRN (progranulin) gene; and,
- accumulation of FUS (fused in sarcoma) protein

There are no published data on LUTS in patients with FTD, but due to the cognitive state these patients have incontinence, either because they forget to take down clothes when they go into the toilet, or they have difficulty finding the toilet, or they may urinate in inappropriate places. Moreover, they may be affected by constipation, diarrhoea or faecal incontinence.

Diagnosis and treatment

There are no studies which show the significance of LUTS in fronto-temporal dementia. The importance of cortical regulation for social control of urinary habits needs evaluation.

Conclusions

- There are no studies available which show the significance of LUTS in patients with fronto-temporal dementia
- Since the underlying pathology is gross atrophy of frontal and temporal lobes, autonomic dysfunction including LUTS can be anticipated, but further research is needed

Recommendations

- The recommendations do not differ from those for other types of dementia

2. CONSTIPATION AND FAECAL INCONTINENCE IN DEMENTIA

Only one paper was retrieved related to the influence of dementia on the prevalence of faecal incontinence [64]. This evaluated a random sample (n= 485) of the population of 85-year-olds from Gothenburg, Sweden. Prevalence of urinary and faecal incontinence and dementia were 38%, 17% and 29% respectively. Dementia-affected men (50%) and women (60%) were more often incontinent than non-affected men (18%) and women (36%). Faecal incontinence was more prevalent in dementia (34/ 8% versus 6/ 7%): both urinary and faecal incontinence were more prevalent in demented women (43% and 20% respectively) than in men (27% and 11%). The prevalence of urinary and faecal incontinence and dementia were higher in residents of a nursing home or hospital (74%, 51% and 92% respectively) than subjects living at home (32%, 9% and 18%): of the dementia residents in an institution, 78% were incontinent compared with 37% living at home.

No specific paper was found on the management of faecal incontinence in people with dementia. Patients may benefit from a bowel habit training programme, which also includes management of constipation with non-pharmacologic (such as exercise and fibre) and pharmacologic measures.

Conclusions

- Although faecal incontinence is prevalent in people with dementia, no paper was found dealing with the disease-specific management of faecal incontinence (LOE3).

Recommendations

- Studies should be undertaken to ascertain management strategies for constipation and faecal incontinence in dementia

3. NORMAL PRESSURE HYDROCEPHALUS

Normal-pressure hydrocephalus (NPH) is characterized by a clinical presentation of gait disturbance, memory deficit, and urinary incontinence, combined with dilated cerebral ventricles and normal cerebrospinal fluid (CSF) pressure [65]. The clinical triad of this disorder is very much akin to those of vascular dementia or white matter disease (WMD), and should be considered before performing brain imaging in relevant patients. The syndrome was first described by Hakim and Adams in 1965 [66]. The effectiveness of the diversion of CSF flow by shunt operation in treating this syndrome is well documented [65] (LOE 2). Population-based MRI studies suggest that the incidence of NPH, or asymptomatic ventriculomegaly with features of idiopathic normal pressure hydrocephalus on MRI (AVIM), is around 1% (0.51-2.9%) in the general population of persons over 65 years of age [67], being estimated as one-tenth of WMD (LOE 3).

3.1. Pathology and disease-specific urinary tract problems

LUTS in NPH include urinary urgency and frequency (OAB). Sakakibara et al. found urinary symptoms in 93% of 42 idiopathic NPH patients [68] (LOE 3). These symptoms included storage symptoms in 93% of patients (Nocturia 64%; urinary urgency, 64%; urgency urinary incontinence, 57%; increased daytime frequency, 36%) and voiding/ post micturition symptoms in 71% (hesitancy 50%; prolongation /poor flow, 50%; sensation of post-void residual, 29%; straining, 21%; intermittency, 14%). In some patients urinary urgency /frequency preceded urinary incontinence. Among the clinical triad of NPH, urinary incontinence was regarded a late symptom, but gait disturbance and OAB can be the early manifestation of NPH.

Urodynamic findings of 42 NPH patients included low Q_{max} (<10 cm/s) in 40%; increased post-void residual (>30 ml) in 43% (average PVR volume 42.1 ml); low volume at first sensation (< 100 ml) in 33%; decreased bladder capacity (< 200 ml) in 57%; and DO in 95% of patients [68] (LOE 3). Although case series are often small (4-12 cases), DO is common (63-100%) [69] [70] (LOE 4). The high prevalence of DO suggests altered brain autonomic control in NPH [71].

3.2. Diagnosis

Diagnosis of NPH may comprise:

- Possible features; gait, cognitive and urinary disorders with typical ventricular dilatation in brain imaging
- Probable features; improved clinical symptoms by 30 ml withdrawal of the cerebrospinal fluid by a lumbar tap (the Tap test)
- Definite; improved clinical symptoms by ventriculoperitoneal shunt surgery, etc.

Functional neuroimaging in normal volunteers has shown that the anterior cingulate, prefrontal cortex and insula are activated in response to bladder filling as compared to an empty bladder [47]. Although NPH is a diffuse brain disease with dilated ventricles, hypoperfusion in the frontal lobe has been documented in NPH patients using PET [72], single-photon emission computed tomography (SPECT) [73], and perfusion-weighted MRI [74] (LOE 3). Therefore, the frontal lobe is thought to be the anatomical substrate for urinary urgency and incontinence in NPH. According to the study by Sakakibara et al, using 97 NPH patients and [123I]-iodoamphetamine (IMP)-SPECT statistical mapping, there was a significant decrease in tracer activity in the right-side-dominant bilateral frontal cortex and the left inferior temporal gyrus in the severe urinary dysfunction group ($p < 0.05$) [75]. The findings indicate that there is a link between right frontal hypoperfusion and urinary dysfunction in NPH. Importantly, bladder dysfunction and frontal lobe hypoperfusion in NPH can improve after shunt surgery. Recovery rate of OAB and urinary incontinence in NPH ranges from 20-80% [65] (LOE 4). After shunt surgery, bladder recovery is related to an increase in mid-cingulate perfusion [76] (LOE 3).

Since there is a surgical shunt therapy for NPH, early diagnosis of NPH in patients with OAB is important. In addition to OAB with/without urinary incontinence, patients with NPH commonly have gait disorder (parkinsonian and wide-based gait) and dementia that is milder than Alzheimer's disease. Differential diagnosis should include vascular dementia or white matter disease. If the shunt surgery failed, or was not applied to individuals with particular reasons (such as dementia), medical management (pharmacological and behavioural) of incontinence is put in place. However, no systematic review has been performed regarding the medical management of urinary incontinence in NPH.

Conclusions

- Clinical manifestations in NPH mimic those of vascular dementia or white matter disease (LOE 3)
- Urinary urgency and increased urinary frequency may precede urinary incontinence in NPH (LOE 3).
- Detrusor overactivity seems to be the most common cause of incontinence in NPH patients (LOE 3).

- Shunt surgery ameliorates urinary incontinence in NPH but the degree of improvement varies significantly (20-80%) (LOE 4).

Recommendations

- Typical gait, cognitive and urinary disorders with ventricular dilatation in brain imaging favours the diagnosis of NPH; a Tap test and shunt surgery may then be indicated (B).
- A systematic literature review is needed regarding the medical management of urinary incontinence in NPH, if shunt surgery is not successful or not undertaken (C).

4. MULTIPLE SYSTEM ATROPHY

Multiple system atrophy (MSA) is an uncommon but well-recognized disease entity that both neurologists and urologists may encounter. The term MSA was introduced by Graham and Oppenheimer in 1969 to describe a disorder of unknown cause affecting extrapyramidal, cerebellar, and autonomic pathways [77]. MSA includes the disorders previously called striatonigral degeneration (SND), sporadic olivopontocerebellar atrophy (OPCA), and Shy-Drager syndrome. The discovery in 1989 of glial cytoplasmic inclusions in the brains of patients with MSA provided a pathological marker for the disorder (akin to Lewy bodies in idiopathic Parkinson's disease (IPD)) and confirmed that SND, OPCA, and Shy-Drager syndrome are the same disease with differing clinical presentations. Immunocytochemistry showed that the glial cytoplasmic inclusions of MSA are ubiquitin-, tau-, and alpha-synuclein (SNCA)-positive, possibly representing a cytoskeletal alteration in glial cells that results in neuronal degeneration. SNCA is a presynaptic neuronal protein encoded by the *SNCA* gene located on chromosome 4. This protein appears to play a role in dopamine and other neurotransmitter metabolism, vesicle trafficking, modification of synaptic transmission, and regulation of membrane permeability. In contrast, pathologically increased expression and abnormal conformation of SNCA are reported to reduce neurotransmitter release by inhibiting synaptic vesicle re-clustering after endocytosis. Familial occurrence is estimated to account for 1.6% of all cases, and data on such cases are being accumulated to identify candidate genes for this disorder, including *SNCA*, *MAPT* (microtubule-associated protein tau), etc.

Autonomic failure (postural hypotension and urinary dysfunction) is fundamental to the diagnosis of MSA: it is diagnosed when the criteria of either postural hypotension (systolic blood pressure fall > 30 mmHg or diastolic > 15 mmHg) or urinary dysfunction (persistent, involuntary urinary incontinence/incomplete bladder emptying) or both are fulfilled, along with

poorly levodopa-responsive parkinsonism or cerebellar dysfunction [78]. Based on the major motor deficits, MSA can be classified as MSA-P (parkinsonism-predominant) or MSA-C (cerebellar-predominant) [77]. Clinical differential diagnosis between MSA-P, the most common clinical form, and IPD is difficult even for specialists. However, the lack of one-side dominance and resting tremor, poor response to levodopa, and rapid progression are all red flags indicating MSA. MSA-C can mostly be distinguished from hereditary spinocerebellar ataxias, although some individuals with such disorders do not have apparent heredity. Autonomic failure (AF) is almost invariably present and can be an initial manifestation (AF-MSA) [79]. Autonomic failure occurs in other neurodegenerative diseases, for example in a subset of patients with IPD (AF-PD), as well as in pure autonomic failure (PAF), both of which are considered Lewy body diseases.

This section reviews the current concepts of urinary dysfunction in MSA, with particular reference to urinary symptoms, (video-)urodynamic assessment and sphincter electromyography (EMG), and patient management.

4.1. Pathology and disease-specific LUT problems

Both overactive bladder and large post-void residuals occur in MSA. The second consensus statement on the diagnosis of MSA recognizes that the disease frequently begins with bladder dysfunction (although erectile dysfunction usually precedes that complaint). Patients may present with urinary incontinence, urinary retention, or a combination of incontinence and incomplete bladder emptying [78]. It is important that other common causes of poor bladder control are excluded by a urologist or uro-gynaecologist before the disorder is attributed to the neurological condition [80]. The prevalence of troublesome urinary symptoms in 256 patients with MSA compared with 158 aged matched control subjects [81] showed that MSA patients had significantly higher increased daytime frequency (45% of women, 43% of men), night time frequency (65%, 69%), urinary urgency (64% of men), and urgency incontinence (75%, 66%) than did the controls. They also had more hesitancy of micturition (62%, 73%), prolonged poor stream (71%, 81%), or intermittent stream (61%, 47%), or the need to strain to void (48%, 55%). Of particular importance is that the quality of life (QOL) index in the MSA group was significantly higher (i.e. worse) in MSA patients for bladder dysfunction (70%, 76%) than that in controls. Many of them show large post-void residual urine volume > 100 ml. Therefore both overactive bladder and large post-void residuals are common in MSA.

In MSA, urinary dysfunction precedes postural hypotension. Of various symptoms of autonomic failure (erectile dysfunction, urinary dysfunction, postural hypotension, respiratory stridor) in patients with MSA, urinary dysfunction has attracted less attention

than postural hypotension, although urinary dysfunction may result in recurrent urinary tract infection and cause morbidity. In addition, urinary incontinence results in impaired self-esteem, stress on the caregiver, and considerable financial cost. Postural hypotension was pointed out first in AF-MSA, which turned out to be a marker of autonomic involvement in this disorder. Both of the original two patients discussed by Shy and Drager had urinary frequency, incontinence, and urinary retention [82]. Other variants (MSA-P and MSA-C) rarely develop postural hypotension in their early stage. However, in the original reports, three of four patients with MSA-P showed voiding difficulty, retention, and urinary incontinence [83].

Thus, what are the most common and earliest autonomic features of MSA? In a study of 121 patients with MSA [84], urinary symptoms (96%) were more common than orthostatic symptoms (43%). The most frequent urinary symptom was difficulty voiding in 79% of the patients, followed by nocturnal urinary frequency in 74%. Other symptoms included urgency in 63%, urgency incontinence in 63%, diurnal urinary frequency in 45%, nocturnal enuresis in 19%, and urinary retention in 8%. The most frequent orthostatic symptom was postural faintness in 43%, followed by blurred vision in 38% and syncope in 19%. These figures are similar to findings reported by other centres [85, 86], and indicate that urinary dysfunction is a more common and often earlier manifestation than postural hypotension in MSA. Many factors might be involved in this phenomenon. Reports of focal lesions have shown that postural hypotension occurs in lesions below the medulla, whereas urinary dysfunction occurs in lesions at many sites in the neuraxis. MSA lesions involve the pons, the hypothalamus, and the basal ganglia, all of which might affect LUT function, as described below.

Urinary dysfunction also precedes motor disorder. Approximately 60% of patients with MSA develop urinary symptoms either prior to or at the time of presentation with the motor disorder [84]. This indicates that many of these patients seek urological advice early in the course of their disease. Since the severity of urinary symptoms is severe enough for surgical intervention, male patients with MSA may undergo urological surgery for prostatic outflow obstruction before the correct diagnosis has been made. The results of such surgery are often transient or unfavourable because of the progressive nature of this disease. Male erectile dysfunction is often the first presentation [84, 87], possibly preceding the occurrence of urinary dysfunction in MSA. The urologist confronted with a patient showing these features should be cautious about embarking on an operative approach. The neurologist encountering a patient with marked urinary symptoms might consider future investigation by brain magnetic resonance imaging (MRI) and sphincter EMG. Since motor disorders in MSA mostly mimic those in IPD, the urogenital distinction between these two diseases is worth considering, although a number of earlier studies on

'Parkinson's disease and the bladder' might inadvertently have included patients with MSA. The prevalence rate of urinary dysfunction and urgency incontinence in MSA is higher than that reported in IPD. In addition, urinary dysfunction is never the initial presentation in IPD.

4.2. Disease specific diagnosis

Since MSA is a neurodegenerative disease that affects multiple brain regions, patients may have a wide range of urodynamic abnormalities that change with progression of the illness. Videourodynamics and sphincter EMG enable assessment of lumbosacral cord functions, which help distinguish MSA from other parkinsonian disorders.

Filling phase abnormalities include overactivity in 33–100% and uninhibited external sphincter relaxation in 33% of MSA [88–90]. Detrusor overactivity seems to be the major cause of urgency incontinence in patients with MSA, and may be associated with uninhibited sphincter relaxation.

Cerebral diseases can lead to a loss of the brain's inhibitory influence on the spino-bulbo-spinal micturition reflex. The information that arises from the lower urinary tract reaches the periaqueductal gray matter (PAG), then goes down to the pontine micturition center (PMC), an area identical to, or just adjacent to, the locus ceruleus, which then activates the descending pathway to the sacral preganglionic neurons innervating the bladder. The basal ganglia are thought to be one of the higher centers for micturition, since lesions of this area lead to bladder overactivity. Positron emission tomography (PET) studies have shown that the hypothalamus, PAG, midline pons, and cingulate cortex are activated during urinary filling. The central pathology of MSA includes neuronal loss of neuromelanin-containing cells in the locus ceruleus [91] and the nigrostriatal dopaminergic system ('putaminal slit sign') [92] and cerebellum, and to a lesser extent in the ponto-medullary raphe ('pontine cross sign') [92, 93] and the frontal cortex [94, 95]. Experimental studies have suggested that the raphe modulates micturition function [96], and also that the cerebellum controls micturition function [97]. A single photon emission computed tomography (SPECT) study has shown that in the urinary storage and micturition phases, but not in the resting phase, activation of the cerebellar vermis was significantly lower in MSA patients than in control subjects [98]. These areas seem to be relevant for the occurrence of bladder overactivity and uninhibited sphincter relaxation in MSA patients.

Incomplete bladder emptying is a significant feature in MSA. In fact, 47% of patients with MSA had post-void residuals (PVR) > 100 ml, whereas no patients with IPD had such levels [88]. The mean PVR volume was 71 ml in the first year, 129 ml in the second year (which exceeded the threshold volume for the start of clean intermittent catheterization (CIC)), and 170 ml in the fifth year from the onset of illness [99]. Pressure-flow analysis showed that bladder underactivity (a weak detrusor contraction) during voiding is more

common in MSA (71% in women and 63% in men) than in IPD (66% in women and 40% in men) [88]. The mean bladder outlet obstruction index (Abrams Griffiths number) are smaller in patients with MSA (12 in women and 28 in men) than in those with IPD (40 in women and 43) [88]. Detrusor-external sphincter dyssynergia is present in 47% of MSA patients [88]. A subset of patients with MSA has bladder overactivity during storage and underactivity during voiding (detrusor hyperactivity with impaired contractile function, DHIC) [100]. The exact mechanism of this phenomenon has yet to be ascertained. However, it has been recognized that the central mechanisms underlying bladder filling and voiding are distinct from each other; i.e. the area promoting micturition is located in the PMC and the frontal cortex, whereas that promoting urinary storage is in the pontine storage center, basal ganglia, raphe, and frontal cortex. Lesions in these areas may cause various combinations of urinary filling and voiding disorders, such as DHIC.

The role of the sympathetic nervous system may be important, and a key feature could be an open bladder neck, which can suggest sympathetic denervation. The bladder neck, also known as the internal (smooth) urethral sphincter, is a component in the maintenance of continence that is innervated by the sympathetic hypogastric nerve. Videourodynamic study is an established method for evaluating bladder neck function. In normal subjects, the bladder neck is closed throughout filling so as to avoid leaking. However, an open bladder neck is found in 46–100% of MSA patients and in 23–31% of PD patients, and an open bladder neck at the start of bladder filling, even without the accompaniment of bladder overactivity, was noted in no PD patients but in 53% of MSA patients ($p < 0.01$) [88]. Because open bladder neck is common in patients with myelodysplasia or a lower thoracic cord lesion at T12-L2 (where the sympathetic thoracolumbar intermediolateral [IML] nuclei are located) and is reproduced by systemic or intraurethral application of α_1 -adrenergic blockers [101], it is likely that an open bladder neck reflects the loss of sympathetic innervation.

Neurogenic changes in the sphincter EMG may suggest somatic denervation. A distinguishing pathology in MSA is neuronal cell loss in the Onuf nucleus, a group of anterior horn cells in the sacral spinal cord [92]. External anal sphincter (EAS)-electromyography (EMG) results for over 600 MSA patients have been reported, with abnormality rates of more than 70% in many studies [102, 103]. Abnormalities have also been recorded in the bulbocavernosus muscles in MSA [104]. A particular importance is not to miss the late components [105].

In a study of 84 probable MSA cases, 62% exhibited neurogenic change [106]. The prevalence was relatively low, presumably because up to 25% of patients had a disease duration of 1 year or less. In such early cases, the diagnosis of MSA should be made with ex-

treme caution. In addition to the clinical diagnostic criteria, we usually add an imaging study and we perform gene analysis to the extent possible. The prevalence of neurogenic change was 52% in the first year after disease onset, which increased to 83% by the fifth year. Therefore, as expected, it is apparent that the involvement of Onuf's nucleus in MSA is time-dependent; and EAS-MUP abnormalities can distinguish MSA from idiopathic PD and other diseases in the first 5 years after disease onset. Receiver-operating characteristic analysis of sphincter EMG showed high diagnostic power in terms of the duration of motor unit potential (MUP) analysis [103].

In the early stages of illness, the prevalence of neurogenic change in MSA does not seem to be high. It is possible that some MSA patients never develop neurogenic change during the course of their illness. Wenning et al. (1994) reported 3 patients with normal EAS-EMG and a postmortem confirmation of MSA [85]. Therefore, a negative result does exclude a diagnosis of MSA. Paviour et al. (2005) reported that among 30 sets of clinical data and postmortem confirmation in MSA cases with a duration of more than 5 years, 24 (80%) had abnormal EAS-EMG, 5 (17%) had a borderline result, and only 1 had a normal EMG [107]. Neurogenic change does not correlate directly with a clinically obvious functional deficit, although urinary incontinence is more severe in the patients with neurogenic change than in those without it.

Prevalence of neurogenic change increases with the severity of gait disturbance (wheel chair bound) [106]. However, neurogenic change was not related to postural hypotension (reflecting adrenergic nerve dysfunction); erectile dysfunction in men (presumably reflecting cholinergic and nitrenergic nerve dysfunction); detrusor overactivity (reflecting the central type of detrusor dysfunction); constipation (presumably reflecting both peripheral and central types of autonomic and somatic dysfunction); or gender [106]. The neurogenic change in EAS-MUP was slightly more common in those with detrusor-sphincter dyssynergia (DSD). It has also been suggested that not only suprasacral pathology, but also sacral/peripheral lesions can produce DSD [108]. Although denervation can be found in the other skeletal muscles in MSA, it occurs much earlier in the external sphincter muscles [109]. This is in contrast to amyotrophic lateral sclerosis, where denervation occurs in most advanced cases (respirator bound).

The neural sites responsible for cardiovascular autonomic failure in MSA are mostly central, in contrast to the peripheral lesions in PAF [80]. However, 31–45% of patients with MSA also have low-compliance detrusor, defined as a maximum bladder capacity/tonic detrusor pressure increase < 20 ml/cmH₂O [84]. Low-compliance detrusor is known to occur in patients with spina bifida or in animals with experimental cauda equina lesions, most probably reflecting neuronal loss of bladder preganglionic neurons in the sacral IML nucleus and their fibers (pelvic nerve). Repeated urodynamic studies in MSA patients show

that the cystometrogram changes from bladder overactivity to low-compliance or atonic detrusor, and from negative to positive bethanechol supersensitivity [84]. Nineteen percent of MSA patients show denervation supersensitivity of the detrusor, indicating peripheral changes [84]. As the disease progresses, symptoms may change from urinary urgency and frequency to those due to incomplete bladder emptying. These findings suggest that the responsible sites of the bladder cholinergic disorder may change from the 'center' (supra-nuclear) to the 'periphery' (nuclear sacral IML and/or infra-nuclear) during the course of the illness. Since MSA primarily affects the preganglionic neurons in the autonomic nervous system [80], bladder findings that suggest postganglionic lesions might reflect trans-synaptic degeneration of the cholinergic fibers.

Besides bladder disorders, patients with MSA may have nocturnal polyuria, which results in nocturnal urinary frequency and morning hypotension. A post-mortem study revealed the degeneration of AVP neurons in the suprachiasmatic nucleus in MSA [104], leading to impairment of the circadian rhythm of the plasma AVP concentration in MSA [110, 111]. In addition, daytime postural hypotension may cause nocturnal polyuria in patients with MSA [112]. This is probably due to a combination of factors that include compensatory supine hypertension at night, leading to increased glomerular filtration.

4.3. Disease specific management

More than half of patients with MSA have urinary dysfunction either prior to or at the time of presentation with motor disorder. Since many of these patients develop incomplete bladder emptying, they may be misdiagnosed as having prostatic hypertrophy. In fact, the results of urological surgery are rarely favourable, since bladder underactivity contributes more to voiding difficulty than does outflow obstruction. Therefore, it is important to avoid inappropriate urological surgery in patients with MSA [80]. A conservative approach with medical measures to manage urinary problems can be effective.

Estimation of the PVR volume is a simple and useful test in patients with MSA; even if their urinary complaints are solely urinary urgency/frequency, they may be unaware that their bladders do not empty completely. If the patient has a significant PVR and is symptomatic, this aspect of the problem should be managed using CIC performed by either the patient or the caregiver. However, in patients with advanced disease and severe neurological disability, a permanent indwelling catheter, either transurethral or suprapubic, or urosheath drainage may be required.

If OAB/DO is present, anticholinergic medication such as tolterodine, oxybutynin, propiverine, or propantheline may be indicated. However, anticholinergic side-effects, particularly dry mouth (probably mediated by M_3 receptors) and constipation ($M_{2/3}$ receptors), may

limit their use in a proportion of the patients. A subset of patients with MSA may develop mild cognitive decline at an advanced stage of the disease. Since the use of anticholinergic drugs carries a risk of cognitive impairment (M_1 receptors) [113], caution is needed. Anticholinergic drugs ameliorate urgency and frequency, but conceivably could reduce bladder contractility during voiding. Therefore, PVR should be measured and the medication should be withdrawn or CIC should be added if there is significant residual. If night-time urinary urgency/frequency is the problem, overnight bladder drainage may be considered [99].

Interactions can arise between drugs to treat bladder, postural hypotension, and motor disorders. Since incomplete bladder emptying in patients with MSA is due mostly to bladder underactivity, drugs acting on outflow obstruction are unlikely to benefit all patients. However, in some patients, alpha-adrenergic blockers may be effective in lessening PVR volumes, due probably to detrusor-sphincter dyssynergia [114]. Uro-selective blockers such as tamsulosin and naftopidil may be chosen, in the hope they have fewer side-effects such as postural hypotension. Importantly, the drugs most commonly used to treat postural hypotension in MSA are adrenergic agonists. Administration of amezinium, an adrenergic drug, may increase PVR volume and the risk of retention [115]. Amezinium most probably stimulates the alpha receptors, both in the vascular wall (alpha_{1B} receptors, particularly in the elderly [116]) and the proximal urethra (alpha_{1AD}-adrenergic receptors).

Pyridostigmine, an acetylcholinesterase inhibitor, can be effective in lessening PVR volumes [117]. Pyridostigmine also lessens postural hypotension, presumably by enhancing nicotinic acetylcholine receptor transmission in the sympathetic ganglia [118, 119].

Dopaminergic receptors: whether centrally acting drugs, such as pergolide (a dopaminergic $D_{1/2}$ -receptor agonist) for parkinsonism, might ameliorate urinary dysfunction in MSA has not been fully studied. Early untreated IPD patients with mild urgency and frequency tend to benefit from levodopa ($D_{1/2}$) treatment. However, levodopa may augment bladder overactivity in IPD patients. Since D_1 selective stimulation inhibits the micturition reflex whereas D_2 selective stimulation facilitates it, the balance of these stimulations may explain the various effects of the drugs. Levodopa ($D_{1/2}$) and its metabolites, such as norepinephrine (noradrenaline), may also contract the bladder neck by stimulating alpha1 adrenergic receptors [115].

Desmopressin is a potent analogue of AVP used in the treatment of diabetes insipidus due to a loss of posterior pituitary AVP secretion. Mathias et al. [111] used 2–4µg of intramuscular desmopressin in patients with autonomic failure including MSA. 5µg of intranasal desmopressin once a night in MSA patients with impaired circadian rhythm of AVP and nocturnal polyuria also appears to be beneficial [120]. This small dose of desmopressin is unlikely to

cause adverse effects, but hyponatremia and signs of cardiac failure should be checked regularly. Desmopressin could also ameliorate morning hypotension resulting from the abnormal loss of body fluid at night [111].

Micturition syncope: Well-known triggers for syncope in MSA include: 1) standing (postural syncope), 2) eating (post-prandial syncope), and 3) exercise (post-exertional syncope) [80]. In addition, syncope in patients with MSA may also be triggered by 4) voiding (micturition syncope) [121]. The detailed link between the bladder and the cardiovascular system is still uncertain in this condition. However, particularly in patients who use abdominal straining when voiding, CIC could lessen micturition syncope.

Recent studies suggest that bladder management may directly, or indirectly, affect survival of MSA [122, 123]. Coon et al. suggested that while the initial onset with autonomic symptoms was not associated with shortened overall survival, early autonomic symptoms in disease course, particularly bladder symptoms and severe urinary symptoms (requiring urinary catheterization), negatively affected survival [122]. Since MSA is a progressive disease that leads to urinary retention, early differential diagnosis from Parkinson's disease is necessary in terms of catheterization [124].

Conclusions:

- Urinary dysfunction is a prominent autonomic feature in patients with MSA, and it is more common (above 90%) and occurs earlier than postural hypotension in this disorder (LOE3).
- In contrast to idiopathic Parkinson's disease, MSA patients have more marked urinary dysfunction, which consists of both urgency incontinence and post-void residuals >100 ml (LOE1,2).
- Videourodynamic and sphincter EMG analyses are important tools for understanding the extent of these dysfunctions and for determining both the diagnosis and management of the disorders (LOE3).
- The common finding is detrusor overactivity, which accounts for urinary urgency and increased frequency (LOE3).
- Detrusor-sphincter dyssynergia, open bladder neck at the start of bladder filling (internal sphincter denervation), and neurogenic sphincter EMG (external sphincter denervation) are all characteristics of MSA (LOE2).
- These features may reflect pathological lesions in the basal ganglia, pontine tegmentum, raphe, intermediolateral cell column, and sacral Onuf's nuclei (LOE4).
- During the course of the disease, the pathophysiological balance shifts from central to peripheral, with bladder emptying disorder coming to predominate (LOE3).

Recommendations:

- Clinical features of MSA may mimic those of IPD, and the potential impact on treatment outcomes should be considered if there is any doubt about the underlying diagnosis (A).
- MSA is a progressive disorder and impaired detrusor contractility is common. Therefore it is important to avoid inappropriate urological surgery in patients with MSA (B/C).
- A conservative approach with medical measures in MSA patients includes anticholinergics for urinary urgency and frequency, desmopressin for nocturnal polyuria, uro-selective alpha-blockers and cholinergic stimulants for voiding difficulty, and CIC (clean, intermittent catheterization) for large PVR (post-void residual) (B).

4.4. Faecal incontinence

Lower gastrointestinal tract (LGIT) dysfunction is also common in patients with MSA. Sakakibara et al. [125] (LOE2) performed a bowel questionnaire in 15 patients with MSA and in 10 age-matched healthy control subjects. The MSA group showed decreased bowel frequency (< 3 times a week) in 9, difficulty in expulsion in 11, and faecal incontinence in 3; the control group showed decreased bowel frequency in only 2, mild difficulty in expulsion in 2, faecal incontinence in none. Therefore, constipation is the major bowel dysfunction in this disorder, although in advanced stages faecal incontinence is not uncommon.

Studies on the mechanism of bowel problems in this disorder are scarce. Stocchi et al. [126] (LOE2) performed anorectal manometry in 16 patients with MSA; 13 patients showed paradoxical anal sphincter contraction on fictive straining. Bardoux et al. [127] (LOE3-4) reported a case of a faecally incontinent patient due to MSA, who showed inability of anal squeezing. Sakakibara et al. [125] (LOE2) performed colonic transit time, sphincter electromyography (EMG) and rectoanal videomanometry in 15 patients with MSA and 10 age-matched healthy control subjects. Compared with the control subjects, MSA patients had significantly prolonged colonic transit time in the rectosigmoid segment and total colon. Sphincter EMG showed neurogenic motor unit potentials in none of control subjects but in 93% of MSA. In the resting state, MSA patients showed a lower anal squeeze pressure (external sphincter weakness) and a smaller increase in abdominal pressure on coughing. During rectal filling, MSA patients showed smaller amplitude in phasic rectal contraction, which was accompanied by an increase in anal pressure that normally decreased, together with leaking in 3 patients. During defecation, most MSA patients could not defecate completely, with larger post-defecation residuals. MSA patients had weak abdominal straining, smaller rectal contraction on defecation and larger anal contraction on defecation (paradoxical sphincter contraction on defecation, or anismus),

though these differences were not statistically significant.

Constipation in MSA most probably results from slow colonic transit, decreased phasic rectal contraction and weak abdominal straining, whereas faecal incontinence results from weak anal sphincter due to denervation. The responsible sites for these dysfunctions are still not known. However, as described in idiopathic Parkinson's disease, they most probably reflect lesions of both central and peripheral nervous systems that regulate the LGIT.

LGIT functional disturbance is often preceded by LUT dysfunction in MSA patients. Abnormalities in colonic transit time and rectoanal videomanometry in MSA were mostly similar to those in idiopathic Parkinson's disease, except for the sphincter denervation and resultant faecal incontinence in MSA.

When treatment of the bowel disorder in MSA is planned, use of objective parameters is recommended in order to clarify the action of drugs. A few such studies are available: Eichhorn and Oertel [128] (LOE3) gave polyethylene glycol 3350, an osmotic agent with high water binding capacity, in 2 patients with MSA, and found an improvement in stool frequency and difficult defecation in both patients. Similarly, Sakakibara et al. [129] (LOE2) measured colonic transit time in 4 patients with MSA. After administration of calcium polycarbophil, an osmotic and highly bulking agent, colonic transit time of total and the right segment shortened significantly. Liu et al. [130] (LOE2) performed colonic transit time and rectoanal videomanometry in 7 patients with MSA. After administration of mosapride citrate, a novel selective 5-HT₄ receptor agonist, the patients showed a shortened total and rectosigmoid segment colonic transit time, lessened first sensation and an augmented amplitude in phasic rectal contraction. During defecation, mosapride augmented the amplitude in rectal contraction and lessened the volume of post-defecation residuals significantly. Similar results were obtained in a study by Sakakibara et al. [131] (LOE2), in which dietary herb extract Dai-Kenchu-To, one active component of which is hydroxy-beta-sanshool (5-HT₃ receptor agonistic action), was prescribed.

MSA is a slowly progressive disease currently without cure. More research is needed to evaluate the pathophysiology of LGIT dysfunction, and to evaluate the effects of different drug treatment modalities.

Conclusions

- Patients with multiple system atrophy have often abnormal bowel function (LOE2).
- The most common bowel disturbances are slow colonic transit, decreased phasic rectal contraction and weak abdominal straining; faecal incontinence results from weak anal sphincter, due to denervation (LOE2).

- Bowel dysfunction, such as constipation, is common and has significant impact on quality of life of patients with multiple system atrophy (LOE3).

Recommendation

- More studies on neurologic bowel dysfunction and management in patients with multiple system atrophy are needed.

5. PARKINSON'S DISEASE

5.1. Urinary incontinence

Parkinson's disease (PD) is a movement disorder due to degeneration of dopaminergic neurons in the substantia nigra and a loss of dopamine-containing nerve terminals in the basal ganglia. Degeneration of the nigrostriatal pathway is accompanied by decreases in corresponding biochemical markers, including dopamine, tyrosine hydroxylase, dopamine metabolites, and dopamine transporter. These central nervous system changes also have influence on autonomic function; the most common problems are gastrointestinal (constipation), perspiratory (hypohidrosis) and urinary system.

LUT dysfunction in PD was estimated to occur in 37-71% in uncontrolled studies. Among these, in a study of Hattori et al. [132] (LOE3), 60% of PD patients had urinary symptoms, which could be divided in the following categories: storage LUTS in 28%, voiding in 11%, and both types in 21%. The prevalence of urinary symptoms correlated with severity of the disease, but not with the duration of illness. Gray et al. [133] (LOE3) reported that LUT functional disturbances in PD are not disease-specific and only correlated with age. In control-based studies [134-137] (LOE2) the prevalence of LUT symptoms (LUTS) was found to be 27-64%, and significantly higher than healthy controls. The majority of patients had onset of the bladder dysfunction after the appearance of motor disorder. Even patients with low disability may report LUTS, though this may not cause impairment of quality of life [138]. In one study, urinary incontinence in PD frequently occurred in conjunction with faecal incontinence, whereas no significant relation was observed between bladder and sexual dysfunction. Bladder dysfunction substantially affects the quality of life in patients with PD. Bladder dysfunction in PD correlates with neurological disability, and stage of disease, both suggesting a relationship between dopaminergic degeneration and LUTS. LUTS was more common in a group of PD patients with older age, as in healthy populations. Among LUTS, nocturia (night-time urinary frequency) is the most prevalent symptom (>60%) [136, 137] (LOE2). Patients also complain of urinary urgency (33-54%), daytime frequency (16-36%), and urinary incontinence in 26% of males and 28% of females. These figures are almost the same in untreated, early PD patients [138]. Although

less common than storage symptoms, PD patients also report voiding symptoms. In the study by Sakakibara et al. [139] (LOE2), PD patients had significantly higher rates of delay in initiating urination (44% of men), prolongation/poor stream (70% of men), and straining (28% of women) compared with the control group. However, despite the voiding symptoms, PD patients have low post-void residuals. Impaired detrusor contractility is reported in urodynamic studies in PD and is related to the degree of motor impairment [140].

Pathology and disease-specific urinary tract problems

The net effect of the basal ganglia on micturition is thought to be inhibitory [141]; in PD, the bladder becomes overactive. Functional neuroimaging during bladder filling resulted in activation in the globus pallidus of normal volunteers and in the putamen in PD patients with detrusor overactivity. In contrast, dopamine transporter imaging (indicating brain dopamine neurons) was decreased in PD patients with urinary dysfunction than in those without it [142]. The micturition reflex is under the influences of nigrostriatal dopamine (both inhibitory in D1 and facilitatory in D2) and GABA (inhibitory). Deep brain stimulation in the subthalamic nucleus results in amelioration of motor disorder as well as increased bladder capacity and decreased post-void residuals [143] (LOE2). Therefore, urinary dysfunction in PD could reflect degeneration of the nigrostriatal dopaminergic cells associated with specific motor disorders. In addition to the nigrostriatal dopaminergic projection, the ventral tegmental area (VTA, the A10 cell group)-limbic cortex and the hypothalamic (the A11 cell group)-spinal cord dopaminergic projections are presumably involved in urinary dysfunction in PD.

In a study of PD and multiple system atrophy (MSA) patients, Sakakibara et al. [88] (LOE2) found urinary symptoms in 72% of PD patients. They were mostly attributed to DO (81%) and external sphincter relaxation problems (33%). During micturition, PD patients did not demonstrate DSD, but impaired detrusor contractility was observed in 66% of women and 40% of men. In addition, patients with PD had partial bladder outlet obstruction, e.g. mean bladder outlet obstruction index was 43 in men. Nevertheless, average volume of post-void residuals in PD was only 18 ml. Similar observations were reported by Defreitas et al. [144] (LOE2).

Specific diagnosis and treatment

In the differential diagnosis of PD and parkinsonian-type MSA, large post-void residuals, open bladder neck, and neurogenic change in sphincter motor unit potentials are common in MSA [80, 88] (LOE2), whereas they are rarely seen in clinically typical PD [145]. However, PD with dementia, or dementia with Lewy bodies, may have large post-void residuals and neurogenic change in the sphincter motor unit potentials [146], thereby mimicking MSA (LOE3). Bladder

dysfunction in PD parallels other autonomic dysfunctions [147], cardiac denervation [148], and falls [149] (LOE3). Nocturnal polyuria is an important cause for nocturia and therefore patients reporting nocturia should fill in a bladder diary.

Guidelines now exist for the management of bladder dysfunction in PD [124]. Levodopa and other antiparkinson medication may affect bladder function in PD. To date the results are not consistent and the responses are not straightforward. Some reports have shown storage-facilitating effects of dopaminergic drugs. Kuno et al. [150] (LOE3) showed that change of bromocriptine to pergolide (D1<2 agonist) brought lessening of nocturia. Others have shown voiding-facilitating effects. In early PD [151] (LOE2) and advanced PD with the on-off phenomenon [152] (LOE2), a single-dose of levodopa exacerbates DO in the filling phase, but also improves bladder emptying through increased detrusor contractility. We still do not know the reasons for the discrepancy between different studies.

There are several factors underlying the complex bladder behaviour in PD. Post-synaptic dopamine D1 (excitatory) and D2 (inhibitory) receptors have a millimolar affinity to dopamine, whereas dendritic D2 (inhibitory) autoreceptors have a picomolar affinity to dopamine. Therefore, when levodopa is administered externally, it may first stimulate dendritic D2 autoreceptors, which might suppress the nigral cells and facilitate the micturition reflex. In cases of PD under long-term treatment with levodopa, dopamine receptors are down-regulated. Bladder overactivity might also involve an activation of D2 receptors in the spinal cord [153] (LOE2). In addition, in experimental animals, single doses of apomorphine showed a biphasic effect [154] (LOE2).

Deep brain stimulation (DBS) is a treatment option in advanced PD. The subthalamic nucleus (STN) is regarded as the key area in the indirect pathway, which is dominant in the parkinsonian state. DBS inhibits many cells within the STN, probably due to depolarization block and release of GABA from activation of inhibitory afferent terminals. In the STN, neuronal firings related to the micturition cycle have been observed in cats [155] (LOE2). DBS increased bladder capacity, facilitated bladder afferent pathways, and augmented activity of the prefrontal cortex in the brain of PD patients [156] (LOE2). In a cohort of 107 patients with advanced PD, patients treated with STN DBS reported the same degree of LUT symptoms compared to patients treated with either conventional oral medication therapy or an apomorphine pump, however had significantly less nocturia [157]. Acute urinary retention has been reported in two patients after subthalamic nucleus DBS [158] and detrusor overactivity has been reported following pedunculo-pontine nucleus DBS [159] (LOE3).

A double-blind, randomized, placebo-controlled study evaluated solifenacin 5-10 mg /day in 23 pa-

tients with PD and LUT symptoms. A significant improvement in the number of micturitions per 24 h period was observed in the solifenacin group compared to placebo at a mean dose of 6 mg/day. In the open label phase, the mean number of urinary incontinence episodes per 24 h period, as well as the number of nocturia episodes, decreased [160] (LOE2). A prospective evaluation of 33 men with PD reporting LUT symptoms taking doxazosin demonstrated a significant improvement in LUT symptoms, LUT-related quality of life and flow rates, though the response to treatment was dependent on the severity of neurological disability [161] (LOE 3).

A systematic review of anticholinergic use (centrally acting) to treat PD was done by Katzenschlager et al. [162] (LOE I). Cognitive adverse events of anticholinergics are a concern, particularly in elderly PD patients. This was first described in 1997 by Donnellan et al. in PD patients with overactive bladder [113] (LOE 3). They gave oxybutynin in four patients, who subsequently developed dementia, which reversed after discontinuation of oxybutynin. Factors underlying the cognitive effects of these medications include: 1) central muscarinic receptor affinity, e.g. high M1-receptor selectivity; and 2) easy penetration of the blood-brain barrier (BBB), e.g. high lipid solubility; a neutral charge or low degree of ionization; and a less bulky (number of rotatable bonds <5) and smaller molecular size (<450Da) [163] (LOE 2). Regarding BBB penetration, most anticholinergics have a molecular size between 300-400Da. Oxybutynin can readily penetrate the CNS, since it has high lipophilicity and neutrality, while anticholinergics have less marked lipophilicity or neutrality. Trospium, a quaternary amine, has a particularly high polarity.

Intradetrusor injections of onabotulinumtoxinA is a promising treatment for managing intractable DO in patients with PD and small case series have demonstrated improvement in clinical and urodynamic parameters [164-166] (LOE3). However the concern is urinary retention that may arise following treatment and the potential need to require catheterisation. This seems to be related to the dosage used and reports of incomplete bladder emptying and catheterisation is reported more when using 200 units compared to 100 units [164, 165].

Tibial nerve stimulation (TNS) has been shown to be effective in short term management of OAB symptoms in patients with PD. Acute percutaneous TNS (PTNS) has been reported to increase functional bladder capacity in PD, and following chronic stimulation urinary frequency and urgency urinary incontinence reduced [167]. However, long term outcomes in PD are lacking. Transcutaneous tibial nerve stimulation (TTNS) was found effective in the treatment of LUTS in 13 patients with PD, with benefits in urinary urgency and nocturia episodes, as well as urodynamic parameters [168]. The number of patients reported having Sacral nerve modulation is insufficient to draw any conclusions [169].

As in MSA, a very important issue in PD affected patients is the indication for pelvic surgery. Myers et al. [170] (LOE2) found that women with PD and LUT complaints have a lower maximum cystometric capacity and a higher rate of DO at lower bladder volumes in comparison with non-neurologic controls. Therefore surgery for stress incontinence in women with PD should be performed only when no significant DO is present, since this type of surgery can evoke or aggravate DO and subsequent urgency incontinence. Roth et al. reported outcomes of 23 patients with PD undergoing transurethral prostate resection for benign prostatic obstruction, emphasizing the importance of careful evaluation before any decision on intervention [171].

Conclusions

- In Parkinson's disease, LUT symptoms are associated with degeneration of dopaminergic neurotransmission (LOE2).
- The most common LUT disturbances are detrusor overactivity during storage, and impaired detrusor contractility during voiding (LOE2).
- The effect of levodopa on LUTS in PD patients remains to be fully elucidated (LOE3).

Recommendations

- Detrusor overactivity in PD patients can be treated with antimuscarinic drugs (B).
- For voiding failure with significant post void residual, the treatment of choice is intermittent catheterization (B).
- OnabotulinumtoxinA is a promising treatment for managing intractable DO in PD, which is associated with a risk for urinary retention and the need for catheterisation. (C)
- LUT surgery for patients with Parkinson's symptoms is an option where MSA is excluded, provided evaluation is detailed (C).
- Stress incontinence surgery should not be offered to patients with significant detrusor overactivity (C).

5.2. Constipation and faecal incontinence

Lower gastrointestinal tract (LGIT) dysfunction is common in Parkinson's disease (PD). In control-based studies, the incidence of decreased stool frequency (< 3 times a week) in PD patients ranges from 20% to 81%, difficulty in stool expulsion 57-67%, and diarrhoea 21% [172, 173] (LOE2). All of these values are significantly higher than in the normal population (range, decreased stool frequency, 0-33%; difficulty in stool expulsion, 26-28%; diarrhoea, 10%). Faecal incontinence affects 10-24% in PD [172, 174] (LOE2). Therefore, constipation is the most prominent LGIT symptom in patients with PD. Indeed, PD is a risk fac-

tor for elderly nursing home residents to have constipation. Bowel dysfunction affects the quality of life in patients with PD. The rate of dissatisfaction for bowel dysfunction (59%) is significantly higher than for urinary (28%) or sexual dysfunction (29%), although the prevalence rate of all three dysfunctions is almost the same (more than 60%). The rate of dissatisfaction for the bowel dysfunction in PD is also significantly higher than in healthy controls (16%) [174] (LOE2).

Difficulty in expulsion and diarrhoea are more common in the higher grade of Hoehn and Yahr staging, suggesting a relationship between dopaminergic degeneration and LGIT symptoms. Faecal incontinence in PD occurs commonly with urinary incontinence, whereas no significant relation has been seen between bowel and sexual dysfunction. Constipation in PD is often associated with a low coefficient of variation in electrocardiographic R to R intervals [175] (LOE3). The findings indicate that parasympathetic dysfunction might underlie these abnormalities.

Intestinal pseudo-obstruction (IPO), also called paralytic ileus, is the most severe presentation of constipation in patients with PD and constitutes a medical emergency. Occurrence of IPO/ volvulus is reported as a potential complication [176] (LOE3). Although rare, emergency IPO needs hospitalization and may lead to a poor outcome. Therefore, preventative treatment of constipation, including consideration of prokinetic drugs is necessary, particularly in elderly PD patients.

There seems to be an association between the frequency of bowel movements and the future risk of developing PD [177, 178] (LOE1). This observation is in line with the pathological staging of PD by Braak et al. [179] (LOE1), in which disease process in the central nervous system starts earlier in the dorsal motor vagal nucleus than in the substantia nigra in PD. From a clinical perspective, it is of particular relevance that patients may see gastroenterologists or physicians first because of their bowel dysfunction, prior to a correct diagnosis of PD being made. Therefore, constipation as the initial presentation of PD is akin to urinary dysfunction as the initial presentation of multiple system atrophy.

Pathology and disease-specific problems

The enteric nervous system generates the peristalsis responsible for bowel content transit. The components of peristalsis are contraction on the oral side of the bolus, and relaxation on the caudal side. Cholinergic receptors have a major role in the contraction proximally. The strength of cholinergic transmission is regulated by opposing receptors; serotonin 5-HT₄ receptor-mediated excitation and dopamine D₂ receptor-mediated inhibition. Post-mortem studies of bowel in PD have shown decrease in dopaminergic myenteric neurons and the appearance of Lewy bodies along the proximal-distal axis, being most frequent in the lower oesophagus, but scarce in the rectum [180-182] (LOE2). Thus PD affects not only the

central, but also the peripheral (enteric) nervous system.

LGIT function primarily consists of [1] colonic transport of the bowel content to the anorectum, [2] transient storage in the anorectum, and [3] defecation. In PD, constipation results primarily from decreased transport and/or disturbed anorectal evacuation. Faecal incontinence may result from disturbed anorectal reservoir function, or overflow secondary to constipation. Previous reports have shown that total colonic transit time (CTT) is increased beyond the normal threshold in 80% of PD patients, which translates into an increased average CTT ranging from 44 hours to 130 hours [172, 174][139, 141, 151] (LOE2), and 89 hours in de novo PD patients [48] (LOE2), all of which are significantly longer than the CTT in controls (range, 20-39 hours). Prolonged CTT has also been documented in PD patients without subjective constipation. Slow colonic transit is the major cause of decreased stool frequency. The slow colonic transit is likely to reflect a decrease in slow waves and spike activities of the colon [147].

In resting anal manometry, the anal pressure of PD patients is low or normal [172, 174, 183] (LOE2). The resting anal pressure may reflect sympathetic innervation in the internal anal sphincter, since lesions or anaesthetic blocks at T12-L3 (where the sympathetic preganglionic neurons are located) substantially lessen the anal pressure. Similarly, most PD patients have normal anal pressure increase on squeezing. This finding corresponds to a lack of neurogenic changes in the external sphincter EMG. Nevertheless, latent anal sphincter dysfunction may explain the faecal incontinence that occurs in most advanced cases. In slow-filling rectoanal videomanometry, PD patients had the same rectal volume at first sensation and a maximum desire to defecate, and the same rectal compliance as control subjects [90, 174] (LOE2). In contrast to the bladder, the normal rectum shows spontaneous phasic contraction. However, the amplitude of the spontaneous phasic rectal contraction in PD patients is significantly less than that in control subjects. The decreased spontaneous phasic rectal contraction may share the same aetiology with the altered CTT.

During defecation, healthy subjects utilize the final wave of spontaneous phasic rectal contractions. However, rectal contraction on defecation in PD patients is smaller than that in controls [174] (LOE2). In addition, abdominal straining is weaker in PD patients. Paradoxical anal sphincter contraction on defecation (PSCD), or anismus, is observed in studies using sphincter EMG, radiography, and anal pressure measurement. The mechanism of the impaired straining in PD may include rigidity and reduced contractility of the axial muscles, and a failure of coordinated glottis closure. However, neuronal degeneration in the brain of PD patients relevant to straining is yet to be clarified. Mathers et al. [184] consider PSCD a focal dystonia. Dysfunction in the suprasacral descend-

ing pathway to the external sphincter may be a contributing factor. Apomorphine was shown to lessen PSCD [184] (LOE2). This effect was not antagonized by domperidone, which does not penetrate the BBB, suggesting that CNS pathology may contribute to PSCD.

Disease-specific diagnosis and treatment

Insoluble dietary fibers produced an improvement in stool consistency and an increase in stool frequency in PD, which paralleled an improvement in levodopa absorption [185] (LOE3). Dietary fibers such as psyllium [186] (LOE2) and polyethylene glycol 3350 [128] (LOE2), or bulking and highly hydrophilic agent polycarbophil [129] (LOE2), improve constipation in neurodegenerative disorders, including PD. Although psyllium does not alter CTT or anorectal parameters in PD patients, polycarbophil shortens the total CTT, particularly in the proximal bowel segments.

It is possible that levodopa and other antiparkinson medication may affect bowel function in PD. Endogenous dopamine is thought to inhibit intestinal motility via D2 receptors. Tateno and Sakakibara performed the quantitative lower-gastrointestinal autonomic test (QL-GAT, a combination of colonic transit and manometry) in 19 early, untreated PD patients before and after administration of 200 mg/day of levodopa [187]. Levodopa augmented rectal contraction, lessened paradoxical anal sphincter contraction on defecation (PSCD, anismus), and thereby ameliorated anorectal constipation, without apparent adverse effects. This might be brought about by both peripheral and central dopaminergic stimulation.

Since levodopa is absorbed from the small intestine, bowel dysfunction in PD may interfere with levodopa absorption, worsen the motor disorder, or even lead to malignant syndrome [173, 188] (LOE3/4). Domperidone, a peripheral D2 receptor antagonist that does not cross the blood-brain barrier, causes a mean 12% increase in peak plasma levodopa concentrations that occurs a mean of 10 min earlier than when levodopa is given alone [189] (LOE3).

The selective 5-HT₄ receptor agonist cisapride [190], though no longer licensed, and newer agents such as mosapride [130] (LOE2) and tegaserod [191] significantly reduce CTT and ameliorate constipation in PD. Mosapride shortened total CTT (particularly the caudal segment), and augmented the amplitude in rectal contraction during defecation in patients with PD [130]. Notably, improvement of parkinsonism is more significant with pergolide-mosapride than with pergolide-domperidone, presumably reflecting better levodopa absorption. Similar results were obtained in PD by dietary herb extract Dai-Kenchu-To, one active component of which is hydroxy-beta-sanshool (5-HT₃ receptor agonistic action) [131] (LOE2). A series has shown a role for Botulinum toxin A injections into the puborectalis muscle [192] (LOE3).

Conclusions

- Patients with PD often have abnormal anorectal function (LOE2).
- The most common bowel disturbances in PD are slow colonic transit, decreased phasic rectal contraction, weak abdominal straining, and paradoxical sphincter contraction on defecation (anismus) (LOE2).
- Bowel dysfunction such as constipation is common and has significant impact on quality of life of PD patients (LOE2).

Recommendations

- More studies on management of neurologic bowel dysfunction in PD are needed.

6. CEREBRAL LESIONS AND CEREBROVASCULAR ACCIDENTS

Lower urinary tract dysfunction (LUTD) may be an integrated part of the neurological syndrome (i.e. a neurogenic LUT dysfunction, most often urinary incontinence (UI)). LUTD may also be a consequence of associated deficits; particularly motor and cognitive dysfunction may lead to UI, which in this case is called "functional". Both neurogenic and functional UI may be combined. Patients themselves, however, rarely link the LUT symptoms to the neurological disorder. Correlation between specific LUT symptom (LUTS) and the lesion site caused by stroke has initially been studied by post mortem or surgical specimens. But with improving modalities of imaging, it becomes possible to correlate symptoms with smaller, more discrete abnormalities. As a rather new insight, slow, diffuse brain ischemia (white matter lesion) recently emerged as a significant factor to produce overactive bladder (OAB) in the elderly. Finally, management of LUTD in stroke is reviewed.

6.1. Stroke

LUTD in stroke may be a consequence of direct involvement of neural structures which are part of the brain neural control of LUT. The consequence is, as will be discussed later, in most events the overactive bladder syndrome (OAB; i.e. urgency and frequency of micturition, and urge UI). Furthermore, there often is a functional component (immobility and loss of initiative/cognition) [193].

Stroke, a major form of cerebrovascular disease (CVD), is a common brain disease that preferentially affects the elderly. LUTD significantly affects quality of life in post-stroke patients [194]. Reports of the prevalence of LUTS in patients with stroke, except for UI, have been scarce. Sakakibara et al. [195] reported on the bladder symptoms of 72 patients who had been admitted with an acute hemispheric stroke

in a neurology department. When assessed at 3 months, 53% were found to have significant LUTS. The commonest problem was nocturnal urinary frequency (36%), then urgency UI (29%) and difficulty in voiding (25%); urinary retention was seen in 6%. Britain et al. [196] reported an incidence of post-stroke LUTS as 64% (in 423 subjects) that was higher than in a control normal population (32%). The major urinary symptoms were: nocturia (49%), UI (33%), urgency (19%), frequency (15%), straining (3.5%) and pain (2.5%). In 1248 stroke patients, Williams et al. [197] found that 83.6% of survivors reported one or more abnormal LUTS at 3 months, nocturia being the most frequent (79.1%), followed by UI (43.5%; urgency type 37.0%, stress type 20.6%) and urinary frequency (17.5%).

Thomas et al. [198] reported UI in 40-60% of patients admitted to hospital after a stroke, with 25% still having problems on hospital discharge, and around 15% remaining incontinent at one year. Amelioration of UI in 25-45% of the patients may reflect amelioration of both functional component (mobility, initiative and cognition) as well as OAB component in this commonest brain disease. Kuptniratsaikul et al. [199] noted bladder/bowel dysfunction in 31.5% among 327 post stroke patients who started rehabilitation.

Studies reporting on stroke localization and LUTD stress the importance of the frontal lobe, and there are no clear reports of bladder dysfunction as a consequence of a single/focal deficit in the parietal, temporal or occipital lobe. Lesions of the anteromedial frontal lobe, its descending pathways and the basal ganglia may be important for bladder dysfunction in stroke patients. Khan et al. [200, 201] reported on post-stroke patients with LUTS, and the majority of patients had frontal cortex and/or internal capsular lesions. Bogousslavsky and Regli noted UI in 22% (6 of 23 cases) of anterior cerebral artery infarction that affects the frontal lobe [202]. Sakakibara and colleagues [195], analysing 72 post-stroke patients irrespective of the presence of LUTS, found a significant correlation between the occurrence of a urinary disturbance and hemiparesis and a negative correlation with hemianopia, brain imaging techniques confirming a more anterior location of brain lesions in the former group. Woessner et al. reported a urinary-incontinent patient whose stroke was localized in the cortical motor area of the bladder/sphincter [203].

Considering LUT neural control one expects LUTD also in brainstem infarcts. An analysis of LUTS of 39 patients who had had brainstem strokes showed that it was dorsally situated lesions that resulted in disturbance of micturition [204]. Forty-nine percent of all the patients had LUTS; nocturnal urinary frequency and voiding difficulty in 28%, urinary retention in 21% and UI in 8%. The problems were more common in those following haemorrhage, possibly because the damage was usually bilateral. MR scanning showed that the responsible lesions were in the pontine reticular nucleus and the reticular formation, adjacent to the medial parabrachial nucleus and the locus coeruleus.

A correlation was found between LUTS and sensory disturbance, abnormal eye movement and inco-ordination. Lateral medullary infarction (Wallenberg syndrome) has been reported to produce voiding difficulty and DSD [205]. In another case, the lesion seemed to extend to basal medulla that produced hemiparesis [206]. Brain stem stroke cases suggested the region is located in the dorsolateral pons including the pontine reticular nucleus and the reticular formation, adjacent to the medial parabrachial nucleus and the locus coeruleus [207]. Yum et al. [208] analysed 30 brainstem infarction cases. They found LUTS in 70% of patients, comprising 46.7% storage disorder and 23.3% emptying disorder. In their series of patients, emptying disorder was more common in medullary lesion (55.6%) than pontine lesion (9.5%). Storage disorder was found only in pontine lesion (61.9%).

There are few reports on LUTD related to other brain areas. Cerebellar stroke has been reported to cause LUTD (detrusor overactivity) [209]. UI is seen in 13% (2/16) of right and 33% (10/30) of left anterior cerebral artery infarctions [210]. Sakakibara et al., however, did not see a clear relationship between stroke laterality and LUTS [195]. Similar findings were reported by others [211]. In contrast, Ersoz et al. [212] divided their post stroke patients with LUTD into infarction and haemorrhage. The infarction group had larger bladder capacity (250.3 ml) and larger post-void residual urine volume (136.1 ml) than haemorrhage group (194.9 ml, 29.5 ml, respectively), indicating a more severe bladder dysfunction. Han et al. [213] found that the infarction group had more detrusor overactivity but less detrusor underactivity (70.7%, 29.3% respectively) than the haemorrhage group (34.65, 65.4% respectively).

Khan et al. [200, 201] demonstrated detrusor overactivity (DO) in 79% of 33 post stroke patients with LUT symptoms. None of them had detrusor-sphincter dys-synergia (DSD) on voiding. The mechanism of DO seems not to be uniform; certainly DO has been described in patients with different locations of lesions in CNS, but is also seen in patients without (obvious) neurological involvement. It is postulated that the micturition reflex is under tonic (mainly inhibitory) influences [214, 215] by the central cholinergic pathway [216] and the fronto-nigro-striatal, dopamine D1-GABAergic direct pathway [139]. Furthermore, it is postulated that in patients with brain lesions DO is an exaggerated spino-bulbo-spinal micturition reflex; PMC normally promotes micturition, and without inhibition, DO develops [141, 214, 215]. The exaggerated micturition reflex is abolished after chemical lesioning of the PMC in stroke rats.

Consequent urodynamic studies showed a more varied picture: in 19 poststroke UI patients Gelber et al. [217] reported DO in 37%, underactive detrusor in 21%, and detrusor-sphincter dyssynergia in 5%. In an urodynamic study of 27 symptomatic stroke patients [218] DO was seen in 40.7% and detrusor areflexia in 3.7%. Similarly, a study of 38 symptomatic stroke

men by Nitti et al. [219] showed DO in 82% and outlet obstruction in 63%. In 57 poststroke patients, Natsume [220] also found detrusor underactivity in 35% men and 43% women; and most of them had so-called detrusor hyperactivity with impaired contraction (DHIC). In contrast to the pathophysiology of DO, little is known about the pathophysiology of 'brain shock' and DHIC [100]. Within the brain, it is known that there are both micturition-inhibiting and micturition-promoting areas. The latter includes A10 ventral tegmental area (VTA)-mesolimbic dopaminergic pathway, D2-subthalamic indirect pathway, and the glutamatergic pontine micturition center (PMC) adjacent to the locus ceruleus and sacral cholinergic preganglionic cells [139]. These pathways might also be involved in many brain diseases affecting the frontal lobe. Gupta et al. [221] found DO in 90% and DSD in 27.5% in their 40 patients with post-stroke UI. Urodynamics in 11 symptomatic patients with brainstem lesions showed DO in 8 (73%), low compliance detrusor in 1 (9%), acontractile detrusor in 3 (27%), non-relaxing sphincter on voiding in 5 (45%) and uninhibited sphincter relaxation in 3 (27%). No statistically significant correlation could be demonstrated between any particular lesion site and urodynamic findings [222].

Early UI following a stroke is a specific indicator of poor prognosis. Wade and Langton-Hewer analysed the symptoms of 532 patients seen within seven days of their stroke and found that the presence of UI appeared to be a more powerful prognostic indicator for poor survival and eventual functional dependence than was a depressed level of consciousness [223]. Others have also reported that the outcome was better in those who remained or became dry [224, 225]. Rotar et al. [226] demonstrated post-stroke UI is a predictor of greater mortality not only at the end of the first week, but also at 6 months and 12 months after stroke.

Gelber et al. [217] found that post-stroke UI was associated with large infarcts, aphasia, cognitive impairment, and functional disability. Nyberg and Gustafson [227] noted a strong link between easy fall and UI. van Kuijk et al. [228] reported that among 143 post-stroke patients, activity of daily living (modified Barthel index) and discharge rate to their own home are negatively related with UI. Landi et al. [229] reported that among 355 poststroke patients, functional (mobility and activity of daily living) decline is related with UI. Pettersen and Wyller [230, 231], among 355 poststroke patients, noted a relation between UI and poor mobility. Paolucci et al. [232] and Daviet et al. [233] reported that, not only immobility and dementia, but also unilateral spatial neglect (mostly due to right hemispheric lesion) strongly correlates with UI after stroke. It seems likely that UI is a strong predicting factor for poor prognosis of stroke for a number of reasons: the same lesion might cause neurogenic bladder dysfunction (neurogenic UI), motor or cognitive impairment (functional UI), or both; falls, gait difficulty and cognitive decline are all marked in severe, bilateral brain lesions; finally UI may secondarily

cause psychological depression and also generally interfere with rehabilitation and quality of life.

6.2. White matter lesions and urinary incontinence in the elderly

Urinary incontinence (UI) is a major concern in geriatric populations, which have grown rapidly in recent decades. In addition, the incidence of urinary frequency/urgency (OAB), with or without UI, is high in the general population over 40 years old and it increases significantly with age. It is widely acknowledged that urinary frequency and poor bladder control have a negative impact on the quality of life, that LUTD in elderly persons adds to their caregivers' burden, and that LUTD is an important factor leading to institutionalization. The mechanisms underlying OAB and UI in the frail elderly are multi-factorial; the factors may include age-related changes in the bladder itself or central nervous system changes innervating the bladder.

Atherosclerosis and subsequent ischemia of the bladder occurs in patients with pelvic peripheral vascular disease. Atherosclerosis is a systemic condition which also affects cerebral arteries supplying the brain. Cerebral white matter disease (WMD) is a common chronic bilateral ischemic brain disease in the elderly. WMD progresses insidiously, and the likelihood of WMD increases significantly with age. It has been proposed that WMD is the pathoanatomical substrate in the brain aetiology of OAB. Thus, it is proposed that WMD leads to three different geriatric syndromes; vascular dementia, vascular parkinsonism, and 'vascular incontinence' [234].

In relation to the cerebral vascular component in vascular incontinence, Sakakibara and colleagues [235] investigated 63 subjects (mean age 73 years) with varying degrees of cerebral WMD or leukoaraiosis. Magnetic resonance imaging (MRI)-defined WMD was graded on a scale of 0 to 4. The prevalence of nighttime urinary frequency in cases of grade 1 WMD was 60%; grade 2, 58%; grade 3, 93%; and grade 4, 91%, respectively, giving an overall prevalence of nighttime urinary frequency of around 75%, which was a more common and earlier feature than UI (40%). Of particular importance was the fact that OAB was not always accompanied by gait disorder or dementia (Grade 1 of WMD), so that it appeared that OAB might be the first clinical manifestation of the observed WMD [235]. Detrusor overactivity (DO) is the major underlying urodynamic observation of vascular incontinence. The incidence of DO in WMD cases is reported as 70%–91% of patients. In Sakakibara's study [235], urodynamic studies were performed in 33 of the subjects. They found that subjects with grade 1–4 WMD had DO significantly more commonly (82%) than those with grade 0 WMD (9%). Post-micturition residuals, low compliance, DSD and uninhibited sphincter relaxation were also more common in grade 1–4 WMD than in grade 0 WMD, though not significantly so.

Population-based MRI studies suggest that the incidence of moderate WMD (periventricular WMD grade >4/9 and subcortical white matter volume >1.5 mL) is approx. 10% (7.6%–24%) in the general population of individuals over 55 years of age. WMD can develop into three different geriatric syndromes: [1] vascular dementia; [2] vascular parkinsonism; and [3] ‘vascular incontinence’ [235, 236]. These three syndromes can present in any combination, but clinically, urinary and gait disorders are more prominent than dementia, and usually precede dementia.

Two studies have shown significant relationship between OAB/UI with WMD [236, 237]. Tadic and Griffiths [236] studied 25 older women (age 71.5 + –7.5 years) with urgency UI, and they reported that brain responses to bladder filling during self-reported ‘urgency’ were most prominent in the frontal regions. Regional activations became more prominent with increased global WMD. Looking at the fiber tracts, the main effect activations and deactivations were superimposed with anterior thalamic radiation and superior longitudinal fasciculus. These results indicated that WMD, particularly the anterior portion, is clearly related to OAB in cognitively intact, elderly persons.

A survey was carried out to look at relationship between DO and higher brain function in 40 WMD patients with OAB (age 60–89 years) [43]. DO was independent of general cognitive status (the mean MMSE score or any of its subdomains). In contrast, the presence of DO was significantly associated with the inhibitory control subdomain in the FAB test. This finding is in agreement with the fact that brain perfusion is most severely reduced in the frontal lobe of subjects with WMD [238]. What exactly this finding means is a matter of debate. One explanation might be that the bladder is under general inhibitory control concerning decision-making [239] and emotion [240] by the prefrontal cortex. In patients with WMD, this neural network might be impaired, leading to both frontal cortex-related behaviour changes and DO.

Both age-related WMD (also called vascular dementia) and Alzheimer’s disease (AD) are common causes of elderly dementia, and are known to be independent risks for OAB/UI. A survey was carried out among 49 mild/moderate dementia patients irrespective of OAB (mean age, 76 years), including AD alone in 9, AD+WMD in 15, and WMD alone in 25 [241]. OAB was most common in WMD alone. Therefore, WMD is a more significant contributor to OAB and UI than AD in elderly dementia patients. It should be mentioned that in WMD, LUTD occurs independently from dementia. The pathological mechanisms for LUTD in AD and WMD remain obscure. However, a single-photon emission computed tomography (SPECT) study showed that frontal hypoperfusion is common in WMD, whereas parietal-temporal hypoperfusion is common in AD [238]. This is in accordance with the finding that in AD, dementia is the predominant symptom, and early UI is extremely rare [242].

6.3. Management of LUTD in stroke patients

An approach for the care of patients with LUTD in brain diseases is applied as a general LUTD treatment regimen, which should depend on the pathophysiology and be individualized. As discussed above, UI in brain diseases can be divided into two types: neurogenic UI (OAB wet) and functional UI (immobility and loss of initiative/cognition). These two types of UI may occur together. However, management of two types of UI differs significantly. Management of neurogenic UI includes anticholinergic drugs to treat bladder directly, and management of functional UI includes behavioural therapy (timed/prompted voiding with physical assistance; bladder/pelvic floor training) and drugs to treat gait (Parkinson’s disease drugs) as well as cognition (Alzheimer’s disease drugs) that further facilitate continence.

In 2005, Thomas et al. [198] undertook meta-analysis of interventions aimed at reducing the occurrence of post-stroke UI. Seven trials with a total of 399 participants were included. Four trials tested an intervention against usual care, including acupuncture, timed voiding, and two types of specialist professional intervention. One cross-over trial tested an intervention (oestrogen) against placebo. One trial tested a combined intervention (sensory-motor biofeedback plus timed voiding) against a single component intervention (timed voiding alone). One trial tested a specific intervention (oxybutynin) against another intervention (timed voiding). The interpretation was that there was insufficient data. A review of behavioural therapies for post-stroke UI was done by Dumoulin et al. [243]. Ti-baek et al. [244] reported on effectiveness of pelvic muscle training in 24 women with post-stroke UI (irrespective of type of UI) with a randomized, controlled and blinded study.

In contrast to the intervention of functional UI (due to immobility and loss of initiative/cognition), drug trials for OAB wet in patients with brain diseases are scarce. Propiverine, an anticholinergic, has been used to treat idiopathic as well as neurogenic DO including brain diseases [245]. Sakakibara et al. [246] used an anticholinergic drug imidafenacin in 62 OAB patients following brain diseases, including 29 with WMD. They found an improvement of OAB after 0.2 mg/day imidafenacin, without cognitive decline. Another study used tolterodine in 13 OAB patients following brain diseases, including five with WMD, showing an improvement of OAB with 4mg/ day tolterodine [247]. The addition of propiverine (a peripheral anticholinergic) to donepezil (a central acetylcholinesterase inhibitor) ameliorates OAB without worsening cognitive function in elderly OAB patients with dementia [248]. Mirabegron, a novel selective adrenergic beta-3 receptor agonist, seems to be promising for lessening DO, with fewer central side effects [249].

For ameliorating post-stroke UI, alternative/ complementary therapies have also been studied. Electro-

acupuncture showed an improvement together with a bladder capacity increase in post-stroke patients [250]. Electro-acupuncture is also used to treat incomplete bladder emptying after stroke [251].

Newer modalities such as botulinum toxin have been applied to post stroke UI. Kuo [252] applied 200U suburothelial injection of botulinum-A toxin in 24 patients with DO due to stroke in 12 and suprasacral spinal cord diseases in 12. He found 91.6% achievement of continence in spinal cord diseases but 50% achievement in stroke.

Transcranial magnetic stimulation at the motor area or the prefrontal cortex was able to lessen DO in multiple sclerosis [253] and Parkinson's disease [254]. In stroke, no similar studies are available.

Conclusions

- Incidence of lower urinary tract dysfunction (LUTD) in stroke patients ranges from 14-53%, principally due to overactive bladder (OAB), being higher when involving the frontal cortex (LOE3).
- White matter disease (WMD) is a chronic, bilateral form of cerebrovascular disease, leading to the high prevalence of OAB (LOE3).
- Since WMD is common particularly in elderly, WMD might be one of anatomical substrates for elderly OAB. (LOE4)
- Neuroimaging studies have shown relationship between LUTD and the frontal cortex in stroke and WMD that regulate the micturition reflex.
- Data on other brain diseases, particularly affecting deep brain structures, are limited. A small infarct affecting the brainstem leads to either OAB or urinary retention. (LOE4)
- Neuroimaging studies have shown relationship between LUTD and the periaqueductal gray and the pontine micturition center that directly relay and modulate the micturition reflex.
- Urinary incontinence (UI) in stroke/WMD can be divided into two types: neurogenic UI (OAB wet) and functional UI (immobility and loss of initiative/cognition). These two types of UI may occur together, but management differs substantially. (LOE3).
- Management of neurogenic UI/OAB includes anticholinergic drugs that do not penetrate the blood-brain barrier easily or beta 3 adrenergic agonists (LOE3).
- Management of functional UI includes behavioural therapy (timed/prompted voiding with physical assistance; bladder/pelvic floor training) and drugs to treat gait as well as cognition that facilitate continence (LOE4), in order to maximize the quality of life in stroke patients.

Recommendations

- Urinary incontinence (UI) in stroke/WMD should be divided into two types: neurogenic UI (OAB wet) and functional UI (immobility and loss of initiative/cognition) (A).
- Neurogenic UI/OAB needs anticholinergic drugs that do not penetrate the blood-brain barrier easily. (B).
- Functional UI needs behavioural therapy (A).

7. MENINGITIS-RETENTION SYNDROME

Meningitis retention syndrome (MRS) is one of the diseases that could cause a relatively uncommon urinary retention in childhood, young adults, and in women [255]. Spina bifida occulta/ tethered cord syndrome is one such disorder known to lead to urinary retention without marked neurological abnormalities, except for saddle anaesthesia. Fowler's syndrome is another disorder that causes urinary retention, particularly in neurologically-intact young women, and isolated urethral sphincter hypertonicity underlies this condition. Benign inflammatory nervous diseases also cause acute urinary retention, in which patients lack apparent urethral outlet obstruction, but exhibit only minor neurological as well as cerebrospinal fluid (CSF) abnormalities. Based on the mechanism of urinary retention, these disorders can be divided into two subgroups: disorder of the peripheral nervous system (PNS) (e.g. sacral herpes, with unilateral sacral pain, sensory signs and often skin rashes in the same area); and disorder of the central nervous system (CNS) (e.g. meningitis-retention syndrome), with fever, headache, stiff neck, and minor pyramidal signs). Previously the latter condition has been only occasionally reported, but now it is recognized as a specific category [256, 257], which is considered to be a very mild form of acute disseminated encephalomyelopathy (ADEM). True prevalence of MRS has not been fully investigated due to the rarity of the condition.

It is postulated that ADEM appears after vaccination or after exanthematous infections, and serological and pathological studies have suggested that ADEM is of parainfectious/ autoimmune origin [258]. Antecedent/ comorbid infections are diverse, e.g. human herpes virus 6 [259]. A combination of signs of encephalitis (e.g. disturbance of consciousness, epilepsy, and hemiparesis), signs of myelitis (e.g., sensory disturbance below the level of the lesion, spastic paraplegia, whereby flaccid paraplegia may occur in the initial shock stage), and lower urinary tract (LUT) / bowel dysfunction typically occur in patients with ADEM. Lesions observed in brain MRI are usually confined to the white matter. Lesions in the spinal

cord involving the conus are also seen. CSF pleocytosis, increased protein, mildly decreased glucose content, increased myelin basic protein (MBP)/oligoclonal bands, and a lack of increased viral titres, are all features of this disease.

Patients with ADEM commonly exhibit LUT dysfunction [260, 261], which varies from urinary retention to urgency incontinence. LUT dysfunction appears to be related to pyramidal tract involvement, and most probably reflects the severity of the spinal cord lesion. Urodynamic findings have included detrusor overactivity in the storage phase, brisk bulbocavernosus reflex, and DSD (reflective of a suprasacral spinal cord lesion); detrusor areflexia in the voiding phase (reflective of either acute spinal shock or conus lesion); and neurogenic sphincter EMG in one of four patients studied (reflective of a conus lesion). The responsible lesion sites in cases of LUT dysfunction have appeared to be the cervico-thoracic spinal cord, and, to a lesser extent, the conus [262] and possibly the spinal nerve roots in patients with ADEM. In addition, cases of ADEM presented with LUT dysfunction as the only remaining consequence of the disease, thus suggesting that LUT innervation was selectively vulnerable in these cases. It is also reported that cases of ADEM/ parainfectious myelitis initially presented with urinary retention [263] or leaves urinary retention as the sole sequel [264].

Although aseptic meningitis is a common neurological disorder, a combination of aseptic meningitis and acute urinary retention (MRS) has not been previously well recognized. The clinical manifestations of Sakakibara's three cases [256] are mostly the same as those of the six reported cases in the literature (including cases written in Japanese). The clinical manifestations of MRS cases differ markedly from those of ADEM, because, other than presenting with aseptic meningitis, MRS cases lack the following: apparent encephalitic signs such as disturbance of consciousness, epilepsy or aphasia; and myelitic signs such as gait abnormalities, or sensory-level abnormalities. Whereas brain and spinal cord lesions typically appear in ADEM, such change is not observed in MRS. However, a reversible splenic lesion was noted in the brain MRI of a patient with MRS [265].

7.1. Disease specific diagnosis

Cerebrospinal Fluid (CSF) examination showed a mononuclear pleocytosis of 38-370 /mm³, normal to increased protein content (up to 260 mg/dl), and normal to mildly decreased glucose content (up to 33% of that in the serum). All viral titres studied in the CSF and the serum of such cases were negative. Nevertheless, it appears likely that the urinary retention in such patients is of neurologic aetiology, since none of the patients appear to exhibit urologic abnormalities such as prostatic hyperplasia, and also because a strong chronological association is observed between the onset of urinary retention with, or just after, the occurrence of the aseptic meningitis. As it is observed

in ADEM, antecedent/ comorbid infections or conditions with MRS include *angiostrongylus cantonensis* [266], Epstein Barr virus [267], and herbal medicine use [268], whereas such antecedent influences are not apparent in the remaining cases [269].

Urodynamic study results have shown that all patients examined had detrusor areflexia, which results in an inability to contract the bladder on voiding, and some patients had an unrelaxing sphincter. Detrusor areflexia originates from various lesion sites along the neural axis; most commonly, peripheral lesions are observed. However, CNS lesions that affect the spinal cord or the brain can also cause detrusor areflexia, which is particularly seen in the acute shock phase of patients with transverse myelitis (often immune-mediated) or ADEM. A case report described repeated urodynamic studies in one patient, in which an initially areflexic detrusor became overactive after a 4-month period, suggesting an upper motor neuron bladder dysfunction [270]. As described above, encephalitic features are absent in patients with MRS. However, three MRS patients (including Sakakibara's cases 1 and 3) showed the brisk lower extremity reflexes suggestive of mild myelitis. In one of Sakakibara's cases, MBP was increased, which is suggestive of CNS demyelination. Therefore, it appears possible that MRS is a very mild variant of ADEM, which selectively affects LUT innervation.

Arriving at a diagnosis is easy when a combination of aseptic meningitis and acute urinary retention is confirmed, although such a diagnosis should be made both urologically and neurologically, in order to exclude sacral herpes, a benign variant of Guillain-Barre syndrome (inflammatory radiculitis), typical ADEM, myelitis with leg weakness [271], herpetic brainstem encephalitis, chemical meningitis, focal subarachnoid bleeding, and other common causes of neurogenic urinary retention (e.g. diabetic neuropathy, lumbar spondylosis, etc.). For the differential diagnosis, detailed history, brain/spinal MRI and nerve conduction study are necessary.

The term "Elsberg syndrome" has been occasionally used, which is rather vaguely assigned to sacral myeloradiculitis of undetermined aetiology, sacral herpes, sacral vasculitic neuropathy, possible MRS, possible ADEM, or conus infarction. However, in contrast to the majority of "Elsberg syndrome" cases, Kennedy, Elsberg, and Lambert (1913) reported five cases of pathology-demonstrated cauda equina radiculitis. Clinical pictures of these cases were characterized by rare CSF abnormalities (only one of the four cases described showed an increased cell count as well as increased protein levels); no clinical meningitis; subacute/chronic course (in one case the course of disease was subacute: 3 months, but in the remaining four cases, the course of disease was chronic: 4.5-36 months); the patients presented with typical cauda equina motor-sensory-autonomic syndrome (in particular, four of the patients had apparent muscle atrophy/weakness in the lumbosacral segment); Wallerian degeneration of the spinal afferent

tracts; and mild upper motor neuron signs. The authors assumed that the aetiology of these cases was either inflammatory or toxic. The exact cause of these five cases remains uncertain, although clinical pictures of these cases resemble, at least in part, those of paraneoplastic or autoimmune lumbosacral radiculoplexus neuropathy [272]. Clinical features of sacral herpes or MRS differ markedly from those of Kennedy's cases.

7.2. Disease specific management

Since MRS has a benign and self-remitting course (i.e., a duration of 2-10 weeks), the effectiveness of immune treatments (e.g., steroid pulse therapy) remains unclear, although such treatments may shorten the duration of the disease. Management of the acute urinary retention is necessary to avoid bladder injury due to overdistension (LOE4).

Since MRS is rare, true prevalence has not been fully investigated and evaluation of this is warranted in future research. Similarly, in order to shorten the urinary retention period, the effectiveness of immune treatments (e.g. steroid pulse therapy) in MRS remains unclear, and future research is desirable.

Conclusions

- Meningitis-retention syndrome, with fever, headache, stiff neck, and minor pyramidal signs, is thought to be a very mild form of acute disseminated encephalomyelopathy (ADEM) encountered by both urologists and neurologists (LOE 2)
- Initially the bladder is areflexic, but soon becomes normal or overactive during the course of the disorder. (LOE 2)

Recommendation

- Management of the acute urinary retention is necessary to avoid bladder injury due to overdistension in patients with MRS (B)

8. ACUTE DISSEMINATED ENCEPHALOMYELITIS (ADEM)

Acute disseminated encephalomyelitis (ADEM), also known as post-infectious encephalomyelitis, is a demyelinating central nervous system (CNS) disorder that usually follows infection, or more rarely vaccination [273]. ADEM can be confused for MS; indeed, the early symptoms of ADEM are similar to an acute relapse of MS. Presence of constitutional symptoms such as fever and headache, and the simultaneous involvement of various parts of the CNS may help differentiate this condition from MS. However, it can be difficult to distinguish the two, and the only sure way is follow up and the observation of any relapses over time.

ADEM is a disease that is characterized by an inflammatory reaction and demyelination in the brain and spinal cord. In contrast to MS, there is a tendency for perivenous localization of pathological changes [274]. Bladder dysfunction is common in ADEM. In a consecutive series of sixty one patients with ADEM, 20 (33%) had evidence of LUTD [261].

Lesions in the cerebral and spinal cord white matter result in LUTD. Both voiding and storage symptoms are reported in ADEM, however the pattern of bladder dysfunction depends upon the time point at which they are assessed. In the acute stage, Panicker et al. reported that voiding dysfunction is more common; in their series of 20 patients, 16 were in urinary retention [261]. Urodynamics demonstrated detrusor overactivity in four patients and underactivity in four patients. Incontinence was reported more often in patients with frontoparietal white matter changes in MR imaging (LOE 3/ 4). In the series of Sakakibara et al., patients were followed up for 3 to 38 months, and seven of nine patients with retention were able to pass urine once again, five had difficulty in voiding and four developed urinary frequency or urgency incontinence. Motor unit analysis of the external sphincter revealed polyphasic neurogenic changes in only one of four patients. They also observed that bladder disturbances in ADEM seemed to be as common and severe as in MS [260] (LOE 3/ 4). LUTD is common especially in patients with lower limb pyramidal involvement [261].

Management of LUTS is essentially supportive. Patients complaining of LUTS should have their post-void residual checked regularly during the progressive phase of ADEM. If retaining urine, an indwelling catheter may be preferable during the acute phase. The need for catheterisation should be reviewed regularly as voiding dysfunction often recovers. If suitable, IC could be considered. Patients with overactive bladder symptoms are likely to benefit from an antimuscarinic medication, once it is confirmed they are not retaining urine.

For future research, there are currently only limited studies evaluating the natural history of LUTD in ADEM and patients should be followed up to assess lower and upper urinary tract changes with time. There is a dearth of information about the role of botulinum toxin or sacral neuromodulation in this condition.

Conclusions

- In the acute phase of ADEM, LUTS may be seen in a third of patients (LOE3/4).
- Both voiding and storage dysfunction are observed in ADEM (LOE3/4).
- Recovery of LUT functions occurs, along with the recovery of motor weakness (LOE3/4).

Recommendations

- Patients with ADEM and bladder symptoms should be managed according to their symptoms, and the findings on urodynamic tests, particularly post-void residual (C).
- LUTS can change as the disease stabilises; re-evaluation during follow-up is therefore recommended (C).
- Patients with overactive bladder symptoms are likely to benefit from antimuscarinic pharmacotherapy, once they are shown not to be retaining urine.

9. SPINAL CANAL STENOSIS

It is not uncommon to develop pelvic floor dysfunction including urinary symptoms in patients with spinal canal stenosis (SCS). It is thought about half of the patients with intractable leg pain in spinal canal stenosis will have urinary difficulty with high post-void residual (PVR) and reduced flow rate and/or incontinence indicating effects on the cauda equina. Such symptoms, including urinary incontinence usually improve after surgical decompression.

One third of patients with achondroplasia developed SCS [275], especially at the lumbar level, and 77% of these had urinary incontinence. According to Johnsson and Sass [276] in the County of South Jutland, Denmark during a 5-year period (1996-2000), the annual incidence of SCS was 272 per million inhabitants. Of 340 cases diagnosed with SCS during that period, only one patient presented with acute cauda equina syndrome. This was a 74-year-old woman with SCS from L2 to L4, who presented with urinary retention and faecal incontinence (FI) for the preceding 24 hours; after urgent surgery she recovered from her anal sphincter paresis within 5 days and from her bladder paresis within 5 weeks.

Goh and colleagues [277] carried out a comprehensive retrospective review of the clinical features, radiological changes and outcome of 75 patients with radiologically diagnosed lumbar SCS; imaging of the lumbar spine showed that moderate to severe central spinal stenosis correlated with complaints of weakness and abnormal motor power on clinical examination. The commonest symptom was numbness or tingling of the legs. According to the study of Inui[4] 58.8% of the 34 patients were diagnosed with neuropathic bladder; however there was no difference in the cross-sectional area of dural sac between those with and without neurogenic bladder dysfunction in patients with lumbar SCS. Nonetheless, the antero-posterior diameter of the dura was shorter in those with bladder dysfunction, and a critical size for the dural sac of patients was reported as 8 mm.

Usually signs and symptoms of compressive neuropathy of multiple lumbar and sacral roots is an indication for surgical intervention, but relatively unknown as a post-operative complication [278]. Four years after diagnosis, 65% had undergone surgical decompression; a third of patients felt that their symptoms had improved while a quarter felt that they had worsened. Imran and Halim [279] reported a 63-year-old man who developed acute cauda equina syndrome due to fat graft compression after decompressive laminectomy, posterior instrumented fusion with pedicle screw fixation for spinal stenosis of L5 and S1 vertebral levels and free fat grafting to cover the exposed dura; three days postoperatively, gradual neurological deficit started with sensory loss and weakness of the affected dermatomes and myotomes followed by FI on the 12th postoperative day; and immediate removal of the fat graft resulted in recovery from cauda equina syndrome. Another case was reported by Tubbs [280]; a Caucasian girl who had idiopathic growth hormone deficiency and Klippel-Feil and Duane's syndromes with symptomatic stenosis of the first cervical vertebrae presented with episodes of loss of tone with subsequent falling, facial cyanosis, UI, hand weakness, and difficulties with swallowing; following suboccipital craniectomy and the removal of the posterior arch of the atlas, her symptoms were resolved and UI improved.

9.1. Disease specific diagnosis

To demonstrate narrowing of the lumbar canal with compression of the cauda equina, CT or MRI is often recommended, to reveal either bony or soft tissue compression [281]. Miyata and colleagues [282] studied the relationship between bladder function and roentgenographic changes in the spinal canals of ossification of posterior longitudinal ligament (OPLL) patients. CO₂-filling cystometry, uroflowmetry and PVR were measured and the vertical extent of OPLL and the degree of SCS was estimated by X-ray films and CT. The occurrence of abnormal detrusor activity had no relationship to the degree of canal stenosis, while the occurrence of an areflexic or underactive detrusor correlated with the vertical extent of OPLL. Yamanishi et al. [283] found DO in 14 lumbar canal stenosis patients (29%) and most of them had voiding symptoms and had storage symptoms which seemed to be caused by the irritation of sacral roots.

9.2. Disease specific management

Of 10 patients followed up after surgical decompression, DO disappeared in 5 patients, improved in 1 patient and remained unchanged in 4 patients [283]. Lee and colleagues [284] did an expansive cervical laminoplasty in patients with non-traumatic cervical spondylosis with myelopathy and found that age greater than 60 years at the time of presentation, duration of symptoms more than 18 months prior to surgery, preoperative bowel or bladder dysfunction, and lower-extremity dysfunction were associated with poorer surgical outcome.

Conclusions

- Patients with spinal stenosis, especially at lumbar levels, may present with bladder and bowel involvement – urinary retention/ incontinence and faecal incontinence (LOE 3/4)
- Lumbar canal stenosis may cause either detrusor underactivity/acontractility or overactivity (LOE 3)
- Imaging helps diagnose spinal stenosis, while urodynamic study categorises neurogenic bladder dysfunction (LOE 3/4)
- Acute symptoms of incontinence or urinary retention may recover after decompression of spinal stenosis (LOE 3/4)

Recommendations

- Surgical decompression is recommended in patients with spinal stenosis having acute symptoms of urinary retention/incontinence and faecal incontinence (A)

10. CAUDA EQUINA SYNDROME

There can be some confusion related to this syndrome. An anatomical discrepancy lies in the fact that the vertebrae and the nerve roots do not correspond all the way down to sacrum. The spinal cord terminates at the level of L1 vertebrae and there is thick column of nerves below this level resembling a horse tail, hence the term “cauda equina” has been coined to describe this arrangement. Damage to these nerve roots produces a characteristic pattern of symptoms called the cauda equina syndrome, which can entail pelvic floor dysfunction in all 3 compartments (including bladder, bowel, sexual abnormalities).

Central lumbar disc prolapse compresses sacral nerve fibers to and from the bladder, the large bowel, the anal and urethral sphincters, and the pelvic floor. Cauda equina syndrome due to central lumbar disc prolapse is relatively rare, the incidence being from 1 to 5% of all prolapsed lumbar disc [285-287]. An annual incidence of 3.4 per million and a prevalence of 8.9 per 100,000 population has been reported. It has been suggested that damage to cauda equina is more common in middle aged men whilst in younger patients it was the conus lesion that was more prevalent [288].

The common causes of cauda equina syndrome are summarised in **Table 15** (below). It is thought that spinal fracture in young men, disc herniations in middle aged and spinal operations in elderly are the main factors leading to cauda equina syndrome (CES) [288].

Table 15. Causes for cauda equina syndrome

Compressive	Noncompressive
Central prolapsed intervertebral disc*	Ischemia- spinal AV malformation causing steal syndrome
Trauma- vertebral fracture*	iatrogenic- spinal surgery*
Tumour- primary, metastatic	Following spinal anaesthesia- rare*
Spinal canal stenosis	Inflammation
Pott's disease- tuberculosis	
Abscess	

***Can present acutely**

10.1. Pathology and disease specific LUT problems

There can be a diverse presentation of CES. This includes low-back pain, bilateral sciatica, saddle anaesthesia, and urinary retention, loss of urethral sensation as well as constipation and erectile dysfunction [286, 289]. Those patients with cauda equina syndrome usually have some sensory disturbance in the sacral dermatomes. A retrospective cohort study with prospective clinical follow-up showed that bowel dysfunction at presentation was associated with sexual problems at follow-up [290].

The most common urinary symptom associated with lumbar disc prolapse is acute urinary retention [291]. At the onset, acontractile detrusor with impaired bladder sensation is a typical urodynamic finding [291, 292]. Severe denervation of pelvic floor [291] and external urethral sphincter is also frequently demonstrated. Detrusor overactivity may occur [283, 291]. Urinary disorders usually follow or accompany more obvious neurologic symptoms, such as lumbar pain and perineal sensory disturbances that prompt the appropriate diagnosis. However, sometimes voiding disturbances may be the only or the first symptom of this condition, which makes it more difficult to diagnose. There can be associated bowel disturbances that might be either constipation or faecal incontinence [288].

The presence of sexual dysfunction can be particularly disabling. There is impairment of sexual sensations and this is associated with erectile dysfunction. However, a combination of these two leads to orgasmic dysfunction which becomes the most bothersome symptom in this group of patients [293].

10.2. Disease specific diagnosis

There should be a high index of suspicion in patients who present with the features described above. The presentation can be either in an acute or chronic setting. The acute symptoms manifest generally after disc herniation or post surgery. The classical presentation includes severe sudden bilateral back pain radiating down both lower limbs with numbness and tingling in saddle region and loss of bladder function. However, only a fifth of patients present with these

classical symptoms [294], as in the majority low back pain, sacral sensory loss and some urinary symptoms are more prevalent. Similar to acute presentation, the symptoms are the same in chronic presentation, though the onset is more insidious.

All patients should undergo a detailed neuro-urologic examination. This includes assessment of sensory, motor and reflexes of lower limbs and anal reflexes [288, 295]. There should be an assessment of post void residual. An urgent MRI assessment is recommended in all patients who present with new onset urinary symptoms concomitantly with lumbar back pain or sciatica, because it is impossible in a significant proportion of patients to exclude the diagnosis of prolapsed intervertebral disc in the context of referral with suspected cauda equina syndrome.

In chronic setting the same investigations are required, though probably not with the same urgency. There might be a need to undertake electrophysiological studies to confirm the diagnosis. Additionally urodynamics and anal manometry might be required to establish the bladder and bowel dysfunction respectively [296].

10.3. Disease specific management

Emergency surgical decompression has been reported to increase the chance of satisfactory neurological recovery in patients with cauda equina syndrome due to central lumbar disc prolapse [297-299]. In a meta-analysis of surgical outcomes, a significant improvement in sensory and motor deficits as well as urinary and rectal function occurred in patients who underwent the surgery within 48 hours, compared with those who had the surgery more than 48 hours after the onset of the cauda equina syndrome [299]. Although there is still a controversy [290], most other reports support the concept that decompression performed within 48 hours of onset of this syndrome resulted in improved functional outcomes [287, 300]. However, acontractile detrusor is usually irreversible, even after immediate decompression [301, 302], although many patients can empty their bladder postoperatively, this may be achieved only by straining or changing voiding postures [302]. In contrast to bladder dysfunction, urethral function shows a better recovery after surgery [303].

The management of pelvic floor dysfunction in an established CES patient requires careful support. The patient needs to start self-catheterization if there is significant residual urine. The patient should be encouraged to relax to pass urine and avoid straining. They need to be monitored with urodynamics owing to the unpredictable nature of recovery [304]. Similar to bladder, the bowel management needs to be optimised according to the individual patient dysfunction. The constipation is relatively easier to control compared to faecal incontinence [296]. The erectile dysfunction can be treated with oral medications but there is no specific treatment available for sensory impairment.

The patients could be put in touch with support groups like www.caudaequina.org

10.4. Research for Cauda Equina Syndrome

For future research, good epidemiological studies on the occurrence of pelvic floor dysfunction are needed. This is increasingly relevant with the advent of new, minimally invasive treatment options for disc prolapse.

Conclusions

- Cauda equina syndrome is a relatively rare complication of lumbar disc prolapse (LOE 3)
- Bladder and bowel manifestations of lumbar disc prolapse include: urinary retention, loss of sensory functions, decreased sexual functions (LOE 3)

Recommendations

- Emergency surgical decompression is the treatment of choice: the optimum timing is considered to be within 48 hours (Grade B/C)
- Full recovery of lower urinary tract functions, including bladder contractility, is unreliable (Grade C)

11. TRANSVERSE MYELITIS

This is a clinical syndrome characterized by an immune mediated process leading to neural injury in the spinal cord. There can be a varied presentation with weakness, sensor alterations and autonomic dysfunction. It can also present as part of a multifocal disease of nervous system. Transverse Myelitis (TM) is reported to have an incidence of 1-4 new cases per million, with bimodal peaks between the ages of 10 and 19 years and 30 and 39 years. There is no sex or familial predisposition.

TM is commonly parainfectious. It can occur in connective tissue diseases, infective myelitis, and idiopathic inflammatory demyelinating disorders including MS. It is thought that only true spinal inflammatory processes should be designated myelitis. Myelitis may selectively affect different parts of the nervous system. The inflammatory distribution is termed poliomyelitis when it is confined to the gray matter and leukomyelitis if it affects the white matter. When the entire thickness of the spinal cord is involved, it is called TM. TM can clinically be divided into acute or subacute depending upon the speed of onset of symptoms and signs. These can affect any of the motor, sensory or autonomic nerves. As a general rule there is well defined upper border of sensory dysfunction.

Lumbar puncture and spinal MRI will usually show signs of acute inflammation. At the height of inflammatory condition about half of patients lose all movements of their legs with almost all having bladder dysfunction. The bladder symptoms are generally a combination of storage and voiding with urgency, difficulty to empty. Additionally, there can be associated bowel dysfunction. The Transverse Myelitis Consortium Working Group has proposed diagnostic criteria looking at motor, sensory, and autonomic dysfunction [305]. The diagnostic criteria include presence of symptoms attributable to spinal cord inflammation, a defined sensory level, and presence of immunoglobulin G with progression to nadir between 4 hours and 21 days. They also proposed a set of exclusion criteria including a history of previous radiation, and abnormal arterial flow patterns of imaging suggestive of another neurologic disease.

TM can present with a diverse array of clinical neurological manifestations. Bladder dysfunction is common and may be the only consequence of TM. Ganesan and Borzyskowski [306] described urinary tract dysfunction after TM in 10 children, with ages ranging from 8 months to 16 years. Nine of 10 children had voiding symptoms and all developed storage symptoms within a month of presentation. Videourodynamics showed a combination of detrusor overactivity and detrusor sphincter dyssynergia (DSD) in most patients. With a median follow-up of 36 months, all had residual bladder dysfunction, with only four being asymptomatic. The degree of bladder recovery was not related to the motor recovery.

In another study Cheng et al. [307] reviewed the long-term urological outcome of 5 children with TM over 15 years. The median length of follow-up was 5 years (2–10 years). Four children recovered completely from paresis; two had no urinary symptoms with normal voiding. However, follow-up urodynamics 3 years later revealed that four out of the five children, including one without any urinary symptom, had residual bladder dysfunction.

Leroy-Malherbe and colleagues [308] studied 21 children at the mean age of 8 years. Bladder dysfunction was present in 85% at presentation. Complete regressive course was noted in 38% of patients, minor sequelae in 39%, and major sequelae after 6 months in 23%. No upper tract deterioration was noted after 3 years. Factors of favourable prognosis were early motor function recovery and early management of bladder dysfunction

Kalita et al. [309] evaluated voiding abnormalities in TM and correlated these with evoked potentials, MRI, and urodynamic findings. Patients with TM had a neurological examination and tibial somatosensory evoked potential (SSEP) and motor evoked potential studies in the lower limbs. Urodynamic studies showed an acontractile or hypocontractile bladder in 10, detrusor overactivity with poor compliance in two, and DSD in three. Persistent abnormalities included detrusor overactivity, dyssynergia, and acontractile

bladder. The urodynamic abnormalities correlated with muscle tone and reflex changes but not with sensory or motor evoked potentials or MRI signal changes.

Sakakibara et al. [310] reported 10 patients with TM. Seven patients had urinary retention and three patients had voiding difficulties within 1 month after the onset of the disease. At 40 months of mean follow-up 9 still had mixed urinary symptoms.

Berger et al. [311] found abnormal detrusor function in all six patients with TM. Computerized tomography scans and myelograms were inconclusive and CSF studies were normal. On recovery the functional outcomes were uniformly good. Bladder abnormalities persisted despite motor recovery. Urodynamic studies revealed DSD in six patients with 2 revealing detrusor overactivity. Sexual dysfunction was reported by 3 men. The authors concluded that prolonged bladder and sexual dysfunction may persist despite a systemic neurological recovery. They recommend urodynamics for initial and follow-up management.

The clinical manifestations of TM is described as a dysfunction of motor, sensory, and autonomic pathways [312]. At maximum deficit, 50% of patients had completely paraplegia with almost all having some degree of bladder dysfunction.

11.1. Treatment of bladder dysfunction in TM

The management of bladder dysfunction is tailored to the abnormality present. The detrusor overactivity and DSD is treated with a combination of antimuscuranics and self catheterization. Persistent overactivity can be controlled with Botulinum toxin A. Monitoring should be undertaken with urodynamics and the management adjusted accordingly.

In longitudinal case series, broadly one-third of patients recovered with little or no long-term sequelae, one-third are left with moderate degree of permanent disability, and one-third has severe disabilities. The predictor of poor outcome is thought to be rapid progression of symptoms, back pain and spinal shock. In a follow-up study Bourre [313, 314] reported on 85 cases to evaluate the rate of conversion to MS as well as predictive factors of long-term disability during a mean follow-up of 8.7 years. They confirmed that presence of oligoclonal bands in the CSF and brain MRI abnormalities increases the risk for conversion to MS. Long-term follow-up of urological function is recommended for all patients with TM.

Conclusions

- Transverse myelitis is an immune mediated process leading to neural injury in spinal cord
- There can be a varied presentation, with weakness, sensor alterations and autonomic dysfunction (LOE 2). It can also present as part of a multifocal disease of nervous system (LOE 2)

- Uniform diagnostic criteria looking at motor, sensory, and autonomic dysfunction have been proposed (LOE 4)
- Presence of defined sensory level and immunoglobulin G with progression to nadir between 4 hours and 21 days is included in the diagnostic criteria (LOE 4)
- Bladder dysfunction is common and may be the only consequence of TM (LOE 2)
- At maximum deficit 50% of patients were completely paraplegic, with almost all having some degree of bladder dysfunction (LOE 3)
- The management of bladder dysfunction is tailored to the abnormality present (LOE 2)

Recommendations

- Uniform diagnostic criteria looking at motor, sensory, and autonomic dysfunction should be used (GR 3)
- The management of bladder dysfunction should be tailored to the abnormality present (GR 2)
- Long-term follow-up of urological function is recommended for all patients with TM (GR 3)

12. NEUROPATHIES AND MUSCLE DISORDERS

12.1. Guillain Barre syndrome

Since the eradication of poliomyelitis, Guillain-Barré syndrome (GBS) has become the most common cause for acute, flaccid paralytic disease in many parts of the world [315]. It presents as a rapidly progressing ascending areflexic motor paralysis, with or without sensory and autonomic dysfunction. Following an initial acute progressive phase, which by definition reaches a nadir within four weeks, there is a plateau phase and finally a recovery phase. Symmetrical limb weakness is the common presentation, however there may be in addition cranial nerve and respiratory muscle weakness. The disorder affects children and adults of all ages and both sexes. GBS is amenable to treatment with intravenous immunoglobulin or plasma exchange. However despite this, 4% to 15% of patients die from this syndrome, most often due to cardiovascular autonomic disturbances, respiratory compromise or aspiration. Nearly 20% have persistent disability [316].

Autonomic dysfunction is a frequently-overlooked complication. Cardiovascular autonomic dysfunction is recognized in up to 60% of GBS patients [317]. However, bladder and bowel dysfunction occurs much less often. Indeed, the presence of bladder or

bowel symptoms at the onset of disease, or their persistence, casts doubt on the diagnosis, so that other conditions, such as spinal cord disease, need to be excluded. During the acute phase, it is often difficult to assess LUTD specifically due to neurological dysfunction. Patients are often catheterized as part of their general nursing care to monitor water balance or maintain hygiene [316]. Furthermore, patients may be on medications such as opiates and tricyclic antidepressants, which in themselves can affect bladder and bowel functions. In the largest study to date, Sakakibara et al. [318] studied 65 patients with definite GBS (meeting clinical and neurophysiological criteria) and LUTD was observed in 27.7% (LOE3/4). This figure is similar to that quoted by Guillain and others in the early papers [319]. The condition is characteristically a symmetrical radiculo-neuropathy predominantly due to demyelination (Acute Inflammatory Demyelinating Polyradiculoneuropathy, AIDP), but also there are subtypes where axonal damage prevails (Acute Motor Axonal Neuropathy, AMAN). There is a dearth of systematic studies evaluating LUTD in GBS. In a few reports [320, 321], detrusor areflexia and disturbed bladder sensation were the common findings, and a non-relaxing urethral sphincter was also seen (LOE3/4). In the study by Sakakibara et al. [318], patients most commonly reported voiding symptoms in 24.6%, including urinary retention in 9.2%. Storage symptoms were noted in 7.7%, urinary urgency in 7.7%. None of the patients in this study became incontinent. Urinary dysfunction was more common in AIDP (39%) than AMAN (19%), although the prevalence of urinary retention was almost the same (AIDP, 7%; AMAN, 11%). Factors that were associated with bladder symptoms included age, severity of motor weakness (Hughes motor grade) and concurrent bowel dysfunction. When patients were followed up, improvement in bladder symptoms paralleled improvement in motor weakness. Interestingly, there was no correlation between the presence of cardiovascular autonomic dysfunction and bladder dysfunction.

Urodynamic studies performed within eight weeks of disease (n=9) showed variable results, demonstrating detrusor underactivity (n=2), DO (n=3), both DO and underactivity (n=5) and non-relaxing urethral sphincter (n=2). Three patients had an elevated post void residual and one patient had reduced bladder sensations [318] (LOE3/4). Their results were similar to the urodynamic findings from Gabavac et al. [321](LOE3/4).

Urinary dysfunction in patients with GBS tends to appear after the onset of motor weakness. However, in two patients with axonal GBS, it was reported that voiding difficulty and motor weakness appeared almost simultaneously [322, 323] (LOE3/4). A close relationship between severity of GBS and bladder dysfunction has been reported (LOE3/4). Lichtenfeld [324] (LOE3/4) has reported urinary retention in one-third of patients requiring ventilator assistance. Even though up to 11% of GBS patients may develop urinary retention at the peak of motor weakness, it will

most often improve along with other neurological signs after supportive patient management, with or without immunomodulation. However bladder dysfunction can persist, and it is reported that urinary retention failed to recover for 10 months, even after a patient (with axonal GBS) regained the ability to walk [323] (LOE3/4).

GBS primarily affects the large myelinated fibers, but pathological studies have demonstrated moderate to severe loss of small myelinated fibers and inflammatory cell infiltration in the lumbosacral spinal roots, sympathetic chain, and spinal cord [315]. It has been postulated that LUTD in GBS may be arising from inflammatory or immunologically mediated damage of the autonomic fibres of the lumbosacral nerves [315] (LOE3/4). Contrast magnetic resonance imaging (MRI) has demonstrated enhancement of the nerve roots of the cauda equina in GBS [325] (LOE3/4). The possible mechanism for DO might be abnormal spontaneous depolarisations in demyelinated nerve fibres, and impairment of inhibitory spinal cord interneurons, both of which can result in lumbosacral autonomic hyperactivity [326] (LOE3/4).

12.2. Treatment of bladder dysfunction after GBS

Management of LUTS is essentially supportive. Patients complaining of LUTS should have their post-void residual checked regularly during the progressive phase of the disease. If retaining urine, an indwelling catheter may be preferable during the acute phase. The need for catheterisation should be reviewed regularly as voiding dysfunction can recover in parallel to recovery of motor weakness, but in some cases this might be delayed. If suitable, IC should be considered. Wosnitzer et al. reported a successful case of sacral neuromodulation for urinary retention that persisted 18 months after GBS [327] (LOE3/4). Patients with overactive bladder symptoms are likely to benefit from an antimuscarinic medication once it is shown they are not retaining urine. Of specific consideration to GBS is the side effect of tachycardia, as many patients may have concomitant cardiovascular autonomic dysfunction.

Follow-up and further research

There are only limited studies evaluating the natural history of LUTD in GBS and long-term follow-up studies of patients are required. Studies evaluating the correlation between LUTD and other evidence for autonomic dysfunction (such as cardiovascular autonomic dysfunction) should be specifically evaluated.

Conclusions

- In the acute phase of GBS, about 25% of patients demonstrate LUT functional problems (LOE3/4).
- Both voiding and storage dysfunction are observed in GBS (LOE3/4).

- Recovery of LUT function occurs along with the recovery of motor weakness. However, in rare cases it might take months (LOE3/4).

Recommendations

- Recovery of LUT functions is expected in GBS; supportive care, including an indwelling catheter or IC, is the treatment of choice for urinary retention (C).
- Patients with overactive bladder symptoms are likely to benefit from an antimuscarinic, once they are shown not to be retaining urine.
- A systematic evaluation of LUTD during the acute phase and recovery following GBS is required to optimize therapy (C).

12.3. Bowel Dysfunction in GBS

Bowel dysfunction occurs less commonly in GBS, in up to 15% of patients [328] (LOE3/4). Adynamic ileus was noted in 17 out of 114 GBS patients. However, cardiovascular symptoms coincided with ileus in only 5 patients, suggesting a different pathophysiology for these two manifestations of autonomic dysfunction. Indeed in 4 patients, mechanical ventilation and immobilization was implicated. In 8 patients, pre-existing conditions such as prior abdominal surgery or incremental doses of opiates could also be linked to ileus. However, case reports by Gazulla Abio et al. (LOE3/4) [329], Sawai et al. (LOE3/4) [322] and Nowe et al. (LOE3/4) [330] have also shown that paralytic ileus can be the initial presenting symptom in GBS.

There is a lack of good systematic studies on bowel disorders in GBS during the acute and chronic phase of GBS. However, there are some reports suggesting an involvement of bowel autonomic fibres in GBS. Sawai et al. (LOE3/4) [322] performed a detailed bowel function test in a 47-year-old man with acute motor axonal neuropathy (AMAN) type of GBS who presented with ileus (also called intestinal pseudo-obstruction) by an abdominal X-ray. Sitzmarks showed prolonged total colonic transit time (86.4 hours; normal 16.0-48.0), suggesting slow transit constipation. Pathological studies of GBS have revealed moderate to severe loss of small myelinated fibers and inflammatory cell infiltration in the lumbosacral spinal roots, sympathetic chain, and spinal cord. Therefore, involvement of bowel autonomic fibers might also occur in GBS.

Adynamic ileus or intestinal pseudo-obstruction occurs in up to 15% of patients during a course of GBS, particularly in those with severe motor dysfunction. Recovery of bowel function usually occurs along with the recovery of motor weakness in GBS, after an intensive immune therapy including intravenous immunoglobulin. There is still a lack of a detailed functional evaluation of the bowel in GBS patients. Such studies are needed in order to optimize the therapy in the future.

Conclusions

- About 15% of patients demonstrate bowel functional problems particularly in the acute phase, but they can also be presenting symptoms (LOE3/4).
- Constipation and intestinal pseudo-obstruction are observed in GBS (LOE3/4).
- Recovery of bowel function usually occurs, along with the recovery of motor weakness.

Recommendation

- Supportive care, including laxatives or enemas, is the treatment of choice (C).

13. FAMILIAL AMYLOID POLYNEUROPATHY

Familial Amyloid Polyneuropathy (FAP) is a rare autosomal dominant neuropathy affecting predominately the peripheral autonomic nerves. Neuropathy starts insidiously in the lower limbs and is characterised by lancinating pains, numbness and impaired temperature sensations.

Autonomic manifestations are common and may be the initial manifestation in nearly 25% of patients [331] (LOE3/4). These include erectile dysfunction, orthostatic hypotension, bladder dysfunction, distal anhidrosis and abnormal pupils. LUTS generally appear early on and are present in 50% of patients within the first three years of the disease. Patients most often present with voiding dysfunction and incontinence (LOE3/4). Often, however, bladder dysfunction may be asymptomatic and uncovered only during investigations. Urodynamic studies have demonstrated reduced bladder sensations, underactive detrusor, poor urinary flow and an open bladder neck. There may be failure of relaxation of the smooth and striated sphincters as well. Ultrasound scans of the bladder may show bladder wall thickening, a finding which becomes more prominent as the disease progresses, and may represent either amyloid deposition in the bladder wall or detrusor hypertrophy secondary to functional obstruction (LOE3/4). 10% of patients with FAP type I may proceed to end stage renal disease [332] and bladder diaries may demonstrate global polyuria. Bladder dysfunction is likely to be due to small nerve fibre damage and deposition of amyloid substance in the detrusor muscle.

Treatment of bladder dysfunction in FAP requires that patients should be followed up regularly, as over-distention is likely to contribute to bladder dysfunction. In the early stage of disease, post-void residual urine will often be less than 100 ml and bladder scheduling and double voiding is often

sufficient. However when bladder emptying deteriorates, intermittent catheterization is required.

Lower gastrointestinal dysfunction results in alternating constipation and diarrhea. This occurs concomitantly with other manifestations such as episodic nausea, vomiting, and malnutrition. Anorectal physiology studies have demonstrated prolonged colonic transit time, low anal pressure at rest and loss of spontaneous phasic rectal contractions during squeeze, suggesting an enteric neuropathy [333] (LOE3/4).

Liver transplantation remains the only potentially curative treatment and gastrointestinal symptoms improve in about half of cases [331]. Studies suggest that bladder dysfunction does not improve following transplantation [334] (LOE3/4). Interestingly, the occurrence of urinary incontinence pre-operatively appears to predict higher post-operative mortality [334].

14. FAMILIAL DYSAUTONOMIA

Familial dysautonomia (FD) or Riley-Day syndrome is the best known of the hereditary sensory and autonomic neuropathies (HSAN). This autosomal recessive condition is characterised by autonomic and small fibre sensory dysfunction.

LUTD occurs in this condition and patients most often present with incontinence, which is mainly stress incontinence, but also overactive bladder symptoms. The limitation of using antimuscarinics is that it can exacerbate an already dry mouth from the underlying autonomic neuropathy. Less often, patients may have voiding dysfunction manifesting with hesitancy for micturition and high post-void residual volumes, and may be predisposed to recurrent urinary tract infections [335] (LOE3/4).

15. CHARCOT-MARIE-TOOTH DISEASE

In a questionnaire based study, bladder and bowel complaints were significantly higher in patients with Charcot-Marie-Tooth disease compared to healthy controls [336] (LOE3/4). Lower urinary tract dysfunction has been reported in a family with proximal lower limb weakness, where it manifested as loss of bladder sensations and urinary retention with detrusor underactivity demonstrated in urodynamics. A hypotonic bladder was reported in urodynamics in a patient with parasympathetic dominant autonomic dysfunction in Charcot-Marie-Tooth Disease Type 2J with the MPZ Thr124Met Mutation [337].

16. AUTONOMIC NEUROPATHIES

A number of autonomic conditions can lead to pelvic floor dysfunction in general and bladder dysfunction in particular. Some conditions are:

1. *Acute Idiopathic Autonomic Neuropathy.* Bladder dysfunction is well recognized in acute idiopathic autonomic neuropathy (acute pandysautonomia). Acute onset autonomic dysfunction is the hallmark, and is thought to be due to lesions of the pre- and postganglionic sympathetic and parasympathetic fibres. Urinary retention and voiding difficulty are common and cystometry demonstrates detrusor areflexia. Bladder dysfunction tends to resolve earlier than other features of autonomic dysfunction, such as orthostatic hypotension. Constipation is common [338] (LOE3/4).
2. *Autoimmune Autonomic Ganglionopathy.* Presentation is with rapid onset of severe autonomic failure: orthostatic hypotension, gastrointestinal dysmotility, anhidrosis, bladder dysfunction, erectile dysfunction and sicca symptoms. Impaired gastrointestinal motility manifesting as gastroparesis and severe constipation is reported in nearly 70% of patients. Bladder dysfunction generally manifests with voiding difficulty and incomplete emptying. Severity and distribution of autonomic dysfunction appear to depend upon the level of antibody titers [339] (LOE3/4). Roughly 50–60% of patients with Autoimmune Autonomic Ganglionopathy have circulating antibodies to the $\alpha 3$ subunit of the ganglionic acetylcholine receptor (AChR) in the acute or subacute stage.
3. *Pure Autonomic Failure.* PAF is a degenerative postganglionic autonomic disorder. Nocturia and voiding dysfunction are common and bladder emptying is often affected. Bladder diaries may demonstrate nocturnal polyuria. Urodynamics may however demonstrate detrusor overactivity in some patients [340]. Bladder dysfunction in PAF appears to be as common as, but less severe than, MSA and this could possibly reflect slower progression of the disease [340] (LOE3/4). Constipation is common.

17. DISORDERS OF THE NEUROMUSCULAR JUNCTION

Widespread autonomic dysfunction is a hallmark of Lambert-Eaton myasthenic syndrome (LEMS). This is associated with antibodies to voltage-gated calcium channel (VGCC) of the P/Q-type and patients can present with erectile dysfunction, constipation and bladder dysfunction [341].

In the more common disorder of the neuromuscular junction, myasthenia gravis, LUTS are rare. This is

presumably because the auto-antibodies are directed against the nicotinic acetylcholine receptors, rather than the muscarinic. However voiding difficulties have been reported and urodynamic studies have revealed detrusor underactivity in these patients. In fact, voiding dysfunction may herald a new diagnosis of myasthenia or an exacerbation of the disease process [342] (LOE3/4). The proposed mechanism is involvement of acetylcholine receptors in the detrusor muscle or pelvic ganglia. Ganglionic acetylcholine receptor antibodies may be present in some patients [343]. Urinary incontinence is a listed side effect of anticholinesterase medications which are used in treating myasthenia gravis [British National Formulary (online)], though in clinical practice this is rarely observed. Intestinal pseudo-obstruction has been reported in patients of myasthenia gravis with subacute autonomic failure.

18. MUSCLE DISORDERS

18.1. Muscular Dystrophies

Case series in boys with Duchenne Muscular Dystrophy (DMD) [344] have reported the occurrence of overactive bladder symptoms, and DO has been demonstrated in urodynamics. Symptoms improve with antimuscarinic medications in Becker's muscular dystrophy [345]. The exact mechanism for DO is uncertain, though it is likely to be due to a disturbance of neural control rather than myopathy of the detrusor or external sphincter. Patients may have severe scoliosis as a consequence of their muscle disorder and this, as well as spinal fusion surgery for correcting scoliosis, can contribute to LUTS because of spinal cord compression. The commonest genitourinary complaints reported in a population based study of males with Duchenne and Becker muscular dystrophy were urinary tract infections, voiding dysfunction (most commonly urinary retention) and renal calculi [346].

Urological and gastrointestinal dysfunction are reported by patients with dystroglycanopathies more commonly than household controls and can negatively impact quality of life [347].

Myotonic dystrophy (MD) is an autosomal dominant disorder caused by unstable trinucleotide repeat expansions. Urinary and bowel complaints are commonly reported, more often in women [348]. The commonest bowel complaint is constipation, however most disabling is fecal incontinence. EMG has demonstrated myotonia and myopathic changes in the external anal sphincter. Bowel incontinence is often refractory to treatment and procainamide (300 mg twice a day) has been proposed as a treatment option [349]. Constipation is usually treated with prokinetics, laxatives and enemas. Bladder dysfunction is variable and less often reported with detrusor overactivity or atonia being documented in urodynamics [350] (LOE3/4).

18.2. Mitochondrial cytopathy

Mitochondrial neurogastrointestinal encephalomyopathy (MNGIE) is a rare autosomal recessive disorder characterized by gastrointestinal, extraocular, peripheral nerve and cerebral white matter involvement. The gastrointestinal disease manifests with intermittent diarrhea and pseudo-obstruction. Mitochondrial DNA abnormalities and/or thymidine phosphorylase mutations in the proper clinical setting are diagnostic [351]. Bowel dysmotility has also been reported in Wolfram syndrome (diabetes insipidus, diabetes mellitus, optic atrophy, and deafness, acronym DIDMOAD) [352]. LUTD has been described and may be associated with urinary retention and dilated upper urinary tracts [352] (LOE3/4).

Conclusions

- Lower urinary tract and bowel dysfunction can occur in a variety of neuromuscular disorders (LOE3/4).
- Both voiding and storage dysfunction are observed in these conditions (LOE3/4).

Recommendations

- Patients with neuromuscular disorders with bladder symptoms should be managed according to their symptoms and the findings of urodynamic tests (C).
- LUT and bowel dysfunction can change as these diseases progress and therefore follow-up is recommended (C).

19. PERIPHERAL NEUROPATHY DUE TO IATROGENIC LESIONS (FOCAL NEUROPATHY)

Surgical procedures in the abdomen and pelvis can lead to a variety of pelvic floor dysfunctions. This can occur from damage to the nerves innervating the pelvic organs, anywhere in the course of these nerves through the cauda equina, the spinal nerve roots, the sacral plexus, or to the various individual nerves that arise from the plexus. Most injuries to these nerves are iatrogenic. Extensive pelvic surgery, such as abdomino-perineal resection for rectal cancer, radical hysterectomy, and aorto-iliac surgery are all likely to damage the pelvic parasympathetic nerves to the bladder and genitalia. Of course this listing is not complete and almost any surgery in the pelvis could damage some nerves e.g. adenectomy, radical prostatectomy, prolapse surgery. Additionally, pelvic irradiation, apart from directly affecting the irradiated tissue, could cause damage to the adjacent nerve fibers, resulting in altered functions. A variety of types of voiding, erectile and fecal dysfunctions can result.

19.1. Hysterectomy (simple and radical)

It is difficult to attribute certain dysfunctions to neuronal damage alone, since hysterectomy directly affects static and dynamic functions of the pelvic structures. Parys et al. [353] (LOE 3) studied 126 women after simple hysterectomy. The results show that 47.0% had DO, 36.7% had urethral obstruction and 24.8% stress incontinence. Sekido et al. [354] (LOE 3) described 9 women treated with radical hysterectomy more than 10 years before the study. Voiding symptoms and/or urinary incontinence were observed in 7 patients. Cystometry revealed impaired bladder sensation, detrusor acontractility, straining on voiding, and impaired relaxation of the sphincter in all investigated patients. In addition, decreased bladder compliance was observed in 5 patients. Axelsen [355, 356] (LOE 2) studied 100 women after radical hysterectomy and found that those women who reported incontinence had lower urethral pressure. In a prospective study of over 1000 women Jackson et al. found hysterectomy to be an independent risk factor of incontinence [357] (LOE 2). Plotti et al. analysed literature between 1952 and 2010 and found that in studies with follow up longer than 12 months, 34% of patients demonstrated DO and lowered compliance [358] (LOE 2).

The introduction of nerve sparing hysterectomy appeared to reduce urinary and sexual dysfunctions in comparison with the standard radical hysterectomy. It was found that autonomic nerve preservation significantly improved morbidity 6 months after treatment [359-362] (LOE 3). There is, however, significant lack of long term observations of patients after radical hysterectomy in terms of lower urinary tract neurogenic dysfunctions.

19.2. Abdominoperineal resection and total mesorectal excision

Retrospective analysis of 52 patients after abdominoperineal resection was performed by Eickenberg et al. [363] (LOE 3). Neurologic bladder dysfunction of various degrees was found in 50% but represented a long-term problem in only 10%. Baumgarner et al. [364], (LOE 3) studied 86 consecutive cases of abdominoperineal resection and described 11 cases of various functional problems of micturition. These reports lack specific tests of LUT functions and are not prospective. At 1 year follow up, dysuria incidence is higher after abdominoperineal resection than after anterior resection [364] (LOE 3).

Curative total mesorectal excision with autonomic nerve preservation can be done with high rates of preservation of such function. Pocard et al. [365] (LOE 3) investigated 20 patients (13 men, 7 women) following curative total mesorectal excision with autonomic nerve preservation for rectal cancer. There was no difference in preoperative and postoperative LUT function, International Prostate Symptom Score or urodynamic results, nor in the results of the quality of urinary function questionnaire. Sexual function and

potency were also unchanged in these men. The authors conclude that autonomic nerve preservation is possible and does not impair urinary and sexual function. Kim et al. [366] (LOE 3) also showed relative safety in preserving sexual and voiding dysfunction in total mesorectal excision with pelvic autonomic nerve preservation. Evaluation was based on uroflowmetry, voided volumes and residual volume, while symptoms were evaluated with the IPSS. There were significant differences in maximum urinary flow rate and voided volume, but no differences in residual volume before and after surgery. The IPSS increased after surgery from 6.2 +/- 5.8 to 9.8 +/- 5.9 ($p < 0.05$).

Similar results were reported by Turaldo et al. [367] (LOE 3) evaluating incidence and pathogenesis of LUT dysfunction after surgical treatment of rectal cancer in a series of 219 patients with normal urinary function pre-operatively. In the immediate follow-up, only 17 patients with dysfunction were observed, 14 stage II, 2 at stage III and 1 at stage IV according to Astler-Koller classification; six months later only 8 patients reported urinary dysfunction and 1 required catheterisation. However no urodynamic studies were performed. There was no correlation of LUT dysfunction with staging, radiotherapy, size of tumour, or surgical technique. However, worse functional results were observed in patients who underwent abdomino-perineal resection.

Lim et al. found that not only surgery but also pre-operative intervention could cause lower urinary tract and anorectal dysfunctions [368]. The maximum resting anal pressures were unchanged after chemoradiation, but the maximum squeeze anal pressures were reduced. They concluded that pre-operative chemoradiation for rectal cancer carries a significant risk of pudendal neuropathy, which might contribute to the incidence of fecal incontinence after restorative proctectomy for rectal cancer [368] (LOE 3). However Langer et al. found that the surgery mostly responsible, not the pre-operative radiotherapy [369] (LOE 3).

Focal injury to peripheral innervation of the bladder and/or sphincter results in decentralization or denervation of the above mentioned organs. Therefore detrusor hypocontractility (acontractility) and/or sphincteric deficiency will be the result of such damage. This in turn will result in impaired bladder emptying and/or stress incontinence. No prospective studies referring specifically to the problem of functional disturbances of the LUT in focal iatrogenic neuronal injury in patients after hysterectomy or colorectal surgery have been performed.

Iatrogenic faecal incontinence can be caused by sphincter damage caused by surgery for anorectal problems, trauma, fistulae and abscesses. Vaginal delivery can cause not only sphincteric, but also neuronal damage to the innervation of the anal sphincter [370] (LOE 3). There is a significant paucity of epidemiological data regarding fecal incontinence after pelvic surgery.

Anorectal reflexes and anorectal manometry may predict recovery of function [371] (LOE 3). An experimental test in this specific patient population was described by Nordling et al. [372] (LOE 3). In patients after radical hysterectomy, those with significant denervation of the bladder had a greater rise in maximum urethral pressure during noradrenaline infusion (>20 cm H₂O) than normal subjects (1-15 cm H₂O). They concluded that urethral supersensitivity to noradrenaline may signify damage of the sympathetic innervation of the LUT.

19.3. Radical Prostatectomy

In a study of the 875 patients 19% developed de novo OAB following RP [373]. After adjusting for age, BMI, smoking status, cancer stage and nerve-sparing status, radiation therapy was associated with an increased relative hazard of OAB. Among men classified with de novo OAB, only 41% received treatment. Post-radical prostatectomy urinary incontinence continues to be one of the most devastating complications, which affects 9-16% of patients. Sphincter injury and bladder dysfunction are the most common causes of developing urinary incontinence.

19.4. Prevention and treatment of bladder dysfunction

Reduction of risk requires detailed knowledge of pelvic neuroanatomy and meticulous preparation of the structures adjacent to nerves potentially at risk [374-377] (LOE 3). Nerve sparing surgery seems to have favourable effect on bladder functions and continence in patients after radical hysterectomy [359, 376, 378] (LOE3). Thus it seems that it is the nerve function, rather than the biomechanics of the urethrovesical complex, which are responsible for incontinence. A method of intraoperative identification of the vesical branches of the pelvic nerves during radical hysterectomy was described by Kuwabara et al. [379] (LOE 3). Postoperative compliance of the detrusor in cases where this method was implemented demonstrated less decrement from pre-operative values than in cases with conventional approaches. These patients required significantly fewer days to achieve residual urine volumes less than 50 ml after surgery.

Nerve sparing technique and intra-operative identification of parasympathetic nerves seem also to play a role in rectal cancer surgery. Kneist and Junginger studied 62 patients undergoing mesorectal excision [380]. Pelvic autonomic nerve preservation was assessed macroscopically and with the aid of intra-operative electrical stimulation of pelvic autonomic nerves. In 46 patients, preservation of parasympathetic nerves was confirmed and these patients remained unchanged in early and long-term urinary function, contrasting with patients in whom preservation of the nerves was not confirmed [380] (LOE 3).

Should injury to the nerves innervating the bladder/urethra complex occur, the treatment should be based on standard principles and on the results of functional examination of the LUT. Zanolla et al. [381]

(LOE 2) suggested that early implementation of rehabilitative treatment (prompted voiding) allows satisfactory functional recovery of the bladder activity in 91% of the symptomatic patients after radical hysterectomy. Another interesting issue is the feasibility of the use of the artificial urinary sphincter to treat stress incontinence in patients with outlet denervation after colorectal surgery, hysterectomy and/ or radiotherapy. Only one study on this subject was identified [382] (LOE 3), describing a series of patients after radical prostatectomy and amongst them a patient after abdominoperineal resection with adjuvant radiation. The authors concluded that this method of incontinence therapy should be the method of choice, however there is a significantly greater risk of revision (38% versus 22% in the literature for low risk groups). Bulking agents may be considered after radical hysterectomy, if no other treatment options are possible. If not resulting from sphincter damage, fecal incontinence after colorectal surgery might be considered for sacral neuromodulation [383] (LOE 3).

19.5. Future research

Future research priorities include good epidemiological research, particularly prospective studies of the true incidence of peripheral injury-related functional disorders of micturition. Descriptive studies of diagnostic testing and therapy are needed. A registry database of urinary and fecal incontinence after different types of pelvic surgery would be a considerable benefit for insight into prevalence and preparation of guidelines on treatment/prophylaxis

Conclusions

- Injury to the bladder/sphincter innervation occurs in 30-50% of patients after extensive pelvic surgery (LOE 3)
- Pelvic irradiation could cause nerve damage affecting bladder and/ or bowel functions (LOE 2).
- Fecal incontinence due to iatrogenic innervation damage could occur after complicated labour, anorectal surgery and pelvic irradiation (LOE 3)
- Focal injury results in impaired detrusor contractions and/ or external urethral sphincter deficiency or detrusor sphincter dyssynergia (LOE 3-4)
- The key means to avoid these complications are nerve sparing techniques and intra-operative nerve identification (LOE 3)

Recommendations

- Patients after extensive pelvic surgery demonstrating functional disorders of micturition should be properly evaluated due to the varied potential underlying mechanisms (C)
- Early rehabilitation of the LUT and of the anal sphincter might improve function in a majority of patients (C)

- Treatment of choice for acontractile bladder in this group remains intermittent catheterization (B)
- Autonomic nerve preservation should be considered when performing surgery for rectal cancer. Targeted voiding history before and after surgery and post-operative post-void residual urine measurements are mandatory to minimise risk of secondary detrusor damage through chronic urinary retention (B)

20. MULTIPLE SCLEROSIS

20.1. Epidemiology

Multiple sclerosis (MS) is the commonest progressive neurological disorder in young people, with a mean age at onset of 30 years, and a prevalence of 40-220 cases per 100,000 people in Europe [384-386], with similar rates in North America [387, 388]. The impact on the quality of life for patients with lower urinary tract dysfunction (LUTD) due to MS is significant. In a cross-sectional study, Nortvedt et al. [389] demonstrated that patients with LUTD had distinctly lower quality of life scores on the SF36 scale in comparison with the population of MS patients that is asymptomatic. The tools for evaluating quality of life taking into account LUTD in MS have been validated, so that variations in it over the course of the illness can be measured [390-392].

LUTD is multifactorial, and typically appears within the first 6 to 10 years of the progression of the illness [393-398]. Once LUTD has started (for 10% of cases LUTD is a primary feature [384]), they will present an increased risk of developing severe urological problems [399].

The prevalence of LUTD in patients with MS is in the order of 30 to 96% [6-8, 10, 11, 13, 14, 16-32]. The range signifies the differences linked to the type of MS, to the duration of the illness, and to the degree of handicap, as well as to a probable under-evaluation by certain practitioners of any urological problems that develop progressively and slowly.

20.2. Urinary tract dysfunction in MS

Symptoms of the storage phase are most frequently reported: urinary frequency (38 to 99%), urgency (26 to 82%), and urgency incontinence (27 to 66 %) [384, 395, 397, 398, 400-402]. Stress urinary incontinence (SUI) has a prevalence of about 56% and patients often report mixed urinary incontinence [384, 403]. Symptoms of the voiding phase are less frequent with a prevalence of 6 to 49% [384, 395, 398, 401] and symptoms of both the storage and voiding phase co-exist in about 50% of patients [384, 398].

Considering the very high frequency of LUTS, it is important that the most appropriate tools are used to

evaluate the urological problems, especially also taking into account that LUTD is often ignored by the doctors who take care of these patients at least partially due to the fact that the patients under-report their symptoms. It is therefore crucial to identify the groups of patients that are at risk so that complex examinations that are seen as risky are not imposed upon the entire population of patients who are suffering from MS [384, 395]. Short evaluation of LUTD in MS patients by neurologists and appropriate referral to urologists could accelerate proper diagnosis and treatment [404]. Thus, the coordinating role of neurologists in LUTD management may considerably improve quality of life in MS patients [404].

In a systematic review by de Sèze et al. [398], the duration of the progression of MS was one of the principal factors that influenced the prevalence of LUTD. Another important factor associated with LUTD was the degree of the patient's physical handicap as estimated by the Expanded Disability Status Scale (EDSS) [398]. This is also a common sense observation in daily clinical practice, i.e. a patient who can compensate for the urgency by going to the toilet beforehand may see the appearance of urgency incontinence following the appearance of a new motor or visual handicap. The appropriate management of this problem can allow the improvement of urinary disorders without any specific action on the bladder or the sphincter. Similar to patients with spinal cord injury, the clinical examination does not always allow the discovery of the specific neurological insults that are associated with LUTD. In addition, no correlation between radiological insults on the central nervous system (localization and intensity) and LUTD has actually been found [398].

Other factors have been controversially discussed as associated with LUTD, such as the type of MS progression (progressive or by crisis), the age at which MS started, sex, age and geographical location where the patient lives [398]. Importantly, older patients with MS will have the same problems as the general population (prostatic enlargement in men and stress urinary incontinence in women), and those problems will of course often be more difficult to treat than in the general population.

Lower urinary tract infections are reported in 13 to 80% (30% in average) [398, 405]. The occurrence of febrile urinary tract infection (pyelonephritis, orchitis, or prostatitis) is estimated at between 2 and 23% (9% on average). In addition to the risk of mortality, an aggravation of MS following an episode of urinary tract infection has been reported [389, 406, 407]. Neurogenic detrusor overactivity is probably a significant factor in the occurrence of upper urinary tract infections. Indeed, intradetrusor injections of onabotulinumtoxinA resulted in a relevant decrease of urinary tract infections [408].

A few studies suggest that the risk for bladder cancer is greater in patients with MS than in the general pop-

ulation, especially in patients under chronic catheterization and having been treated with immunosuppressants (for instance cyclophosphamide) [398, 409]. The overall incidence of bladder cancer in the MS population was 0.29% higher than in the general population (0.018 in men, 0.004 in women) and close to that of patients with SCI (from 0.27 to 9.6%) [398]. The risk for bladder cancer appeared higher in patients with indwelling (transurethral, suprapubic) catheters (incidence 0.7%) and in patients performing intermittent self-catheterisation (incidence 0.23%), with a maximum risk in the sub-population of patients under chronic catheterization having been treated with immunosuppressants (incidence 5.7%) [398, 409]

Complications of the upper urinary tract

Renal calculi were found in 2-10% of the cases, hydronephrosis in 1 to 16% and vesico-uretero-renal reflux in 2 to 15% of the cases [384, 398]. Contrary to patients with SCI and spina bifida, the risk of developing renal failure in patients with MS is generally low [410] and does not appear to be greater than within the general population [411]. However, in patients with MS progressed for more than 10 years, renal failure prevalence as high as 2 to 3% has been reported [384, 399, 412, 413].

Risk factors for urological complications

Although urological complications are less frequently reported in patients with MS compared to those with other neurological disorders such as SCI or spina bifida, they are not rare [384]. Risk factors for urological complications include the MS duration, post void residual, presence of an indwelling catheter, older age, male sex and urodynamic parameters (such as detrusor overactivity, detrusor sphincter dyssynergia, elevated intravesical pressure, low compliance bladder, vesico-uretero-renal reflux) [384, 398, 410, 414].

The role of urodynamics in MS

Urodynamic findings in patients with MS vary widely, and the following findings have reported: detrusor overactivity in 34-91%, detrusor underactivity in ≤37%, low bladder compliance in 2-10%, detrusor sphincter dyssynergia in 5-60%, detrusor sphincter dyssynergia combined with either detrusor overactivity in 43-80% or with detrusor underactivity in 5-9% [384]. Importantly, urodynamic abnormalities can change during the course of disease, pathological findings may be identified in asymptomatic patients and symptomatic patients may have normal urodynamics.

The role of urodynamics in MS is a topic of ongoing debate [384, 410]. Guidelines published by the UK National Institute for Health and Care Excellence (NICE) [415], a UK consensus statement (Fowler et al., 2009) and a Turkish consensus statement [386] recommend not to offer urodynamics (i.e. cystometry and/or pressure-flow studies) routinely to MS patients, whereas the International Francophone Neuro-

Urological Expert Study Group (GENULF) recommends using urodynamics in the initial diagnosis [398]. Thus, the inclusion of urodynamics in the routine assessment of patients with MS is determined by the available local guidance [384]. However, urodynamics are generally recommended in MS patients with risk factors predisposing to upper urinary tract damage, in those with concomitant stress urinary incontinence, in those whose symptoms have failed to respond to first-line treatment or if surgical treatment is being considered [384, 416].

Conclusions

- MS is the commonest progressive neurological disorder in young people (LOE 1)
- The most common LUTS in MS are storage symptoms, followed by voiding symptoms and in many patients both storage and voiding symptoms coexist (LOE 1)
- The risk of developing upper urinary tract damage and renal failure is much lower in patients with MS than in those with SCI or spina bifida (LOE 3)
- The role of urodynamics in MS is a topic of ongoing debate (LOE 2)

Recommendations

- Close collaboration between neurologist and urologist are mandatory and appropriate referral to the urologist is strongly recommended to improve quality of life in the MS patient (B)
- Urodynamics are generally recommended in MS patients with risk factors predisposing to upper urinary tract damage, in those with concomitant stress urinary incontinence, in those whose symptoms have failed to respond to first-line treatment or if surgical treatment is being considered (B)

20.3. Colorectal dysfunction in MS

Epidemiology

Digestive disorders are common in patients who have MS, and can have a significant impact on quality of life (LOE4) [389, 392, 417]. What is more, the patients tend to be ashamed of these problems and seldom report them. Clinicians have few tools at their disposal for evaluating this impairment. Consequently, digestive disorders are often undetected (LOE3-4) [413, 418].

Taking into account the great diversity of definitions in the several studies that are concerned with this problem, one is obliged to regroup the digestive symptoms into two large groups: those symptoms that can be defined as "retentive", including abdominal pain, flatulence, and constipation on the one hand, and those symptoms that can be defined as "irritant", including false urges to defecate, diarrhea,

and/or incontinence of stool and/or gas. Digestive disorders of both types were found in 45 to 68% of the cases (LOE 4) [417-422]. The prevalence of the "retentive" symptoms is higher, ranging from 31% to 54%, compared with 6 to 20% for irritant symptoms [417]. The authors who had sought to flush out the more exceptional episodes of incontinence found a frequency of at least one episode of that type in the months that preceded the interview in 29 to 30% of the cases [418, 419]. The figures were clearly more significant than in the general population, where the "retentive" disorders are estimated to be around 2 to 20% and the "irritant" disorders 2% [423].

Risk factors for digestive disorders in MS have not been identified. The duration of the progress of MS does not appear to be a factor that influences the prevalence of digestive disorders. The factor that seems to be the most important is the estimated degree of disability (LOE3c-4) [422, 424]. Thus, Munteis et al. [424] found in a case control study (LOE 3) a frequency of digestive disorders that exceeded 21.2% if the patients had an EDSS between 0 and 1, compared with 78% if EDSS was greater than 4.5. Other risk factors were suggested (LOE4), such as female gender, the existence of related urinary disorders, age, and taking anticholinergic treatments, but they seemed to have an influence that was less clear [417-422] [424].

Pathophysiology of MS-related digestive disorders

Few studies have been carried out specifically in patients who have multiple sclerosis. One of the difficulties is the frequent existence of related treatments that can themselves bring about the specific symptoms. The colonic transit times can be extended or shortened in those patients who present with digestive disorders [425-427]. Several anorectal manometry anomalies were in evidence: reduced tone and compliance, a reduced sensation of filling and incoordination of the external anal sphincter during expulsion, with an onset of the phenomenon known as paradoxical anal sphincter contraction. In patients with faecal incontinence, a decrease in anal canal pressures and hyper-reactivity of the rectal wall have been shown manometrically. In the most recent of these studies, Munteis et al [424] has found that the anomalies that are found the most often are those of maximal sphincter pressure, of anal inhibitory reflex (which occurred later than in the control population), and the presence of paradoxical contraction of the puborectal musculature during straining. These anomalies might be able to allow the proposal of bio-feedback re-education in affected patients. However, at present the benefit of this approach has not yet been proven.

21. SPINAL CORD LESIONS

Spinal cord injury (SCI) can be a devastating consequence of a variety of insults to the spinal column including road traffic accidents, gunshot wounds, surgical injuries, disc lesions or as a result of sports. It can be accompanied by vertebral fractures. Unlike other neurologic diseases, once established the neurologic status generally remains stable.

21.1. Epidemiology and prevalence

SCI epidemiology has evolved over the last three decades. The incidence in women has increased over time. The male/ female ratio is now is 4:1. The mean age at injury is 37.7+/-17.5 years in 2000-2003 [428]. This comprises incomplete quadriplegics (28%), complete paraplegics (26%), complete quadriplegics (24%) and incomplete paraplegics (18%) [429].

There has been a steady improvement in life expectancy and quality of life after SCI. At present, the life expectancy of paraplegic patients is similar to the general population. This has been accomplished by development of multidisciplinary teams, introduction of clean intermittent self-catheterization (CSIC) and an improved and protocol driven follow-up plan.

The SCI is classified using the American Spinal Injury Association (ASIA) impairment (**Table 16**) scale of motor and sensory function [430].

Table 16: ASIA Impairment scale

A = Complete: No motor or sensory function is preserved in the sacral segments S4–S5.
B = Incomplete: Sensory but not motor function is preserved below the neurological level and includes the sacral segments S4–S5.
C = Incomplete: Motor function is preserved below the neurological level, and more than half of key muscles below the neurological level have a muscle grade less than 3.
D = Incomplete: Motor function is preserved below the neurological level, and at least half of key muscles below the neurological level have a muscle grade of 3 or more.
E = Normal: Motor and sensory function are normal.

It separates into 5 clinical syndromes [4] as follows:

- **Central cord syndrome** is most commonly due to hyperextension injury and results in haemorrhagic necrosis of the central gray matter and some of the medial white matter. Arm function is less at risk than legs because more caudal fibers of the corticospinal and spinothalamic tract are localized in the spine more laterally so are better protected. Bladder dysfunction is also less common.

- **Brown–Séquard syndrome** is a unilateral cord condition. It presents as ipsilateral motor weakness and contralateral sensory impairment of pain and temperature. Bladder dysfunction in the pure condition is uncommon.

- **Anterior cord syndrome** is characterized by injury to the anterior aspects of the cord. The posterior columns and dorsal horns are preserved. There is a motor deficit and loss of pain and temperature sensation below the level of the injury.

- **Conus medullaris and cauda equina syndrome** result from damage to the conus and spinal nerve roots, leading to flaccid paraplegia and sensory loss. Sacral reflexes can be partially or totally lost.

It has been proposed to add an additional scale assessing the autonomic function [431] as it is generally impaired in SCI but not assessed in any classification. This scale involves an assessment of general autonomic function, lower urinary tract, bowel, sexual function and an urodynamic evaluation. The impact of SCI on the pelvic organ function constitutes a major part of this classification.

21.2. Bladder dysfunction after SCI

SCI can be divided into two phases; spinal shock and a chronic phase, and can be categorised according to the level of injury.

Spinal shock

Spinal shock is the period just after the injury. It lasts on average three months. It is characterised by loss of muscle tone and segmental spinal reflexes caudal to the SCI. There is detrusor areflexia and the bladder is acontractile but the bladder neck and proximal urethra remains closed. This areflexia cannot be reversed with bethanechol [432]. The only reflex activity that rapidly returns are the anal or bulbocavernosus reflexes. Spinal shock is initially managed with an indwelling urinary catheter. The recovery of bladder function usually follows that of skeletal muscle reflexes. The removal of an indwelling urinary catheter and initiation of self catheterization should be instituted as soon as practical.

Neurogenic Bladder Dysfunction in the chronic phase

Suprasacral lesions

The spinal shock phase is followed by the appearance of a segmental spinal bladder reflex. This relates to emergence of unmyelinated C-fibers afferent function [433]. As a result, some stimuli can come to influence bladder and sphincter activity that were seemingly irrelevant prior to injury [434, 435]. The sacral micturition centre is disconnected from the control of higher centres and produces what is functionally an isolated spinal cord segment. This results in neurogenic detrusor overactivity (NDO) and detrusor sphincter dyssynergia (DSD). DSD is defined as in-

termittent or complete failure of relaxation of the urinary sphincter during a bladder contraction and voiding. It has been reported to occur in 96% of individuals with suprasacral lesions. In addition to DSD, internal sphincter dyssynergia also has been reported, often occurring at the same time as DSD. Patients present with both storage and voiding dysfunction [436]. DSD can manifest with both complete and incomplete lesions. However, complete injuries are significantly more often associated with DSD. This leads to high voiding pressure, dis-coordinated voiding, residual urine and incontinence. If left untreated, this can lead to recurrent urinary infections, hydronephrosis and renal failure. Ambulatory patients with incomplete spinal cord may have significantly less urinary tract dysfunction, but the urodynamic parameters may still be abnormal.

Detrusor-(external) sphincter dyssynergia

Schurch et al. [437] assessed types of DSD in 105 chronic SCI males and evaluated the change in the DSD pattern over time. Results showed that those with an incomplete sensory and motor SCI presented with DSD type 1 whereas those with complete sensory and motor SCI lesion had DSD type 2 to type 3. At medium to long-term follow-up, a significant change was found in the DSD type. Generally, presence of DSD was determined by increased wire needle EMG activity and/or by dilated bladder neck and proximal urethra during detrusor contraction, in the absence of valsalva or attempt to inhibit voiding. De et al. [438] did a comparative study to explore the diagnostic congruence for DSD between needle EMG and voiding cystourethrogram (VCUG) in the neurogenic population. They found 60% agreement and 40% disagreement between EMG and VCUG for diagnosis of DSD. Binomial testing demonstrated significant disagreement in observed proportions. By retrospectively analyzing clinical data consisting of bladder and EAS EMG from 41 SCI individuals with NDO, Wenzel et al. [439] found that the onset of bladder contractions was detected within 1 sec of the start of the EAS contraction for both synergic and dyssynergic human subjects. They concluded that this detection could be used as a control signal to deliver inhibitory electrical stimulation to arrest nascent bladder contractions.

Autonomic dysreflexia

Autonomic dysreflexia (AD) is a clinical emergency in patients who have a SCI, usually at level T6 or above. It is caused by a massive sympathetic discharge triggered by either a noxious or non-noxious stimulus originating below the level of the SCI. The mechanism might be changes occurring within the spinal and peripheral autonomic circuits. There is a loss of inhibitory and excitatory supraspinal input to the sympathetic preganglionic neurons [440] secondary to the destruction of the descending vasomotor pathways.

AD is characterized by severe hypertension and reflex bradycardia, though tachycardia also may occur. An increase in systolic blood pressure greater than 20

to 30mmHg is considered a dysreflexic episode. The other symptoms could be severe headache, feeling of anxiety, profuse sweating, flushing and piloerection above the injury level with dry and pale skin below. It might also cause blurred vision, nasal congestion, cardiac arrhythmias and atrial fibrillation. It can vary in intensity from mild discomfort to life-threatening. Untreated episodes may cause intracranial haemorrhage, retinal detachment, seizures, and death.

The severity of AD symptoms increases with completeness of injury and higher level of lesion (27% of patients with incomplete quadriplegia vs 91% of patients with complete tetraplegia) [441]. The commonest trigger for AD is bladder or bowel distention.

Immediate recognition and reversal of trigger factors is essential [442]. The treatment consists of non pharmacologic interventions; removing the noxious stimulus, emptying the bladder, sitting the patient up, as recommended by the Consortium for Spinal Cord Medicine. If they fail, and systolic blood pressure continues to be at or above 150mmHg in an adult and 130mmHg in a child 6 to 12 years old, some type of pharmacologic agent should be used, usually Nifedipine 10 mgs sublingual.

Infrasacral lesions

In patients with injury to the sacral pathways there is decentralization of parasympathetic pathways to the detrusor with the loss of somatic innervation to the external sphincter. This results in loss of conscious awareness of bladder filling. There is partial preservation of pain sensation transmitted via hypogastric nerves in some people. Patients present with hesitancy, slow and interrupted stream, feeling of incomplete emptying, and are often in retention. The bladder has little or no contractile ability. Nevertheless, because of loss of compliance of the bladder wall, the bladder may still be subject to high intravesical pressure during filling, especially in individuals with conus medullaris lesions or with partial injuries. In the chronic state there is an increase in adrenergic innervation to the detrusor, resulting in change of functional role from beta- mediated adrenoceptor relaxation to alpha-mediated contraction [443, 444]. The sympathetic nervous system supplies the main innervation to the urethra. However, there may be a contribution of the somatic innervation to external sphincter [445, 446]. The perineal floor electromyography shows denervation of the perineal floor and an underactive urethral sphincter in infrasacral cord lesions.

21.3. Natural History of Neurogenic bladder after SCI

SCI usually causes impairments of urinary functions such as urinary incontinence (UI) and/or difficulty in urination. The studies on prevalence of bladder management in chronic SCI [447-449] (see **Table 17**) demonstrate about 8%-11% of patients had normal voiding, not different from the time after initial rehabilitation; and more normal voiding in tetraplegics than paraplegics [449].

According to the study from Denmark [449], at discharge from the initial rehabilitation period of 233 traumatic SCI patients, bladder-emptying methods were as follows: 12% normal voiding, 57% suprapubic tapping, 19% abdominal pressure, 5% Cr  d   manoeuvre, 11% CIC, 2% SIC, 8% urethral indwelling catheter (IDC), 0.4% suprapubic catheter (SPC), 0.4% sacral-anterior-root-stimulation (SARS), and 5% use of condom-catheter or diaper. When dividing the patients by timing of injury (before 1981 and after 1980), there was a decreasing trend of using suprapubic tapping (drop from over 60% to 45%), abdominal pressure (from over 20% to 15%) and Cr  d   manoeuvre (drop from over 12% to 1%) but there was an increasing trend of using CIC (rise from 0% to 26%). Over time, 37.5% to 46% of SCI persons changed their bladder-emptying management; 28%

found their bladder-emptying methods to be a problem; of these 58% were tetraplegic and the biggest bother in bladder management to the subjects was in the compression or straining group (over 50% of the subjects).

There was a significant difference in the frequency of urinary tract infection (UTI) between the bladder management options [447]; the frequency of UTI was high (about 70%) in the mixed group (65% used CIC with other methods) and the CIC group and less (less than 50%) in the groups with catheter free management. According to the study financed by Medicon Valley Academy and Coloplast A/S and done in Denmark, of those using CIC, 92% reported using hydrophilic-coated catheters [449], but there was no report about frequency of UTI.

Table 17. Studies reporting prevalence of specific bladder management methods in chronic SCI

Study (year)	Subjects	Methods of bladder management
Dahlberg et al. [447]	129 traumatic SCI in Finland; mean time since injury 18 years (SD 13)	Normal voiding: 11% Controlled voiding (assisted voiding or incontinence): 12% CIC: 12%; mixed (CIC with other methods):23% Suprapubic tapping 24% Compression or straining (usually with condom catheter): 12% Catheter or conduit: 5%
Hansen et al. [449]	233 SCI in Denmark (82% males, 47% tetraplegics, mean age at the time of follow-up of 50.5 years and mean time since injury of 24.1 years)	46% changed bladder-emptying method Normal voiding: from 12% to 8% CIC: from 11% to 36% SPC: from 0.4% to 6% Suprapubic tapping: from 57 to 31% Crede manoeuvre: from 5 to 19%
Patki et al. [448]	64 traumatic paediatric onset, ambulant SCI (mean follow-up 7 years; mean age 46 years)	Spontaneous voiding: initial 62.5%; 47.5% of them deteriorated CSIC: initial 31.2%; 25% of them improved SPC: initial 6.3% 37.5% required a change in urological management 68.7% had abnormal urodynamics at the last follow-up

In a large prospective cohort study, Drake *et al.* [450] reported the changes in bladder management method with advancing time after SCI, finding that 29% of patients with SCI for at least 20 years changed method over the 6 year period. Podnar *et al.* [296] studied 55 patients with chronic cauda equina or conus medullaris injury: 76% of the patients reported LUT dysfunction, 70% had urinary incontinence (56% of men and 71% of women); and a post void residual (>100 ml) was found in 40% of men and 17% of women. Perianal sensation was abnormal in 96%, electromyography (EMG) of the external anal sphincter (EAS) muscle in 88%, and sacral reflex in 84% of patients; using multiple linear regression analysis, perianal sensory loss and female gender had a significant positive effect on urinary incontinence score.

21.4. Disease-specific LUT mechanisms

Pontari *et al.* [451] analysed 7 bladder specimens from 6 cervical SCI patients and 1 L1 congenital myelomeningocele (MMC) and compared them with bladder specimens obtained from 8 organ transplant donors to determine whether the muscarinic receptor subtype mediating contraction alters, and found that whereas normal detrusor contractions are mediated by the M3 receptor subtype, in patients with neurogenic bladder dysfunction, contractions can be mediated by the M2 muscarinic receptor subtype.

Drake *et al.* found a marked reduction in the range of transmitters expressed in bladder nerves in SCI [452]. Haferkamp *et al.* [453] evaluated the role of neuropeptide Y in 31 patients with NDO and 7 patients with stress urinary incontinence (SUI) and concluded that the reduction of neuropeptide Y-containing nerves, inhibiting the contractile response of the detrusor, may play a role in the development and persistence of NDO in SCI patients. Oner-lyidođan *et al.*

[454] found that urine 8-iso PGF₂α concentrations were significantly increased in SCI, and the lowest concentrations of urinary 8-iso PGF₂α were observed in the areflexic group.

According to the study of viscerosensory pathway of the lower urinary tract (LUT) by Schmid et al. [455], after electrical stimulation (ES) of the posterior urethral mucosa (single square pulses of 0.2 ms, 2 to 3-fold sensory threshold, 60 mA in complete SCI patients), evoked skin sympathetic responses (SSRs) of the hand could be recorded in 14 of 15 sensory incomplete SCI patients with disturbed urethral sensation but not in 13 sensory complete SCI patients with loss of any urethral sensation. Electrically evoked urethral sensations resembled the subjective desire to void at full bladder reported by controls and patients.

Schmid et al. [456] did a comparative study of motor evoked potentials (MEP) and evoked pressure curves (EPC) from the urethral compressive musculature (UCM) in 9 healthy persons and 33 patients with neurogenic UI (15 SCL, 14 cauda equina lesion, and 4 multiple sclerosis). In healthy subjects the central latency was 19.0 msec, the peripheral latency was 4.25 msec, and the ratio between central and peripheral latencies was 4.4. In patients with incomplete SCL, the central latency was significantly delayed (22.7 msec), whereas the peripheral responses were normal, and the ratio (5.5) was increased. Those with a complete SCL showed no UCM reaction after transcranial stimulation, whereas peripheral responses were normal. The increased ratio of 6.0 indicated a spinal cord lesion. Ten patients with incomplete cauda equina lesions and UI had normal central latencies but prolonged peripheral latencies of 6.7 msec; the ratio of 3.4 indicated a lesion of the sacral caudal roots.

According to Dai and Xiao [457], the thresholds of stimulation on ventral roots were 0.02 ms duration, 0.2-0.4 mA, (mean 0.3 mA±0.07 mA), compared with 0.2-0.4 ms duration, 1.5-3 mA (mean 2.3 mA±0.5 mA) for dorsal root ($P<0.01$) to cause evoked potentials and EMG. Continuous stimulation for about 3-5 seconds on S2 or S3 ventral root (0.02 ms, 20 Hz, and 0.4 mA) could result in bladder detrusor contraction, but the strongest bladder contraction was usually caused by stimulation on the S3 ventral root in 7 of the 10 patients.

21.5. Assessment/investigations

A complete assessment is required for evaluation of bladder dysfunction [458-460], to screen for upper urinary tract damage, evaluate the risk factors and to adapt the management to the patient's disability.

The first detailed assessment is generally performed once the patient has recovered from spinal shock. It includes a complete clinical history, including prior surgery, medications, spinal cord injury date, spinal cord injury evolution, other past medical events, neu-

rologic symptoms, spasticity or autonomic dysreflexia, mental status and comprehension, mobility and hand function and socioeconomic situation. It has also to include a special focus on urinary symptoms, bowel and sexual functions and possible warning signs, such as pain, infection, haematuria, and fever. A 3-day bladder diary could be recorded. However, the spinal cord outcomes partnership endeavour considers that diary-based measures of continence and voiding are not well standardized and have limited sensitivity, accuracy and reliability [461]. Quality of life should also be assessed, using validated questionnaire such as qualiveen, which has been specifically developed for assessing quality of life in relation to bladder function after spinal cord injury [462].

The recommended investigations are kidneys and bladder ultrasonography, creatinine clearance, videourodynamics (VCMG) or urodynamics and urethrocytogram. Other investigations could be performed, such as dimethylmercaptosuccinic acid (DMSA) renography or mercaptoacetyl-triglycine (MAG3) renography, cystoscopy, abdominal CT scan, depending on the abnormalities detected on the initial investigations.

The renal ultrasound looks for upper urinary tract dilation, stone, pyelonephritic scars and atrophy, with bladder scan detecting stone, bladder wall thickness and any large mucosal lesions. A post-void residual volume assessment would be performed if the patient can pass urine spontaneously. In parallel, renal function should be assessed. Currently, creatinine clearance, rather than simply creatinine level, is recommended due to loss of muscle mass in these patients. In case of kidney ultrasound or of renal function abnormality, a renography (DMSA or MAG3), is indicated. Cystatine C has been proposed for assessing renal function in neurological patients [463].

In SCI patients, videocystometrogram (VCMG) is considered the gold standard for understanding bladder and urethral sphincter functioning and for assessing the upper urinary tract damage risks.

21.6. Urodynamic studies

Ockrim et al. [464] found that in men with SCI, cystometric variables and detrusor overactivity (DO) remained consistent over sequential studies while in those with LUT symptom of urgency, a significant decrease in the number and pressure of involuntary detrusor contractions (IDCs) in consecutive cystometries resulted in a reduction of observed DO from 72% to 63% and 48%, in the three studies. Chou et al. [465] did a retrospective study on urodynamic studies to provide reference ranges for "normal" variability in urodynamic parameters that can be considered as "no real change" from one study to the next. Fifty consecutive individuals with SCI had 2 trials (trial 1 and trial 2) of urodynamic studies done 5 minutes apart, and the following data were collected: maximum cystometric capacity, opening pressure, maximum detrusor pressure, volume voided, and postvoid residual (see **Table 18**).

Table 18. Variability in urodynamic parameters for 50 SCI individuals (adapted from Chou et al. [465])

Urodynamic parameters	Maximum 5 th to 95 th percentile		Maximum 10 th to 90 th percentile		Maximum 25 th to 75 th percentile		
	Mean	Increase	Decrease	Increase	Decrease	Increase	Decrease
Cystometric capacity (mL)	234.63	+213.50	-158.05	+126.40	-74.60	+72.00	-27.00
Opening pressure (cmH ₂ O)	54.56	+30	-18.00	+13.70	-12.00	+4.00	-9.50
Maximum detrusor pressure (cmH ₂ O)	60.82	+17.35	-27.80	+10.00	-20.00	+4.00	-10.00
Volume voided (mL)	122.20	+177.25	-176.00	+105.60	-82.00	+50.00	-30.00
Postvoid residual (mL)	176.06	+197.25	-118.00	+131.00	-86.00	+50.00	-30.00

Generao et al. [466] did a retrospective review of SCI cases with 1-year minimum follow up to determine the effect of SCI on the developing bladder and kidneys using video-urodynamics and sonograms. In 42 children (average age at injury of 5.3 years and mean follow up of 5.5 years), 40 used CIC and 37 took antispasmodics. No patient had reflux, hydronephrosis or renal scarring. Safe bladder capacity, the pressure specific volume at 40 cm water or less, was less than the expected capacity in 80%, 58% and 50% of cervical, thoracic and lumbar injured patients but 100%, 76% and 67% respectively of the groups undergoing multiple urodynamics had increasing capacity with time.

Ersoz and Akyuz [467] investigated bladder-filling sensation in 73 consecutive traumatic SCI patients to examine the quality of the preserved sensation and to determine the potential for sensation-dependent bladder emptying. Bladder-filling sensation was present to some degree in all incomplete SCI patients, in 82.4% of the patients with complete lesions below T10, and 38.9% of the patients with complete lesions above T11. There were significant differences between three groups with respect to bladder sensation category. About 86% of the patients with incomplete lesions, 53% of the patients with complete lesions below T10 and 22% of those with lesions above T11 had bladder-filling sensation before P_{ves} reached 25 cmH₂O and simultaneous bladder capacity of more than 150 ml was present in 61.2, 41.2 and 22.2% of the patients in the groups, respectively. Bladder-filling sensation investigations were reliable in terms of bladder filling sensation category in 36 SCI patients who had a second cystometric examination.

To measure bladder mucosal sensory function quantitatively, Ukimura et al. [468] used neuroselective Current Perception Threshold (CPT) tests in 8 healthy volunteers and 38 patients with NBD. Standardized neuroselective CPT measures were obtained from the left index finger and the mucosa of the posterior bladder wall. The CPT values in the bladder could be determined using the neuroselective

measures in all patients but three who had no sensory response (absence of sensation) caused by complete SCI. In the 8 patients with NDO due to incomplete supra-sacral SCI, the bladder CPT value (4.0+/-1.9) at 5Hz was significantly lower than that in the controls (26.2+/-17.7). In the NBD determined to be underactive (n=11, including post pelvic surgery, post infra-sacral level SCI and diabetes patients), the higher CPT values of bladder mucosal sensory functions were found at 5Hz (p<0.05), 250Hz (p=0.07), and 2000Hz compared to the controls. No fibre specificity has so far been found depending on frequency of current used or current type.

21.7. Urinary Tract Complications in SCI patients

Complications related to urethral indwelling catheterization (IDC)

During 2004-2006, at least three papers reported urinary complications related to prolonged urethral IDC: the catheter balloon of a Foley catheter inserted partially and a long-term IDC caused urethral erosion and a severe degree of hypospadias [469]; contracted bladder followed by autonomic dysreflexia (AD), gross haematuria and extravasation of contrast media due to improper technique of voiding cystourethrography [470]; and continuous incontinence despite a catheter and low bladder compliance leading to a urinary diversion to achieve continence [471]. In chronic SCI, IDC was associated with higher mean levels of C-reactive protein (CRP) while intermittent catheterization was associated with lower levels of CRP when compared with other methods of bladder management [472].

Vesicoureteral Reflux (VUR)

VUR seems common among SCI patients with upper motor neuron (UMN) neurogenic bladder. According to the study of Linsenmeyer et al. [473], there was an association of posterior position of ureteral orifices and reflux but no differences were found with regard

to bladder capacity, bladder wall compliance, or voiding pressures between the reflux group and non-reflux group.

Stone formation

Linselmeyer and Linselmeyer [474] found that the majority of bladder stones were calcium phosphate (46.8%) or struvite (26.7%). According to the retrospective study in 32 patients with NBD, Matlaga et al. [475] found renal stones were infectious in aetiology in 37.5% (12 struvite/carbonate apatite) and metabolic in 62.5%. All patients with struvite calculi were infected with urea-splitting bacteria.

Stone formation is usually related to IDC. Ke et al. [476] found bladder calculi with a nidus of hair that could have been introduced into the bladder accidentally during cystostomy catheter replacement. Over 17 years, 28% and 15% of 140 men were diagnosed with bladder and renal stones for a total of 59 and 25 episodes, respectively; bladder stone was more common in patients injured when aged > or = 24 years than in those injured when aged <24 years; patients with complete injury had a greater risk of renal stone formation than those with incomplete injury; renal stone was more common for patients with urethral catheterization than for those voiding spontaneously and for patients with bladder stone than for those without. According to the review by Ost and Lee [477], recurrent UTI, IDC, VUR, and immobilization hypercalcuria were major risk factors for the development of urolithiasis.

According to the retrospective study of Ozawa et al. [478], the incidence of bladder stone in urethral IDC was 1.11 times/100 months, cystostomy was 1.05, contemporary urethral IDC at night time only was 0.96, CIC-wet was 0.61, and CIC-dry was 0.21; and the urethral IDC group had significantly higher incidence of bladder stone than CIC-dry.

Linselmeyer and Linselmeyer [479] did a prospective cohort study by examination of IDC for encrustation at the time of removal for cystoscopy and found that 35% of 49 SCI individuals had bladder stones. Catheter encrustation was noted in 13 patients and 11 of them also had bladder stones i.e. a positive result for catheter encrustation had a positive result for bladder stones 85% of the time. Thirty-six individuals had no catheter encrustation; of these, 16% were found to have bladder stones.

Bacteriuria

In a retrospective study, Jayawardena and Midha [480] suggested that healthy asymptomatic SCI patients who came for annual evaluations should not have routine urine cultures if they are at low risk for UTIs; that is, <6 WBC/HPF in the urine and/or nitrite negative. Svensson et al. [481] studied the occurrence of bacteriuria in SCI patients with NBD who used CIC. Of 344 cultured samples, there were 285 isolates: coagulase-negative Staphylococci (27%),

Enterococci (25%), Klebsiella spp. (19%), and Escherichia coli (12%); and bacteria grew at concentrations of 10^5 - 10^8 cfu/L, but only a few at 10^4 cfu/L. Levendoglu et al. [482] prospectively studied 27 SCI patients who applied CIC during the initial rehabilitation and 40 controls. E. coli was predominantly isolated from the urine and the urethral cultures of both female and male patients; there was concordance between urethra and urine cultures concerning the growth of E. coli; and Pseudomonas was colonized more in male patients. Waites et al. [483] found that among 77.1% of men with bacteriuria, uropathogens were shown in the perineum in 57.4% and in the urethra in 85.2%; differences in the occurrence of uropathogens in men with and without bacteriuria were statistically significant, and organisms were present in higher numbers in men with bacteriuria.

Fournier's gangrene is a recognised risk [484, 485]. Nambiar et al. [485] reported a C4 tetraplegia man presenting with a necrotic ulceration on the ventral aspect of the penis and scrotum of 2 days duration and diagnosed with fulminant Fournier gangrene. Vaidyanathan et al. [486] reported cases of a perirenal haematoma due to warfarin and a tumour like of necrotic slough and debris in the bladder.

Bladder cancer

The reported prevalence is between 0.1 and 10 %. The risk of bladder cancer is greater in SCI patients than in the general population [487, 488](58;59). The histological subtype is a squamous cell carcinoma in up to 80 % of the cases. Symptoms are often non-specific, such as recurrent tract urinary infections or incontinence, and diagnosis is often delayed. The risk factors are indwelling catheter, stones and recurrent urinary tract infections. It is recommended that patients with long term catheters should undergo surveillance cystoscopy and biopsies [489]. However, other groups have performed surveillance cystoscopies and have failed to detect any cancers [490, 491]. The cytology is often abnormal due to chronic inflammation.

Quality of life (QoL)

Oh et al. [492] conducted a prospective trial involving 132 SCI patients and 150 controls matched to age and sex to determine the psychological and social status of patients using CIC. According to health-related quality of life (HRQOL), the Medical Outcomes Study 36-Item Short-Form General Health Survey (SF-36) scores did not reveal any significant differences between the men and women in the patient group. When patients and controls were divided into two groups according to sex and age, the SF-36 scores of the patients were significantly lower than the controls across both sex and all age groups, other than the energy and vitality scale, the differences for which were not statistically significant in women and those younger than 50 years. Later Oh et al. [493] used the Beck Depression Inventory (BDI) with SCI patients on CIC and control group and found that the

average total BDI scores were 20.3+/-1.0 in the patient group and 11.4+/-0.5 in the control group, respectively; 69.6% of 102 the patients reported severe depression; female patients had a 3.8-fold higher risk of depression than male patients; and those who were unable to perform catheterization independently had a 4.6-fold higher risk of depression than those who were able to perform self-catheterization.

21.8. Treatment of NLUTD post SCI

The management is based on a multidisciplinary approach including urologists, rehabilitation physicians, physiotherapists, specialist nurses and often neurosurgeons and gastroenterologists. The goal of management of urinary tract in SCI patients is to preserve the upper urinary tract and renal function, to avoid urological complications and to improve patients' quality of life. There are several guidelines for management of neuropathic bladder dysfunction after SCI related neurogenic bladder [458, 460].

The treatment of bladder dysfunction following a SCI can be divided according to the level of injury (**Table 19**).

Table 19: Treatment of NLUTD associated with spinal cord injury

Bladder dysfunction in suprasacral injuries
To decrease neurogenic detrusor overactivity
Pharmacotherapy
Clean intermittent self-catheterization
Neurotoxins (Vanilloid receptors inactivators)
Botulinum toxin A
Neuromodulation
Sacral anterior root stimulator
Clam cystoplasty
Continent urinary diversion
Ileal conduit
To overcome external sphincter dyssynergia
Pharmacotherapy
Botulinum toxin A
Sphincterotomy
Urethral stents
Bladder Dysfunction in sacral injuries
To improve bladder emptying
Pharmacotherapy

Clean intermittent self-catheterization (clean & self)
Valsalva or crede maneuver
To improve sphincter function
Pharmacotherapy
Bulking agents
Slings
Artificial urinary sphincter
Bladder neck closure (females)

21.9. Treatments to manage neurogenic detrusor overactivity

Medications

Antimuscuranics competitively inhibit acetylcholine at muscarinic receptors. This is associated with detrusor relaxation and lower intravesical pressures. Several antimuscarinics drugs are available, including oxybutynin, tolterodine, propiverine, trospium, solifenacin, darifenacin and fesoterodine. Only a few studies have assessed efficacy and safety of antimuscarinics in NDO [494]. They are broadly equally efficacious, with slightly different side effect profiles (dryness of the mouth, blurred vision for near objects, tachycardia, constipation and drowsiness).

Desmopressin, synthetic analogue of vasopressin, reduces the urine production and has been shown to be useful for the treatment of polyuria in spinal cord injury [495].

Vardenafil has been reported to decrease maximum detrusor pressure and improve maximum cystometric capacity [496].

Intermittent catheterisation (IC)

IC is recommended as the safest method of bladder emptying for SCI persons with NBD, especially for those who have sufficient hand skills or a willing caregiver to perform the catheterization. Mizuno et al. [497] reported a paraplegic woman using CIC for 27 years who had no complications and absence of UI due to underactive and normal capacity bladder. However SCI men on CIC, according to the retrospective comparative study of patients on CIC had a 7.0-fold higher risk of epididymo-orchitis.

Previously, recommended bladder training with CIC was time-dependent, however, some experienced bladder over-distention, especially in those with polyuria, that made an IC programme unmanageable [498]. Polliack et al. [499] compared volume-dependent IC (VDIC) following bladder volume measurement by a portable ultrasound device in SCI patients with time-dependent IC (TDIC). After 12-30 days follow-up, the number of IC per patient per day, the time required to perform volume measurements and IC, and

their total cost, were approximately 44, 49, and 46% lower in the VDIC group than in the TDIC group. UTI was found in three patients in the TDIC group and in none in the VDIC group.

In developed countries, there is a variety of urethral catheters available for SCI individuals. However, in reviewing all controlled trials comparing methods of using catheters in people with neurogenic bladder dysfunction, Jamison et al. [500] could not draw any conclusions regarding the use of different types of catheter. According to the multi-centre RCT of De Ridder et al. [501], 57 SCI male patients completed the 12-month study; 64% of those using the SpeediCath hydrophilic-coated catheter experienced 1 or more UTIs compared to 82% of those using the uncoated polyvinyl chloride (PVC) catheter. Twice as many patients in the SpeediCath group were free of UTI. According to another multi-centre study of Bjerklund Johansen et al. [502], of 378 patients (the mean duration of IC was 4.6 yr) who completed a 12-d trial of the novel hydrophilic catheter: LoFric Primo, 55.2% of the patients were happy to continue with the novel device, which was 74% of patients using standard PVC catheters and 36% of those using prelubricated PVC.

Ozawa et al. [478] applied a contemporary (reusable) balloon catheter at night time only. After a mean follow up of 41 months, the incidence of febrile episode was as follows: CIC-wet 3.36 times/100 months, IDC 2.96, cystostomy 1.26, the contemporary catheter 0.57, and CIC-dry 0.42. The incidence of febrile episode in CIC-wet and IDC were significantly higher than in CIC-dry. The incidence of bladder stone was as follows: IDC 1.11 times/100 months, cystostomy 1.05, the contemporary catheter 0.96, CIC-wet 0.61, and CIC-dry 0.21.

Botulinum toxin type A

This has revolutionised the treatment of NDO since being popularised by Schurch and colleagues [503]. Botulinum toxin is a potent neurotoxin produced by the gram-positive anaerobic bacterium *Clostridium botulinum*. In the bladder, botulinum toxin has a direct effect on the presynaptic vesicular release of acetylcholine but also on sensory pathways [504]. It is associated with a significant improvement in urinary continence (40–80% of patients became completely dry), a decrease in mean maximum detrusor pressure (which became less than 40 cmH₂O in most studies), an increase in maximum bladder capacity and an improvement of patients' quality of life. Injections are performed under local or general anaesthesia using flexible or rigid cystoscopy. Median duration of effect ranges from 7 to 9 months. This treatment has to be considered for individuals with SCI suffering from NDO with urinary incontinence refractory to oral antimuscarinics. The majority of patients have to perform CIC before and after botulinum injections. As a result of pivotal studies [505] a dose of 200U is licensed. A long term study has shown consistent results with repeated injections [506, 507].

Neuromodulation

Electrical stimulation has been used to manage bladder dysfunction in SCI since 1950s. Sacral neuromodulation (SNM) can be used as a second line treatment to control NDO in incomplete spinal cord injury. Sievert and colleagues [508] have demonstrated that use of SNM early in the injury recovery can prevent detrusor overactivity and maintain continence, in addition to preserving bladder capacity, reduced urinary infections and an improved bowel function. This was sustained for more than 2 years.

Sacral Anterior Root Stimulation

Sacral anterior root stimulation (SARS) with sacral deafferentation was first reported by Brindley in the 1970s [509], and results of small case series have been published [510, 511]. Detrusor overactivity is abolished by deafferentation. The electrodes are placed on the sacral anterior roots (S2, S3 and S4) to stimulate detrusor contraction, leading to bladder emptying. This can be used only in patients with complete lesions. The success rate is reported to be around 70%. In addition, this can be used to manage bowel dysfunction and achieve erections with separate programs. Importantly, men have to be informed that posterior rhizotomy will interrupt reflex erections.

Augmentation Cystoplasty

A number of procedures have been proposed to decrease detrusor overactivity and increase bladder capacity including detrusorotomy to subtrigonal cystectomy and ileal bladder substitution [512]. The one that has stood the test of time is clam cystoplasty, this technique involves bivalving the bladder and inserting a 20-30 centimetres of intestine segment in the defect.

The long term results indicate good control of overactivity and incontinence [513]. Generally, this is offered to patients who have failed to respond to botulinum toxin A injections or those with very low compliance bladder and in patients at risk for upper tract damage. If the patient has difficulty performing CIC via the urethra, a cutaneous diversion can be fashioned as well. Bladder augmentation is contraindicated in severe inflammatory bowel disease, significant pelvic irradiation related bowel damage and in patients who refuse CIC. These patients require life-long follow up. They can get a variety of problems including mucus production, persistent asymptomatic or symptomatic bacteriuria, stones, hyperchloremic metabolic acidosis, deterioration of renal function, bowel disturbances and cancer [514].

Cutaneous continent diversion

This is reserved for patients who cannot perform CIC via the native urethra because of congenital abnormalities, obesity, strictures and poor hand mobility. The principles are similar to bladder augmentation but a drainage channel is created between bladder and umbilicus or lower abdominal wall using either appendix (Mitrofanoff procedure) or ileum (Yang-

Monti procedure). Usually, the bladder outlet is left accessible as a safety mechanism. If the native bladder cannot be preserved, a substitution cystoplasty using ileum or colon can be performed. The complications are the same as described above for cystoplasty, with the additional risk of perforation, which can prove fatal if not diagnosed early.

Ileal conduit

This is generally reserved as a fall back option. It is a non-continent procedure, undertaken when there is severe motor and/or cognitive disability or in case of severe complications, alteration of renal function, or urethrocutaneous fistula. A cystectomy is often performed simultaneously as there is a risk of bladder cancer, pyocystitis and spasticity. It can be performed laparoscopically [515]. The complications are mainly related to the uretero-ileal anastomosis, stomal hernia and pyelonephritis.

21.10. Treatments to overcome external sphincter dyssynergia

Medications

A number of medications have been proposed to overcome sphincter dyssynergia but the level of evidence is low. Baclofen can be used orally and intrathecally. High dosages are required with a significant risk of side-effects [516], including effects on erection and ejaculation [517]. The α -blockers that have been evaluated include indoramine, urapidil and tamsulosin. Alpha blockers have been reported to improve flow rate, increase voided volume and improve quality of life with a decrease in maximum urethral pressure. Abrams and colleagues reported that with tamsulosin treatment (0.4 and 0.8 mg once daily), 71% of patients reported an improvement of symptoms with good tolerance and decrease in dysreflexic symptoms [518]. Oral nitric oxide donors have been proposed to decrease urethral resistance in SCI patients [519].

Botulinum toxin A for sphincter

Botulinum toxin type A was first used to control DSD in the 1980s. It can be injected directly in the urethral striated sphincter. It is associated with an improvement in flow, with a decrease in postvoid residual volume and maximal urethral closure pressure. The benefits are variable, between 53 and 100 %, and lasting for 1 - 9 months [520]. These results have not been universally reproducible.

Sphincterotomy

This is a destructive procedure. The aim is to relieve the bladder outlet obstruction by cutting into the external urethral sphincter. It can be performed only in men because patients become incontinent and a condom has to be placed to collect urine. Endoscopic sphincterotomy was developed for the treatment of DSD in the 1950s. It has been demonstrated to be effective for both treatment of DSD and the prevention of genitourinary complications. However, this

technique is associated with a failure rate of 15–50%, erectile dysfunction in 4–40%, perioperative complications such as septicaemia and haemorrhage in 5% of cases, and is irreversible [521]. Balloon dilatation has also been explored but is not advocated due to high failure rate.

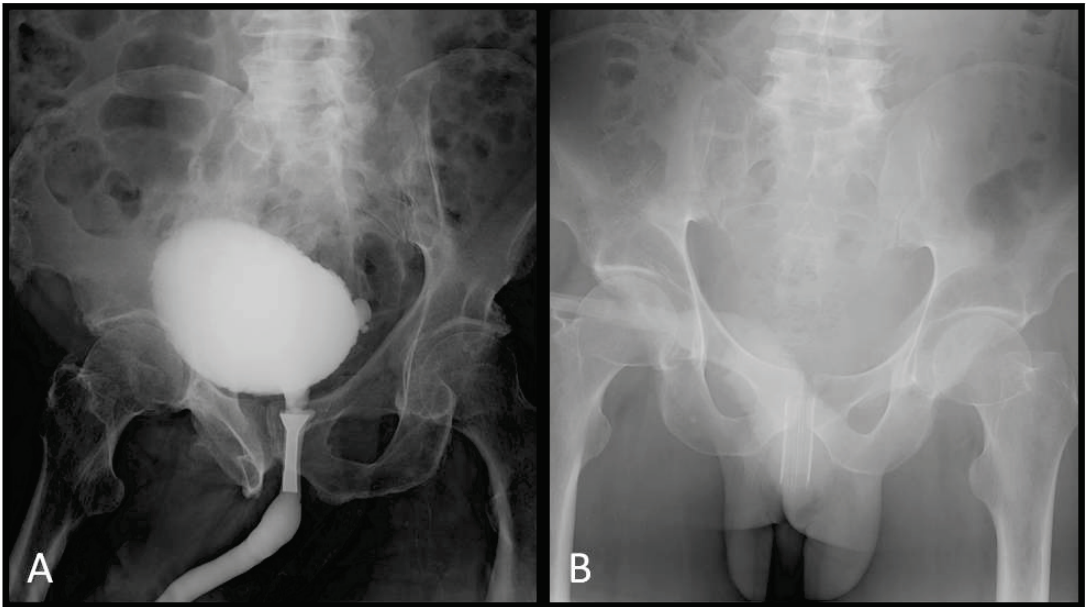

Figure 5: Quadriplegia patients with a temporary urethral sphincter stent (A) and a permanent urethral sphincter stent (B) Adapted from [525]

Urethral Stents

These were popularized in the 1990s. There are 2 varieties available: permanent and temporary stents. The temporary stents could be used as a test to ensure the acceptability of the voiding method, verify the efficacy on bladder emptying and give the patient time to think regarding a definite management strategy. It can also be used as a reversible treatment in patients with a transient problem whilst awaiting for recovery or rehabilitation of the upper limbs. Following temporary urethral sphincter stenting, 70 % of the patients choose a permanent one [522].

The long-term complications with permanent stents (Urolume) are stent encrustation, migration, bladder neck obstruction and if required, difficult stent removal [523]. The complications with temporary stents (Memokath) include a higher rate of stent migration, stent blockage with stone or calcification and recurrent urinary tract infections [524].

21.11. Bladder emptying in sacral injuries

Pharmacotherapy

There are no established medications to facilitate bladder emptying. Bethanechol chloride has been used with only limited success, and bothersome side effects including flushing, headaches and diarrhoea.

Clean intermittent self-catheterization

This is the mainstay to facilitate effective bladder emptying in an underactive detrusor. It is not a difficult technique to master but requires support from healthcare professionals. Generally, a size 14F catheter is used in males and a 12F in females. A variety of catheters are available and it is not uncommon for

patients to try 2 or more types of catheter before finding the most convenient one.

Valsalva or crede maneuver

This entails emptying the bladder by increasing the intra-abdominal pressure. This can be performed by either valsalva technique or bending forward and compressing the lower abdomen. This is not an ideal method but for some SCI patients works quite well, if there is no outflow obstruction. In the absence of recurrent UTI this can be an acceptable technique for bladder emptying in some patients.

21.12. Treatments to improve sphincter function

Pharmacotherapy

These are no longer used as there has been a very limited benefit with their use. The drugs used include pseudoephedrine and phenylpropanolamine. Duloxetine has been shown to increase urethral resistance. Although some studies have shown improvement in continence rates this is generally limited to mild type with quite bothersome gastrointestinal side effects. It has not been specifically tried in neuropathic sphincter incontinence.

Bulking agent injection

This is a minimally invasive technique. It is performed endoscopically. Initially collagen based beads were implanted but they degraded over time. Currently, hypopolymers or silicone based substances (Macropastique-polydimethylsiloxane) are used. They are effective in 60%-80% of cases but the effects are short lasting and quite often multiple injections are required [526]. The main advantage of this therapy is

being minimally invasive and it does not prevent further treatment.

Slings

These are used in females. They can be either autologous or synthetic. They are placed vaginally in the mid urethra. At present the synthetic slings are gaining popularity [527]. The reported efficacy is about 70%. The complications include difficulty in self catheterisation and development of de novo detrusor overactivity. Further research is needed to understand outcomes and risks.

Artificial urinary sphincter

This is the most effective method of achieving continence both in males and females, although the success rate is lower and complications higher than in non SCI patients. The complications include mechanical failure, erosion of the cuff or infection requiring removal of the implant.

Bladder neck closure

This is generally the last resort when other methods have failed. Bladder neck closure is usually performed when the urethra is almost destroyed- generally as a result of long-term catheterization. It is mainly employed in females, as sheath collection of urine cannot be employed, and can be performed either vaginally or abdominally. The initial success rate is about 50%, as the tissues are scarred secondary to infections and trauma and another 25% can be salvaged after a second procedure.

21.13. Prevention of UTI

According to 2 double-blinded, placebo-controlled RCTs [528, 529] studying the effectiveness of cranberry supplement (400-mg cranberry 3 times a day for 4 weeks and 2 g per day for 6 months, at preventing UTIs in SCI individuals with NBD, bacterial count, white blood cell (WBC) count, bacterial counts in urine, urinary pH or episodes of symptomatic UTI did not differ between the placebo and cranberry groups. According to another RCT to determine the effectiveness of methenamine hippurate (MH) (1 g twice-daily) and of cranberry (800 mg twice-daily), MH as well as cranberry did not have a significantly longer UTI-free period compared to placebo [530]. In addition, when taking phosphorus supplementation, there was no significant change in urine pH during the 2-week period compared to when the patient was off supplementation [531].

Antibiotic prophylaxis

Some centres advocate antibiotic prophylaxis for recurrent UTI [532]. Salomon determined the safety and efficacy of a weekly oral cyclic antibiotic (WOCA) regimen consisting of the alternate administration of an antibiotic once per week over a period of at least 2 years to prevent UTI in SCI adult patients; symptomatic UTI dropped from 9.4 to 1.8 per patient-year,

no severe adverse events and no new cases of colonization with multiple drug resistant bacteria were reported [533].

Bladder irrigation

Waites and colleagues [534] conducted a randomized, double-blind comparison of twice daily bladder irrigation using 1 of 3 different solutions for 8 weeks with 30 mL of (a) sterile saline, (b) acetic acid, or (c) neomycin-polymyxin solution in community-residing persons with NBD who used IDC. Results showed that the 3 irrigants had no detectable effect on the degree of bacteriuria or pyuria. There was no significant development of resistance to oral antimicrobials beyond what was observed at baseline, but all groups had a significant increase in urinary pH.

Treatment of UTI

Bycroft and colleagues [532] found few centres routinely treating asymptomatic UTI in SCI individuals using catheters; and the range of recommended duration of treatment for symptomatic UTI was 3-14 days (mean 6.3).

Guidance for further research

Most of the papers relating to epidemiology and pathology of urinary incontinence in spinal cord lesion patients were case series; few papers were clinical trials or RCTs relating to pharmacological treatments. As UTI is a common complication among SCI individuals, further RCT should be done to prove whether a weekly oral cyclic antibiotic for UTI prophylaxis is effective, as well as optimal dosage, effectiveness and safety of bladder relaxants. Regarding types of catheter, RCT should be conducted to prove whether to re-use of catheters is safe. In addition, to make an automatic, event-driven electrical stimulation for the treatment of NDO suitable in a clinical setting further investigations are needed.

21.14. Urological follow-up practice

According to cohort studies [304, 450, 535] there was evolution of bladder management by time, outcomes and complications in both paediatric onset and adult onset SCI; treatment was modified in a substantial proportion of patients over the observation periods. Regular urodynamic follow-up is warranted for protection of the upper urinary tract (UUT) and maintenance of continence, however, urological follow-up practice varied: in Bochum, Germany, follow-up included urodynamic evaluation, sonography of the UUT and LUT, urine examination, and evaluation of renal function and treatment modifications were based on the urodynamic findings [536]; in the Spinal Injuries Units of U.K., all units performed routine upper tract screening, ranging from annually to every 3 years [532].

According to the retrospective chart review of Sepahanah et al. [537], the 24-hour creatinine clearance (CCr) was highly variable from one evaluation to the next and the within-subject standard deviation (SD)

for CCr was 25.9mL/min; for all comparisons of repeatability, variability, and reliability, serum creatinine was superior to CCr, and renal ultrasound results and post-void residuals were the major factors in changing medical management with regard to renal function preservation. To determine the accuracy of bladder stone detection by abdominal x-rays of individuals with SCI, 13/62 (21%) of stones found during cystoscopy were detected by the x-ray; the detection by x-ray was 33% for stones 1.0 cm to 1.49 cm, 33% for stones 1.5 cm to 1.9 cm, and 54% for stones \geq 2.0 cm; and 57% for volumes \geq 1.0 cm³ [474]. In addition, long-term SCI individual with aged 50 to 60 or more should be screened for prostate and bladder cancer [538, 539]; however, PSA cannot be used in patients with IDC and diagnosis should be based on prostatic biopsies [539].

Although SCI patients need lifelong follow-up, no studies have been done on the optimum frequency of follow-up to determine the frequency and the investigations required to achieve this goal. There is an urgent need to undertake prospective evaluation of SCI patients to draw evidence based conclusions for optimal follow-up protocols.

Conclusions

- The profile of muscarinic receptors in the bladder may be altered in patients with neurological disease (LOE 3)
- Skin sympathetic responses and motor evoked potentials may help assess autonomic and somatomotor pathways of the lower urinary tract. (LOE 3)
- In patients with neurological disease, individuals often change their method of bladder management, influenced by a range of factors including renal function. (LOE 2)
- Long-term urethral indwelling catheterization leads to bladder and urethral complications (LOE 3)
- Encrustation of a catheter is predictive of bladder stones; abdominal x-ray is not an adequate method to detect bladder stones (LOE 3)
- Volume-dependent intermittent catheterization may offer advantages compared with time-dependent intermittent catheterization. (LOE 3)
- Combined clean intermittent catheterization during the day time with indwelling contemporary balloon catheter at night time showed less urinary infection than clean intermittent catheterization with incontinence and permanent urethral indwelling catheterization. (LOE 3)
- Increased dosage of Tolterodine or Trospium gave a better effect to control neurogenic detrusor overactivity with incontinence. (LOE 2)

- Urethral flora may be a bacterial source for the development of urinary infection. (LOE 3)
- Low bacterial concentrations in the urine ($<10^5$ cfu/L) of patients on intermittent catheterization might be due to contamination. (LOE 3)
- Cranberry extract, methenamine hippurate or phosphorus supplements were not found to be effective in acidifying urine or preventing urinary tract infection. (LOE 2)
- A weekly oral cyclic antibiotic seemed efficacious in preventing UTI. (LOE 3)
- Bladder irrigation was not effective in reducing bacteriuria in persons with neurogenic bladder using indwelling catheterization. (LOE 2)

Recommendations

- Regular urological monitoring, at least annually, is appropriate to early detect complications and to adjust bladder management in patients with neurogenic bladder dysfunction. (A/B)
- Recommend urine culture only if there is high risk of current urinary tract infection. (C)
- Routinely inspect catheters for encrustation, as an early indicator of risk of bladder stone formation. (C)
- Cystoscopy is necessary if bladder stones are suspected. (C)
- Adjust urinary tract management according to results of urological evaluation and emergence of complications. (B)
- Clear diagnosis of DSD requires VCUG facilitated by EMG. (C)
- Clear instructions on catheter management can help to reduce risk of complications. (B)
- Dosages of bladder relaxant drugs in excess of the licensed doses have been used in attempting to control neurogenic detrusor overactivity and incontinence; if side-effects cannot be tolerated, intravesical botulinum toxin injection are effective. (B)

21.15. Faecal incontinence in SCI

Epidemiology and prevalence

According to Dvorak and colleagues [540], in patients with central cord syndrome, bowel and bladder continence was reported by 81% in those with American Spinal Injury Association (ASIA) motor score improvement from a mean of 58.7 at injury to a mean of 92.3 at follow-up. However, neurogenic bowel dysfunction (NBoD) is common among spinal cord injury (SCI) patients. From 2004 to 2007, there were multiple studies reporting epidemiology of NBoD in chronic spinal cord injured (SCI), from various countries (see section below for details). Apart from SCI, there were

other spinal cord lesions (SCL) that cause NBoD, such as tumours (e.g. a conus medullaris ependymoma and filum terminale lipoma [541]; a clear cell meningioma along the thoracic and lumbar levels [542], neuroblastoma [543]; venous congestive myelopathy, mostly at thoracolumbar and/or conus me-

dullaris levels [544]; and iatrogenic [545]. Tanaka reported 77% of 22 transverse myelitis (average age at onset 8.8 years, mean follow-up 7.1 years) had NBoD [546].

Table 20. Prevalence of neurogenic bowel dysfunctions reported in spinal cord injury patients

Study (year)	Countries	Subjects	Prevalence		
			Faecal incontinence	Constipation	Others
Liem et al. (2004) [547]	Canada	352 SCI (> 20 years)	41.8% (including diarrhea)	47.9%	
Ng et al. (2005) [548]	Australia	110 SCI (duration from injury, median 17 years)	41%	46% (including laxative use)	Abdominal pain 33% Abdominal bloating 22%;
Vallès et al. (2006) [549]	Spain	54 motor complete SCI (mean duration from onset 6 years)	85%	67%	
Vallès et al. (2007) [550]	Spain	109 patients 83% had spinal sacral reflexes (SSR)	31%	27% more in tetra A,B,C	
Pagliacci et al. (2007) [551]	Italy	403 SCI (duration from discharge to follow-up, mean 3 years)	2.7% (20.1% partial)		

21.16. Pathology and disease specific lower gastrointestinal (LGIT) problems

According to electromyography (EMG) of external anal sphincter (EAS), 18 and 22 of 64 patients with cauda equina or conus medullaris lesions had bilateral and unilateral EMG abnormalities [552]. Using anorectal manometry, the maximum anal resting pressure of a 26-lumbosacral SCI patients group with mixed symptoms of constipation and/or FI was slightly lower than that of a 13-normal volunteers control group [553]. During defecation, 88.5% of the patients but 7.7% of the control group significantly showed pelvic floor dysfunction (PFD). Rectoanal inhibitory reflex (RAIR) was identified in both groups. The rectal volume for sustained relaxation of the anal sphincter tone in the lumbosacral SCI patient group was significantly higher than the control group. The mean rectal volume to generate the first sensation was significantly higher in SCI patients than in the control group. Regarding constipation, its association with level of injury was supported by many studies, i.e. upper motor neuron vs lower motor neuron NBoD. Decreased colonic pressure activity was found during sleep in SCI individuals and may contribute to delayed colon transit time after SCI [554].

Furlan and Fehlings [555] examined the characteristics of the top 100 most frequently cited articles (so-called "citation classics") on traumatic SCI that were published between 1986 and 2003, and compared this selected professional literature with the consumers' perspective on the key issues in SCI research. From the SCI consumers' perspective, the areas of greatest interest included motor function, bowel and bladder control, sexual function, and pain. Motor function was the leading topic in the matching list between professional literature and consumers' perspective. According to Anderson's quality of life (QOL) survey of the SCI population [556], regaining arm and hand function was most important to quadriplegics, whereas regaining sexual function was the highest priority for paraplegics; and improving bladder and bowel function was of shared importance to both injury groups. Later, according to a web-based survey of 286 SCI patients aged 18 years or older, bladder and bowel concerns during sexual activity were not strong enough to deter the majority of the population from engaging in sexual activity; however, bladder and/or bowel incontinence during sexual activity was a highly significant concern in women with SCI. In addition, the occurrence of autonomic dysreflexia (AD) during typical bladder or bowel care was a

significant variable predicting the occurrence and distress of AD during sexual activity [557].

FI had 10 times more impact on QOL than those with no FI and NBoD had significant impact on their QOL [558]. They had significantly lower Gastrointestinal QOL score as compared with the normal persons. There were no statistically significant differences in satisfaction or QOL between those with colostomies and those with traditional bowel care programs; however, 55.7% of those with colostomies and 41.7% of those without colostomies were very unsatisfied with their bowel care program [559].

Conservative bowel management

According to the "Neurogenic Bowel Management in Adults with Spinal Cord Injury" Clinical Practice Guideline published by the Consortium for Spinal Cord Medicine, rectal stimulations help assist elimination of the stool: mechanical stimulations – digital rectal stimulation (DRS) and manual evacuation; and chemical stimulations – suppository and mini-enema (liquid suppository). Korsten et al. [560] used a manometric catheter to assess colonic motility at baseline, during DRS, and after DRS and evacuation of barium oatmeal paste in six subjects with SCI. Their results showed that manometric changes in response to DRS were accompanied by expulsion of barium oatmeal paste in every subject by the fifth DRS. In patients with cervical SCI, a significant increase in systolic blood pressure (BP) was induced by insertion of rectal medications and persisted during additional DRS, and AD induced by the manual removal of stool has been reported [561, 562]; however, systolic BP recovered to pre-program values within 5 min after defecation [561].

Uchikawa and colleagues [563] reported a successful bowel movement in 75% of 20 SCI patients by using a modified washing toilet seat equipped with a camera monitor and an electronic bidet to facilitate precise hitting of the anal area with water streams to stimulate bowel movement for a maximum of 30 minutes. Regarding transanal irrigation, a randomised study showed improvement in constipation, FI and symptom-related QOL in SCI individuals [564].

Push up, abdominal massage and a forward-leaning position may aid evacuation by increasing abdominal pressure. Ayaş et al. [565] studied patients with SCI and showed that abdominal massage gave positive effects – increase in frequency of defecation per week, decrease in total colonic transit time and lesser FI.

Oral medications to enhance bowel movement have been used, but evidence of efficacy is lacking. Cisapride does not seem to have clinically useful effects in people with SCI [566]. Korsten et al. [567] did a randomized, blinded design, to test the efficacy of neostigmine in SCI persons with defecation difficulty by infusing one of three intravenous infusates (normal saline, 2 mg neostigmine, or 2 mg neostigmine + 0.4

mg glycopyrrolate – to prevent neostigmine's muscarinic effects) on separate days and determining bowel evacuation of the barium paste, heart rate and airway resistance. Their results indicated that both neostigmine and neostigmine + glycopyrrolate resulted in prompt bowel evacuation. Potentially, neostigmine may be administered by other routes [568].

21.17. Guidance for further research

Most of the studies reported were case series and used different definitions of faecal incontinence and constipation. Therefore further research should be based on internationally acceptable definitions so that they can be compared. In addition, RCTs on rectal or anal stimulations, both mechanical and chemical, as well as medications promoting bowel movement are needed.

Conclusions

- Constipation is more common than faecal incontinence among people with established SCI (LOE 3)
- Constipation is more common in those with preserved sacral reflexes, whereas faecal incontinence is more common in those without sacral reflexes. (LOE 3)
- Faecal incontinence has impact on the QOL of SCI individual and is a substantial concern for women with SCI during sexual activity (LOE 3)
- Digital rectal stimulations aid bowel evacuation in individuals with SCI, in part by increasing left-side colonic motility (LOE 3)
- Transanal irrigation with water improves constipation and quality of life in individuals with SCI (LOE 2)
- Abdominal massage may be effective in enhancing bowel movement and defecation (LOE 3)
- Anal stimulation by water stream may be effective in stimulating bowel movement and shortening bowel care time (LOE)

Recommendations

- Encourage adherence to the clinical practice guidelines on neurogenic bowel management in adults with spinal cord injury (A)
- Apply mechanical stimulation e.g. digital rectal stimulation, to aid bowel evacuation- especially in those with preserved sacral reflexes (B)
- Use chemical stimulants when mechanical stimulation fails (C)
- Beware of autonomic dysreflexia during bowel care, especially in those with a high SCI lesion (C)

- Consider transanal irrigation with water for those with severe chronic constipation and faecal impaction (B)

21.18. Sexuality

The majority of SCI patients (> 60 %) have alterations in sexual functioning. The degree of sexual dysfunction depends on the level and completeness of injury.

Male Sexual dysfunction

There is a significant impact of SCI on male sexual function. Erectile dysfunction occurs in up to 50 % of the patients. Less than 10% can ejaculate spontaneously. The patients with complete lesions above L2 level generally can have reflex and psychogenic erections. Patients with a complete lesion below S2 can generally have psychogenic erections. They have no reflex erections and ejaculation is rare.

As for non-SCI population, first-line treatment of erectile dysfunction is based on phosphodiesterase type-5 (PDE5) inhibitors. The three PDE5 inhibitors currently available are quite effective in treating erectile dysfunction in this patient group. Most of studies reporting the impact of PDE5 inhibitors in spinal cord injury used sildenafil. The reported erectile function improvement with sildenafil is more than 90% [569]. These treatments are also well-tolerated, with mild to moderate side effects including headache and facial flushing.

In case of failure of PDE5 inhibitors, the majority of patients are dissatisfied with a vacuum erection device, as they find it difficult to use- especially in patients with low hand dexterity. Intracavernous injections of vasoactive substances are effective, with a reported intercourse rate of up to 50 %. Priapism is not an uncommon occurrence, though the duration is variable. The injection can be performed by the partner in case of limited manual dexterity. When all conservative treatments fail, a penile prosthesis can be implanted. Like other implants the success rate is lower and complications higher in this patient group.

The majority of SCI patients cannot ejaculate. The most commonly employed technique to obtain semen is vibro-ejaculation. This is performed by a specially designed vibrator. The vibrator's plate is placed underneath glans penis and the vibrations are performed for 1-3 minutes. This is only effective in lesions above T10, as an intact spinal arc is required. The success rate is 60%-80% of cases. It can cause retrograde ejaculation. The complications include bruising and autonomic dysreflexia. In unsuccessful cases and for all patients with a lower motor neuron lesion, the ejaculate can be obtained by electroejaculation. This is performed with a probe in the rectum and stimulating the seminal vesicles with electric current. The success rate is around 98%. This is an invasive method and there is a risk of rectal injury. As it can be quite painful, it is generally performed under

general anaesthesia or sedation for patients with an incomplete lesion.

Fertility in men is impaired after SCI due to erectile dysfunction, ejaculatory failure and abnormal semen characteristics. Alteration of sperm is promoted by urinary tract and genital infections, hormonal and hypothalamic-pituitary testicular axis abnormality, local temperature change and sympathetic nerve alteration [570]. Sperm retrieval is performed with vibro or electroejaculation. In the majority of cases, assisted conception techniques are required to achieve conception.

Conclusions

- There is a significant impact of SCI on male sexual function
- Erectile dysfunction occurs in up to 50 % of the patients
- Less than 10% can ejaculate spontaneously
- Patients with complete lesions above L2 can have reflex & psychogenic erections
- Patients with a complete lesion below S2 have psychogenic erections.

Recommendations

- Oral PDE5Is are the recommended first-line medical treatment (GR A)
- Intracavernous injections of vasoactive drugs (alone or in combination) are the recommended second-line medical treatment (GR A)
- Mechanical devices such as vacuum devices and rings can be effective and may be offered to patients (GR B)
- Vibrostimulation and transrectal electroejaculation are effective methods of sperm retrieval (GR B)

Female sexual dysfunction in SCI

There are only a few reports on female sexual dysfunction after SCI. The level and completeness of spinal-cord injury determines the preservation of psychogenic and reflex lubrication. Women with complete lesion above L2 have reflex lubrication. Those with a complete lesion between L2 and S2 have psychogenic and reflex lubrication and those with a complete lesion below S2 have psychogenic lubrication. Clitoral stimulation can lead to orgasm in patients with S2-S5 lesions.

It has been shown that all the domains of sexual function are altered in SCI women. Only 50% are able to achieve orgasm, with time to orgasm significantly increased. Female sexual function can also be altered by bladder and bowel incontinence and spasticity. Sildenafil has been reported to have a positive effect

on sexual dysfunction in a pilot study, with no associated adverse events [571].

Recommendation

- There is currently no effective medical therapy for the treatment of neurogenic sexual dysfunction in women (GR A)

The fertility in SCI women is not altered as compared to healthy individuals. The first months after injury are associated with amenorrhea but menstruations usually resume relatively soon. All contraceptive methods can be used.

Pregnancy in SCI women can be challenging. There can be issues with premature cervical dilatation and premature labour. The management of urinary tract infections and detrusor overactivity can be difficult as Botulinum toxin A injections are contraindicated in pregnancy. There are no guidelines on the use of antimuscarinics during pregnancy and the impact of these medications on the foetus has not been studied. Clean intermittent catheterization is maintained and often an increased number of catheters are required per day.

The management of labour is another problem. In women with an injury at level T6 and above there is an increased risk of developing autonomic dysreflexia. These women require frequent check-ups and early hospitalization if necessary. However, most women will have successful vaginal deliveries. SCI in itself does not constitute an indication for caesarean section. Probably the most important aspect of the management is involvement of a specialized multidisciplinary team.

Recommendation

- Management of fertility, pregnancy and delivery requires a multidisciplinary approach tailored to individual patient needs and preferences (GR A)

22. SPINA BIFIDA

22.1. Urinary incontinence

Spina bifida is one of the most common birth defects with an annual incidence of about 0.35 per 1000 live births in the US [572], potentially involving all levels of the spinal column but most commonly the lumbosacral area. Associated (Arnold-)Chiari malformation is seen in more than 80% of children, often requiring ventriculo-peritoneal shunting of cerebrospinal fluid. Ingestion of folic acid prior to conception and during the first trimester of pregnancy has significantly reduced the incidence of this problem and other associated neural tube defects. The neurologic defect produced is quite variable and cannot be totally predicted

by the vertebral level of the lesion. Additionally the fibrosis associated with spine closure may tether the cord. Subsequent growth of the infant or child may produce further neurologic problems, manifesting as changes in bladder, bowel and lower extremity function.

The incidence of urinary tract dysfunction in spina bifida is not absolutely known, but most studies suggest it is very high (>90%). Similarly, anorectal dysfunction is very common, but its exact incidence has not been reported.

The two major neuro-urological consequences in patients with spina bifida are urinary incontinence and hydronephrosis leading to renal failure, which can occur early or later in life. There are many studies documenting a variety of urodynamic findings of spina bifida patients such as detrusor overactivity, detrusor underactivity, low compliance, detrusor sphincter dyssynergia or static/ fixed external urethral sphincter [410, 414, 572, 573]

In the past, much attention has been directed at the significance of dyssynergia between the external sphincter and the detrusor, and the associated deterioration of the upper renal tracts in these patients. With the increasing use of IC, more emphasis has been placed on the pressure the bladder is able to generate prior to leaking as a prognostic factor in predicting upper tract deterioration.

Urodynamics is the cornerstone in the diagnosis of urinary tract dysfunction in patients with spina bifida. Urodynamic findings may predict the patients at risk of upper tract deterioration. Controversy continues regarding when to initiate these studies: as soon as possible after back closure; at the first sign of upper tract changes; or before considering management of incontinence. The preponderance of opinion suggests earlier diagnosis of potentially unfavourable factors is advisable.

As hydronephrosis and vesico-ureteric reflux are a consequence of detrusor dysfunction, synchronous fluoroscopic evaluation of the urinary tract is advisable at the time of urodynamics, i.e. video-urodynamics. Similarly, renal ultrasound has become an invaluable routine serial evaluation in these patients, assessing renal growth, development of scarring and, most importantly, hydronephrosis. Repeat urodynamics and ultrasound have a relevant role in this patient population, however, recommendations for timing and frequency of these studies still need to be elucidated. Although renal scans are routinely used, especially in the spina bifida patient with hydronephrosis, the exact role of this study in these patients is not clear.

Urologic treatment depends on the age of the patient and the nature of the urinary tract dysfunction as characterized by urodynamics. Targeting the primary urological abnormality (the dysfunctional and usually poorly compliant bladder) allows implementation of effective treatments, including regular IC, in order to

preserve upper renal tract function and to achieve urinary continence. Associated postural abnormalities may complicate both conservative and interventional therapies.

The mainstay of treatment is IC and antimuscarinic medication. As continence is not at issue in the neonate and infant, treatment may be postponed, unless upper tract changes are present. Some evidence exists pointing to the fact that early initiation of treatment may prevent subsequent deleterious bladder changes. Although intradetrusor onabotulinumtoxinA injections have become an established treatment for refractory neurogenic detrusor overactivity incontinence [410, 414], the value in patients with spina bifida is unclear and there is a lack of high evidence level studies [574]. Surgical treatments should be reserved for patients refractory to conservative treatments, depending on the type of urinary tract dysfunction, and do not differ from the procedures for the general neuro-urological patients [410, 414].

In adult patients who in childhood underwent bladder augmentation surgery, it is thought that there is an increased risk of a development of bladder malignancies. However, this assumption is not supported by high level evidence and screening for bladder malignancies in spina bifida patients with an augmented bladder seems not to be cost-effective (LOE2) [572].

Lumbar-to-sacral nerve re-routing was suggested as an approach to restore voiding and bowel movement in spina bifida patients [575] (LOE3). Another interesting treatment option is fetal surgery, but *in utero* closure of spina bifida seems not to improve lower urinary tract function [576, 577] (LOE3).

Management of incontinence and/or upper tract deterioration mirrors the treatment of neurogenic lower urinary tract dysfunction. Variations in this algorithm include the use of vesicostomy in the younger child who has failed conservative measures and has evidence of deteriorating upper tracts. External sphincterotomy has no routine place in the management of these patients and the use of the appendicovesicostomy in continent LUT reconstruction (Mitrofanoff) has increased. Most studies on surgical management of neurogenic lower urinary tract dysfunction are descriptive (LOE 4) at best.

Data from adult and paediatric surveys show renal damage to be the single most prevalent cause of morbidity and mortality; even in children, 30-40% exhibit evidence of renal damage. Additional factors such as chronic infection and stone formation will then render the kidney more vulnerable to progressive loss of renal mass and subsequent chronic renal failure. Renal transplantation is now considered the optimal treatment for end-stage renal disease in all age groups. Although more prone to complications, recent data on patients with spina bifida or severely abnormal LUTs demonstrate good patient and graft outcomes [578] (LOE 3).

Guidance for further research

Further clarification of the role of fetal surgery to repair the neural tube defect is required, especially in term of prevention of damage to the lower urinary tract. Similarly the role of early intervention, conservative or surgical, needs to be understood better. The timing of surgical intervention needs further study, as well as better quality of life assessments and risk/ benefit analyses of LUT reconstructive procedures. The development of a tissue-engineered substitute for cystoplasty and nerve re-routing is being studied. Finally, the fate of the adult spina bifida patients, especially those who have undergone reconstruction, needs to be documented.

Conclusions

- Spina bifida is one of the most common birth defects (LOE 1)
- Incidence is decreased by appropriately-timed folate ingestion during pregnancy (LOE 2)
- Most patients have lower urinary tract dysfunction which can lead to incontinence and / or upper tract deterioration (LOE 3)
- The majority will derive significant benefit from conservative measures (LOE 3)

Recommendations

- Regular surveillance with urodynamics and renal ultrasound is mandatory from infancy. However the exact timing is not defined. One must observe the general rules for neurogenic lower urinary tract dysfunction (B)
- Early initiation of conservative measures (clean intermittent catheterization, antimuscarinic medication) generally provides protection of the upper urinary tract (B)
- The role of new treatment options, for example biotechnology and nerve surgery, needs to be evaluated (C)
- Extensive surgery is reserved for failed conservative treatment (B)

Bowel problems

Voluntary control of defecation requires rectal sensation, peristalsis and adequate anorectal sphincter function. Neurological defects in patients with spinal lesions may affect one or more of these components, resulting in different types of defecation disorders: fecal incontinence, chronic constipation or both. Incontinence is one of the major stigmas affecting patients born with myelomeningocele [579]. Bowel dysfunction occurs in most children with spinal cord impairment from disease or injury.

Although many different regimens have been used to manage this problem, none has had universal success. Behavioural modification and laxatives failed to

achieve an acceptable result because of the persistence of soiling. A small dose of laxatives alone accomplished nothing while administering a large dose to an incontinent patient only resulted in profound embarrassment [580]. Biofeedback was introduced for use in children with intact rectal sensation, but recent trials have reported less encouraging results. "Digital disimpaction" is unpleasant to perform and only succeeds in emptying the distal rectal ampulla.

Bearing in mind that few of these patients can resist the push of peristalsis, the most effective therapy is complete emptying of the colon, since it takes at least 24–48 h to refill again. This can be achieved nowadays by two ways: retrograde colonic enema (RCE) using a special balloon catheter, or an operative procedure which allows an antegrade continence enema (ACE). In neurological fecal incontinence, standard enemas are difficult, if not impossible, to administer, because there is inability to retain the enema which flows out involuntarily through the weak anus during its instillation. Therefore a catheter-based RCE system has been developed by industry, the application of which can be applied either by the parents or even by children over the age of 7–8 years. Not all children tolerate this procedure, as colonic peristalsis creates pains in some of them. However the reported results are good according to Eire et al. [581]. Shandling et al. [582] reported 100% success in using the enema continence catheter in the management of patients with spina bifida. These authors regard the RCE as one of the best conservative methods of treatment for relieving fecal incontinence originating from myelomeningocele and other neurological problems.

The impact of ACE surgery in the management of patients with myelomeningocele was analysed by Lemelle et al. [579]. 47 patients were treated with ACE, of whom 41 still used the method at a mean time of 4.1 ± 1.9 years after the ACE operation. With ACE, faecal incontinence was significantly improved compared with conventional management, and neither retrograde rectal enema nor digital extraction were required. In most cases, ACE was performed using the appendix or the caecum. Six patients (12.8%) stopped using the ACE for various reasons, from conduit problems due to stomal stenosis or catheterization difficulties, lack of motivation or "too long time to empty the enema". ACE stoma surgery was applied before, concomitantly or after urinary incontinence surgery in 5, 27 and 10 cases respectively. Enemas were performed at most three times a week, and tap water was used in the majority of patients. Mean volume for ACE was 1.2 L (range 0.25–3.0 L). Mean enema time for colonic washout with ACE was 50 ± 19 min (range 15–90 min), however mean washout duration for ACE tended to be shorter with implantation of the conduit on the left-segment of the colon.

Casale et al. [583] were unable to find any differences in the continence rate or stomal complications between total reconstruction (concurrent ACE and continent urine stoma) or staged reconstruction. How-

ever, because of shared pathology, the authors believe that most patients benefit from intervention in both the gastrointestinal and the genitourinary tract. Therefore, a major advantage of total continence reconstruction is avoidance of the morbidity of a second major surgical procedure (LOE 3). Nevertheless, conventional treatment should be tested first, and the efficacy of RCE may be a predictor of the efficacy of ACE on bowel management. Moreover, percutaneous endoscopic insertion is fully reversible and does not present drawbacks potentially encountered with the catheterizable conduit [579]. Nevertheless, experience with the Malone procedure has proved that a suitable continent and catheterizable conduit can be obtained with an appropriate technique. In selected and motivated patients, and with the help of a specialist nurse providing close support in the postoperative period, surgical ACE procedure might be preferred according to the surgeon's experience.

As no absolute indication has been defined for ACE, other criteria should be used to evaluate clinical outcome of bowel management, including health-related quality of life (HRQoL). The development of a disease-specific HRQoL measure for use with myelomeningocele has been proposed by Parkin et al. [584]. HRQoL assessment should be performed prospectively when ACE procedure is planned and performed during pre and post-operative periods. According to Eire et al. [581] ACE procedure and RCE can be the best options for achieving the best social integration. For wheelchair users and other selected patients, the ACE (being faster and easier) is better than the RCE, which needs some help in its use [581, 585].

Sacral neuromodulation has been described also in the therapy of these patients, but the persistence of continence control and tolerance of the patient need to be evaluated for a prolonged period of time. Sacral neuromodulation may only be successful in a small selected number of patients, in whom preserved anatomy of the sacral nerves permits placement of the electrodes on the sacral nerves [586].

Conclusions

- Neurologic bowel dysfunction and bowel problems, including fecal incontinence and constipation, are prevalent among myelomeningocele patients (LOE 3).
- Fecal incontinence and methods of bowel care affect the QoL and social activities of myelomeningocele patients (LOE 3).
- The main goal is to empty the colon as much as possible, to achieve continence during the subsequent 24–48 hours. This can be achieved by retrograde colonic enema using a special balloon catheter, or by an operative procedure which allows an antegrade continence enema (ACE) (LOE 3).

Recommendations

- Colorectal problems require attention in the treatment of myelomeningocele patients (GOR B)
- Appropriate bowel programme / management should be properly designed for each person, after adequate counselling (GOR B)

23. DIABETES MELLITUS

23.1. Epidemiology

Diabetes mellitus (DM) has a prevalence of 1-6% in the United States, depending on the specific criteria utilized to identify the disease. The prevalence is significantly higher amongst the elderly: 21.8% of residents of nursing homes suffered from DM in a multinational eight countries study (the Services and Health for Elderly in Long TERM care (SHELTER) project [587].

Overall, up to 59% of diabetic patients will report urinary symptoms, while 75-100% of those with evidence of peripheral neuropathy will develop NLUTD [588] [589]. The classic "diabetic cystopathy" (impaired bladder sensation, increased capacity, increased post void residual) has been estimated to occur in 43% to 87% of insulin-dependent diabetics, with no sex or age differences [590]. Typically, severely impaired bladder emptying is thought to occur in patients with more long-standing poorly controlled diabetes. It is also described in about 25% of diabetic patients on oral hypoglycemic treatment [591]. A Scandinavian study showed that in patients who have had diabetes for 10 years, the prevalence of diabetic cystopathy in those who were insulin-dependent was 2 to 4 per 1000 and in those on oral hypoglycemic agents was 1 to 3 per 1000. The correlation between diabetic cystopathy and peripheral neuropathy ranged from 75% to 100%. Nephropathy was seen in 30% to 40% of cases [589] (LOE 3). Urodynamic studies have noted a spectrum of findings in DM; those presenting relatively late with severe LUTS have a higher likelihood of impaired bladder sensation, detrusor underactivity and impaired emptying, while those investigated earlier are more likely to have detrusor overactivity and urgency incontinence [592].

23.2. Diabetes and Urinary incontinence

Large prospective studies are now available (the Diabetes Control and Complications Trial (DCCT; 1983-1993) and its observational follow-up study, the Epidemiology of Diabetes Interventions and Complications (EDIC; 1994- present, the Diabetes and Aging Study, NHANES, the Services and Health for Elderly in Long TERM care (SHELTER) project). These confirm the association between DM and incontinence. In gynaecological consultations, DM is a risk factor for incontinence, together with prolapse and

gynaecological surgery [593] [587, 594]. In a controlled study, after adjusting for age, body mass index, parity and history of urinary tract infections, diabetes was significantly associated with any incontinence (OR: 1.99; 95% CI: 1.44-2.74) urgency incontinence (OR: 2.23; 95% CI: 1.38-3.61) and stress incontinence (OR: 1.54; CI: 1.07-2.22) [595] (LOE 1). Gestational DM is an independent risk factor for all types of UI. Compared with women without gestational DM, women with it tended to exhibit more severe symptoms of stress incontinence for up to 2 years postpartum, whereas for urgency or mixed incontinence, more severe symptoms were found only for 6 months postpartum [596].

Among women with type 2 diabetes white race, higher body mass index, higher parity, lower physical activity, current postmenopausal hormone use and diuretic use were risk factors for prevalent and incident UI, whereas hysterectomy, vascular disease and longer duration of diabetes were associated with increased odds of prevalent UI only (Nurses' Health Study I and II) [597]. Diabetes duration, treatment type, peripheral neuropathy, and retinopathy were significantly associated with severe incontinence in multiple regression models adjusted for age, education, and history of UTI [598] (LOE 3). Lewis et al. in a cross-sectional study of 50-90 year old women found that insulin dependent diabetes was strongly associated with UI, while non insulin dependent diabetes was not [599] (LOE 2). In other studies, both the use of insulin (OR 2.62, 95% CI: 1.67-4.13) and of oral glucose-lowering agents (OR 1.81, 95% CI: 1.33-2.45) were predictors of UI in community-dwelling frail older adults with DM [600]. Most, but not all, studies suggest that diabetic measures, such as glycaemic control, may be associated with UI. In women with Type 1 diabetes, incident UI was associated with higher HbA1c levels, independent of other risk factors [601]. Among women with relatively controlled diabetes, each one-unit increase in HbA1c was associated with a 13% increase for any UI and a 34% increase in risk for only stress incontinence but was not significantly associated with urgency or mixed incontinence [602]. In a controlled study, after adjusting for all variables, high HbA1c levels were associated with OAB (odds ratio 1.24, 95% confidence interval 1.06-1.45), urge UI (odds ratio 1.20, 95% confidence interval 1.00-1.45) and nocturia [603]. Compared to women with normal HbA1c participants with DM type II had an increased prevalence of stress and urge UI (38.6% vs 52.5% and 21.7% vs 40.3%, respectively). Diabetes measures (glycaemic control and insulin resistance) were each significantly associated with UI in univariable but not in multivariate models when adjusted for patient body mass index [604]. Also, in community-dwelling frail older adults with DM, UI was not associated with HbA1c level, but with geriatric factors such as the inability to ambulate or transfer independently [600]. In the Diabetes and Aging Study, HbA1c levels were again not associated with the presence or absence of incontinence, alt-

though poor glycemic control (HbA_{1c} ≥9%) was associated with more limitations in daily activities due to incontinence [605]. Also, there is level 2 evidence that poor glycemic control increases the frequency of UTI in women with type 1 diabetes. For every unit increase (1%) in recent HbA_{1c} level, there was a 21% increase in UTI frequency after adjusting for race, hysterectomy status, urinary incontinence), sexual activity, peripheral and autonomic neuropathy and nephropathy [606].

Consequently, the question is whether improved glycemic control can lead to modification of the risk of UI. Available studies to date have demonstrated a variable, positive effect. In the Diabetes Prevention Program Outcomes Study which included 1778 female participants who had been randomly assigned to intensive lifestyle intervention, metformin or placebo, Intensive lifestyle intervention had a modest positive but enduring impact on UI (prevalence 46.7%, 53.1%, 49.9% urinary incontinence/week) [607]. In the Look AHEAD trial in a cohort of overweight/obese men with type 2 DM, intensive lifestyle intervention reduced the odds of prevalent UI by 38% at 1 year compared to diabetes support and education. The prevalence of UI decreased from 11.3% to 9.0% in the intensive lifestyle intervention group and increased from 9.7% to 11.6% in the diabetes support and education group. The intensive lifestyle intervention group also had almost twice the odds of UI resolving compared to the diabetes support and education group [608].

Van Poppel et al. [609] reported neuropathological examination of bladder biopsies from 14 patients with severe insulin-dependent adult-onset diabetes, compared with acetylcholinesterase and S100 staining of 38 control specimens. A decrease in acetylcholinesterase activity, due to axonal degeneration, was found in all cases. An increase in S100 positivity was found in the majority and is due to Schwann cell proliferation as a regeneration attempt after demyelination or axonal degeneration. When acetylcholinesterase activity decreases and an S100 density increase is found in a patient with diabetes, this combination is highly suggestive of diabetic cystopathy amenable to early symptomatic treatment (LOE 2). Because of the uncontrolled hyperglycaemia, patients with DM develop altered NGF activity, which may be a mechanistic factor in the development of diabetic bladder dysfunction [610] [611]. In this respect, electrophysiological studies offer support to associations between diabetic cystopathy and peripheral neuropathy. Hyposensitivity of unmyelinated C-fiber afferents at the distal extremities was found to be an indicator of early-stage diabetic bladder dysfunction in type 2 diabetic women. C-fiber dysfunction at the distal extremities appeared to be concordant with vesical C-fiber neuropathy [612].

Since the peripheral nerves are involved, the clinical manifestations of diabetic cystopathy might be very varied. Usually there is reduced sensation of bladder fullness, and decreased frequency of voiding. This is followed by slowing of the urinary stream and difficulty

in voiding due to impaired detrusor contraction. Post-voiding dribbling may also occur. The impaired bladder emptying and urinary retention predispose to urinary tract infections. A prospective study investigated the temporal effect of DM on the functional disturbances of the LUT in diabetic patients. In a cohort of 181 women with type 2 DM, there appeared to be a time-dependent progression trend in the development of bladder dysfunction, advancing from urodynamic stress incontinence to DO and/or increased bladder sensation and eventually to impaired voiding function. The duration of DM was longer in women with voiding dysfunction (6.8 ± 2.8 years in women with stress incontinence, 7.3 ± 6.5 years in DO and/or increased bladder sensation, and 10.4 ± 8.3 years in women with voiding dysfunction) [613]. Earlier studies had suggested that urine output does not contribute significantly to diabetic cystopathy [614].

Retrospective studies support however an unfavourable effect of DM on detrusor contractile force. Mean maximal flow rate and P_{det}Q_{max} and bladder contractility index were lower in the DM group, in whom mean DM duration was 9.24 ± 7.63 years and mean HbA_{1c} level 7.27 ± 1.43 %. DM duration was significantly correlated with Q_{max}, P_{det}Q_{max}, and BCI. Moreover, the HbA_{1c} level was negatively associated with Q_{max}, P_{det}Q_{max}, and BCI [615]. In diabetic women, poorer glycemic control was associated with an increased likelihood of PVR ≥ 100 mL (OR 1.30, CI 1.06-1.59 for each-one unit increase in HbA_{1c}) [616].

Yamaguchi et al. studied 84 diabetic cystopathy patients [617]. In addition to large post-void residual and decreased sensation, urinary urgency, DO, and increased bladder sensation were seen in 55%, 42% and 14%, respectively. The prevalence of DO in patients with increased bladder sensation was 58%. DO increased with age, but not with the duration of diabetes. Urodynamic characteristics of DO are different between diabetic women and age-matched controls; amplitude of first overactive contraction, volume at first overactive contraction and maximal detrusor pressure were greater in diabetics compared with the non-diabetic group (16.00 cm H₂O vs. 9.00 cm H₂O, 309.00 mL vs. 167.00 mL and 76.48 cm H₂O vs. 55.41 cm H₂O respectively) [618]. In a brain MRI study of 32 cases, the prevalence of multiple cerebral infarctions in patients with DO was 76.5%. The authors concluded that urinary urgency is not uncommon in diabetic cystopathy. Both central and peripheral mechanisms are involved [619] (LOE 3).

Ishigooka et al. [620] (LOE 3) described the results of the ice-water test in diabetic patients with and without cystopathy. 12.5% of patients without cystopathy and 25% of patients with cystopathy did not feel the ice water sensation. Ueda et al. [621] (LOE 2) performed studies evaluating sympathetic skin response in correlation with cystometry. They found that patients without sympathetic skin responses had increased residual urine and decreased detrusor contraction pressure, while patients with lower amplitude of sympathetic skin response and more prolonged latency

than controls had a significant decrease in detrusor contraction pressure. The changes within the bladder function were observed as early as within one year from the diagnosis of diabetes.

Beylot et al. [622] (LOE 2) found that the presence of residual urine in diabetic patients, after exclusion of co-morbidities, was strongly associated with peripheral neuropathy. Ho et al. showed increased bladder sensation, followed by DO in 94 female diabetic patients undergoing urodynamic studies [623]. Those patients with OAB are more likely to have impaired voiding function. In a questionnaire based survey, OAB was twice as prevalent (24.2%) in diabetics compared to the general population, while the presence of symptomatic diabetic polyneuropathy significantly increased the risk for development of OAB [624]. Similarly, in a cross-sectional hospital-based survey of women with type 2 DM, peripheral neuropathy, nephropathy, and presence of metabolic syndrome were significantly associated with moderate to severe LUTS and OAB [625]. In a controlled, questionnaire-based survey, diabetic patients had higher OAB-q scores compared to the control group, with disease duration showing significant correlations with OAB-q scores (LOE1) [626]. In another controlled study DM patients had a significantly higher proportion of OAB symptoms compared with the controls (28.0% vs 16.3%), as well as nocturia (48.0% vs 39.1%)(LOE1) [603].

No specific treatment has been described in regards to the population of patients with diabetic cystopathy. Therefore general rules as for the other bladder conditions with impaired (absent) detrusor contractions should be followed. Sacral Neuromodulation has been used to treat LUTD in DM, with similar long term results as in non DM patients [627]. By contrast, in women undergoing mid-urethral sling procedures for UI lower cure rates were seen in diabetics (0.50; CI 0.35-0.74) [628]. Similarly, in a controlled study, the presence of DM was associated with a significantly smaller reduction of OAB symptoms when treated with antimuscarinics, but the effect attributable to diabetes was small relative to the overall treatment response (LOE1) [629].

Future research should endeavour to give epidemiological information on the incidence of both type I and II diabetes-related functional disorders of micturition, and specific results of therapeutic interventions on each type of incontinence as well as on urinary tract infections. Gender effects should also be investigated.

Conclusions

- Diabetic cystopathy occurs in up to 80% of insulin dependent diabetes mellitus (LOE3)
- Urinary incontinence is strongly associated with diabetes. The current evidence is stronger for insulin dependent diabetes compared with insulin independent diabetes (LOE 2)

- The frequency and severity of Overactive bladder is increased in diabetes, presumably reflecting both central and peripheral mechanisms (LOE 1,2)
- Patients with diabetic cystopathy generally can have OAB and/ or impaired detrusor contractions with increased post-void residual (LOE 3,4)
- The urodynamic characteristics of detrusor overactivity are different in diabetics compared to controls (LOE 3)
- There is an unfavourable effect of diabetes and poor glycemic control on the urodynamic contractile characteristics of the detrusor (LOE 3,4)
- Poor glycemic control is associated with higher risk of increased post-void residual (LOE 3,4)
- In type 1 diabetes, poor glycemic control is associated with higher risk of urinary tract infections (LOE2)
- Recurrent urinary tract infections might be a long term problem (LOE 3,4)
- Intensive lifestyle intervention in diabetics has a positive impact on the prevention and resolution of urinary incontinence (LOE1)
- There is a lack of specific treatment for diabetic cystopathy
- However, the presence of diabetes may negatively affect the outcomes of surgical treatment for stress UI and pharmacotherapy for OAB (LOE 1,2)

Recommendations

- Post void residual measurement and urine dipstick (optional culture) for patients with diabetes mellitus should be performed yearly (C)
- In case of increased post-void residual, prompted voiding might be useful (C/D)
- Treatment of choice for acontractile bladder in this group remains intermittent catheterization (B/C)
- Patients with diabetes and incontinence should receive consultation about the positive effect and consequent need for (intensive) lifestyle intervention and good glycemic control (A)
- Patients should be warned about the negative effect of diabetes on the improvement of stress incontinence and OAB symptoms following appropriate therapeutic interventions (C)

23.3. Faecal Incontinence

Caruana et al. [630] (LOE 3) found that diabetic patients with faecal incontinence showed increased thresholds of phasic external sphincter contraction and had reduced resting/ maximal voluntary anal

sphincter pressures compared with controls. Increased thresholds of conscious rectal sensation in some incontinent patients with diabetes may contribute to faecal incontinence by impairing the recognition of impending defecation. Nakayama et al. [631] (LOE 3) found that age and diabetes have an independent negative influence on faecal incontinence after stroke. Abnormal internal-anal-sphincter function could be contributory in diabetic patients with faecal incontinence [632] (LOE 3). Russo found that acute hyperglycaemia inhibits external anal sphincter function and decreases rectal compliance, which could explain the pathogenesis of faecal incontinence [633] (LOE 3).

Talley and colleagues [634] (LOE 3) studied gastrointestinal symptoms, frequent abdominal pain, bowel-related abdominal pain, reflux, dyspepsia, constipation, diarrhoea and faecal incontinence in diabetic patients. There was a clinically significant decrease in QoL scores in diabetics compared with population norms across all subscales. The impact on QoL in diabetes was predominantly observed in type 2 diabetics. For all the Short Form-36 subscales, GI symptom groups were significantly associated with poorer QoL in diabetes, independent of age, gender, smoking, alcohol use, and type of diabetes.

Cross-sectional analyses of data from the Nurses' Health Study revealed that obesity was associated only with urinary incontinence while type 2 DM was a stronger risk factor for fecal than urinary incontinence [635].

Conclusions

- Faecal incontinence in diabetes patients may be due to impaired anorectal sensation and/or decreased anal closing pressure after hyperglycemic episodes (LOE 3)
- Gastro-intestinal symptoms impact negatively on health-related QoL in diabetes mellitus (LOE 3)

Recommendations

- Patients with diabetes and fecal incontinence should have anorectal manometry performed before introducing therapy for fecal incontinence (C/D)
- More studies on neurologic bowel dysfunction and management in diabetes are needed (B).

[636]. Neurological manifestations of SLE are subacute encephalo-myelopathy, subacute myelopathy (rarely) and chronic encephalomyelopathy. Seizures and psychiatric disorders are the most common manifestations, while spinal cord lesions are uncommon. Symptoms of LUT dysfunction can occur, however, data on prevalence are lacking. Several pathological urodynamic findings are reported [636-638]: slow urinary stream, high post-void residual, high maximum urethral closure pressure, detrusor overactivity, low compliance bladder, low maximum cystometric capacity, or loss of bladder sensation. LUTS in patients with SLE may also be caused by lupus cystitis, a rare entity often associated with lupus mesenteric vasculitis [639].

Conclusions

- About half of the patients with SLE show nervous system involvement. Subacute and chronic encephalomyelopathy may cause LUT dysfunction with varying patterns (LOE 4).

Recommendations

- Urodynamic investigations are necessary to define the underlying pathophysiology of the urinary symptoms, and are relevant to guide treatment (B).

24.2. Herpes Zoster

Herpes zoster (shingles) results from reactivation of the dormant varicella-zoster virus (VZV) resulting in vesicular eruptions of the skin or mucous membranes. Two distinct syndromes due to genital varicella zoster infection, cystitis and urinary retention, have been described. Cystitis classically presents with dysuria, frequency and hematuria and cystoscopic verification of local inflammatory changes on the bladder mucosa should be performed for the diagnosis of herpetic cystitis [640, 641] (LOE 3). Urinary retention may precede the emergence of the characteristic dermatomal skin rash [642], or it may follow initiation of zoster therapy [643].

The overall incidence of LUT dysfunction is 4% [644], however involvement is reported as high as 28 % if cases of lumbosacral involvement are considered. According to Chen et al., voiding dysfunction following herpes zoster can be; 1. Cystitis-associated, whereby direct involvement of the bladder wall results in herpetic cystitis, 2. Neuritis-associated, due to retrograde spread of infection by the VZV from the dorsal root ganglia of the sacral segments, or 3. Myelitis-associated, caused by herpetic myelitis. Occasionally, patients with skin rash in the lumbar or even lower thoracic dermatomes may develop bladder dysfunction and this is thought to be due to spread of VZV to the sacral segments.

Two case reports describe urodynamics findings in herpes-zoster patients. Usually patients develop complete urinary retention, with or without overflow incontinence due to detrusor acontractility and lack of

24. SYSTEMIC AND OTHER CONDITIONS

24.1. Systemic Lupus Erythematosus

Nervous system involvement occurs in about half of patients with systemic lupus erythematosus (SLE)

bladder sensation. Repeat urodynamic studies at week 10 after the onset of the disease demonstrated a return of the detrusor contraction, normalising after 14 weeks [645, 646] (LOE 4).

Herpes zoster-associated voiding dysfunction is a transient phenomenon and is not uncommon in patients with lumbosacral dermatome involvement. Treatment with IC or indwelling catheter placement is recommended in order to avoid secondary damage to the LUT due to chronic urinary retention or UTIs. The disease usually is of a benign clinical course, with recovery of bladder functions.

Conclusions

- 28 % of patients with Herpes zoster in the lumbosacral dermatomes show LUT dysfunction, with impaired voiding as the most common symptom (LOE 4).
- The most common symptom is overflow incontinence due to detrusor acontractility and lack of bladder sensation (LOE 4).
- Voiding dysfunction has a transient course and almost every patient will regain normal voiding within 3-4 months, or at the least achieve balanced bladder function (LOE 3).

Recommendation

- Till functional recovery takes place, urinary tract management with intermittent catheterisation or indwelling catheter is recommended (GOR B).

24.3. HIV

Urinary incontinence

HIV virus belongs to the family of retroviruses. This family of viruses is known for latency, persistent viremia, infection of the nervous system, and weak host immune responses. HIV has high affinity for CD4 T-lymphocytes and monocytes. HIV binds to CD4 cells and becomes internalized. The virus replicates itself by generating a DNA copy by reverse transcriptase. Viral DNA becomes incorporated into the host DNA, enabling further replication. HIV enters the nervous system early, at the time of initial infection, and may immediately cause symptoms, or it may cause delayed-onset symptoms, potentially at any time during the person's lifetime. All parts of the nervous system may be involved. Neurological disorders could be HIV-related, or due to secondary infections, malignancies, metabolic or nutritional problems and to therapy.

It is estimated that up to 80% of patients are symptomatic in terms of nervous system and for 30%, neurological symptoms are the initial clinical problem, in the absence of anti-retroviral treatment. Neurological syndromes may be the sole clinical problem or cause of death. The following brain symptoms have been described: meningitis, dementia, stroke, seizures, and degenerative disorders. For the spinal cord,

transverse myelitis and progressive myelopathy have been observed.

Due to nervous system involvement in HIV infection, consequent effects on LUT function can be anticipated [647]. Shin et al. (LOE3) described a higher prevalence of incontinence in HIV-positive patients as compared to HIV-negative in nursing homes [648]. Whether this represents a true trend, or an observation related to the terminal stage of the disease and associated comorbidities, remains to be elucidated. Gyrttrup et al. (LOE 3) found voiding problems in 12% of HIV-infected patients, mostly in advanced stages of the disease [649].

Virtually all parts of the body could be involved in AIDS patients, either as the primary location of HIV infection or secondary to HIV-related complications. Among the different manifestations, particular attention should be paid to the primary locations as they develop early in the stage of the disease. HIV can affect all areas of the central and peripheral nervous system- for example, HIV-associated dementia, vacuolar myelopathy, distal sensory peripheral neuropathy and myopathy. Pelvic organ dysfunction has, however, been little studied. Patients may develop voiding dysfunction and chronic retention due to lumbosacral polyradiculopathy. Prior to the introduction of the newer anti-retroviral therapies in the 1990s, infection with cytomegalovirus was the most common cause [650] and other causes include lymphomatous infiltration, syphilis or a herpetic radiculopathy due to herpes varicella zoster or simplex. Mahieux et al. (LOE 3) described a case of acute myeloradiculitis due to cytomegalovirus as the initial manifestation of terminal stage HIV [651]. Matsumoto et al. (LOE 3) [652] reported a case of lumbosacral polyradiculopathy where voiding difficulties and lower limb paresis were the primary manifestation of HIV infection. Another pattern of LUT dysfunction is urgency incontinence and DSD [649] in the context of vacuolar myelopathy.

Bladder cancer is a recognised occurrence in these patients [653]. Though rare, they can occur in relatively young HIV-infected patients with a low CD4 nadir, presenting with haematuria. Most of them are smokers, and have aggressive pathological features [654-656].

Begara et al. (LOE 3) performed urodynamic studies in 10 patients with AIDS and voiding disorders and found that the most common symptom was urgency incontinence and the most common urodynamic finding was DSD [657]. In 3 patients they found demonstrable functional disorders of the LUT (2 patients had DO: one of them had a history of encephalopathy from HIV and the other patient had polyneuritis; the third patient had myelitis and a urodynamically-diagnosed sympathetic decentralization. Detrusor areflexia was described in 2 HIV-positive patients by Menendez et al. [658] (LOE 3). One of them had an ascending myelitis of probable herpetic origin, the

other had a cerebral abscess caused by *Toxoplasma gondii*.

Since during the course of the disease all parts of the nervous system can be involved, either as the primary location or secondary to AIDS-related complications, no disease specific diagnosis or treatment can be proposed. It is important to observe that sometimes functional disorders of the LUT can be the first manifestation of the HIV infection. When managing the patient with HIV infection one must bear in mind that both storage and voiding problems can occur and that both should be treated, potentially according to the results of urodynamic studies.

Future research needs to be supported by a stronger evidence base. All reports of HIV and voiding problems are rather anecdotal and no good prospective studies exist. The need for such studies is particularly important, when realizing that it takes up to 20-30 years from HIV infection to AIDS full manifestation, and that new antiviral treatment modalities could prolong the life of a patient with HIV significantly. Particular attention should be paid to primary nervous system involvement by HIV and the voiding dysfunctions that could be the side effects of HIV drug therapy.

Faecal incontinence

As diarrhoea is common in HIV infected patients, faecal incontinence can also occur, mostly due to anal sphincter weakness. The true incidence of HIV neuropathy-related faecal incontinence is not known and further studies are needed [659] (LOE 4). Many of the limitations of knowledge seen with urinary incontinence apply to faecal incontinence.

Conclusions

- HIV can influence the nervous system and LUT function in two ways: as a result of primary infection, or secondary to AIDS-related complications (LOE2/3).
- Nervous system manifestation of HIV infection can be the only sign of infection, and it is therefore important to take the possibility of HIV infection into consideration when facing unusual signs and symptoms from the LUT without any other obvious cause (LOE 3).
- HIV/AIDS is a progressive disease and dynamic changes to the LUT functions can occur during the evolution of the disease (LOE 2).
- Faecal incontinence in HIV/AIDS patients is usually associated with diarrhoea, however the true incidence is not known (LOE 4).
- Bladder cancer should be considered in any HIV patient with haematuria (LOE 4)

Recommendations

- Patients with HIV and nervous system pathological signs and symptoms should be evaluated for functional LUT problems (B).

- Due to the variety of LUT functional damage in HIV patients, dynamic evaluation of LUT function is essential for tailoring of therapy (C).
- No HIV-specific therapy of LUT problems and faecal incontinence is currently available. Due to the variety of functional damage, therapy should be individually tailored, according to the results of functional/ imaging studies (C).
- All HIV patients with haematuria should be screened for bladder cancer (B)

24.4. Neurosyphilis

Neurosyphilis results from longstanding infection with *Treponema pallidum*. Bladder dysfunction is common, though most classically in tabes dorsalis. The predominant neurological manifestations are sensory ataxia and spontaneous lancinating pains. Voiding dysfunction occurs due to involvement of sacral posterior roots and the dorsal column of the spinal cord, resulting in loss of bladder sensation and significantly elevated post-void residual urine. The bladder is atonic, though there may be some myogenic damage from chronic over distention. Some patients may demonstrate detrusor overactivity and DSD [660, 661]. The condition is rare and there is no contemporaneous epidemiological data.

REFERENCES

I. INTRODUCTION

1. Nieselstein RA, van der Werff JF, Verbeek FJ, Valk J, Vermeij-Keers C. Normal and abnormal embryonic development of the anorectum in human embryos. *Teratology*. 1998 Feb; 57:70-8
2. Birder L, de Groat W, Mills I, Morrison J, Thor K, Drake M. Neural control of the lower urinary tract: peripheral and spinal mechanisms. *Neurourol Urodyn*. 2010; 29:128-39
3. Drake MJ, Fowler CJ, Griffiths D, Mayer E, Patton JF, Birder L. Neural control of the lower urinary and gastrointestinal tracts: supraspinal CNS mechanisms. *Neurourol Urodyn*. 2010; 29:119-27
4. Furness JB. The enteric nervous system and neurogastroenterology. *Nat Rev Gastroenterol Hepatol*. 2012 Mar 6:
5. Shafik A. The effect of vesical filling and voiding on the anorectal function with evidence of a 'vesico-anorectal reflex'. *Neurogastroenterol Motil*. 1999 Apr; 11:119-24
6. De Wachter S, de Jong A, Van Dyck J, Wyndaele JJ. Interaction of filling related sensation between anorectum and lower urinary tract and its impact on the sequence of their evacuation. A study in healthy volunteers. *Neurourol Urodyn*. 2007; 26:481-5
7. De Wachter S, Wyndaele JJ. Impact of rectal distention on the results of evaluations of lower urinary tract sensation. *J Urol*. 2003 Apr; 169:1392-4
8. Malykhina AP. Neural mechanisms of pelvic organ cross-sensitization. *Neuroscience*. 2007 Nov 9; 149:660-72
9. NICE. Guideline on Management of incontinence in neurological disease: Introduction (in press). To be available 2012 at <http://www.nice.org.uk>. 2012:
10. Donovan WH. Donald Munro Lecture. Spinal cord injury--past, present, and future. *J Spinal Cord Med*. 2007; 30:85-100
11. Drake MJ. Re: Influences on renal function in chronic spinal cord injured patients. *J Urol*. 2001 Jun; 165:2006

12. Drake MJ, Cortina-Borja M, Savic G, Charlifue SW, Gardner BP. Prospective evaluation of urological effects of aging in chronic spinal cord injury by method of bladder management. *Neurourol Urodyn*. 2005; 24:111-6
13. Fowler CJ, Panicker JN, Drake M, et al. A UK consensus on the management of the bladder in multiple sclerosis. *J Neurol Neurosurg Psychiatry*. 2009 May; 80:470-7
14. Stohrer M, Blok B, Castro-Diaz D, et al. EAU guidelines on neurogenic lower urinary tract dysfunction. *Eur Urol*. 2009 Jul; 56:81-8
15. Abrams P, Amarenco G, Bakke A, et al. Tamsulosin: efficacy and safety in patients with neurogenic lower urinary tract dysfunction due to suprasacral spinal cord injury. *J Urol*. 2003 Oct; 170:1242-51
16. Cruz F, Herschorn S, Aliotta P, Brin M, Thompson C, Lam W, et al. Efficacy and safety of onabotulinumtoxinA in patients with urinary incontinence due to neurogenic detrusor overactivity: a randomised, double-blind, placebo-controlled trial. *Eur Urol*. 2011 Oct;60(4):742-50

II. PATHOPHYSIOLOGY

1. Powell CR. Not all neurogenic bladders are the same: a proposal for a new neurogenic bladder classification system. *Transl Androl Urol*. 2016; Feb;5(1):12-21.
2. Griffiths D. Functional imaging of structures involved in neural control of the LUT. Vodusek DB BF, editor. Amsterdam: Elsevier; 2015.
3. de Groat WC, Griffiths D, Yoshimura N. Neural control of the lower urinary tract. *Compr Physiol*. 2015; Jan;5(1):327-96.
4. Sakakibara R. Lower urinary tract dysfunction in patients with brain lesions. 1 ed. Vodusek DB BF, editor. Amsterdam: Elsevier; 2015.
5. Mehnert U, Nehiba M. [Neuro-urological dysfunction of the lower urinary tract in CNS diseases: pathophysiology, epidemiology, and treatment options]. *Urologe A*. 2012; Feb;51(2):189-97.
6. Siroky MB, Krane RJ. Neurologic aspects of detrusor-sphincter dyssynergia, with reference to the guarding reflex. *J Urol*. 1982 May;127(5):953-7.
7. Shrestha R. Is central nervous system an immune-privileged site? *Kathmandu Univ Med J*. 2013;11:5.

8. Park HS, Park MJ, Kwon MS. Central Nervous System-Peripheral Immune System Dialogue in Neurological Disorders: Possible Application of Neuroimmunology in Urology. *Int Neurourol J*. 2016; May;20(Suppl 1):S8-14.
9. Matsumoto-Miyai K, Yoshizumi M, Kawatani M. Regulatory Effects of 5-Hydroxytryptamine Receptors on Voiding Function. *Adv Ther*. Oct;32 Suppl 1:3-15.
10. Kwon W-A. Learning From Heart Failure: How Will We Lead Bladder Failure Into the Future? *Int Neurourol J*. 2016;20:1-2.
11. Rudy DC, Awad SA, Downie JW. External sphincter dyssynergia: an abnormal continence reflex. *J Urol*. 1988 Jul;140(1):105-10.
12. Khastgir J, Drake MJ, Abrams P. Recognition and effective management of autonomic dysreflexia in spinal cord injuries. *Expert Opin Pharmacother*. 2007 May;8(7):945-56.
13. Habler HJ, Janig W, Koltzenburg M. Activation of unmyelinated afferent fibres by mechanical stimuli and inflammation of the urinary bladder in the cat. *J Physiol*. 1990 Jun;425:545-62.
14. Kaplan SA, Chancellor MB, Blaivas JG. Bladder and sphincter behavior in patients with spinal cord lesions. *J Urol*. 1991 Jul;146(1):113-7.
15. Weld KJ, Dmochowski RR. Association of level of injury and bladder behavior in patients with post-traumatic spinal cord injury. *Urology*. 2000 Apr;55(4):490-4.
16. Weld KJ, Graney MJ, Dmochowski RR. Clinical significance of detrusor sphincter dyssynergia type in patients with post-traumatic spinal cord injury. *Urology*. 2000 Oct 1;56(4):565-8.
17. Aarabi B, Koltz M, Ibrahim D. Hyperextension cervical spine injuries and traumatic central cord syndrome. *Neurosurg Focus*. 2008;25(5):E9.
18. Dvorak MF, Fisher CG, Hoekema J, Boyd M, Noonan V, Wing PC, et al. Factors predicting motor recovery and functional outcome after traumatic central cord syndrome: a long-term follow-up. *Spine (Phila Pa 1976)*. 2005 Oct 15;30(20):2303-11.
19. Sakakibara R, Hattori T, Tojo M, Yamanishi T, Yasuda K, Hirayama K. The location of the paths subserving micturition: studies in patients with cervical myelopathy. *J Auton Nerv Syst*. 1995 Nov 6;55(3):165-8.
20. Yasuda K, Yamanishi T, Hattori T, Murayama N, Sakakibara R, Shimazaki J. Lower urinary tract dysfunction in the anterior spinal artery syndrome. *J Urol*. 1993 Oct;150(4):1182-4.
21. Smith CP, Kraus SR, Nickell KG, Boone TB. Video urodynamic findings in men with the central cord syndrome. *J Urol*. 2000 Dec;164(6):2014-7.
22. Nath M, Wheeler JS, Jr., Walter JS. Urologic aspects of traumatic central cord syndrome. *J Am Paraplegia Soc*. 1993 Jul;16(3):160-4.
23. Sakakibara R, Hattori T, Uchiyama T, Yamanishi T. Urinary dysfunction in Brown-Sequard syndrome. *Neurourol Urodyn*. 2001;20(6):661-7.
24. Scivoletto G, Cosentino E, Morganti B, Farchi S, Molinari M. Clinical prognostic factors for bladder function recovery of patients with spinal cord and cauda equina lesions. *Disabil Rehabil*. 2008;30(5):330-7.
25. Gitelman A, Hishmeh S, Morelli BN, Joseph SA, Jr., Casden A, Kuflik P, et al. Cauda equina syndrome: a comprehensive review. *Am J Orthop (Belle Mead NJ)*. 2008 Nov;37(11):556-62.
26. Podnar S. Bowel dysfunction in patients with cauda equina lesions. *Eur J Neurol*. 2006 Oct;13(10):1112-7.
27. Spector LR, Madigan L, Rhyne A, Darden B, 2nd, Kim D. Cauda equina syndrome. *J Am Acad Orthop Surg*. 2008 Aug;16(8):471-9.
28. Podnar SV, DB. Lower urinary tract dysfunction in patients with peripheral nervous system lesions. Vodusek DB BF, editor. Amsterdam: Elsevier; 2015.
29. Light JK, Beric A, Petronic I. Detrusor function with lesions of the cauda equina, with special emphasis on the bladder neck. *J Urol*. 1993 Mar;149(3):539-42.
30. Kneist W, Kauff DW, Juhre V, Hoffmann KP, Lang H. Is intraoperative neuromonitoring associated with better functional outcome in patients undergoing open TME? Results of a case-control study. *Eur J Surg Oncol*. Sep;39(9):994-9.
31. Puntambekar SP, Patil A, Joshi SN, Rayate NV, Puntambekar SS, Agarwal GA. Preservation of autonomic nerves in laparoscopic total radical hysterectomy. *J Laparoendosc Adv Surg Tech A*. Dec;20(10):813-9.
32. Kaul S, Savera A, Badani K, Fumo M, Bhandari A, Menon M. Functional outcomes and oncological efficacy of Vattikuti Institute prostatectomy with Veil of Aphrodite nerve-sparing: an analysis of 154 consecutive patients. *BJU Int*. 2006 Mar;97(3):467-72.
33. Podnar S, Trsinar B, Vodusek DB. Bladder dysfunction in patients with cauda equina lesions. *Neurourol Urodyn*. 2006;25(1):23-31.

34. Kim SY, Kwon HC, Hyun JK. Detrusor overactivity in patients with cauda equina syndrome. *Spine (Phila Pa 1976)*. 2014; Jul 15;39(16):E955-61.
35. Reitz A. Afferent pathways arising from the lower urinary tract after complete spinal cord injury or cauda equina lesion: clinical observations with neurophysiological implications. *Urol Int*.2012; 89(4):462-7.
3. Clark R and Welk B. Patient reported outcome measures in neurogenic bladder. *Transl Androl Urol* 2016;5(1):22-30
4. Linsenmeyer TA, Oakley A. Accuracy of individuals with spinal cord injury at predicting urinary tract infections based on their symptoms. *J Spinal Cord Med*. 2003 ; 26:352-357
5. Pannek J. Treatment of urinary tract infection in persons with spinal cord injury: guidelines, evidence, and clinical practice. A questionnaire-based survey and review of the literature. *J Spinal Cord Med*. 2011; 34(1): 11-5.
6. Costa P, Perrouin-Verbe B, Colvez A, et al. Quality of life in spinal cord injury patients with urinary difficulties. Development and validation of qualiveen. *Eur Urol* 2001;39:107-13.
7. Bonniaud V, Bryant D, Parratte B, et al. Qualiveen: a urinary disorder-specific instrument for use in clinical trials in multiple sclerosis. *Arch Phys Med Rehabil* 2006;87:1661-3.
8. Kalpakjian CZ, Scelza WM, Forchheimer MB, et al. Preliminary reliability and validity of a Spinal Cord Injury Secondary Conditions Scale. *J Spinal Cord Med* 2007;30:131-9.
9. Tulsy DS, Kisala PA, Tate DG, et al. Development and psychometric characteristics of the SCI-QOL Bladder Management Difficulties and Bowel Management Difficulties item banks and short forms and the SCIQOL Bladder Complications scale. *J Spinal Cord Med* 2015;38:288-302.
10. Jette AM, Tulsy DS, Ni P, et al. Development and initial evaluation of the spinal cord injury-functional index. *Arch Phys Med Rehabil* 2012;93:1733-50.
11. Heinemann AW, Dijkers MP, Ni P, et al. Measurement properties of the Spinal Cord Injury-Functional Index (SCI-FI) short forms. *Arch Phys Med Rehabil* 2014;95:1289-1297.e5.
12. Schurch B, Denys P, Kozma CM, et al. Reliability and validity of the Incontinence Quality of Life questionnaire in patients with neurogenic urinary incontinence. *Arch Phys Med Rehabil* 2007;88:646-52.
13. Possavino F, Preti M, Carone R, et al. Psychometric validation of the Italian version of the I-QoL questionnaire: clinical and urodynamic findings. *Int Urogynecol J* 2013;24:2125-30.
14. Welk B, Morrow S, Madarasz W, et al. The validity and reliability of the neurogenic bladder symptom score. *J Urol* 2014;192:452-7.
15. Vickrey BG, Hays RD, Harooni R, et al. A health-related quality of life measure for multiple sclerosis. *Qual Life Res* 1995;4:187-206.

III.NEUROLOGICAL URINARY INCONTINENCE

EPIDEMIOLOGY

1. Saunders LL, Selassie AW, Hill EG, Nicholas JS, Varma AK, Lackland DT, Patel SJ. *J Trauma*. 2009;66:184-90
2. Williams R, Rigby AS, Airey M, Robinson M, Ford H. Multiple sclerosis: its epidemiological, genetic, and health care impact. *J Epidemiol Comm Health* 1995;49: 563 –569.
3. Lang AE, Lozano AM. Medical Progress: Parkinson's disease. Parts 1 and 2. *NEJM*. 1998;339:1130-1143:1044-1053
4. DeVivo MJ. Epidemiology of traumatic spinal cord injury. In: Kirshblum S, Campagnolo DI, DeLisa JA, eds. *Spinal Cord Medicine*. Baltimore, Md: Lippincott Williams & Wilkins; 2002:69-81
5. Avery JD, Avery JA. Malignant spinal cord compression: a hospice emergency. *Home Healthc Nurse*. 2008;26:457-61

SPECIFIC DIAGNOSTICS

1. Stöhrer M, Castro-Diaz D, Chartier-Kastler E, Del Popolo G, Kramer G, Pannek J, Radziszewski P, Wyndaele JJ. EAU Guidelines on Neurogenic Urinary Tract Dysfunction, In: EAU Guidelines. Edition presented at the 23rd EAU Congress, Milan, Italy. ISBN-13: 978-90-70244-91-0. <http://www.uroweb.org/professional-resources/guidelines/>
2. Stohrer M, Goepel M, Kondo A, Kramer G, Madersbacher H, Millard R, Rossier A, Wyndaele JJ. The standardization of terminology in neurogenic lower urinary tract dysfunction with suggestions for diagnostic procedures. *Neurourol Urodyn* 1999; 18:139-158.
3. Schurch B, Denys P, Kozma CM, et al. Reliability and validity of the Incontinence Quality of Life questionnaire in patients with neurogenic urinary incontinence. *Arch Phys Med Rehabil* 2007;88:646-52.
4. Possavino F, Preti M, Carone R, et al. Psychometric validation of the Italian version of the I-QoL questionnaire: clinical and urodynamic findings. *Int Urogynecol J* 2013;24:2125-30.
5. Welk B, Morrow S, Madarasz W, et al. The validity and reliability of the neurogenic bladder symptom score. *J Urol* 2014;192:452-7.
6. Vickrey BG, Hays RD, Harooni R, et al. A health-related quality of life measure for multiple sclerosis. *Qual Life Res* 1995;4:187-206.

16. Giordano A, Pucci E, Naldi P, et al. Responsiveness of patient reported outcome measures in multiple sclerosis relapses: the REMS study. *J Neurol Neurosurg Psychiatry* 2009;80:1023-8.
17. Hobart J, Lamping D, Fitzpatrick R, et al. The Multiple Sclerosis Impact Scale (MSIS-29): a new patient-based outcome measure. *Brain* 2001;124:962-73.
18. Cella DF, Dineen K, Arnason B, et al. Validation of the functional assessment of multiple sclerosis quality of life instrument. *Neurology* 1996;47:129-39.
19. Gold SM, Heesen C, Schulz H, et al. Disease specific quality of life instruments in multiple sclerosis: validation of the Hamburg Quality of Life Questionnaire in Multiple Sclerosis (HAQUAMS). *Mult Scler* 2001;7:119-30.
20. Gold SM, Schulz H, Stein H, et al. Responsiveness of patient-based and external rating scales in multiple sclerosis: head-to-head comparison in three clinical settings. *J Neurol Sci* 2010;290:102-6.
21. Marrie RA, Miller DM, Chelune GJ, et al. Validity and reliability of the MSQLI in cognitively impaired patients with multiple sclerosis. *Mult Scler* 2003;9:621-6.
22. National Multiple Sclerosis Society. Multiple Sclerosis Quality of Life Inventory (MSQLI). Cited Sep 2, 2015. Available online: [http://www.nationalmssociety.org/For-Professionals/Researchers/Resources-for-Researchers/Clinical-Study-Measures/Multiple-Sclerosis-Quality-of-Life-Inventory-\(MSQLI](http://www.nationalmssociety.org/For-Professionals/Researchers/Resources-for-Researchers/Clinical-Study-Measures/Multiple-Sclerosis-Quality-of-Life-Inventory-(MSQLI)
23. Bates D, Burks J, Globe D, et al. Development of a short form and scoring algorithm from the validated actionable bladder symptom screening tool. *BMC Neurol* 2013;13:78.
24. Burks J, Chancellor M, Bates D, et al. Outcome measures in neurogenic bladder validation of the actionable bladder symptom screening tool for multiple sclerosis patients. *Int J MS Care* 2013;15:182-92.
25. Parkin PC, Kirpalani HM, Rosenbaum PL, et al. Development of a health-related quality of life instrument for use in children with spina bifida. *Qual Life Res* 1997;6:123-32.
26. Moore KN, Jensen L. Testing of the Incontinence Impact Questionnaire (IIQ-7) with men after radical prostatectomy. *J Wound Ostomy Continence Nurs* 2000;27:304-12.
27. Okamura K, Nojiri Y, Osuga Y. Reliability and validity of the King's Health Questionnaire for lower urinary tract symptoms in both genders. *BJU Int* 2009;103:1673-8.
28. Viana R, Viana S, Neto F, et al. Adaptation and validation of the King's Health Questionnaire in Portuguese women with urinary incontinence. *Int Urogynecol J* 2015;26:1027-33.
29. Kelleher CJ, Cardozo LD, Khullar V, et al. A new questionnaire to assess the quality of life of urinary incontinent women. *Br J Obstet Gynaecol* 1997;104:1374-9.
30. Coyne K, Revicki D, Hunt T, et al. Psychometric validation of an overactive bladder symptom and healthrelated quality of life questionnaire: the OAB-q. *Qual Life Res* 2002;11:563-74.
31. Wolpe RE, Toriy AM, Da Silveira GF, et al. Assessing the impact of urinary incontinence on quality of life: systematic review of instruments in Portuguese. *MTP&RehabJournal* 2014;12:201.
32. Irwin PP, Harris M. Patient-reported outcomes in overactive bladder due to idiopathic detrusor overactivity: A correlation of two multi-domain questionnaires with a focus on quality of life and lifestyle goals. *J Clin Urol* 2014;7:403-8
33. Naoemova I, De Wachter S, Wuyts FL, Wyndaele JJ. Reliability of the 24-h sensation-related bladder diary in women with urinary incontinence. *Int Urogynecol J Pelvic Floor Dysfunct.* 2008;19: 955-959
34. Bright E, Cotterill N, Drake M and Abrams P: Developing and Validating the International Consultation on Incontinence Questionnaire Bladder Diary. *Eur Urol*, 66 (2014) 294–300
35. Lombardi G, Del Popolo G. Clinical outcome of sacral neuromodulation in incomplete spinal cord injured patients suffering from neurogenic lower urinary tract symptoms. *Spinal Cord.* 2009; 47(6): 486-91.
36. Wyndaele, J. J.: Correlation between clinical neurological data and urodynamic function in spinal cord injured patients. *Spinal Cord* 1997; 35: 213- 216
37. Schurch B, Schmid DM, Karsenty G, Reitz A. Can neurologic examination predict type of detrusor sphincter-dyssynergia in patients with spinal cord injury? *Urology.* 2005 ; 65: 243-246
38. Wyndaele J J, De Sy W A. Correlation between the findings of a clinical neurological examination and the urodynamic dysfunction in children with myelodysplasia. *J Urol* 1985; 133: 638-640
39. Bross S, Honeck P, Kwon ST, Badawi JK, Trojan L, Alken P Correlation between motor function and lower urinary tract dysfunction in patients with infantile cerebral palsy. *NeuroUrol Urodyn.* 2007; 26: 222-227.

40. Bickenbach, Jerome E., et al. International perspectives on spinal cord injury. Geneva, Switzerland: World Health Organization, 2013.
41. Hill TC, Baverstock R, Carlson KV, Estey EP, Gray GJ, Hill DC, Ho C, McGinnis RH, Moore K, and Parmar R. Best practices for the treatment and prevention of urinary tract infection in the spinal cord injured population: The Alberta context. *Can Urol Assoc J.* 2013 Mar-Apr; 7(3-4): 122–130)
42. Wyndaele J J. A critical review of urodynamic investigations in spinal cord injury patients. *Paraplegia* 1984; 22: 138-144
43. Biering-Sørensen F, Craggs M, Kennelly M, Schick E, Wyndaele JJ. International Urodynamic Basic Spinal Cord Injury Data Set. *Spinal Cord.* 2008 Jan 29.
44. Nguyen HT, Sencan A, Silva A, Carvas FA, Bauer SB. Urodynamic studies are recommended in children with central nervous system tumors regardless of location. *J Urol.* 2010; 184(6): 2516-20.
45. Wein A, Barrett DM. Etiologic possibilities for increased pelvic floor electromyography activity during cystometry. *J Urol.* 1982 May: 127:949-52
46. Sundin T, Petersén I. Cystometry and simultaneous electromyography from the striated urethral and anal sphincters and from levator ani. *Invest Urol.* 1975;13:40-46
47. Kirby AC, Nager CW, Litman HJ, FitzGerald MP, Kraus S, Norton P, Sirls L, Rickey L, Wilson T, Dandreo KJ, Shepherd J, and Zimmern P, for the Urinary Incontinence Treatment Network11. Perineal Surface Electromyography. Does Not Typically, Demonstrate Expected Relaxation During Normal Voiding. *Neurourol Urodyn* 30:1591–1596 (2011)
48. De EJ, Patel CY, Tharian B, Westney OL, Graves DE and Hairston JC. Diagnostic discordance of electromyography (EMG) versus voiding cystourethrogram (VCUG) for detrusor-external sphincter dyssynergy (DESD). *Neurourol Urodyn*, Volume 24, Issue 7, pages 616–621, 2005
49. Perakash I. Detrusor-sphincter dyssynergia and dyssynergic responses: recognition and rationale for early modified transurethral sphincterotomy in complete spinal cord injury lesions. *J Urol.* 1978;120:469-474
50. Rodriguez AA, Awad EA, Price MM. Electromyogram-gas cystometrogram: its use in the management of neurologic bladder of spinal cord injury. *Arch Phys Med Rehabil.* 1978;59:451-454
51. Mayo ME, Kiviat MD. Increased residual urine in patients with bladder neuropathy secondary to suprasacral spinal cord lesions. *J Urol.* 1980;123:726-728
52. Perlow DL, Diokno AC. Predicting LUT dysfunctions in patients with spinal cord injury. *Urology.* 1981 ;18:531-535
53. Koyanagi T, Arikado K, Takamatsu T, Tsuji I. Experience with electromyography of the external urethral sphincter in spinal cord injury patients. *J Urol.* 1982 ;127:272-276
54. Blaivas JG, Sinha HP, Zayed AA, Labib KB. Detrusor-external sphincter dyssynergia: a detailed electromyographic study. *J Urol.* 1981;125:545-548
55. Rudy DC, Awad SA, Downie JW. External sphincter dyssynergia: an abnormal continence reflex. *J Urol.* 1988; 140(1): 105-10
56. Aoki H, Adachi M, Banya Y, Sakuma Y, Seo K, Kubo T, Ohori T, Takagane H, Suzuki Y. Evaluation of neurologic bladder in patients with spinal cord injury using a CMG.EMG study and CMG.UFM.EMG study. *Hinyokika Kiyō.* 1985;31:937-948
57. Kirby RS. Studies of the neurologic bladder. *Ann R Coll Surg Engl.* 1988 ;70:285-288
58. Pavlakis AJ, Siroky MB, Wheeler JS Jr, Krane RJ. Supplementation of cystometrography with simultaneous perineal floor and rectus abdominis electromyography. *J Urol.* 1983 ;129:1179-81
59. Yamamoto T, Sakakibara R, Uchiyama T, Liu Z, Ito T, Awa Y, Yamamoto K, Kinou M, Yamanishi T, Hattori T. When is Onuf's nucleus involved in multiple system atrophy? A sphincter electromyography study. *J Neurol Neurosurg Psychiatry.* 2005 ;76:1645-1648.
60. Rapidi CA, Karandreas N, Katsifotis C, Benroubi M, Petropoulou K, Theodorou C. A combined urodynamic and electrophysiological study of diabetic cystopathy. *Neurourol Urodyn.* 2006; 25:32-38.
61. Schafer W, Abrams P, Liao L, Mattiasson A, Pesce F, Spangberg A, et al. Good urodynamic practices: uroflowmetry, filling cystometry, and pressure-flow studies. *Neurourol Urodyn.* 2002; 21(3): 261-74
62. Bruschini H, Almeida FG, Srougi M. Upper and lower urinary tract evaluation of 104 patients with myelomeningocele without adequate urological management. *World J Urol.* 2006; 24: 224-228.

63. Moslavac S, Dzidic I, Kejla Z. Neurogenic detrusor overactivity: Comparison between complete and incomplete spinal cord injury patients. *Neurourol Urodyn. Neurourol Urodyn* 2008;27:504-6.
64. Abrahamsson K, Olsson I, Sillén U. Urodynamic findings in children with myelomeningocele after untethering of the spinal cord. *J Urol.* 2007 ;177:331-334
65. Kang HS, Wang KC, Kim KM, Kim SK, Cho BK. Prognostic factors affecting urologic outcome after untethering surgery for lumbosacral lipoma. *Childs Nerv Syst.* 2006; 22:1111-1121
66. Perkash I, Friedland GW. Ultrasonographic detection of false passages arising from the posterior urethra in spinal cord injury patients. *J Urol.* 1987;137:701-702
67. Perkash I, Friedland GW. Principles of modern urodynamic studies. *Invest Radiol.* 1987;22:279-289
68. Ko HY, Lee JZ, Park HJ, Kim H, Park JH. Comparison between conventional cystometry and stimulated filling cystometry by diuretics in a neurologic bladder after spinal cord injury. *Am J Phys Med Rehabil.* 2002 ;81:731-735
69. De Gennaro M, Capitanucci ML, Silveri M, Mosiello G, Broggi M, Pesce F. Continuous (6 hour) urodynamic monitoring in children with neurologic bladder. *Eur J Pediatr Surg.* 1996 ;6 Suppl 1:21-24
70. Zermann DH, Lindner H, Huschke T, Schubert J. Diagnostic value of natural fill cystometry in neurologic bladder in children. *Eur Urol.* 1997;32:223-228
71. Martens FM, van Kuppevelt HJ, Beekman JA, Heijnen IC, D'Hauwers KW, Heesakkers JP. No primary role of ambulatory urodynamics for the management of spinal cord injury patients compared to conventional urodynamics. *Neurourol Urodyn.* 2010; 29(8): 1380-6
72. Sakakibara R, Fowler CJ, Hattori T, Hussain IF, Swinn MJ, Uchiyama T, Yamanishi T. Pressure-flow study as an evaluating method of neurologic urethral relaxation failure. *J Auton Nerv Syst.* 2000;80:85-88
73. Nitti VW, Adler H, Combs AJ. The role of urodynamics in the evaluation of voiding dysfunction in men after cerebrovascular accident. *J Urol.* 1996;155:263-266
74. Sakakibara R, Hattori T, Uchiyama T, Yamanishi T, Ito H, Ito K. Neurologic failures of the external urethral sphincter closure and relaxation; a videourodynamic study. *Auton Neurosci.* 2001;86:208-215.
75. Madersbacher H. Combined pressure, flow, EMG and X-ray studies for the evaluation of neurologic bladder disturbance: technique. *Urol Int.* 1977;32:176-183.
76. Zerlin J M, Lebowitz RL, Bauer S B. Descent of the bladder neck: a urographic finding in denervation of the urethral sphincter in children with myelodysplasia. *Radiology.* 1990;174:833-836
77. Ockrim J, Laniado ME, Khoubehi B, Renzetti R, Finazzi Agrò E, Carter SS, Tubaro A. Variability of detrusor overactivity on repeated filling cystometry in men with urge symptoms: comparison with spinal cord injury patients. *BJU Int.* 2005;95:587-590 .
78. Wyndaele J J. Is impaired perception of bladder filling during cystometry a sign of neuropathy? *Br J Urol.* 1993;71:270-273
79. Lee, S. W. & Kim, J. H. The significance of natural bladder filling by the production of urine during cystometry. *Neurourol Urodyn.*2008; 27: 772-4.
80. Wyndaele J J. Studies of bladder sensitivity in patients with myelodysplasia. *Paraplegia.* 1992; 30:333-335.
81. Martens FM, van Kuppevelt HJ, Beekman JA, Rijkhoff NJ, Heesakkers JP. Limited value of bladder sensation as a trigger for conditional neurostimulation in spinal cord injury patients. *Neurourol Urodyn.* 2010; 29(3): 395-400.
82. Ersoz M, Akyuz M. Bladder-filling sensation in patients with spinal cord injury and the potential for sensation-dependent bladder emptying. *Spinal Cord.* 2004 ;42:110-116
83. Shin JC, Chang WH, Jung TH, Yoo JH, Park SN. The determination of sensation-dependent bladder emptying time in patients with complete spinal cord injury above T11. *Spinal Cord.* 2008;46:210-215.
84. Lemack GE, Frohman EM, Zimmern PE, Hawker K, Ramnarayan P. Urodynamic distinctions between idiopathic detrusor overactivity and detrusor overactivity secondary to multiple sclerosis. *Urology.* 2006; 67:960-964.
85. Ayyildiz A, Huri E, Nuhoglu B, Germiyanoglu C. Unexpected complication after cystometry in the hypocompliant urinary bladder: formation of a knot in the double lumen urethral catheter--a case report. *Int Urol Nephrol.* 2006;38:527-529
86. Blok BF, Al Zahrani A, Capolicchio JP, Bilo-deau C, Corcos J. Post-augmentation bladder perforation during urodynamic investigation. *Neurourol Urodyn.* 2007;26:540-542.
87. Pannek J, Nehiba M. Morbidity of urodynamic testing in patients with spinal cord injury: is antibiotic prophylaxis necessary? *Spinal Cord.* 2007;45:771-774

88. Latthe PM, Foon R, Toozs-Hobson P. Prophylactic antibiotics in urodynamics: a systematic review of effectiveness and safety. *Neurourol Urodyn.* 2008;27:167-173.
89. Foon R, Toozs-Hobson P, Latthe P. Prophylactic antibiotics to reduce the risk of urinary tract infections after urodynamic studies. *Cochrane Database Syst Rev.* 2012 Oct 17;10:CD008224. doi: 10.1002/14651858.CD008224.pub2
90. Deffontaines Rufin S, Jousse M, Verollet D, Guinet A, Ismael SS, Amarenco G. Cold perception of the bladder during ice water test. Study on 120 patients. *Ann Phys Rehabil Med.* 2010; 53(9): 559-67
91. Van Meel TD, De Wachter S, Wyndaele JJ. The effect of intravesical oxybutynin on the ice water test and on electrical perception thresholds in patients with neurogenic detrusor overactivity. *Neurourol Urodyn.* 2010; 29(3): 391-4
92. Geirsson G, Lindstrom S, Fall M. Pressure, volume and infusion speed criteria for the ice-water test. *Br J Urol* 1994; 73: 498-503
93. Geirsson G, Fall M. The ice-water test in the diagnosis of detrusor-external sphincter dyssynergia. *Scand J Urol Nephrol* 1995; 29: 457-461
94. Ishigooka M, Hashimoto T, Hayami S, Suzuki Y, Ichianagi O, Nakada T. Thermoreceptor mediated bladder sensation in patients with diabetic cystopathy. *Int Urol Nephrol* 1997; 29: 551-555
95. Ronzoni G, Menchinelli P, Manca A, de Giovanni I.: The ice-water test in the diagnosis and treatment of the neurologic bladder. *Br J Urol* 1997; 79: 698-701
96. Chancellor MB, Lavelle J, Ozawa H, Jung SY, Watanabe T, Kumon H. Ice-water test in the urodynamic evaluation of spinal cord injured patients. *Tech Urol* 1998; 4: 87-91
97. Kozomara M, Bellucci CH, Seifert B, Kessler TM, Mehnert U. Urodynamic investigations in patients with spinal cord injury: should the ice water test follow or precede the standard filling cystometry? *Spinal Cord.* 2015 Nov;53(11):800-2. doi: 10.1038/sc.2015.152. Epub 2015 Sep 22
98. Van Meel T, De Wachter S, Wyndaele JJ Repeated ice water tests and electrical perception threshold determination to detect a neurologic cause of detrusor overactivity. *Urology.* 2007; 70: 772-776.
99. Ismael SS, Epstein T, Bayle B, Denys P, Amarenco G. Bladder cooling reflex in patients with multiple sclerosis. *J Urol.* 2000; 164: 1280-1284
100. De Wachter S, Van Meel T, Wyndaele JJ. Study of the afferent nervous system and its evaluation in women with impaired detrusor contractility treated with bethanechol. *Urology.* 2003; 62: 54-58
101. Lapedes J, Friend CR, Ajemian EP, Reus WF. A new method for diagnosing the neurologic bladder. *Med Bull (Ann Arbor).* 1962 ; 28: 166-180
102. Blaivas JG, Labib KB, Michalik SJ, Zayed AA. Failure of bethanechol denervation supersensitivity as a diagnostic aid. *J Urol.* 1980; 123:199-201
103. Penders L. The bethanechol test in the diagnosis of neurologic bladder. 60 cases. *J Urol (Paris).* 1983 ; 89: 309-315.
104. Pavlakis AJ, Siroky MB, Krane RJ. Neurologic detrusor areflexia: correlation of perineal electromyography and bethanechol chloride supersensitivity testing. *J Urol.* 1983 ; 129: 1182-1184
105. Sidi AA, Dykstra DD, Peng W. Bethanechol supersensitivity test, rhabdosphincter electromyography and bulbocavernosus reflex latency in the diagnosis of neurologic detrusor areflexia. *J Urol.* 1988 ;140 : 335-337
106. Sakakibara R, Uchiyama T, Asahina M, Suzuki A, Yamanishi T, Hattori T. Micturition disturbance in acute idiopathic autonomic neuropathy. *J Neurol Neurosurg Psychiatry.* 2004 ; 75: 287-291
107. Wheeler JS Jr, Culkin DJ, Canning JR.: Positive bethanechol supersensitivity test in neurologically normal patients. *Urology* 1988; 31: 86-89
108. Wheeler JS Jr, Culkin DJ, Walter JS, Flanigan RC. Female urinary retention. *Urology.* 1990; 35: 428-432
109. Mahajan ST, Fitzgerald MP, Kenton K, Shott S, Brubaker L Concentric needle electrodes are superior to perineal surface-patch electrodes for electromyographic documentation of urethral sphincter relaxation during voiding. *BJU Int.* 2006 ; 97:117-120
110. Nordling J, Meyhoff HH. Dissociation of urethral and anal sphincter activity in neurologic bladder dysfunction. *J Urol.* 1979;122:352-356
111. Koyanagi T, Arikado K, Takamatsu T, Tsuji I. Experience with electromyography of the external urethral sphincter in spinal cord injury patients. *J Urol.* 1982 ;127:272-276.
112. Podnar S. Neurophysiology of the neurogenic lower urinary tract disorders. *Clin Neurophysiol.* 2007 ;118:1423-1437

113. Fowler CJ, Kirby RS, Harrison MJ, Milroy EJ, Turner-Warwick R.. Individual motor unit analysis in the diagnosis of disorders of urethral sphincter innervation. *J Neurol Neurosurg Psychiatry*. 1984 ;47:637-641
114. Vodusek D B. Individual motor unit analysis in the diagnosis of urethral sphincter innervation. *J Neurol Neurosurg Psychiatry*. 1989 ;52:812-813
115. Ziemann U, Reimers C D. Anal sphincter electromyography, bulbocavernosus reflex and pudendal somatosensory evoked potentials in diagnosis of neurologic lumbosacral lesions with disorders of bladder and large intestine emptying and erectile dysfunction. *Nervenarzt*. 1996 ;67:140-146.
116. Fowler CJ. Investigational techniques. *Eur Urol*. 1998;34 Suppl 1:10-12
117. Kavia RB, Datta SN, Dasgupta R, Elneil S, Fowler CJ. Urinary retention in women: its causes and management. *BJU Int*. 2006; 97(2): 281-7
118. Opisso E, Borau A, Rijkhoff NJ. Urethral sphincter EMG-controlled dorsal penile/clitoral nerve stimulation to treat neurogenic detrusor overactivity. *J Neural Eng*. 2011; 8(3): 036001
119. De EJ, Patel CY, Tharian B, Westney OL, Graves DE, Hairston JC. Diagnostic discordance of electromyography (EMG) versus voiding cystourethrogram (VCUG) for detrusor-external sphincter dyssynergy (DESD). *Neurourol Urodyn*. 2005;24:616-21
120. Wenzel BJ, Boggs JW, Gustafson KJ, Creasey GH, Grill WM. Detection of neurogenic detrusor contractions from the activity of the external anal sphincter in cat and human. *Neurourol Urodyn*. 2006;25:140-147
121. Hansen J, Borau A, Rodríguez A, Vidal J, Sinkjaer T, Rijkhoff NJ. Urethral sphincter EMG as event detector for neurogenic detrusor overactivity. *IEEE Trans Biomed Eng*. 2007; 54: 1212-1219
122. Light J K, Faganel J, Beric A. Detrusor areflexia in suprasacral spinal cord injuries. *J Urol*. 1985 ;134:295-297
123. Ito T, Sakakibara R, Yasuda K, Yamamoto T, Uchiyama T, Liu Z, Yamanishi T, Awa Y, Yamamoto K, Hattori T. Incomplete emptying and urinary retention in multiple-system atrophy: when does it occur and how do we manage it? *Mov Disord*. 2006; 21: 816-823
124. Sakakibara R, Uchiyama T, Arai K, Yamanishi T, Hattori T. Lower urinary tract dysfunction in Machado-Joseph disease: a study of 11 clinical-urodynamic observations. *J Neurol Sci*. 2004; 218: 67-72
125. Durufle A, Petrilli S, Nicolas B, Robineau S, Guillé F, Edan G, Gallien P. Effects of pregnancy and child birth on urinary symptoms and urodynamics in women with multiple sclerosis. *Int Urogynecol J Pelvic Floor Dysfunct*. 2006; 17: 352-355.
126. Karaman MI, Kaya C, Caskurlu T, Guney S, Ergenekon E. Urodynamic findings in children with cerebral palsy. *Int J Urol*. 2005; 12:717-720
127. Gammie A, Bosch R, Djurhuus JC, et al. Do we need better methods of assessing urethral function: ICI-RS 2013? *Neurourol Urodyn* 2014;33:587-90
128. La Joie WJ, Cosgrove MD, Jones WG. Electromyographic evaluation of human detrusor muscle activity in relation to abdominal muscle activity. *Arch Phys Med Rehabil*. 1976; 57: 382-386
129. Kaplan E, Nanninga B.: Electromyography of the human urinary bladder. *Electromyogr Clin Neurophysiol*. 1978; 18: 63-68
130. Kinder M, Gommer E, Janknegt R, van Waalwijk van Doorn E. Recording the detrusor electromyogram is still a difficult and controversial enterprise. *Neurourol Urodyn*. 1998; 17: 571-3
131. Walter JS, Wheeler JS Jr, Dunn RB. Dynamic bulbocavernosus reflex: dyssynergia evaluation following J Am Paraplegia Soc. 1994 ;17:140-145
132. Kaiho Y, Namima T, Uchi K, Nakagawa H, Aizawa M, Orikasa S. Electromyographic study of the striated urethral sphincter by using the bulbocavernosus reflex: study of the normal voluntary voiding and the involuntary sphincter relaxation. *Nippon Hinyokika Gakkai Zasshi*. 1999 ; 90: 893-900
133. Kaiho Y, Namima T, Uchi K, Nakagawa H, Aizawa M, Takeuchi A, Nishimura Y, Ohnuma T, Orikasa S. Electromyographic study of the striated urethral sphincter by using the bulbocavernosus reflex: study of the normal voluntary voiding and the involuntary sphincter relaxation]. *Nippon Hinyokika Gakkai Zasshi*. 2000; 91:715-722
134. Niu X, Shao B, Ni P, Wang X, Chen X, Zhu B, et al. Bulbocavernosus reflex and pudendal nerve somatosensory-evoked potentials responses in female patients with nerve system diseases. *J Clin Neurophysiol*. 2010; 27: 207-11

135. Schmid DM, Curt A, Hauri D, Schurch B. Motor evoked potentials (MEP) and evoked pressure curves (EPC) from the urethral compressive musculature (UCM) by functional magnetic stimulation in healthy volunteers and patients with neurogenic incontinence. *Neurourol Urodyn.* 2005;24:117-127
136. Di Lazzaro V, Pilato F, Oliviero A, Saturno E, Dileone M, Tonali PA. Role of motor evoked potentials in diagnosis of cauda equina and lumbosacral cord lesions. *Neurology.* 2004 ;63:2266-2271
137. Andersen JT, Bradley WE.: Abnormalities of bladder innervation in diabetes mellitus. *Urology.* 1976; 7: 442-448.
138. Vereecken RL, De Meirsmen J, Puers B, Van Mulders J. Electrophysiological exploration of the sacral conus *J Neurol.* 1982;227:135-144
139. Carbone A, Palleschi G, Parasciani R, Morello P, Conte A, Inghilleri M. et al.: Modulation of viscerosomatic H-reflex during bladder filling: a possible tool in the differential diagnosis of neurologic voiding dysfunctions. *Eur Urol.* 2002 ;42:281-288.
140. Badr G, Carlsson CA, Fall M, Friberg S, Lindström L, Ohlsson B. Cortical evoked potentials following stimulation of the urinary bladder in man. *Electroencephalogr Clin Neurophysiol.* 1982 ;54:494-498
141. Galloway NT, Chisholm GD, McInnes A. Patterns and significance of the sacral evoked response (the urologist's knee jerk). *Br J Urol.* 1985;57:145-147.
142. Mochida K, Shinomiya K, Andou M. Urodynamic and electrophysiologic study of the urinary disturbances caused by cervical myelopathy. *J Spinal Disord.* 1996 ; 9:141-145
143. Curt A, Rodic B, Schurch B, Dietz V. Recovery of bladder function in patients with acute spinal cord injury: significance of ASIA scores and somatosensory evoked potentials. *Spinal Cord.* 1997;35:368-373
144. Mazo EB, Sokolova AA, Krivoborodov GG, Shkol'nikov ME, Moiseev PP. The role of somatosensory evoked potentials in prognosis of efficacy of tibial neuromodulation in patients with hyperactive urinary bladder. *Urologiia.* 2005 ;5:49-52 .
145. Kaneko K, Kato Y, Kojima T, Imajyo Y, Taguchi T. Epidurally recorded spinal cord evoked potentials in patients with cervical myelopathy and normal central motor conduction time measured by transcranial magnetic stimulation. *Clin Neurophysiol.* 2006;117:1467-1473.
146. Kurstjens GA, Borau A, Rodríguez A, Rijkhoff NJ, Sinkjaer T. Intraoperative recording of electroneurographic signals from cuff electrodes on extradural sacral roots in spinal cord injured patients. *J Urol.* 2005 ;174:1482-1487
147. Frankl-Hochwart L, Zuckerkandl O. Die nervösen Erkrankungen der Blase. In: *Spezielle Pathologie und Therapie.* Edited by v. Northnagel. Wien: Holder, 1899
148. Markland C, Chou S, Swaiman KF, Westgate HD, Bradley WE. Evaluation of neurologic urinary dysfunction. *Surg Forum* 1965;16:504-507
149. Kiesswetter, H. Mucosal sensory threshold of urinary bladder and urethra measured electrically. *Urol Int.* 1977;32:437-448
150. Powell PH, Feneley RC. The role of urethral sensation in clinical urology. *Br J Urol.* 1980;52:539-541
151. Frimodt-Moller, C. A new method for quantitative evaluation of bladder sensibility. *Scand J Urol Nephrol.* 1972;6:Suppl 15:135-134
152. Wyndaele J J. Is abnormal electrosensitivity in the LUT a sign of neuropathy? *Br J Urol.* 1993; 72: 575-579.
153. De Wachter S, Wyndaele J J. Quest for standardization of electrical sensory testing in the LUT: the influence of technique related factors on bladder electrical thresholds. *Neurourol Urodyn.* 2003;22:118-122.
154. Ukimura O, Ushijima S, Honjo H, Iwata T, Suzuki K, Hirahara N, Okihara K, Mizutani Y, Kawachi A, Miki T. Neuroselective current perception threshold evaluation of bladder mucosal sensory function. *Eur Urol.* 2004 ;45:70-76
155. De Laet K, De Wachter S, Wyndaele JJ. Current perception thresholds in the lower urinary tract: Sine- and square-wave currents studied in young healthy volunteers. *Neurourol Urodyn.* 2005;24:261-266
156. Griffiths D, Derbyshire S, Stenger A, Resnick N. *J Urol.* 2005 Nov; 174(5):1862-7.
157. Komesu YM, Ketai LH, Mayer AR, Teshiba TM and Rogers RG. Functional MRI of the Brain in Women with Overactive Bladder: Brain Activation During Urinary Urgency. *Female Pelvic Med Reconstr Surg.* 2011; 17(1): 50–54.
158. Fowler CJ, Griffiths DJ. A decade of functional brain imaging applied to bladder control. *Neurourol Urodyn.* 2010;29(1):49-55.
159. Zempleni M-Z, Michels L, Mehnert U, Schurch B and Kollias S. Cortical substrate of bladder control in SCI and the effect of peripheral pudendal stimulation. *NeuroImage,* 49, 2983-2994, 2010

160. Dasgupta R, Critchley HD, Dolan RJ, Fowler CJ. Changes in brain activity following sacral neuromodulation for urinary retention J Urol. 2005 Dec;174(6):2268-72
161. Sakakibara R, Uchida Y, Uchiyama T, Yamanishi T, Hattori T. Reduced cerebellar vermis activation during urinary storage and micturition in multiple system atrophy: 99mTc-labelled ECD SPECT study. Eur J Neurol 2004; 11: 705-8.
162. Kitta T, Kakizaki H, Furuno T, Moriya K, Tanaka H, Shiga T, Tamaki N, Yabe I, Sasaki H and Nonomura K. Brain activation during detrusor overactivity in patients with Parkinson's disease: A Positron Emission Tomography Study. J Urol, 175, 994-998, 2006
163. Herzog J, Weiss P.H, Assmus A, Wefer B, Seif C, Braun PM, Pinsker MO, Herzog H, Volkmann J, Deuschl G and Fink GR. Improved sensory gating of urinary bladder afferents in Parkinson's disease following subthalamic stimulation. Brain, 131,132-145, 2008
164. Herzog J, Weiss P.H, Assmus A, Wefer B, Seif C, Braun PM, Pinsker MO, Herzog H, Volkmann J, Deuschl G and Fink GR. Subthalamic stimulation modulates cortical control of urinary bladder in Parkinson's disease. Brain, 129, 3366-3375, 2006
165. Winge K, Friberg L, Werdelin L, Nielsen KK and Stimpel. Relationship between nigrostriatal dopaminergic degeneration, urinary symptoms and bladder control in Parkinson's disease. EJ Neurology, 12, 842-850, 2005
166. Schurch B, Curt A, Rossier A B. The value of sympathetic skin response recordings in the assessment of the vesicourethral autonomic nervous dysfunction in spinal cord injured patients. J Urol 1997;157:2230-2233
167. Rodic B, Curt A, Dietz V, Schurch B. Bladder neck incompetence in patients with spinal cord injury: significance of sympathetic skin response. J Urol. 2000; 163:1223-1227.
168. Emad R, Zafarghasempour M, Roshanzamir S. Sympathetic skin response in incomplete spinal cord injury with urinary incontinence. Ann Indian Acad Neurol. 2013;16(2):234-8.
2. Drake MJ, Cortina-Borja M, Savic G, Charlifue SW, Gardner BP. Prospective evaluation of urological effects of aging in chronic spinal cord injury by method of bladder management. NeuroUrol Urodyn. 2005; 24:111-6
3. Cameron AP, Wallner LP, Forchheimer MB, et al. Medical and psychosocial complications associated with method of bladder management after traumatic spinal cord injury. Arch Phys Med Rehabil. 2011; 92:449-56
4. Jamison J, Maguire S, McCann J. Catheter policies for management of long term voiding problems in adults with neurogenic bladder disorders. Cochrane Database Syst Rev. 2011; 12:CD004375
5. Colli J, Lloyd LK. Bladder neck closure and suprapubic catheter placement as definitive management of neurogenic bladder. J Spinal Cord Med. 2011; 34:273-7
6. El-Masri WS, Chong T, Kyriakides AE, Wang D. Long-term follow-up study of outcomes of bladder management in spinal cord injury patients under the care of the Midlands Centre for Spinal Injuries in Oswestry. Spinal Cord. 2012; 50:14-21
7. Pan D, Troy A, Rogerson J, Bolton D, Brown D, Lawrentschuk N. Long-term outcomes of external sphincterotomy in a spinal injured population. J Urol. 2009; 181:705-9
8. Pannek J, Gocking K, Bersch U. Clinical usefulness of the memokath stent as a second-line procedure after sphincterotomy failure. J Endourol. 2011; 25:335-9
9. Mehta S, Hill D, Foley N, et al. A Meta-Analysis of Botulinum Toxin Sphincteric Injections in the Treatment of Incomplete Voiding After Spinal Cord Injury. Arch Phys Med Rehabil. 2012; 93: 597-603
10. Khastgir J, Drake MJ, Abrams P. Recognition and effective management of autonomic dysreflexia in spinal cord injuries. Expert Opin Pharmacother. 2007; 8:945-56.
11. Perkash I. Transurethral sphincterotomy provides significant relief in autonomic dysreflexia in spinal cord injured male patients: long-term followup results. J Urol. 2007; 177:1026-9
12. Di Benedetto P. Clean intermittent self-catheterization in neuro-urology. Eur J Phys Rehabil Med. 2011; 47:651-9
13. Xu DF, Zhang S, Wang CZ, et al. Low-frequency electrotherapy for female patients with detrusor underactivity due to neuromuscular deficiency. Int Urogynecol J. 2012; 23: 1007-15

CONSERVATIVE TREATMENT

1. Bothig R, Hirschfeld S, Thietje R. Quality of life and urological morbidity in tetraplegics with artificial ventilation managed with suprapubic or intermittent catheterisation. Spinal Cord. 2012; 50:247-51

14. Abrams P, Agarwal M, Drake M, et al. A proposed guideline for the urological management of patients with spinal cord injury. *BJU Int* 2008; 101:989-94
15. Bladder management for adults with spinal cord injury: a clinical practice guideline for health-care providers. *J Spinal Cord Med*. 2006; 29:527-73
16. Generao SE, Dall'era JP, Stone AR and Kurzrock EA. Spinal cord injury in children: long-term urodynamic and urological outcomes. *J Urol* 2004; 172: 1092-4, discussion 1094.
17. Kochakarn W, Ratana-Olarn K, Lertsithichai P and Roongreungsilp U. Follow-up of long-term treatment with clean intermittent catheterization for neurogenic bladder in children. *Asian J Surg* 2004; 27: 134-6.
18. Dromerick AW and Edwards DF. Relation of postvoid residual to urinary tract infection during stroke rehabilitation. *Arch Phys Med Rehabil* 2003; 84: 1369-72.
19. Wyndaele JJ. Intermittent catheterisation and intermittent self-catheterization have become properly introduced. *Eur Urol* 2007; 52: 220.
20. Guttmann L and Frankel H. The value of intermittent catheterisation in the early management of traumatic paraplegia and tetraplegia. *Paraplegia* 1966; 4: 63-84.
21. De Ridder DJ, Everaert K, Fernandez LG, Valero JV, Duran AB, Abrisqueta ML et al. Intermittent catheterisation with hydrophilic-coated catheters (SpeediCath) reduces the risk of clinical urinary tract infection in spinal cord injured patients: a prospective randomised parallel comparative trial. *Eur Urol* 2005; 48: 991-5.
22. Bjerklund-Johansen T, Hultling C, Madersbacher H, Del Popolo G and Amarenco G. A novel product for intermittent catheterisation: its impact on compliance with daily life--international multicentre study. *Eur Urol* 2007; 52: 213-20.
23. Kovindha A, Mai WN and Madersbacher H. Re-used silicone catheter for clean intermittent catheterization (CIC): is it safe for spinal cord-injured (SCI) men? *Spinal Cord* 2004; 42: 638-42.
24. Getliffe K, Fader M, Allen C, Pinar K and Moore KN. Current evidence on intermittent catheterization: sterile single-use catheters or clean re-used catheters and the incidence of UTI. *J Wound Ostomy Continence Nurs* 2007; 34: 289-96.
25. Wyndaele JJ. Intermittent catheterization: which is the optimal technique? *Spinal Cord* 2002; 40:432-7.
26. Lindehall B, Abrahamsson K, Jodal U, Olsson I and Sillen U. Complications of clean intermittent catheterization in young females with myelomeningocele: 10 to 19 years of followup. *J Urol* 2007; 178: 1053-5.
27. Lindehall B, Abrahamsson K, Hjalmas K, Jodal U, Olsson I and Sillen U. Complications of clean intermittent catheterization in boys and young males with neurogenic bladder dysfunction. *J Urol* 2004; 172: 1686-8.
28. Chen Y, DeVivo MJ and Lloyd LK. Bladder stone incidence in persons with spinal cord injury: determinants and trends, 1973-1996. *Urology* 2001; 58: 665-70.
29. Oh SJ, Ku JH, Jeon HG, Shin HI, Paik NJ and Yoo T. Health-related quality of life of patients using clean intermittent catheterization for neurogenic bladder secondary to spinal cord injury. *Urology* 2005; 65: 306-10.
30. Oh SJ, Shin HI, Paik NJ, Yoo T and Ku JH. Depressive symptoms of patients using clean intermittent catheterization for neurogenic bladder secondary to spinal cord injury. *Spinal Cord* 2006; 44: 757-62.
31. Ozawa H, Uematsu K, Ohmori H, Kondo A, Iwatsubo E and Takasaka S. [Long-term usefulness and safety of the contemporary balloon catheter]. *Nippon Hinyokika Gakkai Zasshi* 2005; 96: 541-7.
32. Pannek J. Transitional cell carcinoma in patients with spinal cord injury: a high risk of malignancy? *Urology* 2002; 59: 240-4.
33. Wall BM, Dmochowski RR, Malecha M, Mangold T, Bobal MA and Cooke CR. Inducible nitric oxide synthase in the bladder of spinal cord injured patients with a chronic indwelling urinary catheter. *J Urol* 2001; 165: 1457-61.
34. Hamid R, Bycroft J, Arya M and Shah PJ. Screening cystoscopy and biopsy in patients with neuropathic bladder and chronic suprapubic indwelling catheters: is it valid? *J Urol* 2003; 170: 425-7
35. Sammer U, Walter M, Knüpfel SC, Mehnert U, Bode-Lesniewska B, Kessler TM. Do We Need Surveillance Urethro-Cystoscopy in Patients with Neurogenic Lower Urinary Tract Dysfunction? *PLoS One*. 2015 Oct 29;10(10):e0140970.
36. Witjes JA, Compérat E, Cowan NC, De Santis M, Gakis G, Lebrét T, et al. EAU guidelines on muscle-invasive and metastatic bladder cancer 2014. Available: [http://www.uroweb.org/gls/pdf/07Muscle Invasive BC_LR.pdf](http://www.uroweb.org/gls/pdf/07Muscle%20Invasive%20BC_LR.pdf).

37. Consortium for Spinal Cord Medicine. Bladder management for adults with spinal cord injury: a clinical practice guideline for health-care providers. *The journal of spinal cord medicine*. 2006; 29(5):527–73.
38. Stern JA and Clemens JQ. Osteomyelitis of the pubis: a complication of a chronic indwelling catheter. *Urology* 2003; 61: 462.
39. Biering-Sorensen F, Bagi P and Hoiby N. Urinary tract infections in patients with spinal cord lesions: treatment and prevention. *Drugs* 2001; 61: 1275-87.
40. Siroky MB. Pathogenesis of bacteriuria and infection in the spinal cord injured patient. *Am J Med* 2002; 113 Suppl 1A: 67S-79S.
41. Ahluwalia RS, Johal N, Kouriefs C, Kooiman G, Montgomery BS and Plail RO. The surgical risk of suprapubic catheter insertion and long-term sequelae. *Ann R Coll Surg Engl* 2006; 88: 210-3.
6. Franco I, Horowitz M, Grady R, Adams RC, de Jong TP, Lindert K et al. Efficacy and safety of oxybutynin in children with detrusor hyperreflexia secondary to neurogenic bladder dysfunction. *J Urol* 2005; 173: 221-5.
7. Gajewski JB, Awad SA. Oxybutynin versus propantheline in patients with multiple sclerosis and detrusor hyperreflexia. *J Urol*. 1986 May; 135:966-8
8. Lee JH, Kim KR, Lee YS, Han SW, Kim KS, Song SH, Baek M, Park K. Efficacy, tolerability, and safety of oxybutynin chloride in pediatric neurogenic bladder with spinal dysraphism: a retrospective, multicenter, observational study. *Korean J Urol*. 2014; 55(12):828-33
9. Stohrer M, Murtz G, Kramer G, Schnabel F, Arnold EP and Wyndaele JJ. Propiverine compared to oxybutynin in neurogenic detrusor overactivity--results of a randomized, double-blind, multicenter clinical study. *Eur Urol* 2007; 51: 235-42.
10. Grigoleit U, Murtz G, Laschke S, Schuldt M, Goepel M, Kramer G et al. Efficacy, tolerability and safety of propiverine hydrochloride in children and adolescents with congenital or traumatic neurogenic detrusor overactivity--a retrospective study. *Eur Urol* 2006; 49: 1114-20; discussion 1120-1.

PHARMACOTHERAPY

1. Stothers L, Tsang B, Nigro M, Lazar D, Macnab A. An integrative review of standardized clinical evaluation tool utilization in anticholinergic drug trials for neurogenic lower urinary tract dysfunction. *Spinal Cord* 2016; 1-7 [epub ahead of print]
2. Hadji N, Previnaire JG, Benbouzid R, Robain G, Leblond C, Miesusset R, Enjalbert M, Soler JM. Are oxybutynin and trospium efficacious in the treatment of detrusor overactivity in spinal cord injury patients? *Spinal Cord* 2014; 52(9):701-5.
3. Amarenco G, Sutory M, Zchoval R, Agarwal M, Del Popolo G, Tretter R, Compion G, De Ridder D. Solifenacin is effective and well tolerated in patients with neurogenic detrusor overactivity: results from the double-blind, randomized, active- and placebo-controlled SONIC urodynamic study. *Neurourol Urodyn*. 2015 Dec 29. [Epub ahead of print]
4. Nicholas RS, Friede T, Hollis S, Young CA. Anticholinergics for urinary symptoms in multiple sclerosis. *Cochrane Database Syst Rev*. 2009;CD004193.
5. Bennett N, O'Leary M, Patel AS, Xavier M, Erickson JR and Chancellor MB. Can higher doses of oxybutynin improve efficacy in neurogenic bladder? *J Urol* 2004; 171: 749-51.
11. Schulte-Baukloh H, Murtz G, Henne T, Michael T, Miller K and Knispel HH. Urodynamic effects of propiverine hydrochloride in children with neurogenic detrusor overactivity: a prospective analysis. *BJU Int* 2006; 97: 355-8.
12. McKeage K. Propiverine: a review of its use in the treatment of adults and children with overactive bladder associated with idiopathic or neurogenic detrusor overactivity, and in men with lower urinary tract symptoms. *Clin Drug Investig* 2013; 33(1):71-91.
13. Störer M, Mürtz G, Kramer G, WArnack W, Primus G, Junga V, Manu-Marin A, Calomfirescu N, Strugala G. Efficacy and tolerability of propiverine hydrochloride extended-release compared with immediate-release in patients with neurogenic detrusor overactivity. *Spinal Cord* 2013; 51:419-23.
14. Mazo EB, Krivoborodov GG, Shkol'nikov ME, Babanina GA, Kozyrev SV and Korshunov ES. [Trospium chloride in the treatment of idiopathic and neurogenic detrusor overactivity]. *Urologiia* 2005; 56-9.
15. Mazo EB and Babanina GA. [Trospium chloride (spasmex) in the treatment of lower urinary tract symptoms in patients with neurogenic hyperactive urinary bladder caused by vertebragenic lesions]. *Urologiia* 2007; 15-9.

16. Staskin DS, Kay G, Tannenbaum C, Goldman HB, Bhashi K, Ling J, Oefelein G. Trospium chloride has no effect in memory testing and is assay undetectable in the central nervous system of older patients with overactive bladder. *Int J Clin Pract.* 2010; 64(9):1294-300
17. Drutz HP, Appell RA, Gleason D, Klimberg I and Radomski S. Clinical efficacy and safety of tolterodine compared to oxybutynin and placebo in patients with overactive bladder. *Int Urogynecol J Pelvic Floor Dysfunct* 1999; 10: 283-9.
18. Horstmann M, Schaefer T, Aguilar Y, Stenzl A and Sievert KD. Neurogenic bladder treatment by doubling the recommended antimuscarinic dosage. *Neurourol Urodyn* 2006; 25: 441-5.
19. Ethans KD, Nance PW, Bard RJ, Casey AR and Schryvers OI. Efficacy and safety of tolterodine in people with neurogenic detrusor overactivity. *J Spinal Cord Med* 2004; 27: 214-8.
20. Chapple CR, Rechberger T, Al-Shukri S, Mefan P, Everaert K, Huang M et al. Randomized, double-blind placebo- and tolterodine-controlled trial of the once-daily antimuscarinic agent solifenacin in patients with symptomatic overactive bladder. *BJU Int* 2004; 93: 303-10.
21. Chapple CR, Cardozo L, Steers WD and Gowler FE. Solifenacin significantly improves all symptoms of overactive bladder syndrome. *Int J Clin Pract* 2006; 60: 959-66.
22. van Rey F, Heesakkers J. Solifenacin in multiple sclerosis patients with overactive bladder: a prospective study. *Adv Urol.* 2011: 2011:834753
23. Krebs J, Pannek J. Effects of Solifenacin in patients with neurogenic detrusor overactivity as a result of spinal cord lesion. *Spinal Cord* 2013; 51:306-9.
24. Zesiewics TA, Evatt M, Vaughan CP, Jahan I, Singer C, Ordorica R, Salemi JL, Shaw JD, Sullivan KL, Non.Motor Working Group of the Parkinson Study Group (PSG). Randomized, controlled pilot trial of Solifenacin succinate for overactive bladder in Parkinson's disease. *Parkinson and Related Disorders* 2015; 21:514-20.
25. Sakakibara R, Tateno F, Yano M, Takahashi O, Sugiyama M, Ogata T, Haruta H, Kishi M, Tsuyusaki Y, Yamamoto T, Uchiyama T, Yamashita T, Yamaguchi C. Imidafenacin on bladder and cognitive function in neurologic OAB patients. *Clin Auton Res* 2013; 23(4):189-95.
26. Malhotra B, El-Tahtawy A, wang EQ, Darekar A, Cossons N, Crook TJ, SCholfield D, Reddy P. Dose-escalating study of the pharmacokinetics and tolerability of esoterodin in children with overactive bladder. *J Pediatr Urol* 2012; 8(4):336-42.
27. Nadeau G, Schröder A, Moore K, Genois L, Lamontagne P, Hamel M, Pellerin E, Bolduc S. Double anticholinergic therapy for refractory neurogenic and nonneurogenic detrusor overactivity in children: long-term results of a prospective open-label study. *Can Urol Assoc J* 2014; 8(5-6):175-80.
28. Amend B, Hennenlotter J, Schafer T, Horstmann M, Stenzl A, Sievert KD. Effective treatment of neurogenic detrusor dysfunction by combined high-dosed antimuscarinics without increased side-effects. *Eur Urol.* 2008 May; 53:1021-8
29. Sakakibara R, Ogata T, Uchiyama T, Kishi M, Ogawa E, Isaka S, Yuasa J, Yamamoto T, Ito T, Yamanishi T, Awa Y, Yamaguchi C, Takahashi O. How to manage overactive bladder in elderly individuals with dementia? A combined use of donepezil, a central acetylcholinesterase inhibitor, and propiverine, a peripheral muscarine receptor antagonist. *J Am Geriatr Soc.* 2009;57(8):1515-7.
30. Kay G, Crook T, Reveda L, et al. Differential effects of the antimuscarinic agents darifenacin and oxybutynin ER on memory in older subjects. *Eur Urol.* 2006 Aug; 50:317-26
31. Staskin D, Kay G, Tannenbaum C, et al. Trospium chloride has no effect on memory testing and is assay undetectable in the central nervous system of older patients with overactive bladder. *Int J Clin Pract.* 2010 Aug; 64:1294-300
32. Wöllner J, Pannek J. Initial experience with the treatment of neurogenic detrusor overactivity with a new beta-3 agonist (Mirabegron) in patients with spinal cord injury. *Spinal Cord* 2015 [epub ahead of print].
33. Wada N, Okazaki S, Kobayashi S, Hashizume K, Kita M, Matsumoto S, Kakizaki H. Efficacy of combination therapy with mirabegron for anticholinergicresistant neurogenic bladder: videourodynamic evaluation [Article in Japanese]. *Hinyokika Kiyo.* 2015 Jan;61(1):7-11.
34. Consroe, P., R. Musty, et al. The perceived effects of smoked cannabis on patients with multiple sclerosis. *Eur Neurol.* 1997; 38(1): 44-8
35. Brady, C. M., R. DasGupta, et al. An open-label pilot study of cannabis-based extracts for bladder dysfunction in advanced multiple sclerosis. *Mult Scler.* 2004;10(4): 425-33.
36. Freeman RM, Adekanmi O, Waterfield MR, Waterfield AE, Wright D, Zajicek J. The effect of cannabis on urge incontinence in patients with multiple sclerosis: a multicentre, randomised placebo-controlled trial (CAMS-LUTS). *Int Urogynecol J Pelvic Floor Dysfunct.* 2006; 17(6):636-41

37. Kavia, R., D. De Ridder, et al. (2010). "RANDOMISED CONTROLLED TRIAL OF SATIVEX TO TREAT DETRUSOR OVER ACTIVITY IN MULTIPLE SCLEROSIS. *Mult Scler* 16(11): 1349-1359.
38. Strittmatter F, Gandaglia G, Benigni F, Bettiga A, Rigatti P, Montorsi F, Gratzke C, Stief C, Colciago G, Hedlund P. Expression of fatty acid amide hydrolase (FAAH) in human, mouse, and rat urinary bladder and effects of FAAH inhibition on bladder function in awake rats. *Eur Urol.* 2012; 61(1):98-106
39. Aizawa N, Hedlund P, Füllhase C, Ito H, Homma Y, Igawa Y. Inhibition of peripheral FAAH depresses activities of bladder mechanosensitive nerve fibers of the rat. *J Urol.* 2014;192(3):956-63.
40. Brendler CB, Radebaugh LC and Mohler JL. Topical oxybutynin chloride for relaxation of dysfunctional bladders. *J Urol* 1989; 141: 1350-2.
41. George J, Tharion G, Richar J, Macaden AS, Thomas R and Bhattacharji S. The effectiveness of intravesical oxybutynin, propantheline, and capsaicin in the management of neuro-pathic bladder following spinal cord injury. *Scientific World Journal* 2007; 7: 1683-90.
42. Evans RJ. Intravesical therapy for overactive bladder. *Curr Urol Rep* 2005; 6: 429-33.
43. Saito M, Watanabe T, Tabuchi F, Otsubo K, Satoh K, Miyagawa I. Urodynamic effects and safety of modified intravesical oxybutynin chloride in patients with neurogenic detrusor overactivity: 3 years experience. *Int J Urol.* 2004 Aug; 11:592-6
44. Hayashi A, Saito M, Okada S, et al. Treatment with modified intravesical oxybutynin chloride for neurogenic bladder in children. *J Pediatr Urol.* 2007 Dec; 3:438-42
45. Guerra LA, Moher D, Sampson M, Barrowman N, Pike J, Leonard M. Intravesical oxybutynin for children with poorly compliant neurogenic bladder: a systematic review. *J Urol.* 2008 Sep; 180:1091-7
46. Van Meel TD, De Wachter S, Wyndaele JJ. The effect of intravesical oxybutynin on the ice water test and on electrical perception thresholds in patients with neurogenic detrusor overactivity. *Neurourol Urodyn.* 2010 Mar; 29:391-4
47. Scheepe JR, de Jong BW, Wolffenbuttel KP, Arentshorst ME, Lodder P, Kok DJ. The effect of oxybutynin on structural changes of the obstructed guinea pig bladder. *J Urol.* 2007 Oct; 178:1807-12
48. Fader M, Glickman S, Haggar V, Barton R, Brooks R and Malone-Lee J. Intravesical atropine compared to oral oxybutynin for neurogenic detrusor overactivity: a double-blind, randomized crossover trial. *J Urol* 2007; 177: 208-13.
49. Humblet M, Verpoorten C, Christiaens MH, Hirche H, Jansen K, Buyse G, van Gool JD. Long-term outcome of intravesical oxybutynin in children with detrusor-sphincter dyssynergie: with special reference to age-dependent parameters. *Neurourol Urodyn* 2015; 34(4): 336-42
50. Schröder A, Albrecht U, Schnitker H, Reitz A, Stein R. Efficacy, safety, and tolerability of intravesically administered 0.1 oxybutynin hydrochloride solution in adult patients with neurogenic bladder: a randomized, prospective, controlled multi-center trial. *Neurourol Urodyn* 2016; 35(5):582-8.
51. Lecci A, Giuliani S, Meini S and Maggi CA. Nociceptin and the micturition reflex. *Peptides* 2000; 21: 1007-21.
52. Lazzeri M, Calo G, Spinelli M, Malaguti S, Guerrini R, Salvadori S et al. Daily intravesical instillation of 1 mg nociceptin/orphanin FQ for the control of neurogenic detrusor overactivity: a multicenter, placebo controlled, randomized exploratory study. *J Urol* 2006; 176: 2098-102.
53. MacDonald R, Monga M, Fink HA, Wilt TJ. Neurotoxin treatments for urinary incontinence in subjects with spinal cord injury or multiple sclerosis: a systematic review of effectiveness and adverse effects. *J Spinal Cord Med.* 2008; 31:157-65
54. de Seze M, Gallien P, Denys P, et al. Intravesical glucidic capsaicin versus glucidic solvent in neurogenic detrusor overactivity: a double blind controlled randomized study. *Neurourol Urodyn.* 2006; 25:752
55. Giannantoni A, Di Stasi SM, Stephen RL, Bini V, Costantini E and Porena M. Intravesical resiniferatoxin versus botulinum-A toxin injections for neurogenic detrusor overactivity: a prospective randomized study. *J Urol* 2004; 172: 240-3.
56. Gevaert T, Vandepitte J, Hutchings G, Vriens J, Nilius B, De Ridder D. TRPV1 is involved in stretch-evoked contractile changes in the rat autonomous bladder model: a study with piperine, a new TRPV1 agonist. *Neurourol Urodyn.* 2007; 26:440-50; discussion 51-3

57. Santos-Silva A, Charrua A, Cruz CD, Gharat L, Avelino A, Cruz F. Rat detrusor overactivity induced by chronic spinalization can be abolished by a transient receptor potential vanilloid 1 (TRPV1) antagonist. *Auton Neurosci*. 2011 Jan 26; 166:35-8
58. Andrade EL, Forner S, Bento AF, et al. TRPA1 receptor modulation attenuates bladder overactivity induced by spinal cord injury. *Am J Physiol Renal Physiol*. 2011 May; 300:F1223-34
59. Artim DE, Bazely F, Daugherty SL, et al. Nitrooleic acid targets transient receptor potential (TRP) channels in capsaicin sensitive afferent nerves of rat urinary bladder. *Exp Neurol*. 2011 Nov; 232:90-9
60. Apostolidis A. Taming the Cannabinoids: New Potential in the Pharmacologic Control of Lower Urinary Tract Dysfunction. *Eur Urol*. 2012 Oct 6; 61:107-9
61. Tyagi V, Philips BJ, Su R, et al. Differential expression of functional cannabinoid receptors in human bladder detrusor and urothelium. *J Urol*. 2009 Apr; 181:1932-8
62. Gratzke C, Streng T, Park A, et al. Distribution and function of cannabinoid receptors 1 and 2 in the rat, monkey and human bladder. *J Urol*. 2009 Apr; 181:1939-48
63. Gratzke C, Streng T, Stief CG, et al. Effects of cannabitor, a novel selective cannabinoid 2 receptor agonist, on bladder function in normal rats. *Eur Urol*. 2010 Jun; 57:1093-100
64. Gratzke C, Streng T, Stief CG, et al. Cannabitor, a selective cannabinoid-2 receptor agonist, improves bladder emptying in rats with partial urethral obstruction. *J Urol*. 2011 Feb; 185:731-6
65. Capasso R, Aviello G, Borrelli F, et al. Inhibitory Effect of Standardized Cannabis sativa Extract and Its Ingredient Cannabidiol on Rat and Human Bladder Contractility. *Urology*. 2011 Feb 8;
66. Walczak JS, Cervero F. Local activation of cannabinoid CB1 receptors in the urinary bladder reduces the inflammation-induced sensitization of bladder afferents. *Mol Pain*. 2011 May 9; 7:31
67. Strittmatter F, Gandaglia G, Benigni F, et al. Expression of fatty acid amide hydrolase (FAAH) in human, mouse and rat urinary bladder and effects by FAAH-inhibition on bladder function in awake rats. *Eur Urol*. 2012; 61:98-106
68. Adhikary S, Li H, Heller J, et al. Modulation of inflammatory responses by a cannabinoid-2-selective agonist after spinal cord injury. *J Neurotrauma*. 2011 Dec; 28:2417-27
69. Stankovich E, Borisov VV and Demina TL. [Tamsulosin in the treatment of detrusor-sphincter dyssynergia of the urinary bladder in patients with multiple sclerosis]. *Urologia* 2004; 48-51.
70. Abrams P, Amarenco G, Bakke A, Buczynski A, Castro-Diaz D, Harrison S et al. Tamsulosin: efficacy and safety in patients with neurogenic lower urinary tract dysfunction due to suprasacral spinal cord injury. *J Urol* 2003; 170: 1242-51.
71. Kroll O, Gajewska E, Zachwieja J, Sobieska M, Mankowski P. An evaluation of the efficacy of selective alpha-blockers in the treatment of children with neurogenic bladder dysfunction – preliminary findings. *Int J Environ Res Public Health* 2016; 13(3) [epub ahead of print]

MINIMALLY INVASIVE TREATMENTS

1. Karsenty G, Denys P, Amarenco G, De Seze M, Gamé X, Haab F, et al. Botulinum toxin A (Botox) intradetrusor injections in adults with neurogenic detrusor overactivity/neurogenic overactive bladder: a systematic literature review. *Eur Urol*. 2008;53(2):275-87.
2. Apostolidis A, Dasgupta P, Denys P, Elneil S, Fowler CJ, Giannantoni A, et al. RECOMMENDATIONS ON THE USE OF BOTULINUM TOXIN IN THE TREATMENT OF LOWER URINARY TRACT DISORDERS AND PELVIC FLOOR DYSFUNCTIONS: A EUROPEAN CONSENSUS PANEL REPORT. *Eur Urol*. 2009;55:100-20.
3. Mangera A, Andersson KE, Apostolidis A, Chapple C, Dasgupta P, Giannantoni A, et al. Contemporary management of lower urinary tract disease with botulinum toxin A: a systematic review of botox (onabotulinumtoxinA) and dysport (abobotulinumtoxinA). *Eur Urol*. 2011 Oct;60(4):784-95.
4. Duthie JB, Vincent M, Herbison GP, Wilson DI, Wilson D. Botulinum toxin injections for adults with overactive bladder syndrome. *Cochrane Database Syst Rev*. 2011;12:CD005493.
5. Mangera A, Apostolidis A, Andersson KE, Dasgupta P, Giannantoni A, Roehrborn C, et al. An updated systematic review and statistical comparison of standardised mean outcomes for the use of botulinum toxin in the management of lower urinary tract disorders *Eur Urol*. 2014;65(5):981-90.

6. Zhang R, Xu Y, Yang S, Liang H, Zhang Y, Liu Y. OnabotulinumtoxinA for neurogenic detrusor overactivity and dose differences: a systematic review. *Int Braz J Urol.* 2015 Mar-Apr;41(2):207-19.
7. Zhou X, Yan HL, Cui YS, Zong HT, Zhang Y. Efficacy and safety of onabotulinumtoxinA in treating neurogenic detrusor overactivity: a systematic review and meta-analysis. *Chin Med J (Engl).* 2015 Apr 5;128(7):963-8.
8. Schurch B, de Seze M, Denys P, Chartier-Kastler E, Haab F, Everaert K, et al. Botulinum toxin type A is a safe and effective treatment for neurogenic urinary incontinence: results of a single treatment, randomized, placebo controlled 6-month study. *J Urol.* 2005 Jul;174(1):196-200.
9. Ehren I, Volz D, Farrelly E, Berglund L, Brundin L, Hultling C, et al. Efficacy and impact of botulinum toxin A on quality of life in patients with neurogenic detrusor overactivity: a randomised, placebo-controlled, double-blind study. *Scand J Urol Nephrol.* 2007;41(4):335-40.
10. Cruz F, Herschorn S, Aliotta P, Brin M, Thompson C, Lam W, et al. Efficacy and safety of onabotulinumtoxinA in patients with urinary incontinence due to neurogenic detrusor overactivity: a randomised, double-blind, placebo-controlled trial. *Eur Urol.* 2011 Oct;60(4):742-50.
11. Herschorn S, Gajewski J, Ethans K, Corcos J, Carlson K, Bailly G, et al. Efficacy of botulinum toxin A injection for neurogenic detrusor overactivity and urinary incontinence: a randomized, double-blind trial. *J Urol.* 2011 Jun;185(6):2229-35.
12. Ginsberg D, Gousse A, Keppenne V, Sievert KD, Thompson C, Lam W, et al. Phase 3 efficacy and tolerability study of onabotulinumtoxinA for urinary incontinence from neurogenic detrusor overactivity. *J Urol.* 2012 Jun;187(6):2131-9.
13. Apostolidis A, Thompson C, Yan X, Mourad S. An exploratory, placebo-controlled, dose-response study of the efficacy and safety of onabotulinumtoxinA in spinal cord injury patients with urinary incontinence due to neurogenic detrusor overactivity. *World J Urol.* 2013 Dec;31(6):1469-74.
14. Denys P, Del Popolo G, Amarenco G, Karsenty G, Le Berre P, Pazzuzzi B, et al. Efficacy and safety of two administration modes of an intradetrusor injection of 750 units dysport(R) (abobotulinumtoxinA) in patients suffering from refractory neurogenic detrusor overactivity (NDO): A randomised placebo-controlled phase IIa study. *Neurourol Urodyn.* 2016 Jan 12.
15. Giannantoni A, Di Stasi SM, Stephen RL, Bini V, Konstantini E, Porena M. Intravesical resiniferatoxin versus botulinum-A toxin injections for neurogenic detrusor overactivity: a prospective randomized study. *J Urol.* 2004;172(1):240-3.
16. Grosse J, Kramer G, Jakse G. Comparing two types of botulinum-A toxin detrusor injections in patients with severe neurogenic detrusor overactivity: a case-control study. *BJU Int.* 2009 Sep;104(5):651-6.
17. Grise P, Ruffion A, Denys P, Egon G, Chartier-Kastler E. Efficacy and tolerability of botulinum toxin type A in patients with neurogenic detrusor overactivity and without concomitant anticholinergic therapy: comparison of two doses. *Eur Urol.* 2010 Nov;58(5):759-66.
18. Abdel-Meguid TA. Botulinum toxin-A injections into neurogenic overactive bladder--to include or exclude the trigone? A prospective, randomized, controlled trial. *J Urol.* 2010 Dec;184(6):2423-8.
19. Chen YC, Kuo HC. The therapeutic effects of repeated detrusor injections between 200 or 300 units of onabotulinumtoxinA in chronic spinal cord injured patients. *Neurourol Urodyn.* 2014 Jan;33(1):129-34.
20. Rovner E, Dmochowski R, Chapple C, Thompson C, Lam W, Haag-Molkenteller C. OnabotulinumtoxinA improves urodynamic outcomes in patients with neurogenic detrusor overactivity. *Neurourol Urodyn.* 2013 Nov;32(8):1109-15.
21. Gomes CM, de Castro Filho JE, Rejowski RF, Trigo-Rocha FE, Bruschini H, de Barros Filho TE, et al. Experience with different botulinum toxins for the treatment of refractory neurogenic detrusor overactivity. *Int Braz J Urol.* 2010 Jan-Feb;36(1):66-74.
22. Ginsberg D, Cruz F, Herschorn S, Gousse A, Keppenne V, Aliotta P, et al. OnabotulinumtoxinA is effective in patients with urinary incontinence due to neurogenic detrusor overactivity [corrected] regardless of concomitant anticholinergic use or neurologic etiology. *Adv Ther.* 2013 Sep;30(9):819-33.
23. Kalsi V, Apostolidis A, Popat R, Gonzales G, Fowler CJ, Dasgupta P. Quality of Life Changes in Patients with Neurogenic versus Idiopathic Detrusor Overactivity after Intradetrusor Injections of Botulinum Neurotoxin Type A and Correlations with Lower Urinary Tract Symptoms and Urodynamic Changes. *Eur Urol.* 2006 Mar;49(3):528-35.

24. Finazzi-Agro E, Topazio L, Perugia C, Lombardi G, Finita Celso M, De Nunzio C, et al. The use of oxybutynin in patients treated by means of botulinum neurotoxin A for neurogenic detrusor overactivity: an observational study. *Spinal Cord*. 2013 Aug;51(8):637-41.
25. Malki M, Mangera A, Reid S, Inman R, Chapple C. What is the feasibility of switching to 200IU OnabotulinumtoxinA in patients with detrusor overactivity who have previously received 300IU? *Cent European J Urol*. 2014;67(1):35-40.
26. Grosse J, Kramer G, Stohrer M. Success of repeat detrusor injections of botulinum a toxin in patients with severe neurogenic detrusor overactivity and incontinence. *Eur Urol*. 2005 May;47(5):653-9.
27. Karsenty G, Reitz A, Lindemann G, Boy S, Schurch B. Persistence of therapeutic effect after repeated injections of botulinum toxin type A to treat incontinence due to neurogenic detrusor overactivity. *Urology*. 2006 Dec;68(6):1193-7.
28. Reitz A, Denys P, Fermanian C, Schurch B, Comperat E, Chartier-Kastler E. Do repeat intradetrusor botulinum toxin type a injections yield valuable results? Clinical and urodynamic results after five injections in patients with neurogenic detrusor overactivity. *Eur Urol*. 2007;52(6):1729-35.
29. Del Popolo G, Filocamo MT, Li Marzi V, Macchiarella A, Cecconi F, Lombardi G, et al. Neurogenic detrusor overactivity treated with english botulinum toxin a: 8-year experience of one single centre. *Eur Urol*. 2008;53(5):1013-20.
30. Stoehrer M, Wolff A, Kramer G, Steiner R, Lmochner-Ernst D, Leuth D, et al. Treatment of neurogenic detrusor overactivity with botulinum toxin A: the first seven years. *Urol Int*. 2009;83(4):379-85.
31. Giannantoni A, Mearini E, Del Zingaro M, Porena M. Six-year follow-up of botulinum toxin A intradetrusorial injections in patients with refractory neurogenic detrusor overactivity: clinical and urodynamic results. *Eur Urol*. 2009 Mar;55(3):705-11.
32. Ghalayini IF, Al-Ghazo MA, Elnasser ZA. Is efficacy of repeated intradetrusor botulinum toxin type A (Dysport((R))) injections dose dependent? Clinical and urodynamic results after four injections in patients with drug-resistant neurogenic detrusor overactivity. *Int Urol Nephrol*. 2009 Jan 31;41(4):805-13.
33. Khan S, Game X, Kalsi V, Gonzales G, Panicker J, Elneil S, et al. Long-term effect on quality of life of repeat detrusor injections of botulinum neurotoxin-a for detrusor overactivity in patients with multiple sclerosis. *J Urol*. 2011 Apr;185(4):1344-9.
34. Kuo HC, Liu SH. Effect of repeated detrusor onabotulinumtoxinA injections on bladder and renal function in patients with chronic spinal cord injuries. *NeuroUrol Urodyn*. 2011 Nov;30(8):1541-5.
35. Chen SF, Kuo HC. Therapeutic outcome and patient adherence to repeated onabotulinumtoxinA detrusor injections in chronic spinal cord-injured patients and neurogenic detrusor overactivity. *J Formos Med Assoc*. 2015 Jul;114(7):583-9.
36. Leitner L, Guggenbuhl-Roy S, Knupfer SC, Walter M, Schneider MP, Tornic J, et al. More Than 15 Years of Experience with Intradetrusor OnabotulinumtoxinA Injections for Treating Refractory Neurogenic Detrusor Overactivity: Lessons to Be Learned. *Eur Urol*. 2016 Sep;70(3):522-8.
37. Rovner E, Kohan A, Chartier-Kastler E, June-mann KP, Del Popolo G, Herschorn S, et al. Long-Term Efficacy and Safety of OnabotulinumtoxinA in Patients with Neurogenic Detrusor Overactivity Who Completed 4 Years of Treatment. *J Urol*. 2016 Jun 2.
38. Al Taweel W, Alzyoud KM. The effect of spinal cord-injury level on the outcome of neurogenic bladder treatment using OnabotulinumtoxinA. *Urol Ann*. 2015 Jul-Sep;7(3):320-4.
39. Deffontaines-Rufin S, Weil M, Verollet D, Peyrat L, Amarenco G. Botulinum toxin A for the treatment of neurogenic detrusor overactivity in multiple sclerosis patients. *Int Braz J Urol*. 2011 Sep-Oct;37(5):642-8.
40. Schulte-Baukloh H, Bigalke H, Miller K, Heine G, Pape D, Lehmann J, et al. Botulinum neurotoxin type A in urology: antibodies as a cause of therapy failure. *Int J Urol*. 2008 May;15(5):407-15; discussion 15.
41. Naumann M, Carruthers A, Carruthers J, Aurora SK, Zafonte R, Abu-Shakra S, et al. Meta-analysis of neutralizing antibody conversion with onabotulinumtoxinA (BOTOX(R)) across multiple indications. *Mov Disord*. 2010 Oct 15;25(13):2211-8.
42. Hegele A, Frohme C, Varga Z, Olbert P, Kranz J, Hofmann R. Antibodies after botulinum toxin a injection into musculus detrusor vesicae: incidence and clinical relevance. *Urol Int*. 2011;87(4):439-44.

43. Schulte-Baukloh H, Herholz J, Bigalke H, Miller K, Knispel HH. Results of a BoNT/A Antibody Study in Children and Adolescents after Onabotulinumtoxin A (Botox(R)) Detrusor Injection. *Urol Int.* 2011;87(4):434-8.
44. Kajbafzadeh AM, Nikfarjam L, Mahboubi AH, Dianat S. Antibody Formation Following Botulinum Toxin Type A (Dysport) Injection in Children With Intractable Bladder Hyper-reflexia. *Urology.* 2010 Jul;76(1):233-7.
45. Peyronnet B, Castel-Lacanal E, Manunta A, Roumiguie M, Marque P, Rischmann P, et al. Failure of botulinum toxin injection for neurogenic detrusor overactivity: Switch of toxin versus second injection of the same toxin. *Int J Urol.* 2015 Dec;22(12):1160-5.
46. Giannantoni A, Rossi A, Mearini E, Del Zingaro M, Porena M, Berardelli A. Botulinum toxin A for overactive bladder and detrusor muscle overactivity in patients with Parkinson's disease and multiple system atrophy. *J Urol.* 2009 Oct;182(4):1453-7.
47. Kulaksizoglu H, Parman Y. Use of botulinum toxin-A for the treatment of overactive bladder symptoms in patients with Parkinson's disease. *Parkinsonism Relat Disord.* 2010 Sep;16(8):531-4.
48. Giannantoni A, Conte A, Proietti S, Giovannozzi S, Rossi A, Fabbrini G, et al. Botulinum toxin type A in patients with Parkinson's disease and refractory overactive bladder. *J Urol.* 2011 Sep;186(3):960-4.
49. Kuo HC. Therapeutic effects of suburothelial injection of botulinum a toxin for neurogenic detrusor overactivity due to chronic cerebrovascular accident and spinal cord lesions. *Urology.* 2006 Feb;67(2):232-6.
50. Ruffion A, Capelle O, Paparel P, Leriche B, Leriche A, Grise P. What is the optimum dose of type A botulinum toxin for treating neurogenic bladder overactivity? *BJU Int.* 2006 May;97(5):1030-4.
51. Mehnert U, Birzele J, Reuter K, Schurch B. The effect of botulinum toxin type a on overactive bladder symptoms in patients with multiple sclerosis: a pilot study. *J Urol.* 2011 Sep;184(3):1011-6.
52. Schurch B, Denys P, Kozma CM, Reese PR, Slaton T, Barron RL. Botulinum toxin A improves the quality of life of patients with neurogenic urinary incontinence. *Eur Urol.* 2007;52(3):850-8.
53. Chancellor MB, Patel V, Leng WW, Shenot PJ, Lam W, Globe DR, et al. OnabotulinumtoxinA improves quality of life in patients with neurogenic detrusor overactivity. *Neurology.* 2013 Aug 27;81(9):841-8.
54. Sussman D, Patel V, Del Popolo G, Lam W, Globe D, Pommerville P. Treatment satisfaction and improvement in health-related quality of life with onabotulinumtoxinA in patients with urinary incontinence due to neurogenic detrusor overactivity. *Neurourol Urodyn.* 2013 Mar;32(3):242-9.
55. Chartier-Kastler E, Rovner E, Hepp Z, Khalaf K, Ni Q, Chancellor M. Patient-reported goal achievement following onabotulinumtoxinA treatment in patients with neurogenic detrusor overactivity. *Neurourol Urodyn.* 2015 Jun;35(5):595-600.
56. Kennelly M, Dmochowski R, Schulte-Baukloh H, Ethans K, Del Popolo G, Moore C, et al. Efficacy and safety of onabotulinumtoxinA therapy are sustained over 4 years of treatment in patients with neurogenic detrusor overactivity: Final results of a long-term extension study. *Neurourol Urodyn.* 2015 Nov 24.
57. Schurch B, Stohrer M, Kramer G, Schmid DM, Gaul G, Hauri D. Botulinum-A toxin for treating detrusor hyperreflexia in spinal cord injured patients: a new alternative to anticholinergic drugs? Preliminary results. *J Urol.* 2000;164(3 Pt 1):692-7.
58. Karsenty G, Carsenac A, Boy S, Reitz A, Tournebise H, Bladou F. Botulinum toxin- A (BTA) in the treatment of neurogenic detrusor overactivity (NDOI)- A prospective randomized study to compare 30 vs. 10 injection sites. *Eur Urol.* 2007;2:245.
59. Samal V, Mecl J, Sram J. Submucosal administration of onabotulinumtoxinA in the treatment of neurogenic detrusor overactivity: pilot single-centre experience and comparison with standard injection into the detrusor. *Urol Int.* 2013;91(4):423-8.
60. Krhut J, Samal V, Nemeč D, Zvara P. Intradetrusor versus suburothelial onabotulinumtoxinA injections for neurogenic detrusor overactivity: a pilot study. *Spinal Cord.* 2012 Dec;50(12):904-7.
61. Chuang YC, Tyagi P, Huang CC, Yoshimura N, Wu M, Kaufman J, et al. Urodynamic and immunohistochemical evaluation of intravesical botulinum toxin A delivery using liposomes. *J Urol.* 2009 Aug;182(2):786-92.
62. Kajbafzadeh AM, Montaser-Kouhsari L, Ahmadi H, Sotoudeh M. Intravesical electromotive botulinum toxin type A administration: part I-- Experimental study. *Urology.* 2011 Jun;77(6):1460-4.

63. Kuo HC, Liu HT, Chuang YC, Birder LA, Chancellor MB. Pilot study of liposome-encapsulated onabotulinumtoxin A for patients with overactive bladder: a single-center study. *Eur Urol.* 2014 Jun;65(6):1117-24.
64. Chuang YC, Kaufmann JH, Chancellor DD, Chancellor MB, Kuo HC. Bladder instillation of liposome encapsulated onabotulinumtoxin A improves overactive bladder symptoms: a prospective, multicenter, double-blind, randomized trial. *J Urol.* 2014 Dec;192(6):1743-9.
65. Kajbafzadeh AM, Ahmadi H, Montaser-Kouhsari L, Sharifi-Rad L, Nejat F, Bazargan-Hejazi S. Intravesical electromotive botulinum toxin type A administration--part II: Clinical application. *Urology.* 2011 Feb;77(2):439-45.
66. Gamé X, Castel-Lacanal E, Bentaleb Y, Thiry-Escudé I, De Boissezon X, Malavaud B, et al. Botulinum toxin A detrusor injections in patients with neurogenic detrusor overactivity significantly decrease the incidence of symptomatic urinary tract infections. *Eur Urol.* 2008;53(3):613-8.
67. Wefer B, Ehlken B, Bremer J, Burgdorfer H, Domurath B, Hampel C, et al. Treatment outcomes and resource use of patients with neurogenic detrusor overactivity receiving botulinum toxin A (BOTOX) therapy in Germany. *World J Urol.* 2010 Jun;28(3):385-90.
68. Mascarenhas F, Cocuzza M, Gomes CM, Leao N. Trigonal injection of botulinum toxin-A does not cause vesicoureteral reflux in neurogenic patients. *Neurourol Urodyn.* 2008;27(4):311-4.
69. Alloussi SH, Lang C, Eichel R, Al-Kaabneh A, Seibold J, Schwentner C, et al. Videourodynamic changes of botulinum toxin A in patients with neurogenic bladder dysfunction (NBD) and idiopathic detrusor overactivity (IDO) refractory to drug treatment. *World J Urol.* 2011 Aug 13.
70. Caremel R, Courtois F, Charvier K, Ruffion A, Journel NM. Side effects of intradetrusor botulinum toxin injections on ejaculation and fertility in men with spinal cord injury: preliminary findings. *BJU Int.* 2012 Jun;109(11):1698-702.
71. De Laet K, Wyndaele JJ. Adverse events after botulinum A toxin injection for neurogenic voiding disorders. *Spinal Cord.* 2005 Jul;43(7):397-9.
72. Girlanda P, Vita G, Nicolosi C, Milone S, Messina C. Botulinum toxin therapy: distant effects on neuromuscular transmission and autonomic nervous system. *J Neurol Neurosurg Psychiatry.* 1992;55:844-5.
73. Dutton JJ. Botulinum-A toxin in the treatment of craniocervical muscle spasms: short- and long-term, local and systemic effects. *Surv Ophthalmol.* 1996;41:51-65.
74. Papagiannopoulou D, Vardouli L, Dimitriadis F, Apostolidis A. Retrograde transport of radiolabelled botulinum neurotoxin type A to the CNS after intradetrusor injection in rats. *BJU Int.* 2016 Apr;117(4):697-704.
75. Coelho A, Oliveira R, Rossetto O, Cruz CD, Cruz F, Avelino A. Intrathecal administration of Botulinum toxin type A improves urinary bladder function and reduces pain in rats with cystitis. *Eur J Pain* 2014;18 (10):1480-9.
76. Schnitzler A, Genet F, Durand MC, Roche N, Bensmail D, Chartier-Kastler E, et al. Pilot study evaluating the safety of intradetrusor injections of botulinum toxin type A: investigation of generalized spread using single-fiber EMG. *Neurourol Urodyn.* 2011 Nov;30(8):1533-7.
77. Fougere RJ, Currie KD, Nigro MK, Stothers L, Rapoport D, Krassioukov AV. Reduction in Bladder-Related Autonomic Dysreflexia after OnabotulinumtoxinA Treatment in Spinal Cord Injury. *J Neurotrauma.* 2016 Apr 13.
78. Comperat E, Reitz A, Delcourt A, Capron F, Denys P, Chartier-Kastler E. Histologic Features in the Urinary Bladder Wall Affected from Neurogenic Overactivity - A Comparison of Inflammation, Oedema and Fibrosis With and Without Injection of Botulinum Toxin Type A. *Eur Urol.* 2006 Feb 6;50(5):1058-64.
79. Apostolidis A, Jacques TS, Freeman A, Kalsi V, Popat R, Gonzales G, et al. Histological Changes in the Urothelium and Suburothelium of Human Overactive Bladder following Intradetrusor Injections of Botulinum Neurotoxin Type A for the Treatment of Neurogenic or Idiopathic Detrusor Overactivity. *Eur Urol.* 2008;53(6):1245-53.
80. Pascali MP, Mosiello G, Boldrini R, Salsano ML, Castelli E, De Gennaro M. Effects of botulinum toxin type a in the bladder wall of children with neurogenic bladder dysfunction: a comparison of histological features before and after injections. *J Urol.* 2011 Jun;185(6 Suppl):2552-7.
81. Dykstra DD, Sidi AA, Scott AB, Pagel JM, Goldish GD. Effects of botulinum A toxin on detrusor-sphincter dyssynergia in spinal cord injury patients. *J Urol.* 1988 May;139(5):919-22.
82. Chen SL, Bih LI, Chen GD, Huang YH, You YH. Comparing a transrectal ultrasound-guided with a cystoscopy-guided botulinum toxin a injection in treating detrusor external sphincter dyssynergia in spinal cord injury. *Am J Phys Med Rehabil.* 2011 Sep;90(9):723-30.

83. de Seze M, Petit H, Gallien P, de Seze MP, Joseph PA, Mazaux JM, et al. Botulinum A toxin and detrusor sphincter dyssynergia: a double-blind lidocaine-controlled study in 13 patients with spinal cord disease. *Eur Urol.* 2002 Jul;42(1):56-62.
84. Gallien P, Reymann JM, Amarenco G, Nicolas B, de Seze M, Bellissant E. Placebo controlled, randomised, double blind study of the effects of botulinum A toxin on detrusor sphincter dyssynergia in multiple sclerosis patients. *J Neurol Neurosurg Psychiatry.* 2005 Dec;76(12):1670-6.
85. Chen YH, Kuo HC. Botulinum A toxin treatment of urethral sphincter pseudodyssynergia in patients with cerebrovascular accidents or intracranial lesions. *Urol Int.* 2004;73(2):156-61; discussion 61-2.
86. Schulte-Baukloh H, Schobert J, Stolze T, Sturzebecher B, Weiss C, Knispel HH. Efficacy of botulinum-A toxin bladder injections for the treatment of neurogenic detrusor overactivity in multiple sclerosis patients: An objective and subjective analysis. *Neurourol Urodyn.* 2006 Feb 8;25(2):110-5.
87. Safari S, Jamali S, Habibollahi P, Arshadi H, Nejat F, Kajbafzadeh AM. Intravesical Injections of Botulinum Toxin Type A for Management of Neuropathic Bladder: A Comparison of Two Methods. *Urology.* 2010 Jul;76(1):225-30.
88. Kuo HC. Therapeutic outcome and quality of life between urethral and detrusor botulinum toxin treatment for patients with spinal cord lesions and detrusor sphincter dyssynergia. *Int J Clin Pract.* 2013 Oct;67(10):1044-9.
89. Utomo E, Groen J, Blok BF. Surgical management of functional bladder outlet obstruction in adults with neurogenic bladder dysfunction. *Cochrane Database Syst Rev.* 2014(5):CD004927.
90. Mehnert U, Boy S, Svensson J, Michels L, Reitz A, Candia V et al. Brain activation in response to bladder filling and simultaneous stimulation of the dorsal clitoral nerve--an fMRI study in healthy women. *Neuroimage* 2008; 41: 682-9.
91. Gladh G, Mattsson S, Lindstrom S. Anogenital electrical stimulation as treatment of urge incontinence in children. *BJU Int.* 2001 Mar; 87:366-71
92. Trsinar B, Kraij B. Maximal electrical stimulation in children with unstable bladder and nocturnal enuresis and/or daytime incontinence: a controlled study. *Neurourol Urodyn.* 1996; 15:133-42
93. Spinelli M, Malaguti S, Giardiello G, Lazzeri M, Tarantola J and Van Den Hombergh U. A new minimally invasive procedure for pudendal nerve stimulation to treat neurogenic bladder: description of the method and preliminary data. *Neurourol Urodyn* 2005; 24: 305-9
94. Spinelli M, Giardiello G, Arduini A, van den Hombergh U. New percutaneous technique of sacral nerve stimulation has high initial success rate: preliminary results. *Eur Urol.* 2003 Jan: 43:70-4
95. Spinelli M, Giardiello G, Gerber M, Arduini A, van den Hombergh U, Malaguti S. New sacral neuromodulation lead for percutaneous implantation using local anesthesia: description and first experience. *J Urol.* 2003 Nov: 170:1905-7
96. Reitz A, Gobeaux N, Mozer P, Delmas V, Richard F, Chartier-Kastler E. Topographic Anatomy of a New Posterior Approach to the Pudendal Nerve for Stimulation. *Eur Urol* 2006; 51: 1350-5
97. Wheeler JS, Jr., Walter JS and Zaszczurynski PJ. Bladder inhibition by penile nerve stimulation in spinal cord injury patients. *J Urol* 1992; 147: 100-3
98. Dalmose AL, Rijkhoff NJ, Kirkeby HJ, Nohr M, Sinkjaer T and Djurhuus JC. Conditional stimulation of the dorsal penile/clitoral nerve may increase cystometric capacity in patients with spinal cord injury. *Neurourol Urodyn* 2003; 22: 130-7.
99. Hansen J, Media S, Nohr M, Biering-Sorensen F, Sinkjaer T and Rijkhoff NJ. Treatment of neurogenic detrusor overactivity in spinal cord injured patients by conditional electrical stimulation. *J Urol* 2005; 173: 2035-9.
100. Ohlsson BL, Fall M, Frankenberg-Sommar S. Effects of external and direct pudendal nerve maximal electrical stimulation in the treatment of the uninhibited overactive bladder. *Br J Urol.* 1989 Oct: 64: 374-80
101. Possover M, Schurch B, Henle KP. New strategies of pelvic nerves stimulation for recovery of pelvic visceral functions and locomotion in paraplegics. *Neurourol Urodyn.* 2010; 29(8):1433-8.
102. Vodusek DB, Light JK, Libby JM. Detrusor inhibition induced by stimulation of pudendal nerve afferents. *Neurourol Urodyn* 1968; 5: 381-9
103. Spinelli M, Malaguti S, Giardiello G, Lazzeri M, Tarantola J, Van Den Hombergh U. A new minimally invasive procedure for pudendal nerve stimulation to treat neurogenic bladder: description of the method and preliminary data. *Neurourol Urodyn.* 2005;24(4):305-9.

104. Goldman HB, Amundsen CL, Mangel J, et al. Dorsal genital nerve stimulation for the treatment of overactive bladder symptoms. *Neurourol Urodyn*. 2008; 27:499-50
105. Horvath EE, Yoo PB, Amundsen CL, Webster GD, Grill WM. Conditional and continuous electrical stimulation increase cystometric capacity in persons with spinal cord injury. *Neurourol Urodyn*. 2010 Mar; 29:401-7
106. Opisso E, Borau A, Rodriguez A, Hansen J, Rijkhoff NJ. Patient controlled versus automatic stimulation of pudendal nerve afferents to treat neurogenic detrusor overactivity. *J Urol*. 2008 Oct; 180:1403-8
107. Martens FM, Heesakkers JP, Rijkhoff NJ. Minimal invasive electrode implantation for conditional stimulation of the dorsal genital nerve in neurogenic detrusor overactivity. *Spinal Cord*. 2011 Apr; 49:566-72
108. Reitz A, Schmid DM, Curt A, Knapp PA, Schurch B. Afferent fibers of the pudendal nerve modulate sympathetic neurons controlling the bladder neck. *Neurourol Urodyn*. 2003; 22:597-601
109. Fjorback MV, Rijkhoff N, Petersen T, Nohr M, Sinkjaer T. Event driven electrical stimulation of the dorsal penile/clitoral nerve for management of neurogenic detrusor overactivity in multiple sclerosis. *Neurourol Urodyn*. 2006; 25:349-55
110. Andrews BJ and Reynard JM. Transcutaneous posterior tibial nerve stimulation for treatment of detrusor hyperreflexia in spinal cord injury. *J Urol* 2003; 170: 926.
111. Krivoborodov GG, Gekht AB and Korshunova ES. [Tibial neuromodulation in the treatment of neurogenic detrusor hyperactivity in patients with Parkinson's disease]. *Urologia* 2006; 3-6.
112. Gobbi C, Digesu GA, Khullar V, El Neil S, Caccia G, Zecca C. Percutaneous posterior tibial nerve stimulation as an effective treatment of refractory lower urinary tract symptoms in patients with multiple sclerosis: preliminary data from a multicentre, prospective, open label trial. *Mult Scler*. 2011 Dec; 17:1514-9
113. Kabay S, Kabay SC, Yucel M, et al. The clinical and urodynamic results of a 3-month percutaneous posterior tibial nerve stimulation treatment in patients with multiple sclerosis-related neurogenic bladder dysfunction. *Neurourol Urodyn*. 2009; 28:964-8
114. Kabay SC, Kabay S, Yucel M, Ozden H. Acute urodynamic effects of percutaneous posterior tibial nerve stimulation on neurogenic detrusor overactivity in patients with Parkinson's disease. *Neurourol Urodyn*. 2009; 28:62-7
115. de Seze M, Raibaut P, Gallien P, et al. Transcutaneous posterior tibial nerve stimulation for treatment of the overactive bladder syndrome in multiple sclerosis: results of a multicenter prospective study. *Neurourol Urodyn*. 2011 Mar; 30:306-11
116. Rijkhoff NJ. Re: Kabay et al.: Acute effect of posterior tibial nerve stimulation on neurogenic detrusor overactivity in patients with multiple sclerosis: urodynamic study. (*Urology* 2008;71:641-645). *Urology*. 2008 Nov; 72:1186
117. Gaziev G, Topazio L, Iacovelli V, Asimakopoulos A, Di Santo A, De Nunzio C, Finazzi-Agrò E. Percutaneous Tibial Nerve Stimulation (PTNS) efficacy in the treatment of lower urinary tract dysfunctions: a systematic review. *BMC Urol*. 2013 Nov 25;13:61
118. Kabay C, Kabay S, Mestan E, Centiner M, Ayas S, Sevim M, Ozden H, Karaman HO. Long term sustained therapeutic effects of percutaneous posterior tibial nerve stimulation treatment of neurogenic overactive bladder in multiple sclerosis patients: 12-month results. *Neurourol Urodyn* 2015; [Epub ahead of print]
119. Baumer T, Lange R, Liepert J, Weiller C, Siebner HR, Rothwell JC et al. Repeated premotor rTMS leads to cumulative plastic changes of motor cortex excitability in humans. *Neuroimage* 2003; 20: 550-60.
120. Centonze D, Petta F, Versace V, Rossi S, Torelli F, Prosperetti C et al. Effects of motor cortex rTMS on lower urinary tract dysfunction in multiple sclerosis. *Mult Scler* 2007; 13: 269-71.
121. Brusa L, Finazzi Agro E, Petta F, et al. Effects of inhibitory rTMS on bladder function in Parkinson's disease patients. *Mov Disord*. 2009 Feb 15; 24:445-8
122. Lemack GE, Dewey RB, Jr., Roehrborn CG, O'Suilleabhain PE and Zimmern PE. Questionnaire-based assessment of bladder dysfunction in patients with mild to moderate Parkinson's disease. *Urology* 2000; 56: 250-4.
123. Krack P, Batir A, Van Blercom N, Chabardes S, Fraix V, Ardouin C et al. Five-year follow-up of bilateral stimulation of the subthalamic nucleus in advanced Parkinson's disease. *N Engl J Med* 2003; 349: 1925-34.
124. Seif C, Herzog J, van der Horst C, Schrader B, Volkmann J, Deuschl G et al. Effect of subthalamic deep brain stimulation on the function of the urinary bladder. *Ann Neurol* 2004; 55: 118-20.

125. Dalmose AL, Bjarkam CR, Sorensen JC, Djurhuus JC and Jorgensen TM. Effects of high frequency deep brain stimulation on urine storage and voiding function in conscious minipigs. *Neurourol Urodyn* 2004; 23: 265-72.
126. Herzog J, Weiss PH, Assmus A, Wefer B, Seif C, Braun PM et al. Subthalamic stimulation modulates cortical control of urinary bladder in Parkinson's disease. *Brain* 2006; 129: 3366-75.
127. Herzog J, Weiss PH, Assmus A, Wefer B, Seif C, Braun PM et al. Improved sensory gating of urinary bladder afferents in Parkinson's disease following subthalamic stimulation. *Brain* 2008; 131: 132-45.
128. Kessler TM, Burkhard FC, Z'Brun S, Stibal A, Studer UE, Hess CW et al. Effect of thalamic deep brain stimulation on lower urinary tract function. *Eur Urol* 2008; 53: 607-12.
129. Hagerty JA, Richards I, Kaplan WE. Intravesical electrotherapy for neurogenic bladder dysfunction: a 22-year experience. *J Urol*. 2007 Oct; 178:1680-3
130. van Kerrebroeck PE, van Voskuilen AC, Heesakkers JP, Lycklama a Nijholt AA, Siegel S, Jonas U, et al. Results of sacral neuromodulation therapy for urinary voiding dysfunction: outcomes of a prospective, worldwide clinical study. *J Urol* 2007;178:2029-2034.
131. Schiøtz HA. One month maximal electrostimulation for genuine stress incontinence in women. *Neurourol Urodyn* 1994;13:43-50.
132. Madersbacher H. Intravesical electrical stimulation for the rehabilitation of the neuropathic bladder. *Paraplegia* 1990;28:349-352.
133. Merrill DC. The treatment of detrusor incontinence by electrical stimulation. *J Urol* 1979;122:515-517.
134. Vodusek DB, Light JK, Libby JM. Detrusor inhibition induced by stimulation of pudendal nerve afferents. *Neurourol Urodyn* 1986;5:381-390.
135. Vodusek DB, Plevnik S, Janez J, Vrtacnik P. Detrusor inhibition on selective pudendal nerve stimulation in the perineum. *Neurourol Urodyn* 1988;6:389-393.
136. Tanagho EA, Schmidt RA, Orvis BR. Neural stimulation for control of voiding dysfunction: a preliminary report in 22 patients with serious neuropathic voiding disorders. *J Urol* 1989;142:340-345.
137. Leng WW, Chancellor MB. How sacral nerve stimulation neuromodulation works. *Urol Clin North Am* 2005;32:11-18.
138. Bemelmans BL, Mundy AR, Craggs MD. Neuromodulation by implant for treating lower urinary tract symptoms and dysfunction. *Eur Urol* 1999;36:81-91.
139. Chartier-Kastler EJ, Ruud Bosch JL, Perrigot M, Chancellor MB, Richard F, Denys P. Long-term results of sacral nerve stimulation (S3) for the treatment of neurogenic refractory urge incontinence related to detrusor hyperreflexia. *J Urol* 2000;164:1476-1480.
140. Blok BF, Groen J, Bosch JL, Veltman DJ, Lammertsma AA. Different brain effects during chronic and acute sacral neuromodulation in urge incontinent patients with implanted neurostimulators. *BJU Int* 2006;98:1238-1243.
141. Braun PM, Baezner H, Seif C, Boehler G, Bross S, Eschenfelder CC, et al. Alterations of cortical electrical activity in patients with sacral neuromodulator. *Eur Urol* 2002;41:562-566; discussion 566-567.
142. Dasgupta R, Critchley HD, Dolan RJ, Fowler CJ. Changes in brain activity following sacral neuromodulation for urinary retention. *J Urol* 2005;174:2268-2272.
143. Kruse MN, de Groat WC. Spinal pathways mediate coordinated bladder/urethral sphincter activity during reflex micturition in decerebrate and spinalized neonatal rats. *Neurosci Lett* 1993;152:141-144.
144. Knüpfer SC, Liechti MD, Mordasini L, Abt D, Engeler DS, Wöllner J, Pannek J, Kiss B, Burkhard FC, Schneider MP, Miramontes E, Kessels AG, Bachmann LM, Kessler TM. Protocol for a randomized, placebo-controlled, double-blind clinical trial investigating sacral neuromodulation for neurogenic lower urinary tract dysfunction. *BMC Urol*. 2014 Aug 13;14:65.
145. Wallace PA, Lane FL, Noblett KL. Sacral nerve neuromodulation in patients with underlying neurologic disease. *Am J Obstet Gynecol* 2007;197:96 e91-95.
146. Bosch RJJ, Groen J. Treatment of refractory urge urinary incontinence with sacral spinal nerve stimulation in multiple sclerosis patients. *Lancet* 1996;348:717-719.
147. Bosch RJJ, Groen J. Neuromodulation: urodynamic effects of sacral (S3) spinal nerve stimulation in patients with detrusor instability or detrusor hyperreflexia. *Behav Brain Res* 1998;92:141-150.
148. Spinelli M, Bertapelle P, Cappellano F, Zanollo A, Carone R, Catanzaro F, et al. Chronic sacral neuromodulation in patients with lower urinary tract symptoms: results from a national register. *J Urol* 2001;166:541-545.

149. Hohenfellner M, Humke J, Hampel C, Dahms S, Matzel K, Roth S, et al. Chronic sacral neuromodulation for treatment of neurogenic bladder dysfunction: long-term results with unilateral implants. *Urology* 2001;58:887-892.
150. Scheepens WA, Jongen MM, Nieman FH, de Bie RA, Weil EH, van Kerrebroeck PE. Predictive factors for sacral neuromodulation in chronic lower urinary tract dysfunction. *Urology* 2002;60:598.
151. Bross S, Braun PM, Weiss J, Martinez Portillo FJ, Knoll T, Seif C, et al. The role of the carbachol test and concomitant diseases in patients with nonobstructive urinary retention undergoing sacral neuromodulation. *World J Urol* 2003;20:346-349.
152. Spinelli M, Malaguti S, Giardiello G, Lazzeri M, Tarantola J, Van Den Hombergh U. A new minimally invasive procedure for pudendal nerve stimulation to treat neurogenic bladder: description of the method and preliminary data. *Neurourol Urodyn* 2005;24:305-309.
153. Schurch B, Reilly I, Reitz A, Curt A. Electrophysiological recordings during the peripheral nerve evaluation (PNE) test in complete spinal cord injury patients. *World J Urol* 2003;20:319-322.
154. Zvara P, Sahi S, Hassouna MM. An animal model for the neuromodulation of neurogenic bladder dysfunction. *Br J Urol* 1998;82:267-271.
155. Guys JM, Haddad M, Planche D, Torre M, Louis-Borrione C, Breaud J. Sacral neuromodulation for neurogenic bladder dysfunction in children. *J Urol* 2004;172:1673-1676.
156. Sievert KD, Amend B, Gakis G, et al. Early sacral neuromodulation prevents urinary incontinence after complete spinal cord injury. *Ann Neurol*. 2010 Jan; 67:74-84
157. Chaabane W, Guillotreau J, Castel-Lacanal E, et al. Sacral neuromodulation for treating neurogenic bladder dysfunction: clinical and urodynamic study. *Neurourol Urodyn*. 2011 Apr; 30:547-50
158. Engeler DS, Meyer D, Abt D, Müller S Schmid H-P. Sacral neuromodulation for the treatment of neurogenic lower urinary tract dysfunction caused by multiple sclerosis: a single-centre prospective series. *BMC Urol* 2015; 15:105
159. Puccini F, Bhide A, Elneil S, Digesu GA. Sacral neuromodulation: an effective treatment for lower urinary tract symptoms in multiple sclerosis. *Int Urogyn J* 2013; 27(3): 347-54.
160. Peters KM, Kandagatla P, Killinger KA, Wolfert C, Boura JA. Clinical outcomes of sacral neuromodulation in patients with neurologic conditions. *Urology* 2013; 81(4):738-44.
161. Chartier-Kastler EJ, Denys P, Chancellor MB, Haertig A, Bussel B, Richard F. Urodynamic monitoring during percutaneous sacral nerve neurostimulation in patients with neurogenic detrusor hyperreflexia. *Neurourol Urodyn* 2001;20:61-71
162. Lombardi G, Musco S, Celso M, Del Corso F, Del Popolo G. Sacral neuromodulation for neurogenic non-obstructive urinary retention in incomplete spinal cord patients: a ten-year follow-up single-centre experience. *Spinal Cord*. 2014 Mar;52(3):241-5.
163. Bertapelle P, Bodo G, Carone R. Detrusor acontractility in urinary retention: detrusor contractility test as exclusion criteria for sacral neurostimulation. *J Urol*. 2008 Jul; 180:215-6
164. Aboseif S, Tamaddon K, Chalfin S, Freedman S, Mourad MS, Chang JH, et al. Sacral neuromodulation in functional urinary retention: an effective way to restore voiding. *BJU Int* 2002;90:662-665.
165. Dasgupta R, Wiseman OJ, Kitchen N, Fowler CJ. Long-term results of sacral neuromodulation for women with urinary retention. *BJU Int* 2004;94:335-337.
166. Goodwin RJ, Swinn MJ, Fowler CJ. The neurophysiology of urinary retention in young women and its treatment by neuromodulation. *World J Urol* 1998;16:305-307.
167. von Heyden B, Steinert R, Bothe HW, Hertle L. Sacral neuromodulation for urinary retention caused by sexual abuse. *Psychosom Med* 2001;63:505-508.

SURGICAL TREATMENT OF URINARY INCONTINENCE

1. Westney OL, Lee JT, McGuire EJ, Palmer JL, Cespedes RD, Amundsen CL. Long-term results of Ingelman-Sundberg denervation procedure for urge incontinence refractory to medical therapy. *J Urol* 2002;168:1044-1047.
2. Cespedes RD, Cross CA, McGuire EJ. Modified Ingelman-Sundberg bladder denervation procedure for intractable urge incontinence. *J Urol* 1996;156:1744-1747.
3. Brindley GS, Polkey CE, Rushton DN. Sacral anterior root stimulators for bladder control in paraplegia. *Paraplegia* 1982;20:365-381.

4. Brindley GS, Polkey CE, Rushton DN, Cardozo L. Sacral anterior root stimulators for bladder control in paraplegia: the first 50 cases. *J Neurol Neurosurg Psychiatry* 1986;49:1104-1114.
5. Vignes JR, De Seze M, Sesay M, Barat M, Guerin J. [Anterior sacral root stimulation with dorsal rhizotomy (Brindley technique)]. *Neurochirurgie* 2003;49:383-394.
6. Bauchet L, Segnarbieux F, Martinazzo G, Frerebeau P, Ohanna F. [Neurosurgical treatment of hyperactive bladder in spinal cord injury patients]. *Neurochirurgie* 2001;47:13-24.
7. Egon G, Barat M, Colombel P, Visentin C, Isambert JL, Guerin J. Implantation of anterior sacral root stimulators combined with posterior sacral rhizotomy in spinal injury patients. *World J Urol* 1998;16:342-349.
8. Kutzenberger J, Domurath B, Sauerwein D. Spastic bladder and spinal cord injury: seventeen years of experience with sacral deafferentation and implantation of an anterior root stimulator. *Artif Organs* 2005;29:239-241.
9. Lucas MG, Thomas DG, Clarke S, Forster DM. Long-term follow-up of selective sacral neurectomy. *Br J Urol* 1988;61:218-220.
10. Mertens P, Sindou M. [Microsurgical sacral drezotomy for the treatment of hyperactive bladder]. *Neurochirurgie* 2003;49:399-403.
11. Sindou M. [Selective posterior radicellotomy in the treatment of spasticity]. *Neurochirurgie* 1977;23:359-366.
12. Dogliotti AM. Traitement des syndromes douloureux de la périphérie par l'alcoolisation sous-arachnoïdienne des racines postérieures à leur émergence de la moelle épinière. *Presse Med* 1931;39:1219-1251.
13. Bors E, Comarr AE, Moulton SH. The role of nerve blocks in the management of traumatic cord bladder: spinal anaesthesia, subarachnoïd alcohol injections, pudendal nerve anaesthesia and vesical neck anaesthesia. *J Urol* 1950;63:653-666.
14. Hoch M, Leriche A, Paparel P, Morel-Journal N, Ruffion A. [Chemical destruction of sacral nerve roots by alcohol injection for the treatment of overactive bladder]. *Prog Urol* 2006;16:584-587.
15. Glémain P, Rivière C, Robert R, Buzelin JM. *Dénervation chirurgicale et hyperactivité vésicale*. London: Elsevier, 1998.
16. Alloussi S, Loew F, Mast GJ, Alzin H, Wolf D. Treatment of detrusor instability of the urinary bladder by selective sacral blockade. *Br J Urol* 1984;56:464-467.
17. Alloussi S, Loew F, Mast GJ, Jung P, Schwertfeger K, Steffens J, et al. Value of selective reversible sacral nerve blockade in the diagnosis and treatment of the urge syndrome. *Eur Urol* 1990;17:30-34.
18. Muller SC, Frohneberg D, Schwab R, Thurhoff JW. Selective sacral nerve blockade for the treatment of unstable bladders. *Eur Urol* 1986;12:408-412.
19. Mulcahy JJ, Young AB. Long-term follow-up of percutaneous radiofrequency sacral rhizotomy. *Urology* 1990;35:76-77.
20. Ferreira RS, Levi d'Ancona CA, Dantas-Filho VP, Rodrigues Netto N, Jr., Miyaoka R. [Percutaneous radiofrequency sacral rhizotomy in the treatment of neurogenic detrusor overactivity in spinal cord injured patients]. *Actas Urol Esp*. 2011 Jun; 35:325-30
21. Tanagho EA, Schmidt RA, Orvis BR. Neural stimulation for control of voiding dysfunction: a preliminary report in 22 patients with serious neuropathic voiding disorders. *J Urol* 1989;142:340-345.
22. Li JS, Hassouna M, Sawan M, Duval F, Elhilali MM. Electrical stimulation induced sphincter fatigue during voiding. *J Urol* 1992;148:949-952.
23. Rijkhoff NJ, Wijkstra H, van Kerrebroeck PE, Debruyne FM. Selective detrusor activation by sacral ventral nerve-root stimulation: results of intraoperative testing in humans during implantation of a Finetech-Brindley system. *World J Urol* 1998;16:337-341.
24. Brindley GS. The first 500 patients with sacral anterior root stimulator implants: general description. *Paraplegia* 1994;32:795-805.
25. van der Aa HE, Alleman E, Nene A, Snoek G. Sacral anterior root stimulation for bladder control: clinical results. *Arch Physiol Biochem* 1999;107:248-256.
26. Martens FM, den Hollander PP, Snoek GJ, Koldewijn EL, van Kerrebroeck PE, Heesakkers JP. Quality of life in complete spinal cord injury patients with a Brindley bladder stimulator compared to a matched control group. *Neurourol Urodyn*. 2011 Apr; 30:551-5
27. Schurch B, Rodic B, Jeanmonod D. Posterior sacral rhizotomy and intradural anterior sacral root stimulation for treatment of the spastic bladder in spinal cord injured patients. *J Urol* 1997;157:610-614.

28. Krasmik D, Krebs J, van Ophoven A, Pannek J. Urodynamic results, clinicafefficacy, and complication rates of sacral intradural deafferentation and sacral anterior root stimulation in patients with neurogenic lower urinary tract dysfunction resulting from complete spinal cord injury. *Neurourol Urodyn*. 2014 Nov;33(8):1202-6.
29. Castaño-Botero JC, Ospina-Galeano IA, Gómez-Illanes R, Lopera-Toro A. Extradural implantation of sacral anterior root stimulator in spinal cord injury patients. *Neurourol Urodyn*. 2015 Jul 24. doi: 10.1002/nau.22838. [Epub ahead of print] PubMed PMID: 26208239.
30. Rasmussen MM, Kutzenberger J, Krogh K, Zepke F, Bodin C, Domurath B, Christensen P. Sacral anterior root stimulation improves bowel function in subjects with spinal cord injury. *Spinal Cord*. 2015 Apr;53(4):297-301
31. Barat M, Egon G, Daverat P, Colombel P, Guerin J, Ritz M, et al. [Electrostimulation of anterior sacral nerve roots in the treatment of central neurogenic bladders. G.S. Brindley's technique. Results of the 40 first French cases]. *J Urol (Paris)* 1993;99:3-7.
32. Van Kerrebroeck PE, Koldewijn EL, Rosier PF, Wijkstra H, Debruyne FM. Results of the treatment of neurogenic bladder dysfunction in spinal cord injury by sacral posterior root rhizotomy and anterior sacral root stimulation. *J Urol* 1996;155:1378-1381.
33. Creasey GH, Grill JH, Korsten M, U HS, Betz R, Anderson R, et al. An implantable neuro-prosthesis for restoring bladder and bowel control to patients with spinal cord injuries: a multicenter trial. *Arch Phys Med Rehabil* 2001;82:1512-1519.
34. Vignes JR, Liguoro D, Sesay M, Barat M, Guerin J. Dorsal rhizotomy with anterior sacral root stimulation for neurogenic bladder. *Stereotact Funct Neurosurg* 2001;76:243-245
35. Noll F, Sauerwein D, Stohrer M. Transurethral sphincterotomy in quadriplegic patients: long-term-follow-up. *Neurourol Urodyn* 1995;14:351-358.
36. Juma S, Mostafavi M, Joseph A. Sphincterotomy: long-term complications and warning signs. *Neurourol Urodyn* 1995;14:33-41.
37. Chancellor M, Rivas D. Complications related to sphincter stent used to the management of detrusor-sphincter dyssynergia. In: Yachia D, editor. *Stenting the urinary system*. Oxford: Isis Medical Media, 1998:437-443.
38. Parikh A, Milroy E. Precautions and complications in the use of the Urolume Wallstent. *Eur Urol* 1995;27:1-7.
39. Gross AJ, Sauerwein DH, Kutzenberger J, Ringert RH. Penile prostheses in paraplegic men. *Br J Urol* 1996;78:262-264.
40. Carson CC. Complications of penile prostheses and complex implantations. In: Carson C, Kirby R, Goldstein I, editors. *Textbook of erectile dysfunction*. Oxford: Isis Medical Media, 1999:435-450.
41. Lundberg PO, Brackett NL, Denys P, Chartier-Kastler E, Sonksen J, Vodusek DB. Neurological disorders: erectile and ejaculatory dysfunction (Committee 17). In: Jardin A, Wagner G, Khoury S, Giuliano F, Padma-Nathan H, Rosen R, editors. *Erectile dysfunction*. Plymouth: Health Publication Ltd, 2000:591-645.
42. Emmett JL, Daut RV, Dunn JH. Role of the external urethral sphincter in the normal bladder and cord bladder. *J Urol* 1948;59:439-454.
43. Ross JC, Damanski M, Giddons N. Resection of the external urethral sphincter in the paraplegic-preliminary report. *J Urol* 1958;79:742-746.
44. Archimbaud JP. Les complications urinaires des dysfonctionnements vésico-sphinctériens neurologiques. In: d'Urologie AF, editor. *Les dysfonctionnements vésico-sphinctériens neurologiques*. Paris: Masson, 1974:153-162.
45. Cukier J, Leger P, Benhamou G, Lacombe, Maury M, Couvelaire R. [Surgical myotomy of the striated sphincter of the urethra. A new subpubic approach. Study of the pathology of the striated sphincter in paraplegics]. *J Urol Nephrol (Paris)* 1971;77:27-50.
46. Reynard JM, Vass J, Sullivan ME, Mamas M. Sphincterotomy and the treatment of detrusor-sphincter dyssynergia: current status, future prospects. *Spinal Cord* 2003;41:1-11.
47. Dollfus P, Jurascheck F, Adli G, Chapus A. Impairment of erection after external sphincter resection. *Paraplegia* 1976;13:290-293.
48. Crane DB, Hackler RH. External sphincterotomy: its effect on erections. *J Urol* 1976;116:316-318.
49. Yalla SV, Fam BA, Gabilondo FB, Jacobs S, Di Benedetto M, Rossier AB, et al. Anteromedian external urethral sphincterotomy: technique, rationale and complications. *J Urol* 1977;117:489-493.
50. Kiviat MD. Transurethral sphincterotomy: relationship of site of incision to postoperative potency and delayed hemorrhage. *J Urol* 1975;114:399-401.

51. Chancellor MB, Gajewski J, Ackman CF, Appell RA, Bennett J, Binard J, et al. Long-term followup of the North American multicenter UroLume trial for the treatment of external detrusor-sphincter dyssynergia. *J Urol* 1999;161:1545-1550.
52. Vapnek JM, Couillard DR, Stone AR. Is sphincterotomy the best management of the spinal cord injured bladder? *J Urol* 1994;151:961-964.
53. Ricottone AR, Prankoff K, Steinmetz JR, Constantino G. Long-term follow-up of sphincterotomy in the treatment of autonomic dysreflexia. *Neurourol Urodyn* 1995;14:43-46.
54. Pan D, Troy A, Rogerson J, Bolton D, Brown D, Lawrentschuk N. Long-term outcomes of external sphincterotomy in a spinal injured population. *J Urol*. 2009 Feb; 181:705-9
55. Pannek J, Gocking K, Bersch U. Clinical usefulness of the memokath stent as a second-line procedure after sphincterotomy failure. *J Endourol*. 2011 Feb; 25:335-9
56. Vainrib M, Reyblat P, Ginsberg DA. Long-term efficacy of repeat incisions of bladder neck/external sphincter in patients with spinal cord injury. *Urology* 2014;84:940-5.)
57. Utomo E, Groen J, Blok BF. Surgical management of functional bladder outlet obstruction in adults with neurogenic bladder dysfunction. *Cochrane Database Syst Rev*. 2014 May 24;5:CD004927. doi: 10.1002/14651858.CD004927.pub4. Review. PubMed PMID: 24859260.
58. Shaw JPR, Milroy E, Timoney AG, Mitchell N. Permanent external sphincter stents in spinal injured patients. *Br J Urol* 1990;66:297-302.
59. Yachia D. Temporary metal stents in bladder outflow obstruction. *J Endourol* 1997;11:459-465.
60. Badlani G. Role of permanent stents. *J Endourol* 1997;11:473-475.
61. Chartier-Kastler E, De Petriconi R, Bussel B, Richard F, Denys P. Etude de faisabilité de la prothèse endourétrale transsphinctérienne striée Diabolo™ dans le traitement de la dys-synergie vésicosphinctérienne striée. *Prog Urol* 2002;12:59A.
62. Game X, Chartier-Kastler E, Ayoub N, Even-Schneider A, Richard F, Denys P. Outcome after treatment of detrusor-sphincter dyssynergia by temporary stent. *Spinal Cord* 2008;46:74-7.
63. Pannek J, Gocking K, Bersch U. Clinical usefulness of the memokath stent as a second-line procedure after sphincterotomy failure. *J Endourol*. 2011 Feb; 25:335-9
64. Hamid R, Arya M, Wood S, Patel HR, Shah PJ. The use of the Memokath stent in the treatment of detrusor sphincter dyssynergia in spinal cord injury patients: a single-centre seven-year experience. *Eur Urol* 2003;43:539-543.
65. Low AI, McRae PJ. Use of the Memokath for detrusor-sphincter dyssynergia after spinal cord injury--a cautionary tale. *Spinal Cord* 1998;36:39-44.
66. Mehta SS, Tophill PR. Memokath stents for the treatment of detrusor sphincter dyssynergia (DSD) in men with spinal cord injury: the Princess Royal Spinal Injuries Unit 10-year experience. *Spinal Cord* 2006;44:1-6.
67. Shah NC, Foley SJ, Edhem I, Shah PJ. Use of Memokath temporary urethral stent in treatment of detrusor-sphincter dyssynergia. *J Endourol* 1997;11:485-488.
68. Vaidyanathan S, Soni BM, Oo T, Sett P, Hughes PL, Singh G. Long-term result of Memokath urethral sphincter stent in spinal cord injury patients. *BMC Urol* 2002;2:12.
69. Corujo M, Badlani G. Epithelialization of permanent stents. *J Endourol* 1997;11:477-480.
70. Chancellor M, Rivas D, Watanabe T, Bennet J, Foote J, Green B, et al. Reversible clinical outcome after sphincter stent removal. *J Urol* 1996;155:1992-1994.
71. Gajewski J, Chancellor M, Ackman D, et al. Removal of Urolume endoprosthesis: experience of the north american study group for detrusor-sphincter dyssynergia application. *J Urol* 2000;163:773-776.
72. Elkassaby AA, Al-Kandari AM, Shokeir AA. The surgical management of obstructive stents used for urethral strictures. *J Urol* 2007;178:204-207.
73. Rodriguez E, Jr., Gelman J. Pan-urethral strictures can develop as a complication of UroLume placement for bulbar stricture disease in patients with hypospadias. *Urology* 2006;67:1290 e1211-1292.
74. Shah DK, Kapoor R, Badlani GH. Experience with urethral stent explantation. *J Urol* 2003;169:1398-1400.
75. Wilson T, Lemack G, Dmochowski R. Urolume stents: lessons learned. *J Urol* 2002;167:2477-2480.
76. Abdul-Rahman A, Ismail S, Hamid R, Shah J. A 20-year follow-up of the mesh wallstent in the treatment of detrusor external sphincter dyssynergia in patients with spinal cord injury. *BJU Int*. 2010 Nov; 106:1510-3

77. Chancellor M, Rivas D, Abdill C, et al. Prospective comparison of external sphincter balloon dilatation and prosthesis placement with external sphincterotomy in spinal cord injured men. *Arch Phys Med Rehabil* 1994;75:297-305.
78. Rivas DA, Chancellor MB, Bagley D. Prospective comparison of external sphincter prosthesis placement and external sphincterotomy in men with spinal cord injury. *J Endourol* 1994;8:89-93.
79. McFarlane JP, Foley SJ, Shah PJR. Balloon dilatation in the treatment of detrusor sphincter dyssynergia. *Spinal Cord* 1997;35:96-98.
80. Chancellor MB, Bennett C, Simoneau AR, Finocchiaro MV, Kline C, Bennett JK, et al. Sphincteric stent versus external sphincterotomy in spinal cord injured men: prospective randomized multicenter trial. *J Urol* 1999;161:1893-1898.
81. Polguer T, Boissier R, Gaillet S, Lenne Aurier K, Savoie PH, Lechevallier E, Coulange C, Karsenty G. [Treatment of detrusor-striated sphincter dyssynergia with permanent nitinol urethral stent: results after a minimum follow-up of 2 years]. *Prog Urol*. 2012 Dec;22(17):1058-63.
82. Ke QS, Kuo HC. Transurethral incision of the bladder neck to treat bladder neck dysfunction and voiding dysfunction in patients with high-level spinal cord injuries. *Neurourol Urodyn*. 2010 Jun; 29:748-52
83. Horton CE, Sadove RC, Jordan GH, Sagher U. Use of the rectus abdominis muscle and fascia flap in reconstruction of epispadias/exstrophy. *Clin Plast Surg* 1988;15:393-397.
84. Parkash S, Bhandari M. Rectus abdominis myocutaneous island flap for bridging defect after cystectomy for bladder exstrophy. *Urology* 1982;20:536-537.
85. Celayir S, Kilic N, Elicevik M, Buyukunal C. Rectus abdominis muscle flap (RAMF) technique for the management of bladder exstrophies: late clinical outcome and urodynamic findings. *Br J Urol* 1997;79:276-278.
86. Ninkovic M, Stenzl A, Schwabegger A, Bartsch G, Prosser R, Ninkovic M. Free neurovascular transfer of latissimus dorsi muscle for the treatment of bladder acontractility: II. Clinical results. *J Urol* 2003;169:1379-1383.
87. Stenzl A, Ninkovic M, Kolle D, Knapp R, Anderl H, Bartsch G. Restoration of voluntary emptying of the bladder by transplantation of innervated free skeletal muscle. *Lancet* 1998;351:1483-1485.
88. Stenzl A, Ninkovic M, Willeit J, Hess M, Feichtinger H, Schwabegger A, et al. Free neurovascular transfer of latissimus dorsi muscle to the bladder. I. Experimental studies. *J Urol* 1997;157:1103-1108.
89. Gakis G, Ninkovic M, van Koeveeringe GA, et al. Functional detrusor myoplasty for bladder acontractility: long-term results. *J Urol*. 2011 Feb; 185:593-9
90. Catz A, Luttwak ZP, Agranov E, Ronen J, Shpaser R, Paz A, et al. The role of external sphincterotomy for patients with a spinal cord lesion. *Spinal Cord* 1997;35:48-52.
91. Fontaine E, Hajri M, Rhein F, Fakacs C, Le Mouel MA, Beurton D. Reappraisal of endoscopic sphincterotomy for post-traumatic neurogenic bladder: a prospective study. *J Urol* 1996;155:277-280.
92. Namiki T. Transurethral sphincteroresection in traumatic tetraplegia. *Urol Int* 1984;39:286-291.
93. Ruutu M, Lehtonen T. External sphincterotomy in patients with spinal cord injury. *Ann Chir Gynaecol* 1982;71:250-254.
94. Carrion HM, Brown BT, Politano VA. External sphincterotomy at the 12 o'clock position. *J Urol* 1979;121:462-463
95. Perakash I. Use of contact laser crystal tip firing Nd:YAG to relieve urinary outflow obstruction in male neurogenic bladder patients. *J Clin Laser Med Surg* 1998;16:33-38.
96. Rivas DA, Chancellor MB, Staas WE, Jr., Gomella LG. Contact neodymium:yttrium-aluminum-garnet laser ablation of the external sphincter in spinal cord injured men with detrusor sphincter dyssynergia. *Urology* 1995;45:1028-1031
97. Fabian KM. Der intraprostatiscche "partielle Katheter"(urologische Spirale). *Urologe [A]* 1980;19:236-238.
98. Nissenkorn I. Experience with a new self retaining intraurethral catheter in patients with urinary retention: a preliminary report. *J Urol* 1989;142:92-94.
99. Soni BM, Vaidyanatham S, Krishnan KR. Use of Memokath, a second generation urethral stent for relief of urinary retention in male spinal cord injured patients. *Paraplegia* 1994;32:480-488.
100. Juma S, Niku S, Broda K, Joseph A. Urolume urethral wallstent in the treatment of detrusor sphincter dyssynergia. *Paraplegia* 1994;32:616-621.

101. Parra R. Treatment of posterior urethral strictures with a Titanium urethral stent. *J Urol* 1991;146:937-1000.
102. Juan Garcia F, Salvador S, Montoto A, Lion S, Balvis B, Rodriguez A, et al. Intraurethral stent prosthesis in spinal cord injured patients with sphincter dyssynergia. *Spinal Cord* 1999;37:54-57.
103. Denys P, Thiry-Escudie I, Ayoub N, Even-Schneider A, Benyahya S, Chartier-Kastler E. Urethral stent for the treatment of detrusor-sphincter dyssynergia: evaluation of the clinical, urodynamic, endoscopic and radiological efficacy after more than 1 year. *J Urol* 2004;172:605-607.
104. Hamid R, Arya M, Patel HR, Shah PJ. The mesh wallstent in the treatment of detrusor external sphincter dyssynergia in men with spinal cord injury: a 12-year follow-up. *BJU Int* 2003;91:51-53.
105. Shah NC, Foley SJ, Edhem I, Shah PJ. Use of Memokath temporary urethral stent in treatment of detrusor-sphincter dyssynergia. *J Endourol.* 1997 Dec; 11:485-8
106. Austin PF, Westney OL, Leng WW, McGuire EJ, Ritchey ML. Advantages of rectus fascial slings for urinary incontinence in children with neuropathic bladders. *J Urol* 2001;165:2369-2371
107. Barthold JS, Rodriguez E, Freedman AL, Fleming PA, Gonzalez R. Results of the rectus fascial sling and wrap procedures for the treatment of neurogenic sphincteric incontinence. *J Urol* 1999;161:272-274.
108. Gosalbez R, Castellan M. Defining the role of the bladder-neck sling in the surgical treatment of urinary incontinence in children with neurogenic incontinence. *World J Urol* 1998;16:285-291.
109. Kakizaki H, Shibata T, Shinno Y, Kobayashi S, Matsumura K, Koyanagi T. Fascial sling for the management of urinary incontinence due to sphincter incompetence. *J Urol* 1995;153:644-647.
110. Belloli G, Campobasso P, Mercurella A. Neuro-pathic urinary incontinence in pediatric patients: management with artificial sphincter. *J Pediatr Surg* 1992;27:1461-1464.
111. Bersch U, Gocking K, Pannek J. The Artificial Urinary Sphincter in Patients with Spinal Cord Lesion: Description of a Modified Technique and Clinical Results. *Eur Urol* 2009; 55:687-93
112. Castera R, Podesta ML, Ruarte A, Herrera M, Medel R. 10-Year experience with artificial urinary sphincter in children and adolescents. *J Urol* 2001;165:2373-2376.
113. Elliott DS, Barrett DM. Mayo Clinic long-term analysis of the functional durability of the AMS 800 artificial urinary sphincter: a review of 323 cases. *J Urol* 1998;159:1206-1208.
114. Fulford SC, Sutton C, Bales G, Hickling M, Stephenson TP. The fate of the 'modern' artificial urinary sphincter with a follow-up of more than 10 years. *Br J Urol* 1997;79:713-716.
115. Gonzalez R, Merino FG, Vaughn M. Long-term results of the artificial urinary sphincter in male patients with neurogenic bladder. *J Urol* 1995;154:769-770.
116. Herndon CD, Rink RC, Shaw MB, Simmons GR, Cain MP, Kaefer M, et al. The Indiana experience with artificial urinary sphincters in children and young adults. *J Urol* 2003;169:650-654; discussion 654.
117. Kryger JV, Levenson G, Gonzalez R. Long-term results of artificial urinary sphincters in children are independent of age at implantation. *J Urol* 2001;165:2377-2379.
118. Lai HH, Hsu EI, Teh BS, Butler EB, Boone TB. 13 years of experience with artificial urinary sphincter implantation at Baylor College of Medicine. *J Urol* 2007;177:1021-1025.
119. Levesque PE, Bauer SB, Atala A, Zurakowski D, Colodny A, Peters C, et al. Ten-year experience with the artificial urinary sphincter in children. *J Urol* 1996;156:625-628.
120. Lopez Pereira P, Somoza Ariba I, Martinez Urrutia MJ, Lobato Romero R, Jaureguizar Monroe E. Artificial urinary sphincter: 11-year experience in adolescents with congenital neuropathic bladder. *Eur Urol* 2006;50:1096-1101; discussion 1101.
121. Patki P, Hamid R, Shah PJ, Craggs M. Long-term efficacy of AMS 800 artificial urinary sphincter in male patients with urodynamic stress incontinence due to spinal cord lesion. *Spinal Cord* 2006;44:297-300.
122. Simeoni J, Guys JM, Mollard P, Buzelin JM, Moscovici J, Bondonny JM, et al. Artificial urinary sphincter implantation for neurogenic bladder: a multi-institutional study in 107 children. *Br J Urol* 1996;78:287-293.
123. Singh G, Thomas DG. Artificial urinary sphincter in patients with neurogenic bladder dysfunction. *Br J Urol* 1996;77:252-255.
124. Snodgrass WT, Elmore J, Adams R. Bladder neck sling and appendicovesicostomy without augmentation for neurogenic incontinence in children. *J Urol* 2007;177:1510-1514.

125. Dave S, Pippi Salle JL, Lorenzo AJ, Braga LH, Peralta-Del Valle MH, Bagli D, et al. Is long-term bladder deterioration inevitable following successful isolated bladder outlet procedures in children with neuropathic bladder dysfunction? *J Urol* 2008;179:1991-1996; discussion 1996.
126. Kryger JV, Gonzalez R, Barthold JS. Surgical management of urinary incontinence in children with neurogenic sphincteric incompetence. *J Urol*. 2000 Jan; 163:256-63
127. Farag F, Koens M, Sievert KD, De Ridder D, Feitz W, Heesakkers J. Surgical treatment of neurogenic stress urinary incontinence: A systematic review of quality assessment and surgical outcomes. *Neurourol Urodyn*. 2016 Jan;35(1):21-5
128. Dyer L, Franco I, Firlit CF, Reda EF, Levitt SB, Palmer LS. Endoscopic injection of bulking agents in children with incontinence: dextranomer/hyaluronic acid copolymer versus polytetrafluoroethylene. *J Urol*. 2007 Oct; 178:1628-31
129. Godbole P, Mackinnon AE. Expanded PTFE bladder neck slings for incontinence in children: the long-term outcome. *BJU Int* 2004;93:139-141
130. Malizia AA, Jr., Reiman HM, Myers RP, et al. Migration and granulomatous reaction after periurethral injection of polytef (Teflon). *Jama*. 1984 Jun 22-29: 251:3277-81
131. Claes H, Stroobants D, Van Meerbeek J, Verbeken E, Knockaert D, Baert L. Pulmonary migration following periurethral polytetrafluoroethylene injection for urinary incontinence. *J Urol*. 1989 Sep: 142:821-2
132. Wan J, McGuire EJ, Bloom DA, Ritchey ML. The treatment of urinary incontinence in children using glutaraldehyde cross-linked collagen. *J Urol*. 1992 Jul: 148:127-30
133. Sundaram CP, Reinberg Y, Aliabadi HA. Failure to obtain durable results with collagen implantation in children with urinary incontinence. *J Urol*. 1997 Jun: 157:2306-7
134. Block CA, Cooper CS, Hawtrey CE. Long-term efficacy of periurethral collagen injection for the treatment of urinary incontinence secondary to myelomeningocele. *J Urol*. 2003 Jan: 169:327-9
135. Bomalaski MD, Bloom DA, McGuire EJ, Panzl A. Glutaraldehyde cross-linked collagen in the treatment of urinary incontinence in children. *J Urol*. 1996 Feb: 155:699-702
136. Perez LM, Smith EA, Parrott TS, Broecker BH, Massad CA, Woodard JR. Submucosal bladder neck injection of bovine dermal collagen for stress urinary incontinence in the pediatric population. *J Urol*. 1996 Aug: 156:633-6
137. Leonard MP, Decter A, Mix LW, Johnson HW, Coleman GU. Treatment of urinary incontinence in children by endoscopically directed bladder neck injection of collagen. *J Urol*. 1996 Aug: 156:637-40; discussion 40-1
138. Chernoff A, Horowitz M, Combs A, Libretti D, Nitti V, Glassberg KI. Periurethral collagen injection for the treatment of urinary incontinence in children. *J Urol*. 1997 Jun: 157:2303-5
139. Kassouf W, Capolicchio G, Berardinucci G, Corcos J. Collagen injection for treatment of urinary incontinence in children. *J Urol*. 2001 May: 165:1666-8
140. Halachmi S, Farhat W, Metcalfe P, Bagli DJ, McLorie GA, Khoury AE. Efficacy of polydimethylsiloxane injection to the bladder neck and leaking diverting stoma for urinary continence. *J Urol*. 2004 Mar: 171:1287-90
141. Lottmann HB, Margaryan M, Bernuy M, et al. The effect of endoscopic injections of dextranomer based implants on continence and bladder capacity: a prospective study of 31 patients. *J Urol*. 2002 Oct: 168:1863-7; discussion 7
142. Hamid R, Arya M, Khastgir J, Patel HR, Shah PJ. The treatment of male stress urinary incontinence with polydimethylsiloxane in compliant bladders following spinal cord injury. *Spinal Cord*. 2003 May: 41:286-9
143. Guys JM, Breaud J, Hery G, Camerlo A, Le Hors H, De Lagausie P. Endoscopic injection with polydimethylsiloxane for the treatment of pediatric urinary incontinence in the neurogenic bladder: long-term results. *J Urol*. 2006 Mar: 175:1106-10
144. Caione P, Capozza N. Endoscopic treatment of urinary incontinence in pediatric patients: 2-year experience with dextranomer/hyaluronic acid copolymer. *J Urol*. 2002 Oct: 168:1868-71
145. Misseri R, Casale AJ, Cain MP, Rink RC. Alternative uses of dextranomer/hyaluronic acid copolymer: the efficacy of bladder neck injection for urinary incontinence. *J Urol*. 2005 Oct: 174:1691-3; discussion 3-4
146. Dean GE, Kirsch AJ, Packer MG, Scherz HC, Zaontz MR. Antegrade and retrograde endoscopic dextranomer/hyaluronic Acid bladder neck bulking for pediatric incontinence. *J Urol*. 2007 Aug: 178:652-5

147. Henly DR, Barrett DM, Weiland TL, O'Connor MK, Malizia AA, Wein AJ. Particulate silicone for use in periurethral injections: local tissue effects and search for migration. *J Urol*. 1995 Jun; 153:2039-43
148. Lottmann HB, Margaryan M, Lortat-Jacob S, Bernuy M, Lackgren G. Long-term effects of dextranomer endoscopic injections for the treatment of urinary incontinence: an update of a prospective study of 61 patients. *J Urol*. 2006 Oct; 176:1762-6
149. Karsenty G, Chartier-Kastler E, Mozer P, Even-Schneider A, Denys P, Richard F. A novel technique to achieve cutaneous continent urinary diversion in spinal cord-injured patients unable to catheterize through native urethra. *Spinal Cord* 2007; 46: 305-310.
150. Castellan M, Gosalbez R, Labbie A, Ibrahim E, Disandro M. Bladder neck sling for treatment of neurogenic incontinence in children with augmentation cystoplasty: long-term followup. *J Urol* 2005;173:2128-2131; discussion 2131.
151. Albouy B, Grise P, Sambuis C, Pfister C, Mitrofanoff P, Liard A. Pediatric urinary incontinence: evaluation of bladder wall wraparound sling procedure. *J Urol* 2007;177:716-719.
152. Athanasopoulos A, Gyftopoulos K, McGuire EJ. Treating stress urinary incontinence in female patients with neuropathic bladder: the value of the autologous fascia rectus sling. *Int Urol Nephrol*. 2012 Oct;44(5):1363-7)
153. Hamid R, Khastgir J, Arya M, Patel HR, Shah PJ. Experience of tension-free vaginal tape for the treatment of stress incontinence in females with neuropathic bladders. *Spinal Cord*. 2003 Feb; 41:118-21
154. Chartier-Kastler E, Ayoub N, Richard F, Ruffion A. [Prosthetic surgery for stress urinary incontinence due to neurogenic sphincter incompetence]. *Prog Urol* 2007;17:600-608
155. Phé V, Léon P, Granger B, Denys P, Bitker MO, Mozer P, Chartier-Kastler E. Stress urinary incontinence in female neurological patients: long-term functional outcomes after artificial urinary sphincter (AMS 800) implantation. *Neurolog Urodyn*. 2016 Apr 15. doi: 10.1002/nau.23019. [Epub ahead of print] PubMed PMID: 27080729
156. Salomon J, Gory A, Bernard L, Ruffion A, Denys P, Chartier-Kastler E. [Urinary tract infection and neurogenic bladder]. *Prog Urol* 2007;17:448-453
157. Bersch U, Gocking K, Pannek J. The artificial urinary sphincter in patients with spinal cord lesion: description of a modified technique and clinical results. *Eur Urol*. 2009 Mar; 55:687-93
158. Herndon CD, Rink RC, Shaw MB, Cain MP, Casale AJ. Experience with non-cycled artificial urinary sphincters. *BJU Int* 2004;93:1049-1052
159. Diokno AC, Sonda LP. Compatibility of genitourinary prostheses and intermittent self-catheterization. *J Urol* 1981;125:659-660.
160. Game X, Bram R, Abu Anz S, et al. Laparoscopic insertion of artificial periprostatic urinary sphincter. *Urology*. 2009 Feb; 73:442 e1-3
161. Jumper BM, McLorie GA, Churchill BM, Khoury AE, Toi A. Effects of the artificial urinary sphincter on prostatic development and sexual function in pubertal boys with meningomyelocele. *J Urol* 1990;144:438-442; discussion 443-434.
162. Young HH. An operation for the cure of incontinence of urine. *Surg Gynecol Obstet* 1919;28:84-90
163. Dees JE. Congenital epispadias with incontinence. *J Urol* 1949;62:513-522.
164. Leadbetter GW, Jr. Surgical Correction of Total Urinary Incontinence. *J Urol* 1964;91:261-266.
165. Sidi AA, Reinberg Y, Gonzalez R. Comparison of artificial sphincter implantation and bladder neck reconstruction in patients with neurogenic urinary incontinence. *J Urol* 1987;138:1120-1122.
166. Jones JA, Mitchell ME, Rink RC. Improved results using a modification of the Young-Dees-Leadbetter bladder neck repair. *Br J Urol* 1993;71:555-561
167. Kropp KA, Angwafo FF. Urethral lengthening and reimplantation for neurogenic incontinence in children. *J Urol* 1986;135:533-536.
168. Mollard P, Mouriquand P, Joubert P. Urethral lengthening for neurogenic urinary incontinence (Kropp's procedure): results of 16 cases. *J Urol* 1990;143:95-97.
169. Snodgrass W. A simplified Kropp procedure for incontinence. *J Urol* 1997;158:1049-1052.
170. Salle JL, de Fraga JC, Amarante A, Silveira ML, Lambert M, Schmidt M, et al. Urethral lengthening with anterior bladder wall flap for urinary incontinence: a new approach. *J Urol* 1994;152:803-806.
171. Salle JL, McLorie GA, Bagli DJ, Khoury AE. Urethral lengthening with anterior bladder wall flap (Pippi Salle procedure): modifications and extended indications of the technique. *J Urol* 1997;158:585-590.

172. Mouriouand PD, Sheard R, Phillips N, White J, Sharma S, Vandenberg C. The Kropp-onlay procedure (Pippi Salle procedure): a simplification of the technique of urethral lengthening. Preliminary results in eight patients. *Br J Urol* 1995;75:656-662
173. Colli J, Lloyd LK. Bladder neck closure and suprapubic catheter placement as definitive management of neurogenic bladder. *J Spinal Cord Med.* 2011;34(3):273-7
174. Shpall AI, Ginsberg DA. Bladder neck closure with lower urinary tract reconstruction: technique and long-term followup. *J Urol* 2004;172:2296-2299
175. Barqawi A, de Valdenebro M, Furness PD, 3rd, Koyle MA. Lessons learned from stomal complications in children with cutaneous catheterizable continent stomas. *BJU Int.* 2004 Dec; 94:1344-7
176. De Vocht TF, Chrzan R, Dik P, Klijn AJ, De Jong TP. Long-term results of bulking agent injection for persistent incontinence in cases of neurogenic bladder dysfunction. *J Urol.* 2010 Feb; 183:719-23
177. Gormley EA, Bloom DA, McGuire EJ, Ritchey ML. Pubovaginal slings for the management of urinary incontinence in female adolescents. *J Urol* 1994;152:822-825; discussion 826-827.
178. Elder JS. Periurethral and puboprostatic sling repair for incontinence in patients with myelodysplasia. *J Urol* 1990;144:434-437
179. Murphy S, Rea D, O'Mahony J, et al. A comparison of the functional durability of the AMS 800 artificial urinary sphincter between cases with and without an underlying neurogenic aetiology. *Ir J Med Sci.* 2003 Jul-Sep: 172:136-8
180. Shankar KR, McGillivray D, Turnock RR, Rickwood AM. Superior transperitoneal dissection for inserting artificial sphincter bladder neck cuffs. *BJU Int.* 2001 Nov; 88:797-8
181. Stohrer M, Castro-Diaz D, Chartier-Kastler E, Kramer G, Mattiasson A, Wyndaele JJ. Guidelines on neurogenic lower urinary tract dysfunction. *Prog Urol.* 2007 May; 17:703-55
182. Mikulicz V. Zur operation der angerborenen blasensplate. *Zentralbl Chir* 1889;26:641-643.
183. Lapedes J, Diokno AC, Silber SJ, Lowe BS. Clean, intermittent self-catheterization in the treatment of urinary tract disease. *Trans Am Assoc Genitourin Surg* 1971;63:92-96.
184. Game X, Karsenty G, Chartier-Kastler E, Ruffion A. [Treatment of neurogenic detrusor hyperactivity: enterocystoplasty]. *Prog Urol* 2007;17:584-596.
185. Meng MV, Anwar HP, Elliott SP, Stoller ML. Pure laparoscopic enterocystoplasty. *J Urol* 2002;167:1386.
186. Gill IS, Rackley RR, Meraney AM, Marcello PW, Sung GT. Laparoscopic enterocystoplasty. *Urology* 2000;55:178-181.
187. Gundeti MS, Acharya SS, Zagaja GP, Shalhav AL. Paediatric robotic-assisted laparoscopic augmentation ileocystoplasty and Mitrofanoff appendicovesicostomy (RALIMA): feasibility of and initial experience with the University of Chicago technique. *BJU Int.* 2011 Mar; 107:962-9
188. Simforoosh N, Tabibi A, Basiri A, Noorbala MH, Danesh AD, Ijadi A. Is ureteral reimplantation necessary during augmentation cystoplasty in patients with neurogenic bladder and vesicoureteral reflux? *J Urol* 2002;168:1439-1441.
189. Lopez Pereira P, Martinez Urrutia MJ, Lobato Romera R, Jaureguizar E. Should we treat vesicoureteral reflux in patients who simultaneously undergo bladder augmentation for neuro-pathic bladder? *J Urol* 2001;165:2259-2261.
190. Soylet Y, Emir H, Ilce Z, Yesildag E, Buyukunal SN, Danismend N. Quo vadis? Ureteric reimplantation or ignoring reflux during augmentation cystoplasty. *BJU Int* 2004;94:379-380.
191. Nasrallah PF, Aliabadi HA. Bladder augmentation in patients with neurogenic bladder and vesicoureteral reflux. *J Urol* 1991;146:563-566.
192. Hayashi Y, Kato Y, Okazaki T, Lane GJ, Kobayashi H, Yamataka A. The effectiveness of ureteric reimplantation during bladder augmentation for high-grade vesicoureteric reflux in patients with neurogenic bladder: long-term outcome. *J Pediatr Surg* 2007;42:1998-2001.
193. Wang JB, Liu CS, Tsai SL, Wei CF, Chin TW. Augmentation cystoplasty and simultaneous ureteral reimplantation reduce high-grade vesicoureteral reflux in children with neurogenic bladder. *J Chin Med Assoc.* 2010 Jul; 74:294-7
194. Misseri R, Rosenbaum DH, Rink RC. Reflux in cystoplasties. *Arch Esp Urol.* 2008 Mar; 61:213-7
195. Gonzalez R, Buson H, Reid C, Reinberg Y. Seromuscular colcystoplasty lined with urothelium: experience with 16 patients. *Urology* 1995;45:124-129.
196. De Badiola F, Ruiz E, Puigdevall J, Lobos P, Moldes J, Lopez Raffo M, et al. Sigmoid cystoplasty with argon beam without mucosa. *J Urol* 2001;165:2253-2255.
197. Lima SV, Araujo LA, Vilar FO. Nonsecretory intestincystoplasty: a 10-year experience. *J Urol* 2004;171:2636-2639; discussion 2639-2640.

198. Shakeri S, Aminsharifi A, Jahanabadi Z. Application of appendicular-based cecal flap for less invasive augmentation cystoplasty: a novel technique. *Urol Int*. 2009; 83:271-6
199. Aminsharifi A, Shakeri S, Yousofzade J, Pakbaz S. In situ reversed ileocystoplasty for less invasive augmentation cystoplasty: an experimental study. *Urol Int*. 2011; 86:273-7
200. Shekarriz B, Upadhyay J, Demirbilek S, Barthold JS, Gonzalez R. Surgical complications of bladder augmentation: comparison between various enterocystoplasties in 133 patients. *Urology* 2000;55:123-128.
201. Chartier-Kastler EJ, Mongiat-Artus P, Bitker MO, Chancellor MB, Richard F, Denys P. Long-term results of augmentation cystoplasty in spinal cord injury patients. *Spinal Cord* 2000;38:490-494.
202. Hasan ST, Marshall C, Robson WA, Neal DE. Clinical outcome and quality of life following enterocystoplasty for idiopathic detrusor instability and neurogenic bladder dysfunction. *Br J Urol* 1995;76:551-557.
203. Gundeti MS, Acharya SS, Zagaja GP, Shalhav AL. Paediatric robotic-assisted laparoscopic augmentation ileocystoplasty and Mitrofanoff appendicovesicostomy (RALIMA): feasibility of and initial experience with the University of Chicago technique. *BJU Int*. 2011 Mar; 107:962-9
204. Erickson BA, Dorin RP, Clemens JQ. Is nasogastric tube drainage required after reconstructive surgery for neurogenic bladder dysfunction? *Urology* 2007;69:885-888.
205. Gurung PM, Attar KH, Abdul-Rahman A, Morris T, Hamid R, Shah PJ. Long-term outcomes of augmentation ileocystoplasty in patients with spinal cord injury: a minimum of 10 years of follow-up. *BJU Int*. 2012 Apr; 109:1236-42
206. Khoury AE, Salomon M, Doche R, Soboh F, Ackerley C, Jayanthi R, et al. Stone formation after augmentation cystoplasty: the role of intestinal mucus. *J Urol* 1997;158:1133-1137.
207. Mathoera RB, Kok DJ, Nijman RJ. Bladder calculi in augmentation cystoplasty in children. *Urology* 2000;56:482-487.
208. DeFoor W, Minevich E, Reddy P, Sekhon D, Polsky E, Wacksman J, et al. Bladder calculi after augmentation cystoplasty: risk factors and prevention strategies. *J Urol* 2004;172:1964-1966.
209. Zhang H, Yamataka A, Koga H, Kobayashi H, Lane GJ, Miyano T. Bladder stone formation after sigmoidocolocystoplasty: statistical analysis of risk factors. *J Pediatr Surg* 2005;40:407-411.
210. Terai A, Ueda T, Kakehi Y, Terachi T, Arai Y, Okada Y, et al. Urinary calculi as a late complication of the Indiana continent urinary diversion: comparison with the Kock pouch procedure. *J Urol* 1996;155:66-68.
211. Palmer LS, Franco I, Kogan SJ, Reda E, Gill B, Levitt SB. Urolithiasis in children following augmentation cystoplasty. *J Urol* 1993;150:726-729.
212. Ginsberg D, Huffman JL, Lieskovsky G, Boyd S, Skinner DG. Urinary tract stones: a complication of the Kock pouch continent urinary diversion. *J Urol* 1991;145:956-959.
213. Stein R, Lotz J, Fisch M, Beetz R, Prellwitz W, Hohenfellner R. Vitamin metabolism in patients with a Mainz pouch I: long-term followup. *J Urol* 1997;157:44-47.
214. Akerlund S, Delin K, Kock NG, Lycke G, Philipson BM, Volkmann R. Renal function and upper urinary tract configuration following urinary diversion to a continent ileal reservoir (Kock pouch): a prospective 5 to 11-year followup after reservoir construction. *J Urol* 1989;142:964-968.
215. Roth S, Semjonow A, Waldner M, Hertle L. Risk of bowel dysfunction with diarrhea after continent urinary diversion with ileal and ileocecal segments. *J Urol* 1995;154:1696-1699.
216. Somani BK, Kumar V, Wong S, Pickard R, Ramsay C, Nabi G, et al. Bowel dysfunction after transposition of intestinal segments into the urinary tract: 8-year prospective cohort study. *J Urol* 2007;177:1793-1798.
217. Feng AH, Kaar S, Elder JS. Influence of enterocystoplasty on linear growth in children with exstrophy. *J Urol* 2002;167:2552-2555; discussion 2555.
218. Gerharz EW, Preece M, Duffy PG, Ransley PG, Leaver R, Woodhouse CR. Enterocystoplasty in childhood: a second look at the effect on growth. *BJU Int* 2003;91:79-83.
219. Mingin GC, Nguyen HT, Mathias RS, Shepherd JA, Glidden D, Baskin LS. Growth and metabolic consequences of bladder augmentation in children with myelomeningocele and bladder exstrophy. *Pediatrics* 2002;110:1193-1198.
220. Vajda P, Pinter AB, Harangi F, Farkas A, Vastyan AM, Oberitter Z. Metabolic findings after colocystoplasty in children. *Urology* 2003;62:542-546; discussion 546.
221. Shaw J, Lewis MA. Bladder augmentation surgery--what about the malignant risk? *Eur J Pediatr Surg* 1999;9 Suppl 1:39-40.

222. Metcalfe PD, Cain MP, Kaefer M, Gilley DA, Meldrum KK, Misseri R, et al. What is the need for additional bladder surgery after bladder augmentation in childhood? *J Urol* 2006;176:1801-1805; discussion 1805.
223. Castellan M, Gosalbez R, Perez-Brayfield M, et al. Tumor in bladder reservoir after gastrocystoplasty. *J Urol*. 2007 Oct: 178:1771-4; discussion 4
224. Higuchi TT, Granberg CF, Fox JA, Husmann DA. Augmentation cystoplasty and risk of neoplasia: fact, fiction and controversy. *J Urol*. 2010 Dec: 184:2492-6
225. Kokorowski PJ, Routh JC, Borer JG, Estrada CR, Bauer SB, Nelson CP. Screening for malignancy after augmentation cystoplasty in children with spina bifida: a decision analysis. *J Urol*. 2011 Oct: 186:1437-43
226. DeFoor W, Tackett L, Minevich E, Wacksman J, Sheldon C. Risk factors for spontaneous bladder perforation after augmentation cystoplasty. *Urology* 2003;62:737-741.
227. Blok BF, Al Zahrani A, Capolicchio JP, Bilo-deau C, Corcos J. Post-augmentation bladder perforation during urodynamic investigation. *Neurourol Urodyn* 2007;26:540-542.
228. Flood HD, Malhotra SJ, O'Connell HE, Ritchey MJ, Bloom DA, McGuire EJ. Long-term results and complications using augmentation cystoplasty in reconstructive urology. *Neurourol Urodyn* 1995;14:297-309.
229. Singh G, Thomas DG. Enterocystoplasty in the neuropathic bladder. *Neurourol Urodyn* 1995;14:5-10
230. McInerney PD, DeSouza N, Thomas PJ, Mundy AR. The role of urodynamic studies in the evaluation of patients with augmentation cystoplasties. *Br J Urol* 1995;76:475-478.
231. Herschorn S, Hewitt RJ. Patient perspective of long-term outcome of augmentation cystoplasty for neurogenic bladder. *Urology* 1998;52:672-678.
232. Blaivas JG, Weiss JP, Desai P, Flisser AJ, Stember DS, Stahl PJ. Long-term followup of augmentation enterocystoplasty and continent diversion in patients with benign disease. *J Urol* 2005;173:1631-1634
233. Mor Y, Leibovitch I, Golomb J, Ben-Chaim J, Nadu A, Pinthus JH, et al. [Lower urinary tract reconstruction by augmentation cystoplasty and insertion of artificial urinary sphincter cuff only: long term follow-up]. *Prog Urol* 2004;14:310-314.
234. Close CE. Autoaugmentation gastrocystoplasty. *BJU Int* 2001;88:757-761.
235. Dewan PA, Anderson P. Ureterocystoplasty: the latest developments. *BJU Int* 2001;88:744-751.
236. Abdel-Azim MS, Abdel-Hakim AM. Gastrocystoplasty in patients with an areflexic low compliant bladder. *Eur Urol* 2003;44:260-265.
237. DeFoor W, Minevich E, Reeves D, Tackett L, Wacksman J, Sheldon C. Gastrocystoplasty: long-term followup. *J Urol* 2003;170:1647-1649; discussion 1649-1650.
238. Husmann DA, Snodgrass WT, Koyle MA, Furness PD, 3rd, Kropp BP, Cheng EY, et al. Ureterocystoplasty: indications for a successful augmentation. *J Urol* 2004;171:376-380.
239. Mahony DT, Laferte RO. Studis of enuresis. IV. Multiple detrusor myotomy: a new operation for the rehabilitation of severe detrusor hypertrophy and hypercontractility. *J Urol* 1972;107:1064-1067.
240. Basiri A, Otoukesh H, Simforoosh N, Hosseini R, Farrokhi F. Kidney transplantation in children with augmentation cystoplasty. *J Urol*. 2007 Jul: 178:274-7
241. Basiri A, Otoukesh H, Hosseini R, Simforoosh N, Moghaddam SM. Kidney transplantation before or after augmentation cystoplasty in children with high-pressure neurogenic bladder. *BJU Int*. 2009 Jan: 103:86-8
242. Mahony DT, Laferte RO. Studis of enuresis. IV. Multiple detrusor myotomy: a new operation for the rehabilitation of severe detrusor hypertrophy and hypercontractility. *J Urol*. 1972 Jun: 107:1064-7
243. Cartwright PC, Snow BW. Bladder autoaugmentation: partial detrusor excision to augment the bladder without use of bowel. *J Urol* 1989;142:1050-1053.
244. Ehrlich RM, Gershman A. Laparoscopic seromyotomy (auto-augmentation) for non-neurogenic neurogenic bladder in a child: initial case report. *Urology* 1993;42:175-178.
245. McDougall EM, Clayman RV, Figenshau RS, Pearle MS. Laparoscopic retropubic auto-augmentation of the bladder. *J Urol* 1995;153:123-126.
246. Mammen T, Balaji KC. Robotic transperitoneal detrusor myotomy: description of a novel technique. *J Endourol* 2005;19:476-479.
247. Poppas DP, Uzzo RG, Britanisky RG, Mininberg DT. Laparoscopic laser assisted auto-augmentation of the pediatric neurogenic bladder: early experience with urodynamic followup. *J Urol* 1996;155:1057-1060.

248. Oge O, Tekgul S, Ergen A, Kendi S. Urothelium-preserving augmentation cystoplasty covered with a peritoneal flap. *BJU Int* 2000;85:802-805.
249. Perovic SV, Djordjevic ML, Kekic ZK, Vukadinovic VM. Detrusorectomy with rectus muscle hitch and backing. *J Pediatr Surg* 2003;38:1637-1641.
250. Frey P, Lutz N, Leuba AL. Augmentation cystoplasty using pedicled and de-epithelialized gastric patches in the mini-pig model. *J Urol* 1996;156:608-613.
251. Nguyen DH, Mitchell ME, Horowitz M, Bagli DJ, Carr MC. Demucosalized augmentation gastrocystoplasty with bladder autoaugmentation in pediatric patients. *J Urol* 1996;156:206-209.
252. Kumar SP, Abrams PH. Detrusor myectomy: long-term results with a minimum follow-up of 2 years. *BJU Int* 2005;96:341-344.
253. Leng WW, Blalock HJ, Fredriksson WH, English SF, McGuire EJ. Enterocystoplasty or detrusor myectomy? Comparison of indications and outcomes for bladder augmentation. *J Urol* 1999;161:758-763.
254. MacNeily AE, Afshar K, Coleman GU, Johnson HW. Autoaugmentation by detrusor myotomy: its lack of effectiveness in the management of congenital neuropathic bladder. *J Urol* 2003;170:1643-1646; discussion 1646.
255. Marte A, Di Meglio D, Cotrufo AM, Di Iorio G, De Pasquale M, Vessella A. A long-term follow-up of autoaugmentation in myelodysplastic children. *BJU Int* 2002;89:928-931.
256. Potter JM, Duffy PG, Gordon EM, Malone PR. Detrusor myotomy: a 5-year review in unstable and non-compliant bladders. *BJU Int* 2002;89:932-935.
257. Rawashdeh YF, Jorgensen TM, Olsen LH, Djurhuus JC. The outcome of detrusor myotomy in children with neurogenic bladder dysfunction. *J Urol* 2004;171:2654-2656.
258. Stohrer M, Kramer G, Goepel M, Lochner-Ernst D, Kruse D, Rubben H. Bladder autoaugmentation in adult patients with neurogenic voiding dysfunction. *Spinal Cord* 1997;35:456-462.
259. Rivas DA, Chancellor MB, Huang B, Epple A, Figueroa TE. Comparison of bladder rupture pressure after intestinal bladder augmentation (ileocystoplasty) and myomyotomy (autoaugmentation). *Urology* 1996;48:40-46.
260. Aboushwareb T, McKenzie P, Wezel F, Southgate J, Badlani G. Is tissue engineering and biomaterials the future for lower urinary tract dysfunction (LUTD)/pelvic organ prolapse (POP)? *Neurourol Urodyn*. 2011 Jun; 30:775-82
261. Fraser M, Thomas DF, Pitt E, Harnden P, Trejdosiowicz LK, Southgate J. A surgical model of composite cystoplasty with cultured urothelial cells: a controlled study of gross outcome and urothelial phenotype. *BJU Int*. 2004 Mar; 93:609-16
262. Caione P, Capozza N, Zavaglia D, Palombaro G, Boldrini R. In vivo bladder regeneration using small intestinal submucosa: experimental study. *Pediatr Surg Int*. 2006 Jul; 22:593-9
263. Ayyildiz A, Akgul KT, Huri E, et al. Use of porcine small intestinal submucosa in bladder augmentation in rabbit: long-term histological outcome. *ANZ J Surg*. 2008 Jan-Feb; 78:82-6
264. Ayyildiz A, Nuhoglu B, Huri E, Ozer E, Gurdal M, Germiyanoglu C. Using porcine acellular collagen matrix (Pelvicol) in bladder augmentation: experimental study. *Int Braz J Urol*. 2006 Jan-Feb; 32:88-92; discussion -3
265. Pattison M, Webster TJ, Leslie J, Kaefer M, Haberstroh KM. Evaluating the in vitro and in vivo efficacy of nano-structured polymers for bladder tissue replacement applications. *Macromol Biosci*. 2007 May 10; 7:690-700
266. Jayo MJ, Jain D, Ludlow JW, et al. Long-term durability, tissue regeneration and neo-organ growth during skeletal maturation with a neo-bladder augmentation construct. *Regen Med*. 2008 Sep; 3:671-82
267. Jayo MJ, Jain D, Wagner BJ, Bertram TA. Early cellular and stromal responses in regeneration versus repair of a mammalian bladder using autologous cell and biodegradable scaffold technologies. *J Urol*. 2008 Jul; 180:392-7
268. Korossis S, Bolland F, Southgate J, Ingham E, Fisher J. Regional biomechanical and histological characterisation of the passive porcine urinary bladder: Implications for augmentation and tissue engineering strategies. *Biomaterials*. 2009 Jan; 30:266-75
269. Jack GS, Zhang R, Lee M, Xu Y, Wu BM, Rodriguez LV. Urinary bladder smooth muscle engineered from adipose stem cells and a three dimensional synthetic composite. *Biomaterials*. 2009 Jul; 30:3259-70
270. Domingos AL, Tucci S, Jr., Garcia SB, de Bessa J, Jr., Cologna AJ, Martins AC. Use of a latex biomembrane for bladder augmentation in a rabbit model: biocompatibility, clinical and histological outcomes. *Int Braz J Urol*. 2009 Mar-Apr; 35:217-24; author reply 25
271. Mondalek FG, Ashley RA, Roth CC, et al. Enhanced angiogenesis of modified porcine small intestinal submucosa with hyaluronic acid-poly(lactide-co-glycolide) nanoparticles: from fabrication to preclinical validation. *J Biomed Mater Res A*. 2010 Sep 1; 94:712-9

272. Roth CC, Mondalek FG, Kibar Y, et al. Bladder regeneration in a canine model using hyaluronic acid-poly(lactic-co-glycolic-acid) nanoparticle modified porcine small intestinal submucosa. *BJU Int.* 2011 Jul; 108:148-55
273. Mauney JR, Cannon GM, Lovett ML, et al. Evaluation of gel spun silk-based biomaterials in a murine model of bladder augmentation. *Biomaterials.* 2011 Jan; 32:808-18
274. Gomez P, 3rd, Gil ES, Lovett ML, et al. The effect of manipulation of silk scaffold fabrication parameters on matrix performance in a murine model of bladder augmentation. *Biomaterials.* 2011 Oct; 32:7562-70
275. Turner A, Subramanian R, Thomas DF, et al. Transplantation of autologous differentiated urothelium in an experimental model of composite cystoplasty. *Eur Urol.* 2011 Mar; 59:447-54
276. Yoo JJ, Olson J, Atala A, Kim B. Regenerative medicine strategies for treating neurogenic bladder. *Int Neurourol J.* 2011 Sep; 15:109-19
277. Zhang Y, Kropp BP, Moore P, et al. Coculture of bladder urothelial and smooth muscle cells on small intestinal submucosa: potential applications for tissue engineering technology. *J Urol.* 2000 Sep; 164:928-34; discussion 34-5
278. Dahms SE, Piechota HJ, Dahiya R, Lue TF, Tanagho EA. Composition and biomechanical properties of the bladder acellular matrix graft: comparative analysis in rat, pig and human. *Br J Urol.* 1998 Sep; 82:411-9
279. Bolland F, Korossis S, Wilshaw SP, et al. Development and characterisation of a full-thickness acellular porcine bladder matrix for tissue engineering. *Biomaterials.* 2007 Feb; 28:1061-70
280. Barrington JW, Dyer R, Bano F. Bladder augmentation using Pelvicol implant for intractable overactive bladder syndrome. *Int Urogynecol J Pelvic Floor Dysfunct* 2006;17:50-53.
281. Atala A, Bauer SB, Soker S, Yoo JJ, Retik AB. Tissue-engineered autologous bladders for patients needing cystoplasty. *Lancet* 2006;367:1241-1246.
282. Chen JL, Kuo HC. Long-term outcomes of augmentation enterocystoplasty with an ileal segment in patients with spinal cord injury. *J Formos Med Assoc.* 2009 Jun; 108:475-80
283. Quek ML, Ginsberg DA. Long-term urodynamics followup of bladder augmentation for neurogenic bladder. *J Urol* 2003;169:195-198.
284. Medel R, Ruarte AC, Herrera M, Castera R, Podesta ML. Urinary continence outcome after augmentation ileocystoplasty as a single surgical procedure in patients with myelodysplasia. *J Urol* 2002;168:1849-1852.
285. Nomura S, Ishido T, Tanaka K, Komiya A. Augmentation ileocystoplasty in patients with neurogenic bladder due to spinal cord injury or spina bifida. *Spinal Cord* 2002;40:30-33.
286. Arikan N, Turkolmez K, Budak M, Gogus O. Outcome of augmentation sigmoidocystoplasty in children with neurogenic bladder. *Urol Int* 2000;64:82-85.
287. Venn SN, Mundy AR. Long-term results of augmentation cystoplasty. *Eur Urol* 1998;34 Suppl 1:40-42.
288. Mast P, Hoebeke P, Wyndaele JJ, Oosterlinck W, Everaert K. Experience with augmentation cystoplasty. A review. *Paraplegia* 1995;33:560-564.
289. Khoury JM, Timmons SL, Corbel L, Webster GD. Complications of enterocystoplasty. *Urology* 1992;40:9-14.
290. Luangkhot R, Peng BC, Blaivas JG. Ileocecostoplasty for the management of refractory neurogenic bladder: surgical technique and urodynamic findings. *J Urol* 1991;146:1340-1344.
291. Robertson AS, Davies JB, Webb RJ, Neal DE. Bladder augmentation and replacement. Urodynamic and clinical review of 25 patients. *Br J Urol* 1991;68:590-597.
292. Hendren WH, Hendren RB. Bladder augmentation: experience with 129 children and young adults. *J Urol* 1990;144:445-453; discussion 460.
293. Sidi AA, Becher EF, Reddy PK, Dykstra DD. Augmentation enterocystoplasty for the management of voiding dysfunction in spinal cord injury patients. *J Urol* 1990;143:83-85.
294. Lockhart JL, Bejany D, Politano VA. Augmentation cystoplasty in the management of neurogenic bladder disease and urinary incontinence. *J Urol* 1986;135:969-971.
295. Asayama K, Kihara K, Shidoh T, Shigaki M, Ikeda T. The functional limitations of tetraplegic hands for intermittent clean self-catheterisation. *Paraplegia* 1995;33:30-33.
296. Mollard P, Gauriau L, Bonnet JP, Mure PY. Continent cystostomy (Mitrofanoff's procedure) for neurogenic bladder in children and adolescent (56 cases: long-term results). *Eur J Pediatr Surg* 1997;7:34-37.
297. Zommick JN, Simoneau AR, Skinner DG, Ginsberg DA. Continent lower urinary tract reconstruction in the cervical spinal cord injured population. *J Urol* 2003;169:2184-2187.

298. Koyle MA, Mingin GC, Furness PD, 3rd, Malone PSJ. The Mitrofanoff (flap valve) principle: application in contemporary continent urinary and gastrointestinal reconstruction. *AUA update series* 2004;23:273-279.
299. Mills RD, Studer UE. Metabolic consequences of continent urinary diversion. *J Urol* 1999;161:1057-1066.
300. Mitrofanoff P. [Trans-appendicular continent cystostomy in the management of the neurogenic bladder]. *Chir Pediatr* 1980;21:297-305.
301. Monti PR, Lara RC, Dutra MA, de Carvalho JR. New techniques for construction of efferent conduits based on the Mitrofanoff principle. *Urology* 1997;49:112-115.
302. Casale AJ. A long continent ileovesicostomy using a single piece of bowel. *J Urol* 1999;162:1743-1745.
303. Dodat H, Denis E, Pelizzo G, Dubois R, Carlizo P, Chavrier Y. [Continent urinary diversion using a tubulized sigmoid segment. An alternative to trans-appendicular diversion]. *Prog Urol* 1998;8:58-61.
304. Cain MP, Rink RC, Yerkes EB, Kaefer M, Casale AJ. Long-term followup and outcome of continent catheterizable vesicostomy using the Rink modification. *J Urol* 2002;168:2583-2585.
305. Close CE, Mitchell ME. Continent gastric tube: new techniques and long-term followup. *J Urol* 1997;157:51-55.
306. Mor Y, Kajbafzadeh AM, German K, Mouriquand PD, Duffy PG, Ransley PG. The role of ureter in the creation of Mitrofanoff channels in children. *J Urol* 1997;157:635-637.
307. Castellan MA, Gosalbez R, Labbie A, Ibrahim E, Disandro M. Outcomes of continent catheterizable stomas for urinary and fecal incontinence: comparison among different tissue options. *BJU Int* 2005;95:1053-1057.
308. Perovic S. Continent urinary diversion using preputial penile or clitoral skin flap. *J Urol* 1996;155:1402-1406.
309. Karsenty G, Chartier-Kastler E, Mozer P, Even-Schneider A, Denys P, Richard F. A novel technique to achieve cutaneous continent urinary diversion in spinal cord-injured patients unable to catheterize through native urethra. *Spinal Cord* 2007.
310. Sylora JA, Gonzalez R, Vaughn M, Reinberg Y. Intermittent self-catheterization by quadriplegic patients via a catheterizable Mitrofanoff channel. *J Urol* 1997;157:48-50.
311. Walsh K, Troxel SA, Stone AR. An assessment of the use of a continent catheterizable stoma in female tetraplegics. *BJU Int* 2004;94:595-597.
312. Moreno JG, Chancellor MB, Karasick S, King S, Abdill CK, Rivas DA. Improved quality of life and sexuality with continent urinary diversion in quadriplegic women with umbilical stoma. *Arch Phys Med Rehabil* 1995;76:758-762.
313. Mor Y, Quinn FM, Carr B, Mouriquand PD, Duffy PG, Ransley PG. Combined Mitrofanoff and antegrade continence enema procedures for urinary and fecal incontinence. *J Urol* 1997;158:192-195.
314. Franc-Guimond J, Gonzalez R. Simplified technique to create a concealed catheterizable stoma: the VR flap. *J Urol* 2006;175:1088-1091.
315. Tekant G, Emir H, Eroglu E, Esenturk N, Buyukunal C, Danismend N, et al. Catheterizable continent urinary diversion (Mitrofanoff principle)--clinical experience and psychological aspects. *Eur J Pediatr Surg* 2001;11:263-267.
316. Watanabe T, Rivas DA, Smith R, Staas WE, Jr., Chancellor MB. The effect of urinary tract reconstruction on neurologically impaired women previously treated with an indwelling urethral catheter. *J Urol* 1996;156:1926-1928.
317. Touma NJ, Horovitz D, Shetty A, Caumartin Y, De Maria J, Luke PP. Outcomes and quality of life of adults undergoing continent catheterizable vesicostomy for neurogenic bladder. *Urology* 2007;70:454-458.
318. Thomas JC, Dietrich MS, Trusler L, DeMarco RT, Pope JCt, Brock JW, 3rd, et al. Continent catheterizable channels and the timing of their complications. *J Urol* 2006;176:1816-1820; discussion 1820.
319. Liard A, Segulier-Lipszyc E, Mathiot A, Mitrofanoff P. The Mitrofanoff procedure: 20 years later. *J Urol* 2001;165:2394-2398.
320. Narayanaswamy B, Wilcox DT, Cuckow PM, Duffy PG, Ransley PG. The Yang-Monti ileovesicostomy: a problematic channel? *BJU Int* 2001;87:861-865.
321. De Ganck J, Everaert K, Van Laecke E, Oosterlinck W, Hoebeke P. A high easy-to-treat complication rate is the price for a continent stoma. *BJU Int* 2002;90:240-243.
322. Pons M, Messaoudi R, Fiquet C, et al. Use of cutaneous flap for continent cystostomy (daoud technique). *J Urol*. 2010 Sep; 184:1116-121

323. Wiesner C, Bonfig R, Stein R, Gerharz EW, Pahernik S, Riedmiller H, et al. Continent cutaneous urinary diversion: long-term follow-up of more than 800 patients with ileocecal reservoirs. *World J Urol* 2006;24:315-318.
324. Carr LK, Webster GD. Kock versus right colon continent urinary diversion: comparison of outcome and reoperation rate. *Urology* 1996;48:711-714.
325. Pazooki D, Edlund C, Karlsson AK, Dahlstrand C, Lindholm E, Tornqvist H, et al. Continent cutaneous urinary diversion in patients with spinal cord injury. *Spinal Cord* 2006;44:19-23.
326. Blaivas JG, Weiss JP, Desai P, Flisser AJ, Stember DS, Stahl PJ. Long-term followup of augmentation enterocystoplasty and continent diversion in patients with benign disease. *J Urol* 2005;173:1631-1634.
327. Stein R, Wiesner C, Beetz R, Pfitzenmeier J, Schwarz M, Thuroff JW. Urinary diversion in children and adolescents with neurogenic bladder: the Mainz experience. Part II: Continent cutaneous diversion using the Mainz pouch I. *Pediatr Nephrol* 2005;20:926-931.
328. Plancke HR, Delaere KP, Pons C. Indiana pouch in female patients with spinal cord injury. *Spinal Cord* 1999;37:208-210.
329. Abdallah MM, Bissada NK, Hamouda HM, Bissada AN. Long-term multi-institutional evaluation of Charleston pouch I continent cutaneous urinary diversion. *J Urol* 2007;177:2217-2220.
330. De Troyer B, Van Laecke E, Groen LA, Everaert K, Hoebeke P. A comparative study between continent diversion and bladder neck closure versus continent diversion and bladder neck reconstruction in children. *J Pediatr Urol*. 2010 Apr; 7:209-12
331. Spahn M, Kocot A, Loeser A, Kneitz B, Riedmiller H. Last resort in devastated bladder outlet: bladder neck closure and continent vesicostomy--long-term results and comparison of different techniques. *Urology*. 2010 May; 75:1185-92
332. Wille MA, Zagaja GP, Shalhav AL, Gundeti MS. Continence outcomes in patients undergoing robotic assisted laparoscopic mitrofanoff appendicovesicostomy. *J Urol*. 2011 Apr; 185:1438-43
333. Vian E, Soustelle L, Viale S, Costa P. [A technique of continent vesicostomy with ileocystoplasty: study of 32 patients]. *Prog Urol*. 2009 Feb; 19:116-21
334. Welk BK, Afshar K, Rapoport D, MacNeily AE. Complications of the catheterizable channel following continent urinary diversion: their nature and timing. *J Urol*. 2008 Oct; 180:1856-60
335. Mhiri MN, Bahloul A, Chabchoub K. [Mitrofanoff appendicovesicostomy in children: indication and results]. *Prog Urol* 2007;17:245-249.
336. Chulamorkodt NN, Estrada CR, Chaviano AH. Continent urinary diversion: 10-year experience of Shriners Hospitals for Children in Chicago. *J Spinal Cord Med* 2004;27 Suppl 1:S84-87.
337. Barqawi A, de Valdenebro M, Furness PD, 3rd, Koyle MA. Lessons learned from stomal complications in children with cutaneous catheterizable continent stomas. *BJU Int* 2004;94:1344-1347.
338. Lemelle JL, Simo AK, Schmitt M. Comparative study of the Yang-Monti channel and appendix for continent diversion in the Mitrofanoff and Malone principles. *J Urol* 2004;172:1907-1910.
339. Kochakarn W, Muangman V. Mitrofanoff procedure in combination with enterocystoplasty for detrusor hyperreflexia with external sphincter dyssynergia: one-year experience of 12 cases. *J Med Assoc Thai* 2001;84:1046-1050.
340. Harris CF, Cooper CS, Hutcheson JC, Snyder HM, 3rd. Appendicovesicostomy: the mitrofanoff procedure-a 15-year perspective. *J Urol* 2000;163:1922-1926.
341. Cain MP, Casale AJ, King SJ, Rink RC. Appendicovesicostomy and newer alternatives for the Mitrofanoff procedure: results in the last 100 patients at Riley Children's Hospital. *J Urol* 1999;162:1749-1752
342. Wiener JS, Antonelli J, Shea AM, et al. Bladder augmentation versus urinary diversion in patients with spina bifida in the United States. *J Urol*. 2011 Jul; 186:161-5
343. Pfister C, Prapotnich D, Mombet A, Veillon B, Brisset JM, Vallancien G. [Technique and results of the "Mini-Bricker" urinary tract diversion after total cystectomy for bladder tumors]. *Prog Urol* 1994;4:953-958.
344. Beurton D, Fontaine E, Grall J, Houlgatte A, Cukier J. [Cutaneous trans-jejunal ureterosomy: an original technique used in 29 patients]. *Prog Urol* 1992;2:381-390.
345. Hubert J, Chammas M, Larre S, Feuillu B, Cheng F, Beis JM, et al. Initial experience with successful totally robotic laparoscopic cystoprostatectomy and ileal conduit construction in tetraplegic patients: report of two cases. *J Endourol* 2006;20:139-143.
346. Hubert J, Feuillu B, Beis JM, Coissard A, Mangin P, Andre JM. Laparoscopic robotic-assisted ileal conduit urinary diversion in a quadriplegic woman. *Urology* 2003;62:1121.

347. Potter SR, Charambura TC, Adams JB, 2nd, Kavoussi LR. Laparoscopic ileal conduit: five-year follow-up. *Urology* 2000;56:22-25.
348. Yohannes P, Khan A, Francis K, Sudan R. Robot-assisted Bricker ileoureteral anastomosis during intracorporeal laparoscopic ileal conduit urinary diversion for prostatocutaneous fistula: case report. *J Endourol* 2004;18:269-272.
349. Ramalingam M, Senthil K, Ganapathy Pai M. Laparoscopy-assisted ileal conduit in sacral agenesis. *J Laparoendosc Adv Surg Tech A*. 2008 Apr; 18:335-9
350. Guillotreau J, Game X, Castel-Lacanal E, Mallet R, De Boissezon X, Malavaud B, et al. [Laparoscopic cystectomy and transileal ureterostomy for neurogenic vesicosphincteric disorders. Evaluation of morbidity]. *Prog Urol* 2007;17:208-212.
351. Chaykovska L, Deger S, Wille A, et al. Kidney transplantation into urinary conduits with ureteroureterostomy between transplant and native ureter: single-center experience. *Urology*. 2009 Feb; 73:380-5
352. Kato H, Hosaka K, Kobayashi S, Igawa Y, Nishizawa O. Fate of tetraplegic patients managed by ileal conduit for urinary control: long-term follow-up. *Int J Urol* 2002;9:253-256
353. Chartier-Kastler EJ, Mozer P, Denys P, Bitker MO, Haertig A, Richard F. Neurogenic bladder management and cutaneous non-continent ileal conduit. *Spinal Cord* 2002;40:443-448.
354. Malone PR, Stanton SL, Riddle PR. Urinary diversion for incontinence--a beneficial procedure? *Ann R Coll Surg Engl* 1985;67:349-352.
355. Samellas W, Rubin B. Management of Upper Urinary Tract Complications in Multiple Sclerosis by Means of Urinary Diversion to an Ileal Conduit. *J Urol* 1965;93:548-552.
356. Hetet JF, Rigaud J, Karam G, Glemain P, Le Normand L, Bouchot O, et al. [Complications of Bricker ileal conduit urinary diversion: analysis of a series of 246 patients]. *Prog Urol* 2005;15:23-29; discussion 29.
357. Singh G, Wilkinson JM, Thomas DG. Supravescical diversion for incontinence: a long-term follow-up. *Br J Urol* 1997;79:348-353.
358. Legrand G, Roupret M, Comperat E, Even-Schneider A, Denys P, Chartier-Kastler E. Functional outcomes after management of end-stage neurological bladder dysfunction with ileal conduit in a multiple sclerosis population: a monocentric experience. *Urology*. 2011 Oct; 78:937-41
359. Malek RS, Burke EC, Deweerd JH. Ileal conduit urinary diversion in children. *J Urol* 1971;105:892-900.
360. Schwarz GR, Jeffs RD. Ileal conduit urinary diversion in children: computer analysis of followup from 2 to 16 years. *J Urol* 1975;114:285-288.
361. Heath AL, Eckstein HB. Ileal conduit urinary diversion in children. A long term follow-up. *J Urol (Paris)* 1984;90:91-96.
362. Pitts WR, Jr., Muecke EC. A 20-year experience with ileal conduits: the fate of the kidneys. *J Urol* 1979;122:154-157.
363. Shapiro SR, Lebowitz R, Colodny AH. Fate of 90 children with ileal conduit urinary diversion a decade later: analysis of complications, pyelography, renal function and bacteriology. *J Urol* 1975;114:289-295.
364. Arnarson O, Straffon RA. Clinical experience with the ileal conduit in children. *J Urol* 1969;102:768-771.
365. Erickson BA, Dorin RP, Clemens JQ. Is nasogastric tube drainage required after reconstructive surgery for neurogenic bladder dysfunction? *Urology* 2007;69:885-888.
366. Somani BK, Kumar V, Wong S, Pickard R, Ramsay C, Nabi G, et al. Bowel dysfunction after transposition of intestinal segments into the urinary tract: 8-year prospective cohort study. *J Urol* 2007;177:1793-1798.
367. Fazili T, Bhat TR, Masood S, Palmer JH, Mufti GR. Fate of the leftover bladder after supravescical urinary diversion for benign disease. *J Urol* 2006;176:620-621.
368. Bennett CJ, Young MN, Adkins RH, Diaz F. Comparison of bladder management complication outcomes in female spinal cord injury patients. *J Urol* 1995;153:1458-1460.
369. Cass AS, Luxenberg M, Gleich P, Johnson CF. A 22-year followup of ileal conduits in children with a neurogenic bladder. *J Urol* 1984;132:529-531.
370. Stonehill WH, Dmochowski RR, Patterson AL, Cox CE. Risk factors for bladder tumors in spinal cord injury patients. *J Urol* 1996;155:1248-1250.
371. Djavan B, Litwiller SE, Milchgrub S, Roehrborn CG. Mucinous adenocarcinoma in defunctionalized bladders. *Urology* 1995;46:107-110.
372. Yap RL, Weiser A, Ozer O, Pazona J, Schaeffer A. Adenocarcinoma arising from a defunctionalized bladder. *J Urol* 2002;167:1782-1783.
373. Yang CC, Clowers DE. Screening cystoscopy in chronically catheterized spinal cord injury patients. *Spinal Cord* 1999;37:204-207.

374. Hamid R, Bycroft J, Arya M, Shah PJ. Screening cystoscopy and biopsy in patients with neuropathic bladder and chronic suprapubic indwelling catheters: is it valid? *J Urol* 2003;170:425-427.
375. Neulander EZ, Rivera I, Eisenbrown N, Wajsman Z. Simple cystectomy in patients requiring urinary diversion. *J Urol* 2000;164:1169-1172.
376. Laven BA, O'Connor RC, Gerber GS, Steinberg GD. Long-term results of endoureterotomy and open surgical revision for the management of ureterointestinal strictures after urinary diversion. *J Urol* 2003;170:1226-1230.
377. Poulakis V, Witzsch U, De Vries R, Becht E. Cold-knife endoureterotomy for nonmalignant ureterointestinal anastomotic strictures. *Urology* 2003;61:512-517; discussion 517.
378. Watterson JD, Sofer M, Wollin TA, Nott L, Dendstedt JD. Holmium: YAG laser endoureterotomy for ureterointestinal strictures. *J Urol* 2002;167:1692-1695.
379. Kouba E, Sands M, Lentz A, Wallen E, Pruthi RS. Incidence and risk factors of stomal complications in patients undergoing cystectomy with ileal conduit urinary diversion for bladder cancer. *J Urol* 2007;178:950-954.
380. Ahmed S, Boucaut HA. Urinary undiversion in 35 patients with neurogenic bladder and an ileal conduit. *Aust N Z J Surg* 1987;57:753-761.
381. Ahmed S, Carney A. Urinary undiversion in myelomeningocele patients with an ileal conduit diversion. *J Urol* 1981;125:847-852.
382. Borden TA, Woodside JR. Urinary tract undiversion in a patient with an areflexic neurogenic bladder: management with intermittent catheterization. *J Urol* 1980;123:956-958.
383. Menon M, Elder JS, Manley CB, Jeffs RD. Undiverting the ileal conduit. *J Urol* 1982;128:998-1000.
384. Breza J, Hornak M, Bardos A, Zvara P. Transformation of the Bricker to a continent urinary reservoir to eliminate severe complications of uretero-ileostomy performed in eight patients among 200 Bricker. *Ann Urol (Paris)* 1995;29:227-231.
385. Cordonnier JJ. Ileocystostomy: followup evaluation of 14 cases. *J Urol* 1962;87:60-62.
386. Cordonnier JJ. Ileocystostomy for neurogenic bladder. *J Urol* 1957;78:605-610.
387. Schwartz SL, Kennelly MJ, McGuire EJ, Faerber GJ. Incontinent ileo-vesicostomy urinary diversion in the treatment of lower urinary tract dysfunction. *J Urol* 1994;152:99-102.
388. Mutchnik SE, Hinson JL, Nickell KG, Boone TB. Ileovesicostomy as an alternative form of bladder management in tetraplegic patients. *Urology* 1997;49:353-357.
389. Abrahams HM, Rahman NU, Meng MV, Stoller ML. Pure laparoscopic ileovesicostomy. *J Urol* 2003;170:517-518.
390. Atan A, Konety BR, Nangia A, Chancellor MB. Advantages and risks of ileovesicostomy for the management of neuropathic bladder. *Urology* 1999;54:636-640.
391. Rivas DA, Karasick S, Chancellor MB. Cutaneous ileocystostomy (a bladder chimney) for the treatment of severe neurogenic vesical dysfunction. *Paraplegia* 1995;33:530-535.
392. Gudziak MR, Tiguert R, Puri K, Gheiler EL, Triest JA. Management of neurogenic bladder dysfunction with incontinent ileovesicostomy. *Urology* 1999;54:1008-1011.
393. Leng WW, Faerber G, Del Terzo M, McGuire EJ. Long-term outcome of incontinent ileovesicostomy management of severe lower urinary tract dysfunction. *J Urol* 1999;161:1803-1806.
394. Hsu TH, Rackley RR, Abdelmalak JB, Tchetgen MB, Madjar S, Vasavada SP. Laparoscopic ileovesicostomy. *J Urol* 2002;168:180-181.
395. Vanni AJ, Cohen MS, Stoffel JT. Robotic-assisted ileovesicostomy: initial results. *Urology* 2009 Oct; 74:814-8
396. Vanni AJ, Stoffel JT. Ileovesicostomy for the neurogenic bladder patient: outcome and cost comparison of open and robotic assisted techniques. *Urology*. 2011 Jun; 77:1375-80
397. Tan HJ, Stoffel J, Daignault S, McGuire EJ, Latini JM. Ileovesicostomy for adults with neurogenic bladders: Complications and potential risk factors for adverse outcomes. *Neurourol Urodyn* 2007.
398. Gauthier AR, Jr., Winters JC. Incontinent ileovesicostomy in the management of neurogenic bladder dysfunction. *Neurourol Urodyn* 2003;22:142-146.
399. Hellenthal NJ, Short SS, O'Connor RC, Eandi JA, Yap SA, Stone AR. Incontinent ileovesicostomy: Long-term outcomes and complications. *Neurourol Urodyn*. 2009; 28:483-6
400. Zimmerman WB, Santucci RA. Ileovesicostomy: update. *Arch Esp Urol*. 2011 Apr; 64:207-18
401. Petrou SP. Incontinent ileovesicostomy in the management of neurogenic bladder dysfunction. *Int Braz J Urol* 2003;29:185-186.

402. Blocksom BH, Jr. Bladder pouch for prolonged tubeless cystostomy. *J Urol* 1957;78:398-401.
403. Lapidus J, Ajemian EP, Lichtwardt JR. Cutaneous vesicostomy. 1960. *J Urol* 2002;167:1147-1151; discussion 1152.
404. Lapidus J, Koyanagi T, Diokno A. Cutaneous vesicostomy: 10-year survey. *J Urol* 1971;105:76-80.
405. Allen TD. Vesicostomy for the temporary diversion of the urine in small children. *J Urol* 1980;123:929-931.
406. Cohen JS, Harbach LB, Kaplan GW. Cutaneous vesicostomy for temporary urinary diversion in infants with neurogenic bladder dysfunction. *J Urol* 1978;119:120-121
407. Lee MW, Greenfield SP. Intractable high-pressure bladder in female infants with spina bifida: clinical characteristics and use of vesicostomy. *Urology* 2005;65:568-571.
408. Mandell J, Bauer SB, Colodny AH, Retik AB. Cutaneous vesicostomy in infancy. *J Urol* 1981;126:92-93.
409. Morrisroe SN, O'Connor RC, Nanigian DK, Kurzrock EA, Stone AR. Vesicostomy revisited: the best treatment for the hostile bladder in myelodysplastic children? *BJU Int* 2005;96:397-400.
410. Snyder HM, 3rd, Kalichman MA, Charney E, Duckett JW. Vesicostomy for neurogenic bladder with spina bifida: followup. *J Urol* 1983;130:724-726.
411. Jayanthi VR, McLorie GA, Khoury AE, Churchill BM. The effect of temporary cutaneous diversion on ultimate bladder function. *J Urol* 1995;154:889-892.
412. Sonda LP, Solomon MH. Twenty-year outcome of cutaneous vesicostomy. *J Urol* 1980;124:326-328.
413. Pannek J. Vesicostomy in adult meningomyelocele patients. Reappraisal of an old technique. *Int Urol Nephrol* 1999;31:643-645.
414. Lacreuse I, Becmeur F, Dheu C, Moog R, Terzic J, Fischbach M. Endoscopic Mic-Key button placement for continent vesicostomy. *J Laparoendosc Adv Surg Tech A* 2010; 20: 297-9
415. Johnston JH. Temporary cutaneous ureterostomy in the management of advanced congenital urinary obstruction. *Arch Dis Child* 1963;38:161-166.
416. Lister J, Cook RC, Zachary RB. Operative management of neurogenic bladder dysfunction in children: ureterostomy. *Arch Dis Child* 1968;43:672-678.
417. Kogan BA, Gohary MA. Cutaneous ureterostomy as a permanent external urinary diversion in children. *J Urol* 1984;132:729-731.
418. MacGregor PS, Kay R, Straffon RA. Cutaneous ureterostomy in children--long-term followup. *J Urol* 1985;134:518-520.
419. Sarduy GS, Crooks KK, Smith JP, Wise HA, 2nd. Results in children managed by cutaneous ureterostomy. *Urology* 1982;19:486-488.
420. Chitale SV, Chitale VR. Bilateral ureterocutaneousostomy with modified stoma: long-term follow-up. *World J Urol* 2006;24:220-223.
421. Lindstedt E, Mansson W. Transuretero-ureterostomy with cutaneous ureterostomy for permanent urinary diversion. *Scand J Urol Nephrol* 1983;17:205-207.

IV. NEUROLOGICAL FAECAL INCONTINENCE

1. Coggrave M, Norton C, Cody JD. Management of faecal incontinence and constipation in adults with central neurological diseases. *Cochrane Database Syst Rev*. 2014 Jan 13;(1):CD002115
2. Preziosi G, Raptis DA, Raeburn A, Thiruppathy K, Panicker J, Emmanuel A. Gut dysfunction in patients with multiple sclerosis and the role of spinal cord involvement in the disease. *Eur J Gastroenterol Hepatol*. 2013 Sep;25(9):1044-50.
3. Cameron AP, Rodriguez GM, Gursky A, He C, Clemens JQ, Stoffel JT. The Severity of Bowel Dysfunction in Patients with Neurogenic Bladder. *J Urol*. 2015 Nov;194(5):1336-41
4. Bajwa A, Emmanuel A. The physiology of continence and evacuation. *Best Pract Res Clin Gastroenterol*. 2009;23(4):477-85
5. Craggs MD, Balasubramaniam AV, Chung EAL, Emmanuel AV. Aberrant reflexes and function of the pelvic organs following spinal injury in man. *Auton Neurosci Basic Clin* 2006; 126-127: 355-70.
6. Fasano A, Visanji NP, Liu LW, Lang AE, Pfeiffer RF. Gastrointestinal dysfunction in Parkinson's disease. *Lancet Neurol*. 2015 Jun;14(6):625-39
7. Sakakibara R1, Odaka T, Uchiyama T, Asahina M, Yamaguchi K, Yamaguchi T, Yamanishi T, Hattori T. Colonic transit time and rectoanal videomanometry in Parkinson's disease. *J Neurol Neurosurg Psychiatry*. 2003 Feb;74(2):268-72.

8. Emmanuel A. Managing neurogenic bowel dysfunction. *Clin Rehabil.* 2010 Jun;24(6):483-8
9. Krogh K, Christensen P, Sabroe S, Laurberg S. Neurogenic bowel dysfunction score. *Spinal Cord* 2006; 44: 625–31
10. Coggrave M, Burrows D, Durand MA. Progressive protocol in the bowel management of spinal cord injuries. *Br J Nurs.* 2006 Nov 9-22;15(20):1108-13
11. Emmanuel AV, Krogh K, Bazzocchi G, Leroi AM, Bremers A, Leder D, van Kuppevelt D, Mosiello G, Vogel M, Perrouin-Verbe B, Coggrave M, Christensen P Consensus review of best practice of transanal irrigation in adults. *Spinal Cord.* 2013 Oct;51(10):732-8.
12. Emmanuel A, Kumar G, Christensen P, Mealing S, Størling ZM, Andersen F, Kirshblum S. Long-Term Cost-Effectiveness of Transanal Irrigation in Patients with Neurogenic Bowel Dysfunction. *PLoS One.* 2016 Aug 24;11(8):e0159394.
13. Christensen P, Krogh K, Perrouin-Verbe B, Leder D, Bazzocchi G, Petersen Jakobsen B, Emmanuel AV. Global audit on bowel perforations related to transanal irrigation. *Tech Coloproctol.* 2016 Feb;20(2):109-15
14. Jarrett ME, Matzel KE, Christiansen J, Baeten CG, Rosen H, Bittorf B, Stösser M, Madoff R, Kamm MA. Sacral nerve stimulation for faecal incontinence in patients with previous partial spinal injury including disc prolapse. *Br J Surg.* 2005 Jun;92(6):734-9
15. Kutzenberger J, Domurath B, Sauerwein D. Spastic bladder and spinal cord injury: seventeen years of experience with sacral deafferentation and implantation of an anterior root stimulator. *Artif Organs.* 2005 Mar;29(3):239-41
16. Malone PS, Ransley PG, Kiely EM. Preliminary report: the antegrade continence enema. *Lancet.* 1990 Nov 17;336(8725):1217-8
17. Krogh K, Christensen P. Neurogenic colorectal and pelvic floor dysfunction. *Best Pract Res Clin Gastroenterol.* 2009;23(4):531-43.
18. Bølling Hansen R, Staun M, Kalhauge A, Langholz E, Biering-Sørensen F. Bowel function and quality of life after colostomy in individuals with spinal cord injury. *J Spinal Cord Med.* 2016 May;39(3):281-9

V. SPECIFIC NEUROLOGICAL DISEASES

1. Grossmann H, Bergmann C, Parker S. Dementia: A Brief Review. *Mt Sinai J Med.* 2006;73:985-92.
2. Honig L, Mayeux R. Natural history of Alzheimer's disease. *Aging* 2001;13:171-82.
3. Burns A, Jacoby R, Levy R. Psychiatric phenomena in Alzheimer's disease. IV: Disorders of behaviour. *Br J Psychiatry.* 1990;157:86-94.
4. Cacabelos R, Rodriguez B, Carrera C, Caamano J, Beyer K, Lao J, et al. APOE-related frequency of cognitive and noncognitive symptoms in dementia. *Methods Find Exp Clin Pharmacol.* 1996;18:693-706.
5. Sakakibara R, Uchiyama T, Yamanishi T, Kishi M. Dementia and lower urinary dysfunction: with a reference to anticholinergic use in elderly population. *Int J Urol.* 2008 15(9):778-88.
6. Hutchinson S, Leger-Krall S, Skodol Wilson H. Toileting: a bio-behavioral challenge in Alzheimer's dementia care. *J Gerontol Nurs.* 1996;22:18-27.
7. Tariot P. Medical management of advanced dementia. *J Am Geriatr Soc.* 2003;51 Suppl:S305-13.
8. Areosa S, Sherriff F. Memantine for dementia. *Cochrane Database Syst Rev.* 2003;3:CD003154.
9. Ransmayr G, Holliger S, Schletterer K, Heidler H, Deibl M, Poewe W, et al. Lower urinary tract symptoms in dementia with Lewy bodies, Parkinson disease, and Alzheimer disease. *Neurology.* 2008 70:299-303.
10. Del Ser T, Munoz D, Hachinsky V. Temporal pattern of cognitive decline and incontinence is different in Alzheimer's disease and diffuse Lewy body disease. *Neurology* 1996;46:682-6.
11. Nobili F, Copello F, Buffoni F, Vitali P, Girtler N, Bordoni C, et al. Timing of disease progression by quantitative EEG in Alzheimer's patients. *J Clin Neurophysiol.* 1999;16:556-73.
12. Nobili F, Copello F, Buffoni F, Vitali P, Girtler N, Bordoni C, et al. Regional cerebral blood flow and prognostic evaluation in Alzheimer's disease. *Dement Geriatr Cogn Disord.* 2001;122:89-97.
13. Sugiyama T, Hashimoto K, Kiwamoto H. Urinary incontinence in senile dementia of the Alzheimer type (SDAT). *Int J Urol.* 1994;1:337- 40.
14. Haddad F, Curd G, Meyers J. Alzheimer's disease with refluxes. *Urol Int.* 1987;422:155-7.

15. Lee SH, Cho ST, Na HR, Ko SB, Park MH. Urinary incontinence in patients with Alzheimer's disease: relationship between symptom status and urodynamic diagnoses. *Int J Urol.* 2014 Jul;21(7):683-7.
16. Franssen E, Souren L, Torossian C, Reisberg B. Utility of developmental reflexes in the differential diagnosis and prognosis of incontinence in Alzheimer's disease. *J Geriatr Psychiatry Neurol.* 1997;101:22-8.
17. Lancioni G, Singh N, O'Reilly M, Sigafoos J, Bosco A, Zonno N, et al. Persons with mild or moderate Alzheimer's disease learn to use urine alarms and prompts to avoid large urinary accidents. *Research in Developmental Disabilities.* 2011;32:1998-2004.
18. Drennan VM, Greenwood N, Cole L, Fader M, Grant R, Rait G, et al. Conservative interventions for incontinence in people with dementia or cognitive impairment, living at home: a systematic review. *BMC Geriatr.* 2012;12:77.
19. Shinotoh H, Aotsuka A, Fukushi K, Nagatsuka S, Tanaka N, Ota T, et al. Effect of donepezil on brain acetylcholinesterase activity in patients with AD measured by PET. *Neurology* 2001;56:408-10.
20. Burns A, Rossor M, Hecker J, Gauthier S, Petit H, Möller H, et al. The effects of donepezil in 17 Alzheimer's disease: Results from a multinational trial. *Dementia and Geriatric Cognitive Disorders.* 1999;10:237-44.
21. Rogers S, Farlow M, Doody R, Mohs R, Friedhoff L. A 24-week, double-blind, placebo-controlled trial of donepezil in patients with Alzheimer's disease. *Neurology* 1998;50:136-45.
22. Becker R. Therapy of the cognitive deficit in Alzheimer's disease; the cholinergic system. In: RE B, E G, editors. *Cholinergic basis for Alzheimer therapy.* Boston: Birkhäuser Boston; 1991. p. 1-22.
23. Sakakibara R, Uchiyama T, Yoshiyama M, Yamanishi T, Hattori T. Preliminary Communication: Urodynamic Assessment of Donepezil Hydrochloride in Patients with Alzheimer's Disease. *Neurourol Urodyn.* 2005;24:273-5.
24. Komatsu K, Yokoyama O, Otsuka N, Kodama K, Yotsuyanagi S, Niikura S. Central muscarinic mechanism of bladder overactivity associated with Alzheimer type senile dementia. *Neurourol Urodyn.* 2000;4:539- 40.
25. Kroger E, Van Marum R, Souverein P, Carmichael PH, Egberts T. Treatment with rivastigmine or galantamine and risk of urinary incontinence: results from a Dutch database study. *Pharmacoepidemiol Drug Saf.* 2015 Mar;24(3):276-85.
26. Sakakibara R, Ogata T, Uchiyama T, Kishi M, Ogawa E, Isaka S, et al. How to manage overactive bladder in elderly individuals with dementia? A combined use of donepezil, a central AChE inhibitor, and propiverine, a peripheral muscarine receptor antagonist. *J Am Geriatr Soc.* 2009 57:1515-7.
27. Sink K, Thomas Jr, Xu H, Craig B, Kritchevsky S, Sands L. Dual use of bladder anticholinergics and cholinesterase inhibitors: long-term functional and cognitive outcomes. *J Am Geriatr Soc.* 2008;56:847-53.
28. Isik AT, Celik T, Bozoglu E, Doruk H. Tropicium and cognition in patients with late onset Alzheimer disease. *J Nutr Health Aging.* 2009 Oct;13(8):672-6.
29. Averbek MA, Altaweel W, Manu-Marin A, Madersbacher H. Management of LUTS in patients with dementia and associated disorders. *Neurourol Urodyn.* 2015 Nov 20.
30. Yamamoto S, Maruyama S, Ito Y, Kawamata M, Nishiyama S, Ohba H, et al. Effect of oxybutynin and imidafenacin on central muscarinic receptor occupancy and cognitive function: a monkey PET study with [(11)C](+)-3-MPB. *Neuroimage.* 2011 58:1-9.
31. Lieu P, Chia H, Heng L, Ding Y, Choo P. Carer-assisted intermittent urethral catheterisation in the management of persistent retention of urine in elderly women. *Ann Acad med Singapore.* 1996;25:562-265.
32. Fratiglioni L, Launer L, Andersen K, Breteler M, Copeland J, Dartigues J, et al. Prevalence of dementia and major subtypes in Europe: a collaborative study of population-based cohorts. Neurologic diseases in the Elderly. Research Group. *Neurology* 2000;54:S 4- S 9.
33. van Dijk E, Breteler M, Schmidt R, Berger K, Nilsson L, Oudkerk M, et al. . The association between blood pressure, hypertension, and cerebral white matter lesions cardiovascular determinants of dementia study. *Hypertension.* 2004;44(6):625-630).
34. Sakakibara R, Panicker J, Fowler C, Tateno F, Kishi M, Tsuyusaki Y, et al. "Vascular incontinence" and normal-pressure hydrocephalus: two common elderly incontinence with brain etiologies. *Current Drug Therapy.* 2012(in press).
35. Hénon H, Durieu I, Guerouaou D, Lebert F, Pasquier F, Leys D. Poststroke dementia : incidence and relationship to prestroke cognitive decline. *Neurology* 2001;57:1216-22.
36. Hofman A, Ott A, Breteler M, Bots M, Slooter A, van Harskamp F, et al. Atherosclerosis, apolipoprotein E and prevalence of dementia and Alzheimer's disease in the Rotterdam study. *Lancet* 1997;349:151-4.

37. Thom D, Haan M, Van Den Eeden S. Medically recognized urinary incontinence and risks of hospitalization, nursing home admission and mortality. *Age Ageing*. 1997;26:367-74.
38. Wardlaw J. Blood-brain barrier and cerebral small vessel disease. *J Neurol Sci* 2010;299:66-71.
39. Lee S, Scott A. Hypoxia positron emission tomography imaging with 18F-fluoromisonidazole. *Semin Nucl Med*. 2007;37:451-61.
40. Hentschel F, Damian M, Krumm B, Froelich L. White matter lesions - age-adjusted values for cognitively healthy and demented subjects. *Acta Neurol Scand*. 2007;115:174-80.
41. Tullberg M, Fletcher E, DeCarli C, Mungas D, Reed B, Harvey D, et al. White matter lesions impair frontal lobe function regardless of their location. *Neurology*. 2004;63:246-53.
42. Hanyu H, Shimuzu S, Tanaka Y, Takasaki M, Koizumi K, Abe K. Cerebral blood flow patterns in Binswanger's disease: a SPECT study using three-dimensional stereotactic surface projections. *J Neurol Sci*. 2004;220:79-84.
43. Haruta H, Sakakibara R, Ogata T, Panicker J, Fowler CJ, Tateno F, et al. Inhibitory control task is decreased in vascular incontinence patients. *Clin Auton Res*. 2013 Apr;23(2):85-9.
44. Sakakibara R, Fowler C, Hattori T. Voiding and MRI analysis of the brain. *Int Urogynecol J Pelvic Floor Dysfunct*. 1999;10:192-9.
45. Fowler C, Griffiths D. A decade of functional brain imaging applied to bladder control. *Neurourol Urodyn*. 2010;29:49-55.
46. Sakakibara R, Tsunoyama K, Takahashi O, Sugiyama M, Kishi M, Ogawa E, et al. Real-time measurement of oxyhemoglobin concentration changes in the frontal micturition area: an fNIRS study. *Neurourol Urodyn*. 2010;29:757-64.
47. Fowler C, Griffiths D, de Groat W. The neural control of micturition. *Nat Rev Neurosci*. 2008;9:453-66.
48. Griffiths D, Tadic S. Bladder control, urgency, and urge incontinence: evidence from functional brain imaging. *Neurourol Urodyn*. 2008;27:466-74.
49. Jirovec M, Wells T. Urinary incontinence in nursing home residents with dementia: the mobility-cognition paradigm. *Appl Nurs Res*. 1990;3:112-7.
50. Yoshimura N, Yoshida O, Yamamoto S, Mori H, Majima M, Mui K. Evaluation of urinary incontinence among the nursing home elderly. *Hinyokika Kyo*. 1991;37:689-94.
51. Eustice S, Roe B, Paterson J. Prompted voiding for the management of urinary incontinence in adults. *Cochrane Database Syst Rev*. 2000;2:CD002113.
52. Suzuki Y, Machida T, Oishi Y, Miyazaki K, Okabe T, Watanabe S, et al. Countermeasures for urinary incontinence in patients with senile dementia: correlation between urinary incontinence severity, senile dementia severity, and activity of daily living. *Hinyokika Kyo*. 1992;38:291-5.
53. Sugiyama T, Matsuda H, Oonishi N, Kiwamoto H, Esa A, Park Y, et al. Anticholinergic therapy of urinary incontinence and urinary frequency associated with the elderly - with special reference to dementia. *Nippon Hinyokika Gakkai Zasshi*. 1993;84:1068-73.
54. Yonou H, Kagawa H, Oda A, Nagano M, Gakiya M, Niimura K. Transurethral resection of the prostate for patients with dementia. *Hinyokika Kyo*. 1999;45:241-4.
55. McKeith I, Galasko D, Kosaka K, Perry E, Dickson D, Hansen L, et al. Consensus guidelines for the clinical and pathological diagnosis of dementia with Lewy bodies (DLB): report of the consortium on DLB international workshop. *Neurology* 1996;47 1113-24.
56. Spillantini M, Schmidt M, Lee V, Trojanowski J, Jakes R, Goedert M. Alpha-synuclein in Lewy bodies. *Nature* 1997;388:839-40.
57. McKeith I, Dickson D, Lowe J, Emre M, O'Brien J, Feldman H, et al. Diagnosis and management of dementia with Lewy Bodies: third report of the DLB consortium. *Neurology* 2005;65 1863-72.
58. Merdes A, Hansen L, Jeste D, Galasko D, Hofstetter C, Ho G, et al. Influence of Alzheimer pathology on clinical diagnostic accuracy in dementia with Lewy bodies. *Neurology* 2003;60:1586-90.
59. Lippa C, Fujiwara H, Mann D, Giasson B, Baba MSchmidt M, Nee LE OCB, Pollen DA, St George-Hyslop P, Ghetti B, Nochlin D, Bird TD, Cairns NJ, Lee VM, Iwatsubo T, Trojanowski JQ. Lewy bodies contain altered alpha-synuclein in brains of many familial Alzheimer's disease patients with mutations in presenilin and amyloid precursor protein genes. *Am J Pathol*. 1998;153:1365-370.
60. Thaisethawatkul P, Boeve B, Benarroch E, Sandroni P, Ferman T, Petersen R, et al. Autonomic dysfunction in dementia with Lewy bodies. *Neurology* 2007;62:1804-8.
61. Ratnavalli E, Brayne C, Dawson K, Hodges J. The prevalence of frontotemporal dementia. *Neurology* 2002;58:1615-21.

62. Gustafson L. Frontal lobe degeneration of non-Alzheimer type. II. Clinical picture and differential diagnosis. *Arch Gerontol Geriatr.* 1987;6:209-23.
63. Varma A, Adams W, Lloyd J, Carson K, Snowden J, Testa H, et al. Diagnostic patterns of regional atrophy on MRI and regional cerebral blood flow change on SPECT in young onset patients with Alzheimer's disease, frontotemporal dementia and vascular dementia. *Acta Neurol Scand.* 2002;105:261-9.
64. Hellström L, Ekelund P, Milsom I, Skoog I. The influence of dementia on the prevalence of urinary and faecal incontinence in 85-year-old men and women. *Arch Gerontol Geriatrics.* 1994;19:11-20.
65. Marmarou A, Black P, Bergsneider M, Klinge P, Relkin N. International NPH Consultant Group. International NPH Consultant Group. Guidelines for management of idiopathic normal pressure hydrocephalus: progress to date. *Acta Neurochir Suppl.* 2005(95):237-40.
66. Hakim S, Adams R. The special clinical problem of symptomatic occult hydrocephalus with normal cerebrospinal pressure. *J Neurol Sci.* 1965;2:307-32.
67. Iseki C, Kawanami T, Nagasawa H, Wada M, Koyama S, Kikuchi K, et al. Asymptomatic ventriculomegaly with features of idiopathic normal pressure hydrocephalus on MRI (AVIM) in the elderly: a prospective study in a Japanese population. *J Neurol Sci.* 2009 15:54-7.
68. Sakakibara R, Kanda T, Sekido T, Uchiyama T, Awa Y, Ito T, et al. Mechanism of bladder dysfunction in idiopathic normal pressure hydrocephalus. *Neurourol Urodyn.* 2008;27:507-10.
69. Jonas S, Brown J. Neurogenic bladder in normal pressure hydrocephalus. *Urology* 1975;5:44-50.
70. Ahlberg J, Noren L, Blomstrand C, Wikkelso C. Outcome of shunt operation on urinary incontinence in normal pressure hydrocephalus predicted by lumbar puncture. *J Neurol Neurosurg Psychiatry.* 1988;51:105-8.
71. de Groat W. Integrative control of the lower urinary tract: preclinical perspective. *Br J Pharmacol.* 2006;147:S25-S40.
72. Oowler B, Momjian S, Czosnyka Z, Czosnyka M, Pena A, Harris N, et al. Normal pressure hydrocephalus and cerebral blood flow: a PET study of baseline values. *J Cereb Blood Flow Metab.* 2004;24:17-23.
73. Sasaki H, Ishii K, Kono A, Miyamoto N, Fukuda T, Shimada K, et al. Cerebral perfusion pattern of idiopathic normal pressure hydrocephalus studied by SPECT and statistical brain mapping. *Ann Nucl Med.* 2007;21:39-45.
74. Walter C, Hertel F, Neumann E, Morsdorf M. Alteration of cerebral perfusion in patients with idiopathic normal pressure hydrocephalus measured by 3D perfusion weighted magnetic resonance imaging. *J Neurol Neurosurg Psychiatry.* 2005;252:1465-71.
75. Sakakibara R, Uchida Y, Ishii K, Kazui H, Hashimoto M, Ishikawa M, et al. Correlation of right frontal hypoperfusion and urinary dysfunction in iNPH: A SPECT study. *Neurourol Urodyn.* 2011 Oct 28. [Epub ahead of print].
76. Sakakibara R, Uchida Y, Ishii K, Hashimoto M, Ishikawa M, Kazui H, et al. Bladder recovery relates with increased mid-cingulate perfusion after shunt surgery in idiopathic normal-pressure hydrocephalus: a single-photon emission tomography study. *Int Urol Nephrol.* 2016 Feb;48(2):169-74.
77. Graham JG, Oppenheimer DR. Orthostatic hypotension and nicotine sensitivity in a case of multiple system atrophy. *J Neurol Neurosurg Psychiatry.* 1969 Feb;32(1):28-34.
78. Gilman S, Wenning GK, Low PA, Brooks DJ, Mathias CJ, Trojanowski JQ, et al. Second consensus statement on the diagnosis of multiple system atrophy. *Neurology.* 2008 Aug 26;71(9):670-6.
79. Neurology CCotAASatAAo. Consensus statement on the definition of orthostatic hypotension, pure autonomic failure, and multiple system atrophy. *Neurology.* 1996 May;46(5):1470.
80. Chandiramani VA, Palace J, Fowler CJ. How to recognize patients with parkinsonism who should not have urological surgery. *Br J Urol.* 1997 Jul;80(1):100-4.
81. Yamamoto T, Sakakibara R, Uchiyama T, Liu Z, Ito T, Awa Y, et al. Questionnaire-based assessment of pelvic organ dysfunction in multiple system atrophy. *Mov Disord.* 2009 May 15;24(7):972-8.
82. Shy GM, Drager GA. A neurological syndrome associated with orthostatic hypotension: a clinical-pathologic study. *Arch Neurol.* 1960 May;2:511-27.
83. Adams RD, Vanbogaert L, Vandereecken H. Striato-Nigral Degeneration. *J Neuropathol Exp Neurol.* 1964 Oct;23:584-608.

84. Sakakibara R, Hattori T, Uchiyama T, Kita K, Asahina M, Suzuki A, et al. Urinary dysfunction and orthostatic hypotension in multiple system atrophy: which is the more common and earlier manifestation? *J Neurol Neurosurg Psychiatry*. 2000 Jan;68(1):65-9.
85. Wenning GK, Ben Shlomo Y, Magalhaes M, Daniel SE, Quinn NP. Clinical features and natural history of multiple system atrophy. An analysis of 100 cases. *Brain*. 1994 Aug;117 (Pt 4):835-45.
86. Gilman S, May SJ, Shults CW, Tanner CM, Kukul W, Lee VM, et al. The North American Multiple System Atrophy Study Group. *J Neural Transm (Vienna)*. 2005 Dec;112(12):1687-94.
87. Kirshhof K, Apostolidis AN, Mathias CJ, Fowler CJ. Erectile and urinary dysfunction may be the presenting features in patients with multiple system atrophy: a retrospective study. *Int J Impot Res*. 2003 Aug;15(4):293-8.
88. Sakakibara R, Hattori T, Uchiyama T, Yamanishi T. Videourodynamic and sphincter motor unit potential analyses in Parkinson's disease and multiple system atrophy. *J Neurol Neurosurg Psychiatry*. 2001 Nov;71(5):600-6.
89. Berger Y, Salinas JN, Blaivas JG. Urodynamic differentiation of parkinson disease and the shy drager syndrome. *Neurourol Urodyn*. 1990;9:117-21.
90. Stocchi F, Carbone A, Inghilleri M, Monge A, Ruggieri S, Berardelli A, et al. Urodynamic and neurophysiological evaluation in Parkinson's disease and multiple system atrophy. *J Neurol Neurosurg Psychiatry*. 1997 May;62(5):507-11.
91. Benarroch EE, Schmeichel AM. Depletion of corticotrophin-releasing factor neurons in the pontine micturition area in multiple system atrophy. *Ann Neurol*. 2001 Nov;50(5):640-5.
92. Ahmed Z, Asi YT, Sailer A, Lees AJ, Houlden H, Revesz T, et al. The neuropathology, pathophysiology and genetics of multiple system atrophy. *Neuropathol Appl Neurobiol*. 2012 Feb;38(1):4-24.
93. Benarroch EE, Schmeichel AM, Low PA, Parisi JE. Involvement of medullary serotonergic groups in multiple system atrophy. *Ann Neurol*. 2004 Mar;55(3):418-22.
94. Fujita T, Doi M, Ogata T, Kanazawa I, Mizusawa H. Cerebral cortical pathology of sporadic olivopontocerebellar atrophy. *J Neurol Sci*. 1993 May;116(1):41-6.
95. Andrew J, Nathan PW. Lesions on the Anterior Frontal Lobes and Disturbances of Micturition and Defaecation. *Brain*. 1964 Jun;87:233-62.
96. Ito T, Sakakibara R, Nakazawa K, Uchiyama T, Yamamoto T, Liu Z, et al. Effects of electrical stimulation of the raphe area on the micturition reflex in cats. *Neuroscience*. 2006 Nov 3;142(4):1273-80.
97. Nishizawa O, Ebina K, Sugaya K, Noto H, Satoh K, Kohama T, et al. Effect of cerebellectomy on reflex micturition in the decerebrate dog as determined by urodynamic evaluation. *Urol Int*. 1989;44(3):152-6.
98. Sakakibara R, Uchida Y, Uchiyama T, Yamanishi T, Hattori T. Reduced cerebellar vermis activation during urinary storage and micturition in multiple system atrophy: 99mTc-labelled ECD SPECT study. *Eur J Neurol*. 2004 Oct;11(10):705-8.
99. Ito T, Sakakibara R, Yasuda K, Yamamoto T, Uchiyama T, Liu Z, et al. Incomplete emptying and urinary retention in multiple-system atrophy: when does it occur and how do we manage it? *Mov Disord*. 2006 Jun;21(6):816-23.
100. Yamamoto T, Sakakibara R, Uchiyama T, Liu Z, Ito T, Awa Y, et al. Neurological diseases that cause detrusor hyperactivity with impaired contractile function. *Neurourol Urodyn*. 2006;25(4):356-60.
101. Yamanishi T, Yasuda K, Sakakibara R, Hattori T, Tojo M. The effectiveness of terazosin, an alpha1-blocker, on bladder neck obstruction as assessed by urodynamic hydraulic energy. *BJU Int*. 2000 Feb;85(3):249-53.
102. Sakakibara R, Uchiyama T, Yamanishi T, Kishi M. Sphincter EMG as a diagnostic tool in autonomic disorders. *Clin Auton Res*. 2009 Feb;19(1):20-31.
103. Yamamoto T, Sakakibara R, Uchiyama T, Yamaguchi C, Nomura F, Ito T, et al. Receiver operating characteristic analysis of sphincter electromyography for parkinsonian syndrome. *Neurourol Urodyn*. 2012 Sep;31(7):1128-34.
104. Ozawa T, Oyanagi K, Tanaka H, Horikawa Y, Takahashi H, Morita T, et al. Suprachiasmatic nucleus in a patient with multiple system atrophy with abnormal circadian rhythm of arginine-vasopressin secretion into plasma. *J Neurol Sci*. 1998 Jan 21;154(1):116-21.
105. Podnar S, Fowler CJ. Sphincter electromyography in diagnosis of multiple system atrophy: technical issues. *Muscle Nerve*. 2004 Jan;29(1):151-6.
106. Yamamoto T, Sakakibara R, Uchiyama T, Liu Z, Ito T, Awa Y, et al. When is Onuf's nucleus involved in multiple system atrophy? A sphincter electromyography study. *J Neurol Neurosurg Psychiatry*. 2005 Dec;76(12):1645-8.

107. Paviour DC, Williams D, Fowler CJ, Quinn NP, Lees AJ. Is sphincter electromyography a helpful investigation in the diagnosis of multiple system atrophy? A retrospective study with pathological diagnosis. *Mov Disord.* 2005 Nov;20(11):1425-30.
108. Takahashi O, Sakakibara R, Tsunoyama K, Tateno F, Yano M, Sugiyama M, et al. Do Sacral/Peripheral Lesions Contribute to Detrusor-Sphincter Dyssynergia? *Low Urin Tract Symptoms.* 2012 Sep;4(3):126-9.
109. Pramstaller PP, Wenning GK, Smith SJ, Beck RO, Quinn NP, Fowler CJ. Nerve conduction studies, skeletal muscle EMG, and sphincter EMG in multiple system atrophy. *J Neurol Neurosurg Psychiatry.* 1995 May;58(5):618-21.
110. Ozawa T, Tanaka H, Nakano R, Sato M, Inuzuka T, Soma Y, et al. Nocturnal decrease in vasopressin secretion into plasma in patients with multiple system atrophy. *J Neurol Neurosurg Psychiatry.* 1999 Oct;67(4):542-5.
111. Mathias CJ, Fosbraey P, da Costa DF, Thornley A, Bannister R. The effect of desmopressin on nocturnal polyuria, overnight weight loss, and morning postural hypertension in patients with autonomic failure. *Br Med J (Clin Res Ed).* 1986 Aug 9;293(6543):353-4.
112. Wilcox CS, Aminoff MJ, Penn W. Basis of nocturnal polyuria in patients with autonomic failure. *J Neurol Neurosurg Psychiatry.* 1974 Jun;37(6):677-84.
113. Donnellan CA, Fook L, McDonald P, Playfer JR. Oxybutynin and cognitive dysfunction. *BMJ.* 1997 Nov 22;315(7119):1363-4.
114. Sakakibara R, Hattori T, Uchiyama T, Suenaga T, Takahashi H, Yamanishi T, et al. Are alpha-blockers involved in lower urinary tract dysfunction in multiple system atrophy? A comparison of prazosin and moxislyte. *J Auton Nerv Syst.* 2000 Mar 15;79(2-3):191-5.
115. Sakakibara R, Uchiyama T, Asahina M, Yoshizawa M, Yamanishi T, Hattori T. Amezinium metilsulfate, a sympathomimetic agent, may increase the risk of urinary retention in multiple system atrophy. *Clin Auton Res.* 2003 Feb;13(1):51-3.
116. Schwinn DA. Novel role for alpha1-adrenergic receptor subtypes in lower urinary tract symptoms. *BJU Int.* 2000 Oct;86 Suppl 2:11-20; discussion -2.
117. Yamanishi T, Yasuda K, Kamai T, Tsujii T, Sakakibara R, Uchiyama T, et al. Combination of a cholinergic drug and an alpha-blocker is more effective than monotherapy for the treatment of voiding difficulty in patients with underactive detrusor. *Int J Urol.* 2004 Feb;11(2):88-96.
118. Sandroni P, Opfer-Gehrking TL, Singer W, Low PA. Pyridostigmine for treatment of neurogenic orthostatic hypotension [correction of hypertension]--a follow-up survey study. *Clin Auton Res.* 2005 Feb;15(1):51-3.
119. Yamamoto T, Sakakibara R, Yamanaka Y, Uchiyama T, Asahina M, Liu Z, et al. Pyridostigmine in autonomic failure: can we treat postural hypotension and bladder dysfunction with one drug? *Clin Auton Res.* 2006 Aug;16(4):296-8.
120. Sakakibara R, Matsuda S, Uchiyama T, Yoshizawa M, Yamanishi T, Hattori T. The effect of intranasal desmopressin on nocturnal waking in urination in multiple system atrophy patients with nocturnal polyuria. *Clin Auton Res.* 2003 Apr;13(2):106-8.
121. Uchiyama T, Sakakibara R, Asahina M, Yamanishi T, Hattori T. Post-micturitional hypotension in patients with multiple system atrophy. *J Neurol Neurosurg Psychiatry.* 2005 Feb;76(2):186-90.
122. Coon EA, Sletten DM, Suarez MD, Mandrekar JN, Ahlskog JE, Bower JH, et al. Clinical features and autonomic testing predict survival in multiple system atrophy. *Brain.* 2015 Dec;138(Pt 12):3623-31.
123. Figueroa JJ, Singer W, Parsaik A, Benarroch EE, Ahlskog JE, Fealey RD, et al. Multiple system atrophy: prognostic indicators of survival. *Mov Disord.* 2014 Aug;29(9):1151-7.
124. Sakakibara R, Panicker J, Finazzi-Agro E, Iacovelli V, Bruschini H, Parkinson's Disease Subcommittee TNPCiTICS. A guideline for the management of bladder dysfunction in Parkinson's disease and other gait disorders. *NeuroUrol Urodyn.* 2016 Jun;35(5):551-63.
125. Sakakibara R, Odaka T, Uchiyama T, Liu R, Asahina M, Yamaguchi K, et al. Colonic transit time, sphincter EMG, and rectoanal videomanometry in multiple system atrophy. *Mov Disord.* 2004 Aug;19(8):924-9.
126. Stocchi F, Badiali D, Vacca L, D'Alba L, Bracci F, Ruggieri S, et al. Anorectal function in multiple system atrophy and Parkinson's disease. *Mov Disord.* 2000 Jan;15(1):71-6.
127. Bardoux N, Leroi AM, Touchais JY, Weber J, Denis P. Difficult defaecation and/or faecal incontinence as a presenting feature of neurologic disorders in four patients. *Neurogastroenterol Motil.* 1997 Mar;9(1):13-8.
128. Eichhorn TE, Oertel WH. Macrogol 3350/electrolyte improves constipation in Parkinson's disease and multiple system atrophy. *Mov Disord.* 2001 Nov;16(6):1176-7.

129. Sakakibara R, Yamaguchi T, Uchiyama T, Yamamoto T, Ito T, Liu Z, et al. Calcium polycarbophil improves constipation in primary autonomic failure and multiple system atrophy subjects. *Mov Disord.* 2007 Aug 15;22(11):1672-3.
130. Liu Z, Sakakibara R, Odaka T, Uchiyama T, Uchiyama T, Yamamoto T, et al. Mosapride citrate, a novel 5-HT₄ agonist and partial 5-HT₃ antagonist, ameliorates constipation in parkinsonian patients. *Mov Disord.* 2005 Jun;20(6):680-6.
131. Sakakibara R, Odaka T, Lui Z, Uchiyama T, Yamaguchi K, Yamaguchi T, et al. Dietary herb extract dai-kenchu-to ameliorates constipation in parkinsonian patients (Parkinson's disease and multiple system atrophy). *Mov Disord.* 2005 Feb;20(2):261-2.
132. Hattori T, Yasuda K, Kita K, Hirayama K. Voiding dysfunction in Parkinson's disease. *Jpn J Psychiatry Neurol.* 1992 Mar;46(1):181-6.
133. Gray R, Stern G, Malone-Lee J. Lower urinary tract dysfunction in Parkinson's disease: changes relate to age and not disease. *Age Ageing.* 1995 Nov;24(6):499-504.
134. Araki I, Kuno S. Assessment of voiding dysfunction in Parkinson's disease by the international prostate symptom score. *J Neurol Neurosurg Psychiatry.* 2000 Apr;68(4):429-33.
135. Lemack GE, Dewey RB, Jr., Roehrborn CG, O'Suilleabhain PE, Zimmern PE. Questionnaire-based assessment of bladder dysfunction in patients with mild to moderate Parkinson's disease. *Urology.* 2000 Aug 1;56(2):250-4.
136. Campos-Sousa RN, Quagliato E, da Silva BB, de Carvalho RM, Jr., Ribeiro SC, de Carvalho DF. Urinary symptoms in Parkinson's disease: prevalence and associated factors. *Arq Neuropsiquiatr.* 2003 Jun;61(2B):359-63.
137. Sakakibara R, Shinotoh H, Uchiyama T, Sakuma M, Kashiwado M, Yoshiyama M, et al. Questionnaire-based assessment of pelvic organ dysfunction in Parkinson's disease. *Auton Neurosci.* 2001 Sep 17;92(1-2):76-85.
138. Uchiyama T, Sakakibara R, Yamamoto T, Ito T, Yamaguchi C, Awa Y, et al. Urinary dysfunction in early and untreated Parkinson's disease. *J Neurol Neurosurg Psychiatry.* 2011 Dec;82(12):1382-6.
139. Sakakibara R, Tateno F, Kishi M, Tsuyuzaki Y, Uchiyama T, Yamamoto T. Pathophysiology of bladder dysfunction in Parkinson's disease. *Neurobiol Dis.* 2012 Jun;46(3):565-71.
140. Terayama K, Sakakibara R, Ogawa A, Haruta H, Akiba T, Nagao T, et al. Weak detrusor contractility correlates with motor disorders in Parkinson's disease. *Mov Disord.* 2012 Dec;27(14):1775-80.
141. Fowler CJ, Griffiths D, de Groat WC. The neural control of micturition. *Nat Rev Neurosci.* 2008 Jun;9(6):453-66.
142. Sakakibara R, Shinotoh H, Uchiyama T, Yoshiyama M, Hattori T, Yamanishi T. SPECT imaging of the dopamine transporter with [(123)I]-beta-CIT reveals marked decline of nigrostriatal dopaminergic function in Parkinson's disease with urinary dysfunction. *J Neurol Sci.* 2001 Jun 15;187(1-2):55-9.
143. Dalmose AL, Bjarkam CR, Sorensen JC, Djurhuus JC, Jorgensen TM. Effects of high frequency deep brain stimulation on urine storage and voiding function in conscious minipigs. *Neurourol Urodyn.* 2004;23(3):265-72.
144. Defreitas GA, Lemack GE, Zimmern PE, Dewey RB, Roehrborn CG, O'Suilleabhain PE. Distinguishing neurogenic from non-neurogenic detrusor overactivity: a urodynamic assessment of lower urinary tract symptoms in patients with and without Parkinson's disease. *Urology.* 2003 Oct;62(4):651-5.
145. O'Sullivan SS, Holton JL, Massey LA, Williams DR, Revesz T, Lees AJ. Parkinson's disease with Onuf's nucleus involvement mimicking multiple system atrophy. *J Neurol Neurosurg Psychiatry.* 2008 Feb;79(2):232-4.
146. Sakakibara R, Ito T, Uchiyama T, Asahina M, Liu Z, Yamamoto T, et al. Lower urinary tract function in dementia of Lewy body type. *J Neurol Neurosurg Psychiatry.* 2005 May;76(5):729-32.
147. Magerkurth C, Schnitzer R, Braune S. Symptoms of autonomic failure in Parkinson's disease: prevalence and impact on daily life. *Clin Auton Res.* 2005 Apr;15(2):76-82.
148. Matsui H, Nishinaka K, Oda M, Komatsu K, Kubori T, Uda F. Does cardiac metaiodobenzylguanidine (MIBG) uptake in Parkinson's disease correlate with major autonomic symptoms? *Parkinsonism Relat Disord.* 2006 Jun;12(5):284-8.
149. Balash Y, Peretz C, Leibovich G, Herman T, Hausdorff JM, Giladi N. Falls in outpatients with Parkinson's disease: frequency, impact and identifying factors. *J Neurol.* 2005 Nov;252(11):1310-5.
150. Kuno S, Mizuta E, Yamasaki S, Araki I. Effects of pergolide on nocturia in Parkinson's disease: three female cases selected from over 400 patients. *Parkinsonism Relat Disord.* 2004 Mar;10(3):181-7.

151. Brusa L, Petta F, Pisani A, Miano R, Stanzione P, Moschella V, et al. Central acute D2 stimulation worsens bladder function in patients with mild Parkinson's disease. *J Urol*. 2006 Jan;175(1):202-6; discussion 6-7.
152. Uchiyama T, Sakakibara R, Hattori T, Yamanishi T. Short-term effect of a single levodopa dose on micturition disturbance in Parkinson's disease patients with the wearing-off phenomenon. *Mov Disord*. 2003 May;18(5):573-8.
153. Ishizuka O, Mizusawa H, Nishizawa O. Roles of dopaminergic receptors in bladder and erectile function at the spinal level. *Asian J Androl*. 2002 Dec;4(4):287-90.
154. Uchiyama T, Sakakibara R, Yoshiyama M, Yamamoto T, Ito T, Liu Z, et al. Biphasic effect of apomorphine, an anti-parkinsonian drug, on bladder function in rats. *Neuroscience*. 2009 Sep 15;162(4):1333-8.
155. Sakakibara R, Nakazawa K, Uchiyama T, Yoshiyama M, Yamanishi T, Hattori T. Micturition-related electrophysiological properties in the substantia nigra pars compacta and the ventral tegmental area in cats. *Auton Neurosci*. 2002 Nov 29;102(1-2):30-8.
156. Herzog J, Weiss PH, Assmus A, Wefer B, Seif C, Braun PM, et al. Improved sensory gating of urinary bladder afferents in Parkinson's disease following subthalamic stimulation. *Brain*. 2008 Jan;131(Pt 1):132-45.
157. Winge K, Nielsen KK. Bladder dysfunction in advanced Parkinson's disease. *Neurourol Urodyn*. 2012 Nov;31(8):1279-83.
158. Fritsche HM, Ganzer R, Schlaier J, Wieland WF, Brawanski A, Lange M. Acute urinary retention in two patients after subthalamic nucleus deep brain stimulation (STN-DBS) for the treatment of advanced Parkinson's disease. *Mov Disord*. 2009 Jul 30;24(10):1553-4.
159. Aviles-Olmos I, Foltynie T, Panicker J, Cowie D, Limousin P, Hariz M, et al. Urinary incontinence following deep brain stimulation of the pedunculopontine nucleus. *Acta Neurochir (Wien)*. 2011 Dec;153(12):2357-60.
160. Zesiewicz TA, Evatt M, Vaughan CP, Jahan I, Singer C, Ordorica R, et al. Randomized, controlled pilot trial of solifenacin succinate for overactive bladder in Parkinson's disease. *Parkinsonism Relat Disord*. 2015 May;21(5):514-20.
161. Gomes CM, Sammour ZM, Bessa Junior J, Barbosa ER, Lopes RI, Sallem FS, et al. Neurological status predicts response to alpha-blockers in men with voiding dysfunction and Parkinson's disease. *Clinics (Sao Paulo)*. 2014;69(12):817-22.
162. Katzenschlager R, Sampaio C, Costa J, Lees A. Anticholinergics for symptomatic management of Parkinson's disease. *Cochrane Database Syst Rev*. 2003(2):CD003735.
163. Sakakibara R, Uchiyama T, Yamanishi T, Kishi M. Dementia and lower urinary dysfunction: with a reference to anticholinergic use in elderly population. *Int J Urol*. 2008 Sep;15(9):778-88.
164. Giannantoni A, Conte A, Proietti S, Giovannozzi S, Rossi A, Fabbrini G, et al. Botulinum toxin type A in patients with Parkinson's disease and refractory overactive bladder. *J Urol*. 2011 Sep;186(3):960-4.
165. Anderson RU, Orenberg EK, Glowe P. OnabotulinumtoxinA office treatment for neurogenic bladder incontinence in Parkinson's disease. *Urology*. 2014 Jan;83(1):22-7.
166. Kulaksizoglu H, Parman Y. Use of botulinum toxin-A for the treatment of overactive bladder symptoms in patients with Parkinson's disease. *Parkinsonism Relat Disord*. 2010 Sep;16(8):531-4.
167. Kabay SC, Kabay S, Yucel M, Ozden H. Acute urodynamic effects of percutaneous posterior tibial nerve stimulation on neurogenic detrusor overactivity in patients with Parkinson's disease. *Neurourol Urodyn*. 2009;28(1):62-7.
168. Perissinotto MC, D'Ancona CA, Lucio A, Campos RM, Abreu A. Transcutaneous tibial nerve stimulation in the treatment of lower urinary tract symptoms and its impact on health-related quality of life in patients with Parkinson disease: a randomized controlled trial. *J Wound Ostomy Continence Nurs*. 2015 Jan-Feb;42(1):94-9.
169. Wallace PA, Lane FL, Noblett KL. Sacral nerve neuromodulation in patients with underlying neurologic disease. *Am J Obstet Gynecol*. 2007 Jul;197(1):96 e1-5.
170. Myers DL, Arya LA, Friedman JH. Is urinary incontinence different in women with Parkinson's disease? *Int Urogynecol J Pelvic Floor Dysfunct*. 1999;10(3):188-91.
171. Roth B, Studer UE, Fowler CJ, Kessler TM. Benign prostatic obstruction and parkinson's disease--should transurethral resection of the prostate be avoided? *J Urol*. 2009 May;181(5):2209-13.
172. Pfeiffer RF. Gastrointestinal, urological, and sexual dysfunction in Parkinson's disease. *Mov Disord*. 2010;25 Suppl 1:S94-7.
173. Ogawa E, Sakakibara R, Kishi M, Tateno F. Constipation triggered the malignant syndrome in Parkinson's disease. *Neurol Sci*. 2012 Apr;33(2):347-50.

174. Sakakibara R, Kishi M, Ogawa E, Tateno F, Uchiyama T, Yamamoto T, et al. Bladder, bowel, and sexual dysfunction in Parkinson's disease. *Parkinsons Dis.* 2011;2011:924605.
175. Wang SJ, Fuh JL, Shan DE, Liao KK, Lin KP, Tsai CP, et al. Sympathetic skin response and R-R interval variation in Parkinson's disease. *Mov Disord.* 1993 Apr;8(2):151-7.
176. Tateno F, Sakakibara R, Kishi M, Ogawa E, Yoshimatsu Y, Takada N, et al. Incidence of emergency intestinal pseudo-obstruction in Parkinson's disease. *J Am Geriatr Soc.* 2011 Dec;59(12):2373-5.
177. Lesser GT. Frequency of bowel movements and future risk of Parkinson's disease. *Neurology.* 2002 Mar 12;58(5):838; author reply -9.
178. Abbott RD, Petrovitch H, White LR, Masaki KH, Tanner CM, Curb JD, et al. Frequency of bowel movements and the future risk of Parkinson's disease. *Neurology.* 2001 Aug 14;57(3):456-62.
179. Braak H, Rub U, Del Tredici K. Cognitive decline correlates with neuropathological stage in Parkinson's disease. *J Neurol Sci.* 2006 Oct 25;248(1-2):255-8.
180. Kupsky WJ, Grimes MM, Sweeting J, Bertsch R, Cote LJ. Parkinson's disease and megacolon: concentric hyaline inclusions (Lewy bodies) in enteric ganglion cells. *Neurology.* 1987 Jul;37(7):1253-5.
181. Wakabayashi K, Takahashi H, Ohama E, Ikuta F. Parkinson's disease: an immunohistochemical study of Lewy body-containing neurons in the enteric nervous system. *Acta Neuropathol.* 1990;79(6):581-3.
182. Singaram C, Ashraf W, Gaumnitz EA, Torbey C, Sengupta A, Pfeiffer R, et al. Dopaminergic defect of enteric nervous system in Parkinson's disease patients with chronic constipation. *Lancet.* 1995 Sep 30;346(8979):861-4.
183. Jost WH. Gastrointestinal dysfunction in Parkinson's Disease. *J Neurol Sci.* 2010 Feb 15;289(1-2):69-73.
184. Mathers SE, Kempster PA, Law PJ, Frankel JP, Bartram CI, Lees AJ, et al. Anal sphincter dysfunction in Parkinson's disease. *Arch Neurol.* 1989 Oct;46(10):1061-4.
185. Astarloa R, Mena MA, Sanchez V, de la Vega L, de Yébenes JG. Clinical and pharmacokinetic effects of a diet rich in insoluble fiber on Parkinson disease. *Clin Neuropharmacol.* 1992 Oct;15(5):375-80.
186. Ashraf W, Pfeiffer RF, Park F, Lof J, Quigley EM. Constipation in Parkinson's disease: objective assessment and response to psyllium. *Mov Disord.* 1997 Nov;12(6):946-51.
187. Tateno F, Sakakibara R, Yokoi Y, Kishi M, Ogawa E, Uchiyama T, et al. Levodopa ameliorated anorectal constipation in de novo Parkinson's disease: The QL-GAT study. *Parkinsonism Relat Disord.* 2011 Nov;17(9):662-6.
188. Shimada J, Sakakibara R, Uchiyama T, Liu Z, Yamamoto T, Ito T, et al. Intestinal pseudo-obstruction and neuroleptic malignant syndrome in a chronically constipated parkinsonian patient. *Eur J Neurol.* 2006 Mar;13(3):306-7.
189. Shindler JS, Finnerty GT, Towilson K, Dolan AL, Davies CL, Parkes JD. Domperidone and levodopa in Parkinson's disease. *Br J Clin Pharmacol.* 1984 Dec;18(6):959-62.
190. Djaldetti R, Koren M, Ziv I, Achiron A, Melamed E. Effect of cisapride on response fluctuations in Parkinson's disease. *Mov Disord.* 1995 Jan;10(1):81-4.
191. Sullivan KL, Staffetti JF, Hauser RA, Dunne PB, Zesiewicz TA. Tegaserod (Zelnorm) for the treatment of constipation in Parkinson's disease. *Mov Disord.* 2006 Jan;21(1):115-6.
192. Cadeddu F, Bentivoglio AR, Brandara F, Marniga G, Brisinda G, Maria G. Outlet type constipation in Parkinson's disease: results of botulinum toxin treatment. *Aliment Pharmacol Ther.* 2005 Nov 15;22(10):997-1003.
193. Brocklehurst JC, Andrews K, Richards B, Laycock PJ. Incidence and correlates of incontinence in stroke patients. *J Am Geriatr Soc.* 1985 Aug;33(8):540-2.
194. Itoh Y, Yamada S, Konoeda F, Koizumi K, Nagata H, Oya M, et al. Burden of overactive bladder symptom on quality of life in stroke patients. *Neurourol Urodyn.* 2013 Jun;32(5):428-34.
195. Sakakibara R, Hattori T, Yasuda K, Yamanishi T. Micturitional disturbance after acute hemispheric stroke: analysis of the lesion site by CT and MRI. *J Neurol Sci.* 1996 Apr;137(1):47-56.
196. Brittain KR, Perry SI, Peet SM, Shaw C, Dallosso H, Assassa RP, et al. Prevalence and impact of urinary symptoms among community-dwelling stroke survivors. *Stroke.* 2000 Apr;31(4):886-91.
197. Williams MP, Srikanth V, Bird M, Thrift AG. Urinary symptoms and natural history of urinary continence after first-ever stroke--a longitudinal population-based study. *Age Ageing.* 2012 May;41(3):371-6.
198. Thomas LH, Barrett J, Cross S, French B, Leathley M, Sutton C, et al. Prevention and treatment of urinary incontinence after stroke in adults. *Cochrane Database Syst Rev.* 2005(3):CD004462.

199. Kuptniratsaikul V, Kovindha A, Suethanapornkul S, Manimmanakorn N, Archongka Y. Complications during the rehabilitation period in Thai patients with stroke: a multicenter prospective study. *Am J Phys Med Rehabil.* 2009 Feb;88(2):92-9.
200. Khan Z, Hertanu J, Yang WC, Melman A, Leiter E. Predictive correlation of urodynamic dysfunction and brain injury after cerebrovascular accident. *J Urol.* 1981 Jul;126(1):86-8.
201. Khan Z, Starer P, Yang WC, Bhola A. Analysis of voiding disorders in patients with cerebrovascular accidents. *Urology.* 1990 Mar;35(3):265-70.
202. Bogousslavsky J, Regli F. Anterior cerebral artery territory infarction in the Lausanne Stroke Registry. Clinical and etiologic patterns. *Arch Neurol.* 1990 Feb;47(2):144-50.
203. Woessner H, Vibhute P, Barrett K. Acute loss of bladder control in a stroke of the frontal cortex. *Neurohospitalist.* 2012 Oct;2(4):129-31.
204. Sakakibara R, Hattori T, Yasuda K, Yamanishi T. Micturitional disturbance and the pontine tegmental lesion: urodynamic and MRI analyses of vascular cases. *J Neurol Sci.* 1996 Sep 15;141(1-2):105-10.
205. Tokushige S, Maekawa R, Nose Y, Shiio Y. [A case of lateral medullary syndrome with neurogenic bladder]. *Rinsho Shinkeigaku.* 2012;52(2):79-83.
206. Naganuma M, Inatomi Y, Yonehara T, Hashimoto Y, Hirano T, Uchino M. [Urinary retention associated with unilateral medullary infarction]. *Rinsho Shinkeigaku.* 2005 Jun;45(6):431-6.
207. Sakakibara R, Hattori T, Yasuda K, Yamanishi T. Micturitional disturbance and the pontine tegmental lesion: urodynamic and MRI analyses of vascular cases. *Journal of Neurological Sciences.* 1996;141:105-10.
208. Yum KS, Na SJ, Lee KY, Kim J, Oh SH, Kim YD, et al. Pattern of voiding dysfunction after acute brainstem infarction. *Eur Neurol.* 2013;70(5-6):291-6.
209. Nardulli R, Monitillo V, Losavio E, Fiore P, Nicolardi G, Megna G. Urodynamic evaluation of 12 ataxic subjects: neurophysiopathologic considerations. *Funct Neurol.* 1992 May-Jun;7(3):223-5.
210. Kumral E, Bayulkem G, Evyapan D, Yuntan N. Spectrum of anterior cerebral artery territory infarction: clinical and MRI findings. *Eur J Neurol.* 2002 Nov;9(6):615-24.
211. Kim TG, Yoo KH, Jeon SH, Lee HL, Chang SG. Effect of dominant hemispheric stroke on detrusor function in patients with lower urinary tract symptoms. *Int J Urol.* 2010 Jul;17(7):656-60.
212. Ersoz M, Tunc H, Akyuz M, Ozel S. Bladder storage and emptying disorder frequencies in hemorrhagic and ischemic stroke patients with bladder dysfunction. *Cerebrovasc Dis.* 2005;20(5):395-9.
213. Han KS, Heo SH, Lee SJ, Jeon SH, Yoo KH. Comparison of urodynamics between ischemic and hemorrhagic stroke patients; can we suggest the category of urinary dysfunction in patients with cerebrovascular accident according to type of stroke? *Neurourol Urodyn.* 2010 Mar;29(3):387-90.
214. Drake MJ, Fowler CJ, Griffiths D, Mayer E, Paton JF, Birder L. Neural control of the lower urinary and gastrointestinal tracts: supraspinal CNS mechanisms. *Neurourol Urodyn.* 2010;29(1):119-27.
215. Birder L, de Groat W, Mills I, Morrison J, Thor K, Drake M. Neural control of the lower urinary tract: peripheral and spinal mechanisms. *Neurourol Urodyn.* 2010;29(1):128-39.
216. Masuda H, Chancellor MB, Kihara K, Sakai Y, Koga F, Azuma H, et al. Effects of cholinesterase inhibition in supraspinal and spinal neural pathways on the micturition reflex in rats. *BJU Int.* 2009 Oct;104(8):1163-9.
217. Gelber DA, Good DC, Laven LJ, Verhulst SJ. Causes of urinary incontinence after acute hemispheric stroke. *Stroke.* 1993 Mar;24(3):378-82.
218. Kong KH, Chan KF, Lim AC, Tan ES. Detrusor hyperreflexia in strokes. *Ann Acad Med Singapore.* 1994 May;23(3):319-21.
219. Nitti VW, Adler H, Combs AJ. The role of urodynamics in the evaluation of voiding dysfunction in men after cerebrovascular accident. *J Urol.* 1996 Jan;155(1):263-6.
220. Natsume O. Detrusor contractility and overactive bladder in patients with cerebrovascular accident. *Int J Urol.* 2008 Jun;15(6):505-10; discussion 10.
221. Gupta A, Taly AB, Srivastava A, Thyloth M. Urodynamics post stroke in patients with urinary incontinence: Is there correlation between bladder type and site of lesion? *Ann Indian Acad Neurol.* 2009 Apr;12(2):104-7.
222. Yoo KH, Lee SJ, Chang SG. Predictive value of the ischemic stroke lesion to detrusor function. *Neurourol Urodyn.* 2010 Sep;29(7):1355-6.
223. Wade DT, Hewer RL. Outlook after an acute stroke: urinary incontinence and loss of consciousness compared in 532 patients. *Q J Med.* 1985 Sep;56(221):601-8.
224. Barer DH, Mitchell JR. Predicting the outcome of acute stroke: do multivariate models help? *Q J Med.* 1989 Jan;70(261):27-39.

225. Barer DH. Continence after stroke: useful predictor or goal of therapy? *Age Ageing*. 1989 May;18(3):183-91.
226. Rotar M, Blagus R, Jeromel M, Skrbec M, Trsinar B, Vodusek DB. Stroke patients who regain urinary continence in the first week after acute first-ever stroke have better prognosis than patients with persistent lower urinary tract dysfunction. *Neurol Urodyn*. 2011 Sep;30(7):1315-8.
227. Nyberg L, Gustafson Y. Fall prediction index for patients in stroke rehabilitation. *Stroke*. 1997 Apr;28(4):716-21.
228. van Kuijk AA, van der Linde H, van Limbeek J. Urinary incontinence in stroke patients after admission to a postacute inpatient rehabilitation program. *Arch Phys Med Rehabil*. 2001 Oct;82(10):1407-11.
229. Landi F, Onder G, Cesari M, Zamboni V, Russo A, Barillaro C, et al. Functional decline in frail community-dwelling stroke patients. *Eur J Neurol*. 2006 Jan;13(1):17-23.
230. Pettersen R, Wyller TB. Prognostic significance of micturition disturbances after acute stroke. *J Am Geriatr Soc*. 2006 Dec;54(12):1878-84.
231. Pettersen R, Stien R, Wyller TB. Post-stroke urinary incontinence with impaired awareness of the need to void: clinical and urodynamic features. *BJU Int*. 2007 May;99(5):1073-7.
232. Paolucci S, Antonucci G, Grasso MG, Pizzamiglio L. The role of unilateral spatial neglect in rehabilitation of right brain-damaged ischemic stroke patients: a matched comparison. *Arch Phys Med Rehabil*. 2001 Jun;82(6):743-9.
233. Daviet JC, Borie MJ, Salle JY, Popielarz S, Verdie C, Munoz M, et al. [Epidemiology and prognostic significance of bladder sphincter disorders after an initial cerebral hemisphere vascular accident]. *Ann Readapt Med Phys*. 2004 Oct;47(8):531-6.
234. Sakakibara R, Panicker J, Fowler CJ, Tateno F, Kishi M, Tsuyuzaki Y, et al. Vascular incontinence: incontinence in the elderly due to ischemic white matter changes. *Neurol Int*. 2012 Jun 14;4(2):e13.
235. Sakakibara R, Hattori T, Uchiyama T, Yamanishi T. Urinary function in elderly people with and without leukoaraiosis: relation to cognitive and gait function. *J Neurol Neurosurg Psychiatry*. 1999 Nov;67(5):658-60.
236. Tadic SD, Griffiths D, Murrin A, Schaefer W, Aizenstein HJ, Resnick NM. Brain activity during bladder filling is related to white matter structural changes in older women with urinary incontinence. *Neuroimage*. 2010 Jul 15;51(4):1294-302.
237. Kuchel GA, Moscufo N, Guttmann CR, Zeevi N, Wakefield D, Schmidt J, et al. Localization of brain white matter hyperintensities and urinary incontinence in community-dwelling older adults. *J Gerontol A Biol Sci Med Sci*. 2009 Aug;64(8):902-9.
238. Hanyu H, Shimuzu S, Tanaka Y, Takasaki M, Koizumi K, Abe K. Cerebral blood flow patterns in Binswanger's disease: a SPECT study using three-dimensional stereotactic surface projections. *J Neurol Sci*. 2004 May 15;220(1-2):79-84.
239. Sakagami M, Pan X, Uttl B. Behavioral inhibition and prefrontal cortex in decision-making. *Neural Netw*. 2006 Oct;19(8):1255-65.
240. Declerck CH, Boone C, De Brabander B. On feeling in control: a biological theory for individual differences in control perception. *Brain Cogn*. 2006 Nov;62(2):143-76.
241. Takahashi O, Sakakibara R, Panicker J, Fowler CJ, Tateno F, Kishi M, et al. White matter lesions or Alzheimer's disease: which contributes more to overactive bladder and incontinence in elderly adults with dementia? *J Am Geriatr Soc*. 2012 Dec;60(12):2370-1.
242. Del-Ser T, Munoz DG, Hachinski V. Temporal pattern of cognitive decline and incontinence is different in Alzheimer's disease and diffuse Lewy body disease. *Neurology*. 1996 Mar;46(3):682-6.
243. Dumoulin C, Korner-Bitensky N, Tannenbaum C. Urinary incontinence after stroke: does rehabilitation make a difference? A systematic review of the effectiveness of behavioral therapy. *Top Stroke Rehabil*. 2005 Summer;12(3):66-76.
244. Tibaek S, Gard G, Jensen R. Pelvic floor muscle training is effective in women with urinary incontinence after stroke: a randomised, controlled and blinded study. *Neurol Urodyn*. 2005;24(4):348-57.
245. McKeage K. Propiverine: a review of its use in the treatment of adults and children with overactive bladder associated with idiopathic or neurogenic detrusor overactivity, and in men with lower urinary tract symptoms. *Clin Drug Invest*. 2013 Jan;33(1):71-91.
246. Sakakibara R, Tateno F, Yano M, Takahashi O, Sugiyama M, Ogata T, et al. Imidafenacin on bladder and cognitive function in neurologic OAB patients. *Clin Auton Res*. 2013 Aug;23(4):189-95.

247. Sakakibara, Tateno F, Yano M, Takahashi O, Sugiyama M, Ogata T, et al. Tolterodine activates the prefrontal cortex during bladder filling in OAB patients: a real-time NIRS-urodynamics study. *Neurourol Urodyn.* 2014 Sep;33(7):1110-5.
248. Sakakibara R, Ogata T, Uchiyama T, Kishi M, Ogawa E, Isaka S, et al. How to manage overactive bladder in elderly individuals with dementia? A combined use of donepezil, a central acetylcholinesterase inhibitor, and propiverine, a peripheral muscarine receptor antagonist. *J Am Geriatr Soc.* 2009 Aug;57(8):1515-7.
249. Tyagi P, Tyagi V, Chancellor M. Mirabegron: a safety review. *Expert Opin Drug Saf.* 2011 Mar;10(2):287-94.
250. Song FJ, Jiang SH, Zheng SL, Ye TS, Zhang H, Zhu WZ, et al. [Electroacupuncture for post-stroke urinary incontinence: a multi-center randomized controlled study]. *Zhongguo Zhen Jiu.* 2013 Sep;33(9):769-73.
251. Yu KW, Lin CL, Hung CC, Chou EC, Hsieh YL, Li TM, et al. Effects of electroacupuncture on recent stroke inpatients with incomplete bladder emptying: a preliminary study. *Clin Interv Aging.* 2012;7:469-74.
252. Kuo HC. Therapeutic effects of suburothelial injection of botulinum a toxin for neurogenic detrusor overactivity due to chronic cerebrovascular accident and spinal cord lesions. *Urology.* 2006 Feb;67(2):232-6.
253. Centonze D, Petta F, Versace V, Rossi S, Torelli F, Prosperetti C, et al. Effects of motor cortex rTMS on lower urinary tract dysfunction in multiple sclerosis. *Mult Scler.* 2007 Mar;13(2):269-71.
254. Brusa L, Finazzi Agro E, Petta F, Sciobica F, Torriero S, Lo Gerfo E, et al. Effects of inhibitory rTMS on bladder function in Parkinson's disease patients. *Mov Disord.* 2009 Feb 15;24(3):445-8.
255. Herbaut AG, Nogueira MC, Wespes E. Urinary retention due to sacral myeloradiculitis: a clinical and neurophysiological study. *J Urol.* 1990 Nov;144(5):1206-8.
256. Sakakibara R, Uchiyama T, Liu Z, Yamamoto T, Ito T, Uzawa A, et al. Meningitis-retention syndrome. An unrecognized clinical condition. *J Neurol.* 2005 Dec;252(12):1495-9.
257. Sakakibara R, Yamanishi T, Uchiyama T, Hattori T. Acute urinary retention due to benign inflammatory nervous diseases. *J Neurol.* 2006 Aug;253(8):1103-10.
258. Schwarz S, Mohr A, Knauth M, Wildemann B, Storch-Hagenlocher B. Acute disseminated encephalomyelitis: a follow-up study of 40 adult patients. *Neurology.* 2001 May 22;56(10):1313-8.
259. Kawamura M, Kaku H, Takayama N, Ushimi T, Kishida S. [Acute urinary retention secondary to aseptic meningoencephalitis in an infant--case report]. *Brain Nerve.* 2007 Nov;59(11):1287-91.
260. Sakakibara R, Hattori T, Yasuda K, Yamanishi T. Micturitional disturbance in acute disseminated encephalomyelitis (ADEM). *J Auton Nerv Syst.* 1996 Sep 12;60(3):200-5.
261. Panicker JN, Nagaraja D, Kovoor JM, Nair KP, Subbakrishna DK. Lower urinary tract dysfunction in acute disseminated encephalomyelitis. *Mult Scler.* 2009 Sep;15(9):1118-22.
262. Pradhan S, Gupta RK, Kapoor R, Shashank S, Kathuria MK. Parainfectious conus myelitis. *J Neurol Sci.* 1998 Dec 11;161(2):156-62.
263. Hiraga A, Sakakibara R, Mori M, Yamanaka Y, Ito S, Hattori T. Urinary retention can be the sole initial manifestation of acute myelitis. *J Neurol Sci.* 2006 Dec 21;251(1-2):110-2.
264. Hiraga A, Sakakibara R, Mori M, Suzuki A, Hattori T. Bilateral lesion in the lateral columns and complete urinary retention: association with the spinal cord descending pathway for micturition. *Neurourol Urodyn.* 2005;24(4):398-9.
265. Tascilar N, Aydemir H, Emre U, Unal A, Atasoy HT, Ekem S. Unusual combination of reversible splenial lesion and meningitis-retention syndrome in aseptic meningomyelitis. *Clinics (Sao Paulo).* 2009;64(9):932-7.
266. Hsu JJ, Chuang SH, Chen CH, Huang MH. Sacral myeloradiculitis (Elsberg syndrome) secondary to eosinophilic meningitis caused by *Angiostrongylus cantonensis*. *BMJ Case Rep.* 2009;2009.
267. Ntziora F, Alevizopoulos A, Konstantopoulos K, Kanellopoulou S, Bougas D, Stravodimos K. Aseptic meningitis with urinary retention: a case report. *Case Rep Med.* 2011;2011:741621.
268. Takahashi O, Sakakibara R, Kishi M, Matsuzawa Y, Ogawa E, Sugiyama M, et al. Herbal medicine-induced meningitis-retention syndrome. *Intern Med.* 2010;49(16):1813-6.
269. Kim TW, Whang JC, Lee SH, Choi JI, Park SM, Lee JB. Acute Urinary Retention due to Aseptic Meningitis: Meningitis-Retention Syndrome. *Int Neurourol J.* 2010 Aug;14(2):122-4.

270. Tateno F, Sakakibara R, Sugiyama M, Takahashi O, Kishi M, Ogawa E, et al. Meningitis-retention syndrome: first case of urodynamic follow-up. *Intern Med.* 2011;50(12):1329-32.
271. Fujita K, Tanaka T, Kono S, Narai H, Omori N, Manabe Y, et al. Urinary retention secondary to *Listeria meningitis*. *Intern Med.* 2008;47(12):1129-31.
272. Dyck PJ, Windebank AJ. Diabetic and nondiabetic lumbosacral radiculoplexus neuropathies: new insights into pathophysiology and treatment. *Muscle Nerve.* 2002 Apr;25(4):477-91.
273. Tenembaum S, Chitnis T, Ness J, Hahn JS, International Pediatric MSSG. Acute disseminated encephalomyelitis. *Neurology.* 2007 Apr 17;68(16 Suppl 2):S23-36.
274. Wender M. Acute disseminated encephalomyelitis (ADEM). *J Neuroimmunol.* 2011 Feb;231(1-2):92-9.
275. Schkrohwsky JG, Hoernschemeyer DG, Carson BS, Ain MC. Early presentation of spinal stenosis in achondroplasia. *J Pediatr Orthop.* 2007 Mar;27(2):119-22.
276. Johnsson KE, Sass M. Cauda equina syndrome in lumbar spinal stenosis: case report and incidence in Jutland, Denmark. *J Spinal Disord Tech.* 2004 Aug;17(4):334-5.
277. Goh KJ, Khalifa W, Anslow P, Cadoux-Hudson T, Donaghy M. The clinical syndrome associated with lumbar spinal stenosis. *Eur Neurol.* 2004;52(4):242-9.
278. Jensen RL. Cauda equina syndrome as a post-operative complication of lumbar spine surgery. *Neurosurg Focus.* 2004 Jun 15;16(6):e7.
279. Imran Y, Halim Y. Acute cauda equina syndrome secondary to free fat graft following spinal decompression. *Singapore Med J.* 2005 Jan;46(1):25-7.
280. Tubbs RS, Oakes WJ, Blount JP. Isolated atlantal stenosis in a patient with idiopathic growth hormone deficiency, and Klippel-Feil and Duane's syndromes. *Childs Nerv Syst.* 2005 May;21(5):421-4.
281. Alvarez JA, Hardy RH, Jr. Lumbar spine stenosis: a common cause of back and leg pain. *Am Fam Physician.* 1998 Apr 15;57(8):1825-34, 39-40.
282. Miyata M, Mizunaga M, Taniguchi N, Kaneko S, Yachiku S, Atsuta Y. Neuropathic bladder dysfunction in patients with ossification of the posterior longitudinal ligament. *Int J Urol.* 1998 Nov;5(6):540-5.
283. Yamanishi T, Yasuda K, Sakakibara R, Murayama N, Hattori T, Ito H. Detrusor overactivity and penile erection in patients with lower lumbar spine lesions. *Eur Urol.* 1998 Oct;34(4):360-4.
284. Lee TT, Manzano GR, Green BA. Modified open-door cervical expansive laminoplasty for spondylotic myelopathy: operative technique, outcome, and predictors for gait improvement. *J Neurosurg.* 1997 Jan;86(1):64-8.
285. Bartels RH, de Vries J. Hemi-cauda equina syndrome from herniated lumbar disc: a neurosurgical emergency? *Can J Neurol Sci.* 1996 Nov;23(4):296-9.
286. Ahn UM, Ahn NU, Buchowski JM, Garrett ES, Sieber AN, Kostuik JP. Cauda equina syndrome secondary to lumbar disc herniation: a meta-analysis of surgical outcomes. *Spine (Phila Pa 1976).* 2000 Jun 15;25(12):1515-22.
287. Shapiro S. Medical realities of cauda equina syndrome secondary to lumbar disc herniation. *Spine (Phila Pa 1976).* 2000 Feb 1;25(3):348-51; discussion 52.
288. Podnar S. Epidemiology of cauda equina and conus medullaris lesions. *Muscle Nerve.* 2007 Apr;35(4):529-31.
289. Kostuik JP, Harrington I, Alexander D, Rand W, Evans D. Cauda equina syndrome and lumbar disc herniation. *J Bone Joint Surg Am.* 1986 Mar;68(3):386-91.
290. McCarthy MJ, Aylott CE, Grevitt MP, Hegarty J. Cauda equina syndrome: factors affecting long-term functional and sphincteric outcome. *Spine (Phila Pa 1976).* 2007 Jan 15;32(2):207-16.
291. Fanciullacci F, Sandri S, Politi P, Zanollo A. Clinical, urodynamic and neurophysiological findings in patients with neuropathic bladder due to a lumbar intervertebral disc protrusion. *Paraplegia.* 1989 Oct;27(5):354-8.
292. Inui Y, Doita M, Ouchi K, Tsukuda M, Fujita N, Kurosaka M. Clinical and radiologic features of lumbar spinal stenosis and disc herniation with neuropathic bladder. *Spine (Phila Pa 1976).* 2004 Apr 15;29(8):869-73.
293. Podnar S, Oblak C, Vodusek DB. Sexual function in men with cauda equina lesions: a clinical and electromyographic study. *J Neurol Neurosurg Psychiatry.* 2002 Dec;73(6):715-20.
294. Jalloh I, Minhas P. Delays in the treatment of cauda equina syndrome due to its variable clinical features in patients presenting to the emergency department. *Emerg Med J.* 2007 Jan;24(1):33-4.
295. Lavy C, James A, Wilson-MacDonald J, Fairbank J. Cauda equina syndrome. *BMJ.* 2009;338:b936.

296. Podnar S. Bowel dysfunction in patients with cauda equina lesions. *Eur J Neurol*. 2006 Oct;13(10):1112-7.
297. Kennedy JG, Soffe KE, McGrath A, Stephens MM, Walsh MG, McManus F. Predictors of outcome in cauda equina syndrome. *Eur Spine J*. 1999;8(4):317-22.
298. Cinotti G, Gumina S, Giannicola G, Postacchini F. Contralateral recurrent lumbar disc herniation. Results of discectomy compared with those in primary herniation. *Spine (Phila Pa 1976)*. 1999 Apr 15;24(8):800-6.
299. Postacchini F. Management of herniation of the lumbar disc. *J Bone Joint Surg Br*. 1999 Jul;81(4):567-76.
300. Henriques T, Olerud C, Petren-Mallmin M, Ahl T. Cauda equina syndrome as a postoperative complication in five patients operated for lumbar disc herniation. *Spine (Phila Pa 1976)*. 2001 Feb 1;26(3):293-7.
301. Bartolin Z, Gilja I, Bedalov G, Savic I. Bladder function in patients with lumbar intervertebral disk protrusion. *J Urol*. 1998 Mar;159(3):969-71.
302. Bartolin Z, Vilendecic M, Derezic D. Bladder function after surgery for lumbar intervertebral disk protrusion. *J Urol*. 1999 Jun;161(6):1885-7.
303. Yamanishi T, Yasuda K, Yuki T, Sakakibara R, Uchiyama T, Kamai T, et al. Urodynamic evaluation of surgical outcome in patients with urinary retention due to central lumbar disc prolapse. *Neurourol Urodyn*. 2003;22(7):670-5.
304. Podnar S, Trsinar B, Vodusek DB. Bladder dysfunction in patients with cauda equina lesions. *Neurourol Urodyn*. 2006;25(1):23-31.
305. Transverse Myelitis Consortium Working G. Proposed diagnostic criteria and nosology of acute transverse myelitis. *Neurology*. 2002 Aug 27;59(4):499-505.
306. Ganesan V, Borzyskowski M. Characteristics and course of urinary tract dysfunction after acute transverse myelitis in. *Dev Med Child Neurol*. 2001 Jul;43(7):473-5.
307. Cheng W, Chiu R, Tam P. Residual bladder dysfunction 2 to 10 years after acute transverse myelitis. *J Paediatr Child Health*. 1999 Oct;35(5):476-8.
308. Leroy-Malherbe V, Sebire G, Hollenberg H, Tardieu M, Landrieu P. [Neurogenic bladder in children with acute transverse myelopathy]. *Arch Pediatr*. 1998 May;5(5):497-502.
309. Kalita J, Shah S, Kapoor R, Misra UK. Bladder dysfunction in acute transverse myelitis: magnetic resonance imaging and neurophysiological and urodynamic correlations. *J Neurol Neurosurg Psychiatry*. 2002 Aug;73(2):154-9.
310. Sakakibara R, Hattori T, Yasuda K, Yamanishi T. Micturition disturbance in acute transverse myelitis. *Spinal Cord*. 1996 Aug;34(8):481-5.
311. Berger Y, Blaivas JG, Oliver L. Urinary dysfunction in transverse myelitis. *J Urol*. 1990 Jul;144(1):103-5.
312. Krishnan C, Kaplin AI, Pardo CA, Kerr DA, Keswani SC. Demyelinating disorders: update on transverse myelitis. *Curr Neurol Neurosci Rep*. 2006 May;6(3):236-43.
313. Bourre B. Prognostic factors of acute partial transverse myelitis-reply. *Arch Neurol*. 2012 Nov 1;69(11):1523-4.
314. Gajofatto A, Benedetti MD. Prognostic factors of acute partial transverse myelitis. *Arch Neurol*. 2012 Nov;69(11):1523; author reply -4.
315. Hughes RA, Cornblath DR. Guillain-Barre syndrome. *Lancet*. 2005 Nov 5;366(9497):1653-66.
316. Hughes RA, Wijdicks EF, Benson E, Cornblath DR, Hahn AF, Meythaler JM, et al. Supportive care for patients with Guillain-Barre syndrome. *Arch Neurol*. 2005 Aug;62(8):1194-8.
317. Asahina M, Kuwabara S, Suzuki A, Hattori T. Autonomic function in demyelinating and axonal subtypes of Guillain-Barre syndrome. *Acta Neurol Scand*. 2002 Jan;105(1):44-50.
318. Sakakibara R, Hattori T, Kuwabara S, Yamanishi T, Yasuda K. Micturitional disturbance in patients with Guillain-Barre syndrome. *J Neurol Neurosurg Psychiatry*. 1997 Nov;63(5):649-53.
319. Guillain G, Barre JA, Strohl A. [Radiculoneuritis syndrome with hyperalbuminosis of cerebrospinal fluid without cellular reaction. Notes on clinical features and graphs of tendon reflexes. 1916]. *Ann Med Interne (Paris)*. 1999 Jan;150(1):24-32.
320. Wheeler JS, Jr., Siroky MB, Pavlakis A, Krane RJ. The urodynamic aspects of the Guillain-Barre syndrome. *J Urol*. 1984 May;131(5):917-9.
321. Grbavac Z, Gilja I, Gubarev N, Bozicevic D. [Neurologic and urodynamic characteristics of patients with Guillain-Barre syndrome]. *Lijec Vjesn*. 1989 Jan-Feb;111(1-2):17-20.

322. Sawai S, Sakakibara R, Uchiyama T, Liu Z, Yamamoto T, Ito T, et al. Acute motor axonal neuropathy presenting with bowel, bladder, and erectile dysfunction. *J Neurol.* 2007 Feb;254(2):250-2.
323. Sakakibara R, Uchiyama T, Tamura N, Kuwabara S, Asahina M, Hattori T. Urinary retention and sympathetic sphincter obstruction in axonal Guillain-Barre syndrome. *Muscle Nerve.* 2007 Jan;35(1):111-5.
324. Lichtenfeld P. Autonomic dysfunction in the Guillain-Barre syndrome. *Am J Med.* 1971 Jun;50(6):772-80.
325. Crino PB, Zimmerman R, Laskowitz D, Raps EC, Rostami AM. Magnetic resonance imaging of the cauda equina in Guillain-Barre syndrome. *Neurology.* 1994 Jul;44(7):1334-6.
326. Zochodne DW. Autonomic involvement in Guillain-Barre syndrome: a review. *Muscle Nerve.* 1994 Oct;17(10):1145-55.
327. Wosnitzer MS, Walsh R, Rutman MP. The use of sacral neuromodulation for the treatment of non-obstructive urinary retention secondary to Guillain-Barre syndrome. *Int Urogynecol J Pelvic Floor Dysfunct.* 2009 Sep;20(9):1145-7.
328. Burns TM, Lawn ND, Low PA, Camilleri M, Wijdicks EF. Adynamic ileus in severe Guillain-Barre syndrome. *Muscle Nerve.* 2001 Jul;24(7):963-5.
329. Gazulla Abio J, Benavente Aguilar I. [Paraparesis, hyperprolactinemia and adynamic ileus in Guillain-Barre syndrome]. *Neurologia.* 2004 Sep;19(7):396-400.
330. Nowe T, Huttemann K, Engelhorn T, Schellinger PD, Kohrman M. Paralytic ileus as a presenting symptom of Guillain-Barre syndrome. *J Neurol.* 2008 May;255(5):756-7.
331. Herlenius G, Wilczek HE, Larsson M, Ericzon BG, Familial Amyloidotic Polyneuropathy World Transplant R. Ten years of international experience with liver transplantation for familial amyloidotic polyneuropathy: results from the Familial Amyloidotic Polyneuropathy World Transplant Registry. *Transplantation.* 2004 Jan 15;77(1):64-71.
332. Lobato L, Ventura A, Beirao I, Miranda HP, Seca R, Henriques AC, et al. End-stage renal disease in familial amyloidosis ATTR Val30Met: a definitive indication to combined liver-kidney transplantation. *Transplant Proc.* 2003 May;35(3):1116-20.
333. Ito T, Sakakibara R, Ito S, Uchiyama T, Liu Z, Yamamoto T, et al. Mechanism of constipation in familial amyloid polyneuropathy: a case report. *Intern Med.* 2006;45(20):1173-5.
334. Adams D, Samuel D, Goulon-Goeau C, Nakazato M, Costa PM, Feray C, et al. The course and prognostic factors of familial amyloid polyneuropathy after liver transplantation. *Brain.* 2000 Jul;123 (Pt 7):1495-504.
335. Saini J, Axelrod FB, Maayan C, Stringer J, Smilen SW. Urinary incontinence in familial dysautonomia. *Int Urogynecol J Pelvic Floor Dysfunct.* 2003 Aug;14(3):209-13; discussion 13.
336. Krhut J, Mazanec R, Seeman P, Mann-Gow T, Zvara P. Lower urinary tract functions in a series of Charcot-Marie-Tooth neuropathy patients. *Acta Neurol Scand.* 2014 May;129(5):319-24.
337. Tokuda N, Noto Y, Kitani-Morii F, Hamano A, Kasai T, Shiga K, et al. Parasympathetic Dominant Autonomic Dysfunction in Charcot-Marie-Tooth Disease Type 2J with the MPZ Thr124Met Mutation. *Intern Med.* 2015;54(15):1919-22.
338. Sakakibara R, Uchiyama T, Asahina M, Suzuki A, Yamanishi T, Hattori T. Micturition disturbance in acute idiopathic autonomic neuropathy. *J Neurol Neurosurg Psychiatry.* 2004 Feb;75(2):287-91.
339. Gibbons CH, Freeman R. Antibody titers predict clinical features of autoimmune autonomic ganglionopathy. *Auton Neurosci.* 2009 Mar 12;146(1-2):8-12.
340. Sakakibara R, Hattori T, Uchiyama T, Asahina M, Yamanishi T. Micturitional disturbance in pure autonomic failure. *Neurology.* 2000 Jan 25;54(2):499-501.
341. Waterman SA. Autonomic dysfunction in Lambert-Eaton myasthenic syndrome. *Clin Auton Res.* 2001 Jun;11(3):145-54.
342. Sandler PM, Avillo C, Kaplan SA. Detrusor areflexia in a patient with myasthenia gravis. *Int J Urol.* 1998 Mar;5(2):188-90.
343. Vernino S, Cheshire WP, Lennon VA. Myasthenia gravis with autoimmune autonomic neuropathy. *Auton Neurosci.* 2001 May 14;88(3):187-92.
344. MacLeod M, Kelly R, Robb SA, Borzyskowski M. Bladder dysfunction in Duchenne muscular dystrophy. *Arch Dis Child.* 2003 Apr;88(4):347-9.
345. Smith MD, Seth JH, Hanna MG, Panicker JN. Detrusor overactivity in Becker muscular dystrophy. *Muscle Nerve.* 2013 Mar;47(3):464-5.
346. Zhu Y, Romitti PA, Caspers Conway KM, Kim S, Zhang Y, Yang M, et al. Genitourinary health in a population-based cohort of males with Duchenne and Becker Muscular dystrophies. *Muscle Nerve.* 2015 Jul;52(1):22-7.

347. Crockett CD, Bertrand LA, Cooper CS, Rahhal RM, Liu K, Zimmerman MB, et al. Urologic and gastrointestinal symptoms in the dystroglycanopathies. *Neurology*. 2015 Feb 3;84(5):532-9.
348. Dogan C, De Antonio M, Hamroun D, Varet H, Fabbro M, Rougier F, et al. Gender as a Modifying Factor Influencing Myotonic Dystrophy Type 1 Phenotype Severity and Mortality: A Nationwide Multiple Databases Cross-Sectional Observational Study. *PLoS One*. 2016;11(2):e0148264.
349. Pelliccioni G, Scarpino O, Piloni V. Procainamide for faecal incontinence in myotonic dystrophy. *J Neurol Neurosurg Psychiatry*. 1999 Aug;67(2):257-8.
350. Sakakibara R, Hattori T, Tojo M, Yamanishi T, Yasuda K, Hirayama K. Micturitional disturbance in myotonic dystrophy. *J Auton Nerv Syst*. 1995 Mar 18;52(1):17-21.
351. Nishino I, Spinazzola A, Papadimitriou A, Hamans S, Steiner I, Hahn CD, et al. Mitochondrial neurogastrointestinal encephalomyopathy: an autosomal recessive disorder due to thymidine phosphorylase mutations. *Ann Neurol*. 2000 Jun;47(6):792-800.
352. Barrett TG, Scott-Brown M, Seller A, Bednarz A, Poulton K, Poulton J. The mitochondrial genome in Wolfram syndrome. *J Med Genet*. 2000 Jun;37(6):463-6.
353. Parys BT, Woolfenden KA, Parsons KF. Bladder dysfunction after simple hysterectomy: urodynamic and neurological evaluation. *Eur Urol*. 1990;17(2):129-33.
354. Sekido N, Kawai K, Akaza H. Lower urinary tract dysfunction as persistent complication of radical hysterectomy. *Int J Urol*. 1997 May;4(3):259-64.
355. Plotti F, Panici PB, Zullo MA, Angioli R. Re: Axelsen SM, Bek KM, Petersen LK. 2007. Urodynamic and ultrasound characteristics of incontinence after radical hysterectomy. *Neurourol Urodyn*. 2008;27(3):260-1; author reply 1.
356. Axelsen SM, Bek KM, Petersen LK. Urodynamic and ultrasound characteristics of incontinence after radical hysterectomy. *Neurourol Urodyn*. 2007;26(6):794-9.
357. Jackson SL, Scholes D, Boyko EJ, Abraham L, Fihn SD. Predictors of urinary incontinence in a prospective cohort of postmenopausal women. *Obstet Gynecol*. 2006 Oct;108(4):855-62.
358. Plotti F, Angioli R, Zullo MA, Sansone M, Altavilla T, Antonelli E, et al. Update on urodynamic bladder dysfunctions after radical hysterectomy for cervical cancer. *Crit Rev Oncol Hematol*. 2011 Nov;80(2):323-9.
359. Ito E, Saito T. Nerve-preserving techniques for radical hysterectomy. *Eur J Surg Oncol*. 2004 Dec;30(10):1137-40.
360. Ceccaroni M, Roviglione G, Spagnolo E, Casadio P, Clarizia R, Peiretti M, et al. Pelvic dysfunctions and quality of life after nerve-sparing radical hysterectomy: a multicenter comparative study. *Anticancer Res*. 2012 Feb;32(2):581-8.
361. Plotti F, Sansone M, Di Donato V, Angioli R, Panici PB. Late morbidity following nerve-sparing radical hysterectomy. *Gynecol Oncol*. 2010 Oct;119(1):169; author reply -70.
362. Cibula D, Velechovska P, Slama J, Fischerova D, Pinkavova I, Pavlista D, et al. Late morbidity following nerve-sparing radical hysterectomy. *Gynecol Oncol*. 2010 Mar;116(3):506-11.
363. Eickenberg HU, Amin M, Klompus W, Lich R, Jr. Urologic complications following abdominoperineal resection. *J Urol*. 1976 Feb;115(2):180-2.
364. Baumgarner GT, Miller HC. Genitourinary complications of abdominoperineal resection. *South Med J*. 1976 Jul;69(7):875-7.
365. Pocard M, Zinzindohoue F, Haab F, Caplin S, Parc R, Tiret E. A prospective study of sexual and urinary function before and after total mesorectal excision with autonomic nerve preservation for rectal cancer. *Surgery*. 2002 Apr;131(4):368-72.
366. Kim NK, Aahn TW, Park JK, Lee KY, Lee WH, Sohn SK, et al. Assessment of sexual and voiding function after total mesorectal excision with pelvic autonomic nerve preservation in males with rectal cancer. *Dis Colon Rectum*. 2002 Sep;45(9):1178-85.
367. Turoldo A, Balani A, Roseano M, Scaramucci M, Guidolin D, Pistan V, et al. [Functional complications of the lower urinary tract after curative exeresis for cancer of the rectum]. *Tumori*. 2003 Jul-Aug;89(4 Suppl):98-102.
368. Lim JF, Tjandra JJ, Hiscock R, Chao MW, Gibbs P. Preoperative chemoradiation for rectal cancer causes prolonged pudendal nerve terminal motor latency. *Dis Colon Rectum*. 2006 Jan;49(1):12-9.
369. Langer R, Neuman M, Ron-el R, Golan A, Bukovsky I, Caspi E. The effect of total abdominal hysterectomy on bladder function in asymptomatic women. *Obstet Gynecol*. 1989 Aug;74(2):205-7.

370. Fitzpatrick M, O'Brien C, O'Connell P R, O'Herlihy C. Patterns of abnormal pudendal nerve function that are associated with postpartum fecal incontinence. *Am J Obstet Gynecol*. 2003 Sep;189(3):730-5.
371. Sangwan YP, Collier JA, Schoetz DJ, Roberts PL, Murray JJ. Spectrum of abnormal rectoanal reflex patterns in patients with fecal incontinence. *Dis Colon Rectum*. 1996 Jan;39(1):59-65.
372. Nordling J, Meyhoff HH, Hald T, Gerstenberg T, Walter S, Christensen NJ. Urethral denervation hypersensitivity to noradrenaline after radical hysterectomy. *Scand J Urol Nephrol*. 1981;15(1):21-4.
373. Hosier GW, Tennankore KK, Himmelman JG, Gajewski J, Cox AR. Overactive Bladder and Storage Lower Urinary Tract Symptoms Following Radical Prostatectomy. *Urology*. 2016 Aug;94:193-7.
374. Hollabaugh RS, Jr., Steiner MS, Sellers KD, Sann BJ, Dmochowski RR. Neuroanatomy of the pelvis: implications for colonic and rectal resection. *Dis Colon Rectum*. 2000 Oct;43(10):1390-7.
375. Schwalenberg T, Neuhaus J, Liatsikos E, Winkler M, Löffler S, Stolzenburg JU. Neuroanatomy of the male pelvis in respect to radical prostatectomy including three-dimensional visualization. *BJU Int*. 2010 Jan;105(1):21-7.
376. Tong XK, Huo RJ. The anatomical basis and prevention of neurogenic voiding dysfunction following radical hysterectomy. *Surg Radiol Anat*. 1991;13(2):145-8.
377. Sakuragi N, Todo Y, Kudo M, Yamamoto R, Sato T. A systematic nerve-sparing radical hysterectomy technique in invasive cervical cancer for preserving postsurgical bladder function. *Int J Gynecol Cancer*. 2005 Mar-Apr;15(2):389-97.
378. Yabuki Y, Asamoto A, Hoshihara T, Nishimoto H, Nishikawa Y, Nakajima T. Radical hysterectomy: An anatomic evaluation of parametrial dissection. *Gynecol Oncol*. 2000 Apr;77(1):155-63.
379. Kuwabara Y, Suzuki M, Hashimoto M, Furugen Y, Yoshida K, Mitsunashi N. New method to prevent bladder dysfunction after radical hysterectomy for uterine cervical cancer. *J Obstet Gynaecol Res*. 2000 Feb;26(1):1-8.
380. Kneist W, Junginger T. Long-term urinary dysfunction after mesorectal excision: a prospective study with intraoperative electrophysiological confirmation of nerve preservation. *Eur J Surg Oncol*. 2007 Nov;33(9):1068-74.
381. Zanolta R, Monzeglio C, Campo B, Ordesi G, Balzarini A, Martino G. Bladder and urethral dysfunction after radical abdominal hysterectomy: rehabilitative treatment. *J Surg Oncol*. 1985 Mar;28(3):190-4.
382. Martins FE, Boyd SD. Artificial urinary sphincter in patients following major pelvic surgery and/or radiotherapy: are they less favorable candidates? *J Urol*. 1995 Apr;153(4):1188-93.
383. Ratto C, Grillo E, Parello A, Petrolino M, Costamagna G, Doglietto GB. Sacral neuromodulation in treatment of fecal incontinence following anterior resection and chemoradiation for rectal cancer. *Dis Colon Rectum*. 2005 May;48(5):1027-36.
384. Phe V, Chartier-Kastler E, Panicker JN. Management of neurogenic bladder in patients with multiple sclerosis. *Nat Rev Urol*. 2016 May;13(5):275-88.
385. Kingwell E, Marriott JJ, Jette N, Pringsheim T, Makhani N, Morrow SA, et al. Incidence and prevalence of multiple sclerosis in Europe: a systematic review. *BMC Neurol*. 2013;13:128.
386. Cetinel B, Tarcan T, Demirkesen O, Ozyurt C, Sen I, Erdogan S, et al. Management of lower urinary tract dysfunction in multiple sclerosis: a systematic review and Turkish consensus report. *Neurourol Urodyn*. 2013 Nov;32(8):1047-57.
387. Dilokthornsakul P, Valuck RJ, Nair KV, Corboy JR, Allen RR, Campbell JD. Multiple sclerosis prevalence in the United States commercially insured population. *Neurology*. 2016 Mar 15;86(11):1014-21.
388. Evans C, Beland SG, Kulaga S, Wolfson C, Kingwell E, Marriott J, et al. Incidence and prevalence of multiple sclerosis in the Americas: a systematic review. *Neuroepidemiology*. 2013;40(3):195-210.
389. Nortvedt MW, Riise T, Myhr KM, Landtblom AM, Bakke A, Nyland HI. Reduced quality of life among multiple sclerosis patients with sexual disturbance and bladder dysfunction. *Mult Scler*. 2001 Aug;7(4):231-5.
390. Bonniaud V, Parratte B, Amarenco G, Jackowski D, Didier JP, Guyatt G. Measuring quality of life in multiple sclerosis patients with urinary disorders using the Qualiveen questionnaire. *Arch Phys Med Rehabil*. 2004 Aug;85(8):1317-23.
391. Bonniaud V, Jackowski D, Parratte B, Paulseth R, Grad S, Margetts P, et al. Quality of life in multiple sclerosis patients with urinary disorders: discriminative validation of the English version of Qualiveen. *Qual Life Res*. 2005 Mar;14(2):425-31.

392. Marrie RA, Cutter G, Tyry T, Vollmer T, Campagnolo D. Disparities in the management of multiple sclerosis-related bladder symptoms. *Neurology*. 2007 Jun 5;68(23):1971-8.
393. Philp T, Read DJ, Higson RH. The urodynamic characteristics of multiple sclerosis. *Br J Urol*. 1981 Dec;53(6):672-5.
394. Gonor SE, Carroll DJ, Metcalfe JB. Vesical dysfunction in multiple sclerosis. *Urology*. 1985 Apr;25(4):429-31.
395. Betts CD, D'Mellow MT, Fowler CJ. Urinary symptoms and the neurological features of bladder dysfunction in multiple sclerosis. *J Neurol Neurosurg Psychiatry*. 1993 Mar;56(3):245-50.
396. Hinson JL, Boone TB. Urodynamics and multiple sclerosis. *Urol Clin North Am*. 1996 Aug;23(3):475-81.
397. Giannantoni A, Scivoletto G, Di Stasi SM, Grasso MG, Vespasiani G, Castellano V. Urological dysfunctions and upper urinary tract involvement in multiple sclerosis patients. *Neurourol Urodyn*. 1998;17(2):89-98.
398. de Seze M, Ruffion A, Denys P, Joseph PA, Perrouin-Verbe B. The neurogenic bladder in multiple sclerosis: review of the literature and proposal of management guidelines. *Mult Scler*. 2007 Aug;13(7):915-28.
399. Giannantoni A, Scivoletto G, Di Stasi SM, Grasso MG, Finazzi Agro E, Collura G, et al. Lower urinary tract dysfunction and disability status in patients with multiple sclerosis. *Arch Phys Med Rehabil*. 1999 Apr;80(4):437-41.
400. Koldewijn EL, Hommes OR, Lemmens WA, Debruyne FM, van Kerrebroeck PE. Relationship between lower urinary tract abnormalities and disease-related parameters in multiple sclerosis. *J Urol*. 1995 Jul;154(1):169-73.
401. Kasabian NG, Krause I, Brown WE, Khan Z, Nagler HM. Fate of the upper urinary tract in multiple sclerosis. *Neurourol Urodyn*. 1995;14(1):81-5.
402. Gallien P, Robineau S, Nicolas B, Le Bot MP, Brissot R, Verin M. Vesicourethral dysfunction and urodynamic findings in multiple sclerosis: a study of 149 cases. *Arch Phys Med Rehabil*. 1998 Mar;79(3):255-7.
403. Murphy AM, Bethoux F, Stough D, Goldman HB. Prevalence of stress urinary incontinence in women with multiple sclerosis. *Int Neurourol J*. 2012 Jun;16(2):86-90.
404. De Ridder D, Van Der Aa F, Debruyne J, D'Hooghe M B, Dubois B, Guillaume D, et al. Consensus guidelines on the neurologist's role in the management of neurogenic lower urinary tract dysfunction in multiple sclerosis. *Clin Neurol Neurosurg*. 2013 Oct;115(10):2033-40.
405. Phe V, Pakzad M, Curtis C, Porter B, Haslam C, Chataway J, et al. Urinary tract infections in multiple sclerosis. *Mult Scler*. 2016 Jun;22(7):855-61.
406. Metz LM, McGuinness SD, Harris C. Urinary tract infections may trigger relapse in multiple sclerosis. *Axone*. 1998 Jun;19(4):67-70.
407. Hillman LJ, Burns SP, Kraft GH. Neurological worsening due to infection from renal stones in a multiple sclerosis patient. *Mult Scler*. 2000 Dec;6(6):403-6.
408. Game X, Castel-Lacanal E, Bentaleb Y, Thiry-Escudie I, De Boissezon X, Malavaud B, et al. Botulinum toxin A detrusor injections in patients with neurogenic detrusor overactivity significantly decrease the incidence of symptomatic urinary tract infections. *Eur Urol*. 2008 Mar;53(3):613-8.
409. De Ridder D, van Poppel H, Demonty L, D'Hooghe B, Gonsette R, Carton H, et al. Bladder cancer in patients with multiple sclerosis treated with cyclophosphamide. *J Urol*. 1998 Jun;159(6):1881-4.
410. Panicker JN, Fowler CJ, Kessler TM. Lower urinary tract dysfunction in the neurological patient: clinical assessment and management. *Lancet Neurol*. 2015 Jul;14(7):720-32.
411. Lawrenson R, Wyndaele JJ, Vlachonikolis I, Farmer C, Glickman S. Renal failure in patients with neurogenic lower urinary tract dysfunction. *Neuroepidemiology*. 2001 May;20(2):138-43.
412. Porru D, Campus G, Garau A, Sorgia M, Pau AC, Spinici G, et al. Urinary tract dysfunction in multiple sclerosis: is there a relation with disease-related parameters? *Spinal Cord*. 1997 Jan;35(1):33-6.
413. Litwiller SE, Frohman EM, Zimmern PE. Multiple sclerosis and the urologist. *J Urol*. 1999 Mar;161(3):743-57.
414. Groen J, Pannek J, Castro Diaz D, Del Popolo G, Gross T, Hamid R, et al. Summary of European Association of Urology (EAU) Guidelines on Neuro-Urology. *Eur Urol*. 2016 Feb;69(2):324-33.
415. The National Institute for Health and Care Excellence. Urinary incontinence in neurological disease: assessment and management. <https://www.nice.org.uk/guidance/cg148>. 2012 [updated 2012; cited]; Available from.

416. Fowler CJ, Panicker JN, Drake M, Harris C, Harrison SC, Kirby M, et al. A UK consensus on the management of the bladder in multiple sclerosis. *J Neurol Neurosurg Psychiatry*. 2009 May;80(5):470-7.
417. Nortvedt MW, Riise T, Frugard J, Mohn J, Bakke A, Skar AB, et al. Prevalence of bladder, bowel and sexual problems among multiple sclerosis patients two to five years after diagnosis. *Mult Scler*. 2007 Jan;13(1):106-12.
418. Hennessey A, Robertson NP, Swingler R, Compston DA. Urinary, faecal and sexual dysfunction in patients with multiple sclerosis. *J Neurol*. 1999 Nov;246(11):1027-32.
419. Chia YW, Fowler CJ, Kamm MA, Henry MM, Lemieux MC, Swash M. Prevalence of bowel dysfunction in patients with multiple sclerosis and bladder dysfunction. *J Neurol*. 1995 Jan;242(2):105-8.
420. Munteis E, Andreu M, Tellez MJ, Mon D, Ois A, Roquer J. Anorectal dysfunction in multiple sclerosis. *Mult Scler*. 2006 Apr;12(2):215-8.
421. Bakke A, Myhr KM, Gronning M, Nyland H. Bladder, bowel and sexual dysfunction in patients with multiple sclerosis--a cohort study. *Scand J Urol Nephrol Suppl*. 1996;179:61-6.
422. Hinds JP, Eidelman BH, Wald A. Prevalence of bowel dysfunction in multiple sclerosis. A population survey. *Gastroenterology*. 1990 Jun;98(6):1538-42.
423. Johanson JF, Lafferty J. Epidemiology of fecal incontinence: the silent affliction. *Am J Gastroenterol*. 1996 Jan;91(1):33-6.
424. Munteis E, Andreu M, Martinez-Rodriguez J, Ois A, Bory F, Roquer J. Manometric correlations of anorectal dysfunction and biofeedback outcome in patients with multiple sclerosis. *Mult Scler*. 2008 Mar;14(2):237-42.
425. Basilisco G, Barbera R, Vanoli M, Bianchi P. Anorectal dysfunction and delayed colonic transit in patients with progressive systemic sclerosis. *Dig Dis Sci*. 1993 Aug;38(8):1525-9.
426. Weber J, Grise P, Roquebert M, Hellot MF, Mihout B, Samson M, et al. Radiopaque markers transit and anorectal manometry in 16 patients with multiple sclerosis and urinary bladder dysfunction. *Dis Colon Rectum*. 1987 Feb;30(2):95-100.
427. Chia YW, Gill KP, Jameson JS, Forti AD, Henry MM, Swash M, et al. Paradoxical puborectalis contraction is a feature of constipation in patients with multiple sclerosis. *J Neurol Neurosurg Psychiatry*. 1996 Jan;60(1):31-5.
428. Jackson AB, Dijkers M, Devivo MJ, Poczatek RB. A demographic profile of new traumatic spinal cord injuries: change and stability over 30 years. *Arch Phys Med Rehabil*. 2004 Nov;85(11):1740-8.
429. Stover SL, Fine PR. The epidemiology and economics of spinal cord injury. *Paraplegia*. 1987 Jun;25(3):225-8.
430. Maynard FM, Jr., Bracken MB, Creasey G, Ditunno JF, Jr., Donovan WH, Ducker TB, et al. International Standards for Neurological and Functional Classification of Spinal Cord Injury. American Spinal Injury Association. *Spinal Cord*. 1997 May;35(5):266-74.
431. Alexander MS, Biering-Sorensen F, Bodner D, Brackett NL, Cardenas D, Charlifue S, et al. International standards to document remaining autonomic function after spinal cord injury. *Spinal Cord*. 2009 Jan;47(1):36-43.
432. Twiddy DA, Downie JW, Awad SA. Response of the bladder to bethanechol after acute spinal cord transection in cats. *J Pharmacol Exp Ther*. 1980 Nov;215(2):500-6.
433. de Groat WC, Kawatani M, Hisamitsu T, Cheng CL, Ma CP, Thor K, et al. Mechanisms underlying the recovery of urinary bladder function following spinal cord injury. *J Auton Nerv Syst*. 1990 Jul;30 Suppl:S71-7.
434. de Groat WC, Ryall RW. Reflexes to sacral parasympathetic neurones concerned with micturition in the cat. *J Physiol*. 1969 Jan;200(1):87-108.
435. Downie JW, Awad SA. The state of urethral musculature during the detrusor areflexia after spinal cord transection. *Invest Urol*. 1979 Jul;17(1):55-9.
436. Norris JP, Staskin DR. History, physical examination, and classification of neurogenic voiding dysfunction. *Urol Clin North Am*. 1996 Aug;23(3):337-43.
437. Schurch B, Schmid DM, Karsenty G, Reitz A. Can neurologic examination predict type of detrusor sphincter-dyssynergia in patients with spinal cord injury? *Urology*. 2005 Feb;65(2):243-6.
438. De EJ, Patel CY, Tharian B, Westney OL, Graves DE, Hairston JC. Diagnostic discordance of electromyography (EMG) versus voiding cystourethrogram (VCUG) for detrusor-external sphincter dyssynergy (DESD). *Neurourol Urodyn*. 2005;24(7):616-21.
439. Wenzel BJ, Boggs JW, Gustafson KJ, Creasey GH, Grill WM. Detection of neurogenic detrusor contractions from the activity of the external anal sphincter in cat and human. *Neurourol Urodyn*. 2006;25(2):140-7.

440. Krassioukov A, Warburton DE, Teasell R, Eng JJ, Spinal Cord Injury Rehabilitation Evidence Research T. A systematic review of the management of autonomic dysreflexia after spinal cord injury. *Arch Phys Med Rehabil*. 2009 Apr;90(4):682-95.
441. Curt A, Nitsche B, Rodic B, Schurch B, Dietz V. Assessment of autonomic dysreflexia in patients with spinal cord injury. *J Neurol Neurosurg Psychiatry*. 1997 May;62(5):473-7.
442. Khastgir J, Drake MJ, Abrams P. Recognition and effective management of autonomic dysreflexia in spinal cord injuries. *Expert Opin Pharmacother*. 2007 May;8(7):945-56.
443. Sundin T, Dahlstrom A, Norlen L, Svedmyr N. The sympathetic innervation and adrenoceptor function of the human lower urinary tract in the normal state and after parasympathetic denervation. *Invest Urol*. 1977 Jan;14(4):322-8.
444. Sundin T, Dahlstrom A. The sympathetic innervation of the urinary bladder and urethra in the normal state and after parasympathetic denervation at the spinal root level. An experimental study in cats. *Scand J Urol Nephrol*. 1973;7(2):131-49.
445. McGuire EJ, Woodside JR, Borden TA, Weiss RM. Prognostic value of urodynamic testing in myelodysplastic patients. *J Urol*. 1981 Aug;126(2):205-9.
446. McGuire EJ, Woodside JR, Borden TA, Weiss RM. Prognostic value of urodynamic testing in myelodysplastic patients. 1981. *J Urol*. 2002 Feb;167(2 Pt 2):1049-53; discussion 54.
447. Dahlberg A, Perttala I, Wuokko E, Ala-Opas M. Bladder management in persons with spinal cord lesion. *Spinal Cord*. 2004 Dec;42(12):694-8.
448. Patki P, Woodhouse J, Hamid R, Shah J, Craggs M. Lower urinary tract dysfunction in ambulatory patients with incomplete spinal cord injury. *J Urol*. 2006 May;175(5):1784-7; discussion 7.
449. Hansen RB, Biering-Sorensen F, Kristensen JK. Bladder emptying over a period of 10-45 years after a traumatic spinal cord injury. *Spinal Cord*. 2004 Nov;42(11):631-7.
450. Drake MJ, Cortina-Borja M, Savic G, Charlifue SW, Gardner BP. Prospective evaluation of urological effects of aging in chronic spinal cord injury by method of bladder management. *Neurourol Urodyn*. 2005;24(2):111-6.
451. Pontari MA, Braverman AS, Ruggieri MR, Sr. The M2 muscarinic receptor mediates in vitro bladder contractions from patients with neurogenic bladder dysfunction. *Am J Physiol Regul Integr Comp Physiol*. 2004 May;286(5):R874-80.
452. Drake MJ, Hedlund P, Mills IW, McCoy R, McMurray G, Gardner BP, et al. Structural and functional denervation of human detrusor after spinal cord injury. *Lab Invest*. 2000 Oct;80(10):1491-9.
453. Haferkamp A, Freund T, Wagener N, Reitz A, Schurch B, Doersam J, et al. Distribution of neuropeptide Y-containing nerves in the neurogenic and non-neurogenic detrusor. *BJU Int*. 2006 Feb;97(2):393-9.
454. Oner-Iyidogan Y, Kocak H, Gurdol F, Kocak T, Erol B. Urine 8-isoprostane F2alpha concentrations in patients with neurogenic bladder due to spinal cord injury. *Clin Chim Acta*. 2004 Jan;339(1-2):43-7.
455. Schmid DM, Reitz A, Curt A, Hauri D, Schurch B. Urethral evoked sympathetic skin responses and viscerosensory evoked potentials as diagnostic tools to evaluate urogenital autonomic afferent innervation in spinal cord injured patients. *J Urol*. 2004 Mar;171(3):1156-60.
456. Schmid DM, Curt A, Hauri D, Schurch B. Motor evoked potentials (MEP) and evoked pressure curves (EPC) from the urethral compressive musculature (UCM) by functional magnetic stimulation in healthy volunteers and patients with neurogenic incontinence. *Neurourol Urodyn*. 2005;24(2):117-27.
457. Dai CF, Xiao CG. Electrophysiological monitoring and identification of neural roots during somatic-autonomic reflex pathway procedure for neurogenic bladder. *Chin J Traumatol*. 2005 Apr;8(2):74-6.
458. Stohrer M, Blok B, Castro-Diaz D, Chartier-Kastler E, Del Popolo G, Kramer G, et al. EAU guidelines on neurogenic lower urinary tract dysfunction. *Eur Urol*. 2009 Jul;56(1):81-8.
459. Pannek J, Stohrer M. A proposed guideline for the urological management of patients with spinal cord injury. *BJU Int*. 2008 Aug;102(4):516-7; author reply 7-8.
460. Abrams P, Agarwal M, Drake M, El-Masri W, Fulford S, Reid S, et al. A proposed guideline for the urological management of patients with spinal cord injury. *BJU Int*. 2008 Apr;101(8):989-94.

461. Alexander MS, Anderson KD, Biering-Sorensen F, Blight AR, Brannon R, Bryce TN, et al. Outcome measures in spinal cord injury: recent assessments and recommendations for future directions. *Spinal Cord*. 2009 Aug;47(8):582-91.
462. Costa P, Perrouin-Verbe B, Colvez A, Didier J, Marquis P, Marrel A, et al. Quality of life in spinal cord injury patients with urinary difficulties. Development and validation of qualiveen. *Eur Urol*. 2001 Jan;39(1):107-13.
463. Thomassen SA, Johannesen IL, Erlandsen EJ, Abrahamsen J, Randers E. Serum cystatin C as a marker of the renal function in patients with spinal cord injury. *Spinal Cord*. 2002 Oct;40(10):524-8.
464. Ockrim J, Laniado ME, Khoubehi B, Renzetti R, Finazzi Agro E, Carter SS, et al. Variability of detrusor overactivity on repeated filling cystometry in men with urge symptoms: comparison with spinal cord injury patients. *BJU Int*. 2005 Mar;95(4):587-90.
465. Chou FH, Ho CH, Chir MB, Linsenmeyer TA. Normal ranges of variability for urodynamic studies of neurogenic bladders in spinal cord injury. *J Spinal Cord Med*. 2006;29(1):26-31.
466. Generao SE, Dall'era JP, Stone AR, Kurzrock EA. Spinal cord injury in children: long-term urodynamic and urological outcomes. *J Urol*. 2004 Sep;172(3):1092-4, discussion 4.
467. Ersoz M, Akyuz M. Bladder-filling sensation in patients with spinal cord injury and the potential for sensation-dependent bladder emptying. *Spinal Cord*. 2004 Feb;42(2):110-6.
468. Ukimura O, Ushijima S, Honjo H, Iwata T, Suzuki K, Hirahara N, et al. Neuroselective current perception threshold evaluation of bladder mucosal sensory function. *Eur Urol*. 2004 Jan;45(1):70-6.
469. Vaidyanathan S, Singh G, Soni BM, Hughes PL, Mansour P, Oo T, et al. Do spinal cord injury patients always get the best treatment for neuropathic bladder after discharge from regional spinal injuries centre? *Spinal Cord*. 2004 Aug;42(8):438-42.
470. Kovindha A, Sivasomboon C, Ovatakanont P. Extravasation of the contrast media during voiding cystourethrography in a long-term spinal cord injury patient. *Spinal Cord*. 2005 Jul;43(7):448-9.
471. Stoffel JT, McGuire EJ. Outcome of urethral closure in patients with neurologic impairment and complete urethral destruction. *Neurourol Urodyn*. 2006;25(1):19-22.
472. Frost F, Roach MJ, Kushner I, Schreiber P. Inflammatory C-reactive protein and cytokine levels in asymptomatic people with chronic spinal cord injury. *Arch Phys Med Rehabil*. 2005 Feb;86(2):312-7.
473. Linsenmeyer TA, House JG, Millis SR. The role of abnormal congenitally displaced ureteral orifices in causing reflux following spinal cord injury. *J Spinal Cord Med*. 2004;27(2):116-9.
474. Linsenmeyer MA, Linsenmeyer TA. Accuracy of bladder stone detection using abdominal x-ray after spinal cord injury. *J Spinal Cord Med*. 2004;27(5):438-42.
475. Matlaga BR, Kim SC, Watkins SL, Kuo RL, Munch LC, Lingeman JE. Changing composition of renal calculi in patients with neurogenic bladder. *J Urol*. 2006 May;175(5):1716-9; discussion 9.
476. Ke HL, Lin HY, Jang MY, Wu WJ. Hair as the nidus for bladder calculi formation complicating suprapubic cystostomy catheterization: a case report. *Kaohsiung J Med Sci*. 2006 May;22(5):243-6.
477. Ost MC, Lee BR. Urolithiasis in patients with spinal cord injuries: risk factors, management, and outcomes. *Curr Opin Urol*. 2006 Mar;16(2):93-9.
478. Ozawa H, Uematsu K, Ohmori H, Kondo A, Iwatsubo E, Takasaka S. [Long-term usefulness and safety of the contemporary balloon catheter]. *Nihon Hinyokika Gakkai Zasshi*. 2005 Jul;96(5):541-7.
479. Linsenmeyer MA, Linsenmeyer TA. Accuracy of predicting bladder stones based on catheter encrustation in individuals with spinal cord injury. *J Spinal Cord Med*. 2006;29(4):402-5.
480. Jayawardena V, Midha M. Significance of bacteriuria in neurogenic bladder. *J Spinal Cord Med*. 2004;27(2):102-5.
481. Svensson E, Ertzgaard P, Forsum U. Bacteriuria in spinal cord injured patients with neurogenic bladder dysfunction. *Ups J Med Sci*. 2004;109(1):25-32.
482. Levendoglu F, Ugurlu H, Ozerbil OM, Tuncer I, Ural O. Urethral cultures in patients with spinal cord injury. *Spinal Cord*. 2004 Feb;42(2):106-9.
483. Waites KB, Canupp KC, DeVivo MJ. Microbiology of the urethra and perineum and its relationship to bacteriuria in community-residing men with spinal cord injury. *J Spinal Cord Med*. 2004;27(5):448-52.
484. Eltorai IM. Fournier gangrene in spinal cord injury: a case report. *J Spinal Cord Med*. 2006;29(1):15-6; author reply 6.

485. Nambiar PK, Lander S, Midha M, Ha C. Fournier gangrene in spinal cord injury: a case report. *J Spinal Cord Med.* 2005;28(2):121-4.
486. Vaidyanathan S, Hughes PL, Mansour P, Soni BM, Singh G, Watt JW, et al. Pseudo-tumours of the urinary tract in patients with spinal cord injury/spina bifida. *Spinal Cord.* 2004 May;42(5):308-12.
487. Kaufman JM, Fam B, Jacobs SC, Gabilondo F, Yalla S, Kane JP, et al. Bladder cancer and squamous metaplasia in spinal cord injury patients. *J Urol.* 1977 Dec;118(6):967-71.
488. Pannek J. Transitional cell carcinoma in patients with spinal cord injury: a high risk malignancy? *Urology.* 2002 Feb;59(2):240-4.
489. Navon JD, Soliman H, Khonsari F, Ahlering T. Screening cystoscopy and survival of spinal cord injured patients with squamous cell cancer of the bladder. *J Urol.* 1997 Jun;157(6):2109-11.
490. Hamid R, Bycroft J, Arya M, Shah PJ. Screening cystoscopy and biopsy in patients with neuropathic bladder and chronic suprapubic indwelling catheters: is it valid? *J Urol.* 2003 Aug;170(2 Pt 1):425-7.
491. Yang CC, Clowers DE. Screening cystoscopy in chronically catheterized spinal cord injury patients. *Spinal Cord.* 1999 Mar;37(3):204-7.
492. Oh SJ, Ku JH, Jeon HG, Shin HI, Paik NJ, Yoo T. Health-related quality of life of patients using clean intermittent catheterization for neurogenic bladder secondary to spinal cord injury. *Urology.* 2005 Feb;65(2):306-10.
493. Oh SJ, Shin HI, Paik NJ, Yoo T, Ku JH. Depressive symptoms of patients using clean intermittent catheterization for neurogenic bladder secondary to spinal cord injury. *Spinal Cord.* 2006 Dec;44(12):757-62.
494. Madersbacher H, Murtz G, Stohrer M. Neurogenic detrusor overactivity in adults: a review on efficacy, tolerability and safety of oral antimuscarinics. *Spinal Cord.* 2013 Jun;51(6):432-41.
495. Zahariou A, Karagiannis G, Papaioannou P, Stathi K, Michail X. The use of desmopressin in the management of nocturnal enuresis in patients with spinal cord injury. *Eura Medicophys.* 2007 Sep;43(3):333-8.
496. Gacci M, Del Popolo G, Macchiarella A, Celso M, Vittori G, Lapini A, et al. Vardenafil improves urodynamic parameters in men with spinal cord injury: results from a single dose, pilot study. *J Urol.* 2007 Nov;178(5):2040-3; discussion 4.
497. Mizuno K, Tsuji T, Kimura A, Liu M, Masakado Y, Chino N. Twenty-seven years of complication-free life with clean intermittent self-catheterization in a patient with spinal cord injury: A case report. *Arch Phys Med Rehabil.* 2004 Oct;85(10):1705-7.
498. Oz B, Olmez N, Memis A, Oruk G. Differential diagnosis of polyuria and polydipsia in a patient with spinal cord injury. *Am J Phys Med Rehabil.* 2005 Oct;84(10):817-20.
499. Polliack T, Bluvshstein V, Philo O, Ronen J, Gelernter I, Luttwak ZP, et al. Clinical and economic consequences of volume- or time-dependent intermittent catheterization in patients with spinal cord lesions and neuropathic bladder. *Spinal Cord.* 2005 Oct;43(10):615-9.
500. Jamison J, Maguire S, McCann J. Catheter policies for management of long term voiding problems in adults with neurogenic bladder disorders. *Cochrane Database Syst Rev.* 2013 Nov 18(11):CD004375.
501. De Ridder DJ, Everaert K, Fernandez LG, Valero JV, Duran AB, Abrisqueta ML, et al. Intermittent catheterisation with hydrophilic-coated catheters (SpeediCath) reduces the risk of clinical urinary tract infection in spinal cord injured patients: a prospective randomised parallel comparative trial. *Eur Urol.* 2005 Dec;48(6):991-5.
502. Bjerklund Johansen T, Hultling C, Madersbacher H, Del Popolo G, Amarenco G, LoFric Primo Study G. A novel product for intermittent catheterisation: its impact on compliance with daily life--international multicentre study. *Eur Urol.* 2007 Jul;52(1):213-20.
503. Schurch B, Stohrer M, Kramer G, Schmid DM, Gaul G, Hauri D. Botulinum-A toxin for treating detrusor hyperreflexia in spinal cord injured patients: a new alternative to anticholinergic drugs? Preliminary results. *J Urol.* 2000 Sep;164(3 Pt 1):692-7.
504. Apostolidis A, Dasgupta P, Fowler CJ. Proposed mechanism for the efficacy of injected botulinum toxin in the treatment of human detrusor overactivity. *Eur Urol.* 2006 Apr;49(4):644-50.
505. Cruz F, Herschorn S, Aliotta P, Brin M, Thompson C, Lam W, et al. Efficacy and safety of onabotulinumtoxinA in patients with urinary incontinence due to neurogenic detrusor overactivity: a randomised, double-blind, placebo-controlled trial. *Eur Urol.* 2011 Oct;60(4):742-50.

506. Kennelly M, Dmochowski R, Ethans K, Karsenty G, Schulte-Baukloh H, Jenkins B, et al. Long-term efficacy and safety of onabotulinumtoxinA in patients with urinary incontinence due to neurogenic detrusor overactivity: an interim analysis. *Urology*. 2013 Mar;81(3):491-7.
507. Kennelly M, Dmochowski R, Schulte-Baukloh H, Ethans K, Del Popolo G, Moore C, et al. Efficacy and safety of onabotulinumtoxinA therapy are sustained over 4 years of treatment in patients with neurogenic detrusor overactivity: Final results of a long-term extension study. *Neurourol Urodyn*. 2015 Nov 24.
508. Sievert KD, Amend B, Gakis G, Toomey P, Badke A, Kaps HP, et al. Early sacral neuromodulation prevents urinary incontinence after complete spinal cord injury. *Ann Neurol*. 2010 Jan;67(1):74-84.
509. Brindley GS. An implant to empty the bladder or close the urethra. *J Neurol Neurosurg Psychiatry*. 1977 Apr;40(4):358-69.
510. Kutzenberger J, Domurath B, Sauerwein D. Spastic bladder and spinal cord injury: seventeen years of experience with sacral deafferentation and implantation of an anterior root stimulator. *Artif Organs*. 2005 Mar;29(3):239-41.
511. Seif C, Junemann KP, Braun PM. Deafferentation of the urinary bladder and implantation of a sacral anterior root stimulator (SARS) for treatment of the neurogenic bladder in paraplegic patients. *Biomed Tech (Berl)*. 2004 Apr;49(4):88-92.
512. Game X, Karsenty G, Chartier-Kastler E, Ruffion A. [Treatment of neurogenic detrusor hyperactivity: enterocystoplasty]. *Prog Urol*. 2007 May;17(3):584-96.
513. Gurung PM, Attar KH, Abdul-Rahman A, Morris T, Hamid R, Shah PJ. Long-term outcomes of augmentation ileocystoplasty in patients with spinal cord injury: a minimum of 10 years of follow-up. *BJU Int*. 2012 Apr;109(8):1236-42.
514. Biers SM, Venn SN, Greenwell TJ. The past, present and future of augmentation cystoplasty. *BJU Int*. 2012 May;109(9):1280-93.
515. Game X, Mallet R, Guillotreau J, Berrogain N, Mouzin M, Vaessen C, et al. Uterus, fallopian tube, ovary and vagina-sparing laparoscopic cystectomy: technical description and results. *Eur Urol*. 2007 Feb;51(2):441-6; discussion 6.
516. Leyson JF, Martin BF, Sporer A. Baclofen in the treatment of detrusor-sphincter dyssynergia in spinal cord injury patients. *J Urol*. 1980 Jul;124(1):82-4.
517. Denys P, Mane M, Azouvi P, Chartier-Kastler E, Thiebaut JB, Bussel B. Side effects of chronic intrathecal baclofen on erection and ejaculation in patients with spinal cord lesions. *Arch Phys Med Rehabil*. 1998 May;79(5):494-6.
518. Abrams P, Amarenco G, Bakke A, Buczynski A, Castro-Diaz D, Harrison S, et al. Tamsulosin: efficacy and safety in patients with neurogenic lower urinary tract dysfunction due to suprasacral spinal cord injury. *J Urol*. 2003 Oct;170(4 Pt 1):1242-51.
519. Reitz A, Knapp PA, Muntener M, Schurch B. Oral nitric oxide donors: a new pharmacological approach to detrusor-sphincter dyssynergia in spinal cord injured patients? *Eur Urol*. 2004 Apr;45(4):516-20.
520. Apostolidis A, Dasgupta P, Denys P, Elneil S, Fowler CJ, Giannantoni A, et al. Recommendations on the use of botulinum toxin in the treatment of lower urinary tract disorders and pelvic floor dysfunctions: a European consensus report. *Eur Urol*. 2009 Jan;55(1):100-19.
521. Fontaine E, Hajri M, Rhein F, Fakacs C, Le Mouel MA, Beurton D. Reappraisal of endoscopic sphincterotomy for post-traumatic neurogenic bladder: a prospective study. *J Urol*. 1996 Jan;155(1):277-80.
522. Game X, Chartier-Kastler E, Ayoub N, Even-Schneider A, Richard F, Denys P. Outcome after treatment of detrusor-sphincter dyssynergia by temporary stent. *Spinal Cord*. 2008 Jan;46(1):74-7.
523. Chancellor MB, Gajewski J, Ackman CF, Appell RA, Bennett J, Binard J, et al. Long-term followup of the North American multicenter UroLume trial for the treatment of external detrusor-sphincter dyssynergia. *J Urol*. 1999 May;161(5):1545-50.
524. Low AI, McRae PJ. Use of the Memokath for detrusor-sphincter dyssynergia after spinal cord injury--a cautionary tale. *Spinal Cord*. 1998 Jan;36(1):39-44.
525. Game X, Kessler TM, Elneil S, Hamid R. Neurogenic Bladder Dysfunction:surgical interventional approaches. . In: Fowler CJ, Panicker JN, Emmanuel A, editors. *Pelvic Organ Dysfunction in Neurological Disease* First ed. Cambridge: Cambridge: University Press; 2010. p. 112-26.
526. Hamid R, Arya M, Khastgir J, Patel HR, Shah PJ. The treatment of male stress urinary incontinence with polydimethylsiloxane in compliant bladders following spinal cord injury. *Spinal Cord*. 2003 May;41(5):286-9.

527. Losco GS, Burki JR, Omar YA, Shah PJ, Hamid R. Long-term outcome of transobturator tape (TOT) for treatment of stress urinary incontinence in females with neuropathic bladders. *Spinal Cord*. 2015 Jul;53(7):544-6.
528. Linsenmeyer TA, Harrison B, Oakley A, Kirshblum S, Stock JA, Millis SR. Evaluation of cranberry supplement for reduction of urinary tract infections in individuals with neurogenic bladders secondary to spinal cord injury. A prospective, double-blinded, placebo-controlled, crossover study. *J Spinal Cord Med*. 2004;27(1):29-34.
529. Waites KB, Canupp KC, Armstrong S, DeVivo MJ. Effect of cranberry extract on bacteriuria and pyuria in persons with neurogenic bladder secondary to spinal cord injury. *J Spinal Cord Med*. 2004;27(1):35-40.
530. Lee BB, Haran MJ, Hunt LM, Simpson JM, Marial O, Rutkowski SB, et al. Spinal-injured neuropathic bladder antiseptis (SINBA) trial. *Spinal Cord*. 2007 Aug;45(8):542-50.
531. Schlager TA, Ashe K, Hendley JO. Effect of a phosphate supplement on urine pH in patients with neurogenic bladder receiving intermittent catheterization. *Spinal Cord*. 2005 Mar;43(3):187-9.
532. Bycroft J, Hamid R, Bywater H, Patki P, Craggs M, Shah J. Variation in urological practice amongst spinal injuries units in the UK and Eire. *Neurourol Urodyn*. 2004;23(3):252-6; discussion 7.
533. Salomon J, Denys P, Merle C, Chartier-Kastler E, Perronne C, Gaillard JL, et al. Prevention of urinary tract infection in spinal cord-injured patients: safety and efficacy of a weekly oral cyclic antibiotic (WOCA) programme with a 2 year follow-up--an observational prospective study. *J Antimicrob Chemother*. 2006 Apr;57(4):784-8.
534. Waites KB, Canupp KC, Roper JF, Camp SM, Chen Y. Evaluation of 3 methods of bladder irrigation to treat bacteriuria in persons with neurogenic bladder. *J Spinal Cord Med*. 2006;29(3):217-26.
535. Patki P, Hamid R, Somayaji S, Bycroft J, Shah PJ, Craggs M. Long-term urological outcomes in paediatric spinal cord injury. *Spinal Cord*. 2006 Dec;44(12):729-33.
536. Nosseir M, Hinkel A, Pannek J. Clinical usefulness of urodynamic assessment for maintenance of bladder function in patients with spinal cord injury. *Neurourol Urodyn*. 2007;26(2):228-33.
537. Sepahpanah F, Burns SP, McKnight B, Yang CC. Role of creatinine clearance as a screening test in persons with spinal cord injury. *Arch Phys Med Rehabil*. 2006 Apr;87(4):524-8.
538. Ruffion A, Comperat E, Roupert M, Chartier-Kastler E. [Bladder cancer and neurogenic bladder]. *Prog Urol*. 2007 May;17(3):431-5.
539. Gignoux A, Chartier-Kastler E, Ruffion A. [Specific features of the early diagnosis of prostate cancer in the presence of neurogenic bladder]. *Prog Urol*. 2007 May;17(3):457-61.
540. Dvorak MF, Fisher CG, Hoekema J, Boyd M, Noonan V, Wing PC, et al. Factors predicting motor recovery and functional outcome after traumatic central cord syndrome: a long-term follow-up. *Spine (Phila Pa 1976)*. 2005 Oct 15;30(20):2303-11.
541. Gallia GL, Burger PC, Suk I, Bagley CA, Wolinsky JP, Garonzik IM, et al. Concomitant conus medullaris ependymoma and filum terminale lipoma: case report. *Neurosurgery*. 2006 Jun;58(6):E1214; discussion E.
542. Dhall SS, Tumialan LM, Brat DJ, Barrow DL. Spinal intradural clear cell meningioma following resection of a suprasellar clear cell meningioma. Case report and recommendations for management. *J Neurosurg*. 2005 Sep;103(3):559-63.
543. Polczynska K, Bien E, Stefanowicz J, Drozyska E, Szolkiewicz A, Stachowicz-Stencel T, et al. [Neurologic symptoms in the course of neuroblastoma in children. Own observations]. *Med Wieku Rozwoj*. 2005 Jul-Sep;9(3 Pt 2):477-86.
544. Rodriguez FJ, Crum BA, Krauss WE, Scheithauer BW, Giannini C. Venous congestive myelopathy: a mimic of neoplasia. *Mod Pathol*. 2005 May;18(5):710-8.
545. Post NH, Wisoff JH, Thorne CH, Weiner HL. Transient syringomyelia leading to acute neurological deterioration after repair of a lipomyelomeningocele: case report. *Neurosurgery*. 2007 Aug;61(2):E426; discussion E.
546. Tanaka ST, Stone AR, Kurzrock EA. Transverse myelitis in children: long-term urological outcomes. *J Urol*. 2006 May;175(5):1865-8; discussion 8.
547. Liem NR, McColl MA, King W, Smith KM. Aging with a spinal cord injury: factors associated with the need for more help with activities of daily living. *Arch Phys Med Rehabil*. 2004 Oct;85(10):1567-77.
548. Ng C, Prott G, Rutkowski S, Li Y, Hansen R, Kellow J, et al. Gastrointestinal symptoms in spinal cord injury: relationships with level of injury and psychologic factors. *Dis Colon Rectum*. 2005 Aug;48(8):1562-8.

549. Valles M, Vidal J, Clave P, Mearin F. Bowel dysfunction in patients with motor complete spinal cord injury: clinical, neurological, and pathophysiological associations. *Am J Gastroenterol*. 2006 Oct;101(10):2290-9.
550. Valles M, Terre R, Guevara D, Portell E, Vidal J, Mearin F. [Bowel dysfunction in patients with spinal cord injury: relation with neurological patterns]. *Med Clin (Barc)*. 2007 Jun 30;129(5):171-3.
551. Pagliacci MC, Franceschini M, Di Clemente B, Agosti M, Spizzichino L, Gisem. A multicentre follow-up of clinical aspects of traumatic spinal cord injury. *Spinal Cord*. 2007 Jun;45(6):404-10.
552. Podnar S. Bilateral vs. unilateral electromyographic examination of the external anal sphincter muscle. *Neurophysiol Clin*. 2004 Oct;34(3-4):153-7.
553. Li WC, Xiao CG. Anorectal functions in patients with lumbosacral spinal cord injury. *Chin J Traumatol*. 2006 Aug;9(4):217-22.
554. Korsten MA, Fajardo NR, Rosman AS, Creasey GH, Spungen AM, Bauman WA. Difficulty with evacuation after spinal cord injury: colonic motility during sleep and effects of abdominal wall stimulation. *J Rehabil Res Dev*. 2004 Jan-Feb;41(1):95-100.
555. Furlan JC, Fehlings MG. A Web-based systematic review on traumatic spinal cord injury comparing the "citation classics" with the consumers' perspectives. *J Neurotrauma*. 2006 Feb;23(2):156-69.
556. Anderson KD. Targeting recovery: priorities of the spinal cord-injured population. *J Neurotrauma*. 2004 Oct;21(10):1371-83.
557. Anderson KD, Borisoff JF, Johnson RD, Stiens SA, Elliott SL. Spinal cord injury influences psychogenic as well as physical components of female sexual ability. *Spinal Cord*. 2007 May;45(5):349-59.
558. Krogh K, Christensen P, Sabroe S, Laurberg S. Neurogenic bowel dysfunction score. *Spinal Cord*. 2006 Oct;44(10):625-31.
559. Luther SL, Nelson AL, Harrow JJ, Chen F, Goetz LL. A comparison of patient outcomes and quality of life in persons with neurogenic bowel: standard bowel care program vs colostomy. *J Spinal Cord Med*. 2005;28(5):387-93.
560. Korsten MA, Singal AK, Monga A, Chaparala G, Khan AM, Palmon R, et al. Anorectal stimulation causes increased colonic motor activity in subjects with spinal cord injury. *J Spinal Cord Med*. 2007;30(1):31-5.
561. Furusawa K, Sugiyama H, Ikeda A, Tokuhiro A, Koyoshi H, Takahashi M, et al. Autonomic dysreflexia during a bowel program in patients with cervical spinal cord injury. *Acta Med Okayama*. 2007 Aug;61(4):221-7.
562. Kirshblum SC, House JG, O'Connor K C. Silent autonomic dysreflexia during a routine bowel program in persons with traumatic spinal cord injury: a preliminary study. *Arch Phys Med Rehabil*. 2002 Dec;83(12):1774-6.
563. Uchikawa K, Takahashi H, Deguchi G, Liu M. A washing toilet seat with a CCD camera monitor to stimulate bowel movement in patients with spinal cord injury. *Am J Phys Med Rehabil*. 2007 Mar;86(3):200-4.
564. Christensen P, Bazzocchi G, Coggrave M, Abel R, Hultling C, Krogh K, et al. A randomized, controlled trial of transanal irrigation versus conservative bowel management in spinal cord-injured patients. *Gastroenterology*. 2006 Sep;131(3):738-47.
565. Ayas S, Leblebici B, Sozay S, Bayramoglu M, Niron EA. The effect of abdominal massage on bowel function in patients with spinal cord injury. *Am J Phys Med Rehabil*. 2006 Dec;85(12):951-5.
566. Coggrave M, Norton C, Cody JD. Management of faecal incontinence and constipation in adults with central neurological diseases. *Cochrane Database Syst Rev*. 2014 Jan 13(1):CD002115.
567. Korsten MA, Rosman AS, Ng A, Cavusoglu E, Spungen AM, Radulovic M, et al. Infusion of neostigmine-glycopyrrolate for bowel evacuation in persons with spinal cord injury. *Am J Gastroenterol*. 2005 Jul;100(7):1560-5.
568. Singal AK, Rosman AS, Bauman WA, Korsten MA. Recent concepts in the management of bowel problems after spinal cord injury. *Adv Med Sci*. 2006;51:15-22.
569. Lombardi G, Macchiarella A, Cecconi F, Del Popolo G. Ten years of phosphodiesterase type 5 inhibitors in spinal cord injured patients. *J Sex Med*. 2009 May;6(5):1248-58.
570. Patki P, Hamid R, Shah J, Craggs M. Fertility following spinal cord injury: a systematic review. *Spinal Cord*. 2007 Feb;45(2):187.
571. Sipski ML, Rosen RC, Alexander CJ, Hamer RM. Sildenafil effects on sexual and cardiovascular responses in women with spinal cord injury. *Urology*. 2000 Jun;55(6):812-5.
572. Veenboer PW, de Kort LM, Chrzan RJ, de Jong TP. Urinary considerations for adult patients with spinal dysraphism. *Nat Rev Urol*. 2015 Jun;12(6):331-9.

573. Snow-Lisy DC, Yerkes EB, Cheng EY. Update on Urological Management of Spina Bifida from Prenatal Diagnosis to Adulthood. *J Urol*. 2015 Aug;194(2):288-96.
574. Hascoet J, Manunta A, Brochard C, Arnaud A, Dampousse M, Menard H, et al. Outcomes of intra-detrusor injections of botulinum toxin in patients with spina bifida: A systematic review. *Neurourol Urodyn*. 2016 May 17.
575. Peters KM, Gilmer H, Feber K, Girdler BJ, Nantau W, Trock G, et al. US Pilot Study of Lumbar to Sacral Nerve Rerouting to Restore Voiding and Bowel Function in Spina Bifida: 3-Year Experience. *Adv Urol*. 2014;2014:863209.
576. Lee NG, Gomez P, Uberoi V, Kokorowski PJ, Khoshbin S, Bauer SB, et al. In utero closure of myelomeningocele does not improve lower urinary tract function. *J Urol*. 2012 Oct;188(4 Suppl):1567-71.
577. Macedo A, Jr., Leal M, Rondon A, Ortiz V, Moron AF, Cavalheiro S. Urological evaluation of patients that had undergone in utero myelomeningocele closure: A prospective assessment at first presentation and early follow-up. Do their bladder benefit from it? *Neurourol Urodyn*. 2015 Jun;34(5):461-4.
578. Muller T, Arbeiter K, Aufricht C. Renal function in meningomyelocele: risk factors, chronic renal failure, renal replacement therapy and transplantation. *Curr Opin Urol*. 2002 Nov;12(6):479-84.
579. Lemelle JL, Guillemin F, Aubert D, Guys JM, Lottmann H, Lortat-Jacob S, et al. A multicentre study of the management of disorders of defecation in patients with spina bifida. *Neurogastroenterol Motil*. 2006 Feb;18(2):123-8.
580. Younoszai MK. Stooling problems in patients with myelomeningocele. *South Med J*. 1992 Jul;85(7):718-24.
581. Eire PF, Cives RV, Gago MC. Faecal incontinence in children with spina bifida: the best conservative treatment. *Spinal Cord*. 1998 Nov;36(11):774-6.
582. Shandling B, Gilmour RF. The enema continence catheter in spina bifida: successful bowel management. *J Pediatr Surg*. 1987 Mar;22(3):271-3.
583. Casale AJ, Metcalfe PD, Kaefer MA, Dussinger AM, Meldrum KK, Cain MP, et al. Total continence reconstruction: a comparison to staged reconstruction of neuropathic bowel and bladder. *J Urol*. 2006 Oct;176(4 Pt 2):1712-5.
584. Parkin PC, Kirpalani HM, Rosenbaum PL, Fehlings DL, Van Nie A, Willan AR, et al. Development of a health-related quality of life instrument for use in children with spina bifida. *Qual Life Res*. 1997 Mar;6(2):123-32.
585. Wald A. Biofeedback for neurogenic fecal incontinence: rectal sensation is a determinant of outcome. *J Pediatr Gastroenterol Nutr*. 1983 May;2(2):302-6.
586. Schmidt RA, Kogan BA, Tanagho EA. Neuroprostheses in the management of incontinence in myelomeningocele patients. *J Urol*. 1990 Apr;143(4):779-82.
587. Szczerbinska K, Topinkova E, Brzyski P, van der Roest HG, Richter T, Finne-Soveri H, et al. The characteristics of diabetic residents in European nursing homes: results from the SHELTER study. *J Am Med Dir Assoc*. 2015 Apr;16(4):334-40.
588. Ellenberg M. Development of urinary bladder dysfunction in diabetes mellitus. *Ann Intern Med*. 1980 Feb;92(2 Pt 2):321-3.
589. Frimodt-Moller C. Diabetic cystopathy: epidemiology and related disorders. *Ann Intern Med*. 1980 Feb;92(2 Pt 2):318-21.
590. Hampel C, Gillitzer R, Pahernik S, Melchior S, Thuroff JW. [Diabetes mellitus and bladder function. What should be considered?]. *Urologe A*. 2003 Dec;42(12):1556-63.
591. Bradley WE. Diagnosis of urinary bladder dysfunction in diabetes mellitus. *Ann Intern Med*. 1980 Feb;92(2 Pt 2):323-6.
592. Bansal R, Agarwal MM, Modi M, Mandal AK, Singh SK. Urodynamic profile of diabetic patients with lower urinary tract symptoms: association of diabetic cystopathy with autonomic and peripheral neuropathy. *Urology*. 2011 Mar;77(3):699-705.
593. Saadia Z. Urinary Problems Amongst Gynecological Consultations. Association Between Prolapse, Gynecological Surgery and Diabetes. *Med Arch*. 2015 Oct;69(5):315-8.
594. Karter AJ, Laiteerapong N, Chin MH, Moffet HH, Parker MM, Sudore R, et al. Ethnic Differences in Geriatric Conditions and Diabetes Complications Among Older, Insured Adults With Diabetes: The Diabetes and Aging Study. *J Aging Health*. 2015 Aug;27(5):894-918.
595. Bani-Issa W, Almomani F, Eldeirawi K. Urinary incontinence among adult women with diabetes in Jordan: epidemiology, correlates and perceived impact on emotional and social well-being. *J Clin Nurs*. 2014 Sep;23(17-18):2451-60.

596. Chuang CM, Lin IF, Horng HC, Hsiao YH, Shyu IL, Chou P. The impact of gestational diabetes mellitus on postpartum urinary incontinence: a longitudinal cohort study on singleton pregnancies. *Bjog*. 2012 Oct;119(11):1334-43.
597. Devore EE, Townsend MK, Resnick NM, Grodstein F. The epidemiology of urinary incontinence in women with type 2 diabetes. *J Urol*. 2012 Nov;188(5):1816-21.
598. Jackson SL, Scholes D, Boyko EJ, Abraham L, Fihn SD. Urinary incontinence and diabetes in postmenopausal women. *Diabetes Care*. 2005 Jul;28(7):1730-8.
599. Lewis CM, Schrader R, Many A, Mackay M, Rogers RG. Diabetes and urinary incontinence in 50- to 90-year-old women: a cross-sectional population-based study. *Am J Obstet Gynecol*. 2005 Dec;193(6):2154-8.
600. Hsu A, Conell-Price J, Stijacic Cencer I, Eng C, Huang AJ, Rice-Trumble K, et al. Predictors of urinary incontinence in community-dwelling frail older adults with diabetes mellitus in a cross-sectional study. *BMC Geriatr*. 2014;14:137.
601. Lenherr SM, Clemens JQ, Braffett BH, Dunn RL, Cleary PA, Kim C, et al. Glycaemic control and risk of incident urinary incontinence in women with Type 1 diabetes: results from the Diabetes Control and Complications Trial and Epidemiology of Diabetes Interventions and Complications study (DCCT/EDIC). *Diabet Med*. 2016 Mar 30.
602. Wang R, Lefevre R, Hacker MR, Golen TH. Diabetes, Glycemic Control, and Urinary Incontinence in Women. *Female Pelvic Med Reconstr Surg*. 2015 Sep-Oct;21(5):293-7.
603. Chiu AF, Huang MH, Wang CC, Kuo HC. Higher glycosylated hemoglobin levels increase the risk of overactive bladder syndrome in patients with type 2 diabetes mellitus. *Int J Urol*. 2012 Nov;19(11):995-1001.
604. Weinberg AE, Leppert JT, Elliott CS. Biochemical Measures of Diabetes are Not Independent Predictors of Urinary Incontinence in Women. *J Urol*. 2015 Dec;194(6):1668-74.
605. Lee SJ, Karter AJ, Thai JN, Van Den Eeden SK, Huang ES. Glycemic control and urinary incontinence in women with diabetes mellitus. *J Womens Health (Larchmt)*. 2013 Dec;22(12):1049-55.
606. Lenherr SM, Clemens JQ, Braffett BH, Cleary PA, Dunn RL, Hotaling JM, et al. Glycemic Control and Urinary Tract Infections in Women with Type 1 Diabetes: Results from the DCCT/EDIC. *J Urol*. 2016 Apr 27.
607. Phelan S, Kanaya AM, Ma Y, Vittinghoff E, Barrett-Connor E, Wing R, et al. Long-term prevalence and predictors of urinary incontinence among women in the Diabetes Prevention Program Outcomes Study. *Int J Urol*. 2015 Feb;22(2):206-12.
608. Breyer BN, Phelan S, Hogan PE, Rosen RC, Kitabchi AE, Wing RR, et al. Intensive lifestyle intervention reduces urinary incontinence in overweight/obese men with type 2 diabetes: results from the Look AHEAD trial. *J Urol*. 2014 Jul;192(1):144-9.
609. Van Poppel H, Stessens R, Van Damme B, Carton H, Baert L. Diabetic cystopathy: neuropathological examination of urinary bladder biopsies. *Eur Urol*. 1988;15(1-2):128-31.
610. Pittenger G, Vinik A. Nerve growth factor and diabetic neuropathy. *Exp Diabetes Res*. 2003 Oct-Dec;4(4):271-85.
611. Cheng JT, Tong YC. Alterations of nerve-growth factor and p75(NTR) expressions in urinary bladder of fructose-fed obese rats. *Neurosci Lett*. 2008 Aug 15;441(1):25-8.
612. Lee WC, Wu HC, Huang KH, Wu HP, Yu HJ, Wu CC. Hyposensitivity of C-fiber afferents at the distal extremities as an indicator of early stages diabetic bladder dysfunction in type 2 diabetic women. *PLoS One*. 2014;9(1):e86463.
613. Lin TL, Chen GD, Chen YC, Huang CN, Ng SC. Aging and recurrent urinary tract infections are associated with bladder dysfunction in type 2 diabetes. *Taiwan J Obstet Gynecol*. 2012 Sep;51(3):381-6.
614. Fayyad AM, Hill SR, Jones G. Urine production and bladder diary measurements in women with type 2 diabetes mellitus and their relation to lower urinary tract symptoms and voiding dysfunction. *Neurourol Urodyn*. 2010 Mar;29(3):354-8.
615. Shin YS, On JW, Kim MK. Clinical significance of diabetes mellitus on detrusor functionality on stress urinary incontinent women without bladder outlet obstruction. *Int Urogynecol J*. 2016 Mar 18.
616. Appa AA, Brown JS, Creasman J, Van Den Eeden SK, Subak LL, Thom DH, et al. Clinical predictors and significance of postvoid residual volume in women with diabetes. *Diabetes Res Clin Pract*. 2013 Aug;101(2):164-9.
617. Yamaguchi C, Sakakibara R, Uchiyama T, Yamamoto T, Ito T, Liu Z, et al. Overactive bladder in diabetes: a peripheral or central mechanism? *Neurourol Urodyn*. 2007;26(6):807-13.

618. Golabek T, Kiely E, O'Reilly B. Detrusor overactivity in diabetic and non-diabetic patients: is there a difference? *Int Braz J Urol.* 2012 Sep-Oct;38(5):652-9; discussion 60.
619. Daneshgari F, Liu G, Birder L, Hanna-Mitchell AT, Chacko S. Diabetic bladder dysfunction: current translational knowledge. *J Urol.* 2009 Dec;182(6 Suppl):S18-26.
620. Ishigooka M, Hashimoto T, Hayami S, Suzuki Y, Ichianagi O, Nakada T. Thermoreceptor mediated bladder sensation in patients with diabetic cystopathy. *Int Urol Nephrol.* 1997;29(5):551-5.
621. Ueda T, Yoshimura N, Yoshida O. Diabetic cystopathy: relationship to autonomic neuropathy detected by sympathetic skin response. *J Urol.* 1997 Feb;157(2):580-4.
622. Beylot M, Marion D, Noel G. Ultrasonographic determination of residual urine in diabetic subjects: relationship to neuropathy and urinary tract infection. *Diabetes Care.* 1982 Sep-Oct;5(5):501-5.
623. Ho CH, Tai HC, Yu HJ. Urodynamic findings in female diabetic patients with and without overactive bladder symptoms. *Neurourol Urodyn.* 2010 Mar;29(3):424-7.
624. Ikeda M, Nozawa K. Prevalence of overactive bladder and its related factors in Japanese patients with diabetes mellitus. *Endocr J.* 2015;62(9):847-54.
625. Karoli R, Bhat S, Fatima J, Priya S. A study of bladder dysfunction in women with type 2 diabetes mellitus. *Indian J Endocrinol Metab.* 2014 Jul;18(4):552-7.
626. Palleschi G, Pastore AL, Maggioni C, Fuschi A, Pacini L, Petrozza V, et al. Overactive bladder in diabetes mellitus patients: a questionnaire-based observational investigation. *World J Urol.* 2014 Aug;32(4):1021-5.
627. Daniels DH, Powell CR, Braasch MR, Kreder KJ. Sacral neuromodulation in diabetic patients: success and complications in the treatment of voiding dysfunction. *Neurourol Urodyn.* 2010 Apr;29(4):578-81.
628. Bohlin KS, Ankardal M, Pedroletti C, Lindkvist H, Milsom I. The influence of the modifiable lifestyle factors body mass index and smoking on the outcome of mid-urethral sling procedures for female urinary incontinence. *Int Urogynecol J.* 2015 Mar;26(3):343-51.
629. Schneider T, Marschall-Kehrel D, Hanisch JU, Michel MC. Does concomitant diabetes affect treatment responses in overactive bladder patients? *Int J Clin Pract.* 2013 Nov;67(11):1138-43.
630. Caruana BJ, Wald A, Hinds JP, Eidelman BH. Anorectal sensory and motor function in neurogenic fecal incontinence. Comparison between multiple sclerosis and diabetes mellitus. *Gastroenterology.* 1991 Feb;100(2):465-70.
631. Nakayama H, Jorgensen HS, Pedersen PM, Raaschou HO, Olsen TS. Prevalence and risk factors of incontinence after stroke. The Copenhagen Stroke Study. *Stroke.* 1997 Jan;28(1):58-62.
632. Schiller LR, Santa Ana CA, Schmulen AC, Hender RS, Harford WV, Fordtran JS. Pathogenesis of fecal incontinence in diabetes mellitus: evidence for internal-anal-sphincter dysfunction. *N Engl J Med.* 1982 Dec 30;307(27):1666-71.
633. Russo A, Botten R, Kong MF, Chapman IM, Fraser RJ, Horowitz M, et al. Effects of acute hyperglycaemia on anorectal motor and sensory function in diabetes mellitus. *Diabet Med.* 2004 Feb;21(2):176-82.
634. Talley NJ, Young L, Bytzer P, Hammer J, Leemon M, Jones M, et al. Impact of chronic gastrointestinal symptoms in diabetes mellitus on health-related quality of life. *Am J Gastroenterol.* 2001 Jan;96(1):71-6.
635. Matthews CA, Whitehead WE, Townsend MK, Grodstein F. Risk factors for urinary, fecal, or dual incontinence in the Nurses' Health Study. *Obstet Gynecol.* 2013 Sep;122(3):539-45.
636. Sakakibara R, Uchiyama T, Yoshiyama M, Yamanishi T, Hattori T. Urinary dysfunction in patients with systemic lupus erythematosus. *Neurourol Urodyn.* 2003;22(6):593-6.
637. Yu HJ, Lee WC, Lee KL, Chen MY, Chen CY, Chen J. Voiding dysfunction in women with systemic lupus erythematosus. *Arthritis Rheum.* 2004 Jan;50(1):166-72.
638. Duran-Barragan S, Ruvalcaba-Naranjo H, Rodriguez-Gutierrez L, Solano-Moreno H, Hernandez-Rios G, Sanchez-Ortiz A, et al. Recurrent urinary tract infections and bladder dysfunction in systemic lupus erythematosus. *Lupus.* 2008 Dec;17(12):1117-21.
639. Koh JH, Lee J, Jung SM, Ju JH, Park SH, Kim HY, et al. Lupus cystitis in Korean patients with systemic lupus erythematosus: risk factors and clinical outcomes. *Lupus.* 2015 Oct;24(12):1300-7.
640. Erol B, Avci A, Eken C, Ozgok Y. Urinary retention, erectile dysfunction and meningitis due to sacral herpes zoster: a case report and review of the literature. *Urol Int.* 2009;82(2):238-41.
641. Holbrook CM, Waller S. The first images of varicella lesions in the bladder. *Arch Dis Child.* 2012 Aug;97(8):732.

642. Hur J. Sacral Herpes Zoster Associated with Voiding Dysfunction in a Young Patient with Scrub Typhus. *Infect Chemother.* 2015 Jun;47(2):133-6.
643. Marques SA, Hortense J. Herpes zoster-associated acute urinary retention in immunocompetent patient. *An Bras Dermatol.* 2014 Nov-Dec;89(6):985-7.
644. Chen PH, Hsueh HF, Hong CZ. Herpes zoster-associated voiding dysfunction: a retrospective study and literature review. *Arch Phys Med Rehabil.* 2002 Nov;83(11):1624-8.
645. Game X, Bigay-Game L, Bialek D, Sailler L, Astudillo L, Rischmann P. [Urinary retention secondary to herpes zoster infection]. *Prog Urol.* 2004 Apr;14(2):224-6; discussion 6.
646. Julia JJ, Cholhan HJ. Herpes zoster-associated acute urinary retention: a case report. *Int Urogynecol J Pelvic Floor Dysfunct.* 2007 Jan;18(1):103-4.
647. Khan Z, Singh VK, Yang WC. Neurogenic bladder in acquired immune deficiency syndrome (AIDS). *Urology.* 1992 Sep;40(3):289-91.
648. Shin JK, Newman LS, Gebbie KM, Fillmore HH. Quality of care measurement in nursing home AIDS care: a pilot study. *J Assoc Nurses AIDS Care.* 2002 Mar-Apr;13(2):70-6.
649. Gyrttrup HJ, Kristiansen VB, Zachariae CO, Krogsgaard K, Colstrup H, Jensen KM. Voiding problems in patients with HIV infection and AIDS. *Scand J Urol Nephrol.* 1995 Sep;29(3):295-8.
650. Cohen BA, McArthur JC, Grohman S, Patterson B, Glass JD. Neurologic prognosis of cytomegalovirus polyradiculomyelopathy in AIDS. *Neurology.* 1993 Mar;43(3 Pt 1):493-9.
651. Mahieux F, Gray F, Fenelon G, Gherardi R, Adams D, Guillard A, et al. Acute myeloradiculitis due to cytomegalovirus as the initial manifestation of AIDS. *J Neurol Neurosurg Psychiatry.* 1989 Feb;52(2):270-4.
652. Matsumoto R, Nakagawa S, Nakayama J, Hashimoto T, Shindo M. [A case of acquired immune deficiency syndrome presenting acute lumbosacral polyradiculopathy due to opportunistic infection of cytomegalovirus]. *Rinsho Shinkeigaku.* 1998 Jul;38(7):653-7.
653. Benabdallah JO, Collins CW, Carucci LR, Moores KE, Gater DR, Klausner AP. Aggressive bladder carcinoma in an HIV-positive man with tetraplegia and neurogenic bladder. *J Spinal Cord Med.* 2011;34(2):248-50.
654. Chawki S, Ploussard G, Montlahuc C, Verine J, Mongiat-Artus P, Desgrandchamps F, et al. Bladder cancer in HIV-infected adults: an emerging concern? *J Int AIDS Soc.* 2014;17(4 Suppl 3):19647.
655. Chawki S, Ploussard G, Montlahuc C, Verine J, Mongiat-Artus P, Desgrandchamps F, et al. Bladder Cancer in HIV-infected Adults: An Emerging Issue? Case-Reports and Systematic Review. *PLoS One.* 2015;10(12):e0144237.
656. Gaughan EM, Dezube BJ, Bower M, Aboulafia DM, Bohac G, Cooley TP, et al. HIV-associated bladder cancer: a case series evaluating difficulties in diagnosis and management. *BMC Urol.* 2009 Aug 31;9:10.
657. Begara Morillas FJ, Salinas Casado J, Silmi Moyano A, Espinosa Fernandez B, Fernandez Lucas C, Roca Arbones V, et al. [Vesicourethral dysfunction in the acquired immunodeficiency syndrome (AIDS)]. *Arch Esp Urol.* 1995 Nov;48(9):915-21.
658. Menendez V, Valls J, Espuna M, Perez A, Barranco MA, Carretero P. Neurogenic bladder in patients with acquired immunodeficiency syndrome. *Neurourol Urodyn.* 1995;14(3):253-7.
659. Snijders F, de Boer JB, Steenbergen B, Schouten M, Danner SA, van Dam FS. Impact of diarrhoea and faecal incontinence on the daily life of HIV-infected patients. *AIDS Care.* 1998 Oct;10(5):629-37.
660. Garber SJ, Christmas TJ, Rickards D. Voiding dysfunction due to neurosyphilis. *Br J Urol.* 1990 Jul;66(1):19-21.
661. Hattori T, Yasuda K, Kita K, Hirayama K. Disorders of micturition in tabes dorsalis. *Br J Urol.* 1990 May;65(5):497-9.

INCONTINENCE IN FRAIL OLDER PERSONS

Chair

Adrian Wagg (Canada)

Members

Liang Kung Chen (Taiwan)

Theodore Johnson II (USA)

Ruth Kirschner-Hermanns (Germany)

George Kuchel (USA)

Alayne Markland (USA)

Catherine Murphy (UK)

Susie Orme (UK)

Joan Ostaszkiwicz (Australia)

George Szonyi (Australia)

Jean Wyman (USA)

CONTENTS

I.	INTRODUCTION	1311
1.	Search strategies	1312
2.	Frailty	1312
II.	URINARY INCONTINENCE	1315
1.	Aetiology & assessment.....	1315
2.	Age related changes relevant to UI in frail older persons	1316
3.	Factors outside the lower urinary tract causing or contributing to urinary incontinence.....	1322
4.	Environmental Factors	1328
5.	Assessment of the frail older person with urinary incontinence.....	1337
6.	Factors in management of the frail older person with urinary incontinence	1339
7.	issues in drug treatment.....	1343
8.	Special issues in frail older men.....	1348
9.	Summary of the evidence.....	1349
10.	Treatment of urinary incontinence in frail older persons	1349
11.	Pharmacological treatment	1358
12.	Surgical treatment in the frail older person.....	1369
III.	NOCTURIA	1373
IV.	FAECAL INCONTINENCE IN FRAIL OLDER PERSONS	1381
V.	CONTINENCE AT THE END OF LIFE	1394
	REFERENCES	1397

INCONTINENCE IN FRAIL OLDER PERSONS

ADRIAN WAGG (CANADA)

LIANG KUNG CHEN (TAIWAN), THEODORE JOHNSON II (USA),

RUTH KIRSCHNER-HERMANN (GERMANY), GEORGE KUCHEL (USA),

ALAYNE MARKLAND (USA), CATHERINE MURPHY (UK), SUSIE ORME (UK),

JOAN OSTASZKIEWICZ (AUSTRALIA), GEORGE SZONYI (AUSTRALIA), JEAN WYMAN (USA)

I. INTRODUCTION

Older people have the highest known prevalence of urinary incontinence (UI) of any group, other than those with specific neurological disease (e.g., spinal cord injury). As the proportion of older people in the populations of the developed world increases, so will the absolute numbers of those with either urinary (UI) or faecal incontinence (FI) or lower urinary tract symptoms [1]. Even if improvement in physical functioning among older people continues, and research in the field is able to demonstrate continuing benefit whilst containing costs, the impact on future health care and long-term care costs will still be profound [2]. Early signals suggest however that the decrease in disability for older people observed in the last two decades of the twentieth century has not been seen in those aged 40 – 64 years [3].

No matter how those in later life, conventionally defined as those of 65 years and older, are described this population is characterized by its variety, ranging from active, community-dwelling, working, healthy nonagenarians to bed-bound, chronically ill, functionally and cognitively-impaired persons in their late 60's. Because the healthier group is closer in phenotype and physiology to middle aged than to frailer older people, information relating to the management of urinary and faecal incontinence in this group is integrated into the other ICI chapters. This chapter focuses on frail older people, emphasizing not only the different aetiologies and treatment of UI and FI, but the additional issues of disease burden, disability, altered responses to drug therapy and the role of caregivers. Those sections in the previous (5th) Consultation, dealing with catheters and the organization of care have been moved to the more relevant chapters. This Consultation sees for the first time a dedicated section dealing with continence at the end of life and examines the effect of both cognitive and physical frailty as the presence of each or both may need different considerations when offering treatments for incontinence.

The committee took the view that where there is a paucity of data reflecting the effectiveness or utility of approaches to the treatment of UI or FI in frail older adults, interventions aimed at community dwelling older adults should be employed with due regard to the likely benefits, harms, feasibility, expectations and outcomes of treatment, rather than not be attempted at all. The committee recognized that frail older people may be “victims” of therapeutic nihilism and may receive standards of care below those received by younger persons [4, 5].

The pathophysiology of UI in the frail elderly requires a broader conception of “disease,” centring on patient-level factors rather than just the bladder or bowel and its neurological control. UI and FI in frail older people is normally a result of multiple interacting risk factors including age-related physiological changes, comorbidity, polypharmacy, functional and cognitive impairments and common pathways between them (Figure 1). Furthermore, the impact of UI or FI in frail older persons extends beyond the affected individual to their caregivers, leading to caregiver stress and an increased likelihood of institutionalisation [6]. Therefore, assessment in frail older persons requires a broader scope than that employed in the care of younger individuals. Failure to address the multifactorial nature of disease and treatment limits not only clinical care and research, but also important opportunities to improve function and quality of life [7]. Management of incontinence in frail older persons is necessarily multicomponent, and must address the many associated factors and shared underlying impairments with other geriatric syndromes (for example, by combining physical exercise with prompted voiding) [8]. Drug therapy must be placed in the context of altered pharmacology, pre-existing polypharmacy and an increased susceptibility to adverse events. The continuing challenge in providing a review of incontinence in frail older people is the relative dearth of Level 1 evidence for interventions. Thus the frail older person presents multiple challenges for research (not the least of which is substantial difficulty in recruiting to clinical trials due to either overt or covert exclusion

and the additional challenge of intervening illness and death) [9]. Despite the oldest-old (those of 80 years of age and above) forming the fastest growing group of affected individuals, intervention studies continue to

be rare. Moreover, trial outcomes need to be more broadly based, incorporating caregivers, a range of care settings, alternative models of care, and goals of care unique to this population [10].

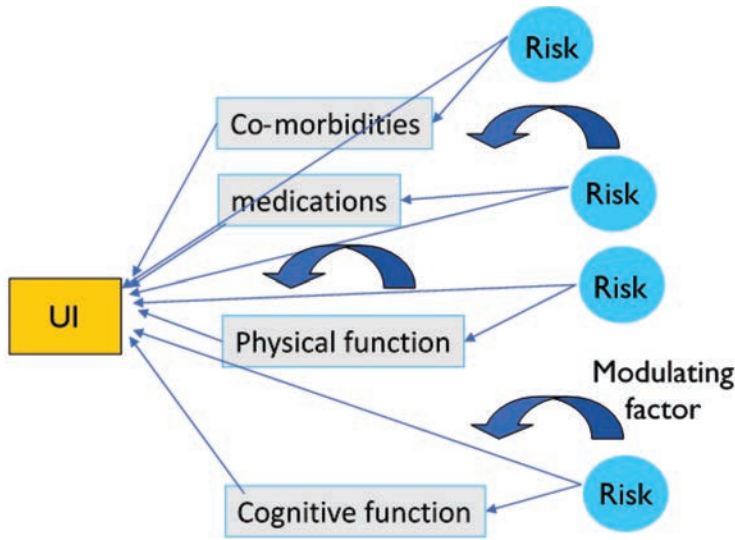

Figure 1. Incontinence as a geriatric syndrome

1. SEARCH STRATEGIES

Given the broad range of this report, we used multiple searches using the following MESH terms (in caps) and phrases, alone and in combination, using the PubMed and Ovid search engines: AGED, AGED OVER 80, ACTIVITIES OF DAILY LIVING, DEPRESSION, elderly, FALLS, frail, FRAIL ELDERLY, FRAILTY, function, geriatrics, LONG TERM CARE, MEDICATIONS, NURSING HOME, older, QUALITY OF LIFE, RANDOMIZED CONTROLLED TRIAL; and BLADDER, GYNAECOLOGICAL SURGICAL PROCEDURES, PELVIC FLOOR, PROSTATE, STRESS INCONTINENCE, SURGERY, URE- THRA, URINARY INCONTINENCE, URINATION DISORDERS, UROGYNECOLOGY, UROLOGY, VAGINA, VOIDING DYSFUNCTION , nocturia OR nocturia OR “night-time voiding” OR “night- time voiding” OR “nocturnal voiding” OR “night- time voids” OR “night-time voids” OR “nocturnal voids” OR “night-time frequency” OR “night-time frequency” OR “nocturnal frequency” OR “night- time urination” OR “night-time urination” OR “nocturnal urination” OR “night-time micturition” OR “night-time micturition” OR “nocturnal micturition” OR “night-time polyuria” OR “night-time polyuria” OR “nocturnal polyuria” OR nocturia) OR ((noctur* OR night*) AND (void* OR urination OR micturition OR polyuria OR pollakiuria OR “LUTS” OR “lower urinary tract symptoms” OR “BPH” OR “benign prostatic hyperplasia”)) AND (“aged, 80 or over” OR aging OR elderly OR older OR “very old” OR senior OR “all aged” OR geriatric OR frail OR aged) AND (“double blind method” OR “double blind”

OR placebos OR placebo OR “controlled clinical trial” OR “randomized controlled trial” OR “random allocation” OR “single blind method” OR “research design” OR “exp clinical trials” OR “clinical trial” OR “single blind” OR “double blind” or “triple blind” OR “single mask*” OR “double mask*” or “triple mask*”) (longitudinal OR “natural history” OR cohort OR incidence OR remission OR progression OR prospective OR “community-based” OR “population-based” OR epidemiol* OR “follow-up”); TOLTERODINE; OXYBUTYNIN; SOLIFENACIN; PROPIVERINE; TROSPIMUM, IMIDAFENACIN; DARIFENACIN; FESOTERODINE; fecal incontinence OR, constipation, R anal incontinence. Ovid Expert Search Filter; Publication years 2010-15. We included, where possible, information from non-English language articles where an English language abstract with sufficient information was available. References in retrieved articles were reviewed for additional relevant articles. We also searched the Cochrane Database and National Guideline Clearinghouse for relevant systematic reviews, meta-analyses, and evidence-based recommendations. A research librarian aided this process.

2. FRAILTY

The proportion of older persons in the population is increasing in almost every country around the world. By 2050, approximately 2000 million people will be aged 60 years or over, and 400 million will be over the age of 80. Frailty is essentially a state of vulnerability to insult, which may be in the form of a relatively minor stressor, from which the individual does not

fully recover. The Consultation has defined “frail older persons” as those over the age of 65 with a clinical presentation or phenotype combining impaired physical activity, mobility, balance, muscle strength, motor processing, cognition, nutrition, and endurance (including feelings of fatigue and exhaustion). This is consistent with the Fried phenotypic approach to frailty in which there is a clear distinction between frailty and disability, and from the accumulation of diseases (deficits) model of Mitnitski and Rockwood [11]. Among persons meeting strict phenotypic criteria for fragility, only 22% also had both comorbidity and disability, 46% had comorbidity without disability, 6% disability without comorbidity, and 27% had neither comorbidity nor disability [12, 13]. Frail people do however usually have multiple chronic medical conditions, take multiple medications, require care from others and assistance to perform some or all of the personal activities of daily living (PADLs) (e.g., bathing, dressing, toileting, and mobility), are often homebound or institutionalized. They have a high risk of intercurrent disease, increased disability, hospitalisation, and death [1]. In the United Kingdom, an examination of 5,450 people aged 60 and over from the English Longitudinal Study of Ageing using Fried criteria found the overall weighted prevalence of frailty to be 14%. Prevalence rose with increasing age, from 6.5% in those aged 60–69 years to 65% in those aged 90 or over. Frailty was more common in women than in men (16% versus 12%). 93% of frail individuals had difficulties with mobility compared to 58% of non-frail individuals [14]. In the United States, using the Fried model of frailty applied to 7,439 participants in the 2011 baseline of the National Health and Aging Trends Study of persons aged 65 and older, 15% (95% CI: 14%, 16%) of the older non-nursing home population was frail, and 45% prefrail (95% CI: 44%, 47%). Frailty was more prevalent at older ages, amongst women, racial and ethnic minorities, those in supportive residential settings, and persons of lower income. Chronic disease and disability prevalence increased steeply with frailty [15]. In Latin America and the Caribbean, a meta-analysis of 29 studies including 43,083 people, of mean age of approximately 60 years, using a variety of frailty assessment scores, identified a prevalence of frailty of 19.6% (95% CI: 15.4–24.3%) with a range of 7.7% to 42.6% [16]. Likewise there have been an increasing number of epidemiological studies assessing the point prevalence of frailty, using a variety of definitions, across a number of countries such as Russia [17], China [18], South Korea [19] and Brazil [20] amongst others [21].

2.1. Frailty and incontinence

Several studies suggest that the relationship between urinary incontinence, faecal incontinence and frailty is not unidirectional. Incident UI in those over age 65 has been associated with a two-fold increased risk of impairment in ADLs, instrumental activities of daily living (IADLs – e.g., transportation, finances, shopping, laundry, housekeeping), and poor performance

on three physical measures, suggesting that incident UI may be an early marker of the onset of frailty [6]. In a Taiwanese study of UI and its association with frailty among 440 men aged 80 years and older using the clinical frailty scale, the prevalence of UI was 19.1%. Frailty was more common among subjects with UI than those without (60.7% vs 32.3%). Men with UI also had more comorbidity, poorer physical function, were more likely to have depressive symptoms, impaired cognitive function, poorer nutritional status, more polypharmacy and a higher likelihood of fecal incontinence than those men who were not frail [22]. In a population-based study of older Mexican Americans, incident but not prevalent UI was independently associated with functional decline in ADLs, IADLs, and physical performance [23]. Another population-based study found an association between UI and IADL decline, but not ADL decline, nursing home admission, or death, after adjustment for age and comorbidity [2]. A Portuguese study showed that older people who presented with either “slowness” or “exhaustion” had a risk of UI almost five times greater than those without [24]. Although one early study suggested that older persons with UI had a higher mortality risk subsequent studies that more fully adjusted for comorbidity and functional status have not found any association [2, 25–27].

2.2. Frailty, continence and consequence

Several multivariate studies suggest that patients with new onset UI at the time of stroke have higher rates of death or disability at 2 years (OR 4.43; 95% CI 1.76 to 11.2) to 5 years (OR 3.21 [95% CI 1.04–9.91]), especially if UI persists (OR 7.47 [95% CI 2.29–24.42]) [28, 29]. Given its association with frailty, it is not surprising that UI remains a risk factor for nursing home admission, particularly in association with a dementia diagnosis. Studies showing a significant association between UI and institutionalisation have been done in Finland (in men, but not women, with urgency UI); [30] Germany; [31] New Zealand (persons > age 65) [32]; US (men more than women) [33], after hip fracture [34], among Hispanic elderly [23], and patients attending a dementia clinic in rural Japan [35]; and Hong Kong [36]. Two studies failed to find a significant association after controlling for comorbidity, using US [2] and Canadian databases [37]. It was estimated that the proportion of US NH admissions attributable to UI in men is 0.10 (95% CI 0.08–0.13) and in women 0.06 (95% CI 0.05–0.09) [38]. The prevalence of UI at NH admission in the U.S. shows variation of almost 50% and differs by race [39] suggesting that patient and caregiver factors and local resources affect the role UI plays in institutionalisation. An issue, particularly in studies of institutionalisation in people with a dementia diagnosis, is the failure to include UI as a risk factor or defining it only by a composite function score [40, 41]. The significant association of faecal incontinence and institutionalisation (odds ratio 1.79, 95% CI: 1.00–3.20), in one Canadian study was lost when adjusted for cognition, ADL dependence, and self-reported health, although a survey of US geriatricians found

that the presence of faecal incontinence was more likely to result in a referral to a nursing home than not [42, 43].

2.3. Cognitive Frailty

Whilst age associated cognitive impairment has received extensive research and clinical interest, cognition has not been conceptualised in a similar fashion to physical frailty. Frailty *per se* includes both physical and cognitive domains. The term cognitive frailty has been operationalised as an heterogeneous clinical manifestation characterised by the simultaneous presence of both physical frailty and cognitive impairment. The key factors defining such a condition include the presence of physical frailty and mild cognitive impairment and excluding concurrent dementia, reflecting reduced cognitive reserve [44]. The exclusion of the dementias may not be useful in that the two features are often intimately intertwined but conceptually the definition may have clinical utility in terms of continence management, where the application of treatment options may vary depending upon the predominant factor influencing frailty. To be able to distinguish those with a vulnerability to cognitive decline amongst persons either with or without physical frailty may be of use, but again, the pathophysiological mechanisms leading to both entities are common and probably shared.

2.4. Dementia

The proportion of people living with dementia, a group of conditions also associated with an impairment in quality of life and physical function increases; prevalence estimates suggest that globally in 2010 35.6 million people lived with dementia with numbers expected to almost double every 20 years, to 65.7 million in 2030 [45],[46]. In addition to the morbidity associated with urinary incontinence in older people, its presence with co-existent dementia increases the likelihood of institutionalisation [47]. Unfortunately, once there, there is evidence of institutional practices, such as *en masse* toileting, making incontinence more likely [48]. Likewise, caregivers identify looking after an older person with dementia and incontinence as being burdensome [49, 50]. Management guidelines for urinary incontinence and lower urinary tract symptoms seldom consider the implications for management in those patients with co-existing medical conditions [51-53]; few discuss management in those with a dementia diagnosis [54]. The likelihood of incontinence increases in association with the severity of dementia but until recently longitudinal studies did not identify an association with incident cases [55, 56]. One longitudinal study of 6,349 community dwelling women found that a decrease in mental functioning as measured by a modified mini mental status exam (MMSE) was not associated with increased frequency of urinary incontinence over 6 years, but did predict a greater impact [57]. Despite strong associations with baseline incontinence in the Canadian Study of Health and Aging, moderate or severe cognitive impairment, measured by the same modified

MMSE, was not associated with incident UI over 10 years [58]. However, in a longitudinal study of 12,432 women aged between 70-75 years with a 3 year follow up there was a strong association with a dementia diagnosis (OR 2.34) [59]. Similarly, over 9 years follow up of 1,453 women aged 65, dementia was strongly associated with incident urinary incontinence (RR 3.0) [6]. Likewise, in a Scottish study, the prevalence of urinary incontinence increased with decreasing mini-mental state scores and was notably more common in those with impairments of attention and orientation, verbal fluency, agitation and disinhibition [60]. In a United Kingdom General Practitioner database, when compared with those without a dementia diagnosis, dementia was associated with approximately three times the rate of diagnosis of urinary incontinence. The incidence rates of first diagnosis per 1,000 person-years at risk (95% confidence interval) for urinary incontinence in the dementia cohort, among men and women respectively, were 42.3 (40.9-43.8) and 33.5 (32.6-34.5) [61]. When assessed urodynamically, most incontinence associated with dementia appears to be related to detrusor overactivity, resulting in urgency incontinence [62, 63].

Incontinence in dementia adds to caregiver burden [64], and influences decisions to relocate people to care homes [6]. Whether successful management of incontinence reduces either this associated burden or alters decisions to institutionalise these people is unknown, evidence is limited to case reports and anecdotal evidence. Family physicians identify dealing with incontinence in dementia as a significant challenge [65]. Likewise there is the concern regarding the influence of antimuscarinic medications on cognition, where there is increasing evidence of cognitive impairment and higher rates of incident dementia diagnosis associated with high antimuscarinic load and long exposure in older persons in epidemiological studies [66, 67], although data in persons with pre-existing dementia are less consistent [68].

Once institutionalised, urinary incontinence becomes a major factor in those with dementia. In a study in Austrian nursing homes, urinary incontinence was present in 84.2% of residents with dementia versus 53.2 % of those without and was highly prevalent even in those with early dementia, affecting 64% of the 277 residents studied [69]. Once admitted to a nursing home, the presence of a dementia diagnosis is associated with a hastening of loss of continence, compared to those residents without. Incontinence is associated with a reduced quality of life and impaired nutrition and mobility in older people with dementia [70, 71], but is sadly neglected in terms of the amount of attention paid to it despite the acknowledged adverse effect on quality of life and the associated costs of management [72].

2.5. Managing incontinence in dementia

Most people with a dementia diagnosis living in the community can potentially be managed in a similar way to any other community dwelling adult, in line

with current guidelines. As noted in the 5th International Consultation on Incontinence, the expectations of both patient and caregiver, the nature of the proposed treatments and likelihood of benefits and harms should be taken into account [73].

Successful and safe management of incontinence in people with more advanced dementia presents additional challenges. For the most part, successful delivery of conservative or behavioural therapies in late life requires the ability for the individual to learn or change behaviour; the active engagement of a caregiver is also required [73]. A dementia diagnosis should not preclude an attempt to manage incontinence with behavioural methods, but for those with a compromised ability to retain behavioural change this is clearly inappropriate. A stepwise approach to initiating interventions and assessing the results seems like a reasonable first step in management, recognising that older people do appear to be more likely to need drug therapy for urgency incontinence than younger persons [74]. For prompted voiding to be successful, a three day trial should result in either a 20% reduction in wet episodes or an increase in spontaneous requests to use the toilet [75]. If this is not successful then the mainstay of management is a strategy of check and change of appropriately assessed containment products [54, 76]. The remaining option is to introduce a fixed voiding schedule, which requires no behavioural change, but this too may be impractical in circumstances where there is limited caregiver support or availability. Even in adequately staffed institutions, evidence suggests that for those who need toileting, the average number of toilet assists per resident is around two per day, sadly short of that which might be needed [77, 78]. A recent systematic review examining the evidence for conservative management approaches for those with dementia living at home concluded, unsurprisingly that there was insufficient evidence to make any recommendation; little, if any, specific guidance for practice in the community exists [79, 80]. The England and Wales National Institute for health and Care Excellence guideline on incontinence in those with neurological disease recommends that treatment be tried on an individual basis [81].

Evidence on pharmacological treatment for UI in those with dementia is lacking; that which does exist is discussed in the pharmacological treatment section.

II. URINARY INCONTINENCE

1. AETIOLOGY & ASSESSMENT

1.1. Background

The aetiology of UI in frail older adults is grounded in the concept of a classical geriatric syndrome, involving multiple interacting risk factors, including age-related changes, comorbidity, and potentially

common pathways between them. This section addresses these components.

1.2. Quality of the data

The data on aetiology of UI in frail older persons remain limited, and observational studies of varying quality constitute much of this literature. Additionally, longitudinal studies of large numbers of frail individuals are difficult to carry out because of paucity in recruitment and the high rate of natural attrition. Despite the lack of such studies, many relatively large, careful descriptive studies and case series, as well as expert consensus processes, have made important contributions to our understanding of the aetiology of UI in this population.

1.3. UI as a geriatric syndrome

In older adults, especially those who are frail, UI forms a classical geriatric syndrome, many of its risk factors are not directly related to the genitourinary tract [82, 83]. Geriatric syndromes have been defined as “multifactorial health conditions that occur when the accumulated effects of impairments in multiple systems render an older person vulnerable to situational challenges” [82]. Thus, large numbers of different baseline as well as precipitating risk factors may interact with each other in influencing the ability of an older individual to remain continent in the face of common daily challenges. This multifactorial complexity, combined with the fact that most individual risk factors typically account for only a small proportion of the overall risk, have greatly complicated the development of a pathophysiological framework for the study of common geriatric syndromes [82]. **Figure 2**

Nevertheless, because common risk factors (e.g. arm and leg weakness, sensory and affective impairment) may be shared by different geriatric syndromes (such as UI, falls, and functional dependence) [84], they may represent particularly attractive sites for the development of interventions [82]. For example, the presence of brain white matter hyperintensities within critical periventricular and subcortical regions could represent key risk factors for the development of different geriatric syndromes such as falls, impairment in executive cognitive function, depressive symptoms, and UI [85]. Functional magnetic resonance imaging (fMRI) studies have identified central nervous system areas that are particularly relevant to urinary storage symptoms and urgency [86, 87]. Therefore, failure of activation within orbitofrontal regions may contribute to an older individuals’ decreased ability to suppress urgency [88]. Connectivity pathways within the right insula and anterior cingulate gyrus may also play a role in maintaining continence supporting the concept that decline in connectivity [88] and coordination between different brain regions represent early critical events in aging. These findings suggest the possibility that interventions to prevent the development of white matter hyperintensities, such as

control of vascular risk factors, could also prevent UI.

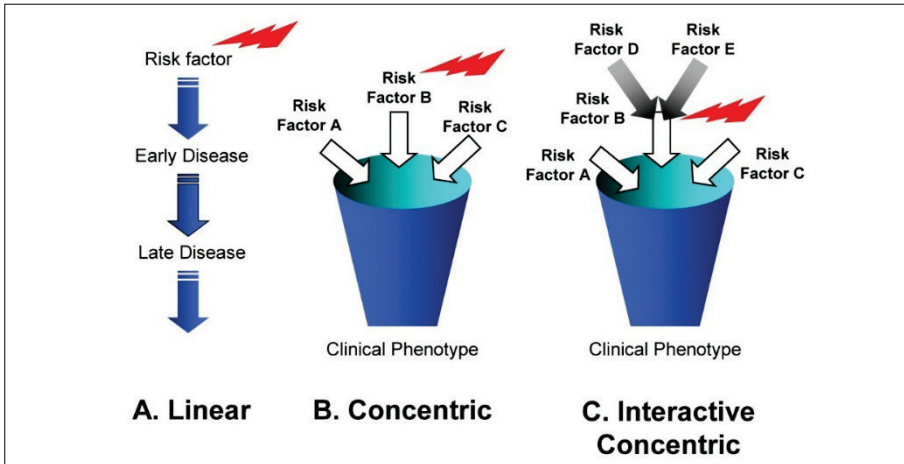

Figure 2. The mechanistic geriatric syndrome

2. AGE RELATED CHANGES RELEVANT TO UI IN FRAIL OLDER PERSONS

Age-related changes in the lower urinary tract (LUT) can function as risk factors for the development, continuation, and worsening of UI in frail elderly persons (Table 1). At the same time, they rarely are alone sufficient to cause UI, and in some persons have no effect on lower urinary tract symptoms (LUTS) or UI. Furthermore, the literature on “normal” LUT ageing has many potentially confounding methodological limitations. Normal ageing changes are difficult to study, because longitudinal data including large numbers of individuals spanning many years are necessary to definitively separate “normal LUT ageing”

from confounding factors and comorbidity. Cross sectional studies are subject to confounding by comorbidity and time-dependent cohort effects, such as change in labour and delivery practices. Thus, to date many studies actually describe “age-related” associations, as opposed to normal ageing. Other limitations include: derivation of much of the cellular and neurochemical data from animal studies; morphologic studies based on cadavers with unknown parity, comorbidity, and LUT symptoms; “age-effects” derived from studies of symptomatic persons; and use of surgical patients at tertiary centres as “normal” controls. Even the definition of “normal” can be difficult: is it continence, absence of LUTS, lack of comorbid disease, or normal physiological testing [89]? The following sections focus on findings from more robust and, where possible, confirmatory studies.

Table 1. Age related changes in the lower urinary tract

Age-Related Change	Potential Effects on Continence
Bladder ultrastructure on electron microscopy Dysjunction pattern Muscle and axon degeneration	Bladder overactivity and urgency UI Impaired bladder contractility, increased residual urine, and decreased functional bladder capacity
Bladder function Decreased capacity Decrease sensation of filling Increased detrusor overactivity Decreased bladder contractile function Increased residual urine	Increased likelihood of urinary symptoms and UI
Urethra Decreased closure pressure in women	Increased likelihood of stress and urgency UI
Prostate	

Age-Related Change	Potential Effects on Continence
Increased incidence of benign prostatic obstruction Increased incidence of prostate cancer	Increased likelihood of urinary symptoms and UI
Decreased oestrogen (women)	Increased incidence of urogenital atrophy related symptoms Increased incidence of recurrent urinary tract infections
Increased night-time urine production	Increased likelihood of nocturia and night-time UI
Altered central and peripheral neurotransmitter concentrations and actions	Increased likelihood of lower urinary tract dysfunction
Altered immune function	Increased likelihood of recurrent urinary tract infections
Increased prevalence of white matter hyperintensities in brain	Increased prevalence of severe urge / urgency, link to cognitive impairment and impaired mobility

2.1. Bladder

Understanding age-related changes in the bladder is complicated by a paucity of longitudinal data, variable definitions of “normal,” and use of potentially biased (and symptomatic) referral populations. It is difficult to isolate such factors as the role of decreased blood flow, poor voiding habits, comorbidity, central and peripheral nervous system innervation, and reflex patterns as determinants of bladder function in older persons. The research focus has been urodynamic function, neurohumoural responsiveness of detrusor smooth muscle, and ultrastructure. While the key role of the urothelium and afferent systems on micturition are increasingly appreciated (See Committee 2, Cell Biology; Committee 3, Neural Control; and Committee 4, Pathophysiology), there are only limited human data on urothelial changes with age. Urodynamic changes associated with age have typically included smaller voided volume, increased residual volume, smaller bladder capacity, and increased involuntary detrusor contractions (detrusor overactivity (DO)). Correlations with age are often small, suggesting that other factors are at least as important [90]. Urodynamic findings may not relate to symptoms: in a urodynamic study of community-based healthy persons over age 55, DO was found in 42% of continent women, one-third of whom were totally free of LUTS [89]. In another study, charts of 53 consecutive females over age 80 undergoing multichannel urodynamics according to ICS standards were retrospectively analysed. These elderly patients presented with LUTS, yet in 11% urodynamic studies were reported as being normal, with considerable other discordance between symptoms and urodynamic findings [91]. Nevertheless, in a cross-sectional study involving ambulatory, cognitively intact, community-dwelling older female volunteers, maximum urethral closure pressure, detrusor contraction strength, and urine

flow rate all declined significantly with age, regardless of whether DO was present or not [92].

The ability of the bladder to empty efficiently also declines in healthy older men and women who have no evidence of bladder outlet obstruction (BOO) or significant confounding disease [89, 93]. A variety of different risk factors associated both with ageing and common comorbid conditions may contribute to age-related declines in detrusor contractile function, which may ultimately lead to detrusor underactivity [94, 95]. Decreased contractile function during voiding in older persons is associated with lower urine flow rates and a small increase in post voiding residual volume (PVR) (generally to < 50 ml) [94]. Even in men with BOO, an elevated PVR may reflect decreased bladder contractile function rather than obstructed voiding [95]. While some studies suggest a myogenic origin of impaired contractility, others suggest that impaired blood supply, with concomitant ischaemic-reperfusion injury causing patchy denervation, leads to decreased contractility (see Committee 3, Neural Control). More recently, Smith highlighted the potential contribution of age- and disease-related declines in bladder afferent sensory activity in contributing to impaired voiding performance seen with detrusor underactivity [96]. Incomplete bladder emptying from all such causes can reduce functional bladder capacity, and thereby contribute to the urinary frequency and nocturia common in frail older persons [94]. The recent development of a model allowing continuous uroflow in mice has led to studies evaluating the impact of normal aging on overall LUT performance [97, 98]. While aging did not influence measures of detrusor expulsive strength, pre-contraction pressures, intervoid intervals, per-void volumes and voiding flow rates all increased with aging [97]. Moreover, aged animals demonstrated a decreased homeostatic ca-

capacity to respond to the challenge of continuous bladder filling, with indirect measures suggesting a role for decreased bladder volume sensitivity [97, 99].

In human studies, the observation that bladder volume at the initial desire to void declines with age may be confounded by comorbid conditions and concurrent medications [100]. Furthermore, unlike the positive association between detrusor contraction strength and DO found in younger subjects, older adults demonstrate a decline in DO-associated detrusor contractile function [92] and detrusor contractility [101]. Moreover, many frail older persons with UI present with a combination of DO on filling and poor contractility during voiding, an association termed detrusor hyperactivity with impaired contractile function (DHIC) [62, 94, 102]. In such cases, the bladder contraction does not empty the bladder fully, leaving a large PVR otherwise not explained by BOO. Because DHIC symptoms can include urgency UI, stress and mixed UI, dribbling, frequency, and nocturia, they may be mistaken for other conditions. At the same time, DHIC may be mistaken for DO with normal contractility because significant detrusor underactivity may be present in the absence of any relevant symptoms. Thus, while it is not possible to speak of precise cutoffs when differentiating between “normal” and “abnormal” PVR values, PVR assessments do provide crucial information into age- and disease-related alterations in overall LUT performance [103].

Ultrastructural studies demonstrate cellular changes associated with age-related changes in detrusor function. One series of such studies involved symptomatic and asymptomatic persons aged 65 - 96, using urodynamic testing and electron microscopy of bladder biopsy specimens, which were read in a blinded fashion using explicit protocols [104-107]. A consistent, one-to-one correlation between specific urodynamic findings and bladder ultrastructure was observed, although there has been considerable debate about the veracity of these findings and they have not been reproduced and have been disputed by the findings of a later study which found the ultrastructural changes described evenly distributed between normal women (n = 15) and women with detrusor overactivity (n = 22) [108]. The small number of asymptomatic patients with no DO, normal contractility, and no obstruction, detrusor muscle fascicles were largely intact, with two distinctive ultrastructural findings that may be related to ageing alone: muscle cell membranes characterized by numerous “dense bands” and markedly depleted caveolae, and slightly widened spaces between muscle cells with limited content of collagen and elastin. Depletion of caveolae may be related to de-differentiation of muscle cells, which could eventually result in the reversion of actively contractile cells to inactive, synthetically immature cells. A similar phenomenon has been reported in atherosclerotic blood vessels and postmenopausal myometrium, and may be related to reports of increased collagen in bladders from older women [104, 109]. Moreover, lack of oestrogen contributes to, and oestrogen re-

placement reverses, both caveolar depletion and detrusor fibrosis [110, 111]. Thus, both ageing and postmenopausal decline in oestrogen levels may contribute to bladder muscle cell differentiation and contractile function [94].

The natural history of these ultrastructural changes remains largely unknown. From the ultrastructural studies described above, a subset of 23 patients was followed longitudinally [112]. The previously observed one-to-one correlation between ultrastructure and function was maintained, but it was unclear whether urodynamic or ultrastructural changes occurred first in subjects who developed or had a change in LUTS. The pattern of dense-bands and non-disruptive muscle cell degeneration varied over time: the DO with dysfunction pattern developed in some subjects, and impaired detrusor contractility and the corresponding degeneration pattern was observed to progress in severity or develop. Other investigators have found similar results but without the one-to-one correlation (e.g., see Brierly et al [113, 114]). Clearly, further work is needed understand the associations between changes in ultrastructure, urodynamic features and clinical syndromes.

In addition to such alterations in ultrastructure, a variety of changes involving relevant nerve fibres, receptors and signalling pathways have also been described in bladder tissues from aged animals, and to lesser extent human biopsies. For example, with ageing overall, sympathetic nerve fibre density may decrease [115, 116]. Bladder biopsies from older subjects with normal urodynamic profiles typically show little or no evidence of axonal degeneration and the density of some CGRP-positive sensory nerves is maintained in old age, yet the impact of aging on other categories of sensory fibres or on motor fibres remains unknown [104, 115]. Examples of other changes include decreased contractility and calcium fluxes in response to cholinergic agonists or depolarization [117]; increased responsiveness to adrenergic agonists with increased expression of the alpha 1D-adrenergic receptor [116]; declines in phosphodiesterase 5 (PDE5) levels and possibly signaling [118]; as well as decreased P2X1 purinergic receptor expression [119]. Unfortunately, the interpretation and generalisability of these findings is often limited by a failure to include intermediate age-points which would allow investigators to distinguish changes attributable to aging as opposed to maturational processes [120, 121].

More recent studies have suggested a role for decreased A2B receptor expression in lower ability of adenosine to relax the detrusor [122]. Also, use of permeabilised bladder muscle strips suggested that IP3-induced calcium release is primarily responsible for the contractions in older rats, thus aging-related decline in carbachol contractions may result from decreased calcium-induced calcium release rather than carbachol-induced calcium sensitisation [123]. The use oxidative stressors has shown that mechanisms

possible related to the TRPM8 (cold sensing TRP melastatin 8) ion channel may compromise urothelial function in aged bladders [124]. Studies conducted with human bladder muscle strips suggested an age-related increase in carbachol-mediated contraction via Rho Kinase pathways [125], associated with lower MLCK expression [126]. Finally, studies conducted in aged mice from a systems-based perspective demonstrated that an increase in neurogenic power during filling accompanies augmented centrally mediated compliance enhancement with aging, thus suggesting the existence of a bladder control model in which brain processes related to micturition may compensate for age-associated changes [127].

2.2. Urethra

Due to their common embryological origin, the urethra undergoes age-related mucosal and stromal changes like the vagina, and urethral changes in older women can be partially inferred from examination of vaginal tissue. Because of the difficulty of obtaining non-cadaveric urethral tissue, data on urethral smooth and striated muscle changes with age are complicated by confounding factors and definitions of controls. Urethral closure pressure decreases with age [128, 129]. Based on a sample of 82 women aged 20-70, urethral closure pressure was found to decrease by 15 cmH₂O per decade [130]. A number of anatomical and physiological changes may account for this decline. Mucosal thinning and lack of proteoglycans reduce urethral wall apposition; this also may contribute to retrograde movement of perineal bacteria into the bladder causing urinary tract infections [131]. These mucosal changes may extend up to the bladder trigone, causing irritation of sensory afferent nerves, and possibly triggering DO [132]. The submucosal venous plexus in the proximal urethra loses its corkscrew shape, the number and volume of arterial vessels decrease, and vascular pulsations lessen [133]. Several studies, using different measurement techniques, have shown that urethral vascular density and blood flow decrease with age, but not vascular flow velocity [134-136]. However, age explained only 9% of the variability in vascular density in one study [134], and none of the studies controlled for vascular risk factors such as hypertension and diabetes. The relative importance of decreased vascular volume versus hypoxia on urethral functional integrity is unclear. Other alterations in the urethral stroma are increased volume of connective tissue, decreased ratio of proteoglycans to collagen, and decrease in nerve density [137, 138].

Cadaver studies suggest that the number and density of urethral striated muscle fibres decrease with age, especially in the ventral wall of the proximal urethra [139, 140]. These authors estimated that striated fibres decrease by 1% per year. Large inter-individual variations were observed, with age and parity accounting for only a small part of the variability, suggesting that other yet to be defined factors are important. These studies also found that cross-sectional

striated muscle fibre area decreased while fibre diameter was preserved. Another cadaver study by the same group found that circular smooth muscle width was 25%-50% higher in younger women (aged 20-39 years) than older (aged 70-89), and that younger women had higher fibre counts [141]. Smooth muscle loss in the older women correlated with loss of striated muscle in the anterior urethra. Moreover, a recent study raised the possibility that TNF-alpha may contribute to age-related rhabdosphincter satellite cell death and muscle loss with aging [142]. Urethral sensation, measured as current perception thresholds, was significantly higher in older women in two studies (by the same authors), one comparing 48 asymptomatic women and 13 with urgency UI [143], and another in asymptomatic women [132]. The authors concluded that age-related LUT sensory neuropathy could contribute to the higher prevalence of overactive bladder (OAB) symptoms with age; however, urethral sensation thresholds were higher in women with urgency UI when controlled for age and parity [143], and the "asymptomatic" older women may have had urodynamic DO [132].

With age, the urethral meatus generally moves toward the vaginal introitus, and may be difficult to see if there is considerable introital stenosis. Caruncles - benign violaceous soft swellings-often appear at the meatus, and are not problematic unless they cause discomfort or obstruction. Urethral diverticula can be a diagnostic challenge, especially in older women, because the symptoms (dysuria, pain, UI, frequency, urgency, dyspareunia) may be attributed to postmenopausal changes, age, OAB, or urgency UI [144]. Diverticula should be considered in women who have repeatedly failed "conventional" UI treatment. Diagnosis requires imaging by voiding cystourethrography, ultrasound, or magnetic resonance scans. Urethral obstruction is relatively uncommon in older women, and is nearly always secondary to other LUT dysfunction (e.g., pelvic organ prolapse) or is iatrogenic (from LUT/pelvic surgery or radiation. In men, age-related decrease in striated sphincter muscle cell density occurs as well, [145, 146] and has been associated with increased muscle cell apoptosis [145]. While some investigations describe an increase in resting prostatic urethral pressure with age, [147] others note the increase occurs only to the sixth decade then subsequently decreases, along with a shortening of sphincteric urethral length [148]. These discrepancies may reflect differences in prostate volume and morphology.

2.3. Pelvic floor

Pelvic floor changes in normal older men have not been well studied. In women, the effect of age on pelvic floor structure and function is difficult to differentiate from the effects of hormonal status and parity [149]. A number of studies are cross sectional rather than longitudinal, and focus on symptomatic women. For example, a questionnaire study of over 4,000 community women aged 25-84 found no association between age and stress UI (SUI), OAB, or anal UI,

after adjustment for obesity, birth history, menopause, and hormone use [150]. Similarly, in a random sample of 343 Austrian women aged 18-79 years, impaired pelvic muscle contraction (graded by the Modified Oxford Scale) was weakly associated with parity and body mass index but not age [151]. In contrast, a study combining an interview, physical exam and transperineal ultrasound identified age as a weak ($r = -0.25$) but statistically significant predictor of pelvic muscle weakness and levator ani morphometry even after controlling for obvious confounders [152]. A recent MRI study was able to distinguish distinct patterns of change in pelvic support in women with stress as opposed to mixed urinary incontinence [153]. Evidence of denervation and changes in pelvic striated muscle fibre number, type, and diameter have been found in asymptomatic and nulliparous women (see Committee 2, Cell Biology). For example, in a sample of 82 nulliparous women, neither levator function (measured by resting vaginal closure force and augmentation of vaginal closure force) nor pelvic organ support (on pelvic exam) showed an association with age [154]. A histomorphometric study, using levator ani muscle from 94 female cadavers (aged 15-58), 10 male cadavers (aged 23-35), and 24 women undergoing pelvic surgery, found that myogenic cell damage was associated with both parity and age (\leq age 35), but there was no difference between nulliparous women, men, and women with pelvic organ prolapse and/or UI [155]. Total collagen content in pelvic muscle and fascia declines with age, with increased cross-linking and decreased elasticity, [156] but this association does not imply a direct causative effect of "ageing." Constipation may independently contribute to pelvic floor dysfunction in older women [157, 158].

2.4. Vagina

The prevalence of age-related changes in the vagina varies with hormonal status, coexistent vascular disease, and the continuation or lack of sexual activity [159]. The postmenopausal decrease in oestrogen plays a part in many age-associated vaginal changes. Oestrogen is trophic for much of the LUT in women, with oestrogen receptors found in the vagina, vestibule, distal urethra, bladder trigone, pelvic muscles, and ligamentum rotundum [160]. Yet, as the Women's Health Initiative trial has shown, one cannot assume that the association between low oestrogen levels and physiological changes implies that hormone replacement will reverse these changes, restore function, or reduce symptoms [161, 162]. Moreover, the data are equivocal whether and how LUT oestrogen receptors change in number, density, or function with age [133].

Following menopause, the vaginal epithelium loses the majority of its superficial and intermediate layers. Mucosal thinning may be associated with inflammation, evident as erythema, telangiectasia, petechiae, friability, and erosions. This may be responsible for urgency and frequency in some frail elderly women. In addition, there is loss of epithelial glycogen and lubrication, and mucosal pH increases from 4.5-5.5 to

7.0-7.4 [163]. These changes can lead to loss of normal adherent flora (lactobacillus), colonisation with pathogenic organisms such as *E. coli* and enterococci, and the observed increase in bacteriuria and recurrent symptomatic urinary tract infections (UTIs) in older women [164].

Vaginal blood flow, which is important for mucosal integrity and submucosal fullness, decreases with age. Whether this is oestrogen-related, and/or due to concomitant vascular disease is not known. Collagen and lipofuscin deposition in the stroma increases, and may be accompanied by invasion by lymphocytes and plasma cells [164]. The combined epithelial and stromal changes are associated with vaginal wall thinning and flattening of rugae [160]. The vaginal vault may shorten and narrow, and the introital opening decrease (and in severe cases become stenotic), which may make vaginal examination, intercourse, and use of pessaries difficult. However, it is not clear that vaginal shortening is clinically relevant: in one case series of over 3,000 women attending a general clinic, total vaginal length decreased by only 0.08 cm every 10 years [165]. Vaginal shape also may be altered by POP. Because of the multiple potential confounding factors discussed above, a causal relationship between urogenital atrophy and urogenital symptoms/LUTS should not be automatically assumed. Very few randomised trials of oestrogen (oral or topical) for urogenital symptoms include women over age 75, use patient-defined outcomes in addition to physiological measures, or evaluate quality of life outcomes [166]. There are insufficient data to provide an evidence-based approach to symptomatic urogenital atrophy in older women. Oral oestrogen should not be used, but expert opinion supports topical oestrogen treatment (cream, intravaginal tablets, or oestrogen-impregnated pessary-like ring). The validation of vaginal self-swab collection specimen collection offers new opportunities for extending relevant questions to epidemiological studies of older women living in the community [167]. Nevertheless, despite all reported biological changes, aging did not interfere with the ability of fibroblasts obtained from older women with prolapse to be successfully reprogrammed [168].

2.5. Prostate

Histological benign prostatic hyperplasia (BPH) is strongly age-related [169], and may lead to prostate enlargement (BPE) and outlet obstruction (BOO). While many LUT changes in women are associated with lower oestrogen levels, BPH results from the development of an oestrogen-predominant hormonal milieu in the prostate. The trophic prostatic androgen, dihydrotestosterone, is formed by the 5- α reduction of testosterone. Dihydrotestosterone levels decrease with age, while oestradiol concentrations increase in the prostate stroma and remain constant in epithelial tissues, leading to an increase in the oestradiol/dihydrotestosterone ratio and promoting stromal proliferation [170, 171]. Epithelial hyperplasia in turn is mediated by an array of stromal factors [172].

Histological BPH occurs in nearly 80% of men by age eighty [169]. Mean prostate volume increases with age but is very variable; its strongest predictor is prostate specific antigen level of >1.4-2 ng/mL [173]. LUTS in men increase linearly over time, with the fastest increase during the seventh decade, such that by age 80 approximately one-third of men have received treatment for moderate to severe LUTS [174]. Natural history studies and randomized intervention trials, however, consistently demonstrate that symptomatic progression of benign prostate disease is not inevitable. LUTS remit in about one-third of symptomatic men without treatment [175]. Approximately one-third to one-half of affected men develops DO. Thus, even in the presence of demonstrable BPE and/or BOO, the aetiology of LUTS is multifactorial, making prostate-related LUTS in older men a diagnosis of exclusion. Nevertheless, age-stratified normative values for prostate volume, PSA level, as well as indicators of clinical symptoms, quality of life measures and urodynamic parameters may help in such decisions [176].

Although most patients are asymptomatic at the time of prostate cancer diagnosis, this is another possible cause of LUTS, including urgency UI, in older men. However, evaluation for prostate cancer in frail elderly men is rarely if ever indicated, given the high likelihood of limited remaining life expectancy.

The evidence as to whether prostatic inflammation, either acute or chronic, contributes to urinary retention and LUTS in frail older men is contradictory. In a single institution case series of 374 men undergoing TURP for acute urinary retention (AUR) or LUTS, pathological evidence of acute inflammation was significantly more common men presenting with AUR than LUTS (70% vs. 45%) [177]. However, in a much smaller case series of 70 men presenting with AUR, there was no association between inflammation from prostate infarction and AUR [178]. Nevertheless, a recent study demonstrated phenotypic changes and an increased differential expression of a variety of genes involved in inflammation and oxidative stress within glandular adjacent stroma microdissected from young and aged mouse prostates [179]. Such changes may play a role in promoting the development of BPH, BPE and cancer in aged prostates [180]. However, recent studies conducted using both human tissues and animal models support the hypothesis that senescence-associated inflammatory pathways contribute to the pathogenesis of BPH [181].

2.6. Other changes

The role of various neurotransmitters in the central and peripheral nervous system in UI is under active investigation (see Committee 2, Cell Biology). Nevertheless, age-related changes in the actions of these neurotransmitters, their receptors, or the cellular events they stimulate may contribute to the development of UI in frail older persons.

The prevalence of both asymptomatic bacteriuria and UTIs increase with age [182], and the two are often found together in frail older persons. Age-related changes in immune function, vaginal epithelium, faecal incontinence, and insufficient hygiene related to disability, cognitive impairment, and/or lack of caretakers may predispose the frail elderly to bacteriuria and recurrent UTIs. However, the role of otherwise asymptomatic bacteriuria (often found in association with pyuria) [183], in the aetiology of UI in frail elderly people remains unclear [184]. Treating otherwise asymptomatic bacteriuria in frail elderly patients with chronic, stable UI does not, in general, reduce UI severity [185]. UTI symptoms may be subtle and non-specific in this population, and include worsening of UI, delirium in patients with dementia, or a minor but important decline in functional ability [185]. At the same time, current consensus criteria for UTI are poorly sensitive and only moderately specific for UTI in frail elderly. In a prospective cohort of 340 nursing home residents, in which UTI was defined as pyuria (>10 white cells) with >100,000 colony forming units on culture, the McGeer, Loeb, and revised Loeb UTI criteria had sensitivities of only 19-30% and specificities of 79-89% [186].

2.7. Role of biological aging mechanisms in ageing and disease-related alterations in lower urinary tract function.

In recent years, there has been a tremendous growth in our knowledge in the basic biological mechanisms that drive aging processes at the level of organisms, systems, organs and individual cells [187-189]. This has led to the emergence of two major concepts within the recently-established field of Geroscience [187-189]. First, it has been proposed that interventions designed to target multiple mechanisms which are known to contribute to biological aging, would have the capacity to prevent or slow the impact of aging on clinically-relevant physiological mechanisms. To that end, the recent observation that dietary restriction in rats reduces aging-related declines in LUT function together with increases in inflammatory mechanisms, suggests that such interventions could represent a promising direction for future research. Conversely, a number of aging changes involving the LUT appear to be augmented in a mouse model of accelerated senescence [190].

Second, the concept of Geroscience suggests that since aging represents the predominant risk factor for many chronic diseases such as atherosclerosis, cancer, dementia and others, such chronic diseases are also likely to share common mechanisms with both aging and each other; and therefore strategies designed to target such pathways would have the potential to delay the onset of such chronic diseases, thus enhancing function, independence and health span in older adults [187-189]. Although there is growing evidence that atherosclerosis and other forms of aging-related cardiovascular dysfunction [191, 192], contribute to declines in LUT function and

symptoms in old age, from the perspective of mechanisms this hypothesis remains to be explored in the context of genitourinary aging.

CONTRIBUTING TO URINARY INCONTINENCE

3. FACTORS OUTSIDE THE LOWER URINARY TRACT CAUSING OR

A hallmark of UI in the frail elderly population is the wide variety of factors and conditions outside the lower urinary tract that can cause or contribute to leakage (**Table 2**).

Table 2. Comorbid conditions that can cause or contribute to UI in frail elderly persons

Conditions	Comments	Implications for Management
Comorbid medical illnesses Diabetes mellitus	Poor control can cause polyuria and precipitate or exacerbate incontinence; also associated with increased likelihood of urgency incontinence and diabetic neuropathic bladder	Better control of diabetes can reduce osmotic diuresis and associated polyuria, and improve incontinence
Degenerative joint disease	Can impair mobility and precipitate urgency UI	Optimal pharmacological and non-pharmacological pain management can improve mobility and toileting ability
Chronic pulmonary disease	Associated cough can worsen stress UI	Cough suppression can reduce stress incontinence and cough-induced urgency UI
Congestive heart failure Lower extremity venous insufficiency	Increased night-time urine production at night can contribute to nocturia and UI	optimising pharmacological management of congestive heart failure, sodium restriction, support stockings, leg elevation, and a late afternoon dose of a rapid acting diuretic may reduce nocturnal polyuria and associated nocturia and night-time UI
Sleep apnoea	May increase night-time urine production by increasing production of atrial natriuretic peptide	Diagnosis and treatment of sleep apnoea, usually with continuous positive airway pressure devices, may improve the condition and reduce nocturnal polyuria and associated nocturia and UI
Severe constipation and faecal impaction	Associated with “double” incontinence (urine and faecal)	Appropriate use of stool softeners Adequate fluid intake and exercise Disimpaction if necessary
Neurological and psychiatric conditions Stroke	Can precipitate urgency UI and less often urinary retention; also impairs mobility	UI after an acute stroke often resolves with rehabilitation; persistent UI should be further evaluated Regular toileting assistance essential for those with persistent mobility impairment Optimising management may improve mobility and improve UI
Parkinson’s disease	Associated with urgency UI; also causes impaired mobility and cognition in late stages	Regular toileting assistance essential for those with mobility and cognitive impairment in late stages Patients presenting with all three symptoms should be considered for brain imaging to rule out this condition, as it may improve a ventricular-peritoneal shunt
Normal pressure hydrocephalus	Presents with UI, along with gait and cognitive impairments	Regular toileting assistance essential for those with mobility and cognitive impairment in late stages

Conditions	Comments	Implications for Management
Dementia (Alzheimer's, multi-infarct, others) Depression	Associated with urgency UI; impaired cognition and apraxia interferes with toileting and hygiene May impair motivation to be continent; may also be a consequence of incontinence	Optimising and pharmacological management of depression may improve UI
Medications	See Table 3	Discontinuation or modification of drug regimen
Functional impairments Impaired mobility Impaired cognition	Impaired cognition and/or mobility due to a variety of conditions listed above and others can interfere with the ability to toilet independently and precipitate UI	Regular toileting assistance essential for those with severe mobility and/or cognitive impairment
Environmental factors Inaccessible toilets Unsafe toilet facilities Unavailable caregivers for toileting assistance	Frail, functionally impaired persons require accessible, safe toilet facilities, and in many cases human assistance in order to be continent	Environmental alterations may be helpful; supportive measures such as pads may be necessary if caregiver assistance is not regularly available

UI = urinary incontinence

3.1. Medications

The risk of difficulty controlling urination in community dwelling older women taking medications with LUT effects was about 30% higher compared to those who did not take such medications (OR 1.31 CI 1.05-1.21). This did not occur in men [193]. Overall 20.5% of these women reported incident incontinence at Year 4(3 years from baseline). Several studies have implicated alpha blockers as causing urinary incontinence in women with an adjusted OR of 4.98 [194, 195] and increasing to OR 8.81 in conjunction with loop diuretics [196]. Oestrogens have been shown to increase risk of incontinence in women OR 1.6 to 2.0. [195, 197] A wide range of medications have been implicated in causing urinary incontinence with varying degrees of evidence [198]. There has even been a case report of hydroxychloroquine causing urinary incontinence [199]. A retrospective analysis of drug dispens-

ing data in a Japanese cohort found that polypharmacy was associated with the use of medications known to contribute to urgency [200]. Similarly, a Canadian cross-sectional study identified a strong association (OR 4.9, 95%CI 3.1-7.9) between polypharmacy, defined as 5 or more medications, and the prescription of a medication known to cause LUTS [201]. However, there is little evidence that polypharmacy in the absence of drugs that cause incontinence has an impact on the lower urinary tract, and it is likely that the association between polypharmacy and urgency relates to the fact that the more drugs an individual is prescribed, the higher the odds that one of them will be a drug known to induce urgency. Elderly patients commenced on new treatments should be monitored for changes in urinary symptoms. Many classes of medications commonly prescribed for the frail elderly can cause or contribute to the development of UI (**Table 3**).

Table 3. Medications that can cause or contribute to UI in frail elderly persons

Medications	Effects on Continence
Alpha adrenergic agonists	Increase smooth muscle tone in urethra and prostatic capsule and may precipitate obstruction, urinary retention, and related symptoms
Alpha adrenergic antagonists	Decrease smooth muscle tone in the urethra and may precipitate stress urinary incontinence in women
Angiotensin converting enzyme inhibitors	Cause cough that can exacerbate UI

Medications	Effects on Continence
Anticholinergics	May cause impaired emptying, urinary retention, and constipation that can contribute to UI. May cause cognitive impairment and reduce effective toileting ability.
Calcium channel blockers	May cause impaired emptying, urinary retention, and constipation that can contribute to UI. May cause dependent oedema which can contribute to nocturnal polyuria
Cholinesterase inhibitors	Increase bladder contractility and may precipitate urgency UI
Diuretics	Cause diuresis and precipitate UI
Lithium	Polyuria due to diabetes insipidus
Opioid analgesics	May cause urinary retention, constipation, confusion, and immobility, all of which can contribute to UI
Psychotropic drugs Sedatives Hypnotics Antipsychotics Histamine ₁ receptor antagonists	May cause confusion and impaired mobility and precipitate UI Anticholinergic effects Confusion
Selective serotonin re-uptake inhibitors	Increase cholinergic transmission and may lead to urinary UI
sodium-glucose cotransporter 2 (SGLT2) inhibitor	Glycosuria and polyuria, increased propensity to urinary tract infection
Others Gabapentin Glitazones Non-steroidal anti-inflammatory agents	Can cause oedema, which can lead to nocturnal polyuria and cause nocturia and night-time UI

UI = urinary incontinence

3.2. Comorbid conditions and functional impairment

Urinary incontinence is more prevalent in the frail elderly, is associated with cognitive impairment, decreased mobility and decreased levels of physical activity and reduced quality of life.

In a group of subjects with Medigap insurance Advancing age has been associated with an increase in the prevalence of urinary incontinence (37.5% in 5530 subjects). Comorbidities associated with urinary incontinence including arthritis of the hip or knee (Relative Risk Ratio (RRR) = 1.21, P<0.001), arthritis of the hand or wrist (RRR = 1.15, P = 0.001), stroke (RRR = 1.18, P = 0.078), other heart conditions (RRR = 1.19, P<0.001), and having any cancer (RRR = 1.13, P = 0.0020). Obesity and being overweight increased the likelihood of having UI (RRR = 1.32, P=0.001 and RRR = 1.14, P = 0.0013, respectively), compared with being at normal weight. Incontinence remained a significant predictor of lower quality of life [202].

The prevalence of urinary incontinence (UI) is increased in the presence of frailty. The elderly are prone to frailty and commonly have co-morbid medical illnesses. In a large population-based observation study UI (defined as use of pads) was independently associated with one or more other geriatric conditions (cognitive impairment, injurious falls, dizziness, vision impairment, hearing impairment) in 60%, two or more conditions in 29% and

three or more in 13% [203]. Elderly subjects with urinary incontinence had a 2.9 fold greater chance of becoming more frail over a 12 month period than those without incontinence (p=0.007) [204].

In a sample of 572 older Latinos participating in a programme to increase walking, medical comorbidity was independently associated with higher rates of UI (OR 1.66). More physical activity was independently associated with lower UI (Odds Ratio (OR) 0.77). Hypertension, congestive heart failure, arthritis, depression and anxiety were associated with a higher prevalence of UI. A linear correlation was found between prevalence of UI and the number of comorbid conditions. (correlation coefficient =0.81) [205].

In an observational study of 6,361 community dwelling women, aged 65 and older, participating in the

study of Osteoporotic Fractures, after adjusting for confounders, women with recent physical function decline (a worsening of 1 standard deviation from baseline) were more likely to report weekly incontinence (OR 1.3) for decline in walking speed over 6 meters and (OR 1.4) for decline to stand from sitting [206]. The Nurses' Health Study found that moderate-intensity low impact physical activity including walking resulted in a 20-25% reduction in the risk of developing UI in older women particularly stress rather urge incontinence [207]. Factors associated with persistent UI were similar to those associated with increasing incidence including lower physical activity levels. The strongest factors for

persistent UI were older age, white race and obesity [208]. Likewise, impaired cognition is associated with an increased likelihood of UI. For example in a UK cross-sectional survey of over 15,051 subjects, persons with cognitive impairment (Mini Mental State Exam score \leq 23, prevalence 18%) were significantly more likely to have UI (adjusted OR 1.3), impaired hearing (OR 1.7), poor vision (OR 1.7) have had at least two falls in the previous six months (OR 1.4), and report poorer health (OR 1.9) [209].

The Jerusalem Cohort Longitudinal study assessed the same community dwelling subjects at age 70, 78 and age 85. Urinary incontinence increased from 14.1% to 31.3% and to 42.5% at age 85. This was associated with an increase in comorbidity and Charlson's disability index of 7.3, 11.7 and 21.7 respectively and increase in geriatric syndromes [210].

A study of 6903 participants (mean age 82.2) in Europe and Ontario receiving home care services identified an increase in Geriatric syndromes (GS) in the presence of associated diseases. Participants presented with an average of 2.6 diseases and 2 GS. Urinary incontinence was present in 47% [211]. A study of 270 subjects aged 65 to 89 reported 26.3% moderate or severe urinary incontinence in the preceding 12 months in 3 groups: frailty (7.4%), pre-frail (45.9%) and non-frail (46.7%). In a second sample of 300 frail subjects aged 90 to 107, 37.4% reported moderate or severe incontinence. Incontinent subjects were 6.5 times more likely to be in the frail group and 2.3 times in the pre-frail with respect to continent subjects. The authors concluded that UI was a marker of frailty [212]. In a cross sectional study of 521 community Brazilian elderly > 60 years were assessed for the association between frailty and geriatric syndromes. Subjects were classified as frail, (\geq 3 criteria) pre-frail (1 or 2 criteria) or robust elderly. Urinary/faecal incontinence occurred in 23.7%, 12.8% and 9.2% respectively. The commonest Geriatric syndrome was cognitive impairment. In this study there was no association between incontinence and frailty [213]. A study of 447 community dwelling nursing home eligible elderly with diabetes found a prevalence of urinary incontinence of 44%. Older age, dependence on others for ambulation or transferring and cognitive impairment were associated with UI [214].

Comorbid conditions can affect incontinence through multiple mechanisms e.g. diabetes mellitus, present in approximately 15-20% of frail elderly may cause UI by diabetes associated LUT dysfunction (DO, OAB, cystopathy and incomplete bladder emptying) or by poor diabetic control (hyperglycaemia causing osmotic diuresis and polyuria). The Nurses Health Studies, NHS and NHS II [215] showed an increase in weekly urgency incontinence (OR 1.4) in women with type 2 diabetes compared to those without. Findings from the NHANES 2001-2002 Survey showed that prevalence of UI was significantly higher in women with impaired fasting glucose and diabetes mellitus compared to those with

normal fasting glucose. Two microvascular complications caused by diabetes, peripheral neuropathic pain and macroalbuminuria, were positively but not statistically significantly associated with weekly UI [216]. In diabetic women, peripheral neuropathy have been significantly associated with LUTS and metabolic syndrome has been associated with OAB [217]. In a younger population of mean age 59 years, the Diabetes and Aging Study found the prevalence of occasional urinary incontinence to be over 65%. HbA_{1c} level was not associated with the presence or absence of urinary incontinence. Women with HbA_{1c} \geq 9% had more limitations in daily activity due to incontinence, defined as self-reported "quite a bit" or "extremely" in the preceding 12 months compared to women with HbA_{1c} < 6% [218]. Higher glycated haemoglobin levels have been associated with increased symptoms of OAB [219].

Incontinence impairs quality of life (QOL) in the elderly [220]. In a cross sectional study of 1124 subjects over 70, (mean age 79.5 years) urinary incontinence prevalence was 18% and the severity of UI increased with age. UI was more common in women, and was associated with worse self-reported health. Incontinent subjects were more likely to require assistance with ADLs, had more depressive symptoms and worse physical performance. Increasing severity of incontinence was negatively associated with QOL as measured by the Short Form-36 [221].

3.3. Neurological & psychiatric disorders

3.3.1 Neurological disorders

A more detailed summary of neurological disorders and their impact on UI is covered in the Chapter on Specific Neurological Diseases. Neurological and psychiatric disorders are highly prevalent in frail older people. Neurological conditions in the elderly commonly associated with urinary incontinence include stroke, Alzheimer's dementia (AD), multi-infarct dementia or mixed AD and vascular dementia, Diffuse Lewy Body (DLB) disease and Parkinson's disease. Less common conditions include Normal Pressure Hydrocephalus (NPH), Progressive Supranuclear Palsy (PSP) and Multiple System Atrophy (MSA). Each of these conditions are associated with the development of brain lesions that can interfere with the micturition pathway and interfere with the normal ability to inhibit voiding as well as affecting cognition. These conditions are associated with impaired mobility and can interfere with the ability to toilet independently.

In Alzheimer's disease, UI is often associated with severe cognitive decline whereas in DLB it usually precedes severe cognitive impairment. Occurrence of UI was significantly earlier 3.2y in DLB compared with 5.9y in AD [222]. NPH should be a diagnostic consideration in any frail older patient who presents with new onset of UI in association with gait disturbance and cognitive impairment. A subset of these patients benefits from surgical implantation of a cerebrospinal fluid shunt [223].

LUTS, UI and urodynamic DO are common in older persons with Parkinson's disease. A logistic regression analysis of 3414 Parkinson's disease patients found a significant correlation of orthostatic hypotension and urinary incontinence with age and duration of the disease. The presence of UI in persons with Parkinson's may in turn increase their risk for disability: in one series of patients with Parkinson's UI increased the risk of falling by nearly six-fold. Urinary symptoms often non-responsive to L Dopa therapy [224]. MSA presents with a combination of impaired autonomic function, parkinsonism (MSA-P) or cerebellar ataxia (MSA-C) or both [225]. It frequently begins with bladder dysfunction and erectile dysfunction in males and is associated with bladder symptoms of DO, often progressing to incomplete emptying. High PVR may help in pointing to a diagnosis of MSA-P rather than Parkinson's disease [226].

With the introduction of magnetic resonance brain imaging into routine clinical practice, radiology reports in older patients have increasingly emphasised the presence of structural abnormalities involving the white matter [227]. Terminology has also undergone a great change, moving away from subcortical atherosclerotic encephalopathy (Binswanger's disease, a specific and relatively rare form of dementia), towards leukoariosis [228] and, most recently, to the concept of white matter signal abnormalities (WMSA) [227, 229]. Brain MRI identified subjects with leukoariosis as more likely to have urinary dysfunction which may precede cognitive impairment particularly in grade 1 disease [230]. White matter hyperintensities (WMH) have been linked to severity of incontinence rather than to its presence [231]. The disorder of bladder control resulting from white matter disease (WMD) has been termed vascular incontinence [232]. WMH load appears to progress in association with ageing and the amount of frontal WMH are predictive of urinary incontinence in amnesic mild cognitive impairment and AD [233].

White matter lesions were found to be a more significant contributor to OAB and incontinence than AD in the elderly [234].

3.3.2 Depression

As in younger persons, frail older persons with UI have a higher risk of depression, a finding that has been replicated across cultures. Depression in older persons with UI may be under-diagnosed and undertreated: in one study of homebound adults with UI and severe depression, only 35% carried a previous diagnosis of depression and only 34% had been prescribed an antidepressant [235]. UI may add to the burden of depression by decreasing life satisfaction [236] and self-rated health, [237] and by its association in frail elders with comorbidity [238].

Studies of the association of depression and UI in older persons are consistent across several depression measures. The validated Center for Epidemiologic Studies-Depression was used in two U.S. stud-

ies: a cross-sectional analysis of nearly 10,000 community-based persons found an adjusted risk ratio for depression with UI 1.39 [95% CI 1.24, 1.55]), [239]. A large community-based study of older Mexican Americans reported adjusted OR for depression 1.94 [95% CI 1.46-2.59) [240]. The emotional disturbances and social isolation subscales of the Nottingham Health Profile Questionnaire was associated with urgency but not stress incontinence [241] and have included studies in Asia [242]. Although no association between UI and depression was found in a Korean study of 135 community living elderly aged greater than 85 years, it used a higher cut-off (>7) on the Geriatric Depression Scale and, unlike many other studies, found no association between UI and mobility [243]. Self-report of depression or sadness has [244],[245] and has not been associated with UI [246].

3.3.3 Psychological distress and quality of life

Psychological distress, assessed by the General Health Questionnaire, was associated with UI in African Americans (adjusted OR 5.60 [95% CI 1.88–16.67]), but not in whites, in a cross-sectional study of community based older persons with mean age 67y. However, a longitudinal analysis of the same population over 13 years found that persons with UI and psychological distress were more likely to report UI-specific functional impairment (e.g., avoidance of social activities, shopping, and physical activities) (adjusted OR 6.55 [95% CI 1.94-22.12]). Additionally, persons with UI and condition-specific functional loss were more likely to develop psychological distress (OR 3.66 [95% CI 1.61–8.33]) [247, 248].

The EpiLUTs a large cross-sectional internet study showed significant impairments in mental health and HRQOL when different urinary symptoms were combined [249, 250]. The US sample of the EpiLUTS study involving 2485 men and 2877 women aged 65 and older found OAB was associated with significant impairment in HRQOL. Rates of Anxiety of >7 on HADS-A were 16.4% for men and 23.6% for women with OAB compared to 3.3% and 8.6% with minimal or no symptoms. Similarly rates for depression on the HADS-D were 17.3% and 15.7% for OAB compared to 4% and 6.4% in those with no or minimal symptoms [251].

A case controlled study of 100 elderly men attending a Urology outpatients matched with 100 age matched controls from the community and Geriatric outpatient clinics found those with moderate to severe LUTS had worse HRQOL. This was evident in a number of ageing male symptoms including depression, decline in feelings of general well-being, decreased sexual performance, decreased muscle strength [252].

The direction of the causal relationship between UI and depression in frail persons is unclear, as nearly all studies were cross-sectional. The results of the one longitudinal study suggested that it is not UI itself but UI-specific functional loss (e.g., avoidance of social activities, attending church, etc.) that is most

closely associated with psychological distress, even after controlling for important covariates [235].

3.3.4 Falls

Urinary urgency and urinary incontinence, urinary frequency, and nocturia have been identified repeatedly as risk factors for falls among community-dwelling older adults [253-259]. Mixed incontinence (a combination of urgency and stress incontinence) has also been associated with falls risk in women 70 years and older [260]. Brown and colleagues [259] performed a secondary analysis of data from an osteoporosis cohort study, examining a group of 6049 community-dwelling older women using regular self-completed questionnaires sent to all participants every four months. In this cohort, followed for an average of three years, those with at least one weekly UUI episode were more likely to fall (OR 1.26, 95%CI 1.14-1.40) than those without. Weekly UUI was also associated with higher odds of sustaining a non-spinal fracture (hazard ratio 1.34 95%CI 1.06-1.69). In this study, stress incontinence was not associated with higher odds of falling (Odds ratio (OR) 1.06, CI 0.95-1.19) or sustaining a fracture (relative hazard 0.98, CI 0.75-1.28).

Analysis of the Concord Health and Ageing in Men Project, a longitudinal study of community-dwelling men in Australia followed 1090 men over a period of 2 years. Here, the presence of urgency incontinence, defined as weekly episodes of UUI, was associated with a higher incidence of falls (OR 2.57 95%CI 1.51 – 4.3) and men with a higher International Prostate Symptom Score storage sub-score, defined as a score of 19 and above, had a higher incident rate of falls (incident rate ratio 1.72 (95%CI 1.24-2.38) [261]. A Japanese study of patients with Parkinson's disease found that increased micturition frequency either by day or night was not associated with falls, but that the presence of urinary urgency was strongly associated with a large increase in the odds of falling (OR 5.14 95%CI 1.51-17.48). Only 14% of the falls reported in this study occurred on the way to or from the toilet [262].

A recent systematic review of the association between falls and LUTS in community-dwelling men aged 60 years and over identified six cross-sectional studies and three prospective cohort studies. The identified data were only suitable for qualitative synthesis but urinary incontinence and storage LUTS were consistently shown to have a weak to moderate association with an increased likelihood of falls. None of the identified studies examined potential causes for these associations; the categorisation of continence or not and degree of accounting for confounding variables was inconsistent across the included studies [263]. A small cross-sectional analysis of community dwelling women aged 65 and over in the US examined the association between nocturia, nocturnal enuresis and falls. Neither severity of UI nor severity of nocturia was associated with an increased risk of falls, but there was a statistically significant association between nocturnal enuresis and impairment of

physical function and the presence of frailty. However, in the multivariable regression model, which included age, physical function, and the frequency of nocturnal enuresis episodes, only physical function remained as significant risk factor for falls [264]. One study, a prospective cohort study of older men in the USA, identified a statistically significant association between straining to void and falls, with a 60% increase in falls risk for those reporting the need to push or strain to initiate urination at least half the time [265]. In hospital, urinary incontinence is associated with an increased propensity to fall in older inpatients [266, 267]. Urinary incontinence is also associated with falls in institutionalised older persons [268, 269]. The underlying reason for the association is not yet clear, although several and multiple mechanisms are most likely. A UK case control study in older community dwelling women presenting to an urban Emergency Department found that only 6% of those with a fall attributed this to their LUTS[270]

3.3.5 Stroke

Conservative interventions (e.g. bladder training, pelvic floor muscle training and prompted voiding) have been shown to have some effect in Cochrane systematic reviews, but have not had their effectiveness demonstrated with stroke patients. UI may have worse prognostic implications after stroke, being associated with greater mortality, a poorer functional recovery and an increased likelihood of institutionalisation than those following strokes who regain continence [271]. Of 1,187 patients aged 60–96 with stroke, those with low bladder maintenance scores (more dysfunction) fared worse with rehabilitation than those with higher scores [272]. There has been little advance in care since the 5th International Consultation. A survey of stroke unit practice in Australia showed that less than half had a formal plan for continence care and in the UK, as part of the national sentinel audits of stroke, there was little advance in continence care [273, 274]. A comparative study of stroke nursing found a dearth of evidence and treatment focused on containment and social continence, highlighting the need for systematic assessment and management [275]. The burden on caregivers of those with incontinence following stroke has been acknowledged [276].

Recommendations for research

Further research is required to:

- Examine the effect of treatment for UI in older people with Parkinson's disease
- Examine the temporal association and mechanism underlying falls and LUTS/UI in frail older persons
- Examine the effect of structured treatment for UI in older people following stroke.

- Examine the impact of interventions comorbid disease on the experience and outcomes of urinary incontinence in frail older persons

Recommendations for practice

Clinicians need to assess and manage coexisting comorbid conditions which are known to have an impact on continence status or the ability to successfully toilet.

4. ENVIRONMENTAL FACTORS

This section addresses those factors unrelated to underlying pathophysiology which affect continence status in frail older persons.

- 4.1 The physical environment
- 4.2 Processes and quality of care
- 4.3 Lack of assessment
- 4.4 Lack of knowledge about incontinence
- 4.5 Practices that reduce/restrict mobility and functional status
- 4.6 Limited or inconsistent access to toileting assistance
- 4.7 A lack of toileting privacy
- 4.8 Reduced staffing levels in long-term aged care homes
- 4.9 The overuse and misuse of continence products
- 4.10 Community / home care / primary care
- 4.11 Acute care / hospital/ Secondary care
- 4.12 Long-term aged care homes
- 4.13 Dignity in care

In this section, we define processes of care as the instrumental procedures involved in the assessment and management of incontinence relating to frail older persons.

4.1. The physical environment

Although the physical environment is considered a risk factor for incontinence in frail older adults, there is limited research on this topic. We located seven publications with evaluative data on this topic: two of these studies were conducted over 40 years ago [277, 278] prior to the establishment of internationally agreed standards for reporting trial data. Three were published from a series of projects conducted in the USA to examine the impact of the physical environment on specific problems of people with Alzheimer's disease and related disorders [279-281]. One qualitative study was identified that employed an ethnographic design [282]. Each of these studies involved individuals in long-term care homes. One study evaluated the prevalence and risk factors for incontinence in a sample of 5,418 community-dwelling frail older adults who were receiving home care services [283]. Environmental barriers as well as the use of physical restraints, along with UTIs were the most common re-

versible risk factors for urinary incontinence: increasing the risk of urinary incontinence by over 50% [283]. In this study, environmental hazards included a lack of access to the toilet, unavailability of grab rails, inappropriate toilet seat height, inadequate lighting, and inadequate toileting substitutes such as commodes or urinals.

Attempts to evaluate the effects of enhancing the physical environment on rates of incontinence in long-term aged care homes were reported by Chanfreau-Rona [277, 278]. In both studies, the intervention involved enhancing visual access to the toilet by painting toilet doors in bright colours and strategically locating pictorial signs and other visual cues. In addition, staff were asked to accompany residents to the toilet at predetermined 'peak times' and to employ operant conditioning techniques to reinforce residents' appropriate toileting behaviour. In the first of these trials, 24 elderly female residents, most of whom had cognitive impairment, were purposively assigned to either the intervention, or to usual care for seven weeks [277]. The same procedures were repeated in a subsequent trial [278]. Although reductions in incontinence were noted for residents in the experimental groups compared to the control groups, the extent to which these reductions were related to the intervention is difficult to determine as both studies lacked power and did not control for confounding factors. Nonetheless, these studies represent an early, multifaceted intervention that involved evaluating the effect of changes to the physical environment to reduce incontinence among frail older adults in long-term care.

According to the first of a series of projects conducted by Namazi and colleagues, the overall physical environment has a considerable impact on the well-being and quality of life of individuals with Alzheimer's Disease (AD), affecting their ability to function in the face of incontinence, distraction and disorientation [280]. One of the projects focused on the clinical utility of using environmental cues (i.e. signage, colour differentiation and images) in a dementia-specific unit to assist compensate for resident's visuo-perceptual deficits [279]. The most effective environmental cue in terms of orienting individuals with AD to the toilet was a combination of using a sign with the word "toilet", together with "wayfinding" arrows on the floor. No single strategy was suitable for all individuals with AD due to the variability in the ability of individuals with AD to perform all of the tasks associated with successful toileting. The researchers therefore recommended "to maximize the remaining strengths of those who are afflicted with AD, each component of the morphology which creates difficulties for AD patients must be identified and treated individually". In essence, individuals with AD may need individually targeted cues that address identified specific deficits.

In a second project, Namazi and colleagues [281] systematically examined toilet use in a dementia-specific unit under two conditions: with the toilet

highly visible to residents, and with the toilet concealed. The frequency of toilet use increased when toilets were visually accessible during the 45 hours of observation. Visibility and accessibility of toilets may be an important factor in supporting individuals to maintain continence.

Toilet accessibility also featured highly in a qualitative study conducted by Sacco-Peterson and Borell [282]. Using ethnographic methods, the researchers collected over 200 hours of field observational data and conducted in-depth interviews with nine residents in a long-term aged care home. They reported that different aspects of the facility's physical and socio-cultural environment influenced residents' abilities to maintain autonomy in self-care. For example, there was an inadequate number of toilets, inadequate privacy for toileting, inappropriate toilet heights, excessive distances to the toilet, and a lack of call light, toilet paper, soap, paper towels, lighting and commodes. Despite the challenges of negotiating this 'defeating ward geography', many residents attempted to participate autonomously in toileting, whilst others were deterred because of a fear of falling.

4.2. Processes & quality of care

In a systematic review of the prevalence and risk factors for urinary incontinence in long-term aged care homes, Offerman and colleagues [284] identified 46 risk factors for urinary incontinence. These factors were grouped into 1) locomotion, 2) cognitive function and 3) drugs. However, in addition to these risk factors, the reviewers stated "differences in the care process and quality of care can also influence urinary incontinence prevalence; reasons for a less-than-optimal approach in long-term care homes may include, for example, inadequate knowledge of and skills for urinary incontinence in general, inability to use guidelines for urinary incontinence care, insufficient staff and poor communication among healthcare professionals" (p. 291). They recommended that risk factors related to care processes be further investigated.

Two studies offer qualitative data on how processes of care in nursing homes may represent a risk factor for incontinence. For example, descriptive information derived from semi-structured interviews with six elderly women from two nursing homes in Canada, suggests that some residents experience an environment characterised by rituals and routines, limited assistance with pad changing, restrictions on the number and type of continence products available, set times for toileting and pad changes, ageism, and a lack of recognition of attempts to maintain continence [285]. Sacco-Peterson and Borell [2004] also found that 'toileting assistance was provided at set times, and 'if residents required more assistance other than at set times, pads were used'. Pad use also correlated with residents' mobility level, rather than their cognitive or continence status. Additionally, night-time use of pads often started following a fall at night. Residents did not divulge their difficulties to staff, and were reluctant to ask for help and thus staff

members were unaware of residents 'difficulties and efforts. Residents valued the capacity to exercise some power and autonomy with regard to self-care, and didn't want to be 'a bother to the nurse'. Thus, their attempts to maintain continence may be undermined by care processes that unintentionally diminish an individual's independent toileting [282].

More recent research reinforces the finding that processes of care in organisational settings are not designed to promote therapeutic continence care for care-dependent older people. For example, in an analysis of data for 46,044 residents in 162 nursing homes in New York State, for June 2006–July 2007, and survey responses from 7,418 workers in the same facilities, Temkin-Greener et al. [286] reported an association between incontinence and nursing home work environment attributes such as teams, consistent assignment and staff cohesion. After adjusting for other factors, they found residents in facilities with stronger staff cohesion to have significantly lower odds of incontinence (OR = 0.924; $p < .001$). A one standard deviation (0.23) increase in the staff cohesion score resulted in 7.6 percent lower odds of incontinence. Likewise, in a longitudinal correlational study, Yoon et al. [287] examined the impact of organizational factors on the quality of UI care (i.e. defined as improvement in UI status or maintenance of continence post admission to Korean long-term care hospitals). After controlling for other factors, they found higher Registered Nurse to patient ratios was significantly associated with better resident UI outcomes.

Thomas et al. [288] conducted a mixed-methods study which explored the organisational context for embedding a systematic voiding programme for patients with UI after stroke in secondary care settings. The researchers concluded there was a focus on containment of UI that was not conducive to therapeutic continence management. In a prospective cohort study of 282 hospitalised older adults, Zisberg et al. [289] found the quality of continence care was one of three factors that directly related to functional decline at discharge. Thus, there are organisational processes beyond individual risk factors that account for potentially modifiable causes of incontinence in care-dependent older persons.

Ostaszkiwicz [290-292] conducted a Grounded theory study to describe and explain the context that affects continence care in long-term aged care homes. The findings suggest a basic social problem that is characterised by multiple constraints to residents' overall care. Factors that contribute to this problem include: (i) a highly regulated work environment; (ii) ethically challenging care; (iii) highly dependent residents; and (iv) a devalued role. Staff responses to this problem include accommodating strategies such as acquiescing, concealing, protecting, adapting, prioritising, normalising, compromising, and ritualising, as well as self-protective distancing strategies such as blanking out, using distancing language, and reframing care. The researcher called for a comprehensive

multifaceted research-based strategy that addresses the social, regulatory, organisational, and personal constraints to evidence-based, ethical, resident-centred care, including continence care. There is a need to counter the pervasive belief that quality continence care for frail older adults is a function of cleaning and containing incontinence. In countries that rely on education about incontinence from the continence product manufacturing industry, the strategy should also counter the dominance of industry-based education. Although independent quality performance standards have been developed for disposable absorbent products there is an absence of standards to promote ethical relationships between healthcare consumers and the continence product manufacturing industry [293].

4.3. Lack of assessment

A comprehensive assessment to determine type and causes of incontinence is an essential precursor to appropriate management. However, many older people with incontinence do not have access to this assessment, and are therefore at risk of remaining incontinent (Table 4). This finding is consistent for older adults across different countries and settings.

4.4. Lack of knowledge about incontinence

A lack of knowledge about incontinence and its management may operate as an antecedent to care processes that inadvertently promote incontinence. Specifically, a lack of knowledge that incontinence is a symptom of a potentially treatable condition, may have the unintended effect of hindering access to diagnosis and treatment.

A number of studies reveal gaps in nurses' and nursing aides' knowledge about and attitudes toward older people with incontinence in long-term aged care [294-313], as well as acute care [310, 314-318]. Other research highlights gaps in medical practitioners' knowledge about incontinence [319-323]. For example, a survey of general practitioners (GPs) knowledge of investigation modalities and treatment options for individuals with faecal incontinence in the UK, found that only 32% were aware of at least one investigation, and 32% were aware of at least one form of surgical treatment [323]. In a cross-sectional national survey to determine knowledge, attitudes, and management of urinary incontinence among family physicians in Canada, less than half (46.0%, 284/617) indicated that they had a clear understanding of incontinence and just 37.9% (232/612) had an organized plan for incontinence problems [322]. Similarly, Teunissen et al [324] reported three main themes from focus groups with 13 GPs in Holland: (i) therapeutic nihilism of GPs and low motivation of patients, (ii): GPs experienced lack of time because of difficulties in explaining the therapy and because of impaired mobility of older patients, (iii) reluctance to treat UI because of the complexity of the problem and co-morbidity.

Knowledge about incontinence and its management in the general community is also lacking, especially

amongst men, those aged 85 and older, and those with lower levels of education [325]. For instance, a nation-wide consumer survey conducted in the USA in 2000, found four in ten people (41%) thought that loss of bladder control was a disease and a similar percentage (38%) believed it was a natural part of ageing [326].

Improvements in knowledge about incontinence in older people are possible. Szonyi and Millard [320] reported a significant improvement in GPs knowledge about incontinence following receipt of an education package. Likewise, Mathis et al. [327] and Ehlman et al. [328] demonstrated improvements in knowledge among nursing home staff following an educational intervention.

Table 4. Evaluative studies on assessment of incontinence in frail older adults

Study	Objective	Sample	Method	Findings
[943] Du Moulin et al., 2009	To assess the prevalence of UI and gain insights into care issues	2866 patients (mean age 80 ± 7.2yrs) living at home receiving home care in Holland	Survey + audit of medical records	Type of UI was diagnosed in 49% of patients. Management did not differ for patients with and without a diagnosis of UI type
[614] Georgiou et al., 2001	To evaluate the recommended outcome measures in clinical practice	1125 residents in 17 residential homes, 14 nursing homes and 5 long-stay wards in UK.	Analysis of data on the UI section of the Royal College of Physicians Continuous Assessment Review and Evaluation Scheme audit tool	Rates of full clinical assessment were 48% for people in residential homes 24% for people in nursing homes 36% for people in long- stay wards
[254] Rodriguez et al., 2007	To explore continence prevalence, knowledge and care	66 care homes in Birmingham, UK	Survey completed by managers or other senior staff	Only two respondents gave information indicative of a full assessment. Most respondents had difficulty identifying the process of assessment.
[257] Pringle-Specht et al., 2002	To determine patterns and treatment of urinary incontinence	145 residents with dementia (mean age 83.3yrs) from 13 special care units in long-term care facilities in USA	Retrospective audit of residents' medical histories using 'Incontinence Patterns Tool' (IPT)	55% of residents with UI and dementia had a documented care plan for treatment of UI 2.1% (n=3) had a current medical diagnosis of bladder incontinence
[245] Wagg et al., 2008	To assess the quality of continence care for older people	Patients from 138 primary care trusts, 195 secondary care trusts, and 27 care homes in UK	Audit of patients' clinical records	Poorly documented aspects of a clinical assessment across all settings: rectal examinations and post-void residual urine volumes. In secondary care trusts, 919/3509 (25%) of histories had documentation of an assessment to determine UI type or cause
[944] Watson et al., 2003	To assess the use of the Agency for Healthcare Policy and Research Guideline for managing UI in nursing homes	200 residents with new UI or newly admitted with UI from 52 nursing homes in upstate New York, USA	Retrospective chart review and Nursing Assistance screening interviews	4 new cases of UI per 100 beds over 12 weeks UI Guideline standards met 20% of cases (0-45%). Aspects of assessment rarely performed rectal examination (15%) digital examination of prostate (15%) pelvic examination (2%)

4.5. Practices that reduce/restrict mobility and functional status

Impaired mobility and ability to perform activities of daily living (ADLs), such as toileting ability, can cause or contribute to incontinence in frail older persons in any setting. Urinary incontinence is associated with severe impairment in ADLs in long-term aged care homes [329, 330]. In a cross-sectional analysis of data from the 2010 National Survey of Residential Care Facilities, Talley et al. [331] found the prevalence of toileting disability was 15% and was highly associated with ADL impairments. Hence, greater emphasis should be given to interventions that reduce the risk of functional decline that may subsequently prevent or delay the onset of incontinence. Two recent trials reveal reductions in the frequency and severity of incontinence from exercise programmes that aim to improve frail older person's functional status [332, 333].

Practices that restrict or minimise a person's mobility and ability to function hinder their ability to reach and use the toilet autonomously. The use of physical restraints is one such practice. Although restraint-free care has been recommended as standard, restraints remain widely used in long-term aged care homes, ranging from 12-47% internationally [334]. In a multivariate analysis of data from 2,014 residents from 270 USA Medicaid-certified nursing homes, Brandeis and colleagues [329] identified that urinary incontinence was independently associated with a number of factors, including the use of restraints of the trunk (OR = 1.7; CI = 1.5,2.0), restrained to a chair (OR = 1.4; CI = 1.2,1.6), and bedrails (OR = 1.3; CI = 1.1,1.5). Similarly, in a community-based sample of frail older adults, the use of physical restraints was identified as a key reversible risk factor for urinary incontinence [283].

4.6. Limited or inconsistent access to toileting assistance

An obvious, yet often overlooked risk factor for incontinence is a lack of toileting opportunities and assistance for individuals who are care-dependent. Research from USA shows that the frequency of toileting assistance provided in long-term aged care homes is too low to maintain continence [78]. In recent years, the UK media has drawn attention to the fact that many people in hospital do not receive timely assistance to use the toilet: a situation that contributed to the establishment of the "Dignity in Care Campaign" – launched in 2006. In response to concerns about neglect in aspects of personal and healthcare, the British Geriatrics Society proposed that the ability to use the toilet in private was in fact, a marker of human rights, and developed a "Behind Closed Doors Campaign". The aim of the campaign was to empower, educate and influence providers and policy makers to adopt a more pro-active stance to demand better continence care. A more recent campaign, again led by the British Geriatrics Society, titled "Do not forget the person" was launched in March, 2010. The extent

to which such awareness raising activities affect day-to-day care processes in the absence of structural change and resources requires evaluation.

Structured toileting programmes require a staff to patient ratio of 1:5. A lack of staffing or institutional understaffing represents a key risk factor for incontinence among individuals who are dependent on another person to use the toilet. There is a need to identify the best methods to implement and sustain toileting assistance programmes, especially when caring for cognitively impaired care-dependent individuals who may be unable to communicate their need for assistance, and when caring takes place in an organisational care setting such as a long-term aged care home [335].

4.7. Lack of toileting privacy

Privacy to void or defaecate are important social factors unrelated to underlying pathophysiology which may affect the continence status of frail older persons. It is possible a lack of toileting privacy to may cause a person to defer or ignore the urge to void or defaecate. According to the findings of a cross sectional survey of 120 adults with FI aged 65 and over and living in either their own homes, a nursing home, or an acute or rehabilitation, privacy to defaecate is usually attainable in one's home, but not in a nursing home. Privacy to defaecate was reported by 23% of respondents in a nursing home, 53% of those in rehabilitation wards, and 50% of those in acute wards [336]. Further research is required to explore the relationship between a lack of toileting privacy and incontinence in frail older adults.

4.8. Reduced staffing levels in long term care

Estimating and achieving the optimal level and skill mix of any workforce is a challenge. In long-term aged care homes where residents' have chronic health problems and complex health needs, maintaining sufficient staffing levels is exacerbated by a high staff turnover. Nurses consistently cite inadequate staffing levels as a major barrier to providing optimal continence care [337-341]. The extent to which patients and residents' continence care needs are considered in formulas designed to establish the right staffing level and skill mix is unclear. The time, resources, knowledge and skill required to conduct an assessment, and offer active, effective management to prevent and/or manage incontinent episodes require consideration in service planning.

4.9. The overuse and misuse of continence products

For many people, continence products represent a means by which they can achieve effective and discrete containment of incontinence, minimise physical discomfort and optimise psychological and social function [342]. At the same time, their overuse and misuse may represent a risk factor for incontinence

and, for pads, urinary tract infection. Although continence products have an important place in the control of incontinence, their use in the general community, in hospital settings, and in long-term aged care homes is widespread (Table 5). For example, in the largest and widest audit of continence care conducted in the UK and involving over 6,000 patients across primary and secondary care trusts, and care homes, containment strategies (i.e. the use of continence products) far exceeded all other forms of documented continence management [343].

Table 5: Evaluative studies on the use of continence products (pads and briefs)

Community / home care / primary care				
Study	Objective	Sample	Method	Results
[943] Du Moulin et al., 2009	To assess the prevalence of UI and gain insights into care issues	2866 patients (mean age 80 ± 7.2yrs) living at home and receiving home care in Holland	Survey + audit of medical records	Pads were used by 59.2% of patients with diagnosis of UI type and by 55.8% of patients with no diagnosis of UI type
[945] Samuelsson et al., 2001	To study age- and sex specific use and costs of freely available incontinence aids in Sweden	2542 women & 1292 men living in their homes (including special accommodation) in a county of Sweden who were using incontinence aids	Audit of incontinence aid prescriptions – data extrapolated to general population	Incontinence aid use 367000 (3.7%) of all people in Sweden 6.4%-women /2.4%-men in the county 765000 (66%) in special accommodation Costs 925 million SK 50% of cost attributable to those aged 80 yrs or >
[247] Sorbye et al., 2008	To determine prevalence and characteristics associated with UI	4010 randomly selected older persons (mean age 82.3 ± 7.3 yrs) living at home in one of 11 European countries and using home care agencies	Cross sectional survey using the International Resident Assessment Instrument for Home Care (RAI-HC)	39% used pads (highest usage in France -52% / lowest usage in Norway and Czech Republic – 29%) Pad use correlated with need for toileting assistance (p<0.001)
[245] Wagg et al., 2008	To assess the quality of continence care for older people	2717 patients from 138 primary care trusts in UK	Audit of patients' clinical records	Containment strategies were used by 1294/2717 (48%) of patients
Acute care / hospital / secondary care				
Study	Objective	Sample	Method	Results
[250] Kadir, 2004	To determine the incidence and appropriateness of incontinence aid use	333 elderly patients in an acute hospital (Singapore)	Survey – patient self report	200/333 (60%) - using some form of aid 101 (50.1%) could have been managed with alternatives
[249] Palese et al., 2007	To evaluate the incidence of pad use and explore appropriateness and reasons for use	396 patients (mean age 76.8 ± 11.8yrs) admitted to medical units in 2 acute care units in Italy	Survey – interview + clinical assessment 3 x day each day during hospitalization	Inpatient use of pads – 218/396 (55.1%). Of this cohort, 120/396 (30.3%) had incontinence prior to admission Rationale for pad use: urinary incontinence associated with acute confusion or dementia
[251]	To determine the prevalence of UI & FI +	447 inpatients (mean age 70 ± 18.7yrs) admitted to 3	Point prevalence survey + an audit of medical	266/446 (60%)- using a continence product/ device

Ostaszkiwicz, et al., 2008	pad use + documentation of incontinence	acute and 1 subacute care hospitals in Australia	records	50/121 (41%) of patients using pads had no UI or FI in the preceding 24 hrs. 18/113 (16%) patient with UI or FI in preceding 24 hrs had no continence product/device
[245] Wagg et al., 2008	To assess the quality of continence care for older people	3683 patients from 195 secondary care trusts (hospitals) in UK	Audit of patients' clinical records	2070/3683 (56%) patients used containment strategies
[253] Zisberg 2011	To determine incidence of incontinence brief [pad] use	465 older patients (mean age 78.6 ± 5.8 yrs) who were not using incontinence briefs prior to admission to medical acute care units in a 900 bed teaching hospital in Israel	Admission interview and then every day after first 48 hrs	65/465(14%) used incontinence briefs during most of their hospitalisation. Brief use was associated with low mobility
Long-term care / nursing homes / skilled nursing facilities / residential aged care / care homes				
Study	Objective	Sample	Method	Results
[255] Brandeis et al., 1997	To describe the frequency and correlates of potentially treatable causes of urinary incontinence	2014 residents (mean age 84.3 ± 8.7) from 270 Medicaide-certified nursing homes in USA	Review of MDS data / Interview with the nursing home staff, and interaction and observation of residents	990/2014 (49%) of residents were incontinent. Of these, 84.0% were managed by pads/briefs. More than one-third (n = 350) of the incontinent residents were managed with two modalities
[258] Omi et al., 2010	To determine daily pad usage & association with UTI, and fluid intake	153 residents (mean age 83 ± 8.2 yrs) from 6 nursing homes in Norway	Number and weight of pads per/resident calculated over 2 days	118/153 (77%) used pads 36/48(75%) men 82/105(78%) women Average number of pad changes p/day-2.7 UTI correlated with pad use but not fluid intake or number of pad changes
[254] Roderiguez et al., 2007	To explore incontinence prevalence, knowledge and care	66 care homes in Birmingham, UK	Questionnaire to care home managers	Several methods to manage incontinence were cited however briefs and pads accounted for over 50% of responses

Community / home care / primary care

Extrapolating data from users of absorbent pads in one area in Sweden, Samuelsson and colleagues [344] found 6.4% of all women and 2.4% of all men in the country, used continence products: equating to 3.7% of the total population. Most of these users were aged over 75 years of age and 21% lived in special accommodation. Other studies have examined use of continence products in targeted populations. For example, among individuals receiving home care services in European countries, rates of continence product use vary from 29-52% (mean 39%) [345] to 57% [346]. And across primary care trusts in the UK, containment strategies are used by 48% of patients [347].

Acute care / hospital/ Secondary care

Rates of continence product use in elderly patients in acute care across several countries are similar and range from 55.1% in Italy [348], 56% in the UK [347] to 60% in Singapore [349] and Australia [350]. Not only are they widely used but they are often used indiscriminately. One of the earliest studies to draw attention to an overreliance on continence products was conducted by Starer and Libow [351] who found more residents using pads than those with incontinence. More recently, Ostaszkievicz and colleagues found that in the inpatient care setting, pads were inappropriately used for some patients, and were underused for others [350]. Of 121 patients who were using pads at the times of the survey, 50(41%) reported no UI or FI in the preceding 24-hours. However, 18% of patients who had no pad did report such an episode. This mismatch between incontinence and pad use has been noted in other research [348, 352].

Long-term aged care homes

We located six studies that provided data on the use of continence products in long term aged care homes. These were conducted in the UK [347, 353], the USA [329, 354, 355], and in Norway [356]. Wagg and colleagues reported that of 488 residents from 27 care homes included in the national audit of continence care in the UK, 307 (63%) used a containment strategy to manage their incontinence [343]. Roderiguez and colleagues reported similar rates based on interview data from managers of 66 care homes in Birmingham [353].

In the USA, Brandeis and colleagues reported a higher rate of pad use (84%) in their sample of 2,014 residents from 270 Medicaid-certified nursing homes [329]. Eighty-four percent were managed with pads/briefs, and more than one third of incontinent patients were managed with two modalities. A recent evaluation of the use of urinary collection devices by 57,302 residents from skilled nursing facilities found that pad use remained relatively stable over a 12 month period [354]. Pad use among a sample of 11,549 newly admitted 75-84 year old residents was 58.7% at admission and 61.1% twelve months later.

This rate was higher for residents aged 85 years of age and older (i.e. 60.3% at admission and 62.6% one year later). In a survey of patterns and treatments of urinary incontinence in 13 special care units in the USA, Pringle-Specht and colleagues (2002) reported that 72% (n=105) of residents used a continence product: the most common type of product being a continence brief or pad (n=93) [355].

According to Omli and colleagues who estimated the daily pad usage of 153 elderly residents from six nursing homes in Norway, 77% of residents use pads [356]. Omli and colleagues also found that residents' pads were changed infrequently (i.e. an average of 2.3 times a day (range 0.5-8.0) for female residents and 3.1 times a day for male residents (range 1.0-9.0). Moreover, urinary tract infections were associated with pad use (41 vs. 11%; P= 0.001): but not with fluid intake or number of pad changes. Residents pad usage did not correlate well with the volume of their incontinence:

As inappropriate use of continence products may contribute to onset, or continuation of, incontinence, it is important that clinicians who advocate or authorise their use, are familiar with evidence-based guidelines that advocate an active approach to diagnosing, preventing and treating incontinence.

Dignity in care

Protecting the dignity of the people who are care-dependent and helping them to maintain optimal continence are key concerns for older persons and their caregivers. However, peoples' opinions on continence care practices that dignify a care-dependent person sometimes differ, resulting in considerable angst [357]. A new conceptual approach to providing continence care titled *The Dignity in Continence Care Framework* developed by Ostaszkievicz (3), aims to improve choice, physiological autonomy, and dignity for people who require assistance to maintain continence or manage incontinence. The biopsychosocial framework represents an integration of contemporary biomedical understandings about incontinence with theoretical concepts from the disciplines of nursing, psychology, and sociology. It is underpinned by two core concepts: 'dignity' and 'care', and is characterised by a focus on: empathic continence care; acknowledgement of personhood; therapeutic communication; authentic partnership in continence care; acknowledgement of stigma, social taboos, and courtesy stigma; and the need for a foundational continence assessment. The framework can be adapted to suit the needs of individual organisations, and guide the implementation and evaluation of education for formal caregivers. Although the framework is conceptually sound, further research is required to evaluate its effect on continence care practices and patient outcomes.

Recommendations for practice

1. Environmental cues such as toilet visibility, signage, colour differentiation and images should

be used to compensate for visuo-perceptual deficits in frail older adults with cognitive impairment.

2. As remaining physical strength and dexterity varies in individuals with cognitive impairment, each component of the toileting process which creates difficulty for such patients should be identified and treated individually.
3. Awareness raising activities should be conducted to enhance day-to-day continence care processes in healthcare settings.
4. Ensure that the time, resources, knowledge and skill required to conduct an assessment, and offer active, effective management and manage UI episodes are considered in service planning.
5. Continue to address gaps in healthcare practitioners' knowledge about preventing and managing incontinence in frail older persons.
6. As inappropriate use of continence products may contribute to onset or continuation of UI, clinicians who advocate or authorise their use, should be familiar with evidence-based guidelines that advocate an active approach to prevention, diagnosis and treatment.

Recommendations for research

Further research is required to:

- Explore the physical environment as a risk factor for UI in frail older adults, and to evaluate the effect of modifying the physical environment.
- Embed processes of care in health care systems to promote frail older adults' autonomy and continence.
- Translate findings about the benefits of exercise programmes to minimise the risks of functional decline, falling, and UI in frail older persons.
- Explore the association between a lack of toileting privacy and UI in frail older adults.
- Identify the best methods to implement and sustain toileting assistance programmes.
- Identify the optimum staffing levels and skill mix required to optimise continence in care-dependent frail older adults.
- Explore the association between the misuse/overuse of continence products and UI.
- Addresses the social, regulatory, organisational, and personal constraints to evidence-based, ethical, resident-centred continence care in long-term aged care homes.
- Counter ageist perspectives that hinder frail older people from access to a comprehensive assessment to prevent, minimise or treat UI

- Explore the influence of the continence product manufacturing industry on how continence care is framed for frail older adults.

5. ASSESSMENT OF THE FRAIL OLDER PERSON WITH URINARY INCONTINENCE

Recommendations for the basic assessment of frail elderly persons with UI are summarised in the algorithm (see Summary Document). Because UI in the frail older person is almost always multifactorial, it is essential to conduct a comprehensive assessment with the goal of identifying all potential contributing factors. Collaboration among primary care physicians, geriatricians, surgical specialists, nurses, other health professionals and caregivers, both formal and informal, may be necessary for optimal assessment and management.

The number of guidelines in the area of urinary incontinence have proliferated since the 5th consultation the majority of these are consistent in their approach. For example, since the last Consultation, the European Association of Urology has developed its published guidelines on UI which bear relevance for frail older men and women. These remain largely based on the findings of the 4th ICI but now include consideration of anticholinergic load when prescribing for older people. Other than this guideline, the impact of comorbidity lying without the lower urinary tract is seldom considered; there remains a need for consideration of this area in both robust and frail multimorbid older persons.

Two groups, the US Assessing Care of Vulnerable Elders (ACOVE) project and the UK Clinical Effectiveness and Evaluation Unit, have developed quality performance measures for UI care in frailer older persons, using structured literature review and expert panel review and have published results based upon surveys of concordance with these guidelines [347, 358-362]. These measures are variably based on the prevailing applicable guidelines of the time. Although both groups have demonstrated using their measures that UI assessment and care by practitioners in the US and the UK is of a poorer standard than that afforded to younger adults, there is evidence that integrated services are more likely to provide a higher standard of UI care [363]. Thus, there is an urgent need to re-establish the fundamentals of UI assessment and management for all health care providers who care for frail older persons with UI and ensure that there is adequate service provision.

a) Identification of frail older persons. Health care providers can case find in older patients with UI for frailty using the Vulnerable Elders Survey, which can be administered in person or by phone [364]. Persons with a score of 3 or greater have four-

fold increase in the risk of death and functional decline compared with persons with lower scores. A patient self-reported scale in which those people classified as either frail or pre-frail had higher frequency of hospitalisation, a higher probability of co-morbidity and higher mortality than those classified as non-frail has also been reported [365]. There has also been increasing interest in the detection of frailty in patients undergoing surgery (see later), as its presence predicts poorer outcomes from hospitalisation and surgery. However, caution still needs to be exercised when classifying an older individual as frail as there is considerable heterogeneity within this group [366]. There may also be a clear distinction between cognitive and physical frailty.

b) Primary care assessment. Physician education using a modified version of the ACOVE model to reach a large group of primary care physicians resulted in between 80% and 92% of them planning to make a change in their practice behaviour [367], although no formal assessment of carry through was undertaken. Geriatricians' and primary care physicians' (PCPs) UI assessments were compared in a randomised multicentre study involving 364 subjects, 42% of whom self-reported UI to the investigators. Geriatricians were significantly more likely to detect UI (59% of cases vs. 16%), regardless of the severity of UI, and were more likely to refer to Continence Programmes (25%); all referrals by PCPs were to urologists [368]. An assessment strategy based on clinical evaluation, simple cystometry, and several criteria for referral was compared with urodynamic diagnosis. Approximately 25% of patients met criteria for referral, half of patients accepted urodynamic evaluation, yet urodynamics changed the treatment plan in only 12% of the patients who did not meet the a priori criteria for referral [369].

Practice patterns and adherence to US UI guidelines were evaluated by retrospective chart review of 300 consecutive patients aged >65y, seen by either an internist or geriatrician for UI at a tertiary care centre. Geriatricians ordered more testing, such as urodynamics, before referring patients to a surgical specialist [370]. Overall, primary care practitioners rarely follow the US Agency for Healthcare Research and Quality UI guidelines, [371] and nursing home practitioners rarely follow the Federal guidance for UI care regarding recommended physical examination, PVR testing, urinalysis, and identification of potentially reversible causes [372]. Okamura and colleagues investigated the diagnosis and treatment of lower urinary tract symptoms (LUTS) by general practitioners (GPs) according to the "Practical manual for LUTS evaluation and treatment in the elderly For GPs (Japanese)" and found adherence to the manual, reinforced by educational and promotional activities resulted better treatment outcomes [373, 374]. A randomised trial of an electronic screening tool was useful in improving conversations about urinary incontinence in older women (not frail) [375].

A systematic review of articles identified only 5 studies meeting eligibility criteria, and all were in women. None of studies found sufficient diagnostic evidence (for different types of UI. The best was a general population study reporting the utility of history and examination for the diagnosis of SUI (positive and negative likelihood ratios 3.23 and 0.40, respectively) [376]. Adding a nurse practitioner to general practitioner care for adult patients with UI can reduce the impact of UI and has been proposed as a cost effective model using the Netherlands as an example [377, 378].

c) Cough stress test. We have found no additional evidence on the utility of the cough stress test since the 4th consultation. Utility of the cough stress test was studied in 97 incontinent female long-term care residents using blinded comparison with single channel cystometry. Of the 77% in whom single channel cystometry diagnosis was congruent with the stress test (i.e., urodynamic DO with negative cough test, no DO and positive cough test), all were correctly classified. No woman with SUI was missed nor were any with DO misclassified [379]. An analysis of 200 older women with UI found that provocative full-bladder cough test was as effective as radiographic or urodynamic pressure measurement in detecting SUI. Clinical diagnosis incorporating the cough test with leakage symptoms was 78% accurate, with only 6% false negatives for SUI, but was only 44% accurate with 45% false negatives for urgency UI [380].

d) Postvoid residual measurement. We identified no studies evaluating the impact of PVR measurement on clinical diagnosis and treatment outcomes. The frail elderly may have a higher prevalence of elevated PVR, especially in association with DHIC. One study of 100 patients consecutively admitted to a geriatric ward found that 34% had PVR > 50 mL; these patients tended to have more UI (57% vs. 38%, $p > .05$), greater functional dependency, and a higher mortality rate (36% vs. 9%) [381]. A study of the residual urine in a randomly selected community dwelling sample of men and women aged 75 years of age found more than 10 ml of residual urine in 91 of the 92 men (median 90 ml; range 10-1502 ml), and in 44 of the 48 women (median 45 ml; range 0-180 ml). The significance of this single measurement could not be estimated [382]. There is considerable variability from test to test. The algorithm for UI suggests situations in which PVR measurement may be warranted, but this is not routinely required as part of the initial assessment in the absence of voiding symptoms.

e) Urodynamic testing. Urodynamic testing is feasible and safe, even in frail nursing home residents [62]. There is no evidence, however, that urodynamic diagnosis changes the outcome of treatment. Expert guidelines have recommended urodynamic testing before surgical or minimally invasive UI treatment in women, but there remains debate about the utility of this approach in men.

f) Ultrasound estimation of bladder weight (UEBW). A single study of men attending a uroflow clinic of mean age 65 (range 23 – 90) detected no statistically significant differences in ultrasound estimated bladder weight between men with Qmax <10mL/min versus those with >15mL/min [383]. In a study of asymptomatic men, UEBW is most closely associated with height; there appears to be little diagnostic utility of this measure [384].

Summary of evidence

- Active case finding and screening for UI in older persons because many do not spontaneously report their symptoms. (Level 1).
- Screening for frailty is possible with short screening instruments (Level 1).
- Current quality of primary care assessment of UI in frail elders is poor (Level 2).
- Cough stress test has moderate accuracy in frail institutionalised women (Level 2).
- No recommendation is possible on the utility of PVR testing in the assessment of UI in frail elderly (Level 4).
- Urodynamic testing is feasible in frail older people (Level 1) but it is unlikely to change management or outcomes except, perhaps, in those considered for surgical treatment of UI (Level 4).

Recommendations for evaluation

The essential first step is to actively case find in the frail elderly, as both UI and FI are generally under-reported.

The second is to identify treatable, potentially reversible conditions and other factors (medications, environment) that can cause or contribute to incontinence. Although UI associated with such factors has been commonly called “transient UI,” this is erroneous, as for most frail older persons incontinence is a chronic and often progressive condition. It is important to evaluate for such contributing factors because their amelioration may improve UI directly, make UI more amenable to other interventions, and overall improve the patient’s (and caregiver’s) quality of life [385]

The common, treatable, potentially reversible conditions that can contribute to UI in frail older people can be defined by the mnemonic DIPPERS ((Delirium, Infection [urinary tract), Pharmaceuticals, Psychological, Excess fluid (in/out), Restricted mobility, and Stool impaction [and constipation]). This is a useful aid to teach and remember these conditions [386]. Cognisance must be made of the potential to over-treat asymptomatic bacteriuria as apparent infection because of the risk of adverse outcome [387].

6. FACTORS IN MANAGEMENT OF THE FRAIL OLDER PERSON WITH URINARY INCONTINENCE

6.1. Background

This section highlights the issues that distinguish management of incontinence in frail older people from that of healthier older adults. These include preferences for care, goals of care, determination of costs and benefit special issues in drug treatment, and issues unique to frail elderly men. They incorporate knowledge of physiological, psychological, sociological, and economic changes associated with frailty and advanced age, and reflect the importance of patient-centred goals and the role and burden of caregivers in this population. These factors provide the context of continence care and should be incorporated into the management of all incontinent frail persons, regardless of the choice of specific treatment.

6.2. Role of comorbidity in management decisions

Many frail older people will have coexisting disability and comorbidity, both of which can influence the clinical presentation and assessment of UI, as well as responsiveness to interventions. Frail older people are not only at higher risk for unintended adverse effects from treatment (e.g., fulminant *Clostridium difficile* colitis from antibiotics used to treat otherwise asymptomatic bacteriuria), but also may realise additive benefit in domains other than UI [385] For example, UI treatment that is aimed at underlying comorbidity and impairment (e.g., topical oestrogen for irritating urogenital atrophy reduces recurrent UTIs); and a nursing home exercise programme done in the course of toileting improves both physical function and UI [333]). Likewise, management of chronic cough from obstructive pulmonary disease may benefit stress urinary incontinence but, aside from the evidence for weight loss [388] and obstructive sleep apnoea [389] (both not in frail older adults), there is little published evidence. The role of dementia is discussed above.

6.3. Defining outcomes from treatment

Outcome measures must be fundamentally different from those used in healthy older persons, because of the heterogeneity of this frail population regarding comorbidity, remaining life expectancy (RLE), patient perceptions, personal values, and the involvement of caretakers and proxy decision makers. Unfortunately, intervention studies in the frail elderly remain focused on objective disease related variables and seldom, if at all, take account of these factors. Subjective outcome goals and measures would be preferable study outcomes in this patient group. Additionally, comorbidity is frequently used as an exclusion criterion in therapeutic trials. A review of care home residents’ views on continence showed that they valued having independent bowel and bladder function, but

believed incontinence to be inevitable and intractable. Residents often had low expectations, and declined further evaluation and treatment [390]. There are few data on older or frail peoples' expectations from specific treatments.

Although quality of life (QoL) is a key concern for UI in all persons (see Committee 5, Initial Assessment Including Quality of Life), and has special relevance in frail elderly with limited RLE, there are few validated QoL outcome measures applicable to this population. Only one validated UI-related QoL measure is derived specifically from patient-based data among persons older than 65, and these subjects were community-dwelling and relatively healthy [391]. None of the ICI-endorsed UI-related QoL measures have been validated in oldest-old or cognitively and/or functionally impaired persons. Traditional UI QoL domains—e.g., impact on IADLs, travel, sexual relations—are often not relevant to frail older persons, and there could be significant effects for social and role function domains. One alternative QoL domain for frail elderly is social interaction, especially for nursing home residents; [392] an analysis of cross sectional and longitudinal data from over 100,000 US nursing home residents found that prevalent and especially incident UI had negative impact on social interactions, particularly among persons with moderate ADL impairment [392]. An analysis of older Medicare benefit over 65 years of age, and including those over 85, found significant impairment of QoL, in accordance with that found in younger people [393].

The profound question when considering UI outcomes in frail older persons is, "Is complete cure ever possible?" In short, this depends on patient factors, specific treatment(s), and the target outcome. While no geriatrician endorses "ageism" and therapeutic nihilism, research evidence suggests that complete

dryness is unlikely for certain frail patients, particularly frail institutionalised persons with severe cognitive and functional impairment. Even "intractable" UI is amenable to interventions that may improve the patient's urinary and bowel function and quality of life. The Committee of the Third ICI introduced an alternative continence paradigm for frail elderly (Figure 3), which subsequently was generalised for all persons with UI [394]. In this paradigm, people with "dependent continence" are dry due to ongoing assistance, behavioural treatment, and/or medications. UI would return if the interventions ceased, a situation analogous to chronic disease models [395] such as "controlled hypertension" or "controlled diabetes." Persons with "independent continence" are cured without need for ongoing treatment (e.g., dry after successful anti-incontinence surgery). For patients who are unable to achieve independent or dependent continence, "contained incontinence" should be possible by use of appropriate products such as pads, catheters, and appliances (See Chapter 20, Management Using Continence Products), thus providing "social continence" or "accepted incontinence." [396]. The balance between the degrees of continence achieved may vary as UI severity changes, and are dependent upon patient and caregiver preferences. These continence outcomes encompass a common need: to be both realistic and hopeful about UI in frail elders while avoiding nihilism and neglect; maintaining comfort and dignity and preventing avoidable complications of UI. The other consideration is that any comorbidities associated with frailty, e.g. dementia and Parkinsonism, are progressive conditions so that treatment goals may need to be re-evaluated as time progresses. Although the ICS standardisation document on outcomes in older patients is now over 15 years old, little progress has been made and many of the identified needs still pertain (see Recommendations for Research).

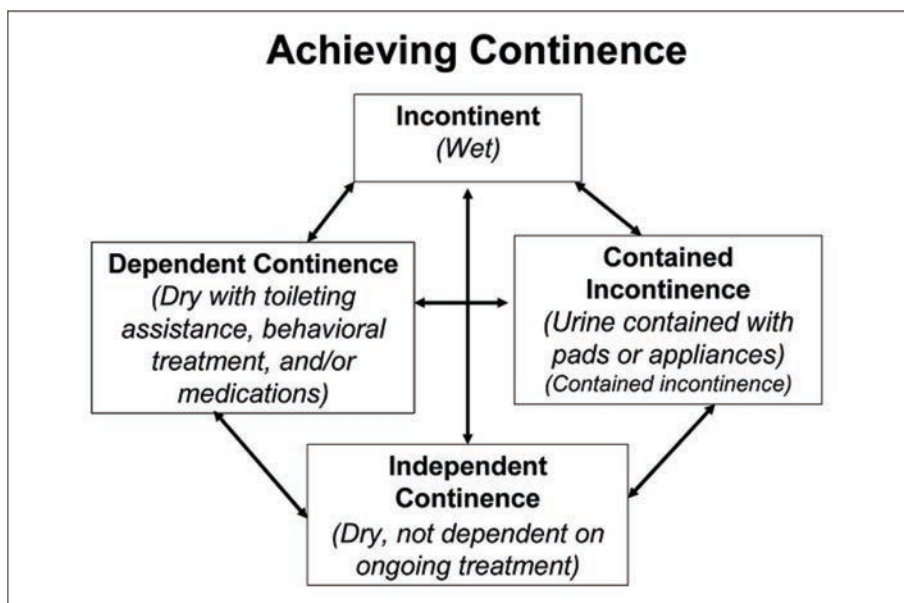

Figure 3. A paradigm for continence

6.4. Role of remaining life expectancy in treatment decisions

Remaining life expectancy (RLE) is a key yet often misunderstood concept in treatment decisions for frail older people. RLE is not uniformly short in this population; moreover, there is a demographic trend of increasing RLE, with a smaller proportion of persons spending their remaining years living with disability [397]. Evidence shows that many health care professionals will underestimate life expectancy [398]. Reference to actuarial tables produced for insurance purposes is often enlightening. Incorporation of RLE into treatment decisions in urology and gynaecology has been studied only in relation to cancer treatment. Two studies, both in prostate cancer, examined specialists' ability to estimate RLE. Canadian urologists were more accurate in estimating longer RLE: using scenarios based on actual patient data, 31% were accurate within 1 year, 67% within 3 years, and 82% in estimating greater than or less than 10 years in 82% of responses [399]. Comprehensive Geriatric Assessment can help estimate remaining life expectancy and can help predict treatment-related morbidity and mortality in older men with prostate cancer [400].

Walter and Covinsky [401] developed a graphical tool for estimating quintiles of RLE by age. Medical conditions most closely associated with shorter RLE are class III/IV congestive heart failure, end-stage renal disease, and oxygen-dependent chronic obstructive pulmonary disease. Estimates of RLE are significantly affected by frailty and cognitive impairment [402]. Functional status has a dramatic impact on life expectancy. For example, 75-year-old men and women without limitations have life expectancies 5 years longer than those with ADL limitation and more

than 1 year longer than those limited in mobility [403]. Alzheimer's dementia decreases RLE profoundly (by nearly 75%) among older persons who otherwise would be in the top quintile of RLE [404]. Compared to older persons with at most one IADL deficit, persons with more deficits have significantly higher 5-year mortality (with two deficit, adjusted RR 1.46 [95% CI 1.20 – 1.78]; with three or more deficits, adjusted RR 1.64 [1.26 – 2.14]) [401].

6.5. Preferences for care

Because there are multiple treatment options available for frail older adults with UI, and individualised care should be emphasised, obtaining patients' and caregivers' opinions regarding preferences and goals for care is essential for quality care planning. It should not be assumed that persons with cognitive impairment are unable to make their care preferences known or participate in treatment decisions and all reasonable efforts to help them to do so should be made. The spectrum of cognitive impairment is large and the wishes of the patient should be paramount. Preferences for toileting and changing were studied in 111 nursing home residents with UI; residents preferred an average of 2 pad changes, 1.5 toilet assists, and 2 walking assists more than they actually received, yet even these levels were lower than guidelines recommend, suggesting that residents may have reduced expectations based on their experience [405]. In a second, residents of board and care facilities and two nursing homes, their family members, and facility nursing staff were given definitions of and information about UI treatment options (indwelling catheter, prompted voiding, adult diapers [sic], electrical stimulation, and medications) [406]. Respondents were asked their preferences between pairs of

treatment options (e.g., “diapers” versus prompted voiding). Most of the board-and-care respondents were continent, although some were undergoing UI treatment at an outpatient clinic. Patients and family members were evenly divided between “definitely” and “probably” preferring prompted voiding versus diapers. Almost 80% of nursing staff, however, preferred prompted voiding to diapers. Families perceived staff members as unwilling to perform prompted voiding, and some thought prompted voiding was degrading to the resident and that it was bothersome to be asked to go to the toilet frequently. Using a similar method, a German study with 117 geriatric hospital patients (mean age 85; 43% with UI), 72 staff members, and 71 family members, found that most patients preferred diapers (79%), medications (78%), and scheduled toileting (79%) over urinary catheters, and 64% preferred scheduled toileting [407]. When choosing between diapers and medication, equal proportions preferred each option. Patients with greater functional dependence were more likely to prefer catheters, and those with experience with diapers were more likely to prefer medications and toileting. Notably, spouses showed moderate to almost perfect agreement with patient preferences, but those of other family proxies had only slight to fair agreement. In a qualitative study of 25 women with pelvic floor dysfunction living in residential facilities, residents expressed a desire to live with their problem rather than undergo assessment and management, emphasizing the need to include the patient in management decisions at the outset [408].

6.6. Cost and benefits of treatment of UI in frail older persons

An overall discussion regarding UI-related costs is covered by Committee 22, Economics of Incontinence. The following discusses UI cost issues specific to the frail elderly.

a) Estimating Costs. For the majority of developed countries, the greatest increase in population is occurring in the oldest old, those > age 85. This group has the highest prevalence of UI, and accordingly the increased prevalence of lower urinary tract symptoms will result in higher UI care costs. Such an increase has already been observed between 1992 and 1998 amongst US women aged > 65 [409]. The costs of care for older persons has been estimated at double that for people under 65, but care for those older persons living in institutions was less than for community dwelling individuals [410]. Likewise, the cost of OAB in five European countries is estimated to rise by one billion Euros between 2000 and 2020 [411] and in the US it has been estimated that by 2030 the greatest increase in demand for UI care (81%) will be in older women aged 60-89 with OAB symptoms [412]. In one US study using of a community managed care population, the presence of OAB and comorbidity doubled the associated costs of UI care [413]. In South Korea, the estimated cost of treating overactive bladder was 117 billion Korean

Won (KRW) in 2006 and 145 billion in 2007. The estimated total cost in treating stress urinary incontinence was 122 billion KRW in 2006 and 59 billion in 2007 [414].

Costs can be expressed as direct costs, indirect costs, and intangible costs [413]. Previous estimates have focused on diagnostic costs, treatment (including routine care and pads), and consequence costs (skin irritation, urinary tract infection, falls, fractures, additional nursing home and hospital admissions, longer hospital length of stay). Direct healthcare costs are most often estimated but there is a lack of meaningful research into indirect costs and those related to comorbidity in the frail elderly. Intangible costs have not been considered in these estimates because of their subjective nature and the methodological difficulty of collection and estimation. Much of the evidence for the cost of UI in older persons has been gathered from either epidemiological surveys or analyses of claims from insurance databases; these have often involved many assumptions or complicated formulae to calculate financial costs. There is a consistent theme that the cost of caring for older adults with UI will increase, but the estimated magnitude of this increase is variable.

For the frail elderly, especially those in long term care, cost calculation is especially complex. The greatest costs for UI care in nursing homes are by far nursing labour costs [415]. Extrapolated costs for nursing home admission due to UI was \$6 billion (2000 US dollars), with institutional costs of UI management and consequences of \$5 billion (2000 U.S. dollars) [416]. In one small 6-month study, the mean daily cost of UI care, including direct nursing care, indirect nursing overhead, and supplies, was \$9.09 (+/- \$ 0.52) per resident (2003 U.S. dollars) [417]. The costs for UI pads alone in Dutch long-term care have been estimated at 160 million Euros [418]. In an Australian sub-acute care setting, the costs of daily UI care was AU \$49, with most spent on staff wages [419]. In Canada, researchers found that 1% increase in UI prevalence was associated with an 11-12% increase in costs [420]. The extra nursing time needed to maintain toileting programmes contributes to high costs [421]. Routine garment and laundry costs may be lower than estimated because in practice residents are not changed as often as needed. In addition, for prompted voiding to remain effective, such things as regular refresher education programmes for staff or wet sensors may be necessary, and thus are rarely considered in cost estimates. Moreover, the time over which the costs and benefit are calculated needs to be explicit because both benefit and costs will change, and patient morbidity and mortality need to be considered. The costs of correcting functional and medical causes of UI are rarely considered. Also, the potential differential in costs across the span of cognitive and functional impairment has seldom been assessed, [422] despite evidence that UI care costs are closely related to the degree of functional impairment [423]. Some surveys suggest that the costs of care for younger community dwelling adults outweighs that

associated with the elderly, but there are wide variations of estimates depending upon the population studies [424].

Costs related to caregivers of frail persons with UI living in the community include lost wages, decreased productivity (both within and outside of the home), the additional number of caretaking hours when a frail person develops UI, [425] and the cumulative effect of increased strain and burden, along with any resultant illness. Overall, there are still limited data on costs of UI treatment in other residential (such as assisted living or rest homes) and acute care settings [426], costs may vary by access to care. Because so many frail elderly are homebound or live in institutions, they often do not have the same access to the UI therapies as other populations. Their health care providers may be limited to primary care physicians, community nurses, and care assistants or aides with little to no expertise in UI management. Specialist consultation may be minimally available in home or long term care settings, leading to a focus solely on behavioural management and/or containment products. An assessment of a multi-component intervention based upon absorbent products, a structured skin care regimen, and nursing advice on incontinence associated dermatitis revealed that incontinent residents used an average of 5.19 absorbent products, at a mean cost of € 1.79 per day. Following introduction of the intervention, the mean number of absorbent products consumed per day was 2.02 per incontinent patient, at a mean cost of € 0.97 per day [427].

Cost relates strongly to reimbursement, which varies considerably from country to country, depending not only on structure of the health system but special programmes for the aged and persons with UI. Within countries, there may be further variation based on insurance, co-insurance, drug versus procedure coverage and incentives, access to care, programmes for vulnerable populations, and urban/rural differences.

b) Benefits and effectiveness of treatment.

The ability to define the benefit of UI treatment in frail older people is highly dependent on the individual, their caregivers, and the health care system. Outcomes research indicates that patients value quality of life, which encompasses many domains beside reduction in UI (See Committees 5A Initial Assessment of Urinary Incontinence in Adult Male and Female Patients and 5B Patient-reported Outcome Assessment). Even cognitively impaired people can still express treatment preferences [407, 428], so it is also possible to evaluate domains of quality of life (e.g., social interaction) [392] and assess treatment satisfaction directly or behaviourally. At the same time, we found no data on the value or utilities frail elderly or their caregivers assign to varying degrees of UI (with or without treatment intervention) versus “dryness.” Standard outcomes such as quality adjusted life years (QALYs) may overestimate effectiveness in older people, [429] not just because of potentially different utilities, but because of the altered importance

of “years of life saved” in a population with variable and limited remaining life expectancy.

The need for novel and specific outcomes for use in both trials of UI interventions and clinical care of incontinent frail elderly people continues. Outcomes measured by single item tools of perceived benefit or satisfaction with treatment are unlikely to be generalisable across the heterogeneous older population. It should not be assumed that perceived benefit of treatment can be measured with the same tools across cultures and health systems, unless such tools are sensitive to differences in such things as reimbursement and provision of continence services and supplies. The association between expectations, preferences, and outcomes needs to be prospectively studied in relevant and representative populations. New approaches and tools to assess UI-specific quality of life in cognitively-impaired frail elderly are needed, as well as better understanding of the interaction between functional impairment and the impact of UI [392]. When QALYs are included as an outcome in UI treatment trials in older persons, they should be specifically analysed by age and also possibly health status.

7. ISSUES IN DRUG TREATMENT

7.1. Age-related changes in pharmacology

Specific age-related changes in pharmacokinetics, alteration in drug absorption, distribution, metabolism and clearance, and their potential effect on UI drugs, are shown in Table 6. Age-related pharmacokinetic changes are rarely considered in planning the duration of time off previous UI medications, placebo-run in periods, and wash-out periods in UI drug trials in older persons. Typically, a two-week washout from other drugs, three weeks for solifenacin and mirabegron, is planned, regardless of age. The numerous factors potentially affecting drug clearance in older, frail patients, as well as previous and/or cross-over compounds, may confound observed drug effects. Age-related changes in pharmacodynamics have been described for benzodiazepines, beta-adrenergic agents, and opiates [430, 431] but there are few available data concerning change, even in these, other than for limited numbers of community dwelling older people, often with median age of around 65 years old.

Availability of low dose agents: One effect of the underrepresentation (if not exclusion) of frail older persons in UI drug studies is a lack of knowledge regarding minimal effective drug doses for this population. The age-related changes in pharmacology noted above suggest that some UI drugs may be effective at lower than standard doses in frail older persons with concomitant decreased adverse effects [432]. This issue is especially relevant for extended release preparations, which cannot be divided into smaller doses. There are some data supporting the effective use of low dose oxybutynin in older persons [433,

434]. Since the last consultation, a single study has assessed low standard doses of trospium chloride and solifenacin in combination in older persons (not frail) average age 69. 4 years in comparison to higher doses showing higher efficacy of combination lower dose therapy [435]

Polypharmacy: Approximately 60% of people over age 65 take at least one prescribed medication, and about one-third take more than five prescribed drugs. In a Swedish analysis of 3 cohorts of older persons examining the trends in medication taking over the years 1987-2007, the prevalence of medication use and polypharmacy increased in the age group 78 years from 2.8 drugs in 1987 to 5.8 drugs in 2007, and for the age group 96+ years from 3.6 to 7.7 [436]. There is evidence from some jurisdictions which suggests a reduction in potentially inappropriate medication exposure in older persons [437]. Similar results have been reported from other countries [438].

In addition, many older persons take over-the-counter, naturopathic or herbal agents and dietary supplements, with the rate of use varying across countries and cultures. In a US analysis of a longitudinal, nationally representative sample of community-dwelling older adults, 62 - 85 years old interviewed twice, initially in 2005-2006 and again in 2010-2011, concurrent use of at least 5 prescription medications increased from 30.6% to 35.8%. The use of over-the-counter medications declined from 44.4% to 37.9%, while the use of dietary supplements increased from 51.8% to 63.7% (P < .001 for both). In 2010-2011, approximately 15.1% of older adults were at risk for a potential major drug-drug interaction compared with an estimated 8.4% in 2005-2006 (P < .001) [439]. The likelihood of adverse drug reactions (ADEs) and drug interactions rises exponentially as the number of medications increases. This has led to the recommendation in geriatric prescribing to “subtract before

adding,” to consider whether target symptoms might be due to medications before adding another drug targeting those symptoms. This approach is relevant in geriatric UI, as UI may have been precipitated and/or worsened by medications (see Table 3). Changes to existing drug regimens should be considered in the management of UI in all frail older people. The national audit of continence care in the United Kingdom reported that of older adults, mean age 80 years, only 27.5% (2082/7572) had documented evidence of a medication review [440].

Adverse drug effects (ADE): ADEs are extremely common in older persons, [441] with rates up to 35% among community-dwelling persons aged > 65 in the US [341], and up to two-thirds of long term care residents [342]. Although the prevalence of drug – drug and drug disease interactions in older persons is high, there are limited data on important clinical outcomes, largely due to the varying nature of the reporting of events[442]. In a recent review of prevalence and contributing factors in developed and developing countries, of the median prevalence of ADR-related hospitalisation was 6.3 % (interquartile range (IQR) 3.3-11.0) and 5.5 % (IQR 1.1-16.9), respectively. The median proportions of preventable ADEs were 71.7 % (62.3-80.0) and 59.6 % (51.5-79.6). Factors associated with increased risk of hospitalisation were older age, female sex, number of medications, renal impairment and heart failure [443]. In a UK series, 59% of ADEs requiring hospital admission involved patients aged > 60 [444]. Factors associated with higher ADEs in older persons are higher drug doses, age-related pharmacological changes, polypharmacy, comorbid conditions and the interactions between them, and female sex [445, 446]. Older people are at higher risk of ADEs

Table 6. Pharmacokinetic changes in older persons

Parameter	Age-associated Changes	UI Drugs Potentially affected
Absorption	Minimal quantitative change despite ↓ gastric motility, yet little known regarding effect on slow-release agents	Extended release preparations
	↓ Skin thickness	Transdermal preparations
Distribution	Decrease in lean body mass leads to ↓ Vd / ↓ T½ for hydrophilic drugs and ↑ Vd/↑ T½ for lipophilic agents	Lipophilic agents, tricyclic antidepressants
	Decreased protein binding in frail patients with low albumin, leading to higher concentration of free drug	Tolterodine
Hepatic metabolism	↓ Phase I reactions (oxidation/ reduction)	Tricyclic antidepressants
	No change in Phase II reactions (glycosylation)	

Parameter	Age-associated Changes	UI Drugs Potentially affected
	↓ Hepatic blood flow and ↓ hepatic mass, leading to reduced clearance for agents with first-pass metabolism	Oxybutynin Tolterodine Solifenacin Darifenacin
	Stereoselective selectivity in metabolism (hypothetical)	Enantiomers
	Cytochrome P450	Oxybutynin Tolterodine Solifenacin Darifenacin Mirabegron 5HMT, clearance only)
Clearance	Decrease in renal clearance	Tolterodine Fesoterodine (5-HMT)

from antimuscarinics because of age, and comorbidity-related changes in muscarinic receptor number and distribution, blood-brain barrier transport, and drug metabolism [447]. Whereas antimuscarinic ADEs in younger persons are bothersome, in the frail elderly they can result in serious morbidity such as sedation, heat intolerance, prolongation of delirium, and falls.

Xerostomia is common in older people [448]. A study of 175 acutely hospitalised community dwelling older people (mean (SD) 82 (5.7) years) and 252 outpatients (mean (SD) 77 (5.7) years) found that 63% of the hospitalised elderly and 57% of outpatients complained of dry mouth. Dry mouth was more common amongst those on multiple medications [449]. In general, older people, women and those taking multiple medications are more likely to report the symptom. Antimuscarinics may exacerbate this condition, leading to concerns about deteriorating dental health and a 2011 warning to the Food and Drug Administration from the American Dental Association (no longer online). meta-analyses of bladder antimuscarinics show minor variations in the incidence of dry mouth from clinical trials, with oxybutynin associated with the highest prevalence [450, 451]. A subcut analysis of a Canadian randomised controlled trial of solifenacin, 5mg/day, versus oxybutynin 5mg tid, examined the tolerability of both drugs in subjects under and over the age of 65 years, the study found that dry mouth was no more common amongst those over the age of 65 but was more common and more severe with oxybutynin [452]. In those over 75 years of age treated with 8mg versus 4mg of fesoterodine from a pooled analysis of data from registration trials, dry mouth was more common in the older sample; this finding was duplicated in a prospective trial of fesoterodine in older patients [453, 454].

Another antimuscarinic ADE to which the frail elderly may be predisposed is decreased visual accommodation, yet this has been specifically evaluated only in young healthy volunteers, [455] and a single prospective cohort including patients up to the age of 60 years [456]. Drug trials typically report only “blurred vision,” without further characterisation.

The incidence of increased post void residual volume (PVR) as an ADE is reported in clinical trials of antimuscarinics for UI or OAB as urinary retention, typically defined of a retained volume above 200mL. Patients with a PVR ≥ 200mL are usually excluded from trials at the outset. When it has been reported, the magnitude of increase is seldom of clinical significant at usual therapeutic doses.

The incidence of acute urinary retention with antimuscarinics in general is low [457] but has not been evaluated in frail older persons. In a trial of fesoterodine in “vulnerable elderly” patients (see specific drugs, below), urinary retention occurred in 9/281 fesoterodine exposed patients over 12 weeks and none exposed to placebo [458]. There is no consensus, other than that used in clinical trials, as to what constitutes a sufficiently high PVR to preclude antimuscarinic treatment or to require dose adjustment of an already prescribed agent. If urinary frequency or UI worsens after an antimuscarinic is started or increased, then PVR should be checked because an increased PVR will lower functional bladder capacity and worsen UI. PVR should be monitored in frail older men treated with antimuscarinics who may not reliably report change in LUTS or voiding difficulty. The majority of men with clinically relevant outlet obstruction are excluded from treatment trials and the results of these should be viewed in that light.

7.2. Anticholinergic medication and cognitive impairment

A major antimuscarinic ADE of concern in frail adults is cognitive decline. There has, since the last consultation been a number of associative reports linking anticholinergic medication to cognitive impairment, an increase in incident dementia diagnosis and a possible increase in mortality [66, 459, 460]. Medications with anticholinergic properties are commonly used by older persons. For example, in a US retrospective, cross-sectional study of adults aged 65 years and older using 2012 American Geriatrics Society Beers Criteria, 9.56% (7.51 million) older adults used potentially inappropriate anticholinergic medications in 2009-2010; those aged 75-84 or ≥ 85 years did, however, have a decreased likelihood of receiving them [461]. Of 964 older persons attending an Australian memory clinic, potentially inappropriate medications affecting cognition were used by 206 (21.4%) patients. Anticholinergics and sedatives were the most common. One hundred and thirteen (11.7%) patients had a clinically significant anticholinergic burden score (≥ 3) [462]. As much as there is a reported increase in overall medication prescribing for older persons, temporal trends also reveal an increase in anticholinergic medication prescribing for older persons [463]. Due to the nature of the cohorts of persons studied, data on medications used for overactive bladder and urgency incontinence are limited to identifying immediate release oxybutynin as a consistent significant factor in exposure. In the study of Gray [67], over 10 years, those with the highest cumulative burden of oxybutynin exposure had a significant association with cognitive impairment.

Cognitive effects may be under-detected because they are clinically subtle, neither asked about nor reported by the patient, or mistaken for age-related diseases and ageing [464, 465]. A 2014 systematic review of the effect of medications with anti-cholinergic properties on cognitive function, delirium, physical function and mortality examined 46 studies including 60,944 participants; 77% of included studies evaluating cognitive function ($n = 33$) reported a significant decline in cognitive ability with increasing anti-cholinergic load. Four of five included studies reported no association with delirium and increasing anti-cholinergic drug load ($P > 0.05$). Five of the eight included studies reported a decline in physical function in users of anticholinergics ($P < 0.05$) [466]. A recent study investigating the association between anticholinergic medication use and neuroimaging biomarkers of brain metabolism and atrophy in 52 cognitively normal adults, mean [SD] age, 73.3 [6.6] years in the Alzheimer's Disease Neuroimaging Initiative and the Indiana Memory and Aging Study found showed lower mean scores on Weschler Memory Scale-Revised Logical Memory Immediate Recall, Trail Making Test Part B and a lower executive function composite score in participants taking anticholinergic medications compared to those participants not taking such medications. Reduced total cortical volume, temporal lobe cortical thickness and greater lateral ventricle

and inferior lateral ventricle volumes were also seen in the participants taking anticholinergic medications compared to those not taking such medications [467]. It is clear that duration of exposure and extent of exposure to medications with anticholinergic properties are significant factors in the observed associations with cognition. Many scales exist which purport to measure anticholinergic burden, each varies in its utility in identifying anticholinergic load. The clinical results in studies using these scales are different depending on the scale used dependent upon the different methods used in their development [468]. Persons with pre-existing cognitive impairment (especially from conditions known to affect central cholinergic pathways) may be at greater risk for cognitive impairment although there are also some data to suggest that those with established dementia may not experience cognitive decline following therapy with anticholinergic agents [68]. Additionally, a recent meta-analysis examined the relationship between serum anticholinergic activity and decline in cognitive performance, delirium, and functional impairment. The review included 4 RCTs, 5 prospective cohort studies, 3 longitudinal cohort studies, 17 cross-sectional studies, and 4 case-control studies. Twenty-four of the retrieved studies examined an association between SAA and cognitive outcomes, 2 studies examined an association with SAA and functional outcomes and 8 studies examined associations between SAA and both cognitive, and functional outcomes. The meta-analysis on 4 RCTs showed no association with higher SAA and cognitive performance however, the pooled data from 4 observational studies showed elevated SAA was associated with reduced cognitive performance ($I^2 = 0.00\%$, $H_2 = 3.37$ and $p\text{-value} = 0.34$) [469].

Whereas the beta-3-agonist, mirabegron, is associated with similar rates of adverse events to the anticholinergic drugs, there are obvious differences, the most obvious being a relative absence of adverse events such as dry mouth and constipation. In a single pooled analysis of mirabegron studies in patients 65 years, the three most common TEAEs in patients randomised to mirabegron 50 mg were hypertension, nasopharyngitis and UTI (9.9, 4.1 and 3.1%, respectively). In the ≥ 65 -year subgroup, over 12 weeks, the incidence of the most common TEAEs was similar for both doses of mirabegron and placebo, except for hypertension, UTI and dizziness, which occurred with a higher incidence in the mirabegron 25 mg group than the placebo or mirabegron 50 mg groups. Hypertension has been a common concern with mirabegron therapy, but in the same pooled analysis, over 12 weeks, in the ≥ 75 -year subgroup, the incidence of hypertension with tolterodine ER 4 mg (comparator) was seen to be higher (21.6%) than with either dose of mirabegron (18.8 and 13.6% for the 25 and 50 mg doses, respectively) or placebo (9.6%). The incidence of hypertension in the oldest patients was also higher with tolterodine (14.5%) than mirabegron 50 mg (9.3%) over a 1-year period [470].

7.3. Drug interactions

Because frail older people take higher numbers of drugs and usually have several comorbid conditions, drug interactions are more common [471]. All antimuscarinic agents for UI will have additive side effects when combined with other anticholinergic agents. Antimuscarinics could potentially alter the absorption of other drugs by slowing gastrointestinal motility.

Drug-drug interactions for oxybutynin, solifenacin, darifenacin, and tolterodine include potent CYP3A4 inhibitors (azole antifungals, macrolide antibiotics, cyclosporin, and vinblastine). Fesoterodine, a pro-drug that is converted to tolterodine by non-specific esterases, is also dependent upon CYP3A4 for its excretion. There is one case report of interaction between tolterodine and warfarin in 2 older patients, which [472] has not been seen in healthy volunteers. Naturopathic/herbal preparations should also be considered for potential interactions, especially in areas where these agents are frequently used. Potential drug-drug interactions with mirabegron, a beta-3-agonist for the treatment of overactive bladder have been evaluated in younger healthy subjects, between mirabegron and metformin, warfarin, digoxin, or a combination oral contraceptive. Changes in maximum concentration of metformin and digoxin were observed, but no dose adjustment of either drug is required when mirabegron is administered concomitantly with metformin, warfarin or the oral contraceptive. The authors suggested that patients receiving mirabegron with digoxin may require additional monitoring of digoxin concentrations with dose adjustments where needed [473].

Evidence regarding the co-prescription of bladder antimuscarinic agents and cholinesterase inhibitors (CEIs) used for dementia are of poor to moderate quality. There is evidence CEIs can cause or worsen UI from a case report [474] and also a case series of 216 consecutive patients with probable Alzheimer's disease attending a memory treatment centre [475], but this finding has not been replicated in a large Dutch dataset analysis [476]. In the case series, CEI treatment was overall associated with 7% risk of new UI: the highest risk was observed in patients with more behaviour problems, and lower risk in patients who demonstrated positive cognitive and/or behavioural response to CEI. Further evidence for an interaction between antimuscarinics and CEIs comes from a database study of nursing home residents in one US state [477]. Residents with dementia, newly treated with cholinesterase inhibitors, were more likely to then be prescribed a bladder antimuscarinic than those residents with dementia not given a cholinesterase inhibitor, an example of a geriatric "prescribing cascade" [478]. In a cross sectional survey to determine the proportion of nursing home residents with overactive bladder or urinary incontinence with potential contraindications to antimuscarinic treatment because of concomitant anticholinergic medications or acetylcholinesterase inhibitors (AChEIs)

71.3% received at least one anticholinergic medication. CEIs and antimuscarinic treatment were prescribed concurrently in 24% [479]. Concomitant use of antimuscarinics (extended release oxybutynin and tolterodine) and cholinesterase inhibitors in nursing home residents was associated with a decline in ADL function in the most functionally able residents but there was no worsening of cognition, probably because the cognitive measure (MDS-COG) was inadequately sensitive. More importantly, there was no case of delirium observed [480]. In a study in which the primary objective was to assess the cognitive impact of trospium chloride in older people with dementia treated with galantamine over a six-month period, 46 subjects with UI and dementia were enrolled, 10 withdrew from the study. No effect on cognition or activities of daily living was detected over the duration of the study. A within group analysis demonstrated an improvement in nocturia and reduction in pad use in this combination group [481]. A small study reported some positive effect of the treatment of UI with propiverine in subjects with probable AD taking cholinesterase inhibitors [482]. The practice appears to be common in Finland [483]. Although intuitively illogical, given the opposing pharmacological actions, there seems to be no reason not to use bladder antimuscarinics for older people with dementia, ensuring that the cholinesterase inhibitor is warranted and effective, that the incontinence is sufficiently bothersome to warrant treatment and that the patient (where possible) and the caregiver are fully informed. The current weight of evidence appears to be that a positive outcome in terms of bladder control can be achieved without a significant detriment in either cognition or activities of daily living.

7.4. Potentially inappropriate drugs for older persons

Efforts at quality improvement for older populations have led to the development in several countries of expert consensus guidelines regarding inappropriate drugs for older persons, although the continuing relevance of these guidelines has been questioned and alternative systems suggested. A revised Beers criteria was introduced in 2015 [484]. These guidelines focus on drugs with lower risk-benefit ratios and higher potential for drug-drug and drug-disease interactions, and are used for nursing home regulation and quality performance measurement. The concerns regarding oxybutynin and tolterodine in causing urinary retention have been removed. All bladder antimuscarinics are included with respect to their anticholinergic properties. More recently, a system for prescribing appropriate medications for older persons, the Fit for The Aged (FORTA) criteria have been published with respect to drugs for lower urinary tract symptoms [485]. These guidelines systematically review available evidence for the use of medications in the population studied (in this case adults >65y with multimorbidity) and assign levels of appropriateness according to the available data. A Delphi process is used to assign drugs into A, Absolutely, B, Beneficial, C, Caution and

D, Don't criteria. Of all lower urinary tract drugs, fesoterodine achieved a Beneficial grade. Most drugs were placed into the Caution category, reflecting either deficiencies in, or absence of, available data.

8. SPECIAL ISSUES IN FRAIL OLDER MEN

Although their ranks thin into the ninth decade, men still comprise a significant portion of frail older persons. The prevalence of UI increases in men after age 80, going from about one-third of the rate in women to become equivalent. Over the past ten years, the prevalence of UI in US male nursing home residents aged 65-74 has increased to a greater extent than in female residents (from 39% to 60%, compared with 45% to 59%) (http://www.cdc.gov/nchs/data/series/sr_03/sr03_036.pdf) At the same time, frail older men are under-represented in UI treatment trials, whether behavioural, pharmacological, or surgical (see also Committee 13: Surgery for Urinary Incontinence in Men). Since the time of the 5th ICI, the European Association of Urology has summarized their recommendations (2015) for Urinary incontinence in frail/older men and women [486]. One prospective study of overactive bladder in older patients included 50% of men, but their results were not separately reported [454].

This under representation is unfortunate, because results from treatment trials in frail women cannot be directly extrapolated to men for several reasons:

- **Differences in comorbidity:** frail older women have higher rates of functional impairment and chronic disease and geriatric syndromes [487] which may mean that frail men may be more likely to respond to behavioural intervention. For older adults who become incontinent, a composite measure of physical performance (rising from a chair, walking, balance) is a better predictor of UI incidence in men than in women [488].
- **Differences in caregivers:** more older men have living spouses who can provide care, with a potential impact on the risk and type of caregiver burden associated with UI management.
- **Prostate cancer:** nearly all men in their ninth decade have histological evidence of prostate cancer. However, it is not clear that frail elderly men have an increased risk of prostate cancer-specific mortality, especially given that their remaining life expectancy (RLE) is primarily affected by comorbid conditions. The need to screen for and treat prostate cancer diminishes with functional status, comorbidity, and RLE [489]. At the same time, more men are living with the sequelae of prostate cancer treatment, particularly stress UI after radical surgery.
- **Benign prostate disease:** the prevalence of histological BPH, BPE, and BOO increase with age,

and is associated with LUTS, UI, and DO. In a urodynamic study of older persons, 29% of men had BOO and 59% had DO as the predominant cause of UI, versus 4% BOO and 61% DO in women [62].

- **Risk of urinary retention:** because of age-related decrease in detrusor contractile function and increased likelihood of BPE and BOO, it is often assumed that frail elderly men have a higher prevalence and risk of urinary retention. However, this has never been demonstrated. Among NH residents with UI, the prevalence of underactive detrusor was similar in women and men (38% and 41%, respectively), despite the higher prevalence of BOO in men [62, 102].
- **Differences in device usage:** A nationally representative survey of adults in the US showed that older men were nearly three times less likely than older women to use pads to contain leakage (15% vs. 45%) [490]. Data from Scandinavia, where some countries provide absorptive pads as part of the health care benefit, showed that this gap might be narrowing (22% vs. 48%), and that increased functional impairment was associated with greater pad usage [345]. In a survey of patients recruited from family practice clinics in the Netherlands, the gender difference for pad usage by older adults with UI was even higher, with 4 out of 5 women using pads versus 1 of 9 men using pads [491]. Men are also more likely to be users of indwelling catheters, both in the long-term care setting [354] and in the community [492].
- **Differences in medical treatments:** there are medications that might be used by only one sex, or might have distinct side effect profiles. For example, alpha-adrenergic antagonists in particular should be cautiously considered in men due to their potential side effect of causing orthostatic hypotension. (Grade C) [486]. The interactions of UI and other conditions with regards to orthostatic hypotension and risk of falls merits attention. In a German registry of 3,414 patients with Parkinson's disease, for those with urinary incontinence (716; 21%), orthostatic hypotension was reported for 14% of the men, yet only 9% of the women [493]. On the other hand, for women and men who had strokes and urinary incontinence, both were equally more likely to sustain a fall after stroke, though women were more likely to sustain an injury (OR 1.5) than were men [494].
- **Differences in surgical treatments:** there are gender-specific devices and surgical approaches that do require active management on the part of the patient. In particular, certain frail older men might not be appropriate for placement of an artificial urinary sphincter due to co-morbidity, medications and cognitive and/or functional impairment would not allow for the individual to manage the device on his own (Grade C) [486].

Despite these issues, evaluation and management of UI in most frail older men follows the same roadmap as for women (see Algorithm).

9. SUMMARY OF THE EVIDENCE

Age-related changes in pharmacokinetics affect antimuscarinic drugs for UI and should be incorporated into treatment planning. (Level 1-2)

Drugs may be effective at lower doses in frailer compared with healthier older persons (Level 3)

Polypharmacy increases the chance of adverse reactions to drug therapy. (Level 1)

Adverse drug events are more common in the frail elderly. (Level 2)

Drug-drug and drug-disease interactions are common in frail older persons (Level 1-3).

Antimuscarinics for treatment of overactive bladder remain as potentially inappropriate medications for frail older people according to the Beer's criteria (Level 3-4)

Specific guidance for drugs for LUTS in older people exists, this may, with caveats, guide practice (Level 3).

10. TREATMENT OF URINARY INCONTINENCE IN FRAIL OLDER PERSONS

10.1. Lifestyle interventions

Several treatable lifestyle risk factors are associated with UI. Modifications in fluid intake, avoidance of caffeine and other bladder irritants, weight loss, smoking cessation, constipation prevention, and physical activity are commonly recommended by health care professionals [416, 495-497] and included in clinical practice guidelines to prevent or reduce UI [498]. We were unable to identify lifestyle interventions, alone or in combination, that have been rigorously evaluated in frail older adults. Those studies available were conducted in healthier younger and older women, with some studies on weight loss interventions conducted in overweight women and men with impaired glucose intolerance or type 2 diabetes mellitus (See Committee 12, Conservative Management). Some interventions may be inappropriate for or impractical to use in frail older adults, for example, weight loss. However, advanced age alone should not preclude use of lifestyle interventions if assessment warrants this. Caution should be exercised in recommending fluid restrictions as inadequate fluid intake and dehydration are common in long-term care residents [499] and newly admitted frail older hospitalized patients [500]. Dehydration may actually increase the risk of UI and its severity in frail older

adults because of its significant association with constipation and delirium, both known risk factors for UI [501, 502].

Quality of the data

Since the 5th ICI we identified two systematic reviews on lifestyle intervention: a review of multiple types of lifestyle interventions in adults [503] and a review focused on volume of daily intake in adults with overactive bladder [504]. These reviews confirmed our earlier findings that there was insufficient evidence on the effect of lifestyle interventions on UI in the frail elderly. There was some evidence that fluid reduction did decrease the severity of overactive bladder symptoms; however, studies in this review were limited as they did not exclude known bladder irritants (e.g., caffeine) from the fluids measured nor did they establish baseline hydration status prior to any fluid modification. Although the authors recommended a 25% reduction in fluid intake could be effective, they cautioned that using a fluid reduction could have serious consequences in the elderly. There was some evidence in small trials [505-507] that raised the possibility that increased hydration for incontinent frail elderly may actually decrease UI. In this review, we located one article reporting on a small cross-over RCT examining the effect of caffeine versus decaffeinated fluids on symptoms of overactive bladder, including UI in women, but were unable to identify the number of oldest-old participants, few, if any appeared frail, and results were not stratified by age [508].

Recommendations (Table 7)

No recommendations are possible regarding lifestyle interventions for UI in the frail elderly (Level 4).

10.2. Behavioural interventions

Behavioural interventions have been a mainstay of UI treatment in the frail elderly, and include two major types: voiding programmes, including use of strategies to suppress urgency and delay voiding, and pelvic floor muscle training (PFMT). More recently, functional training with exercise targeted at improving mobility and toileting skills has been recommended for frail older adults, especially those in long-term care settings, who are at risk for functional decline and UI because of difficulty reaching and accessing the toilet in a timely manner [502]. Behavioural interventions may be especially beneficial for the frail elderly because they have few, if any, side effects.

Voiding Programmes. Voiding programmes are used predominantly with frail older persons, some which require active caregiver participation [509]. These interventions evolved from classical behavioural change theory, using antecedent and/or consequent conditioning to shape the desired behaviour [510]. Voiding programmes can be used for frail older people with cognitive and physical impairments who have difficulty learning new behaviours or difficulty actively participating in self-care activities, as well as

with frail older adults without these impairments. They include:

- **Prompted voiding**, involving prompts to toilet with contingent social approval, is designed to increase patient requests for toileting and self-initiated toileting, and decrease the number of UI episodes. It was first used in the late 1980s for incontinent nursing home residents [386] but has also had limited testing in a homebound older population [511].
- **Habit training** requires the identification of the incontinent person's individual toileting pattern, including UI episodes, usually by means of a bladder diary. A toileting schedule is then devised to pre-empt UI episodes. There is no attempt in habit retraining to alter an individual's voiding pattern [512].
- **Timed voiding** involves toileting an individual at fixed intervals, such as every 2-3 hours. This is considered a passive toileting programme; no attempts are made at patient education or reinforcement of behaviours, or to re-establish a voiding pattern. Other terms used to describe timed voiding are scheduled toileting, routine toileting, and fixed toileting [513].
- **Bladder training (or bladder retraining)** involves a progressive voiding schedule in combination with patient education that incorporates teaching of strategies for suppressing urgency and delaying voiding. This intervention is used in individuals who do not have cognitive or physical impairments [514].

A prior systematic review and metastudy of bladder training, prompted voiding, habit retraining, and timed voiding [515] found limited evidence on the effectiveness of voiding programmes, with the majority of trials not determining the type of UI or sufficiently describing whether comorbidity that possibly contributed to UI was evaluated or treated. Randomised trials in long-term care settings have overwhelmingly depended on research personnel to supervise or conduct the interventions. Studies repeatedly show that, once a trial ends, the long-term care staff rarely maintains the intervention at the same level, if at all. Outcome evaluation is usually limited to "wet checks" (percentage of times the patient is found to be wet on a set schedule) and not UI, and no studies report cure or patient-based outcomes, such as satisfaction and quality of life impact, or staff-based outcomes such as burden.

The context in which care is provided has been implicated in the provision of quality continence care [516], with staff knowledge about UI and UI care an important aspect in continence care delivery [517]. Staff or family caregiver buy-in for the intervention is considered an important component to behavioural interventions [518]. Consideration of organisational and social factors and interplay among older adults, by the health care team, was also identified as important in

the implementation of evidence-based practices [311]. Staffs' beliefs and experience with regulatory policy may also have an unintended, negative effect on provision of continence care in long-term care facilities [292, 519].

Functional Training and Exercise. Functional training involves exercises focused on improving skills involved with toileting and other activities of daily living (ADL). Functional training has also been used in conjunction with prompted voiding, and is referred to as functional incidental training (FIT). In some studies, FIT may be implemented by nursing home care aides (nursing assistants) [8, 520]. Functional training for UI has also been delivered by an occupational or physical therapist [521]. Functional training, with and without prompted voiding significantly reduced UI (measured in wet checks) in two long-term care populations [8, 520]. However, these interventions involve extra staff effort which may limit their feasibility in practice.

Pelvic Floor Muscle Training (PFMT). Although PFMT has been extensively studied in adults and some older people, primarily women and men undergoing prostatectomy, it has had limited study in frail older persons. An early study evaluated the effect of biofeedback-assisted PFMT in homebound older adults and found evidence that it significantly improved UI [522]. Age and frailty alone should not preclude the use of PFMT in appropriate patients with sufficient cognition to participate [523].

Multicomponent Behavioural Interventions. Studies have examined the effectiveness of multicomponent behavioural interventions involving PFMT in combination with bladder training for treatment of UI in women and non-frail older women [524, 525]. A multicomponent behavioural intervention involving pelvic floor muscle exercises, bladder training, and information about lifestyle modifications has also been studied in prevention of UI in community-dwelling older women aged 55 to 80 years [526, 2004]; this intervention might be effective in some frail older women.

Quality of the data and results (Table 7)

Since the 5th International Consultation a systematic review on management of incontinence and promotion of continence in older people in care homes [527], and an umbrella review of other systematic reviews using behavioural interventions for the promotion and management of UI [528] were published. These reviews confirm our findings that voiding programs are conducted primarily with frail older women (age > 80 years) in long-term care settings, with prompted voiding the most common intervention. Both reviews found evidence of the effectiveness of prompted voiding in reducing wetness rates and improving appropriate toileting in the short-term in both long-term care and homebound populations. Bladder training was effective in reducing UI frequency in

older women; however, there was no evidence regarding the effectiveness of timed voiding and habit retraining.

We also located two systematic reviews on conservative interventions for UI in frail older adults. One review examined treatments conducted in frail community-dwelling older populations [529]. The other review with meta-synthesis assessed conservative treatments in older adults and frail older adults in both community and long-term care setting [530]. This review concluded that there is some evidence that conservative treatments can reduce UI and improve quality of life. However, the quality of the evidence varied from low to moderate. These reviews confirm our previous observation on the limited number of studies on behavioural interventions in the oldest-old adults. A limitation identified by both reviews was the lack of an operational definition for frailty which made it difficult to distinguish older from frail older persons, along with incomplete descriptions of the study population in terms of comorbidity and ADL capacity.

Since the 5th ICI, we were unable to locate new articles on prompted voiding, timed voiding, habit training, or bladder training that incorporated randomized controlled trial (RCT) or quasi-experimental designs. However, we did locate two non-randomised studies evaluating the feasibility and effect of an ultrasound-assisted prompted voiding programme for management of UI in hospitalised Japanese older adults [531] and nursing home residents [532]. In a 4-week period evaluating ultrasound-assisted prompted voiding in 88 older hospitalised patients, there were statistically significant –post-test improvements in absorbent pad use (62.5% decreased their use and 26.3% no longer required use, with 37% unchanged) and reduction in caregiver stress [531]. In a 12-week study involving 77 nursing home residents, absorbent pad cost was decreased in 51.9% of participants, overall costs decreased by 11.8%, and quality of life for care workers in subscales of role emotional and mental health were significantly improved [532]. These promising results warrant larger scale testing using more a more rigorous design.

We were unable to locate any studies that reported on prevention of UI in frail older adults. We located five articles reporting on multicomponent behavioural interventions [332, 333, 533-535] (Table 7). Three studies were located that evaluated interventions in community-dwelling older adults. These included a RCT of fitness exercises and PFMT [536] in older women, a secondary analysis of a RCT involving bio-feedback-assisted PFMT and stress UI and urgency suppression techniques in homebound and non-homebound older adults [535] and a RCT evaluating fitness exercises and PFMT with and without the use of a heat and steam sheet placed on the back for 30 minutes daily) in older women with stress, urge, and mixed UI [534]. Two studies were located that evaluated multicomponent behavioural interventions in long-term care populations: a RCT of a group-based education, bladder training and PFMT programme in

care home residents, and a RCT of physical activity and activities of daily living (ADL) training in nursing home residents [333].

There continues to be limited evidence on the use of behavioural interventions in the frail elderly. The majority of studies have been conducted with frail older adults in long-term care settings; few interventions studies have been conducted in hospitalised or homebound older adults. In the previous ICI review we noted limitations in most studies including: small samples with low power to detect significant differences; varied terminology, operational definitions, and measures of UI making comparisons across studies difficult; inconsistent definitions of frailty; limited racial or ethnic diversity or men in samples; little focus on night time UI; little consideration to the psychosocial impact of voiding programmes on frail older adults and caregivers; and no long-term follow-up. Most studies excluded frail older adults with terminal illness. Ethical concerns for human subjects prohibit withholding treatment; thus, true “control” conditions were nearly impossible to create. Prompted voiding protocols varied across studies, with prompted voiding conducted every two hours over 12-hour, 14-hour, and 24-hour schedules. Cost data on voiding programmes was either dated (> 16 years) or was not available.

Table 7. Behavioural interventions

Intervention	Authors	Study Design	Sample	Methods	Results
Systematic Reviews					
Conservative treatments	Talley et al., 2011	Systematic review of conservative treatments in community-dwelling, frail older populations	7 studies (N=683; 75% women)	Literature review according to protocol including quality assessment	Multicomponent behavioural interventions (PFMT and bladder training) effective in reducing UI but low level of evidence Habit training and timed voiding led to modest reductions in UI but not considered clinically significant
Conservative interventions	Flanagan et al., 2012	Systematic review of care interventions for UI and faecal incontinence	33 studies, with 26 studies on UI only (N=1111; majority > 80 years, predominantly female); 7 studies on UI and/or fecal incontinence	Literature searched according to protocol; no quality assessment	Prompted voiding effective Combined prompted voiding and exercise was effective in improving endurance, strength, and continence but no evidence for exercise alone
	Roe et al., 2015	Systematic review of systematic reviews on management of UI and promotion of continence using behavioral interventions	5 systematic reviews; 3 specific to intervention studies (N= and two reviewed descriptive studies	Literature searched according to protocol (all systematic reviews); two reviewers evaluated reviews for methodological quality	Toileting programmes, particularly prompted voiding, is effective in the short term, reliant on staff adherence and resources
Conservative treatments	Stenzelius et al., 2015	Systematic review with metasynthesis on conservative treatments for UI and/or faecal incontinence in frail older populations	23 studies, with 9 moderate to high quality studies (N=895) included in metasynthesis	Literature searched according to protocol with quality assessment	PFMT in combination with physical training was effective in reducing UI and improving quality of life Prompted voiding and toileting assistance with functional exercise reduced UI Nighttime prompted voiding and waking routine had no effect on UI reduction Education had no effect on UI on quality of life
Functional Training and Exercise					
Physical activity and ADL training	Vinsnes et al, 2012	2-arm RCT	98 residents (mean age 84.3 years) in a Norwegian nursing home	3 month treatment of physical activity and individualised functional training by physiotherapist or occupational therapist; control group received usual care	After adjusting for age, sex, and functional status, the treatment group had significantly less urine leakage than the control group which increased their leakage

Multicomponent Behavioral Interventions					
PFMT and functional training	Kim et al., 2011	2-arm RCT	127 community-dwelling Japanese older women (mean age 75.9) with stress, urge, and mixed UI	60-minute exercise class with PFMT and fitness exercises, twice a week for 3 months; followed for 7 months post-treatment	Treatment group had significant cure rates after treatment and follow-up
Physical exercise, PFMT, and heat and steam sheet	Kim et al., 2011	4-arm RCT	147 community-dwelling Japanese older women (Mean age 76) with stress, urge, and mixed UI	3-month group exercise class with PFMT and fitness exercises twice weekly, with or without 30 minutes use of a heat and steam sheet applied to back daily or heat and steam sheet only; control group received general education once monthly for 3 months	Intervention groups significantly improved muscle strength and walking speed compared to control Exercise and use of heat and steam sheet led to significantly greater reductions in UI cure rates than exercise or heat and steam sheet alone Exercise and use of heat and steam sheet led to higher cure rates in women with stress UI than those with urge or mixed UI
Education, PFMT, bladder training, and functional training	Tak et al., 2012	Group RCT	192 residents (mean age 84.6) in 20 participating Dutch care homes	22 week intervention involving weekly group-based classes with education, PFMT, bladder training; control group received usual care	No statistically significant improvement in UI or quality of life Significant improvement in physical performance
PFMT and stress and urge suppression techniques	Engberg et al., 2016	Secondary analysis of RCT	279 homebound and non-homebound American adults aged 60 years and over	3-month intervention with PFMT, 6 weekly electromyography-guided biofeedback, and stress and urge suppression strategies; intervention conducted in homes by registered nurse	UI episodes were significantly decreased in the homebound group with UI

Efficacy

Findings from the 5th ICI and several recent systematic reviews [527-530] indicate that **prompted voiding** is more effective, in the short-term, than no intervention for improving daytime dryness in nursing home residents and some home care clients (**Level of Evidence 1**). Our prior review identified predictors of treatment response using a three-day trial of prompted voiding which included: appropriate toileting rate (the number of times the resident voided into the toilet divided by the total number of voids) greater than 66%, a wet check rate (number of times the resident was wet when physically checked) less than 20%, ability to pass a simple cognitive screening procedure of a one-step command, and the ability to transfer without human assistance [75]. Individuals who meet these indicators should continue on prompted voiding, and all other residents should be managed by “check and change.” This approach allows prompted voiding to be targeted to those nursing home residents who are eligible for and respond to prompted voiding (approximately 40%), and should help decrease the considerable time and labour costs now used for inappropriate, unsuccessful toileting [415].

The large majority of prompted voiding trials have been conducted in the United States, with little evidence of adoption in other countries. There is limited data on the effects of prompted voiding on caregivers, and no data are available on its long-term effects.

There continues to be insufficient evidence to determine if **timed voiding or habit training** improves continence in frail older adults (**Level of Evidence 4**) [537]. **Bladder training** appears to be effective in reducing UI in older women, some of whom may be frail.

Studies on functional training with other behavioural interventions (prompted voiding, PFMT, bladder training) report on improvements in endurance, strength, and walking ability, and subsequently reductions in UI in frail older adults in community-dwelling and long-term care settings. However, functional training alone did not appear effective in reducing UI.

There is some evidence that multicomponent behavioural interventions lead to improvements in UI in frail elderly, although this depends on the specific interventions and the population. There is some evidence that interventions including PFMT with and without functional training may be effective in improving UI in community-dwelling older women. Overall, there is insufficient evidence of effectiveness of functional training in combination with other behavioural interventions such as PFMT and bladder training. There is a need for high quality studies of multicomponent behavioural interventions in frail older adults in all settings, with evidence on their effectiveness in reducing UI, improving quality of life, impact on caregivers, and long-term benefit.

Recommendations for practice

1. Prompted voiding is effective in the short-term treatment of daytime UI in nursing home residents and home-care clients when caregivers comply with the protocol (**Level of Evidence 1**).
2. Prompted voiding is ineffective and should not be used for people who need the assistance of more than one person to transfer, cannot follow a one-step command, have less than a 20% reduction in wet checks or less than a 66% appropriate toileting rate after a three-day trial; these people should be managed with “check and change” (**Level of Evidence 1**).
3. Interventions combining toileting and functional training decrease urine loss and improve endurance in nursing home residents (**Level of Evidence 1**).
4. It is uncertain whether habit retraining reduces UI in frail older persons (**Level of Evidence 4**).
5. It is uncertain whether timed voiding reduces UI in frail older persons (**Level of Evidence 4**).
6. It is uncertain whether bladder training reduces UI in frail older persons (**Level of Evidence 4**).
7. Biofeedback-assisted PFMT in combination with bladder training reduces UI in homebound older adults (**Level of Evidence 2**).
8. Functional training in combination with PFMT reduces UI and improves walking time in frail older women (**Level of Evidence 2**).
9. There are no proven interventions to reduce the incidence of UI in hospitalised frail older persons (**Level of Evidence 4**).

10.3. Interventions with long term care staff and caregivers

Many frail older adults rely on family, caregivers, or residential and/or nursing staff for toileting assistance and personal care. These carers may not be available as frequently as necessary for the frail elderly to maintain continence, and even if available may not be able or willing to provide the needed assistance. Research has shown that the frequency of toileting assistance actually provided in US nursing homes is too low to maintain continence [77, 78]. There is dissonance between nursing home surveyors, nursing staff, and nursing home administrators’ knowledge and beliefs about UI and its management, which may be an important barrier to UI care [299]. Several studies suggest that nurses across all care settings (home care, acute care, and long-term care) settings continue to provide urine containment interventions rather than promoting continence [318, 343, 346, 348, 350, 352, 353, 538]. Moreover, nursing staff preferences for UI management (toileting) often conflict

with those of residents and their families' patient treatment preferences (medications and garments) [406, 408]. Acute care patients' preferences for UI treatment also differ from hospital staff preferences [407]. For example, nurses and physicians preferred scheduled toileting over diapers more than did the patients [407].

Management of UI in long-term care settings is complex, time-intensive, and requires staff training and cost-efficient systems for care delivery [417, 527]. Consistent findings from studies conducted in several countries suggest that lack of knowledge about UI, attitudes toward the elderly and incontinence, and the lack of formal preparation and continuing education influence continence care practices in long-term care settings [307, 539, 540].

Several researchers have recommended a two-pronged behavioural intervention to UI care: one geared towards the nursing home resident and the other geared toward staff members [541-543]. Nursing assistants provide a majority of the direct care in nursing homes and play a key role in the success of behavioral programs; yet they receive the least amount of formal education on UI. Organisational schemes involving use of incentives for nursing assistants to keep residents' continent has been recommended [544].

Several approaches have been studied in an attempt to promote continence and improve the management of incontinence in long term care. One approach involved a specialty practice exemplar model, with a nursing faculty member with expertise in the assessment and treatment of UI having a clinical practice in the nursing home. Assessment and treatment skills ultimately were transferred to the facility nursing staff through several mechanisms, including staff education and improved continence care systems [545]. Quality assurance programmes using incontinence quality indicators have also been proposed [358]. A clinical leadership model involving staff empowerment and mentorship in a subacute setting in Australia was successful in implementing practice-based changes for continence care that were sustainable 2 years after their introduction [546]. This model incorporated unit-based continence care resource nurses to implement evidenced-based strategies in continence care delivery. The effectiveness of clinical leaders may depend on several factors including, but not limited to their educational preparation for the role; the extent to which they feel supported; and the maintenance of the role (i.e., succession planning).

Quality of data

The challenges reported in conducting research in long-term care settings. Factors such as staffing ratios, staff turnover, changes in administrative and regulatory policies, and fiscal issues are beyond researchers' control. In addition, investigators report on issues with staff compliance in implementing research protocols involving toileting programmes and attendance at staff training was not optimal. We were

unable to locate recent articles reporting on staff intervention research to improve continence care in older persons in acute and long-term care settings.

We located one article reporting on the use of an innovative staff training programme of distance learning and coaching for motivating nursing home staff to adopt a best practice toileting programme [547]. This programme involved a series of webinars to nursing home supervisors and staff designed as nursing home champions in 10 states in the US. Although one-third of nursing homes dropped out prior to or soon after the training was initiated, the results supported distance learning and coaching as an effective method of staff training and dissemination of a best practice protocol. Participants' knowledge of incontinence care practices was significantly increased, and there was evidence for the implementation of the toileting programme. The majority of participants preferred this method of training over a traditional 1-2 day conference. Course delivery costs including per facility courses were substantially less than traditional methods of staff training [548]

Results

Interventions with Long-term Care Staff

A recent systematic review on the promotion and management of incontinence in older people in care homes concluded that use of incontinence pads and toileting programmes comprised the most common management strategies, and assessment processes were inconsistently used [528]. Assessment protocols are a key first step in the process of identifying residents' individual continence care needs. Several assessment tools have been developed for this purpose. They include, but are not limited to:

- The Resident Assessment Instrument/Minimum Data Set (RAI/MDS) used in US and other countries' nursing homes
- The 'Continence History, Assessment, Medications, Mobility, Plan' (CHAMMP tool, developed to support the use of the RAI/MDS [549].
- The 'Capital Health Authority (CHA) Screening Tool 'for use within community and clinical settings in Canada [550].
- The 'Continence Assessment Tools for Residential Aged Care' for use within Australian long-term care settings [551].

Toileting assistance programmes also play a central role in optimising continence for frail older adults in long term care settings. One study examined the effect of a scheduled toileting programme and addition of a mechanical lift for patient transfers on the incidence of nursing home staff injury, using a quasi-experimental design [552]. Regular toileting significantly increased, and there were no increase in staff injuries following the programme. Staff also noted less resident agitation. Another study investigating a

multifactorial programme that included toileting assessment in Japanese nursing home residents also reported improvements in residents' continence status. Managerial support was key to the success of the intervention, as was the involvement of a clinical leader on each unit to oversee the protocol [553].

While toileting programmes are effective in reducing incontinence rates when implemented [554], and in-service classes on UI may change staff knowledge and attitudes about UI, in-service classes alone do not improve resident toileting [347]. In one study, only 70% of toileting assists were completed after staff training [541].

In response to nursing staff's knowledge deficits, some researchers have developed and trialled education and awareness-raising strategies, designed to enhance knowledge that would subsequently lead to practice improvements, and in turn, enhance the quality of continence care in long-term care. For example, a number of countries have established post-graduate and continuing education courses that prepare nurses and physiotherapists to address the broad spectrum of continence issues. However, most of this research was conducted prior to 2010 [295, 297, 302, 304, 305, 311, 555], other than a study involving a distance learning with coaching strategy for nurses in long-term care settings [547, 548].

However, the association between improved knowledge and improved practice is not straightforward. Some researchers reported improvements in knowledge that did not translate into improvements in practice [295, 301, 304]. Cognisant of this dilemma, Henderson and Kashka [301], examined the association between knowledge, beliefs, attitudes, and practice about incontinence in US nurses from hospital, home health, and long-term care settings using a tool titled "the Urinary Incontinence Scales". Using a multiple regression analysis, they found that although participants' knowledge and beliefs were positively associated with their self-reported practice, attitude alone had a direct effect on self-rated practice, thus, highlighting the need for educational strategies that address the effective behaviours associated with caring for incontinent persons.

Given the longstanding challenges surrounding the uptake of evidence into practice, results from qualitative studies may be informative in identifying factors that are useful in the adoption of evidence-based practice, particularly in long-term care settings. In one study [556], managerial support was ranked as the most important factor, followed by sufficient resources to implement new learning; the learner's belief in the practicality of training; integration of the learning into ongoing practice; staff feeling valued; on-the-job reinforcement of learning; knowing change of practice is supported; seeing benefits of new approaches; and attitudes toward elderly people. Whilst all of the above mentioned resource factors are important to optimise evidence-based continence care practice, several researchers draw attention to

the need for theory to inform improvements in the quality of care [510, 557, 558]. However, models for translation of research into practice for long term care rely on the belief that usual care staff are able to implement better care if they know what to do and are properly motivated [559]. However, one of the key steps in the process of translating evidence-based knowledge into practice is to identify potential barriers to change.

Research literature on UI in homecare and nursing home settings identify extensive barriers to UI care [346, 372, 559, 560]. In the 5th ICI, barriers to implementing voiding programmes such as prompted voiding in nursing homes included: poor communication, inadequate staffing, staff work load, turnover, absenteeism, and lack of education programmes. Other barriers include the belief by nursing assistants that UI is a normal part of aging and that nothing could be done for it [372] or that use of incontinence pads protect and dignify residents [292]. A further challenge to UI care in long-term care was identified as the differences may exist between documented care, reported care, and actual care [77], and the need for ongoing monitoring.

Another approach to translating evidence-based protocols into practice in long-term care involves the use of quality management programmes. In an early study, Schnelle and colleagues [77] tested a computerised quality management programme for prompted voiding and found the programme was effective in improving dryness for six months while the research staff monitored the database, but only one facility continued the programme after the research ended.

The 5th ICI identified the need for changes at resource and policy levels to address the disincentive inherent with toileting assistance programmes that require significantly more staff time than the practice of checking and changing residents' pads [552] and for maintaining a resident's functional ability to walk to the toilet [520]. For example, in an analysis of the cost and time involved in changing nursing home residents' pads, compared with implementing prompted voiding, or a functional incidental training programme (FIT), researchers found that changing residents' pads averaged 5.5 minutes, compared to 7.7 minutes for prompted voiding, and 13.7 minutes for FIT [520]. Although FIT resulted in significantly better outcomes for residents in terms of their strength, mobility, and continence, it relied on a staff to resident ratio of one aide to five residents [559].

As reduced mobility is a major risk factor for incontinence, further attention should be directed toward developing, implementing, and evaluating interventions that can increase residents' functional skills, or at the very least, minimise their functional decline. Several studies have reported that frail elderly people participating in functional training programmes to improve mobility and toileting skills [75, 333, 521] are able to significantly reduce their UI.

Interventions for continence care in frail older adults should also minimise the incidence of incontinence-associated dermatitis (IAD). Palese and Carniel [427] described a three-phased multi-intervention incontinence care programme in a long-term care facility in Northern Italy that reduced the incidence of IAD, and the number and cost of absorbent products. The intervention consisted of an assessment process, the introduction of new absorbent continence aids, a structured skin care regimen, and advice and education from a Continence Nurse Advisor.

10.4. Interventions to manage night time incontinence in long term care.

Night-time sleep in long-term care residents is often fragmented and disrupted, and much of this sleep disruption is caused by noise, light, and incontinence care routines [561-564]. There is some evidence to suggest residents may spend long periods of time in bed overnight (returning to bed after dinner about 6:30 pm and waking between 0600-0700 hrs), and staff conduct pre-scheduled rounds to reposition residents and change their pads [565]. In one study, although senior staff stated that such rounds were conducted every two hours during the night; the number of observed rounds was 0.3-4.5 per resident [565].

Interventions that have been trialled in an attempt to enhance the quality and duration of sleep for residents with incontinence include:

- A daytime physical activity programme [566]
- A daytime physical activity programme combined with a night staff behaviour programme aimed at reducing noise, light, and sleep-disruptive care practices [566]
- A two to four hourly incontinence care schedule based on an individualised assessment of each resident's skin health [543]
- An individualised incontinence care routine combined with feedback to usual care staff about methods to reduce noise levels [567]
- A two or four hourly prompted voiding schedule based on an individualised assessment of each resident's skin health [568]
- A four or eight hourly pad changing regime based on an individualised assessment of each resident's skin health [569]

The combined findings of these trials along with a recent qualitative study of nursing staff in Australian residential care facilities [570] suggest that continence care at night in long-term care settings can, and should be individualised based on an assessment of residents' skin health; their ability to spontaneously move in bed; their sleep/wake status, and the frequency, severity, and type of the residents' incontinence. It should also be based on an assessment of residents' preferences. One of the main reasons for

residents' sleep disruption is due to the time-honoured practice of waking residents to check their continence status and reposition them in order to minimize the risk of pressure ulcers. In an early RCT, 81 older adults from UK residential homes were randomized to either a four or an eight hourly night time pad changing regime [569]. Investigators found no evidence that the less frequent changing regimen had an effect on skin erythema or on skin pH. However, residents on the less frequent pad changing regime had significantly wetter skin, and five residents developed grade 2 pressure ulcers. Advances in the design and absorbency of pads and of pressure relieving devices may mitigate the number of times residents' need such care. Whilst toileting assistance should be available to residents during the night as well as day, one study suggest that prompted voiding is not effective or well tolerated at night [568]. Further research to guide practice on residents' preferences for night-time continence care, as well as the frequency of night time pad changing regimes and their impact on skin health is needed.

10.5. Interventions with caregivers

Family caregivers of frail older persons with UI report a high level of physical and psychological exhaustion, burden, embarrassment, and social isolation [571, 572]. This is particularly so for family caregivers of individuals with UI and dementia, especially if the care recipients have challenging behaviours [573, 574]. We noted that toileting is a complex event, and as a task it is unaesthetic and unpleasant for caregivers and care recipients. Individuals with dementia have variable responses, with some retaining the ability to toilet appropriately, and in others, toileting can trigger a severe emotional response. Prior research indicates the need by caregivers for information on resources [571]. Some caregivers at home report that the requirements of implementing a behavioural protocol may be more than they could manage [573]. However, in contrast to long-term care staff, family caregivers have higher adherence rates with prompted voiding, and a higher proportion is either somewhat or completely satisfied with the decrease in UI [511].

There has been limited intervention research with family caregivers of frail older adults with UI. Few studies address the caregivers' needs for education and information on continence management, nor are outcome variables included related to caregiver burden and satisfaction. This represents an important gap in the evidence base for UI, and is an opportunity for future research.

Recommendations for practice

- Family caregivers or residential and/or nursing staff dealing with different levels of UI (mild, moderate, severe, catheter managed) have different educational needs and require different levels of support.
- Interventions to support family caregivers of individuals with UI may need to be adapted to suit

formal caregivers or staff in long-term care so that they accommodate the organisational context.

- An individualised approach is recommended to meet the needs and preferences of older people in long-term care.
- Interventions or approaches to caring for an individual with UI and cognitive impairment need to be tailored to the person's unique abilities and disabilities.
- Interventions for UI should be theory-based, multicomponent, interdisciplinary, and person-centred.

11. PHARMACOLOGICAL TREATMENT

11.1. Background

This section deals with the management of frail older persons. The pharmacological management of UI in robust older men and women is discussed in Chapter 8, Pharmacology. Specific treatments for bladder outlet obstruction and associated LUTS in frail elderly men are outside the scope of this chapter; special matters relevant to the care of frail older men with UI are discussed above. For frail older men and women in nursing homes, urinary incontinence and overactive bladder appears to be associated with an excess of concomitant co-morbid conditions compared to continent residents [575] thus frail persons with UI should undergo a comprehensive evaluation of remediable causative factors and, if practical, have had a trial of behavioural and lifestyle interventions prior to initiating pharmacological therapy. Drug treatment should not generally be used for persons who make no attempt to toilet when aided, become agitated with toileting, or are so functionally and cognitively impaired that there is no prospect of meaningful benefit. Even so, a recent study of US nursing home residents suggested that only a small proportion of incontinent residents potentially suitable for drug therapy ever received it [576, 577]. A more recent study identified the high prevalence of potential reasons why treatment with antimuscarinics might not be suitable [479].

11.2. Quality of data

Since the last ICI we located further randomised placebo controlled trials (RCTs) of medication, involving subjects over the age of 80. As before, the majority of studies addressing UI in frail older people are of only modest quality, reflecting their vintage. There have been two large prospective studies of older people, one in Europe and one in the US; the latter targeted at medically complex older people identified by the VES-13 [578]. A systematic review of pharmacological therapy in old and frail older persons as part of the formulation of the Swedish national guidelines has also been published [579]. There has also been a number of *post hoc* pooled analyses of patients over

65 years of age, and reports of sub-groups of patients ≥ 75 years of age taking part in registration studies of medications for overactive bladder. For most studies it remains impossible to identify whether included subjects might be defined as frail, even though the spread of co-morbid condition and co-existing medication suggests a representative sample of medically complex community dwelling older people, except where the study was performed in an institutional environment, in which it is reasonable to assume a high prevalence of functional and cognitive dependence.

The methods of blinding and randomisation in RCTs were seldom specified. Other than those conducted by the pharmaceutical industry, most studies were generally small and potentially under-powered, and others lost power because of high dropout rates due to illness and death (inevitable in trials with frail elderly persons). Because of these issues, many RCTs provide only Level 2 evidence. Some studies in older persons without clear frailty are included here, to recognise an increasing emphasis on including older persons in drug trials.

Precise descriptions of the target population - including the definition of "frail persons" and a comprehensive description of the degree of cognitive and functional impairment were usually absent. Some investigators included information on patients' comorbid conditions and concomitant medication load at baseline; these descriptions are largely descriptive, with no outcomes analyses based upon either factors. Explicit, concurrent behavioural therapy was used in most nursing home studies, yet may have occurred in many others although these are usually specifically prohibited in trials managed by the pharmaceutical industry. Combination therapy, coexistent medications and comorbidity could alter differences between drug and placebo, and therefore make it difficult to compare results directly with results from studies in robust older and younger persons. Outcomes in care home studies were universally assessed by disease related outcomes (largely incontinence episodes, measured by pad-weighing, bladder diaries, and wet-checks), and none report quality of life outcomes. In fact, there is a dearth of understanding about what might be a meaningful outcome measure of continence care to frail older nursing home residents.

In at least six studies, investigators treated subjects with "urinary tract infection" (usually defined as pyuria and bacteriuria in the presence of UI) before initiating antimuscarinic therapy, and one study excluded such subjects. In another, investigators treated urogenital atrophy with oestrogen prior to antimuscarinic therapy, possibly leading to an additional amelioration of symptoms. However, no other reversible or remediable causes were addressed prior to entry or randomisation in most studies.

The generally low quality of trials other than those conducted by the pharmaceutical industry reflect not just study design, but the larger issue of the difficulty of doing large, prospective intervention trials in frail

populations. Moreover, UI in the frail older person is universally a multifactorial problem involving a large number of factors beyond the bladder. Thus, the expectation that drug therapy targeted solely at underlying OAB, DO or SUI would markedly improve/cure UI in this population is unlikely to be realised.

Additionally, the reporting of adverse events relevant to managing frail older people is deficient with a concentration on those which might matter only recently being reported. A meta-analysis examining the measurement and reporting of CNS outcomes showed that, 77% (242/314) of eligible trials identified neither measured nor reported CNS outcomes. Of the remaining 23%, it was difficult to ascertain whether CNS adverse events were systematically measured or spontaneously reported. Only one of 72 trials objectively measured changes in cognitive performance. Age-stratified analyses of CNS outcomes from trials in adults aged 65 and older with overactive bladder were found in only eight publications [580].

Results

Results from randomised trials are summarised in Table 8; the following sections discuss specific drugs in detail.

1. Oxybutynin

The majority of older studies in frail older persons used immediate-release oxybutynin (oxybutynin-IR). There are three studies of extended release oxybutynin (oxybutynin-ER), one examining cognitive effects in nursing home residents with dementia and urgency UI, [581] the other reporting on the effect in cognitively impaired nursing home residents [582] and the last involving community-dwelling women over age 65 [583]. Published trials of the efficacy of transdermal oxybutynin included subjects up to age 100 and in institutional care settings, but did not stratify results by age or comorbidity [584]. Due to concern regarding the association between anticholinergic drugs and cognition (see above) a number of articles [585, 586], national [52] and European guidelines [486] have counselled against the use of oxybutynin immediate release in frail older adults. Since the last consultation, oxybutynin gel has been introduced and its effect on cognitive function in healthy older people assessed [587] in addition to phase 3 trials of the preparation [588], which reported no data from older patients. A small study of 10 US veterans (6 with Mild Cognitive Impairment) with OAB treated with antimuscarinics aged between 60 – 85 years reported significant improvement in at least one subtest score on well-characterised instruments after 4 weeks of withdrawal from medication [589].

The pharmacokinetics of oxybutynin-IR and its active metabolite, N-desethyloxybutynin, in one study tended to show greater plasma levels and bioavailability with increasing frailty and age [590]. Another found peak levels in 21 octogenarians similar to those reported in young normal males (12.5 ng/mL vs. 8.9 ng/mL) [591]. A study of the pharmacokinetics of

transdermal oxybutynin showed no significant difference in plasma levels between young and old (up to 77 years) subjects [592].

Efficacy: Many of the early trials shown here are, perhaps now, only of historical interest. However, there have been few additional studies of newer agents in frail older persons from which to draw data. An early, small (n=15) trial of oxybutynin-IR and habit training in nursing home residents showed no effect on UI episodes [593]. However, in a subsequent and larger study in nursing home residents who had failed prompted voiding alone, the addition of titrated oxybutynin IR resulted in a significant but modest reduction versus placebo [594]. Wet-checks decreased from 27% at baseline to 20% on drug and 24% on placebo, leading the authors to conclude that the improvement was not clinically significant especially given the continuing requirement for nursing intervention. However, their a priori definition of “clinically significant improvement” (one or fewer episodes of daytime UI was achieved by 40% on drug but only 18% on placebo ($p<0.05$)). The dose generally associated with improvement was 2.5 mg three times daily. In another controlled study of UI in long-term care residents (n=24), there was little effect of oxybutynin-IR 5 mg twice daily given for 8 days, but all residents were toileted 10 times daily, and the dose may have been too high and given too infrequently [595]. In a randomised two-month trial in frail community-dwelling elderly, oxybutynin-IR plus bladder training was subjectively and objectively superior to bladder training alone in improving urinary frequency (95% CI 6-27 fewer voids per 2 weeks) but not UI [596]. Insufficient information was available regarding a Japanese study in 75 “elderly” patients to assess the population and outcomes [597]. A study in 416 community dwelling older persons, including the robust elderly, found 68% reported a partial or complete symptomatic cure with 2.5 mg three times daily; 30% of subjects experienced ADEs, but only 10% withdrew because of them [433].

Two identified RCTs in frailer older people examined the efficacy of oxybutynin-ER [582, 583] The other examined the effect on cognition [581] and is discussed below. No published RCTs of transdermal oxybutynin in the frail elderly were found, a post hoc

Table 8. evaluable drug trials in frail older persons

Drug	Study	Design	Setting and pts	Results	Comments
Oxybutynin	Minassian 2007[583]	prospective randomized 12-week, open-label study to investigate the effectiveness of extended release versus immediate release oxybutynin	community-dwelling female population over the age of 65	72 women (23%) were enrolled over 34 months (33 in the immediate release group, and 39 in the extended release group). The study was stopped prematurely	
	Sand 2007[584]	randomized, open-label, assessing health-related quality-of-life (HRQoL) and safety with oxybutynin transdermal system (OXY- TDS)	community-based study of 2878 participants aged ≥ 18 years who had been given a diagnosis of OAB.	There were clinically meaningful and statistically significant improvements in nine of 10 domains in KHQ at the study end; the greatest improvements were in Incontinence Impact (-13.5), Symptom Severity (-12.4), and Role Limitations (-13.3).	No age stratification, not obviously a frail element to the study sample
	Lackner 2011[582]	efficacy of oral extended-release oxybutynin for urge urinary incontinence	4 week trial in 50 older female nursing home residents with mild to severe cognitive impairment.	both groups achieved a significant median decrease in mean urinary incontinence episodes and urinary frequency at 4 weeks ($P = .01-.05$). Staff ratings found that more participants had improvement in urinary symptoms from baseline with oxybutynin than placebo but significant only for delaying evening voiding ($P = .02$).	No between group differences in any outcome
Solifenacin	Herschorn 2011[452]	randomised, multicentre, prospective, double-blind, double-dummy study to compare the incidence and severity of dry mouth and other adverse events in patients <65 years and >65	132 subjects with >1 urgency episode per 24 h, with or without urgency incontinence, and >8 micturitions per 24 h for 3 months.	incidence and severity of dry mouth and other adverse events with solifenacin were similar between younger and older patients. solifenacin 5 mg/day was associated with fewer episodes and lower severity of dry mouth, and a lower discontinuation rate	adverse events were evaluated in subgroups of patients <65 years and >65 years. No stratification otherwise
Drug	Study	Design	Setting and pts	Results	Comments

Drug	Study	Design	Setting and pts	Results	Comments
Darifenacin	Chapple 2007[598]	RCT assessing efficacy, tolerability, safety and quality of life in 400 subjects mean age 72 years	randomized (2:1) to 12 weeks of double-blind treatment with darifenacin 7.5 mg once daily for 2 weeks, then optional titration to 15 mg daily or placebo with sham titration	Mean urgency urinary incontinence episodes decreased significantly with both darifenacin (-88.6%) and placebo (-77.9%; $p > 0.05$), QoL assessments revealed significant improvements with darifenacin versus placebo	Unsure re "frailty" of sample
Fesoterodine	Wagg 2013 [454]	RCT, efficacy and PRO comparing fesoterodine to placebo	794 community dwelling men and women >65 (1/3 >75)	improvement in urgency episodes (-1.92 v -3.47, $p<0.001$), micturitions (-0.93 v -1.91, $p<0.001$), nocturnal micturition (-0.27 v -0.51, $p=0.003$), severe urgency episodes (-1.55, -2.40, $p<0.001$), and incontinence pad use The response on the treatment benefit scale, OAB-S, PPBC, and UPS significantly greater in fesoterodine group	Community dwelling sample, including very elderly, no assessment of frailty, largely cognitively intact
	DuBeau 2013 [458]	12 week double blind, placebo controlled study	562 people of mean age 75 years fulfilling definition of vulnerable elderly	mean reductions in UUI episodes at week 12 versus placebo -0.65 (0.21), $p<0.0018$ and 24h micturition frequency -0.84 (0.23), $p<0.0003$	
	Dell'Atti 2015 [599]	12 weeks prospective randomised study (open label)	108 consecutive patients diagnosed with OAB 56 patients treated with tadalafil 5 mg once daily 52 patients treated with fesoterodine 8 mg once daily	OABSS baseline 9.87 ± 2.68 12/52 6.02 ± 3.59 <0.204 Micturition/24hours baseline 11.92 ± 4.68 12/52 10.82 ± 3.86 <0.001 Urgency episodes/24hours baseline 4.53 ± 0.91 12/52 3.54 ± 1.23 <0.003 Urge incontinence baseline $.73 \pm 1.32$ 12/52 1.02 ± 1.37 <0.001	Older sample, some mention of comorbidities, unable to assess frailty

Drug	Study	Design	Setting and pts	Results	Comments
Trospium chloride	Sand 2011 [600]	Pooled analysis of all pts >75y in 2 12 week RCT and open label follow-up of 1 year	143 subjects (85 trospium ER 58 placebo; mean age 79 years and ranging up to 90 years; 73% female)	Change in mean number of weekly urgency incontinence episodes: -22.17 (69.9% reduction)	

sub-analysis of efficacy in subjects over the age of 65 and improvement in quality of life has been published, but unobtainable [598, 599]. In a small Japanese case series (n=13, mean age 75) in persons with urgency UI and cystometric DO, intravesical oxybutynin caused no significant increase in mean bladder capacity one hour after installation of 5 mg oxybutynin at pH 5.85 [600]. In four patients who continued twice daily installation, two had UI “disappear” and one “markedly decrease” (duration until effect not noted). No patient developed an “increased PVR” (not defined). A study examining the effect of an oxybutynin vaginal ring included some older women (mean age 57.1, ranging up to 85) but results for older women were not reported separately. The vaginal ring statistically significantly reduced mean urgency incontinence episode frequency and urinary frequency, but not urinary frequency. The most commonly reported treatment emergent adverse events were UTI, vaginal discharge and dry mouth [601].

Predictors of efficacy: Predictors of efficacy were examined in one study in persons with urgency UI and urodynamic DO (n=41, mean age 79) treated with 2-4 weeks of oxybutynin-IR (5-15 mg/day) [602]. Factors associated with baseline urine loss (by pad weighing) were impaired cognitive orientation (on the Cambridge Mental Disorders of the Elderly Examination), number of daily voids, and fluid intake. Persistent urine loss after treatment was associated with impaired orientation, reduced sensation of bladder filling during cystometry, and most significantly global cortical under-perfusion on single photon emission computed tomography scan, suggesting that cortical factors are the main determinant of the severity of urgency UI before and after oxybutynin. In a study of 80 older patients (mean age 74), patients with dementia (by Hasegawa dementia scale) were less likely than cognitively intact patients to report subjective improvement in UI with antimuscarinic agents, despite similar objective outcomes [603]. However, these results could reflect treatment-associated cognitive effects.

Adverse reactions: A comparative sub-analysis of oxybutynin IR versus solifenacin in subjects below or above 65 years of age (mean 71 years in >65 year age group) showed subjects receiving oxybutynin IR at a fixed dose of 15mg/day were over eight times more likely to have dry mouth than were the solifenacin treated subjects [452]. In a study which included patients up to the age of 91, but with mean age 61 (SD 12.4) years showed oxybutynin to be non inferior to trospium in terms of resolution of UI episodes, but was associated with twice the incidence of dry mouth (7.7% versus 4.1%) [604].

Cognitive side effects from oxybutynin have been reported in older persons. In one case series, four older men with Parkinson’s disease and mild-severe cognitive impairment developed confusion, psychosis, hallucinations, behavioural disturbance, and/or paranoia after receiving oxybutynin-IR (5-15mg/day), which resolved when oxybutynin was stopped [605]. Of note,

each patient was also on L-dopa (co-beneldopa) and selegiline, and the observed effects could reflect drug-drug interactions. However, these results are belied by a large RCT in which oxybutynin-ER 5 mg daily did not cause more delirium than placebo in NH residents with UI and dementia [581]. Other concerns regarding cognitive function are discussed above.

There are case reports of reversible peripheral neuropathy confirmed by re-exposure in a 70 year old woman taking oxybutynin-IR 5-7.5 mg/day [606] and recurrent heat stroke associated with oxybutynin in one elderly patient [607]. Few studies have addressed cardiac effects. A small study of community dwelling older persons with UI (n=20, mean age 75) found no change in resting heart rate or electrocardiographic evidence of either prolonged PR interval or QTc, or QTc dispersion after 4 weeks of oxybutynin-IR (mean daily dose 7.6 mg [range 2.5-10 mg]) [608]. Using a large administrative database, no association was found between antimuscarinics (oxybutynin, flavoxate, hyoscyamine) and ventricular arrhythmia and sudden death [609]. Post-marketing adverse events with extended release oxybutynin include tachycardia and hallucinations.

2. Tolterodine

Efficacy: Since the last ICI, we identified no further studies of tolterodine for OAB/ DO in frail older persons but tolterodine has increasingly been used as a comparator agent in studies of newer agents in registration trials. Analysis of the studies of tolterodine in “older patients”, however, does not allow any conclusion to be drawn about the frailty status of any older patient. For example, “older” patients in one RCT of tolterodine-ER were all community-dwelling, able to complete a 7-day bladder diary, had a high prevalence of previous antimuscarinic treatment (53-57%), and a low prevalence of arthritis (15-18%), unlike most frail older persons [610]. Although several trials include elderly persons in their ninth and tenth decades, [610-612] the mean age (approximately 64 years) was much lower, persons with “unspecified disease which the investigator thought made the patient unsuitable” and/or “renal disease” were excluded, and results were not stratified by age. In a secondary analysis of a large, open label German trial of tolterodine- IR 2 mg twice daily, higher age was significantly associated with “less favourable efficacy” [613]. However, the absolute difference in odds was only 0.019. There was no association of tolerability with age, only mean age is described, and UI frequency was based on patient report, not bladder diaries, all of which fail to add up to a clinically meaningful difference. In a non-randomised study, tolterodine was given to 48 nursing home residents who did not respond to toileting alone; 31 of these patients had a 29% increase in dryness (versus 16% in residents on toileting alone) [614]. A recent moderate quality short term (1 month) trial of tolterodine (2mg bid) and oxybutynin (5mg tid) in 100 older Iranian women, mean (SD) age 53(12) years with detrusor overactivity showed efficacy in disease related variables with both

drugs – there was no indication of comorbid conditions allowing any conclusion regarding frailty status. Withdrawals, the majority due to dry mouth, occurred in 6% of the oxybutynin and 8% of the tolterodine group [615].

There has been some reporting of trials including older men with BPH/BPE. A trial of 1-year duration of the addition of tolterodine ER 4mg to alpha blocker or 5 ARA therapy in older men (mean age 74.9 years) resulted in a between group, statistically significant decrease in the storage symptom score on the IPSS [616]. A newer trial involving men of mean (SD) age 61 (9.1) comparing tolterodine with either doxazosin or tamsulosin in a 12-week study showed Q_{max} , IPSS, QoL, intravesical pressure (Pves), and bladder compliance (BC) in the doxazosin plus tolterodine group were all significantly better than in the tamsulosin plus tolterodine group ($P=0.03$, $P<0.001$, $P<0.001$, $P=0.027$, and $P=0.044$, respectively). The prevalence of orthostatic hypotension was not reported other than in a general category “headache and dizziness” [617]. A recent review confirmed the greater chance of orthostasis with doxazosin, suggesting its use in older men who are more prone to the effect, be restricted [618]. This is also in concordance with the recent LUTS-FORTA guidance [485], above.

Adverse reactions: There are no prospective systematic data on tolerability in frail older patients. There have been case reports of hallucinations (73 year old woman with dementia [619]) and worsening memory,[620] including a 65 year old cognitively intact woman [621] There is a case report of delirium when tolterodine was given with a cholinesterase inhibitor [622]. Analysis of prescription event monitoring in the UK (mean patient age 63) found a significant association between age (>74 years) and psychiatric events and tachycardia (odds ratios not given) [623]. In a similar database study, the age- and sex-adjusted risk of hallucinations with tolterodine was 4.85 (95% CI 2.72-8.66) compared with 10 other drugs (acarbose, alendronate, famotidine, 3 proton pump inhibitors, finasteride, meloxicam, misoprostol, and nizatidine) chosen for presumed lack of antimuscarinic, cardiovascular, and CNS activity, and available in the database. Important confounders such as other drugs and comorbidity were not evaluated. Similar to oxybutynin-ER, post-marketing information on tachycardia and hallucinations was added to the tolterodine-ER package insert in 2003.

3. Fesoterodine

Efficacy: There are four studies of age related pharmacokinetics in younger versus older subjects (although not frail), a pooled analysis demonstrating efficacy of fesoterodine in subjects over the age of 65, stratified into >65 and >75 year age groups from all prospective registration studies and from 2 only a large prospective study which reported the efficacy of fesoterodine in subjects stratified by age (>65 and >75) years of age and a prospective study in the medically complex or vulnerable elderly [453, 624, 625].

The pharmacokinetic study found no clinically meaningful effect of 5-HMT, the active metabolite of fesoterodine pharmacokinetics or pharmacodynamics after single dose administration of fesoterodine 8 mg. The efficacy of fesoterodine has also been studied in a European trial in 794 elderly men and women with OAB [454], 47% of whom were men. Forty-six percent of subjects reported urgency incontinence episodes at baseline, and 64% had prior treatment with antimuscarinics. At week 12, the improvement from baseline in urgency episodes (-1.92 v -3.47, $p<0.001$), micturitions (-0.93 v -1.91, $p<0.001$), nocturnal micturition (-0.27 v -0.51, $p=0.003$), severe urgency episodes (-1.55, -2.40, $p<0.001$), and incontinence pad use were statistically significantly greater with fesoterodine (pooled 4 and 8mg) than with placebo. The responses on the treatment benefit scales, OAB-S, PPBC, and UPS were also significantly greater in those in the fesoterodine group versus placebo. The results of the open label extension study [626] confirmed the efficacy and tolerability of active drug over a further 12 weeks. A subcut analysis from participants in the study investigated factors associated with dose escalation and identified at baseline, body mass index (OR: 1.06, 95% CI 1.01, 1.12; $P=0.0222$), and male sex (OR: 2.06, 95% CI 1.28, 3.32; $P=0.0028$) and at week 4, change from baseline in urgency episodes (OR: 1.12, 95% CI 1.05, 1.20; $P=0.0008$), patient perception of bladder control (PPBC) (OR: 1.44, 95% CI 1.12, 1.84; $P=0.004$) as significantly affecting the likelihood of dose escalation at week four [627]. The effect of fesoterodine has also been assessed in vulnerable older people as assessed by the Vulnerable Elders Survey [578], which identifies those at risk of death in the following two years. This 12 week double blind, placebo controlled study including 562 people of mean age 75 years resulted in mean reductions in UII episodes at week 12 versus placebo (-0.65 (0.21), $p<0.0018$) and 24h micturition frequency (-0.84 (0.23), $p<0.0003$) [458]. Fesoterodine 8mg has been compared to tadalafil 5mg in a small study evaluating efficacy on OAB symptoms, impact on quality of life and sexual function in older patients. All men were over 65 years of age and 65% of them were over 75 years of age. The most common comorbidities were hypertension 37.8% (39/103), diabetes mellitus 18.4% (19/103), heart disease 16.5% (17/103) and depression 10.6% (11/103). Fesoterodine was effective in treating OAB symptoms in this group of multimorbid older men, whilst tadalafil showed superior efficacy in improving total IPSS and sexual function scores [628].

Adverse effects: The cognitive safety of fesoterodine has been assessed in a single small study of cognitively intact older subjects, using alprazolam as an active control and placebo. There were no statistically significant changes in performance on a computer assisted battery of cognitive tests versus placebo [629].

4. Solifenacin

Efficacy: Solifenacin has been used in combination with mirabegron in a Japanese post marketing study involving patients of approximate mean age of 65 with no description of sample comorbidity or results stratified by age [630]. Otherwise, two studies in older men and women of solifenacin in addition to mirabegron and solifenacin in addition to trospium have been conducted by the same group [631, 632]. The mean (SD) ages of included older people in the solifenacin and mirabegron study was 71.2 and all patients had urodynamically diagnosed detrusor overactivity. No mention was either made of comorbidity or frailty. The included patients in the solifenacin and trospium study had an average age of 69.4 years; once again, no description of comorbid disease or frailty status was given. A sub-cut analysis from a Canadian study which reported tolerability of solifenacin versus oxybutynin in older subjects, reported above [452]. Solifenacin has been compared to imidafenacin in a 1-year open label randomised trial the treatment of The pharmacokinetics of solifenacin in older adults have been assessed in 23 older subjects (mean age 68); t_{max} was longer and there was a higher maximum plasma concentration, but the differences from results in younger patients were small and deemed by the authors to be clinically irrelevant [633]. A secondary analysis of pooled Phase III data in patients aged 65 and older (all community dwelling and fit, mean age 72) found similar efficacy to that reported for younger and middle aged persons [634]. However, direct comparison with subjects < 65 yrs from the same pooled trials was not done. Adverse effects in older frailer patients have not been specifically reported. However, data from an open-label, 12-week trial in patients treated by community urologists found that overall treatment-emergent adverse events were more likely in patients aged >80 years (OR 3.9 [95% CI 1.3-11.5]) and taking concomitant medications (OR 1.8 [95% CI 1.2-2.6]) [635]. Patients with concurrent medications were more likely to be male and on average about 12-14 years older, have comorbid disease, and be administered higher doses of solifenacin, yet had no observed increase in heart rate or blood pressure with solifenacin.

Adverse effects: The cognitive safety of a single dose of 10mg solifenacin was tested versus placebo and 10mg oxybutynin IR in an exploratory study in 12 cognitively intact older subjects. Solifenacin showed no evidence of impaired cognition or self-ratings of mood and alertness versus placebo [636]. In a 3-way crossover design, chronic dosing of 5mg solifenacin, placebo and 5mg bid of oxybutynin were compared using a similar battery of tests in 23 older subjects with mild cognitive impairment. There was no statistically significant effect on cognition of solifenacin versus placebo. Oxybutynin 5mg bid was associated with impairment in power and speed of attention in a *post hoc* analysis of pooled data at 1+2h post dose [637].

5. Darifenacin

Efficacy: There is one RCT of darifenacin for OAB in persons aged ≥ 65 (mean 72), in which there was no statistically significant difference between drug and placebo for the primary end point, UI frequency [638]. There were statistically significant improvements with exposure to drug for urinary frequency (-25.3% vs. -18.5% with placebo; $p < 0.01$) and quality of life, as measured by OAB-q and patient perception of bladder condition. There is also a 2- year extension study in subjects >65, showing maintenance of OAB symptom improvement over the 2-years with 44.4% patients achieving \geq or = 90% reduction in incontinence episodes at 2 years for the 64% (137/214) subjects remaining in the study [639]. Both studies likely recruited robust community dwelling elderly, the extent to which these individuals had multimorbidity was not reported. A study of time to effect of darifenacin conducted using data from 1,059 patients (19-88 years, 85% women) randomised to darifenacin 7.5 or 15 mg once daily or matched placebo in three double-blind 12-week studies, but with no age stratified results showed that, using electronic diary data, darifenacin achieved statistically significant improvements in all OAB symptoms (except nocturnal micturitions) for both darifenacin doses versus placebo at week 2, with further improvements over 6 and 12 weeks [640].

Adverse effects: The cognitive effects of darifenacin have been prospectively studied in a series of trials; there have been no further studies since the last consultation. The first was a 3-period cross-over RCT in 129 older subjects (mean age 71, 54% of those screened), 88% of whom had co-morbid medical conditions and 93% were on other medications [641]. Cognition was assessed using a standardised computer test battery. Darifenacin at 7.5 and 15mg doses did not adversely affect cognition compared to placebo, but results were aggregated so that patients did not serve as their own controls. A subsequent study in cognitively intact older persons ($n = 49$, mean age 66) using a similar computer cognitive test battery compared titrated darifenacin and oxybutynin-ER with placebo over a period of 3 weeks [642]. Oxybutynin-ER but not darifenacin or placebo adversely affected the primary endpoint, delayed recall on the Name-Face Association test. However, oxybutynin was titrated one week earlier than darifenacin, and to a final dose (20 mg daily) much higher than that most commonly used in clinical practice. Also, there were no differences between the two drugs and placebo for many other domains of the cognitive battery.

6. Trospium chloride

Efficacy: Although often promoted for use in the elderly because of the reduced likelihood that the drug crosses the blood-brain barrier, there have been only two studies which has evaluated the agent specifically in older persons, and none in the frail elderly. The study by Kosilov is discussed above [632], and is of moderate quality. The other [643] was a subgroup analysis of pooled data for subjects aged ≥ 75 years

from two randomised, double-blind, multicentre studies of subjects with OAB receiving once-daily trospium 60 mg extended release (ER) or placebo for 12 weeks, followed by 9-month open-label extension periods during which all subjects received trospium ER.

143 (85 trospium ER, 58 placebo; mean age 79 years and ranging up to 90 years; 73% female) were assessed. At week 12 of the double-blind period, trospium ER produced greater improvements from baseline than placebo in voiding diary variables, global assessment, and quality of life indices. Efficacy and tolerability persisted among subjects receiving open-label trospium ER for up to 1 year. Although not assessing frail older persons, the other trial of interest, using all patients from the same studies examined the safety and efficacy outcomes with trospium chloride 60 mg in patients with OAB who were taking 7 or more concomitant medications at baseline. Of all 1135 included patients, 427 were taking seven or more medications (placebo, n = 199; trospium XR, n = 228). Amongst these, there was no significant difference between trospium chloride XR and placebo in the proportion of subjects experiencing one or more TEAEs (64.5% vs 58.3%). The odds of experiencing a TEAE were influenced by concomitant medication use, but not by randomisation to either trospium or placebo. For those taking ≥ 7 concomitant medications, compared to those taking 1-2 concomitant medications, the adjusted odds ratio (OR) for experiencing any TEAE was 3.39 (95% CI 2.39, 4.80) [644].

Adverse effects: The effect of 60mg trospium chloride once daily over 10 days on either learning or memory was assessed in 12 cognitively intact older people (>65 – 75 years). There was no change in standardised testing. Additionally, no trospium was detectable in the CSF of the subjects at day 10 [645, 646]. The pooled analysis of trospium, above noted a 10% occurrence of both dry mouth and constipation associated with trospium exposure [643]. As part of a larger study of trospium chloride 20mg bid, 36 (26 completed). Subjects with UUI and dementia, treated with galantamine and trospium) were examined. Subjects with severe dementia were excluded in this non-randomised, open label study. There was no observable decrement in either cognition, but only measured by MMSE, or ability in terms of activities of daily living in the dually treated group [481].

7. Propiverine

Efficacy: In 46 patients with dementia (mean age 81), there was a 40% decrease in urgency UI with propiverine 20 mg/day for 2 weeks, [647] similar to two small Japanese trials [648, 649] and a German trial in 98 patients [650]. The agent's high protein binding, extensive first pass metabolism, 15-hour half life (in normal younger persons), and renal clearance [647] need to be considered if used in frail older people; this is borne out by the LUTS-FORTA classification for the drug [485].

8. Imidafenacin

There have been no pharmacokinetic studies of imidafenacin in older people [651]. However, a population pharmacokinetic analysis demonstrated that oral clearance was decreased with advancing age, increasing hepatic function parameters (AST and ALP), food intake, and itraconazole co administration [652]. The absorption rate constant was decreased with food intake [653]. The drug is metabolised by the CYP3A4 system, and it is affected by drugs which inhibit this system [651]. There appears to be no effect on digoxin pharmacokinetics in healthy volunteers [654]. There are no trial data on older patients using this agent.

9. Duloxetine

There was a statistically significant reduced rate of clearance of duloxetine in patients over age 65, based on a study in 12 fit women aged 65-77 [655]. The authors felt the differences were not clinically significant given the "similar safety profile of the drug in older and younger women. In three large RCTs in women with SUI, aged 24-83 years, n = 494 [none frail] [656] with OAB, aged 21-84 years [none frail], n = 306 [657]; and with mixed UI, up to age 85 [658], duloxetine decreased UI and urinary frequency, but none stratified outcomes or adverse effects by age. A single randomised controlled study of 265 community dwelling older women, 134 treated with duloxetine, of whom 20% had mild cognitive impairment as classified by the modified mini- mental state exam [636], duloxetine treatment led to a statistically significant decrease in incontinence episode frequency (median percent change 51.6%) versus placebo (32.1%) for stress predominant mixed symptoms, but did not reach significance for stress urinary incontinence (53% v 42%) [659]. Duloxetine is neither approved by the US FDA nor recommended by the UK National Institute of Healthcare and Clinical Excellence on the grounds of cost effectiveness.

10. Mirabegron

Efficacy: There are data on the comparative pharmacokinetics of mirabegron in older people, but not specifically the frail elderly. In available studies, there were no statistically significant differences in mirabegron exposure between older volunteers aged 55 years and above and younger volunteers (18-45 years). Similar results were obtained for those aged 65 years and above. AUC was predicted to be 11% higher in a subject aged 90 years of age [660]. A pooled analysis examining the short term efficacy and longer term safety of mirabegron from patients >65 and >75 years of age included in the registration trials demonstrated a reduction in mean numbers of incontinence episodes and micturitions/24 h from baseline to final visit in patients aged ≥ 65 and ≥ 75 years. The drug was well tolerated: in both age groups. Hypertension and urinary tract infection were among the most common TEAEs over 12 weeks and 1 year. As might be expected, the incidence of dry mouth, a typical anticholinergic TEAE, was up to sixfold higher among the older patients randomised to tolterodine

than any dose of mirabegron [470]. A recent non randomised, open label study examining the effectiveness and safety of solifenacin (10mg) and mirabegron (50mg) in combination versus the single drugs over 6 weeks in 143 women and 95 men over 65 (average age: 71.2) reported a statistically significant additional effect of dual therapy versus monotherapy in terms of a reduction in incontinence episodes [631]. In an open label single centre study involving 60 patients with a mean age of 72.3 years (50-86 years) using urodynamic variables and the overactive bladder symptom score to assess efficacy. Mirabegron, 50 mg once daily over 12 weeks was associated with a reduction in mean OAB symptom score (9.4 to 6.2 points ($P < .001$)), a statistically significant increase in volume at first desire to void and maximum cystometric capacity and an absence in detrusor overactivity in 14 of 35 patients compared with that at baseline ($P < .01$). There was no change in observed voiding function variables. There was neither age stratified reporting of results nor any indication of the frailty status of older persons in this study [661].

11. oestrogen

There have been no additional studies of oestrogen in older women. Oral oestril 3 mg/day has been compared to placebo for 12 weeks in 34 women aged 75 [131]. The group was highly self-selected; complete results were available for 11 with SUI, 12 with urgency UI, and 8 with mixed. Two-thirds of urgency UI and 75% of mixed UI patients reported improvement; there was no effect on SUI. Four patients reported metrorrhagia and mastodynia. A 10 week crossover trial comparing quinoestradiol 0.25 mg four times a day compared with placebo in 18 women in long-term care (type of UI not reported) found a mean 12% decrease in UI episodes vs 22% increase with placebo [662]. The combination of conjugated oestrogen 0.625 mg/day and progesterone 2.5 mg/day was evaluated in a 6 month, placebo- controlled trial in 32 female NH residents with pre- dominantly urgency UI, who also received prompted voiding as a behavioural intervention [663]. In the 21 women who finished the trial, there was no difference in wet checks between drug and placebo despite increased serum oestrogen levels and partial oestrogen effect on vaginal cytology and pH in the women on drug. Two women on the drug developed vaginal spotting, and 10% developed breast tenderness. A similar lack of efficacy despite vaginal changes was found in a case series of 9 frail women (mean age 83) with urgency or mixed UI using an oestrogen-implanted vaginal ring (Estring®) [664].

12. Miscellaneous medications

Readers interested in agents which are seldom used in clinical practice should refer to the 4th International Consultation on Incontinence for data relevant to frail older people for information on:

Emepromium bromide, Flavoxate Propantheline, Imipramine, Flurbiprofen, Procaine haematoporphyrin.

13. Comparative trials

We found no studies that compared antimuscarinic agents in frail older persons. Other comparative studies in community dwelling elderly, where relevant, are mentioned above.

Pharmacological therapy in cognitively impaired persons

The Committee felt that the treatment of older persons with a dementia diagnosis was an important area to consider, particularly where patients are both physically and cognitively frail, cognitively impaired or at risk of cognitive impairment. This section considers drug treatment in those with a dementia diagnosis. Some of the evidence introduced above is recapitulated here.

There is a dearth of systematically collected data upon which to base any firm recommendation for the drug management of incontinence in persons with a dementia diagnosis. There are data from nursing home residents [50, 480, 582, 593, 594], some of whom would have a dementia diagnosis, most likely in increasing proportions in the newer studies, but there are no reports which stratify results by the presence or absence of this diagnosis. Ouslander *et al*, in 1995, reported that the addition of oxybutynin to a prompted voiding programme conferred no additional benefit to the treatment of incontinence in nursing home residents, there was no reduction in overall labour involved in continence care but there was a statistically significant difference, in favour of oxybutynin over placebo, in the proportion of residents achieving their continence criterion of one or fewer incontinent episode per day [594]. The dementias, and Alzheimer's disease in particular, are characterised by a central cholinergic deficit. The loss of cholinergic function in the central nervous system contributes significantly to the cognitive decline associated with advanced age and Alzheimer's dementia [665]. The administration of anticholinergic agents to cognitively intact individuals can lead to similar changes in cognition to those seen in persons with dementia [666]. Likewise, there are epidemiological data linking exposure to anticholinergic agents to cognitive impairment and an increase in incident diagnosis of dementia over the longer term [66, 67, 460, 667-669]. There are though conflicting data on the cognitive effects of anticholinergic agents in those with established Alzheimer's disease, no effect reported over eighteen months in a single study, and in a small case series, adverse effects in some cognitive domains associated with medications for continence which reversed on cessation of the drug [68, 670].

1. Bladder antimuscarinics and cognition

In general, the rates of Central Nervous System side effects reported in clinical trials of bladder antimuscarinics are low, and reports from clinical practice also suggest that they are rare [580, 671]. However, there have been case reports of associated acute cognitive impairment in both cognitively impaired and cognitively intact patients, these effects have been reversible on cessation of the antimuscarinic agent [605,

619, 621, 672]. The specific effects of bladder antimuscarinics on cognition have been assessed in short term, small to medium sized studies in cognitively intact older people and one in those with mild cognitive impairment, but never in those with pre-existing dementia. Trials have used either oxybutynin, diphenhydramine or alprazolam as an active control. Outcome measures have largely been based upon a battery of computer assisted cognitive tests, with the exception of a single study using simulated driving ability [673] and a study using alterations in encephalographic activity as a surrogate measure [674]. The specific trials are mentioned above.

There have also been studies assessing the effects of antimuscarinics on sleep quality, showing an adverse effect of oxybutynin on sleep, with no discernible effect compared to placebo in young, healthy volunteers [675]. In those over the age of 50 years of age, a reduction in sleep quality was found with oxybutynin and tolterodine, reported as clinically insignificant, compared to placebo. No alteration versus placebo was found for trospium chloride [676]. When tolterodine metaboliser state was taken into account, intermediate and poor metabolisers had a significant reduction in REM sleep [677].

2. Bladder antimuscarinics and delirium

A cohort study in 147 hospitalised older patients which examined the association of anticholinergics and delirium found no increased likelihood of developing delirium in those with either possible (OR 0.33 (95%CI 0.1 – 1.03)) or definite anticholinergic medications (OR 0.43 (95% CI = 0.11-1.63)) [678]. There is a single case report of delirium related to solifenacin treatment which resolved following a switch to darifenacin [679] and 2 reports of hallucinations associated with tolterodine treatment, both in cognitively intact patients [619, 680]. These events seem rare given the frequency of use of these medications but do reflect that they should be used with care, particularly in those who might be considered cognitively at risk. As a class, drugs with anticholinergic properties can precipitate delirium in older people, particularly when the anticholinergic load is changed [681].

3. Cholinesterase inhibitors and bladder antimuscarinics

There is evidence cholinesterase inhibitors can cause or worsen UI from a case report and a case series of 216 consecutive patients with probable Alzheimer's disease attending a memory treatment centre [474, 475]. In the latter, CEI treatment was overall associated with 7% risk of new UI: the highest risk was observed in patients with more behaviour problems, and lower risk in patients who demonstrated positive cognitive and/or behavioural response to CEI. Further evidence for an interaction between antimuscarinics and CEIs comes from a database study of nursing home residents in one US state [477]. Residents with dementia, newly treated with cholinesterase inhibitors, were more likely to then be prescribed a bladder antimuscarinic than those residents with dementia

not given a cholinesterase inhibitor, an example of a geriatric "prescribing cascade" [682]. Concomitant use of antimuscarinics (extended release oxybutynin and tolterodine) and cholinesterase inhibitors in nursing home residents was associated with a decline in ADL function in the most functionally able residents but there was no worsening of cognition, probably because the cognitive measure (MDS-COG) was inadequately sensitive. More importantly, there were no cases of delirium observed [480]. A recent study in which the primary objective was to assess the cognitive impact of trospium chloride in older people with dementia treated with galantamine over a six month period hypothesised that galantamine in combination would not result in any adverse outcome. Forty six subjects with UI and dementia were enrolled, 10 withdrew from the study. No effect on cognition or activities of daily living was detected over the duration of the study. A within group analysis demonstrated an improvement in nocturia and reduction in pad use in this combination group [481]. A small study reported some positive effect of the treatment of UI with propriverine in subjects with probable AD taking cholinesterase inhibitors [482]. Although intuitively illogical, given the opposing pharmacological actions, there seems to be no reason not to use bladder antimuscarinics for older people with dementia. The current weight of evidence appears to be that a positive outcome in terms of bladder control can be achieved without a significant detriment in either cognition or activities of daily living.

4. Non - antimuscarinic agents

Although there are 12 – week efficacy and 1 year's safety data on the newer beta-3 agonist mirabegron in older persons from a pooled analysis of registration trials [683], there are no data on frail older persons or those with a dementia diagnosis. However, given the lack of data on functional beta—3 receptors in the human CNS an effect on cognitive dysfunction may be unlikely. There are large observational studies of mirabegron use which are designed to capture cognitive adverse events in progress.

A global assessment of the cognitive and "at risk" status of the patient should be undertaken. Unfortunately, the MMSE and ADAS-Cog seem to be insensitive to change in cognitive impairment due to bladder antimuscarinics [454, 480]. Patients that might be at risk of impaired cognition have been well described [684] and consist of those with mild cognitive impairment, long-standing type II diabetes, poorly controlled hypertension, alcohol misuse, dementia, Parkinson's disease and the other akinetic-rigid syndromes. Those with Parkinson's disease may be exquisitely sensitive to the cognitive adverse effects of antimuscarinics [685]. These individuals will need to be carefully assessed, both prior to, and shortly after, initiation of treatment with bladder antimuscarinics. Treatment may necessarily depend upon a global assessment of cognition during the clinical assessment and, if possible, a carer's impression of change. In addition

to the of likely benefit from drug treatment, considering the life expectancy and wishes of the patient, account should be taken of total anticholinergic load, as this clearly increases the likelihood of cognitive impairment. There is evidence of the short term cognitive safety of bladder antimuscarinics, with the exception of immediate release oxybutynin, for the most part in cognitively intact older adults, and therefore, prescribing bladder antimuscarinics as single agents is, on the whole, probably safe.

Those studies using high doses (20mg) of oxybutynin are associated with an increased likelihood of causing cognitive impairment, which may not be apparent to either the patient or the clinician. This drug should probably be avoided in the elderly at high dose, and in those at cognitive risk, in any case. The other antimuscarinics should be initiated carefully, at the lowest dose for tolerability, with dose increases where indicated for efficacy, and reviewed early.

The length of exposure to anticholinergics seems to be important, studies suggest a lack of decline in those with established dementia [68, 686] but with exposures of at least two years, there is a reported increase in mortality [66, 460]. To what extent this is explained by case mix, comorbidity or other factors is not known and will be the subject of further research. Consideration should be given to limiting the overall exposure of antimuscarinics, particularly if in combination with other drugs with anticholinergic properties.

The recent introduction of mirabegron offers an alternative mechanism for treating OAB with similar efficacy, and theoretically, little chance of cognitive impairment, although mirabegron is a weak inhibitor of the permeability glycoprotein system at high concentrations; this mechanism is responsible for active transport of drugs from the central nervous system. Beta-3-adrenoreceptor mRNA has been isolated from human brain [687] but there are no studies which locate the functional receptor and no studies on cognitive effects of the active drug.

Summary of the evidence

1. Short-term treatment with oxybutynin-IR has small to moderate efficacy in reducing urinary frequency and urgency UI when added to behavioural therapy in long term care residents. **(Level 2)**
2. Low dose oxybutynin-ER does not cause delirium in cognitively impaired nursing home residents **(Level 1)**
3. Oxybutynin-IR has been associated with cognitive adverse effects in persons with dementia and/or Parkinson's disease **(Level 3)**, although the incidence and prevalence are unknown **(Level 4)**
4. Oxybutynin has been associated with tachycardia **(Level 3)**, but not associated with QTc prolongation **(Level 3)** or ventricular arrhythmia **(Level 2)**

5. Oxybutynin is less effective in persons with impaired orientation, cerebral cortical under-perfusion, and reduced bladder sensation **(Level 2)**
6. Oxybutynin is less well tolerated, versus solifenacin, in older people **(level 2)**
7. Fesoterodine is effective in ameliorating the symptoms of OAB in robust community dwelling and medically complex older people, identified by VES-13 **(level 1)**.

There is insufficient evidence to determine the efficacy, tolerability, and safety of the following agents in the frail elderly **(Level 4)**:

- a) Intravesical oxybutynin
- b) Transdermal oxybutynin
- c) Trospium
- d) Tolterodine
- e) Darifenacin
- f) Solifenacin
- g) Mirabegron
- h) Duloxetine
- i) Oral and topical oestrogen
8. Tolterodine has been associated with cognitive impairment and tachycardia (Level 3), although the incidence and prevalence are unknown. (Level 4)
9. Solifenacin (5mg/day) is associated with no impairment of cognition in older persons with mild cognitive impairment versus placebo (level 2)
10. Excessive anticholinergic load is associated with cognitive impairment in frail older adults (level 3)
11. Anticholinergic agents should be prescribed with due regard to underlying anticholinergic load in older persons (level 3)
12. The effect of cholinergic load on persons with mild dementia is uncertain (level 3)

12. SURGICAL TREATMENT IN THE FRAIL OLDER PERSON

12.1. Background

Since the 5th ICI we found for this updated chapter additional trials and 5 review articles on surgical intervention published since January 2012. In providing an evidence-based summary on this topic, we have taken advantage of a professional literature review done and additional literature found through citations found within the search. We revisited the available data and general issues regarding perioperative care

which could improve surgical outcomes in frail elderly.

Despite ongoing reports concerning the aetiology and pathophysiology of UI in older people, information on surgical management of the frail elderly is still scarce [688, 689]. Nevertheless, currently, surgical management of stress incontinence (SUI) in elderly women is the same as in younger stress-incontinent patients [690, 691][567, 568] and also in men choice of surgical intervention, mostly due to urinary incontinence after radical prostatectomy is rather dependent on incontinence severity than on age or comorbidity. However, the outcomes of anti-incontinence surgery in frail elderly patients may be very well affected by inherent co-morbidities, as well as impaired bladder and pelvic floor function. Frailty is a biological syndrome of decreased reserve and resistance to stressors that increases with age. Especially age greater than 80 years, is associated with increased complications.

12.2. Incontinence surgery in frail older women

Surgical intervention is the most effective and durable approach for the treatment of SUI. Especially the minimally invasive nature of the midurethral sling procedures has increased the number of older women, who are considered as surgical candidates for anti-incontinence procedures. Multiple retrospective and prospective cohorts have reported on favourable outcomes of older women undergoing these procedures. In a large secondary analysis of the National Health and Nutrition Examination study Ellington et al. state that risk of perioperative complications are noted to be higher in women aged 80 years or older compared with the younger woman (odds ratio [OR], 1.4; 95% CI, 1.3–1.5) [692].

Many single institution cases series have reported excellent surgical results with well-selected octogenarians and nonagenarians undergoing surgeries for incontinence and other pelvic floor disorders [693]. These patients have been demonstrated to do well with antiincontinence surgery and have significant gains in QOL. However, major gaps in our knowledge exist about which surgical treatments will benefit individual women who may not have been represented in clinical trials because of age, multiple comorbidities, functional disability, or cognitive impairment [692]. It also should be kept in mind that older women are more likely to undergo surgical retreatment for SUI compared to younger women. Research to identify which treatments for UI are most appropriate in real-world settings for different older women is needed.

We identified nine studies dealing with colposuspension and 83 studies investigating different techniques of sling surgeries or other types of surgical procedures using vaginal tapes published after 2012. All studies were targeted at middle aged women and although some studies included older women, results were not stratified by age. Long term outcome evaluation of a subgroup of patients enrolled in the SISTER

study (Design of the Stress Incontinence Surgical Treatment Efficacy Trial (SISTER) only confirmed that age was one of the preoperative baseline factors which were individually associated with recurrent incontinence in a follow-up of up to seven years following incontinence surgery [694].

A wide variety of surgical techniques have been described, among which the mid-urethral sling procedures have gained worldwide popularity. In a large survey with 15,009 patients from the National Health Insurance (NHI) claims dataset in Taiwan the authors compared the surgical trends for female stress urinary incontinence (SUI) during the time frame of 2006–2010 with the timeframe of 1997–2005. Midurethral sling (MUS) application increased significantly from 53.09 % in 2006 to 78.74 % in 2010. This study further confirmed that patients' age is one of the factors that the appropriate surgical type selection should take into account. They also noted that during the course of time more primary SUI surgeries were carried out in patients aged ≥ 60 . The authors suggest that higher incidence of mixed urinary incontinence and pure urgency urinary incontinence in older age groups could be a factor in the decision on the choices of surgical type – but more research is needed to clarify if and with which procedure especially frail elderly benefit and which surgical options to choose for this age group especially in those with mixed urinary incontinence [695].

Several studies have used U.S. national hospital discharge databases to examine surgical rates, but unfortunately they either age-adjusted results [696] or used relatively young cut-off points (e.g., < 50 years) [697]. Even in series that do specifically look at elderly women (mean age 78, range 68-90), most patients are cognitively intact (95%) [698]. Cognitive impairment appears to bias against having surgery: in one study, only 0.11% of operations for UI were done in women with dementia, cerebrovascular disease, or hemiplegia combined. Despite the fact that absolute numbers of ambulatory UI surgery cases in women increased from 1994-1996, the percent done in those aged > 80 years remained the same (4-5%) [699], with the same proportions for pelvic organ prolapse surgery (5%) [700]. In the US, surgery rates in elderly women vary by region and race [701].

One single-centre, community-based series of 54 patients aged 70 years and above provides a picture of this surgical population. Twenty-eight per cent of patients were aged > 80 , four resided in a nursing home or assisted living facility, 82% had significant comorbidities, and 32% were classified as American Society of Anaesthesiology class III risk. Intra-operative complications occurred in 11% of patients; postoperatively, 11% required intensive care monitoring, 6% had serious complications, 7% became delirious, and 9% experienced a slow return of bowel function. The authors concluded that discharge planning was especially important for these patients, and recommended pre-surgical planning with regard to discharge destination and likely need for assistance [702].

Although higher complication rates generally reflect the comorbidity common in frail elders (10.4% complication rate with comorbidity vs. 5.8% without it, $p < .001$) [699], some studies have found age protective (in one, age >73 years is associated with lower risk of vaginal cuff infection and recurrent prolapse following vaginal sacrospinous fixation [703]. The morbidity and mortality for geriatric patients undergoing anti-UI procedures appear to be similar to those of other major non-cardiac surgical procedures [704]. Mortality is inconsistently associated with increased age, and most strongly related to cardiac or cancer complications [705]. Many studies do not uniformly control for the impact of comorbidity on mortality [705]. Pre-operative administration of oestrogen appears ineffective in promoting wound healing [706]. Patient-controlled analgesia provides adequate pain control and sedation and increased patient satisfaction compared with standard administration of medications in cognitively intact geriatric patients [706]. Choice of anaesthetic agent may affect postoperative cognition and urinary retention. The use of methyl naltraxone to treat opioid-related urinary retention or constipation may become an important adjunct to surgical care in frailer patients [707]. There are few age specific data on outcomes available, and no studies systematically examine quality of life, functional outcome, or discharge destination.

With the advent of newer “minimally invasive” procedures, there has come some modicum of use in older, albeit, not frail patients. Injection of bulking agents in women appears to be as little effective in younger women as in elderly patients and age does not appear to relate to outcomes [704]. There are several published reports examining outcomes of tension-free vaginal tape (TVT) in the elderly population. However, most of these studies are limited by short term follow-up, small patient groups and confounding variables [708-710]. Hellberg et al. showed that at three months, women ≥ 75 years old had a cure rate of 81.6% compared with a rate of 92.8% in women <75 years old. At later follow-up, regardless of duration since the TVT procedure, the proportion of women with cure for ‘any’ incontinence decreased with increasing age. Very obese women ≥ 75 years old had a cure rate of 55.7%, compared with 79.9% in women < 60 years old ($p = 0.0001$) [711]. In one single institutional study, authors showed no significant difference in cure rate (85% vs. 91.3%, respectively). However, follow-up was only 10.4 months [712]. In a randomised controlled trial of tension-free vaginal tape (TVT) versus 6-month wait-list control, the intervention group at 6 months had a statistically significantly greater improvement in mean I-QOL score, patient satisfaction score, and urinary problem score [713]. There was no objective measure of cure. Perioperative complications were common, with bladder perforation by needle in one-in-five women (22.6%) which required 24 hours of in-dwelling catheterisation; urinary retention (12.9%), and less than 5% with either a urinary tract infection or new urinary

urgency (3.2%). In an uncontrolled case series examining the use of the suprapubic arch (SPARC) sling procedure, the outcomes in 43 older women (ages 65-91) were separately examined. Objective cure rate was evaluated by clinical and urodynamic examination and subjective cure rate by using a visual analogue score. At a mean follow-up of 36 months (range, 12 - 54 months), objective and subjective cure rates in 997 women were 91% and 95%, respectively [714]. There was statistically significantly improvement in pad weight, pad use and on the visual analogue score. No severe intra- or postoperative complications were observed, and no patient developed *de novo* urgency UI. In a case series, long-term clinical outcomes following placement of a retropubic mid-urethral sling (SPARC) in patients aged 70 and over were compared with outcomes of a younger cohort. Overall success rate after a follow-up of 4 years was 83.2% in the younger group and 53.1% in the group of older patients ($p = 0.0003$) [715]. In a comparative prospective single-centre study examining safety and efficacy of TVT-O in elderly versus younger stress-incontinent women, after mean follow-up of 30 ± 17 months, early and late postoperative morbidity was similar in both groups, except for significantly more cases of postoperative recurrent UTI’s among the elderly women (13.7% vs. 6.2%). The incidence of persistent urodynamically confirmed overt SUI was similar in both age groups (5%). However, asymptomatic urodynamic SUI was significantly more common among elderly patients (19% vs. 3.7%, $P < 0.05$). The incidence of persistent OAB was similar in both groups (68% and 62%, respectively), while *de novo* OAB was significantly more common in elderly patients (11.9% vs. 4.7%, $P < 0.05$) [716].

12.3. Incontinence surgery in frail older men

Since 2012, three studies have examined the effect of sling surgery in men [717-719] and one at the outcome following implantation of an artificial sphincter [720]. Bates et al. [721] conducted a systematic review and meta-analysis of artificial urinary sphincter (AUS) placement after radical prostatectomy (RP) and external beam radiotherapy (EBRT) including 1886 men with mean (SD) age of 66.9 (1.4). They concluded that additional external beam radiation created a risk of infection, erosion and urethral atrophy, resulting in a greater risk of surgical revision and also a higher risk of persistent urinary incontinence compared with RP alone.

But as noted in the 5th ICI, no specific conclusions can be drawn regarding surgical treatment of UI in frail men. Typical studies of anti-UI surgery in elderly men are very small or fail to stratify results by age and/or comorbidity [722, 723]. One small study ($n=46$) found that advanced age was not a risk factor for poor outcome after collagen injection for post-prostatectomy UI [724], while another ($n=12$, mean age 80 years) of trans-urethral resection prostatectomy (TURP) for obstruction-associated urgency UI concluded that cognitively impaired men demonstrated the greatest UI improvement [725]. In a single-institution case series

of men aged > 80 years old undergoing TURP (68% of whom had urinary retention), 80% were satisfied with their outcome. Of the men with retention, 80% were able to void with a small PVR by six weeks. Complication rates were 41% (early) and 22% (late) [726]. Urodynamic evaluation of post-prostatectomy UI was recommended prior to surgical treatment, such as implantation of an artificial sphincter [723].

12.4. Surgery for idiopathic or neurogenic detrusor overactivity

Since the 5th ICI, we located 9 new studies about dose finding, treatment of idiopathic and neurogenic DO evaluating safety, efficacy and improvement of quality of life using intradetrusor injection of onabotulinumtoxinA second line therapy. However, although some larger studies included elderly patients only one paper looked specifically at the frail elderly [727]. The authors concluded that safety and efficacy were similar between elderly patients without frailty and younger patients. However, an increased risk of finding a large post-void residual urine volume and a lower long-term success rate in frail elderly patients were noted.

12.5. General issues in the surgical care of frail older persons.

Frailty is becoming increasingly recognised as an important prognostic factor in surgical outcomes. However measured, the presence of frailty is associated with an increased likelihood of surgical complications, increased lengths of hospital stay and a greater probability of requiring an increased level of care following hospital discharge [728-730]. Important factors in the surgical care of frail patients include: preoperative risk stratification (e.g., American Society of Anaesthesiology class, Charlson index, Modified Cardiac Risk Index, Burden of Illness Score [731]; ensuring adequate nutrition, especially when patients cannot take oral feeding or become delirious; proactive management of comorbid heart disease, diabetes, and pulmonary disease; prevention [732, 733], recognition [734], and treatment of postoperative delirium [735]; adequate pain assessment and treatment, especially in cognitively impaired persons [736]; recognition of the hazards of prolonged bed rest [737] and the prevention [738] and treatment of functional impairment; use of specialised care units for the elderly [739]; and discharge planning regarding rehabilitation, need for assistance, and site of discharge. All need to be actively considered and dealt with in any plan of surgical care of frail elderly patients. Although some single institution case series have reported excellent surgical results with well-selected octogenarians and nonagenarians undergoing surgery for incontinence and other pelvic floor disorders these findings should be treated with caution because they tend to describe the results from surgery in robust, carefully selected patients undergoing procedures at specialised centres. To what extent these results are generalisable is unclear; the true risk of surgery in frail older patients is likely higher than in these reports.

Attention to cognitive and functional outcomes as well as quality of life are also important to consider in this population.

Summary of the evidence

1. No studies were identified regarding gynaecological surgery in institutionalised elderly women. (**Level 4**)
2. Exogenous administration of oestrogen is ineffective in promoting wound healing after gynaecological surgery in older women. (**Level 3**)
3. Injection of bulking agents for SUI appears to give minor benefit in women, however the technique is minimally invasive and age does not appear to correlate with outcomes. (**Level 3**)
4. Injection of onabotulinumtoxinA might be an option also in patients with idiopathic or neurogenic overactive bladder although risk of residual urine and a lower long-term success rate have been described. (**Level 3**)
5. No studies were identified that evaluate functional or quality of life outcomes after UI surgery in frail older persons (**Level 4**)
6. Risks of morbidity and mortality for frail patients undergoing anti-UI procedures are similar to those of other major non-cardiac surgical procedures. (**Level 2**)
7. Surgical mortality risks are still low in elderly persons, and when deaths do occur, they are often due to cardiac or cancer complications. (**Level 2-3**)
8. Operative mortality is inconsistently associated with increased age, and most studies do not uniformly control for comorbid conditions (**Level 2-3**)
9. Patient-controlled analgesia provides adequate pain control and sedation and increased patient satisfaction compared with standard fixed and time-administered medications in cognitively intact geriatric patients. (**Level 2**)
10. Choice of agent for patient-controlled analgesia may affect postoperative cognition. (**Level 3**)
11. Some case series and waitlist-controlled trials suggest that minimally invasive surgical approaches may be useful in older adults, yet these trials may have little to do with whether surgical treatments are appropriate in the frail elderly (**Level 3**)

Recommendations for management

1. Age alone is not a contraindication to surgical treatment of UI (**Grade C**).
2. Urodynamic evaluation should be done before considering surgical treatment of UI in frail older persons (**Grade B**).

3. Preoperative risk should be stratified using established indices (**Grade A**).
4. Validated frailty scales may aid prognostication and planning from post surgical care in frail older adults (**Grade C**).
5. Ensure adequate post-operative nutrition, especially in patients who cannot take oral feeding or who become delirious (**Grade C**).
6. Programmes to prevent post-operative delirium should be utilised (**Grade A**) along with proactive use of established measures to diagnose delirium (**Grade A**).
7. Pain assessment in cognitively impaired persons should use measures specially-designed for this population (**Grade B**).
8. Proactive preventative approaches to hospitalisation-related functional impairment should be used (**Grade A**).
9. Specialised care units may improve selective outcomes for frail older patients (**Grade A**).
10. Discharge planning should begin before surgery takes place (**Grade C**).
11. Patient controlled analgesia can be used in cognitively-intact frail older persons (**Grade B**).
12. Analgesic agents associated with delirium (e.g., meperidine) should be avoided (**Grade B**).
13. Long-term outcomes before the operation should be discussed with the patient (**Grade C**).

Recommendations for research

Further research is required to:

1. identify risk factors for surgical outcome in frail elderly.
2. identify which treatments for UI are most appropriate in real-world settings for different older men and women.
3. define pre- and postsurgical care to improve surgical outcome in frail elderly.

III. NOCTURIA

1.1. Background

Nocturia is defined as waking at night from sleep one or more times to void, with each void being preceded and followed by sleep [740]. Overall, nocturia is a highly prevalent and bothersome symptom [741]. While a single episode of awakening to urinate would be considered nocturia, patients are more likely to be experience significant bother and have decreased quality of life [742], or consult a provider about nocturia if they have three or more episodes [743]. Many clinical trials include only participants with two or

more episodes [744]. Additionally, if only a void interrupting sleep and preceding sleep counts, the annoying situation of waking to void and not being able to return to sleep again would not be nocturia, but would still be disruptive [745]. This definition does not take into account the wide range of sleep patterns of older adults. Since some older adults will spend six hours sleeping while others might spend twelve hours in bed, having three episodes of nocturia would be very different for these individuals [746].

Several detailed reviews on nocturia [747, 748] and two convened consensus conferences reports [744, 749] have helped summarise and update the current knowledge regarding nocturia. Even with these sources, the prevalence, impact, pathophysiology, diagnostic assessment, and treatment of nocturia differ meaningfully with respect to the older adult and the frail elderly [746] and merit a targeted discussion. As is the case with urinary incontinence, nocturia often results from the reduced physiological reserve of multiple systems. Nocturia is associated with increased all-cause mortality and mortality in those falling if they had nocturia (While nocturia has been associated with increased mortality (15-year survival rates of 76.5 and 84.8 percent for individuals with and without nocturia, respectively), this association may be attenuated when adjusting via multivariate analysis (for factors such as hypertension, diabetes, chronic pulmonary disease, cardiac symptoms, smoking, and age) (but perhaps not when adjusted for sleep dysfunction) [750-753]. Older men with nocturia and low body mass may be at increased risk of death [754]. Because of this fact, diagnostic assessment must be detailed and comprehensive, and multi-component interventions may be necessary for successful treatment.

1.2. Quality of the data

There are multiple, quality sources of epidemiological data across a broad range of countries and cultures regarding the prevalence of nocturia and associated risk factors. There is a smaller, but growing, body of evidence regarding the incidence and impact of nocturia. In particular, studies of the pathophysiology of nocturia in the elderly have generally been small and disease-focused, examining a single, potential underlying cause of nocturia. As with UI, there are limited data on optimal diagnostic assessment, and therefore recommendations are generally based on expert opinion [755, 756]. The evidence base regarding treatment, particularly with respect to the frail older person, is somewhat thin. While there are some treatment RCTs, they are small, include few very elderly subjects. The treatment literature regarding vasopressin and its analogues is robust, yet use of the therapy in the older patient continues to be limited because of the side effect of hyponatraemia. We located only limited randomised controlled trial pilot data on the effectiveness of multi-component interventions for nocturia in the elderly [757].

1.3. Prevalence, incidence and impact

The prevalence of nocturia increases with age, and has been reported to be as high as 90% for one episode per night in persons over age 80 [758-763]. The prevalence of two or more episodes among men between 70 and 79 is nearly 50 percent [763, 764]. This increasing prevalence is largely due to age-related conditions that underlie the pathophysiology of nocturia, such as smaller maximum voided volume and increased nocturnal polyuria [765]. (see below). With respect to sex, nocturia in young adults is more common for women than men, but this sex ratio reverses after age 60 when more men have nocturia [764]. For those over 75 years of age, the prevalence of nocturia of at least two or more times is much more common in men (70%) than in women (50%) [766]. It is still a burdensome condition for both sexes in women as well as men, and in a cross-sectional study of over 2000 women aged 40 or older, 40 percent of women who had nocturia had no other urinary tract symptoms [763, 767].

Whilst increased age is associated with more nocturia, what happens to nocturia as an individual ages, is a slightly different question. Nocturia is more prevalent in older populations, yet the concept of incidence of nocturia is difficult as the condition both “begins” and “resolves” over time and varies due to imprecision of self-reporting and estimates as to the frequency over a past period. In one recent study, participants recorded their urination frequency and voided volumes. Over a 2-year period, the incidence rate of nocturia of an average of two or more times per night was 23.9% and the resolution rate was 36.7%. For the oldest adults participating (70-78 years), they had the highest nocturia incidence (47.1%) and the lowest resolution rate (26.2%) compared to their younger counterparts [768]. In an additional study, men receiving placebo as part of a randomized trial for treatment of BPH, nocturia regression varied between 2 and 33 percent, while nocturia progression varied between 8 and 54 percent [769].

Recent data have also highlighted that the prevalence of nocturia in older adults differs by racial group. Multiple population-based epidemiological studies have shown a higher prevalence of nocturia in older men and women who are African-American when compared to whites [763, 770, 771]. While controlling for socioeconomic factors eliminated the differences in prevalence between non-Hispanic whites and Hispanics, differences persisted, although somewhat attenuated, between blacks and whites [772, 773].

Nocturia is also associated with chronic medical conditions such as hypertension [774, 775] (including night time hypertension and absence of night time blood pressure dipping) advancing renal insufficiency [776-778] and cardiovascular disease [779, 780]. Nocturia has been shown to be associated with diabetes mellitus, [774, 775] but nocturia and the metabolic syndrome are associated in younger, but not

older, men [781]. Clinically, nocturia may be the herald symptom of significant underlying medical conditions and problems, which, if overlooked, might result in significant morbidity and even mortality [744]. Therefore, an older patient presenting with bothersome nocturia should be evaluated not only for the causes of nocturia, but also for unrecognized comorbidity, including cardiovascular disease, sleep apnoea, restless leg syndrome, moderate alcohol usage, poor nocturnal glycaemic control, and conditions causing night time pain [744].

Nocturia is associated with other important conditions. Nocturia has been shown to be associated with accidental falls [257, 265]. Frail elderly persons with nocturia, who also have gait and balance disorders and other risk factors for falls, are clearly at increased risk for falls [256, 782], injury and hip fracture [783], and consequent morbidity [254, 753]. Despite these facts, no nocturia treatment trials to date have evaluated any impact on fall reduction. Nocturia also has adverse effects on quality of life [784], including an increased risk of depression and poor self-rated health, probably as the result of the impact on sleep. [785]. Adults with nocturia also complain that nocturia “makes them feel old” and they worry about falling at night [786]. Older individuals described nocturia as simultaneously debilitating, frustrating, distressing and puzzling [787].

To better appreciate the deleterious effects of nocturia, it is important to understand the important associations between nocturia and disrupted sleep [744, 788-790]. When a group of 1,424 elderly individuals, ages 55–84 were presented with a checklist of symptoms that potentially disrupt sleep, nocturia was chosen by 53% of the sample as a self-perceived cause of “every night or almost every night”. Nocturia was cited four times as frequently as pain, which was the next most identified cause of sleep disruption [791], and cited as a frequent reason for insomnia in patients with congestive heart failure [745, 792]. There is growing evidence to suggest that bother from nocturia is related to the number of trips to the bathroom, but also with the difficulty experienced in trying to return to sleep [745, 788, 793, 794]. In particular, those with nocturia who report difficulty in going back to sleep, the prevalence of falls is higher [793]. Nocturia has been shown to be significantly associated with worse scores on sleep questionnaires, and a shorter time to first nocturia void is also associated with worse whole-night sleep [789, 795]. While the relationship between nocturia and sleep disruption might appear to be self-evident, other lower urinary tract symptoms are also highly correlated with sleep disturbances [796].

There has been recent and meaningful development in understanding the impact of nocturia on quality of life, particularly showing that nocturia is related to depression and anxiety [797]. A condition-specific instrument commonly used for assessing the impact of nocturia is the ICIQ-NQOL [798], which was developed using a pool of only men (average age 68.2, age

range 32-88) recruited from urology practices. Given the absence of women and the likely predominance of men with benign prostatic enlargement as informants, there remains a chance that the instrument does not broadly represent the experiences of all individuals who have nocturia. Other focus groups and one-on-one interviews performed independently with a broader representation of both men and women did demonstrate similar themes, suggesting content validity [786]. Two missing themes, however, were that nocturia was an "indication of getting older" and made them fearful of falling. Use of the Nocturia Nocturnal Enuresis and Sleep-interruption Questionnaire, which was specifically developed in older men and older women (60-80), showed a greater impact of nocturia in the younger elderly and a greater bother among women compared to men.[663] Use of the generic quality of life instrument, the 15-D, demonstrated statistically significant and clinically meaningful decreases in 15D score and in all 15D dimensions except eating with increasing nocturia [742]. In this study, older women were less bothered by nocturia than were younger women; older and younger men were equally bothered [742]. In several case series, nocturia was most often identified as the chief complaint related to the lower urinary tract [799] and the least responsive to treatment, particularly in the older patients [799, 800].

Several recent studies have shown strong associations between nocturia and Parkinsons disease (PD), including a negative impact on quality of life, depression, anxiety and severity of disease [801-804]. Nocturia is a frequent, early non-motor symptom in PD that is bothersome, and a common cause of sleep disruption [805, 806]. Nocturia in PD is associated with increasing age of the patient, but also with the increasing severity of PD [807]. Age of onset of PD, in addition to age, may be associated with worse nocturia [808]. Patients with PD have more nocturia episodes than their spouses, and number of nocturia episodes may be related to nighttime and total levodopa dosages [809]. While it might be difficult to clinically separate idiopathic PD from drug-induced parkinsonism, urinary symptoms including nocturia are much more common in PD even after controlling for age and sex [810]. Additionally, nocturia and other non-motor symptoms often began prior to being diagnosed with PD, and may be a biomarker for the condition [810].

Notable recent work has shown nocturia to be associated with poorly controlled diabetes mellitus, congestive heart failure, worsening renal insufficiency is associated with bad outcomes. Whether, or not, these associated conditions should be statistically controlled for is not clear, as they might represent a part of the causal pathway. The association with mortality when examined across the age spectrum shows a stronger relationship with younger individuals than with older [751]. With careful controlling for comorbidities, this association between mortality and nocturia sometimes remains independently significant [811] and other times does not [752]. Though much of the

impact of nocturia is believed to result from its impact on sleep, nocturia remains independently associated with mortality even with controlling for sleep disordered breathing [812].

1.4. Pathophysiology

The pathophysiology of nocturia is multifactorial; this is particularly true for nocturia in frail elderly persons. In age-adjusted analyses from a large survey in Finland, no single factor related to nocturia was present in greater than 50% of those with nocturia [813]. The factors with the greatest impact at the population level were (urinary) urgency, "benign prostatic hyperplasia", and snoring for men, and overweight and obesity, urgency, and snoring for women [765, 813]. Colder ambient weather or internal temperatures may be associated with greater nocturia [814, 815].

A commonly used framework for clinical diagnosis and treatment is that nocturia can be related to one or a combination of three primary underlying causes, all of which increase with age: low bladder capacity usually as a component of OAB, DO, urgency UI, or BOO in men; nocturnal polyuria; and primary sleep disorders [747, 748, 816]. Nocturia was shown in retrospective analysis of 213 cases (mean age 72) who had detrusor overactivity, out of a total of 777 men studied using pre-operative urodynamics to be highly associated with volume at which the first detrusor contraction occurred [817]. Somewhat in contrast, in one prospective case series of 987 ambulatory women aged 55-75 years, a higher post void residual (>200 mL, 100-199 mL, 50-99 mL versus <50 mL) was not associated with reporting more nocturia [818]. While nocturia may be said to result from sleep dysfunction, this relationship is likely bi-directional (with sleep dysfunction also likely resulting from nocturia) [819].

The proportion of 24-hour urine volume produced at night increases with age, even among healthy older adults free of overt comorbid conditions [820, 821]. Studies of frail elderly have shown that the proportion of urine produced at night is close to 50%, rather than less than 30% as in young healthy adults [822-824]. Nocturia is a common symptom in nursing home residents with Parkinson's disease and contributes to worse sleep and worse quality of life [825]. Nocturnal polyuria (NP) is more common in older compared to younger nocturics [683-685], yet the proportion of individuals who have NP is highly sensitive to the definition used [826]. In some elderly persons, this is due to mobilisation of excess volume caused by peripheral oedema, which may be due to venous insufficiency, medications, and/or heart failure. In the case of calcium channel blockers, women younger than 55 years of age, but not older women or men, were shown to have higher rates of nocturia in cross-sectional analyses [827]. In that same study, both hydrochlorothiazide and loop-diuretic usage in men were associated with higher rates of nocturia.

Some studies have suggested that there is an abnormality in the secretion and/or action of arginine vasopressin (AVP) or a loss of the normal diurnal rhythm (with inappropriately low values at night) in many elderly patients with nocturia. [828, 829], which may approach as many as 4% [828]. Another, however, failed to find an association between AVP deficiency (detected by water deprivation testing) and nocturnal polyuria in a series of elderly persons with nocturia [830]. Other research suggests that some frail elderly persons with nocturia have high atrial natriuretic peptide (ANP) levels at night; [831, 832] however, these investigators did not use echocardiography or brain natriuretic peptide levels to detect occult heart failure.

Sleep disordered breathing and sleep apnoea, also have been associated with nocturia and nocturnal UI in the elderly [831, 833-835]. Community-based elderly populations who have higher levels of sleep disordered breathing (>25 breathing events per hour), have nearly double the number of nocturia episodes compared with those with low rates of sleep apnoea [695]. Nocturia is so tightly associated with sleep apnoea that in a population of adult patients presenting to a sleep clinic, it performed similarly as a screening question for OSA when compared to asking about "snoring" [836]; whether this held true for the subset of older patients was not reported. Whether this relates to increased ANP production, [831] mechanical forces on the bladder generated during apnoea events, [834] or other mechanism(s) is unknown.

Nocturia may be a marker or a result of endothelial dysfunction [837], vascular flow disruption, white matter hyper-intensities [838], or inflammation [839].

1.5. Diagnostic assessment

The approach to the assessment of nocturia should be similar to that for UI described above. Special considerations include:

- A frequency-volume chart of at least 24 hours duration that includes timing and volume of each void at night as well as during the day, as well as a specific indication of when the individual went to bed with the intention of going to sleep at night and awoke in the morning. Some patients may find this difficult to perform, [840] but face-to-face explanation of the procedure, a hand-held urinal or a receptacle to place in the toilet to measure volumes, and involvement of caregivers may improve compliance and accuracy.
- Additional questions in the history that focus on the possibility of a primary sleep disorder, such as asking about sleep quality, daytime sleepiness, snoring, and leg movements at night (this history is enhanced by questioning the bed partner).
- Additional history and focused physical examination related to volume overload (e.g., lower extremity venous insufficiency, congestive heart failure); in some cases, additional testing such as

an echocardiogram or a brain natriuretic peptide level may be helpful in ruling out the latter diagnosis.

1.6. Treatment

While many clinical investigations are trials of single agents, experts [746] would argue that treatment of nocturia in elderly patients should be based on a holistic approach informed by identification of multiple potential underlying causes. There is, unfortunately, little high quality evidence for most treatments, and certainly with respect to combined treatments, for nocturia in this age group. As well, cure, or the complete resolution of nocturia, is infrequently achieved in either clinical practice or research.

The most common primary outcome in clinical trials is reduction in nocturia episodes, as measured by voiding diary or self-reported, average nocturia over a given period of time. Some trials have reported the percent of participants who achieving a 33% [698] or 50% [830, 841-845] reduction in nocturia from the baseline level or the percent of individuals having a reduction equal to 1.0 fewer mean nightly episodes of nocturia [841, 843, 844]. There are few treatments that offer robust reductions of nocturia, with most ranging from 0 to 0.8 fewer episodes of nocturia. The net reduction of an intervention, subtracting the benefit seen in the control or placebo arm is often even smaller. Whether this is due to regression to the mean due to random variation in the symptom of nocturia or a result of monitoring and recording night-time voids is unclear. Patient-level outcomes related to general satisfaction questions, nocturia-related bother, and nocturia-specific quality of life are therefore even more meaningful. Most trials examining nocturia as an outcome were performed prior to the validation testing of the ICIQ-NQOL instrument [798]. An additional important target for therapy is reduction in bother due to nocturia. Unfortunately, there have been few meaningful successes in relating the number of nocturia episodes to the hours spent in bed, which may vary considerably in older persons [787].

There are several approaches to drug therapy for elderly patients with nocturia; most of the published guidelines suggest targeting "primary" or "principal" causes of nocturia (e.g., nocturnal polyuria). Because older adults with nocturia have multiple potential causes, treatment often will require combination treatment. While some trials may report statistical significance for reduction in nocturia, the clinical meaningfulness of these changes is suspect [845]. Although no specific data are available on RCTs of multi-component interventions, elderly patients with nocturia may benefit from an approach to treatment [846] that combines behavioural strategies, therapy for medical and sleep disorders, and nocturia-specific drug therapy. In another uncontrolled study, lifestyle modification of 1) restriction of fluid intake, 2) refraining from excess hours in bed, 3) moderate daily exercise and 4) keeping warm in bed resulted in a positive reduction of nocturia from 3.6 episodes per night to

2.7 for 56 participants aged 59-85 (mean age 74.5, 84% male) [847].

1.7. Behavioural approaches and treatment of comorbidity

The use of specific behavioural strategies (e.g. altering fluid intake, reducing sodium intake, leg elevation for oedema) on nocturia in older patients have largely been made based on consensus. Using bedside commodes or urinals, and minimising the distance necessary to reach a toilet and providing a safe, adequately lit path may be helpful in reducing the risk of night-time falls related to nocturia, especially in those with underlying gait instability and other risk factors for falls.

The first secondary data analysis of a RCT which demonstrated that behavioural therapy, with an emphasis on pelvic floor muscle exercises and urgency suppression strategies, showed that nocturia was reduced in women (mean age 68) with urgency-predominant UI [841]. The median reduction of 0.5 episodes per night was significantly more effective than drug treatment with oxybutynin IR titrated from 2.5mg per day to 5.0 mg three times a day, (0.3 episodes) or placebo (no reduction). A second secondary data analysis of an RCT, that did not show benefit with respect to the primary endpoint of urgency incontinence in women (mean age 55), did not show benefit of behavioural therapy when added to tolterodine 4 mg LA for nocturia [848]. An additional RCT in men (mean age 64) examined the impact of the addition of either titrated bladder relaxant therapy (oxybutynin XL 5-30mg) versus behavioural therapy for pelvic floor muscle exercise in whose 24-hour urinary frequency was not resolved with alpha-blocker therapy. In this trial, nocturia was a secondary outcome. In this study, the behavioral group showed greater reductions in nocturia (mean = -0.70 vs. -0.32 episodes/night; $P = .05$) [849]. There are currently no trials of pelvic floor muscle exercises or urgency suppression strategies where individuals were enrolled on the basis of having nocturia with reduction in nocturia as the primary outcome.

Individuals with refractory nocturia may have undiagnosed symptoms of sleep disorders, and many men [850] and women [851] with nocturia have a positive screening test for sleep dysfunction. Those shown to have nocturia and obstructive sleep apnoea (OSA) should be treated for OSA, which can effectively reduce nocturia in many, and may also reduce hypertension associated with OSA [852].

1.8. Pharmacotherapy

1. Antimuscarinic therapy

Members of a recent nocturia consensus conference agreed on the following statements with regards to overactive bladder and antimuscarinics:

1) most patients with nocturia do not have overactive bladder; 2) most patients with OAB do have nocturia;

3) antimuscarinics are not usually efficacious for nocturia; and 4) antimuscarinics may be effective for nocturnal voids due to urgency [749, 853]. In general, if the history, bladder diary, and physical examination suggest that nocturia is related primarily or in part to OAB/DO/urgency UI, then treatment with an antimuscarinic agent should be considered (see Pharmacological Treatment above). There are several trials examining the effect of antimuscarinics for nocturia reduction, including trials of oxybutynin-IR, [841] solifenacin, [634] and tolterodine [854, 855]. Four recent trials have compared placebo to active drug for nocturia without statistical improvement [856-859]. There is evidence to suggest that these agents may be best used in combination with other therapies [860] rather than as single modality therapy. Even when agents from this category have shown statistically significant reductions in nocturia, the net benefit of reduction in nocturia (above that effect shown with placebo) is only by 0.0 to 0.3 episodes. A recent "positive" trial showed a statistical advantage of solifenacin 10 mg over placebo of a net difference of -0.12 episodes per night [861]. Tolterodine demonstrated statistical reduction in nocturia accompanied by urinary urgency (but not overall nocturia) [855]. The clinical importance of nocturnal urgency is evident to the patient with the symptom ("I would like to not wake up and have to rush to the bathroom"), but this outcome is not fully nor well established within the literature. Use of anticholinergic medications should be used with caution in at-risk individuals as they may cause worsening of confusion or delirium.

2. Agents directed towards benign prostatic obstruction

Alpha-adrenergic agents used in patients with symptoms suggestive of BPO have a modest impact on nocturia, with a mean reduction of slightly less than one episode per night [830, 862]. 5-alpha reductase inhibitors [830] and saw palmetto (*Serenoa repens*, saw palmetto berry extract) [863] have not shown statistical benefit for nocturia except in one study within one subset of participants age >70 [842]. This statistical advantage did not persist beyond one year, and the net benefit compared to placebo was a difference of < 0.2 fewer nocturia episodes.

3. Other medication approaches

Among postmenopausal women, one uncontrolled trial of oestradiol in combination with a progestogen showed a dramatic reduction in nocturia over 6 months [864]. There are few studies that have focused on treatment of nocturia with the use of medications for sleep. One RCT evaluated melatonin for treatment of nocturia associated with BOO in older men [865]. Melatonin showed only a trend towards reduction in nocturia compared to placebo (-.03 and -0.05 episodes from baseline 3.1 episodes, respectively) but did significantly reduce reported bother from nocturia. A second study compared the addition of either melatonin or a sedative hypnotic (ril-mazafone) to older men and women (mean age 72)

who were already taking a medication for nocturia, and found the addition of either treatment further reduced nocturia one episode (from 3.5 to 2.5 in both groups) [866]. Reducing volume overload associated with lower extremity venous insufficiency or congestive heart failure with a late afternoon dose of a rapid acting diuretic may be helpful in reducing nocturnal polyuria and nocturia in selected patients [867, 868]. Diuretics (specifically bumetanide and furosemide) have been conferred Level 2 evidence, Grade C recommendation by the Committee for Establishment of the Clinical Guidelines for Nocturia of the Neurogenic Bladder Society [869]. Treating sleep apnoea with continuous positive airway pressure can reduce nocturia severity, but these trials have not usually included the frail elderly [774]. Treatment with very short-acting benzodiazepines for patients with primary insomnia, and with dopaminergic agonists for patients with restless leg syndrome, may improve sleep quality, but there are no data to support these approaches.

4. Antidiuretic treatment: desmopressin

Most older patients with nocturia have increased nocturnal urine output, which is less common in younger patients [870]. Nocturnal urine volume is strongly associated with the number of episodes of nocturia [871]. A large number of studies over the last 20 years have examined the potential role of exogenous AVP (desmopressin or DDAVP) for the treatment of nocturia in older patients [823, 843, 844, 872-886] (Table 10). While many have been uncontrolled case series involving relatively small numbers of subjects, more are robust RCTs. In some cases, however, the inclusion criteria, outcome measures, and route, dosing, and duration of DDAVP treatment have varied considerably. The first two, large RCTs using oral DDAVP employed essentially identical designs, with one conducted in men [844] and the other in women [843]. While these trials included men over age 75, the mean age of the participants was closer to "middle" rather than "old" age (65 and 57, respectively). Both found significant reductions in nocturia and nocturnal urine volume, and increases in mean duration of self-reported first time to night-time awakening from sleep. However, there were some unusual elements of the trial design. The randomised controlled portion was preceded by an open-label dose-titration run-in, with the subsequent exclusion of subjects who did not experience >20% reduction in nocturnal urine volume or who were intolerant to the medication. Although this approach may be useful for targeting therapy in clinical practice, it raises questions about selection bias and the generalisability of the results. Most individuals in DDAVP oral tablet trials were titrated up to an oral dosage of 0.4 mg, [843, 844] yet older patients can have a significant reduction in night-time urine with much lower doses of 0.1 or 0.2 mg orally [882, 887, 888]. A major concern related to DDAVP treatment in elderly patients is fluid retention (which can exacerbate underlying cardiovascular disease) and hyponatraemia. In one study, one of the 57 individuals randomised to 0.1 mg DDAVP for year

was described as having a "consciousness disturbance due to hyponatraemia (116 mmol/l)" which left him unable to "complete the protocol" [887]. Many older persons may have pre-existent hyponatraemia due to a variety of medical conditions and drugs and will develop renal insufficiency or congestive heart failure. One review [889] found the incidence of hyponatraemia with DDAVP in older persons to be 0-9% (depending on definition with the exception of the RCT in men discussed above, in which the incidence of any hyponatraemia was 22% (4% with sodium < 130 mmol/L). Because so few frail elderly were included in these trials, the actual incidence of clinically significant hyponatraemia from DDAVP that might occur with monitoring outside of a clinical trial is unknown. A further review of pooled trial results found that the incidence of hyponatraemia in subjects with normal baseline sodium was <1% (3/336 subjects) in persons < 65 and 8% (22/260) in those >65, and 75% (6/8) in older patients with a low baseline serum sodium [890]. Pharmacodynamic studies in younger older men (aged 55-70) found that DDAVP had a prolonged half-life which was in part responsible for hyponatraemia [891]. DDAVP is not useful in frail older persons in nursing homes with nocturia and/ or night-time UI because of the lack of efficacy for reducing night-time voids and the very high rate of hyponatraemia [888]. The overall safety has been recently reviewed [892] and ddAVP was an addition to the most recent revision of the Beers review for potentially inappropriate medications in the elderly [893].

Several attempts at delivering the efficacy of antidiuretic therapy without the side effects have focused on the dosing, mechanism of achieving anti-diuresis, half-life of the agent, and delivery system. Since the last ICI review, data about the efficacy and safety of an orally-disintegrating tablet formulation of DDAVP have been published [872]. The theoretical advantages of such a formulation would be the ability to deliver smaller and consistent level of the drug. The study design evaluated co-primary outcomes of decrease in night-time voids from baseline versus placebo and the ability to achieve a 33% decline in baseline nocturia. Participants were stratified by age <65 and ≥ 65, with 500 individuals over 65 in the study having safety endpoints. At enrolment, all participants needed to have a serum sodium of >135 mmol/L, an estimated creatinine clearance of greater than 60 ml/min (the largest single reason for exclusion during screening, 15%), and a post void residual of less than 150 mL, and, for men only, a peak uroflow of >5 mL/second. The results showed that for men, the minimal effective dosage was 50 micrograms (-1.38 versus -0.84 for placebo) and for women it was 25 micrograms (-1.22 versus -0.88 for placebo). Side effects appeared in a dose-dependent fashion, that depended upon both age (older had higher side effects) and gender (women had higher side effects). For those participants over 65 years of age, the following percentages of participants had a reduction of sodium of either 125-130 or <125: on 100 micrograms, 14.1% and 4.7%; on 50 micrograms, 6.6% and 2.6%; for 25

micrograms, 2.6% and 0%. While the 2011 nocturia treatment consensus guidelines [744] stated that "the mechanisms behind desmopressin-induced hyponatraemia are well understood", newer information suggests that the hyponatraemia in women is not fully explained by pharmacokinetic profile [894]. For elderly individuals, antidiuretic therapy via DDAVP orally absorbable tablets still has a narrow therapeutic window where the dosage that allows for efficacy in the absence of meaningful and potentially serious side effects may be difficult to find. Severe hyponatremia has occurred even within the context of a clinical trial with enhanced, structured monitoring and use of a lower-dose desmopressin as an adjunct to BPH therapy [881]. There have also been trials with staggered DDAVP and diuretics, which have greatly reduced nocturia [883]. Of the participants who completed the trial, 5% had hyponatraemia, not counting individuals who had hyponatraemia during run in.

Table 10. Selected studies of desmopressin (DDAVP) for older patients

Reference No. (Yr.)	Study Design	N	Sex	Age Mean, (SD)	Nocturia Definition	DDAVP Dose ¹	Outcomes	Level of Evidence
van Kerrebroeck 2007[885]	RCT, placebo controlled Dose titration	127	70%M	63.4 (12.8)	> or =2 voids/night	0.1, 0.2, 0.4 mg	39% reduction in the mean number of nocturnal voids with desmopressin vs. 15% with placebo, p<0.0001 duration of the first sleep period prolonged by 108 min with desmopressin vs. 41 min with placebo; p<0.0001)	2
Johnson 2007[886]	double-blinded, placebo-controlled, crossover trial of individually titrated oral ddAVP.	14	NS	74 (5)	any nighttime void between going to bed and morning awakening	0.1, 0.2, 0.4 mg	NUV in subjects receiving ddAVP treatment was significantly lower than at baseline (197mL reduction,) and than in subjects taking placebo (126mL less,). NUVof subjects at baseline and of those taking placebo were not significantly different	3
Wang 2011 [888]	long-term efficacy and safety of low dose oral desmopressin in elderly patients with benign prostatic hyperplasia	126	M	74.5 (5.99)	2 or more voids nightly nocturnal polyuria =nocturnal urine volume greater than 30% of total daily urine volume	0.1	decrease of 2 or more voids per night) achieved by 35 (61.40%) patients receiving desmopressin and by 8 (13.80%) on placebo (p_0.001).	2
Fu 2011[884]	randomized double-blind treatment period. with DDAVP and staggered furosemide	80	58 men and 22 women,	67 (8)	at least two voids per night	0.1, 0.2, 0.4mg	46% patients in the study group compared with 4 (10%) patients in the control group reported that the treatment had a 50% or greater reduction in the number of nocturnal voids	2

5. Surgical and procedural treatments

Posterior tibial nerve stimulation has been used in OAB trials. A recent trial [895] demonstrated in 214 individuals a favourable outcome for nocturia reduction in the active treatment group (2.9 at baseline to 2.1 with treatment) that was statistically superior to the effect of sham (2.9 to 2.6, net benefit of active over placebo -0.4 reduction). Of note, there were more individuals over 65 years of age (50%) compared to the sham group (41%) biasing against demonstrating benefit if it were true that older adults responded less well; whether or not these gains are maintained without on going treatment is not known [896].

Surgical approaches to treatment of nocturia have long been recognised to be effective, yet overall symptoms improve more than does nocturia specifically. The evidence from trials shows that older patients with the highest symptom scores prior to surgery benefit the most from transurethral resection of the prostate [897], yet nocturia often persists and may be the least responsive symptom for improvement following the procedure [897-899]. Yet, surgery does reduce lower urinary tract symptoms and may result in reductions in nocturia and improvement in many symptom specific QOL areas [900], but not all [901]. In one consecutive group of 56 patients treated with either TURP or radical prostatectomy (mean age 69) for persistent symptoms despite six months of medical therapy. The group monitored postoperative nocturia counts, hours of undisturbed sleep, and the ICIQ-NQOL which were compared to baseline. In this uncontrolled series, patients had significant improvements in all measured domains, including a 0.8 episode reduction per night [902]. The NQOL outcome measure was most favourable in individuals with the greatest reductions in nocturia or the most uninterrupted sleep. One study used a retrospective evaluation of 298 patients (mean age 70) over a 10-year period, and found that younger men with lower preoperative urinary maximum flow rates had the best postoperative results [899]. Not surprisingly, symptoms post-operatively were not strongly correlated with objective urodynamic findings [903]. On average, less than half of the men operated on had a reduction of nocturia by 50% or more [899]. In a rare RCT where 66 men, aged 52–81 years (mean 68.6), who were believed to have nocturia solely due to “benign prostatic hyperplasia” and who had received no previous treatments of any type, were randomized in a 1:1 fashion to either alpha-blocker therapy (tamsulosin 0.4 mg) or TURP. The prostate volumes and baseline nocturia nearly differed in a statistically significant manner at baseline (51 cm³ and 2.0 mean nocturia episodes versus 59 cm³ and 2.4 for those allocated to surgery). Both groups had a reduction of nocturia to 1.5 (3 months) and 1.4 (6 months), as well as statistical improvements in the ICIQ-NQOL. No treatment was superior to the other and both were statistically significantly improved from baseline [900].

Summary of the evidence

Late afternoon administration of a diuretic may reduce nocturia in persons with lower extremity venous insufficiency or congestive heart failure unresponsive to other interventions. **(Level 2)**

If OAB, DO, and/or urgency UI is felt to be a major contributor to nocturia, antimuscarinic agents should be considered. **(Level 3)**

If nocturia is due to insomnia alone, then a very-short acting sedative hypnotic may be considered. **(Level 3)**

DDAVP should not be used in frail elderly because of the risk of hyponatraemia. **(Level 1)**

Recommendations for management

Nocturia investigations should be carried out utilising both frequency-volume charts and validated questionnaires capturing QoL and bother related specific to nocturia (e.g. NQoL). **(GoR C)**

Recommendations for research

- Validation and clarification of the definition of both nocturia (in regards to any night awakening owing to the
- desire to pass urine, the ICS definition vs. the more clinically bothersome nocturia, of 2 or more episodes)
- Studies to elucidate the reason for awakening
- Ways in which to understand, and potentially diminish, the robust effect of placebo/control arms
- Epidemiological research regarding studies of nocturia involving the following aspects: incidence/ natural history, bother, effect on quality of life
- Research regarding what would be a clinically significant improvement
- Further clinical trials examining the impact of sleep focused treatments
- Trials examining the effects of multiple incremental and multicomponent therapies for nocturia
- Algorithms for both initial and subsequent (e.g., cause-specific management of frail elderly, and men versus women would seem to be desirable.

IV. FAECAL INCONTINENCE IN FRAIL OLDER PERSONS

1.1. Background

Faecal Incontinence (FI) in older people is a distressing and social isolating symptom and is associated with a possible increased risk of morbidity [904, 905] and dependency [905-908]. Frailty, defined by having weight loss, and/or limitations to physical activity, along with multi-morbidity may be independent risk

factors for FI in community-based and institutionalised populations of older adults [909-913] Many older individuals with FI will not volunteer the problem to their general practitioner or nurse, and, health care providers do not routinely enquire about the symptom or follow guidelines regarding evaluation and treatment [361, 914, 915]. This 'hidden problem' can therefore lead to a downward spiral of psychological distress, dependency, and poor health. The condition can especially take its toll on informal care providers of home-dwelling patients, [916] with FI being a reason for requesting nursing home placement and even mortality [905, 906, 917, 918].

Even when older people are noted by health care professionals to have FI, the condition is often managed with the use of absorptive or containment products, especially in the long-term care setting where it is most prevalent. Current surveys show that the level of awareness regarding appropriate assessment and treatment options is limited among primary care physicians [919]. The importance of identifying treatable causes of FI in frail older people rather than just managing passively (e.g. pads provision without assessment) is strongly emphasized in national and international guidance, [904, 920] but audits show that adherence to such guidance is generally poor, with non-integrated services, and sub-optimal delivery by professionals of even basic assessment and care [361, 921].

This section covers specific issues for frail older people with FI. Evaluation and management of urinary incontinence and FI should be considered simultaneously given that 40-60% of older adults with and without frailty with urinary incontinence also have fecal incontinence [912, 922-926]. Healthy older people should be managed using the interventions covered in the Chapter 16 "Assessment and Conservative Management of Faecal Incontinence and Quality of Life in Adults."

For the 5th ICI, the literature review covered the period 2008 to 2011. We identified new population-based studies on the prevalence and incidence rates of FI specifically including frail, older adults (see Table 11). Table 11 includes all studies published through from December 2008 through August 2016 which met the following criteria: (1) sample representative of the general population (not a convenience sample or sample recruited from a specialty/primary care medical clinic or other setting in which there is a probable selection bias), (2) sample involving specific models of care for the older adult (i.e., hospital care, home care, long term care), and (3) sample of specific disease or co-morbid condition.

The PUBMED.gov database was searched from December 2011 to August 2016 using the following keywords:

- (i) 'anal, bowel, faecal, fecal' and 'incontinence'
- (ii) constipation
- (iii) 'urinary' and 'incontinence'

(iv) laxatives, enemas, suppositories

(iv) other relevant phrases such as 'comprehensive geriatric assessment' 'stroke'

(v) level of care, 'nursing home,' institutionalisation', long-term care,' 'acute care,' 'hospitalisation'

Additional articles were identified by examining reference lists, and other recent systematic reviews.

1.2. Prevalence and risk factors for FI

Prevalence estimates for FI vary widely: 2.2% to 25% in the general community-dwelling population, 9-30% in older community-dwelling adults, 18% to 33% in acute care settings, and may approach up to 50% in long term care and institutionalised settings [927, 928]. A 2015 systematic review only identified 38 studies with 6 high-quality studies and only 3 studies performed in a representative sample [927]. Incident FI varies from 6% to 17% in community dwelling populations, with less information known about incident rates in specific care settings [929-931]. The variability in the prevalence rates may be related to the case definition and the frequency of FI reported. Case definition may involve frequency of loss and the type of stool consistency or gas, including loss of flatal incontinence, as well as solid and liquid stool. Often, passive FI, or seepage, is not differentiated from solid or liquid stool FI in population-based studies. A few studies have also defined a category of soiling of underwear only. In this review, FI refers to the loss of solid or liquid stool or mucus. Studies are specified that use other definitions, such as flatal incontinence (anal incontinence) or soiling.

Prevalence and incidence estimates of FI in community-dwelling older adults. FI is strongly associated with aging in many studies and studies only involving older adults have higher prevalence estimates. The National Health and Nutrition Examination Survey (NHANES) in the United States (US) provides one of the best estimates of FI prevalence to date because it surveyed both sexes, all major races represented in the US, and a range of older adults by age decade (55-69 and 70 years of age and older) [932, 933]. NHANES also provided separate estimates for different types of FI (e.g., solid, liquid, mucus, and flatus) and frequencies of stool loss. The age-adjusted prevalence of FI (defined as accidental loss of solid, liquid, or mucus incontinence in the month preceding the interview) in the non-institutionalised population of the United States is 8.9% of women and 7.7% of men, with higher rates in older adults (16.6% in adults aged 70 years of age and older, equally prevalent in older men and women) [932, 933]. Liquid stool incontinence was the most common type of FI reported in the NHANES data. Rates of FI in older, frail adults are not sex-specific, with recent studies suggesting equal rates of FI among older men and women [908, 909, 934-938]. Table 11 gives prevalence estimates for FI in older adults where this data is available, but differences in survey methodology make it difficult to interpret or

pool prevalence rates [905, 911, 930, 931, 934, 935, 939-942].

Table 11. Population based surveys of FI prevalence in older adults

Source	Design	Prevalence/Incidence	Risk Factors	Notes
Whitehead et al (2008)[944]	US representative sample of 2229 women and 2079 men, aged 20+ years. FI assessed with the FISI. FI defined as any involuntary loss of mucus, liquid, or solids in the last month.	Prevalence among older adults aged 70+: 15.3% overall No gender differences	Age Loose stool consistency >21 bowel movements/week – women Inability to do activity – women Chronic illnesses – women Poor self-rated health – men Urinary incontinence - men	Cross-sectional, population-based national survey. No subgroup analysis for risk factors in older adults.
Rey et al (2010)[945]	Random sample of 5,400 adults aged 50 yrs and older from Olmstead Co, MN. Respondents (n=1540, 64%) answered questions on FI at baseline in 1993 and 674 responded a mean of 9 years later.	10-year incidence rate was 7% for any FI	Urgency with bowel movements Self-reported diarrhoea Incomplete evacuation Pelvic radiation	Community sample, not population- based No separate analyses by sex Mean age of sample at follow up was 67±9 years
Markland et al (2010)[946]	1000 Medicare beneficiaries age 65+ in 3 counties of Alabama. In-person interviews at baseline and 4- years. Sex/race stratified. FI excluded flatus.	4-year Incidence rates reported. 17% overall for any FI 6% for monthly FI No gender differences	White race/ethnicity - women Chronic diarrhoea – women Urinary incontinence – men and women Depression – women	Population-based longitudinal study with in-person interviews Mean age of 78 ± 5 years
Joh et al (2010)[947]	Convenience-based survey in adult senior centres and health centres in Korea, n=981, mean age 73.6±6.8 years	Prevalence of FI in the previous 3 months, 15.5%. No differences in men and women, p=0.08	Urinary incontinence – men and women Hemorrhoids – men and women Poor self-rated health – men Diabetes – women Infrequent dietary fiber - women	Community sample, not population- based
Sharma et al (2011)[948]	Postal survey of 2000 adults, 18 years and older in New Zealand, mean age 51.6 years	Prevalence of monthly liquid or solid stool was 12.6%	Study did not assess risk factors, only variations in prevalence by 3 scales	No Sex or age group sub-analyses

Source	Design	Prevalence/Incidence	Risk Factors	Notes
AlAmeel (2010)[42]	Population-based Canadian Health and Aging Study, n=8917, among adults 65 years of age and older	4% overall prevalence rate for any FI in the past year	Older age More common among women Poorer self-rated health More dependency in ADLs Cognitive impairment	Population-based study No increased mortality or institutionalization after 10 years when adjusting for all significant confounding factors No separate analyses by sex

New additions to the literature include prevalence estimates of urinary incontinence and FI in populations receiving specialty services in the home, such as home health care/home visits by physicians and other care providers, and in populations receiving hospice care.

Rates of incident (i.e., rate of new onset) FI in non-institutionalised populations have been reported in a few studies [929-931]. These studies surveyed older adults in the community and reported FI incidence rates after 4 years, 6 years, and 9 years, from the initial survey period [929-931]. Incident rates for FI were 17% (95% confidence interval 13.7% to 20.1%) after 4-years in one study (n=557), [930] 9% after 6-years (n=34/252), [929] and 6.3% (95% confidence interval 4.5% to 8.6%) after 9-years in the other (n=683) [931]. For FI occurring at least monthly, the incidence rate was 6% (95% confidence interval 4.0% to 8.3%) after 4-years [930]. Differing FI incidence rates may be due to the age range of those surveyed at baseline. In the Markland et al and Nuotio et al studies, the average age of those surveyed was greater than 70 years of age at 4-years and 6 years, whereas the Rey et al study surveyed adults 50 years and older at baseline.

Prevalence estimates of FI in hospitalised older adults. Like the variability of prevalence rates of FI in community-dwelling population, hospitalised older adult populations also vary depending on the type of acute care setting or hospital setting, type of populations being studied (i.e. those under surveillance for certain types of infections), and duration of the hospital stay. Rates of FI in hospital or acute care settings range from 6-33%. In one study, the rates of FI in the acute care setting for adults (mean age of 67 years) was 33% (50/152 with diarrhoea under surveillance for infections) [943]. In another study, FI (17.6%) was almost as common as urinary incontinence (19.7%) in 608 hospitalised adults (age range 4 years to over 80 years). [944] Another study reported FI occurring in 20% (n=221/1083) hospitalised adults and an increased rate in the intensive care unit setting [945]. Loose stool or watery stool, along with medications, were associated with FI [945]. Older age was associated with increased rates of FI in hospitalised adults [944-946].

Prevalence estimates among older adults receiving home health care. Many older adults receive health care services in the home setting or in a residential setting due to acute or chronic illnesses that are associated with being home bound or needing supportive care. These older adults are considered more independent with supportive care rather than those in long-term care or nursing home settings who require skilled care. Less is known about FI these frail older adults [928]. Using the Outcome and Assessment Information Set (OASIS), a standardised and administrative assessment tool used to document patient needs in home care settings in the United States, urinary incontinence was identified in 27%-33% of

home health care patients and 7%-9% had FI on admission to the home health agency/provider [947]. The Centers for Disease Control (CDC) and the National Center for Health Statistics published a report in 2014 that compares prevalence rates of urinary incontinence, FI, and having both urinary and fecal incontinence across 4 different US representative surveys: NHANES (reported above), the National Home Health and Hospice Care Survey (NHHCS), the National Survey of Residential Care Facilities (NSCRF), and from Long-term Care Data using the Resident Assessment Instrument - Minimum Data Set (MDS) [928]. Rates of any FI reported by home health agency providers was 49% from the NHHCS. FI rates were higher among older adults receiving home health care who resided in residential facilities and long term care (33%) than those residing in a private home or apartment (13%). Similar patterns for FI were seen in older adults receiving hospice care. FI rates were higher among older adults receiving hospice care who resided in residential facilities and long term care (66%) and those in a hospital hospice setting (70%), than those residing in a private home or apartment (41%).

Prevalence and incidence estimates of FI in long-term care residents. Additional studies were identified that reported prevalence rates of FI in nursing home or long-term care resident facilities [913, 928, 948, 949]. Data are limited by the type of facility or type of data used to report FI rates [922, 950-954]. Recent FI prevalence studies confirm high prevalence ranges of FI occurring at least weekly or more often, which varies from 40-57% of long-term care residents [913, 928, 948-951, 955]. However, one recent study using MDS data reported differences in FI prevalence rates from nursing home residents with short-term stays (33%) compared to long-term care (60%) [928]. Little is known about the FI incidence rate in this specific population of frail adults, with rates reported as 20% during a 10-month period after admission for long-term care [918].

Faecal incontinence in older adults – the “hidden” problem. Recent evidence re-affirms that about 30% of adults with FI seek care and that health care practitioners are not likely to inquire or document discussions regarding FI [361, 915, 917, 919, 956, 957]. Increasing awareness is important aspect of the identification, prevention, and treatment of FI in older adults [904]. Using appropriate terminology for FI for individuals that is consistent with health literacy levels may be an important factor. Terminology such as “bowel” or “accidental bowel leakage” may be more appropriate than the term “faecal” or “faecal incontinence” [958]. Barriers that prevent adequate identification and treatment include: social and cultural issues about discussing symptoms, duration of symptoms, perception that treatments may not exist, access to trained health care providers in the community, access to providers in long-term care settings, and access to training and treatment protocols. Given the high prevalence rates of FI in the hospital, home

care, and long term care settings, health care practitioners should directly inquire or directly observe bowel control issues and document any findings. Other high risk groups of older adults that should be questioned about bowel control include older adults that have: mobility problems, cognitive impairment/dementia, frailty syndrome, prior pelvic/lower abdominal radiation exposure, prior anal or rectal surgery, urinary incontinence, chronic constipation, chronic diarrhoea, and older adults with multi-morbidity.

Risk factors associated with FI in older adults.

Age has been established as a risk factor for FI in many population-based studies [908, 925, 934, 959]. Other factors that have been associated with increased rates of FI include: female gender, co-existence of UI, poor general health, physical limitations, cognitive impairment, stool consistency, prior colorectal surgery, and high body mass index [960-964]. However, among population-based studies among older adults, risk factors specific to women (e.g. vaginal deliveries, parturition characteristics) are no longer significantly associated with FI when controlling for all other factor [934, 965]. Many diseases and co-morbid disorders are associated with FI and include: diabetes, dementia-related incontinence, irritable bowel syndrome, inflammatory bowel disease, systemic sclerosis, and neurological diseases, such as cerebrovascular disease [908, 931, 960, 966-970]. The association between faecal incontinence and loose stool consistency (diarrhoea) is robust in community-dwelling populations and nursing home studies [930, 931, 934, 952, 964, 965]. As supported by the epidemiological data, the etiology of faecal incontinence remains multifactorial and treatment depends on the underlying mechanisms or specific co-morbid disorders, as well as the overall burden of multimorbidity including medications used to manage multiple chronic disorders..

Frailty and Multi-morbidity as Risk Factors for FI in older adults. Frailty and multi-morbidity are not often studied as associated factors for FI in representative samples. However, some representative studies have included an evaluation of functional dependency, mobility, multi-morbidity, and other markers of frailty among older women [911, 912, 942].

1.3. Anorectal function in older adults

The pathophysiology of FI is covered elsewhere, this section considers factors physiological factors specific to frail older people.

Quality of the data

Physiological studies of the lower bowel in older adults tend to be variable due to a) a variety of different techniques used in measuring anorectal function, b) unclear definition of the normative range of manometric measures for older people, c) poor matching between cases and controls of clinical factors which may affect gut function (e.g. level of mobility or functional status), or inadequate clinical information, d)

usually small subject numbers, e) few studies deal with subjects over 80 years, and f) improvements in imaging quality with anorectal manometry with new 3-dimensional equipment, endoanal ultrasound, and MRI with and without defecography [971-974]. Studies reviewed are cohort case-control to evaluate age-effect,[975-982] young-old healthy subject comparisons,[983-986] and age- and sex-matched case-control studies of continent versus incontinent patients [987, 988].

Anorectal Function in Healthy Older Adults

Studies of age effect in healthy volunteers have shown a linear reduction with ageing in squeeze pressures (external anal sphincter tone) in women after the age of 70, and in men from the 9th decade onwards [982]. Studies of normal men and women demonstrated a significant but similar linear decrease in anal resting pressure and maximum squeeze pressures in both men and women with increasing age [986, 989]. Studies of asymptomatic females showed a significant decrease in both anal resting and squeeze pressures with age [989, 990]. Two studies comparing young and old continent women found a decrease in anal resting pressure but no decrease in squeeze pressures between the two groups [977, 984]. Age beyond 70 years was associated with reduction in anal resting pressures (internal anal sphincter tone) in both sexes, but to a greater degree in women than men,[980, 982] but not reaching statistical significance [991].

Rectal sensory thresholds may also decrease with aging in healthy older adults despite normal compliance and tone [985]. There was a significant increase in pudendal nerve latencies with age in women; [981] however, clinical practice guidelines do not recommend testing pudendal nerve latencies [992]. In patients older than 65 years there is >30% loss of enteric neurones when compared to people aged 20 to 35 years. This loss is associated with an increase in fatty tissue deposition [866][993]. Increase in thickness of internal sphincter may be related to an increase in collagen deposition, with increased thickness seen in older versus younger women and in older nulliparous women [979, 984]. In addition, the increase in internal sphincter thickness was associated with a significant decrease in the external anal sphincter thickness in women [863] [864][994, 995]. A study of men and women using endoanal MR imaging showed a significant decrease in the external anal sphincter thickness in men but not women with age [996].

Other studies in humans have found increases in elastin and collagen deposition in the myenteric plexus in the colon. It is unclear if rectal motility is affected by healthy aging, [997] but there is an age-related increase in anorectal sensitivity thresholds [981, 985, 986]. Rectal compliance was not affected in one study but reduced rectal sensation was associated with reduced rectal compliance in another [985] [989]. Other studies have evaluated the impact

of the relationship of glycaemic control on gastric emptying and found that fasting blood glucose levels were associated with faster gastric emptying [998].

Gut microbiome and metabolome studies in older adults show that diet and antibiotic usage have an impact on gut microbiome and metabolome findings [999, 1000]. Older adults residing in long-term care have less variation in the gut microbiome compared to older adults in the community [1001]. These changes in the gut microbiome from older adults in long-term care settings may also be influenced by diet and inflammatory biomarkers [1001].

Anorectal function in older adults with faecal incontinence. Studies have reported an age-related increase in pudendal neuropathy in incontinent women, that may be unrelated to squeeze pressures [872][1002, 1003]. A study comparing anorectal function in young (mean age 42) and old (mean age 72) women with FI (patients with constipation and/or pelvic floor dysfunction excluded) showed that older women were more likely to have bilateral pudendal neuropathy, but less likely to have a sphincter deficiency of >90 degree and less likely to have had a previous sphincteroplasty [983]. Anorectal function in older incontinent patients and continent age- and sex-matched controls showed that individuals with FI had reduced anal resting pressures [984, 1004]. In one study comparing 8 older incontinent women (mean age 71.6 SD 7.5) with 9 older continent women (mean age 71.6 SD 7.5) and 9 younger continent women (mean age 28.7 SD (7.3) found women with FI were more likely to have decreased maximum squeeze pressures and levator ani (LA) defects [1005]. Older FI females tolerated lower balloon anorectal manometry volumes before urge to defaecate indicative of rectal hypersensitivity [984].

1.4. Causes of faecal incontinence in older adults

Stool consistency is important aspect of determining the cause and the associated factors for the evaluation of FI in an older adult [930, 931, 965]. Loose, as well as hard, stool can be related to FI in frail, older adults [918, 951, 1006]. Evidence shows that loose stool consistency and chronic diarrhoea are important contributing factors for FI [930, 931, 934, 952, 965]. Loose stool and chronic diarrhoea can result from multiple causes, such as malabsorption syndromes (e.g., lactose intolerance, gluten sensitivity, and fat-malabsorption), acute diarrhoeal illnesses, microcytic colitis, irritable bowel syndrome – with diarrhoea predominant symptoms, and other causes of chronic diarrhoea. Any change in stool consistency along with other warning symptoms (weight loss, bloody stools, change in stool calibre, and painful defaecation) should prompt further evaluation for colorectal cancer. Potential reversible causes of loose stools may include: excessive laxative use, lactose intolerance, drug-related side-effects, bacterial overgrowth, and possible bowel obstruction with “overflow” FI. “Overflow” FI secondary to constipation and stool impaction

is also important to consider in older adults, potentially more common in men than women, [1007, 1008] those with mobility problems, [951, 1006, 1009] and those that reside in nursing home settings [951, 1009].

Overflow incontinence or FI that results from stool impaction can be difficult to diagnose, may be more common in certain frail, older populations, and should be evaluated and treated when suspected. Evidence suggests that constipation and symptoms of constipation are common among nursing home residents with FI [951, 1009, 1010]. However, the true prevalence of impaction and FI in nursing home residents is not clearly identified. Constipation (according to bowel movement frequency) and associated symptoms (straining and incomplete evacuation) were common among nursing home residents in a 4-site randomised controlled trial to improve FI and urinary incontinence among nursing home resident by giving a multi-component intervention involving toileting assistance, exercise, and dietary snacks [951]. At baseline, 81% of the 111 nursing home study participants had less than 3 bowel movements in 5 days. Another study that identified factors associated with FI in different health care settings found that 70% of nursing home residents experienced “fecal loading” compared to 63% in rehabilitation wards, 57% in acute care wards, and 20% in the home care setting [1009].

Urgency associated with bowel movements is also an important bowel-related factor that should be assessed in older adults. Many studies do not evaluate urgency as an independent risk factor. However, among the studies that evaluated a sense of urgency associated with bowel movements, urgency consistently is strongly related to FI and having a negative impact on quality of life even after controlling for other known confounding factors [931, 1011, 1012].

Other bowel-related disorders or complications of prior anorectal surgery and radiation can contribute to FI in older adults who otherwise would be continent, especially when functional status, mobility and cognition become impaired. Other bowel related disorders that have been associated with FI in adults (but not limited to frail older adults) include: haemorrhoids, [983, 1007] posterior compartment prolapse (rectocele), [965] inflammatory bowel disease, [1013] and irritable bowel disease [965, 1014]. Types of prior anorectal surgery that contribute to FI include: haemorrhoid surgery, [1007] prior fistula repair, [1015, 1016] sphincterotomy for anal fissures, [1017] partial or total colectomy, [1018] low anorectal resection and re-anastomosis for colorectal cancer, [1019, 1020] prostatectomy, [937] and prior pelvic/perineal radiation [937, 1021]. All of these bowel-related disorders, surgeries, and radiation should be part of the focused history in older adults with FI. More studies are needed to identify causal pathways for FI in the older adult.

Functional FI, as defined by mobility problems or restraints that restrict accessibility to the toilet despite

normal bowel sensation and capacity, is also cited as a common reason for FI in epidemiological studies among community-dwelling older adults and those in residing in nursing homes [909-911, 918, 924, 942, 952-954, 1022-1024].

Other causes of FI in older adults can be related to **co-morbid chronic disorders, increased body mass index, and multimorbidity**, especially diabetes and neurological disease, which increases the risk having FI. Even after adjusting for age and sex, **diabetes mellitus** is associated with gastrointestinal symptoms including FI in population-based studies, [936, 968, 1025] nursing home residents, [1024] and has been associated with impaired rectal sensitivity and sphincter weakness [966]. **Neurological diseases** that contribute to FI in older adults include cognitive impairment, stroke, traumatic brain injury, and sacral cord dysfunction. Older adults are living longer with significant neurological conditions. Cognitive impairment and dementia have been found to be independent risk factors with FI in older adult populations from epidemiological studies and among those in nursing homes [918, 924, 937, 952]. Having a stroke is an important risk factor for FI with three and half times the rate of FI compared to adults who did not have a stroke in one population-based study [1026]. FI affects 30-56% of stroke survivors in acute period after having a stroke (1-30 days), with a lower prevalence (11%) of FI after 3-months, and 11-22% at 12-months following the initial stroke event [967, 1027]. It is unclear whether the functional disability from having a stroke or that the disruption in neurological pathways (sensory mechanisms) that promote continence contributes more to FI among stroke survivors. Traumatic brain injury has also been linked with urinary incontinence and FI, but limited data exist on older adults from registry studies and single site studies [1028, 1029]. Spinal cord injury (depending on the level of injury) may result in impaired muscular strength of the external anal sphincter, delayed transit time, abnormal defaecation reflexes, and impaired sensation [1030].

Summary of evidence for prevalence and risk factors for FI in frail older people

Summarised below are key points that are specific to the frail elderly population. The level of evidence is given in brackets.

- FI affects 1 in 5 older people (aged 65+) living in the community and in residential care facilities, and half of those residing in long-term care homes [LoE1]
- The prevalence of FI increases with age alone, particularly in the 8th decade and beyond [LoE1]
- The prevalence of FI is higher in the acute hospital, and nursing home setting than in the community [LoE 1], thus the group most affected is frail older people.

- The prevalence of FI in frail older men is equal to or greater than in women in the community and in long-term care residents [LoE 2].
- The prevalence of FI varies dramatically between institutions in nursing home studies due to measurement differences [LoE 2].
- FI usually coexists with urinary incontinence in frail older people [LoE 1]
- Aside from age, the following are primary risk factors for FI in older people [LoE 2]:
 - Stool consistency -- Loose stool
 - Bowel-related disorders, such as prior rectal surgery
 - Impaired mobility
 - Functional impairment
 - Dementia
 - Neurological disease
 - Diabetes mellitus
 - Chronic medical conditions
 - Depression
- Loose stool or diarrhoea may be a cause of transient FI in older people, if the diarrhoea is evaluated and treated [LoE 2]
- Faecal loading and constipation are clinically linked to FI, but there is little epidemiological work assessing this association [LoE 3]
- Physicians and nurses in primary care, acute hospital, and long-term health care settings do not have a high awareness of FI in older people [LoE 2]
- Within nursing homes, there is a low rate of referral by nursing staff of residents to primary care physicians or continence nurse specialists for further assessment of FI [LoE 2], and there is a tendency toward passive management (e.g. use of pads only without further evaluation) [LoE 2]. Faecal loading is often present in older care home residents with FI [LoE 2]
- Older people may be reluctant to volunteer the symptoms of FI to their health care provider for social or cultural reasons, or due to a popular misperception that the condition is part of the aging process and therefore 'nothing can be done about it' [LoE 2]
- FI is associated with reduced quality of life, and poor health perception [LoE 2]

Recommendations – identifying faecal incontinence in frail older people

Bowel continence status should be established by *direct questioning and/or direct observation* in:

- all nursing/long-term care and residential home residents
- hospital inpatients aged 65 and over
- people aged 80 and beyond living at home

- older adults with impaired mobility
- older adults with impaired cognition
- older adults with neurological disease
- older adults with chronic disease, especially diabetes
- older adults with constipation
- Primary care staff, hospital ward staff, home health staff, and long-term care staff should routinely enquire about FI in frail older patients
- Enquiry about FI should be systematic and include stool consistency, severity of FI and impact on activities of daily living and quality of life
- Health care providers should be sensitive to cultural and social barriers discouraging patients from talking about the condition
- Frail older patients with restricted ability to access primary care such as nursing home residents, and those with mobility, chronic illness, or cognitive impairment, should be screened for FI through systematic case-finding methods
- Systematic outreach programmes which make it easier for frail older people and those who care for them to volunteer the problem to their primary care provider should be implemented
- There are significant geographic variations in provision of specialist expertise in bowel care (both medical and nursing) nationally and globally, which may affect case-finding in older people
- Further examination of underlying reasons for the variations in prevalence of FI between nursing homes (standards of care, patient case-mix, reporting) is needed
- Urinary and FI often coexist; continence care workers (e.g. nurse specialists) should be trained in identification and management of fecal as well as urinary incontinence in older people
- Key requirements to improving detection in the practice setting should be implemented:
 - education of health care workers to embed both a sense of value in identifying FI, plus confidence that the condition can be treated
 - protocols should be in place clarifying all details of screening enquiry (who will ask, how to ask, when to ask, and who to ask)
 - patients and caregivers should have access to educational materials at the point of enquiry

1.5. Evaluation of FI in frail older adults

The algorithm contained in this chapter delineates a systematic approach to the clinical evaluation of frail older people with FI.

An initial assessment can be undertaken by any suitably trained health care practitioner, often this will be by either a physician or clinical nurse specialist. In the majority of cases, a clinical history of bowel symptoms, dietary assessment, [1031] and symptom evaluation will provide sufficient diagnostic information upon which to base further management. There are available questionnaires which can assist in this process, although psychometric validation of specific instruments to assess FI severity and impact on quality of life in frail older adults compared to healthy adults are not available. Bowel diaries, including assessments of stool consistency, may also be useful to diagnose the type and frequency of FI [1032]. Self reports of bowel symptoms are reliable and reproducible in older people, including those in long term care [1033].

The use of formal testing is hampered by both lack of relevant data from frail older people and the poor correlation between symptoms and abnormalities [971, 972, 977, 1034-1036]. Evidence that the assessment of faecal incontinence in older people is poorly done despite the existence of guidelines has been a persistent finding throughout the history of this chapter [361, 1037]. What actions need to be taken to ensure that older people receive assessments which are consistent with current guidelines remain to be defined.

Digital rectal examination can assess resting anal sphincter tone, muscle isolation, and squeeze pressure and appears to be as good as sphincter manometry in discriminating continent from incontinent people, although not the frail elderly [1038]. Constipated patients with an empty rectum on digital examination may have high impaction and need further radiological evaluation. Abdominal radiographs to assess the extent of faecal loading and to rule out an obstruction or sigmoid volvulus could be considered. For adults with FI, it is important that current guidelines for colon cancer screening be followed, along with careful consideration of screening in older adults with limited life expectancy [1039, 1040]. While a change in bowel habits with weight loss, anaemia, rectal pain and rectal bleeding should raise the suspicion of an underlying malignancy, prior review of colonoscopy findings and discussion with gastroenterologists for further testing may be warranted. The symptom of FI and chronic constipation does not usually warrant colonoscopic investigation, however, little data exist to guide evaluation in frail older adults. Given the increased difficulty of adequately preparing frail older people for either endoscopy or barium studies and potential increased risks of hyponatraemia with hospitalisation [1041, 1042]; CT colonography may be considered as an alternative investigation where available [1040].

Evaluation of the capacity to successfully toilet should include an assessment of mobility, visual acuity, manual dexterity and cognition. If acceptable to the older person, observing the process of transferring to the toilet, manage their clothing, redress and leave the lavatory is a good measure of ability. Caregivers

should additionally be aware of the surroundings in which the frail older person lives in terms of access, lighting, distance and clutter. The design of commodes should also be considered in the light of the individual's capabilities.

Faecal incontinence is also associated with incontinence-associated dermatitis and with the development of pressure ulcers in older people with impaired mobility although whether this is a causal association is debatable, [1043, 1044] however, an assessment of skin integrity and provision of appropriate pressure relief is important. A pelvic examination to rule out rectal prolapse and posterior compartment vaginal prolapse is also important given the association between FI and prolapse in women [1045-1047].

1.6. Treatment of FI in frail older adults

Quality of data

Trials discussed are based on prior chapter findings, Cochrane reviews for nonsurgical and surgical treatments for FI, [1048-1052] clinical practice guidelines, [920, 992] expert consensus statements, [1053] meta-analysis, [1054] and systematic reviews, including a recent Agency for Healthcare Research and Quality Systematic Review that included studies and case series published from 1980 to June 2015 [1055-1057]. No trials were identified on the prevention of FI in high risk, older adults. Many FI intervention studies have small sample sizes, inadequate power to detect clinically meaningful difference in outcomes, and biased methodology along with low strength of evidence ratings. Given these limitations, FI treatments applicable to older adults were considered and include: multi-component behavioural treatments for FI, pharmacological treatments for FI, treatments aimed at specific populations of older adults (e.g. nursing home populations and neurological conditions), anal bulking injections, transcutaneous and percutaneous tibial nerve stimulation, bowel-control devices, and less-invasive surgical options. Issues related to more invasive surgery, containment with absorptive products, and skin care are discussed in other chapters.

Multi-component biofeedback and behavioural treatments for FI. Given the multifactorial causes for FI in older adults, few studies exist in the literature involving multi-component interventions. In 2012 and 2013 the Cochrane group updated three reports showing a limited number of trials for FI with methodological weaknesses do not allow for a definitive assessment of the role of pelvic floor muscle training and/or biofeedback, pharmacological therapy in the treatment of FI, or the treatment of FI and constipation in adults with central neurological diseases [1048, 1050, 1051].

The Cochrane report on biofeedback and sphincter exercises also noted that some evidence does exist that biofeedback and electric stimulation may enhance the outcome to treatment with pelvic floor muscle exercises compared to exercises alone or sham

treatment [1050]. In a 2016 AHRQ systematic review report, 63 nonsurgical studies were identified with 38 being randomised controlled trials (RCTs). Of the 38 RCTs, 13 evaluated biofeedback and pelvic floor muscle therapy (PFMT) [1055]. The AHRQ report concluded that PFMT and biofeedback with electrostimulation was no more effective than PFMT with biofeedback alone. The report also concluded that more research is needed to establish whether PFMT and biofeedback works for FI. Outcome measures varied considerably in the RCTs and did not allow further evaluation with meta-analysis. Few RCTs exist that treat frail, older adults with PFMT-BF.

Pharmacological treatments for FI. New low-strength evidence exists that psyllium may be beneficial compared to placebo for improving FI episodes (n=206, mean age 55-60 years per randomisation group) [1058] and psyllium was better tolerated while having no differences in efficacy compared to loperamide for improving FI episodes (n=80, mean age 61 ±10 years) [1059]. Overall, the AHRQ report identified few trials with outcomes past 3- or 6-months. Most RCTs evaluated symptoms in middle-aged women. According to the AHRQ review evidence was treatment benefit was insufficient for loperamide, topical phenylephrine, zinc-aluminum ointment, oestrogen cream, and valproate sodium. Clonidine given orally was not effective for improving FI severity compared to placebo (n=44). One small RCT (n=64 women, median age 58, range 27-78 years) evaluated biofeedback compared to loperamide then both groups had combined treatment [1060]. The authors concluded that combined treatment was superior to either treatment alone, but variable times for the interventions and sample size limit these conclusions [1060].

Small studies have also evaluated the safety of a new adrenergic alpha-1 receptor agonist suppository, NRL001, for FI treatment in adults, with safety data in older participants [1061, 1062]. Results from a 4 group parallel designed placebo-controlled RCT (n=446, mean age 62.1 years) did show difference in FI severity scores after 8 weeks of treatment with 3 different dosages of the alpha-1 receptor agonist suppository compared to placebo [1063]. Evidence for pharmacological treatments for improving FI in community-dwelling frail older adults with cognitive or functional impairment was not found.

Treatment of FI in long-term care/nursing home settings. Treatments for FI in long-term care settings also involved the treatment of constipation and faecal loading or faecal impaction. In a French study among 206 nursing home residents in 4 different homes, lactulose alone was compared to lactulose plus daily suppositories along with weekly tap-water enemas for reducing FI episodes. Although there were no differences between the two groups, residents that achieved complete rectal emptying also reduced the number of FI episodes by 35% while also reducing staff workload by 42% (soiled laundry counts) [1010]. Schnelle et al (2010) completed a multi-centre, multi-

component intervention for improving FI and constipation in cognitively impaired nursing home residents (n=112, mean age 86 ± 10 years) [955]. In this controlled trial in 6 United States nursing homes (n=112), the intervention was compared to a usual care control group. The intervention group received toileting assistance, exercise, and choice of food/fluid snacks every 2 hours for 8 hours/day for 3 months. Participants in the intervention group compared to the usual care control group had improvements in bowel movement frequency and the percentage of bowel movements in the toilet (p<0.01), but not the frequency of FI episodes determined by direct checks from research staff. Urinary incontinence episodes also improved with this intervention (p<0.05). Among the 29 nursing home residents who had anorectal manometry, a dyssynergic defaecation pattern was identified in 89%. The authors concluded that this multi-component intervention improved some factors associated with FI in nursing home residents, but further work to improve stool consistency and treatments for dyssynergia may be warranted.

Additional work is ongoing to improve nursing education, evaluation, and treatment of FI in long-term care settings [1064, 1065]. By improving knowledge of nursing staff, outcomes related to FI management and treatment may also improve [1064].

Treatment of FI in Adults with Neurological Conditions The 2013 Cochrane report on the treatment of FI and constipation in adults reviewed evidence from 20 clinical trials involving 902 adults [1048]. From this review, the conclusion was “remarkably little research” and “low methodological quality” evidence exists on bowel management in specific neurological conditions. Most of trials are single-site, measuring outcomes against control and without comparative effectiveness data. Individuals trials did report symptom improvement using bulk-forming laxative (psyllium) in Parkinson’s disease, an isosmotic macrogol laxative to manage bowel symptoms, abdominal massage, electrical stimulation and an anticholinesterase-anticholinergic drug combination (neostigmine-glycopyrrolate) in spinal cord injury compared to no treatment or controls. There was also evidence in favour of transanal irrigation (compared to conservative management) in spinal cord injury, oral carbonated (rather than tap) water, and abdominal massage with lifestyle advice (compared to lifestyle advice alone) in stroke survivors [1048]. In a 2015 RCT among 200 bedridden acute care patients with neurological impairments such as cerebral infarction, traumatic or spontaneous cerebral haemorrhage, intracranial infection, myelitis, and brain tumour, a suspension positioning system similar to that used for immobilised patients with pelvic fractures was evaluated for improvements in FI compared to usual care. Usual care consisted of nursing care for dietary modifications, health education, and social support for caregivers and family treating FI. Rates of perianal faecal contamination, skin breakdown, incontinence associated dermatitis, pressure ulcer development, and urinary tract infection (UTI) were significantly lower in

the suspension positioning system than in the usual care group (p<0.05) at 6-months after treatment [1066].

Perianal injectable bulking agents for the treatment of FI have data limited to healthy adult populations with limited data related to older, frail adults [1052, 1055]. Use of dextranomer tissue-bulking injections were more effective than sham injections for improving FI-free days, 50% reductions in FI episodes and quality of life (n=206, mean age 61 years, age range for recruitment 18-75 years), but not more effective than pelvic floor muscle exercises and biofeedback (n=126) [1055, 1067, 1068].

Percutaneous tibial nerve stimulation (PTNS) for FI compared to sham stimulation has RCT evidence (n=227) [1069]. After 12-weeks of treatment, PTNS (n=115) and sham (n=112) groups had improvements in participants (mean age 58 years) who had at least a 50% reduction in FI episodes without any difference between the groups (38% vs 31%, respectively, p=0.4). However, participants in the PTNS did have some improvements in the total number of FI episodes (p=0.02) and the urge FI episodes (p=0.02) compared to those in the sham stimulation group. In one other pilot study in older adults (mean age 84.2 ± 10 years), transcutaneous posterior tibial nerve stimulation (TPTNS) or sham stimulation was given weekly for 12-weeks to older adults (n=30) in residential care homes. Lower urinary tract symptoms improved during the pilot study, but the rates of improvement in bowel leakage did not meet thresholds for statistical improvement (47% in the TPTNS group, 27% in the sham group, p=0.11) [1070].

Other Nonsurgical Management Options include use of anal plugs and a vaginal bowel control device. Anal plugs (n=76) [1071] and a new vaginal bowel control device (n=110) [1072] have prospective trial data showing improvements in 50% reduction of FI episodes, overall FI episodes, and quality of life. But, sub-group analyses of older adults in either study were not described.

Less invasive surgical management for FI includes sacral nerve modulation and antegrade continence enemas. Sacral Nerve Stimulation has prospective multi-centre trial data showing significant improvements in FI episodes, symptoms, and quality of life compared to baseline measurements [1073]. In the larger studies with data at 2- and 3-years, the mean ages were 54.3 ± 11.3 and 60.5 years (range 30-88 years) without subgroup data from older age participants [1074-1076]. Evaluating and selecting older adults and adults with specific neurological conditions who may benefit from permanent implantation is an important consideration [1077, 1078]. Data on sacral neuromodulation for FI and surgical outcomes including adverse events for frail, older adults are limited [1079]. Other less invasive surgical options include the antegrade continence enemata involving the creation of a proximal colonic stoma to use for the

enema to promote lower bowel evacuation [1057]. There are no data on older adults.

Summary of evidence treatment of FI in frail older people

- Current evidence shows that stimulant laxatives, osmolar laxatives (PEG and lactulose), suppositories and enemas can be effective in treating faecal impaction in older people at risk of overflow [LoE2] . *Included in 5th ICI chapter*
- Complete rectal clearance is required to reduce overflow FI [LoE2] but may be hard to achieve in frail older patients [LoE 2].
- Structured multi-component approaches to bowel care did not reduce the frequency of FI in the nursing home setting, but did improve bowel frequency and number of bowel movements in the toilet [LoE 2]
- Older people with FI may benefit from biofeedback and sphincter strengthening exercises if they are able to comply [LoE 3]
- Loperamide can reduce frequency of FI, particularly when associated with loose stool (once infection and other causes have been excluded) but should be used with caution [LoE 2]
- Additional fibre supplementation to loperamide may not improve FI outcomes [LoE 2]
- Multi-component structured nurse-led assessment and intervention can improve bowel symptoms and alter bowel-related habits in older stroke patients [LoE 2].
- More data are needed on the use of sacral neuromodulation in specific higher risk older age populations.

Recommendations: treatment of FI in frail older people

All following recommendations are Grade C

- Patients identified as having constipation with overflow should have effective bowel clearance (using a combination of laxatives and enemas), and then maintenance therapy with stimulant or osmotic laxatives *Included from 5th ICI chapter*
- Suppositories are useful in treating rectal outlet delay and preventing recurrent rectal impaction with regular use
- Loperamide is a useful treatment in FI, in the absence of constipation, but should be used with caution in older adults
- Causes of loose stool must be identified and treated.

- All frail older people with FI should have structured multidisciplinary assessment and treatment of their bowel problem.

- Patient and caregiver education (using verbal and written materials) should be undertaken to promote self-efficacy and other coping mechanisms, and where appropriate self-management (e.g. reducing risk of constipation and impaction through dietary and lifestyle measures, advice on how to take loperamide). Advice on skin care, odour control, and continence aids is also important.

- Privacy and dignity of care during defecation should be afforded to all older people in institutionalised settings. Particular attention should be paid to this in patients with FI, as privacy may be relatively overlooked in their care.

- Greater emphasis needs to be placed on systematic and effective management of FI in older people backed up by sound communications between all health care providers, especially in the nursing home and acute hospital setting.

- Education of health care providers with regards to heightening awareness of the problem plus methods of identification, assessment and management of FI in older people should be broad-ranging and include geriatricians, general practitioners, hospital physicians, hospital, community, general practice and long-term care nurses, and related disciplines (physiotherapists, occupational therapists, dieticians, pharmacists).

- Cyclical national audit with provider accountability, of current practice in managing FI in older people is needed to lay the ground-work for standardised care, and provide a culture of continuous quality improvement. Such audit tools should be developed using standardised consensus methods. Incentives to providers could be benchmarking their practice against national averages, opportunities to share successful practice change strategies, and professional validation linked to good practice.

Recommendations for research

- Trials of laxative and nonpharmacological treatment and prevention of faecal impaction and overflow are needed to optimise standards of prescribing and care.
- Multicomponent interventions to treat FI in frail older people should be evaluated to assess effective ways of FI management in acute care settings
- Multidisciplinary study assessing the feasibility and efficacy of a step-wise approach to the management of dementia-related FI in nursing home residents (prompted toileting in those with mild to moderate dementia, scheduled toileting plus

suppositories next step, and a bowel programme of controlled evacuation in those with persistent incontinence) would provide useful evidence

- it is important to balance feasibility and practicality in clinical trials versus high strength intervention, i.e. a team of specialist continence nurses in nursing homes are likely to have an impact, but at what cost, and what carry-over will there be when they are gone? Other methods (e.g. pre-post with multivariate case-mix adjustment) should also be considered.
- Evaluation of case-finding methods for FI in different settings including the fundamentals of staff education, screening protocols, patient's educational information would be very informative.
- Testing the feasibility of providing an integrative approach to assessment of FI in the frail older person, including a range of health and social care providers and different health care settings (acute, intermediate or sub-acute, long-term care and community) would be relevant to national implementation of bowel care improvement programmes.
- Examination of the variability of FI rates between nursing homes within single nation states, (taking into consideration case-mix) will highlight problems areas both organisationally and clinically. Nursing home administrative factors such as resident:nurse staff ratios should be evaluated as a contributing factor to FI.
- Further epidemiological studies are required to document causes of FI in frail older people in different health care settings. Such studies should include evaluation of unmet need for patients and caregivers.
- Evaluation of aetiologies, and in particular the pathophysiological basis for high prevalence of FI in older men. Evaluation of potentially preventable causes of loose stools in institutionalised older people, and impact of their treatment on FI.
- Nurse-led initiatives are needed to develop care pathways for assessing of bowel problems in frail older people with a view to establishing integrated service delivery.
- Examine the research question, 'Do educational interventions by health care providers to informal caregivers of home-dwelling older people with FI reduce caregiver burden and improve quality of life for patient and caregiver?'

V. CONTINENCE AT THE END OF LIFE

1.1. Background

Excluding those who die suddenly, most people will experience UI at the end of life [1080-1082] and many will experience FI [1083-1085]. In this section, we consider the specific incontinence issues faced by these patients and their caregivers, focusing on the last weeks and days of life.

Although incontinence is experienced by most people at the end of life, very little is known about the impact that it has or about preferences for care. We found no evidence to support any particular approach to assessment or any management or care interventions. Care at the end of life has much in common with care of the frail elderly, including a focus on maintaining quality of life, and much of this chapter is relevant to end of life care. However, end of life care is characterised by an increasing prevalence of incontinence or toileting difficulties [1084, 1085] and is likely to progressively focus on symptom management and comfort, rather than actively treating underlying causes.

1.2. Quality of data

Given the overall low level of research in end of life care and the methodological difficulties faced by researchers are well acknowledged [1086-1088], the lack of studies on incontinence at this life stage should not be surprising. The only area where relevant large scale studies were found was in the assessment of prevalence of incontinence at the end of life. The only literature found to focus on the assessment or management of incontinence at the end of life were local audits, expert opinions and literature reviews.

1.3. Prevalence and impact

High rates of incontinence at the end of life are associated with functional and cognitive decline, with additional impact from curative and palliative treatment [1089-1091]. Prevalence of UI and FI in the last weeks and months of life varies by diagnosis and proximity to death, with significant correlation with both physical and cognitive functional decline [1080].

In a study of over 7000 community dwelling adults in the last year of life from 1998 to 2010, Singer and colleagues (2015) [1082] found that in the last year of life patients experiencing a period of at least one month with UI or FI ranged from 43.9 to 47.6. Prevalence varied by decedent, with sudden death associated with lowest rate (range 28.6-37.0%) and frailty the highest (65.3 – 67.2%). For patients with dementia, McCarthy et al (1997)[1092] reported a rate of 72% of a sample of 170 patients experienced UI in the final year of life.

Closer to the point of death, rates of incontinence rise. In a retrospective review of medical notes for the last

3 months of life for 229 patients, Jakobsson and colleagues (2008) [1080] found 56.8% experienced urinary incontinence, rising to 72.5 for those who were ADL dependent and 71.4 for those with cognitive impairment for the three month period. A study of 198 nursing home residents with dementia in the Netherlands found 89% were incontinent of urine in the last month of life [1081]. Another study focusing on the impact of caring for the terminally ill (n=151) found the number of patients who required assistance with toileting rose from 37% at 1-3 months before death to 67% in the month before death [6]. In an acute palliative care unit for people with advanced cancer (n=203), Hui et al [1084] reported urinary incontinence increased in last 7 days of life from 30 to 65%, with faecal incontinence rising from 10 to 30%.

Fewer studies report on the impact of incontinence. Hoben and colleagues [1083] reported on the prevalence and burden of symptoms in the last quarter before death for over 6000 nursing home residents. The two most prevalent symptoms were urinary incontinence (at least twice per week) (79.7%) and faecal incontinence (at least once per week) (66.7%). The burden (as rated by care providers) of both urinary and faecal incontinence was found to be medium, with the cost of urinary incontinence rated as high and faecal incontinence rated medium. Veerbeek and colleagues [1093] reported on the patient symptom burden (rated post-death by a nurse closely involved in care) for the last three days of life in different care settings. The burden was found to be higher for non-cancer patients and for patients dying in their own home or a nursing home (compared to an acute setting). For patients dying in their own home or a nursing home, the burden of incontinence was rated higher than that of pain [1093].

It should be noted that, although the prevalence of UI increases in the final few days of life, urine output often decreases. Indeed, decreased urine output is associated with high likelihood of death within three days (Likelihood Ratio 15.2 95% CI: 13.4–17.1) [1094].

1.4. Assessment and management options for urinary or faecal incontinence at the end of life

Assessment

Assessment at the end of life should be focused on thorough investigation of the patient's experience of their symptoms, changing needs and preferences and planning ahead, including a holistic assessment of the impact of symptoms [1095, 1096]. No validated assessment or outcome measurement tools focusing on end of life incontinence were found. Despite the high prevalence of incontinence at the end of life, generic assessment tools assessing a broad range of symptoms at the end of life often exclude reference to incontinence (for example Edmonton Symptom Assessment Scale or Memorial Symptom Assessment Scale). Although many elements of generic incontinence questionnaires discussed in Chapter 6 such as

the Kings Health Questionnaire are unlikely to be relevant at the end of life, they may offer prompts for assessing the impact of incontinence on patients' quality of life.

As patients' ability to communicate deteriorates in the last days and hours of life and many care settings implement a 'dying phase' care pathway to manage symptoms [1097]. A recent Cochrane review of these pathways concluded that there is currently limited evidence to support their use [1098]. In the UK, there has been considerable activity to replace the now withdrawn Liverpool Care Pathway with more individualised care, including the Royal College of Physicians "End-of-Life Care in the Acute Care Setting" [1099] and NICE Guideline "Care of dying adults in the last days of life" [1096]. Neither of these resources refer to incontinence.

Management Options

No studies or guidelines that report on management options at the end of life were found. Generic end of life guidance states that symptom management should focus on minimising the impact of symptoms to maintain quality of life in accordance with the patient's values and preferences [1095, 1096, 1100]. Suitability of active treatment (rather than containment) should be judged on remaining life expectancy, patient preferences and care goals as described earlier in this chapter.

There is no evidence to support any of the pharmacological, lifestyle or behavioural interventions described earlier in this chapter for people in the last days and weeks of life. It is unlikely that most will be apposite, although behavioural interventions such as prompted voiding could have benefits with some patients for a limited time before mobility deteriorates.

Although no studies were found to support interventions with long-term staff and care givers and the end of life population, some of the principles described earlier in this chapter might be relevant. In particular, recommendations for educational support for care givers, adaption of interventions to the local context and individual patients and the use of a multi-component, interdisciplinary and person-centered approach are likely to be valid.

It is likely that management in the last days and weeks will include the use of appropriate absorbent products or containment devices (Chapter 20). IDCs are commonly used, but there is uncertainty about what constitutes best practice at the end of life regarding IDC insertion [1101]. Guidelines widely accept comfort at the end of life as a valid reason for placing a catheter [1102]. An audit of patients who died on two oncology wards in the UK showed that 63% of patients had an IDC during their admission [1103]. According to the findings of another study, involving 61 patients with terminal illness due to cancer admitted to a palliative care unit (PCU), IDCs may be used in up to 75% of such patients [1104]. In this study, 38% (n=23) admitted to the PCU had an IDC

in situ prior to their admission and another 36% (n=22) were catheterised during their admission. Complications associated with the use of IDCs in this cohort included: bacteriuria (n=28), encrustation (n=8), bladder spasms (n=4), fever (n=2), and urethritis (n=2). Despite these complications, staff cited 'patient comfort' as the main rationale for the use of an IDC. Clearly, further research is warranted to guide clinical care in this area.

1.5. Special considerations: Care preferences, place of dying and informal caregivers.

Very little is known about patients' preferences for incontinence care at the end of life, however, more widely, we do know that place of death and maintenance of dignity are viewed as important to patients and their informal caregivers [1095].

The majority of people wish to die at home [1105, 1106], but most do not achieve this wish [1107]. This can be due to the lack of support available in community settings and even in countries where palliative care provision is advanced, the lack of "dying out of hours" services leads to the burden of care falling to informal caregivers [1095, 1100]. As the population ages, healthcare policy makers are increasingly supporting caring for terminally ill patients at home, with the potential for substantial impact on informal caregivers [1085].

The provision of continence care by informal caregivers at the end of life has been found to be potentially problematic for both the patient and the caregiver. Patients often worry about becoming a burden and might not want intimate care provided by family members [1108] and coping with incontinence problems has been demonstrated to greatly add to distress and workload for carers [1109, 1110]. Caregivers have requested more practically focused information to help avoid crises [1111] and report feeling unprepared and unsupported in their role [1112]. To achieve the goal of allowing people to die at home, information, support and guidance for both patient and caregivers needs to be improved [1113]. This should include continence care.

Recommendations for practice

1. Physical and cognitive function will often vary from day-to-day. Regular assessment and individual management plans are required, taking in to account patient preferences and the context of care.
2. Timely environmental or behavioural interventions might be of benefit for individual patients for a limited period dependent on the illness trajectory.
3. Caregivers (professional and informal) should be educated in supporting the changing incontinence needs of dying patients.

Recommendations for research

Further research is required to:

1. Explore the patients' preferences for the management of UI and FI at the end of life.
2. Explore how carers (professional and informal) can be supported to care for the incontinence needs of people dying in different settings.
3. Identify the risks and benefits of using IDCs to provide comfort at the end of life.

Evaluate the impact of environmental and behavioural interventions to improve comfort and quality of life.

REFERENCES

1. Baltes, P.B. and J. Smith, New frontiers in the future of aging: from successful aging of the young old to the dilemmas of the fourth age. *Gerontology*, 2003. 49(2): p. 123-35.
2. Holroyd-Leduc, J.M., K.M. Mehta, and K.E. Covinsky, Urinary incontinence and its association with death, nursing home admission, and functional decline. *J Am Geriatr Soc*, 2004. 52(5): p. 712-8.
3. Martin, L.G., R.F. Schoeni, and P.M. Andreski, Trends in health of older adults in the United States: past, present, future. *Demography*, 2010. 47 Suppl: p. S17-40.
4. Gibson, W., et al., A national benchmark for the initial assessment of men with LUTS: data from the 2010 Royal College of Physicians National Audit of Continence Care. *World J Urol*, 2015.
5. Wagg, A., et al., To what extent are national guidelines for the management of urinary incontinence in women adhered? Data from a national audit. *BJOG : an international journal of obstetrics and gynaecology*, 2011. 118(13): p. 1592-600.
6. Thom, D.H., M.N. Haan, and S.K. Van Den Eeden, Medically recognized urinary incontinence and risks of hospitalization, nursing home admission and mortality. *Age Ageing*, 1997. 26(5): p. 367-74.
7. Fonda, D., Improving management of urinary incontinence in geriatric centres and nursing homes. *Victorian Geriatricians Peer Review Group. Aust Clin Rev*, 1990. 10(2): p. 66-71.
8. Ouslander, J.G., et al., Functional incidental training: a randomized, controlled, crossover trial in Veterans Affairs nursing homes. *J Am Geriatr Soc*, 2005. 53(7): p. 1091-100.
9. McMurdo, M.E., et al., Improving recruitment of older people to research through good practice. *Age and Ageing*, 2011. 40(6): p. 659-65.
10. Fonda, D., Resnick, N. M., Colling, J. et al Outcome measures for research of lower urinary tract dysfunction in frail older people. *Neurology and Urodynamics* 1998 17: p. 273-281.
11. Mitnitski, A.B., A.J. Mogilner, and K. Rockwood, Accumulation of deficits as a proxy measure of aging. *ScientificWorldJournal*, 2001. 1: p. 323-36.
12. Fried, L.P., et al., Frailty in older adults: evidence for a phenotype. *J Gerontol A Biol Sci Med Sci*, 2001. 56(3): p. M146-56.
13. Ferrucci, L., et al., Designing randomized, controlled trials aimed at preventing or delaying functional decline and disability in frail, older persons: a consensus report. *J Am Geriatr Soc*, 2004. 52(4): p. 625-34.
14. Gale, C.R., C. Cooper, and A.A. Sayer, Prevalence of frailty and disability: findings from the English Longitudinal Study of Ageing. *Age Ageing*, 2015. 44(1): p. 162-5.
15. Bandeen-Roche, K., et al., Frailty in Older Adults: A Nationally Representative Profile in the United States. *J Gerontol A Biol Sci Med Sci*, 2015. 70(11): p. 1427-34.
16. Da Mata, F.A., et al., Prevalence of Frailty in Latin America and the Caribbean: A Systematic Review and Meta-Analysis. *PLoS One*, 2016. 11(8): p. e0160019.
17. Gurina, N.A., E.V. Frolova, and J.M. Degryse, A roadmap of aging in Russia: the prevalence of frailty in community-dwelling older adults in the St. Petersburg district--the "Crystal" study. *J Am Geriatr Soc*, 2011. 59(6): p. 980-8.
18. Zheng, Z., et al., Prevalence and Incidence of Frailty in Community-Dwelling Older People: Beijing Longitudinal Study of Aging II. *J Am Geriatr Soc*, 2016. 64(6): p. 1281-6.
19. Jung, H.W., et al., Prevalence of Frailty and Aging-Related Health Conditions in Older Koreans in Rural Communities: a Cross-Sectional Analysis of the Aging Study of Pyeongchang Rural Area. *J Korean Med Sci*, 2016. 31(3): p. 345-52.
20. Calado, L.B., et al., Frailty syndrome in an independent urban population in Brazil (FIBRA study): a cross-sectional populational study. *Sao Paulo Med J*, 2016: p. 0.
21. Biritwum, R.B., et al., Prevalence of and factors associated with frailty and disability in older adults from China, Ghana, India, Mexico, Russia and South Africa. *Maturitas*, 2016. 91: p. 8-18.
22. Wang, C.J., et al., Urinary Incontinence and its Association with Frailty among Men Aged 80 Years and Older in Taiwan: a Cross-Sectional Study. *Rejuvenation Res*, 2016.
23. Miles, T.P., et al., New-onset incontinence and markers of frailty: data from the Hispanic Established Populations for Epidemiologic Studies of the Elderly. *J Gerontol A Biol Sci Med Sci*, 2001. 56(1): p. M19-24.
24. Silva, V.A., K.L. Souza, and M.J. D'Elboux, [Urinary incontinence and the criteria of frailness among the elderly outpatients]. *Revista da Escola de Enfermagem da U S P*, 2011. 45(3): p. 672-8.

25. Donaldson, L.J. and C. Jagger, Survival and functional capacity: three year follow up of an elderly population in hospitals and homes. *J Epidemiol Community Health*, 1983. 37(3): p. 176-9.
26. Herzog, A.R., et al., Urinary incontinence as a risk factor for mortality. *J Am Geriatr Soc*, 1994. 42(3): p. 264-8.
27. Johnson, T.M., 2nd, et al., Urinary incontinence and risk of death among community-living elderly people: results from the National Survey on Self-Care and Aging. *J Aging Health*, 2000. 12(1): p. 25-46.
28. Patel, M., et al., Natural history and effects on 2-year outcomes of urinary incontinence after stroke. *Stroke*, 2001. 32(1): p. 122-7.
29. Baztan, J.J., et al., New-onset urinary incontinence and rehabilitation outcomes in frail older patients. *Age Ageing*, 2005. 34(2): p. 172-5.
30. Nuotio, M., et al., Predictors of institutionalization in an older population during a 13-year period: the effect of urge incontinence. *J Gerontol A Biol Sci Med Sci*, 2003. 58(8): p. 756-62.
31. Welz-Barth, A., C. Garcia-Schurman, and I. Fusgen, [Incontinence, dementia and multiple morbidity--predictive factors for nursing care requirement and nursing home admission]. *Wien Med Wochenschr*, 1998. 148(13): p. 305-8.
32. Weatherall, M., T. Slow, and K. Wiltshire, Risk factors for entry into residential care after a support-needs assessment. *N Z Med J*, 2004. 117(1202): p. U1075.
33. Coward, R.T., C. Horne, and C.W. Peek, Predicting nursing home admissions among incontinent older adults: a comparison of residential differences across six years. *Gerontologist*, 1995. 35(6): p. 732-43.
34. Steiner, J.F., et al., Development and validation of a clinical prediction rule for prolonged nursing home residence after hip fracture. *J Am Geriatr Soc*, 1997. 45(12): p. 1510-4.
35. Matsumoto, M. and K. Inoue, Predictors of institutionalization in elderly people living at home: the impact of incontinence and commode use in rural Japan. *J Cross Cult Gerontol*, 2007. 22(4): p. 421-32.
36. Luk, J.K., P.K. Chiu, and L.W. Chu, Factors affecting institutionalization in older Hong Kong Chinese patients after recovery from acute medical illnesses. *Archives of gerontology and geriatrics*, 2009. 49(2): p. e110-4.
37. Hebert, R., et al., Factors associated with long-term institutionalization of older people with dementia: data from the Canadian Study of Health and Aging. *J Gerontol A Biol Sci Med Sci*, 2001. 56(11): p. M693-9.
38. Morrison, A. and R. Levy, Fraction of nursing home admissions attributable to urinary incontinence. *Value Health*, 2006. 9(4): p. 272-4.
39. Boyington, J.E., et al., Differences in resident characteristics and prevalence of urinary incontinence in nursing homes in the southeastern United States. *Nurs Res*, 2007. 56(2): p. 97-107.
40. Tomiak, M., et al., Factors associated with nursing-home entry for elders in Manitoba, Canada. *J Gerontol A Biol Sci Med Sci*, 2000. 55(5): p. M279-87.
41. Yaffe, K., et al., Patient and caregiver characteristics and nursing home placement in patients with dementia. *JAMA*, 2002. 287(16): p. 2090-7.
42. AlAmeel, T., M.K. Andrew, and C. MacKnight, The association of fecal incontinence with institutionalization and mortality in older adults. *The American journal of gastroenterology*, 2010. 105(8): p. 1830-4.
43. Grover, M., et al., Survey of geriatricians on the effect of fecal incontinence on nursing home referral. *Journal of the American Geriatrics Society*, 2010. 58(6): p. 1058-62.
44. Kelaiditi, E., et al., Cognitive frailty: rational and definition from an (I.A.N.A./I.A.G.G.) international consensus group. *J Nutr Health Aging*, 2013. 17(9): p. 726-34.
45. Ferri, C.P., et al., Global prevalence of dementia: a Delphi consensus study. *Lancet*, 2005. 366(9503): p. 2112-7.
46. Prince, M., et al., The global prevalence of dementia: a systematic review and metaanalysis. *Alzheimer's & dementia : the journal of the Alzheimer's Association*, 2013. 9(1): p. 63-75 e2.
47. Thomas, P., et al., Reasons of informal caregivers for institutionalizing dementia patients previously living at home: the Pixel study. *Int J Geriatr Psychiatry*, 2004. 19(2): p. 127-35.
48. Roe, B., et al., Systematic review of descriptive studies that investigated associated factors with the management of incontinence in older people in care homes. *International journal of older people nursing*, 2013. 8(1): p. 29-49.
49. Kamiya, M., et al., Factors associated with increased caregivers' burden in several cognitive stages of Alzheimer's disease. *Geriatrics & gerontology international*, 2014. 14 Suppl 2: p. 45-55.
50. Ouslander, J.G., et al., Incontinence among elderly community-dwelling dementia patients. Characteristics, management, and impact on caregivers. *J Am Geriatr Soc*, 1990. 38(4): p. 440-5.

51. The management of lower urinary tract symptoms in men, in Clinical guideline 97. 2010, National Clinical Guideline Centre: London, UK.
52. in Urinary Incontinence in Women: The Management of Urinary Incontinence in Women. 2013: London.
53. Lucas, M.G., et al., [European Association of Urology guidelines on assessment and nonsurgical management of urinary incontinence]. *Actas urologicas espanolas*, 2013. 37(4): p. 199-213.
54. Hagglund, D., A systematic literature review of incontinence care for persons with dementia: the research evidence. *J Clin Nurs*, 2010. 19(3-4): p. 303-12.
55. Ouslander, J.G., et al., Incontinence among nursing home patients: clinical and functional correlates. *J Am Geriatr Soc*, 1987. 35(4): p. 324-30.
56. Østbye, T., Borrie, M.J., Hunskar, S., The prevalence of urinary incontinence in elderly Canadians and its association with dementia, ambulatory function, and institutionalization. *Norsk epidemiologi*, 2009. 8(2).
57. Huang, A.J., et al., Urinary incontinence in older community-dwelling women: the role of cognitive and physical function decline. *Obstet Gynecol*, 2007. 109(4): p. 909-16.
58. Ostbye, T., et al., A 10-year follow-up of urinary and fecal incontinence among the oldest old in the community: the Canadian Study of Health and Aging. *Can J Aging*, 2004. 23(4): p. 319-31.
59. Byles, J., et al., Living with urinary incontinence: a longitudinal study of older women. *Age Ageing*, 2009. 38(3): p. 333-8; discussion 251.
60. Alcorn, G., et al., Urinary incontinence in people with Alzheimer's disease. *International journal of geriatric psychiatry*, 2014. 29(1): p. 107-9.
61. Grant, R.L., et al., First diagnosis and management of incontinence in older people with and without dementia in primary care: a cohort study using The Health Improvement Network primary care database. *PLoS medicine*, 2013. 10(8): p. e1001505.
62. Resnick, N.M., S.V. Yalla, and E. Laurino, The pathophysiology of urinary incontinence among institutionalized elderly persons. *N Engl J Med*, 1989. 320(1): p. 1-7.
63. Lee, S.H., et al., Urinary incontinence in patients with Alzheimer's disease: relationship between symptom status and urodynamic diagnoses. *International journal of urology : official journal of the Japanese Urological Association*, 2014. 21(7): p. 683-7.
64. Cassells, C. and E. Watt, The impact of incontinence on older spousal caregivers. *J Adv Nurs*, 2003. 42(6): p. 607-16.
65. Stewart, T.V., et al., Practice patterns, beliefs, and perceived barriers to care regarding dementia: a report from the American Academy of Family Physicians (AAFP) national research network. *Journal of the American Board of Family Medicine : JABFM*, 2014. 27(2): p. 275-83.
66. Fox, C., et al., Anticholinergic medication use and cognitive impairment in the older population: the medical research council cognitive function and ageing study. *Journal of the American Geriatrics Society*, 2011. 59(8): p. 1477-83.
67. Gray, S.L., et al., Cumulative use of strong anticholinergics and incident dementia: a prospective cohort study. *JAMA internal medicine*, 2015. 175(3): p. 401-7.
68. Fox, C., et al., The impact of anticholinergic burden in Alzheimer's dementia-the LASER-AD study. *Age and Ageing*, 2011. 40(6): p. 730-5.
69. Schussler, S., T. Dassen, and C. Lohrmann, Care dependency and nursing care problems in nursing home residents with and without dementia: a cross-sectional study. *Aging clinical and experimental research*, 2014.
70. Xu, D. and R.L. Kane, Effect of urinary incontinence on older nursing home residents' self-reported quality of life. *Journal of the American Geriatrics Society*, 2013. 61(9): p. 1473-81.
71. Rose, A., et al., Severity of urinary incontinence of nursing home residents correlates with malnutrition, dementia and loss of mobility. *Urologia internationalis*, 2013. 91(2): p. 165-9.
72. Lawhorne, L.W., et al., Urinary incontinence: a neglected geriatric syndrome in nursing facilities. *Journal of the American Medical Directors Association*, 2008. 9(1): p. 29-35.
73. Wagg, A., et al., Urinary incontinence in frail elderly persons: Report from the 5th International Consultation on Incontinence. *Neurourology and Urodynamics*, 2014.
74. Lee, K.S., et al., Urinary urgency outcomes after propiverine treatment for an overactive bladder: the 'Propiverine study on overactive bladder including urgency data'. *BJU international*, 2010. 105(11): p. 1565-70.

75. Ouslander, J.G., et al., Predictors of successful prompted voiding among incontinent nursing home residents. *JAMA*, 1995. 273(17): p. 1366-70.
76. Eustice, S., B. Roe, and J. Paterson, Prompted voiding for the management of urinary incontinence in adults. *Cochrane database of systematic reviews*, 2000(2): p. CD002113.
77. Schnelle, J.F., et al., A standardized quality assessment system to evaluate incontinence care in the nursing home. *J Am Geriatr Soc*, 2003. 51(12): p. 1754-61.
78. Schnelle, J.F., et al., The minimum data set urinary incontinence quality indicators: do they reflect differences in care processes related to incontinence? *Med Care*, 2003. 41(8): p. 909-22.
79. Drennan, V.M., et al., Conservative interventions for incontinence in people with dementia or cognitive impairment, living at home: a systematic review. *BMC geriatrics*, 2012. 12: p. 77.
80. Drennan, V.M., et al., Addressing incontinence for people with dementia living at home: a documentary analysis of local English community nursing service continence policies and clinical guidance. *Journal of clinical nursing*, 2013. 22(3-4): p. 339-46.
81. Excellence, N.I.f.H.a.C. Urinary incontinence in neurological disease: Management of lower urinary tract dysfunction in neurological disease. 2012; Available from: <https://www.nice.org.uk/guidance/cg148/chapter/1-guidance>.
82. Inouye, S.K., et al., Geriatric syndromes: clinical, research, and policy implications of a core geriatric concept. *J Am Geriatr Soc*, 2007. 55(5): p. 780-91.
83. DuBeau, C.E., Beyond the bladder: management of urinary incontinence in older women. *Clin Obstet Gynecol*, 2007. 50(3): p. 720-34.
84. Tinetti, M.E., et al., Shared risk factors for falls, incontinence, and functional dependence. Unifying the approach to geriatric syndromes. *JAMA*, 1995. 273(17): p. 1348-53.
85. Kuo, H.K. and L.A. Lipsitz, Cerebral white matter changes and geriatric syndromes: is there a link? *J Gerontol A Biol Sci Med Sci*, 2004. 59(8): p. 818-26.
86. Griffiths, D., et al., Brain control of normal and overactive bladder. *J Urol*, 2005. 174(5): p. 1862-7.
87. Tadic, S.D., et al., Abnormal connections in the supraspinal bladder control network in women with urge urinary incontinence. *Neuroimage*, 2008. 39(4): p. 1647-53.
88. Griffiths, D. and S.D. Tadic, Bladder control, urgency, and urge incontinence: evidence from functional brain imaging. *NeuroUrol Urodyn*, 2008. 27(6): p. 466-74.
89. Resnick, N.M., Elbadawi, A. E., Yalla, S. V., Age and the lower urinary tract: what is normal? *Neurourology and Urodynamics*, 1995. 14: p. 1647.
90. Madersbacher, S., et al., The aging lower urinary tract: a comparative urodynamic study of men and women. *Urology*, 1998. 51(2): p. 206-12.
91. Bromage, S.J., et al., Urodynamics in the octogenarian female: is it worthwhile? *Int Urogynecol J Pelvic Floor Dysfunct*, 2010. 21(9): p. 1117-21.
92. Pfisterer, M.H., et al., The effect of age on lower urinary tract function: a study in women. *Journal of the American Geriatrics Society*, 2006. 54(3): p. 405-12.
93. Malone-Lee, J., Wahedna, I., Characterisation of detrusor contractile function in relation to old-age. *Br J Urol* 1993. 72: p. 873-880.
94. Taylor, J.A., 3rd and G.A. Kuchel, Detrusor underactivity: Clinical features and pathogenesis of an underdiagnosed geriatric condition. *J Am Geriatr Soc*, 2006. 54(12): p. 1920-32.
95. van Koeveeringe, G.A., et al., Detrusor underactivity: a plea for new approaches to a common bladder dysfunction. *Neurourology and Urodynamics*, 2011. 30(5): p. 723-8.
96. Smith, P.P., Aging and the underactive detrusor: a failure of activity or activation? *Neurourology and Urodynamics*, 2010. 29(3): p. 408-12.
97. Smith, P.P. and G.A. Kuchel, Continuous uroflow cystometry in the urethane-anesthetized mouse. *Neurourology and Urodynamics*, 2010. 29(7): p. 1344-9.
98. Smith, P.P., A. Deangelis, and G.A. Kuchel, Detrusor Expulsive Strength Is Preserved, but Responsiveness to Bladder Filling and Urinary Sensitivity Diminished in the Aging Mouse. *American journal of physiology. Regulatory, integrative and comparative physiology*, 2011.
99. Kuchel, G.A., in *Hazzard's Principles of Geriatric Medicine and Gerontology*, J.B. Halter, Hazzard, W. R., Ouslander, J. G., Tinetti, M. E., Wolard, N., Studenski, S., High, K. & Asthana, S. (eds.), Editor. 2010, McGraw Hill: New York. p. 621-630.
100. Collas, D., Malone-Lee, JG, Age associated changes in detrusor sensory function in patients with lower urinary tract symptoms. *Int Urogynecol J Pelvic Floor Dysfunct*, 1996. 7: p. 24-29.

101. Fry, C.H., et al., Influence of age and bladder dysfunction on the contractile properties of isolated human detrusor smooth muscle. *BJU International*, 2011. 108(2 Pt 2): p. E91-6.
102. Resnick, N.M. and S.V. Yalla, Detrusor hyperactivity with impaired contractile function. An unrecognized but common cause of incontinence in elderly patients. *JAMA*, 1987. 257(22): p. 3076-81.
103. Smith, P.P. and G.A. Kuchel, Clinical Meaning of a High Postvoid Residual: When the Value of a Result Is Less and More than One Would Expect. *J Am Geriatr Soc*, 2015. 63(7): p. 1432-4.
104. Elbadawi, A., S.V. Yalla, and N.M. Resnick, Structural basis of geriatric voiding dysfunction. II. Aging detrusor: normal versus impaired contractility. *J Urol*, 1993. 150(5 Pt 2): p. 1657-67.
105. Elbadawi, A., S.V. Yalla, and N.M. Resnick, Structural basis of geriatric voiding dysfunction. I. Methods of a prospective ultrastructural/urodynamic study and an overview of the findings. *J Urol*, 1993. 150(5 Pt 2): p. 1650-6.
106. Elbadawi, A., S.V. Yalla, and N.M. Resnick, Structural basis of geriatric voiding dysfunction. III. Detrusor overactivity. *J Urol*, 1993. 150(5 Pt 2): p. 1668-80.
107. Elbadawi, A., S.V. Yalla, and N.M. Resnick, Structural basis of geriatric voiding dysfunction. IV. Bladder outlet obstruction. *J Urol*, 1993. 150(5 Pt 2): p. 1681-95.
108. Carey, M.P., et al., A prospective evaluation of the pathogenesis of detrusor instability in women, using electron microscopy and immunohistochemistry. *BJU Int*, 2000. 86(9): p. 970-6.
109. Levy, B.J. and T.N. Wight, Structural changes in the aging submucosa: new morphologic criteria for the evaluation of the unstable human bladder. *J Urol*, 1990. 144(4): p. 1044-55.
110. Zhu, Q., et al., Estrogen and postnatal maturation increase caveolar number and caveolin-1 protein in bladder smooth muscle cells. *The Journal of urology*, 2004. 171(1): p. 467-71.
111. Zhu, Q., et al., Role of ovarian hormones in the pathogenesis of impaired detrusor contractility: evidence in ovariectomized rodents. *The Journal of urology*, 2001. 166(3): p. 1136-41.
112. Elbadawi, A., et al., Structural basis of geriatric voiding dysfunction. VII. Prospective ultrastructural/urodynamic evaluation of its natural evolution. *J Urol*, 1997. 157(5): p. 1814-22.
113. Brierly, R.D., et al., A prospective evaluation of detrusor ultrastructural changes in bladder outlet obstruction. *BJU Int*, 2003. 91(4): p. 360-4.
114. Brierly, R.D., et al., A prospective controlled quantitative study of ultrastructural changes in the underactive detrusor. *The Journal of urology*, 2003. 169(4): p. 1374-8.
115. Warburton, A.L. and R.M. Santer, Sympathetic and sensory innervation of the urinary tract in young adult and aged rats: a semi-quantitative histochemical and immunohistochemical study. *The Histochemical journal*, 1994. 26(2): p. 127-33.
116. Dmitrieva, N., G. Zhang, and H. Nagabukuro, Increased alpha1D adrenergic receptor activity and protein expression in the urinary bladder of aged rats. *World journal of urology*, 2008. 26(6): p. 649-55.
117. Gomez-Pinilla, P.J., M.J. Pozo, and P.J. Camello, Aging differentially modifies agonist-evoked mouse detrusor contraction and calcium signals. *Age*, 2011. 33(1): p. 81-8.
118. Muller, D., et al., Cyclic GMP signaling in rat urinary bladder, prostate, and epididymis: tissue-specific changes with aging and in response to Leydig cell depletion. *Reproduction*, 2011. 142(2): p. 333-43.
119. Chua, W.C., et al., Age-related changes of P2X(1) receptor mRNA in the bladder detrusor from men with and without bladder outlet obstruction. *Experimental gerontology*, 2007. 42(7): p. 686-92.
120. Coleman, P.D., Finch, C. E., Joseph, J. A., The need for multiple time points in aging studies. *Neurobiol Aging*, 1990. 11: p. 1-2.
121. Miller, R.A., Nadon, N. L., Principles Of Animal Use For Gerontological Research. 2005, American Federation for Aging Research (AFAR).
122. Weller, J., et al., Age-related decrease of adenosine-mediated relaxation in rat detrusor is a result of A2B receptor downregulation. *Int J Urol*, 2015. 22(3): p. 322-9.
123. Durlu-Kandilci, N.T., M. Denizalti, and I. Sahin-Erdemli, Aging changes agonist induced contractile responses in permeabilized rat bladder. *Age (Dordr)*, 2015. 37(4): p. 9807.
124. Nocchi, L., et al., Induction of oxidative stress causes functional alterations in mouse urothelium via a TRPM8-mediated mechanism: implications for aging. *Aging Cell*, 2014. 13(3): p. 540-50.
125. Kirschstein, T., et al., Age-dependent contribution of Rho kinase in carbachol-induced contraction of human detrusor smooth muscle in vitro. *Acta Pharmacol Sin*, 2014. 35(1): p. 74-81.

126. Kirschstein, T., et al., Inverse relationship of Rho kinase and myosin-light chain kinase expression in the aging human detrusor smooth muscle. *BMC Urol*, 2015. 15: p. 104.
127. Smith, P.P., A. DeAngelis, and R. Simon, Evidence of increased centrally enhanced bladder compliance with ageing in a mouse model. *BJU Int*, 2014.
128. Rud, T., Urethral pressure profile in continent women from childhood to old age. *Acta obstetrica et gynecologica Scandinavica*, 1980. 59(4): p. 331-5.
129. Hilton, P. and S.L. Stanton, Urethral pressure measurement by microtransducer: the results in symptom-free women and in those with genuine stress incontinence. *Br J Obstet Gynaecol*, 1983. 90(10): p. 919-33.
130. Trowbridge, E.R., et al., Effects of aging on lower urinary tract and pelvic floor function in nulliparous women. *Obstetrics and gynecology*, 2007. 109(3): p. 715-20.
131. Samsioe, G., et al., Occurrence, nature and treatment of urinary incontinence in a 70-year-old female population. *Maturitas*, 1985. 7(4): p. 335-42.
132. Kenton, K., et al., Urethral and bladder current perception thresholds: normative data in women. *The Journal of urology*, 2007. 178(1): p. 189-92; discussion 192.
133. Forsberg, J.G., A morphologist's approach to the vagina--age-related changes and estrogen sensitivity. *Maturitas*, 1995. 22 Suppl: p. S7-S15.
134. Yang, J.M., S.H. Yang, and W.C. Huang, Functional correlates of Doppler flow study of the female urethral vasculature. *Ultrasound in obstetrics & gynecology : the official journal of the International Society of Ultrasound in Obstetrics and Gynecology*, 2006. 28(1): p. 96-102.
135. Siracusano, S., et al., Application of ultrasound contrast agents for the characterization of female urethral vascularization in healthy pre- and postmenopausal volunteers: preliminary report. *European Urology*, 2006. 50(6): p. 1316-22.
136. Liang, C.C., et al., Three-dimensional power Doppler measurement of perfusion of the peri-urethral tissue in incontinent women -- a preliminary report. *Acta Obstet Gynecol Scand*, 2006. 85(5): p. 608-13.
137. Carlile, A., et al., Age changes in the human female urethra: a morphometric study. *The Journal of urology*, 1988. 139(3): p. 532-5.
138. Verelst, M., J.M. Maltau, and A. Orbo, Computerised morphometric study of the paraurethral tissue in young and elderly women. *Neurourological Urodyn*, 2002. 21(6): p. 529-33.
139. Perucchini, D., et al., Age effects on urethral striated muscle. II. Anatomic location of muscle loss. *American journal of obstetrics and gynecology*, 2002. 186(3): p. 356-60.
140. Perucchini, D., et al., Age effects on urethral striated muscle. I. Changes in number and diameter of striated muscle fibers in the ventral urethra. *American journal of obstetrics and gynecology*, 2002. 186(3): p. 351-5.
141. Clobes, A., J.O. DeLancey, and D.M. Morgan, Urethral circular smooth muscle in young and old women. *Am J Obstet Gynecol*, 2008. 198(5): p. 587 e1-5.
142. Hanada, M., et al., Growth inhibition and apoptosis induction by tumor necrosis factor-alpha in human urethral rhabdosphincter satellite cells. *J Urol*, 2010. 183(6): p. 2445-50.
143. Kenton, K., M.P. Fitzgerald, and L. Brubaker, Striated urethral sphincter activity does not alter urethral pressure during filling cystometry. *Am J Obstet Gynecol*, 2005. 192(1): p. 55-9.
144. Romanzi, L.J., A. Groutz, and J.G. Blaivas, Urethral diverticulum in women: diverse presentations resulting in diagnostic delay and mismanagement. *The Journal of urology*, 2000. 164(2): p. 428-33.
145. Strasser, H., et al., Urinary incontinence in the elderly and age-dependent apoptosis of rhabdosphincter cells. *Lancet*, 1999. 354(9182): p. 918-9.
146. Rother, P., et al., Anatomic basis of micturition and urinary continence. Muscle systems in urinary bladder neck during ageing. *Surgical and radiologic anatomy : SRA*, 1996. 18(3): p. 173-7.
147. Bagi, P., et al., Pressure/cross-sectional area relations in the proximal urethra of healthy males. Part 1: Elastance and estimated pressure in the uninstrumented urethra. *Eur Urol*, 1995. 28(1): p. 51-7.
148. Hammerer, P., et al., Urethral closure pressure changes with age in men. *The Journal of urology*, 1996. 156(5): p. 1741-3.
149. Tinelli, A., et al., Age-related pelvic floor modifications and prolapse risk factors in postmenopausal women. *Menopause*, 2010. 17(1): p. 204-12.
150. Lawrence, J.M., et al., Prevalence and co-occurrence of pelvic floor disorders in community-dwelling women. *Obstet Gynecol*, 2008. 111(3): p. 678-85.

151. Talasz, H., et al., Evaluation of pelvic floor muscle function in a random group of adult women in Austria. *International Urogynecology Journal and Pelvic Floor Dysfunction*, 2008. 19(1): p. 131-5.
152. Weemhoff, M., K.L. Shek, and H.P. Dietz, Effects of age on levator function and morphology of the levator hiatus in women with pelvic floor disorders. *International urogynecology journal*, 2010. 21(9): p. 1137-42.
153. Pontbriand-Drolet, S., et al., Differences in pelvic floor morphology between continent, stress urinary incontinent, and mixed urinary incontinent elderly women: An MRI study. *Neurourological Urodyn*, 2016. 35(4): p. 515-21.
154. Kenton, K., et al., Aging and overactive bladder may be associated with loss of urethral sensation in women. *Neurourology and Urodynamics*, 2007. 26(7): p. 981-4.
155. Jundt, K., et al., Is the histomorphological concept of the female pelvic floor and its changes due to age and vaginal delivery correct? *Neurourology and Urodynamics*, 2005. 24(1): p. 44-50.
156. Norton, P.A., Pelvic floor disorders: the role of fascia and ligaments. *Clinical obstetrics and gynecology*, 1993. 36(4): p. 926-38.
157. Spence-Jones, C., et al., Bowel dysfunction: a pathogenic factor in uterovaginal prolapse and urinary stress incontinence. *Br J Obstet Gynaecol*, 1994. 101(2): p. 147-52.
158. Buntzen, S., et al., Anal and rectal motility responses to distension of the urinary bladder in man. *International journal of colorectal disease*, 1995. 10(3): p. 148-51.
159. Bachmann, G., Urogenital ageing: an old problem newly recognized. *Maturitas*, 1995. 22 Suppl: p. S1-S5.
160. Stenberg, A., G. Heimer, and U. Ulmsten, The prevalence of urogenital symptoms in postmenopausal women. *Maturitas*, 1995. 22 Suppl: p. S17-S20.
161. Rossouw, J.E., et al., Risks and benefits of estrogen plus progestin in healthy postmenopausal women: principal results From the Women's Health Initiative randomized controlled trial. *JAMA : the journal of the American Medical Association*, 2002. 288(3): p. 321-33.
162. Grady, D., et al., Cardiovascular disease outcomes during 6.8 years of hormone therapy: Heart and Estrogen/progestin Replacement Study follow-up (HERS II). *JAMA : the journal of the American Medical Association*, 2002. 288(1): p. 49-57.
163. Samsioe, G., Urogenital aging--a hidden problem. *Am J Obstet Gynecol*, 1998. 178(5): p. S245-9.
164. Juthani-Mehta, M., et al., Diagnostic accuracy of criteria for urinary tract infection in a cohort of nursing home residents. *J Am Geriatr Soc*, 2007. 55(7): p. 1072-7.
165. Tan, J.S., et al., Determinants of vaginal length. *American journal of obstetrics and gynecology*, 2006. 195(6): p. 1846-50.
166. Cardozo, L., et al., A systematic review of estrogens for recurrent urinary tract infections: third report of the hormones and urogenital therapy (HUT) committee. *International Urogynecology Journal and Pelvic Floor Dysfunction*, 2001. 12(1): p. 15-20.
167. Lindau, S.T., et al., Vaginal self-swab specimen collection in a home-based survey of older women: methods and applications. *The journals of gerontology. Series B, Psychological sciences and social sciences*, 2009. 64 Suppl 1: p. i106-18.
168. Wen, Y., et al., Reprogramming of fibroblasts from older women with pelvic floor disorders alters cellular behavior associated with donor age. *Stem Cells Transl.Med.*, 2013. 2(2): p. 118-128.
169. Berry, S.J., et al., The development of human benign prostatic hyperplasia with age. *J Urol*, 1984. 132(3): p. 474-9.
170. Shibata, Y., et al., Changes in the endocrine environment of the human prostate transition zone with aging: simultaneous quantitative analysis of prostatic sex steroids and comparison with human prostatic histological composition. *Prostate*, 2000. 42(1): p. 45-55.
171. Griffiths, K., Estrogens and prostatic disease. *International Prostate Health Council Study Group. The Prostate*, 2000. 45(2): p. 87-100.
172. Kramer, G., D. Mitteregger, and M. Marberger, Is benign prostatic hyperplasia (BPH) an immune inflammatory disease? *Eur Urol*, 2007. 51(5): p. 1202-16.
173. Roehrborn, C.G., et al., Serum prostate-specific antigen and prostate volume predict long-term changes in symptoms and flow rate: results of a four-year, randomized trial comparing finasteride versus placebo. *PLESS Study Group. Urology*, 1999. 54(4): p. 662-9.
174. Jacobsen, S.J., et al., Treatment for benign prostatic hyperplasia among community dwelling men: the Olmsted County study of urinary symptoms and health status. *J Urol*, 1999. 162(4): p. 1301-6.

175. McConnell, J.D., M.J. Barry, and R.C. Bruskewitz, Benign prostatic hyperplasia: diagnosis and treatment. Agency for Health Care Policy and Research. Clin Pract Guidel Quick Ref Guide Clin, 1994(8): p. 1-17.
176. Berges, R. and M. Oelke, Age-stratified normal values for prostate volume, PSA, maximum urinary flow rate, IPSS, and other LUTS/BPH indicators in the German male community-dwelling population aged 50 years or older. World journal of urology, 2011. 29(2): p. 171-8.
177. Mishra, V.C., et al., Does intraprostatic inflammation have a role in the pathogenesis and progression of benign prostatic hyperplasia? BJU Int, 2007. 100(2): p. 327-31.
178. Anjum, I., et al., Prostatic infarction/infection in acute urinary retention secondary to benign prostatic hyperplasia. J Urol, 1998. 160(3 Pt 1): p. 792-3.
179. Bianchi-Frias, D., et al., The effects of aging on the molecular and cellular composition of the prostate microenvironment. PLoS ONE, 2010. 5(9).
180. Sprenger, C.C., S.R. Plymate, and M.J. Reed, Aging-related alterations in the extracellular matrix modulate the microenvironment and influence tumor progression. International journal of cancer. Journal international du cancer, 2010.
181. Vital, P., et al., The senescence-associated secretory phenotype promotes benign prostatic hyperplasia. Am J Pathol, 2014. 184(3): p. 721-31.
182. Juthani-Mehta, M., Asymptomatic bacteriuria and urinary tract infection in older adults. Clin Geriatr Med, 2007. 23(3): p. 585-94, vii.
183. Ouslander, J.G., et al., Pyuria among chronically incontinent but otherwise asymptomatic nursing home residents. Journal of the American Geriatrics Society, 1996. 44(4): p. 420-3.
184. Nicolle, L.E., Urinary tract infection in geriatric and institutionalized patients. Curr Opin Urol, 2002. 12(1): p. 51-5.
185. Ouslander, J.G., et al., Does eradicating bacteriuria affect the severity of chronic urinary incontinence in nursing home residents? Ann Intern Med, 1995. 122(10): p. 749-54.
186. Juthani-Mehta, M., et al., Role of dipstick testing in the evaluation of urinary tract infection in nursing home residents. Infect Control Hosp Epidemiol, 2007. 28(7): p. 889-91.
187. Kennedy, B.K., et al., Geroscience: linking aging to chronic disease. Cell, 2014. 159(4): p. 709-713.
188. Lopez-Otin, C., et al., The hallmarks of aging. Cell, 2013. 153(6): p. 1194-217.
189. Burch, J.B., et al., Advances in geroscience: impact on healthspan and chronic disease. J Gerontol A Biol Sci Med Sci, 2014. 69 Suppl 1: p. S1-3.
190. Triguero, D., A. Lafuente-Sanchis, and A. Garcia-Pascual, Changes in nerve-mediated contractility of the lower urinary tract in a mouse model of premature ageing. Br J Pharmacol, 2014. 171(7): p. 1687-705.
191. Tarcan, T., et al., Age-related erectile and voiding dysfunction: the role of arterial insufficiency. Br.J.Urol., 1998. 82 Suppl 1: p. 26-33.
192. Nomiya, M., K.E. Andersson, and O. Yamaguchi, Chronic bladder ischemia and oxidative stress: new pharmacotherapeutic targets for lower urinary tract symptoms. Int J Urol, 2015. 22(1): p. 40-6.
193. Ruby, C.M., et al., Medication use and control of urination among community-dwelling older adults. J Aging Health, 2005. 17(5): p. 661-74.
194. Marshall, H.J. and D.G. Beevers, Alpha-adrenoceptor blocking drugs and female urinary incontinence: prevalence and reversibility. Br J Clin Pharmacol, 1996. 42(4): p. 507-9.
195. Ruby, C.M., et al., The effect of medication use on urinary incontinence in community-dwelling elderly women. J Am Geriatr Soc, 2010. 58(9): p. 1715-20.
196. Peron, E.P., et al., Antihypertensive drug class use and differential risk of urinary incontinence in community-dwelling older women. J Gerontol A Biol Sci Med Sci, 2012. 67(12): p. 1373-8.
197. Jackson, R.A., et al., Urinary incontinence in elderly women: findings from the Health, Aging, and Body Composition Study. Obstet Gynecol, 2004. 104(2): p. 301-7.
198. Tsakiris, P., M. Oelke, and M.C. Michel, Drug-induced urinary incontinence. Drugs Aging, 2008. 25(7): p. 541-9.
199. Carnovale, C., et al., A case of urinary incontinence by hydroxychloroquine in a geriatric patient. J Clin Pharm Ther, 2013. 38(2): p. 169-71.
200. Hashimoto, M., et al., Prescription rate of medications potentially contributing to lower urinary tract symptoms and detection of adverse reactions by prescription sequence symmetry analysis. J Pharm Health Care Sci, 2015. 1: p. 7.
201. Kashyap, M., M. Tu le, and C. Tannenbaum, Prevalence of commonly prescribed medications potentially contributing to urinary symptoms in a cohort of older patients seeking care for incontinence. BMC Geriatr, 2013. 13: p. 57.

202. Hawkins, K., et al., The prevalence of urinary incontinence and its burden on the quality of life among older adults with medicare supplement insurance. *Qual Life Res*, 2011. 20(5): p. 723-32.
203. Cigolle, C.T., et al., Geriatric conditions and disability: the Health and Retirement Study. *Ann Intern Med*, 2007. 147(3): p. 156-64.
204. Alencar, M.A., Transitions in Frailty Status in Community-Dwelling Older Adults. *Topics in Geriatric Rehabilitation*, 2015. 31(2): p. 105-112.
205. Smith, A.L., et al., Correlates of urinary incontinence in community-dwelling older Latinos. *J Am Geriatr Soc*, 2010. 58(6): p. 1170-6.
206. Huang, A.J., et al., Urinary incontinence in older community-dwelling women: the role of cognitive and physical function decline. *Obstet Gynecol*, 2007. 109(4): p. 909-16.
207. Danforth, K.N., et al., Physical activity and urinary incontinence among healthy, older women. *Obstet Gynecol*, 2007. 109(3): p. 721-7.
208. Devore, E.E., V.A. Minassian, and F. Grodstein, Factors associated with persistent urinary incontinence. *Am J Obstet Gynecol*, 2013. 209(2): p. 145 e1-6.
209. Rait, G., et al., Prevalence of cognitive impairment: results from the MRC trial of assessment and management of older people in the community. *Age Ageing*, 2005. 34(3): p. 242-8.
210. Jacobs, J.M., et al., Changing profile of health and function from age 70 to 85 years. *Gerontology*, 2012. 58(4): p. 313-21.
211. Vetrano, D.L., et al., Chronic diseases and geriatric syndromes: The different weight of comorbidity. *Eur J Intern Med*, 2016. 27: p. 62-7.
212. Berardelli, M., et al., Urinary incontinence in the elderly and in the oldest old: correlation with frailty and mortality. *Rejuvenation Res*, 2013. 16(3): p. 206-11.
213. Closs V E, Z.P., Gomes I, Schwanke CHA, Frailty and Geriatric Syndromes in elderly assisted in primary health care. *Acta Scientiarum*, 2016. 38(1): p. 9-18.
214. Hsu, A., et al., Predictors of urinary incontinence in community-dwelling frail older adults with diabetes mellitus in a cross-sectional study. *BMC Geriatr*, 2014. 14: p. 137.
215. Danforth, K.N., et al., Type 2 diabetes mellitus and risk of stress, urge and mixed urinary incontinence. *J Urol*, 2009. 181(1): p. 193-7.
216. Brown, J.S., et al., Prevalence and risk factors for urinary incontinence in women with type 2 diabetes and impaired fasting glucose: findings from the National Health and Nutrition Examination Survey (NHANES) 2001-2002. *Diabetes Care*, 2006. 29(6): p. 1307-12.
217. Tai, H.C., et al., Metabolic syndrome components worsen lower urinary tract symptoms in women with type 2 diabetes. *J Clin Endocrinol Metab*, 2010. 95(3): p. 1143-50.
218. Lee, S.J., et al., Glycemic control and urinary incontinence in women with diabetes mellitus. *J Womens Health (Larchmt)*, 2013. 22(12): p. 1049-55.
219. Chiu, A.F., et al., Higher glycosylated hemoglobin levels increase the risk of overactive bladder syndrome in patients with type 2 diabetes mellitus. *Int J Urol*, 2012. 19(11): p. 995-1001.
220. Ko, Y., et al., The impact of urinary incontinence on quality of life of the elderly. *Am J Manag Care*, 2005. 11(4 Suppl): p. S103-11.
221. Aguilar-Navarro, S., et al., The severity of urinary incontinence decreases health-related quality of life among community-dwelling elderly. *J Gerontol A Biol Sci Med Sci*, 2012. 67(11): p. 1266-71.
222. Del-Ser, T., D.G. Munoz, and V. Hachinski, Temporal pattern of cognitive decline and incontinence is different in Alzheimer's disease and diffuse Lewy body disease. *Neurology*, 1996. 46(3): p. 682-6.
223. Meier, U., A. König, and C. Miethke, Predictors of outcome in patients with normal-pressure hydrocephalus. *Eur Neurol*, 2004. 51(2): p. 59-67.
224. Wullner, U., et al., Autonomic dysfunction in 3414 Parkinson's disease patients enrolled in the German Network on Parkinson's disease (KNP e.V.) the effect of ageing. *European Journal of Neurology*, 2007. 14(1405-1408).
225. Gilman, S., et al., Second consensus statement on the diagnosis of multiple system atrophy. *Neurology*, 2008. 71: p. 670-676.
226. Hahn, K. and G. Ebersbach, Sonographic assessment of urinary retention in multiple system atrophy and idiopathic Parkinson's. *Movement Disorders*, 2005. 20(11): p. 499-502.
227. Pantoni, L., Leukoaraiosis: from an ancient term to an actual marker of poor prognosis. *Stroke*, 2008. 39(5): p. 1401-3.
228. Hachinski, V.C., P. Potter, and H. Merskey, Leuko-araiosis. *Arch Neurol*, 1987. 44(1): p. 21-3.

229. Pantoni, L. and J.H. Garcia, The Significance of Cerebral White Matter Abnormalities 100 Years After Binswanger's Report: A Review. *Stroke*, 1995. 26(7): p. 1293-1301.
230. Sakakibara, R., et al., Urinary function in elderly people with and without leukoaraiosis: relation to cognitive and gait function. *J Neurol Neurosurg Psychiatry*, 1999. 67(5): p. 658-60.
231. Kuchel, G.A., et al., Localization of the brain white matter hyperintensities and urinary incontinence in community-dwelling older adults. *Journals of Gerontology Series A-Biological Science & Medical Sciences*, 2009. 64(8): p. 902-909.
232. Sakakibara, R., et al., Vascular incontinence: incontinence in the elderly due to ischemic white matter changes. *Neurol Int*, 2012. 4(2): p. e13.
233. Ogama, N., et al., Frontal white matter hyperintensity predicts lower urinary tract dysfunction in older adults with amnesic mild cognitive impairment and Alzheimer's disease. *Geriatr Gerontol Int*, 2016. 16(2): p. 167-74.
234. Takahashi, O., et al., White matter lesions or Alzheimer's disease: which contributes more to overactive bladder and incontinence in elderly adults with dementia? *J Am Geriatr Soc*, 2012. 60(12): p. 2370-1.
235. Engberg, S., et al., Prevalence and recognition of depressive symptoms among homebound older adults with urinary incontinence. *Journal of Geriatric Psychiatry & Neurology*, 2001. 14: p. 130-9.
236. Dugan, E., et al., The association of depressive symptoms and urinary incontinence among older adults. *J Am Geriatr Soc*, 2000. 48: p. 413-416.
237. Johnson, T.n., et al., The association of urinary incontinence with poor self-rated health. *J Am Geriatr Soc*, 1998. 46: p. 693-9.
238. Herzog, A., et al., Urinary incontinence and psychological distress among older adults. *Psychology & Aging*, 1988. 3: p. 115-21.
239. Fultz, N.H., et al., The impact of own and spouse's urinary incontinence on depressive symptoms. *Social Science & Medicine*, 2005. 60(11): p. 2537-2548.
240. Black, S., J. Goodwin, and K. Markides, The association between chronic diseases and depressive symptomatology in older Mexican Americans. *Journals of Gerontology Series A-Biological Sciences & Medical Sciences*, 1998. 53: p. M188-94.
241. Grimby, A., et al., The influence of urinary incontinence on the quality of life of elderly women. *Age & Ageing*, 1993. 22: p. 82-9.
242. Yoshida, Y., et al., Prevalence and characteristics of urinary incontinence in community-dwelling-elderly as determined by comprehensive health examination and interview for the prevention of geriatric syndrome and bed-ridden state. *Nippon Ronen Igakkai Zasshi - Japanese Journal of Geriatrics*, 2007. 44: p. 83-9.
243. Song, H. and J. Bae, Prevalence of urinary incontinence and lower urinary tract symptoms for community-dwelling elderly 85 years of age and older. *Journal of Wound, Ostomy, & Continence Nursing*, 2007. 34: p. 535-41.
244. Ko, Y., et al., The impact of urinary incontinence on quality of life of the elderly. *Am J Managed Care*, 2005. 11(4 Suppl): p. S103-11.
245. Malmstrom, T.K., et al., Urinary and Fecal Incontinence and Quality of Life in African Americans. *J Am Geriatr Soc*, 2010. 58: p. 1941-1945.
246. Fultz, N.H. and A.R. Herzog, Self-Reported Social and Emotional Impact of Urinary Incontinence. *Journal of the American Geriatrics Society*, 2001. 49(7): p. 892-899.
247. Bogner, H.R., et al., Urinary incontinence and psychological distress in community-dwelling older adults. *J Am Geriatr Soc*, 2002. 50(3): p. 489-95.
248. de Vries, H.F., G.M. Northington, and H.R. Bogner, Urinary incontinence (UI) and new psychological distress among community dwelling older adults. *Arch Gerontol Geriatr*, 2012. 55(1): p. 49-54.
249. Coyne, K.S., et al., The burden of lower urinary tract symptoms: evaluating the effect of LUTS on health-related quality of life, anxiety and depression: EpiLUTS. *British Journal Urology International*, 2009. 103(Suppl): p. 4-11.
250. Coyne, K.S., et al., Urinary Incontinence and its Relationship to Mental Health and Health-Related Quality of Life in Men and Women in Sweden, the United Kingdom, and the United States. *European Urology*, 2011: p. in press.
251. Sexton, C.C., et al., Prevalence and Effect on Health-Related Quality of Life of Overactive Bladder in Older Americans: Results from the Epidemiology of Lower Urinary Tract Symptoms Study. *J Am Geriatr Soc*, 2011. 59: p. 1465-1470.
252. Perchon, L.F.G., et al., Quality of Life in Elderly Men with Aging Symptoms and Lower Urinary Tract Symptoms (LUTS). *Neurol. Urodyn.*, 2011. 30: p. 1473-1477.
253. Hui-Chi, H., A checklist for assessing the risk of falls among the elderly. *Journal of Nursing Research*, 2004. 12(2): p. 131-142.

254. Nakagawa, H., et al., Impact of nocturia on bone fracture and mortality in older individuals: a Japanese longitudinal cohort study. *The Journal of urology*, 2010. 184(4): p. 1413-8.
255. Nakagawa, H., Ikeda, Y., Nui, K., Ohmori-Matsuda, K., Nakaya, N., Imanishi, R., Nagatomi, R., Tsuji, I., Arai, Y., Does nocturia increase fall-related fractures and mortality in a community dwelling elderly population aged 70 years and over? Results of a 3 year prospective cohort study in Japan. *Neuro Urol*, 2008. 27(7): p. 674 - 675.
256. Vaughan, C.P., Brown, C.J., Goode, P.S., Burghio, K.L., Allman, R.M., Johnson, T.M., 2nd., The association of nocturia with incident falls in an elderly community-dwelling cohort. *Int J Clin Pract*, 2010 64(5): p. 577-583. .
257. Stewart, R.B., et al., Nocturia: a risk factor for falls in the elderly. *J Am Geriatr Soc*, 1992. 40(12): p. 1217-20.
258. Coyne, K.S., et al., The prevalence of lower urinary tract symptoms (LUTS) in the USA, the UK and Sweden: results from the Epidemiology of LUTS (EpiLUTS) study. *BJU international*, 2009. 104(3): p. 352-60.
259. Brown, J.S., et al., Urinary incontinence: does it increase risk for falls and fractures? Study of Osteoporotic Fractures Research Group. *J Am Geriatr Soc*, 2000. 48(7): p. 721-5.
260. Takazawa, K. and K. Arisawa, Relationship between the type of urinary incontinence and falls among frail elderly women in Japan. *J Med Invest*, 2005. 52(3-4): p. 165-71.
261. Noguchi, N., et al., Lower Urinary Tract Symptoms and Incident Falls in Community Dwelling Older Men: The Concord Health and Ageing in Men Project. *J Urol*, 2016.
262. Sakushima, K., et al., Influence of urinary urgency and other urinary disturbances on falls in Parkinson's disease. *J Neurol Sci*, 2016. 360: p. 153-7.
263. Noguchi, N., et al., A systematic review of the association between lower urinary tract symptoms and falls, injuries, and fractures in community-dwelling older men. *Aging Male*, 2016: p. 1-7.
264. Pahwa, A.K., et al., Nocturnal Enuresis as a Risk Factor for Falls in Older Community Dwelling Women with Urinary Incontinence. *J Urol*, 2016. 195(5): p. 1512-6.
265. Parsons, J.K., et al., Lower urinary tract symptoms increase the risk of falls in older men. *BJU Int*, 2009. 104(1): p. 63-8.
266. Hitcho, E.B., Krauss, M.J., Birge, S., Claiborne-Dunagan, W., Fischer, J., Johnson, S. et al., Characteristics and circumstances of falls in a hospital setting: A prospective analysis. *J Gen Int Med*, 2004. 19(7): p. 732-739.
267. Abreu, H.C., et al., Incidence and predicting factors of falls of older inpatients. *Rev Saude Publica*, 2015. 49: p. 37.
268. Cameron, I.D., et al., Interventions for preventing falls in older people in nursing care facilities and hospitals. *Cochrane database of systematic reviews*, 2010(1): p. CD005465.
269. Kron, M., et al., Risk indicators for falls in institutionalized frail elderly. *American journal of epidemiology*, 2003. 158(7): p. 645-53.
270. Edwards, R., K. Hunter, and A. Wagg, Lower urinary tract symptoms and falls in older women: a case control study. *Maturitas*, 2015. 80(3): p. 308-11.
271. van Almenkerk, S., et al., What predicts a poor outcome in older stroke survivors? A systematic review of the literature. *Disabil Rehabil*, 2013. 35(21): p. 1774-82.
272. Mizrahi, E.H., et al., Bladder management and the functional outcome of elderly ischemic stroke patients. *Arch Gerontol Geriatr*, 2010.
273. Jordan, L.A., et al., Continence management in acute stroke: a survey of current practices in Australia. *J Adv Nurs*, 2010.
274. Wilson, D., et al., Urinary incontinence in stroke: results from the UK National Sentinel Audits of Stroke 1998-2004. *Age and Ageing*, 2008. 37(5): p. 542-6.
275. Booth, J., et al., Rehabilitation nurses practices in relation to urinary incontinence following stroke: a cross-cultural comparison. *J Clin Nurs*, 2009. 18(7): p. 1049-58.
276. Tseng, C.N., et al., A Qualitative Study of Family Caregiver Experiences of Managing Incontinence in Stroke Survivors. *PLoS One*, 2015. 10(6): p. e0129540.
277. Chanfreau-Rona, D., S. Bellwood, and B. Wylie, Assessment of a behavioural programme to treat incontinent patients in psychogeriatric wards. *Br J Clin Psychol*, 1984. 23 (Pt 4): p. 273-9.
278. Chanfreau-Rona, D., Wylie, B., Bellwood, S., Behaviour treatment of daytime incontinence in elderly male and female patients. *Behavioural Psychotherapy*, 1986. 14(1): p. 13-20.
279. Namazi, K.H., Johnson, B.D., Environmental effects on incontinence problems in Alzheimer's disease patients. *American Journal of Alzheimer's Disease and other dementias and research*, 1991. 6: p. 16-21.

280. Namazi, K.H., Johnson, B.D., Environmental modifications in a specially designed unit for the care of patients with Alzheimer's disease: An overview and introduction. *American Journal of Alzheimer's Disease and other dementias and research*, 1991. 6: p. 3-6.
281. Namazi, K.H.a.J., B.D., Physical environmental cues to reduce the problems of incontinence in Alzheimer's disease units. *American Journal of Alzheimer's Disease and other dementias and research*, 1991. 6: p. 22-28.
282. Sacco-Peterson, M. and L. Borell, Struggles for autonomy in self-care: the impact of the physical and socio-cultural environment in a long-term care setting. *Scand J Caring Sci*, 2004. 18(4): p. 376-86.
283. Landi, F., et al., Potentially reversible risk factors and urinary incontinence in frail older people living in community. *Age Ageing*, 2003. 32(2): p. 194-9.
284. Offermans, M.P., et al., Prevalence of urinary incontinence and associated risk factors in nursing home residents: a systematic review. *Neurourol Urodyn*, 2009. 28(4): p. 288-94.
285. MacDonald, C.D. and L. Butler, Silent no more: elderly women's stories of living with urinary incontinence in long-term care. *J Gerontol Nurs*, 2007. 33(1): p. 14-20.
286. Temkin-Greener, H., et al., Nursing home work environment and the risk of pressure ulcers and incontinence. *Health Serv Res*, 2012. 47(3 Pt 1): p. 1179-200.
287. Yoon, J.Y., et al., The impact of organizational factors on the urinary incontinence care quality in long-term care hospitals: a longitudinal correlational study. *Int J Nurs Stud*, 2012. 49(12): p. 1544-51.
288. Thomas, L.H., et al., Evaluating a systematic voiding programme for patients with urinary incontinence after stroke in secondary care using soft systems analysis and Normalisation Process Theory: findings from the ICONS case study phase. *Int J Nurs Stud*, 2014. 51(10): p. 1308-20.
289. Zisberg, A., et al., Hospital-associated functional decline: the role of hospitalization processes beyond individual risk factors. *J Am Geriatr Soc*, 2015. 63(1): p. 55-62.
290. ., O.J., Providing continence care in residential aged care facilities: A Grounded theory study, in nursing. 2013, Deakin University, Melbourne, Australia: Melbourne, Australia.
291. Ostaszkievicz, J., O'Connell, B., Dunning, T. , Ethical challenges associated with providing continence care in residential aged care facilities: Findings from a Grounded theory study. *Australian & New Zealand Continence Journal*, 2014. 20(4): p. 179-186.
292. Ostaszkievicz, J., B. O'Connell, and T. Dunning, Fear and overprotection in Australian residential aged-care facilities: The inadvertent impact of regulation on quality continence care. *Australas J Ageing*, 2016. 35(2): p. 119-26.
293. Muller, N. and E. McInnis, The development of national quality performance standards for disposable absorbent products for adult incontinence. *Ostomy Wound Manage*, 2013. 59(9): p. 40-55.
294. Mansson-Lindstrom, A., Dehlin, O., Isacson, A., Urinary incontinence and napkins. *Scandinavian Journal of Caring Sciences*, 1992. 6(4): p. 211-218.
295. Campbell, E.B., et al., Effect of an incontinence training program on nursing home staff's knowledge, attitudes, and behavior. *Gerontologist*, 1991. 31(6): p. 788-94.
296. Cheater, F.M., Nurses' educational preparation and knowledge concerning continence promotion. *J Adv Nurs*, 1992. 17(3): p. 328-38.
297. Collette, C., G. Bravo, and M. Tu le, Development of a urinary incontinence educational program using a competency-based approach and case method. *J Nurses Staff Dev*, 2009. 25(4): p. E5-E10.
298. Collette, C., G. Leclerc, and M. Tu le, Effectiveness of a geriatric urinary incontinence educational program for nursing staff. *Nurs Leadersh (Tor Ont)*, 2003. 16(4): p. 99-109.
299. DuBeau, C.E., J.G. Ouslander, and M.H. Palmer, Knowledge and attitudes of nursing home staff and surveyors about the revised federal guidance for incontinence care. *Gerontologist*, 2007. 47(4): p. 468-79.
300. Freundl, M. and J. Dugan, Urinary incontinence in the elderly: knowledge and attitude of long-term care staff. *Geriatr Nurs*, 1992. 13(2): p. 70-5.
301. Henderson, J.S. and M.S. Kashka, Development and testing of the Urinary Incontinence Scales. *Urol Nurs*, 1999. 19(2): p. 109-19.
302. Karłowicz, K.A., Evaluation of the Urinary Incontinence Scales to measure change after experiential learning: a pilot study. *Urol Nurs*, 2009. 29(1): p. 40-6.
303. Karłowicz, K.A. and K.L. Palmer, Engendering student empathy for disabled clients with urinary incontinence through experiential learning. *Urol Nurs*, 2006. 26(5): p. 373-8.

304. Lekan-Rutledge, D., Diffusion of innovation. A model for implementation of prompted voiding in long-term care settings. *J Gerontol Nurs*, 2000. 26(4): p. 25-33.
305. Palmer, M.H., Nurses' knowledge and beliefs about continence interventions in long-term care. *J Adv Nurs*, 1995. 21(6): p. 1065-72.
306. Resnick, B., et al., Nursing staff beliefs and expectations about continence care in nursing homes. *J Wound Ostomy Continence Nurs*, 2006. 33(6): p. 610-8.
307. Saxer, S., et al., Knowledge, beliefs, attitudes, and self-reported practice concerning urinary incontinence in nursing home care. *J Wound Ostomy Continence Nurs*, 2009. 36(5): p. 539-44.
308. Saxer, S., et al., Nurses' knowledge and practice about urinary incontinence in nursing home care. *Nurse Educ Today*, 2008.
309. Stevens, A.B., Teaching and maintaining behavior management skills with nursing assistants in a nursing home. *The Gerontologist*, 1998. 38(3): p. 379-384.
310. Vinsnes, A.G., et al., Healthcare personnel's attitudes towards patients with urinary incontinence. *J Clin Nurs*, 2001. 10(4): p. 455-62.
311. Vinsnes, A.G., Harkless, G. E., & Nyronning, S., Unit-based intervention to improve urinary incontinence in frail elderly. *Nordic Journal of Nursing Research & Clinical Studies*, 2007 27(3): p. 53.
312. Yu, L.C., et al., Urinary incontinence: nursing home staff reaction toward residents. *J Gerontol Nurs*, 1991. 17(11): p. 34-41.
313. Williams, K.S., N.J. Crichton, and B. Roe, Disseminating research evidence. A controlled trial in continence care. *J Adv Nurs*, 1997. 25(4): p. 691-8.
314. Connor, P.A. and B.M. Kooker, Nurses' knowledge, attitudes, and practices in managing urinary incontinence in the acute care setting. *Medsurg Nurs*, 1996. 5(2): p. 87-92, 117.
315. Norheim, A., Vinsnes, A. G., Staff's attitudes towards hospitalised elderly patients with urinary incontinence. *Nordic Journal of Nursing Research & Clinical Studies*, 2005 25. (1): p. 21-25.
316. Mason, M. and S. Tully, Urinary incontinence in the older acute care population: effects of knowledge, attitudes and beliefs of nurses on continence management. *Perspectives*, 2002. 26(3): p. 4-9.
317. Cooper, G. and E. Watt, An exploration of acute care nurses' approach to assessment and management of people with urinary incontinence. *J Wound Ostomy Continence Nurs*, 2003. 30(6): p. 305-13.
318. Dingwall, L. and E. McLafferty, Do nurses promote urinary continence in hospitalized older people?: An exploratory study. *J Clin Nurs*, 2006. 15(10): p. 1276-86.
319. Knowledge, attitudes, and practices of physicians regarding urinary incontinence in persons aged > or = 65 years--Massachusetts and Oklahoma, 1993. *MMWR Morb Mortal Wkly Rep*, 1995. 44(40): p. 747, 753-4.
320. Szonyi, G. and R.J. Millard, Controlled trial evaluation of a General Practitioner education package on incontinence: use of a mailed questionnaire. *Br J Urol*, 1994. 73(6): p. 615-20.
321. Albers-Heitner, P., et al., Adherence to professional guidelines for patients with urinary incontinence by general practitioners: a cross-sectional study. *Journal of evaluation in clinical practice*, 2008. 14(5): p. 807-11.
322. Swanson, J.G., et al., Urinary incontinence in Canada. National survey of family physicians' knowledge, attitudes, and practices. *Can Fam Physician*, 2002. 48: p. 86-92.
323. Thekkinkattil, D.K., et al., Awareness of investigations and treatment of faecal incontinence among the general practitioners: a postal questionnaire survey. *Colorectal Dis*, 2008. 10(3): p. 263-7.
324. Teunissen, D., et al., Urinary incontinence in the elderly: attitudes and experiences of general practitioners. A focus group study. *Scand J Prim Health Care*, 2006. 24(1): p. 56-61.
325. Branch, L.G., et al., Urinary incontinence knowledge among community-dwelling people 65 years of age and older. *J Am Geriatr Soc*, 1994. 42(12): p. 1257-62.
326. Muller, N., What Americans understand and how they are affected by bladder control problems: highlights of recent nationwide consumer research. *Urol Nurs*, 2005. 25(2): p. 109-15.
327. Mathis, S., et al., Bladder buzz: the effect of a 6-week evidence-based staff education program on knowledge and attitudes regarding urinary incontinence in a nursing home. *J Contin Educ Nurs*, 2013. 44(11): p. 498-506.
328. Ehlman, K., Wilson, A., Dugger, R., Eggleston, B., Coudret, N., Mathis, S., Nursing home staff members' attitudes and knowledge about urinary incontinence: the impact of technology and training. *Urologic Nursing*, 2012. 32: p. 205-13.

329. Brandeis, G.H., et al., The prevalence of potentially remediable urinary incontinence in frail older people: a study using the Minimum Data Set. *J Am Geriatr Soc*, 1997. 45(2): p. 179-84.
330. De Gagne, J.C., et al., Sociodemographic and health indicators of older women with urinary incontinence: 2010 National Survey of Residential Care Facilities. *J Am Geriatr Soc*, 2013. 61(6): p. 981-6.
331. Talley, K.M., et al., Factors associated with toileting disability in older adults without dementia living in residential care facilities. *Nurs Res*, 2014. 63(2): p. 94-104.
332. Tak, E.C., et al., Does improved functional performance help to reduce urinary incontinence in institutionalized older women? A multicenter randomized clinical trial. *BMC geriatrics*, 2012. 12: p. 51.
333. Vinsnes, A.G., et al., Effect of physical training on urinary incontinence: a randomized parallel group trial in nursing homes. *Clinical interventions in aging*, 2012. 7: p. 45-50.
334. Evans, D., Wood, J., Lambert, L., A review of physical restraint minimization in the acute and residential care settings. *Journal of Advanced Nursing*, 2002. 40(6): p. 616-625.
335. Ostaszkiwicz, z.J., Eustice, S., Roe, B., Thomas, L.H., French, B., Islam, T., O'Connell, B., Cody, J.D., Toileting assistance programmes for the management of urinary incontinence in adults. [Protocol]. *Cochrane Database of Systematic Reviews*, 2013(6).
336. Akpan, A., M.A. Gosney, and J. Barrett, Privacy for defecation and fecal incontinence in older adults. *J Wound Ostomy Continence Nurs*, 2006. 33(5): p. 536-40.
337. Mather, K.F. and T. Bakas, Nursing assistants' perceptions of their ability to provide continence care. *Geriatr Nurs*, 2002. 23(2): p. 76-81.
338. Harke, J.M. and K. Richgels, Barriers to implementing a continence program in nursing homes. *Clin Nurs Res*, 1992. 1(2): p. 158-68.
339. Lekan-Rutledge, D., M.H. Palmer, and M. Belyea, In their own words: nursing assistants' perceptions of barriers to implementation of prompted voiding in long-term care. *Gerontologist*, 1998. 38(3): p. 370-8.
340. Tannenbaum, C., D. Labrecque, and C. Lepage, Understanding barriers to continence care in institutions. *Can J Aging*, 2005. 24(2): p. 151-9.
341. O'Connell, B., et al., Development, implementation, and evaluation of a continence education package in acute and subacute care settings. *J Wound Ostomy Continence Nurs*, 2005. 32(2): p. 101-11.
342. Getliffe, K., et al., Absorbent products for incontinence: 'treatment effects' and impact on quality of life. *J Clin Nurs*, 2007. 16(10): p. 1936-45.
343. Wagg, A., et al., Continence care for older people in England and Wales: data from a national audit. *Journal of wound, ostomy, and continence nursing : official publication of The Wound, Ostomy and Continence Nurses Society / WOCN*, 2008. 35(2): p. 215-20.
344. Samuelsson, E., L. Mansson, and I. Milsom, Incontinence aids in Sweden: users and costs. *BJU Int*, 2001. 88(9): p. 893-8.
345. Sorbye, L.W., et al., Urinary incontinence and use of pads--clinical features and need for help in home care at 11 sites in Europe. *Scand J Caring Sci*, 2009. 23(1): p. 33-44.
346. Du Moulin, M.F., et al., Urinary incontinence in older adults receiving home care diagnosis and strategies. *Scand J Caring Sci*, 2009. 23(2): p. 222-30.
347. Wagg, A., et al., National audit of continence care for older people: management of urinary incontinence. *Age and Ageing*, 2008. 37(1): p. 39-44.
348. Palese, A., et al., Incontinence pad use in patients admitted to medical wards: an Italian multicenter prospective cohort study. *J Wound Ostomy Continence Nurs*, 2007. 34(6): p. 649-54.
349. Kadir, F.S., The "Pamper" generation: an explorative study into the use of incontinence aids in a local acute peripheral care setting. *Singapore nursing journal*, 2004. 31 (4): p. 34-38.
350. Ostaszkiwicz, J., B. O'Connell, and L. Millar, Incontinence: managed or mismanaged in hospital settings? *International journal of nursing practice*, 2008. 14(6): p. 495-502.
351. Starer, P. and L.S. Libow, Obscuring urinary incontinence. Diapering of the elderly. *J Am Geriatr Soc*, 1985. 33(12): p. 842-6.
352. Zisberg, A., et al., In-hospital use of continence aids and new-onset urinary incontinence in adults aged 70 and older. *Journal of the American Geriatrics Society*, 2011. 59(6): p. 1099-104.
353. Rodriguez, N.A., C.M. Sackley, and F.J. Badger, Exploring the facets of continence care: a continence survey of care homes for older people in Birmingham. *J Clin Nurs*, 2007. 16(5): p. 954-62.
354. Rogers, M.A., et al., Use of urinary collection devices in skilled nursing facilities in five states. *J Am Geriatr Soc*, 2008. 56(5): p. 854-61.

355. Specht, J.K., S.S. Lyons, and M.L. Maas, Patterns and treatments of Urinary incontinence on special care units. *J Gerontol Nurs*, 2002. 28(5): p. 13-21.
356. Omli, R., et al., Pad per day usage, urinary incontinence and urinary tract infections in nursing home residents. *Age Ageing*, 2010. 39(5): p. 549-54.
357. Ostaszkiwicz, J. Reframing continence care in care-dependence. *Geriatric Nursing*. 2017. <http://dx.doi.org/10.1016/j.gerinurse.2017.03.014>
358. Fung, C.H., et al., Quality indicators for the screening and care of urinary incontinence in vulnerable elders. *J Am Geriatr Soc*, 2007. 55 Suppl 2: p. S443-9.
359. Schnelle, J.F. and R.L. Smith, Quality indicators for the management of urinary incontinence in vulnerable community-dwelling elders. *Ann Intern Med*, 2001. 135(8 Pt 2): p. 752-8.
360. Gibson, W. and A. Wagg, Are older women more likely to receive surgical treatment for stress urinary incontinence since the introduction of the mid-urethral sling? An examination of Hospital Episode Statistics data. *BJOG*, 2015.
361. Harari, D., et al., National audit of continence care: adherence to National Institute for Health and Clinical Excellence (NICE) guidance in older versus younger adults with faecal incontinence. *Age Ageing*, 2014. 43(6): p. 785-93.
362. Gibson, W., et al., A national benchmark for the initial assessment of men with LUTS: data from the 2010 Royal College of Physicians National Audit of Continence Care. *World J Urol*, 2016. 34(7): p. 969-77.
363. Wagg, A., et al., Do self-reported 'integrated' continence services provide high-quality continence care? *Age and Ageing*, 2009. 38(6): p. 730-3.
364. Saliba, D., et al., The Vulnerable Elders Survey: a tool for identifying vulnerable older people in the community. *Journal of the American Geriatrics Society*, 2001. 49(12): p. 1691-9.
365. Barreto, P.d.S., C. Greig, and A.M. Ferrandez, Detecting and categorizing frailty status in older adults using a self-report screening instrument. *Archives of gerontology and geriatrics*, 2012. 54(3): p. e249=54.
366. Montero-Odasso, M., et al., Identifying mobility heterogeneity in very frail older adults. Are frail people all the same? *Archives of gerontology and geriatrics*, 2009. 49(2): p. 272-7.
367. Warshaw, G.A., et al., Community physician education in geriatrics: applying the assessing care of vulnerable elders model with a multisite primary care group. *Journal of the American Geriatrics Society*, 2010. 58(9): p. 1780-5.
368. McDowell, B.J., et al., Identification and intervention for urinary incontinence by community physicians and geriatric assessment teams. *J Am Geriatr Soc*, 1994. 42(5): p. 501-5.
369. Ouslander, J., et al., Prospective evaluation of an assessment strategy for geriatric urinary incontinence. *J Am Geriatr Soc*, 1989. 37(8): p. 715-24.
370. Torres, C., et al., Clinical approach to urinary incontinence: a comparison between internists and geriatricians. *Int Urol Nephrol*, 2001. 33(3): p. 549-52.
371. Bland, D.R., et al., The effects of implementation of the Agency for Health Care Policy and Research urinary incontinence guidelines in primary care practices. *J Am Geriatr Soc*, 2003. 51(7): p. 979-84.
372. Watson, N.M., et al., Use of the Agency for Health Care Policy and Research Urinary Incontinence Guideline in nursing homes. *J Am Geriatr Soc*, 2003. 51(12): p. 1779-86.
373. Okamura, K., et al., Diagnosis and treatment of lower urinary tract symptoms in the elderly by general practitioners. *Geriatr Gerontol Int*, 2008. 8(2): p. 119-25.
374. Okamura, K., Nojiri, Y., Ohshima, S., Practical Manual for LUTS Evaluation and Treatment in the Elderly for General Practitioners. 2005.
375. Schussler-Fiorenza Rose, S.M., et al., Increasing Discussion Rates of Incontinence in Primary Care: A Randomized Controlled Trial. *J Womens Health (Larchmt)*, 2015. 24(11): p. 940-9.
376. van Gerwen, M. and A.L. Lagro-Janssen, [Diagnostic value of patient history and physical examination in elderly patients with urinary incontinence; a literature review]. *Ned Tijdschr Geneesk*, 2006. 150(32): p. 1771-5.
377. Albers-Heitner, P.C., et al., Effectiveness of involving a nurse specialist for patients with urinary incontinence in primary care: results of a pragmatic multicentre randomised controlled trial. *International journal of clinical practice*, 2011. 65(6): p. 705-12.
378. Holtzer-Goor, K.M., et al., Cost-Effectiveness of Including a Nurse Specialist in the Treatment of Urinary Incontinence in Primary Care in the Netherlands. *PLoS One*, 2015. 10(10): p. e0138225.

379. Resnick, N.M., et al., Misdiagnosis of urinary incontinence in nursing home women: prevalence and a proposed solution. *Neurourol Urodyn*, 1996. 15(6): p. 599-613; discussion 613-8.
380. Diokno, A.C., T.J. Wells, and C.A. Brink, Urinary incontinence in elderly women: urodynamic evaluation. *J Am Geriatr Soc*, 1987. 35(10): p. 940-6.
381. Grosshans, C., Y. Passadori, and B. Peter, Urinary retention in the elderly: a study of 100 hospitalized patients. *J Am Geriatr Soc*, 1993. 41(6): p. 633-8.
382. Bonde, H.V., et al., Residual urine in 75-year-old men and women. A normative population study. *Scandinavian journal of urology and nephrology*, 1996. 30(2): p. 89-91.
383. Bright, E., R. Pearcy, and P. Abrams, Ultrasound estimated bladder weight in men attending the uroflowmetry clinic. *Neurourology and Urodynamics*, 2011. 30(4): p. 583-6.
384. Morris, V., et al., A cross-sectional study of ultrasound estimated bladder weight in a sample of men and women without lower urinary tract symptoms. *Neurourology and Urodynamics*, 2009. 28(8): p. 995-7.
385. Ouslander, J.G., Intractable incontinence in the elderly. *BJU Int*, 2000. 85 Suppl 3: p. 72-8; discussion 81-2.
386. DuBeau, C.E., et al., Incontinence in the frail elderly: report from the 4th International Consultation on Incontinence. *Neurourology and Urodynamics*, 2010. 29(1): p. 165-78.
387. Nicolle, L.E., Urinary tract infections in the elderly. *Clin Geriatr Med*, 2009. 25(3): p. 423-36.
388. Auwad, W., et al., Moderate weight loss in obese women with urinary incontinence: a prospective longitudinal study. *Int Urogynecol J Pelvic Floor Dysfunct*, 2008. 19(9): p. 1251-9.
389. Fitzgerald, M.P., M. Mulligan, and S. Parthasarathy, Nocturic frequency is related to severity of obstructive sleep apnea, improves with continuous positive airways treatment. *Am J Obstet Gynecol*, 2006. 194(5): p. 1399-403.
390. Ostaszkievicz, J., O'Connell, B., Dunning, T. Residents' perspectives on urinary incontinence: A review of literature. *Scandinavian Journal of Caring Sciences*. 2012. 26(4):761-72.
391. DuBeau, C.E., D.K. Kiely, and N.M. Resnick, Quality of life impact of urge incontinence in older persons: a new measure and conceptual structure. *J Am Geriatr Soc*, 1999. 47(8): p. 989-94.
392. Dubeau, C.E., S.E. Simon, and J.N. Morris, The effect of urinary incontinence on quality of life in older nursing home residents. *J Am Geriatr Soc*, 2006. 54(9): p. 1325-33.
393. Hawkins, K., et al., The prevalence of urinary incontinence and its burden on the quality of life among older adults with medicare supplement insurance. *Quality of life research : an international journal of quality of life aspects of treatment, care and rehabilitation*, 2011. 20(5): p. 723-32.
394. Fonda, D. and P. Abrams, Cure sometimes, help always--a "continence paradigm" for all ages and conditions. *Neurourol Urodyn*, 2006. 25(3): p. 290-2.
395. Mitteness, L.S. and J.C. Barker, Stigmatizing a "normal" condition: urinary incontinence in late life. *Med Anthropol Q*, 1995. 9(2): p. 188-210.
396. DuBeau, C.E., Urinary incontinence management: new questions from old assumptions. *J Am Geriatr Soc*, 2001. 49(6): p. 829-30.
397. Cai, L., Lubitz, J., Was there compression of disability for older Americans from 1992 to 2003? . *Demography*, 2007. 44: p. 479-495.
398. Wirth, R. and C.C. Sieber, Health care professionals underestimate the mean life expectancy of older people. *Gerontology*, 2012. 58(1): p. 56-9.
399. Krahn, M.D., et al., The ten-year rule revisited: accuracy of clinicians' estimates of life expectancy in patients with localized prostate cancer. *Urology*, 2002. 60(2): p. 258-63.
400. Sajid, S., et al., Individualized decision-making for older men with prostate cancer: balancing cancer control with treatment consequences across the clinical spectrum. *Seminars in oncology*, 2011. 38(2): p. 309-25.
401. Walter, L.C. and K.E. Covinsky, Cancer screening in elderly patients: a framework for individualized decision making. *JAMA*, 2001. 285(21): p. 2750-6.
402. Fried, L.P., et al., Risk factors for 5-year mortality in older adults: the Cardiovascular Health Study. *JAMA*, 1998. 279(8): p. 585-92.
403. Keeler, E., et al., The impact of functional status on life expectancy in older persons. *The journals of gerontology. Series A, Biological sciences and medical sciences*, 2010. 65(7): p. 727-33.
404. Larson, E.B., et al., Survival after initial diagnosis of Alzheimer disease. *Ann Intern Med*, 2004. 140(7): p. 501-9.

405. Simmons, S.F. and J.F. Schnelle, Strategies to measure nursing home residents' satisfaction and preferences related to incontinence and mobility care: implications for evaluating intervention effects. *Gerontologist*, 1999. 39(3): p. 345-55.
406. Johnson, T.M., et al., Urinary incontinence treatment preferences in long-term care. *J Am Geriatr Soc*, 2001. 49(6): p. 710-8.
407. Pfisterer, M.H., et al., Geriatric patients' preferences for treatment of urinary incontinence: a study of hospitalized, cognitively competent adults aged 80 and older. *Journal of the American Geriatrics Society*, 2007. 55(12): p. 2016-22.
408. O'Dell, K.K., C. Jacelon, and A.N. Morse, 'I'd rather just go on as I am'--pelvic floor care preferences of frail, elderly women in residential care. *Urol Nurs*, 2008. 28(1): p. 36-47.
409. Anger, J.T., et al., Increasing costs of urinary incontinence among female Medicare beneficiaries. *J Urol*, 2006. 176(1): p. 247-51; discussion 251.
410. Wilson, L., et al., Annual direct cost of urinary incontinence. *Obstet Gynecol*, 2001. 98(3): p. 398-406.
411. Reeves, P., et al., The current and future burden and cost of overactive bladder in five European countries. *Eur Urol*, 2006. 50(5): p. 1050-7.
412. Ouslander, J.G., et al., Overactive bladder: special considerations in the geriatric population. *Am J Manag Care*, 2000. 6(11 Suppl): p. S599-606.
413. Hu, T.W., et al., Estimated economic costs of overactive bladder in the United States. *Urology*, 2003. 61(6): p. 1123-8.
414. Sung, W., et al., Socioeconomic costs of overactive bladder and stress urinary incontinence in Korea. *International neurourology journal*, 2012. 16(1): p. 23-9.
415. Schnelle, J.F., et al., Reduction of urinary incontinence in nursing homes: does it reduce or increase costs? *J Am Geriatr Soc*, 1988. 36(1): p. 34-9.
416. Landefeld, C.S., et al., National Institutes of Health state-of-the-science conference statement: prevention of fecal and urinary incontinence in adults. *Annals of internal medicine*, 2008. 148(6): p. 449-58.
417. Frantz, R.A., et al., Implementing an incontinence management protocol in long-term care. *Clinical outcomes and costs. J Gerontol Nurs*, 2003. 29(8): p. 46-53.
418. Albers-Heitner, P., et al., The effects of involving a nurse practitioner in primary care for adult patients with urinary incontinence: the Promo-Con study (Promoting Continence). *BMC Health Serv Res*, 2008. 8: p. 84.
419. Morris, A.R., et al., Costs of managing urinary and faecal incontinence in a sub-acute care facility: a "bottom-up" approach. *Neurourol Urodyn*, 2005. 24(1): p. 56-62.
420. Wodchis, W.P., G.F. Teare, and G.M. Anderson, Cost and quality: evidence from Ontario long term care hospitals. *Med Care*, 2007. 45(10): p. 981-8.
421. Shih, Y.C., A.G. Hartzema, and S. Tolleson-Rinehart, Labor costs associated with incontinence in long-term care facilities. *Urology*, 2003. 62(3): p. 442-6.
422. Borrie, M.J. and H.A. Davidson, Incontinence in institutions: costs and contributing factors. *CMAJ*, 1992. 147(3): p. 322-8.
423. Green, J.P., et al., Urinary incontinence in sub-acute care--a retrospective analysis of clinical outcomes and costs. *Med J Aust*, 2003. 178(11): p. 550-3.
424. Onukwugha, E., et al., The total economic burden of overactive bladder in the United States: a disease-specific approach. *The American journal of managed care*, 2009. 15(4 Suppl): p. S90-7.
425. Langa, K.M., et al., Informal caregiving time and costs for urinary incontinence in older individuals in the United States. *J Am Geriatr Soc*, 2002. 50(4): p. 733-7.
426. Engberg, S., J. Kincade, and D. Thompson, Future directions for incontinence research with frail elders. *Nurs Res*, 2004. 53(6 Suppl): p. S22-9.
427. Palese, A. and G. Carniel, The effects of a multi-intervention incontinence care program on clinical, economic, and environmental outcomes. *Journal of wound, ostomy, and continence nursing* : official publication of The Wound, Ostomy and Continence Nurses Society / WOCN, 2011. 38(2): p. 177-83.
428. Mezey, M., et al., Decision-making capacity to execute a health care proxy: development and testing of guidelines. *J Am Geriatr Soc*, 2000. 48(2): p. 179-87.
429. Baltussen, R., R. Leidl, and A. Ament, The impact of age on cost-effectiveness ratios and its control in decision making. *Health Econ*, 1996. 5(3): p. 227-39.
430. Bressler, R. and J.J. Bahl, Principles of drug therapy for the elderly patient. *Mayo Clin Proc*, 2003. 78(12): p. 1564-77.

431. Avorn, J., Rochon, P.A., Principles of pharmacology, in *Geriatric Medicine: An Evidenced Based Approach*, C.K. Cassel, Leipzig, R., Cohen, H.J., Larson, E.B., Meier, D.E., Editor. 2003, Springer: New York. p. 65-81.
432. Rochon, P.A., et al., Age- and gender-related use of low-dose drug therapy: the need to manufacture low-dose therapy and evaluate the minimum effective dose. *J Am Geriatr Soc*, 1999. 47(8): p. 954-9.
433. Bemelmans, B.L., L.A. Kiemeny, and F.M. Debruyne, Low-dose oxybutynin for the treatment of urge incontinence: good efficacy and few side effects. *Eur Urol*, 2000. 37(6): p. 709-13.
434. Malone-Lee, J., D. Lubel, and G. Szonyi, Low dose oxybutynin for the unstable bladder. *BMJ*, 1992. 304(6833): p. 1053.
435. Kosilov, K.V., et al., Comparative effectiveness of combined low- and standard-dose tiroprium and solifenacin for moderate overactive bladder symptoms in elderly men and women. *Urol Int*, 2014. 93(4): p. 470-3.
436. Craftman, A.G., et al., Time trends in 20 years of medication use in older adults: Findings from three elderly cohorts in Stockholm, Sweden. *Arch Gerontol Geriatr*, 2016. 63: p. 28-35.
437. Moriarty, F., et al., Trends and interaction of polypharmacy and potentially inappropriate prescribing in primary care over 15 years in Ireland: a repeated cross-sectional study. *BMJ Open*, 2015. 5(9): p. e008656.
438. Nishtala, P.S. and M.S. Salahudeen, Temporal Trends in Polypharmacy and Hyperpolypharmacy in Older New Zealanders over a 9-Year Period: 2005-2013. *Gerontology*, 2015. 61(3): p. 195-202.
439. Qato, D.M., et al., Changes in Prescription and Over-the-Counter Medication and Dietary Supplement Use Among Older Adults in the United States, 2005 vs 2011. *JAMA Intern Med*, 2016. 176(4): p. 473-82.
440. Wagg, A., *National Audit of Continence Care*. 2010, Royal College of Physicians of London: London.
441. Cresswell, K.M., et al., Adverse drug events in the elderly. *Br Med Bull*, 2007. 83: p. 259-74.
442. Gnjidic, D. and K. Johnell, Clinical implications from drug-drug and drug-disease interactions in older people. *Clin Exp Pharmacol Physiol*, 2013. 40(5): p. 320-5.
443. Angamo, M.T., et al., Adverse-Drug-Reaction-Related Hospitalisations in Developed and Developing Countries: A Review of Prevalence and Contributing Factors. *Drug Saf*, 2016. 39(9): p. 847-57.
444. Patel, H., et al., Trends in hospital admissions for adverse drug reactions in England: analysis of national hospital episode statistics 1998-2005. *BMC Clin Pharmacol*, 2007. 7: p. 9.
445. Hofer-Dueckelmann, C., et al., Adverse drug reactions (ADRs) associated with hospital admissions - elderly female patients are at highest risk. *International journal of clinical pharmacology and therapeutics*, 2011. 49(10): p. 577-86.
446. Rodenburg, E.M., B.H. Stricker, and L.E. Visser, Sex differences in cardiovascular drug induced adverse reactions causing hospital admissions. *British journal of clinical pharmacology*, 2012.
447. Feinberg, M., The problems of anticholinergic adverse effects in older patients. *Drugs Aging*, 1993. 3(4): p. 335-48.
448. Hopcraft, M.S. and C. Tan, Xerostomia: an update for clinicians. *Australian dental journal*, 2010. 55(3): p. 238-44; quiz 353.
449. Pajukoski, H., et al., Prevalence of subjective dry mouth and burning mouth in hospitalized elderly patients and outpatients in relation to saliva, medication, and systemic diseases. *Oral surgery, oral medicine, oral pathology, oral radiology, and endodontics*, 2001. 92(6): p. 641-9.
450. Kessler, T.M., et al., Adverse event assessment of antimuscarinics for treating overactive bladder: a network meta-analytic approach. *PLoS ONE*, 2011. 6(2): p. e16718.
451. Buser, N., et al., Efficacy and adverse events of antimuscarinics for treating overactive bladder: network meta-analyses. *European Urology*, 2012. 62(6): p. 1040-60.
452. Herschorn, S., et al., Tolerability of solifenacin and oxybutynin immediate release in older (> 65 years) and younger (<= 65 years) patients with overactive bladder: sub-analysis from a Canadian, randomized, double-blind study. *Current medical research and opinion*, 2011. 27(2): p. 375-82.
453. Kraus, S.R., et al., Efficacy and tolerability of fesoterodine in older and younger subjects with overactive bladder. *Urology*, 2010. 76(6): p. 1350-7.
454. Wagg, A., et al., Flexible-dose fesoterodine in elderly adults with overactive bladder: results of the randomized, double-blind, placebo-controlled study of fesoterodine in an aging population trial. *Journal of the American Geriatrics Society*, 2013. 61(2): p. 185-93.

455. Chapple, C.R. and L. Nilvebrant, Tolterodine: selectivity for the urinary bladder over the eye (as measured by visual accommodation) in healthy volunteers. *Drugs R D*, 2002. 3(2): p. 75-81.
456. Altan-Yaycioglu, R., et al., Ocular side-effects of tolterodine and oxybutynin, a single-blind prospective randomized trial. *Br J Clin Pharmacol*, 2005. 59(5): p. 588-92.
457. Chapple, C., Antimuscarinics in men with lower urinary tract symptoms suggestive of bladder outlet obstruction due to benign prostatic hyperplasia. *Curr Opin Urol*. 20(1): p. 43-8.
458. Dubeau, C.E., et al., Effect of Fesoterodine in Vulnerable Elderly Subjects with Urgency Incontinence: A Double-Blind, Placebo Controlled Trial. *The Journal of urology*, 2013.
459. Gray, S.L., Anderson, M.L., Dublin, S., Hanlon, J.T., Hubbard, R., Walker, R., Yu, O., Crane, P.K., Larson, E.B., Cumulative use of strong anticholinergics and incident dementia: a prospective cohort study. *JAMA Internal Medicine*, 2015. 175(3): p. 401-7.
460. Carriere, I., et al., Drugs with anticholinergic properties, cognitive decline, and dementia in an elderly general population: the 3-city study. *Archives of internal medicine*, 2009. 169(14): p. 1317-24.
461. Kachru, N., et al., Potentially inappropriate anticholinergic medication use in community-dwelling older adults: a national cross-sectional study. *Drugs Aging*, 2015. 32(5): p. 379-89.
462. Cross, A.J., et al., Potentially Inappropriate Medications and Anticholinergic Burden in Older People Attending Memory Clinics in Australia. *Drugs Aging*, 2016. 33(1): p. 37-44.
463. Sumukadas, D., et al., Temporal trends in anticholinergic medication prescription in older people: repeated cross-sectional analysis of population prescribing data. *Age Ageing*, 2014. 43(4): p. 515-21.
464. Kay, G.G., et al., Antimuscarinic drugs for overactive bladder and their potential effects on cognitive function in older patients. *J Am Geriatr Soc*, 2005. 53(12): p. 2195-201.
465. Wagg, A., The cognitive burden of anticholinergics in the elderly- implications for the treatment of overactive bladder. *European Urology Review*, 2012. 7((1)): p. 42-49.
466. Fox, C., et al., Effect of medications with anticholinergic properties on cognitive function, delirium, physical function and mortality: a systematic review. *Age Ageing*, 2014. 43(5): p. 604-15.
467. Risacher, S.L., et al., Association Between Anticholinergic Medication Use and Cognition, Brain Metabolism, and Brain Atrophy in Cognitively Normal Older Adults. *JAMA Neurol*, 2016. 73(6): p. 721-32.
468. Villalba-Moreno, A.M., et al., Systematic review on the use of anticholinergic scales in poly pathological patients. *Arch Gerontol Geriatr*, 2016. 62: p. 1-8.
469. Salahudeen, M.S., T.Y. Chyou, and P.S. Nishtala, Serum Anticholinergic Activity and Cognitive and Functional Adverse Outcomes in Older People: A Systematic Review and Meta-Analysis of the Literature. *PLoS One*, 2016. 11(3): p. e0151084.
470. Wagg, A., et al., The efficacy and tolerability of the beta3-adrenoceptor agonist mirabegron for the treatment of symptoms of overactive bladder in older patients. *Age Ageing*, 2014. 43(5): p. 666-75.
471. Laroche, M.L., et al., Is inappropriate medication use a major cause of adverse drug reactions in the elderly? *Br J Clin Pharmacol*, 2007. 63(2): p. 177-86.
472. Colucci, V.J. and M.P. Rivey, Tolterodine-warfarin drug interaction. *Ann Pharmacother*, 1999. 33(11): p. 1173-6.
473. Groen-Wijnberg, M., et al., Pharmacokinetic Interactions Between Mirabegron and Metformin, Warfarin, Digoxin or Combined Oral Contraceptives. *Eur J Drug Metab Pharmacokinet*, 2016.
474. Hashimoto, M., et al., Urinary incontinence: an unrecognised adverse effect with donepezil. *Lancet*, 2000. 356(9229): p. 568.
475. Starr, J.M., Cholinesterase inhibitor treatment and urinary incontinence in Alzheimer's disease. *J Am Geriatr Soc*, 2007. 55(5): p. 800-1.
476. Kroger, E., et al., Treatment with rivastigmine or galantamine and risk of urinary incontinence: results from a Dutch database study. *Pharmacoepidemiol Drug Saf*, 2015. 24(3): p. 276-85.
477. Siegler, E.L. and M. Reidenberg, Treatment of urinary incontinence with anticholinergics in patients taking cholinesterase inhibitors for dementia. *Clin Pharmacol Ther*, 2004. 75(5): p. 484-8.
478. Gill, S., Mamdani, M, Naglie, G, Streiner, DL, Bronskill, SE, Kopp, A, Shulman, KI, Lee, PE, Rochon, PA., A prescribing cascade involving cholinesterase inhibitors and anticholinergic drugs. . *Arch Intern Med*, 2005 165(7): p. 808-13.

479. Zarowitz, B.J., et al., Challenges in the Pharmacological Management of Nursing Home Residents with Overactive Bladder or Urinary Incontinence. *J Am Geriatr Soc*, 2015. 63(11): p. 2298-307.
480. Sink, K.M., et al., Dual use of bladder anticholinergics and cholinesterase inhibitors: long-term functional and cognitive outcomes. *Journal of the American Geriatrics Society*, 2008. 56(5): p. 847-53.
481. Isik, A.T., et al., Tropicium and cognition in patients with late onset Alzheimer disease. *J Nutr Health Aging*, 2009. 13(8): p. 672-6.
482. Sakakibara, R., et al., How to manage overactive bladder in elderly individuals with dementia? A combined use of donepezil, a central acetylcholinesterase inhibitor, and propiverine, a peripheral muscarine receptor antagonist. *J Am Geriatr Soc*, 2009. 57(8): p. 1515-7.
483. Torvinen-Kiiskinen, S., et al., Concomitant use of acetylcholine esterase inhibitors and urinary antispasmodics among Finnish community-dwelling persons with Alzheimer disease. *J Clin Psychopharmacol*, 2014. 34(6): p. 722-7.
484. Panel., A.G.S.B.C.U.E., American Geriatrics Society 2015 Updated Beers Criteria for Potentially Inappropriate Medication Use in Older Adults. *Journal of the American Geriatrics Society*, 2015. 63(11): p. 2227-2246.
485. Oelke, M., et al., Appropriateness of oral drugs for long-term treatment of lower urinary tract symptoms in older persons: results of a systematic literature review and international consensus validation process (LUTS-FORTA 2014). *Age Ageing*, 2015. 44(5): p. 745-55.
486. Lucas, M.G., Bedretdinova, D., Berghmans, L.C., Bosch, J.L.H.R., Burkhard, F.C., Cruz, F., Nambiar, A.K., Nilsson, C.G., Tubaro, A., Pickard, R.S. . Guidelines on urinary incontinence. web page 2015 5/9/2016; 2015:[]
487. Lee, P.G., C. Cigolle, and C. Blaum, The co-occurrence of chronic diseases and geriatric syndromes: the health and retirement study. *Journal of the American Geriatrics Society*, 2009. 57(3): p. 511-6.
488. Goode, P.S., et al., Population based study of incidence and predictors of urinary incontinence in black and white older adults. *The Journal of urology*, 2008. 179(4): p. 1449-53; discussion 1453-4.
489. Scherr, D., P.W. Swindle, and P.T. Scardino, National Comprehensive Cancer Network guidelines for the management of prostate cancer. *Urology*, 2003. 61(2 Suppl 1): p. 14-24.
490. Johnson, T.M., 2nd, et al., Self-care practices used by older men and women to manage urinary incontinence: results from the national follow-up survey on self-care and aging. *Journal of the American Geriatrics Society*, 2000. 48(8): p. 894-902.
491. Teunissen, T.A. and A.L. Lagro-Janssen, Sex differences in the use of absorbent (incontinence) pads in independently living elderly people: do men receive less care? *Int J Clin Pract*, 2009. 63(6): p. 869-73.
492. Gage, H., et al., Community prevalence of long-term urinary catheters use in England. *Neurourol Urodyn*, 2016.
493. Wullner, U., Schmitz-Hubscha, T., Antonyb, G., Fimmersa, R., Spottkea, A., Oertelb, W. H., Deuschlc, G., Klockgetherra, T., Eggertb, K. on behalf of the KNP e.V., Autonomic dysfunction in 3414 Parkinson's disease patients enrolled in the German Network on Parkinson's disease (KNP e.V.): the effect of ageing. *European Journal of Neurology*, 2007. 14: p. 1405-1408
494. Divani, A.A., et al., Risk factors associated with injury attributable to falling among elderly population with history of stroke. *Stroke; a journal of cerebral circulation*, 2009. 40(10): p. 3286-92.
495. Brown, C.T., et al., Lifestyle and behavioural interventions for men on watchful waiting with uncomplicated lower urinary tract symptoms: a national multidisciplinary survey. *BJU Int*, 2003. 92(1): p. 53-7.
496. Wyman, J.F., K.L. Burgio, and D.K. Newman, Practical aspects of lifestyle modifications and behavioural interventions in the treatment of overactive bladder and urgency urinary incontinence. *Int J Clin Pract*, 2009. 63(8): p. 1177-91.
497. Kincade, J.E., et al., Randomized clinical trial of efficacy of self-monitoring techniques to treat urinary incontinence in women. *Neurourol Urodyn*, 2007. 26(4): p. 507-11.
498. Lucas, M.G., et al., EAU guidelines on assessment and nonsurgical management of urinary incontinence. *Eur Urol*, 2012. 62(6): p. 1130-42.
499. Gaspar, P.M., Comparison of four standards for determining adequate water intake of nursing home residents. *Research and theory for nursing practice*, 2011. 25(1): p. 11-22.
500. McCrow, J., et al., Associations Between Dehydration, Cognitive Impairment, and Frailty in Older Hospitalized Patients: An Exploratory Study. *J Gerontol Nurs*, 2016. 42(5): p. 19-27.

501. Voyer, P., et al., Precipitating factors associated with delirium among long-term care residents with dementia. *Appl Nurs Res*, 2011. 24(3): p. 171-8.
502. Rose, A., et al., Severity of urinary incontinence of nursing home residents correlates with malnutrition, dementia and loss of mobility. *Urol Int*, 2013. 91(2): p. 165-9.
503. Imamura, M., et al., Lifestyle interventions for the treatment of urinary incontinence in adults. *Cochrane Database Syst Rev*, 2015(12): p. CD003505.
504. Callan, L., D.L. Thompson, and D. Netsch, Does Increasing or Decreasing the Daily Intake of Water/Fluid by Adults Affect Overactive Bladder Symptoms? *J Wound Ostomy Continence Nurs*, 2015. 42(6): p. 614-20.
505. Spangler, P.F., Risely, T.R., Bilyew, D.D. , , The management of dehydration and incontinence in nonambulatory geriatric patients. *J Appl Behav Anal*, 1984. 17(3): p. 397-401.
506. Dowd, T.T., J.M. Campbell, and J.A. Jones, Fluid intake and urinary incontinence in older community-dwelling women. *Journal of community health nursing*, 1996. 13(3): p. 179-86.
507. Schnelle, J.F., et al., A controlled trial of an intervention to improve urinary and fecal incontinence and constipation. *J Am Geriatr Soc*, 2010. 58(8): p. 1504-11.
508. Wells, M.J., et al., The effect of caffeinated versus decaffeinated drinks on overactive bladder: a double-blind, randomized, crossover study. *J Wound Ostomy Continence Nurs*, 2014. 41(4): p. 371-8.
509. Roe, B., et al., Systematic reviews of bladder training and voiding programmes in adults: a synopsis of findings from data analysis and outcomes using metastudy techniques. *Journal of advanced nursing*, 2007. 57(1): p. 15-31.
510. Palmer, M.H., Use of health behavior change theories to guide urinary incontinence research. *Nursing Research*, 2004. 53(6 Suppl): p. S49-55.
511. Engberg, S., et al., Effectiveness of prompted voiding in treating urinary incontinence in cognitively impaired homebound older adults. *J Wound Ostomy Continence Nurs*, 2002. 29(5): p. 252-65.
512. Ostaszkievicz, J., L. Johnston, and B. Roe, Habit retraining for the management of urinary incontinence in adults. *Cochrane Database Syst Rev*, 2004(2): p. CD002801.
513. Ostaszkievicz, J., B. Roe, and L. Johnston, Effects of timed voiding for the management of urinary incontinence in adults: systematic review. *J Adv Nurs*, 2005. 52(4): p. 420-31.
514. Fantl, J.A., et al., Bladder training in the management of lower urinary tract dysfunction in women. A review. *J Am Geriatr Soc*, 1990. 38(3): p. 329-32.
515. Roe, B., et al., Systematic reviews of bladder training and voiding programmes in adults: a synopsis of findings on theory and methods using metastudy techniques. *Journal of advanced nursing*, 2007. 57(1): p. 3-14.
516. Dingwall, L., Promoting effective continence care for older people: a literature review. *Br J Nurs*, 2008. 17(3): p. 166-72.
517. Park, S., et al., Knowledge, attitudes, beliefs, and practices in registered nurses and care aids about urinary incontinence in Korean nursing homes: a cross-sectional survey. *J Wound Ostomy Continence Nurs*, 2015. 42(2): p. 183-9.
518. French, B., et al., Client and clinical staff perceptions of barriers to and enablers of the uptake and delivery of behavioural interventions for urinary incontinence: qualitative evidence synthesis. *J Adv Nurs*, 2017. 73(1): p. 21-38.
519. Cheater, F.M., Overcoming the barriers to optimum continence care: the need for an expanded approach to implementation. *Int J Older People Nurs*, 2009. 4(1): p. 70-5.
520. Schnelle, J.F., et al., Functional Incidental Training, mobility performance, and incontinence care with nursing home residents. *J Am Geriatr Soc*, 1995. 43(12): p. 1356-62.
521. van Houten, P., W. Achterberg, and M. Ribbe, Urinary incontinence in disabled elderly women: a randomized clinical trial on the effect of training mobility and toileting skills to achieve independent toileting. *Gerontology*, 2007. 53(4): p. 205-10.
522. McDowell, B.J., et al., Effectiveness of behavioral therapy to treat incontinence in homebound older adults. *J Am Geriatr Soc*, 1999. 47(3): p. 309-18.
523. Hagglund, D., A systematic literature review of incontinence care for persons with dementia: the research evidence. *J Clin Nurs*. 19(3-4): p. 303-12.
524. Wyman, J.F., et al., Comparative efficacy of behavioral interventions in the management of female urinary incontinence. *Continence Program for Women Research Group. Am J Obstet Gynecol*, 1998. 179(4): p. 999-1007.
525. Subak, L.L., et al., The effect of behavioral therapy on urinary incontinence: a randomized controlled trial. *Obstetrics and gynecology*, 2002. 100(1): p. 72-8.

526. Diokno, A.C., et al., Prevention of urinary incontinence by behavioral modification program: a randomized, controlled trial among older women in the community. *J Urol*, 2004. 171(3): p. 1165-71.
527. Flanagan, L., et al., Systematic review of care intervention studies for the management of incontinence and promotion of continence in older people in care homes with urinary incontinence as the primary focus (1966-2010). *Geriatr Gerontol Int*, 2012. 12(4): p. 600-11.
528. Roe, B., L. Flanagan, and M. Maden, Systematic review of systematic reviews for the management of urinary incontinence and promotion of continence using conservative behavioural approaches in older people in care homes. *J Adv Nurs*, 2015. 71(7): p. 1464-83.
529. Talley, K.M., J.F. Wyman, and T.A. Shamliyan, State of the science: conservative interventions for urinary incontinence in frail community-dwelling older adults. *Nursing outlook*, 2011. 59(4): p. 215-20, 220 e1.
530. Stenzelius, K., et al., The effect of conservative treatment of urinary incontinence among older and frail older people: a systematic review. *Age Ageing*, 2015. 44(5): p. 736-44.
531. Iwatsubo, E., et al., Individually tailored ultrasound-assisted prompted voiding for institutionalized older adults with urinary incontinence. *Int J Urol*, 2014. 21(12): p. 1253-7.
532. Suzuki, M., et al., Ultrasound-assisted prompted voiding for management of urinary incontinence of nursing home residents: Efficacy and feasibility. *Int J Urol*, 2016. 23(9): p. 786-90.
533. Kim, H., H. Yoshida, and T. Suzuki, The effects of multidimensional exercise on functional decline, urinary incontinence, and fear of falling in community-dwelling elderly women with multiple symptoms of geriatric syndrome: a randomized controlled and 6-month follow-up trial. *Archives of gerontology and geriatrics*, 2011. 52(1): p. 99-105.
534. Kim, H., H. Yoshida, and T. Suzuki, Effects of exercise treatment with or without heat and steam generating sheet on urine loss in community-dwelling Japanese elderly women with urinary incontinence. *Geriatrics & gerontology international*, 2011. 11(4): p. 452-9.
535. Engberg, S. and S.M. Sereika, Effectiveness of Pelvic Floor Muscle Training for Urinary Incontinence: Comparison Within and Between Non-homebound and Homebound Older Adults. *J Wound Ostomy Continence Nurs*, 2016. 43(3): p. 291-300.
536. Kim, H., H. Yoshida, and T. Suzuki, The effects of multidimensional exercise treatment on community-dwelling elderly Japanese women with stress, urge, and mixed urinary incontinence: A randomized controlled trial. *International journal of nursing studies*, 2011.
537. Roe, B., et al., Systematic review of the management of incontinence and promotion of continence in older people in care homes: descriptive studies with urinary incontinence as primary focus. *Journal of advanced nursing*, 2011. 67(2): p. 228-50.
538. Mandl, M., Halfens, R.J.G., Lohrmann, C. , , Incontinence care in nursing homes: a cross-sectional study. *Int J Adv Nurs*, 2015. 71 (9): p. 2142-52.
539. Lin, S.Y., Wang, R-H., Lin, C-C., Chiang, H-Y. , Competence to provide urinary incontinence care in Taiwan's nursing homes. Perceptions of nurses and nursing assistance. *J Wound Ostomy Continence Nurs.*, 2012. 39 (2): p. 187-193.
540. Ehlman, K., Wilson, A., Dugger, R., Eggleston, B., Coudret, N., Mathis, S. , Nursing home staff members' attitudes and knowledge about urinary incontinence: the impact of technology and training. *urological Nursing*, 2012. 32 (4): p. 205-13.
541. Colling, J., et al., The effects of patterned urge-response toileting (PURT) on urinary incontinence among nursing home residents. *J Am Geriatr Soc*, 1992. 40(2): p. 135-41.
542. Creason, N.S., et al., Prompted voiding therapy for urinary incontinence in aged female nursing home residents. *J Adv Nurs*, 1989. 14(2): p. 120-6.
543. Schnelle, J.F., et al., Individualizing nighttime incontinence care in nursing home residents. *Nurs Res*, 1998. 47(4): p. 197-204.
544. Hu, T.W., et al., A clinical trial of a behavioral therapy to reduce urinary incontinence in nursing homes. Outcome and implications. *JAMA*, 1989. 261(18): p. 2656-62.
545. Schnelle, J.F., Cruise, P.A., Rahman, A., Ouslander, J.G. , Developing rehabilitative behavioral interventions for long-term care: technology transfer, acceptance, and maintenance issues. *J Am Geriatr Soc*, , 1998. 46(6): p. 771-7.
546. Ostaszkiwicz, J., A clinical nursing leadership model for enhancing continence care for older adults in a subacute inpatient care setting. *J Wound Ostomy Continence Nurs*, 2006. 33(6): p. 624-9.

547. Rahman, A.N., et al., Distance learning: a strategy for improving incontinence care in nursing homes. *Gerontologist*, 2010. 50(1): p. 121-32.
548. Rahman, A.N., Schnelle, J.F., Osterweil, D. , Implementing toileting trials in nursing homes: evaluation of a dissemination strategy. *Geriatr Nurs* 2014. 35:: p. 283-89.
549. Bucci, A.T., Be a continence champion: use the CHAMMP tool to individualize the plan of care. *Geriatr Nurs*, 2007. 28(2): p. 120-4; quiz 125.
550. Jansen, L. and D. Forbes, The psychometric testing of a urinary incontinence nursing assessment instrument. *J Wound Ostomy Continence Nurs*, 2006. 33(1): p. 69-76.
551. O'Connell, B., J. Ostaszkiwicz, and M. Hawkins, A suite of evidence-based continence assessment tools for residential aged care. *Australasian journal on ageing*, 2011. 30(1): p. 27-32.
552. Engst, C., et al., Implementation of a scheduled toileting program in a long term care facility: evaluating the impact on injury risk to caregiving staff. *AAOHN J*, 2004. 52(10): p. 427-35.
553. Tanaka, Y., et al., Can an individualized and comprehensive care strategy improve urinary incontinence (UI) among nursing home residents? *Arch Gerontol Geriatr*, 2009. 49(2): p. 278-83.
554. Ryden, M.B., et al., Value-added outcomes: the use of advanced practice nurses in long-term care facilities. *Gerontologist*, 2000. 40(6): p. 654-62.
555. Kincade, J.E., et al., Bladder management in adult care homes. Review of a program in North Carolina. *J Gerontol Nurs*, 2003. 29(10): p. 30-6; quiz 54-5.
556. Stolee, P., Hiller, L.M., Esbaugh, J., Bol, N., McKellar, L., Gauthier, N. , Factors associated with the effectiveness of continuing education in long-term care. *Gerontologist*, , 2005. 45 (3): p. 300-405.
557. Roe, B., et al., Translating research on incontinence into practice. *Nurs Res*, 2004. 53(6 Suppl): p. S56-60.
558. Popejoy, L.L., Rantz, M.J., Conn, V., Wipke-Tevis, D., Grando, V.T., Porter, R. , Improving quality of care in nursing facilities. *Gerontological clinical nurse specialist as research nurse consultant. J Gerontol Nurs*,, 2000. 26(4): p. 6-13.
559. Schnelle, J.F., et al., Translating clinical research into practice: a randomized controlled trial of exercise and incontinence care with nursing home residents. *J Am Geriatr Soc*, 2002. 50(9): p. 1476-83.
560. Remsburg, R.E., et al., Staff compliance with and ratings of effectiveness of a prompted voiding program in a long-term care facility. *J Wound Ostomy Continence Nurs*, 1999. 26(5): p. 261-9.
561. Jacobs, D., et al., Twenty-four-hour sleep-wake patterns in a nursing home population. *Psychology and aging*, 1989. 4(3): p. 352-6.
562. Bliwise, D.L., J.S. Carroll, and W.C. Dement, Predictors of observed sleep/wakefulness in residents in long-term care. *Journal of gerontology*, 1990. 45(4): p. M126-30.
563. Schnelle, J.F., et al., Nighttime sleep and bed mobility among incontinent nursing home residents. *J Am Geriatr Soc*, 1993. 41(9): p. 903-9.
564. Schnelle, J.F., et al., The nighttime environment, incontinence care, and sleep disruption in nursing homes. *J Am Geriatr Soc*, 1993. 41(9): p. 910-4.
565. Cruise, P.A., et al., The nighttime environment and incontinence care practices in nursing homes. *J Am Geriatr Soc*, 1998. 46(2): p. 181-6.
566. Alessi, C.A., et al., A randomized trial of a combined physical activity and environmental intervention in nursing home residents: do sleep and agitation improve? *J Am Geriatr Soc*, 1999. 47(7): p. 784-91.
567. Schnelle, J.F., et al., The nursing home at night: effects of an intervention on noise, light, and sleep. *J Am Geriatr Soc*, 1999. 47(4): p. 430-8.
568. Ouslander, J.G., N. Ai-Samarrai, and J.F. Schnelle, Prompted voiding for nighttime incontinence in nursing homes: is it effective? *J Am Geriatr Soc*, 2001. 49(6): p. 706-9.
569. Fader, M., et al., Management of night-time urinary incontinence in residential settings for older people: an investigation into the effects of different pad changing regimes on skin health. *J Clin Nurs*, 2003. 12(3): p. 374-86.
570. Ostaszkiwicz, J., B. O'Connell, and T. Dunning, Night-time continence care in Australian residential aged care facilities: findings from a grounded theory study. *Contemp Nurse*, 2016. 52(2-3): p. 152-62.
571. Shimanouchi, S., T. Kamei, and M. Hayashi, Home care for the frail elderly based on urinary incontinence level. *Public Health Nurs*, 2000. 17(6): p. 468-73.
572. Santini, S., G. Andersson, and G. Lamura, Impact of incontinence on the quality of life of caregivers of older persons with incontinence: A qualitative study in four European countries. *Arch Gerontol Geriatr*, 2016. 63: p. 92-101.

573. Hutchinson, S., S. Leger-Krall, and H. Skodol Wilson, Toileting: a biobehavioral challenge in Alzheimer's dementia care. *J Gerontol Nurs*, 1996. 22(10): p. 18-27.
574. Upton, N. and V. Reed, The meaning of incontinence in dementia care. *Int J Psychiatr Nurs Res*, 2005. 11(1): p. 1200-10.
575. Zarowitz, B.J., et al., Clinical Burden and Non-pharmacologic Management of Nursing Facility Residents with Overactive Bladder and/or Urinary Incontinence. *The Consultant pharmacist : the journal of the American Society of Consultant Pharmacists*, 2015. 30(9): p. 533-42.
576. Narayanan, S., et al., Is drug therapy for urinary incontinence used optimally in long-term care facilities? *Journal of the American Medical Directors Association*, 2007. 8(2): p. 98-104.
577. Jumadilova, Z., et al., Urinary incontinence in the nursing home: resident characteristics and prevalence of drug treatment. *Am J Manag Care*, 2005. 11(4 Suppl): p. S112-20.
578. Min, L., et al., The vulnerable elders-13 survey predicts 5-year functional decline and mortality outcomes in older ambulatory care patients. *J Am Geriatr Soc*, 2009. 57(11): p. 2070-6.
579. Samuelsson, E., et al., Effect of pharmacological treatment for urinary incontinence in the elderly and frail elderly: A systematic review. *Geriatr Gerontol Int*, 2015. 15(5): p. 521-34.
580. Paquette, A., P. Gou, and C. Tannenbaum, Systematic review and meta-analysis: do clinical trials testing antimuscarinic agents for overactive bladder adequately measure central nervous system adverse events? *Journal of the American Geriatrics Society*, 2011. 59(7): p. 1332-9.
581. Lackner, T.E., et al., Randomized, placebo-controlled trial of the cognitive effect, safety, and tolerability of oral extended-release oxybutynin in cognitively impaired nursing home residents with urge urinary incontinence. *Journal of the American Geriatrics Society*, 2008. 56(5): p. 862-70.
582. Lackner, T.E., et al., Efficacy of oral extended-release oxybutynin in cognitively impaired older nursing home residents with urge urinary incontinence: a randomized placebo-controlled trial. *Journal of the American Medical Directors Association*, 2011. 12(9): p. 639-47.
583. Minassian, V.A., et al., Randomized trial of oxybutynin extended versus immediate release for women aged 65 and older with overactive bladder: lessons learned from conducting a trial. *Journal of obstetrics and gynaecology Canada : JOGC = Journal d'obstetrique et gynecologie du Canada : JOGC*, 2007. 29(9): p. 726-32.
584. Sand, P., et al., Oxybutynin transdermal system improves the quality of life in adults with overactive bladder: a multicentre, community-based, randomized study. *BJU international*, 2007. 99(4): p. 836-44.
585. Gibson, W., et al., Are we shortchanging frail older people when it comes to the pharmacological treatment of urgency urinary incontinence? *Int J Clin Pract*, 2014. 68(9): p. 1165-73.
586. Biardeau, X., L. Campeau, and J. Corcos, We should not use oxybutynin chloride in OAB. *Neurourol Urodyn*, 2016.
587. Kay, G.G., et al., Cognitive effects of oxybutynin chloride topical gel in older healthy subjects: a 1-week, randomized, double-blind, placebo- and active-controlled study. *Clinical drug investigation*, 2012. 32(10): p. 707-14.
588. Staskin, D.R., et al., Efficacy and safety of oxybutynin chloride topical gel for overactive bladder: a randomized, double-blind, placebo controlled, multicenter study. *The Journal of urology*, 2009. 181(4): p. 1764-72.
589. Monnot, M. and E. Ross, Urinary Urgency Medications May Compromise Discrete rather than Global Cognitive Skills. *Dement Geriatr Cogn Dis Extra*, 2012. 2(1): p. 238-47.
590. Hughes, K.M., et al., Measurement of oxybutynin and its N-desethyl metabolite in plasma, and its application to pharmacokinetic studies in young, elderly and frail elderly volunteers. *Xenobiotica*, 1992. 22(7): p. 859-69.
591. Ouslander, J.G., et al., Pharmacokinetics and clinical effects of oxybutynin in geriatric patients. *J Urol*, 1988. 140(1): p. 47-50.
592. Zobrist, R.H., et al., Pharmacokinetics and metabolism of transdermal oxybutynin: in vitro and in vivo performance of a novel delivery system. *Pharm Res*, 2003. 20(1): p. 103-9.
593. Ouslander, J.G., et al., Habit training and oxybutynin for incontinence in nursing home patients: a placebo-controlled trial. *J Am Geriatr Soc*, 1988. 36(1): p. 40-6.
594. Ouslander, J.G., et al., Does oxybutynin add to the effectiveness of prompted voiding for urinary incontinence among nursing home residents? A placebo-controlled trial. *J Am Geriatr Soc*, 1995. 43(6): p. 610-7.
595. Zorzitto, M.L., et al., Oxybutynin chloride for geriatric urinary dysfunction: a double-blind placebo-controlled study. *Age Ageing*, 1989. 18(3): p. 195-200.
596. Szonyi, G., et al., Oxybutynin with bladder retraining for detrusor instability in elderly people: a randomized controlled trial. *Age and Ageing*, 1995. 24(4): p. 287-91.

597. Uchibayashi, T., et al., [Assessment of the use of oxybutynin hydrochloride (Pollakis tablets) in the elderly]. *Hinyokika Kyo*, 1991. 37(9): p. 1077-85.
598. Newman, D.K., The MATRIX study: evaluating the data in older adults. *Director*, 2008. 16(3): p. 15-9.
599. Newman, D.K., The MATRIX study: assessment of health-related quality of life in adults with the use of transdermal oxybutynin. *Director*, 2008. 16(1): p. 22-5.
600. Mizunaga, M., et al., [Intravesical oxybutynin hydrochloride in the treatment of urge incontinence in the elderly]. *Nippon Hinyokika Gakkai Zasshi*, 1996. 87(6): p. 923-7.
601. Gittelman, M., H. Weiss, and L. Seidman, A phase 2, randomized, double-blind, efficacy and safety study of oxybutynin vaginal ring for alleviation of overactive bladder symptoms in women. *J Urol*, 2014. 191(4): p. 1014-21.
602. Griffiths, D.J., et al., Urge incontinence in elderly people: factors predicting the severity of urine loss before and after pharmacological treatment. *Neurourol Urodyn*, 1996. 15(1): p. 53-7.
603. Sugiyama, T., et al., [Anticholinergic therapy of urinary incontinence and urinary frequency associated with the elderly--with special reference to dementia]. *Nippon Hinyokika Gakkai Zasshi*, 1993. 84(6): p. 1068-73.
604. Zellner, M., et al., Trosipium chloride and oxybutynin hydrochloride in a german study of adults with urinary urge incontinence: results of a 12-week, multicenter, randomized, double-blind, parallel-group, flexible-dose noninferiority trial. *Clinical therapeutics*, 2009. 31(11): p. 2519-39.
605. Donnellan, C.A., et al., Oxybutynin and cognitive dysfunction. *BMJ*, 1997. 315(7119): p. 1363-4.
606. Patel, H.R., et al., Can oxybutynin cause peripheral neuropathy? *J Urol*, 2002. 168(2): p. 646.
607. Adubofour, K.O., et al., Oxybutynin-induced heatstroke in an elderly patient. *Ann Pharmacother*, 1996. 30(2): p. 144-7.
608. Hussain, R.M., et al., Effect of oxybutynin on the QTc interval in elderly patients with urinary incontinence. *Br J Clin Pharmacol*, 1996. 41(1): p. 73-5.
609. Wang, P.S., et al., Urinary antispasmodic use and the risks of ventricular arrhythmia and sudden death in older patients. *J Am Geriatr Soc*, 2002. 50(1): p. 117-24.
610. Zinner, N.R., A. Mattiasson, and S.L. Stanton, Efficacy, safety, and tolerability of extended-release once-daily tolterodine treatment for overactive bladder in older versus younger patients. *J Am Geriatr Soc*, 2002. 50(5): p. 799-807.
611. Millard, R., et al., Clinical efficacy and safety of tolterodine compared to placebo in detrusor overactivity. *J Urol*, 1999. 161(5): p. 1551-5.
612. Drutz, H.P., et al., Clinical efficacy and safety of tolterodine compared to oxybutynin and placebo in patients with overactive bladder. *Int Urogynecol J Pelvic Floor Dysfunct*, 1999. 10(5): p. 283-9.
613. Michel, M.C., et al., Does gender or age affect the efficacy and safety of tolterodine? *J Urol*, 2002. 168(3): p. 1027-31.
614. Ouslander, J.G., et al., Implementation of a nursing home urinary incontinence management program with and without tolterodine. *J Am Med Dir Assoc*, 2001. 2(5): p. 207-14.
615. Aziminekoo, E., et al., Oxybutynin and tolterodine in a trial for treatment of overactive bladder in Iranian women. *J Family Reprod Health*, 2014. 8(2): p. 73-6.
616. Chung, S.D., et al., The efficacy of additive tolterodine extended release for 1-year in older men with storage symptoms and clinical benign prostatic hyperplasia. *Neurourology and Urodynamics*, 2011. 30(4): p. 568-71.
617. Cao, Y., et al., A Randomized, Open-Label, Comparative Study of Efficacy and Safety of Tolterodine Combined with Tamsulosin or Doxazosin in Patients with Benign Prostatic Hyperplasia. *Med Sci Monit*, 2016. 22: p. 1895-902.
618. Oelke, M., A. Gericke, and M.C. Michel, Cardiovascular and ocular safety of alpha1-adrenoceptor antagonists in the treatment of male lower urinary tract symptoms. *Expert opinion on drug safety*, 2014. 13(9): p. 1187-97.
619. Tsao, J.W. and K.M. Heilman, Transient memory impairment and hallucinations associated with tolterodine use. *N Engl J Med*, 2003. 349(23): p. 2274-5.
620. Womack, K.B. and K.M. Heilman, Tolterodine and memory: dry but forgetful. *Arch Neurol*, 2003. 60(5): p. 771-3.
621. Salvatore, S., et al., Cognitive dysfunction with tolterodine use. *Am J Obstet Gynecol*, 2007. 197(2): p. e8.
622. Edwards, K.R. and J.T. O'Connor, Risk of delirium with concomitant use of tolterodine and acetylcholinesterase inhibitors. *J Am Geriatr Soc*, 2002. 50(6): p. 1165-6.

623. Layton, D., G.L. Pearce, and S.A. Shakir, Safety profile of tolterodine as used in general practice in England: results of prescription-event monitoring. *Drug Saf*, 2001. 24(9): p. 703-13.
624. Malhotra, B.K., N. Wood, and R. Sachse, Influence of age, gender, and race on pharmacokinetics, pharmacodynamics, and safety of fesoterodine. *International journal of clinical pharmacology and therapeutics*, 2009. 47(9): p. 570-8.
625. Sand, P.K., et al., Long-term safety, tolerability and efficacy of fesoterodine in subjects with overactive bladder symptoms stratified by age: pooled analysis of two open-label extension studies. *Drugs Aging*, 2012. 29(2): p. 119-31.
626. Wagg, A., et al., Long-term safety, tolerability and efficacy of flexible-dose fesoterodine in elderly patients with overactive bladder: open-label extension of the SOFIA trial. *Neurourol Urodyn*, 2014. 33(1): p. 106-14.
627. Wagg, A., et al., Factors associated with dose escalation of fesoterodine for treatment of overactive bladder in people >65 years of age: A post hoc analysis of data from the SOFIA study. *Neurourol Urodyn*, 2015. 34(5): p. 438-43.
628. Dell'Atti, L., Efficacy of Tadalafil once daily versus Fesoterodine in the treatment of overactive bladder in older patients. *Eur Rev Med Pharmacol Sci*, 2015. 19(9): p. 1559-63.
629. Kay, G.G., et al., Evaluation of cognitive function in healthy older subjects treated with fesoterodine. *Postgraduate medicine*, 2012. 124(3): p. 7-15.
630. Yamaguchi, O., et al., Safety and efficacy of mirabegron as 'add-on' therapy in patients with overactive bladder treated with solifenacin: a post-marketing, open-label study in Japan (MILAI study). *BJU Int*, 2015. 116(4): p. 612-22.
631. Kosilov, K., et al., A randomized, controlled trial of effectiveness and safety of management of OAB symptoms in elderly men and women with standard-dosed combination of solifenacin and mirabegron. *Arch Gerontol Geriatr*, 2015. 61(2): p. 212-6.
632. Kosilov, K.V., et al., Effectiveness of Solifenacin and Trosipium for Managing of Severe Symptoms of Overactive Bladder in Patients With Benign Prostatic Hyperplasia. *Am J Mens Health*, 2016. 10(2): p. 157-63.
633. Krauwinkel, W.J., et al., Effect of age on the pharmacokinetics of solifenacin in men and women. *Int J Clin Pharmacol Ther*, 2005. 43(5): p. 227-38.
634. Wagg, A., J.J. Wyndaele, and P. Sieber, Efficacy and tolerability of solifenacin in elderly subjects with overactive bladder syndrome: a pooled analysis. *The American journal of geriatric pharmacotherapy*, 2006. 4(1): p. 14-24.
635. Michel, M.C., et al., Cardiovascular safety and overall tolerability of solifenacin in routine clinical use: a 12-week, open-label, post-marketing surveillance study. *Drug Saf*, 2008. 31(6): p. 505-14.
636. Wesnes, K.A., et al., Exploratory pilot study assessing the risk of cognitive impairment or sedation in the elderly following single doses of solifenacin 10 mg. *Expert opinion on drug safety*, 2009. 8(6): p. 615-26.
637. Wagg, A., et al., Randomised, multicentre, placebo-controlled, double-blind crossover study investigating the effect of solifenacin and oxybutynin in elderly people with mild cognitive impairment: the SENIOR study. *European Urology*, 2013. 64(1): p. 74-81.
638. Chapple, C., et al., Darifenacin treatment of patients >or= 65 years with overactive bladder: results of a randomized, controlled, 12-week trial. *Current medical research and opinion*, 2007. 23(10): p. 2347-58.
639. Hill, S., et al., Long-term darifenacin treatment for overactive bladder in patients aged 65 years and older: analysis of results from a 2-year, open-label extension study. *Current medical research and opinion*, 2007. 23(11): p. 2697-704.
640. Khullar, V., et al., Time-to-effect with darifenacin in overactive bladder: a pooled analysis. *Int Urogynecol J*, 2011. 22(12): p. 1573-80.
641. Lipton, R.B., K. Kolodner, and K. Wesnes, Assessment of cognitive function of the elderly population: effects of darifenacin. *J Urol*, 2005. 173(2): p. 493-8.
642. Kay, G., et al., Differential effects of the antimuscarinic agents darifenacin and oxybutynin ER on memory in older subjects. *European Urology*, 2006. 50(2): p. 317-26.
643. Sand, P.K., et al., Trosipium chloride once-daily extended release is efficacious and tolerated in elderly subjects (aged >= 75 years) with overactive bladder syndrome. *BJU international*, 2011. 107(4): p. 612-20.
644. Sand, P.K., et al., Once-daily trosipium chloride 60 mg extended release in subjects with overactive bladder syndrome who use multiple concomitant medications: Post hoc analysis of pooled data from two randomized, placebo-controlled trials. *Drugs Aging*, 2011. 28(2): p. 151-60.

645. Staskin, D., Kay, G., Tannenbaum, C., Goldman, H.B., Bhashi, K., Ling, J., Oefelein, M.G., Trospium chloride has no effect on memory testing and is assay undetectable in the central nervous system of older patients with overactive bladder. *International journal of Clinical Practice*, 2010. 64(9): p. 1294 - 1300.
646. Staskin, D., Kay, G., Tannenbaum, C., Goldman, H.B., Bhashi, K., Ling, J., Oefelein, M.G., Trospium chloride is undetectable in older human central nervous system. *Journal of the American Geriatrics Society*, 2010. 58(8): p. 1618 - 1619.
647. Madersbacher, H. and G. Murtz, Efficacy, tolerability and safety profile of propiverine in the treatment of the overactive bladder (non-neurogenic and neurogenic). *World J Urol*, 2001. 19(5): p. 324-35.
648. Mori, S., et al., [Bladder dysfunction in dementia patients showing urinary incontinence: evaluation with cystometry and treatment with propiverine hydrochloride]. *Nippon Ronen Igakkai Zasshi*, 1999. 36(7): p. 489-94.
649. Otomo, E., Maruyama, S., Kobayashi, I. et al, Clinical evaluation of propiverine hydrochloride (P-4) on urinary disturbances due to neurological diseases. *Japan J Pharmacol*, 1990. 18: p. 1731.
650. Dorschner, W., et al., [The elderly patient with urge incontinence or urge-stress incontinence - efficacy and cardiac safety of propiverine]. *Aktuelle Urol*, 2003. 34(2): p. 102-8.
651. Kanayama, N., et al., Drug-drug interactions in the metabolism of imidafenacin: role of the human cytochrome P450 enzymes and UDP-glucuronic acid transferases, and potential of imidafenacin to inhibit human cytochrome P450 enzymes. *Xenobiotica*, 2007. 37(2): p. 139-54.
652. Ohno, T., et al., Effect of itraconazole on the pharmacokinetics of imidafenacin in healthy subjects. *J Clin Pharmacol*, 2008. 48(3): p. 330-4.
653. Ohno, T., et al., Absolute bioavailability of imidafenacin after oral administration to healthy subjects. *Br J Clin Pharmacol*, 2008. 65(2): p. 197-202.
654. Nakade, S., et al., No effect of imidafenacin, a novel antimuscarinic drug, on digoxin pharmacokinetics in healthy subjects. *Drug Metab Pharmacokinet*, 2008. 23(2): p. 95-100.
655. Skinner, M.H., et al., Effect of age on the pharmacokinetics of duloxetine in women. *Br J Clin Pharmacol*, 2004. 57(1): p. 54-61.
656. van Kerrebroeck, P., et al., Duloxetine versus placebo in the treatment of European and Canadian women with stress urinary incontinence. *BJOG*, 2004. 111(3): p. 249-57.
657. Steers, W.D., et al., Duloxetine compared with placebo for treating women with symptoms of overactive bladder. *BJU Int*, 2007. 100(2): p. 337-45.
658. Bent, A.E., et al., Duloxetine compared with placebo for the treatment of women with mixed urinary incontinence. *NeuroUrol Urodyn*, 2008. 27(3): p. 212-21.
659. Schagen van Leeuwen, J.H., et al., Efficacy and safety of duloxetine in elderly women with stress urinary incontinence or stress-predominant mixed urinary incontinence. *Maturitas*, 2008. 60(2): p. 138-47.
660. Astellas Pharma Global Development, I.A., Mirabegron (YM178) for the treatment of overactive bladder: Advisory Committee Briefing Document. Deerfield, IL, USA. 2012, Astellas Pharma Global Development, Inc (APGD)
661. Matsukawa, Y., et al., Urodynamic evaluation of the efficacy of mirabegron on storage and voiding functions in women with overactive bladder. *Urology*, 2015. 85(4): p. 786-90.
662. Judge, T.G., The use of quinestradol in elderly incontinent women, a preliminary report. *Gerontol Clin (Basel)*, 1969. 11(3): p. 159-64.
663. Ouslander, J.G., et al., Effects of oral estrogen and progestin on the lower urinary tract among female nursing home residents. *J Am Geriatr Soc*, 2001. 49(6): p. 803-7.
664. Ouslander, J.G., E. Cooper, and D. Godley, Estrogen treatment for incontinence in frail older women. *J Am Geriatr Soc*, 1999. 47(11): p. 1383-4.
665. Terry, A.V., Jr. and J.J. Buccafusco, The cholinergic hypothesis of age and Alzheimer's disease-related cognitive deficits: recent challenges and their implications for novel drug development. *The Journal of pharmacology and experimental therapeutics*, 2003. 306(3): p. 821-7.
666. Flicker, C., S.H. Ferris, and M. Serby, Hypersensitivity to scopolamine in the elderly. *Psychopharmacology*, 1992. 107(2-3): p. 437-41.
667. Ancelin, M.L., et al., Non-degenerative mild cognitive impairment in elderly people and use of anticholinergic drugs: longitudinal cohort study. *BMJ*, 2006. 332(7539): p. 455-9.
668. Low, L.F., K.J. Anstey, and P. Sachdev, Use of medications with anticholinergic properties and cognitive function in a young-old community sample. *International journal of geriatric psychiatry*, 2009. 24(6): p. 578-84.

669. Campbell, N., et al., The cognitive impact of anticholinergics: a clinical review. *Clinical interventions in aging*, 2009. 4: p. 225-33.
670. Jewart, R.D., et al., Cognitive, behavioral, and physiological changes in Alzheimer disease patients as a function of incontinence medications. *Am J Geriatr Psychiatry*, 2005. 13(4): p. 324-8.
671. Movig, K.L., et al., Association between oxybutynin and neuropsychiatric adverse effects not confirmed in daily practice. *J Am Geriatr Soc*, 2001. 49(2): p. 234-5.
672. Shiota, T., et al., Temporary cognitive impairment related to administration of newly developed anticholinergic medicines for overactive bladder: two case reports. *BMC research notes*, 2014. 7: p. 672.
673. Herberg, K., Alltags - und Verkehrssicherheit unter Inkontinenz - Medikation. *Neue Untersuchungen zum Sicherheitspotential urologischer Anticholinergika*. . *Med Welt*, 1999. 50: p. 217-22.
674. Pietzko, A., et al., Influences of trospium chloride and oxybutynin on quantitative EEG in healthy volunteers. *European journal of clinical pharmacology*, 1994. 47(4): p. 337-43.
675. Diefenbach, K., et al., Randomised, double-blind study of the effects of oxybutynin, tolterodine, trospium chloride and placebo on sleep in healthy young volunteers. *Clin Drug Investig*, 2003. 23(6): p. 395-404.
676. Diefenbach, K., et al., Effects on sleep of anticholinergics used for overactive bladder treatment in healthy volunteers aged > or = 50 years. *BJU Int*, 2005. 95(3): p. 346-9.
677. Diefenbach, K., et al., Effect of tolterodine on sleep structure modulated by CYP2D6 genotype. *Sleep Med*, 2008. 9(5): p. 579-82.
678. Campbell, N., et al., Association between prescribing of anticholinergic medications and incident delirium: a cohort study. *Journal of the American Geriatrics Society*, 2011. 59 Suppl 2: p. S277-81.
679. Stuhc, M., Solifenacin-induced delirium and hallucinations. *General hospital psychiatry*, 2013. 35(6): p. 682 e3-4.
680. Williams, S.G. and J. Staudenmeier, Hallucinations with tolterodine. *Psychiatr Serv*, 2004. 55(11): p. 1318-9.
681. van Munster, B.C., et al., Longitudinal assessment of serum anticholinergic activity in delirium of the elderly. *Journal of psychiatric research*, 2012. 46(10): p. 1339-45.
682. Gill, S.S., et al., A prescribing cascade involving cholinesterase inhibitors and anticholinergic drugs. *Archives of internal medicine*, 2005. 165(7): p. 808-13.
683. Wagg, A., Cardozo, L., Nitti, V.W., Castro-Diaz, D., Auerbach, S., Blauwet, M.B., Siddiqui, E. , The efficacy and tolerability of the beta-3 adrenoceptor agonist mirabegron for the treatment of symptoms of overactive bladder in older patients. *Age and Ageing*, 2014.
684. Wagg, A., C. Verdejo, and U. Molander, Review of cognitive impairment with antimuscarinic agents in elderly patients with overactive bladder. *International journal of Clinical Practice*, 2010. 64(9): p. 1279-86.
685. Ehrt, U., et al., Use of drugs with anticholinergic effect and impact on cognition in Parkinson's disease: a cohort study. *J Neurol Neurosurg Psychiatry*, 2010. 81(2): p. 160-5.
686. Whalley, L.J., et al., Anticholinergic Drugs in Late Life: Adverse Effects on Cognition but not on Progress to Dementia. *Journal of Alzheimer's disease : JAD*, 2012.
687. Rodriguez, M., et al., Evidence for the presence of beta 3-adrenergic receptor mRNA in the human brain. *Brain Res Mol Brain Res*, 1995. 29(2): p. 369-75.
688. Delancey, J.O., Why do women have stress urinary incontinence? *Neurourol Urodyn*, 2010. 29 Suppl 1: p. S13-7.
689. DeLancey, J.O., et al., Stress urinary incontinence: relative importance of urethral support and urethral closure pressure. *J Urol*, 2008. 179(6): p. 2286-90; discussion 2290.
690. Butler, R.N., et al., Love and sex after 60: how to evaluate and treat the sexually-active woman. *Geriatrics*, 1994. 49(11): p. 33-4, 37-8, 41-2.
691. Carey, J.M. and G.E. Leach, Transvaginal surgery in the octogenarian using cadaveric fascia for pelvic prolapse and stress incontinence: minimal one-year results compared to younger patients. *Urology*, 2004. 63(4): p. 665-70.
692. Ellington, D.R., E.A. Ereksion, and H.E. Richter, Outcomes of Surgery for Stress Urinary Incontinence in the Older Woman. *Clin Geriatr Med*, 2015. 31(4): p. 487-505.
693. Malek, J.M., et al., The effect of age on stress and urgency urinary incontinence outcomes in women undergoing primary midurethral sling. *Int Urogynecol J*, 2015. 26(6): p. 831-5.
694. Tennstedt, S., Design of the Stress Incontinence Surgical Treatment Efficacy Trial (SIS-TER). *Urology*, 2005. 66(6): p. 1213-7.

695. Wu, C.J., et al., The surgical trends and time-frame comparison of primary surgery for stress urinary incontinence, 2006-2010 vs 1997-2005: a population-based nation-wide follow-up descriptive study. *Int Urogynecol J*, 2014. 25(12): p. 1683-91.
696. Olsen, A.L., et al., Epidemiology of surgically managed pelvic organ prolapse and urinary incontinence. *Obstet Gynecol*, 1997. 89(4): p. 501-6.
697. Boyles, S.H., A.M. Weber, and L. Meyn, Procedures for pelvic organ prolapse in the United States, 1979-1997. *Am J Obstet Gynecol*, 2003. 188(1): p. 108-15.
698. FitzGerald, M.P. and L. Brubaker, Colpocleisis and urinary incontinence. *Am J Obstet Gynecol*, 2003. 189(5): p. 1241-4.
699. Boyles, S.H., A.M. Weber, and L. Meyn, Procedures for urinary incontinence in the United States, 1979-1997. *Am J Obstet Gynecol*, 2003. 189(1): p. 70-5.
700. Brown, J.S., et al., Pelvic organ prolapse surgery in the United States, 1997. *Am J Obstet Gynecol*, 2002. 186(4): p. 712-6.
701. Shah, A.D., et al., The age distribution, rates, and types of surgery for stress urinary incontinence in the USA. *Int Urogynecol J Pelvic Floor Dysfunct*, 2008. 19(1): p. 89-96.
702. Toglia, M.R. and T.E. Nolan, Morbidity and mortality rates of elective gynecologic surgery in the elderly woman. *American journal of obstetrics and gynecology*, 2003. 189(6): p. 1584-7; discussion 1587-9.
703. Boyles, S.H., et al., Complications associated with transobturator sling procedures. *Int Urogynecol J Pelvic Floor Dysfunct*, 2007. 18(1): p. 19-22.
704. Solomon, D.H., LoCicero, J. 3rd, Rosenthal, R.A., *New Frontiers in Geriatrics Research: An Agenda for Surgical and Related Medical Specialties*. 2004., New York: American Geriatrics Society.
705. Miller K.S.M., R., H., Granieri, E., Andrews, W. New York, American Geriatrics Society 2004:225-67. , *New Frontiers in Geriatric Research*, D.H. Solomon, LoCicero, J. 3rd, Rosenthal, R.A., Editor. 2004, American Geriatrics Society: New York. p. 225 - 267.
706. Coleman, A.L., Bierman, A.S. , *New Frontiers in Geriatrics Research. An agenda for surgical and related medical specialties*, in *New Frontiers in Geriatrics Research. An agenda for surgical and related medical specialties*, D.H. Solomon, LoCicero, J. 3rd, Rosenthal, R.A., Editor. 2004, American Geriatrics Society: New York. p. 369-419.
707. Rosow, C.E., et al., Reversal of opioid-induced bladder dysfunction by intravenous naloxone and methylnaltrexone. *Clinical pharmacology and therapeutics*, 2007. 82(1): p. 48-53.
708. Lo, T.S., et al., Use of intravenous anesthesia for tension-free vaginal tape therapy in elderly women with genuine stress incontinence. *Urology*, 2002. 59(3): p. 349-53.
709. Sevestre, S., et al., Results of the tension-free vaginal tape technique in the elderly. *European Urology*, 2003. 44(1): p. 128-31.
710. Karantanis, E., M.M. Fynes, and S.L. Stanton, The tension-free vaginal tape in older women. *BJOG : an international journal of obstetrics and gynaecology*, 2004. 111(8): p. 837-41.
711. Hellberg, D., et al., The very obese woman and the very old woman: tension-free vaginal tape for the treatment of stress urinary incontinence. *Int Urogynecol J Pelvic Floor Dysfunct*, 2007. 18(4): p. 423-9.
712. Ku, J.H., et al., Age is not a limiting factor for midurethral sling procedures in the elderly with urinary incontinence. *Gynecol Obstet Invest*, 2006. 61(4): p. 194-9.
713. Campeau, L., et al., A multicenter, prospective, randomized clinical trial comparing tension-free vaginal tape surgery and no treatment for the management of stress urinary incontinence in elderly women. *Neurourol Urodyn*, 2007. 26(7): p. 990-4.
714. Dalpiaz, O., G. Primus, and L. Schips, SPARC sling system for treatment of female stress urinary incontinence in the elderly. *Eur Urol*, 2006. 50(4): p. 826-30; discussion 830-1.
715. Kim, J., et al., Worse long-term surgical outcomes in elderly patients undergoing SPARC retropubic midurethral sling placement. *BJU international*, 2011. 108(5): p. 708-12.
716. Groutz, A., et al., The safety and efficacy of the "inside-out" trans-obturator TVT in elderly versus younger stress-incontinent women: a prospective study of 353 consecutive patients. *Neurourology and Urodynamics*, 2011. 30(3): p. 380-3.
717. Mascle, L., et al., [Multicenter study of Advance (R) suburethral sling for treatment of postoperative urinary incontinence of male]. *Prog Urol*, 2015. 25(5): p. 249-55.
718. Comiter, C.V., et al., The virtue sling--a new quadratic sling for postprostatectomy incontinence--results of a multinational clinical trial. *Urology*, 2014. 84(2): p. 433-8.

719. Leruth, J., D. Waltregny, and J. de Leval, The inside-out transobturator male sling for the surgical treatment of stress urinary incontinence after radical prostatectomy: midterm results of a single-center prospective study. *Eur Urol*, 2012. 61(3): p. 608-15.
720. Simma-Chiang, V., et al., Outcomes of artificial urinary sphincter placement in men after radical cystectomy and orthotopic urinary diversions for the treatment of stress urinary incontinence: the University of Southern California experience. *Urology*, 2012. 79(6): p. 1397-401.
721. Bates, A.S., Martin, R.M., Terry, T.R., Complications following artificial urinary sphincter placement after radical prostatectomy and radiotherapy: a meta-analysis, in American Urology Association Annual Scientific Meeting. 2014: Orlando, FL, USA,.
722. Gousse, A.E., et al., Artificial urinary sphincter for post-radical prostatectomy urinary incontinence: long-term subjective results. *J Urol*, 2001. 166(5): p. 1755-8.
723. Groutz, A., et al., The pathophysiology of post-radical prostatectomy incontinence: a clinical and video urodynamic study. *The Journal of urology*, 2000. 163(6): p. 1767-70.
724. Martins, F.E., et al., Adverse prognostic features of collagen injection therapy for urinary incontinence following radical retropubic prostatectomy. *J Urol*, 1997. 158(5): p. 1745-9.
725. Gormley, E.A., et al., Effect of transurethral resection of the prostate on detrusor instability and urge incontinence in elderly males. *Neurourol Urodyn*, 1993. 12(5): p. 445-53.
726. Brierly, R.D., et al., Is transurethral resection of the prostate safe and effective in the over 80-year-old? *Annals of the Royal College of Surgeons of England*, 2001. 83(1): p. 50-3.
727. Liao, C.H. and H.C. Kuo, Increased risk of large post-void residual urine and decreased long-term success rate after intravesical onabotulinumtoxinA injection for refractory idiopathic detrusor overactivity. *The Journal of urology*, 2013. 189(5): p. 1804-10.
728. Suskind, A.M., et al., Frailty and the Role of Obliterative versus Reconstructive Surgery for Pelvic Organ Prolapse: A National Study. *J Urol*, 2016.
729. Suskind, A.M., et al., Impact of frailty on complications in patients undergoing common urological procedures: a study from the American College of Surgeons National Surgical Quality Improvement database. *BJU Int*, 2016. 117(5): p. 836-42.
730. Suskind, A.M., et al., Preoperative Frailty Is Associated With Discharge to Skilled or Assisted Living Facilities After Urologic Procedures of Varying Complexity. *Urology*, 2016. 97: p. 25-32.
731. Inouye, S.K., et al., Burden of illness score for elderly persons: risk adjustment incorporating the cumulative impact of diseases, physiologic abnormalities, and functional impairments. *Medical care*, 2003. 41(1): p. 70-83.
732. Inouye, S.K., et al., The Hospital Elder Life Program: a model of care to prevent cognitive and functional decline in older hospitalized patients. Hospital Elder Life Program. *Journal of the American Geriatrics Society*, 2000. 48(12): p. 1697-706.
733. Bogardus, S.T., Jr., et al., The effects of a targeted multicomponent delirium intervention on postdischarge outcomes for hospitalized older adults. *The American journal of medicine*, 2003. 114(5): p. 383-90.
734. Inouye, S.K., et al., Clarifying confusion: the confusion assessment method. A new method for detection of delirium. *Annals of internal medicine*, 1990. 113(12): p. 941-8.
735. Britton, A. and R. Russell, Multidisciplinary team interventions for delirium in patients with chronic cognitive impairment. *Cochrane database of systematic reviews*, 2001(1): p. CD000395.
736. Herr, K.A. and L. Garand, Assessment and measurement of pain in older adults. *Clinics in geriatric medicine*, 2001. 17(3): p. 457-78, vi.
737. Allen, C., P. Glasziou, and C. Del Mar, Bed rest: a potentially harmful treatment needing more careful evaluation. *Lancet*, 1999. 354(9186): p. 1229-33.
738. Sager, M.A., et al., Hospital admission risk profile (HARP): identifying older patients at risk for functional decline following acute medical illness and hospitalization. *Journal of the American Geriatrics Society*, 1996. 44(3): p. 251-7.
739. Counsell, S.R., et al., Effects of a multicomponent intervention on functional outcomes and process of care in hospitalized older patients: a randomized controlled trial of Acute Care for Elders (ACE) in a community hospital. *Journal of the American Geriatrics Society*, 2000. 48(12): p. 1572-81.
740. van Kerrebroeck, P., et al., The standardisation of terminology in nocturia: report from the Standardisation Sub-committee of the International Continence Society. *Neurourol Urodyn*, 2002. 21(2): p. 179-83.

741. Agarwal, A., Eryuzlu, L.N., Cartwright, R., Thorlund, K., Tammela, T.L., Guyatt, G.H.5., Auvinen, A., Tikkinen, K.A., What is the most bothersome lower urinary tract symptom? Individual- and population-level perspectives for both men and women. *European Urology*, 2014. 65(6): p. 1211-1217.
742. Tikkinen, K.A., et al., Nocturia frequency, bother, and quality of life: how often is too often? A population-based study in Finland. *Eur Urol*, 2010. 57(3): p. 488-96.
743. Chen, F.Y., et al., Perception of nocturia and medical consulting behavior among community-dwelling women. *Int Urogynecol J Pelvic Floor Dysfunct*, 2007. 18(4): p. 431-6.
744. Weiss, J.P., et al., The evaluation and treatment of nocturia: a consensus statement. *BJU Int*, 2011. 108(1): p. 6-21.
745. Vaughan, C.P., et al., Self-rated sleep characteristics and bother from nocturia. *Int J Clin Pract*, 2012. 66(4): p. 369-73.
746. Dubeau, C.E., Tsui, J.F., Nocturia in the Elderly, in *Nocturia: Causes, Consequences, and Clinical Approaches*, e.a. J.P. Weiss, Editor. 2012, Springer: New York. p. 147-155.
747. Ouslander, J.G., et al., Nighttime urinary incontinence and sleep disruption among nursing home residents. *J Am Geriatr Soc*, 1998. 46(4): p. 463-6.
748. Weiss, J.P. and J.G. Blaivas, Nocturia. *The Journal of urology*, 2000. 163(1): p. 5-12.
749. Weiss, J.P., et al., Nocturia: new directions. *Neurourol Urodyn*, 2011. 30(5): p. 700-3.
750. Chung, M.S., et al., Prevalence and associated risk factors of nocturia and subsequent mortality in 1,301 patients with type 2 diabetes. *Int Urol Nephrol*, 2014. 46(7): p. 1269-75.
751. Kupelian, V., et al., Association of nocturia and mortality: results from the Third National Health and Nutrition Examination Survey. *J Urol*, 2011. 185(2): p. 571-7.
752. van Doorn, B., et al., Mortality in older men with nocturia. A 15-year followup of the Krimpen study. *J Urol*, 2012. 187(5): p. 1727-31.
753. Galizia, G., et al., Association between nocturia and falls-related long-term mortality risk in the elderly. *J Am Med Dir Assoc*, 2012. 13(7): p. 640-4.
754. Negoro, H., et al., Underweight body mass index is a risk factor of mortality in outpatients with nocturia in Japan. *BMC Res Notes*, 2015. 8: p. 490.
755. Van Kerrebroeck, P., et al., The standardization of terminology in nocturia: report from the standardization subcommittee of the International Continence Society. *BJU Int*, 2002. 90 Suppl 3: p. 11-5.
756. Weatherall, M., The risk of hyponatremia in older adults using desmopressin for nocturia: a systematic review and metaanalysis. *Neurourol Urodyn* 2004. 23: p. 302-5.
757. Johnson, T.M., 2nd, et al., Pilot Results from a Randomized Trial in Men Comparing Alpha-Adrenergic Antagonist versus Behavior and Exercise for Nocturia and Sleep. *Clin Ther*, 2016.
758. Hale, W.E., et al., Symptom prevalence in the elderly. An evaluation of age, sex, disease, and medication use. *J Am Geriatr Soc*, 1986. 34(5): p. 333-40.
759. Malmsten, U.G., et al., Urinary incontinence and lower urinary tract symptoms: an epidemiological study of men aged 45 to 99 years. *J Urol*, 1997. 158(5): p. 1733-7.
760. Pinnock, C. and V.R. Marshall, Troublesome lower urinary tract symptoms in the community: a prevalence study. *Med J Aust*, 1997. 167(2): p. 72-5.
761. Perry, S., et al., An epidemiological study to establish the prevalence of urinary symptoms and felt need in the community: the Leicestershire MRC Incontinence Study. *Leicestershire MRC Incontinence Study Team. J Public Health Med*, 2000. 22(3): p. 427-34.
762. Schatzl, G., et al., Cross-sectional study of nocturia in both sexes: analysis of a voluntary health screening project. *Urology*, 2000. 56(1): p. 71-5.
763. Markland, A.D., et al., Prevalence of nocturia in United States men: results from the National Health and Nutrition Examination Survey. *J Urol*, 2011. 185(3): p. 998-1002.
764. Tikkinen, K.A., et al., Is nocturia equally common among men and women? A population based study in Finland. *J Urol*, 2006. 175(2): p. 596-600.
765. van Doorn, B., et al., Determinants of nocturia: the Krimpen study. *J Urol*, 2014. 191(4): p. 1034-9.
766. Wehrberger, C., et al., Lower urinary tract symptoms and urinary incontinence in a geriatric cohort - a population-based analysis. *BJU Int*, 2012. 110(10): p. 1516-21.
767. Hsu, A., et al., The burden of nocturia among middle-aged and older women. *Obstet Gynecol*, 2015. 125(1): p. 35-43.

768. van Doorn, B., et al., Once nocturia, always nocturia? Natural history of nocturia in older men based on frequency-volume charts: the Krimpen study. *J Urol*, 2011. 186(5): p. 1956-61.
769. Vaughan, C.P., et al., The fluctuation of nocturia in men with lower urinary tract symptoms allocated to placebo during a 12-month randomized, controlled trial. *J Urol*, 2014. 191(4): p. 1040-4.
770. Burgio, K.L., et al., Prevalence and correlates of nocturia in community-dwelling older adults. *J Am Geriatr Soc*, 2010. 58(5): p. 861-6.
771. Gopal, M., et al., Investigating the associations between nocturia and sleep disorders in perimenopausal women. *J Urol*, 2008. 180(5): p. 2063-7.
772. Kupelian, V., et al., Are racial/ethnic disparities in the prevalence of nocturia due to socioeconomic status? Results of the BACH survey. *J Urol*, 2009. 181(4): p. 1756-63.
773. Dessie, S.G., et al., Bladder Symptoms and Attitudes in an Ethnically Diverse Population. *Female Pelvic Med Reconstr Surg*, 2016. 22(1): p. 37-42.
774. Fitzgerald, M.P., et al., The association of nocturia with cardiac disease, diabetes, body mass index, age and diuretic use: results from the BACH survey. *J Urol*, 2007. 177(4): p. 1385-9.
775. Johnson, T.M., 2nd, et al., Evaluating potentially modifiable risk factors for prevalent and incident nocturia in older adults. *J Am Geriatr Soc*, 2005. 53(6): p. 1011-6.
776. Obayashi, K., K. Saeki, and N. Kurumatani, Independent Associations Between Nocturia and Nighttime Blood Pressure/Dipping in Elderly Individuals: The HEIJO-KYO Cohort. *J Am Geriatr Soc*, 2015. 63(4): p. 733-8.
777. Plantinga, L., et al., Association of sleep-related problems with CKD in the United States, 2005-2008. *Am J Kidney Dis*, 2011. 58(4): p. 554-64.
778. Hillier, P., M.S. Knapp, and R. Cove-Smith, Circadian variations in urine excretion in chronic renal failure. *Q J Med*, 1980. 49(196): p. 461-78.
779. Rembratt, A., J.P. Norgaard, and K.E. Andersson, Nocturia and associated morbidity in a community-dwelling elderly population. *BJU Int*, 2003. 92(7): p. 726-30.
780. Asplund, R., Nocturia in relation to sleep, somatic diseases and medical treatment in the elderly. *BJU Int*, 2002. 90(6): p. 533-6.
781. Kupelian, V., et al., Association of lower urinary tract symptoms and the metabolic syndrome: results from the Boston area community health survey. *The Journal of urology*, 2013. 189(1 Suppl): p. S107-14; discussion S115-6.
782. Yamanishi, T., et al., Nocturia Quality-of-Life questionnaire is a useful tool to predict nocturia and a risk of falling in Japanese outpatients: a cross-sectional survey. *Int J Urol*, 2014. 21(3): p. 289-93.
783. Temml, C., et al., Nocturia is an age-independent risk factor for hip-fractures in men. *NeuroUrol Urodyn*, 2009. 28(8): p. 949-52.
784. Kupelian, V., et al., Nocturia and quality of life: results from the Boston area community health survey. *Eur Urol*, 2012. 61(1): p. 78-84.
785. Coyne, K.S., et al., The prevalence of nocturia and its effect on health-related quality of life and sleep in a community sample in the USA. *BJU Int*, 2003. 92(9): p. 948-54.
786. Mock, L.L., et al., Content validation of symptom-specific nocturia quality-of-life instrument developed in men: issues expressed by women, as well as men. *Urology*, 2008. 72(4): p. 736-42.
787. Booth, J.M., et al., Exploring older peoples' experiences of nocturia: a poorly recognised urinary condition that limits participation. *Disabil Rehabil*, 2010. 32(9): p. 765-74.
788. Yoshimura, K., et al., Differences and associations between nocturnal voiding/nocturia and sleep disorders. *BJU Int*, 2010. 106(2): p. 232-7.
789. Obayashi, K., K. Saeki, and N. Kurumatani, Quantitative association between nocturnal voiding frequency and objective sleep quality in the general elderly population: the HEIJO-KYO cohort. *Sleep Med*, 2015. 16(5): p. 577-82.
790. Sacomori, C., et al., Excessive daytime sleepiness and nocturia in women. *Sleep Med*, 2014. 15(6): p. 677-80.
791. Bliwise, D.L., et al., Nocturia and disturbed sleep in the elderly. *Sleep Med*, 2009. 10(5): p. 540-8.
792. Andrews, L.K., et al., "I'd eat a bucket of nails if you told me it would help me sleep:" perceptions of insomnia and its treatment in patients with stable heart failure. *Heart Lung*, 2013. 42(5): p. 339-45.
793. Endeshaw, Y., Correlates of Self-Reported Nocturia Among Community-Dwelling Older Adults. *J Gerontol A Biol Sci Med Sci*, 2009.
794. Vaughan, C.P., et al., Nocturia and overnight polysomnography in Parkinson disease. *NeuroUrol Urodyn*, 2013. 32(8): p. 1080-5.

795. Bliwise, D.L., et al., Short time to first void is associated with lower whole-night sleep quality in nocturia patients. *J Clin Sleep Med*, 2015. 11(1): p. 53-5.
796. Helfand, B.T., et al., The relationship between lower urinary tract symptom severity and sleep disturbance in the CAMUS trial. *J Urol*, 2011. 185(6): p. 2223-8.
797. Oelke, M., B. Wiese, and R. Berges, Nocturia and its impact on health-related quality of life and health care seeking behaviour in German community-dwelling men aged 50 years or older. *World J Urol*, 2014. 32(5): p. 1155-62.
798. Abraham, L., et al., Development and validation of a quality-of-life measure for men with nocturia. *Urology*, 2004. 63(3): p. 481-6.
799. Welliver, C., et al., Analyzing Why Men Seek Treatment for Lower Urinary Tract Symptoms and Factors Associated With Nonimprovement. *Urology*, 2015. 86(5): p. 862-7.
800. Singam, P., et al., Nocturia in patients with benign prostatic hyperplasia: evaluating the significance of ageing, co-morbid illnesses, lifestyle and medical therapy in treatment outcome in real life practice. *Aging Male*, 2015. 18(2): p. 112-7.
801. Scullin, M.K., et al., A Neurodegenerative Disease Sleep Questionnaire: principal component analysis in Parkinson's disease. *J Neurol Sci*, 2014. 336(1-2): p. 243-6.
802. Robinson, J.P., et al., Lower urinary tract symptoms in men with Parkinson disease. *J Neurosci Nurs*, 2013. 45(6): p. 382-92; quiz E1-2.
803. Rana, A.Q., et al., Association between nocturia and anxiety in Parkinson's disease. *Neurol Res*, 2015. 37(7): p. 563-7.
804. Zhang, L.M. and X.P. Zhang, Investigation of Urination Disorder in Parkinson's disease. *Chin Med J (Engl)*, 2015. 128(21): p. 2906-12.
805. Zis, P., et al., Non-motor symptoms burden in treated and untreated early Parkinson's disease patients: argument for non-motor subtypes. *Eur J Neurol*, 2015. 22(8): p. 1145-50.
806. Telarovic, S., D. Mijatovic, and I. Telarovic, Effects of various factors on sleep disorders and quality of life in Parkinson's disease. *Acta Neurol Belg*, 2015. 115(4): p. 615-21.
807. Rana, A.Q., et al., Prevalence of nocturia in Parkinson's disease patients from various ethnicities. *Neurol Res*, 2014. 36(3): p. 234-8.
808. Zhou, M.Z., et al., The association between non-motor symptoms in Parkinson's disease and age at onset. *Clin Neurol Neurosurg*, 2013. 115(10): p. 2103-7.
809. Sringean, J., et al., How well do Parkinson's disease patients turn in bed? Quantitative analysis of nocturnal hypokinesia using multisite wearable inertial sensors. *Parkinsonism Relat Disord*, 2016. 23: p. 10-6.
810. Kim, J.S., et al., Nonmotor symptoms in drug-induced parkinsonism and drug-naive Parkinson disease. *Can J Neurol Sci*, 2013. 40(1): p. 36-41.
811. Lightner, D.J., et al., Nocturia is associated with an increased risk of coronary heart disease and death. *BJU Int*, 2012. 110(6): p. 848-53.
812. Parthasarathy, S., et al., Nocturia, sleep-disordered breathing, and cardiovascular morbidity in a community-based cohort. *PLoS One*, 2012. 7(2): p. e30969.
813. Tikkinen, K.A., et al., A systematic evaluation of factors associated with nocturia—the population-based FINNO study. *Am J Epidemiol*, 2009. 170(3): p. 361-8.
814. Cartwright, R., et al., Is there seasonal variation in symptom severity, uroflowmetry and frequency-volume chart parameters in men with lower urinary tract symptoms? *Scott Med J*, 2014. 59(3): p. 162-6.
815. Saeki, K., K. Obayashi, and N. Kurumatani, Indoor cold exposure and nocturia: a cross-sectional analysis of the HEIJO-KYO study. *BJU Int*, 2016. 117(5): p. 829-35.
816. Abrams, P., et al., The role of desmopressin in the treatment of adult nocturia. *BJU Int*, 2002. 90 Suppl 3: p. 32-6.
817. Shahab, N., et al., The profiles and patterns of detrusor overactivity and their association with overactive bladder symptoms in men with benign prostatic enlargement associated with detrusor overactivity. *Neurourol Urodyn*, 2009. 28(8): p. 953-8.
818. Huang, A.J., et al., Clinical significance of post-void residual volume in older ambulatory women. *Journal of the American Geriatrics Society*, 2011. 59(8): p. 1452-8.
819. Araujo, A.B., et al., Sleep related problems and urological symptoms: testing the hypothesis of bidirectionality in a longitudinal, population based study. *J Urol*, 2014. 191(1): p. 100-6.
820. Kirkland, J.L., et al., Patterns of urine flow and electrolyte excretion in healthy elderly people. *Br Med J (Clin Res Ed)*, 1983. 287(6406): p. 1665-7.
821. Blanker, M.H., A.M. Bohnen, and J.L. Ruud Bosch, Nocturia in relation to sleep, somatic diseases and medical treatment in the elderly. *BJU Int*, 2003. 91(1): p. 125.

822. Miller, M., Nocturnal polyuria in older people: pathophysiology and clinical implications. *J Am Geriatr Soc*, 2000. 48(10): p. 1321-9.
823. Rembratt, A., J.P. Norgaard, and K.E. Andersson, Desmopressin in elderly patients with nocturia: short-term safety and effects on urine output, sleep and voiding patterns. *BJU Int*, 2003. 91(7): p. 642-6.
824. Ouslander, J., et al., The dark side of incontinence: nighttime incontinence in nursing home residents. *J Am Geriatr Soc*, 1993. 41(4): p. 371-6.
825. Weerkamp, N.J., et al., Nonmotor symptoms in nursing home residents with Parkinson's disease: prevalence and effect on quality of life. *J Am Geriatr Soc*, 2013. 61(10): p. 1714-21.
826. Goessaert, A.S., et al., Nocturnal Polyuria: Excess of Nocturnal Urine Production, Excess of Definitions-Influence on Renal Function Profile. *J Urol*, 2016. 195(3): p. 670-6.
827. Hall, S.A., et al., Commonly used antihypertensives and lower urinary tract symptoms: results from the Boston Area Community Health (BACH) Survey. *BJU Int*, 2012. 109(11): p. 1676-84.
828. Asplund, R. and H. Aberg, Diurnal variation in the levels of antidiuretic hormone in the elderly. *J Intern Med*, 1991. 229(2): p. 131-4.
829. Ouslander, J.G., et al., Arginine vasopressin levels in nursing home residents with nighttime urinary incontinence. *J Am Geriatr Soc*, 1998. 46(10): p. 1274-9.
830. Johnson, T.M., 2nd, et al., Changes in nocturia from medical treatment of benign prostatic hyperplasia: secondary analysis of the Department of Veterans Affairs Cooperative Study Trial. *J Urol*, 2003. 170(1): p. 145-8.
831. Umlauf, M.G., et al., Obstructive sleep apnea, nocturia and polyuria in older adults. *Sleep*, 2004. 27(1): p. 139-44.
832. Ouslander, J., et al., Atrial natriuretic peptide levels in geriatric patients with nocturia and nursing home residents with nighttime incontinence. *J Am Geriatr Soc*, 1999. 47(12): p. 1439-44.
833. Dahlstrand, C., et al., Snoring--a common cause of voiding disturbance in elderly men. *Lancet*, 1996. 347(8996): p. 270-1.
834. Bliwise, D.L., C.L. Adelman, and J.G. Ouslander, Polysomnographic correlates of spontaneous nocturnal wetness episodes in incontinent geriatric patients. *Sleep*, 2004. 27(1): p. 153-7.
835. Pressman, M.R., et al., Nocturia. A rarely recognized symptom of sleep apnea and other occult sleep disorders. *Arch Intern Med*, 1996. 156(5): p. 545-50.
836. Romero, E., et al., Nocturia and snoring: predictive symptoms for obstructive sleep apnea. *Sleep Breath*, 2010. 14(4): p. 337-43.
837. Inci, M., et al., Relationship between endothelial dysfunction and nocturia with benign prostatic hyperplasia. *Scand J Urol*, 2013. 47(5): p. 384-9.
838. Wehrberger, C., et al., The relationship between cerebral white matter hyperintensities and lower urinary tract function in a population based, geriatric cohort. *Neurourol Urodyn*, 2014. 33(4): p. 431-6.
839. Hung, S.F., S.D. Chung, and H.C. Kuo, Increased serum C-reactive protein level is associated with increased storage lower urinary tract symptoms in men with benign prostatic hyperplasia. *PLoS One*, 2014. 9(1): p. e85588.
840. Abrams, P. and B. Klevmark, Frequency volume charts: an indispensable part of lower urinary tract assessment. *Scand J Urol Nephrol Suppl*, 1996. 179: p. 47-53.
841. Johnson, T.M., 2nd, et al., Effects of behavioral and drug therapy on nocturia in older incontinent women. *J Am Geriatr Soc*, 2005. 53(5): p. 846-50.
842. Johnson, T.M., 2nd, et al., The effect of doxazosin, finasteride and combination therapy on nocturia in men with benign prostatic hyperplasia. *J Urol*, 2007. 178(5): p. 2045-50; discussion 2050-1.
843. Lose, G., et al., Efficacy of desmopressin (Minirin) in the treatment of nocturia: a double-blind placebo-controlled study in women. *Am J Obstet Gynecol*, 2003. 189(4): p. 1106-13.
844. Mattiasson, A., et al., Efficacy of desmopressin in the treatment of nocturia: a double-blind placebo-controlled study in men. *BJU Int*, 2002. 89(9): p. 855-62.
845. Smith, A.L. and A.J. Wein, Outcomes of pharmacological management of nocturia with non-antidiuretic agents: does statistically significant equal clinically significant? *BJU Int*, 2011. 107(10): p. 1550-4.
846. Vaughan, C.P., et al., A multicomponent behavioural and drug intervention for nocturia in elderly men: rationale and pilot results. *BJU international*, 2009. 104(1): p. 69-74.
847. Soda, T., et al., Efficacy of nondrug lifestyle measures for the treatment of nocturia. *J Urol*, 2010. 184(3): p. 1000-4.

848. Fitzgerald, M.P., et al., Nocturia, nocturnal incontinence prevalence, and response to anticholinergic and behavioral therapy. *Int Urogynecol J Pelvic Floor Dysfunct*, 2008.
849. Burgio, K.L., et al., Behavioral versus drug treatment for overactive bladder in men: the Male Overactive Bladder Treatment in Veterans (MOTIVE) Trial. *Journal of the American Geriatrics Society*, 2011. 59(12): p. 2209-16.
850. Rai, A., et al., Could nocturia be an indicator of an undiagnosed sleep disorder in male veterans? *Urology*, 2015. 85(3): p. 641-7.
851. Zebede, S., et al., Prevalence of obstructive sleep apnea detected by the Berlin Questionnaire in patients with nocturia attending a urogynecology unit. *Int Urogynecol J*, 2015. 26(6): p. 881-5.
852. Destors, M., et al., Nocturia is an independent predictive factor of prevalent hypertension in obstructive sleep apnea patients. *Sleep Med*, 2015. 16(5): p. 652-8.
853. Weiss, J.P., et al., The New England Research Institutes, Inc. (NERI) Nocturia Advisory Conference 2012: focus on outcomes of therapy. *BJU international*, 2013. 111(5): p. 700-16.
854. Kaplan, S.A., et al., Tolterodine and tamsulosin for treatment of men with lower urinary tract symptoms and overactive bladder: a randomized controlled trial. *JAMA : the journal of the American Medical Association*, 2006. 296(19): p. 2319-28.
855. Rackley, R., et al., Nighttime dosing with tolterodine reduces overactive bladder-related nocturnal micturitions in patients with overactive bladder and nocturia. *Urology*, 2006. 67(4): p. 731-6; discussion 736.
856. Vardy, M.D., et al., Effects of solifenacin on overactive bladder symptoms, symptom bother and other patient-reported outcomes: results from VIBRANT - a double-blind, placebo-controlled trial. *Int J Clin Pract*, 2009. 63(12): p. 1702-14.
857. Chapple, C., et al., A pooled analysis of three phase III studies to investigate the efficacy, tolerability and safety of darifenacin, a muscarinic M3 selective receptor antagonist, in the treatment of overactive bladder. *BJU Int*, 2005. 95(7): p. 993-1001.
858. Nitti, V.W., et al., Efficacy and tolerability of tolterodine extended-release in continent patients with overactive bladder and nocturia. *BJU Int*, 2006. 97(6): p. 1262-6.
859. Herschorn, S., et al., Tolerability of 5 mg solifenacin once daily versus 5 mg oxybutynin immediate release 3 times daily: results of the VECTOR trial. *The Journal of urology*, 2010. 183(5): p. 1892-8.
860. Kaplan, S.A., et al., Tolterodine extended release improves overactive bladder symptoms in men with overactive bladder and nocturia. *Urology*, 2006. 68(2): p. 328-32.
861. Yokoyama, O., et al., Efficacy of solifenacin on nocturia in Japanese patients with overactive bladder: impact on sleep evaluated by bladder diary. *The Journal of urology*, 2011. 186(1): p. 170-4.
862. Chapple, C.R., et al., Silodosin therapy for lower urinary tract symptoms in men with suspected benign prostatic hyperplasia: results of an international, randomized, double-blind, placebo- and active-controlled clinical trial performed in Europe. *European Urology*, 2011. 59(3): p. 342-52.
863. Barry, M.J., et al., Effect of increasing doses of saw palmetto extract on lower urinary tract symptoms: a randomized trial. *JAMA*, 2011. 306(12): p. 1344-51.
864. Kok, A.L., et al., Micturition complaints in postmenopausal women treated with continuously combined hormone replacement therapy: a prospective study. *Maturitas*, 1999. 31(2): p. 143-9.
865. Drake, M.J., I.W. Mills, and J.G. Noble, Melatonin pharmacotherapy for nocturia in men with benign prostatic enlargement. *J Urol*, 2004. 171(3): p. 1199-202.
866. Sugaya, K., et al., Effects of melatonin and ril-mazafone on nocturia in the elderly. *J Int Med Res*, 2007. 35(5): p. 685-91.
867. Pedersen, P.A. and P.B. Johansen, Prophylactic treatment of adult nocturia with bumetanide. *Br J Urol*, 1988. 62(2): p. 145-7.
868. Reynard, J.M., et al., A novel therapy for nocturnal polyuria: a double-blind randomized trial of frusemide against placebo. *Br J Urol*, 1998. 81(2): p. 215-8.
869. Committee for Establishment of the Clinical Guidelines for Nocturia of the Neurogenic Bladder, S., Clinical guidelines for nocturia. *Int J Urol*, 2010. 17(5): p. 397-409.
870. Weiss, J.P., et al., Age related pathogenesis of nocturia in patients with overactive bladder. *J Urol*, 2007. 178(2): p. 548-51; discussion 551.
871. Avulova, S., et al., Determinants of nocturia severity in men, derived from frequency-volume charts. *Scand J Urol*, 2015. 49(2): p. 185-8.

872. Weiss, J.P., et al., Desmopressin orally disintegrating tablet effectively reduces nocturia: results of a randomized, double-blind, placebo-controlled trial. *Neurourol Urodyn*, 2012. 31(4): p. 441-7.
873. Seiler, W.O., H.B. Stahelin, and U. Hefti, Desmopressin reduces night urine volume in geriatric patients: implication for treatment of the nocturnal incontinence. *Clin Investig*, 1992. 70(7): p. 619.
874. Asplund, R. and H. Aberg, Desmopressin in elderly subjects with increased nocturnal diuresis. A two-month treatment study. *Scand J Urol Nephrol*, 1993. 27(1): p. 77-82.
875. Asplund, R. and H. Aberg, Desmopressin in elderly women with increased nocturnal diuresis. A short-term study. *Br J Urol*, 1993. 72(1): p. 42-5.
876. Asplund, R., Sundberg, B, Bergtsson, P., Oral desmopressin for nocturnal polyuria in elderly subjects: a double blind, placebo-controlled randomized exploratory study. *BJU Int* 1999. 83: p. 591-5.
877. Assassa, R.P., D.E. Osborn, and C.M. Castleden, Male lower urinary tract symptoms: is surgery always necessary? *Gerontology*, 1998. 44(2): p. 61-6.
878. Cannon, A., et al., Desmopressin in the treatment of nocturnal polyuria in the male. *BJU Int*, 1999. 84(1): p. 20-4.
879. Chancellor, M.B., et al., Beneficial effect of intranasal desmopressin for men with benign prostatic hyperplasia and nocturia: preliminary results. *Tech Urol*, 1999. 5(4): p. 191-4.
880. Kuo, H.C., Efficacy of desmopressin in treatment of refractory nocturia in patients older than 65 years. *Urology*, 2002. 59(4): p. 485-9.
881. Wang, C.J., et al., Low dose oral desmopressin for nocturnal polyuria in patients with benign prostatic hyperplasia: a double-blind, placebo controlled, randomized study. *The Journal of urology*, 2011. 185(1): p. 219-23.
882. Rezakhaniha, B., N. Arianpour, and S. Si-roosbakhsh, Efficacy of desmopressin in treatment of nocturia in elderly men. *Journal of research in medical sciences : the official journal of Isfahan University of Medical Sciences*, 2011. 16(4): p. 516-23.
883. Fu, F.G., H.J. Lavery, and D.L. Wu, Reducing nocturia in the elderly: a randomized placebo-controlled trial of staggered furosemide and desmopressin. *Neurourol Urodyn*, 2011. 30(3): p. 312-6.
884. van Kerrebroeck, P., et al., Desmopressin in the treatment of nocturia: a double-blind, placebo-controlled study. *Eur Urol*, 2007. 52(1): p. 221-9.
885. Johnson, T.M., et al., The relationship between the action of arginine vasopressin and responsiveness to oral desmopressin in older men: a pilot study. *J Am Geriatr Soc*, 2007. 55(4): p. 562-9.
886. Bae, J.H., et al., The effects of long-term administration of oral desmopressin on the baseline secretion of antidiuretic hormone and serum sodium concentration for the treatment of nocturia: a circadian study. *J Urol*, 2007. 178(1): p. 200-3.
887. Wang, C.J., et al., Low dose oral desmopressin for nocturnal polyuria in patients with benign prostatic hyperplasia: a double-blind, placebo controlled, randomized study. *J Urol*, 2011. 185(1): p. 219-23.
888. Johnson, T.M., 2nd, et al., Oral ddAVP for nighttime urinary incontinence in characterized nursing home residents: a pilot study. *J Am Med Dir Assoc*, 2006. 7(1): p. 6-11.
889. Weatherall, M. and T. Arnold, Nocturia in adults: draft New Zealand guidelines for its assessment and management in primary care. *N Z Med J*, 2006. 119(1234): p. U1976.
890. Rembratt, A., A. Riis, and J.P. Norgaard, Desmopressin treatment in nocturia; an analysis of risk factors for hyponatremia. *Neurourol Urodyn*, 2006. 25(2): p. 105-9.
891. Rembratt, A., et al., Pharmacokinetics and pharmacodynamics of desmopressin administered orally versus intravenously at daytime versus night-time in healthy men aged 55-70 years. *Eur J Clin Pharmacol*, 2004. 60(6): p. 397-402.
892. Ebell, M.H., T. Radke, and J. Gardner, A systematic review of the efficacy and safety of desmopressin for nocturia in adults. *J Urol*, 2014. 192(3): p. 829-35.
893. By the American Geriatrics Society Beers Criteria Update Expert, P., American Geriatrics Society 2015 Updated Beers Criteria for Potentially Inappropriate Medication Use in Older Adults. *J Am Geriatr Soc*, 2015. 63(11): p. 2227-46.
894. Juul, K.V., et al., Gender difference in antidiuretic response to desmopressin. *Am J Physiol Renal Physiol*, 2011. 300(5): p. F1116-22.
895. Peters, K.M., et al., Randomized trial of percutaneous tibial nerve stimulation versus Sham efficacy in the treatment of overactive bladder syndrome: results from the SUmT trial. *The Journal of urology*, 2010. 183(4): p. 1438-43.

896. MacDiarmid, S.A., et al., Long-term durability of percutaneous tibial nerve stimulation for the treatment of overactive bladder. *The Journal of urology*, 2010. 183(1): p. 234-40.
897. Hakenberg, O.W., C.B. Pinnock, and V.R. Marshall, Does evaluation with the International Prostate Symptom Score predict the outcome of transurethral resection of the prostate? *J Urol*, 1997. 158(1): p. 94-9.
898. Meyhoff, H.H. and J. Nordling, Long term results of transurethral and transvesical prostatectomy. A randomized study. *Scand J Urol Nephrol*, 1986. 20(1): p. 27-33.
899. Seki, N., et al., Analysis of the prognostic factors for overactive bladder symptoms following surgical treatment in patients with benign prostatic obstruction. *Neurourol Urodyn*, 2009. 28(3): p. 197-201.
900. Simaioforidis, V., et al., Tamsulosin versus transurethral resection of the prostate: effect on nocturia as a result of benign prostatic hyperplasia. *Int J Urol*, 2011. 18(3): p. 243-8.
901. Wada, N., et al., Nocturia and sleep quality after transurethral resection of the prostate. *Int J Urol*, 2014. 21(1): p. 81-5.
902. Margel, D., et al., Predictors of nocturia quality of life before and shortly after prostatectomy. *Urology*, 2007. 70(3): p. 493-7.
903. Seki, N., et al., Analysis of the prognostic factors for overactive bladder symptoms following surgical treatment in patients with benign prostatic obstruction. *Neurourol Urodyn*, 2008.
904. Landefeld, C.S., et al., National Institutes of Health state-of-the-science conference statement: prevention of fecal and urinary incontinence in adults. *Ann Intern Med*, 2008. 148(6): p. 449-58.
905. AlAmeel, T., M.K. Andrew, and C. MacKnight, The association of fecal incontinence with institutionalization and mortality in older adults. *Am J Gastroenterol*, 2010. 105(8): p. 1830-4.
906. Nakanishi, N., et al., Mortality in relation to urinary and faecal incontinence in elderly people living at home. *Age & Ageing*, 1999. 28(3): p. 301-6.
907. Alayne D. Markland, P.S.G.K.L.B.D.T.R.H.E.R.P.S.R.M.A., Correlates of Urinary, Fecal, and Dual Incontinence in Older African-American and White Men and Women. *Journal of the American Geriatrics Society*, 2008. 56(2): p. 285-290.
908. Quander, C.R., et al., Prevalence of and factors associated with fecal incontinence in a large community study of older individuals. *American Journal of Gastroenterology*, 2005. 100(4): p. 905-9.
909. Goode, P.S., et al., Prevalence and correlates of fecal incontinence in community-dwelling older adults. *Journal of the American Geriatrics Society*, 2005. 53(4): p. 629-35.
910. Nelson, R., et al., Community-based prevalence of anal incontinence. *JAMA*, 1995. 274(7): p. 559-61.
911. Erekson, E.A., et al., Functional disability among older women with fecal incontinence. *Am J Obstet Gynecol*, 2015. 212(3): p. 327.e1-7.
912. Wu, J.M., et al., Urinary, fecal, and dual incontinence in older U.S. Adults. *J Am Geriatr Soc*, 2015. 63(5): p. 947-53.
913. Jerez-Roig, J., et al., Prevalence of fecal incontinence (FI) and associated factors in institutionalized older adults. *Arch Gerontol Geriatr*, 2015. 60(3): p. 425-30.
914. Dunivan, G.C., et al., Fecal incontinence in primary care: prevalence, diagnosis, and health care utilization. *Am J Obstet Gynecol*, 2010. 202(5): p. 493.e1-6.
915. Kunduru, L., et al., Factors that affect consultation and screening for fecal incontinence. *Clin Gastroenterol Hepatol*, 2015. 13(4): p. 709-16.
916. Finne-Soveri, H., et al., Increased work-load associated with faecal incontinence among home care patients in 11 European countries. *Eur J Public Health*, 2008. 18(3): p. 323-8.
917. Grover, M., et al., Survey of geriatricians on the effect of fecal incontinence on nursing home referral. *J Am Geriatr Soc*, 2010. 58(6): p. 1058-62.
918. Chassagne, P., et al., Fecal incontinence in the institutionalized elderly: incidence, risk factors, and prognosis. *Am J Med*, 1999. 106(2): p. 185-90.
919. Thekkinkattil, D.K., et al., Awareness of investigations and treatment of faecal incontinence among the general practitioners: a postal questionnaire survey. *Colorectal Dis*, 2008. 10(3): p. 263-7.
920. Norton, C., et al., Management of faecal incontinence in adults: summary of NICE guidance. *BMJ*, 2007. 334(7608): p. 1370-1371.
921. Wagg, A., et al., Do self-reported 'integrated' continence services provide high-quality continence care? *Age Ageing*, 2009. 38(6): p. 730-3.
922. Chiang, L., et al., Dually incontinent nursing home residents: clinical characteristics and treatment differences. *Journal of the American Geriatrics Society*, 2000. 48(6): p. 673-6.

923. Markland, A.D., et al., Correlates of urinary, fecal, and dual incontinence in older African-American and white men and women. *J Am Geriatr Soc*, 2008. 56(2): p. 285-90.
924. Nakanishi, N., et al., Urinary and fecal incontinence in a community-residing older population in Japan. *Journal of the American Geriatrics Society*, 1997. 45(2): p. 215-9.
925. Roberts, R.O., et al., Prevalence of combined fecal and urinary incontinence: a community-based study. *Journal of the American Geriatrics Society*, 1999. 47(7): p. 837-41.
926. Teunissen, T.A., et al., Prevalence of urinary, fecal and double incontinence in the elderly living at home. *Int Urogynecol J Pelvic Floor Dysfunct*, 2004. 15: p. 10 - 3; discussion 13.
927. Ng, K.S., et al., Fecal Incontinence: Community Prevalence and Associated Factors--A Systematic Review. *Dis Colon Rectum*, 2015. 58(12): p. 1194-209.
928. Gorina, Y., et al., Prevalence of incontinence among older americans. *Vital Health Stat 3*, 2014(36): p. 1-33.
929. Nuotio, M., et al., Six-year follow-up and predictors of urgency-associated urinary incontinence and bowel symptoms among the oldest old: a population-based study. *Arch Gerontol Geriatr*, 2009. 49(2): p. e85-90.
930. Markland, A.D., et al., Incidence and risk factors for fecal incontinence in black and white older adults: a population-based study. *J Am Geriatr Soc*, 2010. 58(7): p. 1341-6.
931. Rey, E., et al., Onset and Risk Factors for Fecal Incontinence in a US Community. *Am J Gastroenterol*, 2009.
932. Ditah, I., et al., Prevalence, Trends, and Risk Factors for Fecal Incontinence in United States Adults, 2005–2010. *Clinical Gastroenterology and Hepatology*, (0).
933. Whitehead, W.E., et al., Fecal incontinence in US adults: epidemiology and risk factors. *Gastroenterology*, 2009. 137(2): p. 512-7, 517 e1-2.
934. William, E.W., et al., Fecal Incontinence in US Adults: Epidemiology and Risk Factors. *Gastroenterology*, 2009. 137(2): p. 512.
935. Sharma, A., et al., Determining levels of fecal incontinence in the community: a New Zealand cross-sectional study. *Dis Colon Rectum*, 2011. 54(11): p. 1381-7.
936. Joh, H.K., M.K. Seong, and S.W. Oh, Fecal incontinence in elderly Koreans. *J Am Geriatr Soc*, 2010. 58(1): p. 116-21.
937. Shamliyan, T.A., et al., Prevalence and risk factors of fecal incontinence in community-dwelling men. *Rev Gastroenterol Disord*, 2009. 9(4): p. E97-110.
938. Pretlove, S., et al., Prevalence of anal incontinence according to age and gender: a systematic review and meta-regression analysis. *International Urogynecology Journal*, 2006. 17(4): p. 407.
939. Brubaker, L., et al., Mixed incontinence: comparing definitions in non-surgical patients. *Neurourol Urodyn*, 2011. 30(1): p. 47-51.
940. Tamanini, J.T., et al., The prevalence of fecal incontinence and associated risk factors in older adults participating in the SABE study. *Neurourol Urodyn*, 2015.
941. Bharucha, A.E., et al., Epidemiology, pathophysiology, and classification of fecal incontinence: state of the science summary for the National Institute of Diabetes and Digestive and Kidney Diseases (NIDDK) workshop. *Am J Gastroenterol*, 2015. 110(1): p. 127-36.
942. Townsend, M.K., et al., Risk factors for fecal incontinence in older women. *Am J Gastroenterol*, 2013. 108(1): p. 113-9.
943. Bliss, D.Z., et al., Fecal incontinence in hospitalized patients who are acutely ill. *Nursing Research*, 2000. 49(2): p. 101-8.
944. Junkin, J. and J.L. Selekof, Prevalence of incontinence and associated skin injury in the acute care inpatient. *J Wound Ostomy Continence Nurs*, 2007. 34(3): p. 260-9.
945. Stokes, A.L., et al., Prevalence of Fecal Incontinence in the Acute Care Setting. *J Wound Ostomy Continence Nurs*, 2016. 43(5): p. 517-22.
946. Shahin, E.S. and C. Lohrmann, Prevalence of fecal and double fecal and urinary incontinence in hospitalized patients. *J Wound Ostomy Continence Nurs*, 2015. 42(1): p. 89-93.
947. Westra, B.L., et al., Predicting improvement in urinary and bowel incontinence for home health patients using electronic health record data. *J Wound Ostomy Continence Nurs*, 2011. 38(1): p. 77-87.
948. Ihnat, P., et al., Fecal incontinence among nursing home residents: Is it still a problem? *Arch Gerontol Geriatr*, 2016. 65: p. 79-84.
949. Blekken, L.E., et al., Exploring faecal incontinence in nursing home patients: a cross-sectional study of prevalence and associations derived from the Residents Assessment Instrument for Long-Term Care Facilities. *J Adv Nurs*, 2016. 72(7): p. 1579-91.

950. Li, Y., et al., The "Nursing Home Compare" measure of urinary/fecal incontinence: cross-sectional variation, stability over time, and the impact of case mix. *Health Serv Res*, 2010. 45(1): p. 79-97.
951. Schnelle, J.F., et al., Prevalence of constipation symptoms in fecally incontinent nursing home residents. *J Am Geriatr Soc*, 2009. 57(4): p. 647-52.
952. Johanson, J.F., F. Irizarry, and A. Doughty, Risk factors for fecal incontinence in a nursing home population. *Journal of Clinical Gastroenterology*, 1997. 24(3): p. 156-60.
953. Nelson, R.L. and S.E. Furner, Risk factors for the development of fecal and urinary incontinence in Wisconsin nursing home residents. *Maturitas*, 2005. 52(1): p. 26-31.
954. Peet, S.M., C.M. Castleden, and C.W. McGrother, Prevalence of urinary and faecal incontinence in hospitals and residential and nursing homes for older people.[comment]. *BMJ*, 1995. 311(7012): p. 1063-4.
955. Schnelle, J.F., et al., A controlled trial of an intervention to improve urinary and fecal incontinence and constipation. *J Am Geriatr Soc*, 2010. 58(8): p. 1504-11.
956. Nyrop, K.A., et al., Likelihood of Nursing Home Referral for Fecally Incontinent Elderly Patients is Influenced by Physician Views on Nursing Home Care and Outpatient Management of Fecal Incontinence. *J Am Med Dir Assoc*, 2011.
957. Brown, H.W., S.D. Wexner, and E.S. Lukacz, Factors associated with care seeking among women with accidental bowel leakage. *Female Pelvic Med Reconstr Surg*, 2013. 19(2): p. 66-71.
958. Brown, H.W., et al., Accidental bowel leakage in the mature women's health study: prevalence and predictors. *International Journal of Clinical Practice*, 2012. 66(11): p. 1101-1108.
959. Nelson, R.L., Epidemiology of fecal incontinence. *Gastroenterology*, 2004. 126(1 Suppl 1): p. S3-7.
960. Varma, M., et al., Fecal Incontinence in Females Older Than Aged 40 Years: Who is at Risk? *Diseases of the Colon & Rectum*, 2006.
961. Abramov, Y., et al., Risk factors for female anal incontinence: new insight through the Evans-ton-Northwestern twin sisters study. *Obstetrics & Gynecology*, 2005. 106(4): p. 726-32.
962. Goode, P.S., et al., Prevalence and correlates of fecal incontinence in community-dwelling older adults. *J Am Geriatr Soc*, 2005. 53(4): p. 629-35.
963. Khullar, V., et al., Prevalence of faecal incontinence among women with urinary incontinence.[comment]. *British Journal of Obstetrics & Gynaecology*, 1998. 105(11): p. 1211-3.
964. Nelson, R., S. Furner, and V. Jesudason, Fecal incontinence in Wisconsin nursing homes: prevalence and associations. *Diseases of the Colon & Rectum*, 1998. 41(10): p. 1226-9.
965. Bharucha, A.E., et al., Bowel disturbances are the most important risk factors for late onset fecal incontinence: a population-based case-control study in women. *Gastroenterology*, 2010. 139(5): p. 1559-66.
966. Wald, A., Systemic diseases causing disorders of defecation and continence. *Seminars in Gastrointestinal Disease*, 1995. 6(4): p. 194-202.
967. Harari, D., et al., New-Onset Fecal Incontinence After Stroke: Prevalence, Natural History, Risk Factors, and Impact. *Stroke*, 2003. 34(1): p. 144-150.
968. Bytzer, P., et al., Prevalence of gastrointestinal symptoms associated with diabetes mellitus: a population-based survey of 15,000 adults.[see comment]. *Archives of Internal Medicine*, 2001. 161(16): p. 1989-96.
969. Wang, J., et al., Pelvic floor disorders and quality of life in women with self-reported irritable bowel syndrome. *Aliment Pharmacol Ther*, 2010. 31(3): p. 424-31.
970. Thoua, N.M., et al., Fecal Incontinence in Systemic Sclerosis Is Secondary to Neuropathy. *Am J Gastroenterol*, 2011.
971. Bharucha, A.E. and J.G. Fletcher, Recent advances in assessing anorectal structure and functions. *Gastroenterology*, 2007. 133(4): p. 1069-74.
972. Ratuapli, S.K., et al., Phenotypic identification and classification of functional defecatory disorders using high-resolution anorectal manometry. *Gastroenterology*, 2013. 144(2): p. 314-322.e2.
973. Bharucha, A.E., et al., Epidemiology, Pathophysiology, and Classification of Fecal Incontinence: State of the Science Summary for the National Institute of Diabetes and Digestive and Kidney Diseases (NIDDK) Workshop. *Am J Gastroenterol*, 2015. 110(1): p. 127-136.
974. Noelting, J., et al., Semi-automated vectorial analysis of anorectal motion by magnetic resonance defecography in healthy subjects and fecal incontinence. *Neurogastroenterology & Motility*, 2012. 24(10): p. e467-75.
975. Terra, M.P., et al., MRI in evaluating atrophy of the external anal sphincter in patients with fecal incontinence. *AJR Am J Roentgenol*, 2006. 187(4): p. 991-9.

976. Lam, T.J., D.J. Kuik, and R.J. Felt-Bersma, Anorectal function evaluation and predictive factors for faecal incontinence in 600 patients. *Colorectal Dis*, 2012. 14(2): p. 214-23.
977. Noelting, J., et al., Normal values for high-resolution anorectal manometry in healthy women: effects of age and significance of rectoanal gradient. *Am J Gastroenterol*, 2012. 107(10): p. 1530-6.
978. Odunsi, S.T., et al., Reproducibility and performance characteristics of colonic compliance, tone, and sensory tests in healthy humans. *Dig Dis Sci*, 2010. 55(3): p. 709-15.
979. Huebner, M., et al., Age Effects on Internal Anal Sphincter Thickness and Diameter in Nulliparous Females. *Diseases of the Colon & Rectum*.
980. McHugh, S.M. and N.E. Diamant, Effect of age, gender, and parity on anal canal pressures. Contribution of impaired anal sphincter function to fecal incontinence. *Digestive Diseases & Sciences*, 1987. 32(7): p. 726-36.
981. Ryhammer, A.M., S. Laurberg, and K.M. Bek, Age and anorectal sensibility in normal women. *Scandinavian Journal of Gastroenterology*, 1997. 32(3): p. 278-84.
982. Matheson, D.M. and M.R. Keighley, Manometric evaluation of rectal prolapse and faecal incontinence. *Gut*, 1981. 22(2): p. 126-9.
983. Wang, J.Y., et al., Fecal incontinence: does age matter? Characteristics of older vs. younger women presenting for treatment of fecal incontinence. *Dis Colon Rectum*, 2008. 51(4): p. 426-31.
984. Lewicky-Gaupp, C., et al., Anal sphincter structure and function relationships in aging and fecal incontinence. *American Journal of Obstetrics and Gynecology*. In Press, Corrected Proof.
985. Lagier, E., et al., Influence of age on rectal tone and sensitivity to distension in healthy subjects. *Neurogastroenterol Motil*, 1999. 11(2): p. 101-7.
986. Gundling, F., et al., Influence of gender and age on anorectal function: normal values from anorectal manometry in a large caucasian population. *Digestion*, 2010. 81(4): p. 207-13.
987. Felt-Bersma, R.J., E.C. Klinkenberg-Knol, and S.G. Meuwissen, Anorectal function investigations in incontinent and continent patients. Differences and discriminatory value. *Diseases of the Colon & Rectum*, 1990. 33(6): p. 479-85; discussion 485-6.
988. Salvioi, B., et al., Rectal compliance, capacity, and rectoanal sensation in fecal incontinence. *American Journal of Gastroenterology*, 2001. 96(7): p. 2158-68.
989. Fox, J., et al., Effect of Aging on Anorectal and Pelvic Floor Functions in Females. *Diseases of the Colon & Rectum*, 2006. 49(11): p. 1726.
990. Ryhammer, A.M., S. Laurberg, and F.H. Sorensen, Effects of age on anal function in normal women. *Int J Colorectal Dis*, 1997. 12(4): p. 225-9.
991. Laurberg, S. and M. Swash, Effects of aging on the anorectal sphincters and their innervation. *Dis Colon Rectum*, 1989. 32(9): p. 737-42.
992. Paquette, I.M., et al., The American Society of Colon and Rectal Surgeons' Clinical Practice Guideline for the Treatment of Fecal Incontinence. *Dis Colon Rectum*, 2015. 58(7): p. 623-36.
993. Gomes, O.A., R.R. de Souza, and E.A. Liberti, A preliminary investigation of the effects of aging on the nerve cell number in the myenteric ganglia of the human colon. *Gerontology*, 1997. 43(4): p. 210-7.
994. Papachrysostomou, M., et al., Significance of the thickness of the anal sphincters with age and its relevance in faecal incontinence. *Scand J Gastroenterol*, 1994. 29(8): p. 710-4.
995. Frudinger, A., et al., Female anal sphincter: age-related differences in asymptomatic volunteers with high-frequency endoanal US. *Radiology*, 2002. 224(2): p. 417-23.
996. Rociu, E., et al., Normal anal sphincter anatomy and age- and sex-related variations at high-spatial-resolution endoanal MR imaging. *Radiology*, 2000. 217(2): p. 395-401.
997. Loening-Baucke, V. and S. Anuras, Sigmoidal and rectal motility in healthy elderly. *J Am Geriatr Soc*, 1984. 32(12): p. 887-91.
998. Bharucha, A.E., et al., Relationship Between Glycemic Control and Gastric Emptying in Poorly Controlled Type 2 Diabetes. *Clin Gastroenterol Hepatol*, 2014.
999. Jeffery, I.B., D.B. Lynch, and P.W. O'Toole, Composition and temporal stability of the gut microbiota in older persons. *Isme j*, 2016. 10(1): p. 170-82.
1000. O'Toole, P.W. and I.B. Jeffery, Gut microbiota and aging. *Science*, 2015. 350(6265): p. 1214-5.
1001. Claesson, M.J., et al., Gut microbiota composition correlates with diet and health in the elderly. *Nature*, 2012. 488(7410): p. 178-84.

1002. Vernava, A.M., 3rd, W.E. Longo, and G.L. Daniel, Pudendal neuropathy and the importance of EMG evaluation of fecal incontinence. *Dis Colon Rectum*, 1993. 36(1): p. 23-7.
1003. van Meegdenburg, M.M., E. Heineman, and P.M. Broens, Pudendal Neuropathy Alone Results in Urge Incontinence Rather Than in Complete Fecal Incontinence. *Dis Colon Rectum*, 2015. 58(12): p. 1186-93.
1004. Barrett, J.A., et al., Anal function in geriatric patients with faecal incontinence. *Gut*, 1989. 30(9): p. 1244-51.
1005. Lewicky-Gaupp, C., et al., Fecal incontinence in older women: are levator ani defects a factor? *Am J Obstet Gynecol*, 2010. 202(5): p. 491.e1-6.
1006. Gage, H., et al., Correlates of constipation in people with Parkinson's. *Parkinsonism Relat Disord*, 2011. 17(2): p. 106-11.
1007. Riss, S., et al., Haemorrhoids, constipation and faecal incontinence: is there any relationship? *Colorectal Dis*, 2011. 13(8): p. e227-33.
1008. Burgell, R.E., et al., Fecal incontinence in men: coexistent constipation and impact of rectal hyposensitivity. *Dis Colon Rectum*, 2012. 55(1): p. 18-25.
1009. Akpan, A., M.A. Gosney, and J. Barret, Factors contributing to fecal incontinence in older people and outcome of routine management in home, hospital and nursing home settings. *Clin Interv Aging*, 2007. 2(1): p. 139-45.
1010. Chassagne, P., et al., Does treatment of constipation improve faecal incontinence in institutionalized elderly patients? *Age & Ageing*, 2000. 29(2): p. 159-64.
1011. Bharucha, A.E., et al., Relation of Bowel Habits to Fecal Incontinence in Women. *Am J Gastroenterol*, 2008. 103(6): p. 1470.
1012. Markland, A.D., et al., Factors impacting quality of life in women with fecal incontinence. *Dis Colon Rectum*, 2010. 53(8): p. 1148-54.
1013. Papathanasopoulos, A.A., et al., Increased fatigability of external anal sphincter in inflammatory bowel disease: significance in fecal urgency and incontinence. *J Crohns Colitis*, 2010. 4(5): p. 553-60.
1014. J, W., et al., Pelvic floor disorders and quality of life in women with self-reported irritable bowel syndrome. *Alimentary Pharmacology & Therapeutics*. 31(3): p. 424-431.
1015. Ritchie, R.D., J.M. Sackier, and J.P. Hodde, Incontinence rates after cutting seton treatment for anal fistula. *Colorectal Dis*, 2009. 11(6): p. 564-71.
1016. Abbas, M.A., C.H. Jackson, and P.I. Haigh, Predictors of outcome for anal fistula surgery. *Arch Surg*, 2011. 146(9): p. 1011-6.
1017. Rotholtz, N.A., et al., Long-term assessment of fecal incontinence after lateral internal sphincterotomy. *Tech Coloproctol*, 2005. 9(2): p. 115-8.
1018. Levack, M.M., et al., Sigmoidectomy syndrome? Patients' perspectives on the functional outcomes following surgery for diverticulitis. *Dis Colon Rectum*, 2012. 55(1): p. 10-7.
1019. Scheer, A.S., et al., The long-term gastrointestinal functional outcomes following curative anterior resection in adults with rectal cancer: a systematic review and meta-analysis. *Dis Colon Rectum*, 2011. 54(12): p. 1589-97.
1020. Nikoletti, S., et al., Bowel problems, self-care practices, and information needs of colorectal cancer survivors at 6 to 24 months after sphincter-saving surgery. *Cancer Nurs*, 2008. 31(5): p. 389-98.
1021. Maeda, Y., et al., Faecal incontinence following radiotherapy for prostate cancer: a systematic review. *Radiother Oncol*, 2011. 98(2): p. 145-53.
1022. Borrie, M.J. and H.A. Davidson, Incontinence in institutions: costs and contributing factors. *CMAJ Canadian Medical Association Journal*, 1992. 147(3): p. 322-8.
1023. Edwards, N.I. and D. Jones, The prevalence of faecal incontinence in older people living at home.[comment]. *Age & Ageing*, 2001. 30(6): p. 503-7.
1024. Aslan, E., et al., The prevalence of and the related factors for urinary and fecal incontinence among older residing in nursing homes. *J Clin Nurs*, 2009. 18(23): p. 3290-8.
1025. De La Luz Nieto, M., et al., Factors associated with fecal incontinence in a nationally representative sample of diabetic women. *Int Urogynecol J*, 2015. 26(10): p. 1483-8.
1026. Brittain, K., et al., Isolated Urinary, Fecal, and Double Incontinence: Prevalence and Degree of Soiling in Stroke Survivors. *Journal of the American Geriatrics Society*, 2006. 54(12): p. 1915-1919.
1027. Nakayama, H., et al., Prevalence and risk factors of incontinence after stroke. *The Copenhagen Stroke Study*. *Stroke*, 1997. 28(1): p. 58-62.
1028. Foxx-Orenstein, A., et al., Incidence, risk factors, and outcomes of fecal incontinence after acute brain injury: Findings from the traumatic brain injury model systems national database. *Archives of Physical Medicine and Rehabilitation*, 2003. 84(2): p. 231.

1029. Leary, S.M., et al., Incontinence after brain injury: prevalence, outcome and multidisciplinary management on a neurological rehabilitation unit. *Clin Rehabil*, 2006. 20(12): p. 1094-9.
1030. Vallès, M. and F. Mearin, Pathophysiology of bowel dysfunction in patients with motor incomplete spinal cord injury: comparison with patients with motor complete spinal cord injury. *Dis Colon Rectum*, 2009. 52(9): p. 1589-97.
1031. Bliss, D.Z., et al., Comparison of the nutritional composition of diets of persons with fecal incontinence and that of age- and gender-matched controls. *J Wound Ostomy Continence Nurs*, 2000. 27(2): p. 90-1, 93-7.
1032. Fisher, K., D.Z. Bliss, and K. Savik, Comparison of recall and daily self-report of fecal incontinence severity. *J Wound Ostomy Continence Nurs*, 2008. 35(5): p. 515-20.
1033. Harari, D., et al., Constipation: assessment and management in an institutionalized elderly population. *J Am Geriatr Soc*, 1994. 42(9): p. 947-52.
1034. Coss-Adame, E., et al., Accuracy and Reproducibility of High-definition Anorectal Manometry and Pressure Topography Analyses in Healthy Subjects. *Clin Gastroenterol Hepatol*, 2015. 13(6): p. 1143-50.e1.
1035. Fox, J.C., et al., Effect of aging on anorectal and pelvic floor functions in females. *Dis Colon Rectum*, 2006. 49(11): p. 1726-35.
1036. Richter, H.E., et al., Endoanal ultrasound findings and fecal incontinence symptoms in women with and without recognized anal sphincter tears. *Obstet Gynecol*, 2006. 108(6): p. 1394-401.
1037. Potter, J., et al., National audit of continence care for older people: management of faecal incontinence. *Age Ageing*, 2007. 36(3): p. 268-73.
1038. Orkin, B.A., S.B. Sinykin, and P.C. Lloyd, The digital rectal examination scoring system (DRESS). *Dis Colon Rectum*, 2010. 53(12): p. 1656-60.
1039. Bibbins-Domingo, K., et al., Screening for Colorectal Cancer: US Preventive Services Task Force Recommendation Statement. *Jama*, 2016. 315(23): p. 2564-75.
1040. Bacchus, C.M., et al., Recommendations on screening for colorectal cancer in primary care. *Cmaj*, 2016. 188(5): p. 340-8.
1041. Weir, M.A., et al., Hyponatremia and sodium picosulfate bowel preparations in older adults. *Am J Gastroenterol*, 2014. 109(5): p. 686-94.
1042. Serper, M., et al., Patient factors that affect quality of colonoscopy preparation. *Clin Gastroenterol Hepatol*, 2014. 12(3): p. 451-7.
1043. Park, K.H. and H. Choi, Prospective study on Incontinence-Associated Dermatitis and its Severity instrument for verifying its ability to predict the development of pressure ulcers in patients with fecal incontinence. *Int Wound J*, 2016. 13 Suppl 1: p. 20-5.
1044. Beekman, D., et al., A systematic review and meta-analysis of incontinence-associated dermatitis, incontinence, and moisture as risk factors for pressure ulcer development. *Res Nurs Health*, 2014. 37(3): p. 204-18.
1045. Siproudhis, L., et al., Overt rectal prolapse and fecal incontinence. *Dis Colon Rectum*, 2008. 51(9): p. 1356-60.
1046. Andy, U.U., et al., The relationship between fecal incontinence, constipation and defecatory symptoms in women with pelvic floor disorders. *Neurourol Urodyn*, 2016.
1047. Klingele, C.J., et al., Pelvic Organ Prolapse in Defecatory Disorders. *Obstet Gynecol*, 2005. 106(2): p. 315-320.
1048. Coggrave, M., C. Norton, and J.D. Cody, Management of faecal incontinence and constipation in adults with central neurological diseases. *Cochrane Database Syst Rev*, 2014(1): p. Cd002115.
1049. Maeda, Y., S. Laurberg, and C. Norton, Perianal injectable bulking agents as treatment for faecal incontinence in adults. *Cochrane Database Syst Rev*, 2013(2): p. Cd007959.
1050. Norton, C., G. Hosker, and M. Brazzelli, Bio-feedback and/or sphincter exercises for the treatment of faecal incontinence in adults. *Cochrane Database Syst Rev*, 2000(2): p. CD002111.
1051. Omar, M.I. and C.E. Alexander, Drug treatment for faecal incontinence in adults. *Cochrane Database Syst Rev*, 2013. 6: p. CD002116.
1052. Maeda, Y., S. Laurberg, and C. Norton, Perianal injectable bulking agents as treatment for faecal incontinence in adults. *Cochrane Database Syst Rev*, 2013. 2: p. CD007959.
1053. Whitehead, W.E., et al., Treatment of Fecal Incontinence: State of the Science Summary for the National Institute of Diabetes and Digestive and Kidney Diseases Workshop. *Am J Gastroenterol*, 2015. 110(1): p. 138-146.
1054. Chan, D.S. and R.J. Delicata, Meta-analysis of antegrade continence enema in adults with faecal incontinence and constipation. *Br J Surg*, 2016. 103(4): p. 322-7.

1055. Forte, M.L., et al., AHRQ Comparative Effectiveness Reviews, in *Treatments for Fecal Incontinence*. 2016, Agency for Healthcare Research and Quality (US): Rockville (MD).
1056. Forte, M.L., et al., *Systematic Review of Surgical Treatments for Fecal Incontinence*. *Dis Colon Rectum*, 2016. 59(5): p. 443-69.
1057. Patel, A.S., et al., *Use of Antegrade Continence Enema for the Treatment of Fecal Incontinence and Functional Constipation in Adults: A Systematic Review*. *Dis Colon Rectum*, 2015. 58(10): p. 999-1013.
1058. Bliss, D.Z., et al., *Dietary fiber supplementation for fecal incontinence: a randomized clinical trial*. *Res Nurs Health*, 2014. 37(5): p. 367-78.
1059. Markland, A.D., et al., *Loperamide Versus Psyllium Fiber for Treatment of Fecal Incontinence: The Fecal Incontinence Prescription (Rx) Management (FIRM) Randomized Clinical Trial*. *Dis Colon Rectum*, 2015. 58(10): p. 983-993.
1060. Sjudahl, J., et al., *Combination therapy with biofeedback, loperamide, and stool-bulking agents is effective for the treatment of fecal incontinence in women - a randomized controlled trial*. *Scand J Gastroenterol*, 2015. 50(8): p. 965-74.
1061. Bell, D., et al., *A randomised, controlled, cross-over study to investigate the pharmacodynamics, pharmacokinetics and safety of 1R,2S-methoxamine hydrochloride (NRL001) in healthy elderly subjects*. *Colorectal Dis*, 2014. 16 Suppl 1: p. 27-35.
1062. Bell, D., et al., *A double-blind, placebo-controlled, randomised, parallel-group, dose-escalating, repeat dose study in healthy volunteers to evaluate the safety, tolerability, pharmacodynamic effects and pharmacokinetics of the once daily rectal application of NRL001 suppositories for 14 days*. *Colorectal Dis*, 2014. 16 Suppl 1: p. 36-50.
1063. Siproudhis, L., et al., *Libertas: a phase II placebo-controlled study of NRL001 in patients with faecal incontinence showed an unexpected and sustained placebo response*. *Int J Colorectal Dis*, 2016. 31(6): p. 1205-16.
1064. Blekken, L.E., et al., *Feasibility, acceptability, and adherence of two educational programs for care staff concerning nursing home patients' fecal incontinence: a pilot study preceding a cluster-randomized controlled trial*. *Implement Sci*, 2015. 10: p. 72.
1065. Blekken, L.E., et al., *Effect of a multifaceted educational program for care staff concerning fecal incontinence in nursing home patients: study protocol of a cluster randomized controlled trial*. *Trials*, 2015. 16: p. 69.
1066. Su, M.Y., et al., *A prospective, randomized, controlled study of a suspension positioning system used with elderly bedridden patients with neurogenic fecal incontinence*. *Ostomy Wound Manage*, 2015. 61(1): p. 30-9.
1067. Graf, W., et al., *Efficacy of dextranomer in stabilised hyaluronic acid for treatment of faecal incontinence: a randomised, sham-controlled trial*. *Lancet*, 2011. 377(9770): p. 997-1003.
1068. Dehli, T., et al., *Sphincter training or anal injections of dextranomer for treatment of anal incontinence: a randomized trial*. *Scand J Gastroenterol*, 2013. 48(3): p. 302-10.
1069. Knowles, C.H., et al., *Percutaneous tibial nerve stimulation versus sham electrical stimulation for the treatment of faecal incontinence in adults (CONFIDeNT): a double-blind, multicentre, pragmatic, parallel-group, randomised controlled trial*. *Lancet*, 2015.
1070. Booth, J., et al., *A feasibility study of transcutaneous posterior tibial nerve stimulation for bladder and bowel dysfunction in elderly adults in residential care*. *J Am Med Dir Assoc*, 2013. 14(4): p. 270-4.
1071. Lukacz, E.S., M.M. Segall, and S.D. Wexner, *Evaluation of an Anal Insert Device for the Conservative Management of Fecal Incontinence*. *Dis Colon Rectum*, 2015. 58(9): p. 892-8.
1072. Richter, H.E., et al., *A vaginal bowel-control system for the treatment of fecal incontinence*. *Obstet Gynecol*, 2015. 125(3): p. 540-7.
1073. Mowatt, G., C. Glazener, and M. Jarrett, *Sacral nerve stimulation for faecal incontinence and constipation in adults*. *Cochrane Database Syst Rev*, 2007(3): p. CD004464.
1074. Wexner, S.D., et al., *Sacral nerve stimulation for fecal incontinence: results of a 120-patient prospective multicenter study*. *Ann Surg*, 2010. 251(3): p. 441-9.
1075. Mellgren, A., et al., *Long-term efficacy and safety of sacral nerve stimulation for fecal incontinence*. *Dis Colon Rectum*, 2011. 54(9): p. 1065-75.
1076. Matzel, K.E., et al., *Sacral spinal nerve stimulation for faecal incontinence: multicentre study*. *Lancet*, 2004. 363(9417): p. 1270-6.
1077. Wallace, P.A., F.L. Lane, and K.L. Noblett, *Sacral nerve neuromodulation in patients with cardiac pacemakers*. *Am J Obstet Gynecol*, 2007. 197(1): p. 94.e1-3.
1078. Wallace, P.A., F.L. Lane, and K.L. Noblett, *Sacral nerve neuromodulation in patients with underlying neurologic disease*. *Am J Obstet Gynecol*, 2007. 197(1): p. 96.e1-5.

1079. Maeda, Y., et al., Postoperative issues of sacral nerve stimulation for fecal incontinence and constipation: a systematic literature review and treatment guideline. *Dis Colon Rectum*, 2011. 54(11): p. 1443-60.
1080. Jakobsson, E., et al., Clinical problems at the end of life in a Swedish population, including the role of advancing age and physical and cognitive function. *Scand J Public Health*, 2008. 36(2): p. 177-82.
1081. Vandervoort, A., et al., Advance directives and physicians' orders in nursing home residents with dementia in Flanders, Belgium: prevalence and associated outcomes. *Int Psychogeriatr*, 2012. 24(7): p. 1133-43.
1082. Singer, A.E., et al., Symptom trends in the last year of life from 1998 to 2010: a cohort study. *Ann Intern Med*, 2015. 162(3): p. 175-83.
1083. Hoben, M., et al., Impact of Symptoms and Care Practices on Nursing Home Residents at the End of Life: A Rating by Front-line Care Providers. *J Am Med Dir Assoc*, 2016. 17(2): p. 155-61.
1084. Hui, D., et al., Symptom Expression in the Last Seven Days of Life Among Cancer Patients Admitted to Acute Palliative Care Units. *J Pain Symptom Manage*, 2015. 50(4): p. 488-94.
1085. Brazil, K., et al., Caregiving and its impact on families of the terminally ill. *Aging Ment Health*, 2003. 7(5): p. 376-82.
1086. Higginson, I.J., Research challenges in palliative and end of life care. *BMJ Support Palliat Care*, 2016. 6(1): p. 2-4.
1087. Seymour, J., Payne, S., Reid, D., Sargeant, A., Skilbeck, J., Smith, P., Ethical and methodological issues in palliative care studies., *Journal of Research in Nursing*, 2005. 10(2): p. 169-188.
1088. Sampson, E.L., et al., A systematic review of the scientific evidence for the efficacy of a palliative care approach in advanced dementia. *Int Psychogeriatr*, 2005. 17(1): p. 31-40.
1089. Loganathan, A., et al., Pudendal nerve injury in men with fecal incontinence after radiotherapy for prostate cancer. *Acta Oncol*, 2015. 54(6): p. 882-8.
1090. Seo, H.J., et al., Comparison of Robot-Assisted Radical Prostatectomy and Open Radical Prostatectomy Outcomes: A Systematic Review and Meta-Analysis. *Yonsei Med J*, 2016. 57(5): p. 1165-77.
1091. Cherny, N.I., Evaluation and management of treatment-related diarrhea in patients with advanced cancer: a review. *J Pain Symptom Manage*, 2008. 36(4): p. 413-23.
1092. McCarthy, M., J. Addington-Hall, and D. Altman, The experience of dying with dementia: a retrospective study. *Int J Geriatr Psychiatry*, 1997. 12(3): p. 404-9.
1093. Veerbeek, L., et al., The last 3 days of life in three different care settings in The Netherlands. *Support Care Cancer*, 2007. 15(10): p. 1117-23.
1094. Hui, D., et al., Clinical signs of impending death in cancer patients. *Oncologist*, 2014. 19(6): p. 681-7.
1095. people, L.A.f.t.c.o.d. Leadership Alliance for the care of dying people. One Chance to get it right 2014; Available from: https://www.gov.uk/government/uploads/system/uploads/attachment_data/file/323188/One_chance_to_get_it_right.pdf.
1096. Excellence, N.I.f.H.a.C. Care of dying adults in the last days of life. 2015.
1097. Perkins, E., et al., in The care of dying people in nursing homes and intensive care units: a qualitative mixed-methods study. 2016: Southampton (UK).
1098. Chan, R.J., J. Webster, and A. Bowers, End-of-life care pathways for improving outcomes in caring for the dying. *Cochrane Database Syst Rev*, 2016. 2: p. CD008006.
1099. 2015., R.C.o.P.N. Acute care resource: End-of-life care in the acute care setting. 2015; Available from: <https://www.rcplondon.ac.uk/projects/outputs/acute-care-resource-end-life-care-acute-care-setting>.
1100. ., T.C.i.E.o.L.C.P.B. What's important to me? A Review of Choice in End of Life Care. 2015; Available from: https://www.gov.uk/government/uploads/system/uploads/attachment_data/file/407244/CHOICE_REVIEW_FINAL_for_web.pdf.
1101. Farrington, N., M. Fader, and A. Richardson, Managing urinary incontinence at the end of life: an examination of the evidence that informs practice. *Int J Palliat Nurs*, 2013. 19(9): p. 449-56.
1102. Gould, C.V., et al., Guideline for prevention of catheter-associated urinary tract infections 2009. *Infect Control Hosp Epidemiol*, 2010. 31(4): p. 319-26.
1103. Farrington, N., et al., Indwelling urinary catheter use at the end of life: a retrospective audit. *Br J Nurs*, 2014. 23(9): p. S4, S6-10.
1104. Fainsinger, R.L., et al., The use of urinary catheters in terminally ill cancer patients. *J Pain Symptom Manage*, 1992. 7(6): p. 333-8.

1105. Office for National Statistics England. National Survey of Bereaved People (VOICES). 2015; Available from: <http://www.ons.gov.uk/people-populationandcommunity/healthandsocial-care/healthcaresystem/bulletins/nationalsurveyofbereavedpeoplevoices/england2015#preferences-and-choice-at-the-end-of-life>.
1106. Gomes, B., Higginson, I.J., Factors influencing death at home in terminally ill patients with cancer: systematic review. *BMJ*, 2006. 332(7540): p. 515-21.
1107. Gomes, B., et al., Preferences for place of death if faced with advanced cancer: a population survey in England, Flanders, Germany, Italy, the Netherlands, Portugal and Spain. *Ann Oncol*, 2012. 23(8): p. 2006-15.
1108. Gott M., S., J., Bellam,y G., Clark, D., Ahmedzai, S., Older people's views about home as a place of care at the end of life. *Palliat Med*, 2004. 18(5): p. 460-67.
1109. Rossa, D., Lamura, G. The impact of incontinence management on informal caregivers' quality of life. *Aging clinical and experimental research* 2015.; Available from: <http://link.springer.com/article/10.1007%2Fs40520-015-0367-7>.
1110. Flaherty, J.H., D.K. Miller, and R.M. Coe, Impact on caregivers of supporting urinary function in noninstitutionalized, chronically ill seniors. *Gerontologist*, 1992. 32(4): p. 541-5.
1111. Strategy, E.o.L.C., Promoting high quality care for all adults at the end of life. 2008, Department of Health: London.
1112. Woodman, C., J. Baillie, and S. Sivell, The preferences and perspectives of family caregivers towards place of care for their relatives at the end-of-life. A systematic review and thematic synthesis of the qualitative evidence. *BMJ Support Palliat Care*, 2016. 6(4): p. 418-429.
1113. Wye, L., et al., What works in 'real life' to facilitate home deaths and fewer hospital admissions for those at end of life?: results from a realist evaluation of new palliative care services in two English counties. *BMC Palliat Care*, 2014. 13: p. 37.

ADULT CONSERVATIVE MANAGEMENT

Chair

C. DUMOULIN (CANADA)

Members

T. ADEWUYI (UK)
J. BOOTH (UK)
C. BRADLEY (USA)
K. BURGIO (USA)
S. HAGEN (UK)
K. HUNTER (CANADA)
M. IMAMURA (UK)
M. MORIN (CANADA)
S. MORKVED (NORWAY)
R. THAKAR (UK)
S. WALLACE (UK)
K. WILLIAMS (UK)

The present chapter would not have been possible without the work of the previous editors, Katherine Moore [2013], Jean hay Smith [2008] and don Wilson [2000, 2004]. They produced the remarkable framework for the present review. In addition, we would like to acknowledge the indispensable contribution of Pauline Campbell to the reviewing, analysis and reporting of POP section. Finally, this chapter would not have been possible without the untiring dedication of Yvonne Ruella.

CONTENTS

I.	INTRODUCTION	1445	REFERENCES	1611
II.	URINARY INCONTINENCE IN WOMEN	1446		
1.	Lifestyle Modification Interventions	1446		
2.	Pelvic Floor Muscle Training (PFMT)...	1453		
3.	Weighted Vaginal Cones (VC)	1491		
4.	Electrical Stimulation (EStim)	1499		
5.	Posterior Tibial Nerve Stimulation (PTNS)	1512		
6.	Magnetic Stimulation (MStim)	1521		
7.	Scheduled Voiding Regimens	1524		
8.	Complementary and Alternative Medicines	1531		
9.	Future Research Directions	1534		
III.	PELVIC ORGAN PROLAPSE (POP)	1537		
1.	Lifestyle Modification Intervention	1537		
2.	Pelvic Floor Muscle Training.....	1547		
3.	Pessaries	1565		
4.	Recommendations	1575		
IV.	URINARY INCONTINENCE IN MEN	1576		
1.	Lifestyle	1576		
2.	Pelvic Floor Muscle Training (PFMT)...	1593		
3.	Electrical Stimulation (EStim)	1598		
4.	Magnetic Stimulation (MStim)	1598		
5.	Penile Vibratory Stimulation (PVS)	1599		
6.	Scheduled Voiding Regimens	1599		
7.	Complementary and Alternative Medicines	1600		
8.	Summary.....	1600		
V.	URINARY INCONTINENCE IN MEN AND WOMEN	1602		
1.	Posterior Tibial Nerve Stimulation (PTNS)	1602		

ADULT CONSERVATIVE MANAGEMENT

C. DUMOULIN (CANADA)

*T. ADEWUYI (UK), J. BOOTH (UK), C. BRADLEY (USA), K. BURGIO (USA), S. HAGEN (UK),
K. HUNTER (CANADA), M. IMAMURA (UK), M. MORIN (CANADA), S. MORKVED (NORWAY),
R. THAKAR (UK), S. WALLACE (UK), K. WILLIAMS (UK)*

I. INTRODUCTION

Conservative management of urinary incontinence (UI) or pelvic organ prolapse (POP) is defined as any intervention not involving surgical or pharmacological approaches (1). These comprise lifestyle modification, pelvic floor muscle training (PFMT) (either alone or with the addition of biofeedback), vaginal cones, electrical stimulation, magnetic stimulation, posterior tibial nerve stimulation, scheduled voiding regimens, complementary/alternative medicines and supportive rings/pessaries. In this chapter, we cover studies that provide comparative data between a conservative management approach and the absence of treatment or placebo, between two conservative management approaches or between a conservative management approach and medications or surgery.

Conservative management approaches are considered relatively low cost and non-invasive, with minimal adverse effects that are typically guided by a healthcare professional and depend on user participation. It is generally accepted that conservative interventions are part of initial management at the primary care level for individuals suffering from either UI or POP. Conservative intervention is also indicated for those for whom other treatments are inappropriate, for example, those unwilling to undergo or unfit for surgery and women who plan future pregnancies. Other indications include individuals awaiting surgery or who wish to delay surgery and those whose symptoms are not severe enough for surgical intervention.

The research base on which to judge the effectiveness of conservative interventions is growing although some aspects, such as lifestyle modification interventions and alternative and complementary medicines in particular, require considerably more well-designed trials. In this chapter we add to the 2013 5th Edition ICI chapter on conservative management (2), integrate the evidence and upgrade the recommendations from the 5th ICI. We also add a new section on posterior tibial nerve stimulation with its levels of evidence and recommendation.

The updated literature search covered publications from July 1st, 2011 to September 9th, 2015 according to the following search strategy:

- Cochrane Incontinence systematic reviews

Relevant Cochrane systematic reviews were identified, for each section of this Chapter, by two of the authors (CD, SW) assessing the full list of reviews (Cochrane Incontinence (3) or on request). The leads for each section were given lists of these relevant reviews. Additional searches of the Cochrane Incontinence Specialised Register were provided to each section author to bring the searches up to date or, if there was a gap in review coverage, a full search of the Register was conducted (search date: September 9th, 2015).

- Additional searches for this ICI Chapter

Electronic searches

We identified relevant trials from the Cochrane Incontinence Specialised Register. For more details of the search methods used to build the Register please see the Group's module in the Cochrane Library (4). The Register contains trials identified from the Cochrane Central Register of Controlled Trials (CENTRAL), MEDLINE, MEDLINE In-Process, ClinicalTrials.gov, [WHO ICTRP](http://WHOICTRP), [UK Clinical Research Network Portfolio](http://UKClinicalResearchNetworkPortfolio) and hand searching of journals and conference proceedings. The search covered:

- For sections covered by existing Cochrane reviews – from the date of last search for the published version of the review to September 9th, 2015.
- For sections not covered by existing Cochrane reviews – complete search of all contents of the Register on September 9th, 2015.
- Searching other sources

We searched the reference lists of relevant articles for other relevant trials.

We did not impose any language or other limitations on any of the searches described above.

II. URINARY INCONTINENCE IN WOMEN

1. LIFESTYLE MODIFICATION INTERVENTIONS

Lifestyle modification Interventions for women

A number of lifestyle factors may play a role in either the development or resolution of UI. Lifestyle modification interventions are defined as application of interventions in management of lifestyle-related health problems (1). They are low cost, non-invasive alterations in lifestyle such as weight loss; dietary changes; fluid intake modification; reduction in caffeinated, carbonated and alcoholic drinks; avoidance of constipation; stopping smoking; and physical activity.

As reported in the 5th ICI (2013) evidence for the efficacy of lifestyle modification interventions for urinary incontinence is lacking, there are few lifestyle modification interventions that have received scrutiny in randomised controlled trials, although weight loss and dietary factors have been examined and prospective studies and observational studies have been undertaken for diet, smoking and constipation. For more details, refer to ICI 5th Edition (2).

This review section updates the evidence on the use of lifestyle modification interventions to improve incontinence and related symptoms in females. It revealed 10 potentially eligible new trials. Table 1 illustrates the number of studies included in the 5th ICI edition as well as the new studies identified in the current update. Characteristics of each new trial are presented in subsequent tables for each lifestyle modification intervention for which there is new data.

In continuity with the last edition of the ICI chapter on conservative management and to ensure consistency throughout the chapter, the primary outcomes to be reported were *patient-reported outcomes*: cure and cure and improvement, UI-specific or POP-specific quality of life or symptoms-validated questionnaire and/or number of leakages (as per the diary). Cure and improvement were based on patients' self-report when available; if not, cure and improvement based on quantifiable measures such as a diary and pad tests were reported.

Secondary outcomes were *clinician-reported outcomes* (pad test, POPQ score, etc.). These were chosen in relation to each subsection's specificity and in continuity with our previous chapter.

Each subsection concludes with the level of evidence, grade of recommendations and factors affecting outcome. Separate chapters in this 6th Edition address incontinence in the frail older person, children, pessaries and products for continence, those with neurological conditions and those suffering from faecal incontinence.

Where summary statistics are presented, the raw data from which these are derived can be found in the tables within each subsection, in trial reports and systematic reviews cited in the chapter. The Chapter is intended as a stand-alone document and adds to the comprehensive reports from previous ICI editions.

Table 1 Studies included in the updated review 2016

Lifestyle modification Interventions	ICI 2013	ICI 2016	Total
Weight loss	3 RCT 4 prospective cohort 7 cross sectional cohort 1 retrospective cohort 1 case control study	2 RCT 1 cohort study 1 meta-analysis 1 prospective longitudinal study	5 RCT 13 cohort studies 1 case control study 1 meta- analysis 1 prospective longitudinal study
Physical activity	2 prospective cohort 2 observational cohort	1 prospective cohort study 1 case control study	3 prospective cohort studies 2 observational cohort study 1 case control study
Smoking	2 case control studies	1 RCT (pilot, secondary analysis)	1 RCT pilot 2 case control studies
Dietary factors	3 observational studies	1 case control study 1 prospective cohort study 1 cross sectional cohort study	3 observational studies 1 case control study 1 prospective cohort study 1 cross sectional cohort study

Questions addressed are:

- Are lifestyle modification interventions (e.g. weight loss, increased/decreased physical activity/ smoking cessation/ dietary or fluid change) effective in the prevention of UI?
- Are lifestyle modification interventions (e.g. weight loss, increased/decreased physical activity/ smoking cessation/ dietary or fluid change) better than no treatment, placebo or control in the treatment of UI?
- Is one lifestyle modification intervention (e.g. weight loss, increased/decreased physical activity/ smoking cessation/ dietary or fluid change) better than another?

In 2015 a Cochrane review was published (5) which included all available trials of lifestyle modification interventions for urinary incontinence. These trials are included in this review, along with new trial data since the Cochrane search was undertaken (October 27th, 2014) as well as other cohort evidence where no trial data are available.

1.1. Prevention

Are lifestyle modification interventions (e.g. weight loss, increased/decreased physical activity/ smoking cessation/ dietary or fluid change) effective in the prevention of UI?

In the last ICI chapter (5th ICI, 2013), there were no trials on prevention of UI. No new trials have been published.

Based on the clear lack of evidence in the literature of RCTs or observational studies of lifestyle modification interventions to prevent UI, no evidence based recommendations can be made.

Prevention should be an area for future research investment and comprise robust economic evaluation to determine the benefits of prevention strategies in specific age groups.

1.2. Treatment

1.2.1 Weight Loss by Obese or Overweight Women

Urinary incontinence and obesity are both common problems for women. It is recognised that obese women have higher intra-abdominal pressures than non-obese women, and it has been suggested that this chronically elevated pressure may predispose to incontinence by weakening pelvic floor support structures (6).

One new trial was identified which examined weight loss in overweight/obese women (7) (Table 2). The study was conducted to determine the effect of an intensive weight loss programme over 4 years on a subset of female participants (n=2739), previously

outlined in the Look AHEAD trial(7). All participants were randomised to an intensive weight loss programme or a diabetes support and education group. Self-report of incontinence, nocturia and daytime voiding frequency were recorded at baseline and 1 year. Each kilogramme of weight loss reduced the odds of developing UI at one year by 3% (OR 0.97, 95% CI (0.95-0.99); p=0.1). There was uncertainty over the risk of selection bias for several key parameters, including: random sequence generation and allocation concealment. Performance bias was unclear as the blinding of participants and staff was not undertaken. The study ensured the blinding of outcome assessment but did not provide complete outcome data and provided only selective reporting indicating possible reporting bias.

A single study not identified in our previous searches from 2008 was discovered (8). This prospective longitudinal study examined the effect of weight loss offered as part of a weight reduction programme which included low calorie diet and exercise, 64 obese incontinent women were included. Weight loss of ≥5% of baseline weight was associated with significant reduction in pad test loss (median difference, 19 g; 95% confidence interval, 13-28 g; p < 0.001). They also report a statistically significant improvement in quality of life measures. They suggest that weight reduction of 5% of initial body weight can improve UI severity and its effects on quality of life in obese women. There was uncertainty over the risk of bias in all parameters for this study due to the poor reporting style.

Further analysis on the effect of weight loss on changes in health-related quality of life are reported by Pinto *et al.* 2012 (9). In a study conducted for the Programme to Reduce Incontinence by Diet and Exercise (PRIDE), a longitudinal cohort analysis was undertaken of 338 obese and overweight women with UI and health related quality of life assessed at baseline, 6 and 18 months. They concluded that weight loss and increased physical activity but not reduction in frequency of UI were strongly associated with improvements in QoL.

More recently in 2014 a systematic review and meta-analysis of non-surgical weight loss interventions in overweight women was published by Vissers *et al.* (10) drawing on the studies from the ICI 2013 chapter and the more recent Cochrane review (2015); this concluded that whilst few (n=6) studies were available, non-surgical weight loss should be considered standard practice for overweight women with UI. This review did not identify any additional studies for inclusion here. It is important to note that this review sought to determine the effect of non-surgical weight loss interventions on urinary incontinence in overweight women, but, in fact, included studies of both obese and overweight women.

Table 2 Summary of data on weight loss

Author, year	Comparator	N	Study population	Age	Outcomes/results	Follow up	Notes (side effects, loss of follow up, risk of bias)
Phelan 2012(1)	Intensive weight-loss vs a structured education programme on weight loss	2994	Women in a diabetes trial	Group 1 57.8 Group 2 58.1	Decrease of at least 2 incontinence episodes a week assessed by a validated self report questionnaire. Mean weight loss at 1 year Group 1 : 7.7 group 2 0.7; p value<0.0001	12 months	Random sequence generation: unclear Allocation concealment – unclear Blinding of participants – high risk Blinding of outcome assessment – low risk Incomplete outcome data – unclear risk Selective reporting – unclear risk
Breyer 2014(2)	Intensive weight loss versus a structured education programme on weight loss	1910	Men in a diabetes trial	59.9	Decrease in incontinence episodes or cure assessed by a validated self-report questionnaire	12 months	Random sequence generation : unclear Allocation concealment – unclear Blinding of participants – high risk Blinding of outcome assessment – low risk Incomplete outcome data – unclear risk Selective reporting – unclear risk
Auwad 2008(3)	Commercial programme of diet and exercise versus no control group	64	Obese women with urodynamically proved urinary incontinence	52.2	Decrease in pad test loss	18 months	Blinding of outcome assessment – unclear risk Incomplete outcome data – unclear risk Selective reporting – unclear risk
Pinto 2012(4)	Behavioural weight loss intervention versus a structured education programme on weight loss	338	Overweight and obese women with UI	53 +- 11 years (SD)	Health related QoL	18 months	Secondary analysis of data: Random sequence generation : low risk Allocation concealment – low risk Blinding of participants – high risk Blinding of outcome assessment – low risk Incomplete outcome data – low risk Selective reporting – unclear risk

1. Phelan S, Kanaya AM, Subak LL, Hogan PE, Espeland MA, Wing RR, *et al.* Weight Loss Prevents Urinary Incontinence in Women With Type 2 Diabetes: Results From the Look AHEAD Trial. *Journal of Urology.* 2012;187(3):939-44.
2. Breyer BN, Phelan S, Hogan PE, Rosen RC, Kitabchi AE, Wing RR, *et al.* Intensive Lifestyle Intervention Reduces Urinary Incontinence in Overweight/Obese Men with Type 2 Diabetes: Results from the Look AHEAD Trial. *Journal of Urology.* 2014;192(1):144-9.
3. Auwad W, Steggle P, Bombieri L, Waterfield M, Wilkin T, Freeman R. Moderate weight loss in obese women with urinary incontinence: a prospective longitudinal study. *Int Urogynecol J Pelvic Floor Dysfunct.* 2008;19(9):1251-9.
4. Pinto AM, Subak LL, Nakagawa S, Vittinghoff E, Wing RR, Kusek JW, *et al.* The effect of weight loss on changes in health-related quality of life among overweight and obese women with urinary incontinence. *Quality of Life Research.* 2012;21(10):1685-94.

Summary

Evidence from 1 RCT, 2 cohort studies and one meta-analysis support lifestyle modification interventions promoting weight loss as a tool to reduce urinary incontinence in women who are overweight or obese. Weight loss of 5% of initial body weight has an impact on the reduction of urinary incontinence symptoms and the odds of developing UI at one year can be reduced by 3% for every kilogram lost by overweight and obese women. **(Level of Evidence: 1)**

Recommendations

Weight loss as a non-surgical intervention, should be recommended to obese and overweight women with UI. **(Grade of Recommendation: A)**

1.2.2 Physical Activity

No new RCT data have been published on either the benefits of moderate physical activity or the adverse effect of strenuous activity on UI in women. One relevant prospective cohort study (11) and one case control study have been reported since the last review Table 3.

The prospective cohort study (11) determined that low physical activity may be a causal factor in the development of overactive bladder. This study developed a hypothetical causative model for OAB involving secondary analysis from the Leicestershire UK MRC Incontinence study and included 3411 women free from OAB and 277 incident cases aged 40+. The study used graphical chain modelling to EStimate the associations between variables and identify the likely causal pathways. Low physical activity was a direct risk factor linked to the development of over active bladder (OAB) with incontinence (RR 2.47;95% CI 1.82, 3.36). They identified the need for further research to demonstrate a causal link between lifestyle and OAB. This study was difficult to combine as it used sophisticated statistical modelling to determine a causative model for use in future research. This research indicated that poor lifestyle factors causally linked to diabetes and obesity and suggest that this may contribute to the onset of OAB. The authors identify that low physical activity could be an important modifiable causal factor for OAB operating via pathways involving obesity or diabetes.

Summary

Non RCT evidence is building which suggests that moderate exercise decreases the incidence of UI although the level of evidence remains low **(Level of Evidence: 3)**.

Recommendations:

In the absence of robust randomised controlled trials **(Grade of Recommendation: C)**

1.2.3 Strenuous Physical Activity

The previous ICI identified no research evidence which suggested that strenuous exercise causes UI. Minimal uncontrolled data did suggest that women engaged in occupations which involved heavy lifting may be predisposed to genital prolapse or UI (12). A case control study conducted by Nygaard *et al.* (13) to determine lifetime physical activity and stress incontinence enrolled 1528 women between the ages of 39-65. Each participant underwent a Pelvic Organ Prolapse Quantification examination, 213 cases were identified and matched 1:1 to controls. Physical activity was measured using the Lifetime Physical Activity Questionnaire in which women recall their past physical activity. Lifetime strenuous activity was not associated with SUI (OR, 1.11; 95% CI, 0.99-1.25) and increased lifetime activity did not affect the odds of developing SUI (OR, 1.11; 0.99-1.25; p=0.06) (Table 3).

Summary

Evidence for the association between strenuous physical activity and incontinence need to be replicated using larger populations and more robust design before recommendations can be made. No further data was identified. **(Level of Evidence: 3)**

Recommendations:

In the absence of robust randomised controlled trials **(Grade of Recommendation: C)**

1.2.4 Smoking

In 2014, a pilot study investigated the effect of smoking cessation on overactive bladder symptoms (14). The authors explored the hypothesis that smoking abstinence would be associated with improvements in OAB symptoms. The sample was randomised to one of three arms: 1) very low nicotine cigarettes; 2) very low nicotine cigarettes and a 21g nicotine patch; 3) patch alone. All participants had at least one OAB symptom including urinary frequency, urgency, nocturia or urgency urinary incontinence, smoked 10-40 cigarettes a day for a year and were in good physical and mental health. The ICIQ-OAB was used at baseline and 12 weeks, 6 weeks after completion of the trial intervention. Outcomes included self-report of smoking cessation and OAB symptoms and score. 96 (47%) of the 202 participants met the inclusion criteria for this secondary analysis and 57 (59%) (37 women and 20 men) completed the study and were included in the analysis. Data was not presented separately for women and men. Those who were abstinent from smoking at 12 weeks were more likely to have a reduction in urinary frequency (p=0.042) and the ICIQ-OAB score showed no change for those who were abstinent or those who resumed smoking (4.6±0.5 vs 4.3±0.3, respectively, p=ns). The authors conclude that smoking cessation and its effect on OAB would need to undergo more rigorous evaluation in further trials with larger sample size to determine the effect of smoking abstinence on OAB symptoms (Table 4).

Summary

Data suggest that smoking increases the risk of more severe UI. This small new study indicates that urinary frequency may be improved by smoking abstinence. **(Level of Evidence: 3)**

Recommendations

There remains a need for further prospective studies of smoking cessation for urinary symptoms **(Grade of Recommendation: C)**

1.2.5 Dietary Modification (Elimination Diet)

Dietary factors can be divided into three groups: Diet; Fluid Intake and Caffeine. There have been no new published RCTs evaluating the effect of diet or fluid intake on urinary incontinence, but one small new RCT (15), three new observational studies (1 case control study, 1 prospective cohort study, 1 cross sectional cohort study) examining the effect of caffeine on urinary incontinence, one in men presented in section IV (16), one in women (17) and one in both men and women (18) (Table 5).

A small double blind randomised crossover study by Wells *et al.* of 14 patients with OAB was conducted in which women were allocated to one of two groups. Group A were allocated to a 14 day caffeinated drink period followed by a 14 day de-caffeinated period. Groups B were allocated to a 14 day de-caffeinated period followed by a 14 day caffeinated period. Both were preceded by a 14 day run-in period. The primary outcome was reported episodes of urgency, frequency and volume per void recorded in a 3 day diary. Secondary outcomes included OAB symptom severity and health related quality of life (QOL). Of the eleven women who completed the study, a significant reduction of urgency ($p<0.1$) and frequency ($p<0.5$) were reported. Risk of bias was minimised using a double blind design, but conclusions must be cautious due to the very small sample size (15).

Three studies examined the association between caffeine and UI, Gleason *et al.* (2013) (17) examined the association in women in the US and Hirayama *et al.* (2012)(18) in men and women in Japan and Davis *et al.* (2012)(16) in a male sample in the US.

In the cross sectional female US survey study, UI status was collected using the Incontinence Severity Index and food diaries were used to collect data on caffeine intake in 4309 women aged 20 or over. This study found an association between caffeine consumption in the highest quartile ($>204\text{mg}$ day) was associated with any UI (prevalence odds ratio 1.47, 95% CI 1.07, 2.01), but not moderate or severe. Caffeine consumption at the very highest level was found to be associated with UI in a very large sample of US women. All parameters in terms of risk of bias reporting were unclear or high risk. The blinding of participants and personnel and blinding of outcome assessment were at high risk of bias and the likelihood of

incomplete outcome data and selective reporting was also high.

Hirayama and Lees study comprised a sample of 683 men and 298 women (results for men are reported separately) aged 40-75 who completed a food frequency questionnaire and the Consultation on Incontinence short Form (ICI-SF). The data showed a slight increase in the risk of UI at the highest level of caffeine consumption (similar to the US data), but this was not significant after adjusting for confounding factors with OR: 95% CI, 1.12 (0.57-2.22) for women. The risk of bias reporting was largely unclear in this study with blinding of participants and personnel and blinding of outcome assessment, incomplete outcome data and selective reporting all of high risk. The sample of women did not show an association between caffeine and UI, they suggest the need for further larger samples to explore any association further.

Summary

There have been no new data on dietary content modification and UI since 2013, the existing evidence suggests that dietary content may play a role in urinary incontinence **(Level of Evidence: 3)**.

Minimal evidence exists on the role of macronutrient intake and reduction of UI. Fluid intake may play a minor role in the pathogenesis of UI **(Level of Evidence: 2)**.

Caffeine consumption is likely to play a role in exacerbating UI and related symptoms such as urgency and frequency. Small clinical trials suggest that decreasing caffeine intake improves continence. **(Level of Evidence: 2)**, new epidemiological evidence from a large cross sectional study supports this conclusion however it does not change the **Level of Evidence: Level 2**.

Recommendations

Recommendations for fluid intake and dietary intake have not changed **(Grade of Recommendation: B)**. Further RCTs to assess the role of diet in UI are warranted.

A reduction in caffeine intake is recommended for those with incontinence and related symptoms **(Grade of Recommendation: B)** Larger RCTs to assess the effect of caffeine and other dietary factors are feasible and important.

Table 3 Summary of data on physical activity

Author, year	Comparator groups	N	Study population	Age	Assessment	Follow up	Outcomes
McGrother 2012(1)	Development of a Causative model for OAB	3411	Women in a UK epidemiological study of UI free from OAB at baseline	40+	Food frequency questionnaire and OAB recorded in a postal questionnaire	no	Low physical activity linked to the onset of OAB. Older women reporting less activity than their peers had more than double the risk of developing OAB.
Nygaard 2015 (2)	Case control study	1538	Women seeking gynaecological primary care	39-65	POP assessment, severity index score (indicating SUI), Lifetime physical activity questionnaire	no	SUI odds increased with overall lifetime activity (OR 1.20 per 70 additional metabolic equivalent of task-h/wk; 95% CI, 1.02-1.41.

1. McGrother CW, Donaldson MMK, Thompson J, Wagg A, Tincello DG, Manktelow BN. Etiology of overactive bladder: A diet and lifestyle model for diabetes and obesity in older women. *Neurourology and Urodynamics*. 2012;31(4):487-95.
2. Nygaard IE, Shaw JM, Bardsley T, Egger MJ. Lifetime physical activity and female stress urinary incontinence. *American Journal of Obstetrics and Gynecology*. 2015;213(1).

Table 4 Summary of data on smoking cessation

Author, year	Comparator	N	Study population	Age	Outcomes/results	Follow up	Notes (side effects, loss of follow up, risk of bias)
Wyman <i>et al.</i> 2014 (1)	Low nicotine cigarette alone vs low nicotine cigarette combined with 21mg nicotine patch vs patch alone	202	Subset of adult participants in a smoking cessation trial	18-70	ICIQ-OAB Self-reported smoking status and cessation	12 weeks	Subset of participants: Random sequence generation: uncertain Allocation concealment – uncertain Blinding of participants – uncertain Blinding of outcome assessment – uncertain Incomplete outcome data – low risk Selective reporting – unclear risk

1. Wyman J, Allen A, Hertsgaard L, Overson E, Allen S, Hatsukami D. Effect of Smoking Cessation on Overactive Bladder Symptoms in Adults: A Pilot Study. *Neurourology and Urodynamics*. 2014;33(6):866-7

Table 5 Summary of data on caffeine consumption

Author, year	Comparator	N	Study population	age	Outcomes/results	Follow up	Notes (limitations)
Davis 2013 (1)	Association between caffeine and UI in US men	3960	Publically available data from the National Health and Nutrition Examination Surveys	20+	Incontinence Severity Index (ISI) Structured dietary recall	no	Cross sectional design means that no causation can be determined. The ISI needs additional validation for use in men. 25% of

Author, year	Comparator	N	Study population	age	Outcomes/results	Follow up	Notes (limitations)
			2005-2006 and 2007-2008 in men				the sample was excluded due to missing UI and dietary data.
Gleason 2013 (2)	Association between caffeine and UI in US women	4309	Publically available data from the National Health and Nutrition Examination Surveys 2005-2006 and 2007-2008 in women	20+	Incontinence Severity Index (ISI) Structured dietary recall	no	The cross sectional design means that no causation can be determined. Analysis depended on self report. Questions for UI type were not validated and data was not analysed according to UI type or severity.
Hirayama 2012(3)	Association between caffeine use and UI in Japanese adults	981	Community dwelling Japanese men and women	40-75	ICIQ-SF	18 months	Cross sectional study: No cause-effect relationship could be established due to the study design. Classification of urine loss was based on self report
Wells 2014 (4)	Group A were allocated to a 14 day caffeinated drink period followed by a 14 day de-caffeinated period. Groups B were allocated to a 14 day de-caffeinated period followed by a 14 day caffeinated period.	14 community dwelling women	Women patient with OAB	18+	Reported episodes of urgency, frequency and volume per voids recorded in a 3 day diary	no	Small double blind randomised crossover study

1. Davis NJ, Vaughan CP, Johnson TM, Goode PS, Burgio KL, Redden DT, *et al.* Caffeine Intake and its Association with Urinary Incontinence in United States Men: Results from National and Nutrition Examination Surveys 2005-2006 and 2007-2008. *Journal of Urology.* 2013;189(6):2170-4.
2. Gleason JL, Richter HE, Redden DT, Goode PS, Burgio KL, Markland AD. Caffeine and urinary incontinence in US women. *International Urogynecology Journal.* 2013;24(2):295-302.
3. Hirayama F, Lee AH. Is caffeine intake associated with urinary incontinence in Japanese adults? *J Prev Med Public Health.* 2012;45(3):204-8.
4. Wells MJ, Jamieson K, Markham TC, Green SM, Fader MJ. The effect of caffeinated versus decaffeinated drinks on overactive bladder: a double-blind, randomized, crossover study. *Journal of wound, ostomy, and continence nursing : official publication of The Wound, Ostomy and Continence Nurses Society.* 2014;41(4):371-8.

1.2.6 Constipation

No new trials on constipation were found. Therefore, the evidence remains the same (small observational studies) suggesting that chronic straining may be a risk factor for the development of UI (**Level of Evidence: 3**).

Recommendation

Further research is needed to define the role of straining in the pathogenesis of UI.

1.3. Other LUTS

No data were found.

1.4. Factors Affecting Outcome

No data were found.

2. PELVIC FLOOR MUSCLE TRAINING (PFMT)

Pelvic floor muscle training (PFMT) is defined as exercise to improve PFM strength, endurance, power, relaxation or a combination of these parameters (1). PFMT remains a key factor in the treatment of UI. Because pelvic floor muscle (PFM) integrity appears to play an important role in the continence mechanism (see report from Chapter 4: Pathophysiology), there is a biological rationale to support the use of PFMT in preventing and treating SUI in women (19-21). The role of PFMT in the treatment of UUI came later, when it was recognized that PFM contraction can also be used to occlude the urethra to prevent leakage during detrusor contraction, as well as inhibit and suppress detrusor contraction (22, 23). More details about the biological rationale regarding PFMT for SUI and UUI can be found in the last edition of this chapter (2).

PFMT is an intervention that involves the understanding of PFM activation and the pursuit of a repeated PFM exercise programme over time. Because effectiveness depends on the participant's adherence during the intervention and afterwards (in the maintenance phase), a better understanding of adherence mechanisms and how they can be promoted is of major importance. The 2011 International Continence Society State of the Science Seminar on Adherence produced 4 papers and a Consensus Statement reviewing present literature and making recommendations to increase PFMT adherence that could be useful, both in the clinical and research settings UI (24-28)

This section presents evidence for the use of PFMT in the prevention and treatment of UI in women. Questions addressed are:

- Is PFMT effective in the prevention of UI?
- Is PFMT better than no treatment, placebo or control treatments in the treatment of UI?

- Is one type of PFMT programme better than another in the treatment of UI?
- Is PFMT better than other treatments in the treatment of UI?
- Does the addition of PFMT to other treatments add any benefit in the treatment of UI?
- What factors might affect the outcome of PFMT in the treatment of UI?
- What is the effect of PFMT on other lower urinary tract symptoms (LUTS)?

2.1. Prevention and Treatment (Pregnant and Postnatal Women Only)

This subsection specifically considers PFMT for the prevention and treatment of UI in pregnant and postnatal women (called childbearing women). As the physiological changes of childbearing can affect PFM function, it is possible that the effect of PFMT might differ in this group compared to non-childbearing women; therefore, this group is treated separately.

Since the last ICI (2013), 11 randomised controlled trials aiming at prevention and/or treatment of UI were identified and reviewed for this subsection (29) (30) (31) (32) (33) (34) (35) (36) (37) (38) (39) (Table 6). An updated Cochrane review was published in 2012, analysing data from 22 trials involving 8485 women (40). Trials in this section have been grouped in 3 areas: 1) trials of PFMT for prevention of UI (performed in women without UI symptoms when randomised); 2) trials of PFMT for treatment of UI; and 3) trials of PFMT for the prevention and treatment of UI (participants with and without UI symptoms enrolled). Trials were further separated into those beginning during pregnancy (antenatal) or postnatal.

The primary outcome of interest was self-reported UI (cure, improvement, number of leakage episodes). Other outcomes of interest included adherence measures.

2.1.1 Is PFMT Effective in the Prevention of UI in Childbearing Women?

This section addresses the question of PFMT effectiveness for primary and secondary prevention of UI in childbearing women. Clinically it can be difficult to effectively screen trial participants to ensure that a disease process is altogether absent (for primary prevention studies) or present, although asymptomatic (for secondary prevention). Trials investigating prevention of UI usually enrol people purely on the basis of the absence of symptoms. Thus, the trials in this section likely represent a combination of primary and secondary prevention effects.

Since last chapter edition three new prevention trials were found (30, 36, 38) (Table 6) adding to the six previously existing trials.

Two studies (30) (38) recruited nulliparous or primiparous women during pregnancy, and one recruited

"pregnant women" (36). Primigravidae were recruited at weeks 6-9 (30), 10-14 (38) and 14-20 (36). In all trials, PFMT began during pregnancy while controls received usual antenatal care, which may have included advice on PFMT, from their maternity caregivers (30) (36) (38) There were some variations in the PFMT parameters (intensity and supervision) (Table 6).

Quality of data

Two were RCTs (30, 38), while one was a quasi-randomized trial (36). Allocation concealment appeared adequate only in the trial by Pelaez (2014) (38). The outcome assessors were not blinded in the trials by Kocaoz (2013) (36) and Pelaez (2014)(38), while Barakat (2011)(30) gives no information about blinding of evaluators. Dropout rates were 16% (30), 10-14% (38) and 22% (36), and quite similar in both study groups. Outcomes were measured at various times: outcome in late pregnancy was measured only after delivery (30), 36 weeks of pregnancy (38); 28 and 32 weeks of pregnancy then at three months postpartum (36). None of the trials applied intention-to treat analysis.

Results

- Late pregnancy (34 weeks or later): Pelaez (38) found a statistically significantly lower frequency of UI ($p < 0.001$) in the intervention group compared to the control group between 36 and 40 weeks of pregnancy, and concluded that PFMT was effective in primary prevention of UI in primiparous pregnant women, while Barakat (30) reported no difference in frequency of urine loss between the exercise (supervised moderate physical exercise including PFMT) and control groups in late pregnancy.
- Mid postpartum (three to six month postpartum): Kocaoz (36) reported a statistically significant difference between the intervention and control groups in terms of development of stress urinary incontinence at the 28th and 32nd weeks of pregnancy and the 12th postpartum week ($p < 0.05$).

Summary

Two studies documented the effectiveness of PFMT on primary prevention of UI during pregnancy (36, 38). One study included only nulliparous women and reported UI in late pregnancy (38). The other study also included multiparous women and reported UI in late pregnancy and 12 weeks postpartum (36). **(Level of Evidence: 1)**

Recommendations

Offer continent, pregnant women a supervised (including regular health professional contact) and intensive strengthening PFMT programme to prevent antepartum and postpartum UI **(Grade of Recommendation: A)**

Research recommendation

Additional trials with long-term follow-up (more than 12 months postnatal) are needed to determine long-term benefits of antenatal PFMT.

The only study including multiparous women is a quasi-randomized trial. Thus, large and good-quality RCTs are needed to investigate the effect of antepartum PFMT on preventing postpartum UI in multiparous women.

2.1.2 Is PFMT Effective in the Treatment of UI in Childbearing Women?

Since last chapter edition two trials assessing the treatment effect of postnatal PFMT were found (29) (34) (Table 6) adding to the four previously existing trials.

Kim (2012) recruited a mix of primiparous and multiparous incontinent women less than six weeks (34) after delivery, while Åhlund (2013) recruited only primiparous women 10-16 weeks after delivery (29). The control group in the trial by Åhlund received standard care, which included ante and postpartum advice on PFMT (1), whereas the control group/unsupervised training group in Kim's study were instructed in PFMT and followed the same PFMT programme as the supervised training group (34). The PFMT interventions varied (Table 6).

Quality of data

Both studies were RCTs, but random allocation concealment was inadequate. In one trial (34) evaluators were blinded to group allocation. Åhlund (2013) and Kim (2012) reported an 8% and 1% loss to follow up, respectively. Similar dropout rates were found in both study groups in both trials. Outcomes were measured, before, 3 months after delivery (34) and 6 months after delivery (29). Kim did not report analysis by intention-to-treat, while information is lacking in the trial by Åhlund.

Results

In the trial by Åhlund the results showed significantly improved continence in both groups, however there was no between group comparison. Kim reported significant difference in UI symptoms in favour of the supervised PFMT group.

Summary

Data from one trial showed significantly better treatment effect of supervised PFMT compared to unsupervised PFMT. The other trial did not compare difference in treatment effect between groups. The addition of the new trials does not change the level of evidence. **(Level of Evidence: 1)**

Recommendations

PFMT should be offered as first line conservative therapy to women with persistent UI symptoms three

months after delivery. (**Grade of Recommendation: A**)

An 'intensive' PFMT programme (in terms of supervision and exercise content) is likely to increase the treatment effect. (**Grade of Recommendation: B**)

Research recommendation

There is a need for at least one large, pragmatic, well-conducted and explicitly reported trial with long term follow-up (five plus years) of postpartum PFMT that investigates the long term effect of 'intensive' PFMT.

2.1.3 Is PFMT Effective in the Mixed Prevention and Treatment of UI in Childbearing Women?

Since last chapter edition six mixed prevention and treatment trials were found adding to the ten previously existing trials. Five trials assessed the effect of antenatal PFMT (31) (35) (37) (39) (32), and one the effect of postnatal PFMT (33) (Table 6).

In five trials, nulliparous, primiparous or multiparous women were randomised to either supervised antepartum PFMT or usual antepartum care (31) (32) (35) (37) (39). One study randomised nulliparous women to supervised postpartum PFMT or usual postpartum care (33). Ko (2011) and Miguelutti (2013) recruited nulliparous women and Stafne (2012) multiparous women between 16-24 weeks' gestation. Bø's study (2011) differed in that the primary aim was to assess the effect of regular exercise on weight gain in pregnancy. Primiparous, sedentary women within the first 24 weeks of pregnancy were recruited. Fritel (2015) included nulliparous women between 20-28 weeks of gestation.

i) Antepartum PFMT versus usual care

The PFMT interventions varied (Table 6).

Quality of data

- Antepartum PFMT versus usual care: The four RCTs had adequate random allocation generation and concealment and thus had a low risk of bias (31) (32) (37) (39). In two of the trials a blinded method of collecting patient-reported incontinence symptom data was used (32) (39). Sample sizes varied between 105 and 855 women (31) (39), and the proportions of lost to follow up were 20%, 2%, 33% and 11% respectively (31) (37) (32) (39). Losses to follow up in intervention and control groups were quite similar in all trials. Intention-to-treat analysis was performed by all, except for Bø (2011).
- Postpartum PFMT versus usual care or no PFMT: Random allocation generation and concealment was adequate and a blinded method of collecting patient-reported incontinence symptom was used in the trial by Hilde (2013) (33). Lost to follow up was 9%, in the control 14% and

in the exercise group 3%. Analysis was by intention-to-treat.

Results

i) Antepartum PFMT versus usual care

Ko (2011), Miguelutti (2013) and Stafne (2012) showed that women who were randomised to antepartum PFMT had significantly less risk of UI in late pregnancy compared to a group receiving usual care in late pregnancy.

Three of the new five new mixed prevention and treatment trials assessing the effect of antenatal PFMT (35) (37) (39), reported a significant effect of PFMT during pregnancy, and 3 months after delivery (35). Bø (2011) found no difference in late pregnancy and 3 months postpartum, between a group following an aerobic fitness class including PFMT and a control group. While Fritel (2015) showed no difference in prevalence or severity of UI between a group receiving written instructions and a group receiving an additional eight PFMT sessions with a midwife or physiotherapist in late pregnancy, 2 and 12 months postpartum.

Some adherence outcomes were included for four antepartum (31) (35) (32) (39) trials; >80% of the PFMT women attended every group session, and at 36 gestational weeks, 87% reported PFMT practice at least 75% of the time (35); 40% of the exercise group attended >80% of the weekly exercise classes (31); 67% of the women in the intervention group and 40% in the control group performed PFMT three times per week or more (39); 54% in the intervention and 63% in the control group performed postpartum PFMT (32).

ii) Postpartum PFMT versus usual care or no PFMT

The only new mixed prevention and treatment trial assessing the effect of postnatal PFMT (33), found no differences in the prevalence of UI between a supervised PFMT group and a control group receiving instructions in correct PFM contractions and written information. Adherence was 96% in the intervention group (33).

Table 6 Summary of PFMT data on prevention and treatment (pregnant and postnatal women)

Author, year	Comparator	N	Study population	Modality details or parameters	Outcomes/results	Follow up	Notes (side effects, loss of follow up...)
Ahlund 2013(1)	Control group (n=49): instructions and control of correct PFM contractions and written information about PFMT. Intervention group (n=49): instructions and control of correct PFM contractions, written information about PFMT and follow up by midwife	N=98	Primiparous women with SU1, 10-16 weeks after delivery Multi centre Sweden	Three visits with midwife during the intervention period. A 6 months home PFM program including three fast contractions, three times 8-12 slow velocity (6 seconds), close to maximum contractions	Significantly (p<0.05) improved continence score (0-20) in both groups at 6 months postpartum. Difference between groups was not reported.	no	Loss to follow up: 16% CG: 7/49 IG: 9/49
Bo 2011 (2)	Control (n=53): standard care Intervention (n=52): 12-16 wk' aerobic fitness class including PFMT	N= 105	Nulliparous, sedentary women within the first 24 weeks of pregnancy With and without UI at inclusion. Single centre Norway	12 -16 weeks of aerobic exercise classes twice per week during pregnancy, including intensive PFMT (in a group) led by aerobic instructor. Additional home exercises 10 max contractions (each held for six seconds) and to the last 4 were 3-4 fast contractions added x 3, per day. Correct VPFMC was not checked at enrolment.	No significant difference between groups: Self reported UI at 36-38 weeks of pregnancy: Control: 7/53 Intervention: 9/52 Self reported UI at 3 months postpartum: Control: 6/53 Intervention: 5/52	no	Loss to follow up: 20% CG: 11/53 IG: 10/52
Barakat 2011 (3)	Control group (n=40): standard care Intervention group (n=40): Physical conditioning program 45 minutes 3 times per week from inclusion to week 38-39. PFMT included during the last trimester.	N= 80	Sedentary women within 6-9 weeks of pregnancy. Without UI at inclusion. Single centre Spain	Exercises to strengthen the PFM included in a general exercise program with 45 minutes sessions x 3 per week, during the last trimester. No further details about the PFMT program.	No significant difference in frequency of urine loss (CIQ-SF Incontinence classification) in late pregnancy. (Questionnaire answered after delivery).	no	Loss to follow up: 16% CG: 6/40 IG: 7/40

Author, year	Comparator	N	Study population	Modality details or parameters	Outcomes/results	Follow up	Notes (side effects, loss of follow up...)
Fritel 2015 (4)	Control group (n=142): standard care including written instructions about PFMT Intervention group (n=140): Individual supervised PFMT	N=282	Nulliparous women between 20-28 weeks of gestation. With and without UI at inclusion. Multicentre France	The PFMT group received eight individual training sessions supervised by a midwife or a physiotherapist, once per week between the sixth and eighth month of pregnancy. Each session lasted 20-30 minutes and included evaluation of pelvic floor muscle contraction. Sessions consisted of standing contractions (5 minutes), lying contractions (10 minutes) and learning how to start a pelvic floor muscle contraction just before exerting intraabdominal pressure (the Knack). Women were encouraged to perform daily PFMT. No specific instructions on the number or intensity of the contractions were given.	No significant difference between groups in UI severity (ICIQ-UI SF score) and prevalence at 2 and 12 months postpartum: UI severity at 2 months postpartum (mean, SD): Control: 2.3 (\pm 3.4) Intervention 1.7 (\pm 2.9) UI severity at 12 months postpartum: Control: 2.1 (\pm 3.3) Intervention: 1.9 (\pm 3.7)	Yes 12 months	Loss to follow up: 33% CG: 45/142 IG: 47/140
Hilde 2013 (5)	Control group (n=88): receiving instructions in correct PFM contractions and written information Intervention group (n=87): supervised PFMT	N=175	Singleton primiparous women Who delivered vaginally after more than 32 weeks of gestation Single centre Norway	PFMT in groups supervised by physiotherapist once per week in 16 weeks (starting 6-8 weeks after delivery), and daily home training with three sets of 8 to 12 contractions close to maximum	No significant differences in the percentage of women with UI at six months postpartum between a supervised PFMT group and a control group receiving instructions in correct PFM contractions and written information. UI 6 months postpartum: Control: 39% Intervention: 35%	no	Loss to follow up: 9% CG: 3/88 IG: 12/87
Kim 2012 (6)	Control (n=10): unsupervised PRMT Intervention (n=10): Supervised PFMT	N=18,	Mix of primiparous and multiparous incontinent women less than six weeks after delivery. All with UI at inclusion. Single centre Korea	PFMT in various positions (20 repetitions with 10 second holding), abdominal strengthening exercises and trunk stabilisation using a therapeutic ball. Twenty three one-hour sessions of training with physiotherapist, three times per week in an 8 week period. Additional daily home training program	Significant difference (p=0.001) in change in values for UI symptoms ((BFLUTS) between groups, in favour of the IG (mean, SD): Control: -18 (\pm 5.5) Intervention: -27 (\pm 6.2)	no	Loss to follow up: 10% CG: 9/10 IG: 9/10

Author, year	Comparator	N	Study population	Modality details or parameters	Outcomes/results	Follow up	Notes (side effects, loss of follow up...)
Ko 2011 (7)	Control: Routine antenatal care. Intervention: Individual PFMT with physiotherapist once per week between 20-36 weeks pregnancy with additional home exercises 3 sets of 8 contractions (each held for 6 seconds) repeated twice daily. Instructed to contract the PFM when coughing or sneezing.	N=300	Nulliparous women recruited at 16-24 weeks of pregnancy. With and without UI at inclusion. Single centre, Taiwan	The PFMT group met individually with a physical therapist for instruction and assessment of correct contraction. The PFMT included three sets of eight contractions repeated twice daily. Additional group therapy occurred weekly in 45 minute sessions over a 12 week period.	Self reported UI at 36 wk' pregnancy p<0.01: Control: 76/150 (51%) Intervention: 52/150 (34%) Self reported UI at 3days postpartum p=0.06: Control:62/150 (41%) Intervention:46/150 (30%) Self reported UI at 6 weeks postpartum p=0.06: Control: 53/150 (35%) Intervention: 38/150 (25%) Self reported UI at 6 months postpartum p=0.04: Control: 42/150 (27%) Intervention: 25/150 (16%)	Yes 6 months	Loss to follow up: 0%
Kocaoz 2013 (8)	Quasi randomized trial Control group (n=68): ? Intervention group (n=68): Instructions in PFMT and information.	N=136	Continent, pregnant women at week 14-20 of pregnancy. Without UI at inclusion. Single centre Turkey	Correct voluntary PFM contraction was checked prior to training Daily PFMT, three sets of 10 contractions. Maximal contraction of the PFM and hold for 10 seconds, and quick contractions	A statistically significant difference was found between control and intervention group in SUI development at 28 th and 32 nd weeks of gestation and the 12 th week postpartum.	yes 12 th week postpartum	Loss to follow up: 25% CG: 18/68 IG: 16/68

Author, year	Comparator	N	Study population	Modality details or parameters	Outcomes/results	Follow up	Notes (side effects, loss of follow up...)
Miquelutti 2013 (9)	Control group (n=100): standard care Intervention group (n=97): Additional physical and educational activities including information about PFMT.	N=205	Nulliparous low risk women at 18 weeks of gestation. With and without UI at inclusion. Multi centre Brazil	On the days of prenatal visits; consisted of physical exercises, educational activities and instructions on exercises to be performed at home. The PFMT should be performed daily at home and included rapid (30 times) and sustained maximal contractions (20 times holding for 10 seconds) in sitting and standing positions.	The risk of UI was significantly lower in the intervention group at 30 weeks of pregnancy: CG 62% IG 43% RR 0.69 (95% CI 0.51-0.93) and 36 weeks of pregnancy: CG 68% IG 41% RR 0.60 (95% CI 0.45-0.81)	no	Loss to follow up: 2% CG: 2/102 IG: 6/103
Pelaez 2014 (10)	Control group (n=96) Intervention group (n=73)	N=169	Healthy, primiparous pregnant women in gestational week 10-14. Without UI at inclusion. Single centre Spain	Correct voluntary PFM contraction was checked prior to training The intervention consisted of 70-78 group sessions; 10 minutes of PFMT three times per week in 22 weeks	At 36 weeks of pregnancy there was statistically significant (p=0.001) difference in frequency of UI and in ICIQ-UI SF score in favour of the intervention group. CG 2.7 (SD4.1) IG 0.2 (SD 1.2)	no	Loss to follow up: 16% CG: 7/96 IG: 10/73
Stafne 2012 (11)	Control group (n=426): standard care Intervention group (n=429): 12 weeks of PFMT	N=855	Multiparous women between 16-24 weeks gestation. With and without UI at inclusion. Multi centre Norway	The PFMT group met individually with a physical therapist for instruction and assessment of correct contraction, and PFMT protocol was similar to that described previously by Mørkved (1997, 2003), including three sets of eight contractions repeated twice daily. Additional group therapy occurred weekly in 45 minute sessions over a 12 week period.	Self-reported UI at 34-38 weeks of pregnancy: Any UI (p=004): CG 192/365 (53%) IG 166/397 (42%) UI once per week or more (p=0.004): CG 68/365 (19%) IG 44/397 (11%)	no	Loss to follow up: 11% CG: 61/426 IG: 32/429

- Ahlund S, Nordgren B, Wilander EL, Wiklund I, Friden C. Is home-based pelvic floor muscle training effective in treatment of urinary incontinence after birth in primiparous women? A randomized controlled trial. *Acta Obstetricia et Gynecologica Scandinavica*. 2013;92(8):909-15.
- Bo K, Haakstad LA. Is pelvic floor muscle training effective when taught in a general fitness class in pregnancy? A randomised controlled trial. *Physiotherapy*. 2011;97(3):190-5.

3. Barakat R, Pelaez M, Montejo R, Luaces M, Zakynthinaki M. Exercise during pregnancy improves maternal health perception: A randomized controlled trial. *American journal of obstetrics and gynecology*. 2011;204(5):402.
4. Fritel X, de TR, Bader G, Savary D, Gueye A, Deffieux X, *et al*. Preventing Urinary Incontinence With Supervised Prenatal Pelvic Floor Exercises: A Randomized Controlled Trial. *Obstetrics & Gynecology*. 2015;126(2):370-7.
5. Hilde G, Staer-Jensen J, Siafarikas F, Ellstrom EM, Bo K. Postpartum pelvic floor muscle training and urinary incontinence: a randomized controlled trial [Erratum appears in: *Obstet Gynecol*. 2014 Sep;124(3):639]. *Obstetrics & Gynecology*. 2013;122(6):1231-8.
6. Kim EY, Kim SY, Oh DW. Pelvic floor muscle exercises utilizing trunk stabilization for treating postpartum urinary incontinence: randomized controlled pilot trial of supervised versus unsupervised training. *Clinical Rehabilitation*. 2012;26(2):132-41.
7. Ko PC, Liang CC, Chang SD, Lee JT, Chao AS, Cheng PJ. A randomized controlled trial of antenatal pelvic floor exercises to prevent and treat urinary incontinence. *Int Urogynecol J*. 2011;22(1):17-22.
8. Kocaoz S, Eroglu K, Sivaslioglu AA. Role of pelvic floor muscle exercises in the prevention of stress urinary incontinence during pregnancy and the postpartum period. *Gynecologic & Obstetric Investigation*. 2013;75(1):34-40.
9. Miquelutti MA, Cecatti JG, Makuch MY. Evaluation of a birth preparation program on lumbopelvic pain, urinary incontinence, anxiety and exercise: A randomized controlled trial. *BMC Pregnancy and Childbirth*. 2013;13(154).
10. Pelaez M, Gonzalez-Cerron S, Montejo R, Barakat R. Pelvic floor muscle training included in a pregnancy exercise program is effective in primary prevention of urinary incontinence: a randomized controlled trial. *Neurourology & Urodynamics*. 2014;33(1):67-71.
11. Stafne S, Salvesen K, Romundstad P, Torjusen I, Morkved S. Does regular exercise including pelvic floor muscle training prevent urinary and anal incontinence during pregnancy? A randomised controlled trial. *BJOG: an International Journal of Obstetrics & Gynaecology*. 2012;119(10):1270-80.

Summary

The effect of antepartum PFMT or postpartum PFMT, in groups of women where some did and some did not have prior UI symptoms, varied by study with some showing a benefit on UI prevalence whereas others did not. The characteristics of the new trials, all methodologically robust, that demonstrated reduced UI prevalence in late pregnancy (35) (37) (39) and six months postpartum (35), were high adherence to a supervised PFM strength training program and home exercises. **(Level of Evidence: 2)**

However, a similar training protocol in postpartum women by Hilde (2013) did not show any difference between groups. Even if the combined results from the published trials still are not conclusive, the benefit of PFMT in the majority of the studies and the lack of adverse effects of PFMT should be taken into account.

Recommendations

Health providers should carefully consider the cost/benefit of population-based approaches to health professional taught antepartum or postpartum PFMT, that is, health professional instruction to all pregnant or postpartum women regardless of their current or prior continence status

(Grade of Recommendation antepartum PFMT: A)

(Grade of Recommendation postpartum PFMT: B)

Where a population approach is used, the 'best' evidence to date suggests the following: (a) an intervention comprising of a daily home PFMT and weekly physiotherapist-led exercise classes for 12 weeks, starting at 16-24 weeks' gestation for pregnant women, and (b) an individually taught strengthening PFMT programme that incorporates adherence strategies for postpartum women who have had a forceps delivery or a vaginal delivery of a large baby (4000g or more). **(Grade of Recommendation: C)**

2.2. Prevention (Other Women)

Although there are multiple trials of PFMT for prevention of UI in peri-partum women (see section II.2.1) and in men undergoing prostatectomy (see section IV.2), there is little research on prevention of UI in non-childbearing women. A single randomised trial (41) was found that investigated the preventive effects of a multi-component behavioural modification program, including PFMT, Bladder Training (BT), and other behavioural skills, compared to no intervention in 359 older women who were essentially continent (0-5 days of incontinent episodes in previous year). The intervention was a 2-hour class followed 2-4 weeks later with an individualized session to test PFMT technique and reinforce adherence. After 12 months, continence status was the same or better in 56% of the prevention group compared to 41% of the control ($p=0.01$).

In this trial, randomisation was conducted prior to eligibility assessment, leading to a relatively high rate of non-completion (97/238 in the treatment group and 65/242 in the control group; 162/480 overall). Analysis was not ITT. The method of randomisation was not described but the randomization block size was set at 16 to minimize the chance of prior recruiter knowledge of subject assignment. The assessors were not blinded.

Summary

There is preliminary evidence that PFMT may help prevent UI in older women. **(Level of Evidence: 2)**

However, more definitive trials are needed to clarify the effects of this multi-component program or other approaches to using PFMT as a prevention strategy in older women.

Recommendations

Without robust randomised controlled trials on the preventive effect of PFMT on UI the **Grade of Recommendation** is **Grade C (New)**.

With limited new data on the effects of preventive PFMT on UI in older women, this association should be investigated further.

2.3. Treatment (Other Women)

2.3.1 Is PFMT Better than No Treatment, a Placebo, or a Control Group Treatment?

This updated literature review identified 19 new trials that compared PFMT to no treatment, sham treatment, or control treatment. Six trials were excluded from this summary because they selected women with "OAB," "lower urinary tract symptoms," or "pelvic floor dysfunction," thereby including women without urinary incontinence (42-47). Some included continent women, while others did not provide sufficient information to determine the continence status of participants. One additional trial was excluded due to insufficient detail about the intervention needed to discern whether PFMT was part of the treatment (48), and one was not considered because the sample consisted of residents in long-term care facilities (49). The 11 additional trials included in the analysis were diverse and included studies from 10 countries (See Table 7). Samples included young, nulliparous volleyball athletes, older women, peri-and post-menopausal women, obese women, and gynaecological cancer survivors. Most samples were drawn from community-dwelling populations.

PFMT Details

Most trials involved 12 weeks (3 months) of intervention, but some were of 6 weeks (50) or 8 weeks duration (51). Most involved supervised PFMT accompanied by a regimen of home-based exercises by a physiotherapist or nurse. One study tested a new smart phone application (52) with no face-to-face

contact. In several trials, PFMT was delivered on an individual basis (50, 53-57), while others were conducted in a group class (51, 58). Some trials were restricted to PFMT with or without functional PFM contraction to prevent SUI episodes (stress strategies, the Knack) (50, 57), while in others, PFMT was embedded in a multi-component programme with other behavioural or exercise components (Table 7). One trial included PFMT in a broader programme of general physical exercise (58).

Risk of Bias

Some of these 11 trials may have been limited by small sample size. Only 3 included more than 100 women, 3 included 50-100 women, and 5 had fewer than 50 participants. Two trials reported intent-to-treat analysis (52, 55). Three reported the method of randomisation (54, 55, 58); five reported concealment (52, 55, 58-60); and two reported using blinded outcome assessors (55, 58). Two studies were reported as abstracts making it difficult to assess some aspects of the methods and data quality (52, 55).

Results

A variety of outcome measures were used, including bladder diaries, validated questionnaires, global patient ratings, and pad test. Most trials used multiple measurements to evaluate outcomes.

Bladder diaries were used in 7 studies to assess change in incontinent episode frequency (52, 54-59). In all studies, reductions in incontinence episode frequency were significantly greater in the treatment group.

The UDI or UDI-6 was used in 4 trials to report change in urinary symptoms (54, 55, 57, 60). Significant differences were found in the two larger trials (54, 55). The ICIQ-UI was used as an outcome measure in two trials (51, 52), both demonstrating greater benefit for PFMT compared to control.

In 4 trials, the IIQ-7 was used to assess change in impact of UI. Two found significant between group differences (54, 59); one found significant change in the treatment group, but not in the control group; and the third did not observe improvement on this condition-specific quality of life measure (60).

The PGI-I was the primary outcome in one study that found 80% of women in the treatment group and 40% in the control group were "much better" or "very much better" (60). Similarly, in another trial, 55.7% of women in the treatment group were "better" compared to 5% in the control group (52).

Urine loss, assessed by 1-hour pad test (with provocation), was the primary outcome for one trial (50). Reductions in urine loss were greater in both treatment groups (individualized PFMT and group administered PFMT) compared to the control group. In four other studies that used a pad test as a secondary outcome, significant reduction and group differences

were reported in two (54, 56), no differences in a third (55), the within and between group differences did not reach statistical significance (57).

Summary

PFMT is effective as a stand-alone therapy, as part of multi-component therapies embedding PFMT with concomitant behavioural strategies, lifestyle changes, and as part of more general physical exercise programmes to improve physical function in older women.

Results expand the evidence base to include PFMT implemented by mobile technology, with a potentially broader reach, cost savings, and impact on rural health.

Benefits are shown across age cohorts and UI type, in various cultural contexts, using several different training regimens, and assessed by multiple outcome measures. **(Level of Evidence: 1)**

Recommendations

Supervised PFMT should be offered as a first-line conservative therapy for women of all ages with urinary incontinence **(Grade of Recommendation: A)**.

2.3.2 Is One Type of PFMT Programme Better than Another?

A number of factors can influence the outcome of a PFMT programme such as the way it is taught and/or supervised, the parameters of the actual exercises, and adherence to the training regimen. What, therefore, is the most effective PFMT programme?

This updated search revealed 24 new potentially eligible RCTs to address this question. Of them, one was excluded due to insufficient information on the incontinence outcome and inter-group comparison (61) and three because they did not report any incontinence outcomes but focused on PFM outcomes (62-64). Table 8 shows the studies included in the previous edition as well as those identified in this update. Characteristics of each new RCT are presented in Table 9.

Table 7 Summary of data on PFMT vs no treatment, a placebo or a control group treatment

Study	Comparator	N	Study Population	Intervention	Outcomes/Results	Notes
Abdulaziz 2012 (1)	No therapy	N=56 Tx: 29 CG: 27	Obese, older, peri-menopausal Saudi women with SUI (40-50 years)	3 months of supervised PFMT taught at physio clinic; 10 repetitions of 8 maximal contractions each, progressed to 12; 36 sessions	Fewer UI episodes on self-report (not BD) and better score on VAS (but $p>0.05$ for group diff) Tx group: significant change and 90% cured CG: no change and 19% cured	Small N may have affected results
Asklund 2015 Abstract (2)	Delayed treatment	N=123 Tx: 62 CG: 61	Women with weekly SUI (≥ 18 years; mean 45 years)	3 months of Smart phone app; PFMT exercises at different levels (6 basic and 6 advanced); graphic support and functions for statistics and reminders. No face-to-face contact	Web-based questionnaires and 2-day leakage diary; ICIQ-UI-SF, PGII, IEF, ICIQ-LUTSqol, use of incontinence aids, patient satisfaction (Tx group only). Tx group showed greater improvements on all outcomes ($p<0.001$).	ITT analysis Allocation concealment with sequentially numbered envelopes
Celiker 2015 (3)	Wait-list	N=130 Tx: 65 CG: 65	Women with SUI/MUI Excluded weak muscles	12-weeks of PFMT, 30 min sessions, supervised by physiotherapist, X3 per week initially, taught by perineal palpation, individually prescribed, home-based exercise. Included advice on bladder hygiene	UDI-6, IIQ-7, 3-day bladder diary, stop test, pad test. Tx group showed significant improvement on all outcomes and greater improvements than CG ($p<0.0001$).	Not ITT; randomization computer generated; allocation concealment Tx included behavioral/lifestyle advice.
Dumoulin 2011 (4) Abstract	Education program on osteoporosis (3 hours) and follow-up phone calls	N=48 Tx: 24 CG: 24	Postmenopausal women with osteoporosis and SUI, UUI, or MUI (55+ years)	12 weeks of Individualized PFMT, weekly 30-min PT sessions; daily home exercise; BF, urge control, BT, dietary advice and constipation advice.	7-day BD, 24-hour pad test, UDI. Post-treatment, Tx group had greater improvements on IEF ($p=0.04$) and UDI ($p=0.04$), but not pad test. At 1-year follow up, there were significant differences on IEF ($p=0.04$), UDI ($p=0.03$) and pad test ($p=0.01$).	Randomization computer generated Allocation concealment ITT analysis Blinded assessors No adverse events Tx included behavioral/lifestyle advice.
Ferreira 2014 (5)	Summary of PFMR education program via pamphlet	N=32 Tx: 16 CG: 16	Nulliparous, female volleyball athletes with SUI (13-30 years)	3 months of PFMR; "educational action," awareness of PFM, and informational pamphlet; weekly visits; home exercise - 30 sustained contractions and 4 quick contractions daily; daily bladder diary for awareness	7-day BD and pad test (15 min during practice). Tx group showed greater reductions on IEF ($p<0.001$) and pad test ($P<0.001$).	Randomization by lottery (participant drawing paper from a box) Small N

Study	Comparator	N	Study Population	Intervention	Outcomes/Results	Notes
Karger 2015 (6)	No Tx	N=50 Tx: 25 CG: 25	Elderly women with SUI (60-74 years)	Two months; eight 45-min group training classes taught by a nurse; 8-12 contractions in each of 3 positions, 6-8 second contractions with 3-4 fast contractions added; home exercise: 8-12 high intensity contractions, X3 daily. Strength, awareness, and relaxation training for other muscle groups.	ICIQ-UI and self-esteem. Group differences observed on ICIQ-UI ($p=0.001$), and on individual items of frequency, amount of leakage, and QoL.	Tx included other types of exercise.
Kim 2011 (7)	General health class monthly for 3 months	N=127 Tx: 63 CG :64	Elderly Japanese women with SUI, UUI, or MUI (70+ years)	3 months, multi-dimensional exercise Tx; twice weekly group classes, PFM and general strength exercise. PFMT: 10 fast contractions (3 sec), 10 sustained contractions (8-10 sec); lying, sitting, and standing positions. One-hour class X1/month during 7-month follow-up. Home exercise: 2-3 sets as learned in class, at least X3/week for 30 min/day	Primary outcome was cure based on 7-day BD and ratings on 5-point scale (in BD); ICIQ Tx group showed greater change in urine leak score ($p=0.007$) and cure. Tx group 44.1% cure rate post-Tx and 39.3% at 7-month follow up vs 1.6% and 1.6% in CG ($p<0.001$).	Not ITT Computer generated randomization Randomization procedure blinded Blinded assessors
Leong 2015 (8)	Advice and pamphlet on management of UI	N=56 Tx: 27 CG: 28	Older Chinese women with SUI, UUI, or MUI (55+ years)	12-week PT program, 30-min individual training sessions, 8 sessions taught with manual palpation and verbal feedback; progressive exercise program starting with 10 slow submaximal contractions (5 sec) increasing to 25 per session; urge suppression + bladder training (BT).	7-day BD, IIQ-SF-7, 11-point VAS for perception of improvement and satisfaction. Tx group showed greater improvement in IEF ($p<0.001$) and IIQ-7 ($p=0.001$) and greater perception of improvement ($p=0.004$) and satisfaction ($p=0.001$). Reductions significant in Tx group only.	Computer generated randomization and allocation concealment Tx accompanied by urge suppression and bladder training
McLean 2013 (9)	No treatment	N=40 Tx: 20 CG: 20	Women with predominant SUI (18+ years)	12-week individualized PFMT program with weekly 30-min sessions; PFMT taught by manual palpation; home exercise: 3 sets of 12 PFM contractions daily	3-day BD, pad test, IIQ-7, UDI-6. Tx group showed greater changes on IEF (intragroup $p=0.007$) and IIQ-7 (intragroup $p=0.0003$); Neither group had significant change on pad test or UDI-6	Randomization by automated computer algorithm. Primary purpose of the study was to examine urethral morphology and mobility. Measures of UI were secondary outcomes.

Study	Comparator	N	Study Population	Intervention	Outcomes/Results	Notes
Pereira 2011 (10)	No treatment	N=49 Group: 17 Individ: 17 CG:15	Women with SUI only (18+ years)	6 weeks PFMT in group or individual sessions; two 1-hour sessions weekly (12 sessions); taught by vaginal palpation in both Tx groups; 3 s and 5-10 s contractions; repetitions and duration progressed; average of 100 contractions per session.	Primary outcome: pad test; secondary King's questionnaire and satisfaction. Both Tx groups showed greater improvement on pad test than CG (p<0.0001). Improvements shown in both Tx groups but not CG.	Randomization was by participants drawing envelope from a box; assessments not blinded; not ITT Purpose of the study was to examine group vs individual. No adverse events. Small N
Rutledge 2014 (11)	Usual care (no handout)	N=40 Tx: 20 CG: 20	Gyn cancer survivors with UI (37-79 years)	12 weeks; single 15-min training session; taught using levator ani palpation; 10 contractions 5 s duration; handout on behavioral management tips: fluid intake, reduction of caffeine and bladder irritants; constipation management; Home exercise: 3 sets of exercises daily for 12 weeks.	PGI-I and UDI-6 PGII: 80% in Tx group vs 40% in CG were "much better" or "very much better" (p=0.02). UDI-6: Groups not significantly different: Tx 70% vs CG 50% reported lack of bother (p=0.62).	Randomization generated by random number table. Allocation concealment Not ITT analysis Treatment included behavioral/lifestyle advice.

1. Abdulaziz K, Hasan T. Role of pelvic floor muscle therapy in obese perimenopausal females with stress incontinence: A randomized control trial. The Internet Journal of Gynecology and Obstetrics. 2012;16(2):34-42.
2. Asklund I, editor Treatment of stress urinary incontinence via a smartphone application. Report from an ongoing randomised controlled study. Medicine 20 Conference; 2014: JMIR Publications Inc., Toronto, Canada.
3. Tosun OC, Mutlu EK, Ergenoglu A, Yeniel A, Tosun G, Malkoc M, *et al.* Does pelvic floor muscle training abolish symptoms of urinary incontinence? A randomized controlled trial. Clinical rehabilitation. 2015;29(6):525-37.
4. Dumoulin C, Sran M, Lieblch P, Wilson P. Physiotherapy significantly reduces leakage in postmenopausal women with osteoporosis and urinary incontinence: result of a parallel randomised controlled trial. Neurology & Urodynamics. 2011;30(6):985.
5. Ferreira S, Ferreira M, Carvalhais A, Santos PC, Rocha P, Brochado G. Reeducation of pelvic floor muscles in volleyball athletes. Revista da Associação Médica Brasileira. 2014;60(5):428-33.
6. Jahromi MK, Talebizadeh M, Mirzaei M. The Effect of Pelvic Muscle Exercises on Urinary Incontinency and Self-Esteem of Elderly Females With Stress Urinary Incontinency, 2013. Global journal of health science. 2015;7(2):71.
7. Kim H, Yoshida H, Suzuki T. The effects of multidimensional exercise treatment on community-dwelling elderly Japanese women with stress, urge, and mixed urinary incontinence: a randomized controlled trial. International journal of nursing studies. 2011;48(10):1165-72.
8. Leong B, Mok N. Effectiveness of a new standardised Urinary Continence Physiotherapy Programme for community-dwelling older women in Hong Kong. Hong Kong Medical Journal 2015;21(1):30-7.
9. McLean L, Varette K, Gentilcore-Saulnier E, Harvey MA, Baker K, Sauerbrei E. Pelvic floor muscle training in women with stress urinary incontinence causes hypertrophy of the urethral sphincters and reduces bladder neck mobility during coughing. Neurourology and urodynamics. 2013;32(8):1096-102.

10. Pereira VS, Correia GN, Driusso P. Individual and group pelvic floor muscle training versus no treatment in female stress urinary incontinence: a randomized controlled pilot study. *European Journal of Obstetrics & Gynecology and Reproductive Biology*. 2011;159(2):465-71.
11. Rutledge TL, Rogers R, Lee S-J, Muller CY. A pilot randomized control trial to evaluate pelvic floor muscle training for urinary incontinence among gynecologic cancer survivors. *Gynecologic oncology*. 2014;132(1):154-8.

Table 8 Studies comparing different PFMT programs included in the previous review (5th ICI) and current update (6th ICI)

	Studies included in the previous review (5 th ICI)	New studies identified in this update (6 th ICI)	Total
1. Supervision of training: amount of contact with health professionals	6	4	10
2. Supervision of training: individual versus group supervision	6	2	8
3. Exercise program: direct versus indirect exercises	6	2	8
4. Exercise program: generic versus individualized exercises	1	0	1
5. Exercise program: submaximal versus near maximal contractions	1	0	1
6. Exercise program: daily versus three times per week	1	0	1
7. Exercise program: addition of upright exercise position	1	0	1
8. Exercise program: addition of strength training to motor learning	1	1	2
9. Exercise program: addition of abdominal or hip muscle exercises	1	3	4
10. Exercise program: addition of intravaginal resistance device	3	2	5
11. Exercise program: addition of adherence strategy	2	0	2
12. Exercise program: addition of biofeedback	9	6	15

Table 9 Summary of data on different PFMT programs comparisons

Author, year	Comparator	N	Study population	Modality details or parameters	Outcomes/Results	Follow-up	Notes
Cruz <i>et al.</i> 2014 (1) - Abstract	Supervised PFMT (43) vs Unsupervised (36)	79	Primigravidas with UI at 21-26 weeks of pregnancy	Supervised group – 5-6 biweekly sessions supervised by a physiotherapist Unsupervised group: same treatment protocol	<u>Self-reported cure</u> : Non- sign. difference btw groups in cure rate (p=0.052) Supervised 16/20 (74%) Unsupervised 10/21 (48%) <u>ICIQ-SF</u> : Supervised group pre-Tx 8.1±3.7 to post-Tx 1.2±2.5 Unsupervised PFMT group pre-Tx 7.7±5.0 to post-Tx 4.7±5.6 Sign. difference btw treatments (p=0.016)	3 weeks	Large dropout rate: 23/43 supervised PFMT 15/36 unsupervised PFMT
Delgado <i>et al.</i> 2013 (2) Abstract was included in the ICI 5 th edition	PFMT (24) vs PFMT + resistance device (28)	52	Women with SUI or MUI (stress predominant)	PFMT: As below without device PFMT +resistance; 5 quick and 5 slow (sustained), high-intensity contractions daily. Advised to hold contractions as long as possible, relaxing their PFM for an equivalent time before repeating the process. Intravaginal resistance: instructions to use the Pelvic-Toner Device concurrently whilst exercising. Two clinic visits and one phone call	<u>Reported cure</u> (based on the Q11 of the ICIQFluts) PFMT 0/13 PFMT+resistance 1/15 Non-sign. difference btw groups (p=0.429) <u>Improvement</u> (post-Tx) PFMT 10/19 PFMT+resistance 11/21 Non-sign. difference btw groups	16 weeks of treatment, outcomes assessed at post-Tx and at 6 month follow-up	Dropouts (at 6 month) PFMT 9/24 PFMT + resistance 15/28

Author, year	Comparator	N	Study population	Modality details or parameters	Outcomes/Results	Follow-up	Notes
Donahoe-Filmore <i>et al.</i> 2011 (3)	PFMT (5) vs PFMT + hip muscle training (6)	11	11 women with SUI (urodynamic diagnosis)	PFMT: 10 repetitions of 10s PFM contraction/5-10s rest, 10 repetitions of 1-2s contraction 10s contraction, PFM and transverse abdominis contraction PFMT + hip muscle training: PFMT training while performing resisted hip contraction with a ball /elastic band, 10 repetitions of 5s (PFM contraction+TrA+squeezing a ball) and 10 repetitions of 5s (PFM contraction+TrA+hip external rotation resisted with an elastic band) Both groups were instructed to perform the exercises twice a day, 7 days/week for 12 weeks. Both also had 3 sessions supervised with a physiotherapist	<u>ICIQ-IU-SF</u> Delta between treatments -5.0±4.7 (p=0.35) <u>UDI-6</u> Delta between treatments 10.25±3.5 (p=0.043) in favor of combined treatment <u>Incontinence severity index</u> Delta between treatments -5.25±2.48 (p=0.139)	12 weeks of treatment, outcomes assessed post-Tx	Dropouts: PFMT (1/5) PFMT + hip muscle training (4/6) Results should be interpreted with caution (n=11)
Ferreira <i>et al.</i> 2012(4) (pilot RCT)	Supervised PFMT (20) vs Unsupervised (home) PFMT (18)	38	Women with mild to moderate SUI (urodynamic diagnosis)	Both groups received a leaflet and attended a 1h educational session including verification of adequate PFM contraction <u>Supervised PFMT:</u> Same as home program + weekly 45 min session <u>Unsupervised (Home) PFMT:</u> 8-10 PFM contraction, 10s contraction followed by four quick contractions/5-10s rest, three times a day, in different positions for 6 months with monthly motivational phone call	<u>Self-reported cure/improvement:</u> The rate of women who thought they were cured, almost cured, or feeling better was 100% in supervised PFMT and 64.7% in home PFMT (p=.018) <u>7-day bladder diary:</u> Supervised PFMT pre-Tx 11.3±5.1 to post-Tx 4.5±5.1 (p<.05) Unsupervised PFMT pre-Tx 11.3±5.7 to post-Tx 6.4±7.5 (p<0.05) Similar reductions on pad test were registered in both groups (p=0.125) <u>Pad test:</u> Supervised PFMT pre-Tx 3.6±1.9 to post-Tx 1.90±1.5 (p<0.05) Unsupervised PFMT pre-Tx 3.8±3.0 to post-Tx 2.0±2.0 (p<0.05) Similar reductions on pad test were registered in both groups (p=0.530)	6 month of treatment, outcomes assessed post-Tx	Dropout Supervised PFMT 3/20 Unsupervised PFMT 1/18

Author, year	Comparator	N	Study population	Modality details or parameters	Outcomes/Results	Follow-up	Notes
Fitz <i>et al.</i> 2015 (5)- abstract	Supervised (25) vs Unsupervised (25)	63	Women with predominance of SUI and more than 2 g of leakage (pad test)	Supervised: 24 sessions, twice weekly. 3 sets of 30 contractions followed by 3 fast-twitch contractions Unsupervised: Same exercise protocol, appointment once a month for exercise adjustment	<u>Bladder diary:</u> Post-Tx score in supervised 0.6±0.9 and unsupervised group 0.9±1.4 Non-sign. difference btw groups (p=0.944) <u>Pad test</u> Supervised 3.8±6.6 and unsupervised 16.0±28.2 Sign. difference btw groups (p=0.026) <u>QoL</u> Non sign. difference btw groups (0.661)	3 months of treatment, outcome assessed at post-Tx	13 dropouts (on is not mentioned in which group)
Galea <i>et al.</i> 2013 (6)	PFMT (11) vs PFMT+BF (clinic) (12)	23	Women with SUI or UUI (over 60 years old)	PFMT: correct PFM contraction was verified through vaginal palpation at the first visit PFMT+BF: Ultrasound imaging was used as a visual BF. The visual feedback was progressively reduced throughout sessions	<u>King's health questionnaire</u> Non-sign. difference btw groups <u>7-day bladder diary</u> PFMT pre-Tx 2(5) to post-Tx 2(3) PFMT+BF pre-Tx 8(8) to post-Tx 3(5) Non-sign. difference btw groups (p=0.868) <u>Pad test</u> PFMT pre-Tx 2.1(11.3) to post-Tx 0.2(4.2) PFMT+BF pre-Tx 6(54) to post-Tx 0(4.8) Non-sign. difference btw groups (p=0.428)	10 weeks of treatment, outcomes assessed at 3 month post-Tx	PFMT 0/11 PFMT+BF 1/12

Author, year	Comparator	N	Study population	Modality details or parameters	Outcomes/Results	Follow-up	Notes
Hirakawa <i>et al.</i> 2013 (7)	PFMT (23) vs PFMT +BF (home and clinic) (23)	46	Women with SUI (more than 1 episode per week)	<p>PFMT: 5 individually supervised sessions over 12 weeks of treatment. PFM contraction taught with palpation of the perineal body. 10 repetitions of 5s contraction/10s rest, 10 repetitions of 2s contraction/4s rest, Knack, twice daily</p> <p>PFMT +EMG biofeedback: same as above but with EMG BF at home and at the clinic</p>	<p><u>ICIQ-UI-SF:</u> PFMT pre-Tx 12.0±3.5 to post-Tx 8.3±3.5 (p<0.001) PFMT+BF: pre-Tx 11.2±3.9 to post-Tx 7.8±3.3 (p=0.002) Non-sign. difference btw groups <u>King's health questionnaire</u> Non-sign. difference btw groups <u>Bladder diary</u> PFMT pre-Tx 1.9±1.8 to post-Tx 1.2±1.4 (p=0.028) PFMT+BF: pre-Tx 1.2±0.7 to post-Tx 0.8±1.2 (non-sign.) Non-sign. difference btw groups <u>Pad test:</u> PFMT pre-Tx 11.7±18.9 to post-Tx 7.7±15.4 (non-sign.) PFMT+BF: pre-Tx 21.3±38.2 to post-Tx 9.9±15.1 (non-sign.) Non-sign. difference btw groups</p>	12 weeks of treatment, outcomes assessed post-Tx	Dropouts: PFMT 3/23 vs PFMT +BF 4/23

Author, year	Comparator	N	Study population	Modality details or parameters	Outcomes/Results	Follow-up	Notes
Jordre <i>et al.</i> 2014 (8)	Resisted hip rotation training (14) vs PFMT (16)	30	30 SUI women (with at least 2 SUI episodes per month)	<p>Resisted hip rotation: -10 hip external/internal rotation during breathing -10 repetitions each of hip external rotation (resistance band) and internal rotation (with a ball) No PFM contraction PFMT: 20 5s contraction and 20 quick flicks Vaginal palpation was performed only when required</p> <p>Both programs were performed twice daily. Weekly recheck were scheduled (in person or over the phone)</p>	<p><u>Subjective improvement</u> Hip training 69.6±21.4 post-Tx PFMT 52.8±32.2 post-Tx Non-sign. difference btw groups (p=0.24) <u>UDI</u> Hip training: pre-Tx 142.3±69.8 to post-Tx 79.8±56.6 (p=0.02) PFMT: pre-Tx 145.2±54.0 to post-Tx 77.7±60.4 (p<0.01) Non-sign. difference btw groups (p=0.90) <u>IIQ</u> Hip training: pre-Tx 151.3±77.2 to post-Tx 122.5±68.2 (p=0.03) PFMT: pre-Tx 140.7±39.4 to post-Tx 119.8±59.6 (p<0.01) Non-sign. difference btw groups (p=0.70) <u>Bladder diary</u> Hip training: pre-Tx 5.2±6.2 to post-Tx 0.1±0.1 (p<0.01) PFMT: pre-Tx 3.3±3.5 to post-Tx 1.1±3.4 (p<0.01) Women received hip training had sign. more reduction of UI episodes (p=0.03)</p>	6 weeks of treatment, outcomes assessed post-Tx	Dropout Resisted hip rotation 2/14 vs PFMT1/16
Jungin <i>et al.</i> 2014 (9)	PFMT with bladder neck effective relearning (42) vs PFMT (38)	80	Women with SUI or MUI	<p>PFMT with bladder neck effective relearning: PFM contraction and Knack taught with ultrasound biofeedback 3 sessions supervised over 3 months of treatment PFMT: PFMT with EMG biofeedback - 3 supervised sessions. PFM contractions (80% of the maximum, 8s contraction/10 s rest, for 10 min)</p>	<p><u>Improvement:</u> PFMT with bladder neck effective 10(28%) had some improvement and 15 (42%) reported great improvement PFMT 12 (46%) and 8 (31%) had some and great improvement, respectively Non-sign. difference btw the two groups (p=0.365) There were 14 women in the PFMT group who switch group after trial completion</p>	3 months of treatment, outcomes assessed post-Tx	Dropouts: PFMT with bladder neck effective relearning 6/42 PFMT 7/38

Author, year	Comparator	N	Study population	Modality details or parameters	Outcomes/Results	Follow-up	Notes
Kashanian <i>et al.</i> 2011 (10)	PFMT (50) vs PFMT + resistance device (41)	91	Women with SUI or MUI	PFMT: 6-8s contraction/6s rest Twice daily for 15 min PFMT + resistance device: twice daily for 15 min	Number of UI (self-reported) The data were categorized in ranges of different frequencies. Sign. changes in both groups (p<0.0001) Non-sign. difference btw groups UDI PFMT pre-Tx 45.1±15.5 to post-Tx 71.8±11.2 (p<0.0001) PFMT + resistance pre-Tx 39.9±13.5 to post-Tx 69.9±10.1 (p<0.0001) Non-sign. difference btw groups (p=0.418) IIQ PFMT pre-Tx 44.7±23.0 to post-Tx 67.7±20.20 (p<0.0001) PFMT+resistance pre-Tx 37.2±12.10 to post-Tx 62.52±12.13 (p<0.0001) Non-sign. difference btw groups (p=0.162)	12 weeks of treatment, outcomes assessed 3 month post-Tx	Dropouts: PFMT 4/50 PFMT + resistance device 2/41
Kim <i>et al.</i> 2012 (11)	Supervised PFMT + trunk stabilization (10) vs Unsupervised PFMT + trunk stabilization (10)	20	Women with postpartum UI	Supervised PFMT and trunk stabilization: 23 1-h sessions, 3x/week, for eight weeks; PFM contractions in different positions Unsupervised: same protocol but only one demonstration session	Bristol Female Lower Urinary Tract Symptom questionnaire – Urinary symptoms (changes) Supervised –27.22±6.20 Unsupervised –18.22±5.49 Quality of life Supervised –5.33±2.96 Unsupervised –1.78±3.93) Total score Supervised –32.56±8.17 Unsupervised –20.00±6.67) All outcomes favored the supervised group (P<0.05)	8 weeks of treatment, outcomes assessed post-Tx	Dropout: Supervised 1/10 Unsupervised 1/10

Author, year	Comparator	N	Study population	Modality details or parameters	Outcomes/Results	Follow-up	Notes
Konstantinidou <i>et al.</i> 2013 (12)- abstract Results were also presented in two other abstracts (13, 14) It should be underlined that lower sample size were reported in the 2011 abstract.	PFMT (25) vs PFMT + transverse abdominis exercises (21)	46	Women with SUI or MUI (stress predominant) (minimum of 7 episodes per week and a 3-4 score at the Oxford scale)	PFMT monotherapy Transverse abdominis exercises combined with PFMT Limited information was provided about the training protocol	<u>KHQ</u> PFMT: pre-Tx 342.9±28.2 to post-Tx 198.3±18.4 (p<0.0001) PFMT+TrA : pre-Tx 327.1±38.4 to post-Tx 193.1±24.7 (p=0.0003) Non-sign. difference btw the two groups (p=0.76) <u>Bladder diary</u> PFMT: pre-Tx 4.36±0.6 to post-Tx 1.8±0.3, (p<0.0001) PFMT+TrA : pre-Tx 3.4±0.4 to post-Tx 1.2±0.2 (p<0.0001) Non-sign. difference btw groups	3 months of treatment, outcomes assessed post-Tx	Dropouts are not reported
Lamb <i>et al.</i> 2009 (15)	Group PFMT (111) vs Individual PFMT (63)	174	Women with SUI and/or UUI	Group PFMT: Three 1h session for 3 weeks, average of 10 women per class, individual assessment with PFM examination if required Individual PFMT: Same as group intervention but individually supervised	<u>Symptoms severity index</u> Group changes from baseline 2.34±0.44 Individual changes from baseline 1.71±0.57 Non-sign. difference btw groups (p=0.38) <u>Self-rated assessment of treatment benefit</u> Group changes from baseline 5.37±0.29 Individual changes from baseline - 6.34±0.38 Higher perceived benefit for individual treatment (p=.0462) <u>Incontinence related QoL</u> Group changes from baseline - 14.40±1.75 Individual changes from baseline - 14.81±2.50 Non-sign. difference btw groups (p=.89)	3 weeks of treatment, outcomes assessed 6 months after randomisation	Dropout: Group PFMT 13/111 Individual PFMT 3/63

Author, year	Comparator	N	Study population	Modality details or parameters	Outcomes/Results	Follow-up	Notes
Liebergall-Wischnitzer <i>et al.</i> 2013 (16) (This is a follow-up of the 2009 study)	Paula method (119) vs PFMT (126)	245	Women with SUI	Paula : 12 individual 45-min session PFMT : 6 group sessions over 12 weeks	<u>Frequency of UI</u> (low or high) No sign. deterioration of UI in 6 months in both groups Paula method: 25 (39.7%) reported a low frequency rate of UI episodes PFMT: 18 (22.8%) in the PFMT group reported a low frequency Sign. difference btw groups (p=0.03)	12 weeks of treatment, follow-up at 6-month post-Tx	Dropout Paula 55/119 PFMT 47/126 The two groups differed according to the amount of supervision received (PFMT had group supervision and less sessions).
Manonai 2013 (17) -abstract	PFMT vs PFMT +BF (home) (sample size in each group not specified)	61	Women with SUI	PFMT: verbal instruction about PFM contraction, 15 min of PFM exercises, three times a day for 16 weeks PFMT+BF: same as above but with pressure BF	<u>Incontinence related QoL</u> PFMT pre-Tx 51.1±15.9 to post-Tx 70.6±15.5 (sign.) PFMT+BF: pre-Tx 53.9±18.3 to post-Tx 72.6±10.81 (sign.) Non-sign. difference btw groups	16 weeks of treatment, outcomes assessed post-Tx	Dropouts: one in each groups
Marques <i>et al.</i> 2014 (18)-abstract (19) protocol	PFMT (15) vs PFMT + hip muscle training (20)	35	Women with SUI (urodynamic diagnosis)	Both groups received 20 individually supervised sessions, twice a week PFMT: PFM contraction verified by vaginal palpation in the first 8 sessions PFMT: same PFMT program with the addition of hip muscle strengthening (with progressive increases in loads)	<u>Bladder diary</u> (5 days) Non-sign difference btw the two groups (p=0.172)	10 weeks of treatment, outcomes assessed post-Tx	Dropout not reported

Author, year	Comparator	N	Study population	Modality details or parameters	Outcomes/Results	Follow-up	Notes
Pereira <i>et al.</i> 2011 (20)	Group PFMT (17) vs Individual PFMT (17) vs Control (15)	49	Women with SUI	Group PFMT: Two 1h weekly sessions for 6 weeks. Approximately 100 contractions (3s contraction/6s rest and 5-10 s contraction/10-20 rest). Contraction taught individually at baseline Individual PFMT Same as above but individually supervised Control (15) No treatment	1-h pad test: Group: pre-Tx 1.88±2.85 to post-Tx 0.46±0.45 (p=0.05) Individual: pre-Tx 4.22±5.21 to post-Tx 0.45±0.90 (p=.0006) Non-sign. difference btw groups <u>King health questionnaire</u> Only the personal relationships and emotion differed btw the two groups and favored individual PFMT (p.043)	6 weeks of treatment, outcomes assessed post-Tx	Dropout: Group PFMT 2/17 Individual PFMT 2/17 Control 0/15 No adverse effects reported
Ong <i>et al.</i> 2015 (21) Results also presented in the following abstracts (22, 23)	PFMT (19) vs PFMT+ BF (home and clinic) (21)	40	Women with SUI	PFMT: 4 sessions individually supervised (20-min), 3-5 sets of 10 repetitions (3-10s contraction/ 3-10s rest). 3-5 sets of 10 repetitions (2s contraction/2s rest) PFMT + biofeedback: Same as above but with use of the Vibrance device at home and in the clinic	<u>Subjective cure</u> (based on the Q6 of the Australian pelvic floor questionnaire) PFMT 10/16 PFMT+BF 12/21 Non-sign. difference btw groups (p=.742) <u>Australian pelvic floor questionnaire</u> (total score) PFMT post-Tx 7.8±5.1 PFMT+BF post-Tx 11.3±8.3 Non-sign. difference btw groups (p=0.157)	16 weeks of treatment, outcomes assessed at 4 weeks of treatment and post-Tx	Dropouts: PFMT 3/19 PFMT+ biofeedback 0/21

Author, year	Comparator	N	Study population	Modality details or parameters	Outcomes/Results	Follow-up	Notes
Prudencio 2014 (24) abstract	PFMT (51) Vs PFMT+VC (55) Vs PFMT+BF (clinic) (50)	156	SUI women	The 3 groups received 20 sessions of 45 min (twice a week for 3 months). PFMT included isolated rapid and sustained contractions of the PFM and at the end functional exercises with contraction of the same muscle group by differentiating just the use or not of associated instruments. (No further information was provided on treatment in the abstract)	<u>Cure of SUI</u> Non-sign. difference btw groups (p=0.267) PFMT 39.2% (20/51continent) PFMT+BF 44% (22/50continent) <u>KHQ:</u> The 3 groups significantly improved from baseline (p<0.001) PFMT preTx74±18 to postTx43±17 (p<0.001) PFMT+BF preTx70±21 to postTx50±15 Sign. Difference btw groups (p<0.001). It is not specified which groups differ	3 months	Dropout not specified
Shin <i>et al.</i> 2012 (25) Results also presented in the following abstracts (26, 27)	PFMT (30) vs PFMT+BF (home) (30)	60	Women with UI (type not specified)	PFMT: 20 min, twice a day, 5x/week for 6 months PFMT +BF: same as above but with the pressure device	<u>ICIQ-SF:</u> PFMT pre-Tx 8.8±4.7 to post-Tx 8.2±5.1 (non-sign.) PFMT+BF: pre-Tx 9.0±3.9 to post-Tx 7.0±2.7 (p<0.05) <u>KHQ</u> PFMT pre-Tx 6.84±15.9 to post-Tx 59.2±19.2 (non-sign.) PFMT+BF: pre-Tx 69.5±14.2 to post-Tx 48.7±12.3 (p<0.001) <u>Bladder diary</u> PFMT pre-Tx 9.7±3.3 to post-Tx 8.0±3.2 (non-sign.) PFMT+BF: pre-Tx 8.6±4.0 to post-Tx 5.1±4.6 (p<0.001) Comparison btw groups not reported. Sign. reduction of leakage frequency, KHQ and ICIQ occurred in BF group but not in PFMT group	6 months of treatment, outcomes assessed at 6 weeks and 6 months	Dropouts : PFMT 6/30 vs PFMT+BF (home) 0/30

1. Cruz C, Riesco ML, Zanetti M. Supervised pelvic floor muscle training to treat urinary incontinence during pregnancy: A randomized controlled trial. *Neurourology and Urodyn.* 2014;33(6(abstract#403)):867-8.
2. Delgado D, White P, Trochez R, Drake MJ. A pilot randomised controlled trial of the pelvic toner device in female stress urinary incontinence. *Int Urogynecol J* 2013;24:1739-45.

3. Donahoe-Fillmore B, Chomy W, Brahler CJ, Ingley A, Kennedy J, Osterfeld V. A comparison of two pelvic floor muscle training programs in females with stress urinary incontinence: A pilot study. *The Journal of Applied Research*. 2011;11(2):73-83.
4. Ferreira M, Clara P, Duarte JA, Rodrigues R. Exercise programmes for women with stress urinary incontinence. *Primary Health Care*. 2012;22(3):24-7.
5. Fitz FF, Stupp L, Costa TF, Sartori MG, Girao MJ, Castro RA. Supervised versus non-supervised pelvic floor muscle training for stress urinary incontinence: Randomized controlled trial. *Int Urogyn J*. 2015;26(Suppl1):145-6.
6. Galea M, Tisseverasinghe S, Sherburn M. A randomised controlled trial of transabdominal ultrasound biofeedback for pelvic floor muscle training in older women with urinary incontinence. *Australian and New Zealand Continence Journal*. 2013;19(2):38-44.
7. Hirakawa T, Suzuki S, Kato K, Gotoh M, Yoshikawa Y. Randomized controlled trial of pelvic floor muscle training with or without biofeedback for urinary incontinence. *International Urogynecology Journal*. 2013;24(8):1347-54.
8. Jordre B, Schweinle W. Comparing resisted hip rotation with pelvic floor muscle training in women with stress urinary incontinence: A pilot study. *J Womens Health Phys Therap*. 2014;38(2):81-9.
9. Junginger B, Metz M, Baessler K. Comparison of a bladder neck effective pelvic floor rehabilitation program and EMG-biofeedback augmented pelvic floor muscle training: a randomized controlled trial *Neurourology and Urodynamics* 2014;33(6):970-1.
10. Kashanian M, Ali SS, Nazemi M, Bahasadri S. Evaluation of the effect of pelvic floor muscle training (PFMT or Kegel exercise) and assisted pelvic floor muscle training (APFMT) by a resistance device (Kegelmaster device) on the urinary incontinence in women "comparison between them : a randomized trial". *European Journal of Obstetrics & Gynecology and Reproductive Biology*. 2011;159(1):218-23.
11. Kim EY, Kim SY, Oh DW. Pelvic floor muscle exercises utilizing trunk stabilization for treating postpartum urinary incontinence: randomized controlled pilot trial of supervised versus unsupervised training. *Clinical Rehabilitation*. 2012;26(2):132-41.
12. Konstantinidou E, Kalaitzi M, Mytilekas K, Mikos T, Ioannides E, Hatzichristou D. Is there a role for training of the transversus abdominis muscles in the physiotherapy schemes applied in the treatment of female urinary incontinence? . *Proceedings of the 43rd Annual Meeting of the International Continence Society (ICS)*. 2013.
13. Konstantinidou E, Kalaitzi M, Mytilekas K, Ioannides E-I, Hatzichristou D, Apostolidis A. Does the type of physiotherapy affect the quality of life and clinical outcomes in female urinary incontinence? A comparative study of two physiotherapy schemes *European Urology Supplements* 2013;12(1):e733.
14. Konstantinidou E, Mikos T, Kalaitzi M, Oeconomou A, Mytilekas K, Papameletiou V. Real-time ultrasonographic evaluation of the levator ani and transversus abdominis muscles: is there a role in female urinary incontinence? . *Neurourology and Urodynamics* 2011;30(6):1111-2.
15. Lamb SE, Pepper J, Lall R, Jorstad-Stein EC, Clark MD, Hill L, *et al*. Group treatments for sensitive health care problems: a randomised controlled trial of group versus individual physiotherapy sessions for female urinary incontinence. *BMC Womens Health*. 2009;9:26.
16. Liebergall-Wischnitzer M, Paltiel O, Lavy Y, Shveiky D, Manor O, Hochner-Celnikier D. Long-term efficacy of Paula method as compared with pelvic floor muscle training for stress urinary incontinence in women. *J Wound Ostomy Continence Nurs*. 2013;40(1):90-6.
17. Manonai J, Kamthaworn S, Petsarb K, Wattanayingcharoenchai R. Development of a pelvic floor muscle strength evaluation device *Neurourology and Urodynamics*. 2013;32(6):657-8.

18. Marques S, Haddad J, Passaro A, Silveira S, Baracat E, Ferreira E. Effectiveness of the strengthening of pelvic floor muscles, adductors of hip, gluteus maximus and gluteus medius in the treatment of stress urinary incontinence: blind randomized clinical trial - partial results. Proceedings of the 44th Annual Meeting of the International Continence Society (ICS). 2014.
19. Marques S. Comparison of the Efficacy of Two Kinesiotherapy Protocols for Stress Urinary Incontinence in Women: Randomized Blind Clinical Trial. Ref ID: 61587 Trials registry number(s): NCT01948713. 2013.
20. Pereira VS, Correia GN, Driusso P. Individual and group pelvic floor muscle training versus no treatment in female stress urinary incontinence: a randomized controlled pilot study. European Journal of Obstetrics & Gynecology and Reproductive Biology. 2011;159(2):465-71.
21. Ong TA, Khong SY, Ng KL, Ting JRS, Kamal N, Yeoh WS, *et al.* Using the Vibrance Kegel Device With Pelvic Floor Muscle Exercise for Stress Urinary Incontinence: A Randomized Controlled Pilot Study. Urology. 2015;86(3):487-91.
22. Jesse T, Teng A, Azad R, Keng L, Su Y, Prevalthe P, *et al.* A randomized control trial to compare the effectiveness of pelvic floor exercises with the vibrance kegel device compared to standard kegel pelvic floor exercises for the treatment of stress urinary incontinence in females International Journal of Urology 2012;19 (Suppl A1):214.
23. Ng K, Ting J, Ong T, Khong S, Razack A. Randomised controlled trial comparing standard pelvic floor muscle exercises versus vibrance kegel device enhanced pelvic floor muscle exercises in women with urinary stress incontinence. BJU International. 2013;111(Suppl 1):107.
24. Prudencio C, Barbosa A, Derobio AL, Anezio A, Vesentini G, Almeida AP, editors. Comparison of three physiotherapy methods for treatment of stress urinary incontinence: impact in quality of life and muscle function. Proceedings of the 44th Annual Meeting of the International Continence Society (ICS), 2014 Oct 20-24, 2014; 2014; Rio de Janeiro, Brazil.
25. Shin J, Sul C, Na Y, Song K, Lim J, Yun C, *et al.* Effectiveness of perinometer biofeedback pelvic floor muscle exerciser with ExTT-101tm in female stress urinary incontinence. Proceedings of the 42nd Annual Meeting of the International Continence (ICS) (Beijing, China). 2012.
26. Shin J, Song K, Na Y, Lim J, Sul C, Hwang E, *et al.* Effectiveness of Biofeedback Training with EXTT-101TM in Female Stress Urinary Incontinence. Urology. 2011;78(3):S399.
27. Na Y, Lim J, Song K, Sul C, Shin J, Oh T, *et al.* Effectiveness of biofeedback training with ExTT-101 (trademark) in female stress urinary incontinence: Portable self education system. International Urogynecology Journal. 2011;22(3):S1819.

Quality of data

Of the 20 RCTs, 12 provided sufficient detail supporting adequate randomisation and allocation concealment methods (34, 50, 65-74). Of these, seven RCTs stated that the outcome assessors were blinded (34, 65-70). Pereira *et al.* (50) reported adequate randomisation and concealment but the evaluators were not blinded. Of the remaining eight RCTs, seven did not report sufficient information on allocation concealment methods and had unblinded assessors (75-81).

None of the included trials was large and half (10/20) included only 20 to 51 participants per group (65, 68, 69, 72, 74, 75, 77, 79-81). Eight had fewer than 20 participants per comparison group (34, 50, 70, 71, 73, 76, 78, 82). Six of the eight were reported as a pilot study (70-73, 76, 78). Only two RCTs had a larger sample size involving a total of 174 (66) and 245 women (67).

In four RCTs, a dropout rate of more than 46% in one study arm was reported. For instance, Dohanhoe *et al.* (78) reported 60% dropout in the PFMT combined with hip training and 20% in the PFMT group. Delgado *et al.* (72) had 37% and 57% in the PFMT group and PFMT combined with resistance, respectively. Liebergall-Wischnitzer *et al.* (67) reported a 46% and 37% dropout rate in the paula and PFMT group, respectively while Cruz *et al.* (65) had 42-53% dropout in the supervised and unsupervised PFMT group. The results of these RCTs should therefore be interpreted with extreme caution (65, 67, 72, 78).

Ongoing RCTs

Based on a research on protocol registry database, there is currently one ongoing large non-inferiority RCT comparing group versus individual supervised PFMT (83) (comparison 2). Involving 364 elderly women with SUI or MUI, this study is expected to be completed by March 2017. Moreover, the study of Buen *et al.* (84) is also ongoing and will compare the efficacy of PFMT and Pilates in preventing and treating UI (N=80) (comparison 3). The study of Navarro *et al.* (85) will evaluate the efficacy of hypopressive exercises in 78 women with various pelvic floor disorders including UI (comparison 3). Expected in July 2017, the study of Radlinger *et al.* (51) will assess the benefit of adding motor learning to PFMT in 96 women suffering from SUI or MUI (Comparison 8). Rao *et al.* (86) undertook a study comparing the addition of abdominal muscle training to PFMT in 300 women (Comparison 9). Three upcoming RCTs will assess the benefit of adding clinic-based BF to PFMT (87-89).

Results

- Comparison 1. Supervision of training: amount of contact with health professionals?

Subgroup 1.1: additional group supervision

No further studies investigated the effect of adding an additional supervised group exercise session.

Subgroup 1.2: additional phone calls

No new studies investigated the effect of adding supervisory phone calls to PFMT programmes.

Subgroup 1.3: individual supervision versus no supervision

Four new RCTs were included in this comparison (34, 65, 71, 75). The PFMT programmes evaluated differed with regard to the amount of health-professional contact but were similar in type and quantity of PFM exercises.

Self-reported cure: Women in the supervised group were more likely to report cure in comparison with women following unsupervised PFMT (71). Although non-statistically significant, Cruz *et al.* (65) also reported a higher cure rate in the supervised group.

Improvement: Two RCTs reported improvement in UI symptoms as assessed with validated questionnaires (34, 65). Both showed that women receiving supervised treatment reduced their UI symptoms significantly more than women in the unsupervised arm (34, 65).

Leakage episodes: There was no statistically significant difference in the number of leakage episodes when comparing supervised and unsupervised PFMT in women (71, 75).

Pad tests: Two of the four RCTs measured UI severity with pad testing (71, 75). Fitz *et al.* (13) showed that supervised treatment resulted in a more significant reduction of leakage than unsupervised PFMT while Ferreira *et al.* (71) reported a non-significant difference.

- Comparison 2. Supervision of training: individual versus group

Two new RCTs were included in this comparison; both studies used the same PFMT program and differed only according to the type of supervision (group vs individual). It should also be underlined that Pereira *et al.* (50) conducted an individual assessment of the PFM to teach active PFM contraction to all women prior to class training while Lamb *et al.* (66) included this assessment only when required.

Self-reported cure: No data were reported.

Improvement: Non-significant differences in the symptom severity index were found between group and individual PFMT in the study of Lamb *et al.* (66) However, both Lamb *et al.* (66) and Pereira *et al.* (50) favoured individual treatment with regard to self-rated treatment benefits and the impact of UI (personal relationships and emotion domains), respectively. The study of Pereira *et al.* (50) involving 17 women per group, may be insufficiently powered to detect significant difference between groups. In the study of Lamb *et al.* (66), a large sample was included (n=174).

However, the information was limited in regard to whether this sample was sufficient to conclude treatment equivalence (as per sample size calculation in non-inferiority design).

Leakage episodes: No data were reported.

Pad test: Only the study of Pereira *et al.* (50) used the pad test and reported a non-significant difference between the two groups.

- Comparison 3. Exercise programme: direct versus indirect exercises

This comparison encompassed six subgroups evaluating direct versus indirect training. In “direct” PFMT, women specifically performed voluntary contractions of the pelvic floor muscles while in the “indirect” PFMT, women focused on other muscle groups in order to facilitate or stimulate pelvic floor muscle contractions.

Subgroup 3.1: PFMT versus sham/imitation

No new studies were found comparing PFMT to sham or imitation PFMT treatments (e.g. crossing the ankles and pulling the legs apart).

Subgroup 3.2: PFMT versus the 'Paula method'

The previous ICI chapter on conservative management included the study of Liebergall-Wischnitzer *et al.* (90) comparing PFMT to the Paula method. The 6-month follow-up of this study was included in the current review (67). It should be emphasized that the two groups did not receive the same amount of supervision by a health professional because the Paula group was individually supervised and the PFMT group had group teaching.

Subgroup 3.3: PFMT versus the 'Sapsford' approach

Our search revealed no new RCTs evaluating incontinence outcomes for this subgroup.

Subgroup 3.4: PFMT versus Pilates

No new RCT were found evaluating Pilates treatment in comparison to PFMT.

Subgroup 3.5: PFMT versus hip rotator training

One RCT was included in this subgroup evaluating the effectiveness of hip external and internal rotator training compared to PFMT (76).

Subgroup 3.6: PFMT versus hypopressive training

Our search revealed no RCT including hypopressive training conducted in women with UI.

Self-reported cure: No data were reported in the different subgroups.

Improvement: Liebergall-Wischnitzer *et al.* (67) in subgroup 3.2 showed that UI results were maintained at the 6-month follow-up in both the Paula method and the PFMT groups. Women who received the Paula method intervention were more likely to report

a lower rate of UI than women after PFMT. In subgroup 3.5, non-significant differences were found between hip rotator training and PFMT with regard to subjective UI improvement and UI symptoms and related impact (76).

Leakage episodes: Jordre *et al.* (76), subgroup 3.5, reported that women who received hip training had significantly fewer UI episodes than women in the PFMT group.

Pad test: Neither of the two new RCTs used pad-testing measurements.

- Comparison 4. Exercise programme: generic versus individualized exercises

No further evidence was available.

- Comparison 5. Exercise programme: submaximal versus near maximal contractions

No further evidence was available.

- Comparison 6. Exercise programme: daily versus three times per week.

No further evidence was available.

- Comparison 7. Exercise programme: addition of upright exercise position.

No further evidence was available.

- Comparison 8. Exercise programme: addition of strength training to motor learning.

Junginger *et al.* (68) evaluated PFMT and motor re-learning taught with ultrasound imaging in comparison to regular PFMT using EMG biofeedback in women with SUI or MUI. Both groups had the same amount of contact with health professionals.

Self-reported cure: No data were reported.

Improvement: There was no difference between the two groups in the number who reported ‘some’ or ‘great’ improvement. However, women in the PFMT group were more likely to switch to the motor relearning group at RCT completion.

Leakage episodes: No data reported.

Pad tests: The pad-testing measure was not included (68).

- Comparison 9. Exercise programme: addition of abdominal or hip muscle exercises.

This comparison encompassed two subgroups evaluating the addition of either abdominal muscle (subgroup 9.1) or hip muscle (subgroup 9.2) training to PFMT.

Subgroup 9.1: PFMT vs PFMT+ abdominal muscle exercises

One new RCT evaluates the effectiveness of adding transverse abdominis exercises to PFMT (77). Limited information was available about the training protocol in this abstract report.

Subgroup 9.2: PFMT vs PFMT+ hip muscle exercises

Two RCTs investigated the addition of hip muscle exercises to PFMT in women with SUI (78, 82). The same amount of health-professional supervision was given to each group (78, 82).

Self-reported cure: No trial reported this outcome.

Improvement: There was no significant benefit of adding abdominal muscle exercises to PFMT in the study of Konstantinidou *et al.* (77) (subgroup 9.1). Likewise, Donahoe-Fillmore *et al.* (78) showed a non-significant difference between adding hip muscle exercises to PFMT training as assessed with the King's health question and the Incontinence Severity Index (sub-group 9.2). Results from the UDI-6 questionnaire, favoured the combined treatment (78). These findings should be interpreted with caution given the small sample size of Donahoe-Fillmore *et al.*'s study (78) (n=11).

Leakage episodes: Non-significant differences in leakage episodes were found when adding abdominal muscle (77) or hip muscle exercises (82).

Pad and paper towel tests: No data were reported.

- Comparison 10. Exercise programme: addition of intravaginal resistance device

The study of Delgado *et al.* (2009) (91), presented as an abstract, was included in the previous ICI edition. The complete published manuscript has now been included in the current review (72) along with a new study evaluating the addition of an intravaginal resistance device to PFMT in women with SUI or MUI (69). Both RCTs were the same in all aspects except that one group used an intravaginal device designed to increase resistance to the PFM contraction. In both RCTs, the resistance device was composed of a spring-loaded device with two limbs (69, 72).

Self-reported cure: There was no statistically significant difference between the groups in terms of the number of women who indicated they were 'cured' (72).

Improvement: There was no statistically significant difference between the groups in terms of self-reported improvement and reduction of symptoms as assessed with standardised questionnaires (69, 72).

Leakage episodes: No data were reported for this outcome.

Pad and paper towel tests: No data reported.

- Comparison 11. Exercise programme: addition of adherence strategy

No new RCTs investigated the efficacy of adding adherence strategies to PFMT.

- Comparison 12 Teaching programme: Addition of biofeedback (BF)

Six new RCTs compared PFMT alone to PFMT assisted with BF (70, 73, 74, 79-81). In these RCTs, the comparison groups were similar according to the amount of supervision and the intensity of training; they differed only with regard to the addition of biofeedback.

Two RCTs investigated clinic-based BF using pressure perineometry (79) and ultrasound imaging (70). Prudencio *et al.* (79) included women with SUI while Galea *et al.* (70) also evaluated women with UUI. Duration of treatment varied from 10 weeks (70) to 3 months (79).

Four RCTs evaluated home-based biofeedback using a Vibrance device (73), EMG BF (74) and pressure BF (80, 81). Of these, three were conducted in women with SUI (73, 74, 81) and one did not specify the type of UI of women included (80). In all RCTs, the same PFMT program was used in the comparison groups and differed only with regards to the addition of BF. Treatment duration varied from 12 weeks (74), 16 weeks (73, 81) and 6 months (80).

Self-reported cure: There was no statistically significant difference in terms of the number of women who indicated they were 'cured' between PFMT alone or combined with home-based (73) or clinic-based BF (79).

Improvement: Galea *et al.* (70) reported a non-significant benefit of adding clinic-based BF as assessed with the King's health questionnaire. Using the same questionnaire, Prudencio *et al.* (79) conversely reported a significant difference between groups but did not reveal which of the three treatment arms differed. With regard to home-based BF, three of the four RCTs reported a non-significant difference between PFMT combined or not with BF. Shin *et al.* (44) did not conduct any inter-group comparisons but reported a significant reduction of incontinence only in the group which received BF.

Leakage episodes: Galea *et al.* (70) found a non-significant difference in leakage episodes in women receiving or not clinic-based BF. Likewise, non-significant benefits were found when adding home-based BF to PFMT (74).

Pad and paper towel tests: Galea *et al.* (70) reported a non-significant benefit of adding clinic-based BF to PFMT as assessed with pad-testing measurements. Also, Hirakawa *et al.* (74) found a non-significant difference between women receiving or not home-based BF.

Summary

Based on current evidence, PFMT with regular (e.g. weekly) supervision is better than PFMT with little or no supervision (**Level of Evidence: 1**). However, data were unclear as to whether supervision was more effective in individual or group settings. Sufficiently powered studies using appropriate design should be undertaken to investigate this comparison.

Based on limited evidence (6 previous RCTs and 2 new RCTs), 'indirect' methods of PFMT (e.g. the 'Paula method' or 'Sapsford' approach) are not better than direct PFMT. However, some data were confounded by differences in the amount of contact time with health professionals or the small sample size, which made it difficult to detect clinically significant differences (**Level of Evidence 2: unchanged**).

No robust recommendation can be made with regard to the type or specification of training (i.e. generic versus individualized exercises, submaximal versus near maximal contractions, daily versus three times per week, addition of upright exercise position).

There remains insufficient evidence as to whether the combination of PFMT with other treatment modalities (i.e. motor learning, abdominal- or hip-muscle training, intra-vaginal resistance device) could increase its efficacy.

With regard to clinic-based BF, new evidence (2 studies) reported no statistically significant differences between BF-assisted and non-BF groups for self-reported cure, improvement, or frequency of leakage episodes (**Level of Evidence: 1**).

Likewise, there is no statistically significant differences between home BF and non-BF groups for self-reported cure, improvement, frequency of leakage episodes and pad-test measures in women with SUI (**Level of Evidence: 2**).

Recommendations

Clinicians should offer and provide the most intensive health professional-led PFMT programme possible within service constraints. (**Grade of Recommendation: A**).

Although studies are limited, there does not appear to be clear benefit for adding other modalities (i.e. motor learning, abdominal- or hip-muscle training, intra-vaginal resistance device) to PFMT (**Grade of Recommendation: B**).

There is no clear benefit from adding clinic- (**Grade of Recommendation: A**) or home-based BF (**Grade of Recommendation: B**) to a PFMT program.

Implications for research

Comparisons of PFMT approaches are, *de facto*, comparisons of two active treatments. It is therefore difficult to determine which approach is best unless (a) the differences in outcome are large or (b) the RCTs are designed with sufficient sample size to find

small to moderate differences. Finding the best approach to PFMT remains among the highest research priorities. Future studies should be sufficiently powered to detect clinically important differences.

2.3.3 Is PFMT Better than Other Treatments?

Trials were considered for inclusion in this section if they compared PFMT with another stand-alone intervention, e.g. vaginal cones, bladder training, drug therapy. The 2013 ICI review concluded that PFMT is better than EStim, BT, or vaginal cones for women with SUI and better than duloxetine because of its side-effects. PFMT and surgery were both effective, but PFMT was recommended as first-line therapy because it is less invasive. For women with UUI or MUI, PFMT and BT were both deemed effective, with some evidence to suggest an advantage for PFMT. Evidence was sparse for a comparison between PFMT and drug therapies.

Seven new trials were found that compared PFMT to another stand-alone treatment.

PFMT was compared to vaginal cones (92-94), surgery (95), continence pessary, (96, 97), drug therapy (98), and bladder training (98). One trial was a head-to-head comparison of PFMT to surgery (95). The other trials had more than two arms. They included PFMT alone and another treatment alone, but were also designed to evaluate combinations of treatments (See Tables 10 and 13).

Trials addressed the following comparisons:

i) PFMT versus vaginal cones (VC):

One recent Cochrane review compared PFMT to VC (92). This review considered the eleven studies included in this consultation along with two other RCTs (93, 94). Moreover, our literature search revealed the study of Golmakani *et al.* (60). Details of these new trials are presented in Table 13.

ii) PFMT versus EStim:

No new trials have been published.

iii) PFMT versus Bladder training (BT):

The Kafri trial examined the effects of PFMT alone and BT alone in the context of its 4-arm design (98). All groups had significant improvement at 3 and 12 months on all parameters, including UUI episodes. But, no significant time X group interactions were found that would indicate a difference between PFMT and BT (Table 10).

iv) PFMT versus drug therapy:

The trial by Kafri and colleagues examined the effects of PFMT alone compared to anticholinergic drug therapy alone in the context of a 4-arm design (98). All groups had significant improvement at 3 and 12 months on all parameters, including UUI episodes but, no significant time X group interactions were found that would indicate a difference between PFMT and drug therapy (Table 10).

v) PFMT versus surgery:

The single trial of surgery compared PFMT to mid-urethral sling in women with stress predominant UI (95). It was a multi-site trial involving 23 medical centres and 83 physiotherapists (Table 10).

vi) PFMT vs continence pessary:

A single new trial compared PFMT to continence pessary in women with stress predominant UI (96, 97). It was a multi-site trial conducted by the Pelvic Floor Disorders Network of the National Institute on Child Health and Human Development (NICHD) (Table 10).

Quality of data

i) PFMT versus VC:

Randomization and adequate allocation concealment were reported in the three new RCTs (93, 94, 99). Of these, two indicated that outcome assessors were blinded (93, 99). In the third study, the evaluator was unblinded (94). Sample sizes were small ranging from 15 to 30 women with SUI per group (93, 94, 99). Dropout rates were higher in the VC groups in two studies (93, 99); no loss to follow up was reported in the study of Pereira *et al.* (94). Substantial attrition occurred in the study of Harvey *et al.* (93) with dropouts reaching 41% in the PFMT group and 72% in the VC group. Follow-up beyond the post-treatment evaluation was reported by Pereira *et al.* (94) in a subsequent publication with a 12-month post-treatment assessment (100).

ii) PFMT versus EStim: Not applicable.

iii) PFMT versus BT:

Risk of Bias - This trial was not a head-to-head comparison of PFMT and drug therapy, but rather a comparison of four treatment approaches including BT and combined therapy. Randomization method and allocation concealment were described. Analysis was conducted by ITT. It was not clear whether assessors were blinded.

iv) PFMT versus drug therapy:

This trial was not a head-to-head comparison of PFMT and drug therapy, but rather a comparison of four treatment approaches including BT and combined therapy. Randomization method and allocation concealment were described. Analysis was conducted by ITT. It was not clear whether assessors were blinded.

v) PFMT versus surgery:

Randomization method and allocation concealment were reported. Analysis included ITT and other approaches. It was not clear whether assessors were blinded. Fifteen women in the surgery group and 28 in the PFMT group did not start treatment after randomization. The ITT analyses did not include these individuals. Nineteen women in the surgery group and 28 in the PFMT group were lost to follow-up after starting treatment.

vi) PFMT vs continence pessary:

Randomization method and allocation concealment were reported. Analyses were performed by ITT.

Results and Summary

i) PFMT versus VCs:

As underlined in Herbison *et al.*'s meta-analysis (92) comprising 13 RCTs, most studies had a small sample size and differed according to the PFMT regimen (92). There was also limited overlap between outcomes. No statistically significant differences between PFMT and VC were found in subjective improvement or cure (reported in six RCTs) (Risk ratio (RR) for failure 0.97, 95% CI 0.75 to 1.24) (92). There were no significant differences in subjective cure (reported in five RCTs) (RR for failure 1.01, 95% CI 0.91 to 1.13) (92). Pooled data from these RCTs showed substantial heterogeneity. Likewise, inconsistency between RCTs was noted in relation to leakage episodes whereas a non-significant difference between treatments was observed (mean difference 0.00, 95% CI -0.20 to 0.20) (92). With regard to improvement in pad test, non-significant differences were found in the meta-analysis based on six RCTs (RR for failure 1.00, 95% CI 0.76 to 1.31). However, the new study of Golmakani *et al.* (60) favoured PFMT when using the 1-h pad test and the leakage index. With regard to quality of life improvement, the three new RCTs found a non-significant difference between PFMT and VC treatments (93, 94, 99). Three RCTs included in the Herbison review as well as the study of Golmakani *et al.* (60) reported the inability for some women to use VCs and adverse effects such as pain, vaginitis, bleeding and a sense of unpleasantness or inconvenience.

In the 14 RCTs (13 from the new Cochrane review, 11 of which were discussed in the previous ICI chapter edition and 1 additional RCT) that compared PFMT with VC in women with SUI, limited evidence suggests that VC appear to have similar effects or are not superior to PFMT (**Level of Evidence: 1**). There were no statistically significant differences between interventions in subjective improvement or cure (reported in six RCTs), subjective cure (reported in five RCTs), or leakage episodes per day (reported in four RCTs), and no improvement in the pad test (reported in six RCTs). The additional RCT favoured PFMT using both the 1-h pad test and the leakage index. VC treatment may be inappropriate in some cases due to the inability to use and potential side effects as reported in four RCTs (i.e. pain, vaginitis, bleeding and a sense of unpleasantness or inconvenience).

ii) PFMT versus EStim:

No new trials were found. Previous pooled data demonstrated that self-reported cure and cure/improvement were more likely in PFMT than in EStim groups (**Level of Evidence: 1**).

iii) PFMT versus BT:

There is evidence for an advantage of PFMT over BT for women with SUI (**Level of Evidence: 2**).

There does not appear to be a significant difference between PFMT and BT in UUI and MUI women (**Level of Evidence: 2**).

iv) PFMT versus drug therapy:

There is weak evidence that PFMT is more beneficial than drug therapy, but not enough evidence to change previous recommendations (**Level of Evidence: 2**).

v) PFMT versus surgery:

On the primary outcome, PGI-I at 12 months, perceived improvement was significantly greater in the surgery group compared to the PFMT group: 90.8% of women in the surgery group reported being “much better” or “very much better” compared to 64.6% in the PFMT group. Change in the UDI UI domain and OAB domain were also significantly greater with surgery and a higher proportion of women in the surgery group had subjective and objective cure.

The one new trial of PFMT compared to surgery appeared well-designed and adequately powered, providing evidence that mid-urethral sling may be more effective than PFMT for treatment of SUI in women (**Level of Evidence: 2**).

vi) PFMT vs continence pessary:

The PFMT/behavioural group had better outcomes on the PFDI SUI subscale and greater patient satisfaction. The groups were not significantly different on the PGI-I, UI episode frequency, or outcome measures, including domains of the PFDI and PFIQ.

There may be some benefit for PFMT over continence pessary alone, the evidence is not strong enough to recommend one treatment over the other (**Level of Evidence: 2; Grade of Recommendation: D**).

Recommendations

For women with SUI:

- PFMT and VC are both effective as conservative therapy, although PFMT is better because inability of use and side effects are experienced with VC in some women (**Grade of Recommendation: B**).
- PFMT is better than EStim as first line conservative therapy (**Grade of Recommendation: B**).
- PFMT is better than BT as first line conservative therapy (**Grade of Recommendation: B**).
- PFMT and drug therapy are both effective as first line therapy, although PFMT is better because of side effects experienced with drug therapy (**Grade of Recommendation: B**).

- Surgery is more effective than PFMT, but potential benefit should be weighed against potential adverse events. PFMT should be offered as first line therapy due to its being less invasive. (**Grade of Recommendation: B New**).
- PFMT and continence pessary are both effective in first line conservative therapy (**Grade of Recommendation: B New**).

For women with SUI or MUI:

- VC do not appear to be better than PFMT in the treatment of UI. PFMT should be recommended as first-line conservative therapy (**Grade of Recommendation: B**).

VC with supervised training sessions by a trained health professional can be offered to women who can and are prepared to use them (**Grade of Recommendation: B**).

VC may be inappropriate for some women due to inability to insert or retain the cone or because of side effects and discomfort.

For women with UUI or MUI:

- PFMT and BT are effective first-line conservative therapy (**Grade of Recommendation: B**).
- PFMT is better than oxybutynin as first line therapy (**Grade of Recommendation: B**).

For women with UUI

- PFMT and BT are effective first line conservative therapy (**Grade of Recommendation: B**).

Research recommendation

Larger, good quality trials are needed to address each of the above comparisons if these are of interest to women. In planning comparisons researchers should consider carefully the potential impact of different levels of supervisory intensity between groups, particularly in comparisons of conservative therapies.

Table 10 Summary of data on PFMT vs other treatments

Author, year	Comparator	N	Study Population	Intervention	Outcomes/Results	Notes
Kafri 2013 (1)	Drug therapy (anticholinergic) BT	N=164 DT: 42 BT: 41 PFMT: 40 Combined: 41	Women with UUI, No SUI (45-75 years)	PFMT based on National Institute for Health and Clinical Excellence (NICE) recommendations. Included behavioral guidance 3 sets of 8-12 slow maximal contractions sustained for 6-8 s in different positions. Daily home-based exercise prescribed.	Number of voids and UUI episodes, QOL-rul, Urogyn VAS. All groups had significant improvement at 3 and 12 months on all parameters (p<0.001). No significant timeXgroup interactions (except favoring combination group)	Comparison was in the context of 4-arm trial, including arm for combined Tx. Randomization method and allocation concealment described. ITT analysis Not clear whether assessors were blinded
Richter 2010 (2) Kenton 2012 (3)	Intravaginal pessary	N=446 PFMT: 146 Pessary: 149 Combined: 151	Women with predominant SUI (18+ years)	12 weeks of supervised PFMT and behavioral strategies (PFM pre-contraction for SUI; urge suppression for concomitant UUI). Implemented in 4 visits at 2-week intervals. Home exercise: written prescriptions X3 daily exercise between visits.	Primary: PGI-I and SUI subscale of the PFDI at 3 months (FU 6 & 12 months) Secondary: Satisfaction, PFDI, PFIQ PFMT/behavioral group had better outcomes on the PFDI SUI subscale (49% vs 33% reporting no bothersome SUI symptoms, p=0.006) and greater satisfaction (75% vs 63%, p=0.02). Groups not significantly different on the PGI-I (49% vs 40% "much better" or "very much better," (p=0.09), UI episodes on bladder diary, or other outcome measures including other domains of the PFDI and PFIQ.	Comparison was in context of 3-arm trial, including arm for combined Tx Multi-site trial Randomization method and allocation concealment reported ITT analysis

Author, year	Comparator	N	Study Population	Intervention	Outcomes/Results	Notes
Labrie 2013 (4)	Mid-urethral sling	N=460 PFMT: 230 Surgery: 230	Women with predominant SUI (35-80 years)	Supervised, somewhat individualized program conducted by 83 PTs according to Dutch guidelines. Treatments given at 1-week or 2-week intervals with an intended 9 sessions in 9-18 weeks. Goal to build up to 8 to 12 maximal contractions X3 per day. Use of touch, tapping, massage, BF, or functional electrical stimulation allowed to increase muscle awareness as needed.	Assessed at 12 months Primary: PGI-I, 90.8% in surgery group were "much better" or "very much better" vs 64.4% in PFMT. Secondary: UDI, IIQ, PGI-S Both groups had significant improvement in UDI and IIQ domain scores. Change in UDI greater for surgery than PFMT on UI and OAB domains (P<0.001, .02) Subjective cure: (single question) 85.2% in surgery vs 53.4% in PFMT Objective cure: (cough test) 76.5% in surgery vs 58.8% in PFMT After 12 months, 99 women (49.0%) had crossed over to surgery after a mean 31.7 weeks.	Multi-site trial (23) Randomization computerized on central server Allocation not concealed Not clear whether assessors were blinded. 65 adverse events reported - all in surgery group. Analysis included modified ITT and other approaches. 15 in surgery group and 28 in PFMT group did not start treatment after randomization. 19 in surgery group and 28 in PFMT group were lost to follow-up after starting Tx.

1. Kafri R, Deutscher D, Shames J, Golomb J, Melzer I. Randomized trial of a comparison of rehabilitation or drug therapy for urgency urinary incontinence: 1-year follow-up. *Int Urogynecol J.* 2013;24(7):1181-9.
2. Richter HE, Burgio KL, Brubaker L, Nygaard IE, Ye W, Weidner A, *et al.* Continence pessary compared with behavioral therapy or combined therapy for stress incontinence: a randomized controlled trial. *Obstet Gynecol.* 2010;115(3):609-17.
3. Kenton K, Barber M, Wang L, Hsu Y, Rahn D, Whitcomb E, *et al.* Pelvic floor symptoms improve similarly after pessary and behavioral treatment for stress incontinence. *Female Pelvic Med Reconstr Surg.* 2012;18(2):118-21.
4. Labrie J, Berghmans BL, Fischer K, Milani AL, van der Wijk I, Smalbraak DJ, *et al.* Surgery versus physiotherapy for stress urinary incontinence. *N Engl J Med.* 2013;369(12):1124-33.

2.3.4 Does the Addition of PFMT to Other Treatments Add Benefit?

Six trials addressed the following comparisons (Table 11):

i) PFMT+VC vs VC: Both the Herbison *et al.* meta-analysis (92) and the ICI 5th edition (2) included two studies comparing combined PFMT/VC versus VC. No new RCTs with the same comparators were identified.

ii) PFMT + EStim vs EStim: A single trial examined the effects of adding PFMT to vaginal EStim in 48 women with SUI (101). No significant differences were found between the groups.

iii) PFMT+ BT vs BT: Two trials examined the effects of adding PFMT to BT, one in 108 women with SUI, UUI, or MUI (102), the other in 164 women with UUI (no SUI) (98). In the first, significantly more patients in the combined therapy group reported cure or improvement and greater improvements on several secondary outcomes. In the second trial, all groups had significant improvement, but there were no significant interactions indicating differential group effects.

iv) PFMT + drug therapy vs drug therapy alone: A single trial examined the effects of adding PFMT to intravaginal oestriol in 206 postmenopausal women with SUI and vaginal atrophy (103). Combined therapy resulted in significantly greater improvement than oestriol only.

v) PFMT + continence pessary vs continence pessary:

A single trial examined combined pessary + PFMT to pessary alone in 446 women with stress predominant UI (97). The combined therapy group had significantly better outcomes on the PGI-I and the PFDI and reported greater satisfaction with treatment.

vi) PFMT + surgery vs surgery:

A single, multi-centre trial examined the effects of perioperative behavioural and pelvic floor muscle training (BPMT) in 374 women undergoing surgery to treat both apical prolapse and SUI (104). The group receiving BPMT resulted in no greater improvements in urinary symptoms compared to usual peri-operative care at 6 or 24-month follow up.

Summary

The literature on the effect of adding PFMT to another stand-alone therapy remains relatively small.

There is no evidence of benefit in adding PFMT to VC in women with SUI (**Level of Evidence: 2**).

There may be some benefit for adding PFMT when using a continence pessary (**Level of Evidence: 2**).

PFMT may add benefit in terms of reducing SUI over intravaginal estrogen alone when treating women with vaginal atrophy (**Level of Evidence: 2**).

There is some evidence that there may be benefit in adding PFMT to BT (**Level of Evidence: 2**).

There is no evidence of improved outcomes with perioperative PFMT for women undergoing surgery for apical prolapse and SUI, or for adding PFMT to EStim in women with SUI (**Level of Evidence: 2**).

Recommendation

In women using VC, it does not appear to help to add PFMT (**Grade of Recommendation: C**).

For the treatment of SUI, UUI, or MUI in women, consider a combination of PFMT and BT rather than BT alone (**Grade of Recommendation: C**).

For treatment of UUI (tolterodine) but not for SUI (duloxetine), consider adding PFMT to drug therapy (**Grade of Recommendation: B**),

When treating women with SUI and vaginal atrophy, consider combining PFMT and intravaginal oestrogen over estrogen alone (**Grade of Recommendation: C New**).

Note, many of these recommendations are based on single RCTs of variable quality. Larger, good-quality RCTs are needed to address each of the above comparisons. Furthermore, these studies examine the effects of combining therapies as an initial approach. Less is known about the effects of combining therapies in a stepped fashion when women do not achieve the desired outcomes with a single therapy (i.e. active PFMT than resisted PFMT with cones such as in progressive muscle training overload).

Table 11 Summary of data on PFMT + another treatment vs the other treatment

Study	Comparator	N	Study Population	Intervention	Outcomes/Results	Notes
Richter 2010 (1)	Continence pessary alone	N=446	Women with stress predominant UI	Pessary + behavioral training Behavioral training program - supervised PFMT + behavioral strategies: PFMT pre-contraction for SUI and urge suppression for concomitant UUI. Treatment implemented in 4 visits at 2-week intervals and included written prescriptions for home exercise X3 daily between visits.	Primary: PGI-I and SUI subscale of UDI at 3 months Results - Combined therapy group had significantly better outcomes on the PGI-I (53.3% vs 39.6% reporting "much better" or "very much better," p=.02) and the PFDI (44.0% vs 32.9% reporting no bothersome SUI symptoms (p=.05). Combined group also reported greater satisfaction with treatment (78.7% vs 63.1%, p=.003). The groups were not significantly different on number of UI episodes on bladder diary. Group differences not sustained to the 12-month follow up.	Multi-site trial conducted by the NICHD Pelvic Floor Disorders Network with randomization to 3 arms: pessary alone, behavioral training alone, combined Tx Data quality – Randomization method and allocation concealment were reported. Analysis conducted by ITT
Barber 2014 (2)	Surgery alone for prolapse and SUI	N=374	Women undergoing surgery to treat both apical vaginal prolapse and SUI	Surgery + perioperative behavioral and pelvic floor muscle training (BPMT) PFMT program - Single session 2-4 weeks prior to surgery; 4 postoperative visits (2, 4-6, 8, & 12 weeks) Individualized, supervised program of progressive home PFME, education on healthy bladder and bowel habits, and behavioral strategies to reduce UI episodes (PFM pre-contraction for SUI, urge suppression for UUI) Home PFME prescribed for X3 daily with duration increasing to 10 sec.	Primary: UDI at 6 months Results – Perioperative BPMT not associated with greater improvements in urinary symptoms at 6 months or 24-month follow-up	Multi-center 2X2 factorial trial with 2 distinct randomizations: First: to perioperative BPMT or usual care Second: to one of 2 surgical approaches for prolapse, each with concomitant retropubic midurethral sling for SUI. Data quality – Randomization method and allocation concealment reported.
Capobianco 2012 (3)	Intravaginal estrogen alone (estriol ovules, 1m daily for 2	N=206	Postmenopausal women with SUI and vaginal atrophy, no DO	Estrogen + PFMT with EStim (per Castro, 25) PFMT was for 6 months and included EStim. Further details lacking, but per	Outcome based on change in patient rating of SUI as none, mild, moderate, or severe before and after 6 months of treatment.	Data quality - Randomization method not described. Group allocation was concealed. Analysis was by ITT AEs were reported

Study	Comparator	N	Study Population	Intervention	Outcomes/Results	Notes
	wks, then 2.wk for 6 months)			reference to a previous article, PFMT was conducted in 45-minute group sessions X3 per week under the supervision of a physiotherapist.	Results - Combined therapy resulted in significantly greater improvement than estriol only. 73.5% (61/83) of treated and 9.7% (10/103) showed improvement in UI (p<.01)	Not clear all women actually had SUI.
Kafri 2013 (4)	BT alone	N=164	Women with UUI, no SUI (ages 45-75)	Bladder training + PF rehab and behavioral. PFMT program based on the National Institute for Health and Clinical Excellence (NICE) recommendations. Women practiced 3 sets of 8-12 slow maximal contractions sustained for 6-8 s in different positions. Daily home-based exercise was prescribed, and urge suppression using PFM contraction was taught.	Number of voids and UUI episodes, voids/24 hours, QoL-r-UI, Urogyn VAS, number of pads Results - analysis was by repeated measures ANOVA with all four groups, including tests for main effects and group X time interactions. However, statistical analysis did not include comparisons between individual groups. All groups had significant improvement at 3 and 12 months on all parameters, (p<.001) but there were no significant interactions. UI episodes decreased by 1.7/day in BT and 4.0/day in combined therapy, but a test of this difference was not conducted. Only CPFR showed significant reduction in voids/24 hours.	Comparison was in context of 4-arm trial: BT alone, PFMT alone, drug therapy alone, and combined Tx. Data quality –Randomization method and allocation concealment described. Analysis conducted by ITT. Not clear whether assessors were blinded.
Kaya 2015 (5)	BT alone	N=108	Women with SUI, UUI, MUI	BT + PFMT for 6 weeks High-intensity PFMT program conducted in 4 visits across 6 weeks by an experienced physical therapist. Home-based exercise regimen initiated with 5 sets of exercises per day and progressed to 30 sets per day (600 PFM contractions).	Primary: global rating of improvement on a 4-point scale (worse, unchanged, improved, cured). Secondary: UI severity, symptom distress, QOL, UI episodes, voids/day. Results – Significantly more patients in the combined therapy group reported cure or improvement (100% vs 82.7%, p=.001). Greater improvements observed for combined therapy on secondary outcomes, including severity of UI (ISI; p=.001),	Data quality –Randomization method and allocation concealment described. Analysis conducted by ITT. Not clear whether assessors were blinded.

Study	Comparator	N	Study Population	Intervention	Outcomes/Results	Notes
					UDI-6 (p=.001), IIQ-7 (p=.005), and incontinent episode frequency per bladder diary (p=.024).	
Furst 2014 (6)	EStim alone Vaginal probe; two 30-min sessions per week; frequencies of 4Hz and 50Hz; fixed intensity (20mA); 4 s stimulation/rest cycles	N=48	Women with SUI (Mean age 49.6)	EStim + PFMT for 3 months PFMT program – individually designed by PT, 2 30-min sessions per week. PFMT and EStim conducted on alternate days. No home PFME program	Improvements in urinary symptoms, IEF per bladder diary, satisfaction (perception of need or not to repeat or change Tx); assessments at 3, 12 and 96 months. Results – Both groups showed improvement in leakage episodes and voiding intervals. No significant between group differences.	Data quality – Randomization method described; allocation concealed. Analysis not conducted by ITT (only included patients who had not received any additional therapy)

- Richter HE, Burgio KL, Brubaker L, Nygaard IE, Ye W, Weidner A, *et al.* Continence pessary compared with behavioral therapy or combined therapy for stress incontinence: a randomized controlled trial. *Obstet Gynecol.* 2010;115(3):609-17.
- Barber MD, Brubaker L, Burgio KL, Richter HE, Nygaard I, Weidner AC, *et al.* Comparison of 2 transvaginal surgical approaches and perioperative behavioral therapy for apical vaginal prolapse: the OPTIMAL randomized trial. *JAMA.* 2014;311(10):1023-34.
- Capobianco G, Donolo E, Borghero G, Dessole F, Cherchi PL, Dessole S. Effects of intravaginal estriol and pelvic floor rehabilitation on urogenital aging in postmenopausal women. *Archives of gynecology and obstetrics.* 2012;285(2):397-403.
- Kafri R, Deutscher D, Shames J, Golomb J, Melzer I. Randomized trial of a comparison of rehabilitation or drug therapy for urgency urinary incontinence: 1-year follow-up. *Int Urogynecol J.* 2013;24(7):1181-9.
- Kaya S, Akbayrak T, Gursen C, Beksac S. Short-term effect of adding pelvic floor muscle training to bladder training for female urinary incontinence: a randomized controlled trial. *International Urogynecology Journal.* 2015;26(2):285-93.
- Furst MC, Mendonca RR, Rodrigues AO, Matos LL, Pompeo AC, Bezerra CA. Long-term results of a clinical trial comparing isolated vaginal stimulation with combined treatment for women with stress incontinence. *Einstein.* 2014;12(2):168-74.

3. WEIGHTED VAGINAL CONES (VC)

Weighted vaginal cones (VC) were developed as a method for testing PFM function and to provide progressive muscular overload during PFM strengthening exercises (105). In theory, when a cone is inserted into the vagina, the sensation of 'losing the cone' provides strong sensory feedback that prompts the PFM to contract to prevent the cone from slipping out. Women start in a standing position with a weighted cone held inside the vagina for at least one minute, incrementally adding time and increased cone weight whilst standing or walking. The goal is to walk around for 20 minutes without losing the cone; the gradual increase in cone weight maintains muscle overload over the course of the exercise programme.

There are various cone weights and sizes (Figure 1). However, the effectiveness of the VC training method is unclear. Because orientation of the vagina is not completely vertical, some women can retain the cone without actually contracting the pelvic floor. Radiology has also demonstrated that the cones can rest in a transverse position (106). Depending on the axis of the vagina, women need to produce different force intensities to retain the cone. Thus, using VC as a measure of PFM function may not be a valid method. Finally, some women may find it impossible to insert the cones due to a narrowed vaginal opening or, conversely, to retain it due to an enlarged vaginal opening, prolapse, or an insufficient PFM contraction, one incapable of holding even the lightest cone.

This section examines the evidence for VC in the prevention and treatment of UI in women. Questions addressed:

- Are VC better than no treatment, placebo or control for the prevention of UI?
- Are VC better than no treatment, placebo or control for the treatment of UI?

- Are VC as effective as other treatments for the treatment of UI?
- Are VC combined with PFMT better than PFMT alone for the treatment of UI?

3.1. Prevention

No previous (prior to last Consultation) or new RCT investigating either the primary or secondary prevention effects of training with VC for women with UI were found.

3.2. Treatment

A Cochrane review specifically addressing the effectiveness of VC in the treatment of UI was updated in March 2013 (92) This meta-analysis and four new studies form the basis of this subsection (79, 99, 107, 108). Table 12 illustrates the number of studies included in the 5th ICI and in the Cochrane review of Herbison *et al.* (92) as well as the new studies identified in the current update. Characteristics of each RCT not included in the previous ICI are presented in Table 13.



Figure 1 Weighted vaginal cones

Table 12 Studies of VC included in the previous review (5th ICI), in the Cochrane meta-analysis of Herbison *et al.* and current update (6th ICI)

	Studies included in the previous review (5th ICI)	Studies included in the Cochrane review of Herbison <i>et al.</i>	New studies identified in this update (6th ICI)
PFMT vs VCs (<i>section II.2.3.3i</i>)	11	13	1
PFMT/VCs vs VCs (<i>section II.2.3.4i</i>)	2	2	0
VCs vs no treatment, placebo or control treatments	4	5	0
VCs vs EStim	5	6	0
PFMT/VCs vs PFMT	2	2	3

Table 13 Summary of data on VC

Author, year	Comparator	N	Study population	Modality details or parameters	Outcomes/Results	Follow-up	Notes
Golmakani 2014 (1)	PFMT (30) vs VCs (30)	60	Women with SUI (at least 3 episodes per week)	<p><u>Behavioral Intervention including PFMT</u>: 10 to 40 repetitions daily, Knack and urge, suppression technique, Bladder training</p> <p><u>VCs</u>: 6 cones (20 to 70 g) Cone held passively (without PFM contraction) for 15 min twice a day Active PFM contractions with the cone inserted (30 x 5-s contractions) Supervision included weekly phone call and in-person assessment every 2 weeks</p>	<p><u>Detection SUI severity questionnaire (mild/moderate/severe)</u>: Sign. reduction in both groups ($p \leq 0.04$) Non-sign. difference btw treatments ($p=0.52$)</p> <p><u>Leakage index</u>: Sign. reduction in both groups PFMT pre-Tx 16.2±4.5 to post-Tx 3.2±0.15 ($p < 0.001$) VCs pre-Tx 16.6±4.8 to post-Tx 6.1±2.5 ($p < 0.001$) Greater changes in PFMT than VCs ($p=0.001$)</p> <p><u>7-day diary</u> Sign. reduction in both groups PFMT pre-Tx 1.2±1.3 to post-Tx 0.5±0.5 ($p=0.001$) VC pre-Tx 1.0±1.0 to post-Tx 0.8±0.7 ($p=0.001$) Non-sign. difference btw treatments ($p=0.52$)</p> <p><u>1-h pad test</u> Sign. reduction in both groups PFMT pre-Tx 35.8±6.8 to post-Tx 12.8±3.8 ($p < 0.001$) VC pre-Tx 36.1±7.1 to post-Tx 19.5±5.2 ($p < 0.001$) Greater change in PFMT than VC ($p=0.008$)</p> <p><u>Incontinence QoL and King's Health questionnaires</u>: Sign. improvement in both groups. Non-sign. difference btw treatments</p>	12 weeks of treatment, treatment, outcomes assessed post-Tx	<p>Dropouts: VCs 5/30 PFMT 4/30</p> <p>Side effects reported for VCs: Candida vaginitis and difficulty with the device reported in 5 women</p>

Author, year	Comparator	N	Study population	Modality details or parameters	Outcomes/Results	Follow-up	Notes
Harvey 2006 (2) - abstract	PFMT (19) vs VCs (25)	44	Women with urodynamically proven SUI	PFMT: 10 weekly sessions of biofeedback with trained nurse VCs: Hold for 15 min daily	<u>Cure (based on pad test):</u> PFMT 2/19 VCs 2/25 Women from both groups decreased their pad weight, but the difference btw groups was non-sign. (p=.39) PFMT:6.0 g, 95% CI -2.3 to 14.3 VCs: 3.0 g 95% IC 0.3 to 5.7 <u>UDI-6:</u> All women had reduced scores, but the changes were neither clinically nor statistically significant I-QoL: Subjects in both arms showed an improvement on I-QoL, with no difference btw groups (p=0.86)	10 weeks, outcomes assessed at 6 months post-Tx	Dropout PFMT: 12/29 VCs 18/25 High dropout rate- No potential explanations provided
Pereira 2012 (3)	VCs (15) vs PFMT (15) vs Control (15)	45	Postmenopausal women with SUI (at least 1 episode of urinary leakage in the previous month)	VCs: 12 sessions, 2x 40 min/week, 5 cones 20-100 g, it is reported that the same exercises as the PFMT group were achieved with the cone inserted PFMT: 100 contractions/session, 6 weeks with twice-weekly sessions of 40 min, 3s contraction/6s rest and some help for 5-10s/ 10-20s rest Control: no treatment for 6 weeks, after which they received physiotherapy	<u>1-h pad test:</u> VCs pre-Tx7.36±8.76 to FU 0.36±0.38 (p<.001) PFMT pre-Tx3.70±4.35 to FU 0.19±0.27 (p<.001) Control pre-Tx3.87±5.56 to post Tx 3.65±4.94 (p=.19) Non-significant difference btw the VC and PFMT groups (p=.10) Significant difference btw the VCs and control group (p<.001) <u>King's Health Questionnaire</u> (quality of life - incontinence impact) VCs pre-Tx75.56±32.0 to FU 17.78±17.2 (p<.001) PFMT pre-Tx55.82±39.32 to post-Tx 7.69±14.6 (p<.001) Control pre-Tx59.98±33.81 to post Tx 57.84±29.48 (p=.39) Non-significant difference btw the VC and PFMT groups (p=.32) Significant difference btw the VC and control groups (p<.001)	6 weeks of treatment, outcomes assessed 6 weeks after treatment	Dropout VCs: 0/15 PFMT:2/15 Control: 2/15 No adverse effects reported in the three groups

Author, year	Comparator	N	Study population	Modality details or parameters	Outcomes/Results	Follow-up	Notes
Porta Roda 2013 (4) abstract and poster	VC+PFMT (37) vs PFMT (33)	70	SUI or stress predominant MUI in parous women	VCS (vaginal sphere, pelvic gym) and PFMT twice/day, 5 days/week PFMT same as above Both treatment arms were supervised (5 sessions)	<u>Subjective cure/improvement</u> VC+PFMT 24/30 PFMT 26/35 RR 1.08 95% CI 0.83 to 1.40 (non-sign. difference btw groups) <u>ICIQ-UI-SF:</u> Sign. improvement in both groups (improvement occurred earlier in the PFMT+VC group) VC+PFMT pre-Tx 8.6±2.6 to post-Tx 4.8±3.5 (p<0.01) PFMT pre-Tx 8.9±2.3 to post-Tx 5.7±3.5 (p<0.01) PFMT+VCs showed higher improvement than PFMT at the 3-month visit (p<0.05) (non-sign. for the 6-month visit) <u>1-hour pad-test:</u> Sign. improvement in the PFMT+VC group pre-Tx 3.3±4.8 to post-Tx 1.9±3.7 (p<0.01) Non-sign. improvement in the PFMT group PFMT pre-Tx 1.5±3.0 to post-Tx 1.9±3.3 (non-sign.) Non-sign. difference btw treatments <u>King's Health Questionnaire (KHQ):</u> Non-sign. difference from baseline and btw treatment PFMT+VC showed higher adherence to treatment than PFMT alone	6 months of treatment, outcomes assessed at each visit as well as post-Tx	Dropouts: PFMT +VCs: 2/37 PFMT: 3/33 Mild adverse events at the beginning of treatment (i.e. second treatment visit). 4 in PFMT + VCs 1 in PFMT No events were reported in the subsequent visits The nature of the events is not specified
Prudencio 2014 (5) abstract	PFMT (51) vs PFMT+VCs (55) vs PFMT+BF (50)	156	SUI women	3 groups received: 20 sessions of 45 min (twice a week for 3 months) PFMT included isolated rapid and sustained contractions and functional exercises (differentiating just the use or not of associated instruments) (no further information was provided on VCs in the abstract)	<u>Cure of SUI</u> PFMT+VCs 30/55 PFMT 20/51 RR 1.39 95% CI .91 to 2.11 <u>KHQ:</u> All groups significantly improved from baseline (p<0.001) PFMT pre-Tx 74±18 to post-Tx 43±17 PFMT+VCs pre-Tx 62±17 to post-Tx 31±8 Difference btw groups (p<0.001). It is not specified which of the 3 groups differed	3 months of treatment, outcomes assessed post-Tx	Dropout not specified

Author, year	Comparator	N	Study population	Modality details or parameters	Outcomes/Results	Follow-up	Notes
Santos 2009 (6)	VCs (21) vs EStim (24)	45	Women with SUI (urodynamic diagnosis)	VCs: Participants attended 2 sessions of 45 min per week. Cones 20-100 g EStim: 2x 20-min weekly session for 4 months supervised by a physiotherapist. Intravaginal EStim, Frequency 50 Hz, Intensity 10-100 mA and pulse duration 1 ms	<u>Subjective cure or improvement:</u> VCs 13/21 vs EStim 14/24 RR: 1.06 (0.66-1.71) <u>Leakage episodes per day:</u> VCs 0.21 (0.24) vs EStim 0.33 (0.79) Mean difference -0.12 (-0.45 to 0.21) <u>Improvement on pad test:</u> VCs 10/21 vs EStim 12/24 RR 0.95 (0.52- 1.73)	4 months of treatment with outcomes assessed post-Tx	No loss to follow-up
Stupp 2011 (7) abstract	PFMT (22) vs PFMT+ proprioception and awareness training (including VC) (22)	44	Women with SUI or MUI	PFMT (3 sets of 8 contractions. 6s contraction: 8s rest and 3 fast contractions) verbal commands given by a physiotherapist PFMT + proprioception and awareness training, including 3 additional sessions with a physiotherapist a) session 1: education (anatomy and function of the PFM), diaphragmatic breathing, visualization with a mirror b) session 2: proprioceptive technique with a VC c) session 3: PFMT contraction during increases in intra-abdominal pressure (Knack)	<u>Subjective cure (SUI during cough):</u> Combined treatment group 12/21 PFMT alone 7/21 RR 1.71 95% CI 0.84 to 3.48 <u>KHQ:</u> Sign. improvement in several domains of the KHQ in women in the combined treatment. Non- sign. improvement in the PFMT group Statistical comparisons btw group are not reported	12 weeks of treatment outcomes assessed post-Tx	Dropouts PFMT: 1/22 PFMT + proprioception and awareness training 1/22

1. Golmakani N, Khadem N, Arabipoor A, Kerigh BF, Esmaily H. Behavioral Intervention Program versus Vaginal Cones on Stress Urinary Incontinence and Related Quality of Life: A Randomized Clinical Trial. *Oman Med J.* 2014;29(1):32-8.
2. Harvey MA, Johnston SL. A randomized, single-blind, prospective trial comparing pelvic floor physiotherapy with biofeedback versus weighted vaginal cones in the treatment of female genuine stress urinary incontinence: a pilot study. *Int J Urogyn J.* 2006;17(Suppl 2):S235-S6.
3. Pereira VS, de Melo MV, Correia GN, Driusso P. Vaginal cone for postmenopausal women with stress urinary incontinence: randomized, controlled trial. *Climacteric.* 2012;15(1):45-51.
4. Porta Roda O, Simo Gonzalez M, Reula Blasco MC, Diaz Lopez MA, Diaz Bellido P, Vara Paniagua J. Use of a vaginal spheres device in the conservative treatment of stress urinary incontinence: a randomized controlled trial *Neurourol Urodyn.* 2013;32(6):661-3.

5. Prudencio C, Barbosa A, Derobio AL, Anezio A, Vesentini G, Almeida AP, editors. Comparison of three physiotherapy methods for treatment of stress urinary incontinence: impact in quality of life and muscle function. Proceedings of the 44th Annual Meeting of the International Continence Society (ICS), 2014 Oct 20-24, 2014; 2014; Rio de Janeiro, Brazil.
6. Santos PF, Oliveira E, Zanetti MR, Arruda RM, Sartori MG, Girao MJ, *et al.* [Electrical stimulation of the pelvic floor versus vaginal cone therapy for the treatment of stress urinary incontinence]. *Rev Bras Ginecol Obstet.* 2009;31(9):447-52.
7. Stupp L, Yamamoto D, Fonseca T, Resende AM, Ploger C, Oliveira E. Proprioception and awareness training prior pelvic floor muscle exercises for treatment of urinary incontinence: randomized controlled trial. *Int Urogyn J.* 2011;22(Suppl 1):S162-S4.

3.2.1 Are VC Better than No Treatment, Placebo or Control Treatments?

The meta-analysis published by Herbison *et al.* (92) comprised 5 RCTs comparing VC to a control treatment. Except for Pereira *et al.* (94) (presented in Table 13), these studies were part of the ICI previous edition. Our literature search identified no further RCT.

Quality of data

In the study of Pereira *et al.* (94), adequate allocation concealment and randomisation was reported. The evaluator was however not blinded to patient assignment. No attrition was reported in the VC group while 13% dropped out from the control group. No adverse effects were reported in this RCT.

Results

As discussed in Herbison *et al.*'s meta-analysis (92), women in the VC groups were more likely to report they were *cured* than the controls (RR for failure 0.84, 95%CI 0.76 to 0.94). VCs were also better than control treatment in the *subjective reporting of cure or improvement* (RR for failure 0.72, 95%CI 0.52 to 0.99). Further, Pereira *et al.* (94) reported better incontinence-related QOL and a significant reduction in the 1-h pad test for women in the VC group compared to the control treatment.

Summary

VCs with supervised training sessions by a trained health professional are better than control treatments for subjective reporting of *cure* or *cure/improvement* and the QOL impact on the treatment of SUI (**Level of Evidence: 1**).

However, VC treatment may be inappropriate in some cases due to potential reported side effects (92).

Recommendations

For women with SUI, VCs with supervised training sessions by a trained health professional may be offered as a first-line conservative therapy to those who can and are prepared to use them (**Grade of Recommendation: B**).

Trained health professional assessment is recommended. VC may be inappropriate in some cases due to inability to insert or retain the cone or because of side effects and discomfort. (**Grade of Recommendation: D**).

3.2.2 Are VC As Effective as Other Treatments?

VC have been compared with PFMT and EStim, but not with other therapies such as drug treatment, BT or surgery.

i) VC versus PFMT

This comparison is addressed in Section II.2.3.3. Details of the VC and PFMT programs for each trial are presented in Table 13.

ii) VC versus EStim

Since the last ICI edition, a meta-analysis update was published. (92) It comprised the same trials as in the ICI 5th edition as well as the study of Santos *et al.* (109) (presented in Table 13). Our literature search revealed no further trials.

Quality of data

i) VC versus PFMT: See Section II.2.3.3.

ii) VC versus EStim

In the study of Santos *et al.* (109), participants were randomly assigned to treatments while blinding of assessors and allocation concealment were not clearly reported. No losses to follow-up were reported (109).

Results

i) VC versus PFMT: See Section II.2.3.3.

ii) VC versus EStim

As reported in the Herbison *et al.* meta-analysis (92), there was no statistically significant difference between VC and EStim in the pooled data of three trials with regard to self-reported *cure* (RR for failure 1.26 95% CI 0.85 to 1.87). Non-significant differences also emerged from the pooled data of three RCTs with respect to improvement in pad test (RR 1.21 95%CI 0.90 to 1.63) and leakage episodes (Mean difference -0.05 95% CI -0.27 to 0.17). Herbison *et al.* (92) reported discomfort or side effects associated to both EStim and VC (VC: abdominal pain, vaginitis, bleeding, motivational problems and difficulties using the VC. EStim: tenderness and bleeding, discomfort or motivational and other difficulties in using the EStim).

Summary

The meta-analysis of Herbison *et al.* (92) including six RCTs revealed no significant difference between VCs and EStim in terms of *self-reported cure*, *cure/improvement*, improvement in pad test or the number of leakage episodes; both the VC and EStim groups reported adverse events.

VC and EStim seem equally effective in the treatment of SUI and MUI. (**Level of Evidence: 1**). Side effects and discomfort appear to limit their utility in clinical practice. (**Grade of Recommendation: D**).

3.2.3 Are VC Combined with PFMT Better than PFMT Alone?

Both Herbison *et al.*'s meta-analysis(92) and the ICI 5th edition relied on two RCTs comparing combined PFMT/VC to PFMT alone. Our search revealed three additional studies presented as published abstracts (79, 107, 108). Details of the PFMT/VC and PFMT are presented in Table 13.

Quality of data

Limited information on method and results were available from these published abstracts (79, 107, 108). Although participants were randomly assigned, no information on allocation concealment and blinding of assessors was provided. The sample sizes were relatively small with no more than 39 patients per treatment arm. Dropouts ranged from 0 (79) to 13% (108) in the PFMT group and 0% (79, 108) to 5% (107) in the combined treatment.

Results

Including two RCTs, Herbison's meta-analysis reported no significant differences between PFMT/VC and PFMT alone for either *cure* or *cure/improvement*. Likewise, the results from the three additional RCT failed to show any significant difference between treatments in terms of *subjective cure* (79, 108) and *subjective cure/improvement* (107). Porta Roda *et al.* reported that improvement occurred earlier in the combined group (after 3 months of treatment) but this was not maintained at the end of the treatment (6 months of treatment) (107).

Summary

Limited evidence suggests no benefit from adding VCs to PFMT for women with SUI (**Level of Evidence: 2**).

Recommendations

No recommendation is possible for combination intervention. Adequately powered studies are needed to confirm or refute the advantages of adding VCs to PFMT (No Recommendation).

3.3. Other Lower Urinary Tract Symptoms (LUTS)

In the previous ICI, two RCTs reported data on the efficacy of VC on urgency and nocturia (Williams *et al.* 2006) and nocturia (Gameiro *et al.* 2010). Our search revealed no new RCTs on other lower urinary tract symptoms.

3.4. Factors Affecting Outcome

None of the RCTs above addressed the effect of age or other factors on the outcome of VC training. Nonetheless, in the 22 RCTs included here, on average, 22% of the women being treated with VCs (range 0 to 63%) withdrew from the study or dropped out. Although few RCTs examined the causes of attrition, among those that reported causal factors low compliance, motivational problems, unpleasantness, aesthetic dislike, discomfort, and bleeding were implicated although no one reason predominated.

4. ELECTRICAL STIMULATION (ESTIM)

The theoretical basis of neuromuscular electrical stimulation (EStim) interventions has emerged with increasing understanding of the neuroanatomy and physiology of the central and peripheral nervous systems. The mechanisms of action vary depending on the cause(s) of UI and the structure(s) being targeted e.g. PFM or detrusor, peripheral or central nervous system. In general, the aim of EStim for SUI appears to be to increase proprioception and/or to improve the muscle function of an atrophied or weak PFM, while for UUI the objective seems to be to inhibit detrusor overactivity (DO) (1).

EStim is provided by clinic-based mains powered machines or portable battery powered stimulators (Figure 2) with a seemingly infinite combination of current types, waveforms, frequencies, intensities, electrode types and placements (Figure 3). Without a clear biological rationale, it is difficult to make choices about different ways of delivering EStim. Additional confusion is created by the relatively rapid developments in the area of EStim, and a wide variety of stimulation devices and protocols that have been developed even for the same condition.



Figure 2 Neuromuscular electrical stimulation equipment

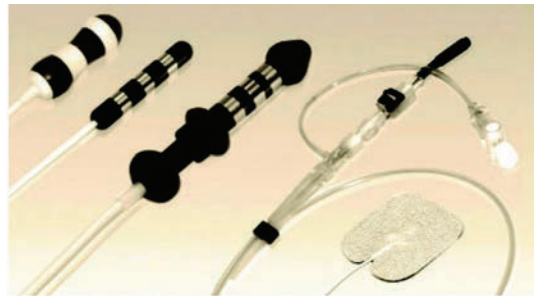

Figure 3 Neuromuscular electrical stimulation electrodes

Finally, the nomenclature used to describe EStim remains inconsistent. EStim has not only been described based on the type of current being used (e.g. faradic, interferential), but also on the structures targeted (e.g. neuromuscular), the current intensity (e.g. low-intensity, or maximal stimulation), and the proposed mechanism of action (e.g. neuromodulation). In this section, EStim type and parameters are reported in line with International Continence Society definitions (1).

This section presents the evidence for the use of EStim in the prevention and treatment of UI in women. Questions addressed are:

- Is EStim effective in the prevention of UI?
- Is EStim better than no active treatment (placebo, sham, control or no treatment) for treatment of UI?
- Is one type of EStim better than another in the treatment of UI?
- Is EStim better than other treatments in the treatment of UI?
- Does the addition of EStim to other treatments add any benefit in the treatment of UI?
- What is the effect of EStim on other LUTS?
- What factors might affect the outcome of EStim in the treatment of UI?

Eligible interventions were non-invasive EStim without implanted electrodes. (Magnetic stimulation and posterior tibial nerve stimulation are described in Sections II.5 and II.6). Other criteria for inclusion were (1) randomised or quasi-randomised (alternate allocation) trial design, (2) women with UI or other LUTS, (3) no participants with incontinence due to neurological or cognitive impairment and (4) no pregnant or postpartum women (within 12 months of childbirth). Trial data reported in conference abstracts as well as full-text papers were included. EStim compared with PFMT and vaginal cones are covered in previous sections (sections II.2.3.3 and II.3.2.2). This section focuses on EStim compared with no active treatment or other conservative treatments.

The primary outcomes were cure rates (the number of women with no urinary incontinence episode at time of assessment) and improvement rates (the number of women improved, including cure). There was considerable variability in the way these outcomes were measured. Women's self-report was given priority but for studies in which it was not reported, the rate based on diaries was used as a proxy; where diary data were also not reported, the rate based on pad tests or any other definitions chosen by the trialists was used (110). Data on health-related quality of life and adverse effects were also extracted. Data at the end of the prescribed treatment phase, or at the first outcome measurement, if later, were used in the analysis. Any treatment effects

shown are likely to reflect maximum effect of each intervention. Data from further follow-up were also recorded.

Due to the small number of available studies per intervention, data were sub-grouped by dominant type or pattern of incontinence: (1) studies with all or at least 50% of participants having SUI alone or a predominant symptom of SUI (as defined by trial investigators), (2) studies with all or >50% of participants having UUI alone or a predominant symptom of UUI (as defined by trial investigators), (3) other studies of participants with UI in which neither stress- or urgency-UI represented a predominant symptom in the study population ('UI all types' hereafter), and (4) studies of overactive bladder (OAB) or DO in which it was unclear whether all participants had UI.

Single EStimates with 95% confidence intervals (CI) were derived for each study comparison using odds ratios (OR) for dichotomous variables or mean difference (MD) for continuous variables. Summary EStimates were calculated using random effects models if there was more than one study reporting the same outcome (meta-analysis).

'Risk of bias' in the included studies was assessed for allocation concealment (selection bias) and completeness of outcome data (attrition bias), using relevant items in a standard tool developed by the Cochrane Urinary Incontinence Group (111). Risk of bias regarding blinding to the allocated intervention was high in most included studies: blinding of participants and care providers is not always feasible (other than the use of sham EStim), and blinding of outcome assessors is equally difficult for self-reported outcomes such as cure, improvement and quality of life.

Description of intervention in included studies of EStim

Nine new trials were identified for this update, making a total of 42 trials included in this section. All new trials targeted women with SUI or predominant SUI. No new studies for predominant UUI, DO or OAB (incontinent or not) were found for this update. Findings for UUI, UI all types, DO and OAB are therefore unchanged from 5th ICI. The number of included studies by dominant type or pattern of incontinence is summarised in Table 14.

In addition, there was one study, published in Portuguese, which was a three-arm trial comparing EStim and PFMT (N = 24), PFMT (N = 25) and control (N = 22) (112). This trial could not be incorporated here, as an English translation was not available.

The EStim parameters and protocols in this section are summarised in Table 15. Some approaches to treatment are now less common, such as the use of interferential current or external electrodes. There was considerable variation in the intervention protocol. Although the biological rationale and purpose of EStim might be different depending on diagnosis, there was no consistency in the EStim protocols used for women with SUI, UUI, UI all types, or DO.

4.1. Prevention

No published trials were found.

Table 14 Studies of EStim included in the previous review (5th ICI) and current update (6th ICI)

	Studies included in the previous review (5 th ICI)	New studies identified in this update (6 th ICI)	Total
EStim vs No active treatment			
SUI or predominant SUI	9	4	13
UII or predominant UII	3	0	3
UI all types	2	0	2
DO/OAB (dry or wet)	3	0	3
One type of EStim vs another			
SUI or predominant SUI	2	4	6
UII or predominant UII	0	0	0
DO/OAB (dry or wet)	2	0	2
EStim vs other treatment			
SUI or predominant SUI	1	No study found	1
UII or predominant UII	1		1
DO/OAB (wet or dry)	4		4
EStim+PFMT vs PFMT			
SUI or predominant SUI	8 (no BF)	2 (no BF)	10
	2 (with BF)	1 (with BF)	3
UII or predominant UII	0	0	0
UI all types	2 (no BF)	0	2

BF = biofeedback

Table 15 Summary of EStim protocols

Author, year	Current	Current Intensity	Pulse Shape & Duration	Frequency (Hz)	Duty Cycle	Electrodes	Treatment Duration	Target UI
Alves 2011 (1)	Biphasic	Max tolerable intensity	Study arm 1: 100ms; Study arm 2: 700ms	Study arm 1: medium frequency 2000Hz; Study arm 2: low frequency 50Hz	Single ratio: 1:2 (4s on, 8s off)	Single vaginal electrode	20min session, 2x a week: 6wks	SUI

Author, year	Current	Current Intensity	Pulse Shape & Duration	Frequency (Hz)	Duty Cycle	Electrodes	Treatment Duration	Target UI
Correia 2014 (2)	Biphasic	Max tolerable intensity	Duration: 700µsec	Single freq: 50Hz	Single ratio: 1:2 (4s on, 8s off) + 2s rise, 2s fall	Study arm 1: 4 electrodes (2 in the suprapubic region and 2 medial to the ischial tuberosity); Study arm 2: Single vaginal electrode	20min session, 2x a week, by physiotherapist: 6wks	SUI
Huebner 2011 (3)	NR	Range 20-80mA	NR	Single freq: 50Hz	Study arm 1: Active contracting of PFM 8s. After reaching the maximum contraction, electrical stimulation was added for 8s. Resting 15s; Study arm 2: Stimulation 8s. Resting 15s. Active contracting of PFM 8s. Resting 15s.	Single vaginal electrode	15min session, 2x a day, home treatment with 5 clinic visits: 12wks	SUI
Jeyaseelan 2003* (4)	NR	NR	NR	Range not defined	A longer duty cycle than is traditionally used	NR	NR	SUI
Lopès 2014 (5)	Rectangular biphasic	NR	Duration: 400µsec	3 frequencies available: 50Hz for SUI, 20Hz for MUI, 12.5Hz for pure urgency	NR	Vaginal electrode	20min session, 3x a day, home treatment: 6mths	SUI
Maher 2009* (6)	NR	NR	NR	NR	NR	Study arm 1: external electrodes; Study arm 2: single vaginal electrode	30min session, 4x a week, home treatment: 8wks (outcome reported at 4wks)	SUI

Author, year	Current	Current Intensity	Pulse Shape & Duration	Frequency (Hz)	Duty Cycle	Electrodes	Treatment Duration	Target UI
Patil 2010 (7)	Interferential	Max tolerable intensity	NR	Freq range: 0-100Hz	NR	4 electrodes (2 flat electrodes placed anteriorly over the obturator foramen, and 2 electrodes placed posteriorly medial to ischial tuberosity on either side of the anus)	First session 15min, other sessions 30min, 3x a week, by physiotherapist: 4wks.	SUI
Pereira 2012 (8)	NR	Max tolerable intensity	Duration: 700µsec	Single freq: 50Hz	Single ratio: 1:2 (4s on, 8s off)	4 electrodes (2 in the suprapubic region and 2 medial to the ischial tuberosity)	20min session, 2x a week, by physiotherapist: 6wks	SUI
Terlikowski 2013 (9)	NR	NR	200 to 250µsec	Freq range: 10-40Hz	Single ratio: 1:2 (15s on, 30s off)	Single vaginal electrode	20min session, 2x a day, home treatment: 8 weeks..	SUI

* abstract only.

Footnotes: EStim = electrical stimulation, freq= current frequency, PFM = Pelvic floor muscle, PFMC= Pelvic floor muscle contraction, VPFMC= voluntary Pelvic floor muscle contraction

- Alves PG, Nunes FR, Guirro EC. Comparison between two different neuromuscular electrical stimulation protocols for the treatment of female stress urinary incontinence: a randomized controlled trial. *Revista Brasileira de Fisioterapia*. 2011;15(5):393-8.
- Correia GN, Pereira VS, Hirakawa HS, Driusso P. Effects of surface and intravaginal electrical stimulation in the treatment of women with stress urinary incontinence: randomized controlled trial. *European Journal of Obstetrics and Gynecology and Reproductive Biology*. 2014;173(1):113-8.
- Huebner M, Riegel K, Hinninghofen H, Wallwiener D, Tunn R, Reisenauer C. Pelvic floor muscle training for stress urinary incontinence: a randomized, controlled trial comparing different conservative therapies. *Physiother Res Int*. 2011;16(3):133-40.
- Jeyaseelan S, Oldham JA. Can the effects of pelvic floor muscle exercises be enhanced with a new pattern of electrical stimulation in women with stress incontinence (Abstract). *Proceedings of the World Confederation for Physical Therapy (WCPT), 14th International Congress, 7-12 June, Barcelona. 2003.*
- Lopès P, Rimbault F, Scheffler M, Andre C, Cappelletti MC, Mares P. [Multicentric prospective randomized and controlled study assessing effectiveness of intravaginal electrostimulation at home compared to usual care in female patients with urinary incontinence and prior perineal reeducation]. [French]. *Gynecologie, Obstetrique & Fertilité*. 2014;42(11):779-86.
- Maher RM, Crowe L, Caulfield B. Comparison of two methods of electrical muscle stimulation training of pelvic floor musculature in the treatment of stress urinary incontinence (Abstract). *Journal of Women's Health Physical Therapy*. 2009;33(1):24.

7. Patil SP, Nagrale AV, Ganvir SD. Additive effect of interferential therapy over pelvic floor exercises. *International Journal of Therapy & Rehabilitation*. 2010;17(11):596-602.
8. Pereira VS, Bonioli L, Correia GN, Driusso P. [Effects of surface electrical stimulation in older women with stress urinary incontinence: a randomized controlled pilot study]. [Spanish]. *Actas Urológicas Españolas*. 2012;36(8):491-6.
9. Terlikowski R, Dobrzycka B, Kinalski M, Kuryliszyn-Moskal A, Terlikowski SJ. Transvaginal electrical stimulation with surface-EMG biofeedback in managing stress urinary incontinence in women of premenopausal age: a double-blind, placebo-controlled, randomized clinical trial. *International Urogynecology Journal*. 2013;24(10):1631-8.

Table 16 Summary of data on EStim vs no active treatment

Author, year	Comparator	N randomised	Study population	Duration (months)	Outcome**
SUI or predominantly SUI					
Correia 2014 (1)	ES (31) vs No treatment (17)	48	SUI alone	1.5	Cure: NR Improvement: NR QoL via KHQ Surface ES vs no treatment, N = 32, mean difference 54.45 lower, 95% CI 73.44 to 35.46 lower; Vaginal ES vs no treatment, N = 32, mean difference 56.67 points lower, 95% CI 75.30 to 38.04 lower Adverse effects: NR
Lopès 2014 (2)	ES (78) vs No treatment (86)	164	SUI or SUI-predominant MUI	6	Cure: NR Self-reported improvement: 63/76 vs 58/85 QoL via ICIQ: N = 161, mean difference in change from baseline 3.10 lower, 95% CI 4.39 to 1.81 lower Adverse effects: reported with no detail
Pereira 2012 (3)	ES (7) vs No treatment (7)	14	SUI alone	1.5	Cure: NR Improvement: NR QoL via KHQ: N = 14, mean difference 42.95 lower, 95% CI 70.74 to 15.16 lower Adverse effects: no events noted
Terlikowski 2013 (4)	ES + BF [†] (68) vs Sham ES + BF [†] (34)	102	USI alone	2	Self-reported cure: 29/64 vs. 2/29 Self-reported improvement: 41/64 vs 6/29 QoL via I-QoL: N = 93 at 8 weeks (end of treatment), mean difference 22.3 higher, 95% CI 15.52 to 29.08 higher; N = 93 at 16 weeks (8 weeks after treatment), mean difference 30.20 higher, 95% CI 22.18 to 38.22 higher Adverse effects: smarting and discomfort

Note: For modality details or parameters, see Table 14.

106 NR = not reported; ICIQ = International Consultation of Incontinence Questionnaire (higher scores indicate greater impact on QoL, i.e. a higher score indicates a lower QoL); I-QoL = Incontinence Quality of Life Questionnaire (higher scores indicate higher QoL); KHQ = King's Health Questionnaire (higher scores indicate greater impairment);

**Source of cure and improvement outcome: women's self-report was given priority but for studies in which it was not reported, quantification of outcomes based on diaries, pad tests or any other definitions chosen by trialists were used as a proxy.

† Electromyography-assisted biofeedback

1. Correia GN, Pereira VS, Hirakawa HS, Driusso P. Effects of surface and intravaginal electrical stimulation in the treatment of women with stress urinary incontinence: randomized controlled trial. *European Journal of Obstetrics and Gynecology and Reproductive Biology*. 2014;173(1):113-8.
2. Lopès P, Rimbault F, Scheffler M, Andre C, Cappelletti MC, Mares P. [Multicentric prospective randomized and controlled study assessing effectiveness of intravaginal electrostimulation at home compared to usual care in female patients with urinary incontinence and prior perineal reeducation]. [French]. *Gynecologie, Obstetrique & Fertilité*. 2014;42(11):779-86.
3. Pereira VS, Bonioli L, Correia GN, Driusso P. [Effects of surface electrical stimulation in older women with stress urinary incontinence: a randomized controlled pilot study]. [Spanish]. *Actas Urologicas Espanolas*. 2012;36(8):491-6.
4. Terlikowski R, Dobrzycka B, Kinalski M, Kurylczyn-Moskal A, Terlikowski SJ. Transvaginal electrical stimulation with surface-EMG biofeedback in managing stress urinary incontinence in women of premenopausal age: a double-blind, placebo-controlled, randomized clinical trial. *International Urogynecology Journal*. 2013;24(10):1631-8.

4.2. Treatment

4.2.1 Is EStim Better than No Active Treatment (Placebo, Sham, Control or No Treatment) for Treatment of UI?

Four new studies including 267 women with SUI or predominant SUI (113-116). Participants in one of these studies were women who had responded positively to physiotherapy treatment for their UI (10-15 sessions), with EStim used to maintain the benefit of initial physiotherapy (114). One study (115) was a pilot study for a newly identified study (113).

Characteristics of the new studies comparing EStim with no active treatment are presented in Table 16. No active treatment consisted of no treatment (113, 115), sham EStim (116) or usual care (114). One study was a three-arm trial. Two of the arms using surface and intravaginal EStim (N = 31) were combined and compared with the 'no treatment' arm (N = 17) (113).

Quality of data

Three studies reported adequate methods of allocation concealment, namely third party involvement (113, 116) or opaque (and sealed) envelopes with third party involvement (115) in the allocation procedure. One study did not describe methods used for allocation concealment (116). Trial results were reported for everyone who entered the trial in one study (115) but this was not done in the others. One study is funded by the manufacturer of the study stimulator (114).

Results

SUI or predominant SUI. When adding new studies to those previously reported, pooled data suggest that cure rates were, on average, higher for EStim compared with no active treatment but the difference was not statistically significant (N = 434, 22% vs 5%, OR 2.43, 95% CI 0.89 to 6.60) (116-123). Improvement rates were statistically significantly higher for EStim compared with no active treatment (N = 613, 53% vs 30%, OR 3.64, 95% CI 1.82 to 7.27) (114, 116-118, 120-124), although there was some evidence of statistical heterogeneity for the improvement rate (I-squared = 45%). The result of this meta-analysis using additional data from newly identified studies remains similar to the analysis performed in the 5th ICI, except that effect size was larger and confidence interval for cure was wider, and effect size was smaller and confidence interval was narrower for improvement.

Quality of life was reported in seven studies, using diverse measures. Six studies, including 4 new studies, found statistically significant differences favouring EStim compared with no active treatment (113-116, 118, 119), and one previous study found no significant differences between the groups (125). All new studies that reported this outcome favoured EStim: one (114) used the International Consultation on Incontinence Questionnaire (ICIQ), one (116) used the

Incontinence Quality of life (I-QoL) questionnaire, and two used the King's Health Questionnaire (KHQ) (113, 115).

Adverse effects appeared uncommon. One new study reported bleeding in one and discomfort in three of 64 participants using the active EStim device and none of 29 participants in the sham EStim device (116). This is in line with two previous studies that reported tenderness and bleeding (118), and vaginal irritation, pain or infection (123) associated with the device. Another study reported that one participant each in the treatment (N = 78) and control (usual care; N = 86) groups was lost to follow-up due to adverse effects (no further detail was provided) (114).

Summary

A total of 21 studies assessed the effect of EStim compared with no active treatment, including 13 in women with SUI or predominant SUI, three in UUI or predominant UUI, two in all types of UI, and three in DO/OAB (incontinent or no).

Findings from update analysis using the additional data from newly identified studies were broadly similar to those from the 5th ICI. Included studies were generally assessed as having a high risk of bias.

EStim might be more effective than no treatment in improving symptoms and quality of life in women with SUI and improving symptoms in women with UUI, although this may not result in cure (**Level of Evidence: 2**).

Information on quality of life was sparsely reported particularly for UUI or DO, and the limited data that were available were not consistent. Adverse effects appear uncommon but some women experienced discomfort with the treatment device. Scant data were available on long-term performance.

Recommendations

EStim might be better than no treatment to improve symptoms and quality of life in SUI women (**Grade of Recommendation: B**).

EStim may be considered for treatment to improve symptoms for UUI (**Grade of Recommendation: B**).

However, this recommendation should be viewed with caution until the findings are supported or refuted in further trials; it would be particularly useful if further trials used validated and reliable quality life measures as a primary outcome indicator particularly for UUI.

4.2.2 Is One Type of EStim Better than Another in the Treatment of UI?

Four new studies including 145 women with SUI and predominant SUI (113, 126-128) were found. The characteristics of the new studies comparing one type of EStim with another are presented in Table 17. Different variants of EStim were assessed, either alone

(113, 126, 128) or as an adjunct to PFMT and bio-feedback (127).

Table 17 Summary of data on different types of EStim comparisons

Author, year	Comparator	N randomised	Study population	Duration (months)	Outcome**
SUI or predominantly SUI					
Alves 2011 (1)	Medium frequency ES vs Low frequency ES (number per group not reported)	24	SUI alone	1.5	Cure based on pad test: 10/10 vs 10/10 Improvement: NR QoL: NR Adverse effects: NR
Correia 2014 (2)	Surface ES (15) vs Vaginal ES (16)	31	SUI alone	1.5	Cure: NR Improvement: NR QoL via KHQ: N = 30, mean difference 2.22 higher, 95% 6.95 lower to 11.39 higher Adverse effects: NR
Huebner 2011 (3)	Dynamic ES + PFMT + BF [†] (36) vs Conventional ES + PFMT + BF [†] (36)	72	SUI or SUI-predominant MUI	3	Cure: NR Improvement: NR QoL via KHQ: N = 61, mean difference in change from baseline 4.10 lower, 95% CI 6.77 to 1.43 lower Adverse effects: allergic reaction to lubricant
Maher 2009* (4) (ongoing)	External ES vs Vaginal ES (number per group not reported)	18	SUI alone	2 (outcome measured at 1 month)	Cure: NR Improvement: NR QoL: NR Adverse effects: NR

Note: For modality details or parameters, see Table 14.

NR = not reported; KHQ = King's Health Questionnaire (higher scores indicate greater impairment);

* abstract only;

**Source of cure and improvement outcomes: women's self-report was given priority but for studies in which it was not reported, quantification of outcomes based on diaries, pad tests or any other definitions chosen by trialists was used as a proxy.

[†] Electromyography-assisted biofeedback

1. Alves PG, Nunes FR, Guirro EC. Comparison between two different neuromuscular electrical stimulation protocols for the treatment of female stress urinary incontinence: a randomized controlled trial. *Revista Brasileira de Fisioterapia*. 2011;15(5):393-8.
2. Correia GN, Pereira VS, Hirakawa HS, Driusso P. Effects of surface and intravaginal electrical stimulation in the treatment of women with stress urinary incontinence: randomized controlled trial. *European Journal of Obstetrics and Gynecology and Reproductive Biology*. 2014;173(1):113-8.
3. Huebner M, Riegel K, Hinninghofen H, Wallwiener D, Tunn R, Reisenauer C. Pelvic floor muscle training for stress urinary incontinence: a randomized, controlled trial comparing different conservative therapies. *Physiother Res Int*. 2011;16(3):133-40.
4. Maher RM, Crowe L, Caulfield B. Comparison of two methods of electrical muscle stimulation training of pelvic floor musculature in the treatment of stress urinary incontinence (Abstract). *Journal of Women's Health Physical Therapy*. 2009;33(1):24.

One study comparing external and vaginal EStim for women with SUI, available only as an abstract, did not report any of the specified outcomes and thus did not contribute to the analysis (128). Since there is little duplication of EStim interventions, it was not thought appropriate to combine study findings.

Quality of data

Allocation concealment was adequate in one study which involved a third party in the allocation procedure (113). The other three studies did not mention allocation concealment (126-128). Data were reported only for those who completed the trial in two studies (126, 127) but it was unclear in the other two studies if trial results were reported for everyone who entered the trial (113, 128).

Results

SUI or predominant SUI. One new small study comparing medium and low frequency EStim found no difference for cure rates (126). The results for improvement rates are as reported in two previous studies (129, 130).

While no information was available on quality of life and adverse effects in the 5th ICI, two new studies reported quality of life using the KHQ. The first study comparing 'dynamic' EStim (contract pelvic floor muscles, and then add stimulation at maximal contraction) with 'conventional' EStim (perform stimulation, rest, and contract pelvic floor muscles) found a statistically significant difference favouring 'dynamic' ES, although study authors considered the difference to be small and not clinically important (127). The second study comparing surface and vaginal EStim found no statistically significant difference between the groups (113).

One new study in which EStim was performed as an adjunct to PFMT and biofeedback reported that one of 72 participants had an allergic reaction to biofeedback lubricant and withdrew from the study, although it was unclear in which group these adverse effects occurred (127).

Summary

A total of eight studies assessed the effect of one approach of EStim compared with another, with six in women with SUI and predominant SUI and two in women with DO. No study focusing on UUI or predominant UUI was identified.

Findings from an updated analysis using the additional data from newly identified studies were broadly similar to those from the 5th ICI. Included studies generally had a high risk of bias. There were eight small trials comparing different EStim protocols; the clinical heterogeneity between studies meant it was not appropriate to pool the data.

Based on a single trial (130) for women with SUI, maximal clinic-based stimulation may be more effective than low-intensity home-based stimulation in improving symptoms, although no data were available on cure rates, quality of life and adverse effects (**Level of Evidence: 2**).

The other studies did not find clinically important differences between stimulation groups for the specified outcomes; the studies were small and may have been underpowered. Further comparisons of EStim protocols are needed.

Recommendations

For women with SUI maximal clinic-based EStim might be better than daily low-intensity home-based EStim in improving symptoms (**Grade of Recommendation: B**).

There is a need for studies to elucidate the purpose and biological rationale for EStim in different diagnostic groups, so these can then be tested and compared in clinical trials.

4.2.3 Is EStim Better than Other Treatments for UI?

No new study was found that investigated whether EStim is better than other treatments for UI. The level of evidence and recommendations remains unchanged from the previous review (5th ICI) formed on the basis of six studies (124, 131-135).

Summary

The 5th ICI included six studies, including one in women with SUI, one in women with predominant UUI, and four in women with OAB/DO (wet or dry).

Included studies were generally assessed as having a high risk of bias. With small numbers per comparison group available, there is insufficient evidence to determine if EStim is better than vaginal oestrogens in women with SUI, propantheline bromide in women with UUI, or oxybutynin and tolterodine for DO (**Level of Evidence: 2**).

Recommendation

Based on current limited evidence, EStim could be considered as an alternative to medical treatment. Medical treatments (drugs) appear to be no more effective than EStim (**Grade of Recommendation: B**). These findings need to be investigated further with high quality trials, if it is a clinical question of interest to women.

4.2.4 Does the Addition of EStim to Other Treatments Add Any Benefit in the Treatment of UI?

Three new studies including 52 women including women with SUI and predominant SUI were found (127, 136, 137). The characteristics of these new

studies are presented in Table 18. Two studies (136, PFMT and biofeedback (ESim + PFMT + BF vs 137) combined EStim with PFMT (EStim + PFMT vs PFMT + BF)..

PFMT), while the other (127) combined EStim with

Table 18 Summary of data on EStim + another treatment vs the other treatment

Author	Comparator	N randomised	Study population	Duration (months)	Outcome**
SUI or predominantly SUI					
Jeyaseelan 2003* (1)	ES + PFMT (6?) vs PFMT (7?)	13?	SUI alone	2	Cure: NR Improvement: NR QoL via IIQ (% change from baseline): N = 6, median -27%, range -63 to 0, vs. N = 7, median 0%, range -67 to 200 QoL via UDI (% change from baseline): N = 6, median -32%, range -50 to -18, vs. N = 7, median 0%, range -43 to 180 Adverse effects: NR
Patil 2010 (2)	ES + PFMT (55) vs PFMT (55)	13	USI alone	1	Cure: NR Improvement: NR QoL via IIQ: N = 102, mean difference 12.53 lower, 95% CI 19.45 to 5.61 lower Adverse effects: NR
Huebner 2011 (3)	ES + PFMT + BF† (72) vs PFMT + BF† (36)	26	SUI or SUI-predominant MUI	3	Cure: NR Improvement: NR QoL via KHQ Dynamic ES+PFMT+BF vs PFMT+BF: N = 55, mean difference in change from baseline 4.60 lower, 95% CI 7.43 to 1.77 lower; Conventional ES+PFMT+BF vs PFMT+BF: N = 60, mean difference in change from baseline 0.50 lower, 95% CI 3.22 lower to 2.22 higher Adverse effects: allergic reaction to lubricant

Note: For modality details or parameters, see Table 14.

NR = not reported; IIQ = Incontinence Impact Questionnaire (lower scores indicate better QoL); KHQ = King's Health Questionnaire (higher scores indicate greater impairment); UDI = Urogenital Distress Inventory (higher scores indicate greater discomfort);

**Source of cure and improvement outcome: women's self-report was given priority but for studies in which it was not reported, quantification of outcomes based on diaries, pad tests or any other definitions chosen by trialists were used as a proxy.

† Electromyography-assisted biofeedback

1. Jeyaseelan S, Oldham JA. Can the effects of pelvic floor muscle exercises be enhanced with a new pattern of electrical stimulation in women with stress incontinence (Abstract). Proceedings of the World Confederation for Physical Therapy (WCPT), 14th International Congress, 7-12 June, Barcelona. 2003.
2. Patil SP, Nagrale AV, Ganvir SD. Additive effect of interferential therapy over pelvic floor exercises. International Journal of Therapy & Rehabilitation. 2010;17(11):596-602.
3. Huebner M, Riegel K, Hinninghofen H, Wallwiener D, Tunn R, Reisenauer C. Pelvic floor muscle training for stress urinary incontinence: a randomized, controlled trial comparing different conservative therapies. Physiother Res Int. 2011;16(3):133-40.

One study was a three-arm trial that included both 'dynamic' EStim (stimulation added at maximum contraction of pelvic floor muscles) and 'conventional' EStim (stimulation followed by rest and pelvic floor muscle contraction) as two of the study arms (127). These arms were combined in the analysis. One study is a pilot study, available only as abstract, with limited information (136).

Quality of data

Allocation concealment was inadequate in one study which used opaque sealed envelopes but with no indication of third party involvement in the allocation procedure (137). The other two studies did not mention allocation concealment (127, 136). In two studies, data were reported only for those who completed the trial (127, 137) and it was unclear in the other study if trial results were reported for everyone who entered the trial (136).

Results

i) EStim + PFMT vs PFMT

SUI or predominant SUI. Two new studies assessing EStim as an adjunct to PFMT compared with PFMT alone, contributed no additional data in terms of cure, improvement and adverse effects. The 5th ICI previous analysis for these outcomes therefore remains unchanged.

Three studies reported data on quality of life with inconsistent results. One previous study found no statistically significant differences between the group (138), whereas one new study using the Incontinence Impact Questionnaire (IIQ) found a statistically significant difference favouring the group which combined EStim with PFMT (137). The results from another new study based on either the IIQ or the Urogenital Distress Inventory were inconclusive, due to the pilot nature of the study and small sample size (N = 13) (136).

ii) EStim + PFMT with biofeedback vs PFMT with biofeedback

SUI. One new study assessed EStim as an adjunct to PFMT and biofeedback compared with PFMT and biofeedback alone. This was a three-arm trial, assessing a combination of either 'dynamic' or 'conventional' EStim with PFMT and biofeedback, compared with PFMT and biofeedback alone (127).

This study did not provide any data on cure and improvement rates (127). Thus, the 5th ICI analysis of improvement rates based on two studies (129, 130) remains unchanged, with no available information on cure rates.

While no information was available on quality of life and adverse effects for this comparison in the 5th ICI, the new study (127) reported that quality of life scores based on the King's Health Questionnaire improved statistically significantly for the group which combined

'dynamic' EStim with PFMT and biofeedback, compared with PFMT and biofeedback alone, although study authors did not consider the difference to be clinically important. No significant difference was found for the group combining 'conventional' EStim with PFMT and biofeedback, compared with PFMT and biofeedback alone.

In the same study (127), one of 72 participants had an allergic reaction to biofeedback lubricant and withdrew from the study, although it was unclear in which group this occurred.

Summary

A total of 15 studies assessed the effect of EStim as an adjunct to another treatment, compared with the other treatment alone. All but two studies included women with SUI or predominant SUI. No study focusing on UUI or predominant UUI was identified.

Findings from update analysis using the additional data from newly identified studies were broadly similar to those from the 5th ICI. For comparisons of EStim with PFMT versus PFMT alone, there was no clear evidence of a difference between the groups in women with SUI or predominantly SUI in terms of cure and improvement. Evidence for quality of life outcomes was not consistent across studies (**Level of Evidence: 2**). There was also no evidence to suggest that the addition of EStim to a BF-assisted PFMT was more effective than BF-assisted PFMT in women with SUI (**Level of Evidence: 2**). A few women experienced adverse effects with EStim. There is no evidence to draw any conclusion about the effect of adding EStim to PFMT for women with UUI.

Recommendations

The addition of EStim to PFMT or BF-assisted PFMT programmes does not appear to add benefit (**Grade of Recommendation: B**); combinations of techniques need to be investigated further with high quality trials if this is a clinical/research question of interest to women.

4.3. Other LUTS

In the 5th ICI, there were no trials that analysed the effect of EStim in women with other LUTS alone. No new published trials were found.

4.4. Factors Affecting Outcome

None of the included trials addressed the effect of age, or any other factor, on outcomes of EStim. There was no clear indication from the included trials that EStim could not be tolerated by elderly. There is no reason, therefore, to either exclude older women from studies of EStim, or not to offer EStim as part of a conservative management programme, except where recognised precaution with use of intra-vaginal electrodes in women with vaginal atrophy and contraindications such as a cardiac pacemaker are present.

One newly identified study including elderly women (over 60 years old) highlighted the potential embarrassment perceived by the elderly with regard to conventional intra-vaginal stimulation and suggested that surface EStim may be a more acceptable method for this population (115).

Of note, in a prospective cohort of 3,198 women treated with home-managed EStim in Norway during 1992-1994, there was no association between self-reported improvement and age (139). In the same cohort, success rates as defined by clinicians were higher in younger individuals but this effect was not significant after controlling for other factors.

Aside from age, other factors may have the potential to mitigate treatment outcome. On the basis of trial reports to date, it appeared that there was considerable variation in EStim protocols with no consistent pattern emerging. EStim protocols are also often poorly reported, lacking detail of stimulation parameters, devices and methods of delivery. The wide range of protocols that have been tested may have affected the effect EStimates reported in this section. ICS/UGA has produced a physiotherapy interventions terminology paper in the last year, and authors are encouraged to refer to this paper when reporting EStim parameters in a publication (1).

It is not clear whether one diagnostic group may benefit more than another from EStim. It has been hypothesised that, in women with SUI who cannot voluntarily contract the PFM to begin a PFMT programme, EStim might help initiate or substitute for a voluntary contraction. However, most studies focusing on the efficacy of EStim do use EStim to initiate or substitute for a voluntary PFM contraction (140). To date, there has been no trial addressing this hypothesis.

As with all conservative therapy modalities, one of the key factors to the success or failure of EStim is treatment adherence. Some authors commented on adherence or reported adherence data. Of the new studies identified for this 6th ICI update, one study reported that adherence to EStim was satisfactory (116) and another reported that the EStim regimen was adhered to by over >75% of participants (114). However, adherence measures were highly variable, making comparison across studies difficult.

5. POSTERIOR TIBIAL NERVE STIMULATION (PTNS)

Posterior tibial nerve stimulation (PTNS) is a form of peripheral neurostimulation targeted towards symptom relief of OAB and UUI (141). Indirect access to the sacral plexus is achieved by intermittent, electrical stimulation of the posterior tibial nerve, which lies behind the medial malleolus. PTNS may be minimally invasive, involving insertion of a fine needle close to the nerve (Percutaneous PTNS), or non-invasive, using skin surface electrodes applied to the medial malleolar area (Transcutaneous PTNS)(141).

PTNS aims to stimulate the sacral nerve plexus through the afferent fibres of the posterior tibial nerve, a mixed nerve containing L5-S3 fibres (142). The S3 nerve root contains sensory fibres from the pelvic floor and parasympathetic motor efferent fibres to the detrusor as well as the pelvic sphincters and the pelvic floor muscles. Afferent nerve stimulation can therefore lead to activation of inhibitory sympathetic neurons and suppression of detrusor contraction through a direct sacral route. Urodynamic studies have shown that electrical stimulation of the posterior tibial nerve increases cystometric capacity and suppresses detrusor contraction (143-145). The full mechanism of action of treatment effect for PTNS is not yet understood, however it is thought that the observed effects may be related to a neuroplastic reorganisation of sacral spinal reflexes and regulation of cortical excitability (146, 147).

Percutaneous PTNS is performed as an outpatient procedure. It involves inserting a 34-gauge needle 3–5 cm cephalad to the medial malleolus. The needle is connected to a low-voltage stimulator device, and a

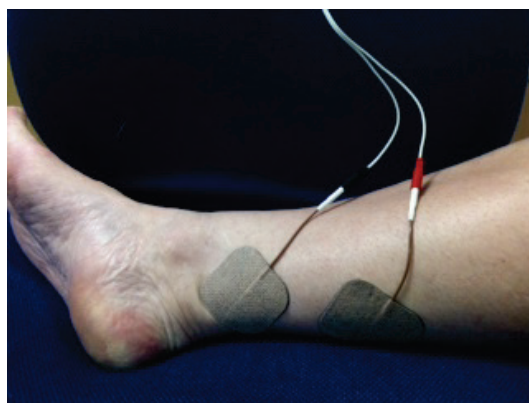

Figure 4 PTNS equipment

grounding pad is placed on the bottom of the foot just below the smallest toe. Transcutaneous PTNS may be delivered either in clinic or self-administered at home. Self-adhesive electrodes are placed behind the medial malleolus and 10cm proximal to this. The positive lead is connected to the proximal electrode and the negative to the distal electrode and both are connected to a portable battery-powered stimulator. The intensity level of the stimulation current for percutaneous PTNS and transcutaneous PTNS is determined once correct positioning has been established by noting sensory and motor (hallux) reaction (Figure 4).

This section presents the evidence for the use of PTNS in the prevention and treatment of UI in women. Since this is a new section for the Conservative Management chapter, the same search strategy as EStim section was used although no date restrictions have been applied to the literature search.

Table 19 Summary of PTNS protocols

Author, year	Current	Current Intensity	Pulse Shape & Duration	Frequency (Hz)	Duty Cycle	Electrodes	Treatment Duration	Target UI
Bellette 2009 (1)	NR	NR	NR	NR	NR	NR	2 months	OAB
Finazzi-Agrò 2010 (2)	NR	0 – 10 mA; increased until flexion of big toe or fanning of all toes become noticeable	200 microseconds	20 Hz	NR	One surface electrode on the medial aspect of the calcaneus	3 months	UUI
Manriquez 2013* (3)	NR	NR	NR	NR	NR	NR	3 months	OAB
Marques 2008* (4)	Biphasic	VIF (variation of intensity and frequency)	200 microseconds	10 Hz	NR	Two transcutaneous electrodes	1 month	OAB
Peters 2010* (5)	NR	NR	NR	NR	NR	NR	3 months	OAB
Preyer 2007* (6)	NR	NR	NR	NR	NR	NR	3 months	UUI
Preyer 2015 (7)	NR	NR	NR	NR	NR	NR	3 months	OAB
Sancaktar 2010 (8)	NR	0.5 – 10Ma; adjusted in accordance to patient's tolerance	0.2 milliseconds	20 Hz	NR	NR	3 months	OAB
Schreiner 2010 (9)	Continuous mode	10 – 50mA; according to sensitivity and hallux mobilisation	200 milliseconds	10 Hz	NR	Negative electrode on medial malleolus and the positive electrode was 10cm proximal to this on the right leg along the nerve path	3 months	UUI
Souto 2014 (10)	NR	NR	250 microseconds	10 Hz	NR	Negative surface electrode placed behind medial malleolus and positive electrode placed 10cm above it	3 months	OAB

Author, year	Current	Current Intensity	Pulse Shape & Duration	Frequency (Hz)	Duty Cycle	Electrodes	Treatment Duration	Target UI
Vecchioli-Scaldazza 2013 (11)	NR	NR	NR	NR	NR	NR	1.5 months	OAB

* abstract only.

NR = not reported

1. Bellette PO, Rodrigues-Palma PC, Hermann V, Riccetto C, Bigozzi M, Olivares JM. [Posterior tibial nerve stimulation in the management of overactive bladder: a prospective and controlled study]. [Spanish]. *Actas Urológicas Españolas*. 2009;33(1):58-63.
2. Finazzi-Agrò E, Petta F, Sciobica F, Pasqualetti P, Musco S, Bove P. Percutaneous tibial nerve stimulation effects on detrusor overactivity incontinence are not due to a placebo effect: a randomized, double-blind, placebo controlled trial. *Journal of Urology*. 2010;184(5):2001-6.
3. Manriquez VI, Naser ME, Gomez M, Guzman R, Valdevenito R, Lecannelier J, *et al.* Transcutaneous tibial nerve stimulation versus long release oxibutinin in the treatment of patients with overactive bladder. A randomized control trial (Abstract number 013). *International Urogynecology Journal and Pelvic Floor Dysfunction*. 2013;24(Suppl 1):S14.
4. Marques A, Herrmann V, Ferreira N, Bellette P. Transcutaneous posterior tibial nerve stimulation in overactive bladder (Abstract number 471). *Proceedings of the 38th Annual Meeting of the International Continence Society (ICS), 2008 Oct 20-24, Cairo, Egypt*. 2008.
5. Peters K, Carrico D, Perez-Marrero R, Khan A, Wooldridge L, Davis G, *et al.* 12 week results from the SUMIT trial: percutaneous tibial nerve stimulation vs validated sham in those exposed to pharmacologic therapy (Abstract number 125). *Neurourology and Urodynamics*. 2010;29(6):988-9.
6. Preyer O, Gabriel B, Mailath-Pokorny M, Doerfler D, Laml T, Umek W, *et al.* Peripheral tibial neurostimulation (PTNS) versus tolterodine in the treatment of women with urge urinary incontinence and urge symptoms (Abstract number 246). *International Urogynecology Journal and Pelvic Floor Dysfunction*. 2007;18(Suppl 1):S139-S40.
7. Preyer O, Umek W, Laml T, Bjelic-Radisic V, Gabriel B, Mittlboeck M, *et al.* Percutaneous tibial nerve stimulation versus tolterodine for overactive bladder in women: a randomised controlled trial. *European Journal of Obstetrics, Gynecology, & Reproductive Biology*. 2015;191:51-6.
8. Sancaktar M, Ceyhan ST, Akyol I, Muhcu M, Alanbay I, Mutlu EC, *et al.* The outcome of adding peripheral neuromodulation (stoller afferent neuro-stimulation) to anti-muscarinic therapy in women with severe overactive bladder. *Gynecological Endocrinology*. 2010;26(10):729-32.
9. Schreiner L, dos Santos TG, Knorst MR, da Silva Filho IG. Randomized trial of transcutaneous tibial nerve stimulation to treat urge urinary incontinence in older women. *International Urogynecology Journal*. 2010;21(9):1065-70.
10. Souto SC, Reis LO, Palma T, Palma P, Denardi F. Prospective and randomized comparison of electrical stimulation of the posterior tibial nerve versus oxybutynin versus their combination for treatment of women with overactive bladder syndrome. *World Journal of Urology*. 2014;32(1):179-84.
11. Vecchioli-Scaldazza C, Morosetti C, Berouz A, Giannubilo W, Ferrara V. Solifenacin Succinate versus Percutaneous Tibial Nerve Stimulation in Women with Overactive Bladder Syndrome: Results of a Randomized Controlled Crossover Study. *Gynecologic & Obstetric Investigation*. 2013;75(4):230-4.

Table 20 Summary of data on PTNS vs no active treatment

Author, year	Intervention	N randomised	Study population	Duration (months)	Outcome**
UUI					
Finazzi-Agrò 2010 (1)	Percutaneous PTNS (18) vs Sham percutaneous PTNS (17)	35	UUI	3	Cure: NR Improvement based on diary: 12/17 vs. 0/15 QoL via I-QoL (mean): N = 17, change from pre 69.6 to post 81.3, p = 0.025 vs. N = 15, change from pre 69.5 to post 70.6, p = 0.619 Adverse effects: no serious events
DO/OAB					
Bellette 2009 [†] (2)	Transcutaneous PTNS (21) vs Sham transcutaneous PTNS (16)	37	OAB	2	Not available [†]
Marques 2008* (3)	Transcutaneous PTNS vs Sham transcutaneous PTNS (number per group not reported)	43	OAB (some had SUI and UUI)	1	Cure: NR Improvement: NR QoL: NR Adverse effects: NR

Note: For modality details or parameters, see Table 19.

NR = Not reported; I-QoL = Incontinence Quality of Life Questionnaire (higher scores indicate higher QoL); OAB-q = Overactive Bladder Questionnaire (higher scores indicating worse condition);

* abstract only

**Source of cure and improvement outcome: women's self-report was given priority but for studies in which it was not reported, quantification of outcomes based on diaries, pad tests or any other definitions chosen by trialists were used as a proxy.

[†] Publication in Spanish with English abstract. English translation of the main text was not available at the time of writing.

1. Finazzi-Agrò E, Petta F, Sciobica F, Pasqualetti P, Musco S, Bove P. Percutaneous tibial nerve stimulation effects on detrusor overactivity incontinence are not due to a placebo effect: a randomized, double-blind, placebo controlled trial. *Journal of Urology*. 2010;184(5):2001-6.
2. Bellette PO, Rodrigues-Palma PC, Hermann V, Ricetto C, Bigozzi M, Olivares JM. [Posterior tibial nerve stimulation in the management of overactive bladder: a prospective and controlled study]. [Spanish]. *Actas Urológicas Españolas*. 2009;33(1):58-63.
3. Marques A, Herrmann V, Ferreira N, Bellette P. Transcutaneous posterior tibial nerve stimulation in overactive bladder (Abstract number 471). *Proceedings of the 38th Annual Meeting of the International Continence Society (ICS), 2008 Oct 20-24, Cairo, Egypt. 2008.*

Questions addressed are:

- Is PTNS effective in the prevention of UI?
- Is PTNS better than no active treatment (placebo, sham, control or no treatment) for treatment of UI?
- Is one type of PTNS better than another in the treatment of UI?
- Is PTNS better than other treatments in the treatment of UI?
- Does the addition of PTNS to other treatments add any benefit in the treatment of UI?
- What is the effect of PTNS on other LUTS?
- What factors might affect the outcome of PTNS in the treatment of UI?

Eligible interventions were PTNS/neurostimulation/neuromodulation, percutaneous or transcutaneous. Eligibility criteria for study participants and outcomes, as well as criteria used to assess 'risk of bias' in the included studies, were identical to those used in the previous section on EStim (Section II.4).

Description of intervention in included studies of PTNS

A total of 11 studies were eligible and are summarised in Table 19 (148-158).

5.1. Prevention

No studies that investigated either primary or secondary prevention of UI or LUTS were identified.

5.2. Treatment

5.2.1 Is PTNS Better than No Active Treatment (Placebo, Sham, Control or No Treatment) for Treatment of UI?

Three studies compared PTNS with no active treatment (Table 20) (148, 149, 151). One study included women with UUI (149) and two included women with OAB where some but not all participants had UI. No study focusing on SUI or predominant SUI was found.

A placebo or a sham procedure was employed as a comparator in all three studies. In two studies, the sham procedure was described as having electrodes placed without turning on the electrical generator (148, 151). In another study (149), the electrical generator was turned on only for a few seconds to allow the patient to experience a mild sensation; prior to treatment, patients in both groups had been counselled that the subsequent absence of the sensation was due to adaptation. The choice of a different needle position in the sham group was to eliminate any presumed response that could arise from the acupuncture effect from piercing the skin cephalad to the medial malleolus (149).

Quality of data

One study described using a computer generated randomisation list (149); other studies did not report randomisation techniques (148, 151). No study reported information on allocation concealment. Results were reported for everyone who entered the trial in one study (148), and another study reported 5% attrition rate from PTNS group and 13% from the sham group and that the reasons for drop out from each group were unrelated to the treatment (149), however it was unclear whether the other study had missing data (151).

Results

(a) *UUI*. No included studies reported information on cure rates. One study (149) reported that improvement rates were significantly higher for PTNS compared with no active treatment (reported p value <0.001). I-QoL scores found a significant difference between the groups which was due to a lack of significant change after the sham procedure and to the significant increase (improved quality of life) after PTNS (149). No serious adverse effects were reported in either group but patients in both groups reported occasional transient pain at the stimulation site (149).

(b) *DO/OAB*. There was no information on cure rates.

Summary

The three included studies were small (35-43 participants). All were generally assessed as having a high risk of bias. Data pooling was not possible. Data available from two studies on women with UUI or OAB suggests PTNS may be more effective than no active treatment in improving symptoms and quality of life, although no data were available on cure (**Level of Evidence: 2**). The included studies reported no serious adverse effects associated with either active or sham treatment (**Level of Evidence: 2**). No evidence was available for women with SUI or predominant SUI.

Recommendations

For women with UUI or OAB, PTNS may be more effective than no active treatment in symptom control (**Grade of Recommendation: C New**).

More studies with larger sample sizes and consistent and clear reporting of core outcomes would be beneficial in reaching a conclusion on the effectiveness of PTNS over no active treatment.

5.2.2 Is One Type of PTNS Better than Another in the Treatment of UI?

No study was found for this comparison.

5.2.3 Is PTNS Better than Other Treatments for Treatment of UI?

Five studies compared PTNS with drug treatment (Table 21).

Table 21 Summary of data on PTNS vs other treatments

Author, year	Comparator	N randomised	Study population	Duration (months)	Source of outcome**
UUI					
Preyer 2007* (1)	Percutaneous PTNS (16) vs Tolterodine (15)	31	UUI	3	Cure: NR Improvement: NR QoL via unspecified tool (higher scores indicate improvement): mean 4.4 higher, 95% CI 1.7 to 7.1 higher vs mean 4.6 higher, 95% CI 2.1 to 7.0 higher, reported p value = 0.93 Adverse effects: unspecified events noted
DO/OAB					
Manriquez 2013* (2)	Transcutaneous PTNS vs Oxybutynin (number per group not reported)	56	OAB	3	Cure: NR Improvement: NR QoL via OAB-q: no significant difference, no data Adverse effects: NR
Preyer 2015 (3)	Percutaneous PTNS (18) vs Tolterodine (18)	36	OAB (wet or dry)	3	Cure: NR Improvement: NR QoL via VAS, change from baseline, median [range]: N = 18, 1.9 [0 to 8] vs N = 18, 2.7 [0 to 8.5], reported p-value = 0.07 Adverse effects: pain, dry mouth, dizziness
Souto 2014 (4)	Transcutaneous PTNS (25) vs Oxybutynin (25)	50	OAB	3	Cure: NR Improvement: NR QoL via ICIQ-SF, mean [range]: 7.2 [0 to 18] vs 9.8 [0 to 18] at 3 months (treatment end), 8.3 [0 to 20] vs 13.3 [8 to 20] at 6 months (i.e. 3 month after treatment) QoL via ICIQ-OAB, mean [range]: 5.9 [1 to 11] vs 4.6 [0 to 10] at 3 months, 6.1 [1 to 20] vs 9.2 [4 to 13] at 6 months Adverse effects: NR
Vecchioli-Scaldazza 2013† (5)	Percutaneous PTNS (20) vs Solifenacin Succinate (SS) (20)	40	OAB (some had UUI)	1.5	Cure: NR Improvement: NR QoL via PGI-I (Wilcoxon test for paired sample, mean, SD): Group A (SS→PTNS): post SS 2.9 (1.1), post PTNS 2.1 (0.7); Group B (PTNS→SS): post SS 3.1 (1.0), post PTNS 2.3 (0.7) QoL via OAB-q: significant improvement in all groups both with SS and PTNS Adverse effects: NR

Note: For modality details or parameters, see Table 19.

NR = not reported; ICIQ-SF = International Consultation on Incontinence-Short Form (higher scores indicate increased severity); ICIQ-OAB = International Consultation on Incontinence-OAB (higher scores indicate increased severity); OAB-q = Overactive Bladder Questionnaire (higher scores indicating worse condition); PGI-I = Patient Global Impression of Improvement Questionnaire (lower scores indicate greater improvement); VAS = Global response assessment on visual analogue scale (higher scores indicate greater impact on QoL);

* abstract only

**Source of outcome: women's self-report was given priority but for studies in which it was not reported, quantification of outcomes based on diaries, pad tests or any other definitions chosen by trialists was used as a proxy.

† Crossover study with a three-month washout period for both groups.

1. Preyer O, Gabriel B, Mailath-Pokorny M, Doerfler D, Laml T, Umek W, *et al.* Peripheral tibial neurostimulation (PTNS) versus tolterodine in the treatment of women with urge urinary incontinence and urge symptoms (Abstract number 246). *International Urogynecology Journal and Pelvic Floor Dysfunction*. 2007;18(Suppl 1):S139-S40.
2. Manriquez VI, Naser ME, Gomez M, Guzman R, Valdevenito R, Lecannelier J, *et al.* Transcutaneous tibial nerve stimulation versus long release oxibutinin in the treatment of patients with overactive bladder. A randomized control trial (Abstract number 013). *International Urogynecology Journal and Pelvic Floor Dysfunction*. 2013;24(Suppl 1):S14.
3. Preyer O, Umek W, Laml T, Bjelic-Radicic V, Gabriel B, Mittlboeck M, *et al.* Percutaneous tibial nerve stimulation versus tolterodine for overactive bladder in women: a randomised controlled trial. *European Journal of Obstetrics, Gynecology, & Reproductive Biology*. 2015;191:51-6.
4. Souto SC, Reis LO, Palma T, Palma P, Denardi F. Prospective and randomized comparison of electrical stimulation of the posterior tibial nerve versus oxybutynin versus their combination for treatment of women with overactive bladder syndrome. *World Journal of Urology*. 2014;32(1):179-84.
5. Vecchioli-Scaldazza C, Morosetti C, Berouz A, Giannubilo W, Ferrara V. Solifenacin Succinate versus Percutaneous Tibial Nerve Stimulation in Women with Overactive Bladder Syndrome: Results of a Randomized Controlled Crossover Study. *Gynecologic & Obstetric Investigation*. 2013;75(4):230-4.

PTNS was compared with solifenacin succinate in one (158), tolterodine in two (153, 154) and oxybutynin in two (150, 157). The target population had OAB (with UI in some but not all of the participants) except for one study (153) where it was UUI. No study focusing on SUI or predominant SUI was found. One study used a cross-over design (158). Another study was a three-arm trial comparing PTNS versus oxybutynin versus PTNS and oxybutynin; only the findings for PTNS vs oxybutynin are reported here (157).

Quality of data

One study described using a computer generated sequence using adaptive randomisation, where allocation was centralised using telephone (154). Permuted blocks were used in one study but it was unclear whether there was allocation concealment (150). Other studies did not report such information on allocation concealment nor provided details on the randomisation process (153, 157, 158). In one study there was a dropout rate of 11% in both groups (154). In another study (158), a two-arm crossover trial of PTNS and Solifenacin where group A had Solifenacin then PTNS after a washout period and group B had PTNS then Solifenacin, there was a dropout rate of 30% from the group A and 20% from group B; the reasons were refusal of further treatment (10% vs 5%), no indication for starting treatment (10% vs 15%). A further 10% dropped out from group A as a result of adverse effects of treatment. Twenty-six percent of participants were excluded from analysis in one study (157) because they failed to comply with 12 weeks of treatment and/or did not attend follow up at six months; the reasons for non-compliance or missing data were not reported. In one study (150), it was unclear whether results were reported for everyone

who entered the trial, while in another (153) the authors did not account for all drop-outs.

Results

(a) UUI. There was no information on cure and improvement (153). Quality of life outcomes, measured using an unspecified tool, improved in both groups, although there was no statistically significant difference between them (153). One study reported unspecified adverse events in one of 16 participants and six of 15 participants in the PTNS and Tolterodine groups respectively; authors did not specify the nature of these adverse events (153).

(b) OAB. Data on cure or improvement were not reported. Quality of life outcomes were reported in four studies. Three of these found no significant difference between the groups, based on the Overactive Bladder Questionnaire in one study (150), OAB-q and the Patient Global Impression of Improvement (PGI-I) in another (158) and a visual analogue scale in the third (154). One study using ICIQ-SF and ICIQ-OAB reported that post-treatment scores decreased (indicating symptom reduction) in both groups at 12 weeks of treatment, although the score increased (indicating symptoms worsened) significantly for the oxybutynin group in contrast to the PTNS group. The PTNS group maintained their scores at 6 months follow-up (12 weeks after the cessation of treatment) (157). One study reported that adverse events were observed in three of 18 (17%) participants in the PTNS group (mainly pain at the puncture site) and nine of 18 (50%) participants in the tolterodine group (mainly dry mouth and dizziness) (154).

Summary

Five studies were included. These were small (36-56 participants) and generally assessed as having a high risk of bias. There were limited and widely heterogeneous data. Two studies (one for UUI, one for OAB) reported that quality of life improved over time for both PTNS and drug treatment groups with no significant difference between them, while two other studies (for OAB) found no significant difference in quality of life between PTNS and drug treatment post-intervention (**Level of Evidence: 2**). However, one study on women with OAB found that the improvement in quality of life was longer lasting following the cessation of treatment with PTNS than after tolterodine (**Level of Evidence: 2**). Data available from two studies on women with UUI or OAB suggests that PTNS is associated with a lower rate of adverse events than tolterodine and when they occurred, there were not as bothersome as those associated with tolterodine (**Level of Evidence: 2**). No evidence was available for women with SUI or predominant SUI.

Recommendations

There is no significant difference between PTNS and tolterodine in terms of quality of life, however PTNS may be considered as both may improve quality of life (**Grade of Recommendation: B New**).

PTNS may be considered for women as it is associated with fewer and less bothersome adverse effects than those from drug treatment (**Grade of Recommendation: B New**).

Recommendations

More randomised controlled trials with large sample sizes and clear and consistent reporting of core outcome data would be beneficial in reaching a firm conclusion on the effectiveness of PTNS over other treatments.

5.2.4 Does the Addition of PTNS to Other Treatments Add Any Benefit in the Treatment of UI?

Three studies assessed the effect of PTNS as an adjunct to another treatment, compared with the other treatment alone or with PTNS alone (Table 22). One study included women with UUI (reported as OAB incontinent) and combined PTNS with PFMT and bladder training (PTNS plus PFMT plus bladder training vs PFMT plus bladder training) (156). Two other studies included women with OAB (where some but not all participants had UI) and combined PTNS with a drug. One study combined PTNS using the Stoller afferent neuro-stimulation (SANS) protocol with Tolterodine (PTNS plus Tolterodine vs Tolterodine) (155). The other study was a three-arm trial of PTNS versus Oxybutynin versus PTNS plus Oxybutynin; only the findings for PTNS plus Oxybutynin versus Oxybutynin

are reported here (157). No study focusing on SUI or predominant SUI was found.

Quality of data

All studies reported adequate methods of randomisation, including the use of a list of random numbers (155), simple random number generator (156) and online randomisation (157). Allocation concealment was not mentioned in any of the study reports. In one study, there was 10% missing data from the group who had tolterodine alone, while there were no missing data in the combination therapy group (155). In another study, there was 5% missing data from the PTNS group only; the reported reason for the attrition was due to health problems unrelated to therapy (156). In the third study, 24% dropped out of the oxybutynin group while 16% were excluded from the analysis in the combination therapy group. The reasons patients failed to complete the trial were not reported and it is unclear whether they were related to treatment (157).

Results

(a) UUI. No information was available on cure rates. One study reported that improvement rates were statistically significantly higher for the group combining PTNS with PFMT and bladder training compared with PFMT and bladder training alone (156). None of the participants reported significant adverse effects (156). ICIQ-SF scores improved for both groups but the combination treatment group had a significantly greater improvement (156). Similar results were found for KHQ; the combination treatment group showed a significantly greater improvement (156).

(b) OAB. No information was available on cure and improvement. Two studies reported quality of life outcomes. One study using the short form of Incontinence Impact Questionnaire (IIQ-7) reported that post-treatment scores decreased (indicating less impact of UI on daily living) in both groups but this decrease in the group combining PTNS and drug was greater than the group using drug alone (155). Another study reported that ICIQ-SF scores decreased (indicating symptom reduction) in both groups at 12 weeks of treatment, although the score increased (indicating symptoms worsened) significantly for the group using drug alone compared with the group combining PTNS and drug at 6 month follow-up (12 weeks after the cessation of treatment) (157). ICIQ-OAB results from the same study found that the combination treatment group had a greater improvement in OAB symptoms compared with the group using drug alone at 12 weeks of treatment; ICIQ-OAB scores increased (worsening in symptoms) for the group using drug alone in contrast to the other group that maintained their scores at 6-month follow-up (157). No information was available on cure and improvement.

Table 22 Summary of data on PTNS + another treatment vs the other treatment

Author, year	Comparator	N randomised	Study population	Duration (months)	Outcome**
UUI					
Schreiner 2010 (1)	Transcutaneous PTNS + PFMT + bladder training (26) vs PFMT + bladder training (26)	52	UUI	3	Cure: NR Improvement based on diary: 19/25 vs 7/26 QoL via ICIQ-SF, change from baseline, mean (SD): 7.2 (4.3) vs. 2.6 (3.3), reported p-value <0.001 QoL via KHQ: reported p-value <0.05 favouring the combination treatment group; no data Adverse effects: no events noted
OAB					
Sancaktar 2010 (2)	SANS (Percutaneous) + Tolterodine (20) vs Tolterodine (20)	40	OAB (some had UUI)	3	Cure: NR Improvement: NR QoL via IIQ-7, mean (SD): SANS + Tolterodine, change from pre 19.0 (2.0) to post 9.0 (0.8), p <0.001; Tolterodine, change from pre 18.1 (2.5) to post 11.2 (2.7), p <0.001 Adverse effects: dry mouth, constipation, headache, local irritation of puncture site
Souto 2014 (3)	TENS (Transcutaneous) + Oxybutynin (25) vs Oxybutynin (25)	50	OAB	3	Cure: NR Improvement: NR QoL via ICIQ-SF, mean [range]: 7.9 [0 to 14] vs 9.8 [0 to 18] at 3 months (treatment end), 7.4 [0 to 14] vs 13.3 [8 to 20] at 6 months (i.e. 3 month after treatment) QoL via ICIQ-OAB, mean [range]: 2.9 [0 to 5] vs 4.6 [0 to 10] at 3 months, 3.0 [0 to 5] vs 9.2 [4 to 13] at 6 months Adverse effects: NR

Note: For modality details or parameters, see Table 19.

NR = not reported; ICIQ-SF = International Consultation on Incontinence-Short Form (higher scores indicate increased severity); ICIQ-OAB = International Consultation on Incontinence-OAB (higher scores indicate increased severity); IIQ-7 = short form of Incontinence Impact Questionnaire (lower scores indicate better QoL); KHQ = King's Health Questionnaire (higher scores indicate greater impairment);

SANS = Stoller Afferent Nerve Stimulation of the posterior tibial nerve;

TENS = Transcutaneous Electrical Nerve Stimulation of the posterior tibial nerve;

TTNS = Transcutaneous Tibial Nerve Stimulation;

**Source of cure and improvement outcome: women's self-report was given priority but for studies in which it was not reported, quantification of outcomes based on diaries, pad tests or any other definitions chosen by trialists was used as a proxy.

1. Schreiner L, dos Santos TG, Knorst MR, da Silva Filho IG. Randomized trial of transcutaneous tibial nerve stimulation to treat urge urinary incontinence in older women. *International Urogynecology Journal*. 2010;21(9):1065-70.
2. Sancaktar M, Ceyhan ST, Akyol I, Muhcu M, Alanbay I, Mutlu EC, *et al*. The outcome of adding peripheral neuromodulation (stoller afferent neuro-stimulation) to anti-muscarinic therapy in women with severe overactive bladder. *Gynecological Endocrinology*. 2010;26(10):729-32.
3. Souto SC, Reis LO, Palma T, Palma P, Denardi F. Prospective and randomized comparison of electrical stimulation of the posterior tibial nerve versus oxybutynin versus their combination for treatment of women with overactive bladder syndrome. *World Journal of Urology*. 2014;32(1):179-84.

Adverse events were reported by one study comparing PTNS plus tolterodine with tolterodine alone (155). In this study, severe dry mouth, severe constipation, headache and local irritation at puncture site were reported in both treatment groups, and skin irritation for the group using PTNS. Two of 18 participants (11%) experienced more than one adverse event in the tolterodine group compared with one of 20 participants (5%) in the group combining PTNS with tolterodine.

Summary

Three small studies were included (40-52 participants). The included studies were assessed as having a high risk of bias. No data were available on cure and improvement rates for this comparison. Data from one study suggests that the addition of PTNS to PFMT and bladder training was more effective in improving symptoms and quality of life than PFMT and bladder training alone in women with UII (**Level of Evidence: 2**).

Data from two studies suggest that adding PTNS to drug treatment resulted in a greater improvement in quality of life than the drug treatment alone in women with OAB, and this effect was sustained for a longer term (6 months) for the treatment with PTNS than the treatment without PTNS (**Level of Evidence: 2**). Adverse events appear uncommon for either group in the same study. No evidence was available for women with SUI or predominant SUI.

Recommendations

PTNS may be considered for symptom control when chosen in combination interventions by women with UII or OAB (**Grade of Recommendation: B New**).

This recommendation should be viewed with caution until these findings are supported or refuted in further trials.

5.3. Other LUTS

No trials were identified that analysed the effect of PTNS in women with other LUTS alone, e.g. frequency of voiding, urgency and/or nocturia.

5.4. Factors Affecting Outcome

The included studies did not address the effect of factors that could potentially affect the response to treatment with PTNS. A greater discussion of the factors that affect outcome is provided in the section on urinary incontinence in men and women (see section V.1.4).

6. MAGNETIC STIMULATION (MSTIM)

MStim has been developed for “non-invasive” stimulation of both central and peripheral nervous systems (159). MStim for the treatment of UI was reported for the first time in 1999 by Galloway (160). In contrast to EStim, extracorporeal magnetic innervation (more



Figure 5 MStim machine

commonly called magnetic stimulation) stimulates the PFM and sacral nerve roots without insertion of an anal or vaginal probe (161). For treatment, the individual is positioned in a chair. Within the seat is a magnetic field generator (therapy head) that is powered and controlled by an external power unit (Figure 5). A concentrated steep gradient magnetic field is directed vertically through the seat of the chair. When seated, the individual's perineum is centred in the middle of the seat, which places the PFM and sphincters directly on the primary axis of the pulsing magnetic field (Figure 6). Because of their anatomical location, it is thought that all tissues of the perineum can be penetrated by the magnetic field. According to Galloway (1999) no electricity, but only magnetic flux enters the body from the device. Goldberg (2000) has suggested that, in contrast to electrical current, the conduction of magnetic energy is unaffected by tissue

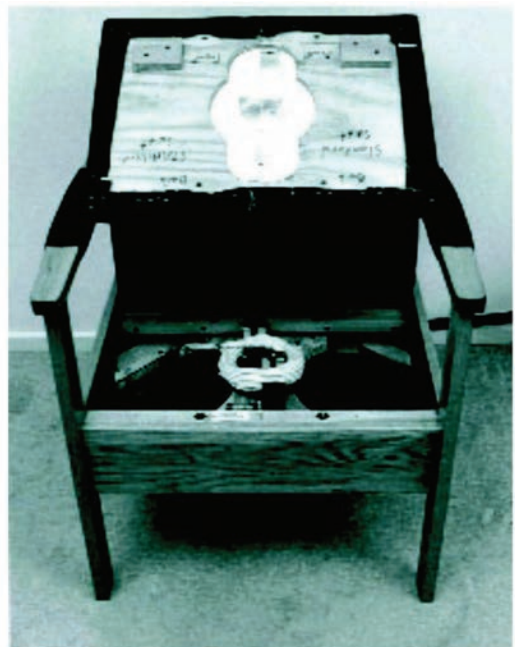

Figure 6 Pulsing magnetic field

impedance, creating a theoretical advantage in its clinical application compared to EStim. Conventional magnetic stimulators deliver, at frequencies of 10 to 50 Hz, repetitive pulses of current lasting less than 100 μ sec (161) and 275 Φ s (160) in duration. Size and strength of the magnetic field is determined by adjustments of this amplitude by the therapist (160).

Possible advantages of MStim are that it is performed through clothing, needs no probes, skin preparation, or contact with the skin surface. On the other hand, the need for repeated clinic based treatment sessions is a potential disadvantage. In contrast to EStim, MStim lacks portability, although a study by But in 2003 (162) reported the development of a portable small electromagnetic device (Pulsegen) for home use that fit into the underwear and was designed for continuous use for up to 8 weeks.

The mechanism of action of MStim is not fully understood (163). Some authors have suggested that in SUI stimulation of the PFM causes external sphincter contraction (164), acts as a passive PFMT exercise (165), and increases maximal urethral closure pressure (162). In UUI, MStim might suppress DO through activation of pudendal nerve afferents blocking parasympathetic detrusor motor fibres at the spinal reflex arc, activation of inhibitory hypogastric sympathetic neurons, or a combination of both mechanisms (166). Stimulation of sympathetic fibres maintaining smooth muscle tone within the intrinsic urethral sphincter and modulation of pudendal nerve afferent branches stimulating an inhibitory spinal reflex at the S3 nerve root, are also suggested to play a role in this mechanism of action (166).

In this section the evidence is considered for the use of MStim for the prevention and treatment of UI in women. Questions addressed are:

- Is MStim effective in the prevention of UI?
- Is MStim better than no active treatment (placebo, sham, control or no treatment) for the treatment of UI?
- Is one type of MStim better than another in the treatment of UI?
- Is MStim better than other treatments in the treatment of UI?
- Does the addition of MStim to other treatments add any benefit in the treatment of UI?
- What is the effect of MStim on other LUTS?
- What factors might affect the outcome of MStim in the treatment of UI?

Eligible interventions were non-invasive magnetic stimulations. Eligibility criteria for study participants and outcomes, as well as criteria used to assess 'risk of bias' in the included studies, were identical to those described in the previous sections on EStim and PTNS (Sections II.4 and II.5).

Description of intervention

In addition to eleven studies included in the 5th ICI, two new trials were identified for this update. The number of included studies by dominant type or pattern of incontinence is summarised in Table 23. Table 24 illustrates the intervention characteristics of the two new trials.

6.1. Prevention

In the last ICI chapter, there were no trials on prevention of UI or LUTS. No new published trials were found.

6.2. Treatment

6.2.1 Is MStim Better Than no Active Treatment (Placebo, Control or no Treatment)?

Two new studies including 162 women were identified (167, 168). In one study the majority of female participants had SUI (refractory to first-line management) (167). The other study included all types of UI (168).

Characteristics of the two new studies comparing magnetic stimulation with no active treatment are presented in Table 25. In both studies the no active treatment consisted of sham treatment. One study assessed the efficacy of a magnetic stimulator developed for home use (168), whereas in the other study treatment was provided in the outpatient clinic setting (167). Since there was little duplication of MStim interventions, or sample populations, in the eleven trials, it was inappropriate to combine study findings.

Quality of data

Allocation concealment was considered to be adequate in one study that used an independent research assistant in the randomisation process (168). The other study did not describe methods used for allocation concealment (167). In both studies, data were reported only for those participants who completed the study (167, 168). In particular, in the study by Wallis (2012), 19% (12/62) of participants from the intervention group and 15% (9/60) in the eleven trials, it was inappropriate to combine study findings.

Results

i) SUI. No additional data on cure and improvement were available for this update. The results for cure and improvement rates are as reported in two previous studies (169, 170).

Information on quality of life was provided in three studies, including one new study (167), but the results were not consistent. Two previously reported studies found no significant differences between the groups (169, 170), whereas the new study reported better quality of life at 18 weeks after active treatment compared with sham treatment, based on the Urge-Urinary Distress Inventory and the Overactive Bladder Questionnaire (167).

Table 23 Studies of MStim included in the previous review (5th ICI) and current update (6th ICI)

	Studies included in the previous review (5 th ICI)	New studies identified in this update (6 th ICI)	Total
MStim vs No active treatment			
SUI or predominant SUI	3	1	4
UII or predominant UII	1	0	1
MUI	1	0	1
UI all types	1	1	2
DO/OAB (wet or dry)	3	0	3
One type of MStim vs another			
SUI or predominant SUI	0	No study found	0
UII or predominant UII	0		0
UI all types	1		1
MStim vs other treatment	No study found	No study found	0
MStim+PFMT vs PFMT			
SUI or predominant SUI	1	No study found	1
UII or predominant UII	0		0

Table 24 Summary of data on MStim

Study	Intervention description
Tsai 2014 (1)	A Magstim Rapid2 with a 70-mm figure-8 coil. Treatment administered over the bilateral third sacral roots, with the maximal tolerable intensity, which was typically 70% to 80% of the maximal stimulator output, for 20 minutes each day for 12 consecutive weekdays. The stimulation frequency and the stimulation-on time and -off time were fixed at 5Hz, 10 seconds, and 20 seconds, respectively.
Wallis 2012 (2)	A commercially available undergarment incorporating 15 static magnets of 800-1200 Gauss arranged anterior, posterior, and inferior to the pelvis. Women were asked to wear it for a minimum of 6 consecutive hours during the day and at least 6 hours overnight for 3 months.

1. Tsai PY, Wang CP, Hsieh CY, Tsai YA, Yeh SC, Chuang TY. Long-term sacral magnetic stimulation for refractory stress urinary incontinence. *Archives of Physical Medicine & Rehabilitation*. 2014;95(12):2231-8.
2. Wallis MC, Davies EA, Thalib L, Griffiths S. Pelvic static magnetic stimulation to control urinary incontinence in older women: a randomized controlled trial. *Clinical Medicine & Research*. 2012;10(1):7-14

Two studies (one new) reported no adverse effects (167, 169).

ii) All types of UI. One new study that provided stimulation using an undergarment with embedded magnets reported that improvement rates were statistically significantly higher for active compared with no treatment, although the result did not hold in sensitivity analysis (168). No information was available regarding cure rates.

With respect to quality of life measures, no statistically significant difference was found based on the Bristol Female Lower Urinary Tract Symptoms (BFLUTS) questionnaire (168).

In the same study, participants reported problems with comfort and wearability of the garment, which were considered by study authors to have contributed to a relatively high attrition rate of 20%. Commonly cited problems include the attraction to metal objects; embedded magnets sticking to each other and making it difficult to put on; and also the garment being bulky and very warm to wear, especially in the subtropical climate of the study area (168).

Summary

A total of 11 studies assessed the effect of MStim compared with no active treatment, including four focusing on SUI or predominant SUI, one on UII, one on MUI, two on all types of UI, and three on OAB/DO (where only some but not all had UI).

Findings, using the additional data from newly identified studies were broadly similar to those in the 5th ICI.

For women with SUI, MStim might be more effective than sham in improving (not necessarily curing) symptoms (**Level of Evidence: 2**),

Data from two small trials of MStim (12 and 6 sessions) examining the effect on quality of life were conflicting (**Level of Evidence: 2**).

For women with UII, evidence from a small trial (171) suggests that active MStim might result in better quality of life than sham (**Level of Evidence: 2**), although there is some uncertainty surrounding this, as data was limited and no statistical test was performed.

Active MStim was associated with higher cure rates than sham in a small trial (172) with women with MUI (**Level of Evidence: 2**), and also higher cure and improvement rates in another small trial (162) with women with all types of UI (**Level of Evidence: 2**) but no such difference was observed for women with DO (wet or dry) (**Level of Evidence: 2**). In general, adverse effects appear uncommon.

Recommendations

No recommendation is possible based on current conflicting evidence (**Grade of recommendation D**).

6.2.2 Is One Approach to MStim Better than Another?

No new study comparing one approach of MStim with another was found for this update. The level of evidence and recommendations remains unchanged from the 5th ICI.

Summary and Recommendation

The 5th ICI included one study with women presenting UI symptoms (173). There is insufficient evidence to determine if one type of MStim is better than another (**Level of Evidence: 2**). No recommendation is possible (**Grade of Recommendation: D**).

6.2.3 Is MStim Better than Other Treatments?

There were no trials for this comparison in the 5th ICI chapter. No new published trials were found for this update.

6.2.4 Does the Addition of MStim to Other Treatments Add Any Benefit in the Treatment of UI?

No new study was found investigating the effect of adding MStim to other treatments compared with the other treatments alone. The level of evidence and recommendations remains unchanged.

Summary and Recommendation

The previous 5th ICI included one study in women with SUI (174). The addition of MStim to PFMT does not appear to be beneficial (**Level of Evidence: 2**).

Adding MStim to PFMT does not appear to be beneficial (**Grade of Recommendation: C**). This hypothesis needs to be investigated further with high quality trials, if it is a clinical question of interest to women.

6.3. Other LUTS

No trials were identified that analysed the effect of MStim in women with other LUTS alone, i.e., frequency of voiding, urgency and/or nocturia.

6.4. Factors Affecting Outcome

None of the included trials addressed the effect of age, or any other factor, on outcome of MStim. In one early prospective multi-centre study, factors predicting success of MStim were included (160). Treatment success was associated with no prior hysterectomy, no prior anti-incontinence operations, UI symptoms for fewer than 10 years, and no use of medications known to cause UI. Brodak has suggested that detrusor response to MStim might be better in 'thin' individuals (presumably due to a shorter distance between the stimulating coil and the sacral nerve roots) and at low bladder volumes (175). Overall, little is known about the factors affecting the outcome of MStim.

7. SCHEDULED VOIDING REGIMENS

Scheduled voiding regimens

This section examines the evidence on use of scheduled voiding regimens in cognitively intact, non-institutionalized women with UUI, SUI, and MUI and provides recommendations for their use in clinical practice. A summary of the search strategy and inclusion/exclusion criteria for selecting studies for review is provided (see section I). The chapters on the Frail Elderly and Neurogenic Incontinence provide detailed review of scheduled voiding regimens that are used in those with cognitive impairment, or UI secondary to central nervous system or spinal cord disease (see chapter 11).

Types of Scheduled Voiding Regimens

Bladder training is a broad term often used to describe any type of a scheduled toileting intervention. This has created conceptual confusion in interpreting research reports where few details are provided other than the statement that bladder training was used. The types of scheduled voiding regimens can be categorised as: bladder training, timed voiding, habit training, and prompted voiding (176). Although these regimens share a common feature of a toileting schedule, they differ on the basis of adjustments to the voiding schedule, the active or passive involvement of the patient, the nature of patient education including the teaching of strategies to control urgency and prevent stress leakage, the use of reinforcement techniques, and the nature of the interactions between clinicians and patients. In practice, however, scheduled voiding regimens may share aspects of one or more of these features.

Table 25 Summary of data on MStim vs no active treatment

Author	Comparator	N randomised	Study population	Duration (months)	Outcome**
Predominantly SUI					
Tsai 2014 (1)	MStim (20) vs Sham MStim (20)	40	>50% of study sample had SUI alone	outcome measured at 4.5 months	Cure: NR Improvement: NR QoL: OQB-q: N = 30, mean difference 23.80 lower, 95% CI 36.28 to 11.32 lower QoL via Urge-UDI: N = 30, mean difference 1.80 lower, 95% CI 2.64 to 0.96 lower Adverse effects: no events observed
All types of UI					
Wallis 2012 (2)	MStim (62) vs Sham MStim (60)	122	SUI, UUI or MUI	3	Cure: NR Self-reported improvement: 26/46 vs 18/50 QoL via BFLUTS (median change in score, IQR): UI symptoms, N = 101, 1.5 (3.0) vs 1.5 (3.0), p = 0.80; Sexual function, N = 101, 0 (0.75) vs 0 (0), p = 0.80; Quality of life, N = 101, 1.0 (5.0) vs 0 (5.0), p = 0.28 Adverse effects: discomfort of the garment

Note: For modality details or parameters, see Table 24.

NR = not reported; BFLUTS = Bristol Female Lower Urinary Tract Symptoms (higher scores indicate more severe complaints); OAB-q = Overactive Bladder Questionnaire (higher scores indicating worse condition); Urge-UDI = Urge-Urinary Distress Inventory (higher scores indicate worse condition);

**Source of cure and improvement outcome: women’s self-report was given priority but for studies in which it was not reported, quantification of outcomes based on diaries, pad tests or any other definitions chosen by trialists was used as a proxy.

1. Tsai PY, Wang CP, Hsieh CY, Tsai YA, Yeh SC, Chuang TY. Long-term sacral magnetic stimulation for refractory stress urinary incontinence. *Archives of Physical Medicine & Rehabilitation*. 2014;95(12):2231-8.
2. Wallis MC, Davies EA, Thalib L, Griffiths S. Pelvic static magnetic stimulation to control urinary incontinence in older women: a randomized controlled trial. *Clinical Medicine & Research*. 2012;10(1):7-14.

Bladder training

Bladder training (also referred to as bladder drill, bladder discipline, bladder re-education, and bladder re-training) involves a programme of patient education along with a scheduled voiding regimen with gradually progressive voiding intervals. Specific goals of bladder training are to correct faulty habit patterns of frequent urination (if present), improve control over bladder urgency, prolong voiding intervals, increase bladder capacity, reduce incontinent episodes, and restore patient confidence in controlling bladder function. The underlying mechanism of how bladder training achieves its effect is poorly understood. Several hypotheses have been proposed including improved cortical inhibition over detrusor contractions; improved cortical facilitation over urethral closure during bladder filling; improved central modulation of afferent sensory impulses; altered behaviour resulting from better individual awareness of the lower urinary tract function and circumstances that cause UI, and

increasing the “reserve capacity” of the lower urinary tract system (177-179).

Timed voiding

Timed voiding is a fixed voiding schedule that remains unchanged over the course of treatment (176). The goal is to prevent UI by providing regular opportunities for bladder emptying prior to exceeding bladder capacity. Timed voiding has been recommended for patients who cannot participate in independent toileting (180). It also has applicability for use in outpatient settings with incontinent women who have infrequent or irregular voiding patterns (181) and men who are independent in their voiding function (182).

Habit training

Habit training is a toileting schedule matched to the individual’s voiding pattern based on their voiding diary. The toileting schedule is assigned to fit a time interval that is shorter than the person’s normal voiding

pattern and precedes the time when incontinent episodes are expected. Thus, the voiding interval may be lengthened or shortened throughout the day depending on the patient's voiding pattern with the goal to pre-empt UI. Habit training is usually implemented by caregivers in institutional settings with cognitively and/or physically impaired adults, but it has also been tested in homebound older adults (183). It is potentially useful for adults without cognitive or physical impairment, who have a consistent pattern of UI (181).

Prompted voiding

Prompted voiding refers to a caregiver education programme in combination with a scheduled voiding regimen, typically every two hours. It is used to teach people with or without cognitive impairment to initiate their own toileting through requests for help and positive reinforcement from caregivers when they do so (184). It has been used primarily in institutionalized settings with cognitively and physically impaired older adults.

Section Overview

This section examines evidence for the use of bladder training and timed voiding for the prevention and treatment of UI in non-institutionalised women of all ages without cognitive or mobility impairment. However, the majority of evidence available pertains to the effects of bladder training, thus this is the focus of this section.

Previously, no trials were identified that tested habit training or prompted voiding for UI in independent-living women without cognitive or physical impairment, and no new trials meeting these criteria were identified in this update. Therefore, evidence for use of habit training and prompted voiding is not included in this section.

Questions addressed in this section include:

- Can scheduled voiding regimens prevent UI?
- What is the most appropriate bladder training protocol?
- Is bladder training better than no treatment, placebo or control treatments?
- Is bladder training better than other treatments?
- Can any other treatment be added to bladder training to add benefit?
- Does the addition of bladder training to other treatments add any benefit?
- Is timed voiding effective at treating UI?
- What is the effect of bladder training on other LUTS?
- What factors might affect the outcome of bladder training?

7.1. Prevention

Previously no trials had examined scheduled voiding regimens as a sole intervention in the prevention of UI. In this update, no further trial was identified.

7.2. Treatment

Previous recommendations related to bladder training as treatment for UI were based on review of individual published trials and three systematic reviews that provided descriptive synthesis with evidence grading (180, 185, 186), including a published Cochrane review last updated in 2006 (185). In this ICI update, 5 additional trials were identified and are described in the relevant sections below (98, 102, 156, 187, 188).

7.2.1 What Is the Most Appropriate Bladder Training (BT) Protocol?

Previously no trials were identified that compared two or more methods of bladder training (BT), and none were identified for this update. In the absence of trials comparing two or more approaches, a content analysis was performed looking at the protocols used in trials investigating the effects of BT. It has been updated for this edition. Twenty-two trials on BT involving a total of 3194 women have been identified, including 5 trials involving 732 women added since the last update (98, 102, 156, 187, 188). Several of the trials previously reviewed (189-194) and 2 of the new trials identified for this update (156, 187) provided no or minimal details regarding the specific BT protocol used. In trials that did provide some description, BT protocols were implemented in differing ways. In the following review of BT protocols, information from studies added in this update are integrated with information from previously reviewed studies.

All protocols involved some type of patient education, namely:

- Brief verbal (191, 192) or written instructions (195, 196)
- Verbal, written, and audio-visual instruction (177, 179, 197)
- Introduction to an individual who successfully completed BT (193)

If specified, the education was provided by nurses (177, 179, 189, 190, 198, 199), general practitioners (200), or physiotherapists (98, 102, 188).

Scheduling of voids varied in the following ways:

- Assignment of the initial voiding interval varied from 30 minutes to two hours, with one hour being the most common interval based upon the participant's voiding pattern or 30 minutes beyond the participant's average (195, 201) or longest (102) voiding interval.

- Adjustments to the voiding interval varied from 15 to 30 minutes, with 30 minutes the most common interval. Increases were made daily for inpatient regimens (193), after 48 hours of dryness (202), every four to five days (201), or weekly if schedule was well-tolerated (102, 177, 179).
- Goals for optimal voiding interval varied from three to four hours.
- Voiding was 'mandatory' with restriction of voiding in between assigned toileting times even if UI occurred (193), a scheduled voiding regimen that allowed interruptions in the schedule if urgency became unbearable (177, 179, 199), or self-scheduling of voiding with a target goal to reach (195).
- Voids were not scheduled (allowed) during sleeping hours (193); none of the other protocols identified how voids were handled during sleeping hours.

In some protocols the scheduled voiding regimen was supplemented by specific strategies to control urgency and/or stress leakage, including distraction and relaxation (102, 177, 179, 188, 195, 199), and pelvic floor muscle contraction (102, 177, 190, 196). In other studies there was encouragement to suppress urge but it was not clear what strategies were used (192, 200, 203). Feedback techniques included self-monitoring (177, 179, 191, 194, 199), goal setting with feedback of progress (198), and positive reinforcement (177, 179, 201).

Several protocols included use of adjunctive treatments:

- Fluid and caffeine adjustments (197, 199, 203)
- Fluids allowed up to a certain level (1,500 ml) (202)
- No fluid modifications (102, 177, 179, 195, 200)
- Advice on constipation prevention (199)

Both in and outpatient BT programmes have been used. Early inpatient BT programmes involved five to 13 days of hospitalisation to ensure strict protocol adherence (193). Outpatient programmes are more commonly described and the amount of health professional contact ranged from weekly visits for six weeks with fortnightly telephone calls for six additional weeks (177), to weekly visits (179, 188, 189), fortnightly visits (102, 201), and monthly visits (202). A "simplified" BT treatment with minimal to no health professional contact (instructions given to patients on a one page instruction sheet) has also been tested (195, 196).

Overall, there is a lack of consistency in BT protocols. Based on the protocols described, a reasonable outpatient BT protocol, based on expert opinion is shown in Figure 7.

Typical Bladder Training Regimen

- An initial voiding interval typically beginning at one hour during waking hours, which is increased by 15 to 30 minutes per week depending on tolerance of the schedule (such as fewer incontinent episodes than the previous week, minimal interruptions to the schedule, and the patient's feeling of control over urgency and confidence to expand the voiding interval), until a two to three hour voiding interval is achieved. A shorter initial voiding interval, e.g. 30 minutes or less, may be necessary for patient whose baseline micturition patterns reveal an average daytime voiding interval of less than one hour.
- Education about normal bladder control and methods to control urgency such as distraction and relaxation techniques and PFM contraction.
- Self-monitoring of voiding behaviour using diaries or logs in order to determine adherence to the schedule, enhance self-awareness, evaluate progress, and determine whether the voiding interval should be changed (for example, see Figure 7).
- A supervising health care professional to monitor progress, suggest adjustments to the voiding interval, and provide positive reinforcement to patient undergoing BT at least weekly during the training period.
- If there is no improvement after three weeks of BT, re-evaluation is warranted and other treatment options would be considered. Inpatient BT programmes may follow a more rigid scheduling regimen with progression of the voiding interval on a daily basis.

Summary

There is still no trial evidence to suggest the most effective method or specific BT parameters. For those undertaking BT it is likely that more health professional contact will be better than less, based on the developing evidence for PFMT, which like BT, requires behavioural change (**Level of Evidence: 4**). The literature suggests several areas that could be investigated in future trials, including the instructional approach, supervisory intensity, strategies for controlling urgency, scheduling parameters, frequency of schedule adjustments, length of treatment, and use of adjunctive treatments.

Recommendations

Clinicians and researchers are advised to refer to the operant conditioning and educational literature to provide a rationale for their choice of their approach to BT. The ICS Consensus statement and review pa-

pers on Adherence and PFMT could be useful to clinicians and researchers (24-27). **(Grade of Recommendation: D).**

Clinicians should provide the most intensive BT supervision that is possible within service constraints **(Grade of Recommendation: D).**

More research is needed to investigate which BT parameters, supervisory intensity, and adjunctive treatments are most effective. Future trials should include outcomes that matter to patients, including the length and frequency of supervisory contact.

7.2.2 Is BT Better than No Treatment, Placebo or Control Treatments?

BT as sole therapy has been used in the treatment of DO, urodynamic SUI, MUI, UUI, UUI with a stable bladder, and OAB (also called urgency-frequency syndrome).

No new trials were identified that addressed this question. Previously 5 RCTs reporting on 515 women were identified that compared the effect of BT to no treatment or control (179, 189, 194, 199, 200). Of 4 trials with relevant analysable data (179, 189, 194, 200), 3 reported improvements in the BT group compared to the control group (179, 194, 200). The trial quality and detailed results were presented in previous editions of this chapter.

Summary

The few available trials (reviewed previously) were small and of variable quality. No new trials were identified in this update.

There is limited **Level 1** evidence that BT may be an effective treatment for women with UUI, SUI, and MUI **(Level of Evidence: 1).**

Recommendations

BT should be recommended as first line conservative therapy for UI in women **(Grade of Recommendation: A).**

Additional high quality studies are needed that examine the effect of BT versus no treatment in treatment of women with UUI, SUI, and MUI.

7.2.3 Is BT Better than Other Treatments?

This section, considered trials which compared BT alone versus another active therapy.

For the comparison of BT versus PFMT see II.2.3.3.

The only other comparison for which trials were found was BT versus drug therapy. One additional trial was identified for this update (98). Previously, two small trials were identified that randomized 131 women with UUI to BT or drug treatment (193, 201).

Kafri *et al.* (98) randomized 184 women with UUI to one of four groups: BT, PFMT, tolterodine extended release 4 mg or combined behavioural therapy (BT and PFMT). Results from the BT and drug treatment group comparison are included here, while results of

Monday

Continence Program For Women
Treatment Log

Diet No: _____ Day: _____

Midnight to Noon

Noon to Midnight

WEEKLY VOIDING INTERVAL: 1 1/2 hours

Treatment Number	<u>2</u>	No. of Scheduled Voidings/Urinated	<u>2</u>
No. of Scheduled Voidings	<u>12</u>	Nocturnal Frequency	<u>1</u>
No. of Scheduled Voidings Missed	<u>1</u>	Incontinence Episodes	<u>2</u>
		Day Missed (Y/N)	<u>N</u>

A

Instructions: Use this table to indicate all unscheduled voidings, including intermissions in scheduled voiding intervals, and all incontinent voidings.

TIME	URINATE IN TOILET	LEAKING ACCIDENT	COMMENTS
12-1 AM			
1-2 AM			
2-3 AM	✓		
3-4 AM			
4-5 AM			
5-6 AM			
6-7 AM			
7-8 AM			
8-9 AM			
9-10 AM	✓	✓	strong urge
10-11 AM			
11-12 NOON			
12-1 PM	✓		
1-2 PM			
2-3 PM			
3-4 PM		✓	cough
4-5 PM			
5-6 PM			
6-7 PM			
7-8 PM			

Figure 7 Bladder diary

the BT vs PFMT comparison are included in section II.2.3.3.

Quality of data

Kafri *et al.* (98, 201) was a single-blinded trial in which 83 women were randomized to drug treatment or BT and followed up for 12 months. A power calculation and adequate random allocation concealment were reported. Drug tolerability and adverse events were assessed, but side effects were reported in a composite outcome only. Intent-to-treat principles were followed. Drop out at 3 months was higher in the drug treatment compared to BT group (36% vs 5%) (98).

Results

In Kafri (98), the number of self-reported UUI episodes in the past week significantly decreased at 3 and 12 months in both the BT and drug treatment groups. Between group comparisons suggested no difference in outcomes. Differential dropout suggested drug treatment was associated with more adverse effects, but this was not clearly reported. These results were similar to one previously reviewed trial in short-term outcomes (201), but in that trial symptoms recurred more often after drug treatment than after BT at 6 months follow-up. Another older trial found BT superior to drug treatment at 3 months follow-up (193). Both previously reviewed trials found adverse effects common in the drug treatment groups, but not in BT groups.

Summary

Despite an additional trial, it remains unclear whether BT or drug therapy is more effective for women with DO or UUI (**Level of Evidence: 1**).

This result is consistent with the findings of the Cochrane review (185), which concluded that there was not enough evidence to determine whether first line therapy should be BT or anticholinergic drugs.

Recommendations

When considering BT and anticholinergic drug for women with DO or UUI, either may be effective (**Grade of Recommendation: B**).

BT may be preferred by women and clinicians because it is not associated with the drug related side effects (**Grade of Recommendation: D**).

7.2.4 Can Any Other Treatment Be Added to BT to Add Benefit?

To be included here, trials needed to investigate the effects of BT versus BT plus therapy A to address the additive benefit of therapy Three new trials were identified that tested the additional benefit of PFMT, drug therapy and tibial nerve transcutaneous electrical stimulation when added to BT (102, 156, 187). One trial addressed the added benefit of PFMT to BT (102) and is considered in the section on PFMT (II.2.3.4). A 2010 randomized trial tested the additive effects of

tibial nerve transcutaneous electrical stimulation in 51 older women undergoing “routines of care” which included BT and Kegel exercises (156). As BT was combined with pelvic floor exercise treatment in both groups and no details were provided about the BT protocol, it was not possible to determine the effects of BT alone, and it is not considered further here. The third trial tested the addition of oxybutynin, imipramine or placebo to BT in 282 men and women with DO who had failed at least 8 weeks treatment of BT alone (187). However, very limited information is available on the methods and results (abstract only). This trial was also not considered further.

Prior editions of this chapter identified trials addressing the additional benefit of caffeine reduction, PFMT, and drug therapy when combined with BT. The caffeine reduction trial was included in the Lifestyle Interventions (II.1) section (203), and the trial addressing additional benefit of PFMT when added to BT was included in the PFMT section (II.2.3.4) (177). Three trials previously identified tested the added benefit of drug therapy to BT treatment. One of these tested a drug that is no longer available (terodiline), and is not considered further (192). The remaining trials included one that randomized 34 women and men with DO to BT or BT plus imipramine therapy (202), and another that randomized 60 women and men to BT and placebo or BT plus immediate release oxybutynin (191). No difference was seen in incontinence outcomes between the groups in either trial, although subjective improvement was greater with addition of a drug in one (191). Data quality and detailed results from these trials were reviewed in past editions of this chapter.

Summary

No new trials contributed evidence in this area. In two small trials (reviewed in previous editions) comparing BT (or BT plus placebo) versus BT plus drug in DO, there was a suggestion that the effect of BT might be enhanced by active drug (**Level of Evidence: 2**). However, both trials were small, conducted in gender-mixed sample populations, and outcomes were not common to both trials. Thus, there is insufficient evidence to derive a conclusion related to the effectiveness of augmenting BT with drug therapy.

Recommendations

Direct comparisons of BT versus BT with drug for UI treatment are needed to address the question of whether the effect of BT can be augmented by drug therapy. No recommendation is possible (**Grade of recommendation D**).

7.2.5 Does the Addition of BT to Other Treatment Add Benefit?

To be included here, trials needed to investigate the effects of Therapy A versus Therapy A plus BT to assess the added benefit of BT over Therapy A alone. A search for trials that investigated the effects of PFMT alone versus PFMT plus BT, and drug therapy

alone versus drug therapy plus BT was performed. No new trials focused on this question were identified.

Three trials were reviewed in previous editions of this chapter, including one older study that compared BT, PFMT and combination therapy in 204 community-dwelling women with SUI and/or DO (177). Two larger RCTs compared a “simplified” BT (administered by providing participants with a 1 page written instructions on BT) plus drug therapy (tolterodine (2mg twice daily) (190, 195) and solifenacin (5/10mg daily)(195)) to drug therapy alone in women and men with OAB with or without UUI. UI outcomes were secondary endpoints in these trials.

Summary

A single trial found combining BT with PFMT improved short-term outcomes compared to PFMT alone, but the added benefit did not persist three months later (**Level of Evidence: 2**).

There is no evidence for an added benefit of combining brief written BT instructions with tolterodine (2mg twice daily) or solifenacin (5/10mg daily) compared to drug therapy alone for urgency incontinence (**Level of Evidence: 2**), although these trials were likely underpowered to study UI outcomes.

Recommendations

With no new trials contributing evidence in this update, the available evidence (single trial) supports the use of BT as a supplement to PFMT in improving short-term outcomes, but not longer-term results (**Grade of Recommendation: C**).

Limited evidence suggests the addition of written information on BT for women with OAB taking an antimuscarinic drug does not further improve UI (**Grade of Recommendation: B**).

More research is needed using an appropriately supervised BT programme combined with drug therapy versus drug alone.

7.2.6 Is Timed Voiding Effective at Treating UI?

The Cochrane review on timed voiding for management of UI in adults was last updated in 2010 (204). Ostaszkiwicz (2010) considered randomized and quasi-randomised trials only and identified two trials comparing timed voiding combined with additional interventions (including medications) to usual care. Both trials were conducted in nursing homes and most participants were elderly women with cognitive impairment. Neither study recruited participants that met criteria for inclusion here.

No new trials were identified that tested timed voiding for UI in women without cognitive or physical disability. Previously, two older non-randomised studies, excluded from the Cochrane review, reported findings on the effects of timed voiding in women with UUI, stable bladders with UUI, and MUI (205, 206). One of

these, a small, double-blind crossover study compared timed voiding plus anticholinergic drug therapy (terodiline) to timed voiding plus placebo (205). As terodiline is no longer available, this study was not considered further. The second study was a small case series of 20 women with mild UI treated with timed voiding and followed from 6 weeks to 8 months after treatment (206). A successful outcome (not objectively quantified) was reported in 79% of participants.

Summary

There are no RCTs, or high quality observational studies, providing evidence on the effects of timed voiding for UI in cognitively intact, community-dwelling women, and no new trials considering this were identified. Based upon the data from one small uncontrolled study, it seems a two-hour timed voiding schedule may be beneficial in treating women with mild UI, infrequent voiding patterns, and stable bladder function (**Level of Evidence: 3**).

Recommendations

Timed voiding with a two-hour voiding interval may be considered as a sole intervention for women with mild UI or infrequent voiding patterns (**Grade of Recommendation: C**) Timed voiding may also be considered as an adjunct to other treatment.

7.3. Other LUTS

Two new trials were identified that reported frequency outcomes. Kafri *et al.* (98) compared BT to drug treatment and reported on frequency outcomes (others reviewed in section II.7.2 above). A second trial addressed the added benefit of PFMT to BT (102) and reported frequency as a secondary outcome. This trial is considered in the section on PFMT (II.2.3.4).

Older trials (from past editions of this chapter), which also contributed evidence related to other LUTS outcomes, compared BT to drug therapy (190, 193, 201), BT to no treatment (179, 189, 194), BT plus placebo to BT and drug treatment (191), and additive effects of a simplified BT program to drug treatment (195, 196).

Quality of data

The quality of data in the new trial that tested BT vs drug treatment was described earlier (II.VII.2c).

Results

i) Urgency: No new trials reported on urgency outcomes. In previously reviewed trials, urgency results were conflicting. An older trial suggested BT was superior to drug treatment (193), but another reported greater improvement in urgency after drug treatment or combined drug and BT treatment compared to BT alone (190). Two larger trials found no additional improvement in urgency when a simplified BT treatment was added to drug treatment for OAB (195, 196).

ii) Daytime (diurnal) frequency:

A newly identified trial found frequency improved at 3 and 12 months after treatment with BT, drug treatment (tolterodine extended release 4 mg), or a combined BT and PFMT group (98). On average, subjects reported 2 to 4 fewer voids per 24 hours after treatment. Between group differences were not reported.

In previously reviewed trials, frequency improved to a greater extent in BT groups compared to no treatment (179, 189, 194). In trials testing BT compared to drug treatment, frequency improved in both groups similarly (190, 201), or to a greater extent in the BT group (193). In one trial testing the additive effect of drug treatment to BT, a greater reduction in frequency was reported in the BT plus drug treatment group compared to BT plus placebo group (191). Lastly, two trials found that “simplified” BT significantly augmented the effect of drug alone. BT with tolterodine had greater improvement in voiding frequency compared to drug alone (33% versus 25% improvement, respectively; $p < 0.001$) and BT with solifenacin reduced the number of voids in 24 hours to a greater extent compared to drug alone (2.8 versus 2.1 fewer voids in 24 hours; $p < 0.001$) (195, 196).

iii) Nocturia: No new trials were identified reporting on nocturia. Three previously reviewed trials reported data in comparisons of BT with no treatment, and found reductions in nocturia after BT but not in the control group (179, 189, 194). Four previously reviewed trials compared BT with drug therapy. Two smaller trials found BT superior compared to drug treatment in treating nocturia (193, 201). Another trial compared BT plus placebo versus BT plus drug (191) and found no difference in nocturnal micturition frequency. Song (2006) reported that nocturia improved similarly in women with OAB treated with BT (56.1%), tolterodine (65.4%), and combined treatment (66.3%) (190).

Summary

No trials were identified which tested the effectiveness of BT compared to no treatment or a control for urgency. It remains unclear whether BT or drug treatment is more effective in treating urgency (**Level of Evidence: 2**).

Several trials, including one newer study, suggest BT is effective at improving frequency, (**Level of Evidence: 1**), but it is unclear whether BT or drug treatment is more effective (**Level of Evidence: 2**). Two larger, higher quality trials show that the addition of “simplified” BT to drug treatment does not provide additional benefit in treating urgency, but does improve frequency (**Level of Evidence: 1**). A few small, randomized trials of variable quality suggest BT is effective at treating nocturia (**Level of Evidence: 2**). Additional small trials do not find that BT (or BT added to drug treatment) is more effective at treatment of nocturia than drug treatment, but evidence is limited (**Level of Evidence: 2**).

Recommendations

Insufficient evidence exists to support either the use of BT to treat urgency in women with UI and/or OAB, or to guide the choice of BT vs drug treatment as initial treatment aimed at urgency (**Grade of Recommendation: D**).

Routine addition of a “simplified” BT to drug therapy does not provide additional improvement in urgency, but should be considered in treatment of voiding frequency in women with UI and OAB (**Grade of Recommendation: B**).

BT should be offered as treatment for urinary frequency and nocturia (**Grade of recommendation: B**), but in choosing between BT and an anticholinergic drug for women with frequency, either may be effective (**Grade of Recommendation: B**).

7.4. Factors Affecting Outcome

Few trials on BT have examined predictors of treatment response. New trials reviewed for this update did not contribute additional information related to predictors of timed voiding or BT treatment response.

8. COMPLEMENTARY AND ALTERNATIVE MEDICINES

There is limited, but growing evidence that complementary and alternative medicines (CAMs) may influence physiological function and/or health outcomes. CAMs include those therapies that are not part of the traditional biomedical model, such as meditation, imagery, hypnosis, acupuncture and naturopathic and herbal remedies.

This section reviews the current evidence for the effects of CAMs on UI in cognitively intact, community-dwelling women. Studies focused on UI in women with neurogenic aetiologies (for example, UI associated with stroke or multiple sclerosis) have been excluded. A summary of the search strategy used for selecting studies for review is provided in section I.

In the 5th ICI, a single RCT focused on hand acupuncture therapy was reviewed here. Given the lack of evidence, no recommendations related to CAMs were made for women with UI. Since then, additional RCTs and a Cochrane review have been published. Many of these trials tested various acupuncture techniques for UI; these are reviewed and summarized below.

Small individual trials testing other types of CAM therapy (for example, meditation and relaxation therapies and natural supplements) for UI were identified in the current search, many labelled as pilot trials. As recommendations cannot be made based on the minimal evidence available for any individual type of CAM therapy, these are not formally reviewed here. As interest in CAM therapies grows and more evidence accrues, additional types of non-traditional therapies may be reviewed in future editions.

Acupuncture and UI

Acupuncture and related techniques have been performed as part of Eastern medicine for thousands of years. Related therapies may include body acupuncture, hand acupuncture, electroacupuncture and acupressure, amongst others. Their mechanisms of action are not fully understood, but discussions of these mechanisms related to treatment of UI from traditional Chinese medicine and other perspectives are available (207, 208).

8.1. Prevention

In the 5th ICI, no trials examined acupuncture for the prevention of UI. In this update, no new trials were identified.

8.2. Treatment

8.2.1 Acupuncture for Treatment of SUI

Previously, one low-quality RCT that studied the effect of hand acupuncture vs control (no treatment) for female SUI in 52 women (209) was identified. In this update, a recently-published Cochrane review of acupuncture and SUI was reviewed (207), which included one trial of acupuncture vs drug treatment for SUI (210). An additional trial of acupressure for the treatment of is included in this update (211).

The 2013 Cochrane review considered evidence for acupuncture interventions from traditional Chinese medicine (body acupuncture, scalp acupuncture, electroacupuncture, warm acupuncture, fire needle and elongated needle), and did not consider trials of other interventions, such as hand acupuncture and acupressure (207). The authors searched and reviewed English and Chinese language publications. Only 1 trial was included (many were excluded because they combined acupuncture with other treatments or compared different types of acupuncture). The single eligible trial randomized 60 women to acupuncture vs a drug treatment (midrodine) and reported subjective improvement and cure and adverse effects at 6 to 12 weeks (207).

Chang *et al.* completed an RCT of 81 women with urodynamic SUI, randomized to 3 groups including acupressure, sham acupressure and “usual care” including PFMT (taught at baseline) (211). The treatment and sham groups underwent 3 weekly treatment sessions for 10 weeks. No information was provided on performance of PMFT (or other treatments) in the “usual care” group (or the other treatment groups). Outcomes were assessed after the 10-week treatment period. The primary outcome was pelvic floor muscle strength. Numbers of urine leak episodes from a 4-day diary and a subjective assessment of urine incontinence severity were also assessed.

Quality of data

Randomization concealment was inadequate in both trials (207, 211). No blinding or partial blinding was performed. Few participants withdrew from the trials

(<5%). Adverse effects were reported in 1 reviewed trial (207).

Results

More women reported improvement in the acupuncture group (73% vs 33%; risk ratio 2.2 (95% CI 1.3-3.8)) compared to drug treatment (207). Cure rates were low and not different between the groups (13% vs 7%; risk ratio 2.0 (95% CI 0.4, 10.1)). Adverse effects were reported in the drug group only (including headache, dizziness, and thirst).

In the trial comparing acupressure, sham acupressure vs PFMT alone, numbers of incontinence episodes were unchanged and did not differ between groups, although self-reported severity of leakage improved to a greater extent in the acupressure compared to the sham acupressure group ($p=0.04$) and to PFMT alone ($p=0.01$) (211). Adverse effects were not reported.

Summary

A single trial suggests acupuncture may be better than drug treatment in SUI (**Level of Evidence: 2**), but the low quality and atypical comparator group limits the impact of these results.

A single trial suggests mixed results for acupressure compared to sham treatment or usual care in treatment of SUI (**Level of Evidence: 2**), but the low quality and small numbers limit these findings. There is inadequate evidence to know if acupuncture or acupressure treatments are effective for SUI in women.

Recommendations

No recommendations can be made regarding the use of acupuncture or acupressure for SUI in women. High-quality RCTs are needed.

8.2.2 Acupuncture for Treatment of OAB, UUI and Mixed UI

In this update, two recently-published reviews were identified which focused on acupuncture for women with OAB, UUI or Mixed UI, as well as an additional trial (not included in the reviews) (208, 212, 213).

Paik *et al.* (208) performed a systematic review of RCTs published in English or Korean language journals testing acupuncture and acupressure treatments for UI. Four small RCTs were found eligible for that review. One of these studied acupressure for SUI and is discussed in the section above (211), but 3 are considered in this section, all published before 2010 (214-216). A second review focused on acupuncture and OAB in non-comparative and comparative trials (212). This review identified 4 RCTs relevant to this section (comparative trials of acupuncture for women with UI), 3 of which were also included in the review by Paik *et al.* (214-217). Thus, in total 5 RCTs (four included in the recently published reviews and 1 additional trial) are included in this edition. Study populations included women with OAB and UUI (214,

215), OAB with or without UUI (217), MUI and UUI (216) and MUI (213).

Two trials compared acupuncture to sham or placebo acupuncture (215, 216). One was a pilot RCT which tested acupuncture vs sham acupuncture (sham needles which didn't puncture the skin were used) in 9 women with mixed or urgency UI (216). The second trial randomised 74 women with OAB including UUI to acupuncture vs acupuncture performed at relaxation points (215). Two trials compared acupuncture to drug treatment, including an older trial that tested acupuncture vs oxybutynin 5 mg twice daily in 39 women with OAB with UUI (214). A recent, larger trial randomized 272 women with OAB with or without UUI to acupuncture or tolterodine 2 mg twice daily (217). Last, Jin *et al.* studied combination therapy with electroacupuncture plus tolterodine 2 mg twice daily versus electroacupuncture alone in 71 women with MUI (213).

Acupuncture techniques and regimens differed widely among the studies, including different acupuncture points treated. Treatments occurred 1 to 3 times weekly, lasted 4 to 8 weeks and outcomes were assessed immediately after treatment or 2 to 12 weeks later.

Quality of data

Randomization concealment was considered adequate in 2 of 5 trials (215, 217), one testing acupuncture vs placebo acupuncture and one comparing acupuncture to drug treatment (tolterodine). Blinding of participants and assessors was done in the trials testing acupuncture with a sham or placebo treatment (215, 216). Participants were not blinded in the 3 trials involving acupuncture and drug treatments (213, 214, 217), and assessors were blinded in only 1 of these (217). Sample size calculations were reported in only one trial (215). Adverse effects were described in 4 of 5 trials (214-217).

Results

Overall, no differences were seen in primary outcomes when comparing acupuncture with sham or placebo treatment and when comparing acupuncture with drug treatment. One small trial comparing acupuncture vs sham acupuncture in women with MUI reported greater reductions in overall incontinence episodes and urgency incontinence episodes in the acupuncture group after 4 weeks of treatment (67.5% vs 16.7% and 75.2% vs 24.9%, respectively), but statistical significance was not reached (216). Another trial of acupuncture vs sham acupuncture (relaxation points) in women with OAB and with UUI found a non-significant reduction in incontinence episodes (59 and 40% in the treatment and placebo groups) (215). For acupuncture treatment compared to drug therapy (oxybutynin or tolterodine) in women with OAB, no difference was seen in improvement in UUI episodes between treatment groups (214, 217). In one, frequency and urgency improved but UUI was unchanged and in the other, frequency, urgency and UUI improved,

but no between group differences were reported (214). In the trial comparing combination treatment with electroacupuncture and tolterodine to electroacupuncture alone for MUI, both groups had significant reductions in overall UI episodes and in urine leakage volume on pad test, but these outcomes did not differ between groups. Significantly more women in the combination treatment group had a more than 50% improvement in number of UI episodes (76 vs 59%, $p < 0.05$) (213).

No serious adverse effects occurred. Minor bruising and bleeding as well as some discomfort with needle placement were described (214-217).

Summary

Two trials (small to medium size) of varying quality found no or limited benefit in testing acupuncture to various sham treatments for MUI and OAB/UUI in women (**Level of Evidence: 2**).

Several factors limit these results, including small sample size, risk of bias and heterogeneity of active and sham treatments. Two trials comparing acupuncture to drug therapy in women with OAB, UUI and MUI found no difference between treatments (**Level of Evidence: 2**). One low quality trial suggested combination therapy of electroacupuncture plus drug for MUI was superior to electroacupuncture alone (**Level of Evidence: 2**).

Recommendations

When choosing between acupuncture and anticholinergic drug for women with OAB, UUI and MUI, either may be effective (**Grade of Recommendation: B**).

There is insufficient evidence to make a recommendation related to the effectiveness of augmenting electroacupuncture with drug therapy (**Grade of recommendation: D**). High-quality RCTs are needed, including standardized acupuncture treatment regimens.

Conclusions

Limited evidence is available for the use of acupuncture techniques for the treatment of UI in women. Challenges in this area (in performing research as well as in interpreting the literature) include a lack of consistency in acupuncture techniques and regimens and controversy regarding the best comparator (sham or placebo acupuncture) (218). Also, much of the literature is not published in English language journals. Given the limitations to the quality and the heterogeneous nature of evidence available, few formal recommendations are possible related to use of acupuncture for SUI, UUI, MUI or overall UI in women. More rigorously-conducted RCTs are needed in this area.

9. FUTURE RESEARCH DIRECTIONS

9.1. Summary

Even with the number of reasonable trials on conservative management of UI in women, the standards of trial conduct and reporting varied considerably. It is strongly recommended that future RCTs on conservative management include power and sample size calculation, account for potential risk of bias, intervention content and intensity, and choice of outcome measures prior to conducting the trial.

9.2. Recommendations for practice

While some recommendations are underpinned by good and consistent evidence of effects, there remains a need for further testing because of **insufficient Level 1 and Level 2 evidence**.

9.2.1 Lifestyle Intervention

Treatment:

Nonsurgical weight loss should be considered a first line treatment to reduce UI in obese and overweight women (**Grade of Recommendation: A**).

Moderate exercise may help in decreasing the incidence of UI: this effect may be mediated by weight control (**Grade of Recommendation: C**).

Caffeine reduction may help in improving incontinence symptoms (**Grade of Recommendation: B**).

Minor decrease of fluid intake (by 25%) may be recommended provided baseline consumption is not less than 30 ml/Kg a day (**Grade of Recommendation: B**).

9.2.2 PFMT (Principal Recommendation)

PFMT in the prevention of UI in childbearing women: Continent, pregnant women should be offered a supervised (including regular health professional contact) and intensive strengthening antepartum PFMT programme to prevent antepartum and postpartum UI (**Grade of Recommendation: A**).

PFMT in the treatment of UI in childbearing women: PFMT should be offered as first line conservative therapy to women with persistent UI symptoms three months after delivery (**Grade of Recommendation: A**).

An 'intensive' PFMT programme (in terms of supervision and exercise content) is likely to increase the treatment effect (**Grade of Recommendation: B**).

PFMT in the prevention/treatment of UI in childbearing women: Health providers should carefully consider the cost/benefit of population based approaches to health professional taught antepartum or postpartum PFMT, that is, health professional instruction to all pregnant or postpartum women regardless of their current or prior continence status (**Grade of**

Recommendation antepartum PFMT: A). (Grade of Recommendation postpartum PFMT: B).

Where a population approach is used, the 'best' evidence to date suggests the following: (a) an intervention comprising of a daily home PFMT and weekly physiotherapist-led exercise classes for 12 weeks, starting at 16-24 weeks' gestation for pregnant women, and (b) an individually taught strengthening PFMT programme that incorporates adherence strategies for postpartum women who have had a forceps delivery or a vaginal delivery of a large baby (4000g or more) (**Grade of recommendation: C**).

i) Other women PFMT

Prevention:

There is preliminary evidence that PFMT may help prevent UI in older women. (**Grade of Recommendation: C New**).

Treatment:

Supervised PFMT should be offered as first line conservative therapy to women urinary incontinence (**Grade of Recommendation: A**).

Clinicians should provide the most intensive health professional-led PFMT program possible within service constraints because programs that are taught and supervised by health-professionals are better than those with little or no supervision (**Grade of Recommendation A**).

Although studies are limited, there does not appear to be clear benefit for adding other modalities (i.e. motor learning, abdominal- or hip-muscle training, intra-vaginal resistance device) to PFMT (**Grade of Recommendation: B**).

There is no clear benefit from adding clinic- (**Grade of Recommendation B**) or home-based BF (**Grade of Recommendation B**) to a PFMT program. The use of clinic or home-based BF should remain a therapist/individual decision based on individual's needs and service constraints.

ii) Other women PFMT vs other intervention

For women with SUI:

- PFMT and VC are both effective as conservative therapy, although PFMT is superior (**Grade of Recommendation: B**).
- PFMT is better than EStim as first line conservative therapy (**Grade of Recommendation: B**).
- PFMT is better than BT as first line conservative therapy (**Grade of Recommendation: B**).
- PFMT and drug therapy are both effective as first line therapy, PFMT avoids the adverse effects experienced with drug therapy (**Grade of Recommendation: B**).
- Surgery is more effective than PFMT, but potential benefit should be weighed against potential

adverse events. PFMT should be offered as first line conservative therapy (**Grade of Recommendation: B New**).

- PFMT and continence pessary are both effective as first line conservative therapy (**Grade of Recommendation: B New**).

For women with SUI or MUI:

- VC does not appear to be better than PFMT in the treatment of UI. PFMT should be recommended as first-line conservative therapy (**Grade of Recommendation: B**).

VCs with supervised training sessions by a trained health professional can be offered to women who can and are prepared to use them (**Grade of Recommendation: B**).

VC may be inappropriate for some women due to inability to insert or retain the cone or because of side effects and discomfort.

For women with UUI or MUI:

- PFMT and BT should be offered as effective first-line conservative therapies (**Grade of Recommendation: B**).
- PFMT is better than oxybutynin as first line therapy (**Grade of Recommendation: B**).

For women with UUI

PFMT and BT should be offered as effective first line conservative therapy (**Grade of Recommendation: B**).

iii) Other women PFMT + other intervention vs PFMT

In women using VC, it does not appear to help to add PFMT (**Grade of Recommendation: C**).

For the treatment of SUI, UUI, or MUI in women, consider a combination of PFMT and BT rather than BT alone (**Grade of Recommendation: C**).

For treatment of UUI (tolterodine) but not for SUI (duloxetine), consider adding PFMT to drug therapy (**Grade of Recommendation: B**),

When treating women with SUI and vaginal atrophy, consider combining PFMT and intravaginal oestrogen over estrogen alone may be better than estrogen alone (**Grade of Recommendation: C New**).

9.2.3 Cones

For women with SUI, VC with supervised training sessions by a trained health professional may be offered as a first-line conservative therapy to those who can and are prepared to use them (**Grade of Recommendation: B**).

VC may be inappropriate in some cases due to inability to insert or retain the cone or because of side effects and discomfort. Trained health professional assessment is recommended (**Grade of Recommendation: D**).

VC and EStim seem equally effective in the treatment of SUI and MUI. Side effects and discomfort caused by both VC and EStim appears to limit their utility in clinical practice (**Grade of Recommendation: B**).

If this combined intervention proves to be of interest to women, then adequately powered studies are needed to confirm or refute the advantages of adding VCs to PFMT (**No Recommendation**).

9.2.4 EStim

EStim might be better than no treatment to improve symptoms and quality of life in SUI women (**Grade of Recommendation: B**).

EStim may be considered for treatment to improve symptoms for UUI (**Grade of Recommendation: B**).

For women with SUI maximal clinic-based EStim might be better than daily low-intensity home-based EStim in improving symptoms (**Grade of Recommendation: B**).

Based on current limited evidence, EStim could be considered as an alternative to medical treatment. (**Grade of Recommendation: B**).

The addition of EStim to PFMT or BF-assisted PFMT programmes does not appear to add benefit (**Grade of Recommendation: B**).

9.2.5 PTNS

For women with UUI or OAB, PTNS may be more effective than no active treatment in symptom control (**Grade of Recommendation: C New**).

There is no significant difference between PTNS and tolterodine in terms of quality of life, however PTNS may be considered as both may improve quality of life and PTNS is less invasive (**Grade of Recommendation: B New**).

PTNS may be considered for women as it is associated with fewer and less bothersome adverse effects than those from drug treatment (**Grade of Recommendation: B New**).

PTNS may be considered for symptom control when chosen in combination interventions such as with PFMT plus bladder training, or drug treatment by women with UUI or OAB (**Grade of Recommendation: B New**).

9.2.6 Magnetic Stimulation

No recommendation is possible based on current conflicting evidence (**Grade of recommendation: D**).

No recommendation is possible regarding optimum type of MStim (**Grade of Recommendation: D**).

The addition of MStim to PFMT in treatment of SUI does not appear to be beneficial (**Grade of Recommendation: C**).

9.2.7 Bladder Training

BT should be recommended as first line conservative therapy for UI in women (**Grade of Recommendation: A**).

Clinicians should provide the most intensive BT supervision that is possible within service constraints (**Grade of Recommendation: D**).

Clinicians and researchers are advised to refer to the operant conditioning and educational literature to provide a rationale for their choice of their approach to BT. (**Grade of Recommendation: D**).

When considering BT and anticholinergic drug for women with DO or UUI, either may be effective (**Grade of Recommendation: B**).

BT may be preferred by women and clinicians because it is not associated with the drug related side effects (**Grade of Recommendation: D**).

The available evidence (single trial) supports the use of BT as a supplement to PFMT in improving short-term outcomes, but not longer-term results (**Grade of Recommendation: C**).

Limited evidence suggests the addition of written information on BT for women with OAB taking an anti-muscarinic drug does not further improve UI (**Grade of Recommendation: B**).

Timed voiding with a two-hour voiding interval may be considered as a sole intervention for women with mild UI or infrequent voiding patterns (**Grade of Recommendation: C**) Timed voiding may also be considered as an adjunct to other treatment.

Insufficient evidence exists to support the use of BT to treat urgency in women with UI and/or OAB, or to guide the choice of BT vs, drug treatment as initial treatment aimed at urgency (**Grade of Recommendation: D**).

Routine addition of a "simplified" BT to drug therapy does not provide additional improvement in urgency, but should be considered in treatment of voiding frequency in women with UI and OAB (**Grade of Recommendation: B**).

BT should be offered as treatment for urinary frequency and nocturia (**Grade of recommendation: B**), but in choosing between BT and an anticholinergic drug for women with frequency, either may be effective (**Grade of Recommendation: B**).

9.2.8 Complementary and Alternative Medicine

Acupuncture:

The limited evidence available to date does not support the use of acupuncture when compared to sham or placebo treatment for women with OAB, UUI and MUI.

When choosing between acupuncture and anticholinergic drug for women with OAB, UUI and MUI, either may be effective (**Grade of Recommendation: B**).

There is insufficient evidence to make a recommendation related to the effectiveness of augmenting electroacupuncture with drug therapy (**Grade of recommendation: D**).

High-quality RCTs are needed, including standardized acupuncture treatment regimens.

9.3. Future Research Direction

All future trials must be designed, implemented and reported in ways that maximise their usefulness in practice; this includes being well powered, with longer term follow up, with evaluation of cost-effectiveness and planned secondary analysis of trial data to investigate predictors of effectiveness. Readers are referred to the revised CONSORT statement for guidance (219).

9.3.1 Lifestyle Modification Intervention

Prevention should be an area for future research investment and comprise robust economic evaluation to determine the benefits of lifestyle modification strategies in women with UI.

With limited new data on the effects of physical activity (moderate or strenuous), smoking cessation, diet modification and constipation, their association with UI development or symptom reduction should be investigated further.

Separate investigation of the impact of lifestyle modification interventions on nocturia, diurnal frequency, urgency and UI should be undertaken.

9.3.2 PFMT in Antenatal and Postnatal women

- Additional trials with longer-term follow-up (greater than 12 months postnatal) are needed to determine long-term benefits of antenatal PFMT.
- Large and good-quality RCTs are needed to investigate the effect of antepartum PFMT on preventing postpartum UI in multiparous women.
- Large and good-quality RCTs are needed to investigate the effect of intensive post-partum PFMT on preventing postpartum UI in women. Attention must be given to high risk subgroups.
- There is a need for at least one large, pragmatic, well-conducted and explicitly reported trial with long term follow-up (five plus years) of postpartum PFMT that investigates the long term effect of 'intensive' PFMT for persistent postnatal UI.

9.3.3 PFMT in Women (Others)

The effect of PFMT in the prevention of UI in women should be studied further.

Larger, good quality trials are needed to address comparisons between PFMT regimens, PFMT and other modalities or PFMT + another modality and PFMT alone, if these are of interest to women. In planning comparisons, researchers should consider carefully power calculation, intervention intensity and the potential impact of different levels of supervisory intensity between groups, particularly in comparisons of conservative therapies.

9.3.4 Vaginal Cones

Larger, good quality trials are needed to address comparisons between VC and other modalities, and VC+ other modalities compared to VC, if these are of interest to women. In planning comparisons researchers should consider carefully power calculation, intervention intensity and the potential impact of different levels of supervisory intensity between groups, particularly in comparisons of conservative therapies.

9.3.5 EStim/PTNS/MStim

Larger, good quality trials are needed to address comparisons between EStim/PTNS/MStim and no treatment, EStim/PTNS/MStim and other modalities, EStim/PTNS/MStim + other modalities and EStim/PTNS/MStim, if these are of interest to women. In planning comparisons researchers should consider carefully power calculation, intervention intensity and the potential impact of different levels of supervisory intensity between groups, particularly in comparisons of conservative therapies.

9.3.6 Scheduled Voiding Regimen

Larger, good quality trials are needed to address comparisons between BT and no treatment, BT and other modalities, BT + other modalities and BT, if these are of interest to women. In planning comparisons researchers should consider carefully power calculation, intervention intensity and the potential impact of different levels of supervisory intensity between groups, particularly in comparisons of conservative therapies.

III. PELVIC ORGAN PROLAPSE (POP)

Pelvic organ prolapse (POP) refers to the loss of support for the uterus, bladder, colon or rectum leading to prolapse of one or more of these organs into the vagina. Prolapse is characterised by a variety of pelvic floor symptoms (2), the most commonly reported being a sensation of bulging into the vagina. Treatment depends on the severity of the prolapse and its symptoms, and the woman's general health (2). Conservative treatment is generally considered for those with a lesser degree of prolapse, those who wish to have more children, those with frailty or those unwilling to undergo surgery. Conservative management, defined here as lifestyle modification interventions, PFMT and pessaries, was first reviewed in the 3rd ICI

and in the 5th was recommended as first-line treatment for prolapse.

The aims of conservative treatment in the management of POP include:

- preventing the prolapse becoming worse;
- decreasing the frequency or severity of symptoms caused by prolapse (pelvic pressure, vaginal bulging, backache, urinary, bowel and sexual dysfunction);
- aversion or delaying of the need for surgery.

In this section the evidence is presented for the use of conservative management of POP, utilising information from Cochrane systematic reviews (220-222), and literature identified via a search strategy summarised in Section I. For included trials, risk of bias (RoB) was assessed using the Cochrane Collaborations RoB tool (223). For other types of study, bias was assessed using the Critical Appraisal Skills Programme (CASP) (224) checklist item relating to adjustment in analysis for potential confounding risk factors.

1. LIFESTYLE MODIFICATION INTERVENTION

Lifestyle modification interventions include weight loss, reducing exacerbating activities (e.g. lifting, coughing) and treating constipation, and are intended to avoid worsening of the prolapse by decreasing intra-abdominal pressure.

1.1. Prevention

1.1.1 Quality of Data

No trials of lifestyle modification interventions to prevent prolapse were identified in this update. However, 12 observational studies (retrospective reviews, prospective surveys and case-control studies) that examined the association between modifiable lifestyle factors such as occupation (involving heavy lifting/strenuous physical activity), bodyweight, smoking, constipation, nutrition and the development of prolapse have been published since last review, which add to the 33 previously described (9 in 5th edition, 15 in 4th edition and 9 in 3rd edition). These are reported and summarised in Table 26. Studies often examined multiple risk factors and contribute evidence to more than one section below. If modifiable lifestyle factors are established as risk factors for prolapse these could be targeted with a view to prevention.

1.1.1.1 Association Between POP and Occupation and Physical Activity

To date, the potential relationship between occupation and physical activity on prolapse has received scant attention (5 studies in 3rd edition (225), 5 in 4th edition(226), 3 in 5th edition(2)). A recent narrative lit-

erature review (227) investigated the effect of physical activity and occupation on the development of prolapse. The review authors identified 10 studies, all of which have been reviewed in-depth in previous editions of this chapter. They concluded that the evidence linking physical activity and occupation with an increased risk for POP was weak and inconclusive.

Our systematic search identified a further 5 additional studies, included (228-232). The key characteristics of these studies are described in Table 26.

Akmal *et al.* (2012) conducted a retrospective study of women in one Ethiopian hospital treated surgically for prolapse over three years (230). Medical interns extracted data from the women's medical records on demographics, medical, surgical and obstetric history, symptoms and risk factors. Only univariate analysis was performed and therefore the study was judged to be at high risk of bias (Table 26).

Bathla *et al.* 2014 (232) carried out a retrospective review of case notes for women who presented with prolapse at mobile surgical camps in a remote village of Himachal Pradesh between 2009- 2013. Women underwent POP-Q assessment prior to surgery. The aim was to study the epidemiological risk factors for prolapse, including occupation and nutrition (see below). The analysis was mainly descriptive although the authors report they did "correlation regression", but it was not clear what this was, and therefore the results were difficult to interpret and at high risk of bias (Table 26).

Gumanga *et al.* (2014) undertook a prospective study of women presenting with prolapse at gynaecological outpatients at a hospital in Ghana over two years (2010-2011), describing occupational, socio-cultural practices and obstetric characteristics and how they related to severity of prolapse (231). Data collected included demographics, reproductive history and pelvic examination findings. Women were included if they complained of a mass in the vagina and had demonstrable descent on pelvic examination. There was no control group so analysis of risk factors was not possible, thus the study was at high risk of bias (Table 26).

Lonnée-Hoffmann *et al.* (2015) recently reported on a cross sectional study they undertook in women 30 years or older in one Nordic county in the Nord-Trøndelag Health Study (228). Outcome measures examined were self-reported prolapse surgery, age at survey, socio-demographic factors, and information on risk factors for prolapse (smoking, chronic obstructive pulmonary disease, asthma, constipation a decade previously, and measured body mass index) (see Table 26). Multivariable logistic regression was used for analysis thus the study was judged to be at low risk of bias.

Nygaard *et al.* (2014) conducted a retrospective case-control study of women with prolapse (descent ≥ 1 cm beyond the hymen) and without prolapse (descent ≤ 1 cm above the hymen), age and site

matched, to assess the impact of lifetime physical activity on the risk of prolapse (229). Women were recruited from primary care or community advertisements, and were not seeking treatment for prolapse. Physical activity was measured using the Lifetime Physical Activity Questionnaire (LPAQ), which assesses physical activity over four periods (start of menstruation to age 21, 22-34, 35-50, and 51-65 years), and includes leisure activity, outdoor work, and housework. The Occupation Questionnaire (OQ), part of the LPAQ, was also used. Multivariable models were fitted to assess the effect of physical activity on prolapse indicating a low risk of bias for this study (Table 26).

1.1.1.2 Association Between POP and Body Weight

There has been little agreement on whether an increase in weight (or increased waist circumference or higher BMI) is linked with an increased risk of POP. Seventeen studies have evaluated the effects of bodyweight on POP since the previous editions (4 in 5th edition, 5 in 4th edition, 6 in 3rd edition) (228, 233-248). In addition, two reviews have recently been published on this topic (249, 250) (Table 26). The former literature review included a study by Kudish and colleagues (2009) – which had not previously been included in earlier editions of this chapter – it is therefore included here (251).

1.1.1.3 Association Between POP and Smoking

Three studies on the relationship between smoking and prolapse were identified (228, 232, 252). In addition, Kudish (2009) investigated smoking as a risk factor (251).

Estanol and colleagues (252) studied female smokers and non-smokers with and without prolapse in a cross-sectional study in one centre. Smokers and non-smokers without prolapse were age matched to smokers and non-smokers with prolapse. The aim was to examine the impact of smoking on collagen markers (MMP-9) and vitamin C, in those with and without prolapse. Women with prolapse had a bulge at or beyond the hymen on examination, and answered positively to two Pelvic Floor Distress Inventory (PFDI) questions on the feeling of a bulge or a visible bulge in the last 12 months. A univariate analysis of the associations was carried out, thus a high risk of bias was assumed (Table 26).

A significant association between POP and smoking has also been reported in 2 studies above (228, 251). Bathla *et al.*, (2014) also noted that 30-57% of their sample were smokers; collectively these studies suggest that smoking is a risk factor for POP.

Table 26 Summary of data on lifestyle factors and POP

Author, year	Study design/Comparator	N	Study population	Modality details/methods employed	Outcomes/results	Follow up	Notes (side effects, loss of follow up...)
POP and Occupation/Physical activity							
Akmele 2012 (1)	Retrospective descriptive case note analysis	129	Patients who were admitted and operated on in the gynaecology ward in one hospital in Ethiopia. All the women with POP who were admitted and treated during the study period were included; no sampling technique was employed	Demographic and medical characteristics were extracted based on the initial medical history and physical examination documentation in the case records	Type of occupation was strongly associated with stage of prolapse. Housewives were more likely to have stage IV (vs stage III) prolapse compared to farmers.	None	Data was available for 129 out of a possible 143 women. No multivariate analysis to allow for other confounding variables.
Bathla 2014(2)	Retrospective descriptive case note analysis	157	157 women who had POP surgery conducted in 5 mobile surgical camps in Shillai, Himachal Pradesh from 2009 to 2013 ("Project Prolapse").	Epidemiological data and POP-Q data were collected.	Factors contributing to POP believed to be "poor nutritional status (mean weight 41.1 kg), multiparity (mean 3.5), early marriage (mean age 18.2 years), unassisted home deliveries (100%), premature bearing down (23.8%), early postpartum resumption of strenuous activity (54.7%) and smoking (33%)". This was not based on statistical analysis.	None	"Statistical analysis was performed using correlation regression analysis", but limited data presented. No multivariate analysis performed.
Gumanga 2014 (3)	Prospective observational study	118	POP cases, out-patients seen over 2-year study period at a teaching hospital in Ghana.	Questionnaires and physical exam in patients whose main complaints included "a mass falling from the vagina" or "bulging mass" or "sensation of mass in the vagina".	Main occupations were trading of produce 66/118 (55.9%) and farming 44/118 (37.3%)	None	Authors report that occupational factors might contribute to the severity of POP in this sample. Analysis undertaken is unclear but appears not to be multivariate analysis.

Author, year	Study design/ Comparator	N	Study population	Modality details/methods employed	Outcomes/results	Follow up	Notes (side effects, loss of follow up...)
Lonnee-Hoffmann 2015 (4)	Cross-sectional survey	20,285	All women aged ≥ 30 years in one Nordic county invited to take part	Women were sent questionnaires and attended screening stations. Risk factors assessed: smoking, chronic obstructive pulmonary disease, asthma, constipation a decade previously, and measured BMI	POP surgery was reported by 1,123 (5.3 %). Only women reporting more lifting in addition to walking had significantly higher odds of reporting POP surgery compared with women with sedentary occupation in the age-adjusted model	None	Authors also report that constipation reported a decade prior, above-normal BMI, and COPD were significant non-obstetric risks for prolapse surgery. Multivariable analysis performed.
Nygaard 2014 (5)	Retrospective case-control study	382	191 POP cases and 191 age and recruitment-site matched controls, aged between 39-65 years, not seeking prolapse treatment	Women were asked to complete Lifetime Physical Activity and Occupation Questionnaires based on self-reported activities	No associations between odds of POP and overall lifetime physical activity, lifetime leisure activity, or lifetime strenuous activity	None	Authors suggest that strenuous activity during teenage years may have an association with POP, and recommend further prospective research in this area Multivariable analysis??
POP and Smoking (see also entries for Bathla 2014, Kudish 2009 and Lonnee-Hoffmann 2015)							
Estanol 2015 (6)	Cross-sectional study	96	4 groups of women: smokers with POP (n=16), non-smokers with POP (n=16), smokers without POP (n=32) and non-smokers without POP (n=32)	Fasting blood panel, including plasma procollagen 1-N propeptide (P1NP), matrix metalloproteinase 9 (MMP-9), and vitamin C. These are markers of collagen metabolism. Smokers were defined as smoking 1 pack or more a day for at least 1 year; non-smokers were defined as not having smoked for at least 7 years	Comparing women with POP and without, there were no significant differences in vitamin C, P1NP and MMP-9 levels, independent of smoking status. MMP-9 levels were higher and vitamin C lower in smokers compared to non-smokers.	None	Small sample size; was not sufficiently large to detect a true difference, particularly in those with prolapse. No multivariable analysis

Author, year	Study design/ Comparator	N	Study population	Modality details/methods employed	Outcomes/results	Follow up	Notes (side effects, loss of follow up...)
POP and Bowel function (see also entries for Kudish 2009 and Lonnee-Hoffmann 2015)							
Bezerra 2014 (7)	Cross-sectional survey	172	Participants referred to one tertiary urogynecology outpatient clinic with self-reported symptoms of PFD: POP [POP-Q \geq stage II and/or UI]	Medical history, series of questionnaires (ICIQ-SF; KHQ; PISQ-12), Cleveland Constipation Scale and physical exam using the PERFECT scheme.	No differences in prolapse status between patients with and without anal incontinence and/or bowel disorders.	None	No multivariable analysis
Elbiss 2015 (8)	Cross-sectional	429	Women attending family development centres in United Arab Emirates, 29.6% reported POP symptoms	Questionnaire included items for details of socio-demographic, obstetrics, medical and surgical history. Presence of a lump in/out of vagina was taken as presence of POP.	Chronic constipation and chest disease, level of education, occupation birth weight and BMI were independent risk factors for having POP symptoms.	None	Multivariable analysis was performed. Authors recommended additional healthcare campaigns to raise awareness about risk factors for POP
POP and Nutrition (see also entries for Estanol, 2015)							
Navaneethan 2015 (9)	Prospective case-control study	120	Women with (n=51) or without (n=69) PFD on examination when attending outpatient clinic at one tertiary care centre in South India	Medical history and clinical examination (POP-Q) were performed. Serum 25-hydroxy vitamin D levels were measured in all participants	23/51 had POP alone, 9/51 had POP+SUI; vitamin D levels were not significantly associated with POP	None	Multivariable analysis performed to adjust for age.
Parker-Autrey 2012 (10)	Retrospective chart review	394	Women over 19 years old attending a Urogynecology Care Clinic from 2008 to 2010 who had vitamin D measured.	Diagnosis categorized as PDF (SUI, UUI, FI, POP) (n=268) or general GYN (n=126). Demographic and medical characteristics were extracted. PFDI-SF 20, IIQ-7, Medical, Epidemiologic, and Social Aspects of Aging (MESA) questionnaire.	Only higher IIQ-7 scores were significantly related to having insufficient vitamin D.	None	Multivariable logistic regression model used to adjust for age, BMI, ethnicity, and use of vit. D supplementation

Author, year	Study design/ Comparator	N	Study population	Modality details/methods employed	Outcomes/results	Follow up	Notes (side effects, loss of follow up...)
POP and body weight							
Myers <i>et al.</i> , 2012(11)	Secondary data analysis of RCT	338	Overweight and obese women with UI	Women were randomised either into an intensive 6- month weight loss or to the control group (educational program) Symptomatic prolapse was defined as a positive response to at least 1 prolapse subscale question of the UDI. "Bother" was defined as responses of slight, moderate, or great.	Increasing BMI was associated with only "feeling" a vaginal bulge. (13% of obese women reported feeling vaginal bulging compared with overweight women (0%).	Evaluated for prolapse symptoms at baseline and 6 months	At 6 months, there were no significant differences in improvement of self- reported bothersome prolapse symptoms in women in the weight loss or the control group Multivariable analysis was performed.
Kudish 2009 (12)	Secondary analysis of a 5-yr clinical trial	16608	Post-menopausal women aged 50-79 yrs	Degree of prolapse assessed using the WHI Prolapse Classification System	Prolapse risk in overweight and obese women (compared with the women with healthy BMI) increased by 32% and 48% for cystocele, by 37% and 58% for rectocele, and by 43% and 69% for uterine prolapse, respectively	Annual pelvic exam over a 5 year interval	Being overweight or obese is associated with progression of POP. Authors reported that "weight loss was not significantly associated with regression of POP", and argued that pelvic floor damage related to weight gain could be irreversible Multivariable analysis was performed.

Abbreviations: PFDI-20: pelvic floor distress inventory short form 20, PFIQ-7: pelvic floor impact questionnaire short form; PFM: pelvic floor muscles; PFMT: pelvic floor muscle training; POP-Q: Pelvic Organ Prolapse Quantification system; PISQ-12: Pelvic organ prolapse/urinary incontinence sexual questionnaire' POP-SS: pelvic organ prolapse symptom score; QoL: quality of life; RCT: randomized controlled trial; sEMG: surface electromyography; SR: systematic review; UI: urinary incontinence

1. Akmel M, Segni H. Pelvic organ prolapse in jimma university specialized hospital, southwest ethiopia. *Ethiop J Health Sci.* 2012;22(2):85-92.
2. Bathla S, Verghese G, Kalla V, Sharma TC, Dam S, Agarwal N, *et al.* Reaching the unreached: Mobile surgical camps in a remote village of Himachal Pradesh. *J Midlife Health.* 2014;5(3):139-42.
3. Gumanga SK, Munkaila A, Malechi H. Social demographic characteristics of women with pelvic organ prolapse at the Tamale Teaching Hospital, Ghana. *Ghana Med J.* 2014;48(4):208-13.

4. Lonnee-Hoffmann RA, Salvesen O, Morkved S, Schei B. Self-reported pelvic organ prolapse surgery, prevalence, and nonobstetric risk factors: findings from the Nord Trondelag Health Study. *Int Urogynecol J*. 2015;26(3):407-14.
5. Nygaard IE, Shaw JM, Bardsley T, Egger MJ. Lifetime physical activity and pelvic organ prolapse in middle-aged women. *Am J Obstet Gynecol*. 2014;210(5):477 e1-12.
6. Estanol MV, Crisp CC, Oakley SH, Kleeman SD, Fellner AN, Pauls RN. Systemic markers of collagen metabolism and vitamin C in smokers and non-smokers with pelvic organ prolapse. *Eur J Obstet Gynecol Reprod Biol*. 2015;184:58-64.
7. Bezerra LRPS, Vasconcelos Neto JA, Vasconcelos CTM, Karbage SAL, Lima AC, Frota IPR, *et al*. Prevalence of unreported bowel symptoms in women with pelvic floor dysfunction and the impact on their quality of life. *International Urogynecology Journal and Pelvic Floor Dysfunction*. 2014;25(7):927-33.
8. Elbiss HM, Osman N, Hammad FT. Prevalence, risk factors and severity of symptoms of pelvic organ prolapse among Emirati women. *BMC Urology*. 2015;15(1):no pagination.
9. Navaneethan PR, Kekre A, Jacob KS, Varghese L. Vitamin D deficiency in postmenopausal women with pelvic floor disorders. *J Midlife Health*. 2015;6(2):66-9.
10. Parker-Autry CY, Markland AD, Ballard AC, Downs-Gunn D, Richter HE. Vitamin D status in women with pelvic floor disorder symptoms. *Int Urogynecol J*. 2012;23(12):1699-705.
11. Myers DL, Sung VW, Richter HE, Creasman J, Subak LL. Prolapse symptoms in overweight and obese women before and after weight loss. *Female pelvic medicine & reconstructive surgery*. 2012;18(1):55-9.
12. Kudish BI, Iglesia CB, Sokol RJ, Cochrane B, Richter HE, Larson J, *et al*. Effect of weight change on natural history of pelvic organ prolapse. *Obstet Gynecol*. 2009;113(1):81-8.

1.1.1.4 Association Between POP and Bowel Function

Previously there were 8 studies that had examined the potential impact of bowel disorders/ or bowel dysfunction on prolapse (4 in 5th edition, 4 in 4th edition). This update adds a further 4 studies. Two are described below; two have been described above (Lonnee-Hoffman *et al.*, 2012; Kudish *et al.*, 2009).

Bezerra *et al.* (2014) undertook a cross-sectional study of women with pelvic floor disorders (POP-Q ≥ stage II and/or urinary incontinence) presenting at a tertiary urogynaecology clinic in Brazil (253). The aim was to report the prevalence, bother, and impact on quality of life (QoL) of unreported bowel symptoms, to improve the patient care. Those with and without defaecatory or anal continence problems were compared. A number of measures were used depending on the presence/absence of bowel and urinary incontinence symptoms: ICIQ-SF, King's Health Questionnaire, PISQ-12, the Wexner score, Cleveland Clinic Florida Incontinence Scale, Cleveland Clinic Florida Constipation Scale (mild, moderate or severe). All women completed the SF-36 and had their pelvic floor assessed by a physiotherapist using the PERFECT scheme. Only univariate analysis was performed, putting the study at a high risk of bias (Table 26).

Elbiss and colleagues (238) carried out a cross-sectional study of parous Emirati women 30 years or older attending three family development centres in Al-Ain in one year. The objective was to estimate the prevalence of prolapse and its risk factors. The study used a self-developed questionnaire, which was piloted and revised before use. The questionnaire covered demographic, obstetrics, and medical history, prolapse symptoms (lump coming down in the vagina, lump coming out of vagina or lump felt or seen outside vagina), other vaginal symptoms and the need to digitate to empty bladder or bowel. Following univariate analysis, multivariable binary logistic regression analysis (prolapse symptoms versus no prolapse symptoms) was performed including all significant variables to determine which were independent risk factors for prolapse (Table 26). This study was judged as having a low risk of bias.

1.1.1.5 Association Between POP and Nutrition

Two studies were identified in previous editions of the chapter that examined the effects of anaemia (4th edition) and vitamin D (5th edition) on prolapse. A further 2 studies relating to vitamin D are included in this update (Table 26).

Navaneethan *et al.* (2015) conducted a case-control study of postmenopausal women with and without pelvic floor disorders, in particular, symptoms of urinary incontinence or prolapse. It was not clear how the women were selected but the study took place in a department of obstetrics and gynaecology in South

India. A clinical and obstetric history was taken, examination performed (POP-Q and stress test) and vitamin D measured in all women. A multivariable logistic regression analysis was undertaken to assess the relationship between vitamin D and PFD adjusting for other variables (254). A low risk of bias was assumed (Table 26).

Parker-Autry *et al.* (2012) in Alabama, US, undertook a retrospective review of women who were new urogynaecology outpatients presenting over a two-year period (2008 to 2010) and who then had vitamin D measured within one year of that visit. 25(OH)D < 15 ng/ml was defined as being deficient in vitamin D, and 15 to 29 ng/ml as having insufficient vitamin D. Women were classified into two groups, either PFD (having SUI, UUI, FI or POP) or general gynaecology (no PFD) (Table 26). Demographic, medical, and laboratory data were extracted from the initial history and physical examination notes. Questionnaire responses from the clinic visit were also available (PFDI-SF 20 (including the UDI, CRADI, POPDI) and IIQ-7). Multivariable logistic regression was used to examine the association between vitamin D status and pelvic floor disorder symptoms, with adjustment for age, BMI, race/ethnicity, and the use of vitamin D supplementation. This study was judged to be at low risk of bias.

1.1.2 Results

1.1.2.1 Association Between POP and Occupation and Physical Activity

In the Akmel *et al.* (2012) study, 143 prolapse cases were examined and complete data retrieved for 129 cases. The mean age of the women was 42 years (range 22 to 72 years), mean parity was 6.5 (range 1 to 14) and all had stage III (56%) or IV (44%) prolapse. Significant univariate associations were found between age, parity and rurality and stage of prolapse. Occupation was significantly associated with prolapse stage in that farmers were more likely to have a lower stage and housewives a higher stage of prolapse (230).

In the retrospective case analysis described by Bathla *et al.* (2014), 192/490 surgical case presentations were gynaecological and 82% of these were prolapse (99% involving the anterior compartment). These women were aged between 30 and 70 (mean 47 years), had mean parity of 3.5, and all had unassisted home deliveries. Premature bearing down during delivery was reported for 24%. Women on average resumed strenuous physical work and sexual activity 20 days after giving birth. 33% were smokers and 55% lifted heavy weights uphill. The authors reported non-significant correlations between POP-Q stage and parity, resumption of physical activity and weight (232).

Out of 4403 outpatients, 118 cases (2.7%) of prolapse were seen over the study period in the Gumanga (2014) paper, with a mean age of 46 years (SD 15 years) and mean parity 4.4 (SD 1.7). For 57%

of women their deliveries had been exclusively at home. Women were predominantly farmers (37%) or traders (56%) (231).

Of all women in the county 30 years or older, 20,285 (50.3%) were included in the Lonnee-Hoffman (2012) study; of which 1,123 (5.5%) reported having undergone prolapse surgery. In the multivariable models, the odds of having prolapse surgery were shown to be significantly greater for women with BMI of 25 or greater, and for those who reported “marked” constipation (as compared to no or mild constipation). There was no relationship with smoking, asthma or occupation (228).

One hundred and ninety-one cases and an equal amount of matched controls were recruited in the Nygaard *et al.* (2014) study. The mean age of women was 50 years (SD 7). Cases tended to have a higher BMI than controls, and had significantly greater parity and more vaginal deliveries. Vaginal bulge was more prevalent in the cases than controls, but there was no difference in other pelvic floor symptoms. The authors found no evidence that physical activity (lifetime overall activity, leisure or strenuous physical activity) was associated with risk of prolapse in multivariable models. The exception was that strenuous physical activity in the teenage years showed a significant relationship with the odds of prolapse, indicating an increased risk of prolapse for those reporting 21 hours/week or more of strenuous physical activity when a teenager (229).

Elbiss (2015) found nature of occupation to be a significant predictor of prolapse symptoms (see below); women with non-physical jobs were more likely to report symptoms.

1.1.2.2 Association Between POP and Body Weight

Vergeldt *et al.* (2015) systematically identified 8 studies that examined the association of higher BMI and POP and presented the results in a narrative synthesis. The authors reported that 4/8 studies identified that higher BMI was a significant risk factor for POP; 3/8 found no relationship between high BMI and the development of primary POP and 1/8 study found that a “higher BMI slightly protective”. The authors reported that the relationship between weight and POP was inconsistent; thus no conclusions can be reliably drawn (250). This well-conducted review was judged to be at low risk of bias.

Kudish and colleagues (2009) explored the relationship between prolapse progression (or regression) and weight change in 16,608 post-menopausal women (Table 26). This secondary analysis study was based on longitudinal data from the WHI E+P trial; a double-blinded RCT. Women aged between 50 and 79 years received annual pelvic examinations over a 5-year interval. The majority of women enrolled in the study gained weight, and the overall prolapse prevalence (stage I-III) increased from 40.9% at baseline to 43.8% by year 5. The risk of all types of

prolapse increased in overweight and obese women compared to post-menopausal women with normal BMIs (Table 26). When the data was adjusted for women diagnosed with prolapse at baseline and baseline BMI, a 10% weight loss was associated with minimal change in overall POP (251). This study was judged to be at low risk of bias.

1.1.2.3 Association Between POP and Smoking

In the Estanol (2015) study, a total of 96 women were recruited: 32 with prolapse (16 smokers, 16 non-smokers) and 64 without prolapse (32 smokers, 32 non-smokers) (252). Smokers with prolapse had lower levels of vitamin C and higher levels of MMP-9, compared to non-smokers with prolapse, but this relationship was not statistically significant. However, comparing smokers without prolapse to non-smokers without prolapse, there were significant differences in both vitamin C and MMP-9, suggesting an impact of smoking on these collagen markers. Ignoring smoking status, vitamin C and MMP-9 levels in women with prolapse were similar to those without prolapse. The authors suggest that the damage to connective tissue that leads to prolapse may be different from the harm caused by cigarette smoking.

Lonnee-Hoffman *et al.* (2015) found no association between smoking and whether a woman reported having had prolapse surgery or not (228). Bathla *et al.* (2104) commented that 33% of the women having prolapse surgery were smokers (232).

1.1.2.4 Association Between POP and Bowel Function

Bezerra and colleagues reported that a total of 172 women with prolapse and/or urinary incontinence participated and initially none of them reported defecatory problems or anal incontinence, although 54.6% reported one or both on interview. Those with AI/defecatory problems were no more likely to report prolapse (sensation of a ball in the vagina) than those without these problems (68% versus 65%). Stage of prolapse was not associated with AI/defecatory problems either (253).

Of the 482 eligible women in the Elbiss (2015) study, 429 (89%) participated, of which 127 (29.6%) reported prolapse symptoms. Those women with and without prolapse symptoms did not differ in terms of age. Of the factors significantly associated with prolapse in the univariate analysis (BMI, education level, nature of occupation, history of chronic chest disease, constipation, diabetes, previous instrumental delivery, maximum birth weight, history of urinary incontinence and previous surgery for urinary incontinence) six were independent risk factors in the multivariable analysis: history of constipation, education level, chronic chest disease, nature of occupation, maximum birth weight and BMI. Women were more likely to have prolapse symptoms if they had chronic

chest disease or constipation, higher BMI or maximum birth weight, lower education level, and were a housewife or had a non-physical job (238).

Lonnee-Hoffman *et al* (2015) found that marked constipation (as compared to no or mild constipation) was significantly associated with having prolapse surgery (228).

1.1.2.5 Association Between POP and Nutrition

Navaneethan *et al* (2015) reported that of the 120 women who participated: 42.5% had PFD (54.9% prolapse alone, 27.4% SUI alone, 17.6% SUI and prolapse) and 57.5% had no PFD. Multivariable analysis showed that, after adjustment for age, having any PFD was associated with having lower vitamin D levels and being five years or more post-menopausal. However having prolapse was only associated with the latter, and there was no significant relationship with vitamin D (254).

Of 550 women potentially eligible to participate in the Parker-Autry (2012b) study, 394 were included (268 in the PFD group and 126 in the no PFD group). The prevalence of vitamin D insufficiency was 51% in the PFD group. Vitamin D insufficiency was independently associated only with IIQ-7 score. That is, there was no relationship with prolapse symptoms (255).

Summary

- There remain no trials of lifestyle modification interventions to prevent prolapse. Some new observational studies have added to our knowledge of potentially helpful ways to modify lifestyle risk factors.
- Two new good quality observational studies (228, 229) suggested occupation and physical activity are not risk factors for prolapse surgery or prolapse 1cm or more beyond the hymen on examination. A third study however found women who were housewives or in a non-physical occupation were more likely to report prolapse symptoms (238). The vast majority of studies reported in previous editions supported an association between current heavy occupational lifting and prolapse, overall therefore the evidence seems to be conflicting, and this may be due to different ways of defining prolapse (**Level of Evidence: 3; Grade of Recommendation: D Conflicting therefore no recommendation**).
- Recent evidence on the relationship between prolapse and bodyweight is conflicting. (**Level of Evidence: 3; Grade of Recommendation: D Conflicting therefore no recommendation**).
- Smoking was found not to be associated with prolapse in two studies: a matched case control study (Estanol) (high risk) and large cross-sectional survey with multivariable analysis (Lonnee-Hoffman) (low risk). No studies were found

in earlier editions (**Level of Evidence: 3; No recommendation**).

- Evidence from previous editions regarding the association between constipation or straining at stool and prolapse was conflicting. Two new, low risk studies, which adjusted for covariates, concluded that constipation was associated with both prolapse symptoms and having prolapse surgery, contributing more evidence of an association (**Level of Evidence: 3; Grade of Recommendation: C New; Majority evidence of an association**).
- Two new, low risk studies on vitamin D supported previous findings (1 study, 5th Edition) of no association with prolapse (**Level of Evidence: 3; Grade of Recommendation: C Majority evidence of no association**).

1.2. Treatment

Previously no studies that evaluated the effectiveness of lifestyle modification interventions in the treatment of women with POP had been identified. Subsequently we have identified one trial, which measured prolapse outcomes after weight loss programmes (243). Not all trial participants had prolapse however, which limits the usefulness of this evidence (see Table 26).

Quality of data

Myers and colleagues (2012) performed a secondary analysis of data from the PRIDE trial of an intensive weight loss programme versus an educational programme for urinary incontinence in overweight and obese women (243). Prolapse symptoms were measured at baseline and six months (post-intervention) using the prolapse items from the UDI. Any positive response to any questionnaire items indicated the presence of prolapse symptoms. A subgroup of women agreed to have urodynamics and POP-Q assessment before and after intervention. Women were classified as overweight, obese or severely obese according to their BMI. Women who had prolapse symptoms at baseline were analysed at 6 months for differences between the randomised groups. The risk of bias was judged as low in relation to selection, detection and attrition for the original PRIDE trial (6) in a recent Cochrane review (5).

Results

Myers *et al.*, (2012) reported that 338 women were randomised and 110 had urodynamics and POP-Q (243). Of the women randomised, 16% were overweight, 58% obese and 26% severely obese. At baseline 53% reported at least one prolapse symptom, but this did not differ across BMI groups. A significantly greater proportion of obese women reported feeling vaginal bulge compared to overweight women (10% severely obese vs 14% obese vs 0% overweight), but the mean number of prolapse symptoms did not differ across the BMI groups. The proportion

with prolapse beyond the hymen was 17% overall but did not differ across the BMI groups (24% overweight group, 17% obese group, 13% severely obese group). Post-intervention the intensive weight loss group had lost significantly more weight than the control group (mean 7.8kg vs 1.5kg). Over 70% reported cure or improvement in prolapse symptoms, although this was no different between the intensive weight loss group and the educational group. There was also no significant difference in prolapse beyond the hymen between weight loss intervention and educational groups. The findings would suggest a lack of relationship between weight loss and improvements in prolapse. However, the trial was designed for women with urinary incontinence rather than prolapse, and the post-intervention comparison was not randomised.

Summary

Currently, there is evidence from secondary analysis of one robust trial regarding the role of weight loss in the treatment of POP. The trial however was in overweight and obese women with UI, some of whom had prolapse. It would appear that weight loss in both groups led to an improvement in prolapse, however there was no relationship between degree of weight loss (intensive vs normal weight loss programme). Any weight loss may improve prolapse in overweight or obese women and UI. **(Level of Evidence: 2; Grade of Recommendation: D).**

2. PELVIC FLOOR MUSCLE TRAINING

The pelvic floor muscles play a critical role in giving structural support to the pelvic organs and pelvic openings. It is hypothesized that improving pelvic floor muscle function may improve this structural support for the pelvic organs.

A programme of supervised PFMT includes assessment of the woman's pelvic floor muscles and her ability to contract these muscles; education about the pelvic floor muscles and how they support the pelvic organs; instruction in how to correctly perform pelvic floor muscle exercises and "the Knack" (pelvic floor muscle bracing against increased intra-abdominal pressure, for example when coughing and sneezing) (256). An individualised exercise programme is prescribed for the woman to follow. Adjuncts to PFMT (such as biofeedback) or other physical therapies (such as neuromuscular EStim) may be used. These therapies aim to improve PFM strength, endurance, coordination and function. Other forms of physical therapy involving diaphragmatic aspiration are emerging.

2.1. Prevention

Quality of data

Previously there were no trials of PFMT for prevention of prolapse, only evidence from cross-sectional studies of a possible association between pelvic floor muscle function and risk of prolapse. Two RCTs have now been identified that evaluate the role of PFMT in prevention of prolapse (257, 258). A summary of the setting, design and study population of prevention trials is presented in Table 27. Blinding of patients is generally not possible in trials of PFMT so this is not taken into consideration in the risk of bias analysis.

Bo *et al* (2013) (258) carried out a trial in primiparous women after vaginal delivery of a singleton infant after 32 weeks gestation, comparing supervised PFMT with written advice to do PFMT (control), to prevent and treat prolapse. All women had received written recommendations to perform PFMT in the delivery ward. The PFMT group attended a weekly PFMT class for 4 months starting at 6-8 weeks postpartum, and performed home-based exercise. The control group had no further supervision or follow-up. Outcomes measured at 6 weeks and 6 months post-partum included POP-Q stage, bladder neck position (transperineal ultrasound) and symptom of vaginal bulge (ICIQ-VS). The trial was judged as low risk for selection bias, performance and detection bias, attrition bias and reporting bias. However, the trial was judged as unclear for other types of bias (Table 27).

The PREVPROL trial, undertaken by Hagen and colleagues, compared PFMT versus lifestyle advice leaflet as secondary prevention for women with pre-clinical signs of prolapse (257). Participants were women originally enrolled in a longitudinal follow-up of post-natal incontinence (at 3 months, 6 and 12 years) after giving birth in 1993/94. Those, who had not sought treatment for prolapse, but who showed early signs of prolapse (POP-Q stage I, II or III) were invited to take part. They were randomised to receive either a programme of PFMT (individualised physiotherapy appointments, maintenance via Pilates-based classes (progressive Pilates-based exercises, pelvic floor muscle training as given in the one-to-one intervention, core exercises from the "Pelvicore Technique with Kari Bo" DVD) and annual one-to-one check-ups) or a prolapse prevention lifestyle advice leaflet. Women were followed up at 1 and 2 years in terms of their prolapse symptoms (POP-SS), prolapse-related QoL, uptake of prolapse treatment, symptoms of urinary incontinence (ICIQ-UI SF), anorectal or sexual dysfunction (PISQ-12), perceived health benefit, and cost-effectiveness.

The trial was judged as low risk for selection bias, performance and detection bias, attrition bias, reporting bias and other types of bias (Table 27).

Results

One hundred and seventy-five primiparous women were randomised in the Bo (2013) study, 87 to PFMT and 88 to control, mean age 30. At 6 months post-

partum there was no difference between groups in the prevalence of symptoms of bulging either inside or outside the vagina. There was no difference between groups in the prevalence of stage II prolapse at 6 months, or in any of the individual POP-Q measurements, or the bladder neck position (258).

In the PREVPROL trial 414 women were randomised, 207 to PFMT and 207 to control, mean age 46 years (257). There was a significantly lower POP-SS score at 2 years in the PFMT group compared to the control group, indicating fewer symptoms. Women in the control group were significantly more likely to have sought treatment for prolapse symptoms by 2 years. No significant difference was found between the groups in the percentage who experienced any urine leakage at 2 years, although there was a significant difference in favour of the intervention group in the ICIQ-UI short form score. Faecal urgency and leakage, and sexual function were not significantly different between the groups at 2 years. Women in the intervention group were more likely to say they felt a health-related benefit from the study compared to the control women.

Summary

Currently, there is evidence from two robust trials regarding the role of PFMT in the prevention of POP. The trials were in different populations of women however (postnatal women, 13% of whom had stage II prolapse, and middle-aged women with mild prolapse, 55% with stage II or greater, who had not sought treatment) and drew differing conclusions. It would appear that in younger post-natal women PFMT does not influence the development of prolapse by 6 months, whereas in older women, more than 12 years after giving birth, there was a significant benefit of PFMT in terms of fewer prolapse symptoms after 2 years and less uptake of treatment. PFMT can prevent symptoms of prolapse which develop in the longer term after childbirth but not immediately after giving birth.

Postnatal: Level of Evidence: 1; Grade of Recommendation: B New; majority evidence from RCT of no effect for postnatal.

12 years post-childbirth: Level of Evidence 1; Grade of Recommendation: B New; Majority evidence from RCT of effect in the long term after childbirth.

2.2. Treatment

Quality of data

Evidence from trials now exists relating to the role of PFMT in the treatment of prolapse. The role of PFMT as an adjunct to surgery or pessary has also been the subject of randomised studies. A Cochrane review specifically addressing this question was first published in 2004 (259), and updated in 2011 (220) and 2016 (in preparation) (221).

2.2.1 PFMT Alone

Thirteen trials now exist in this area, six of which were previously reported in previous consultations. Key characteristics of the seven new trials, and new published information about two earlier trials, are summarised in Table 28. Narrative descriptions of these trials are reported below.

Alves and colleagues carried out a trial in post-menopausal women in which they compared a general fitness programme (control) with a PFMT programme (intervention) (47). Both groups performed a fitness programme twice weekly for 6 weeks including global muscle stretching, endurance and functional exercises. In addition, the intervention group took part in a physiotherapist-supervised PFMT programme in groups of seven, 30 minutes twice weekly for 6 weeks. The control group women were taught about pelvic floor muscles and how to contract them correctly, but without any training. Outcomes were assessed after the intervention at 6 weeks. The trial was generally judged as low risk for performance and detection bias, attrition bias, reporting bias and other types of bias. However it was unclear if opaque envelopes were used in the allocation process, and an intention to treat analysis was not performed (Table 28).

Culligan and colleagues compared a standardised PFMT programme with a standardised Pilates programme in community women with POP-Q stage I prolapse to see if they provided similar improvements in PFM strength (260). The PFMT programme, made up of twice weekly 1-hour sessions for 12 weeks, included computerized biofeedback, vaginal manipulation, neuromuscular re-education, and manual therapy. Participants completing 20 or more of the 24 possible sessions were defined as “successful”. The control group attended a Pilates programme with the same pattern of sessions where they were taught full-body exercises focusing on the “core muscles”, and the pelvic floor in particular. Women were assessed at baseline and after the intervention at 12 weeks in terms of PFM strength and pelvic floor symptoms and impact (PFDI-20), Short Form Pelvic Floor Impact Questionnaire (PFIQ-7). The trial was judged as low risk for selection bias, attrition bias, reporting bias and other types of bias. However, performance and detection bias was judged as unclear risk of bias as it was unclear if outcome assessors were blinded (see Table 28).

Due *et al.* (2016) undertook a trial in women with symptomatic prolapse of stage II or greater, comparing a structured lifestyle advice programme plus PFMT (combined group) with lifestyle programme alone (lifestyle group) (261). The PFMT included both group PFMT (6 sessions over 12 weeks) and individual home training after an assessment and individual instruction. Women were assessed using the Patient Global Index of Improvement scale (PGI-I), POP-Q, PFDI-20, PFIQ-7 and PISQ-12 at baseline, immediately post-intervention (3 months) and at 6 months.

The trial was judged as low risk for selection bias, performance and detection bias, attrition bias, reporting bias and other types of bias (261) (see Table 28).

Frawley *et al.* (2012) carried out a trial in four Australian centres involving women with symptomatic prolapse stage I to III, randomised to PFMT or a lifestyle advice leaflet (control) (262). This trial protocol was based on that of the UK POPPY trial (263) described below with some slight adjustments and additional measurements. Women were assessed at baseline, 6 and 12-month follow-up for PFM function (manometric and digitally-assessed strength and endurance (ICS scale)), prolapse symptoms (POP-SS) and severity/type (POP-Q). The trial was judged as low risk for selection bias, performance and detection bias, reporting bias and other types of bias. However, the trial was considered to have high risk of attrition bias. Communication with the author provided explanations about the dropout observed (Table 28).

Giraud *et al's* (2011) trial compared PFMT plus negative pressure abdominal work (intervention group) with PFMT plus abdominal hollowing exercise (control group) in women with untreated stage I or II prolapse (264). Both groups were taught correct contraction of the pelvic floor muscles and given tailored lifestyle advice on ways of reducing intra-abdominal pressure, as well as a standardised lifestyle advice sheet. There was no description of 1) the negative pressure abdominal work or 2) abdominal hollowing exercises but they are described elsewhere as 1) hypopressive exercises, which are thought to result in negative pressure in the thoracic cavity and involuntary contraction of the pelvic floor and abdominal wall, and 2) pulling the belly button in towards the spine. The intervention duration was 24 weeks, with individual supervision twice weekly for one hour each session during the first 3 months, followed by once a week for the last 3 months. Women were assessed at baseline and at 24 weeks for prolapse symptom severity (P-QOL), prolapse severity (POP-Q) and PFM strength (Oxford scale). The trial was judged as low risk for selection bias (randomisation only), performance and detection bias and reporting bias. The trial was judged as unclear risk of bias for selection bias (allocation concealment), attrition bias, and other types of bias (264) (Table 28).

Hagen and colleagues carried out a multicentre trial (POPPY trial) comparing an individualised PFMT programme (including lifestyle advice) with a lifestyle advice leaflet (control group) (263). Participants were outpatients attending with newly-diagnosed, symptomatic stage I, II, or III prolapse. The PFMT intervention which was delivered by a specialist women's health physiotherapist over 16 weeks in 5 sessions included teaching of anatomy and function of pelvic floor muscles, the correct exercise technique and 'the Knack', and a prescription of a home exercise programme. A standardised lifestyle advice leaflet and tailored lifestyle advice were given. The control group received the lifestyle advice leaflet by post. Outcomes

measured at 6 and 12 months were prolapse symptoms (POP-SS), prolapse-related QoL, need for further prolapse treatment, bladder, bowel and sexual symptoms. POP-Q was measured at baseline and 6 months. The trial was judged as low risk for selection bias, performance and detection bias, attrition bias, reporting bias and other types of bias (Table 28).

Kashyap and colleagues reported a single-centre trial in parous women with stage I to III prolapse, which compared taught pelvic floor muscle training plus a self-instruction manual (SIM) with the SIM alone as the control intervention (265). One person delivered the training to all intervention women. This included explanation of anatomy and function of pelvic floor muscles, PFMT training, plus exercise practice and checking for correct PFM contractions by vaginal examination. Pressure manometry was included for biofeedback and motivation. A home exercise programme was prescribed for 3 times daily. Women were instructed to perform the intervention for 24 weeks. After the initial training session, there were 6 follow up visits (at weeks 1, 3, 6, 12, 18 and 24). The content of the manual was not described and therefore what written instruction the control group received is unclear. Women were assessed at baseline and at 1, 3, 6, 12, 18 and 24 weeks using the POP-SS, a visual analogue scale and the PFIQ-7. The trial was judged as low risk for selection bias. However, the trial was judged as high risk for performance and detection bias, attrition bias, reporting bias and other types of bias (see Table 28).

Stupp/Resende carried out a three-arm trial comparing PFMT versus hypopressive exercises (diaphragmatic breathing) plus voluntary pelvic floor muscle contraction (PFMT+HE) versus lifestyle advice only (266, 267). Participating women were attending a urogynaecology service in Sao Paulo, Brazil, and had untreated stage II anterior or posterior prolapse. The PFMT intervention involved three physiotherapy appointments to learn how to perform PFMT correctly (weeks 0, 1, 2). Then a 12-week home exercise programme was prescribed consisting of three sets of exercises daily. The PFMT+HE group had three appointments (weeks 0, 1, 2) during which they had instruction in correctly performing hypopressive exercises and pelvic floor muscle contractions, and how to do these simultaneously. They practiced the exercises for 12 weeks. Both of these groups completed an exercise diary, had a telephone call from the physiotherapist every two weeks and a monthly appointment (weeks 6, 10, 14). The control group received one appointment, were given lifestyle advice and were instructed how to perform PFM contractions. However, it was unclear with whom the appointment was held, or whether the instruction was verbal or included a digital assessment. A standardised lifestyle advice sheet was given to all women containing global stretching exercises and advice on weight loss, constipation, coughing and avoidance of heavy lifting.

Table 27 Summary of data on POP prevention

Author, year	Comparator	N	Study population	Modality details or parameters	Outcomes/results	Follow up	Notes (side effects, loss of follow up...)
Bø 2013 (1)	Parallel group RCT; 2 groups, PFMT vs control	175	Primiparous women, vaginal delivery, singleton infant, ≥ 32 weeks	All women: written advice in delivery ward to perform PFMT. 2 trained physiotherapists taught PFM contraction and assessed PFM function before randomisation by observation of the perineum and vaginal palpation. PFMT group: weekly PFMT classes delivered by trained physiotherapists for 4 months starting at 6-8 weeks postpartum. Performed home-based exercise, 3 sets of 8-12 close to maximum PFM contractions per day. Control group: no further supervision or follow-up during the intervention period.	Stage of POP and bladder neck position. Secondary outcomes: symptoms of POP (sensation of bulging) using International Consultation on Incontinence Vaginal Symptoms questionnaire	Assessed at 6 weeks (pre-test) and 6 months' (post-test) postpartum	Randomisation was computer generated and opaque sealed envelopes were used. Outcome assessors were blinded and the groups were comparable at baseline. Intention-to-treat analysis was employed and dropouts were clearly reported. The trial was judged as potentially having an unclear risk of bias as the authors noted that " <i>because of ethical reasons the control group was not discouraged from performing PFMT on their own, but they were asked to follow the prescription for the group they were randomised to.</i> "
Hagen 2014 (2)	Parallel group RCT; 2 groups, PFMT versus control (lifestyle advice leaflet)	407	Primi and multiparous women assessed for pelvic floor dysfunction 12 years after an index birth; women involved in the ProLong cohort study (3) who have POP-Q stage I, II or III); no previous treatment for prolapse (surgery, pessary, PFMT)	Intervention: 1:1 PFMT taught using digital palpation delivered in 5 physiotherapy appointments over 16 weeks, followed by Pilates-based classes, including PFMT. Classes were carried out in 6-week block (one class per week) and each woman was offered two 6-week blocks. Exercise DVD was provided for home use. Women offered a 1:1 physiotherapy annual review appointment at 1 and 2 years after randomisation. Control group: sent a lifestyle advice leaflet containing advice on weight loss, and avoidance of constipation, heavy lifting, coughing and high impact exercise.	POP-SS, Prolapse-related QoL, uptake of prolapse treatment, symptoms of urinary incontinence, anorectal or sexual dysfunction, women's perceived health benefit, and cost-effectiveness	Data collected at baseline, 1 and 2 years post randomisation	Randomisation was generated using a computer program located at the Trial Office on a password-protected PC. Outcome assessors were blinded and the groups were comparable at baseline. Intention-to-treat analysis was employed and dropouts were adequately reported. Questionnaire response rate: 81% year 1, 86% year 2 follow-up. Attendance at annual review appointments: 52% and 46% at year 1 and year 2 respectively, and uptake of classes in the UK was 33% and 17% at 1st and 2nd block respectively. By year 2, 77% in the intervention group reported they had done PFM exercises in the last 4 weeks

Abbreviations: PFM: pelvic floor muscles; PFMT: pelvic floor muscle training; POP-SS: pelvic organ prolapse symptom score; QoL: quality of life; RCT: randomized controlled trial

1. Bo K, Hilde G, Tennfjord MK, Jensen JS, Siafarikas F, Engh ME. Randomized controlled trial of pelvic floor muscle training to prevent and treat pelvic organ prolapse in postpartum primiparous women. *Neurourology and Urodynamics*. 2013;32(6):806-7.
2. Hagen S, Glazener C, McClurg D, MacArthur C, Herbison P, Wilson D, *et al*. A multicentre randomised controlled trial of a pelvic floor muscle training intervention for the prevention of pelvic organ prolapse (PREVPROL). *Neurourology and Urodynamics*. 2014;33(6):852-3.
3. Glazener C, Elders A, Macarthur C, Lancashire RJ, Herbison P, Hagen S, *et al*. Childbirth and prolapse: long-term associations with the symptoms and objective measurement of pelvic organ prolapse. *BJOG*. 2013;120(2):161-8.

Table 28 Summary of data on PFMT vs no active treatment for POP

Author, year	Study design/ Comparator	N	Study population	Modality details or parameters	Outcomes/results	Follow up	Notes (side effects, loss of follow up...)
Alves 2015 (1)	Parallel group RCT, 2 groups, PFMT vs control	30	Women ≥5 years postmenopausal, with urogynecological complaints	Intervention: PFMT taught using digital palpation. Groups of 7 women; 12 sessions, twice weekly for 30 minutes, over six weeks. Include pelvic mobility exercises, stretching, strengthening and relaxation in supine, sitting, on Gym Ball, squatting and standing, along with PFM contractions, consisting of 4 sets of 10 fast contractions and 4 sets of 10 sustained contractions, 8 seconds hold followed 16 seconds relaxation All women: performed a Fitness Program based on global muscle stretching, endurance and functional exercises for the elderly	POP-Q, ICIQ-VS, ICIQ-UI SF, ICIQ-OAB, PFM assessment (digital palpation, sEMG), treatment satisfaction (VAS, 0-10)	Assessed at baseline and post intervention (6 weeks).	Generally low ROB. Randomisation by draw, with each participant blindly drawing a sealed envelope containing a pre-printed card; however it was unclear whether opaque envelopes were used. Outcome assessors were blinded. Sample size calculation was reported and the groups were comparable at baseline. ITT not employed but dropouts were adequately reported. High attrition rate for the intervention group; 30/42 women completed the trial.
Culligan 2010(2)	Parallel group RCT; 2 groups, standardised PFMT program vs standardised Pilates program	62	Non pregnant community women with POP-Q stage I, with or without complaint of pelvic floor dysfunction	Intervention: 1:1 PFMT, 24 1-hour sessions, twice weekly for 12 weeks. Included computerized biofeedback, vaginal manipulation, neuromuscular re-education, and manual therapy. Authors imply women taught contraction used digital palpation. Control: Pilates, 24 1-hour sessions, twice weekly for 12 weeks. Taught full-	PFDI-20; PFIQ-7, PFM strength (vaginal pressure)	Assessed at baseline and post-intervention at 12 weeks	Generally low ROB. Randomised using blocked random assignment, and allocation concealment used sequentially numbered opaque sealed envelopes. Unclear whether participants and outcome assessors were blinded. Groups were comparable at baseline. Although intention-to-treat analysis

Author, year	Study design/ Comparator	N	Study population	Modality details or parameters	Outcomes/results	Follow up	Notes (side effects, loss of follow up...)
				body exercises designed to emphasize the "core muscles" and pelvic floor.			was not employed, dropouts were adequately reported. Authors reported that seven of the eight participants who dropped out of the PFMT arm reported doing so because they found the treatments "unpleasant in some way". All Pilates and PFMT sessions were free to the participants, who were also paid up to \$75 for completion of the study protocol.
Due 2016 (3)	Parallel group RCT; 2 groups, Combined group (PFMT plus structured lifestyle advice program) and lifestyle group (structured lifestyle advice program alone)	109	Women ≥ 18 years with POP symptoms and a POP-Q \geq stage II	Intervention: group PFMT and home training after a digital assessment and individual instruction. 6 group sessions delivered over 12 weeks. Include the Knack, home exercise 5 days a week (3 sets of up to 10, 10 second contractions). Plus lifestyle advice program as below. Control group: Lifestyle advice program, 6 1-hour group teaching sessions including information on POP-promoting factors, reducing pelvic floor pressure, bladder and bowel function, diet, body image and physical activity. No PFMT.	POP-Q; PFDI-20; PFIQ-7; PISQ-12; Patient Global Index of Improvement scale (PGI-I)	Assessed at baseline, immediately post-intervention (3 months) and 6 months	Low ROB for selection bias, performance and detection bias, attrition bias, reporting bias and other types of bias "Majority of the women in the lifestyle advice group ($p \leq 0.001$) had sought further treatment at six months follow-up, mainly as PFMT"
Frawley 2012 (4)	Parallel group RCT; 2 groups, PFMT vs control (lifestyle advice leaflet)	168	Women with symptomatic POP of stage I, II or III	This trial used the same protocol as the UK POPPY trial with some slight adjustments and additional measurements (see Hagen 2010 below)	POP-Q; POP-SS; PFM manometric strength and endurance; digitally assessed PFM strength/endurance (ICS scale)	Data collected at baseline and 6 and 12 month follow up	Generally low ROB. Randomisation was computer generated and participants were allocated to the trial using a remote randomisation service. Outcome assessors were blinded. Potentially high risk for attrition bias. Dropouts were accounted for

Author, year	Study design/ Comparator	N	Study population	Modality details or parameters	Outcomes/results	Follow up	Notes (side effects, loss of follow up...)
							but no explanations given for high attrition rates at 6 and 12 month follow up. Attrition was greater in the PFMT group at 6 months (14.3% vs 10.7%) but greater in the lifestyle group at 12 months (5.6% vs 21.3%).
Giraudó 2011 (5)	Parallel group RCT; 2 groups, PFMT plus negative pressure abdominal work vs PFMT plus abdominal hollowing exercise	44	Women with untreated stage I or II prolapse. No mention of whether women had symptoms.	Both interventions: PFMT delivered over 24 weeks, 1:1 supervised sessions twice-weekly for 1 hour for 3 months, once a week for last 3 months. Women taught to contract the PFM correctly by vaginal palpation. Tailored lifestyle advice given on reducing intra-abdominal pressure plus standardised lifestyle advice sheet (advice on weight loss, constipation, avoidance of heavy lifting, coughing and high-impact exercise). Groups: individualised PFM contraction with either abdominal hollowing exercises or negative pressure abdominal work.	Prolapse symptom severity measured via P-QOL Questionnaire. Prolapse severity (POP-Q) and PFM strength (Oxford scale). ICIQ-UI SF also used but not reported.	Assessed at baseline and at 24 weeks	ROB was judged as low or unclear. Randomisation was computer generated, but allocation concealment was not described. The physician involved in the trial was blinded to study group allocation, but there was insufficient information about the blinding of participants. The groups were comparable at baseline and all pre-specified outcomes were reported. However although dropouts were accounted for, it was not clear when the women were excluded, and which group they had originally been allocated to.
Hagen 2014(6)	Parallel group RCT; 2 groups, individualised programme of PFMT vs prolapse lifestyle advice leaflet	447	Female outpatients with newly-diagnosed, symptomatic stage I, II, or III POP	Intervention: Anatomy/function of PFM explained, taught to correctly contract PFM (vaginal palpation, PERFECT) and pre-contracting against increases in abdominal pressure. 5 physiotherapy appointments delivered over 16 week period (weeks 0, 2, 6, 11 & 16). Home exercise prescribed - 3 sets of exercises per day: 10 maximum voluntary contractions held for up to 10s, with 4s rest between; after 1 minute rest, up	POP-SS; POP-Q; women's perceived change in prolapse; interference due to prolapse; days of symptoms; uptake of prolapse treatment; ICIQ UI-SF; PISQ; SF-12	Assessed at 12 months, except POP-Q assessed at 6 months	Low ROB. Randomisation was computer generated, and university-based trial coordinator accessed the web-based application and then informed the woman, and the physiotherapist as necessary, of the allocated group. Outcome assessors and investigators (who were gynaecologists at trial sites), were masked to group allocation; the

Author, year	Study design/ Comparator	N	Study population	Modality details or parameters	Outcomes/results	Follow up	Notes (side effects, loss of follow up...)
				to 50 rapid contractions. Standardised lifestyle advice leaflet and tailored lifestyle advice given. Control group: received the same lifestyle advice leaflet by post.			statistician was masked until after data analysis. ITT analysis was employed and dropouts were adequately reported.

Author, year	Study design/ Comparator	N	Study population	Modality details or parameters	Outcomes/results	Follow up	Notes (side effects, loss of follow up...)
Kashyap 2013 (7)	Parallel group RCT; 2 groups, PFMT and a self-instruction manual (SIM) vs SIM alone	140	Parous women attending gynaecology outpatient department, aged 20–70 years, who were willing to attend follow-up visits	Intervention: anatomy/function of PFMs explained. 1:1 PFMT training, plus exercise practice and checking for correct contractions of PFM by vaginal examination. Pressure manometry for biofeedback and motivation. Given SIM. After training session, 6 follow up visits (weeks 1, 3, 6, 12, 18 and 24). Home exercise programme of 3 times/daily set of exercises comprising 10 voluntary contractions, held for 10s each with 10s rest in between. Participants performed the intervention as described for 24 weeks. Control: SIM plus 3 follow-up visits (weeks 6, 18 and 24). Home exercise prescribed as above.	POP-SS; symptoms measured by visual analog scale (VAS), PFIQ-7, POP-Q	Assessed at baseline and at 1, 3, 6, 12, 18 and 24 weeks	Low risk for selection bias as the trialists had used a block randomisation method for randomisation, and a physician, who was not involved in the study, performed the patient allocation. Potential for high risk of bias, as “the study design did not include blinding”. There was a crossover of 4 participants from group B to group A <i>after</i> randomisation. Details of attrition were not well reported: it was indicated that analysis was performed on all 140 participants however there was also reference to individuals “missing” and “lost to follow-up”. Self-completed exercise diary but unclear how well adherence was actually delivered as planned.
Resende 2008/ Stupp 2011 (8, 9)	3-arm RCT; PFMT training vs hypopressive	58	Women with stage II POP and not undergoing surgery to correct it during	PFMT: Session 1 (week 0), anatomy/function of PFMs explained, training on PFM contractions, observation on correct performance. Follow up sessions	POP-Q; symptom severity (Prolapse Quality of Life (P-QoL)); PFM	Baseline evaluation and immediately	Low or unclear ROB. Randomisation was computer generated, but allocation concealment was not described.

Author, year	Study design/ Comparator	N	Study population	Modality details or parameters	Outcomes/results	Follow up	Notes (side effects, loss of follow up...)
	exercises plus PFMT vs lifestyle advice & instruction on PFM contraction (1 appointment)		the study. Not on hormonal treatment, not had previous PFMT or pelvic floor surgery. Recruited during routine consultation.	at weeks 1 (vaginal palpation), 2, 6, 10 and 14. 12 week home exercise programme of 3 sets of exercises daily: 1 set of 8-12 maximum contractions held 6-10s, double time rest between each contraction, then 3-5 fast contractions. Bi-weekly telephone calls. PFMT+HE: Hypopressive exercises plus PFMT (3 sessions). Monthly appointments, 12 week home exercise programme. Bi-weekly telephone calls. Control group: 1 appointment for lifestyle advice and instruction in PFM contraction. All: Standardized lifestyle advice sheet about weight loss, fluid intake, constipation and avoidance of heavy lifting.	function assessment (strength and endurance), electrical activity measured (sEMG)	after intervention (at 3 months)	The main investigator was blind to the study groups and not involved in delivering the intervention. Groups were comparable at baseline and dropouts were accounted for. Attrition was evident only in the control group where 16/21 (76%) were analysed. Single trial reported over multiple papers (confirmed by author). Reports do not agree about number of participants, age. Authors state: "The women who took part in the present study also participated in a randomized, controlled trial on PFMT to reduce POP, the results of which are not available yet. Therefore, in this study, we considered only the results regarding PFM function."
Wiegiersma 2014 (10)	Two parallel RCTs. POPPS 1 (described here) 2 groups; PFMT vs watchful waiting	287	Women aged at least 55 years with symptomatic mild POP identified via screening survey in 15 GP practices	Intervention: Explanation of the function of pelvis/pelvic floor/ pelvic floor dysfunctions, taught "the Knack". Weekly visits to pelvic physiotherapist until able to correctly contract and relax PFM (assessed by digital palpation), then 2-3 weeks intervals. Home exercise 3-5 times a week, 2 or 3 times a day. Advice on lifestyle (diet, body weight) and toilet habits. Control: no treatment or recommendations	Assessed 3 months from the start of treatment (or from randomisation for control group): PFDI-20, PFIQ-7, POP-Q, SF-12, PISQ-12, patients' perceived change in symptoms (VAS) , PFM function (ICS method)	Data collected at baseline and at 3, 12, and 24 months after the start of treatment	Low ROB. Block randomisation; independent statistician generated the allocation sequence. Research physicians and pelvic physiotherapists were blinded to all answers on the participant completed questionnaires, and research physicians were blinded to the outcomes of the previous POP-Q measurements and previous evaluations of pelvic floor muscle function. ITT analysis employed; dropouts and missing data were accounted for.

Abbreviations: PFDI-20: pelvic floor distress inventory short form 20, PFIQ-7: pelvic floor impact questionnaire short form; PFM: pelvic floor muscles; PFMT: pelvic floor muscle training; POP-Q; Pelvic Organ Prolapse Quantification system; PISQ-12: Pelvic organ prolapse/urinary incontinence sexual questionnaire' POP-SS: pelvic organ prolapse symptom score; QoL: quality of life; RCT: randomized controlled trial; sEMG: surface electromyography

1. Alves FK, Riccetto C, Adami DB, Marques J, Pereira LC, Palma P, *et al.* A pelvic floor muscle training program in postmenopausal women: A randomized controlled trial. *Maturitas.* 2015;81(2):300-5.
2. Culligan PJ, Scherer J, Dyer K, Priestley JL, Guignon-White G, Delvecchio D, *et al.* A randomized clinical trial comparing pelvic floor muscle training to a Pilates exercise program for improving pelvic muscle strength. *Int Urogynecol J.* 2010;21(4):401-8.
3. Due U, Brostrom S, Lose G. Lifestyle advice with or without pelvic floor muscle training for pelvic organ prolapse: a randomized controlled trial. *Int Urogynecol J.* 2016;27(4):555-63.
4. Frawley HC, Hagen S, Sherburn M, Neumann P, Herbison P, Hay-Smith J, *et al.* Changes in prolapse following pelvic floor muscle training: A randomised controlled trial. *Neurourology and Urodynamics.* 2012;31(6):938-9.
5. Giraud D, Beccaria N, Lamberti G. Pelvic floor muscle training, negative pressure abdominal exercise and pelvic organ prolapse symptoms: A randomized clinical trial. *Neurourology and Urodynamics.* 2011;30(6):1009-11.
6. Hagen S, Stark D, Glazener C, Dickson S, Barry S, Elders A, *et al.* Individualised pelvic floor muscle training in women with pelvic organ prolapse (POPPY): a multicentre randomised controlled trial. *Lancet.* 2014;383(9919):796-806.
7. Kashyap R, Jain V, Singh A. Comparative effect of 2 packages of pelvic floor muscle training on the clinical course of stage I-III pelvic organ prolapse. *Int J Gynaecol Obstet.* 2013;121(1):69-73.
8. Stupp L, Magalhaes Resende AP, Oliveira E, Castro RA, Castello Girao MJB, Ferreira Sartori MG. Pelvic floor muscle training for treatment of pelvic organ prolapse: An assessor-blinded randomized controlled trial. *International Urogynecology Journal and Pelvic Floor Dysfunction.* 2011;22(10):1233-9.
9. Resende APM, Stupp L, Bernardes BT, Oliveira E, Castro RA, Girao MJBC, *et al.* Can hypopressive exercises provide additional benefits to pelvic floor muscle training in women with pelvic organ prolapse? *Neurourology and urodynamics.* 2012;31(1):121-5.
10. Wiegersma M, Panman CM, Kollen BJ, Vermeulen KM, Schram AJ, Messelink EJ, *et al.* Pelvic floor muscle training versus watchful waiting or pessary treatment for pelvic organ prolapse (POPPS): design and participant baseline characteristics of two parallel pragmatic randomized controlled trials in primary care. *Maturitas.* 2014;77(2):168-73.

Women were assessed at baseline and immediately after intervention (at 3 months) using POP-Q (blinded assessment); PFM strength and endurance (Oxford scale), electrical activity (sEMG) and symptom severity and impact (P-QoL). The trial was judged as low risk for selection bias (randomisation) and unclear risk for allocation concealment. The trial was also judged at low risk for performance and detection bias, attrition bias, reporting bias and other types of bias (266, 267) (Table 28).

Wiegiersma and team conducted a trial in primary care (POPP1) of women aged ≥ 55 years with symptomatic mild prolapse (above the hymen) (268). Women in the trial were randomised to either PFMT or watchful waiting. Women in the PFMT group were given an explanation of pelvic floor anatomy and pelvic floor dysfunction, were taught “the Knack”, and given lifestyle advice. They had weekly visits with the pelvic physiotherapist initially. The intervals between appointments were extended when they could correctly contract and relax their PFMs. Home exercise was recommended three to five times a week, twice or three times each day. Data were collected at baseline and at 3, 12, and 24 months after the start of treatment. The primary outcomes were change in bladder, bowel, and pelvic floor symptoms, as measured by the PFDI-20, assessed at three months. Secondary outcomes were condition specific and general quality of life, sexual functioning, and degree of prolapse, PFM function, and patients' perceived change in symptoms from the start of the study. The POPP1 trial was judged as low risk for selection bias, performance and detection bias, attrition bias, reporting bias and other types of bias (Table 28).

Results

In the Alves (2015) trial, 42 women were randomised, 21 in each group, however there was high attrition and only data from 18 and 12 women in the intervention and control group respectively were analysed. Two in the intervention group did not complete the treatment due to health or family problems, while 9 in the control group refused to complete the final physical exam: these women were excluded from the sample. There was a significant difference in favour of the intervention group in terms of decreased anterior prolapse, but no difference in posterior prolapse or the ICIQ-VS score. There was a significant difference between the groups in the ICIQ-OAB and ICIQ-UI SF scores after treatment, with improvement occurring only in the intervention group. There was a greater increase in PFM contractility (measured both by digital palpation and sEMG) in the PFMT intervention group compared to the general fitness control group at 6 weeks. Satisfaction with the treatment was reported to be greater in the intervention group (47).

Sixty-two women were randomised in the Culligan (2010) trial; 32 to PFMT and 30 to Pilates (control), of which 8 and 2 withdrew respectively (260). Seven of the 8 who dropped out of the PFMT arm did so because they found the treatment unpleasant, while the

2 in the Pilates arm withdrew for health reasons unrelated to the trial. All women could correctly contract their pelvic floor muscles (as assessed by perineometry at baseline) and most did not have pelvic floor symptoms at baseline. Both groups demonstrated improved PFDI-20 and PFIQ-7 scores and pelvic floor muscle strength, at 12 weeks, but these improvements were not significantly different between the groups. The authors concluded that it is feasible for a Pilates exercise program to strengthen the pelvic floor muscles of women with stage I prolapse.

In the Due (2016) trial, 109 women were randomised, 56 to the combined group and 53 to the lifestyle group (261). Of these 43% had POP stage III and 57% had POP stage II. Follow-up at 3 and 6 months was 82% and 78% complete respectively. Significantly more women in the combined group indicated improvement in the PGI-I at 3 and 6 months. There was no difference between groups in any PFDI-20 or PFIQ-7 scores at 3 months. Both groups improved significantly in the total PFDI-20 score and its subscores by 3 months, except the lifestyle group had no improvement in the POPDI sub-score. Significant improvement in PFIQ-7 could only be found in the lifestyle advice group. It was unclear if there were any differences between groups in PFDI/PFIQ at 6 months. The PISQ-12 and objective prolapse stage did not improve significantly. Significantly more women (68% vs 28%) in the lifestyle advice group had sought further treatment (mainly PFMT) at 6 months follow-up. The authors concluded that there was a small benefit of both lifestyle advices alone or combined with PFMT for women with stage II or III prolapse. There was a significant difference in the primary outcome (PGI-I) in favour of the combined group, but this was not really highlighted.

In the Frawley (2012) trial, 168 women were randomised to either the PFMT group (n=84) or the control group (n=84), with 12 and 9 lost to follow-up by 6 months and a further 4 and 16 by 12 months respectively, 19% and 30% in total (262). 82% of women in the PFMT group attended 4 or 5 of the 5 physiotherapist appointments. The POP-SS score was significantly lower, indicating fewer symptoms, in the PFMT group compared to the control group at both 6 and 12 months. There was no difference in POP-Q stage between groups at 6 or 12 months, although there was some evidence of a difference at 12 months between groups, in the posterior wall POP-Q measurements, Ap and Bp, in favour of the PFMT group. Digital muscle strength was significantly stronger in the PFMT group compared to the control group at 6 months but not at 12 months. There were no significant differences between groups in manometry outcomes, except total work performed was higher in the PFMT group at 6 months. The intervention was concluded to be beneficial immediately following the intervention, and after a further 6 months.

In a conference abstract, Girardo and colleagues reported 47 women were randomised but 3 were excluded because they could not contract their pelvic

floor muscles, leaving 44, 23 intervention (PFMT + negative pressure abdominal work) and 21 control (PFMT + abdominal hollowing) (264). Improvement in prolapse symptoms and POP-Q values from baseline to 24 weeks was significantly greater in the intervention group compared with the control group. There was evidence of an improvement in PFM strength and endurance in both groups, but no significant difference between the groups. The authors concluded there may be benefit of adding negative pressure core exercises to PFMT for women with stage I and II prolapse.

Of the 447 women enrolled in the POPPY trial, 225 women were randomised to intervention and 222 to control (263). 84% and 66% of women completed questionnaires at 6 and 12 months respectively, with no differential drop-out. POP-Q re-assessments at 6 months were obtained for 75% (168) and 77% (171) of women respectively. 80% in the intervention group attended 4 or 5 of the 5 appointments. Women in the intervention group had a significantly greater reduction in prolapse symptoms at 6 and 12 months than those in the control group, although they were no more likely than control women to have a reduced severity of prolapse at 6 months. At 12 months, significantly more women in the control group than the intervention group had received further treatment. In particular significantly more women in the control group (27% vs 1%) had had a referral for PFMT. At 6 months, all aspects of daily life, and sexual, bladder, and bowel function (except for faecal incontinence), were significantly better in the intervention group compared to the control group. This was not sustained at 12 months. It was concluded that one-to-one PFMT is effective for improving symptoms in women with stage I to III prolapse in the medium term.

In the Kashyap trial, 140 women were randomised, 70 per group, although four women transferred from the control group to the training plus manual group and the group in which these women were analysed was unclear (265). Improvements were reported in POP-SS, VAS and PFIQ-7 scores in both groups from baseline to week 24. There were significant differences between groups in the change in POP-SS with the intervention group reporting greater symptom improvement. There was also significantly more improvement in the intervention group in terms of the VAS scores and the PFIQ-7 scores. Five women in the intervention group had an improved POP-Q stage compared to one woman in the control group. The authors concluded that one-to-one PFMT plus the SIM led to more symptom improvement than the SIM alone.

The Stuppe-Resende trial was reported over multiple publications (4 conference abstracts, 2 papers and a trial register entry) (confirmed by personal communication with an author), reporting on different comparisons amongst the three trial groups, and not all reports agreed on participant details (e.g. the number of participants, age) making it difficult to interpret the findings. 63 women were randomised in the trial: 21

to PFMT, 21 to PFMT plus hypopressive exercise, 21 to lifestyle group. Five women in the lifestyle group discontinued leaving 58 women at follow-up. The PFMT group women were more likely than the control group to have an improvement in their POP-Q stage of prolapse, both anterior and posterior. The domains and symptoms scores from the P-QoL were compared before and after in each group separately, but no between-group comparisons were made. However, the authors concluded erroneously that since the PFMT group scores improved significantly and the control groups did not, the PFMT group had benefited more. Pelvic floor muscle assessment outcomes were compared between the three groups (266). Significant differences were found between the PFMT and PFMT+HE groups when compared to the control group, in favour of the PFMT groups, in terms of Oxford score, contraction endurance and muscle activity (SEMG). No significant difference was found between the PFMT and PFMT+HE groups in terms of Oxford score and muscle activity (SEMG), however PFMT group did significantly better than PFMT+HE in terms of contraction endurance.

Wiegiersma trialists screened 4,465 women to identify those with mild prolapse (n=365) (268). Of these, 287 women were randomised, 145 to PFMT and 142 to watchful waiting, of which 250 (87%) completed the trial follow-up. Women in the intervention group improved their PFDI-20 score significantly more than those in the watchful waiting group, and were also more likely to report overall symptom improvement (57% vs 13%). There were no other significant differences between the trial groups including improvement in POP-Q stage. The authors concluded that the difference in PFDI-20 may not be clinically significant and that more studies are needed to examine the factors affecting success.

Summary

Results from an additional seven new trials are now available and more complete reports for two of the six earlier trials.

There have been different types of control groups used in the trials to date: minimal intervention control e.g. lifestyle leaflet or watchful waiting; other type of exercise as control e.g. Pilates or general fitness; lifestyle intervention as control; other form of delivery of PFMT as control e.g. self-instruction PFMT manual. One small trial compared PFMT of two different types (PFMT with negative pressure abdominal work and PFMT with abdominal hollowing).

Most evidence (8 trials) exists for PFMT versus a minimal intervention control, and it can now be concluded more confidently that PFMT significantly reduces pelvic floor symptoms in women with stage I to III prolapse. Evidence of effectiveness for PFMT relating to the specific symptom of a vaginal bulge or something coming down associated with prolapse was Level 1, but less consistent.

Six of these trials reported change in POP-Q stage, but a beneficial effect on the stage was reported in only 1 of these, and thus there was evidence of no effect of PFMT on prolapse stage.

In the other categories, four out of six trials providing data were small and very likely underpowered although they were otherwise at low risk of bias (Alves n=42, Culligan n=62, Giraudo n=47, Stupp n=63).

Of the remaining two, Due (n=109) found PFMT plus lifestyle advice to be superior to a lifestyle advice programme in terms of overall improvement on the Patient Global Index of Improvement Scale, but not prolapse symptoms or POP-Q severity, where both groups improved [46]. Kashyap (n=140) found a taught course of PFMT plus self-instruction manual was better than a self-instruction manual alone in improving prolapse symptoms [50]. The difference in findings might in part be due to different PFMT interventions: group PFMT delivered in the Due trial versus one-to-one PFMT in the Kashyap trial.

Based on previous studies and new evidence there is now evidence of benefit that PFMT is effective in reducing pelvic floor symptoms in women with prolapse (**Consistent Level of Evidence: 1, Grade of recommendation: A**). There is some evidence of benefit showing that PFMT is effective in alleviating specific prolapse symptoms (e.g. vaginal bulge) (**Majority Level of Evidence: 1, Grade of recommendation: C**). There is no evidence that PFMT is effective in reducing severity of prolapse based on POP-Q stage (**Consistent Level of Evidence: 1, Grade of recommendation: B**).

2.2.2 PFMT and Surgery

Two trials have been reported in previous editions of this chapter (269, 270). There have been an additional 4 trials published since the last edition (104, 271-274). Three trials compared surgery plus PFMT with surgery alone, and one trial compared surgery with PFMT (275). The latter did not report on prolapse outcomes and is therefore not discussed further. Salient features of each trial are described in Table 29.

Quality of data

Barber and colleagues carried out the OPTIMAL 2x2 factorial trial of PFMT as an adjunct to vault prolapse surgery (104). This trial compared two methods of suspending the vaginal vault in women undergoing surgery for prolapse. Additionally, participants were randomised either to adjunctive post-operative PFMT or routine care, to assess whether such adjunct therapy improves both anatomical and symptomatic outcomes two years after surgery.

The adjunct intervention consisted of one pre-operative visit and four post-operative visits with a behavioural interventionist for PFMT and education in behavioural strategies. Routine care was usual peri-operative teaching and post-operative instructions. The authors' primary outcomes were urinary symptoms at

6 months (PFDI-UDI), and prolapse symptoms (PFDI-POPDI) and anatomical failure (descent on the POP-Q or retreatment) at 24 months after surgery (Table 29).

The OPTIMAL trial was judged as low risk for selection bias, performance and detection bias, attrition bias, reporting bias and other types of bias (104) (Table 29).

McClurg and colleagues undertook a pilot trial of pre- and post-operative PFMT for women undergoing a primary prolapse repair (274). Women were randomised to either the intervention group receiving PFMT or the control group receiving usual care. Prior to surgery all women were seen by a physiotherapist to complete baseline outcome measures. Those in the intervention group were also seen once pre-operatively by another physiotherapist to be taught pelvic floor muscle exercises and the Knack. Women were advised to do three sets of exercise per day. After 6 weeks the intervention group women were seen for 5 visits over 16 weeks and an individualised home exercise programme was prescribed and advice given. Control group women received a lifestyle advice leaflet. Both groups completed outcome measures at 6 and 12 months post-surgery: POP-SS (primary), ICIQ-UI SF, ICIQ-BS, PISQ-12, SF-12, and PFM assessment (PERFECT and modified Oxford scale) (Table 29). The feasibility trial was generally judged as low risk for selection bias, attrition bias, reporting bias and other types of bias. However, there was potential for performance and detection bias (see Table 29) (274).

Pauls *et al.* (2011) (271, 272) undertook a trial in women undergoing vaginal reconstruction, comparing PFMT as an adjunct to surgery with standard care. Women were having planned surgical correction, including a native tissue vaginal repair with or without a vaginal hysterectomy or suburethral sling. PFMT consisted of one appointment 2 weeks before their scheduled surgery date, and five post-operatively, each with a specialist pelvic floor physiotherapist. The control group attended appointments with physician assessment alone at all the same post-operative intervals. There was a final follow-up assessment at 24 weeks (Table 29). The primary outcome was quality of life measured using the WHOQOL-Bref. Secondary outcomes included PFDI-20, PFIQ-7, POP-Q assessment, the Female Sexual Function Index (FSFI), PISQ-12, a modified Oxford scale for pelvic floor strength and contraction, short form General Health Survey (SF-12), and a 24-hour voiding diary (271, 272). The trial was judged as low risk for selection bias, performance and detection bias, attrition bias, reporting bias and all other types of bias (Table 29).

Table 29 Summary of data on PFMT + surgery for POP

Author, year	Comparator	N	Study population	Modality details or parameters	Outcomes/results	Follow up	Notes (side effects, loss of follow up)
Barber 2014 (1)	2 x 2 factorial RCT: comparing to surgery types +/- PFMT	374	Women having surgical repair for apical or uterine POP of stage II or greater, who also have SUI	Women were randomised to both surgery type and PFMT. Surgery: 1) sacrospinous ligament fixation, or 2) uterosacral vaginal vault suspension Perioperative PFMT: 1) 1:1 PFMT (1 pre-operative + 4 post-operative visits for PFMT (2,4,6,8 and 12 weeks), examination at each visit, and exercise and education in behavioural strategies), or 2) usual care (usual peri-operative teaching and post-operative instructions)	Outcomes for PFMT: long-term improvement in anatomic outcomes (POP-Q) and prolapse symptoms (POPDI subscale of the PFDI); short term (6 months) improvement in urinary symptoms (UDI subscale of PFDI).	6, 12 and 24 months	Low ROB for selection bias, performance and detection bias, attrition bias, reporting bias and other types of bias
McClurg 2010 (2)	Parallel group RCT; 2 groups, treatment group (surgery and PFMT sessions) vs a control group (usual care)	57	Women attending the gynaecological clinic and for whom primary surgery was recommended due to their POP symptoms	Intervention: 1 pre-operative + 5 post-operative appointments within a period of 12 weeks. Pre-operatively, anatomy and function of PFMs, types of prolapse and the surgical procedure discussed with information about recovery/return to normal activities. Women taught by digital palpation to contract PFMs and 'the Knack'. Home exercise, 3 sets per day of 10 maximum contractions (up to 10s hold) with 4s rest between, 1-min rest followed by 10 fast contractions. Control: received the same lifestyle advice leaflet.	POP-SS; ICIQ-UI SF; ICIQ-BS; PISQ-12; SF-12; PFM assessment (PERFECT, modified Oxford scale).	All outcomes were measured at baseline, 6 and 12 months	Generally judged as low ROB. Randomisation generation and allocation concealment were judged as adequate. Outcome assessors reported as being blinded but researchers involved in the trial were not blinded and it is unclear what direct involvement they may have had with each participant. Groups were comparable at baseline, but there were more complaints of bowel dysfunction in the treatment group. Dropouts were clearly accounted for and all pre-specified outcomes were adequately reported.

Author, year	Comparator	N	Study population	Modality details or parameters	Outcomes/results	Follow up	Notes (side effects, loss of follow up)
Pauls 2013 (3)	Parallel group RCT; 2 groups, PFMT vs standard care in women undergoing vaginal reconstruction	49	Women aged > 18 years having surgical correction to include a native tissue vaginal repair +/- a vaginal hysterectomy or suburethral sling	Intervention: physiotherapy appointment 2 weeks before surgery, and 2, 4, 6, 8, and 12 weeks postoperatively, in conjunction with a physician assessment. Sessions covered bladder and bowel function, pain management, breathing and relaxation, core exercises, scar tissue mobilization, increased strengthening and training over time. Control: attended appointments (biweekly until 12 weeks postoperatively) with physician assessment alone at intervals as above.	PFDI-20, PFIQ-7, POP-Q, Female Sexual Function Index (FSFI), PISQ-12, SF-12, WHO-QOL Bref, modified Oxford scale for PFM strength and contraction, 24-hour voiding diary	Assessments undertaken at baseline (some limited assessment at appointments occurred at 2, 4, 6, 8 weeks), and follow-up assessments at 12 and 24 weeks	Low ROB. Randomisation generation and allocation concealment were judged as adequate. Outcome assessors were blinded appropriately. Groups were comparable at baseline, dropouts were all accounted for and all pre-specified outcomes were reported. The trial is fully reported in two main papers.

Abbreviations: PFM: pelvic floor muscles; PFMT: pelvic floor muscle training; POP: pelvic organ prolapse; POP-SS: pelvic organ prolapse symptom score; QoL: quality of life; RCT: randomized controlled trial; ROB: risk of bias; SUI: stress urinary incontinence; UI: urinary incontinence

1. Barber MD, Brubaker L, Burgio KL, Richter HE, Nygaard I, Weidner AC, *et al.* Comparison of 2 transvaginal surgical approaches and perioperative behavioral therapy for apical vaginal prolapse: the OPTIMAL randomized trial. *JAMA*. 2014;311(10):1023-34.
2. McClurg D. A two group, single-blind, randomised controlled study to assess the feasibility of physiotherapy following surgery for prolapse to avoid recurrence. <http://isrctn.org/ISRCTN08203452010>.
3. Pauls RN, Crisp CC, Novicki K, Fellner AN, Kleeman SD. Impact of physical therapy on quality of life and function after vaginal reconstructive surgery. *Female Pelvic Med Reconstr Surg*. 2013;19(5):271-7.

Results

In the OPTIMAL trial, 408 women were randomised, 34 withdrew prior to surgery leaving 374 women randomised to PFMT (n=186) or usual care (n=188). There was no significant difference at 6 months or 24 months between the PFMT and usual care groups in the prolapse scores or POP-Q. The routine use of PFMT was concluded to be unnecessary (104).

McClurg (2010) randomised 57 women from three sites, 28 to PFMT and 29 to control, with the majority of women (n=27, 47%) coming from one site. By 6 months there was significant improvement in both groups on prolapse, bladder, bowel and general health measures, but no difference between groups. Analysing 12 month data from the highest recruiting site where longer follow-up was possible (there were significant recruitment and logistical issues at other sites which caused delays and limited the follow-up), there were significant differences between groups in POP-SS and SF-12: prolapse symptoms and general health were more improved in the PFMT groups (274).

In Pauls (2013) trial, a total of 57 women were randomised, 29 to physiotherapy and 28 to control, and 49 completed the study (24 and 25 respectively). Improvement over baseline was found in both groups in quality of life, PFDI and PFIQ measures, but there were no differences between groups. The PFMT group had better muscle strength after 12 weeks, but at 24 weeks this was no longer evident. (271, 272).

Summary

Although there were three new randomised studies reporting prolapse outcomes, only one trial (OPTIMAL) was both at low risk of bias and of adequate size (104). It found no evidence of an effect on prolapse symptoms or stage at 2 years of adding PFMT to surgery in women having vault prolapse repair (**Level of Evidence: 1**). The other two small trials provided no evidence of an effect of PFMT.

Peri-operative PFMT does not improve prolapse symptoms in women undergoing surgery for vault prolapse (**Grade of Recommendation: B New**).

2.2.3 PFMT and Pessary

Three RCTs have been published since the 5th Edition when previously there had been none. Details of the categories and treatment components of the active interventions are provided in Table 30.

i) Pessary + PFMT vs pessary

Hagen and colleagues carried out a pilot trial in which women with stage I to IV prolapse of any type who had successfully been fitted with a pessary were randomised to have PFMT or not. PFMT was delivered by a specialist women's health physiotherapist in 5 appointments over 16 weeks (276) (Table 30). The pessary was removed at 6 months and outcomes (POP-SS, prolapse-related quality of life, prolapse

severity (POP-Q), and perceived change in prolapse since pessary fitted) measured at 7 months. The authors aimed to randomise 50 women from 4 centres to inform the development of a larger trial. The PEPPY trial was judged as low risk for selection bias, performance and detection bias, attrition bias, reporting bias and all other types of bias (276, 277).

ii) PFMT vs PFMT + pessary

Cheung and colleagues carried out a trial in women with symptomatic stage I to III prolapse with no previous treatment for prolapse, who were randomised to either a vaginal ring pessary+ PFMT, or PFMT alone (278). Both groups were taught and encouraged to do PFMT standardized pelvic floor exercise training course which included a teaching session within 2 weeks after the first consultation and three individual training sessions at 4, 8, and 16 weeks. Women were advised to practice daily with at least two sets of 8–12 preset exercise repetitions per day, with 8–10 exercises per session at least two times per week. Change in urinary symptoms was measured using the PFDI (including PFDI-UDI) before, 6 months and 12 months after the treatment. The PFIQ was also completed at 12 months. The trial was judged as low risk for selection bias, performance and detection bias, attrition bias, reporting bias and other types of bias (Table 30).

iii) Colpexin sphere +PFMT vs PFMT

Manonai and colleagues (2012) studied the use of the Colpexin sphere in women with Stage I or II prolapse (279). The Colpexin sphere is an intra-vaginal device similar to a pessary except it requires the woman to actively contract her pelvic floor muscles to keep the device in place. Women were randomised to either PFMT alone (control) or PFMT along with a Colpexin sphere (study group). All women were instructed to perform three sets of exercises daily. Those in the Colpexin group exercised with the device *in situ*. The intervention duration was 16 weeks. Pelvic floor muscle strength was measured using the Colpexin pull test and digitally using the Brink scale, at baseline, 4, 8, 12 and 16 weeks after treatment. There were no specific prolapse outcomes reported. Participants were excluded if compliance with the daily pelvic floor exercise was less than 80%. The trial was judged as low risk for selection bias, performance and detection bias, attrition bias, reporting bias and other types of bias (Table 30).

Results

Of the 31 eligible women recruited to the PEPPY trial, 16 were randomised, eight to the pessary alone group and eight to the pessary plus PFMT group. The mean age of women was 63 years (SD 14); 25% had stage I prolapse, 50% stage II, and 25% stage III. Compliance with the intervention was good: 75% of intervention women attended 4 or 5 appointments. With such a small sample size statistical analysis was not carried out.

Table 30 Summary of data on PFMT + pessary / other medical devices for POP

Author, year	Comparator	N	Study population	Modality details or parameters	Outcomes/results	Follow up	Notes (side effects, loss of follow up...)
Cheung 2016(1)	Parallel group RCT; 2 groups, Vaginal ring pessary + PFMT vs PFMT	276	Women had symptomatic prolapse (Stage I- Stage III), had received no previous treatment	Intervention: vaginal pessary, (ring pessary was used). Women also received regular PFMT. Home exercise performed at least 3 times a week and 2 times each day. Control: PFMT alone.	Total scores on PFDI and PFIQ. Change of urinary symptoms measured by PFDI-UDI and subscales (obstructive, irritative, stress).	Data collected at baseline and 6 months (PFDI-UDI only) and 12 months after treatment.	Low ROB for selection bias, performance and detection bias, attrition bias, reporting bias and other types of bias
Hagen 2010(2)	Feasibility pilot RCT; 2 groups, PFMT in conjunction with pessary management vs pessary management alone	16	Women with prolapse of any type, of stage I to IV, with a pessary newly successfully fitted (still in place after 2 weeks)	PFMT was delivered at 5 appointments over 16 weeks (as per Hagen 2010 in Table 28) with the pessary in place. Control: pessary management alone.	POP-SS, prolapse-related quality of life, prolapse severity (POP-Q), and perceived change in prolapse since pessary fitted.	Data collected at baseline (after pessary fitted but before randomization), 6 months post-randomization (with pessary <i>in situ</i> , then pessary removed), and 7 months post-randomization without pessary.	Low ROB for performance and detection bias, attrition bias, reporting bias and all other types of bias. Poor recruitment was a key issue within the trial – target was to randomise 50 women
Manonai 2012(3)	Parallel group RCT; 2 groups, Colpexin sphere with PFMT vs PFMT alone	91	Women aged 20 years+, prolapse stage I or II	All participants: taught about home-based practice with booklet of PFM. Visual inspection of contraction. Home exercise involved tightening the PFMs, holding for 10s, relaxing 10s and doing 10 repetitions 3 times a day for a period of 16 weeks. Colpexin+PFMT: exercised as above with the Colpexin sphere <i>in situ</i> .	ICIQ-VS (Thai version), POP-Q, PFM strength (Colpexin pull test, digital test using Brink scale)	POP-Q and ICIQ-VS at baseline and 16 weeks. PFM data collected at baseline, 4, 8, 12 and 16-week after starting treatment.	Low ROB. Random sequence generation was computer generated and information for decoding randomisation was kept secure and opaque sealed envelopes were used during the allocation process. Although ITT analysis was not employed, all dropouts were clearly accounted for. The groups were comparable at baseline and the authors reported a sample size calculation.

Abbreviations: PFM: pelvic floor muscles; PFMT: pelvic floor muscle training; POP-SS: pelvic organ prolapse symptom score; RCT: randomized controlled trial

- Cheung RY, Lee JH, Lee LL, Chung TK, Chan SS. Vaginal Pessary in Women With Symptomatic Pelvic Organ Prolapse: A Randomized Controlled Trial. *Obstet Gynecol.* 2016.
- Hagen S. Pessary Plus Physiotherapy for Pelvic Organ Prolapse (PEPPY). <http://ClinicalTrialsgov/show/NCT011368892010>.
- Manonai J, Hamsomboon T, Sarit-apirak S, Wattanayingcharoenchai R, Chittacharoen A, Suthutvoravut S. Effect of Colpexin Sphere on pelvic floor muscle strength and quality of life in women with pelvic organ prolapse stage I/II: a randomized controlled trial. *Int Urogynecol J.* 2012;23(3):307-12.

However, from observing the mean scores it was apparent that symptoms in both groups were worse a month after the pessary had been removed (month 7) compared to baseline (when the pessary had been in place for 2 weeks), and there was no indication of a symptom or objective benefit for those women who had received PFMT on any of the outcomes. In both groups 2 out of 7 women said their prolapse was the same or worse at 6 months after the pessary had been inserted. Recruitment was problematic in the trial, and it was concluded that this would need to be addressed before moving to a larger trial (276, 277).

Of the initial 311 women recruited to the Cheung trial, 276 were randomised, 137 to PFMT treatment and 139 to vaginal pessary plus PFMT. Authors reported in one abstract an intention-to-treat analysis of the difference between the groups in PFDI-UDI and its subscores, and on the prevalence of women with SUI, UUI and voiding difficulties (278). Prolapse outcomes were not reported. Although there was significant improvement on all outcomes at 12 months, there was no significant difference between the groups. In a second abstract the authors reported a non-randomised comparison of those women who continued successfully with their pessary until 12 months (n=78) and those who continued successfully with pelvic floor exercises only (n=118) (278). At 12 months the pessary group had significantly better scores than the PFMT group on all the PFDI and PFIQ scores and subscores. This would seem to suggest that generally pessary and pelvic floor exercises are equally effective at improving urinary symptoms in women with prolapse, however in the select subgroup of women who adhere to treatment, the pessary provides extra benefit in reducing pelvic floor symptoms (278).

A total of 91 women were randomised in the Manonai (2012) trial, 45 in the study group and 46 in the control group. Eighty-five women (93%, equal in both groups) completed the 16-week assessment with 80% compliance to daily exercise. There was no significant difference in improvement in pelvic floor muscle strength between the groups at 16 weeks; either measured using the pull test or the digital assessment (279).

Summary

Three new trials were found, one comparing pessary alone versus pessary plus PFMT and two comparing pessary plus PFMT versus PFMT alone. The first was a pilot trial with recruitment difficulties and a very small sample, which did not contribute to the evidence (276). The other two trials were larger and concluded no difference between pessary plus PFMT and PFMT alone in terms of muscle strength at 4 months (279) or prolapse symptoms at 12 months (non-randomised comparison) (278). Combined pessary and PFMT and PFMT alone can be equally effective (**Level of Evidence: 1**)

PFMT + pessary may be as effective as PFMT alone in reducing symptoms. (**Grade of Recommendation: B New; however; some caution since the two trials considered two very different devices**).

3. PESSARIES

A pessary is defined as a device that is inserted into the vagina to provide structural support to one or more of descending vaginal compartments, i.e., the uterus, anterior vaginal wall (and bladder), posterior vaginal wall (and rectum) and/or vaginal apex (with or without small intestine after a prior hysterectomy) (280). They offer a non-surgical option for the treatment of urinary incontinence and pelvic organ prolapse (POP). This section, discusses evidences for use of pessary to prevent or treat POP; evidence for use of pessaries to prevent or treat UI will be covered in chapter 20.

A range of vaginal pessaries (Figure 8) exist which can be broadly divided into two types: support and space-filling pessaries. Support pessaries lie along the vaginal axis, with the posterior component sitting in the posterior fornix and the anterior component coming to rest just under the symphysis pubis, thus providing a supportive shelf for the descending pelvic organs. As there is no evidence to support the use of a specific type of pessary, choice is based on clinical experience and trial and error. It is generally accepted that the ring pessary should be tried first because of ease of insertion and removal, and if this fails, other pessaries can be used (281).

A recent review of data obtained from public use files from the Centres for Medicare and Medicaid Services in the United States over a 10-year period from 1999 to 2009 showed that the rates of pessary insertion were consistent at 11-13% over the period (282). In the United Kingdom, a postal survey demonstrated that 87% of consultants use vaginal pessaries for management of POP (283). The likely candidates for vaginal pessaries are those with co-morbid medical conditions, those who still wish to bear children, as interim relief prior to surgery and for those who prefer



Figure 8 Pessaries

non-surgical treatment (284). Other indications include vaginal laxity, neonatal prolapse mainly seen in association with neural tube defects such as spina bifida and prolapse during pregnancy (285).

Factors that predict the type of treatment chosen for POP have been evaluated in various studies. Younger women (286) and those with a higher incidence of stress incontinence (286) are more likely to refuse pessary use. Age greater than 65 years at the time of pessary insertion and more severe prolapse (Stage III-IV) were more predictive for pessary discontinuation at one year (287-289). Ko *et al.* (2011) found that substantially older women or post menopausal women opted for a pessary rather than surgery, and more sexually active women expressed a significantly greater preference for surgery. In addition to opting for surgery over pessary use, younger sexually active women are more likely to change from conservative to surgical treatment over a one-year period (290).

3.1. Prevention of POP with Pessaries

Previously no trials had examined pessaries as an intervention in the prevention of POP. In this update, no further trials were identified.

3.2. Treatment of POP with Pessaries

3.2.1 Pessary Alone

Three new studies were included. Study details are presented in table 31. Ding *et al.* (291) evaluated 81 women with stage 3 and 4 prolapse who were successfully fitted with a ring pessary with support after 3 months. Subjective evaluation was carried out using non-validated questions and prolapse was objectively assessed using POP-Q.

To evaluate if the cube pessary can be used as a first line treatment, Nemeth *et al.* (292) prospectively evaluated 78% of women who had a cube pessary inserted after one year. Subjective outcome was established by using a non-validated questionnaire as a validated questionnaire was not available in Hungarian. As one of the aims of the study was to evaluate if it was well tolerated, the authors rated the process of pessary insertion and general wellbeing on a numeric rating scale and also on a patient global improvement scale.

Brazell *et al.* (293) reported findings from a secondary analysis of a study that sought to evaluate if pessary use was associated with improvement in bulge symptoms and improvement in body image (294). They focused on bowel symptoms using the Colorectal Anal Distress Inventory, a subscale of PFDI-20 and Colorectal Anal Impact Questionnaire, a subscale of PFIQ-7. The study had a high attrition rate as only 43 women of the initial 104 had complete data at 12 months.

Results

The study by Ding *et al.* (295) found improvement in prolapse and bladder symptoms 3 months after use

of a ring pessary with support in women with stage 3 and 4 prolapse. Of the 74% who were initially successfully fitted with the pessary, 10% failed to retain the pessary at 3 months. Their findings contradict the manufacturer's recommendations regarding use of this type of pessary in early prolapse. Of interest, 82.7% women who were of the median age of 70 years were able to manage the pessary themselves indicating that with proper counselling and encouragement hospital care can be minimised.

The cube pessary seemed to be a viable option for sexually active women to self-manage their pessary as Nemeth *et al.* (292), were able to demonstrate a significant improvement in general wellbeing in the 78% women who were still using the pessary at 12 months, 85% rated pessary care use as easy or very easy.

Brazell *et al.* (293) demonstrated a significant improvement in both bowel related symptoms and quality of life. Patients who completed the 12-month follow-up were significantly older and more likely to have stage 3 and 4 prolapse compared to stage 2.

3.2.2 Pessary Versus no Treatment

No new studies were identified.

3.2.3 Pessary and PFMT

- Pessary versus PFMT

One new study was identified. A RCT comparing PFMT to pessary treatment in 160 women (PFMT n=79, pessary n=81) aged ≥55 years with advanced POP. A pessary was fitted successfully in 47/81 (58 %)women (296). Only those women in whom a pessary was fitted successfully, were compared. Risks of bias were high as both participant and evaluator were not blinded and an ITT analysis was not performed.

In women aged ≥55 years with an advanced symptomatic POP, PFMT resulted in a significant but not clinically relevant improvement of pelvic floor symptoms after 3 months (PFDI-20). There was no difference between PFMT and pessary treatment. PFMT was more effective in improving anterior wall POP than pessary treatment on POP-Q (Table 31).

- Pessary plus PFMT versus PFMT

Refer to section III.2.3.2

- Pessary plus PFMT versus Pessary

Refer to section III.2.3.2

3.2.4 Pessary Versus Surgery

One new study was identified (297), making a total of three studies comparing pessary versus surgery (Table 32). All were prospective, observational cohort case controlled. The new study by Lone *et al.* (297) evaluated 133 women who opted for surgery and 154 who opted for surgery one year after pessary treatment using the ICIQ-VS and ICIQ-UI (297). Women

who had surgery were older with no difference in characteristics like body mass index, parity, ethnicity, history of hysterectomy and prolapse surgery. 69% women who used pessary and 67% women who had surgery completed the questionnaire at one year. The non-randomised design of the study with approximately 30% attrition rate suggested a high risk of bias.

Three studies (285, 297, 298) compared patient related outcomes after pessary use and surgery. Abdool demonstrated a significant improvement in prolapse, urinary, bowel and sexual function in both treatment arms but no difference between the two groups. Using the ICIQ-VS and ICIQ-UI, Lone *et al.* found a statistically significant vaginal, sex, QOL and urinary symptoms score improvement in both groups but no statistically significant difference was noted between the surgery and pessary groups. However, Barber (2006) found that subjects in the surgery group had significantly greater improvement in each of the scales of the PFDI and the prolapse and urinary scales of the PFIQ than did the pessary group.

3.2.5 Comparison of One Pessary to Another

No new trial was identified for this update, making a total of one trial included in this section comparing pessary to another device. Cundiff (299) conducted the largest multi-centre crossover trial, comparing a ring with support and a Gellhorn pessary for the treatment of symptomatic stage II or greater symptomatic prolapse in 134 women. There were no significant differences between groups in baseline characteristics. Participants were fitted with one of the pessaries for three months, and with the second for a further three months. During each three-month period, data was collected at one, six and twelve weeks from women who had a successful fit. Outcomes were measured at enrolment, three and 12 months, and included objective assessment using POP-Q and subjective assessment using PFDI, PFIQ, and a sexual function questionnaire. Allocation was by computer-generated random numbers using permuted blocks of variable size. Opaque, sealed envelopes were used to store the random allocation. Participants and clinicians were not blind to the allocation, but data was coded such that the analysis was conducted blind. Those women who were successfully fitted were asked to wear the pessary for three months, but if they discontinued prior to three months' data collection was accelerated. Attrition rates in the study were high with only 85 of the 134 women completing the study leading to high risk of bias. However, the trial was not underpowered due to the cross over design.

Cundiff *et al.* (299) found a statistically and clinically significant improvement in the majority of the PFDI scales and many of the PDIQ scales with both pessaries but no difference between the ring or Gellhorn pessary. Approximately 60% of women offered a pessary continued treatment in the long term irrespective of the type of device.

Success rates

There is no agreement as to what constitutes a successful fitting of a pessary. Some consider success if a pessary was perceived comfortable by a patient when retained during Valsalva and voiding at the initial visit, while others consider it success if a patient continues to use the pessary until the following visit to the doctor. Thus quoted rates of successful fitting vary widely with differing follow-up times. (Table 33). Reasons for failure range from expulsion due to complications such as vaginal discharge, erosion, *de novo* SUI, pain, voiding difficulty and constipation (Table 33). The risk factors for failure also vary, making it difficult to draw conclusions.

Complications

Minor complications after pessary insertion range from vaginal discharge, erosion, *de novo* SUI, bleeding, pain and constipation (Table 33). A recent study by Collins (300) has shown that women who have a pessary are more likely to be bothered by discharge (30.0% vs 2.1%, $p < .001$) and this develops early and may be due to an inflammatory process in the vagina (300). Using the cube pessary appears to be complication free, probably because it has to be removed on a regular basis.

Rarely major complications may occur. Neglected pessaries present with more serious complications namely fistula formation and peritonitis. Erosion into the bowel or bladder and dense adhesions to other pelvic structures have been reported. Unusual complications of cervical entrapment, small bowel incarceration, and hydronephrosis have also been reported (301).

Conclusion

As in the most recent Cochrane review (222) and 1 recent RCT, there is no good quality evidence from randomised controlled trials on which to base the management of POP using pessaries.

Prospective case controlled cohort studies suggest that pessaries are a viable option for women who complain of symptomatic prolapse. **(Level of Evidence: 3).**

There appears to be no advantage of pessary use over PFMT, from one high risk of bias RCT **(Level of Evidence: 3).**

One single randomised study, with a high attrition rate of 40% found no significant difference between ring pessaries with support and the Gellhorn pessary in PFDI and PFQI scores **(Level of Evidence: 2).**

Table 31 Summary of data on PFMT vs pessary for POP

Author/ year	Study design	Comparison group	Participants	Type of pessary	Subjective assessment	Objective assessment	Length of follow-up	Improvement in symptoms
Panman CM, 2014	RCT	PFMT (n=79): No standard protocol – individual adaptation in line with normal practice (included being able to use electrical stimulation) vs PESSARY (n 81): Fitting – opted for 2 week try of pessary with refit at 2 weeks if necessary and max of 3 refits.Fitted by 'trained research physician'	160 women aged \geq 55 years with self identified POP symptoms (on screening) POP at or beyond hymen (POPQ)	First ring, then ring with support and then Shaatz or Gellhorn	Primary outcome: PFDI-20	Secondary: change in POP-Q stage	3 months	No sign diff. in PFDI POP-Q Anterior compartment: 26.5% \geq 1 stage change in PFMT v 7.1% pessary p=0.013 * No ITT, only 47 of 81 (58%) with successful fitting included in analysis

Foot notes: RCT- Randomised Controlled study, PFDI- Pelvic Floor Distress Inventory, PFMT- Pelvic floor muscle training, POP- pelvic organ prolapse

Table 32 Summary of data on pessary for POP

Author/ year	Study design	Comparison group	Participants	Type of pessary	Subjective and Objective assessment	Objective assessment	Length of follow-up	Improvement in symptoms
Abdool <i>et al.</i> 2011 (1)	Prospective observational cohort case controlled	Pessary treatment compared to surgery	359	Ring, Gellhorn, Cube, Donut	Sheffield prolapse questionnaire	Baden-Walker	12 months	Awareness of lump, prolapse coming out of vagina, dragging pain in lower abdomen, low back pain, voiding difficulty, need to push prolapse to void, urinary urgency, fecal urgency, sexual satisfaction, interference with physical activity and quality of life

Author/ year	Study design	Comparison group	Participants	Type of pessary	Subjective and Objective assessment	Objective assessment	Length of follow-up	Improvement in symptoms
Barber <i>et al.</i> 2006 (2)	Prospective observational cohort case controlled	Pessary treatment (3 months) compared to surgery (6 months) for pelvic organ prolapse	Pessary (n=42) Surgery (n=64)	Ring and Gellhorn	PFDI and PFIQ	POP-Q	3 months for pessary	Significant improvement in prolapse and urinary scales of the PFDI. No change in the colorectal scale. No change in the PFIQ scales
Brazell <i>et al.</i> 2014 (3)	Prospective observational cohort	N/A	43	Ring with support and Gellhorn	PFDI-20 PFIQ-7	POP-Q	12 months	CRADI-8 mean scores decreased by 6.9 and CRAIQ-7 decreased by 8.1
Clemons <i>et al.</i> 2004 (4)	Prospective observational cohort	N/A	100	Ring and Gellhorn	Not validated	POP-Q	2 months	Bulge (90% to 3%) Pressure (49% to 3%) Discharge (12% to 0%) Splinting (14% to 0%) SUI 45% UI 46% Voiding difficulty 53%
Cundiff <i>et al.</i> 2007 (5)	Randomised cross-over	Ring with support to Gellhorn	134	Ring with support to Gellhorn	PFDI,PFIQ, Sexual Function Questionnaire	POP-Q	6 months	Statistically and clinically significant improvements in majority of the PFDI and many PFIQ scales in both pessaries, but no clinically significant differences between the two pessaries
Ding <i>et al.</i> 2015 and 2016 (6, 7)	Prospective observational study	N/A	81 with Stage III and IV	Ring with support	Not validated	POP-Q	3 months	Improved bulging (90.4% to 23.3%) Decreased pelvic pressure (64.4% to 13.7%) Improved urinary symptoms as follows Voiding – 97.8% Splinting- 100% Urge urinary incontinence- 76.9% Stress urinary incontinence- 58.1%

Author/ year	Study design	Comparison group	Participants	Type of pessary	Subjective and Objective assessment	Objective assessment	Length of follow-up	Improvement in symptoms
Fernando <i>et al.</i> 2006 (8)	Prospective observational cohort	N/A	203	Ring, Gellhorn, Cube, Donut	Sheffield prolapse questionnaire	Baden Walker	4 months	Awareness of lump (71%), prolapse coming out of vagina (52%), vaginal soreness (21%), dragging sensation in lower abdomen 24%), lower back ache (30%), difficulty emptying bladder (40%), push prolapse to void (29%), urinary urgency (38%), urge urinary incontinence (29%), stress urinary incontinence (40%), incomplete emptying of bowels (28%), rectal digitation to empty bowels (12%), vaginal digitation to empty bowel (7%), faecal urgency (30%), urge faecal incontinence (20%), frequency of sexual intercourse (16%), sexual satisfaction (11%)
Jones <i>et al.</i> 2008 (9)	Prospective observational cohort	N/A	90	Ring, Incontinence ring, Gellhorn, Oval	PFDI	POP-Q	3 months	Improvement in the overall PFDI scale and all subscales with the exception of colorectal distress inventory
Komesu <i>et al.</i> 2007 (10)	Prospective observational cohort	Compare PF symptoms in patients who continue and discontinue pessary use	64	Choice of pessary left to discretion of the provider	PFDI-20	POP-Q	6-12 months	In the continuation group final PFDI-20 total, bladder and prolapse scale scores were better than the discontinuation group.
Kuhn <i>et al.</i> 2009 (11)	Prospective observational cohort	N/A	73	Cube	Female Sexual Function Index, Sheffield questionnaire, Kings Health Questionnaire	POP-Q	3 months	Improvement in feeling of bulge, improvement in stool outlet problems, overactive bladder symptoms. Improvement in sexual desire, orgasm, lubrication and satisfaction after therapy

Author/ year	Study design	Comparison group	Participants	Type of pessary	Subjective and Objective assessment	Objective assessment	Length of follow-up	Improvement in symptoms
Lone <i>et al.</i> 2015 (12)	Prospective observational study	Pessary treatment versus surgery	269	Ring, Gellhorn, Cube, Donut	ICIQ-VS ICIQ-UI	POP-Q	12 months	Statistically significant vaginal, sex, QOL and urinary symptoms score improvement in both groups. There was no statistically significant difference was noted between the surgery and pessary groups.
Nemeth <i>et al.</i> 2013 (13)	Prospective observational study	N/A	78	Cube pessary	Non-validated questionnaire (Hungarian)	POP-Q	12 months	Improved general wellbeing score
Patel <i>et al.</i> 2010 (14)	Prospective observational cohort	N/A	75	Ring, Ring with support, Gellhorn	Body Image Scale (BIS) and PFDI-20, PFIQ, Prolapse subscale of PFIQ	POP-Q	3 months	Improvement in body image scale scores, PFDI-20 scores, PFIQ scores

Foot notes: N/A-Not applicable, SUI- Stress Urinary Incontinence, UUI-Urge urinary incontinence, RCT- Randomised Controlled study, P- Prospective Observational study, PFDI- Pelvic Floor Distress Inventory, UDI -Urinary Distress Inventory, ICIQ-VS- International Consultation on Incontinence- Vaginal Symptoms, ICIQ- UI- International Consultation on Incontinence- Urinary Incontinence, CES-D – The center for Epidemiological Depression Measures, MOS Scores- Medical Outcome Study (MOS) Social Support Survey

1. Abdool Z, Thakar R, Sultan AH, Oliver RS. Prospective evaluation of outcome of vaginal pessaries versus surgery in women with symptomatic pelvic organ prolapse. *Int Urogynecol J.* 2011;22(3):273-8.
2. Barber MD, Walters MD, Cundiff GW, Group PT. Responsiveness of the Pelvic Floor Distress Inventory (PFDI) and Pelvic Floor Impact Questionnaire (PFIQ) in women undergoing vaginal surgery and pessary treatment for pelvic organ prolapse. *Am J Obstet Gynecol.* 2006;194(5):1492-8.
3. Brazell HD, Patel M, O'Sullivan DM, Mellen C, LaSala CA. The impact of pessary use on bowel symptoms: one-year outcomes. *Female Pelvic Med Reconstr Surg.* 2014;20(2):95-8.
4. Clemons JL, Aguilar VC, Tillinghast TA, Jackson ND, Myers DL. Patient satisfaction and changes in prolapse and urinary symptoms in women who were fitted successfully with a pessary for pelvic organ prolapse. *Am J Obstet Gynecol.* 2004;190(4):1025-9.
5. Cundiff GW, Amundsen CL, Bent AE, Coates KW, Schaffer JI, Strohbehm K, *et al.* The PESSRI study: symptom relief outcomes of a randomized crossover trial of the ring and Gellhorn pessaries. *Am J Obstet Gynecol.* 2007;196(4):405 e1-8.
6. Ding J, Chen C, Song XC, Zhang L, Deng M, Zhu L. Successful use of ring pessary with support for advanced pelvic organ prolapse. *Int Urogynecol J.* 2015;26(10):1517-23.
7. Ding J, Chen C, Song XC, Zhang L, Deng M, Zhu L. Changes in Prolapse and Urinary Symptoms After Successful Fitting of a Ring Pessary With Support in Women With Advanced Pelvic Organ Prolapse: A Prospective Study. *Urology.* 2016;87:70-5.

8. Fernando RJ, Thakar R, Sultan AH, Shah SM, Jones PW. Effect of vaginal pessaries on symptoms associated with pelvic organ prolapse. *Obstet Gynecol.* 2006;108(1):93-9.
9. Jones K, Yang L, Lowder JL, Meyn L, Ellison R, Zyczynski HM, *et al.* Effect of pessary use on genital hiatus measurements in women with pelvic organ prolapse. *Obstet Gynecol.* 2008;112(3):630-6.
10. Komesu YM, Rogers RG, Rode MA, Craig EC, Gallegos KA, Montoya AR, *et al.* Pelvic floor symptom changes in pessary users. *Am J Obstet Gynecol.* 2007;197(6):620 e1-6.
11. Kuhn A, Bapst D, Stadlmayr W, Vits K, Mueller MD. Sexual and organ function in patients with symptomatic prolapse: are pessaries helpful? *Fertil Steril.* 2009;91(5):1914-8.
12. Lone F, Thakar R, Sultan AH. One-year prospective comparison of vaginal pessaries and surgery for pelvic organ prolapse using the validated ICIQ-VS and ICIQ-UI (SF) questionnaires. *Int Urogynecol J.* 2015;26(9):1305-12.
13. Nemeth Z, Nagy S, Ott J. The cube pessary: an underESTimated treatment option for pelvic organ prolapse? Subjective 1-year outcomes. *Int Urogynecol J.* 2013;24(10):1695-701.
14. Patel M, Mellen C, O'Sullivan DM, LaSala CA. Impact of pessary use on prolapse symptoms, quality of life, and body image. *Am J Obstet Gynecol.* 2010;202(5):499 e1-4.

Table 33 Summary of data on pessary success rates and risk factors for failure

Author/ year	Number	Types of pessaries	Study design	Follow-up period	Success rate n (%)	Reason for failure	Risk factors
Abdool <i>et al.</i> 2011 (1)	554	Ring, Gellhorn, Cube, Donut	Prospective observational case controlled cohort	12 months	243 (68%)	N/A	N/A
Brazell <i>et al.</i> 2014 (2)	104	Ring with	Prospective observational study	12 months	34(41%)	N/A	N/A
Ding <i>et al.</i> 2015 and 2016 (3, 4)	81	Ring with support	Prospect observational cohort	3 months	73 (67%)	Feeling of discomfort and pressure, a desire for surgical correction, extrusion of pessary, bothersome <i>de novo</i> stress incontinence	No specific risk factors like stage or type of prolapse identified
Fernando <i>et al.</i> 2006 (5)	203	Ring, Gellhorn, Cube, Donut	Prospective observational cohort	2 weeks	153 (75%)	Failure to retain pessary, pain/bleeding/discomfort, worsening symptoms	Increasing parity, previous hysterectomy

Author/ year	Number	Types of pessaries	Study design	Follow-up period	Success rate n (%)	Reason for failure	Risk factors
Handa <i>et al.</i> 2002 (6)	56	Ring, Donut, Gellhorn, Cube	Prospective observational cohort	3 months	36 (64.3%)	Discomfort, expulsion	-
Jones <i>et al.</i> 2008 (7)	90	Ring, Incontinence ring, Gellhorn, Oval	Prospective observational cohort	3 months	42 (47%)	Failure to retain, Inadequate relief of symptoms	Large baseline measurement of the perineal body at rest Large levator hiatus
Komesu <i>et al.</i> 2007 (8)	64*	Choice of pessary left to discretion of the provider	Prospective observational cohort	6-12 months	64 (56%)	failure to retain, uncomfortable	Prolapse score decrease to 77% of baseline
Kuhn <i>et al.</i> 2009 (9)	73	Cube	Prospective observational cohort	12 months	32 (44%)	Pessary expulsion, desire for surgery, bothersome <i>de novo</i> SUI, inability to remove or insert pessary, pain or feeling of discomfort, unspecified	N/A
Lone <i>et al.</i> 2011 (10)	246	Ring, Gellhorn, Cube, Donut	Prospective observational cohort	5 years	53 (28.3%)	Expulsion, excoriation/bleeding, pain/discomfort, constipation	N/A
Patel <i>et al.</i> 2010 (11)	75	Ring, Ring with support, Gellhorn	Prospective observational cohort	3 months	54 (79%)	Failure to retain, ineffective	N/A
Nemeth <i>et al.</i> 2012 (12)	78	Cube	Prospective observational cohort	12 months	62 (79%)	Stress incontinence Vaginal discomfort	Parity, previous hysterectomy and/or colpoperineorrhaphy, Difficult insertion
Wu <i>et al.</i> 1997 (13)	110	Ring with and without diaphragm, Cube	Prospective observational cohort	Initial visit	81 (74%)	Failure to sustain support of the prolapse, intolerable urinary incontinence, vaginal discharge, pelvic pain, vaginal abrasions and erosions	Younger women, previous pelvic surgery, history of stress incontinence prior to pessary insertion

Foot notes: N/A = not applicable; N/R = not reported,*Includes patients with incontinence and/or prolapse

1. Abdool Z, Thakar R, Sultan AH, Oliver RS. Prospective evaluation of outcome of vaginal pessaries versus surgery in women with symptomatic pelvic organ prolapse. *Int Urogynecol J.* 2011;22(3):273-8.
2. Brazell HD, Patel M, O'Sullivan DM, Mellen C, LaSala CA. The impact of pessary use on bowel symptoms: one-year outcomes. *Female Pelvic Med Reconstr Surg.* 2014;20(2):95-8.

3. Ding J, Chen C, Song XC, Zhang L, Deng M, Zhu L. Successful use of ring pessary with support for advanced pelvic organ prolapse. *Int Urogynecol J*. 2015;26(10):1517-23.
4. Ding J, Chen C, Song XC, Zhang L, Deng M, Zhu L. Changes in Prolapse and Urinary Symptoms After Successful Fitting of a Ring Pessary With Support in Women With Advanced Pelvic Organ Prolapse: A Prospective Study. *Urology*. 2016;87:70-5.
5. Fernando RJ, Thakar R, Sultan AH, Shah SM, Jones PW. Effect of vaginal pessaries on symptoms associated with pelvic organ prolapse. *Obstet Gynecol*. 2006;108(1):93-9.
6. Handa VL, Jones M. Do pessaries prevent the progression of pelvic organ prolapse? *Int Urogynecol J Pelvic Floor Dysfunct*. 2002;13(6):349-51; discussion 52.
7. Jones K, Yang L, Lowder JL, Meyn L, Ellison R, Zyczynski HM, *et al*. Effect of pessary use on genital hiatus measurements in women with pelvic organ prolapse. *Obstet Gynecol*. 2008;112(3):630-6.
8. Komesu YM, Rogers RG, Rode MA, Craig EC, Gallegos KA, Montoya AR, *et al*. Pelvic floor symptom changes in pessary users. *Am J Obstet Gynecol*. 2007;197(6):620 e1-6.
9. Kuhn A, Bapst D, Stadlmayr W, Vits K, Mueller MD. Sexual and organ function in patients with symptomatic prolapse: are pessaries helpful? *Fertil Steril*. 2009;91(5):1914-8.
10. Lone F, Thakar R, Sultan AH. One-year prospective comparison of vaginal pessaries and surgery for pelvic organ prolapse using the validated ICIQ-VS and ICIQ-UI (SF) questionnaires. *Int Urogynecol J*. 2015;26(9):1305-12.
11. Patel M, Mellen C, O'Sullivan DM, LaSala CA. Impact of pessary use on prolapse symptoms, quality of life, and body image. *Am J Obstet Gynecol*. 2010;202(5):499 e1-4.
12. Nemeth Z, Nagy S, Ott J. The cube pessary: an underESTimated treatment option for pelvic organ prolapse? Subjective 1-year outcomes. *Int Urogynecol J*. 2013;24(10):1695-701.
13. Wu V, Farrell SA, Baskett TF, Flowerdew G. A simplified protocol for pessary management. *Obstetrics and gynecology*. 1997;90(6):990-4.

4. RECOMMENDATIONS

There is growing attention being paid to the effectiveness of conservative interventions for POP. There are encouraging signs of more rigorous research in the area.

4.1. Recommendations for Practice

4.1.1 Lifestyle Modification

1. Constipation is associated with development of prolapse (**Grade of Recommendation: C New**).
2. Smoking cessation, while generally recommended, cannot be recommended specifically for the avoidance of prolapse development (**Grade of Recommendation: D**).
3. Vitamin D deficiency is not associated with development of prolapse (**Grade of Recommendation: C New**).

4.1.2 Pelvic Floor Muscle Training (PFMT)

1. PFMT does not influence the development of prolapse post-natally (**Grade of Recommendation: B New**).
2. PFMT intervention delivered 12 years+ after childbirth can reduce symptoms of prolapse which develop in the longer term (**Grade of Recommendation: B New**).
3. There is evidence of benefit that PFMT is effective in reducing pelvic floor symptoms (**Grade of recommendation: A New**).
4. There is some evidence of benefit showing that PFMT is effective in alleviating specific prolapse symptoms (e.g. vaginal bulge) (**Grade of recommendation: C New**).
5. There is no evidence that PFMT is effective in reducing severity of prolapse based on POP-Q stage (**Grade of recommendation: B New**).
6. Peri-operative PFMT does not improve prolapse symptoms in women undergoing surgery for vault prolapse (**Grade of Recommendation: B New**).
7. Combined pessary and PFMT and PFMT alone can be equally effective in reducing symptoms and increasing muscle strength and should be considered for treatment (**Grade of Recommendation: B New**).

4.1.3 Pessaries

1. In a choice between the Gellhorn pessary and a ring with support, offer either to improve prolapse symptoms and reduce their impact (**Grade of Recommendation: B**).

4.2. Future Research Directions

4.2.1 Lifestyle Interventions

1. Trials of interventions for constipation are needed to assess their effectiveness in preventing/treating prolapse.
2. Studies to fully investigate the association between occupation/heavy lifting, and bodyweight and prolapse are needed as current evidence is conflicting. These studies should ensure that:
 - i. Occupation, physical activity and diet are assessed rigorously, using instruments with sound psychometric properties.
 - ii. Potential confounding variables are considered. Attempts are made to overcome recall bias inherent in assessing lifetime occupational history, and healthy worker bias, which is a problem when attempting to compare prolapse in women currently employed in heavy labour type jobs versus others.
 - iii. Outcome measures used are valid and reliable, and are consistent across studies; prolapse symptoms should be the primary outcome within studies, followed by prolapse anatomical severity.

4.2.2 Pelvic Floor Muscle Training (PFMT)

1. Further studies are needed to confirm the role of physical therapies in the prevention of POP.
2. Further trials are needed to add to the evidence regarding:
 - i) The effectiveness of PFMT for different stages and types of prolapse.
 - ii) The role of PFMT as an adjunct to surgery for anterior and posterior prolapse.
3. More trials needed to improve the evidence relating to the following comparisons:
 - i) Low versus high intensity supervision of PFMT (taught PFMT vs self-instruction manual already trialled)
 - ii) Individual versus group PFMT (group PFMT vs group lifestyle already trialled)
 - iii) PFMT versus surgery (anterior/posterior repair vs PFMT already trialled)
 - iv) PFMT versus pessary. (PFMT vs PFMT plus pessary already trialled)

The assessment and measurement of POP and the assessment of prolapse symptoms need to be made in a standardised fashion using a validated outcome measure (such as the POP-Q examination). A single validated symptom tool was not apparent in new studies, but the PFDI, PFIQ and POP-SS tools were most commonly used and may provide a useful basis for comparisons across trials in future.

4.2.3 Pessarie for Prolapse

Although the use of pessaries has been common clinical practice and has been used for many centuries robust evidence of their use is lacking. There is a pressing need for well-designed randomised studies using validated measures for subjective and objective assessment. Areas that need focus are:

- Pessary versus no treatment
- Pessary versus PFMT
- Pessary versus surgery
- Risk benefit of the use of local oestrogen in conjunction with a pessary
- Progression or regression of prolapse using in women using pessaries
- Optimal management protocols for pessary usage e.g. indications, interval between pessary changes, complications and their treatment and which pessary is indicated for a specific type of prolapse.

IV. URINARY INCONTINENCE IN MEN

As in earlier consultations, UI in men remains under-reported and under-studied in comparison to studies of women. Pooled prevalence of UI in community based men ranges from 4.81-32.17%. (302). UI and other LUTS in men increase with age, with variation in prevalence rates reflecting different study populations, definitions of incontinence and methods (303). Despite the prevalence of UI and LUTS in older men, the only aspect which continues to receive systematic consideration with respect to conservative management is post-prostatectomy urinary incontinence after radical prostatectomy (RP). The primary conservative approach for prevention and treatment of UI after RP, or transurethral resection (TURP), remains PFMT, with or without some form of biofeedback (BF). PFMT, in combination with anal EStim, BF or transcutaneous electrical nerve stimulation (TENS), MStim, and novel therapies such as dyadic planning and concentration have been utilised for UI in men.

The PFMT, EStim, MStim and PTNS interventions, and other combinations of PFMT with general exercise and other approaches, in the current review were kept in the same organizational format as the previous consultation to reflect evolving evidence and emerging directions of research. All new studies of EStim and MStim in men undergoing or post prostatectomy combined these modalities with PFMT and thus were included under the PFMT section. Penile vibratory stimulation (PVS) was added as a novel technology category. The study on PVS involved men incontinent after RP, but did not include PFMT, so was kept in a separate section, as were studies of

EStim and MStim for non-prostatectomy related incontinence or other LUTS. Studies on PTNS are presented in section V.1.

A literature search of relevant systematic reviews and reports of RCTs and quasi-RCTs was updated. No other types of study designs were considered. One systematic review, an update of the Cochrane systematic review on conservative management of post-prostatectomy incontinence, was identified (304). For this review, 14 new published trials (305-318) and eight abstracts (319-326) were identified. Table 34 provides summary information on the 22 trials added in this review. One study previously included only as an abstract (327) is now included as a full publication (328). This study is included in the table as in the full publication with additional information that was not previously included in the abstract. The published peer reviewed journal publication (329) of a previously included report of two parallel trials (RP and TURP arms) was added to the references which previously included an abstract and health technology report (330, 331). One study previously excluded as it was a study in progress (332) was included this time as a peer reviewed publication of a completed trial (307). Nine ongoing trials were identified from trial registries, but not included in this review.

1. LIFESTYLE

Lifestyle recommendations such as smoking cessation, healthy eating, appropriate body weight, avoiding excessive caffeine or alcohol are all part of a primary care approach and are intended to be preventative in the onset of obesity, cardiovascular disease, diabetes. Up until the last ICI edition, no trial had addressed the topic of lifestyle interventions alone in men with UI. In this edition, a few new trials have been added.

1.1. Weight Loss by Obese or Overweight Men

One new trial was identified on weight loss in overweight/obese men (7, 333) and has been added in this update. This was the partner study to Phelan, Kanaya *et al.* (2012) conducted to determine the effect of an intensive weight loss programme over 4 years previously outlined in the look AHEAD trial - on a subset of male participants (n=1910). Men were randomised to an intensive weight loss programme or diabetes support and education group. Self-report of incontinence, nocturia and daytime voiding frequency were recorded at baseline and 1 year. The odds of prevalent UI at one year were reduced by 38% in the intensive lifestyle modification intervention group compared to the support and education group, with UI decreasing from 11% to 9% in men. As reported for women there was uncertainty over the risk of selection bias for a number of key parameters including: random sequence generation and allocation concealment. Performance bias was unclear as the blinding of participants and staff was not undertaken. Both

studies did ensure the blinding of outcome assessment but neither provided complete outcome data and both provided only selective reporting indicating possible reporting bias (Table 2).

1.2. Smoking

One new trial was found however data was not presented separately for women and men. (Refer to section II.1.2.4 for more details)

1.3. Dietary Modification in Men

In a separate sample (from the study by Davis, Vaughan *et al.* 2013 presented in Lifestyle intervention in women's section II.1.2.5) 3960 men over 20 were included (16).

The authors found that the highest level of caffeine intake was associated with having moderate to severe UI (1.72, 95% 1.18-2.49 and 2.08, 95% 1.15-3.77) respectively. All parameters in terms of risk of bias reporting were unclear or high risk. The blinding of participants and personnel and blinding of outcome assessment were at high risk of bias and the likelihood of incomplete outcome data and selective reporting was also high.

A sample of 683 men aged 40-75 who completed a food frequency questionnaire and the Consultation on Incontinence short Form (ICI-SF) as part of the Hiramama study (18). The data showed a slight increase in the risk of UI at the highest level of caffeine consumption (similar to the US data), but this was not significant after adjusting for confounding factors with OR: 95% CI, 1.36 (0.65-2.88) in the male participants. The risk of bias reporting was largely unclear in this study with blinding of participants and personnel and blinding of outcome assessment, incomplete outcome data and selective reporting all of high risk. Results of sex stratified analysis of the data from the sample of Japanese men and women did not show an association between caffeine and UI, the authors suggest the need for further larger samples to explore any association further (Table 5).

Summary

Evidence from 1 RCT supports lifestyle modification interventions promoting weight loss as a tool to reduce urinary incontinence in men who are overweight or obese. **(Level of Evidence: 2; 1 new RCT).**

Evidence from a small new RCT indicates that urinary frequency may be improved by smoking abstinence, **(Level of Evidence: 3).**

Caffeine consumption is likely to play a role in exacerbating UI in men. New epidemiological evidence from a large cross sectional study supports this conclusion **(Level of Evidence: 3).**

Recommendations

Weight loss: Where weight loss through lifestyle changes should be recommended to obese and overweight men with UI, particularly those with type 2 diabetes. **(Grade of Recommendation: B New)**

Smoking abstinence should be recommended for men with UI. **(Grade of Recommendation: C New)**

A reduction in caffeine intake is recommended for those with incontinence symptoms; evidence suggest the equivalent of 2 cups of coffee a day (250mg) is associated with urinary incontinence in both men and women. **(Grade of Recommendation: C)**

Larger RCTs to assess effect of lifestyle modification interventions are important.

Table 34 Summary of data on conservative management in male urinary incontinence

Author, year	Comparator	N	Study population	Modality details or parameters	Outcomes/results	Follow up	Notes (side effects, loss of follow up...)
Pelvic Floor Muscle Training (PFMT)							
Ahmed <i>et al.</i> 2012 (1)	3 group comparison PFME vs PFMT plus EStim vs PFMT plus EStim plus biofeedback	N= 90 men randomized, N=80 completed trial Group 1 n= 26 Group 2 n=26 Group 3 n= 28 Randomization by computer generated random number list in sealed envelopes. Surgeons blinded to randomization. Blinding of outcomes assessor not indicated.	Men undergoing RP for clinically localized prostate cancer	Treatments started one week after catheter removal, twice weekly for 12 weeks Group 1 PFME (control) Group 2 PFMT plus EStim starting one week after catheter removal, twice weekly for 12 weeks Group 3 PFMT plus EStim plus biofeedback starting one week after catheter removal, twice weekly for 12 weeks EStim – electrodes on skin over sacrum Biofeedback - surface electrodes on abdomen and perineum	Primary outcome 24 hour pad test, secondary was quality of life assessed with IIQ-7. Mean leakage significantly lower in Group 3 (EStim plus biofeedback) at 6 through 24 weeks ($p < 0.05$) Significant differences in continence at weeks 12 and 24 with Group 3 having more continent patients, followed by Group 2. Concluded early EStim and biofeedback decrease duration and degree of postprostatectomy UI	Continence assessed at baseline, 6, 12 and 24 weeks	Dropouts: none reported Sample size analysis reported (n=80) Dropouts Group 1= 4 (2 radiotherapy, 2 postoperative complications) Group 2 = 2 (both radiotherapy) Group 3 = 4 (2 radiotherapy, 2 declined followup) No intention to treat analysis.
Baroni <i>et al.</i> 2013(2) Abstract only	Intervention (individual PFMT and group treatment) vs control (individual PFMT)	N= 40 men Divided into two groups (randomization not described). Intervention: n = 16 patients mean age 61.8 years Control n = 24 mean age 67.5 Assessor blind to allocation until assignment.	Men with SUI or mixed UI after RP (time after surgery not reported)	Intervention: 5 individual training sessions with a physical therapist followed by small groups sessions (total 15 sessions at the rehabilitation centre), home exercises. Control: individual training sessions with physical therapist.	Outcomes included adherence to training program (exercise at home), self report of change in continence using VAS scale and number of pads, quality of life ICIQ-SF, cost effectiveness (therapist time). Non significant difference in home practice (intervention 69% vs 58% controls). No difference between groups	Initial briefing by therapist, final evaluation one month after rehabilitation.	Dropouts: none reported. No sample size analysis reported.

Author, year	Comparator	N	Study population	Modality details or parameters	Outcomes/results	Follow up	Notes (side effects, loss of follow up...)
					on VAS or pads used per week. Authors conclude group treatment allows cost effective improvement.		
Burkert <i>et al.</i> 2011(3)	Intervention (dyadic PFME planning) vs one of three controls	N = 112 prostatectomy patients and their partner (dyads). 2x2 mixed design. Couples randomized in blocks of four to one of four groups Intervention n= 28, Controls n= 29, 29 and 26 Research assistants blinded to allocation Mean age of patients 62.8 years, partners 59.3 years.	Men undergoing laparoscopic RP who had a partner willing to participate	All patients received standard care including written information on PFME 1 day post surgery (PFME 3x day for 10 minutes), physical therapist introduced PFME on day 3 or 4. Discharge day all participated in single 30 minute planning session intervention with completion of planning sheet for health behaviours (in dyad or individually). Intervention: dyad PFME planning Control: (dyadic nutrition planning, Control: individual PFME planning, Control: individual nutrition planning	Main outcome: self reported dyadic planning and PFME. Self reported dyadic PFME planning increased with both the dyadic and individual PFME planning session. No effect on PFME was found. Continence was not an outcome.	Questionnaires at 2 days, 2 weeks, 1, 3 and 6 months post-surgery.	Dropouts Intervention n=5 Control: dyadic nutrition planning n=2 Control individual PFME planning n=7 Control: individual nutrition planning n= 4 Sample size analysis required 112 couples (dyads). Intention-to-treat analysis completed.
Collado, Serra 2013 (4) Abstract only	Intervention PFMT plus BF pre-op vs Control PFME after RP	N= 193 patients recruited Randomization and blinding detail not provided. N= 179 included in final analysis	Men with localized prostate cancer scheduled for RP	Intervention: starting 3 weeks before surgery included weekly assisted BF sessions (surface electrodes) with periodic, rapid, intense and maximal	Primary outcome: Degree of continence improvement compared to week 1 during followup (continence not defined)	No detailed description. Pad tests reported for week 1, week 6, month 3, month 6 and 1 year.	Dropouts –detail only for intervention group n=5 (2 perineal pain, 2 post RP complication, 1 left treatment. No sample size calculation provided.

Author, year	Comparator	N	Study population	Modality details or parameters	Outcomes/results	Follow up	Notes (side effects, loss of follow up...)
		Intervention = 87 Control = 92		strength contractions and transversus abdominis activation plus daily PFMT performed at home with written instruction (no detail on whether it was continued post-operatively) Control: oral instruction on PFME post surgery, structured program of BF, transversus abdominis activation and PFMT 3 months post surgery	Secondary outcomes 24 hour pad test and ICIQ-UI SF score Significant difference in continence improvement reported for week 6, month 3, month 6 and 1 year favouring intervention group. Difference in 24 hour pad test significant only at 3rd month, favouring intervention group.		No intention-to-treat analysis.
Dijkstra-Eshuis <i>et al.</i> 2015 (5)	Intervention PFMT plus biofeedback pre-op vs Control PFME post-op	N=122 patients recruited, N= 121 randomized. Pre-operatively. Mean age 63.7 years. Randomization by computer generated random numbers (block randomization, variable block size). Therapists and participants blinded to randomization until first visit. Intervention n= 65 Control n= 56	Men undergoing laparoscopic RP (one surgeon), prostate cancer state T1 or T2.	All participants assessed pre-op by physical therapist Intervention: once weekly 30 minute session of PFMT with biofeedback pre-op x 4 weeks provided by physical therapist with twice daily practice at home. Told to restart immediately after catheter removal. Written instructions for 2 sets of 30 contractions. Control: standard care of written PFME instructions on catheter removal (7-10 days post surgery)	Primary outcome: urinary continence defined as no leakage on 24 hour pad test and self report by KHQ, IPSS and PeLFI (pelvic floor inventories) 20.8% of patients continent at 6 weeks, 43.6% at 3 months, 61.5% at 6 months, 72.3 % at 9 months, 77.2% at one year. No difference in SUI or QoL between intervention and control at any time points. Authors suggested that post-prostatectomy UI likely due to intrinsic sphincter deficiency that cannot be treated with exercise.	Questionnaires, 24 hour diary and pad test at 6 weeks, 3, 6, 9 and 12 months post-operatively. PeLFT and examination of the pelvic floor pre-operatively and 1 year post-operatively.	Dropouts Intervention: language barrier (1), lost to followup (4), discontinued intervention (4) Control: Lost to followup (4), discontinued intervention (6) Sample size analysis was 124 patients in each group (n=248), interim analysis planned at 122 patients. Trial halted as interim analysis showed no benefit.

Author, year	Comparator	N	Study population	Modality details or parameters	Outcomes/results	Follow up	Notes (side effects, loss of follow up...)
Geraerts <i>et al.</i> 2013 (6)	Intervention PFMT plus biofeedback pre-op vs Control PFMT post-op	N= 180 men Computer generated randomization using permuted blocks for strata (age <65/≥65, surgical approach open/robot assisted laproscopic Intervention n= 91 Control n=89	Men undergoing open or robot assisted laproscopic RP (3 surgeons)	Intervention: 30 minute session of therapist guided PFMT with biofeedback weekly starting 3 weeks prior to surgery plus home program of 60 contractions per day. Restarted PFME day 4 post-op with catheter <i>in situ</i> Control: PFMT after catheter removal Both groups: Post-op weekly session to discuss bladder diary and have guided session with digital or EMG biofeedback plus home program. PFMT continued until continent	Primary outcome: incidence of continence and time to continence. Continence defined as 3 consecutive days of 0gm urine loss on 24 hour pad test. Other measures were: 1 hour pad test, VAS, IPSS, KHQ (QoL). No difference between groups on duration of UI, pad test, VAS or IPSS. Median time continence was 30 (control) and 31 (intervention) days. Intervention group scored better on impact of incontinence at 3 and 6 months	Pre-operative baseline and 1, 3, 6 and 12 months post-operatively	Dropouts: Intervention n=6 died (1), stroke (1), transport problems (3), refused further participation (1) Control n= 4 transport problems (2), refused further participation (2) Sample size analysis required 166 for power.
Ghanem <i>et al.</i> 2013 (7) Abstract only	Intervention PFME pre-op vs Control PFME post-op	N=100 men randomized. Randomization technique not described. Intervention N=50 Control N=50	Men with localized prostate cancer undergoing radical prostatectomy	Intervention: PFME protocol for 2 weeks prior to surgery (detail not provided) with post-operative PFME program. Control: postoperative PFME program only	Continence defined as using 0-1 pads. Also completed the ICIQ SF male. More intervention patients continent at 14 weeks than controls ($p < 0.05$). 70% of patients in both groups continent at 18 weeks, 85 % by 54 weeks.	Timepoints for measurement not clear, last dated reported at 54 weeks post-op.	Dropouts: not described Sample size analysis not described.
Hou <i>et al</i> 2013 (8)	Intervention post-op PFME vs control	N= 66 randomized. Randomization technique not described.	Men undergoing TURP for benign prostatic hyperplasia.	Intervention: PFME after removal of catheter day 2 post-op. Instructed to contract PFM for 5 seconds, relax for 10 seconds.	Outcome: early recovery of bladder function post TURP using the IPSS and SF-36. Q-max (maximum urinary flow), voided	Baseline and 1, 4 and 12 weeks post-op	Dropouts n= 5 (group assignment not identified) delay in catheter removal prior to discharge (2), lost to followup (3).

Author, year	Comparator	N	Study population	Modality details or parameters	Outcomes/results	Follow up	Notes (side effects, loss of follow up...)
		N= 61 completed study (intervention n= 32; control n= 29)		Surface EMG to confirm PFM contraction. Home program 5 minutes practice 3 x per day. Weekly telephone reminders. Control: not described	volume and PVR (post void residual volume). At 12 weeks, intervention group had significantly less severe LUTS compared to control (p<0.001), Qmax (p=0.026) and QoL physical (p=0.029) and mental health domains (p= 0.005). No significant differences in voided volume or PVR.		Sample size analysis not provided. No intention-to-treat analysis.
Kakihara <i>et al.</i> 2007 (9)	Intervention (PFMT with EStim) vs PFME only	N=20 men from a single urology clinic, mean age 64.3 years Randomly divided into two groups (detail on randomization technique not provided) Intervention group n=10, control n=10 N=18 in final analysis for pad test and visual analogue data : intervention n=8, control n=10	Men with urinary incontinence post RP (minimum of 6 months post-op, had undergone urodynamic testing)	Intervention: Physical therapy taught functional PFMT with EStim. PFME started with 2s contractions increasing daily by 1s until 10s reached. Patients were instructed to do 90 contractions/day at home (divided equally into 3 times per day). Also had EStim with endo-anal electrode weekly. UUI – 8 Hz increasing to 10 Hz after 3 months, for SUI 35Hz increasing to 50 Hz after 3 months. Control: Physical therapy taught functional PFMT only	UI measured with 1 hour pad test (incontinence < 2 gm), visual analogue scales for incontinence patient perception of the problem, and pad use Intervention group: 4 patients UUI, 6 had SUI, mean time post surgery 12.3 months. Control group: 5 had UUI, 5 SUI, meantime post surgery 16.8 months Significant decrease in urine loss on pad test and self report baseline to 12 months in both groups. No difference between groups	Measures at baseline, visit 2, and 3, 6 and 12 months.	Dropouts Intervention n=2 discharged at 3rd and 6th months, reason not provided. Control n=3 discharged at 3rd, 6th and 12th as regained continence Length of time EStim continued for the intervention group unclear. No sample size or intention-to-treat analysis reported.
Kongtragul <i>et al.</i> 2014 (10)	Intervention (PFME with concentration	N= 138 men recruited from a single hospital	Men 17-80 years of age with prostate	Intervention: Starting 3 weeks post-operatively, PFME with	Primary outcome was urinary incontinence	Measurements at baseline (3 weeks post surgery) and	Dropouts Intervention n=1 (refused treatment)

Author, year	Comparator	N	Study population	Modality details or parameters	Outcomes/results	Follow up	Notes (side effects, loss of follow up...)
	therapy) vs control (PFME only)	N= 135 cases in final analysis (n= 68 intervention, n= 67 control) Randomization technique not given. Sample stratified for time of catheter removal (prior to or after discharge) and type of surgery (no further detail provided).	cancer who had no incontinence prior to radical prostatectomy surgery	concentration therapy (concentrating on the exercise and eliminating other issues or use of the <i>rehabilitation health spa rock</i> - not clearly described). PFME was practiced 240 times daily by holding and relaxing muscle tension around the anus. Control: PFME only	(incontinence ≥ 2 gm urine on 1 hour pad test) 65/68 in intervention group compared to 48/67 controls achieved continence ($p < 0.001$) More men in intervention group 66/68 practiced regularly than in control group 34/67 ($p < 0.001$)	weekly for up to 3 months	Control n=2 (refused treatment) Needed 69 cases in each group for power. No intentiontotreat analysis.
Laurienzo <i>et al.</i> 2013 (11)	3 groups Pre-op PFMT plus EStim vs pre-op PFMT vs control	N= 58 men recruited. Randomization by computer generated list. All intervention provided by a single therapist N= 49 completed study (n= 17 PFME plus EStim, n= 17 PFME, n= 15 control)	Men with prostate cancer stage T2 waiting RP	Intervention Group 1: 10 pre-op physiotherapy sessions of EStim using rectal probe. Tonic fibers – 20HZ, 700 microseconds, work time 6s, rest 6s. Phasic fibers – 65 HZ, 150 microseconds, work time 6s, rest 18s. Five exercises for PFM contraction. Group 2: 10 pre-op physiotherapy sessions with only the PFME. Control Pre-op information on prostate anatomy only No post-op PFM rehabilitation for any group	Primary outcome: continence assessed by 1 hour pad test (> 2 gm incontinence). Secondary outcomes: ICIQ-SF, SF-36 No significant differences between groups on pad test at any time points. No differences in QoL (SF-36)	Measurements at 1, 3 and 6 months post surgery.	Dropouts N=9 (detail on group not provided). Desistance (sic)(2), adjuvant radiotherapy (1), urethral stenosis (1), urinary fistula (1), surgical risk (1), inadequate followup (1) No sample size analysis described. No intention-to-treat.
Laurienzo <i>et al</i> 2015 (12)	3 groups	N=123 men incontinent after RP	Men with more than 3 gram loss	Assisted PFMT described as two	Outcomes Incontinence and quality of life using the	Patients evaluated pre-	Dropouts not discussed.

Author, year	Comparator	N	Study population	Modality details or parameters	Outcomes/results	Follow up	Notes (side effects, loss of follow up...)
Abstract only	PFMT plus EStim vs PFMT vs control	Randomization by computer, sealed envelopes. Group 1 n=40 control, no treatment Group 2 n=41 assisted PFMT Group 3 n=42 EStim with assisted PFME No details on blinding.	of urine on a 1 hour pad test one month after RP	series of ten exercises taught by verbal command EStim protocol was 20 minute sessions twice weekly over 7 weeks. Frequency 35 HZ	ICQ-SF, erectile dysfunction by IIEF-5, IPSS, 1 hour pad test, evaluation of pelvic floor with perineometer. No differences between groups in quality of life, erectile dysfunction or PFM strength at any time point post-surgery. Pad test data not provided.	operatively and then at 1, 3, and 6 months post RP	Sample size analysis not provided.
Martini <i>et al</i> 2011 (13) Abstract only	Intervention pre-op PFMT vs control	N= 70 men recruited N= 49 with pelvic floor impairment identified on exam randomized to intervention or control. Intervention n=24 Control n=25 Randomization details not provided.	Men undergoing laparoscopic RP for localised prostate cancer T1-T3	Intervention: 5 sessions of physical therapist guided PFMT 2-3 weeks before surgery, PFME continued post-op Control: usual care – written instruction on PFME provided post-operatively	Outcome: focus on PFI as a potential factor in post RP UI. Continence defined by not wearing a pad. Other: 24 hour pad test, pad use, 7 day bladder diary, QoL. Patients with PFI used more pads and had more SUI episodes. PFI independent predictor of UI at 3 and 6 months. For those with PFI, UI on getting up and squatting was significantly lower in intervention group at 1 month (p=0.006) but not other time points.	Measurement pre-op baseline, and 1, 3 and 6 months post-op.	Dropouts: not identified. Sample size analysis not provided.
Morihoro <i>et al</i> 2011 (14) Abstract only	Intervention post-operative PFME with EStim vs control PFME	N= 34 men Randomized post-operatively to 2 groups. Randomization technique not described. Intervention n=20 Control = 14	Men who had undergone laparoscopic RP	Intervention: PFME and EStim 2x daily for 15 minutes for one month after catheter removal, starting on day 5 after surgery. Control: PFME alone	Outcome UI, defined as not needing a pad to keep clothing dry. Recovery of urinary continence significantly favored intervention group at 12 months (p = 0.007). Multivariate analysis showed EStim associated	Measurement at 1, 3, 6, and 12 months.	Dropouts: not described. No sample size analysis based on multivariate or other analysis provided.

Author, year	Comparator	N	Study population	Modality details or parameters	Outcomes/results	Follow up	Notes (side effects, loss of follow up...)
					with continence recovery at 6 and 12 months.		
Ng 2014 (15) Abstract only	Intervention pre-op PFMT vs control	N=66 men Randomization technique not given.	Men undergoing radical prostatectomy	Intervention: PFMT started 3 weeks pre-operatively from advanced practice nurse. Control: Standard care (no detail provided).	Primary outcome: urine loss on 24 hour pad test. Secondary outcomes: incontinence impact and potency satisfaction. Earlier return to continence in intervention group at 3 months compared to controls (p=0.002). Intervention group also had higher score on potency at 3 months (p = 0.005).	Measures at 1,2, 3 and 6 months	Dropouts: no information provided.
Ocampo-Trujillo <i>et al.</i> 2014 (16)	Intervention (pre-op PFMT with biofeedback) vs control (standard pre-op teaching only)	N=16 men, mean age 58 years Randomized to 2 groups Intervention n=8, control n=8 Randomization –single blind, centralized. Researchers blind to group assignment prior to enrollment.	Men > 40 years waiting RP for prostate cancer (T<3 N0M0 PSA<20)	Intervention: Intensive PFMT 3 times daily for 4 weeks prior to surgery. Biofeedback audible and visual signals, anal pressure probe. Control: standard pre-operative diet and general health teaching	24 hour pad test for continence, histological analysis of muscle tissue from external sphincter of urethra. Health related quality of life assessed with UCLA-PCI and SF 12. Continence defined as 3 consecutive days of no urine loss on 24 hour pad test, results not reported. 6/8 intervention vs 4/8 of controls did not need pads at 8 weeks. Self report of symptoms favoured improvement in intervention group (no p values provided except for erectile dysfunction). Intervention patients had higher values in cross sectional area of external	Measurements (pad test, health related quality of life) at week 0 prior to surgery and week 8 post-op. Histology samples taken at the end of the intervention and on day of surgery.	Dropouts: none No histology samples taken prior to start of intervention.

Author, year	Comparator	N	Study population	Modality details or parameters	Outcomes/results	Follow up	Notes (side effects, loss of follow up...)
					sphincter muscle than controls (p=0.03)		
Park <i>et al.</i> 2012 (17) Previously only in abstract form.	Intervention (combined exercise with PFME vs control (PFME only)	N= 66 men 65 years or older recruited. Random allocation by random number generator, sealed envelopes N= 39 completed study. (n= 26 in intervention group, n= 25 in control) Participants not blinded; surgeons and research assistant completing evaluation questionnaires not blinded.	Men who had undergone laparoscopic RP.	Intervention: Exercise (resistance, pelvic flexibility and Kegel exercises) initiated post-op week 3 for 12 weeks (twice weekly). Control : Kegel exercises only Detail of Kegal (PFME) exercises not provided. Exercise program developed by sport science experts, detail of who supervised the intervention not provided.	Continence a secondary outcome Measured by 24 hour pad test. Urinary continence was < 1 gm Significant improvement (p= 0.033) in favour of intervention group at time of last visit (15 weeks post-op). Concluded intervention group had an earlier return to continence.	Measurements at 1 week prior to surgery, 3 weeks post-op and after the intervention (15 weeks post-op)	Dropouts Intervention: n=7 (other unrelated surgery, TURP for urethral stricture, non compliance, new employment) Control: n=8 (other unrelated surgery, adjuvant radiotherapy, non compliance, new employment) No intention-to-treat.
Pedriali <i>et al.</i> 2014 (18) Abstract only	Intervention post-op pilates vs control PFME plus EStim	N= 69 Randomization technique not described N=54 completed study (n=26 intervention, n= 28 control)	Men one month after RP	Intervention: 10 sessions mat Pilates exercises with certified Pilates physical therapist Control: 10 sessions of PFME plus EStim with physical therapist. Both: Written instructions for home exercises corresponding to treatment.	Outcomes: continence on 24 hour pad test, number of pads used, ICIQ-SF Significant reduction in urine loss/24 hours and pads used, improvement in QoL in both groups. 58% of intervention and 50% of controls achieved continence as measured by no pad use (p=0.57) Authors concluded Pilates as efficacious as control condition and may reduce health care costs.	Time points of measurement not provided, 3 months of treatment mentioned.	Dropouts: no details provided. No information on sample size calculation provided.
Serda <i>et al.</i> 2014 (19)	Intervention post-op combined exercise with PFME vs	N= 69 men with prostate cancer (any stage) who had undergone prostatectomy +/-	Men with no prior incontinence recruited after treatment for	Intervention: Progressive strength program in 3 consecutive stages: global posture re-	UI assessed by 20 minutes pad test. Type of incontinence measured by UI-4, intensity and frequency of urine loss by	Data collected at baseline and 24 weeks.	Dropouts Intervention: n=3 (medical reason, cognitive problem, metastasis)

Author, year	Comparator	N	Study population	Modality details or parameters	Outcomes/results	Follow up	Notes (side effects, loss of follow up...)
	control no intervention	hormone or hormone and radiotherapy randomized to 2 groups. n= 36 intervention n= 33 control Mean age 71 in both groups. N=66 completed	prostate cancer (time period not identified). Details of randomization approach not provided.	education, PFMT, exercises to radiate muscle strength. Duration 24 weeks, 16 weeks of supervised work, 8 of autonomous exercise. PFMT performed with music, focus on biofeedback (sense of awareness). Slow twitch ($\leq 1s$) and fast twitch (5s) contractions. Control group: watchful waiting by telephone contact	Sandvik scale and VAS-UI and FACT-P (urinary related QoL). Also included data on obesity, muscle resistance, constipation and activity. 33.33% of intervention group had stress UI compared to 36.36% controls. The rest had urgency UI or mixed UI. Significant improvement on VAS-UI scale regarding intensity UI symptoms favouring intervention group. QoL improvement greater in those with greater improvement in UI. Pad test dated/number achieving continence not reported.	Calculated sample size achieved.	Control: None No intention-to-treat.
Tienforti <i>et al.</i> 2012 (20)	Intervention (pre-operative and post-operative PFMT with biofeedback) vs control group (post-op PFME only)	N= 34 men screened and recruited pre-op, computer generated randomization schedule. N= 32 men in the final analysis (n= 16 in intervention, age 60-74; n= 16 in control age 52-74). No significant differences between intervention and control groups in age, disease stage, intra or post-operative features.	Men undergoing standard open retropubic RP for localized prostate cancer at one centre.	Intervention: Pre-operative biofeedback (anal probe, reference electrode on anterior superior iliac spine) with teaching on PFM the day prior to surgery. After catheter removal, oral and written PFME with structured exercise program (3 daily 10 minutes sets 5 second contractions followed by 5 seconds relaxation) lying/sitting/standing, recorded in diary. Monthly	Recovery of continence (self report on ICIQ-UI) primary outcome. Significant difference in achievement of continence favoring intervention group at 1, 3 and 6 month followups. 10/16 intervention vs 1/16 control patients continent at 6 months. Patients in intervention group reported higher QoL (IPSS QoL), difference not significant Concluded pre-operative biofeedback with PFME and monthly assisted	Measurements at baseline, 1, 3 and 6 months.	Dropouts Intervention: n=1 (intolerance to rectal probe insertion) Control: n=1 (intraoperative surgical complications) No intention-to-treat.

Author, year	Comparator	N	Study population	Modality details or parameters	Outcomes/results	Follow up	Notes (side effects, loss of follow up...)
				supervised biofeedback and motivation sessions Control: oral and written instructions on home PFME post-op after catheter removal, no diary, monthly followup Pre-op session provided by a dedicated caregiver.	sessions improves recovery to continence.		
Zopf <i>et al.</i> 2015 (21)	Intervention (combined exercise with PFME vs control (no intervention)	N = 85 men who had undergone prostatectomy for prostate cancer. n= 56 in intervention group n= 29 in control group N= 70 (50 intervention, 20 control) completed followup	Men recruited 6-12 weeks after prostatectomy +/- radiation. Multicentre, partially randomized controlled trial. Patients who consented to randomization were to be randomized, patients who refused randomization were to receive intervention of their choice. As all patients indicated a group preference, trial was not randomized.	Intervention: 15 month supervised multimodal exercise program (aerobic, resistance and PFME) with one of 4 community sports groups. Exercise 60 minutes per week Details of PFME not provided. Control: No intervention	Multiple secondary outcomes including urinary incontinence as measured by 20 minute pad test. Primary endpoint was physical fitness. Significant improvement in UI for intervention group between baseline and post testing (p= 0.005). No significant difference between intervention and control. Significant improvement of self reported urinary symptoms (EORTC-QLQ PR 25) in favour of intervention group.	Measures for UI at 3 time points, detail not provided. Authors identify poor compliance with pad testing was a limitation. Calculated sample size not achieved, limited power to detect differences between groups.	Dropouts Intervention: n=6, reasons not related to intervention Control: dropouts not described. Intention-to-treat analysis performed.
Penile Vibratory Stimulation (PVS)							

Author, year	Comparator	N	Study population	Modality details or parameters	Outcomes/results	Follow up	Notes (side effects, loss of follow up...)
Fode 2015 (22)	Intervention PVS vs control delayed PVS	N= 39 randomized by computer generated list 1 :1 ratio N= 31 in analysis (Group 1 early intervention n= 19; Group 2 delayed intervention n=20)	Men with UI > 1 year post RP. All patients had previously received PFMT with RP.	12 week study. Intervention: PVS for first 6 weeks of study. Stimulation of ventral surface of glans once daily; 10 seconds of stimulation followed by 10 second pause repeated 10 times. Control: delayed intervention – no intervention in first 6 weeks, PVS in second 6 weeks	Primary outcome: difference in leakage measured by 24 hour pad test and 72 hour voiding diary. Subjective assessment by ICIQ-SF, IPSS and satisfaction questionnaire. Early intervention group: 12/15 had reduction in leakage on pad test baseline to 6 weeks (p = 0.021); maintained in 8/12 at 12 weeks (p= 0.04) Delayed intervention group: reduction (not significant) with treatment weeks 6-12. No significant difference between groups at 6 weeks. Pooled analysis: Significant overall median decline in urine loss on 24 hour pad test (p= 0.07) Authors suggest sufficient evidence to move to larger trial.	Measures at baseline prior to inclusion and 6 and 12 weeks.	Drop outs: Group 1 early intervention n=4 lung infection (1), pain on stimulation (2), non compliance (1) Group 2 delayed intervention n= 5 untreated diabetes (1), urinary tract infection (2), change in drinking habit (1) discontinued after 6 weeks non compliance (kept in analysis) (1) Sample size calculation was n=50, enrollment stopped early as sample size deemed adequate for purpose (pilot)
Scheduled Voiding Regimes							
Burgio 2011 (23)	Combined behavioural treatment (PFME, urge suppression, delayed voiding) vs drug therapy	N=143 men from 2 sites. Randomized using sealed envelopes after stratification for voiding frequency Behaviour treatment n=73 Drug therapy n=70	Men with continued OAB symptoms after treatment with an alpha blocker for prostatic obstruction.	Intervention: 8 weeks (4 clinic visits) combined behavioural treatment composed of elements of bladder training (PFME, urge suppression techniques and delayed voiding). Verbal instruction by	Primary outcome: post treatment 24 hour voiding frequency on 7 day bladder diary. Other OAB symptoms (nocturia, urgency, incontinence) also collected on bladder diary. Secondary outcomes: global	Baseline assessment and measure, post treatment measures.	Intention-to-treat analysis undertaken. Dropouts reported: n=9 in behavioural therapy group, n= 10 in drug therapy group.

Author, year	Comparator	N	Study population	Modality details or parameters	Outcomes/results	Follow up	Notes (side effects, loss of follow up...)
				nurse practitioners, and PFME guided practice using verbal feedback based on anal palpation. Daily practice of 45 exercises (3 sessions of 15 exercises). Also used fluid management. Control: drug therapy with oxybutynin 5-30mg.	perception of improvement and patient satisfaction. Results Frequency: both groups had statistically significant improvement from baseline to after treatment. Equivalence analysis showed post treatment voiding frequency equivalent between behaviour and drug therapy groups ($p < 0.001$) Behaviour therapy group had greater reduction of nocturia episodes, but urgency scores were lower in the drug therapy group. No difference in reduction in incontinence episodes.		

BF – biofeedback; RP – radical prostatectomy; TURP – transurethral prostatectomy; PFME – pelvic floor muscle exercises; PFMT – Pelvic floor muscle training; PVS – Penile vibratory stimulation; ICIQ-SF – International Consultation on Incontinence Questionnaire Short Form; IPSS – International Prostate Symptom Score

- Ahmed MT, Mohammed AH, Mansour AA. Effect of pelvic floor electrical stimulation and biofeedback on the recovery of urinary continence after radical prostatectomy. *Turkish Journal of Physical Medicine and Rehabilitation*. 2012;58(3):171-7.
- Baroni M, Lorenzetti R, Renzi C, Brizzi A, Branchini W, Altavilla MG, *et al*. Approach HTA (health technology assessment) to treat urinary incontinence after radical prostatectomy (Abstract number 23). *Neurourology and urodynamics*. 2013;32:S20.
- Burkert S, Scholz U, Gralla O, Roigas J, Knoll N. Dyadic planning of health behavior change after prostatectomy: a randomized controlled trial planning intervention. *Social Science and Medicine*. 2011;73:783-92.
- Collado Serra A, Pellicer Cabo M, Ramirez Backhaus M, Dominguez-Escrib J, Rubio-Briones J, Gomez-Ferrer A, *et al*. Intensive preoperative Pelvic Floor Muscle Training reduce duration and severity of stress urinary incontinence after radical prostatectomy: A randomized controlled trial (Abstract number 1007). *European Urology Supplements*. 2013;12(1):e1007-e8.
- Dijkstra-Eshuis J, Van den Bos TWL, Splinter R, Bevers RFM, Zonneveld WCG, Putter H, *et al*. Effect of preoperative pelvic floor muscle therapy with biofeedback versus standard care on stress urinary incontinence and quality of life in men undergoing laparoscopic radical prostatectomy: a randomized control trial. *Neurourology and urodynamics*. 2015;34:144-50.

6. Geraerts I, Van Poppel H, Devoogdt N, Joniau S, Van Cleynenbreugel B, De Groef A, *et al.* Influence of preoperative and postoperative pelvic floor muscle training (PFMT) compared with postoperative PFMT on urinary incontinence after radical prostatectomy: a randomized controlled trial. *European urology*. 2013;64:766-72.
7. Ghanem A, Khallaf M, Assem A, Hassan A. Does preoperative pelvic floor muscle exercise improve post prostatectomy urinary incontinence (Abstract 695)? . Conference: Annual Meeting of the International Continence Society ICS, Barcelona, Spain. 2013.
8. Hou CP, Chen TY, Chang CC, Lin YH, Chang PL, Chen CL, *et al.* Use of the SF-36 quality of life scale to assess the effect of pelvic floor muscle exercise on aging males who received transurethral prostate surgery. *Clinical Interventions in Aging*. 2013;8:667-73.
9. Kakiyama C, Sens Y, Ferreira U. Effect of functional training for the pelvic floor muscles with or without electrical stimulation in cases of urinary incontinence following radical prostatectomy. *Revista Brasileira de Fisioterapia*. 2007;11(6):481-6.
10. Kongtragul J, Tukhanon W, Tudpuksa P, Suedee K, Tienchai S, Leewansangtong S, *et al.* Effects of adding concentration therapy to Kegel exercise to improve continence after radical prostatectomy, randomized control. *Journal of the Medical Association of Thailand*. 2014;97(5):513-7.
11. Laurienzo CE, Sacomani CAR, Rodrigues TR, de Cassio Zequi SGGCLA. Results of preoperative electrical stimulation of pelvic floor muscles in the continence status following radical retropubic prostatectomy. *International Brazilian Journal of Urology*. 2013;39:182-8.
12. Laurienzo C, Magnabosco W, Jabur F, Gameiro M, Yamamoto H, Guerra R, *et al.* Post-prostatectomy urinary incontinence and erectile dysfunction: The role of pelvic floor rehabilitation (Abstract number 527). Conference: Annual Meeting of the International Continence Society, ICS Montreal, QU, Canada. *Neurourology and urodynamics*. 2015;34:S449-S50.
13. Martini M, Bernardini S, Blanc E, Piretta K, Tappero R. Relationship between integrity of pelvic floor function and recovery of continence after laparoscopic prostatectomy and effects of preventive pelvic floor muscle training in males with pelvic floor weakness (Abstract 14). Conference: Annual Congress of the Italian Urodynamics Society, Turin, Italy. *Neurourology and urodynamics*. 2011;30(SUPPL 1):11-2.
14. Morihoro N, Masatsugu I, Shinji K, Kenichi T, Kazumasa M, Shiro B. Effectiveness of sacral surface therapeutic electrical stimulation (SSTES) on early recovery of urinary incontinence after laparoscopic radical prostatectomy: a prospective study. *Neurourology and urodynamics*. 2011;30(6):889-90.
15. Ng SI. A Randomised Controlled Trial Study of the Efficacy of Intensive Pre-Operative Pelvic Floor Muscle Training to Decrease Post-Prostatectomy Urinary Incontinence (Abstract number OP.4.7Dec.38). *International Journal of Urology*. 2014;21:A169.
16. Ocampo-Trujillo A, Carbonell-Gonzalez J, Martinez-Blanco A, Diaz-Hung A, Munoz CA, Ramirez-Velez R. Pre-operative training induces changes in the histomorphometry and muscle function of the pelvic floor in patients with indication of radical prostatectomy. *Actas Urológicas Espanolas*. 2014;38(6):378-84.
17. Park SW, Kim TN, Nam JK, Ha HK, Shin DG, Lee W, *et al.* Recovery of overall exercise ability, quality of life, and continence after 12 week combined exercise intervention in elderly patients who underwent radical prostatectomy: A randomized controlled study. *Urology*. 2012;80:299-306.
18. Pedriali F, Gomes C, Soares L, Urbano M, Moreira E, de AS. The efficacy of pilates compared to pelvic floor muscle training associated with electrical stimulation in the recovery of post-prostatectomy urinary incontinence: A randomized controlled trial (Abstract number 306). *Neurourology and urodynamics*. 2014;33(6):742-3.
19. Serda BC, Marcos-Gragera R. Urinary incontinence and prostate cancer: a progressive rehabilitation program design. *Rehabil Nurs*. 2014;39(6):271-80.
20. Tienforti D, Sacco E, Marangi F, D'Addessi A, Racioppi M, Galino G, *et al.* Efficacy of an assisted low-intensity programme of perioperative pelvic floor muscle training in improving the recovery of continence after radical prostatectomy: a randomized controlled trial. *BJU international*. 2012;110:1004-11.

21. Zopf EM, Bloch W, Machtens S, Zumbe J, Rubben H, Marschner S, *et al.* Effects of a 15-month supervised exercise program on physical and psychological outcomes in prostate cancer patients following prostatectomy: The ProRehab study. *Integrative Cancer Therapies*. 2015;14(5):409-18.
22. Fode M, Sonksen J. Penile vibratory stimulation in the treatment of post-prostatectomy incontinence: a randomized pilot study. *Neurourology & Urodynamics*. 2015;34(2):117-22.
23. Burgio KL, Goode PS, Johnson TM, Hammontree L, Ouslander JG, Markland AD, *et al.* Behavioral vs. drug treatment for overactive bladder in men: The Motive Trial. *Journal of the American Geriatrics Society*. 2011;59(12):2209-16.

2. PELVIC FLOOR MUSCLE TRAINING (PFMT)

Almost all studies of PFMT in men focused on UI associated with prostate surgery. In the 5th ICI, improvement in the quality of trials included was found when compared to earlier reports, although heterogeneity and varying outcome measures continued to affect the ability to compare trial findings. Studies in the first part of this section remain grouped into three types: pre-operative interventions, mixed pre- and post-operatives' studies of all men undergoing prostatectomy and studies of post-operative interventions for men with established incontinence. A total of 20 new RCTs of PFMT alone or combined with other conservative interventions focused on prostate surgery were added to the 38 studies from the previous ICI reports. Nineteen of the new trials involved men pre or post RP (N= 1597 randomized), one trial involved men post TURP (N= 66 randomized). Recommendations are at the end of the section.

2.1. Pre-Operative RP PFMT

Trials in this section compared pre-operative interventions. Three new trials of pre-operative PFMT intervention (313, 314, 320) were identified and added to the two previously included trials. Ocampo-Trujillo (314) compared pre-operative PFMT with BF (n=8) to standard pre-operative teaching (n=8). Laurienzo (313) randomized to three groups, reporting group numbers for only the 49 of 58 men that completed the study: pre-operative PFME plus EStim (n= 17), pre-operative PFME (n=17) and control which received only pre-operative information on prostate anatomy (n=15). Collado-Serra (320) also reported group numbers for those completing (179 or 193) and compared an intervention group receiving pre-operative PFMT plus BF (n=87) to a control group (n=92) receiving only oral PFME instruction post-surgery followed by PFMT plus BF 3 months later.

Quality of data

Ocampo-Trujillo (2013) used a centrally randomised, single blind approach, with researchers blind to the group assignment prior to enrolment. No information on sample size analysis or post hoc power analysis was provided. This was a very small study that was likely underpowered. There were no dropouts from the study. Laurienzo (2013) described randomization using a computer-generated list. Detail of blinding was not provided and a single therapist provided all interventions. There was no report of sample size calculation, post hoc power analysis or intention-to-treat analysis. Nine dropouts were reported, but the group from which they withdrew was not given. Collado Serra (2013) study was available only as an abstract and did not report how participants were randomized or if there was any blinding. There was no information on sample size, and no intention-to-treat analysis reported. Only dropouts from the intervention group (n=5) were described.

Results

Ocampo-Trujillo and colleagues (2013) did not report the results of the 24-hour pad test data but did report that 6/8 (75%) of the intervention group compared to 4/8 (50%) of the control did not require pads at 8 weeks. The authors also report a statistically significant difference in objective measures of muscle tissue from the external sphincter of the urethra favouring the intervention group. As no histology samples were taken prior to the intervention, the claim that the difference is due to the intervention cannot be supported. Subjective report of symptoms reportedly favoured improvement in the intervention group. Laurienzo (2013) reported no differences between intervention and control groups at any time point (1, 3 and 6 months post-surgery) on objective measure of incontinence (one-hour pad test). There were no differences between the two interventions and one control group on subjective report of quality of life. Collado Serra (2013) reported improvement in continence at week 6, month 3, month 6 and 1-year favouring intervention group, but did not clearly define its primary outcome. Significant difference on objective 24-hour pad test was only at 3 months favouring the intervention group.

2.2. Pre-Operative and/or Post-Operative RP PFMT, Post RP Continence Status Not Established Prior to Intervention

Trials in this section addressed the effect of PFMT initiated pre-operatively and/or post-operatively but before post-op continence/incontinence was established. In these studies, men were recruited pre-operatively or immediately post-operatively and the investigators compared a treatment group that received the intervention pre-operatively and/or post-operatively RP to a group receiving an intervention only post-operatively. Nine new studies (305-307, 309, 315, 321, 323, 324, 326) were added to the 10 previously included trials, for a total of 19 trials in the category, over three subsections.

2.2.1 Pre-Operative PFMT Instruction with Post-Operative Home PFMT Versus Control

Four new trials (307, 321, 323, 326) were added to three previously included studies. In the previous consultation, studies varied in support of an earlier return to continence with PFME plus or minus biofeedback. Dijkstra-Eshuis (2015) compared an intervention group that received pre-operative PFMT plus BF with home practice and post-operative home PFME (n=65) to a control group that received written post-operative PFME instruction (n=56). Ghanem (2013), available only in abstract, compared an intervention group with a PFME programme two weeks pre-operatively and continued post-operatively (n=50) to a control group that received only a postoperative PFME programme (n=50). Detail of the PFME programme was not provided. Ng (2014), also only available in abstract, compared an intervention (of PFMT

starting 3 weeks pre-operatively to a control group that received standard care. A total of 66 men participated, but numbers randomized to each group and details of the standard care were not provided. Martini (2011), again in abstract only, described an intervention group (n=24) that received five physiotherapy guided PFMT sessions 2-3 weeks pre-operatively, with continued PFME post-operatively. The control group (n=25) received post-operative written instruction on PFME.

Quality of data

Dijkstra-Eshuis and colleagues (2015) reported adequate random allocation concealment. Participants and therapists were blinded to randomisation until first visit. They also reported results of follow up were sent to clinic of the single surgeon performing the RP, but blinding of outcome assessment is not made explicit. Sample size analysis was provided, intention-to-treat was not addressed. Dropouts in both intervention (n=9/65, 13.6% and control groups (n=10/56, 18%) were described. Three studies (321, 323, 326) were available only as abstracts with randomisation, blinding, sample size calculation and dropouts not described.

Results

In all new studies, the primary outcome was continence measured by either the pad test or number of pads used, secondary outcomes were self-report of symptoms and/or quality of life on standardised questionnaires. Dijkstra-Eshuis *et al.* (2015) found no differences between intervention and control at any time points on the primary objective outcome (24-hour pad test) or on secondary self-reported symptom and quality of life measures but the trial was stopped prior to full recruitment after a planned interim analysis showed no demonstrated benefit, with the authors concluding that post RP UI is likely due to intrinsic sphincter injury and not treatable with exercise. Two other studies (321, 326) reported an earlier postoperative return to continence (at 14 weeks and 3 months respectively) favouring the intervention group, but the effect was not demonstrated later time points. Similarly, Martini (2011), who included only men with demonstrated pelvic floor impairment prior to surgery, reported significantly less UI on getting up and squatting (no quantification provided) in the intervention group at 1 month but not at later time points.

2.2.2 Pre-Operative PFMT Instruction Followed by supervised Post-Operative PFMT Versus Post-Operative PFMT

Two new trials (309, 315) were added to the previous four studies in this subsection, making a total of six studies included. Tienforti (2012) randomized 34 men undergoing RP, but reported only on group assignment for those completing the study. The intervention (n=16) was pre-operative and post-operative PFMT with BF, started the day before surgery and continuing monthly, with daily home practice, during follow-up. The control group (n=16) received oral and written

instructions post-operatively with no monthly follow-up. Geraerts (2013) compared the intervention (n=91) of PFME plus BF and a home program starting 3 weeks prior to surgery with PFME starting 4 days post-operatively to a control group (n=89) that started PFMT post-operatively. Both groups received weekly post-operative treatment that included BF and bladder diary review, with PFMT continuing until continence achieved.

Quality of data

Tienforti (2012) used a computer-generated randomisation schedule. Information on blinding to group assignment and outcome assessment was not provided. In this small study, no sample size calculation or intention-to-treat was reported. Dropouts in each group, one in each intervention and control (6% from each group) were described. Geraerts (2013) used computer generated randomisation using stratification for age and surgical approach, blinding to group assignment and outcome assessment was not provided. In this large trial, sample size calculation recruited an adequate sample to power the study. Intention-to-treat analysis was not discussed. There were n=6/91 (7%) dropouts in the intervention group, and n=4/89 (5%) in the control, reasons were provided.

Results

The newer studies continue to report variable results. Tienforti (2012) found a significant difference in achieving continence at one, three and six months favouring the intervention group, but this was by self-report of symptoms, with no objective measure of continence included as an outcome. In the Geraerts (2013) study, which was larger and of good quality, there were no differences between the groups with regards to objective duration of UI measured by 24-hour pad test or self-reported symptoms at any time point. The intervention group scored better on impact of incontinence at 3 and 6 months, but not at 12 months follow up.

2.2.3 Post-Operative PFMT Immediately Before or After Catheter Removal (No Pre-Operative Instruction)

Three new trials (305, 306, 324) were found comparing post-operative PFMT immediately before or after catheter removal, bringing the total to six. In the previous consultation, there was considerable heterogeneity in intervention and findings. Ahmed (2012), compared three groups, reporting on group assignment only for those completing the trial. Group 1, the control group (n=26), received PFME post-operatively. Group 2 (intervention, n=26) started PFME plus EStim after catheter removal for 12 weeks, and Group 3 (intervention, n=28) started PFME plus EStim and BF after catheter removal for 12 weeks. Morihoro (2011) was available only in abstract form, and compared an intervention group (n=20) that received PFMT with EStim for one month after catheter removal to a control group (n=14) assigned to PFME

alone. Burkert (2011), using a 2x2 mixed design, randomized patients and their partners to one intervention group (n=28) that received dyadic PFME planning or to 3 control groups (n= 29, 29 and 26) that received dyadic nutrition planning, individual PFME planning or individual nutrition planning.

Quality of data

Morohiro (2011) available only as an abstract, did not describe randomisation, blinding, sample size calculation or dropouts. Ahmed (2012) randomised using computer generated random numbers in sealed envelopes. Surgeons were blinded to randomisation but blinding of the outcomes assessor was not clear. Sample size was met, and dropouts from each group described: control n= 4/26+4 (13%), intervention Group 2 n= 2/26+2 (7%) and intervention Group 3 n=4/28+4 (12.5%). No intention-to-treat analysis was undertaken. In the Burkert (2011) study, research assistants were blinded to allocation. Sample size calculation and intention-to-treat were not discussed. Dropouts for the intervention group n=5/28 (18%) and three control groups (n= 2/29 (7%), 7/29 (24%), 4/26 (15%) were presented but no reasons for withdrawal were provided.

Results

Ahmed (2012) reported more men continent at 12 and 24 weeks post RP in the two intervention groups (PFMT plus EStim and PFMT plus EStim and BF) compared to PFMT alone using the objective 24-hour pad test as primary outcome. Mean leakage was significantly lower in intervention Group 3 at 6 through 24 weeks. Morihoro (2012) found recovery of urinary continence favoured the intervention group (PFMT with EStim) at 12 months. Incontinence was measured by subject report of requiring a pad to keep clothing dry. Burkert reported only adherence to PFMT with no continence data provided. There were no differences between the groups.

Summary

A total of 9 new trials are now included which apply a variety of pre- or immediately post-operative or post-catheter removal PFMT based interventions (or a combination of both, plus or minus BF and EStim). As in earlier consultations, differences between intervention and control groups were modest and short term, and often reflect self-reported but not objective data such as the pad test. Few differences were sustained up to 12 months post-surgery. Many of the studies reviewed were small, varied in design and quality, and had different outcome measures. The two larger studies that were of better quality (307, 309) found no difference between intervention and control groups. The authors of one of larger study (307) suggested post RP UI is likely often due to a mechanism such as intrinsic sphincter deficiency that is not amenable to exercise based treatment. It is possible that this is true for some men with persistent UI post RP, and they may require surgical rather than conservative intervention. Studies that include evaluation of the extent

of sphincter function using imaging techniques would be helpful in understanding the subpopulations where conservative treatments are most helpful. There is modest evidence but inconsistent evidence that therapist delivered PFMT with or without BF or EStim before or after surgery may support an earlier return of continence after RP in some men up to 3-6 months post-surgery, however this difference is not significant at 12 months post-surgery (**Level of Evidence: 2**).

Variation in outcomes measurement remains problematic. As concluded in the previous consultation, it is possible that the emphasis on quantitative outcomes (i.e. pad test) is not meaningful to participants as men appear to find therapy helpful and value the direction provided by a therapist. Studies comparing the effectiveness of pre- versus post-operative PFMT, and the number of sessions required, are needed so that practitioners may advise men about pre-operative preparation and budget conscious health services can make informed decisions on programme funding. In designing such studies, the natural history of UI after radical prostatectomy must be considered because the spontaneous recovery rate means that sample sizes must be large to detect any differences between protocols. As well, attempts to identify which men might benefit more, such as in the study by Martini (2011) who focused the intervention on those with identified pelvic floor impairment, need to be undertaken.

Recommendations

Some pre-operative instruction or immediate post-operative instruction in PFMT for men undergoing RP may be helpful in earlier recovery of continence (**Grade of Recommendation: B Clarified**).

Use of BF to assist PFMT should remain a therapist/patient decision based on economics and preference. (**Grade of Recommendation B**).

2.3. Post-Operative RP PFMT for Incontinent Men

Trials in this section addressed the effect of PFMT post-operatively after incontinence was established. In these studies, incontinent men were recruited at variable lengths of time after surgery.

2.3.1 PFMT with Digital Rectal Feedback (DRE) After Radical Prostatectomy

No new trials were identified to add to the previous five trials in which PFMT was taught using digital rectal feedback (DRE) to men incontinent after RP.

Summary

There are no new trials to clarify whether PFMT taught by DRE offers any benefit over and above verbal or written instruction, (**Level of Evidence: 2**).

Recommendations

The recommendation is unchanged (**Grade of Recommendation: B**).

2.3.2 PFMT with BF After Radical Prostatectomy

No new trials were found under this category to add to the six previously included trials.

Recommendations

The use of BF in clinic, over and above home PFMT, should remain a therapist/individual decision based on economics and preference. (**Grade of Recommendation: B**).

2.3.3 PFMT Plus or minus BF with EStim or MStim after Radical Prostatectomy

Three new trials (311, 322, 325) were added to the eight previously included in this section. As in the earlier consultation, a problem of heterogeneity of study samples in this category was noted. Kakiyama (2007) compared an intervention of physiotherapy lead PFMT with EStim (n=10) to PFMT alone (n=10) in men a minimum 6 months post-surgery (mean 12.3 months for intervention group, 16.8 months for control). Pedriali (2014) recruited incontinent men one-month post RP and assigned them to post-operative pilates (n=26) versus PFMT plus EStim (n=28), but reported group assignment in only the 54/69 (78%) of men completing the study Laurienzo (2015), available only in abstract, also included men incontinent one-month post RP, randomising to three groups: Group 1 control (no treatment) (n=40), Group 2 PFMT (n=41) and Group 3 PFMT plus EStim (n=42).

Quality of data

Kakiyama (2007) did not provide information on randomisation or blinding. No sample size calculation was given. Dropout numbers for each group were given, but the reasons for dropping out of the intervention group were not provided. Three participants were discharged from the control group at 3, 6 and 12 months as continence was achieved and were included in the final analysis. Pedriali (2014), available only as an abstract, did not provide details of randomisation, blinding, sample size calculation or dropouts. Laurienzo (2015) was only available in abstract, but did describe randomisation approach, but not blinding, sample size calculation or dropouts.

Results

In the Kakiyama (2007) trial, there was improvement in urine loss on 1-hour pad test in both groups between baseline and 12 months, but no difference in

men receiving PFMT with EStim compared to those who received only PFMT. Men had undergone urodynamic testing, and both those with UUI and SUI were included. Pedriali (2014) reported 58% of the Pilates group and 50% of the EStim plus PFME achieved continence, as measured by use of no pads. The difference was not statistically significant and the authors concluded that Pilates, which includes pelvic floor strengthening, is as efficacious as EStim plus PFME. Laurienzo (2015) reported no differences between controls and two intervention groups (PFMT, PFMT with EStim) at any time points, objective pad test results not provided, subjective reports of quality of life and symptoms only.

Summary

Data suggest no further benefit of EStim when added to PFMT over PFMT alone for men with incontinence post RP (**Level of Evidence: 2**).

Recommendations

There does not appear to be any benefit of adding EStim to a PFMT programme for men with persistent post-prostatectomy incontinence. (**Grade of Recommendation: B**).

2.3.4 PFMT Compared to or Plus Other Interventions After Radical Prostatectomy

Four new trials (312, 316, 318, 319) were identified that combined PFMT post-operatively with other novel interventions in men with post prostatectomy incontinence, adding to the two previously included studies. The previous consultation found variation in intervention and time since surgery. Zopf (2015) recruited men 6-12 weeks post RP, and assigned them to either an intervention of a multimodel exercise programme with PFME (n=50) or a control group that received no intervention (n=20). Serda (2014), using a two group design, randomised men post RP to a combined exercise and PFME intervention group (n=36) or control with no intervention (n=33). Time after surgery was not reported. Kongtragul (2014) randomised 138 incontinent men recruited in hospital after RP. Group assignment was reported only for those completing the study; 68 men were in the intervention group with PFME and concentration therapy (no detail provided) starting 3 weeks post-surgery. The control group (n=67) received only PFME. Baroni (2013) was available only in abstract. Men with SUI or mixed UI after RP (time after surgery not reported) were assigned to an intervention of individual PFMT and group treatment (n= 16). Controls (n=24) received only individual PFMT.

Quality of data

The Zopf (2015) study had intended to randomise those who consented, but as all participants refused randomisation and gave a group preference, blinding of outcome measurement was not described. The authors indicated intention-to-treat analysis was undertaken but the study did not achieve the calculated

sample size and was thus underpowered. Dropouts from the intervention group only (n=6/50 12%) were described, but reasons were not provided. Serda (2014) randomised participants but did describe how this was done. Blinding to outcome assessment was not reported. Calculated sample size was achieved, number of dropouts (intervention group (n=3/36 8%; control 0/33) and reason for withdrawal was provided. Baroni (2013) was available only in abstract and had no detail on randomisation but reported the assessor was blinded until assignment. Sample size calculation and dropouts were not described. Kongtragul (2014) did not describe the approach to randomisation or blinding, but dropouts (intervention n=1/68+1, 1%; control n=2/67+2, 3%) were described. The study did not achieve the number in each group required for power to detect a difference between groups.

Results

Zopf (2015) reported a significant improvement in UI, as measured by the 20-minute pad test, from baseline to post testing, but no significant difference between intervention (exercise plus PFMT) and controls (no intervention). However, a significant difference between the groups on reported urinary symptoms was found. Serda (2014) reported a significant improvement in favour of the intervention group (combined exercise and PFME) on self-report of the intensity of urinary symptoms, but did not report the results of the 20-minute pad test. Baroni (2013) reported no significant difference between intervention and control on the VAS, number of pads used or home practice. In the study of concentration exercises plus PFME (Kongtragul 2014), significant differences were found between intervention and control groups on achieving continence measured by the 1-hour pad test.

Summary

Interventions were varied: general exercise plus PFME (316, 318) PFME with concentration therapy (not defined by author) (312) and individual PFMT compared to individual and group therapy (319). There was also heterogeneity of samples in terms of time since surgery. There is some early evidence that novel interventions, such as general exercise programmes, use of support groups and concentration exercises added to PFME after RP for incontinent men may be beneficial, but this is very limited. Some of the trials are small and of low quality. Larger studies of high quality are needed to determine the benefits of these adjuncts to PFME.

2.4. Pre-Operative TURP PFMT

No new trials were identified. Little research has been dedicated to UI after TURP as the incidence of UI after TURP is reported to be very low.

2.5. Pre-Operative and/or Post-Operative TURP PFMT

No new trials were identified.

Summary

In the absence of sufficient data from rigorous and well-reported trials it is not known if PFMT reduces UI following TURP. More systematic investigation of the natural history of UI after TURP is probably needed, to establish the potential cost/benefit of intervention, before further trials are initiated.

2.6. Post-Operative TURP PFMT for Incontinent Men

One new study (310) was added. The previous consultation reported limited evidence in this area. The larger well designed study previously included showed no benefit in terms of objective measures of incontinence. Hou (2013) reported group assignment only for those completing the study. The intervention group (n=32) was given instruction in PFME two days after surgery when the catheter was removed, and instructed to practice daily at home, with weekly telephone reminders. The control group (n=29) activity was not described.

Quality of data

Approach to randomisation, blinding, sample size calculation and dropouts in the smaller, newly included trial (Hou 2013) were not described.

Results

Hou (2013) found a statistically significant difference in self-report of symptom severity favouring the intervention group at 12 weeks. No objective measure of incontinence, such as the pad test, was reported.

Summary

There continues to be limited evidence on the benefit of PFME post TURP. The new smaller trial suggests a potential benefit on perception of symptom severity of UI, but no objective data were reported.

2.7. Factors Affecting Outcome

Based on the current evidence, it appears that time from surgery to implementation of exercises does affect outcome and that by three months after surgery less improvement is noted. Future trials should consider analysis to evaluate the effect of sphincter insufficiency, pelvic floor dysfunction, urethral length, length of time from prostatectomy, co-morbid conditions, prior pelvic surgery, medications, other risk factors (including smoking and alcohol use) on treatment outcome.

2.8. PFMT for Other LUTS

2.8.1 PFMT for Post-Micturition Dribble (PMD)

No new trials were identified to add to the two previously included trials.

Recommendations

Offer men with PMD instruction to do a strong PFM contraction immediately after voiding, or urethral massage to empty the urethra (**Grade of Recommendation: C**).

3. ELECTRICAL STIMULATION (ESTIM)

An extensive overview of EStim in men is reported in the 5th consultation(2). Rectal or surface electrodes are most common; surface electrodes are positioned over the perineal region. EStim can also be applied via the posterior tibialis nerve (PTN). Trials of EStim in men post-prostatectomy combined this treatment with PFME, and are included in the sections on post-prostatectomy treatment above.

3.1. Prevention of UI

No new trials were identified. There remain no studies on the effect of EStim for prevention of non-post prostatectomy UUI or SUI in men.

3.2. Treatment of UI

No new trials were added to the nine previously included RCTs, four of which included PFME plus EStim post prostatectomy. New trials that combined EStim with PFME were reported in the PFMT section above as the separate effects of EStim alone cannot be assessed.

3.2.1 Is EStim Better than No Treatment, Placebo or Control Treatments?

No new trials were identified to add to the two previously included trials. Both previously included trials did not separate male and female results. In the continued absence of sufficient data from rigorous and well-reported trials it is not known if EStim, as a stand-alone treatment for male UUI or SUI, is better than no treatment, placebo or control treatments.

3.2.2 Is One Approach to EStim Better Than Another?

No new trial was identified. No studies comparing EStim protocols were included in previous consultations.

3.2.3 Is EStim Better Than Other Treatments?

No new trials were identified. Three studies, two comparing EStim to Mstim and one EStim to medication,

had been included in previous consultations. Details of these were provided in the 5th consultation (Moore 2013): insufficient data exist to establish if EStim is better than either intervention. Both studies combined male and female data.

3.2.4 Does the Addition of EStim to Other Treatments Add Benefit?

All of the studies combining EStim with other treatments included the PFMT plus EStim combination, and are reviewed under the Pelvic Floor Muscle Training section.

3.3. Other LUTS

No new studies were identified. No previous studies of EStim alone for other LUTS were included in previous consultations.

3.4. Factors Affecting Outcome

The previous consultation identified age, type of incontinence (SUI post prostatectomy versus OAB and UUI) and other factors (types of electrodes, frequency and duration of treatment) as potentially affecting outcomes. No trials have investigated these factors in males.

4. MAGNETIC STIMULATION (MSTIM)

Although MStim has been used to treat UI after RP and to inhibit DO, no new studies were identified.

4.1. Prevention of UI

No trials investigating the primary or secondary prevention effects of MStim for men with UI were found.

4.2. Treatment of UI

No new trials to add to the three trials (two published, one abstract without data) identified and described in the 5th consultation were found. Only the two published trials were included in the previous consultation.

4.2.1 Is MStim Better Than No Treatment, Placebo or Control Treatment?

No studies were found addressing this question.

4.2.2 Is One Approach to MStim Better Than Another?

No studies were found addressing this question.

4.2.3 Is MStim Better Than Other Treatments?

No new studies were identified.

4.3. Other LUTS

No studies were found.

4.4. Factors Affecting Outcome

The relationship between age (or any other factor, such as treatment parameters, treatment adherence, or diagnosis) and the outcome of MStim has yet to be determined.

5. PENILE VIBRATORY STIMULATION (PVS)

This is a novel conservative treatment, based on the stimulation of the pudendal nerve via penile vibratory stimulation (PVS) to treat SUI in men post prostatectomy.

PVS has been shown to increase external sphincter pressure in men with spinal cord injury (334, 335), and vibratory stimulation applied to the perineum in healthy women also increased external urethral pressure (336).

5.1. Prevention of UI

No trials of prevention were identified.

5.2. Treatment of UI

One new trial was identified (308). Fode (2015) randomised 39 men with UI over one-year post RP to two groups. Group 1 (n= 19) was the early intervention group who received PVS using a commercially available hand held personal vibrator for 6 weeks. Stimulation was performed on the ventral surface of the penis once daily with 10 seconds of stimulation followed by a ten second pause, repeated 10 times. Group 2 was the delayed treatment control group, who had no intervention the first 6 weeks, but performed PVS in the second 6 weeks.

Quality of data

Computer generated randomisation technique was described, but blinding of outcome measurement was not (308). A sample size calculation was provided, but the authors report stopping recruitment early as the study was a pilot and the sample achieved was thought to be adequate. Drop outs in both early (n=4/19, 21%) and delayed (n=5/20, 25%) intervention groups were described, with one of five dropouts in the delayed intervention group kept in the analysis, although others were not. The participant kept in had a pattern of non-compliance over the study, and discontinued after 6 weeks.

Results

Primary outcome was difference in leakage measured by 24 pad test. Participants also completed voiding diary. Results showed a significant improvement in the early intervention group from baseline to 6 weeks, but not in the delayed intervention group. Pooled analysis results from both early and delayed intervention groups showed significant overall median decline in urine loss on 24-hour pad test (p= 0.07).

Conclusion

This was a small pilot study of a novel intervention. Further well designed studies are needed to understand the place for PVS in treatment of male UI. No recommendation can be made.

5.3. Other LUTS

No trials were identified.

6. SCHEDULED VOIDING REGIMENS

Scheduled voiding regimens include bladder training, timed voiding, habit training and prompted voiding. They are frequently combined to achieve maximum benefits. Although there is evidence to suggest that scheduled voiding regimens, especially bladder training and timed voiding, are commonly used in the treatment of men with UI and other LUTS, there has been substantially less research that addresses their use in men compared to the literature on their use in women, leaving insufficient evidence to comment on effectiveness.

6.1. Prevention of UI

No trials investigating the preventive effects of scheduled voiding regimens for men with UI were found.

6.2. Treatment of UI

6.2.1 Bladder Training

One new trial of a mixed behavioural treatment approach composed of elements of bladder training compared to drug therapy in men with OAB was identified (317) and added to the five previously included trials of bladder training that have included men. Burgio (2011) compared a combined behavioural treatment (PFME, urgency suppression, delayed voiding) to drug therapy (n=73) with drug therapy (individually titrated extended release oxybutynin) for OAB (n = 70). This category previously included studies that have included BT plus caffeine reduction, BT plus placebo or anticholinergic drug therapy

Quality of data

Burgio and colleagues (2011) used sealed envelopes to randomise, blinding of person(s) gathering data on outcomes was not described. Sample size analysis was not given, but intention-to-treat analysis was undertaken. Dropouts from each group (combined behavioural therapy n=9/73, 12%; drug therapy n=10/70, 14%) were reported, reasons were not provided.

Results

Primary outcome was 24-hour voiding frequency recorded on a seven-day bladder diary. Secondary outcomes were other OAB symptoms, perception of improvement and satisfaction.

Results showed that treatment with behavioural strategies (bladder training) compared to pharmacological

treatment was equivalent. There was no significant difference between incontinence episodes between the behaviour and drug therapy groups.

6.2.2 Timed Voiding

No new trials were identified.

6.3. Other LUTS

One new study was identified for treatment of other LUTS in men. The newly included study, described above (317) also measured OAB symptoms, with the primary outcome being frequency of voiding.

Quality of data

Refer to C.VI.2a above.

Results

Primary outcome was 24-hour voiding frequency recorded on a seven-day bladder diary. Secondary outcomes were other (non UUI) OAB symptoms including nocturia and urinary urgency; perception of improvement and satisfaction. Treatment with behavioural strategies (bladder training) compared to pharmacological treatment was equivalent. The behaviour therapy group had greater reduction in nocturia episodes, but urgency scores were lower in the drug therapy group.

Summary

In men, behavioural treatment may be just as effective for some LUTS, including UI, as pharmacological therapy. Further studies of high quality are needed before a recommendation for practice can be supported.

6.4. Factors Affecting Outcome

Age: No new trials were found addressing age as a factor affecting outcome.

Other: No studies were identified on other factors affecting outcome of BT or prompted voiding in men.

7. COMPLEMENTARY AND ALTERNATIVE MEDICINES

Therapies include acupuncture, relaxation, meditation, imagery, hypnosis, naturopathic and herbal remedies. In previous consultations, only trials of acupuncture therapy were found in men with UI. Studies were small, objective measured of UI were missing and long-term follow-up was lacking, leaving only limited evidence on the effectiveness of acupuncture for men with UI.

7.1. Prevention of UI

No new trials were identified on the preventative role of complementary therapies in men.

7.2. Treatment UI

No new trials were identified.

7.2.1 What Is the Most Effective Acupuncture Protocol?

No new trials were identified.

7.2.2 Acupuncture Versus No Treatment, Sham Acupuncture or Any Other Treatment

No new trials were identified.

7.3. Other LUTS

No new trials were identified.

7.4. Factors Affecting Outcome

No new trials were identified.

8. SUMMARY

Despite the prevalence of UI and LUTS in older men, research continues to focus mainly on men following radical prostatectomy. Overall, the effect of conservative treatment (lifestyle interventions, physical therapies, schedule voiding regimes, complementary therapies) for men has received much less research attention compared to women.

8.1. Recommendations for Practice

There is generally insufficient **Level 1 or 2 evidence** on which to base recommendations for practice, and most recommendations are, in effect hypotheses, that need further testing in research.

Lifestyle interventions

Weight loss through lifestyle changes should be recommended to obese and overweight men with UI, particularly those with type 2 diabetes. **(Grade of Recommendation: Grade B New)**

Smoking abstinence should be recommended for men with UI **(Grade of Recommendation: C New)**

A reduction in caffeine intake is recommended for those with incontinence symptoms. **(Grade of Recommendation: C New)**

Pelvic floor muscle training (PFMT)

- Some pre-operative or immediate post-operative instruction in PFMT for men undergoing radical prostatectomy may be helpful in earlier recovery of continence. **(Grade of Recommendation: B Clarified).**
- In men with persistent post-prostatectomy incontinence, PFMT taught by digital rectal examination (DRE) may be undertaken but it is unclear whether this offers any benefit over and above verbal or written instruction in PFMT **(Grade of Recommendation: B Clarified).**
- Use of BF in clinic, over and above home PFMT should remain a therapist/patient decision based

on economics and preference (**Grade of Recommendation: B**).

- There does not appear to be any benefit of adding EStim to a PFMT programme for men with persistent post-prostatectomy incontinence (**Grade of Recommendation: B**).
- Use of a strong pelvic floor muscle contraction immediately after voiding, or urethral massage to empty the urethra, should be offered for symptoms of post-micturition dribble (**Grade of Recommendation: C**).

Electrical Stimulation (EStim)

For men with persistent post-prostatectomy incontinence there does not appear to be any benefit of adding EStim to a PFMT programme (**Grade of Recommendation: B**).

8.2. Future Research Directions

Despite recognition that there is much scope for research on the effects of conservative therapies for UI and LUTS in men in the 6th consultation, this remains largely unexplored. Research that is urgently needed, in the opinion of committee members, is highlighted with the use of italics. The committee continues to support the recommendations that apply to all future studies in men, namely:

- All future intervention studies must be designed to allow standardised and comprehensive reporting of results based on the ICS and CONSORT recommendations.
- The natural history of UI after radical prostatectomy must be considered in study design as the spontaneous recovery rate means that sample sizes must be large to detect any differences between protocols.
- More research is needed to find out what are the most important outcomes for men with UI, so such measures can be incorporated as the primary outcome measures in further trials.
- Data is needed to establish to the cost, and cost effectiveness, of conservative therapies in men with UI.
- Surgical approaches with laparoscopy or robotics offer promising improvements in visualisation for nerve-sparing procedures; further research should address continence and erectile function after these newer surgical procedures.

8.2.1 Lifestyle Interventions

- The effects of interventions such as weight, caffeine reduction, constipation and physical activity are priorities for future research.

8.2.2 Pelvic Floor Muscle Training (PFMT)

- Further studies to test the hypothesis that pre-operative proprioceptive training plus PFMT is

more effective than PFMT alone to prevent UI in men undergoing radical prostatectomy.

- A comparison of pre-operative versus post-operative PFMT verbal and written feedback to reduce prevalence and severity of UI following radical prostatectomy is needed.
- Methods of PFMT instruction and supervision require further investigation. Two areas of research interest are:
 - Whether PFMT taught by DRE offers any benefit over and above verbal or written instruction.
 - The effect of group exercise as peer support may be helpful to a healthy recovery.
- Future studies should focus on identification of men more likely to benefit from conservative interventions, such as those with pelvic floor dysfunction, and screening those with potential intrinsic sphincter deficiency post-surgery. This might be established using imaging. Men with extensive sphincter deficiency should be referred for urological intervention. Studies of conservative measures including PFMT should include those with milder damage in order to determine efficacy in this group.
- More systematic investigation of the natural history of UI after TURP is needed, to establish the potential cost/benefit of intervention, before further trials are initiated.
- The relationship between age, or any other factor (urethral length, PFM function), and the outcome of PFMT for UI in men, and predictors of success needs to be investigated.

8.2.3 Electrical Stimulation (EStim) and Magnetic Stimulation (MStim)

- It is not known if pre- or post-operative EStim or MStim has a role in reducing UI after radical prostatectomy.
- RCTs in larger samples, with long-term follow up, are needed to investigate all aspects of the effectiveness of EStim and MStim as a treatment for UI in men, including:
 - Either type of stimulation versus no treatment, sham stimulation or other control conditions.
 - Comparisons of both EStim and MStim protocols.
 - EStim versus MStim.
 - Either type of stimulation versus medication.
 - Whether the addition of either type of stimulation to other treatments adds benefit, in particular, the addition of stimulation to PFMT.

- The effect of age, and other factors, on outcome of stimulation. Older men may have more co-morbid conditions than young men and a more pragmatic ap-proach to inclusion in EStim studies is needed.

8.2.4 Scheduled Voiding Regimens

- RCTs of voiding regimens and combinations of conservative treatments in men with OAB and UUI are needed. Further comparison of these conservative approaches to drug therapy would be helpful for clinicians in recommending treatment to patients.

V. URINARY INCONTINENCE IN MEN AND WOMEN

1. POSTERIOR TIBIAL NERVE STIMULATION (PTNS)

Posterior tibial nerve stimulation (PTNS) is a form of peripheral neuromodulation targeted towards symptom relief of OAB and UUI (141). Evidence for the use of PTNS for the prevention and treatment of UI in men or in adults (study with men and women with results combined) is presented below.

Questions addressed are:

- Can PTNS prevent UI?
- Is PTNS better than no treatment, placebo or control treatments for UI?
- Is PTNS better than other treatments for UI?
- Does the addition of PTNS to other treatments add any benefit?
- What is the best programme of PTNS for UI in adults?
- What is the effect of PTNS on LUTS other than UI?
- What factors might affect the outcome of PTNS?

A literature search for reports of relevant systematic reviews and reports of RCTs and quasi-RCTs was performed (see section I). Trial data reported in conference abstracts as well as full text papers were included. Since this is a new section for the Conservative Management chapter no date restrictions were applied.

Eligibility criteria:

1. Reports of RCTs or quasi-randomised trials of PTNS, percutaneous or transcutaneous.
2. Adult men and women with UI and/or OAB (with or without urgency incontinence) presentation of data for men only or combined for men and women. Trials including women only are presented in section II.5.

Evidence overview

A total of 7 RCTs of posterior tibial nerve stimulation (PTNS) in adults were identified (337-343) and one Cochrane systematic review of anticholinergic drugs versus non-drug active therapies for non-neurogenic overactive bladder syndrome in adults (141), in which PTNS trials with adults of both sexes and men only were included. Only one randomised trial of PTNS in men has been reported (344), which addressed post-stroke neurogenic bladder dysfunction and therefore did not meet the inclusion criteria for the conservative management chapter. No trials of non-neurogenic bladder dysfunction have been reported for men only.

The trial data is summarised in tables 35 to 38.

Three randomised trials compared PTNS with a sham intervention (337-339).

Four trials were comparative:

- Two compared different anticholinergics (340, 341)
- Two compared different stimulation protocols (342, 343)

Percutaneous PTNS was used in 5 randomised trials (337, 339-342)

Transcutaneous PTNS was used in 2 (338, 343).

No direct comparisons of percutaneous and transcutaneous PTNS for treatment of UI have been undertaken in the adult population or in men only.

On the basis of the included studies, percutaneous PTNS seems to involve a standard protocol with regard to stimulation parameters of frequency and session-duration using the Urgent PC™ stimulator. However, the number of individual sessions, overall duration of programme and timing of delivery protocols may vary. There is also variation between percutaneous and transcutaneous stimulation parameters and one transcutaneous device study (343) did not report stimulation parameters, preventing comparison with other results. This variability reflects the limited understanding of the mechanisms of PTNS, which cannot be assumed to be identical for both percutaneous and transcutaneous routes. Further investigation is required for both percutaneous and transcutaneous PTNS to determine the most effective type of stimulation and treatment protocols.

1.1. Prevention of UI

There have been no studies on the effect of PTNS for prevention of UUI/OAB in adults or in men only.

1.2. Treatment of UI

1.2.1 Is PTNS Better Than No Treatment, Placebo or Control Treatments for UI?

Three randomised controlled trials address this question in adult men and women. One RCT (337) is adequately powered whereas Vohra (339) and Booth (338) are both pilot RCTs.

Quality of evidence

Computerised randomisation was used in all three studies with adequate allocation concealment reported in two (337, 338) and unclear in one (339). Subjects and outcome assessors were blinded throughout in two studies (337, 338), with blinding unclear in one (339). Two studies reported intention-to-treat analysis (337, 338); the type of analysis was not reported in one (339). There was no apparent inequality in loss to follow-up across the groups: in one trial (345) seven subjects were lost to follow-up in the PTNS and 5 in the sham group thus 94% and 95% respectively were analysed. Two of the 30 subjects (6.6%), both from the sham group, discontinued in one trial (338) and one subject (4.5%) from the control group discontinued in the other trial (339). Mild or moderate treatment related adverse events were reported by 6 PTNS subjects in one trial (337). They included ankle bruising (1 of 110, 0.9%) discomfort at needle site (2 of 110, 1.8%) bleeding at the needle site (3 of 110, 2.7%) and tingling in the leg (1 of 110, 0.9%). No subjects in the transcutaneous PTNS trial (338) reported adverse events and presence of adverse events was unclear in one study (339). Two trials were reported as pilots with no sample size calculation (338, 339) and one was adequately powered (337) however the payment of subjects for time and expense was a potential limitation and the efficacy achieved may not be equivalently reflected in translating to real world practice. Long term follow-up to 3 years post-initial treatment was reported by Peters (345). Overall risk of bias was low in two trials (337, 338) and high in one (339).

Results

No study reported cure rates for UI, however all three trials reported improvements. In the SUMiT trial (337) 37.9% PTNS subjects reported moderate or markedly improved urgency incontinence compared to 22.1% sham subjects ($p=0.02$). Voiding diary analysis showed PTNS to be statistically superior to sham in reducing urge incontinence episodes ($p=0.002$) from a median of 3.0 episodes accompanied by moderate to severe urgency per day at baseline, to a median of 0.3 episodes at 13 weeks ($p<0.0001$). In the two pilot trials Booth (338) reported improved ICIQ-UI SF in 10 of 15 (67%) transcutaneous PTNS group and 6 of 13 (46%) sham group ($p=0.132$, NS); Vohra reported significantly reduced UI in 7 of 11 PTNS subjects but no estimates of effect size were provided; data was not differentiated for men and women. In one large trial (337) PTNS subjects reported statistically significant improvements in overall bladder symptoms with

54.5% reporting moderate or markedly improved Global Response Assessment (GRA) from baseline compared to 20.9% of sham subjects ($p<0.001$). A significant difference between the groups in favour of PTNS was found for the OAB-q quality of life scores ($p=0.006$) and the SF-36 general health survey quality of life scores significantly improved between baseline and 13 weeks for the PTNS group in the physical ($p=0.002$) and mental ($p=0.049$) domain scales. One pilot trial (339) reported significant improvements in quality of life (QoL questionnaires not specified and SF-36) but provided no data or figures to support this.

A prospective study to assess long-term outcomes and determine frequency of top-up stimulation sessions required was reported (345). Fifty responders to the original trial underwent a fixed 14-week tapered stimulation protocol, followed by a personal treatment plan aimed at maintaining improvements. Twenty-nine of 50 (58%) completed the outcomes. 77% of these maintained moderate or marked improvement in OAB symptoms at three years with a median 1.1 treatments each month.

Summary

The results of two trials, one rigorous, well-reported trial and one low quality pilot trial, showed that percutaneous PTNS is a safe and more effective intervention than a sham treatment for improving urgency incontinence in adults with OAB/UUI.

There is evidence that, with regular treatment, effects are sustained for up to 3 years. **(Level of Evidence: 1)**.

One small high quality pilot trial indicates that transcutaneous PTNS is safe and may be more effective than sham stimulation for reducing UI and urinary symptoms in older adults in institutional care. Further studies are needed to determine the effectiveness of transcutaneous PTNS. **(Level of Evidence: 2)**.

Recommendation

Percutaneous PTNS can be offered to men and women (adults) with UUI/OAB who do not achieve satisfactory results from first line lifestyle and behavioural intervention and pharmacological therapy. **(Grade of Recommendation: B New)**.

In this population, Transcutaneous PTNS may be a useful option to test in the adult with UUI/OAB earlier in the algorithm, following lifestyle and behavioural interventions and before more invasive therapies are considered.

1.2.2 Is PTNS Better Than Other Treatments for UI?

One RCT compared PTNS with another treatment for UI. The other treatment was extended release tolterodine 4mg daily (341). There are no trials comparing transcutaneous PTNS with other treatments.

Quality of evidence

1:1 randomisation to percutaneous PTNS or tolterodine was implemented using a random block design stratified by investigational site however the success of allocation concealment was unclear. Blinding of subjects, clinicians or assessors was not possible given the different nature of the interventions. An intention to treat analysis was not undertaken. Seven subjects (14%) withdrew from the drug group and 9 (18%) from the percutaneous PTNS group; none due to adverse effects. Adverse effects were mild or moderate in both groups with 14.3% (7 subjects) from the tolterodine arm reporting moderate adverse effects and 16.3% (8 subjects) from the percutaneous PTNS group. Percutaneous PTNS related adverse events included leg cramps, intermittent foot/toe pain, generalised swelling, headache, haematuria, inability to tolerate stimulation, worsening incontinence and vasovagal response to needle placement. A sample size calculation was provided and the study was adequately powered for a non-inferiority margin of 20% in number of voids per 24 hours. Long-term follow-up of percutaneous PTNS subjects for nine months after initial treatment completion was reported (346). The overall risk of bias was high.

Results

Data was reported for the whole group with no differentiation by sex. The global response assessment (GRA) demonstrated that subjective assessment of bladder symptom change compared to baseline was statistically significant with 79.5% (35) of the percutaneous PTNS group reporting cure (1) or improvement (34) and 54.8% (23) of the tolterodine group reporting cure (2) or improvement (21) ($p=0.01$). Both groups had improved significantly. Symptoms of UUI reported in the voiding diaries improved significantly in both groups however there was no significant difference between the groups for these measures. Quality of life scores showed statistically significant improvements for both treatment groups ($P<0.001$) but between group differences were not statistically significant. The percutaneous PTNS group reported statistically significantly less dry mouth than the tolterodine group ($p=0.01$) and a non-significant lower rate of constipation.

Follow-up to determine duration of effect up to 12 months from baseline was offered to percutaneous PTNS responders (those who reported a successful response to GRA after 12 weeks) (346). Thirty-three of the 35 responders chose to continue. The GRA showed sustained improvements in 96% at 12 months with a mean of 21 days between treatment sessions.

Summary

Evidence from a single RCT indicates that percutaneous PTNS may be as effective as tolterodine for urgency UI with an improved side effect profile; however, design limitations suggest caution and further studies are recommended to establish the effects of percutaneous PTNS and transcutaneous PTNS in

comparison to other pharmacological treatments (**Level of Evidence: 2**).

As there were no trials comparing transcutaneous PTNS with another active treatment trials are also needed to determine the effects of transcutaneous PTNS compared to common anticholinergic drugs used to treat UUI/OAB in adults.

Recommendation

Percutaneous PTNS can be offered as an alternative to tolterodine for OAB/UUI in adult men and women. (**Grade of Recommendation: B New**).

1.2.3 Does the Addition of PTNS to Other UI Treatment Add Any Benefit?

One RCT was identified (340) that compared percutaneous PTNS with percutaneous PTNS and oxybutynin for treatment of patients with overactive bladder (with or without incontinence) and urodynamically diagnosed detrusor overactivity (DO).

Quality of evidence

Randomisation following urodynamic studies into percutaneous PTNS group or percutaneous PTNS plus 5mg daily oxybutynin hydrochloride was reported but no description of method of randomisation. Adequacy of allocation concealment and blinding of subjects, clinicians or assessors was not reported nor was type of analysis, which was unclear. It appears that no subject dropped out and reported adverse events were mild: percutaneous PTNS plus drug group - seven reported dry mouth, one blurred vision; percutaneous PTNS group - one reported a small haematoma, one local tenderness. There was no sample size calculation, no long-term follow-up and overall risk of bias was high.

Results

Four of five subjects receiving percutaneous PTNS only and all five subjects receiving percutaneous PTNS and oxybutynin, with urgency UI reported cure on voiding diary. The numbers were too small for statistical analysis. Overall treatment response was defined as patient-reported improvement in OAB symptoms of frequency, urgency and urge incontinence by > 35% and occurred in 61.6% percutaneous PTNS group and 83.2% percutaneous PTNS plus oxybutynin group. The between group difference was not statistically significant.

Summary

The evidence is limited to a single low quality trial (**Level of Evidence: 2**) which indicates there may be additional effects if oxybutynin is added to a programme of percutaneous PTNS. Further trials are needed to establish whether the addition of an anticholinergic drug enhances the effectiveness of percutaneous PTNS in adults with UUI/OAB and which drugs provide the greatest effect.

As there were no trials comparing transcutaneous PTNS added to another active treatment with the active treatment alone studies are also needed to determine the effects of adding transcutaneous PTNS to first line lifestyle and behavioural treatments for OAB and UUI including bladder training and percutaneous PFMT, with these first line lifestyle and behavioural treatments alone.

Recommendation

Oxybutynin may be considered in addition to percutaneous PTNS in adults with DO. **(Grade of Recommendation: B New)**.

This hypothesis needs to be investigated further with high quality trials

1.2.4 What is the Best PTNS Protocol for UI in Adults?

Two RCTs compared different stimulation protocols (342, 343). Details are provided in table 38.

Quality of the evidence

Randomisation methods were not described for either study. Allocation concealment could not be determined from the reports and blinding of subjects or clinicians was not possible with this design. Neither study reported the type of analysis undertaken. Primary outcomes were reported at the end of the (342) treatment protocol. No long-term follow up was reported. Withdrawals were high (29.2 %) in the Seth (343) pilot trial, with 8 of the 14 withdrawals being device related, although no significant adverse events occurred. There were no withdrawals in the Finazzi-Agro trial and no adverse events reported.

Results

In the Finazzi-Agro (342) trial 4 of 11 (36%) subjects with UI in the weekly percutaneous PTNS group and 5 of 11 (45%) subjects with UI in the 3 X weekly percutaneous PTNS group reported complete cure after treatment. Overall success of >50% reduction in micturition episodes/24 hours or (if incontinent) UI episodes/24 hours was confirmed for 11 of 17 (63%) subjects in the weekly percutaneous PTNS group and 12 of 18 (67%) subjects in the 3 times weekly percutaneous PTNS group. Subjective improvement was reported after 6-8 sessions, regardless of frequency of delivery. In the Seth (343) trial 18 of 34 (54%) subjects who completed the 12week protocol were responders, who rated their improvement as moderate to significant on the General Response Assessment (GRA). Statistically significant improvements in ICIQ-OAB ($p=0.001$) and ICIQ LUTSqol ($p=0.000$) were reported for both daily and weekly stimulation groups. There were no statistically significant differences in ICIQ or bladder diary parameters between those with idiopathic and OAB of neurogenic origin.

Summary

Two small trials indicate that no additional benefit is conferred by a more than once weekly stimulation protocol for percutaneous or transcutaneous PTNS. However, it is possible that symptom improvement may be more rapid with a more frequent delivery protocol **(Level of Evidence: 2)**.

Further rigorous and well-reported trials are needed to establish the most effective timing and duration of PTNS protocols.

Recommendation

Percutaneous or transcutaneous PTNS should be delivered at least once weekly and the protocol determined by patient preference. **(Grade of Recommendation: B New)**.

1.3. What is the Effect of PTNS on LUTS Other Than UI?

No trials were identified that analysed the effect of PTNS in adults or men with other LUTS alone i.e. frequency of voiding, urgency, nocturia and integrated reporting of UI and other LUTS was a feature of all studies. For percutaneous PTNS compared with sham percutaneous PTNS, in one large well reported trial, the percutaneous PTNS group reported statistically significant improvements in voiding diary symptoms of frequency, night-time voids and voids with moderate to severe urgency, compared to the sham group (337). A small pilot trial reported reduced day and night time frequency and urgency after 12 weekly 30 minute percutaneous PTNS sessions by 63% of percutaneous PTNS subjects, although no EStimates of effect size were provided. The elimination of detrusor overactivity on repeat urodynamic testing was also shown (339).

For transcutaneous PTNS compared with sham transcutaneous PTNS one trial in care home residents (338) reported statistically significantly improved total American Urological Association Symptom Index AUASI urinary symptom scores for 87% of the transcutaneous PTNS group compared to 31% sham group ($p<0.001$).

When comparing percutaneous PTNS with another treatment one trial (341) reported significant reduction in bladder diary reports of void frequency, nocturia, moderate to severe urgency episodes in both groups and no between group differences.

One trial comparing two percutaneous PTNS protocols (342) reported a statistically significant reduction in frequency ($p=0.01$) for both once and three times weekly treatment regimes.

Table 35 Summary of data on PTNS vs no treatment in man and women

Study	Comparator groups	N	Study population	Modality details or parameters	Outcomes	Follow up
Percutaneous posterior tibial nerve stimulation						
Peters (2010) (1)	Treatment group: Percutaneous PTNS Active electrode: 34 gauge needle provides sensation. Inactive electrode: calcaneal surface electrode. Control group: Sham Percutaneous PTNS Placebo needle with sensation of insertion. Inactive	220	Adults (≥ 18) with OAB symptoms Males: 46 Females: 174 Results reported together	Pulse width: not reported Frequency: 20 Hz Intensity: 0.5-9mA according to sensory & motor response. Duration: 30 minutes Number sessions: 12 Programme length: 12 weeks	Primary outcome: Moderate/marked improvement in 7 level GRA at week 13 Secondary outcomes: Change in individual GRA symptoms 3-day voiding diary parameters OABq scores SF-36 QoL scores	Week 13
Vohra (2002) (2)	Treatment group: Percutaneous PTNS Active electrode: 34 gauge needle provides sensation. Inactive electrode: calcaneal surface electrode. Control group: Sham Percutaneous PTNS Described as 'PTNS treatment without nerve stimulation'	22	Adults with urgency frequency syndrome of > 6 months and urodynamic detrusor overactivity Males: not reported Females: not reported Results reported together	Pulse width: not reported Frequency: 20 Hz Intensity: 0.5-10mA according to sensory & motor response. Duration: 30 minutes Number sessions: 12 Programme length: 12 weeks	Micturition diary QOL questionnaires Repeat urodynamics SF-36	12 weeks
Transcutaneous posterior tibial nerve stimulation						
Booth 2013 (3)	Treatment group: Transcutaneous PTNS Active: Surface electrode medial malleolus provides sensation. Inactive: surface electrode 10cm proximal to medial malleolus, Control group: Sham Transcutaneous PTNS Surface electrodes X2 positioned below lateral malleolus and 10cm	30	Older adults (≥ 65) resident in care homes with urinary symptoms and/or incontinence Males: 6 Females: 24 Results reported together	Pulse width: 200 μ S Frequency: 10 Hz Intensity: 1-50mA according to sensory & motor threshold and subject comfort. Duration: 30 minutes Number sessions: 12 Programme length: 6 weeks	AUASI ICIQ-UI SF PVR	Week 6

	proximal to avoid posterior tibial nerve current applied 2 mA				
--	---	--	--	--	--

Footnotes; GRA : Global Response Assessment, UUI : urinary urge incontinence, OABq : Overactive Bladder Questionnaire, SF-36 : 36-Item Short Form Health Survey; AUASI : American Urological Association Symptom Index; ICIQ-UI SF : International Consultation on Incontinence Questionnaire on Urinary Incontinence Short Form; PVR : post-void residual urine volume; PTNS: Posterior tibial nerve stimulation

1. Peters KM, Carrico DJ, Perez-Marrero R, Khan AU, Wooldridge LS, Davis GL, *et al.* Randomized trial of percutaneous tibial nerve stimulation versus Sham efficacy in the treatment of overactive bladder syndrome: results from the SUMiT trial. *The Journal of urology.* 2010;183(4):1438.
2. Vohra AK, Britchford A, Neale E, Husain I, Waterfall N, editors. The efficacy of stoller afferent nerve stimulation in frequency/urgency syndrome: A randomised control trial. *Proceedings of the International Continence Society (ICS) 32nd Annual Meeting, Aug 28-30; 2002.*
3. Booth J, Hagen S, McClurg D, Norton C, MacInnes C, Collins B, *et al.* A feasibility study of transcutaneous posterior tibial nerve stimulation for bladder and bowel dysfunction in elderly adults in residential care. *Journal Of The American Medical Directors Association.* 2013;14(4):270.

Table 36 Summary of data on PTNS vs other active treatments in men and women

Author, year	Comparator groups	N	Study population	Modality details or parameters	Outcomes/results	Follow up
Peters (2009) (1)	Treatment group: Percutaneous PTNS Active electrode: 34 gauge needle provides sensation. Inactive electrode: calcaneal surface electrode. Comparator treatment group: Daily tolterodine ER 4mg	100	Adults with urinary frequency of at least 8 voids/24 hours Males: 6 Females: 94 Results reported together.	Pulse width: not reported Frequency: 20 Hz Intensity: 0.5-9mA according to sensory & motor response. Duration: 30 minutes Number sessions: 12 Programme length: 12 weeks	Primary outcome: mean reduction in number of urinary voids in 24 hours Secondary outcomes: change in 24 hour UUI episodes, number of voids causing waking, daily voided volume, episodes of urgency. OABq Investigator & subject OAB ratings using GRA.	12 weeks

Footnotes; GRA : Global Response Assessment, UUI : urinary urge incontinence, OABq : Overactive Bladder Questionnaire ER : extended release PTNS : Posterior tibial nerve stimulation

1. Peters KM, MacDiarmid SA, Wooldridge LS, Leong FC, Shobeiri SA, Rovner ES, *et al.* Randomised trial of percutaneous tibial nerve stimulation versus extended-release tolteridine: Results from the overactive bladder innovative therapy trial. *Journla of Urology.* 2009;182(3):1055-61.

Table 37 Summary of data on PTNS + another active vs PTNS

Author, year	Comparator groups	N	Study population	Modality details or parameters	Outcomes/results	Follow up
Karademir 2005 (1)	Treatment group: Percutaneous PTNS plus oral oxybutynin hydrochloride 5mg daily Active electrode: 34 gauge needle provides sensation. Inactive electrode: calcaneal surface electrode. Comparator treatment group: Percutaneous PTNS Active electrode: 34 gauge needle provides sensation. Inactive electrode: calcaneal surface electrode.	43	Adults with \geq 6 month history of OAB symptoms and DO on UDS Males: 5 Females: 38 Results reported together	Pulse width: 200 μ S Frequency: 20 Hz Intensity: 0.5-9mA according to sensory & motor response. Duration: 60 minutes Number sessions: 8 Programme length: 8 weeks	Outcomes measured with Bristol Urinary Questionnaire and voiding diary. Improvements in symptoms by >70%, 35-70% and <35% represented complete remission, partial remission and no response.	8 weeks

Posterior tibial nerve stimulation: PTNS

1. Karademir K, Baykal K, Sen B, Senkul T, Iseri C, Erden D. A peripheric neuromodulation technique for curing detrusor overactivity: Stoller afferent neurostimulation. Scandinavian journal of urology and nephrology. 2005;39(3):230.

1.4. Factors Affecting Outcomes

None of the included percutaneous PTNS trials addressed the effect of age or any other factor on prediction of outcome of PTNS. Effectiveness of transcutaneous PTNS in older adults resident in care homes was the focus of one study where the mean age was 84.2 years (338). The adherence to the transcutaneous PTNS was 100% for all participants, with no adverse effects reported and a response to therapy similar to that found with younger groups. A prospective study (347) of prognostic factors for successful percutaneous PTNS showed that gender, age, weight, body mass index, indication for percutaneous PTNS, duration of symptoms, number and type of previous treatments, number of UI episodes/24 hours, voiding frequency/24 hours and total IQoL scores were all unrelated to the success or not of percutaneous PTNS in men and women with OAB, non-obstructive urinary retention or chronic pelvic pain. A low Mental Component Summary Score on the SF-36 was a negative predictive factor for success of percutaneous PTNS, both subjectively and objectively. Additionally patients with detrusor over-activity had poorer outcomes than those without, as did those with low bladder capacity at baseline (143). This means that there is no reason to exclude older adults, those with a long symptom history, weight difficulties, severe symptoms or failure of previous treatments and they should be offered PTNS where indicated, except where recognised contraindications to PTNS, such as a cardiac pacemaker are present. Only in those patients with poor mental health and/or DO and/or low capacity bladders at baseline should the possibility of limited success be considered.

New factors are emerging which may influence understanding of potential effects for different diagnostic groups. In one pilot study (343) urinary neurotrophin levels (nerve growth factor and brain derived neurotrophic factor) were measured. Results indicated that for idiopathic OAB higher levels of nerve growth factor at baseline may predict poor response to transcutaneous PTNS. Level of brain derived neurotrophic factor significantly reduced over the treatment course in those who responded to transcutaneous PTNS, which suggests a potential biomarker for response in idiopathic OAB but the reduction was not seen in responders with neurological disease. Further investigation is required to fully understand the influence of these patient factors.

Summary

The evidence on which to base recommendations for best practice in the use of PTNS to treat OAB/UUI in men and women is sparse, for both percutaneous and transcutaneous PTNS. However it is sufficiently robust to support the use of percutaneous PTNS when less intensive and invasive behavioral treatment options have failed (**Level of Evidence: 1**) and there is the suggestion that percutaneous PTNS may be as effective as some drug therapy, making it a viable alternative (**Level of Evidence: 2**).

Only two small trials investigated transcutaneous PTNS but the promising results indicate that further well-designed and reported trials would allow decisions to be made about the place of transcutaneous PTNS in the treatment algorithms for OAB/UUI in men and women.

Health economic information is required to establish the cost effectiveness of the different forms of PTNS, particularly in comparison to pharmacotherapy.

Recommendations for practice:

In adults with OAB/UUI percutaneous PTNS is better for improving UUI than no treatment or sham and should be offered to adults with UUI/OAB who do not achieve satisfactory results from first-line lifestyle and behavioral interventions or drug therapy. (**Grade of Recommendation: B New**)

At least weekly PTNS sessions should be offered during an active treatment program with regular top-ups provided to sustain benefits for up to three years. (**Grade of Recommendation: B New**)

Transcutaneous PTNS is a safe treatment option and may be offered to frail older adults with UI or urinary symptoms however definitive evidence of effectiveness is needed. (**Grade of Recommendation: C New**)

Percutaneous PTNS can be offered as an alternative to tolterodine for OAB/UUI in adult men and women. (**Grade of Recommendation: B New**).

Oxybutynin may be considered in addition to percutaneous PTNS in adults with DO. (**Grade of Recommendation: B New**).

Future research directions:

Currently available evidence compares percutaneous PTNS with older antimuscarinics. Future rigorous trials should compare percutaneous PTNS with other commonly used antimuscarinics and beta 3 adrenergic agonists for efficacy and adverse effect profiles, in men and women with OAB/UUI.

The effectiveness of adding drug therapy to percutaneous PTNS should be investigated in high quality trials with adults with OAB/UUI.

Definitive evidence of the effectiveness of transcutaneous PTNS to treat OAB/UUI in adults is needed and its place in the treatment algorithm defined.

Research comparing transcutaneous PTNS with all types of drug therapy is required.

Direct comparison of percutaneous PTNS and transcutaneous PTNS to treat OAB/UUI in adults should be investigated.

Further rigorous and well-reported trials are needed to establish the most effective dose of percutaneous PTNS and transcutaneous PTNS, including the timing and duration of PTNS protocols.

Table 38 Summary of data PTNS protocols comparisons

Author, year	Comparator	N	Study population	Modality details or parameters	Outcomes	Follow up
Percutaneous posterior tibial nerve stimulation						
Finazzi-Agro 2005 (1)	Treatment group A: weekly Percutaneous PTNS Active electrode: 34 gauge needle provides sensation. Inactive electrode: calcaneal surface electrode. Comparator treatment group B: 3 x weekly Percutaneous PTNS Active electrode: 34 gauge needle provides sensation. Inactive electrode: calcaneal surface electrode.	35	Adults with refractory OAB syndrome Males : 7 Females: 28 Results reported together	Pulse width: not reported Frequency: 20 Hz Intensity: 0.5-9mA according to sensory & motor response. Duration: 30 minutes Number sessions: 12 Programme length: 12 weeks (Group A); 4 weeks (Group B)	24 hour BD IQoL SF36 UDS Success defined as those who reported micturition episodes/24hours or incontinence episodes/24 hours reduced by $\geq 50\%$	4 weeks (3X weekly PTNS) 12 weeks (1 X weekly PTNS)
Transcutaneous posterior tibial nerve stimulation						
Seth 2014 (2)	Treatment group Transcutaneous PTNS using Geko™ device weekly Comparator treatment group Transcutaneous PTNS using Geko™ device daily	48	Adults with idiopathic (24 subjects) or neuropathic (24 subjects) OAB Males NR Females NR Results reported together	Pulse width: not reported Frequency: not reported Intensity: not reported Duration: 30 minutes Number sessions: 12 (weekly group), 84 (daily group) Programme length: 12 weeks	Outcomes: Responder defined as those rating moderate to significant improvement on GRA at 12 weeks Change in individual GRA symptoms ICIQ-OAB, ICIQ-LUTSqol BD parameters	12 weeks

Footnotes; GRA : Global Response Assessment, UDS : Urodynamic studies; SF-36 :36-Item Short Form Health Survey; ICIQ-OAB : International Consultation on Incontinence Questionnaire on Overactive Bladder; ICIQ-LUTSqol : International Consultation on Incontinence Quality of Life questionnaire; BD parameters : bladder diary parameters; PTNS: Posterior tibial nerve stimulation

1. Finazzi Agrò E, Campagna A, Sciobica F, Petta F, Germani S, Zuccalà A, *et al.* Posterior tibial nerve stimulation: is the once-a-week protocol the best option? *Minerva urologica e nefrologica = The Italian journal of urology and nephrology.* 2005;57(2):119.
2. Seth J, Gonzales G, Haslam C, Ochulor J, Elneil S, Vashisht A, editors. Single centre randomised pilot study of two regimens (30mins daily or 30 mins weekly for 12 weeks) of Transcutaneous Tibial Nerve Stimulation using an adhesive skin patch for the treatment of Overactive Bladder (OAB) Symptoms. Proceedings of the 44th Annual Meeting of the International Continence Society (ICS), 2014 Oct 20-24; 2014.

REFERENCES

1. Bo K, Frawley H, Haylen B, Abramov Y, Almeida F, Berghmans B, et al. An international urogynecological association (IUGA) / international continence society (ICS) joint report on the terminology for the conservative and non-pharmacological management of female pelvic floor dysfunction (Accepted). N&U. 2016.
2. Moore K, Dumoulin C, Bradley C, Burgio K, Chambers T, Hagen S, et al. Adult Conservative Management. In: Abrams P, Cardozo L, Khoury S, Wein AJ, editors. 5th International Consultation on Incontinence. 5th ed. Paris: ICUD-EAU; 2013. p. 1101-227.
3. Group CI. Cochrane Incontinence Group [cited 2016 24 August 2016]. Available from: <http://incontinence.cochrane.org/our-reviews>
4. Grant AM, Cody DJ, Glazener CMA, Hay-Smith J, Herbison P, Lapitan MC, et al. About The Cochrane Collaboration (Cochrane Review Groups (CRGs)2012.
5. Imamura M, Williams K, Wells M, McGrother C. Lifestyle interventions for the treatment of urinary incontinence in adults. *Cochrane Database Syst Rev.* 2015;12:CD003505.
6. Subak LL, Wing R, West DS, Franklin F, Vittinghoff E, Creasman JM, et al. Weight loss to treat urinary incontinence in overweight and obese women. *N Engl J Med.* 2009;360(5):481-90.
7. Phelan S, Kanaya AM, Subak LL, Hogan PE, Espeland MA, Wing RR, et al. Weight Loss Prevents Urinary Incontinence in Women With Type 2 Diabetes: Results From the Look AHEAD Trial. *Journal of Urology.* 2012;187(3):939-44.
8. Auwad W, Steggles P, Bombieri L, Waterfield M, Wilkin T, Freeman R. Moderate weight loss in obese women with urinary incontinence: a prospective longitudinal study. *Int Urogynecol J Pelvic Floor Dysfunct.* 2008;19(9):1251-9.
9. Pinto AM, Subak LL, Nakagawa S, Vittinghoff E, Wing RR, Kusek JW, et al. The effect of weight loss on changes in health-related quality of life among overweight and obese women with urinary incontinence. *Quality of Life Research.* 2012;21(10):1685-94.
10. Vissers D, Neels H, Vermandel A, De Wachter S, Tjalma WAA, Wyndaele JJ, et al. The effect of non surgical weight loss interventions on urinary incontinence in overweight women: a systematic review and meta analysis. *Obesity Reviews.* 2014;15(7):610-7.
11. McGrother CW, Donaldson MMK, Thompson J, Wagg A, Tincello DG, Manktelow BN. Etiology of overactive bladder: A diet and lifestyle model for diabetes and obesity in older women. *Neurourology and urodynamics.* 2012;31(4):487-95.
12. Jorgensen S, Hein HO, Gyntelberg F. Heavy lifting at work and risk of genital prolapse and herniated lumbar disc in assistant nurses. *Occupational medicine.* 1994;44(1):47-9.
13. Nygaard IE, Shaw JM, Bardsley T, Egger MJ. Lifetime physical activity and female stress urinary incontinence. *American Journal of Obstetrics and Gynecology.* 2015;213(1).
14. Wyman J, Allen A, Hertsgaard L, Overson E, Allen S, Hatsukami D. Effect of Smoking Cessation on Overactive Bladder Symptoms in Adults: A Pilot Study. *Neurourology and urodynamics.* 2014;33(6):866-7.
15. Wells MJ, Jamieson K, Markham TC, Green SM, Fader MJ. The effect of caffeinated versus decaffeinated drinks on overactive bladder: a doubleblind, randomized, crossover study. *Journal of wound, ostomy, and continence nursing : official publication of The Wound, Ostomy and Continence Nurses Society.* 2014;41(4):371-8.
16. Davis NJ, Vaughan CP, Johnson TM, Goode PS, Burgio KL, Redden DT, et al. Caffeine Intake and its Association with Urinary Incontinence in United States Men: Results from National and Nutrition Examination Surveys 2005-2006 and 2007-2008. *Journal of Urology.* 2013;189(6):2170-4.
17. Gleason JL, Richter HE, Redden DT, Goode PS, Burgio KL, Markland AD. Caffeine and urinary incontinence in US women. *International Urogynecology Journal.* 2013;24(2):295-302.
18. Hirayama F, Lee AH. Is caffeine intake associated with urinary incontinence in Japanese adults? *J Prev Med Public Health.* 2012;45(3):204-8.
19. Kegel AH. Progressive resistance exercise in the functional restoration of the perineal muscles. *Am J Obstet Gynecol.* 1948;56(2):238-48.
20. Delancey JO. Structural aspects of urethrovaginal function in the female. *Neurourology and urodynamics.* 1988;7(6):509-19.
21. Miller J, Ashton-Miller J, DeLancey J. The Knack: use of precisely timed pelvic muscle contraction can reduce leakage in SUI. *Neurourology and urodynamics.* 1996;15(4):392-3.

22. Godec C, Cass AS, Ayala GF. Bladder inhibition with functional electrical stimulation. *Urology*. 1975;6(6):663-6.
23. Burgio KL, Whitehead WE, Engel BT. Urinary incontinence in the elderly. Bladder-sphincter biofeedback and toileting skills training. *Ann Intern Med*. 1985;103(4):507-15.
24. McClurg D, Frawley H, Hay-Smith J, Dean S, Chen SY, Chiarelli P, et al. Scoping review of adherence promotion theories in pelvic floor muscle training - 2011 ICS state-of-the-science seminar research paper i of iv. *Neurourology and urodynamics*. 2015;34(7):606-14.
25. Dumoulin C, Alewijnse D, Bo K, Hagen S, Stark D, Van Kampen M, et al. Pelvic-Floor-Muscle Training Adherence: Tools, Measurements and Strategies-2011 ICS State-of-the-Science Seminar Research Paper II of IV. *Neurourology and urodynamics*. 2015;34(7):615-21.
26. Hay-Smith J, Dean S, Burgio K, McClurg D, Frawley H, Dumoulin C. Pelvic-floor-muscle-training adherence "modifiers": A review of primary qualitative studies-2011 ICS State-of-the-Science Seminar research paper III of IV. *Neurourology and urodynamics*. 2015;34(7):622-31.
27. Frawley HC, McClurg D, Mahfooza A, Hay-Smith J, Dumoulin C. Health professionals' and patients' perspectives on pelvic floor muscle training adherence-2011 ICS State-of-the-Science Seminar research paper IV of IV. *Neurourology and urodynamics*. 2015;34(7):632-9.
28. Dumoulin C, Hay-Smith J, Frawley H, McClurg D, Alewijnse D, Bo K, et al. 2014 consensus statement on improving pelvic floor muscle training adherence: International Continence Society 2011 State-of-the-Science Seminar. *Neurourology and urodynamics*. 2015;34(7):600-5.
29. Ahlund S, Nordgren B, Wilander EL, Wiklund I, Friden C. Is home-based pelvic floor muscle training effective in treatment of urinary incontinence after birth in primiparous women? A randomized controlled trial. *Acta Obstetrica et Gynecologica Scandinavica*. 2013;92(8):909-15.
30. Barakat R, Pelaez M, Montejo R, Luaces M, Zakyntinaki M. Exercise during pregnancy improves maternal health perception: A randomized controlled trial. *American journal of obstetrics and gynecology*. 2011;204(5):402.
31. Bo K, Haakstad LA. Is pelvic floor muscle training effective when taught in a general fitness class in pregnancy? A randomised controlled trial. *Physiotherapy*. 2011;97(3):190-5.
32. Fritel X, de TR, Bader G, Savary D, Gueye A, Deffieux X, et al. Preventing Urinary Incontinence With Supervised Prenatal Pelvic Floor Exercises: A Randomized Controlled Trial. *Obstetrics & Gynecology*. 2015;126(2):370-7.
33. Hilde G, Staer-Jensen J, Siafarikas F, Ellstrom EM, Bo K. Postpartum pelvic floor muscle training and urinary incontinence: a randomized controlled trial [Erratum appears in: *Obstet Gynecol*. 2014 Sep;124(3):639]. *Obstetrics & Gynecology*. 2013;122(6):1231-8.
34. Kim EY, Kim SY, Oh DW. Pelvic floor muscle exercises utilizing trunk stabilization for treating postpartum urinary incontinence: randomized controlled pilot trial of supervised versus unsupervised training. *Clinical Rehabilitation*. 2012;26(2):132-41.
35. Ko PC, Liang CC, Chang SD, Lee JT, Chao AS, Cheng PJ. A randomized controlled trial of antenatal pelvic floor exercises to prevent and treat urinary incontinence. *Int Urogynecol J*. 2011;22(1):17-22.
36. Kocaoz S, Eroglu K, Sivaslioglu AA. Role of pelvic floor muscle exercises in the prevention of stress urinary incontinence during pregnancy and the postpartum period. *Gynecologic & Obstetric Investigation*. 2013;75(1):34-40.
37. Miquelutti MA, Cecatti JG, Makuch MY. Evaluation of a birth preparation program on lumbopelvic pain, urinary incontinence, anxiety and exercise: A randomized controlled trial. *BMC Pregnancy and Childbirth*. 2013;13(154).
38. Pelaez M, Gonzalez-Cerron S, Montejo R, Barakat R. Pelvic floor muscle training included in a pregnancy exercise program is effective in primary prevention of urinary incontinence: a randomized controlled trial. *Neurourology & Urodynamics*. 2014;33(1):67-71.
39. Stafne S, Salvesen K, Romundstad P, Torjusen I, Morkved S. Does regular exercise including pelvic floor muscle training prevent urinary and anal incontinence during pregnancy? A randomised controlled trial. *BJOG: an International Journal of Obstetrics & Gynaecology*. 2012;119(10):1270-80.
40. Boyle R, Hay-Smith EJ, Cody JD, Morkved S. Pelvic floor muscle training for prevention and treatment of urinary and faecal incontinence in antenatal and postnatal women. *Cochrane Database Syst Rev*. 2012;10:CD007471.
41. Diokno AC, Sampsel CM, Herzog AR, Raghunathan TE, Hines S, Messer K, et al. Prevention of urinary incontinence by behavioral modification program: a randomized, controlled trial among older

- women in the community. *The Journal of urology*. 2004;171(3):1165-71.
42. Berzuk K, Shay B. Effect of increasing awareness of pelvic floor muscle function on pelvic floor dysfunction: a randomized controlled trial. *International urogynecology journal*. 2015;26(6):837-44.
 43. Lucio AC, Perissinoto MC, Natalin RA, Prudente A, Damasceno BP, D'ancona CAL. A comparative study of pelvic floor muscle training in women with multiple sclerosis: its impact on lower urinary tract symptoms and quality of life. *Clinics*. 2011;66(9):1563-8.
 44. Tak EC, van Hespden A, van Dommelen P, Hopman-Rock M. Does improved functional performance help to reduce urinary incontinence in institutionalized older women? A multicenter randomized clinical trial. *BMC geriatrics*. 2012;12(1):1.
 45. Voorham J, De Wachter S, Van Den Bos T, Putter H, Lycklama à Nijeholt G, Voorham-Van Der Zaalm P. The effect of EMG biofeedback assisted pelvic floor muscle therapy on symptoms of the overactive bladder syndrome in women: A randomised controlled trial 2015.
 46. Yang EJ, Lim J-Y, Rah UW, Kim YB. Effect of a pelvic floor muscle training program on gynecologic cancer survivors with pelvic floor dysfunction: a randomized controlled trial. *Gynecologic oncology*. 2012;125(3):705-11.
 47. Alves FK, Ricetto C, Adami DB, Marques J, Pereira LC, Palma P, et al. A pelvic floor muscle training program in postmenopausal women: A randomized controlled trial. *Maturitas*. 2015;81(2):300-5.
 48. Singh A, Kumari S, Jain V. Why behavior therapy for urinary incontinence has been ignored by doctors/women? . *Climacteric*2011.
 49. Kang H, Hong G-RS. Effect of Muscle Strength Training on Urinary Incontinence and Physical Function: A Randomized Controlled Trial in Long-term Care Facilities. *Journal of Korean Academy of Nursing*. 2015;45(1).
 50. Pereira VS, Correia GN, Driusso P. Individual and group pelvic floor muscle training versus no treatment in female stress urinary incontinence: a randomized controlled pilot study. *European Journal of Obstetrics & Gynecology and Reproductive Biology*. 2011;159(2):465-71.
 51. Jahromi MK, Talebizadeh M, Mirzaei M. The Effect of Pelvic Muscle Exercises on Urinary Incontinency and Self Esteem of Elderly Females With Stress Urinary Incontinency, 2013. *Global journal of health science*. 2015;7(2):71.
 52. Asklund I, editor Treatment of stress urinary incontinence via a smartphone application. Report from an ongoing randomised controlled study. *Medicine 20 Conference*; 2014: JMIR Publications Inc., Toronto, Canada.
 53. Abdulaziz K, Hasan T. Role of pelvic floor muscle therapy in obese perimenopausal females with stress incontinence: A randomized control trial. *The Internet Journal of Gynecology and Obstetrics*. 2012;16(2):34-42.
 54. Tosun OC, Mutlu EK, Ergenoglu A, Yeniel A, Tosun G, Malkoc M, et al. Does pelvic floor muscle training abolish symptoms of urinary incontinence? A randomized controlled trial. *Clinical rehabilitation*. 2015;29(6):525-37.
 55. Dumoulin C, Sran M, Lieblisch P, Wilson P. Physiotherapy significantly reduces leakage in postmenopausal women with osteoporosis and urinary incontinence: result of a parallel randomised controlled trial. *Neurology & Urodynamics*. 2011;30(6):985.
 56. Ferreira S, Ferreira M, Carvalhais A, Santos PC, Rocha P, Brochado G. Reeducation of pelvic floor muscles in volleyball athletes. *Revista da Associação Médica Brasileira*. 2014;60(5):428-33.
 57. McLean L, Varette K, Gentilcore-Saulnier E, Harvey MA, Baker K, Sauerbrei E. Pelvic floor muscle training in women with stress urinary incontinence causes hypertrophy of the urethral sphincters and reduces bladder neck mobility during coughing. *Neurourology and urodynamics*. 2013;32(8):1096-102.
 58. Kim H, Yoshida H, Suzuki T. The effects of multidimensional exercise treatment on community dwelling elderly Japanese women with stress, urge, and mixed urinary incontinence: a randomized controlled trial. *International journal of nursing studies*. 2011;48(10):1165-72.
 59. Leong B, Mok N. Effectiveness of a new standardised Urinary Continence Physiotherapy Programme for community dwelling older women in Hong Kong. *Hong Kong Medical Journal* 2015;21(1):30-7.
 60. Rutledge TL, Rogers R, Lee S-J, Muller CY. A pilot randomized control trial to evaluate pelvic floor muscle training for urinary incontinence among gynecologic cancer survivors. *Gynecologic oncology*. 2014;132(1):154-8.
 61. Assis LC, Dias A, Barbosa AMP, Santini ACM, Sousa VO, Vianna LS. Contribution of early intensive prolonged pelvic floor exercises. *American Journal of Epidemiology*. 2011;(Abstract number 782-S). 173(Suppl 11):S196.

62. Siva Priya R, Kokila V, Malai K, Kumar S. Effectiveness of Antenatal Motor Relearning Approach of Diaphragm, Deep Abdominal and Pelvic Floor Muscles Versus Kegels Exercises on Postpartum Pelvic Floor Muscle Strength. *Indian Journal of Physiotherapy & Occupational Therapy*. 2014;8(1):203-7.
63. Bo K, Hilde G, Staer-Jensen J, Braekken IH. Can the Paula method facilitate co-contraction of the pelvic floor muscles? A 4D ultrasound study. *Int Urogynecol J*. 2011;22(6):671-6.
64. Kamel D, Thabet A, Tantawy S, Radwan M. Effect of abdominal versus pelvic floor muscle exercises in obese Egyptian women with mild stress urinary incontinence: A randomised controlled trial. *Hong Kong Physiotherapy Journal* 2013;31(1):12-8.
65. Cruz C, Riesco ML, Zanetti M. Supervised pelvic floor muscle training to treat urinary incontinence during pregnancy: A randomized controlled trial. *Neurourology and urodynamics*. 2014;33(6(abstract#403)):867-8.
66. Lamb SE, Pepper J, Lall R, Jorstad-Stein EC, Clark MD, Hill L, et al. Group treatments for sensitive health care problems: a randomised controlled trial of group versus individual physiotherapy sessions for female urinary incontinence. *BMC Womens Health*. 2009;9:26.
67. Liebergall-Wischnitzer M, Paltiel O, Lavy Y, Sheviki D, Manor O, Hochner-Celnikier D. Long term efficacy of Paula method as compared with pelvic floor muscle training for stress urinary incontinence in women. *Journal of wound, ostomy, and continence nursing : official publication of The Wound, Ostomy and Continence Nurses Society*. 2013;40(1):90-6.
68. Junginger B, Metz M, Baessler K. Comparison of a bladder neck effective pelvic floor rehabilitation program and EMG biofeedback augmented pelvic floor muscle training: a randomized controlled trial. *Neurourology and urodynamics*. 2014;33(6):970-1.
69. Kashanian M, Ali SS, Nazemi M, Bahasadri S. Evaluation of the effect of pelvic floor muscle training (PFMT or Kegel exercise) and assisted pelvic floor muscle training (APFMT) by a resistance device (Kegelmaster device) on the urinary incontinence in women "comparison between them : a randomized trial". *European Journal of Obstetrics & Gynecology and Reproductive Biology*. 2011;159(1):218-23.
70. Galea M, Tisseverasinghe S, Sherburn M. A randomised controlled trial of transabdominal ultrasound biofeedback for pelvic floor muscle training in older women with urinary incontinence. *Australian and New Zealand Continence Journal*. 2013;19(2):38-44.
71. Ferreira M, Clara P, Duarte JA, Rodrigues R. Exercise programmes for women with stress urinary incontinence. *Primary Health Care*. 2012;22(3):24-7.
72. Delgado D, White P, Trochez R, Drake MJ. A pilot randomised controlled trial of the pelvic toner device in female stress urinary incontinence. *nt Urogynecol J* 2013;24:1739-45.
73. Ong TA, Khong SY, Ng KL, Ting JRS, Kamal N, Yeoh WS, et al. Using the Vibrance Kegel Device With Pelvic Floor Muscle Exercise for Stress Urinary Incontinence: A Randomized Controlled Pilot Study. *Urology*. 2015;86(3):487-91.
74. Hirakawa T, Suzuki S, Kato K, Gotoh M, Yoshikawa Y. Randomized controlled trial of pelvic floor muscle training with or without biofeedback for urinary incontinence. *International Urogynecology Journal*. 2013;24(8):1347-54.
75. Fitz FF, Stupp L, Costa TF, Sartori MG, Girao MJ, Castro RA. Supervised versus non-supervised pelvic floor muscle training for stress urinary incontinence: Randomized controlled trial. *Int Urogyn J*. 2015;26(Suppl1):145-6.
76. Jordre B, Schweinle W. Comparing resisted hip rotation with pelvic floor muscle training in women with stress urinary incontinence: A pilot study. *J Womens Health Phys Therap*. 2014;38(2):81-9.
77. Konstantinidou E, Kalaitzi M, Mytilekas K, Mikos T, Ioannides E, Hatzichristou D. Is there a role for training of the transversus abdominis muscles in the physiotherapy schemes applied in the treatment of female urinary incontinence? . *Proceedings of the 43rd Annual Meeting of the International Continence Society (ICS)*. 2013.
78. Donahoe-Fillmore B, Chomy W, Braehler CJ, Ingle A, Kennedy J, Osterfeld V. A comparison of two pelvic floor muscle training programs in females with stress urinary incontinence: A pilot study. *The Journal of Applied Research*. 2011;11(2):73-83.
79. Prudencio C, Barbosa A, Derobio AL, Anezio A, Vesentini G, Almeida AP, editors. Comparison of three physiotherapy methods for treatment of stress urinary incontinence: impact in quality of life and muscle function. *Proceedings of the 44th Annual Meeting of the International Continence Society (ICS)*, 2014 Oct 20-24, 2014; 2014; Rio de Janeiro, Brazil.
80. Shin J, Sul C, Na Y, Song K, Lim J, Yun C, et al. Effectiveness of perinometer biofeedback pelvic floor muscle exerciser with ExTT-101tm

in female stress urinary incontinence. Proceedings of the 42nd Annual Meeting of the International Continence (ICS) (Beijing, China). 2012.

81. Manonai J, Kamthaworn S, Petsarb K, Wattanayingcharoenchai R. Development of a pelvic floor muscle strength evaluation device Neurourology and urodynamics. 2013;32(6):657-8.
82. Marques S, Haddad J, Passaro A, Silveira S, Baracat E, Ferreira E. Effectiveness of the strengthening of pelvic floor muscles, adductors of hip, gluteus maximus and gluteus medius in the treatment of stress urinary incontinence: blind randomized clinical trial - partial results. Proceedings of the 44th Annual Meeting of the International Continence Society (ICS). 2014.
83. Dumoulin C. Physiotherapy compared to individual physiotherapy to treat urinary incontinence in aging women: A randomized controlled trial. Ref ID: 60909 Trials registry number(s): NCT02039830. 2012.
84. Buen M. Clinical trial: influence of the practice of Pilates on the incidence of urinary incontinence, perineal strength low back pain in the third trimester. Ref ID: 64504 Trials registry number(s): RBR-4wkr8y. 2014.
85. Navarro B, MT. Randomized Clinical Trial on the Effectiveness of Hipopressive Exercises Versus Classical Perineal Physiotherapy in Women With Pelvic Floor Dysfunction. Ref ID: 64750 Trials registry number(s): NCT02259712. 2013.
86. Rao B, Nayak S. Prevalence and Physiotherapy intervention for Pelvic floor dysfunction in women of Udipi Taluk. Ref ID: 47889 Trials registry number(s): CTRI/2012/12/003226. 2012.
87. Hagen S. OPAL: A multicentre randomised trial of the effectiveness and cost effectiveness of basic versus bio feedback mediated intensive pelvic floor muscle training for female stress or mixed urinary incontinence. Ref ID: 64519 Trials registry number(s): ISRCTN57746448; UKCRN15841 2014.
88. Haruna M, Asai Y. Effect of postpartum pelvic floor muscle training with ultrasound biofeedback on recovery of pelvic floor muscle function: a randomized controlled trial. Ref ID: 66324 Trials registry number(s): JPRN-UMIN000015878. 2014.
89. Bertotto A. Evaluating the effectiveness of pelvic Floor muscle training with and without EMG biofeedback and quality of life in peri and postmenopausal women with stress urinary incontinence. Ref ID: 67535 Trials registry number(s): NCT02275728. 2014.
90. Liebergall-Wischnitzer M, Hochner-Celnikier D, Lavy Y, Manor O, Shveiky D, Paltiel O. Randomized trial of circular muscle versus pelvic floor training for stress urinary incontinence in women. J Womens Health (Larchmt). 2009;18(3):377-85.
91. Delgado D, Drake M. A randomized study to compare the pelvic toner device against standard pelvic floor exercises in the treatment of stress urinary incontinence in women (Abstract 486). 39th annual meeting of the International Continence Society; Sept 29th to October 30rd; San Francisco, California 2009.
92. Herbison GP, Dean N. Weighted vaginal cones for urinary incontinence. Cochrane Database Syst Rev. 2013;7:CD002114.
93. Harvey MA, Johnston SL. A randomized, single blind, prospective trial comparing pelvic floor physiotherapy with biofeedback versus weighted vaginal cones in the treatment of female genuine stress urinary incontinence: a pilot study. Int J Urogyn J. 2006;17(Suppl 2):S235-S6.
94. Pereira VS, de Melo MV, Correia GN, Driusso P. Vaginal cone for post menopausal women with stress urinary incontinence: randomized, controlled trial. Climacteric. 2012;15(1):45-51.
95. Labrie J, Berghmans BL, Fischer K, Milani AL, van der Wijk I, Smalbraak DJ, et al. Surgery versus physiotherapy for stress urinary incontinence. N Engl J Med. 2013;369(12):1124-33.
96. Kenton K, Barber M, Wang L, Hsu Y, Rahn D, Whitcomb E, et al. Pelvic floor symptoms improve similarly after pessary and behavioral treatment for stress incontinence. Female Pelvic Med Reconstr Surg. 2012;18(2):118-21.
97. Richter HE, Burgio KL, Brubaker L, Nygaard IE, Ye W, Weidner A, et al. Continence pessary compared with behavioral therapy or combined therapy for stress incontinence: a randomized controlled trial. Obstet Gynecol. 2010;115(3):609-17.
98. Kafri R, Deutscher D, Shames J, Golombp J, Melzer I. Randomized trial of a comparison of rehabilitation or drug therapy for urgency urinary incontinence: 1-year follow-up. Int Urogynecol J. 2013;24(7):1181-9.
99. Golmakani N, Khadem N, Arabipoor A, Kerigh BF, Esmaily H. Behavioral Intervention Program versus Vaginal Cones on Stress Urinary Incontinence and Related Quality of Life: A Randomized Clinical Trial. Oman Med J. 2014;29(1):32-8.

100. Pereira VS, de Melo MV, Correia GN, Driusso P. Long term effects of pelvic floor muscle training with vaginal cone in post-menopausal women with urinary incontinence: a randomized controlled trial. *Neurourology and urodynamics*. 2013;32(1):48-52.
101. Furst MC, Mendonca RR, Rodrigues AO, Matos LL, Pompeo AC, Bezerra CA. Long term results of a clinical trial comparing isolated vaginal stimulation with combined treatment for women with stress incontinence. *Einstein*. 2014;12(2):168-74.
102. Kaya S, Akbayrak T, Gursen C, Beksac S. Short-term effect of adding pelvic floor muscle training to bladder training for female urinary incontinence: a randomized controlled trial. *International Urogynecology Journal*. 2015;26(2):285-93.
103. Capobianco G, Donolo E, Borghero G, Dessole F, Cherchi PL, Dessole S. Effects of intravaginal estriol and pelvic floor rehabilitation on urogenital aging in postmenopausal women. *Archives of gynecology and obstetrics*. 2012;285(2):397-403.
104. Barber MD, Brubaker L, Burgio KL, Richter HE, Nygaard I, Weidner AC, et al. Comparison of 2 transvaginal surgical approaches and perioperative behavioral therapy for apical vaginal prolapse: the OPTIMAL randomized trial. *JAMA*. 2014;311(10):1023-34.
105. Peattie AB, Plevnik S, Stanton SL. Vaginal cones: a conservative method of treating genuine stress incontinence. *British Journal of Obstetrics and Gynaecology*. 1988;95(10):1049-53.
106. Hahn I, Milsom I, Ohlsson BL, Ekelund P, Uhlemann C, Fall M. Comparative assessment of pelvic floor function using vaginal cones, vaginal digital palpation and vaginal pressure measurements. *Gynecologic and Obstetric Investigation*. 1996;41(4):269-74.
107. Porta Roda O, Simo Gonzalez M, Reula Blasco MC, Diaz Lopez MA, Diaz Bellido P, Vara Paniagua J. Use of a vaginal spheres device in the conservative treatment of stress urinary incontinence: a randomized controlled trial. *Neurourology and urodynamics*. 2013;32(6):661-3.
108. Stupp L, Yamamoto D, Fonseca T, Resende AM, Ploger C, Oliveira E. Proprioception and awareness training prior pelvic floor muscle exercises for treatment of urinary incontinence: randomized controlled trial. *Int Urogyn J*. 2011;22(Supp 1):S162-S4.
109. Santos PF, Oliveira E, Zanetti MR, Arruda RM, Sartori MG, Girao MJ, et al. [Electrical stimulation of the pelvic floor versus vaginal cone therapy for the treatment of stress urinary incontinence]. *Rev Bras Ginecol Obstet*. 2009;31(9):447-52.
110. Imamura M, Abrams P, Bain C, Buckley B, Cardozo L, Cody J, et al. Systematic review and economic modelling of the effectiveness and cost-effectiveness of non-surgical treatments for women with stress urinary incontinence. *Health Technology Assessment (Winchester, England)*. 2010;14(40):1-506.
111. Grant AM, Cody DJ, Glazener CMA, Hay-Smith J, Herbison P, Lapitan MC, et al. Cochrane Incontinence Group. About the Cochrane Collaboration (Cochrane Review Groups (CRGs)). *The Cochrane Library [serial on-line]*. 2007(4).
112. Beuttenmüller L, Cader SA, Macena RHM, Araujo NDS, Nunes EFC, Dantas EHM. Floor muscles contraction in women with stress urinary incontinence underwent to exercises and electric stimulation therapy: a randomized study [Portuguese]. *Fisioterapia e Pesquisa*. 2011;18(3):210-6.
113. Correia GN, Pereira VS, Hirakawa HS, Driusso P. Effects of surface and intravaginal electrical stimulation in the treatment of women with stress urinary incontinence: randomized controlled trial. *European Journal of Obstetrics and Gynecology and Reproductive Biology*. 2014;173(1):113-8.
114. Lopès P, Rimbault F, Scheffler M, Andre C, Cappelletti MC, Mares P. [Multicentric prospective randomized and controlled study assessing effectiveness of intravaginal electrostimulation at home compared to usual care in female patients with urinary incontinence and prior perineal reeducation]. [French]. *Gynecologie, Obstetrique & Fertilité*. 2014;42(11):779-86.
115. Pereira VS, Bonioli L, Correia GN, Driusso P. [Effects of surface electrical stimulation in older women with stress urinary incontinence: a randomized controlled pilot study]. [Spanish]. *Actas Urológicas Espanolas*. 2012;36(8):491-6.
116. Terlikowski R, Dobrzycka B, Kinalski M, Kuryliszyn-Moskal A, Terlikowski SJ. Transvaginal electrical stimulation with surface-EMG biofeedback in managing stress urinary incontinence in women of premenopausal age: a double-blind, placebo controlled, randomized clinical trial. *International Urogynecology Journal*. 2013;24(10):1631-8.
117. Hofbauer J, Preisinger F, Nurnberger N. [The value of physical therapy in genuine female stress incontinence]. [German]. *Zeitschrift Fur Urologie Und Nephrologie*. 1990;83(5):249-54.

118. Bo K, Talseth T, Holme I. Single blind, randomised controlled trial of pelvic floor exercises, electrical stimulation, vaginal cones, and no treatment in management of genuine stress incontinence in women. *BMJ*. 1999;318(7182):487-93.
119. Castro RA, Arruda RM, Zanetti MR, Santos PD, Sartori MG, Girao MJ. Single-blind, randomized, controlled trial of pelvic floor muscle training, electrical stimulation, vaginal cones, and no active treatment in the management of stress urinary incontinence. *Clinics (Sao Paulo, Brazil)*. 2008;63(4):465-72.
120. Luber KM, Wolde-Tsadik G. Efficacy of functional electrical stimulation in treating genuine stress incontinence: a randomized clinical trial. *Neurourology & Urodynamics*. 1997;16(6):543-51.
121. Laycock J, Jerwood D. Does pre modulated interferential therapy cure genuine stress incontinence? *Physiotherapy*. 1993;79(8):553-60.
122. Brubaker L, Benson JT, Bent A, Clark A, Shott S. Transvaginal electrical stimulation for female urinary incontinence. *American Journal of Obstetrics & Gynecology*. 1997;177(3):536-40.
123. Sand PK, Richardson DA, Staskin DR, Swift SE, Appell RA, Whitmore KE, et al. Pelvic floor electrical stimulation in the treatment of genuine stress incontinence: a multicenter, placebo-controlled trial. *American Journal of Obstetrics & Gynecology*. 1995;173(1):72-9.
124. Henalla SM, Hutchins CJ, Robinson P, MacVicar J. Non-operative methods in the treatment of female genuine stress incontinence of urine. *Journal of Obstetrics and Gynaecology*. 1989;9(3):222-5.
125. Jeyaseelan SM, Haslam EJ, Winstanley J, Roe BH, Oldham JA. An evaluation of a new pattern of electrical stimulation as a treatment for urinary stress incontinence: a randomized, double-blind, controlled trial. *Clinical Rehabilitation*. 2000;14(6):631-40.
126. Alves PG, Nunes FR, Guirro EC. Comparison between two different neuromuscular electrical stimulation protocols for the treatment of female stress urinary incontinence: a randomized controlled trial. *Revista Brasileira de Fisioterapia*. 2011;15(5):393-8.
127. Huebner M, Riegel K, Hinninghofen H, Wallwiener D, Tunn R, Reisenauer C. Pelvic floor muscle training for stress urinary incontinence: a randomized, controlled trial comparing different conservative therapies. *Physiother Res Int*. 2011;16(3):133-40.
128. Maher RM, Crowe L, Caulfield B. Comparison of two methods of electrical muscle stimulation training of pelvic floor musculature in the treatment of stress urinary incontinence (Abstract). *Journal of Women's Health Physical Therapy*. 2009;33(1):24.
129. Wilson PD, Al Samarrai T, Deakin M, Kolbe E, Brown AD. An objective assessment of physiotherapy for female genuine stress incontinence. *British Journal of Obstetrics & Gynaecology*. 1987;94(6):575-82.
130. Knight S. Evaluation of neuromuscular electrical stimulation in the treatment of genuine stress incontinence. *Physiotherapy*. 1998;84(2):61-71.
131. Wise BG, Haken J, Cardozo LD, Plevnik S. A comparative study of vaginal cone therapy, cones + Kegel exercises, and maximal electrical stimulation in the treatment of female genuine stress incontinence (Abstract number 76). *Neurourology & Urodynamics*. 1993;12(4):436-7.
132. Arruda RM, Castro RA, Sousa GC, Sartori MG, Baracat EC, Girao MJ. Prospective randomized comparison of oxybutynin, functional electrostimulation, and pelvic floor training for treatment of detrusor overactivity in women. *International Urogynecology Journal*. 2008;19(8):1055-61.
133. Lin LS, Song YF, Song J, Chen MF. [A clinical study of pelvic floor electrical stimulation in treatment of overactive bladder] [Chinese]. *Chung-Hua Fu Chan Ko Tsa Chih [Chinese Journal of Obstetrics & Gynecology]*. 2004;39(12):801-3.
134. Wang AC, Chih SY, Chen MC. Comparison of electric stimulation and oxybutynin chloride in management of overactive bladder with special reference to urinary urgency: a randomized placebo controlled trial. *Urology*. 2006;68(5):999-1004.
135. Smith JJ, 3rd. Intravaginal stimulation randomized trial. *The Journal of urology*. 1996;155(1):127-30.
136. Jeyaseelan S, Oldham JA. Can the effects of pelvic floor muscle exercises be enhanced with a new pattern of electrical stimulation in women with stress incontinence (Abstract). *Proceedings of the World Confederation for Physical Therapy (WCPT), 14th International Congress, 7-12 June, Barcelona. 2003.*
137. Patil SP, Nagrale AV, Ganvir SD. Additive effect of interferential therapy over pelvic floor exercises. *International Journal of Therapy & Rehabilitation*. 2010;17(11):596-602.
138. Goode PS, Burgio KL, Locher JL, Roth DL, Umlauf MG, Richter HE, et al. Effect of behavioral training with or without pelvic floor electrical stimulation on stress incontinence in

- women: a randomized controlled trial. *JAMA*. 2003;290(3):345-52.
139. Indrekvam S, Sandvik H, Hunskaar S. A Norwegian national cohort of 3198 women treated with home managed electrical stimulation for urinary incontinence: Effectiveness and treatment results. *Scandinavian Journal of Urology and Nephrology*. 2001;35(1):32-9.
 140. Moore KN. Treatment of urinary incontinence in men with electrical stimulation: is practice evidence based? *Journal of Wound, Ostomy, & Continence Nursing*. 2000;27(1):20-31.
 141. Rai BP, Cody JD, Alhasso A, Stewart L. Anticholinergic drugs versus non drug active therapies for non neurogenic overactive bladder syndrome in adults. *The Cochrane Database Of Systematic Reviews*. 2012;12:CD003193.
 142. Slovak M, Chapple CR, Barker AT. Non-invasive transcutaneous electrical stimulation in the treatment of overactive bladder. *Asian Journal of Urology*. 2015;2(2):92-101.
 143. Vandoninck V, van Balken MR, Finazzi Agro E, Petta F, Micali F, Heesakkers J, et al. Percutaneous Tibial Nerve Stimulation in the Treatment of Overactive Bladder: Urodynamic Data. *Neurourology and urodynamics*. 2003;22:227-32.
 144. Amarenco G, Ismael SS, Even-Schneider A, Raibaut P, Demaille-Wlodyka S, Parratte B, et al. Urodynamic effect of acute transcutaneous posterior tibial nerve stimulation in overactive bladder. *The Journal of urology*. 2003;169(6):2210-5.
 145. Klingler HC, Pycha A, Schmidbauer J, Marberger M. Use of peripheral neuromodulation of the S3 region for treatment of detrusor overactivity: a urodynamic based study. *Urology*. 2000;56(5):766-71.
 146. Finazzi-Agro E, Rocchi C, Pachatz C, Petta F, Spera E, Mori F, et al. Percutaneous tibial nerve stimulation produces effects on brain activity: study on the modifications of the long latency somatosensory evoked potentials. *Neurourology and urodynamics*. 2009;28(4):320-4.
 147. Apostolidis A. Neuromodulation for intractable OAB. *Neurourology and urodynamics*. 2011;30(5):766-70.
 148. Bellette PO, Rodrigues-Palma PC, Hermann V, Riccetto C, Bigozzi M, Olivares JM. [Posterior tibial nerve stimulation in the management of overactive bladder: a prospective and controlled study]. [Spanish]. *Actas Urológicas Espanolas*. 2009;33(1):58-63.
 149. Finazzi-Agrò E, Petta F, Sciobica F, Pasqualetti P, Musco S, Bove P. Percutaneous tibial nerve stimulation effects on detrusor overactivity incontinence are not due to a placebo effect: a randomized, double blind, placebo controlled trial. *Journal of Urology*. 2010;184(5):2001-6.
 150. Manriquez VI, Naser ME, Gomez M, Guzman R, Valdevenito R, Lecannelier J, et al. Transcutaneous tibial nerve stimulation versus long release oxibutinin in the treatment of patients with overactive bladder. A randomized control trial (Abstract number 013). *International Urogynecology Journal and Pelvic Floor Dysfunction*. 2013;24(Suppl 1):S14.
 151. Marques A, Herrmann V, Ferreira N, Bellette P. Transcutaneous posterior tibial nerve stimulation in overactive bladder (Abstract number 471). *Proceedings of the 38th Annual Meeting of the International Continence Society (ICS)*, 2008 Oct 20-24, Cairo, Egypt. 2008.
 152. Peters K, Carrico D, Perez-Marrero R, Khan A, Wooldridge L, Davis G, et al. 12 week results from the SUMIT trial: percutaneous tibial nerve stimulation vs validated sham in those exposed to pharmacologic therapy (Abstract number 125). *Neurourology and urodynamics*. 2010;29(6):988-9.
 153. Preyer O, Gabriel B, Mailath-Pokorny M, Doerfler D, Laml T, Umek W, et al. Peripheral tibial neurostimulation (PTNS) versus tolterodine in the treatment of women with urge urinary incontinence and urge symptoms (Abstract number 246). *International Urogynecology Journal and Pelvic Floor Dysfunction*. 2007;18(Suppl 1):S139-S40.
 154. Preyer O, Umek W, Laml T, Bjelic-Radicic V, Gabriel B, Mittlboeck M, et al. Percutaneous tibial nerve stimulation versus tolterodine for overactive bladder in women: a randomised controlled trial. *European Journal of Obstetrics, Gynecology, & Reproductive Biology*. 2015;191:51-6.
 155. Sancaktar M, Ceyhan ST, Akyol I, Muhcu M, Alanbay I, Mutlu EC, et al. The outcome of adding peripheral neuromodulation (stoller afferent neuro-stimulation) to anti-muscarinic therapy in women with severe overactive bladder. *Gynecological Endocrinology*. 2010;26(10):729-32.
 156. Schreiner L, dos Santos TG, Knorst MR, da Silva Filho IG. Randomized trial of transcutaneous tibial nerve stimulation to treat urge urinary incontinence in older women. *International Urogynecology Journal*. 2010;21(9):1065-70.
 157. Souto SC, Reis LO, Palma T, Palma P, Denardi F. Prospective and randomized comparison of electrical stimulation of the posterior tibial nerve

- versus oxybutynin versus their combination for treatment of women with overactive bladder syndrome. *World Journal of Urology*. 2014;32(1):179-84.
158. Vecchioli-Scaldazza C, Morosetti C, Berouz A, Giannubilo W, Ferrara V. Solifenacin Succinate versus Percutaneous Tibial Nerve Stimulation in Women with Overactive Bladder Syndrome: Results of a Randomized Controlled Cross-over Study. *Gynecologic & Obstetric Investigation*. 2013;75(4):230-4.
 159. Barker AT, Freeston IL, Jalinous R, Jarratt JA. Magnetic stimulation of the human brain and peripheral nervous system: an introduction and the results of an initial clinical evaluation. *Neurosurgery*. 1987;20(1):100-9.
 160. Galloway NT, El-Galley RE, Sand PK, Appell RA, Russell HW, Carlan SJ. Extracorporeal magnetic innervation therapy for stress urinary incontinence. *Urology*. 1999;53(6):1108-11.
 161. Goldberg RP, Sand PK. Electromagnetic pelvic floor stimulation: applications for the gynecologist. *Obstet Gynecol Surv*. 2000;55(11):715-20.
 162. But I. Conservative treatment of female urinary incontinence with functional magnetic stimulation. *Urology*. 2003;61(3):558-61.
 163. Quek P. A critical review on magnetic stimulation: What is its role in the management of pelvic floor disorders? *Current Opinion in Urology*. 2005;15(4):231-5.
 164. Craggs MD, Sheriff MKM, Shah PJR, Fowler CJ, Petersen T. Response to multipulse magnetic stimulation of spinal nerve roots mapped over the sacrum in man (Abstract). *Journal of Physiology*. 1995;483(Suppl):127P-8P.
 165. Kralj B. Conservative treatment of female stress urinary incontinence with functional electrical stimulation. *European Journal of Obstetrics Gynecology and Reproductive Biology*. 1999;85(1):53-6.
 166. Lindstrom S, Fall M, Carlsson CA, Erlandson BE. The neurophysiological basis of bladder inhibition in response to intravaginal electrical stimulation. *Journal of Urology*. 1983;129(2):405-10.
 167. Tsai PY, Wang CP, Hsieh CY, Tsai YA, Yeh SC, Chuang TY. Longterm sacral magnetic stimulation for refractory stress urinary incontinence. *Archives of Physical Medicine & Rehabilitation*. 2014;95(12):2231-8.
 168. Wallis MC, Davies EA, Thalib L, Griffiths S. Pelvic static magnetic stimulation to control urinary incontinence in older women: a randomized controlled trial. *Clinical Medicine & Research*. 2012;10(1):7-14.
 169. Fujishiro T, Enomoto H, Ugawa Y, Takahashi S, Ueno S, Kitamura T. Magnetic stimulation of the sacral roots for the treatment of stress incontinence: an investigational study and placebo controlled trial. *Journal of Urology*. 2000;164(4):1277-9.
 170. Manganotti P, Zaina F, Vedovi E, Pistoia L, Rubilotta E, D'Amico A, et al. Repetitive magnetic stimulation of the sacral roots for the treatment of stress incontinence: a brief report. *Europa Medicophysica*. 2007;43(3):339-44.
 171. Suzuki T, Yasuda K, Yamanishi T, Kitahara S, Nakai H, Suda S, et al. Randomized, double-blind, sham controlled evaluation of the effect of functional continuous magnetic stimulation in patients with urgency incontinence. *Neurourology & Urodynamics*. 2007;26(6):767-72.
 172. But I, Faganelj M, Sostaric A. Functional magnetic stimulation for mixed urinary incontinence. *Journal of Urology*. 2005;173(5):1644-6.
 173. Lee JS, Hong JY, Kim MH, Seo JT. Comparative study of the pelvic floor magnetic stimulation with BIOCON-2000 (trademark) in female urinary incontinence patients. *Korean Journal of Urology*. 2004;45(5):438-43.
 174. Gilling P, Kennett K, Bell D, Wrigley T, Fraundorfer M. A double blind randomised trial comparing magnetic stimulation of the pelvic floor to sham treatment for women with stress urinary incontinence (Abstract). *Neurourology & Urodynamics*. 2001;20(4):432-3.
 175. Brodak PP, Bidair M, Joseph A, Szollar S, Juma S. Magnetic stimulation of the sacral roots. *Neurourology & Urodynamics*. 1993;12(6):533-40.
 176. Hadley EC. Bladder training and related therapies for urinary incontinence in older people. *JAMA*. 1986;256(3):372-9.
 177. Wyman JF, Fantl JA, McClish DK, Bump RC. Comparative efficacy of behavioral interventions in the management of female urinary incontinence. *American Journal of Obstetrics and Gynecology*. 1998;179(4):999-1007.
 178. Wyman JF, Fantl JA. Bladder training in ambulatory care management of urinary incontinence. *Urologic Nursing*. 1991;11(3 Sep):11-7.
 179. Fantl J, Wyman JF, McClish DK, et al. Efficacy of bladder training in older women with urinary incontinence. *JAMA*. 1991;265(5):609-13.

180. Fantl JA, Newman DK, Colling JC, DeLancey JO, Kees C, Loughery R. Urinary incontinence in adults: acute and chronic management. *Clinical Practice Guideline: Update 1996*;2.
181. Wyman JF. Treatment of urinary incontinence in men and older women: the evidence shows the efficacy of a variety of techniques. *American Journal of Nursing*. 2003;Suppl:26-35.
182. Burgio KL, Stutzman RE, Engel BT. Behavioral training for post-prostatectomy urinary incontinence. *The Journal of urology*. 1989;141(2):303-6.
183. Colling J, Owen TR, McCreedy M, Newman D. The effects of a continence program on frail communitydwelling elderly persons. *Urologic Nursing*. 2003;23(2):117-22, 27-31.
184. Eustice S, Roe B, Paterson J. Prompted voiding for the management of urinary incontinence in adults. *Cochrane Database of Systematic Reviews*. 2000(2).
185. Wallace SA, Roe B, Williams K, Palmer M. Bladder training for urinary incontinence in adults. *Cochrane Database of Systematic Reviews*. 2004(1).
186. Berghmans LCM, Hendriks HJM, De Bie RA, Van Waalwijk ESC, Van D, Bø K, et al. Conservative treatment of urge urinary incontinence in women: a systematic review of randomized clinical trials. *BJU International*. 2000;85(3):254-63.
187. Assassa P, Williams K, Lambert P, Abrams K, Turner D, Shaw C, et al. A double blind randomised placebo controlled trial of the effectiveness of bladder training with oxybutynin or imipramine in the management of detrusor overactivity (DO) (Abstract number 330). *Proceedings of the Joint Meeting of the International Continence Society (ICS) and the International Urogynecological Association*, 2010 Aug 23-27, Toronto, Canada. 2010.
188. Sherburn M, Bird M, Carey M, Bo K, Galea MP. Incontinence improves in older women after intensive pelvic floor muscle training: an assessor blinded randomized controlled trial. *Neurourology & Urodynamics*. 2011;30(3):317-24.
189. Yoon HS, Song HH, Ro YJ. A comparison of effectiveness of bladder training and pelvic muscle exercise on female urinary incontinence. *Int J Nurs Stud*. 2003;40(1):45-50.
190. Song C, Park JT, Heo KO, Lee KS, Choo MS. Effects of bladder training and/or tolterodine in female patients with overactive bladder syndrome: a prospective, randomized study. *J Korean Med Sci*. 2006;21:1060-3.
191. Szonyi G, Collas DM, Ding YY, Malone-Lee JG. Oxybutynin with Bladder Retraining for Detrusor Instability in Elderly People: A Randomized Controlled Trial. *Age and Ageing*. 1995;24(4):287-91.
192. Wiseman PA, Malone-Lee J, Rai GS. Terodiline with bladder retraining for treating detrusor instability in elderly people. *BMJ*. 1991;302(6783):994-6.
193. Jarvis GJ. A controlled trial of bladder drill and drug therapy in the management of detrusor instability. *Br J Urol*. 1981;53(6):565-6.
194. Jarvis GJ, Millar DR. Controlled trial of bladder drill for detrusor instability. *Br Med J*. 1980;281(6251):1322-3.
195. Mattiasson A, Blaakaer J, Høye K, Wein AJ, The Tolterodine Scandinavian Study G. Simplified bladder training augments the effectiveness of tolterodine in patients with an overactive bladder. *BJU International*. 2003;91(1):54-60.
196. Mattiasson A, Masala A, Morton R, Bolodeoku J. Efficacy of simplified bladder training in patients with overactive bladder receiving a solifenacin flexible dose regimen: results from a randomized study. *BJU International*. 2010;105(8):1126-35.
197. Diokno AC, Ocampo MS, Jr., Ibrahim IA, Karl CR, Lajiness MJ, Hall SA. Group session teaching of behavioral modification program (BMP) for urinary incontinence: a randomized controlled trial among incontinent women. *International Urology and Nephrology*. 2010;42(2):375-81.
198. Dougherty MC, Dwyer JW, Pendergast JF, Tomlinson BU, Boyington AR, Vogel WB, et al. Community based nursing: Continence care for older rural women. *Nursing Outlook*. 1998;46(5):233-44.
199. Dougherty MC, Dwyer JW, Pendergast JF, Boyington AR, Tomlinson BU, Coward RT, et al. A randomized trial of behavioral management for continence with older rural women. *Research in Nursing & Health*. 2002;25(1):3-13.
200. Lagro-Janssen A, Debruyne F, AJA S, Van Weel C. The Effects of Treatment of Urinary Incontinence in General Practice. *Family Practice*. 1992;9(3):284-9.
201. Colombo M, Zanetta G, Scalabrino S, Milani R. Oxybutynin and bladder training in the management of female urinary urge incontinence: a randomized study. *Int Urogynecol J Pelvic Floor Dysfunct*. 1995;6(2):63-7.

202. Castleden CM, Duffin HM, Gulati RS. DOUBLEBLIND STUDY OF IMIPRAMINE AND PLACEBO FOR INCONTINENCE DUE TO BLADDER INSTABILITY. *Age and Ageing*. 1986;15(5):299-303.
203. Bryant CM, Dowell CJ, Fairbrother G. Caffeine reduction education to improve urinary symptoms. *Br J Nurs*. 2002;11(8):560-5.
204. Ostaszkiwicz J, Johnston L, Roe B. Timed voiding for the management of urinary incontinence in adults. *Cochrane Database of Systematic Reviews*. 2004(1).
205. Klarskov P, Gerstenberg TC, Hald T. Bladder training and terodiline in females with idiopathic urge incontinence and stable detrusor function. *Scand J Urol Nephrol*. 1986;20(1):41-6.
206. Godec CJ. Timed voiding-- a useful tool in the treatment of urinary incontinence. *Urology*. 1984;23(1):97-100.
207. Wang Y, Zhishun L, Peng W, Zhao J, Liu B. Acupuncture for stress urinary incontinence in adults. *Cochrane Database of Systematic Reviews*. 2013(7):Art. No.: CD009408.
208. Paik S-H, Han S-R, Kwon O-J, Ahn Y-M, Lee B-C, Ahn S-Y. Acupuncture for the treatment of urinary incontinence: A review of randomized controlled trials. *Experimental and Therapeutic Medicine*. 2013;6(3):773-80.
209. Kim JH, Nam D, Park MK, Lee ES, Kim SH. Randomized control trial of hand acupuncture for female stress urinary incontinence. *Acupuncture & Electro Therapeutics Research*. 2008;33(3-4):179-92.
210. Bi W. Clinical study on electro-acupuncture treatment of female stress incontinence. *Chinese Archives of Traditional Medicine*. 2007;25(6):1284-5.
211. Chang KK, Wong TK, Wong TH, Leung AW, Chung JW. Effect of acupressure in treating urodynamic stress incontinence: a randomized controlled trial. *American Journal of Chinese Medicine*. 2011;39(6):1139-59.
212. Forde JC, Jaffe E, Stone BV, Te AE, Espinosa G, Chughtai B. The role of acupuncture in managing overactive bladder; a review of the literature. *International Urogynecology Journal*. 2016:1-7.
213. Jin C, Zhou X, Pang R. Effect of electroacupuncture combined with tolterodine on treating female mixed urinary incontinence. *Journal of Wound, Ostomy, & Continence Nursing*. 2014;41(3):268-72.
214. Kelleher CJ, Filshie J, Burton G, Khullar V, Cardozo LD. Acupuncture and the treatment of irritative bladder symptoms. *Acupuncture in Medicine*. 1994;12:9-12.
215. Emmons SL, Otto L. Acupuncture for overactive bladder: a randomized controlled trial. *Obstetrics & Gynecology*. 2005;106(1):138-43.
216. Engberg S, Cohen S, Sereika SM. The efficacy of acupuncture in treating urge and mixed incontinence in women: a pilot study. *Journal of Wound, Ostomy, & Continence Nursing*. 2009;36(6):661-70.
217. Yuan Z, He C, Yan S, Huang D, Wang H, Tang W. Acupuncture for overactive bladder in female adult: a randomized controlled trial. *World Journal of Urology*. 2015;33(9):1303-8.
218. Dincer F, Linde K. Sham interventions in randomized clinical trials of acupuncture—a review. *Complementary Therapies in Medicine*. 2003;11(4):235-42.
219. Schulz KF, Altman DG, Moher D, Group C. CONSORT 2010 Statement: updated guidelines for reporting parallel group randomised trials. *Trials*. 2010;11:32.
220. Hagen S, Stark D. Conservative prevention and management of pelvic organ prolapse in women. *Cochrane Database Syst Rev*. 2011(12):CD003882.
221. Hagen S, Stark D, Campbell P. Conservative prevention and management of pelvic organ prolapse in women. *Cochrane Database Syst Rev*. 2016 (in prep).
222. Bugge C, Adams EJ, Gopinath D, Reid F. Pessaries (mechanical devices) for pelvic organ prolapse in women. *Cochrane Database Syst Rev*. 2013(2):CD004010.
223. Higgins J, Green S. *Cochrane Handbook for Systematic Reviews of Interventions: The Cochrane Collaboration*; 2011.
224. CASP. *Critical Appraisal Skills Programme 2015*.
225. Abrams P. *Incontinence, 3rd International Consultation on Incontinence*. 3rd ed2004.
226. Hay Smith J, Berghams B, Burgio K, Dumoulin C, Hagen S, Moore K, et al. *Adult conservative Management In: Abrams P, Cardozo L, Khoury S, Wein A, editors. Incontinence*. 4th ed2009.
227. Majumdar A, Saleh S, Hill M, Hill SR. The impact of strenuous physical activity on the development of pelvic organ prolapse. *J Obstet Gynaecol*. 2013;33(2):115-9.
228. Lonnee-Hoffmann RA, Salvesen O, Morkved S, Schei B. Self reported pelvic organ prolapse surgery, prevalence, and nonobstetric risk factors: findings from the Nord Trondelag Health Study. *Int Urogynecol J*. 2015;26(3):407-14.

229. Nygaard IE, Shaw JM, Bardsley T, Egger MJ. Lifetime physical activity and pelvic organ prolapse in middle aged women. *Am J Obstet Gynecol.* 2014;210(5):477 e1-12.
230. Akmel M, Segni H. Pelvic organ prolapse in jimma university specialized hospital, southwest ethiopia. *Ethiop J Health Sci.* 2012;22(2):85-92.
231. Gumanga SK, Munkaila A, Malechi H. Social demographic characteristics of women with pelvic organ prolapse at the Tamale Teaching Hospital, Ghana. *Ghana Med J.* 2014;48(4):208-13.
232. Bathla S, Verghese G, Kalla V, Sharma TC, Dam S, Agarwal N, et al. Reaching the unreached: Mobile surgical camps in a remote village of Himachal Pradesh. *J Midlife Health.* 2014;5(3):139-42.
233. Aston BL, Sheehan L, Mawu G, Roberts C, Barnick C. Do women seeking treatment for pelvic floor dysfunction have higher than average BMI's? *International Urogynecology Journal and Pelvic Floor Dysfunction.* 2011;22:S129.
234. Aytan H, Ertunc D, Tok EC, Yasa O, Nazik H. Prevalence of pelvic organ prolapse and related factors in a general female population. *Turk Jinekoloji ve Obstetrik Dernegi Dergisi.* 2014;11(3):176-80.
235. Chen Y, Johnson B, Li F, Lin X, Chen J, Chen C, et al. Weight at one year postpartum affects the development of pelvic organ prolapse. *Reproductive Sciences.* 2014;21(3 SUPPL 1):221A.
236. Cuicchi D, Lombardi R, Cariani S, Leuratti L, Lecce F, Cola B. Clinical and instrumental evaluation of pelvic floor disorders before and after bariatric surgery in obese women. *Surgery for obesity and related diseases : official journal of the American Society for Bariatric Surgery.* 2013;9(1):69-75.
237. Direkvand-Moghadam A, Ghazanfari Z, Sayehmiri K. Predictive Factors For Pelvic Organ Prolapse In Iranian Women's, An Ordinal Logistic Approc. *Journal of Clinical and Diagnostic Research.* 2014;8(1):96-9.
238. Elbiss HM, Osman N, Hammad FT. Prevalence, risk factors and severity of symptoms of pelvic organ prolapse among Emirati women. *BMC Urology.* 2015;15(1):no pagination.
239. Espitia de la Hoz FJ. Risk factors associated with female genital prolapse: Case control study. *Urologia Colombiana.* 2015;24(1):12-8.
240. Glazener C, Elders A, Macarthur C, Lancashire RJ, Herbison P, Hagen S, et al. Childbirth and prolapse: long term associations with the symptoms and objective measurement of pelvic organ prolapse. *BJOG.* 2013;120(2):161-8.
241. Gozukara YM, Akalan G, Tok EC, Aytan H, Ertunc D. The improvement in pelvic floor symptoms with weight loss in obese women does not correlate with the changes in pelvic anatomy. *International urogynecology journal.* 2014;25(9):1219-25.
242. Johnson P, Larson K, Hsu Y, DeLancey J, Fenner D, Morgan D. Self reported experiences of recurrent prolapse. *International Urogynecology Journal and Pelvic Floor Dysfunction.* 2011;22:S865-S6.
243. Myers DL, Sung VW, Richter HE, Creasman J, Subak LL. Prolapse symptoms in overweight and obese women before and after weight loss. *Female pelvic medicine & reconstructive surgery.* 2012;18(1):55-9.
244. Perez A, Palau MJ, Sanchez E, Rodriguez L, Flores L, Hergueta BN, et al. Long term study on the effect of weight loss in women with obesity and urinary incontinence. *Neurourology and urodynamics.* 2013;32(6):541-2.
245. Wein AJ. Re: Impact of surgically induced weight loss on pelvic floor disorders: Editorial comment. *Journal of Urology.* 2013;189(5):1817.
246. Whitcomb EL, Horgan S, Donohue MC, Lukacz ES. Impact of surgically induced weight loss on pelvic floor disorders. *International Urogynecology Journal and Pelvic Floor Dysfunction.* 2012;23(8):1111-6.
247. Young N, Atan I, Dietz HP. Obesity: How much does it matter for female pelvic organ prolapse? *BJOG: An International Journal of Obstetrics and Gynaecology.* 2015;122:390.
248. Awwad J, Sayegh R, Yeretzian J, Deeb ME. Prevalence, risk factors, and predictors of pelvic organ prolapse: a community based study. *Menopause.* 2012;19(11):1235-41.
249. Ramalingam K, Monga A. Obesity and pelvic floor dysfunction. *Best Pract Res Clin Obstet Gynaecol.* 2015;29(4):541-7.
250. Vergeldt TF, Weemhoff M, Int'Hout J, Kluivers KB. Risk factors for pelvic organ prolapse and its recurrence: a systematic review. *Int Urogynecol J.* 2015;26(11):1559-73.
251. Kudish BI, Iglesia CB, Sokol RJ, Cochrane B, Richter HE, Larson J, et al. Effect of weight change on natural history of pelvic organ prolapse. *Obstet Gynecol.* 2009;113(1):81-8.
252. Estanol MV, Crisp CC, Oakley SH, Kleeman SD, Fellner AN, Pauls RN. Systemic markers of collagen metabolism and vitamin C in smokers

- and non-smokers with pelvic organ prolapse. *Eur J Obstet Gynecol Reprod Biol.* 2015;184:58-64.
253. Bezerra LRPS, Vasconcelos Neto JA, Vasconcelos CTM, Karbage SAL, Lima AC, Frota IPR, et al. Prevalence of unreported bowel symptoms in women with pelvic floor dysfunction and the impact on their quality of life. *International Urogynecology Journal and Pelvic Floor Dysfunction.* 2014;25(7):927-33.
 254. Navaneethan PR, Kekre A, Jacob KS, Varghese L. Vitamin D deficiency in postmenopausal women with pelvic floor disorders. *J Midlife Health.* 2015;6(2):66-9.
 255. Parker-Autry CY, Markland AD, Ballard AC, Downs-Gunn D, Richter HE. Vitamin D status in women with pelvic floor disorder symptoms. *Int Urogynecol J.* 2012;23(12):1699-705.
 256. Miller JM, Ashton-Miller JA, Delancey J. A pelvic floor muscle pre-contraction can reduce cough related urine loss in selected women with SUI. *Journal of the American Geriatric Society.* 1998;46:870-4.
 257. Hagen S, Glazener C, McClurg D, MacArthur C, Herbison P, Wilson D, et al. A multicentre randomised controlled trial of a pelvic floor muscle training intervention for the prevention of pelvic organ prolapse (PREVPROL). *Neurourology and urodynamics.* 2014;33(6):852-3.
 258. Bo K, Hilde G, Tennfjord MK, Jensen JS, Siafarikas F, Engh ME. Randomized controlled trial of pelvic floor muscle training to prevent and treat pelvic organ prolapse in postpartum primiparous women. *Neurourology and urodynamics.* 2013;32(6):806-7.
 259. Hagen S, Stark D, Maher C, Adams E. Conservative management of pelvic organ prolapse in women. *Cochrane Database Syst Rev.* 2004(2):CD003882.
 260. Culligan PJ, Scherer J, Dyer K, Priestley JL, Guingon-White G, Delvecchio D, et al. A randomized clinical trial comparing pelvic floor muscle training to a Pilates exercise program for improving pelvic muscle strength. *Int Urogynecol J.* 2010;21(4):401-8.
 261. Due U, Brostrom S, Lose G. Lifestyle advice with or without pelvic floor muscle training for pelvic organ prolapse: a randomized controlled trial. *Int Urogynecol J.* 2016;27(4):555-63.
 262. Frawley HC, Hagen S, Sherburn M, Neumann P, Herbison P, Hay-Smith J, et al. Changes in prolapse following pelvic floor muscle training: A randomised controlled trial. *Neurourology and urodynamics.* 2012;31(6):938-9.
 263. Hagen S, Stark D, Glazener C, Dickson S, Barry S, Elders A, et al. Individualised pelvic floor muscle training in women with pelvic organ prolapse (POPPY): a multicentre randomised controlled trial. *Lancet.* 2014;383(9919):796-806.
 264. Giraudo D, Beccaria N, Lamberti G. Pelvic floor muscle training, negative pressure abdominal exercise and pelvic organ prolapse symptoms: A randomized clinical trial. *Neurourology and urodynamics.* 2011;30(6):1009-11.
 265. Kashyap R, Jain V, Singh A. Comparative effect of 2 packages of pelvic floor muscle training on the clinical course of stage I-III pelvic organ prolapse. *Int J Gynaecol Obstet.* 2013;121(1):69-73.
 266. Resende APM, Stupp L, Bernardes BT, Oliveira E, Castro RA, Girao MJBC, et al. Can hypopressive exercises provide additional benefits to pelvic floor muscle training in women with pelvic organ prolapse? *Neurourology and urodynamics.* 2012;31(1):121-5.
 267. Stupp L, Magalhaes Resende AP, Oliveira E, Castro RA, Castello Girao MJB, Ferreira Sartori MG. Pelvic floor muscle training for treatment of pelvic organ prolapse: An assessor blinded randomized controlled trial. *International Urogynecology Journal and Pelvic Floor Dysfunction.* 2011;22(10):1233-9.
 268. Wieggersma M, Panman CM, Kollen BJ, Vermeulen KM, Schram AJ, Messelink EJ, et al. Pelvic floor muscle training versus watchful waiting or pessary treatment for pelvic organ prolapse (POPPTS): design and participant baseline characteristics of two parallel pragmatic randomized controlled trials in primary care. *Maturitas.* 2014;77(2):168-73.
 269. Jarvis SK, Hallam TK, Lujic S, Abbott JA, Vancaillie TG. Peri-operative physiotherapy improves outcomes for women undergoing incontinence and or prolapse surgery: Results of a randomised controlled trial. *Australian and New Zealand Journal of Obstetrics and Gynaecology.* 2005;45:300-3.
 270. Frawley HC, Phillips BA, Bø K, Galea MP. Physiotherapy as an adjunct to prolapse surgery: An assessor blinded randomized controlled trial. *Neurourology and urodynamics.* 2010;29:719-25.
 271. Pauls RN, Crisp CC, Novicki K, Fellner AN, Kleeman SD. Impact of physical therapy on quality of life and function after vaginal reconstructive surgery. *Female Pelvic Med Reconstr Surg.* 2013;19(5):271-7.
 272. Pauls RN, Crisp CC, Novicki K, Fellner AN, Kleeman SD. Pelvic floor physical therapy:

- impact on quality of life 6 months after vaginal reconstructive surgery. *Female Pelvic Med Reconstr Surg*. 2014;20(6):334-41.
273. McClurg D. A two group, single-blind, randomised controlled study to assess the feasibility of physiotherapy following surgery for prolapse to avoid recurrence. <http://isrctn.org/ISRCTN08203452010>.
 274. McClurg D, Hilton P, Dolan L, Monga A, Hagen S, Frawley H, et al. Pelvic floor muscle training as an adjunct to prolapse surgery: a randomised feasibility study. *International Urogynecology Journal*. 2014;25(7):883-91.
 275. Eftekhar T, Sohrabi M, Haghollahi F, Shariat M, Miri E. Comparison effect of physiotherapy with surgery on sexual function in patients with pelvic floor disorder: A randomized clinical trial. *Iran J Reprod Med*. 2014;12(1):7-14.
 276. Bugge C, Williams B, Hagen S, Logan J, Glazener C, Pringle S, et al. A process for Decision making after Pilot and feasibility Trials (ADePT): development following a feasibility study of a complex intervention for pelvic organ prolapse. *Trials*. 2013;14(353):353.
 277. Hagen S. Pessary Plus Physiotherapy for Pelvic Organ Prolapse (PEPPY). <http://ClinicalTrials.gov/show/NCT011368892010>.
 278. Cheung RY, Lee JH, Lee LL, Chung TK, Chan SS. Vaginal Pessary in Women With Symptomatic Pelvic Organ Prolapse: A Randomized Controlled Trial. *Obstet Gynecol*. 2016.
 279. Manonai J, Harnsomboon T, Sarit-apirak S, Wattanayingcharoenchai R, Chittacharoen A, Suthutvoravut S. Effect of Colpexin Sphere on pelvic floor muscle strength and quality of life in women with pelvic organ prolapse stage I/II: a randomized controlled trial. *Int Urogynecol J*. 2012;23(3):307-12.
 280. Haylen BT, Maher CF, Barber MD, Camargo S, Dandolu V, Digesu A, et al. An International Urogynecological Association (IUGA) / International Continence Society (ICS) Joint Report on the Terminology for Female Pelvic Organ Prolapse (POP). *Neurourology and urodynamics*. 2016;35(2):137-68.
 281. Oliver R, Thakar R, Sultan AH. The history and usage of the vaginal pessary: a review. *Eur J Obstet Gynecol Reprod Biol*. 2011;156(2):125-30.
 282. Khan AA, Eilber KS, Clemens JQ, Wu N, Pashos CL, Anger JT. Trends in management of pelvic organ prolapse among female Medicare beneficiaries. *Am J Obstet Gynecol*. 2015;212(4):463 e1-8.
 283. Gorti M, Hudelist G, Simons A. Evaluation of vaginal pessary management: a UK-based survey. *J Obstet Gynaecol*. 2009;29(2):129-31.
 284. Thakar R, Stanton S. Management of genital prolapse. *BMJ*. 2002;324(7348):1258-62.
 285. Abdool Z, Thakar R, Sultan AH, Oliver RS. Prospective evaluation of outcome of vaginal pessaries versus surgery in women with symptomatic pelvic organ prolapse. *Int Urogynecol J*. 2011;22(3):273-8.
 286. Powers K, Lazarou G, Wang A, LaCombe J, Bensinger G, Greston WM, et al. Pessary use in advanced pelvic organ prolapse. *Int Urogynecol J Pelvic Floor Dysfunct*. 2006;17(2):160-4.
 287. Clemons JL, Aguilar VC, Sokol ER, Jackson ND, Myers DL. Patient characteristics that are associated with continued pessary use versus surgery after 1 year. *Am J Obstet Gynecol*. 2004;191(1):159-64.
 288. Ko PC, Lo TS. Delayed onset advanced pelvic organ prolapse after pelvic trauma in a nulliparous young female: case report. *Int Urogynecol J*. 2011;22(6):757-9.
 289. Ko PC, Lo TS, Tseng LH, Lin YH, Liang CC, Lee SJ. Use of a pessary in treatment of pelvic organ prolapse: quality of life, compliance, and failure at 1-year follow-up. *J Minim Invasive Gynecol*. 2011;18(1):68-74.
 290. Sullivan SA, Davidson ER, Bretschneider CE, Liberty AL, Geller EJ. Patient characteristics associated with treatment choice for pelvic organ prolapse and urinary incontinence. *Int Urogynecol J*. 2016;27(5):811-6.
 291. Ding J, Chen C, Song XC, Zhang L, Deng M, Zhu L. Successful use of ring pessary with support for advanced pelvic organ prolapse. *Int Urogynecol J*. 2015;26(10):1517-23.
 292. Nemeth Z, Nagy S, Ott J. The cube pessary: an underestimated treatment option for pelvic organ prolapse? Subjective 1-year outcomes. *Int Urogynecol J*. 2013;24(10):1695-701.
 293. Brazell HD, Patel M, O'Sullivan DM, Mellen C, LaSala CA. The impact of pessary use on bowel symptoms: one year outcomes. *Female Pelvic Med Reconstr Surg*. 2014;20(2):95-8.
 294. Patel M, Mellen C, O'Sullivan DM, LaSala CA. Impact of pessary use on prolapse symptoms, quality of life, and body image. *Am J Obstet Gynecol*. 2010;202(5):499 e1-4.
 295. Ding J, Chen C, Song XC, Zhang L, Deng M, Zhu L. Changes in Prolapse and Urinary Symptoms After Successful Fitting of a Ring Pessary With Support in Women With Advanced Pelvic Organ Prolapse: A Prospective Study. *Urology*. 2016;87:70-5.

296. Panman CM, Wiegersma M, Kollen BJ, Berger MY, Lisman - van Ieeuwen Y, Dekker JH. Effects of pelvic floor muscle training and pessary treatment in women ≥ 55 years with an advanced pelvic organ prolapse. *Int Urogynecol J* 2014;25 ((Suppl 1):S1-S240):S79.
297. Lone F, Thakar R, Sultan AH. One-year prospective comparison of vaginal pessaries and surgery for pelvic organ prolapse using the validated ICIQ-VS and ICIQ-UI (SF) questionnaires. *Int Urogynecol J*. 2015;26(9):1305-12.
298. Barber MD, Walters MD, Cundiff GW, Group PT. Responsiveness of the Pelvic Floor Distress Inventory (PFDI) and Pelvic Floor Impact Questionnaire (PFIQ) in women undergoing vaginal surgery and pessary treatment for pelvic organ prolapse. *Am J Obstet Gynecol*. 2006;194(5):1492-8.
299. Cundiff GW, Amundsen CL, Bent AE, Coates KW, Schaffer JI, Strohbehn K, et al. The PESSRI study: symptom relief outcomes of a randomized crossover trial of the ring and Gellhorn pessaries. *Am J Obstet Gynecol*. 2007;196(4):405 e1-8.
300. Collins S, Beigi R, Mellen C, O'Sullivan D, Tulikangas P. The effect of pessaries on the vaginal microenvironment. *Am J Obstet Gynecol*. 2015;212(1):60 e1-6.
301. Vierhout ME. The use of pessaries in vaginal prolapse. *Eur J Obstet Gynecol Reprod Biol*. 2004;117(1):4-9.
302. Shamliyan TA, Wyman JF, Ping R, Wilt TJ, Kane RL. Male urinary incontinence: prevalence, risk factors, and preventative interventions. *Reviews in Urology*. 2009;11(3):145-66.
303. Milsom I, Altman D, Cartwright R, Lapitan MC, Nelson R, Sillen U, et al. Epidemiology of urinary incontinence (UI) and other lower urinary tract symptoms (LUTS), pelvic organ prolapse (POP) and anal incontinence (AI). In: Abrams P, Cardozo L, Khoury S, editors. 5th International Consultation on Incontinence. 5th: ICUD-EAU; 2013.
304. Anderson CA, Omar MI, Campbell SE, Hunter KF, Cody JD, Glazener CMA. Conservative management for postprostatectomy urinary incontinence. *Cochrane Database of Systematic Reviews*. 2015;1(Art. No.: CD001843).
305. Ahmed MT, Mohammed AH, Mansour AA. Effect of pelvic floor electrical stimulation and biofeedback on the recovery of urinary continence after radical prostatectomy. *Turkish Journal of Physical Medicine and Rehabilitation*. 2012;58(3):171-7.
306. Burkert S, Scholz U, Gralla O, Roigas J, Knoll N. Dyadic planning of health behavior change after prostatectomy: a randomized controlled trial planning intervention. *Social Science and Medicine*. 2011;73:783-92.
307. Dijkstra-Eshuis J, Van den Bos TWL, Splinter R, Bevers RFM, Zonneveld WCG, Putter H, et al. Effect of preoperative pelvic floor muscle therapy with biofeedback versus standard care on stress urinary incontinence and quality of life in men undergoing laparoscopic radical prostatectomy: a randomized control trial. *Neurourology and urodynamics*. 2015;34:144-50.
308. Fode M, Sonksen J. Penile vibratory stimulation in the treatment of post-prostatectomy incontinence: a randomized pilot study. *Neurourology & Urodynamics*. 2015;34(2):117-22.
309. Geraerts I, Van Poppel H, Devoogdt N, Joniau S, Van Cleynenbreugel B, De Groef A, et al. Influence of preoperative and postoperative pelvic floor muscle training (PFMT) compared with postoperative PFMT on urinary incontinence after radical prostatectomy: a randomized controlled trial. *European urology*. 2013;64:766-72.
310. Hou CP, Chen TY, Chang CC, Lin YH, Chang PL, Chen CL, et al. Use of the SF-36 quality of life scale to assess the effect of pelvic floor muscle exercise on aging males who received transurethral prostate surgery. *Clinical Interventions in Aging*. 2013;8:667-73.
311. Kakiyama C, Sens Y, Ferreira U. Effect of functional training for the pelvic floor muscles with or without electrical stimulation in cases of urinary incontinence following radical prostatectomy. *Revista Brasileira de Fisioterapia*. 2007;11(6):481-6.
312. Kongtragul J, Tukhanon W, Tudpudsa P, Suedee K, Tienchai S, Leewansangtong S, et al. Effects of adding concentration therapy to Kegel exercise to improve continence after radical prostatectomy, randomized control. *Journal of the Medical Association of Thailand*. 2014;97(5):513-7.
313. Laurienzo CE, Sacomani CAR, Rodrigues TR, de Cassio Zequi SGGCLA. Results of preoperative electrical stimulation of pelvic floor muscles in the continence status following radical retropubic prostatectomy. *International Brazilian Journal of Urology*. 2013;39:182-8.
314. Ocampo-Trujillo A, Carbonell-Gonzalez J, Martinez-Blanco A, Diaz-Hung A, Munoz CA, Ramirez-Velez R. Preoperative training induces changes in the histomorphometry and muscle function of the pelvic floor in patients

- with indication of radical prostatectomy. *Actas Urológicas Españolas*. 2014;38(6):378-84.
315. Tienforti D, Sacco E, Marangi F, D'Addessi A, Racioppi M, Galino G, et al. Efficacy of an assisted low intensity programme of perioperative pelvic floor muscle training in improving the recovery of continence after radical prostatectomy: a randomized controlled trial. *BJU international*. 2012;110:1004-11.
 316. Zopf EM, Bloch W, Machtens S, Zumbé J, Rubben H, Marschner S, et al. Effects of a 15-month supervised exercise program on physical and psychological outcomes in prostate cancer patients following prostatectomy: The ProRehab study. *Integrative Cancer Therapies*. 2015;14(5):409-18.
 317. Burgio KL, Goode PS, Johnson TM, Hammontree L, Ouslander JG, Markland AD, et al. Behavioral vs. drug treatment for overactive bladder in men: The Motive Trial. *Journal of the American Geriatrics Society*. 2011;59(12):2209-16.
 318. Serda BC, Marcos-Gragera R. Urinary incontinence and prostate cancer: a progressive rehabilitation program design. *Rehabil Nurs*. 2014;39(6):271-80.
 319. Baroni M, Lorenzetti R, Renzi C, Brizzi A, Branchini W, Altavilla MG, et al. Approach HTA (health technology assessment) to treat urinary incontinence after radical prostatectomy (Abstract number 23). *Neurourology and urodynamics*. 2013;32:S20.
 320. Collado Serra A, Pellicer Cabo M, Ramirez Backhaus M, Dominguez-Escrig J, Rubio-Briones J, Gomez-Ferrer A, et al. Intensive preoperative Pelvic Floor Muscle Training reduce duration and severity of stress urinary incontinence after radical prostatectomy: A randomized controlled trial (Abstract number 1007). *European Urology Supplements*. 2013;12(1):e1007-e8.
 321. Ghanem A, Khallaf M, Assem A, Hassan A. Does preoperative pelvic floor muscle exercise improve post prostatectomy urinary incontinence (Abstract 695)? . Conference: Annual Meeting of the International Continence Society ICS, Barcelona, Spain. 2013.
 322. Laurienzo C, Magnabosco W, Jabur F, Gameiro M, Yamamoto H, Guerra R, et al. Post prostatectomy urinary incontinence and erectile dysfunction: The role of pelvic floor rehabilitation (Abstract number 527). Conference: Annual Meeting of the International Continence Society, ICS Montreal, QU, Canada. *Neurourology and urodynamics*. 2015;34:S449-S50.
 323. Martini M, Bernardini S, Blanc E, Piretta K, Tappero R. Relationship between integrity of pelvic floor function and recovery of continence after laparoscopic prostatectomy and effects of preventive pelvic floor muscle training in males with pelvic floor weakness (Abstract 14). Conference: Annual Congress of the Italian Urodynamics Society, Turin, Italy. *Neurourology and urodynamics*. 2011;30(SUPPL 1):11-2.
 324. Morihoro N, Masatsugu I, Shinji K, Kenichi T, Kazumasa M, Shiro B. Effectiveness of sacral surface therapeutic electrical stimulation (SSTES) on early recovery of urinary incontinence after laparoscopic radical prostatectomy: a prospective study. *Neurourology and urodynamics*. 2011;30(6):889-90.
 325. Pedriali F, Gomes C, Soares L, Urbano M, Moreira E, de AS. The efficacy of pilates compared to pelvic floor muscle training associated with electrical stimulation in the recovery of post prostatectomy urinary incontinence: A randomized controlled trial (Abstract number 306). *Neurourology and urodynamics*. 2014;33(6):742-3.
 326. Ng SI. A Randomised Controlled Trial Study of the Efficacy of Intensive Pre-Operative Pelvic Floor Muscle Training to Decrease Post-Prostatectomy Urinary Incontinence (Abstract number OP.4.7Dec.38). *International Journal of Urology*. 2014;21:A169.
 327. Park SW, Park CS, Kim TN, Lee W, Nam JK, Lee SD, et al. The effects of a 12-week's combined exercise intervention on physical function and mental health after radical prostatectomy in elderly patients with prostate cancer: A prospective, randomized controlled study. (Abstract 1309). Conference: 2011 Annual Meeting of the American Urological Association, AJA Washington, DC United States. *Journal of Urology*. 2011;185(4 SUPPL. 1):e524.
 328. Park SW, Kim TN, Nam JK, Ha HK, Shin DG, Lee W, et al. Recovery of overall exercise ability, quality of life, and continence after 12 week combined exercise intervention in elderly patients who underwent radical prostatectomy: A randomized controlled study. *Urology*. 2012;80:299-306.
 329. Glazener C, Boachie C, Buckley B, Cochran C, Dorey G, Grant A, et al. Urinary incontinence in men after formal one-to-one pelvic floor muscle training following radical prostatectomy or transurethral resection of the prostate (MAPS): two parallel randomised controlled trials. *Lancet*. 2012;379(9814):328-37.
 330. Glazener C, Boachie C, Buckley B, Cochran C, Dorey G, Grant A, et al. A randomised

- controlled trial of conservative treatment (pelvic floor muscle training and bladder training) for urinary incontinence in men after prostate surgery (MAPS) (Abstract 200). Conference: Joint Annual Meeting of the International Continence Society, ICS and International Urogynecological Association, IUGA Toronto, ON Canada. *Neurourology and urodynamics*. 2010;29(6):1093-4.
331. Glazener C, Boachie C, Buckley B, Cochran C, Dorey G, Grant A, et al. Conservative treatment for urinary incontinence in Men After Prostate Surgery (MAPS): two parallel randomised controlled trials. *Health technology assessment (Winchester, England)*. 2011;15(24):1-296.
 332. Voorham-van der Zalm PJ, Stoetman A, Putter H, Bevers R, Pelger R. Effect of preoperative pelvic 1226 floor physiotherapy versus standard care on incontinence in men undergoing radical laparoscopic prostatectomy: an ongoing study. (Abstract number 590). Proceedings of the Joint Meeting of the International Continence Society (ICS) and the International Urogynecological Association; August 23-27, 2010; Toronto, Canada 2010.
 333. Breyer BN, Phelan S, Hogan PE, Rosen RC, Kitabchi AE, Wing RR, et al. Intensive Lifestyle Intervention Reduces Urinary Incontinence in Overweight/Obese Men with Type 2 Diabetes: Results from the Look AHEAD Trial. *Journal of Urology*. 2014;192(1):144-9.
 334. Sønksen J, Ohl DA, Wedemeyer G. Sphincteric events during penile vibratory ejaculation and electroejaculation in men with spinal cord injuries. *Journal of Urology*. 2001;165:426-9.
 335. Laessøe L, Sønksen J, Bagi P, Biering-Sørensen F, Ohl DA, McGuire EJ, et al. Effects of ejaculation by penile vibratory stimulation on bladder capacity in men with spinal cord lesions. *Journal of Urology*. 2003;169:2216-9.
 336. Sønksen J, Ohl DA, Bonde B, Laessøe L, McGuire EJ. Transcutaneous mechanical nerve stimulation using perineal vibration: A novel method for the treatment of female stress urinary incontinence. *Journal of Urology*. 2007;178(5):2025-8.
 337. Peters KM, Carrico DJ, Perez-Marrero R, Khan AU, Wooldridge LS, Davis GL, et al. Randomized trial of percutaneous tibial nerve stimulation versus Sham efficacy in the treatment of overactive bladder syndrome: results from the SUmIT trial. *The Journal of urology*. 2010;183(4):1438.
 338. Booth J, Hagen S, McClurg D, Norton C, MacInnes C, Collins B, et al. A feasibility study of transcutaneous posterior tibial nerve stimulation for bladder and bowel dysfunction in elderly adults in residential care. *Journal Of The American Medical Directors Association*. 2013;14(4):270.
 339. Vohra AK, Britchford A, Neale E, Husain I, Waterfall N, editors. The efficacy of stoller afferent nerve stimulation in frequency/urgency syndrome: A randomised control trial. Proceedings of the International Continence Society (ICS) 32nd Annual Meeting, Aug 28-30; 2002.
 340. Karademir K, Baykal K, Sen B, Senkul T, Iseri C, Erden D. A peripheric neuromodulation technique for curing detrusor overactivity: Stoller afferent neurostimulation. *Scandinavian journal of urology and nephrology*. 2005;39(3):230.
 341. Peters KM, MacDiarmid SA, Wooldridge LS, Leong FC, Shobeiri SA, Rovner ES, et al. Randomised trial of percutaneous tibial nerve stimulation versus extended release tolteridine: Results from the overactive bladder innovative therapy trial. *Journal of Urology*. 2009;182(3):1055-61.
 342. Finazzi Agrò E, Campagna A, Sciobica F, Petta F, Germani S, Zuccalà A, et al. Posterior tibial nerve stimulation: is the once-a-week protocol the best option? *Minerva urologica e nefrologica = The Italian journal of urology and nephrology*. 2005;57(2):119.
 343. Seth J, Gonzales G, Haslam C, Ochulor J, Elneil S, Vashisht A, editors. Single centre randomised pilot study of two regimens (30mins daily or 30 mins weekly for 12 weeks) of Transcutaneous Tibial Nerve Stimulation using an adhesive skin patch for the treatment of Overactive Bladder (OAB) Symptoms Proceedings of the 44th Annual Meeting of the International Continence Society (ICS), 2014 Oct 20-24; 2014.
 344. Monteiro ES, Coin de Carvalho LB, Fukujima MM, Lora MI, Fernandes do Prado F. Electrical Stimulation of the Posterior Tibialis Nerve Improves Symptoms of Poststroke Neurogenic Overactive Bladder in Men: A Randomized Controlled Trial. *Urology*. 2014;84:509-14.
 345. Peters KM, Carrico DJ, Wooldridge LS, Miller CJ, MacDiarmid SA. Percutaneous tibial nerve stimulation for the long-term treatment of overactive bladder: 3-year results of the STEP study. *The Journal of urology*. 2013;189(6):2194.
 346. MacDiarmid SA, Peters KM, Shobeiri SA, Wooldridge LS, Rovner ES, Leong FC, et al. Long-term durability of percutaneous tibial nerve stimulation for the treatment of overactive bladder. *The Journal of urology*. 2010;183(1):234.

347. van Balken MR, Vergunst H, Bemelmans BLH. Prognostic Factors for Successful Percutaneous Tibial Nerve Stimulation. *European Urology*. 2006;49:360-5.

SURGICAL TREATMENT OF URINARY INCONTINENCE IN MEN

Chair

H.B. Goldman (USA)

Members

M.A. Averbeck (Brazil)
H. Bruschini (Brazil)
C. Comiter (USA)
T. Hanus (Czech Republic)
S. Herschorn (Canada)
C. Woodhouse (UK)

CONTENTS

I. INTRODUCTION	1632	VII. INCONTINENCE AFTER NEOBLADDER CONSTRUCTION FOR BLADDER CANCER	1659
1. Materials and Methods.....	1633	VIII. INCONTINENCE AFTER TRAUMATIC INJURIES OF THE URETHRA AND PELVIC FLOOR	1659
II. EVALUATION PRIOR TO SURGICAL THERAPY	1633	IX. CONTINUING PEDIATRIC PROBLEMS INTO ADULTHOOD: THE EXSTROPHY-EPISPADIAS COMPLEX	1661
1. Urodynamic Testing.....	1635	1. Initial Management of the Exstrophy-Epispadias Complex.....	1661
III. INCONTINENCE AFTER RADICAL PROSTATECTOMY FOR PROSTATE CANCER	1637	2. Management of Persisting Incontinence	1663
1. Incidence and Prevalence	1637	3. Recommendations	1665
2. Risk Factors	1638	X. DETRUSOR OVERACTIVITY AND REDUCED BLADDER CAPACITY	1666
3. Pathophysiology	1640	1. Refractory Urgency Incontinence and Idiopathic Detrusor Overactivity	1666
4. Surgical and Minimally Invasive Treatments.....	1641	2. Reduced Bladder Capacity	1675
5. Evidence Based Comparison of AUS and Slings	1650	XI. URETHROCUTANEOUS AND RECTOURETHRAL FISTULAE	1677
6. Timing of Surgical Intervention.....	1651	1. Urethrocutaneous Fistula (UCF).....	1677
IV. INCONTINENCE AFTER PROSTATECTOMY FOR BENIGN DISEASE	1651	2. RECTOURETHRAL FISTULA (RUF)...	1677
1. Incidence and Risk Factors.....	1651	XII. THE ARTIFICIAL URINARY SPHINCTER (AUS)	1687
2. Timing of Surgical Intervention.....	1654	1. Availability and Cost	1687
3. Surgical Treatment Options	1654	2. Indications	1687
V. INCONTINENCE AFTER EXTERNAL BEAM RADIOTHERAPY AND SURGERY FOR PROSTATE CANCER	1655	3. Surgical Techniques.....	1688
1. Surgical Treatment.....	1656	4. Complications.....	1690
VI. INCONTINENCE AFTER OTHER TREATMENTS FOR PROSTATE CANCER	1657	5. Durability of AUS Components	1692
1. Brachytherapy of the Prostate	1657	6. Diagnostic Procedures Related to Artificial Sphincter Failure	1693
2. Cryosurgical Ablation of the Prostate.....	1658	7. Treatment of Complications	1694
3. High-Intensity Focused Ultrasound... ..	1658	8. Consensus Protocol For Follow-up of Patients With AUS	1695

XIII. NEW TECHNOLOGIES UNDER EVALUATION	1696
<hr/>	
1. Introduction	1696
2. Flowsecure Artificial Urinary Sphincter (Rbm-Med)	1696
3. Periurethral Constrictor (Silimed).....	1696
4. ZSI 375 (Zephyr Surgical Implants)....	1697
5. Aroyo (GT Urological).....	1697
6. Stem Cells.....	1697
XIV. SUMMARY AND RECOMMENDATIONS	1697
<hr/>	
1. Evaluation and Recommendations	1697
2. Incontinence Post-Prostatectomy For BPO And Post-Radical Prostatectomy For Prostate Cancer.....	1697
3. Incontinence Following External Beam Radiation for Prostate Cancer	1698
4. Incontinence Following Pelvic Trauma	1698
5. Incontinence in Adult Epispadias Exstrophy Complex	1698
6. Refractory Urgency Incontinence and Detrusor Overactivity.....	1698
7. Reduced Capacity Bladder	1699
8. Urethrocutaneous Fistula and Rectourethral Fistula	1699
9. Management of AUS Complications ..	1699
10. New Technologies.....	1699
11. Future Research Directions	1699
12. Clinical Trial Recommendations	1699
REFERENCES	1700

SURGICAL TREATMENT OF URINARY INCONTINENCE IN MEN

H.B. GOLDMAN (USA)

*M.A. AVERBECK (BRAZIL), H. BRUSCHINI (BRAZIL), C. COMITER (USA),
T. HANUS (CZECH REPUBLIC), S. HERSCHORN (CANADA), C. WOODHOUSE (UK)*

I. INTRODUCTION

Surgery for male incontinence is an important aspect of treatment with the changing demographics of society and the continuing large numbers of men undergoing surgery and other treatments for prostate cancer.

Basic evaluation of the patient is similar to other areas of incontinence and includes primarily a clinical approach with history, pad testing, frequency-volume chart or bladder diary, and physical examination. Since most of the surgeries apply to patients with incontinence after other operations or trauma, other investigations such as radiographic imaging of the lower urinary tract, cystoscopy, and urodynamic studies may provide important information for the treating clinician.

Although prostatectomy for benign disease has become less frequent in many countries, the complication of incontinence is a rare but unfortunate occurrence that merits treatment. After a period of conservative therapy has been tried, surgical treatment is indicated following similar strategies applied in post-prostate cancer treatment incontinence i.e. slings and artificial urinary sphincter (AUS).

Despite the changes in prostate-specific antigen (PSA) testing following the recent US Preventive Services Task Force Statement (USPSTF),^{1,2} radical prostatectomy (RP) for prostate cancer is performed far more frequently now than 15 to 20 years ago, with nearly two-thirds of surgical cases performed via the robotic-assisted laparoscopic approach in the United States.³

The diffusion of minimally invasive radical prostatectomy (MIRP) in the United States may have led to adverse patient outcomes due to rapid surgeon adoption and collective inexperience.⁴ According to an analysis of the Surveillance, Epidemiology and End RESULTS-Medicare dataset, which identified men who had open RP and MIRP for prostate cancer from 2003-2009, MIRP was associated with a higher risk of voiding dysfunction (HR 1.31, 95% CI 1.20-1.43) and ED (HR 1.43, 95% CI 1.31-1.56), but a lower risk

of bladder outlet obstruction (HR 0.86, 95% CI 0.75-0.97). Approximately 5-25% of patients will experience incontinence that fails to improve with conservative management, and a substantial minority will ultimately undergo surgical treatment.⁵ The AUS has provided a satisfactory result in most cases, regardless of the degree of urinary incontinence, with a positive impact on quality of life. Sling procedures have emerged as an efficacious treatment in many men with mild to moderate stress urinary incontinence, however, they have not proven predictably successful in men with higher degrees of incontinence. Injectable agents have not shown durable long-term results. Volume adjustable balloons have been limited in their utility due to a high complication rate. Newer techniques involving adjustable urethral slings have demonstrated efficacy similar to that of non-adjustable slings, with the potential advantage of postoperative alterations in sling tensioning (tightening) but a higher complication rate.

Stratification of treatment based on the degree of stress incontinence is now feasible. Men with milder degrees of incontinence and normal bladder function are candidates for either artificial urinary sphincter placement or sling surgery, each with similar success rates. Sling surgery appears to have a lower risk of surgical complications in this population and patient preference may be for a sling vs a mechanical device in this group of patients.⁶ On the other hand, with more severe incontinence, AUS surgery has a more predictable success profile than does sling surgery.

Incontinence following radiation therapy, cryosurgery, high-intensity focused ultrasound, other pelvic operations and trauma is a particularly challenging problem because of tissue damage inside and outside the lower urinary tract. In such instances, periurethral bulking, sling procedures, and inflatable periurethral balloons have generally proven inefficacious and worsening of incontinence may happen after such surgery. The AUS is the most successful surgical procedure in this setting, but is associated with a higher rate of complications compared to implantation following surgery in the absence of adjuvant cancer therapy. With tissue damage beyond the urinary

TABLE 1. Classification of Surgically Correctable Problems

<p>Sphincter Related</p>	<p><i>Postoperative</i> <i>Post-prostatectomy for prostate cancer</i> <i>Post-prostatectomy for benign disease</i> <i>TURP and radiation for prostate cancer</i> <i>Post-cystectomy and neobladder for bladder cancer</i> <i>Post-traumatic</i> <i>After prostatic-membranous urethral reconstruction</i> <i>Pelvic floor trauma</i> <i>Unresolved pediatric urologic incontinence</i> <i>Exstrophy and epispadias</i></p>
<p>Bladder Related</p>	<p><i>Refractory urgency incontinence</i> <i>Small fibrotic bladder</i></p>
<p>Fistulae</p>	<p><i>Prostatorectal (urethrorectal)</i> <i>Urethrocutaneous</i></p>

sphincter, other surgical approaches may be necessary. Patients with unresolved problems from childhood and with associated incontinence from detrusor overactivity may benefit from a variety of complex reconstructive surgical procedures. Patients with primarily overactive bladder symptoms who have failed conservative management may benefit from neurostimulation or botulinum toxin injection. Other complicated problems encountered include urethrocutaneous fistulae, and fistulae between the prostate, bladder neck, or urethra and rectum. Surgical reconstruction, in experienced hands, often in a staged manner, is usually successful.

With decades of worldwide use of the AUS in the surgical management of male incontinence, its complications and their management are well known. Durability of the device is an important aspect that impacts on outcome and cost of treatment. A growing body of literature regarding male sling surgery, its indications, factors affecting outcome, and complications and their management, has changed the landscape of incontinence surgery over the past 10 years.

Although the literature is replete with well-done cohort studies, there is a continuing need for prospective randomized clinical trials, especially needed for adequate comparisons among surgical techniques.

1. MATERIALS AND METHODS

The committee was charged with the responsibility of assessing and reviewing the outcomes of surgical therapy that have been published since the Fifth Consultation⁷ for non-neurogenic male incontinence. Arti-

cles from peer-reviewed journals, abstracts from scientific meetings, and literature searches by hand and electronically formed the basis of this review. The outcomes were analyzed, discussed among the members of the committee and included in the chapter.

The incontinence problems were classified according to their etiology, ie, either primarily sphincter or bladder related, and are listed in Table 1. Treatment of fistulae is covered separately.

Specific recommendations are made on the basis of published results and determined by the levels of evidence. Consensus of the committee determined the recommendations, which are found at the end of the chapter. Recommendations for future research are also included.

II. EVALUATION PRIOR TO SURGICAL THERAPY

Recommendations for evaluation prior to surgery have not changed substantially from the last edition in 2013.⁷ A basic history and physical is the cornerstone of this evaluation. The history should focus on the precipitating events (surgery, trauma, etc) that led to the incontinence, the evolution over time of the leakage symptoms (has there been improvement, etc), what precipitates the leakage (straining, cough, exercise, etc – suggestive of stress urinary incontinence (SUI) or the sudden sense of the urge to void particularly in the absence of any physical activity – suggestive of urgency urinary incontinence) as well as other potential comorbidities. A general sense of

the degree of both of these symptoms, sexual function and pad use is important as well. The physical examination should note any gross urine leakage per meatus with patient straining or coughing as well as general characteristics of the lower abdomen, perineal area and penis and scrotum. Assessment of upper extremity function is important to assess manual dexterity for manipulation of an implanted device. A brief neuro-urological examination (perineal sensation, anal tone, voluntary contraction and relaxation of the anal sphincter, bulbocavernosus reflex⁸) should be performed. A urinalysis to rule out infection or signs of inflammation or hematuria should be obtained.

A frequency-volume chart,⁹ or bladder diary (indicating daytime and nighttime frequency of micturition, incontinence episodes, voided volumes, 24-hour urinary output, etc.) is also helpful. According to Wyman et al,¹⁰ the 7-day diary can be considered as the gold standard for voiding diaries. Schick et al¹¹ demonstrated that a 4 day frequency-volume chart gives a reliable snapshot of the patient's situation. However, in obvious situations (eg post-prostatectomy incontinence where the patient coughs and leaks during exam such a diary may not be necessary. A pad test quantifies the severity of incontinence and may be the most objective measure of the incontinence. Severity of incontinence (quantified by pad weight) affects surgery outcomes. In men with greater than 200 g/d urine loss, the transobturator sling has been associated with lower success rates.¹² The 24-hour pad test and micturition diary are reliable instruments for assessing the degree of urinary loss and number of incontinent episodes, respectively. Increasing test duration to 48 and 72 hours increases reliability but is associated with decreased patient compliance.¹³ Overall, the 24-hour home test is the most accurate

pad test for quantification and diagnosis of urinary incontinence because it is the most reproducible.¹⁴ The 1-hour pad test may be used because it is easily done and standardized, however there is no strict parallel with the 24-hour pad test and it may underestimate the weakness of the sphincter in the later part of the day. A pad test may be helpful in quantifying leak in AUS failures.

Postvoid residual urine measurement is a good estimation of voiding efficiency.^{15,16} These basic investigations are recommended in incontinent males prior to surgical therapy.

Blood testing (BUN, creatinine, glucose) is recommended only if compromised renal function is suspected or if polyuria (in the absence of diuretics) is documented by the frequency-volume chart.¹⁷

Further evaluation should be adapted to the particular patient. Cysto-urethroscopy will verify the integrity of the urethral wall (anterior aspect of the distal sphincteric mechanism in post-TURP incontinence,¹⁸ erosion by the cuff of the artificial sphincter, and the status of the bladder (trabeculation, stone, diverticula, etc). It will allow observation of the urethral sphincter and voluntary contraction on the part of the patient. The presence or absence of urethral, prostatic, or bladder neck stenosis is also necessary to ascertain prior to incontinence surgery, especially in patients who have undergone treatment for prostate cancer.

Imaging techniques include plain film of the abdomen (KUB or Kidneys, Ureters, Bladder), in cases of incontinence following artificial sphincter implantation when during the original procedure the hydraulic system was filled with contrast medium. A KUB immediately following sphincter implantation serves as a reference point for subsequent comparisons.¹⁹ Figure 1 illustrates the case of a young spina bifida patient in

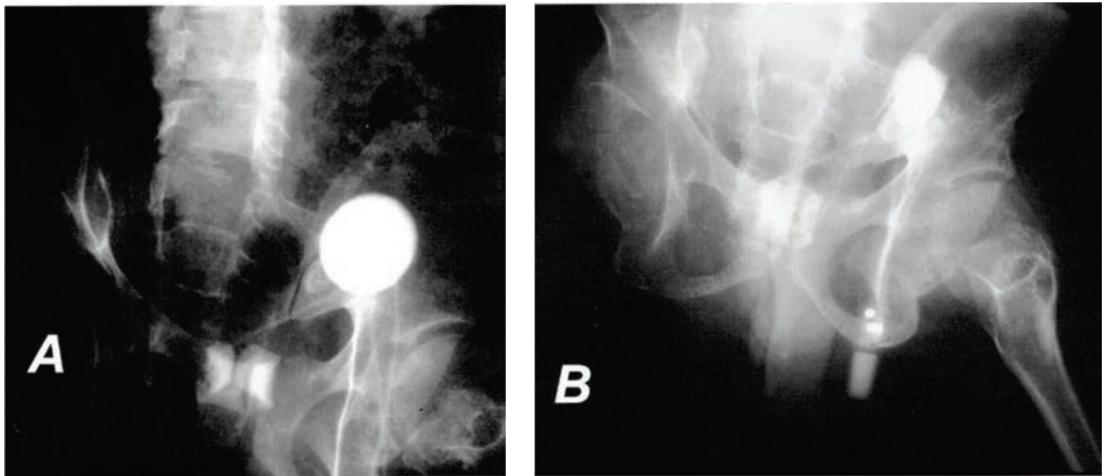

Figure 1. Young spina bifida patient who had a bladder neck artificial sphincter implanted. After more than 10 years, he became incontinent. Early abdominal plain film, A, shows a full reservoir. After leakage started abdominal plain film, B, demonstrates loss of fluid from the reservoir.

whom an artificial sphincter has been implanted with the cuff around the bladder neck. After more than 10 years, he became suddenly incontinent. Comparing the second KUB to the original one clearly demonstrated fluid loss from the system. Contrast studies include cystography which may demonstrate an open bladder neck when bladder denervation is suspected²⁰ (e.g., following abdominoperineal resection of the rectum). CT or MRI may be useful as well particularly in cases where there is concern that components of the AUS have shifted or herniated (Figure 2A and B).

Cystourethrography may be used to demonstrate a fistula, stricture or urethral diverticulum eg, following healing of the urethral wall erosion caused by the cuff of the artificial urinary sphincter. Ultrasound is widely used not only to evaluate the upper urinary tract, but also to evaluate postvoid residual urine. The sensitivity of 66.7% and specificity of 96.5% when post-void residual is 100 ml or more is adequate for routine clinical use.²¹ It has been shown to be cost-effective when compared to catheterization.²² Other modalities, for example transurethral ultrasound²³ and magnetic resonance imaging of the external sphincter are still under development.

1. URODYNAMIC TESTING

Urodynamic studies (UDS) have traditionally been performed in men under consideration for invasive

When performing UDS there are specific issues that must be considered. Sphincter weakness can be documented by the Valsalva²⁴ or cough²⁵ abdominal leak point pressure. However, in patients with incontinence secondary to RP who develop bladder neck stenosis, the urethral catheter can create obstruction giving false values for VLPP. Catheter size seems to have a significant influence even with a small size 7-F urethral catheter,²⁶ and the correlation is extremely high between the test-retest leak point pressure when the same size of catheter is used.^{27,28} In male patients, abdominal leak point pressure may be evaluated via a rectal catheter because a urethral catheter is much more likely to invalidate VLPP measurements than it does in female.²⁹ It has become evident that bladder volume influences VLPP, ie, it decreases with bladder filling.^{30,31,32} However, this observation is not consistent.³³ Unfortunately, there is no agreed standardization of the technique currently which somewhat limits its usefulness.³⁴ Measurement of leak point volume may also provide information on the functional capacity of the bladder.³⁵

Retrograde leak point pressure has been used to study incontinence following placement of an artificial sphincter.^{36,37} It correlates with the lowest abdominal leak point pressure.³⁸ The intraoperative use of this technique has been proposed and this allows early recognition of intraoperative urethral injury and mechanical malfunction.³⁹ Intraoperative retrograde perfusion sphincterometry may be helpful to determine

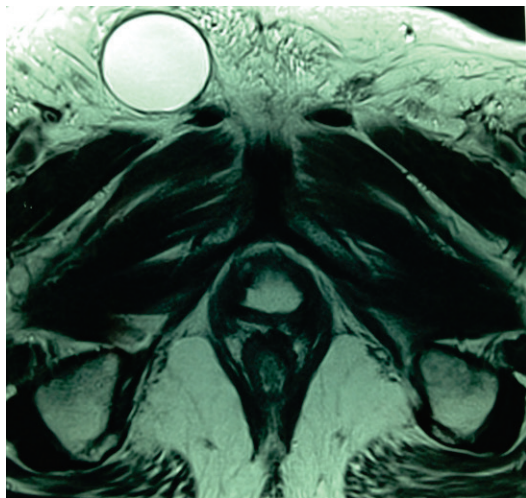

Figure 2A

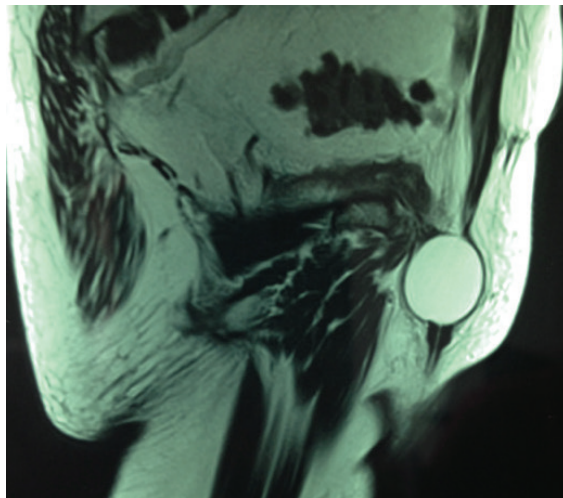

Figure 2B

"Courtesy of Drs Luis Augusto Seabra Rios and Márcio Augusto Averbeck and by permission of Urologia Essencial"

treatment in order to assess Valsalva Leak Point Pressure (VLPP), detrusor overactivity and bladder compliance. However, there are now several studies, which call into question the use of routine UDS in men with pure SUI. These studies will be commented on at the end of this section.

the appropriate tension on male slings.⁴⁰ Similarly, others have utilized repeated intraoperative abdominal leak point pressure (ALPP) measurements to adjust the tension for male slings.⁴¹ Electrophysiologic studies, mainly sphincter electromyography, may be useful to document denervation of the pelvic

floor when nerve injury or neuropathology is suspected.⁴²

Detrusor function is best evaluated by multichannel urodynamics. Its main purpose is to detect **detrusor overactivity and/or decreased compliance during bladder filling**. It can be coupled with fluoroscopic imaging - video-urodynamics. It has also been proposed by some that fluoroscopy be replaced by transrectal ultrasound.^{43,44} Ultrasound measurement of bladder wall thickness was proposed as a better predictor of bladder outlet obstruction than uroflowmetry⁴⁵ but is still controversial.⁴⁶ In some cases with severe SUI and “early” leakage the urethra/bladder neck can be occluded to get a better idea of detrusor characteristics.

Non-invasive pressure-flow urodynamic evaluation based on Doppler ultrasound seems to have potential for diagnosing bladder outlet obstruction.⁴⁷ However invasive pressure-flow studies are still the gold standard in the incontinent male to rule out bladder outlet obstruction accompanied by detrusor overactivity⁴⁸ which in turn can cause incontinence.

In most recently published studies, urodynamic testing has been done prior to surgery.^{49,50,51,52,53} Cystoscopy is frequently done as well.^{52,54,55,56,57,58} However, as noted above, there are some reports that question the value of urodynamics studies in predicting outcomes after surgery. Thiel et al⁵⁹ found no evidence that patients with detrusor overactivity, low first sensation filling, decreased compliance or low bladder capacity had worse outcomes after artificial sphincter placement in 86 men. Trigo Rocha et al⁶⁰ also found that preoperative urodynamic findings such as detrusor overac-

leak pressure, bladder outlet obstruction, and mildly reduced compliance did not lead to a bad outcome after artificial sphincter implantation. Ballert et al⁶¹ studied the association between patients with or without detrusor overactivity, and postoperative outcome after male sling surgery, and found no difference in the number of pads used postoperatively. Finally, Lai et al⁶² reviewed 129 patients with post-prostatectomy incontinence, all of whom had multichannel videourodynamics, and noted that the presence of adverse preoperative urodynamic features (such as detrusor overactivity, early sensation of desire to void, reduced cystometric capacity of <200cc, low abdominal LPP <30 cm H₂O, low peak flow <10 cm H₂O and poor bladder contractility) did not negatively affect the continence results after AUS implantation. However, it should be noted that after discussion with a panel of experts (ICI meeting, Tokyo, September 2016) it is evident that there is a difference of practice between North American and other urologists - the non-North Americans are much more likely to obtain urodynamics preoperatively in all cases.

The proposed evaluation of the incontinent male is summarized in Table 2.

TABLE 2 Evaluation Prior to Surgical Therapy

<ul style="list-style-type: none"> • <i>History</i> • <i>Physical examination</i> • <i>Urinalysis</i> • <i>Urine culture</i> • <i>Post-void residual (by ultrasound)</i> • <i>Voiding diary (2-7 days)</i> <ul style="list-style-type: none"> ○ <i>Polyuria without diuretics: BUN, Creatinine, Glucose</i> • <i>Pad-test</i> • <i>Cystourethroscopy</i> • <i>Urodynamics</i> <ul style="list-style-type: none"> ○ <i>Multichannel urodynamics:</i> <ul style="list-style-type: none"> ▪ <i>To characterize the incontinence and to detect detrusor overactivity, decreased compliance and/or outflow obstruction</i>
--

tivity, impaired detrusor contraction, low valsalva

III. INCONTINENCE AFTER RADICAL PROSTATECTOMY FOR PROSTATE CANCER

1. INCIDENCE AND PREVALENCE

Urinary incontinence occurring after RP is a substantial problem. Despite improvements in continence preservation⁶³ during the 1990s and 2000s primarily due to a better understanding of the pathophysiology and improvements in surgical technique, continence rates have generally plateaued over the past decade. As RP has continued to increase in popularity as a treatment for prostate cancer, especially with the advent of robotic-assisted surgery, the prevalence of post prostatectomy incontinence (PPI) has increased in developed countries, which has led to an overall increase in the number of patients affected.

Data from large multicenter studies and prostate cancer databases suggest that following RP, 1% to 40% of patients complain of persistent urinary incontinence. The incidence of post prostatectomy incontinence (PPI) depends on the definition of urinary incontinence and the length of follow-up.^{64,65,66} In addition to numerous definitions of incontinence, the tools used to evaluate incontinence vary from self-administered validated and non-validated questionnaires, to interviews from a data manager, to response to the surgeon's inquiry, to insurance database inquiries regarding secondary surgical procedures. It should be noted that SUI also affects men who have not had surgery for prostate cancer, occurring at a baseline prevalence of 1.3%-4.8%.^{67,68} In addition, men with

prostate cancer who choose radiation therapy, androgen ablation, or even watchful waiting also develop urinary incontinence, recently reported at rates of up to 12%, 11%, and 3%, respectively.^{69,70} In addition to urinary incontinence, bothersome lower urinary tract symptoms may affect patients following any treatment (or even watchful waiting) for prostate cancer.

Typically, reports of large cohorts use definitions that include "total control/perfect continence/dry", "occasional leakage but no pad", and "less than one pad". Because 1/3 to 1/2 of men who do not wear pads will have occasional leakage of urine,^{64,71} it is important to distinguish among those men who leak enough to require pad use vs those who do not, as it has been demonstrated that health related quality of life (QOL) is strongly correlated with the level of incontinence. Wearing one pad, even if this pad is considered "a security pad", more significantly affects the quality of life than wearing no pad at all.^{72,73} In addition, not all men who leak will elect to have further treatment. Most large cohort studies indicate that between 6% and 9% of patients undergo subsequent surgical treatment for PPI following prostate cancer surgery.^{74,75,76,77} Several large cohort studies are listed in Table 3.^{66,71,73,78,79,80,81,82,83,84,85,86,87,88,89,90,91,92,93,94,95,96}

Another bothersome type of incontinence occurring during orgasm in men post-prostatectomy has been termed 'climacturia' and may significantly affect the quality of men with post-prostatectomy potency.⁹⁷

Finally, some men may experience post-micturition dribbling. This can usually be managed with urethral milking or pelvic floor muscle contraction.

TABLE 3. Continence Rates After Radical Prostatectomy According to Definition of Continence

Authors	N	Mean age (yrs)	Continence Follow-Up at 12 Months			Type of Surgery
			Total control without any pad or leakage (%)	No pad use but loses a few drops of urine (%)	Use none or 1 pad per day (%)	
Anstasidis et al ⁹⁰	70 230	65 64			67 72	RRP LRP
Augustin et al ⁸⁷	368	63.3			87.5	RRP
Boris et al ⁹⁴	50 50	64 64			96 96	RRP RALP
Deliveliotis et al ⁸²	149	66.5		92.6		RPP
Di Pierro et al ⁹⁵	75 75	64 63	80 89			RRP RALP
Harris et al ⁸³	508	65.8		96		RPP
Hofmann et al ⁸⁵	83			74.7	88	RRP±Rx
Jacobsen et al ⁸⁹	172 67	64 61	87 83		88 50	RRP LRP

Authors	N	Mean age (yrs)	Continenence Follow-Up at 12 Months			Type of Surgery
			Total control without any pad or leakage (%)	No pad use but loses a few drops of urine (%)	Use none or 1 pad per day (%)	
Kielb et al ⁷⁸	90	59.6	76		99	RRP
Krambeck et al ⁹²	588 294	61 61		94 92		RRP RALP
Lepor and Kac ⁸⁰	92	58.7	44.6		94.6	RRP
Liss et al ⁷³	420	61	54	67	82	RALP
Madalinska et al ⁸¹	107	62.6	33	65		RRP
Maffezzini et al ⁸⁴	300	65.5		88.8		RRP
Olsson et al ⁶⁶	115	65.2	56.8	78.4	100	LRP
Rassweiler et al ⁸⁸	219 219	65 64			89.9 90.3	RRP LRP
Reynolds et al ⁹⁶	1005	60	28	68	90	RALP
Rocco et al ⁹³	240 120	63 63			88 87	RRP RALP
Ruiz-Deya et al ⁸⁶	200	63			93	RPP
Sacco et al ⁹¹	985	65	83	92	93	RRP
Sebesta et al ⁷⁹	675	< 65	43.7	69.2	82.2	RRP
Wallerstedt et al ⁷¹	1163	63	67	78	90	RRP or RALP

RRP = radical retropubic prostatectomy, RPP = radical perineal prostatectomy, LRP = laparoscopic radical prostatectomy

Rx = radiotherapy, RALP = robotic assisted laparoscopic prostatectomy

2. RISK FACTORS

Reported risk factors for incontinence following RP include patient age at surgery, socio-economic status, preoperative continence status, obesity, pre-surgical bladder dysfunction, stage of disease, surgical technique (including nerve sparing, bladder neck preservation, and posterior reconstruction of Denonvilliers' musculofascial plate, anterior periurethral suspension sutures,^{98,99} prior radiation therapy, preoperative length and intraoperative preservation of the membranous urethra, prior transurethral resection of the prostate (TURP), postoperative radiation or cryotherapy, and vascular comorbidities. However, various studies have come to conflicting conclusions regarding the importance of specific risk factors. Predisposing factors contributing to incontinence after TURP have been less clearly defined, probably because the incidence is so low, (and the plethora of minimally invasive therapies is reducing the popularity of TURP surgery), making the accumulation of large prospective series of this type of incontinence difficult. However, previous external beam radiation and prior brachytherapy does predispose to post-TURP incontinence (Section V and VI in this chapter).

Preoperative voiding dysfunction and pre-existing urinary incontinence have been reported as risk factors for postoperative SUI. Patients with more severe lower urinary tract symptoms, measured by validated symptoms scores, had a lower return to continence than did patients with more mild symptoms, even when controlling for age.¹⁰⁰ While preoperative lower urinary tract symptoms, including urgency incontinence and "overflow incontinence" may improve with de-obstruction secondary to extirpative surgery,¹⁰¹ preoperative SUI does not improve following RP. Several recent cohort studies have demonstrated that preoperative sphincteric insufficiency (demonstrated by either the pre-existing clinical sign of SUI or the urodynamic finding of lower maximal urethral closure pressure) predicts postoperative SUI.^{102,103} Preoperative bladder dysfunction can also contribute to postoperative incontinence. Pre-existing abnormalities of detrusor function may predispose to leakage following surgery, especially in the setting of neurogenic detrusor overactivity due to Parkinson's disease, dementia or spinal cord injury.¹⁰⁴

Advancing age as a risk factor is supported by several studies^{77,101,105,106,107,108,109,110,111}. However, Steiner et al¹¹² found no correlation between age and continence status, but only 21 of the 593 patients were 70 years or older. Others have found advancing age and

the number of comorbidities to have a negative impact on the recovery time for continence during the first year after RP;¹¹³ although, the rate at one and two years did not seem to be significantly affected.¹¹⁴ Mohamad and colleagues¹¹⁵ reviewed 16,524 patients who underwent RRP in public hospitals, covering 95% of all procedures in Austria between 1992 and 2003. They found that increasing age was associated with an increased risk of future AUS implantation. In those aged 45-49, 0.5% were bothered enough by PPI to merit AUS placement, while those age 70-74 were five times as likely to undergo AUS placement for PPI.¹¹⁵ Similarly, Rogers et al¹¹⁶ demonstrated that age affected postoperative continence status following laparoscopic RRP. In those < 50 years old, 100% achieved 0-1 pad per day continence at 1 year, which decreased to 91% and 81% for those age 50-59 and > 60 yrs, respectively ($P<0.01$).¹¹⁶ Nilsson et al¹¹⁷ reported that age at surgery predicted—in an exponential manner—the long-term risk for urinary incontinence, with an estimated relative increase of 6% per year.

Strasser and colleagues hypothesized that age related sphincteric changes may be responsible for the age-related increase in postoperative SUI, and successfully demonstrated a progressive reduction in sphincter striated muscle cells with age.²³ In addition to age, overall well-being has also been related to the risk of PPI. For example, a recent study from Italy demonstrated that both age and Charlson comorbidity index were independent predictors of return to urinary continence.¹¹⁰ It is especially interesting to note that in this particular cohort study, there were no variables related to the prostate cancer itself that were significantly correlated with urinary continence. A large study from Sweden recently demonstrated that in addition to age as a risk factor (relative risk of 2.4 between the oldest and youngest quartiles), educational level also impacted incontinence, with low educational level, as compared with high educational level, being associated with a 2.5 times risk of incontinence.¹¹⁷

Obesity, especially when coupled with physical inactivity, appears to be a risk factor for PPI in men undergoing RRP. Obesity with a BMI > 30 was reported as a risk factor with an incontinence rate of 25.8% vs 8.7% in BMI <30 in a series of 252 men after RRP.¹¹⁸

Wolin et al¹¹⁹ demonstrated that greater than one year after surgery, obese men were markedly more likely to have urinary incontinence (defined as any pad use) than were non obese men, while this risk was exacerbated by sedentary lifestyle, and ameliorated by at least 1 hour of physical activity per day (preoperatively). Nonobese active men were 26% less likely to have urinary incontinence than obese inactive men. In obese men who were physically active, the relative risk of urinary incontinence was 15% less than in the inactive obese men.¹¹⁹

Most large series have found no correlation between the stage of disease and incontinence

rates.^{106,107,120,121,122} Loeb and colleagues¹²³ specifically demonstrated excellent continence rates even in high-risk (high local stage) patients. However, in certain cases, the stage of disease may affect the surgical technique (ie, nerve sparing) and incontinence rates may be higher, but this appears to be a reflection on surgical technique and not disease stage.¹⁰⁸ Yang et al¹¹¹ reported that neoadjuvant hormonal ablation was associated with a lower risk of urinary incontinence, and while patients with higher stage disease may have been more likely to receive hormonal ablation preoperatively, it is not clear that stage of disease was an important risk factor.

Regarding surgical technique, the many parameters involved in continence may explain difficulties in understanding the benefit of certain technical points. Perineal prostatectomy is done by only a limited number of urologists but is still advocated for markedly obese patients and the continence rate is reported as similar to the retropubic route.^{83,94,124,125} Bladder neck preservation has been reported to improve continence at 1 month¹²⁶ and at 3 months¹²¹ but no difference was found at 6 and 12 months.^{127,128} Nerve sparing has no significant impact according to Steiner et al¹¹² and Lepor and Kaci.⁸⁰ Recently Pick et al¹²⁹ reported that nerve sparing, whether unilateral or bilateral, did not affect continence rates following RALP. However, others did find benefit.¹⁰² In particular, Nandipati and colleagues¹³⁰ reported that in a cohort of 152 patients followed prospectively, bilateral nerve sparing surgery was associated with a shorter time to regain continence as well as improved long-term continence rates compared to non-nerve sparing surgery. They additionally found that increased age was a risk factor for post-prostatectomy incontinence. Burkhard et al¹³¹ similarly demonstrated a positive effect of nerve-sparing surgery on postoperative continence. In a prospective cohort study of 536 patients, PPI developed in 1/75 (1.3%), 11/322 (3.4%), and 19/139 (13.7%) with attempted bilateral, attempted unilateral and without attempted nerve sparing, respectively. Attempted nerve sparing was in fact the only statistically significant factor influencing urinary continence after RRP in this cohort.¹³¹ Based upon comparison of preoperative and postoperative urodynamics, nerve sparing appears to reduce the risk of PPI—via minimizing decreases in maximal urethral closure pressure and functional urethral length, but without affecting bladder function.¹³² Two recent reports have linked preoperative sexual function with postoperative continence. While those who are sexually active preoperatively may be more likely to have their cavernosal nerves spared during surgery, it appears that the preoperative status has a significant effect on postoperative continence rather than the nerve sparing technique.^{126,129,133}

Robotic-assisted laparoscopic RP has not only become a standard treatment for men with prostate cancer, but has become the most popular surgical option. In contrast to the initial robotic experience, where the body of available data on postoperative incontinence did not demonstrate an obvious differences in urinary

continence rates between open and laparoscopic/robotic approaches,^{88,89,90,92,93,94,95,134,135,136} more recent reports have indeed shown a lower rate of incontinence following robotic surgery compared to traditional open surgery. While one randomized comparison of laparoscopic RP with and without robotic assistance did not show a significant difference in urinary continence,¹³⁷ there has been more recent demonstration of statistically significantly superior continence outcomes with robotic assisted laparoscopic RP compared to *open* RP.^{138,139,140,141}

While no specific reconstructive technique has been definitively shown to affect long-term continence, the postoperative appearance of the bladder outlet on cystogram has been shown to correlate with early and late postoperative incontinence. Specifically, a sharper bladder neck angle with a more downwardly displaced bladder neck predicts PPI as early as 1 month, and as late as 24 months postoperatively.¹⁴² In addition to the angle per se, the bladder neck location in relation to the superior edge of the symphysis can also predict incontinence at 12 months postoperatively. Patients in the highest tertile of bladder neck to pubic symphysis ratio (distance from superior edge of pubic symphysis to the bladder neck divided by the total pubic symphysis height) had a nearly 20% incontinence rate at 1 year postoperatively, compared to a 2.8% rate in those in the lowest tertile.¹⁴³

Is Radical Retropubic Prostatectomy associated with higher risk of urinary incontinence in patients previously submitted to HoLEP or TURP due to Benign Prostatic Enlargement?

Suardi et al¹⁴⁴ evaluated the feasibility and safety of nerve-sparing radical retropubic prostatectomy (NSRRP) for localized prostate cancer after HoLEP for BOO due to BPE. Fifteen consecutive patients with prostate cancer following HoLEP underwent NSRRP. They were matched with an equal number of patients who also underwent NSRRP following TURP (TURP group) or open prostatectomy (OP group). Mean follow-up was 23.8 ± 10.5 mo. At last follow-up evaluation no statistical differences were found among the groups in terms of UI, as measured with the first question of the ICIQ-SF. The groups showed no statistical differences in UI rate. Six-month continence rates were 93.3%, 93.3% and 80% for HoLEP (N=15), TURP (N=15) and open prostatectomy (N=15), respectively ($P>0.05$).

3. Pathophysiology

Post-prostatectomy incontinence, like any urinary incontinence, may be caused by bladder dysfunction, sphincter dysfunction or a combination of both. Urodynamic studies are helpful to rule out bladder outlet obstruction or significant bladder dysfunction. In addition to incontinence symptoms, storage and voiding symptoms may be investigated.^{124,145} Urodynamics demonstrates that sphincter incompetence occurs as the sole cause in more than two-thirds of patients,

while isolated bladder dysfunction (detrusor overactivity, poor compliance, detrusor underactivity during voiding) is uncommon, occurring in less than 10%.^{146,147,148,149}

Sphincter and bladder dysfunction can coexist in at least one-third of incontinent patients. Bladder dysfunction may occur de novo after prostatectomy perhaps induced by bladder denervation; may be caused by outlet obstruction, or may be related to pre-existing factors such as age. Impaired detrusor contractility, which occurs in 29%–61% of patients (de novo in approximately 47%), and poor compliance, which occurs in 8%–39% of patients (de novo in approximately half), have traditionally been thought to resolve in the majority of patients within 8 months.^{149,150} However, two recent prospective urodynamic studies have demonstrated that decreased vesical compliance can occur in up to one-third of patients following RP, and persist in 28% at 36 months, while detrusor underactivity can occur in half of the patients, and persist in 25% at 36 months.^{150,151} Decreased sphincter resistance may be due to tissue scarring in some cases and reflected by a low urethral compliance, however this parameter is difficult to measure.¹⁴⁶ Scarring may lead to an anastomotic stricture evidenced by endoscopy or urethrography, and is clinically suspected when both incontinence and decreased force of stream coexist.

The preoperative length of the membranous urethra determined on MRI has been shown to be significantly related to time to postoperative continence. When urethral length was greater than 12 mm, 89% of the patients were continent at one year, vs 77% with or less than this length.¹⁵² Urodynamic studies revealed that a reduced functional urethral length was a predictive parameter of incontinence.^{102,153,154} A recent elegant study of *intraoperative* stretched urethral length (from the urogenital diaphragm to the prostatic apex with cephalad retraction) and cut urethral length (length of preserved urethral stump) during RALP revealed that although in this cohort, MRI urethral length did not correlate well with continence, the intraoperative measurements correlated significantly with time to continence.¹⁵⁵ Different components of the urethra may also be involved. The urethral intrinsic component responsible for passive continence as well as the extrinsic component responsible for active continence may be involved as has been demonstrated in a urodynamic alpha blockade test.¹⁵⁶ This may explain passive incontinence despite a high voluntary urethral pressure or that measured during an active squeeze by the patient. Postoperative disruption of the innervation of the posterior urethra may also be involved and can affect both motor and sensory functions.^{157,158} In clinical practice, urodynamic evaluation of urethral weakness may be assessed by resistance to antegrade leakage (ALPP or VLPP), retrograde leakage, or profilometric measurement (MUCP).¹⁵⁹ However no such parameters have been correlated to outcomes of treatments for the correction of post-prostatectomy incontinence. It should be

noted that increasing age is a strong predictor of incontinence.^{160,161,162,163,164,165} The fact that increasing age predicts incontinence reflects the natural history that atrophy of the rhabdosphincter and degeneration of neural pathways occurs with aging, thereby affecting postoperative continence status.

The state of a patient's pelvic floor may also influence continence or return to continence after RP. Physiotherapy and pelvic floor rehabilitation have been shown to improve or enhance continence (decreased time to final continence level) in the postoperative period in two randomized studies, but only if such measures are instituted before or immediately after catheter removal.^{166,167} Maximum difference between physiotherapy and no treatment is achieved at 3 months, with almost no difference at 12 months. Another study showed that providing patients with instructions for pelvic floor muscle exercise alone was equivalent to biofeedback or electrical stimulation.¹⁶⁸ A randomized study in which randomization occurred 6 weeks after surgery showed no difference in continence at 6 months.¹⁶⁹ On the other hand, a recent trial from Brazil did demonstrate significant difference in 12-month continence rates, quality of life, and lower urinary tract symptoms in general when randomizing patients to biofeedback-pelvic floor muscle training vs verbal instructions alone.¹⁷⁰ Studies in which physiotherapy was used as a treatment modality for established incontinence have shown more variable results.^{171,172,173,174} A recent randomized trial of formal one-to-one pelvic-floor muscle training vs advice alone for incontinent men 6 weeks after RP failed to demonstrate any difference in continence rates at 12 months. Nor did the physiotherapy improve SUI after TURP.¹⁷⁵ Overall, the data indicate that pelvic floor therapy accelerates the return to continence but does not change the ultimate outcome.

No medical treatment is available to cure post-prostatectomy incontinence. Duloxetine at 60 mg per day could improve mild or moderate incontinence but half of the patients had side effects and 25% stopped the treatment because of adverse effects in two short non-randomized series. This treatment is not approved in many countries and is only a treatment option to improve symptoms in selected patients informed of side effects.¹⁷⁶

4. SURGICAL AND MINIMALLY INVASIVE TREATMENTS

4.1. Urethral Bulking Agents

Urethral bulking is a minimally invasive treatment proposed for post prostatectomy incontinence, and theoretically works by adding bulk and increasing coaptation at the level of the bladder neck and distal sphincter. It can be done in an office or outpatient setting in a retrograde or antegrade fashion. Several different agents have been used for urethral bulking in men including bovine collagen (Contigen®), silicone

macroparticles (Macroplastique®), ethylene vinyl alcohol copolymer (Tegress®), Dextranomer hyaluronic acid (Deflux®), and carbon-coated zirconium beads (Durasphere®). All agents share the similar problems including the need for multiple injections, deterioration of effect over time, and very low cure rates.

For collagen, "success rates" for post-prostatectomy incontinence ranged from 36–69%, with 4–20% of patients reporting being dry.^{177,178,179,180,181,182,183,184} Unfortunately, the end points in most of these studies are subjectively based, making comparisons difficult; however, it is clear that cure rates (total dryness) are low, and multiple injections were required to achieve modest rates of subjective improvement. There was no advantage of delivery technique (retrograde vs. antegrade). Several authors identified factors which negatively affect results including extensive scarring or stricture formation, previous radiation, and high grade stress incontinence and low ALPP.^{178,180,181,184} One study reported more favorable results for collagen in treating incontinence after transurethral prostatectomy as opposed to RP (35.2% 'social continence' vs 62.5%).¹⁸¹ It appears that collagen injection did not adversely affect outcomes of artificial sphincter implantation and did not increase the complication rate.¹⁸⁵ Nor did collagen injection adversely affect the outcome of the bone-anchored male sling (BAMS).^{186,187} The cost efficacy of injections remains to be determined. Collagen is no longer available as an injectable agent.

Other bulking agents such as polydimethylsiloxane (Macroplastique®) have shown some initial success, but results also deteriorate over time. Bugel and co-workers¹⁸⁸ treated 15 patients. They noted rapid deterioration after initial improvements with success rates of 40%, 71%, 33%, and 26% at 1, 3, 6, and 12 months respectively. They also noted that a urethral closure pressure of at least 30 cm H₂O was essential for success. Kymala et al¹⁸⁹ prospectively studied 50 patients with mild to moderate SUI (average 48 cc on 1 hour pad test), with 12% achieving short-term continence following 1 injection, and an additional 20%, 18%, and 10% achieving continence with 2, 3, and 4 injections respectively. Follow-up, however, was limited to 3 months. More recently, a Korean study with 6 month follow-up showed 43% success at 3 months following Macroplastique injection, which decreased to 32% at 6 months. Lower ALPP and a history of radiation correlated with treatment failure.¹⁹⁰ In a randomized trial of AUS vs Macroplastique injection in patients with minimal SUI (the majority had SUI following BPH surgery, with more than 1/3 of the cohort suffering from SUI following RRP), Imamoglu and colleagues demonstrated no difference in success with AUS vs Macroplastique. However, in patients with more severe incontinence, AUS was superior, with minimal improvement following transurethral Macroplastique.⁵⁶ As one would expect, due to the poor efficacy of periurethral bulking agents, their use for treating PPI had decreased dramatically over the past decade, from 80% of cases in 2004, to 60% in

2010,¹⁹¹ and to < 40% in 2013.¹⁹² While the efficacy of periurethral injection is indeed limited, improvements with injection are better than those seen with more conservative management, and better than no treatment at all, with no demonstrable differences in outcome with respect to a transurethral vs periurethral injection method, and no differences in outcome between proximal urethral or bladder neck injection site.¹⁹³

With regard to the newer (not FDA approved for male SU1) injectable bulking agents, dextranomer hyaluronic acid has been reported in men with PPI and in men with neurogenic ISD. Four of four patients with PPI failed to improve, and 1 of 2 neurogenic patients (both with detrusor areflexia, wet between catheterizations) failed.¹⁹⁴ With ethylene vinyl alcohol copolymer (Tegress®) in a report by Hurtado et al,¹⁹⁵ not only was the failure rate high, but also the complication rate was unacceptable. In 17 men, who averaged 1.4 injection sessions followed at a mean of 4 months, 10 had complications, with erosion of injected material in 41.1%, and with only a minority of patients achieving a 50% decrease in leakage. Tegress® has been withdrawn from the market. Carbon-coated zirconium beads have been similarly reported to be inefficacious, with a recent report of 8 men with mild to moderate incontinence receiving a relatively large average injected volume (23.8 mL), none of whom achieved subjective or objective cure.¹⁹⁶

There has been interest in the use of autologous muscle cells, stem cells, and fibroblasts as an injectable sphincter-restorative agent for PPI. Transurethral injection of living muscle stem cells to reconstitute the deficient urethral sphincter has been reported. Mitterberger and colleagues¹⁹⁷ demonstrated a 67% continence rate at an average of 1 year follow-up in a cohort of men suffering from PPI who were treated with transurethral ultrasound guided injections of autologous fibroblasts and myoblasts obtained from skeletal muscle biopsies. An earlier report from the same group demonstrated that men with PPI achieved a 52% dry rate with injection of adult autologous stem cells, which was superior to a similar cohort of men treated with collagen injection.¹⁹⁸ However, it must be pointed out that there was a retraction issued by the editors of *The Lancet*¹⁹⁹ for a previous article on the treatment of female SU1 with autologous cells published by the same group.²⁰⁰ The project was investigated by the AGES PharmMed, a department of the Austrian Government's Agency for Health and Food Safety. The editors stated that in their view "the conclusions of the official investigation pinpoint so many irregularities in the conduct of their work that, taken together, the paper should be retracted from the published record." Current research has focused on the relatively abundant adipose derived stem cells and muscle derived stem cells, which are believed to be easier to harvest (higher yield) than are autologous bone-marrow derived stem cells.²⁰¹ In a recent large scale trial of muscle derived cells for treating male sphincteric incompetence, Gerullis et al²⁰²

demonstrated complete continence in 12% and improvement in 42% of 222 men at 1 year post injection.

Conclusion: Bulking agents remain the most minimally invasive treatment for post RP incontinence after conservative measures. All agents for which there is peer-reviewed data available, show only modest success rates with very low cure rates. Effects tend to deteriorate over time. It remains to be seen if improvements in outcomes can be achieved with alternative agents, or if the concept of urethral bulking has achieved its maximal benefit with the agents available now. It is the opinion of the committee that the use of bulking agents for the treatment of male urinary incontinence should only be utilized when other more effective treatments are contraindicated (**Level of evidence 3; Grade of recommendation C**).

4.2. Male Sling

The male sling procedure is based upon the concept of urethral support and external urethral compression, and has established itself as an accepted and efficacious treatment for PPI. The male sling is actually based on a concept similar to that described by Kaufman and associates in the early 1970s.^{203,204,205} At that time a high rate of failure, septic complications and pelvic pain as well as the advent of the mechanical AUS led to the abandonment of the Kaufman prosthesis. Now with the higher prevalence of PPI and patient desire for less invasive surgery and a non-mechanical device the concept has been revisited. Procedures have been developed based on principles used to treat female stress urinary incontinence. These procedures rely on compression from the ventral side of the urethra rather than the circular compression caused by a natural or artificial sphincter. Therefore, most successful sling surgeries rely on a device that is placed under tension, occluding the urethra at rest, and during stress maneuvers.^{206,207,208}

Schaeffer et al²⁰⁹ described the bulbourethral sling which uses Dacron bolsters placed under the urethra, which are suspended to the anterior rectus fascia by sutures. Data on this procedure are limited to retrospective analyses from the two authors who described the procedure: it did not gain widespread popularity. In the initial report from two centers, 64 patients were included and 56% were "dry" and 8% "improved" at a mean follow up of 22.4 months.²⁰⁹ Almost one-third needed secondary retightening procedures and patients with radiation fared poorly. Subsequently, Clemens et al²¹⁰ reported a questionnaire-based study of 66 men from a single institution and 41% were cured and 51% improved but mean follow up was only 9.6 months. They also reported that the

bulbourethral sling did not cause significant outlet obstruction.²¹¹

The long-term efficacy of the bulbourethral sling was evaluated in 2005, where 95 patients were followed retrospectively at an average of 4 years postoperatively. With follow-up questionnaires returned by 71 patients, the authors found that patients who had undergone radiation, had worse outcomes with 14% dry and 43% requiring 1 or 2 or fewer pads daily. Moderate to severe pain was reported by 12% of patients after 4 years. Patients who had not had radiation treatment had a cure rate of 42% and 72% used only 0-2 pads per day for mild leakage.²¹² Others have described a bulbourethral sling using a polypropylene mesh graft with or without a porcine dermis backing (presumably to reduce the risk of erosion).⁵⁷ In two small studies of 9²¹³ and 16⁵⁷ patients, cure rates range from 56-69% and failure rates from 22-25% at a mean follow up of 14 months. John described the bulbourethral composite suspension where porcine dermis is secured to the bulbospongiosus muscle and a 1 cm wide polypropylene sling is placed over this and passed through the retropubic space to emerge from two suprapubic incisions (similar to the tension free vaginal tape procedure in women).⁵⁷ He reported a 69% cure and additional 6% improvement in 19 patients, with a mean follow up of 14 months. Eight intraoperative bladder perforations healed without complication.

Xu and colleagues described a bulbourethral composite suspension utilizing a suburethral polyester patch plus a narrow polypropylene tape passed from a perineal incision to a suprapubic incision. At an average of 28 months, 22 (85%) of 26 patients were successfully treated.²¹⁴

Wadie described 2 year follow-up on a polypropylene bulbourethral sling suspended by nylon sutures and fixed in front of the rectus sheath.²¹⁵ Eighty-five percent were dry at 2 years though 25% had undergone retightening of the sling between 3 and 6 months. This sling made of easily obtainable materials might prove particularly useful in settings that do not have easy availability of some of the commercially produced slings (Figure 3).

A common method of sling fixation involved use of bone anchors. The bone anchored male sling (BAMS) obviated the need for any suprapubic incision for suture passage and fixation. In 2001, Madjar et al²¹⁶ reported on 14 patients with post RP incontinence that underwent the procedure with a synthetic or cadaveric fascial sling. At a mean follow up of 12.2 months, 86% were "cured" wearing none or 1 pad. Comiter²¹⁷ reported a 76% cure and 14% "substantially improved" rate in 21 men with post prostatectomy incontinence using polypropylene mesh with a mean follow up of 12 months.¹⁸⁶ In a 2005 update, the same author reported that with a median of 48 months follow-up, 65% of patients remained pad free and 15% required 1 pad per day. Urodynamic follow



Figure 3 – homemade polypropylene sling (Wadie)

up in 22 men, revealed that the sling had no substantial effects on voiding function and no one was obstructed postoperatively.²¹⁸ Onur and colleagues²¹⁹ reported on 46 men with a mean follow-up of 17 months (6-26). They used different materials for the sling (allograft dermis, allograft fascia lata, porcine small intestine submucosal (SIS) graft, synthetic mesh, and a composite of synthetic and dermis). Overall they reported 41% of patients dry and 35% improved (50% reduction in the number of pads). All patients in whom allograft or xenograft alone was used failed. A 24-month update revealed a patient satisfaction rate of 70% and a 74% improvement in leakage at a median of 24 months.²²⁰ Giberti et al²²¹ reported that in 36 men followed for an average of 41 months, 62% were cured and 70% were satisfactorily improved. In the subset that had a synthetic sling implanted, a higher success rate was experienced, with 77% achieving cure. Complications included sling infection in 4.8%, and de novo detrusor overactivity in 7.1%. Carmel et al²²² reported that at an average follow up of 36 months, in a cohort of 45 men with moderate to severe PPI, 78% were improved by pad use, 76% had dry ICS 1-hour pad tests, and 72% were satisfied or very satisfied. Infection occurred in 1 patient, and pain resolved in all patients by 12 weeks postoperatively.

However, the morbidity (infection, pubic bone osteitis, perineal pain) related to bone screws coupled with the emergence of effective alternatives has decreased the popularity of the bone-anchored sling, which is no longer commercially available.

The transobturator (TO) male sling technique was introduced in 2004²²³ and has become the most common approach for male sling placement, since the early reports of 2007.^{53,223,224} Whereas this sling does compress the bulbar urethra, another mechanism of action is proposed to rely on proximal urethral relocation. It is hypothesized that inefficacious coaptation of the urethral sphincter complex results from lax-

ity of posterior urethral support and relative misalignment of the proximal urethra.²²⁵ A TO sling that restores the pre-prostatectomy configuration by realigning the mobile sphincter complex can remedy this proximal urethral descent. Following appropriate sling tensioning, the bulbar urethra is relocated proximally, by a distance of 2-3 cm, into the higher pressure pelvic outlet, functioning as a “backstop” during straining.²²⁶ This approach relies more on rotation of the dorsal surface of the proximal bulbous urethra and indirect support of the sphincteric urethra, rather than on direct compression of the urethral lumen.²²⁷ Membranous urethral rather than bulbar urethral placement of the sling was introduced with the TO sling with the aim of relocating the urethra in a more proximal direction. However this type of sling surgery close to the membranous urethra requires a deeper dissection compared to that needed for bulbar or perineal urethra compression slings. Over the past few years, there have been several case series reporting greater than 2-year follow-up. Success rates are generally between 50 and 80%, with cure/dry rates averaging 50%. An early report from the Cleveland Clinic showed diminished efficacy over time, with patient-determined success decreasing from 87.3% to 62.5% with the retroluminal sling, with average daily pad use more than doubling over 2 years postoperatively.²²⁸ However, others have shown sustained efficacy over time. Rehder et al²²⁹ followed 156 patients with varying degree of incontinence (24% 1-2 ppd, 40% 3-4 ppd, 35% ≥ 5 ppd) for a median of 36 months. 53.0% were cured, and an additional 23.8% were improved, with 23.2% considered treatment failures. Mascle et al²³⁰ reported their 66 patients with an average of 3 years follow-up, and 39.4% achieved continence, with an additional 40.5% improved. Interestingly, success related strongly to degree of preoperative leakage, with 94%, 74% and 56% achieving surgical success with mild (1 ppd), moderate (2-3 ppd) and severe (>3 ppd) leakage. In another report of the TO male sling with > 2 year follow-up, similar efficacy was demonstrated, with 80% success, which similarly varied with the degree of incontinence. 86% success was achieved in those with < 100 g/d leakage, vs only 40% success in those with > 400 g/d leakage.²³¹ Kowalik’s group also showed a 60% cure rate and 13% improvement rate in 30 patients with median 39 months follow-up, also with the finding that higher pad weight (in this report > 200 g/d) predicted surgical failure.²³²

The I-Stop TOMS, another transobturator sling, differs from the AdVance sling in that it has four arms and a larger surface area of mesh placed over the bulbar urethra, and relies on tensioning each corner of the sling. In addition, the bulbar urethra is not detached from the perineum, so urethral repositioning does not occur. Rather, the sling is compressive at the bulbar urethra. A prospective multicenter study²³³ was recently published with 122 patients after minimum follow-up of 12 months for 84% of them, and showed a cure rate of 60% and improvement with only one pad per day in 20%. There were no erosions

or acute urinary retention. Wound infection was reported in 2% and all resolved. In a smaller cohort of 40 patients, who were followed for 2 years, 45% realized a successful outcome at 6 months, but this diminished to 38% at 24 months. There were no reported complications.²³⁴ A different “inside-out” TO sling also positioned over the bulbar urethra²³⁵ was implanted in 173 men, of whom 49% were cured and an additional 35% improved at a median follow-up of 24 months.²³⁶

For the TO sling, transient urinary retention has been reported in 3 to 23%, typically resolving by 12 weeks.²³⁷ Perineal pain rates vary widely from 0 to > 20%, depending on the definition of postoperative pain, but most reports show significant pain in < 10% of patients, which resolves by 3 months postoperatively.^{238,239,240} Serious complications requiring sling explantation are rare, and are generally reported as < 1%.²³⁷

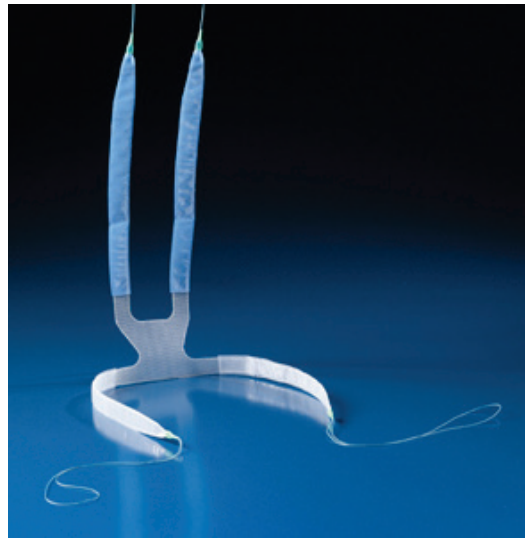

Figure 4. Virtue sling

The newest iteration of the nonadjustable male sling is the VIRTUE® Male Sling (Coloplast, Humlebaek, Denmark) -- an implantable, sub-urethral, permanent, non-absorbable support sling (Figure 4). The sling is a synthetic suburethral mesh made of knitted, monofilament polypropylene that measures 5.5 cm x 7 cm, with superior and inferior extension arms. Quadratic fixation is achieved with both transobturator and prepubic (PP) components.²²⁴ This hybrid sling is based upon the mechanisms of action of the TO sling and the BAMS, providing a broad area of urethral compression *and* achieving proximal relocation of the membranous urethra. The sling has been shown to increase the retrograde leak pressure in 22 patients from 33.4 to 68.8 cm water after tensioning intraoperatively, with an increase in urethral resistance from both the TO component *and* the PP component.⁴⁰ In a multinational study comparing the original surgical treatment to a revised procedure with a novel fixation

mechanism, 1 year success improved from 41.9% in the unfixed cohort to 79.2% in the fixation group. Furthermore, pad weight reduction of 88.3% was realized after 1 year in the fixation group, compared to only 51% reduction in the unfixed cohort.²⁴¹ However, McCall et al²⁴² reported higher failure rates (68%) in the long-term (mean follow-up = 55 months). According to this retrospective series, failure was more likely in patients with external beam radiation therapy ($P=0.02$) and there was no association of procedure failure with age ($P=0.65$) or severity of incontinence ($P=0.17$). However, there appear to be differences in the surgical technique between these studies and thus a direct comparison may not be possible. Other studies are ongoing at this time.

Three adjustable retropubic slings have recently been introduced, with the objective of overcoming potential problems of overcorrection or under correction of continence: the "Argus",²⁴³ REMEEX²⁴⁴ and ATOMS²⁴⁵ slings. The Argus suburethral sling is composed of a silicone cushion attached to two silicone cone columns that are passed with needles through the obturator foramen from the perineum to both inguinal areas.²⁴⁶ In a multicenter trial of the Argus sling in 48 patients,²⁴⁶ a 73% continence rate and additional 10% improvement rate was reported after an average of 7.5 months. Erosion and infection necessitated sling removal in 10% of patients. Adjustments were indicated for persistent incontinence as well as for urinary retention.²⁴⁶ In an update reported of 47 patients after a mean follow up of 45 months, 66% were dry and 79% used ≤ 1 pad per day.²⁴⁷ Hubner's group²⁴⁸ reported similarly favorable results, with 79% of 101 men achieving dryness at an average of 2.2 years postoperatively. Thirty-nine percent required adjustment (10% loosening, 29% tightening) at a mean of 104 days after surgery. Erosion or infection necessitated explantation in 16% at a mean of 1 year. A report from the Netherlands²⁴⁹ revealed a 72% success rate for the Argus at a median follow up of 27 months. Outcome was dependent on the degree of preoperative incontinence, with surgical success in 92% of men with mild leakage (1-2 ppd), 67% in men with moderate leakage (3-5 ppd) and 67% in those with severe (> 5 ppd) incontinence. Explantation was required in 11%, due to infection, erosion, sling rupture or pain. Bladder perforation occurred in 16%, and de novo urethral stricture requiring treatment in 12%. Dalpiaz et al²⁵⁰ reported less favorable results, with 79% of 29 patients achieving dryness and 76% satisfaction in the short term, but the dry rate and satisfaction rates deteriorated to 17% and 28% respectively at 35 months. Complications occurred in $> 80\%$ of cases, with a 35% explanation rate, 14% de novo urgency rate, and a single instance each of urethral stricture and ureteral injury. In a retrospective cohort study of 16 men status post AUS explantation for erosion,²⁵¹ who were treated with an

Argus sling or repeat AUS, men receiving the AUS had a better outcome. Of those who underwent repeat AUS implantation, 63% were cured, and an additional 25% were improved, with only 12% failing. Notably 75% of the Argus patients failed to improve. The most recent report of the Argus sling involved a prospective 2-center study of 42 patients with varying degrees of leakage (range 53-885 g/d) who had a transobturator adjustable device. At a mean follow-up of 28.8 months, results of this sling were similar to the results of the retropubic device: 61.9% were dry, 26.2% of patients were improved, and 11.9% failed. Median adjustments were 1.7 per patient, and there were no instances of acute retention. Three wound infections were managed surgically, but did not require device explantation.²⁵²

The REMEEX adjustable sling is composed of a monofilament suburethral sling connected to a suprapubic mechanical regulator with two monofilament traction threads. The mechanical regulation part, the varitensor, is a subcutaneous permanent implant, which is placed over the rectus fascia 2 cm above the pubis; the implant allows adjustment of suburethral pressure from outside the body by means of an external manipulator.^{244,253} In a prospective multicenter Phase II trial of the REMEEX adjustable sling, 51 patients were followed for an average of 32 months (range: 16-50). With 90% of patients requiring at least 2 adjustments, a continence rate of 64.7% was achieved, with an additional 19.6% reporting improvement over baseline.^{Error! Bookmark not defined.} More recent, but smaller studies have also shown promising results. Navalon Verdejo et al²⁵⁴ reported that 3 of 5 men were dry at an average of 1.4 months, with the other 2 patients experiencing marked improvement. Four of 5 patients experienced recurrent SU1, which was resolved after surgical re-adjustment via the varitensor. A study with lower success rates was reported from Spain with a cohort of 14 men at an average of 18.6 months postoperatively, 42% are dry and 33% are improved.²⁵⁵ However, bladder perforation occurred intraoperatively in 29%, sling explantation was required in 21%, urinary retention occurred in 36%, and readjustment was necessary in 83%.

The newest adjustable sling is the ATOMS system, composed of a transobturator-placed mesh tape with a soft inflatable silicone cushion, connected to a refillable inguinal titanium port. Adjustments are made via inflation of the silicone cushion rather than by manipulation of the sling arms. In a single center cohort study of 36 patients, only 38.9% achieved social continence. Furthermore, an explantation rate of 27.7% precludes the widespread adoption of this experimental device.²⁵⁶

Sling results are shown in Table

^{49,50,57,209,212,213,214,216,217,218,219,220,221,244,246,257,258,259,260}

TABLE 4. Results of Sling Procedures in Males with Stress Urinary Incontinence

Authors	N	Mean Follow-Up (mos)	Sling Type	Cured (%)	Improved (%)	Failed (%)
Athanasopoulos et al ²⁶³	43	24	Synthetic BAMS	51	30	19
Bauer et al ²⁶⁹	126	27	AdVance	52	23	25
Bochove-Overgaauw et al ²⁴⁹	100	27	Argus-adjustable	40	32	28
Carmel et al ²²²	45	36	Synthetic BAMS	36	40	24
Castle et al ²⁵⁹	42	18	Synthetic BAMS	16	24	60
Cespedes & Jacoby ²⁵⁸	9	13	Perineal BAMS	66.7	11.1	22.2
Claudon et al ²⁶¹	106	12	Synthetic BAMS	61	14.5	24
Comiter ²¹⁷	48	48	Synthetic BAMS	65	20	15
Cornel et al ²⁷¹	36	12	AdVance	9	46	46
Cornu et al ²⁶⁸	136	21	AdVance	62	16	22
Dalpiazz et al ²⁵⁰	29	35	Argus-adjustable	17	11	72
Dikranian et al ⁴⁹	36 20	12 12	Organic Synthetic BAMS	56 87	31 13	13 0
Fischer et al ⁵⁰	62	15	Synthetic BAMS	34	24	42
Gallagher et al ²⁶⁰	24	15	Synthetic BAMS	38	37	25
Giberti et al ²²¹	36	41	Synthetic or organic BAMS	62	8	30
Grise et al ²³³	122	12	I-STOP TOMS	60	27	13
Guimaraes et al ²⁶²	62	28	Synthetic or organic BAMS	65	23	12
Hubner et al ²⁴⁸	101	27	Argus-adjustable	79	0	21
Jimenez et al ²⁵⁵	14	19	REEMEX-adjustable	42	33	25
John ⁵⁷	16	14	Polypropylene suspended suprapubically plus porcine skin collagen	69	6	25
Leruth et al ²³⁶	173	24	Inside-out transorbtorator	49	25	16
Madjar et al ²¹⁶	16	12	Synthetic BAMS	86	14	0
Migliari et al ²¹³	9	14	Polypropylene needle suspension	55.6	22.2	22.2
Moreno-Sierra et al ²⁴³	48	7.5	Argus-adjustable	73	10	17
Onur et al ²¹⁹	46	18	Synthetic or organic BAMS	41	35	24
Rajpurkar et al ²²⁰	46	24	Synthetic or organic BAMS	37	37	26
Rehder et al ²³⁸	118	12	AdVance	74	17	9
Romano et al ²⁴⁶	51	32	Argus-adjustable	64.7	19.6	15.7
Romano et al ²⁴⁷	47	45	Argus-adjustable	66	13	21
Schaeffer et al ²⁰⁹	64	18	Vascular graft bolsters with needle suspension	56	8	36
Sousa-Escandon et al ²⁴⁴	6	18	REMEEEX-adjustable	83.3	17	—
Stern et al ²¹²	75	48	Bulbourethral suspension	36	32	32
Thüroff et al ²⁵⁷	22	10.3	Fascial sling with suprapubic and perineal approaches	63.6	9	27.3

Authors	N	Mean Follow-Up (mos)	Sling Type	Cured (%)	Improved (%)	Failed (%)
Ulrich & Comiter ²¹⁸	36	25	Perineal synthetic BAMS	67	25	8
Xu et al ²¹⁴	26	28.3	Bulbourethral composite suspension	73	19	8

BAMS = bone-anchored male sling

4.2.1 Adjustable vs Nonadjustable Slings

While there are few studies comparing the nonadjustable vs the adjustable male sling procedures, overall, the two types of slings appear equally efficacious. Author-reported success for the fixed slings generally ranges from 54-91% (average=76%) for the fixed sling compared to 28-100% (average=78%) for the adjustable models. Whereas the adjustability does not appear to increase the overall efficacy of the surgery, it does, by definition, increase the need for surgical revision/tightening. In one nonrandomized study comparing outcomes of an adjustable (Argus) vs non-adjustable (AdVance) sling, more patients chose the adjustable device (25 vs 19). With mean follow-up of 36 and 33 months respectively, there was no statistically significant difference in continence or satisfaction rates. However, the Argus group had a 24% surgical revision rate, vs only 5% in the AdVance group.²⁶¹ Thus, it does not appear that adjustability improves continence compared to a fixed male sling placed with proper tension with adequate fixation.

4.2.2 Sling Complications

Due to the small size of most reported cohort series of BAMS patients, the precise complication rate is not known.²⁵⁹ However, reports from the largest cohorts of patients reveal an infection rate ranging from 0-6%, and a urethral erosion rate of 0-2%.^{50,217,259} Bother-some scrotal pain or numbness affects 16%-72% of patients postoperatively, but has been reported to resolve in nearly all patients by 3 months.^{217,221} Post-operative urinary retention was reported in 2-12% of patients. In most cases, it was self-limited and resolved in within 2 weeks^{54,220,222,260,262} or rarely required loosening after one month.⁵⁰

Infection of the perineal incision/mesh occurred in 3-12%. These infections usually required removal of the implanted sling. Some superficial infections were successfully treated with antibiotics. In men with postoperative mesh infections, 76% (19/25) required surgical explantation of the sling.^{54,217,221,222,259,262,263} The majority of infections occurred early; however, late infections at 3 months and 1 year have been reported.^{54,222}

Urethral erosion is a well-defined complication in the female SUI population. It has not been frequently reported with any type of male sling; although, there are case reports for erosion of the bone-anchored sling, the retroluminal sling, and the adjustable sling, yet no such instances of erosion have been reported for the quadratic sling.^{253,247,264} Pre-existing risk factors for sling erosion have not been established, but have

been ascribed to unrecognized iatrogenic urethral injury.²⁶⁵ It has therefore been suggested that inside-out trocar passage minimizes the risk of iatrogenic urethral injury.²⁶⁶

Abnormal postoperative pain or paresthesia is thought to be from compression or intraoperative disruption of the perineal nerves, or from healing around the newly placed bone screws. This complication is difficult to characterize because there is no standard level of pain that is considered abnormal. While some series acknowledged that the majority of patients experience mild pain for 1-3 months after surgery,²⁵⁹ others reported only those with severe pain that required explantation of the sling.²⁶⁰ The pain generally resolves within 3 months^{217,219,222,259,262} although persistent pain beyond 3 months has been reported.^{50,54} Sling removal has been reported in two patients for persistent pain.^{50,54}

De novo detrusor overactivity or urinary urgency has been reported in 1-14% of patients, and can be treated with oral anticholinergics when necessary. One patient required sling explantation due to this complication.⁵⁴

While the bone-anchored sling is rarely performed anymore, bone screw dislodgement can happen as a late complication and has been reported in 3 patients.^{217,262,267} This caused recurrent incontinence and in such rare instances, the bone anchor may be replaced, and the sling tension can be re-established.

The most common complications reported with the TO sling are perineal pain and urinary retention and studies are needed to establish the best rates between success and side effects among different slings. Pain beyond the normal perioperative period has been reported to affect 0-20% of patients, and urinary retention has been reported in 3-21% of cases. While incision or explantation for retention is rare, the need for catheterization can persist for up to 12 weeks,^{238,268,269} with rare instances of retention lasting > 3 months.²⁷⁰ Less commonly experienced is wound infection, with only rare sling infection or erosion requiring explantation.^{264,269,271} Unlike the BAMS, however, there are occasional instances of worsening incontinence following TO sling placement, which likely occur if the sling is not adequately fixed in position, and allowed to migrate proximally and posterior to the urethra, thereby exerting a pulling effect that opens the dysfunctional urethral sphincter.^{271,272}

Rates of recurrent incontinence following successful sling surgery are generally low.^{50,217,220,273} However, up to 13% of patients who undergo sling placement

will ultimately receive an AUS.¹⁹² Rather than routinely offering AUS for sling failure, there have been recent cohort studies regarding repeat sling surgery in the patient who has failed primary sling placement. Soljanik et al²⁷³ reported a cohort of 35 men undergoing a second TO sling. Success rate at 6 months was 79% (46% dry, 33% improved), and was maintained at 76% at an average of 16.6 months, demonstrating that the TO sling may be an effective treatment for managing SUI after a prior failed sling surgery. There was one urethral injury and a 23.6% rate of urinary retention, neither of which adversely affected the surgical outcome. Of note, all patients had a positive repositioning test, and were deemed appropriate candidates for repeat sling placement.²⁷³ Martinez et al²⁷⁴ reported their cohort of men who received a salvage TO sling, and noted that in men who either did not realize sling efficacy or who had early sling failure (< 6 months), success with salvage surgery was lower (20% cure, 20% improved) vs the success rate in those who had initially achieved continence, but developed recurrent leakage later (> 6 months). This latter group realized a 62.5% cure and 12.5% improvement rate at 1 year following repeat sling surgery.²⁷⁴

4.2.3 Predictors Of Success

As the male sling has realized increased popularity, and has become the most common procedure offered for the treatment of PPI,¹⁹² there is a growing body of literature identifying those factors that predispose to sling failure. Several cohort studies have demonstrated that prior radiation therapy is associated with diminished efficacy of the male sling, probably due to urethral fibrosis and inadequate urethral coaptation.^{53,212,219,221,236,253,275,276,277} A history of prior urethral stricture,²⁷⁸ pelvic radiation,^{209,259,279,280} or prior incontinence surgery^{218,251,259,281} decreases sling efficacy.

Urodynamic predictors of failure include the presence of a short functional urethral length, a low maximal urethral closure pressure and abdominal leak point pressure,²⁸² and a negative repositioning test.²⁸³ Pre-treatment severity of incontinence measured by the degree of leakage also appears to influence sling results. Several reports indicate that those with more severe leakage do not achieve similar continence rates when compared to those with milder leakage.^{219,221,259,263,284,285} Fischer and colleagues⁵⁰ were able to quantify, in prospective fashion, that leakage greater than 423 gm on preoperative pad weight predicted an inferior outcome, compared to those men with less leakage on preoperative pad weight test. In their report, 62 patients with SUI were followed prospectively. All patients were rigorously evaluated with 24-hour pad test, urodynamics and validated incontinence questionnaires. Success was determined by the Patient Global Impression of Improvement. Overall, 36/62 (58%) of surgeries were successful at a mean follow-up of 15 months. The only preoperative predictive factor was 24-hour pad weight. If pad weight was less than 423 gm, there was a 6-fold

greater success rate compared to those with a preoperative pad weight of greater than 423 gm.

Finally, there are technique-associated drivers of success. The use of organic (resorbable) material is less efficacious than synthetic (permanent) sling material.^{219,221,259,286} The treatment of male SUI with a suburethral sling requires tension that can only be maintained with the use of synthetic material. In addition, poor suture fixation of the TO sling and failure to adequately tunnel the sling arms are also related to poor efficacy.^{266,278} Similarly, the quadratic sling without proper fixation has a substantially lower success rate than does the sling with properly fixated prepubic and transobturator sling components.²⁶⁶

Conclusion

In the intermediate term, the male sling appears to be a reasonable option. Slings have surpassed the artificial sphincter as the most common surgical treatment for PPI. The European Association of Urology Guidelines has concluded that there is limited short-term evidence that fixed slings cure or improve post-prostatectomy incontinence in patients with mild to moderate incontinence (LOE 3) and that men with severe incontinence, previous radiotherapy or urethral stricture surgery may have poorer outcomes (LOE 3). Additionally, there is no evidence that one type of male sling is better than another (LOE 3) and there is no evidence that adjustability of the male sling offers additional benefit over other types of sling (LOE 3). However, in the UK, the National Clinical Guidelines Centre in The Management of Lower Urinary Tract Symptoms in Men has stated that implanted compression devices and slings can be offered to men with SUI within the context of a randomized clinical trial.²⁸⁷

The best candidates appear to be those with lower and moderate degrees of incontinence, who have neither had previous radiation nor AUS placement. With non-circumferential urethral compression, the male sling appears to have a lower risk of urethral erosion and atrophy than does the AUS in the intermediate term. In men with mild to moderate degrees of SUI, or for patients demanding a less invasive procedure or non-mechanical device, the male sling has established itself as a viable alternative to the artificial sphincter. When given a choice of surgery, patients have been reported to overwhelmingly choose the male sling over an artificial urinary sphincter. Kumar et al⁶ reported that in men with moderate PPI (pad weight 100 to 400 gm/24 hours) who were recommended to receive an AUS or a male sling, 92% opted for the sling. Interestingly, even when the surgeon recommended an AUS for severe leakage (> 400 gm/24 hours), 25% still opted for the sling. Intermediate and long-term data support the BAMS and transobturator male sling as durable treatments for PPI, while short-term outcomes of the quadratic sling

are also favorable. (Level of evidence 3; Grade of recommendation C)

4.3. Artificial Urinary Sphincter

The artificial urinary sphincter remains the most effective long-term surgical treatment for post RP incontinence due to sphincteric insufficiency (Figure 5). However, due to the cost, the perceived cumbersome nature of the device with resultant patient reluctance to have or inability to use a mechanical implant, and the fear of complications, it is not suitable for all patients. In addition the development of less invasive techniques (as described above) potentially gives patients new options for treatment. Ultimately the choice of AUS will be based upon patient dexterity, economics, degree of incontinence, previous incontinence surgery, and expectations from surgery. Patient preference was tested in a study by Kumar et al.⁶ Based on the magnitude of their incontinence patients either had an AUS (high grade incontinence) or sling (low grade incontinence) or a choice between the two (moderated grade incontinence) recommended. Outcomes, length of experience and complications were reviewed with the patients. Of interest, all recommended to have a sling chose a sling, 75% recommended to have an AUS had an AUS while of those given a choice 92% chose a sling. This sheds some light on patient preferences in this area.

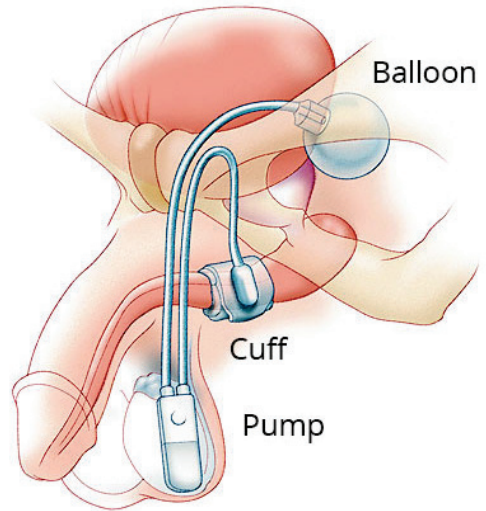

Figure 5. Artificial urethral sphincter

bulking agents became popular, and sling surgery has since surpassed the AUS in number of procedures performed annually. To this end, it is likely that the advent of the male slings has increased the rate of surgery in men with milder incontinence who may not otherwise have opted for an artificially sphincter. The success rates for AUS as defined by a continence status of zero to one pad per day ranges from 59% to 90%,^{290,291} as shown in Table 5.^{60,290,292,293,294,295,296,297,298,299,300,301}

The AUS has the longest track record of success in the treatment of PPI. Two older studies have reported that about half of the patients with severe incontinence will undergo AUS implantation.^{288,289} However, these studies were conducted before male slings and

TABLE 5. Results of the Artificial Urinary Sphincter in Post-Radical Prostatectomy Incontinence

Authors	N	Follow-Up (yrs)	0 or 1 pad/day
Fleshner & Herschorn ²⁹⁴	30	3	87%
Goldwasser et al ²⁹⁹	42	1.2	82%
Gousse et al ³⁰⁶	71	7.7	59%
Haab et al ²⁹⁸	36	7.2	80%
Hoy et al ³¹⁹	48	24	88.2%
Kim et al ³⁰⁰	124	6.8	82%
Klijn et al ²⁹⁷	27	3	81%
Lai et al ³⁰¹	218	3.1	69%
Lim et al ³²⁰	13	29.8	72.7%
Madjar et al ²⁹⁶	71	7.7	59%
Martinez-Salamanca et al ⁹⁷⁵	32	1	96%
Martins & Boyd ²⁹³	28	2	85%
Montague ²⁹²	66	3.2	75%
Mottet et al ²⁹⁵	96	1	86%
Perez & Webster ²⁹⁰	49	3.7	85%
Trigo Rocha et al ⁶⁰	40	4.5	90%

Just as reported rates of incontinence following prostate cancer surgery depend on the definition of incontinence, continence rates with the AUS can vary with the definition of continence, the method of evaluation, and the length of follow-up. The lowest rates are from patient administered questionnaires when pad free rates range from 10-72%.^{293,302,303,304,305,306} Nevertheless, high satisfaction rates of 87% to 90% are consistently reported, even without total continence.^{294,298,302}

One potential downside of the AUS is the need for periodic revisions in a number of patients. Revision and explantation rates due to mechanical failure, urethral atrophy, infection and erosion vary considerably among studies with respectively reports of 8-45% and 7-17%.³⁰⁶ In a large cohort reported by Lai and colleagues,³⁰¹ non-mechanical failure decreased from 17% to 9% and mechanical failure decreased from 21% to 8% following introduction of the narrow back cuff and mean time to reoperation was 26.2 months (mean 2-68 months). With a Kaplan-Meier analysis, the overall 5-year expected product survival was 75%. Only 6% of devices failed mechanically, at an average of 68.1 months, with 75% of patients requiring no revisions at 5 years. Actuarial freedom from revision at 5 years was estimated at 50%-75%. Interestingly, there do not appear to be any urodynamic factors that predict AUS failure in men with ISD. Whereas the male sling has been shown to have inferior success rates in patients with severe leakage, the AUS has been reported to have predictable success regardless of the degree of incontinence and regardless of detrusor hypocontractility, detrusor overactivity, low abdominal leak point pressure, or diminished compliance.⁶² While the success of the AUS in treating incontinence is not adversely affected by pre-operative detrusor overactivity, the rate of persistent overactive bladder symptoms may be high (71%), and patients must be counselled accordingly.³⁰⁷

The long-term efficacy of the AUS was demonstrated by Fulford et al³⁰⁸ who reported that at 10-15 year follow-up, 75% of patients with an implanted AUS either had died or died with a functioning device. Revisions include replacement of the malfunctioning part, cuff replacement, repositioning or downsizing due to urethral atrophy, a second or tandem cuff^{309,310} or transcorporal cuff placement.³¹¹ Transcorporal cuff placement, which involves inserting the cuff through the corporal bodies to avoid perforating the dorsal aspect of the urethra, can be particularly useful for patients with prior radiation or urethral erosion; however potency, if present, may be compromised. Some have advocated tandem cuffs not only as a salvage procedure, but also as a primary procedure for men with severe incontinence.^{312,313} However, O'Connor et al reported no difference in continence outcome and a higher revision rate in patients undergoing double-cuff implant vs single-cuff after longer follow up.³¹⁴

There is conflicting evidence regarding whether or not there is an increased revision rate for patients who received pelvic radiation.^{291,293,315} A recent report,

however, showed that the relative risk of erosion is significantly higher in those who had radiotherapy compared to those who did not – RR 4.05, 95% confidence interval (CI) 1.1-15.3 – and that this risk of erosion has not diminished despite improvement in radiation technique and equipment.³¹⁶ The results of continence for radiated patients are variable with some studies showing lower success rates^{290,315} while others do not.³⁰⁵ A recent report on the artificial sphincter in patients with a “fragile urethra” (history of radiation, prior urethroplasty or prior AUS) demonstrated outcomes similar to those reported for low risk patients – with continence achieved in 77% and improvement in 97%, with explantation secondary to erosion in only 7%.³¹⁷ It has been recommended that such patients have a lower pressure reservoir and/or longer period of deactivation time.²⁹³

5. EVIDENCE BASED COMPARISON OF AUS AND SLINGS

There are few comparative studies of the artificial sphincter and the various male slings, and no prospective randomized trials comparing the devices. However, there have been some recent cohort studies comparing outcomes of the AUS with those of specific male slings in certain patient populations. While no one device is preferred in all patients in all clinical situations, there are some recommendations made in the literature regarding the preferred treatment in certain patient populations depending on prior radiation, prior incontinence surgery, degree of urinary incontinence, and bladder contractility.

Adequate urethral tissue compliance is necessary for successful urethral compression and/or proximal repositioning with a sling. Radiation and previous AUS explantation, both of which may result in a relatively non-compressible urethra, are associated with diminished sling efficacy. It has been reported that 13% of men who have sling surgery will ultimately be treated with an artificial urinary sphincter.¹⁹² There is no evidence, however, that the efficacy of the AUS is diminished in those with prior sling placement. While there are trials of repeat sling surgery in those who have failed initial sling placement,^{274,273} the AUS has a substantially higher success rate than does repeat sling placement, as the risk of persistent incontinence is six times higher with repeat sling than with AUS implantation.³¹⁸ It is, therefore, the Committee's recommendation that with the exception of the occasional patient with persistent mild to moderate SUI following prior sling, with a positive repositioning test, AUS implantation is the treatment of choice for persistent PPI because it can provide the circumferential urethral compression necessary for adequate coaptation even in the setting of diminished urethral compliance.

In men who have not been radiated and have not had prior incontinence surgery, factors such as degree of leakage, proximal urethral mobility, and detrusor con-

tractility can help determine the preferred surgical approach. In a retrospective review of 124 patients with mild to moderate PPI (≤ 5 pads per day), 76 of whom underwent TO sling surgery vs 48 who underwent AUS placement, Hoy et al showed relative equivalence in surgical outcome. Specifically, there was no statistical difference in continence (88.2% vs 87.5%), satisfaction (93% vs 92%) or complication rate (19.7% vs 16.7%). However, those complications associated with the AUS were more severe than those following sling surgery.³¹⁹ In a comparison of men with mild-moderate PPI receiving AUS (N=20) or adjustable TO sling (N=20), Lim et al³²⁰ reported no statistically significant difference in efficacy (72.7% vs 85% success). However, there was a greater rate of pain reported in the adjustable sling group (30% vs 7.7%), and sling explantation was required three times more often in the sling group.

In those with mild to moderate leakage and a positive repositioning test or adequate urethral mobility on video urodynamics, a compressive or transobturator sling is a reasonable approach, with lower complication rates compared to AUS placement and without an adverse effect on future AUS placement. With detrusor underactivity, the TO sling may be preferred versus a compressive sling, given its non-compressive mechanism of action. In the setting of detrusor underactivity in this group with moderate incontinence, AUS is preferred. With leakage > 400 g/day (moderate to severe), AUS is the recommended option, however a compressive sling is also a reasonable alternative in the patient who does not desire an AUS.

Conclusion

The AUS (AMS 800) remains the most predictably successful surgery for the treatment of PPI secondary to sphincteric insufficiency in patients with severe incontinence, in those who have had external beam radiation treatment and in those who have had prior sling or AUS implantation (**Level of evidence 2; Grade of recommendation A**). It has the largest body of literature reporting long-term success and this success and high patient satisfaction seem to outweigh the need for periodic revisions in some patients. Intermediate term data with the male sling demonstrates that the sling is equally efficacious with a lower rate of severe complications in patients with mild-moderate SUI, provided that those patients have not failed previous AUS surgery, have not had radiation treatment, and have normal bladder contractility. (**Level of evidence 2; Grade of recommendation B**)

6. TIMING OF SURGICAL INTERVENTION

There are no clear data on timing of a surgical intervention for the treatment of PPI, either with benign or malignant disease. Therefore, at present guidelines

as to timing of the surgery cannot be formulated. A certain period of watchful waiting supplemented with conservative measures, particularly pelvic floor physiotherapy, seems to be a reasonable option. Thus, conservative management may be tried for periods of up to 6-12 months depending on whether there is any progress noted by the patient. Observational studies of men following prostate cancer surgery typically demonstrate improvement in continence from the early postoperative period until the end of the first year.¹¹⁹ In addition, it is common for clinical trials of non-operative management to follow patients for up to 12 months postoperatively, usually with improvement in both the intervention and the control groups during that year of follow up.¹⁷⁰ In a prospective cohort study of men undergoing RRP, Lepor and Kaci⁸⁰ demonstrated continued recovery of continence up to 24 months postoperatively, from 80.6% at 3 months to 95.2% at 12 months, plateauing at 98.5% at 24 months. Other cohort studies have demonstrated a plateau in continence rates at 12 months.^{321,322} Since continence may improve up to 12 months postoperatively, and possibly even until 24 months, it is generally recommended that behavioral/conservative management be utilized during the first year after prostate cancer surgery. However, a recent consensus group recommended that in patients experiencing no improvement in SUI symptoms at 6 months it is reasonable to proceed with intervention at that point.⁸⁶⁶

There have been some studies evaluating the effect of early interventional treatment for incontinence. Schneider and colleagues³²³ demonstrated a beneficial effect on the earlier return to continence with early injection of periurethral bulking agent. Results were better in the subgroup of 34 patients that were injected early (mean 23 days postoperatively) compared to 10 patients treated at a mean of 26 months postoperatively. It could not be demonstrated, however, that long-term continence is improved by early injection of bulking agent. Similarly, Jones and colleagues³²⁴ demonstrated in a comparative cohort study of RRP patients treated either with or without a simultaneous suburethral sling, that sling placement at the time of RRP resulted in an earlier return to continence. There was no difference after 24 months. (**Level of evidence 4; Grade of recommendation C**)

IV. INCONTINENCE AFTER PROSTATECTOMY FOR BENIGN DISEASE

1. INCIDENCE AND RISK FACTORS

The incidence of urinary incontinence after prostatectomy for benign disease has been reviewed and described in the AHCPR "Benign Prostatic Hyperplasia" Clinical Practice Guidelines.³²⁵ The following rates of

stress incontinence and total incontinence, respectively, were reported:

- Open surgery (retropubic or transvesical prostatectomy): 1.9% and 0.5%.
- TUIP (transurethral incision of the prostate): 1.8% and 0.1%.
- TURP (transurethral resection of the prostate): 2.2% and 1.0%.

These figures were based on studies reported before 1990. Several other series were published after 1990. These series were reviewed for the 1st, 2nd, and 3rd International Consultations on Incontinence.^{7,326,327} A clear description of the method of follow-up and assessment of the continence status was indicated in only about one third of these studies. The incidence of incontinence after open surgery, TURP, TUIP and HoLEP is low: the reported percentages ranged between 0 and 8.4%. Since the method of assessment of the continence status and the definition of incontinence is rarely stated it is actually not possible to make a distinction between stress, urgency and mixed urinary incontinence. On the other hand, the category urinary incontinence represents a heterogeneous group of adverse events, including total and partial urinary incontinence, temporary or persistent incontinence.³²⁸ There is generally no clear indication that the incidence is affected by patient age or (resected) prostatic volume.³²⁶ However, a recent study out of Brazil did demonstrate that the rate of urinary incontinence following BPH surgery is higher in older patients. Most of the increased incidence in incontinence was due to bladder dysfunction rather than to sphincter insufficiency. In a retrospective chart review from Wendt-Nordahl and colleagues,³²⁹ the incidence of incontinence following TURP was reported to have decreased over 17 years, from 3.3% in 399 patients operated on between 1987 and 1997, compared to 1.3% in 550 patients operated on from 1997-2004. It is not clear whether this statistically significant ($P < 0.05$) difference was due to improvement in surgical technique or patient characteristics. However both the earlier and later incontinence rates are consistent with those in the AHCPH and AUA guidelines reports.

In 2003, the AUA published guidelines for the management of “benign prostatic hyperplasia”.³³⁰ The estimated frequency of incontinence following TURP was 3% (from 19 trials that included > 5000 patients). However, the Veterans Affairs Cooperative Study, reported an incontinence rate of only 1% in TURP patients, which was not different from the watchful waiting arm.³³¹ The AUA conducted a meta-analysis of RCTs comparing TURP with TUIP or transurethral electrovaporization, which did not reveal any statistically significant differences in incontinence rates.^{330,332,333,334,335,336} According to the 2010 AUA updated guideline,³²⁸ urinary incontinence was reported at rates between 0.5% and 8% after open prostatectomy, with several studies^{337,338} reporting much lower rates of permanent incontinence.

However, this update³²⁸ provided limited additional information on incontinence. Randomized controlled studies involving HoLEP compared to TURP presented controversial information. Urinary incontinence rate was similar in one study,³³⁹ while in another series³⁴⁰ it was reported as increased in the HoLEP population. The AUA Panel recognized that this rate was higher than expected but felt the general urologist’s experience with HoLEP was less than other technologies and the report warranted observation.

In the past 2 decades, a wide range of innovative transurethral procedures have been introduced in urological practice and challenged the supremacy of the two standard surgical options (monopolar transurethral resection of the prostate and open prostatectomy). These alternative transurethral procedures comprise laser therapies (enucleation, vaporization, and resection techniques) and bipolar devices permitting bipolar TURP or bipolar enucleation.³⁴¹

Transurethral holmium laser enucleation of the prostate (HoLEP) has become a standard treatment for BPO. Review of RCTs by the AUA as well as a meta-analysis of early RCTs comparing TURP with HoLEP did not reveal any significant differences in incontinence rates.^{330,336,342,343,344,345,346,347,348} While incontinence did not increase with age in men undergoing HoLEP with morcellation, it was noted that the overall complication rate—including bladder mucosal injury, urethral stricture disease, and bladder neck stenosis was higher in patients with prostate volumes > 50 g.³⁴⁹ Moreover, it does not appear that either bipolar resection of the prostate or photovaporization of the prostate are associated with a substantially different rate of urinary incontinence than are other BPH surgeries.³⁵⁰ While incontinence following PVP is comparable to that of other BPH surgeries, and more often than not improves over 12-36 months postoperatively with conservative management, the rate of postoperative dysuria is higher than that of TURP, recently reported at a rate of 10.1%.³⁵¹

Concerning HoLEP, Vavassori et al³⁴⁹ reported the outcomes of a prospective study assessing safety, efficacy, and medium-term durability of this technique combined with mechanical morcellation. Three hundred and thirty patients were followed for 3 years. Transient stress urinary incontinence was reported in 7.3% of patients. Incontinence typically resolved spontaneously within 3 months except in two patients who experienced persistent stress urinary incontinence at 36-month follow-up.

Nam et al³⁵² investigated the factors associated with occurrence of recovery from transient urinary incontinence (TUI) in 391 patients who underwent HoLEP. TUI after HoLEP occurred in 65 patients (16.6%), 52 patients of whom (80.0%) showed recovery within three months. Stress and urgency urinary incontinence and postvoid dribbling occurred in 16 patients (4.1%), 29 patients (7.4%), and 33 patients (8.4%), respectively. Age (odds ratio [OR]=3.494; 95%

CI=1.565 ~7.803; $P=0.002$) and total operation time (OR=3.849; 95% CI=1.613~9.185; $P=0.002$) were factors that significantly affected the occurrence of TUI.

Summary of Comparative Studies Published in the Last Decade

Electrovaporization With Monopolar Energy vs TURP

According to a systematic review³⁵³ and meta-analysis conducted by the Ontario Health Technology Advisory Committee, which included twelve RCTs comparing electrovaporization using monopolar energy with TURP (mean sample size of 104; range 50–235), 622 and 623 patients were randomized to electrovaporization and TURP respectively. Mean follow-up ranged from 6 months to 5 years. Rates of urethral stricture and UI were also similar between the techniques. UI occurred in 3.9% and 3.7% of electrovaporization and TURP patients, respectively. Overall incidence of 'irritative' urinary symptoms was 16.3% in electrovaporization and 11.7% in TURP patients.

HoLEP vs TURP

A meta-analysis included 4 RCTs,^{345,346,348,353,354} with sample sizes ranging from 61 to 200, comparing HoLEP to TURP. Overall, 233 and 228 patients were randomized to the HoLEP and TURP arms, respectively, and were followed for 1 year postoperatively. The mean prostate size reported by these studies ranged from 53.5 to 77.8 mL in HoLEP patients and from 49.9 to 70 mL in TURP patients. Stress incontinence occurred in four patients (1.7%) who underwent HoLEP and in three TURP patients (1.3%). Rigatti et al³⁵⁴ reported that 25 (44%) of the HoLEP group and 17 (38.6%) of the TURP group also developed urgency incontinence. Two of the trials reported that postoperative 'irritative' voiding symptoms (described as burning) were more frequent in the HoLEP arm compared with the TURP arm. Rigatti et al³⁵⁴ reported 'burning symptoms' in 33 (58.9%) of the HoLEP patients and 13 (29.5%) of the TURP patients. Gupta et al³⁴⁵ reported a higher rate of 'dysuria' in the HoLEP arm (10%) compared with the TURP arm (2%).

Another systematic review and meta-analysis was conducted by Tan et al³⁴⁰ and included four studies. No statistically significant differences between pooled estimates were noted between HoLEP and TURP for stress urinary incontinence (1.5 vs 1.5%; $P=0.980$).

Wilson et al³⁵⁵ compared HoLEP with TURP for men with bladder outlet obstruction (BOO) secondary to BPH with a minimum of 24-month follow-up. Sixty-one patients were randomized to either HoLEP or TURP. All patients had BOO proven on urodynamic studies preoperatively (prostate size 40-200 g). UI was present in 48% of HoLEP patients and 38% of TURP patients preoperatively (not including post-micturition dribbling). Six of the 15 incontinent patients in the HoLEP group and eight of 11 in the TURP group

regained continence postoperatively. Only one patient (in the HoLEP group) had new onset SUI noted at 12 months, which had resolved by 24 months. One patient in the TURP group had UUI at 24 months, which did not require treatment.

A RCT³⁵⁶ with a 4-year follow-up ($N = 120$) compared HoLEP with TURP. Incontinence occurred in two patients (3.3%) in the HoLEP arm and in one patient (1.7%) in the TURP arm. The incidence of postoperative dysuria was not reported in this study.

HoLEP vs Transurethral Electro vaporization of the Prostate

A study by Gupta et al³⁴⁵ compared the results of HoLEP, TVR, and TURP. One hundred and fifty patients (50 in each group) were prospectively randomized. Patients in all three groups had comparable characteristics before surgery. Mean operating duration and intraoperative irrigant used for TVR was less than for HOLEP or TURP, and blood loss with HOLEP and TVR was less than with TURP (all $P < 0.001$). Postoperative irrigation, nursing contact time, and catheter duration were significantly less for HOLEP than TURP or TVR, and for TVR than TURP. One patient in the HoLEP arm developed incontinence, compared with none in the TVR arm. Transient dysuria occurred more frequently in TVR patients: five (10%) in HoLEP vs nine (18%) in TVR patients.

Potassium Titanyl Phosphate vs TURP

One RCT³⁵⁷ ($N = 100$) with long-term follow-up (3–6 years) compared laser prostatectomy using KTP with TURP in smaller size prostates. The rate of UI was the same in both arms (one patient in each) and none of the patients in this study developed postoperative 'irritating voiding' symptoms to such a degree that additional medications were required beyond those routinely provided upon discharge.

Monopolar vs Bipolar TURP

Cornu et al³⁴¹ conducted a systematic review and meta-analysis of functional outcomes and complications following transurethral procedures for lower urinary tract symptoms resulting from benign prostatic obstruction (BPO). A total of 69 RCTs (8517 enrolled patients) were included. At 12-month follow-up, the UI rates (defined in most studies as SUI that appeared after the intervention) were similar following M-TURP and B-TURP.

Greenlaser Laser Photovaporization of the Prostate (PVO) vs TURP

More recently, Bachmann et al³⁵⁸ published a randomized controlled trial comparing TURP to GreenLight XPS PVP for men with BPO. A total of 291 patients were enrolled at 29 sites in 9 European countries. Patients were randomized 1:1 to undergo GreenLight PVP or TURP. Of the 291 enrolled patients 281 were randomized and 269 received treat-

ment. At 12 months 4 patients treated with Green-Light XPS and 4 who underwent TURP had persistent UI.

Pereira-Correia et al³⁵⁹ assessed urodynamic parameters and voiding function in BPH patients who underwent PVP (N=10) vs TURP (N=10). In this small case-series, PVP group had a higher postoperative rate of UI when compared to the TURP group ($P < 0.04$). Five (50%) patients in PVP group developed UUI, which was not associated with detrusor overactivity in the urodynamic evaluation (first month after surgery), but had spontaneous resolution between 3 and 12 months postoperatively.

In summary, the incidence of UI after open surgery, TURP (monopolar and bipolar), TUIP, and laser therapies (including enucleation, vaporization, and resection techniques) is low, and does not differ appreciably among the various techniques. Lower urinary tract symptoms, such as dysuria and urgency, seem to be prevalent in the early postoperative period after novel laser therapies.

2. TIMING OF SURGICAL INTERVENTION

There are no clear data on timing of a surgical intervention for the treatment of incontinence, as mentioned above in the section on post-RP. Therefore, at present, guidelines as to the timing of surgery cannot be formulated. A certain period of watchful waiting supplemented with conservative measures, particularly pelvic floor physiotherapy, seems to be a reasonable option. More recently, a RCT³⁶⁰ showed that a Pilates exercise program proved to be as effective as conventional pelvic floor muscle exercises (PFME) to speed up continence recovery in patients with post-RP UI, and could be considered for patients who do not adhere to conventional treatment. Thus, conservative management may be tried for periods of up to 6-12 months depending on whether there is any progress noted by the patient. **(Level of evidence 4; Grade of recommendation C).**

In addition, a study by Filocamo et al³⁶¹ demonstrated that pelvic floor muscle exercises, with or without duloxetine, may speed up recovery of urinary continence in selected patients. **(Level of evidence 1; Grade of recommendation A).**

3. SURGICAL TREATMENT OPTIONS

3.1. Artificial Sphincter

The literature on this subject was reviewed for the 1st, 2nd, and 3rd International Consultations on Incontinence.^{7,326,327} Candidates for treatment with the artificial urinary sphincter (AUS) are patients with incontinence due to intrinsic sphincter deficiency that have normal bladder compliance.³⁶² Detrusor overactivity is not a contraindication.³⁰⁷ The AUS has been placed

around the bulbar urethra via a perineal route or transverse scrotal routes³⁶³ or around the bladder neck.^{7,326,327} The above mentioned review of the results obtained with the AUS indicated that more than 70% of the men treated with the AUS for this indication are dry or almost dry after a follow-up of more than 2-3 years. However, most series on the AUS include both men with post-prostatectomy incontinence related to benign and malignant disease.³²⁶

In summary, the AUS is a successful surgical treatment option for post-prostatectomy incontinence. It is the most commonly performed surgery for post-prostatectomy incontinence, with the longest follow-up and therefore longest record of success. **(Level of evidence 2; Grade of recommendation A)**

3.2. Injectable Agents

Most series include post-prostatectomy incontinence after treatment for benign and malignant disease, with the majority after prostate cancer surgery. For collagen, "success rates" range from 36-69%, with 4-20% of patients reporting being dry.^{177,178,179,180,181,182,183,184} Study results are inconsistent with both TURP³⁶⁴ and RP³⁶⁵ showing better outcomes.

Other bulking agents such as polydimethylsiloxane PDMS (Macroplastique®) have shown some initial success, but results also deteriorate over time. Bugel and co-workers¹⁸⁸ treated 15 patients. They noted rapid deterioration of initial improvements with success rates of 40%, 71%, 33%, and 26% at 1, 3, 6, and 12 months respectively. As mentioned previously in the section on post-RP incontinence Kylmala et al¹⁸⁹ prospectively studied 50 patients with mild to moderate SUI (average 48 cc on 1 hour pad test), with 12% achieving continence following 1 injection, and an additional 20%, 18%, and 10% achieving continence with 2, 3, and 4 injections respectively. Follow-up, however, was only 3 months. In a randomized trial of AUS vs Macroplastique injection in patients with minimal SUI (the vast majority had SUI following BPO surgery, with less than 1/3 of the cohort suffering from SUI following RP), Imamoglu and colleagues⁵⁶ demonstrated no difference in success with AUS vs Macroplastique. However, in patients with more severe incontinence, AUS was superior, with minimal improvement following transurethral Macroplastique. There has also been some initial work with sphincteric injections of muscle stem cells.^{197,198}

Bulking therapy fails in up to 75% of men. Of those who are improved only a minority actually becomes dry with short-term follow-up. Although bulking therapy may be slightly more efficacious in treating SUI following TURP compared to SUI following prostate cancer surgery, bulking is of limited value in those men with all but minimal SUI and should only be used when other treatments are contraindicated. **(Level of evidence 3; Grade of recommendation C).**

3.3. Male Sling Procedures

Since Frangenheim³⁶⁶ described his first successful urethral sling suspension for post-traumatic stress urinary incontinence in 1914, various sling materials and surgical methods have been reported. Rectus fascia, as described by Frangenheim,³⁶⁶ has distinct advantages over alloplastic materials with respect to erosion and infection risks. Allograft off-the-shelf-materials like lyophilized fascia lata have a higher infection risk than does autologous fascia, whereas the use of synthetic materials like polypropylene mesh or polytetrafluoroethylene slings are associated with a higher incidence of urethral erosion.³⁶⁷ According to various published techniques, the sling can be placed either underneath the bladder neck, the urethral bulb or the membranous portion of the urethra. The principle of continence support is similar for all sling procedures and comprises passive compression of the urethra, which is dependent on the applied sling tension.²⁵⁷ This mode of action favours sling procedures as a treatment option for intrinsic sphincter deficiency. However, the sling tension needed for restoration of continence has not been standardized, with tensioning techniques ranging from perfusion sphincterometry, to a cough test, to visual approximation,^{219,368} and therefore the success of the procedure probably depends heavily on the surgeon's experience and the degree of sphincteric incompetence. Overcorrection with consequent urinary retention (especially in the setting of detrusor underactivity) and under correction with persistent or recurrent incontinence are certainly possible, which may adversely affect continence, bladder emptying, and patient satisfaction. Most series of sling surgeries deal with a preponderance of men following prostate cancer surgery. Therefore, it is difficult to draw conclusions about any differences in sling efficacy between those with SUI following BPH surgery vs those with SUI following RP due to small numbers of BPH patients most the cohort series.

V. INCONTINENCE AFTER EXTERNAL BEAM RADIOTHERAPY AND SURGERY FOR PROSTATE CANCER

The risk of incontinence after external beam radiotherapy (EBRT) for prostate cancer is variable and ranges from 0 to 23.9%. Lawton et al³⁶⁹ reported a risk of urinary complications of 7.7% in more than 100 patients, proportional to dose. Perez et al³⁷⁰ found incontinence in only 5 of 738 patients. Shipley et al³⁷¹ reviewed more than 2500 cases with an incontinence rate of 0.5%. Similar incidences have been reported in more recent series. Madalinska et al⁸¹ reported an incidence of 6-7%. With three-dimensional conformal radiotherapy, Weil and colleagues³⁷² reported no incontinence in 168 consecutive patients and Hanlon et al,³⁷³ in a series of 195 men, found that post treatment urinary

symptoms were no different from a control group without cancer. With conformal radiotherapy, Sandhu et al³⁷⁴ reported a 9% incidence of stress incontinence in 110 patients. The impact of EBRT followed by prostatic boost, for a total of 66-70 Gy, was evaluated. Scalliet and co-workers³⁷⁵ reported urinary incontinence in 16% of 230 patients, however, Fransson and colleagues³⁷⁶ reported an increase in urinary incontinence on a patient-administered symptom bother scale 3 years after treatment in 153 men compared to pretreatment status. The increase was from a mean of 0, at the start to 2 out of 10 at 3 years. Ponholzer et al³⁷⁷ reported incontinence in 18.8% of a group of 82 men who were surveyed 4.4 year after EBRT for prostate cancer. Furthermore urinary incontinence worsened from year 2 to year 6 in a cohort of 147 men treated with 3D conformal RT.³⁷⁸ Budaus et al³⁷⁹ conducted a review of radiation series published from 1999-2010 and concluded that early storage symptoms are commonly reported but long-term incontinence is not.

Stereotactic body radiation therapy (SBRT) is an innovative form of radiation therapy that is disseminating into practice for the treatment of prostate cancer. Compared with the more standard intensity-modulated radiation therapy (IMRT), SBRT is technologically more intensive and delivers higher doses of radiation per treatment, with an entire course of treatment delivered in up to five visits. In comparison, since IMRT typically delivers a complete course of radiation in 7 to 9 weeks, SBRT may be less expensive overall. The accelerated radiation therapy course associated with SBRT may also mean higher radiobiologic doses than standard fractionated IMRT, which may lead to greater local cancer control³⁸⁰ and possibly greater toxicity. Yu et al³⁸⁰ reported in a retrospective national US Medicare sample, that at 24 months, the odds ratio of requiring a workup for either urinary incontinence or obstruction was 2.23 GU of SBRT vs IMRT. Furthermore, Halpern et al³⁸¹ reported using the Surveillance, Epidemiology, and End Results (SEER) program and Medicare linked data, that after 2 years, urinary incontinence was seen in 23.9% of patients treated with SBRT vs 19.9% treated with IMRT.

Pre-radiotherapy transurethral prostatectomy (TURP) appears to be a risk factor for incontinence. Jonler et al³⁸² reported an incontinence rate of 11% with pretreatment TURP. Green et al³⁸³ and Lee et al³⁸⁴ also reported a higher risk of incontinence with pretreatment TURP vs those without with 5.4% and 2% respectively. In a recent systematic review Ishiyama et al³⁸⁵ reported that among the 14 papers of the prior-TURP group, 13 demonstrated higher incontinence rates in patients with TURP compared with patients without TURP. Four papers demonstrated a statistically significant increase of incontinence in patients with TURP. One paper also reported a higher incontinence rate with TURP vs no-TURP after EBRT (8% vs 1.5%).³⁸⁶

Salvage or adjuvant radiotherapy is frequently given after radical prostatectomy and the impact on continence is controversial. Petrovich et al³⁸⁷ reported no difference in incontinence in 2 cohorts of patients, one with and one without adjuvant radiation. In a follow-up study the same group reported no late toxicity.³⁸⁸ Fontaine et al³⁸⁹ also reported no change in continence status in 16 of 17 men after salvage radiation. However, Petroski et al³⁹⁰ reported that postoperative radiotherapy worsened continence in 26% of 129 patients followed for a median of 5 years. Sowerby et al³⁹¹ reported urinary incontinence at 3 years in 24.5% of 162 men who underwent adjuvant radiation and 23.5% of 490 men who underwent delayed or salvage radiation for prostate cancer. On the other hand, salvage radical prostatectomy following external beam radiotherapy has been generally reported to have a high incidence of urinary incontinence^{392,393,394,395} possibly because of radiation induced fibrosis of the external sphincter.³⁹³ In a recent systematic review of 27 series of salvage prostatectomy, Matei et al³⁹⁵ reported a 47.8% average incontinence rate (range 19%-79%). The incontinence rate was not lower with laparoscopic or robotic approaches. Cozzarini et al³⁹⁶ demonstrated that older age and greater radiation dose in the salvage setting, and younger age and hypertension in the adjuvant setting, resulted in worse urinary dysfunction

1. SURGICAL TREATMENT

Results of surgical treatment of incontinence in this setting are based on retrospective clinical series. In the past the most commonly published treatment modality was the artificial urinary sphincter as therapy for sphincter damage. As discussed and referenced in the following paragraphs, the series published contain both patients who had and had not received radiotherapy and collagen injections have also been reported in various case series.

Historically there has been a highly variable revision rate of 22% to 55% reported for the artificial sphincter following radiotherapy (Table 6^{293,290,291,301,304,315,397,398,399}).

There are also variabilities in reported differences between radiated vs non-radiated patients. Most recent studies have shown similar outcomes after radiation^{291,301,400} except for a Canadian study which demonstrated that the relative risk (RR) of erosion was significantly higher in those who had radiotherapy compared to those who did not (RR 4.05, 95% CI 1.1–15.3).³¹⁶ Bates et al⁴⁰¹ conducted a systematic review of surgical revision outcomes of 1886 patients from 15 studies and continence outcomes in 949

patients from 11 studies while comparing radiated and non-radiated patients. The AUS revision rate was higher after RP + radiation vs. RP alone, with a random effects risk ratio of 1.56 (95% CI 1.02-2.72; $P < 0.050$). However, the authors pointed out that if the largest reported studies which contained approximately 60% of the patients were pooled the relative risk for surgical revision changes to 1.51 (95% CI 0.52-4.38; $P = 0.440$) or non-significant. Furthermore, in a large recently reported series of 489 men with 181 having had radiation, Rivera et al⁴⁰⁰ reported that on univariate and multivariate analyses radiation therapy was not associated with increased rates of device infection/erosion or urethral atrophy and there was no difference in device survival between radiated and non-radiated individuals (Table 6).

Although recent clinical studies may not have shown significant differences in outcomes, there are theoretical radiation effects on the lower urinary tract that are relevant. There may be radiation induced vasculitic fibrosis of the urethra.²⁹³ Radiation may also induce detrusor overactivity or poor compliance leading to urgency incontinence.⁴⁰¹ Recurrence of bladder neck contracture may be more common.³⁰¹ Radiation has also identified as a co-morbidity associated with erosion⁴⁰² and infection.⁴⁰³ In order to avoid problems it is generally recommended that the cuff be inserted outside the radiated field.⁴⁰⁴

Collagen injection has also been reported for incontinence after radical prostatectomy and adjuvant radiation^{179,183,364,405,406,407} or after salvage radical prostatectomy following radiotherapy.^{186,408} Continence results are poorer compared to those without radiation.³⁶⁵ Lee et al¹⁹⁰ reported similarly poor results with Macroplastique with success in 1 of 4 radiated patients after 6 months.

The male perineal bone-anchored sling has been reported in patients following adjuvant RT. In Comiter's group with the perineal compression sling 3 with radiation had no adverse sequelae.¹⁸⁶ Similarly, in the series of Onur et al²¹⁹ radiation did not cause a worse outcome. However, Schaeffer et al²⁰⁹ reported that prior irradiation was the only identified factor that predisposed to failure. Their success rate following a single sling procedure was only 29% (2/7) for irradiated patients, and the corresponding rate for non-irradiated patients was 68% (39/57).²⁰⁹ They postulated that the sling acts by compressing and elevating the urethra, thereby increasing urethral resistance to abdominal pressures. Theoretically, radiation-induced fibrosis of the urethral and periurethral tissues would make compression and elevation more difficult by reducing tissue compliance and mobility..

TABLE 6. The Artificial Sphincter for Incontinence After Radiotherapy

Authors	N	Revision Rate After Radiotherapy	Continence
Martins & Boyd ²⁹³	34/81	38% for whole group	88%
Wang & Hadley ³⁹⁷	16	25% (infection and erosion – 12.5%)	87%
Perez & Webster ²⁹⁰	11/75	55%	63%
Gundian et al ³⁹⁸	15/56	22%	90%
Elliott & Barrett ³⁰⁴	46/313	22%	—
Manunta et al ³¹⁵	15/72	53% (infection and erosion – 20%)	73%
Gomha & Boone ²⁹¹	28/86	25% (similar to a non-radiated control group)	64%
Lai et al ³⁰¹	60/176	20% v 32% for non-radiated group	69%
Sathianathen et al ³⁹⁹	29 radiated 48 non-radiated	10.3% 12.5%	86.2% 87.5%
Rivera et al ⁴⁰⁰	181 radiated 308 non-radiated	Device survival (1 y, 5 y) 92%, 77% 90%, 74%	N/A N/A

Multiple studies with AdVance slings have shown worse results after radiation,^{53,409,410,411,412} although Kretschmer et al⁴¹³ recently reported no adverse effect of radiation on outcomes with AdVance XP in 7 previously radiated patients with mild to moderate incontinence after a mean follow-up of almost 3 years

Experience with the Argus adjustable retropubic sling was reported in 22 men by Hubner et al.²⁴⁸ After a mean follow-up 1.5 years, 2 were removed for infection/erosion and the rest were dry. The ATOMS adjustable sling was reported in 31 men with moderate to severe post-prostatectomy incontinence and radiation.⁴¹⁴ After a mean of 17.8 months 58% were dry, 29% were improved, and 13% failed. A mean of 3.8 fluid adjustments were administered to the whole cohort of 99 men.

Adjustable balloons (proACT™) have been used in the post-radiation patient with stress incontinence but reported risk factors for failure and complications were prior external beam radiotherapy.^{55,415} Kocjancic and colleagues⁴¹⁶ reported a continence rate of 67% in non-radiated patients compared to 36% in radiated patients.

In summary, despite the reported higher incidence of complications of the artificial sphincter in post-prostatectomy patients after radiation in a number of studies, it has provided acceptable treatment benefits. Injectable agents have yielded poor results. Other techniques such as slings may be adversely affected by radiation. Adjustable slings may be

TABLE 7. Incontinence After Brachytherapy for Prostate Cancer

Authors	Incontinence (%)	Post TURP (%)	No TURP (%)
Beyer et al ⁴¹⁷	1	—	—
Blasko et al ⁴¹⁸	6	17	0

considered but more evidence in the post-radiation patient is needed. (Level of evidence 3; Grade of recommendation D)

VI. INCONTINENCE AFTER OTHER TREATMENTS FOR PROSTATE CANCER

1. BRACHYTHERAPY OF THE PROSTATE

Brachytherapy is a form of radiation therapy in which radioactive materials (seeds) are placed directly into the prostate gland. The incidence of incontinence following this modality is given in Table 7^{417,418,419,420,421,422,423,424,425,426,427,428,429,430} and is usually related to the treatment of post-brachytherapy urinary retention.

Many series have reported retention to be associated with larger initial prostate volumes.⁴³¹ In a systematic review of brachytherapy series, Crook et al⁴²⁶ reported the incidence of retention to be 1-14%. Many patients require prolonged or permanent alpha blocker or a TURP.

Authors	Incontinence (%)	Post TURP (%)	No TURP (%)
Stock et al ⁴¹⁹	0	—	—
Wallner et al ⁴²⁰	0	—	—
^a Kaye et al ⁴²¹	4	11	1
^a Blasko et al ⁴²²	13	—	—
Hu and Wallner ⁴²³	6	70	—
Benoit et al ⁴²⁴	6.6	—	—
Merrick et al ⁴²⁵	0	—	—
Crook et al ⁴²⁶	5.6	13	—
^a Talcott et al ⁴²⁷	45 ^b	83	39
Barkati et al ⁴²⁹	0	—	—
Moack et al ⁴³⁰	—	25.3	3.1

^a**Implant plus external beam radiation**

^b**Any incontinence**

The main risk factor for incontinence after brachytherapy is TURP. Hu and Wallner⁴²³ reported on the incidence of urinary incontinence after TURP/TUIP following prostate brachytherapy for prostate cancer. Of 10 patients who underwent the outlet relaxing procedures for refractory urinary obstruction, 7 developed some degree of permanent urinary incontinence. They surmised that the cause may be multifactorial and may include physical damage to the urinary sphincters and the radiation dose to the urethral region. More recently Mock et al⁴³⁰ reported that in the 79 men who required a channel TURP out of a total of 2495 patients, 20 (25.3%) had urinary incontinence compared with 3.1% of those who underwent seed implantation only ($P<0.001$).

Surgical therapy when required has usually included the artificial sphincter.^{424,432} High dose brachytherapy that is administered over a short period of time may have reduced toxicity.⁴³³ Urethrorectal fistula is another complication that has been reported in 1.8% of patients in a large U.S. medicare retrospective review.⁴²⁴ Salvage brachytherapy leads to a higher rate of urinary tract complications.^{394,434}

2. CRYOSURGICAL ABLATION OF THE PROSTATE

Cryosurgical ablation of the prostate is used for clinically localized prostate cancer either as primary treatment or after unsuccessful external beam radiation therapy. The frequency of the main lower

urinary tract complications are listed in Table 8^{435,436,437,438,439,440,441,442,443,444,445,446,447,448,449} The artificial sphincter has been mentioned as one of the treatments for incontinence.^{446,449} Cryotherapy is an adverse factor for bulking agents. Urethrorectal fistulae can also occur in up to 5% of treated patients.⁴⁴⁹ Severe incontinence and fistulae that occasionally result may have to be treated with extirpative surgery and diversion.⁴⁵⁰

3. HIGH-INTENSITY FOCUSED ULTRASOUND

Transrectal high-intensity focused ultrasound (HIFU) is another minimally invasive treatment for prostate cancer. HIFU destroys prostate cells by coagulative necrosis of the tissue without damaging the structures intervening between the transrectal probe and the target tissue.⁴⁵¹ Reports of efficacy also include morbidity. In a systematic review involving 37 articles/abstracts, Rebillard et al⁴⁵² reported that stress incontinence occurs in 6-28%, urethra/bladder neck stenosis in 1-31%, and rectourethral fistula in 0-3% of treated patients. With improvements in techniques the risk of severe complications may be decreasing.^{452,453} In a systematic review from 2000-2011, Cordeiro et al⁴⁵⁴ noted that the rate of incontinence ranged from <1-34.3%. Dickinson and colleagues⁴⁵⁵ recently reported that 105/189 (56%) patients from a UK multicenter registry were leak free and pad free at 5 years after HIFU.

TABLE 8. Lower Urinary Tract Complications After Cryosurgery for Prostate Cancer

Authors	N	Incontinence (%)	Bladder Outlet Obstruction (%)
Shinohara et al ⁴³⁵	102	15	23
Bahn et al ⁴³⁶	210	3	9
Cox and Crawford ⁴³⁷	63	27	29
Wieder et al ⁴³⁸	83	2.5	13
Cohen et al ⁴³⁹	239	4	2.2
Coogan and McKiel ⁴⁴⁰	95	3.5	6
Sosa et al ⁴⁴¹	1467	11	6.8
Long et al ⁴⁴²	145	83/2.0 ^a	17.2
Pisters et al ⁴⁴³	150	60	43
Derakhshami et al ⁴⁴⁴	48	10.4	22.9
Long et al ⁴⁴⁵	975	7.5	13
de la Taille et al ⁴⁴⁶	43	9	4
Robinson et al ⁴⁴⁷	46	29 (urinary bother)	—
Dhar et al ⁴⁴⁸	860	0.9 (8/460)	6
Siddiqui et al ⁴⁴⁹	179	2.7	23.5

^aPreviously radiated/not previously radiated

VII. INCONTINENCE AFTER NEOBLADDER CONSTRUCTION FOR BLADDER CANCER

The incidence of continence after neobladder construction following radical cystectomy for bladder cancer ranges from 85 to 100% during the day and 51 to 100% at night (Table 9).^{456,457,458,459,460,461,462,463,464,465,466,467,468,469,470} Most patients achieve daytime continence after one year and nighttime continence after 2 years. Clifford et al⁴⁷⁰ recently reviewed their experience in 188 patients. They reported, with validated questionnaires, that daytime continence increased from 59% at <3 months to 92% at 12-18 months. Nighttime continence increased from 28% at <3 months to 51% at 18-36 months.

Most of the published reports do not comment on specific surgical management and imipramine is mentioned as treatment only occasionally. Martins and Boyd²⁹³ reported on 8 patients treated with the AUS for persistent sphincter weakness incontinence. Six of these underwent revisions, 3 for infection and/or erosion and 3 for inadequate cuff compression. They cautioned against the use of the AUS and suggested alternatives such as intermittent catheterization at night. However, O'Connor and colleagues⁴⁷¹ reported a successful outcome, after AUS, with no complications in 5/5 men with incontinence after neobladder, with a mean follow-up of 22 months and Simma-Chiang et al⁴⁷² reported

success in 11/12 men 22 months after AUS implant. Vainrib et al⁴⁷³ reported on the use of the AUS in 36 patients with a mean follow-up of 40 months. Data were available in 29 patients. Post AUS, incontinence persisted in 8 (27.6%) patients and 60% needed revisions over time. The bone-anchored sling has been reported for one case⁴⁷⁴ and the AdVance sling for 2 cases²⁴⁰ Injectables have only been reported in women following neobladder construction.⁴⁷⁵

In summary there are not enough data upon which to recommend definitive surgical therapy, although the artificial sphincter is reasonable. **(Level of evidence 3; Grade of recommendation C-D).**

VIII. INCONTINENCE AFTER TRAUMATIC INJURIES OF THE URETHRA AND PELVIC FLOOR

Incontinence following posterior urethral injuries occurs in 0-20% of patients^{476,477} and is thought to be due to the extent of injury rather than to the method of management.

The data on surgical treatment are all retrospective case series and the most commonly published surgical therapy is the AUS. The series published contain both patients with and without traumatic injuries. Perez and Webster²⁹⁰ reported on 27 patients after urethral or bladder neck strictures.

TABLE 9. Continence After Neobladder Construction for Bladder Cancer

Authors	N	Follow-Up (mos)	Continence (%)	
			Day	Night
Alcini et al ⁴⁵⁶	34	12	100	83
Cancrini et al ⁴⁵⁷	89	24 (22% with SUI)	97	83
Elmajian et al ⁴⁵⁸	266	24	85	85
Studer et al ⁴⁵⁹	100	24	92	80
Benson et al ⁴⁶⁰	32	25	94	74
Abol-Enein and Ghoneim ⁴⁶¹	60	24	90	80
Rogers and Scardino ⁴⁶²	20	24	90	55
Hautmann et al ⁴⁶³	211	66	85	85
Hautmann et al ⁴⁶⁴	363	57	95	95
Steven and Poulsen ⁴⁶⁵	166	32.4	100	100 (after 5 years)
Abol-Enein and Ghoneim ⁴⁶⁶	353	38	93.3	80
Carrion et al ⁴⁶⁷	56 ileum	41	91	68
	57 colon	41	86	68
Nieuwenhuijzen et al ⁴⁶⁸	62	>12	90	67
	60 (sexuality preserving)	>12	96	67
Yadav et al ⁴⁶⁹	42	27.2	100	93.8
Clifford et al ⁴⁷⁰	188	18-36	92	51

The revision rate was 41% and the continence rate was 85%. In a subsequent report from this centre on reoperations the patients with traumatic injuries were not discussed separately.⁴⁷⁸ In Montague's²⁹² series, 22 out of 166 patients had incontinence after trauma. He did not separate the results of this group from those of the other patients. Martins and Boyd²⁹³ reported on only one patient out of 81 with a traumatic urethral injury. This patient was dry and required no revisions. Venn et al⁴⁰⁴ reported on 2 with pelvic trauma out of a total of 70. Mundy and Andrich reported successful AUS implant in 7 out of 8 patients after reconstruction for pelvic fracture-related injuries.⁴⁷⁹ **(Level of evidence 3; Grade of recommendation C).**

Bladder neck reconstruction, by excising the scar and narrowing the calibre, was reported by Iselin and Webster⁴⁸⁰ in 6 patients who had incontinence with an open bladder neck on cystourethrography, following urethroplasty for traumatic strictures. Bladder neck closure with a Mitrofanoff catheterizable abdominal stoma has also been reported as treatment following severe urethral or bladder trauma.⁴⁸¹ **(Level of evidence 3; Grade of recommendation C)**

For patients with severe bladder neck strictures and incontinence after prostate surgery, Meulen et al⁴⁸² and the group from Baylor^{301,483} reported on the use of a Urolume stent with a bulbar artificial sphincter. The Urolume stent is no longer available. A novel

approach which has yet to be tested in more studies involves the use of a non-permanent Allium urethral stent.⁴⁸⁴ The stent is a self-expandable coiled metal structure that is covered with a polymeric coating. It is inserted transurethrally and can be removed by unravelling it with an attached tab. The study involved 14 men with recalcitrant postoperative posterior urethral stenosis and stress incontinence. The stent was left indwelling for 6 months and then removed. After another 6 months the artificial sphincter was inserted if restenosis had not occurred. After a mean of 13 months following AUS placement, 13/14 did not restenose and all are dry. None of the men had undergone radiation.

Alternative management with perineal urethroplasty and subsequent artificial sphincter placement in 6 patients was reported by Simonato et al⁴⁸⁵ Patil et al⁴⁸⁶ reported on 8 patients with recalcitrant posterior urethral stenosis and defunctionalized bladders. Seven had radical prostatectomy (6/7 with radiation) and one had traumatic disruption. They were treated with cystectomy, neobladder creation and urethral pull-through for the AUS was subsequently implanted. After a median of 58 months all were socially continent with a median of 2 revisions. Palmer et al⁴⁸⁷ reported their series of 20 men with posterior urethral stenosis and long strictures treated with a ventral buccal mucosa graft and gracilis muscle flap. Five men were incontinent. Of 3 who

subsequently had an AUS, 2 had it removed due to infection.

In summary, the AUS provides a reasonable outcome in appropriate cases. Since there are few reports of alternative therapies the C recommendations were based primarily on expert opinion as to what is reasonable surgical therapy in very difficult cases. (Level of evidence 3; Grade of recommendation C)

IX. CONTINUING PEDIATRIC PROBLEMS INTO ADULTHOOD: THE EXSTROPHY-EPISPADIAS COMPLEX

1. INITIAL MANAGEMENT OF THE EXSTROPHY-EPISPADIAS COMPLEX

1.1. NATURE OF THE EXSTROPHY BLADDER

In considering the management of incontinence in adults who were born with exstrophy or isolated epispadias, it is helpful to understand the nature of the bladder plate and the muscles around it. There is slowly accumulating data that show that they are not identical to normal. Less is known about changes over time either in those closed in the first few days of life or having had a delayed primary closure (DPC).

The bladder plate is smaller than a normal bladder and so can only achieve a normal capacity if it can grow, or stretch without losing its proper structure. Microarray analysis shows that the bladders are developmentally immature. The number of myelinated nerve fibers in the detrusor is reduced in newborn exstrophy bladders compared to that of control neonates who had died from cardiac causes.⁴⁸⁸ The innervation of the muscle as defined by the muscarinic and other neuropeptide receptors are the same as in controls.^{489,490}

The muscle appears structurally normal when stained for actin and myosin, but there are functional changes which persist in cell culture. Cellular proliferation is normal and there is a near normal response to stretch in vitro.^{491,492,493} At birth, there is an excess of collagen in relation to smooth muscle which improves with age but never reaches the same ratio as normal controls: by the time reconstruction is completed smooth muscle in exstrophy children is 31.5% of the bladder wall and 56.5% in normal controls.^{494,495}

These findings, taken together, suggest that the bladder has less ability to stretch or achieve good compliance, the detrusor is less efficient and the response to medication may be different from that in other conditions. Some promising basic research has suggested that mesenchymal stem cells obtained from

bone marrow may be used to grow smooth muscle for use in augmenting bladders such as that in exstrophy.⁴⁹⁶ This is not a clinical reality at present.

Control of the bladder outlet depends on proper function of the pelvic floor musculature and of the urethral sphincters. In exstrophy infants who have not had an osteotomy, the pelvic floor muscles have normal bulk, but abnormal orientation, especially in their relationship to the urethra.⁴⁹⁷ They are unable, therefore, to contribute to urethral continence at the primary closure. Varma et al have described wrapping the levator ani as a loop in front of the urethra.⁴⁹⁸

The existence of the urethral sphincters is uncertain. There is no histological study to show their presence or innervation. However, some muscle found dorsally around the urethral plate and spread over the corpora has been described as sphincteric. It has been wrapped around the urethra at primary reconstruction.⁴⁹⁸ Electromyographic studies of continent children have shown normal electrical traces even when such formal reconstruction has not been done.⁴⁹⁹

The prostate is a flat plate of normal size, lying behind the urethra and not wrapped around it.⁵⁰⁰ Growth of the prostate at puberty will not improve continence.

A further problem with the assessment of outcomes of exstrophy reconstruction is that there is no satisfactory definition of continence. In a review of the literature, Lloyd et al⁵⁰¹ identified six definitions of continence, the commonest of which was 'three hour dry interval'. Most worryingly, 1372 of the 2681 children in the studies reviewed were said by the authors to be continent even though no definition was given in 68% of the studies!

A dry interval of three hours implies that the bladder has a fixed capacity beyond which the pressure becomes higher than that of the fixed outflow resistance. Providing the child recognizes this point, a visit to the lavatory will avoid incontinence. This is not true continence but a means of managing poor bladder control. The evidence base is three at best.

Epispadias is a more rare condition. There are very few data on the bladder and sphincters for this diagnosis alone. In general the bladder is of better volume and there may be some active sphincter function in those at the better end of the spectrum.

1.2. Early Management

The early reconstruction of bladder exstrophy is clearly important but not a subject for this chapter. Only an outline will be considered. Techniques have gradually evolved over the last 100 years since the first (transiently) successful closure described by Trendelenberg in 1906.⁵⁰² A most important development, at least in Western countries has been the concentration of cases in a small number of highly specialized centers. Although reasonable results have been reported from general pediatric units, the best results, as with other complex surgery, are found in high volume units.^{503,504,505}

Broadly, there are three approaches to early reconstruction:

- Staged repair, originally described by Oesterling and Jeffs.⁵⁰⁶ Here the principle is to close the bladder in the first operation. The bladder neck and epispadias repair are then done as a second stage. This has evolved into the modern staged repair of exstrophy (MSRE).
- Complete primary repair of bladder exstrophy (CPRE) often attributed to Grady et al⁵⁰⁷ The objective is to close the bladder and bladder neck and to repair the epispadias in one operation. Although more than one operation is often needed, the important principle is to create bladder outflow resistance as early as possible. This should allow proper development of bladder volume and compliance. A further bladder neck reconstruction may be needed in up to 40% of children.⁵⁰⁸
- Single stage radical soft tissue mobilization (RSTM), usually called the Kelly operation.⁵⁰⁹ The entire anterior pelvic contents with blood and nerve supply are mobilized from the pelvic sidewall, reconstructed and repositioned more posteriorly in the pelvis. There is no osteotomy, but the radical mobilization allows abdominal wall closure without osteotomy.

Each of these is subject to many modifications by different surgeons, which makes comparison of results difficult. Not surprisingly, there are no controlled trials. If only reported outcomes are considered continence rates in children have improved from close to zero in 1906 to about 90% in specialist centers.

Patients who are now the subjects of adult follow-up will have been operated between 20 and 30 years ago and often longer. Only a handful of adults who have had the RSTM have been reported. It is often difficult to tell which of the other two techniques have been used when reviewing adult outcomes and, in terms of management of persistent incontinence, it probably does not matter.

1.3. Late Bladder Function

There are very few data on the continence rate in adults, and there are no controlled trials. In the small number of studies in adults, the type of original reconstruction is usually ignored.

For the children who have done well, there is some evidence that continence may not be maintained into adulthood. In a follow-up of 56 patients for a minimum of 20 years, 13 were found who were continent and voiding naturally at 10 years old. However, by 20 years old, only three were still in this situation. The remainder were augmented or on clean intermittent catheterization (CIC) or both. The patients had been operated in the 1960s and early 1970s by older techniques than are currently used. In a further review from the same unit of a cohort 15 years later and with at least 20 years of follow-up only one of 50 patients was voiding normally.^{510,511}

When specifically sought, the incidence of lower urinary tract symptoms (LUTS) is high. Taskinen et al⁵¹² used the Danish Prostatic Symptom Score (DAN-PSS) in an investigation of 32 patients aged 16 to 44. All of seven men and two of four women who had not had an augmentation had disturbing incontinence. Amongst those with epispadias alone, six of eight men and four of five women had disturbing incontinence. Seven of the 19 exstrophy patients had had an augmentation, five of whom were completely continent and two lost small volumes on rare occasions. Moderate or severe symptoms that could be attributed to over active bladder were found in 80% of patients, but there were no urodynamic data. Surprisingly, only one of 17 patients who expressed an opinion wanted further surgery, especially if it would result in the need for CIC.

Late failure has several possible causes. Perhaps the most important is that the outflow resistance generated by bladder neck reconstruction is mainly fixed with little or no sphincteric action. Voiding is, therefore, always against obstruction. Deterioration in bladder function would come either from detrusor failure or from overactivity. Borer et al found detrusor overactivity in six of 13 children (46%) who had had a staged repair but in none of 19 who had had CPRE.⁴⁹⁹

Another problem was identified by Yerkes et al⁵¹³ In an investigation of 18 children who were said by themselves and their parents to be 'continent and voiding well', none were, in fact, voiding normally. Apart from infections, stones and a dry interval of two hours, there were major objective bladder dysfunctions in all patients. Seventy-two percent had a residual urine of at least a third of bladder capacity; 70% had a flow rate below 10 mL/sec; 30% had staccato stream; and 36% voided by Credé's maneuver.

Finally, there is the problem of the definition of continence discussed above. When free from the discipline of childhood it quickly becomes apparent that the coffee, sodas and alcohol that soon become a part of an adolescent's life, expose the fact that a 'dry interval' is no longer 'continence'.

1.4. Renal Function

Most of the reported upper urinary tract anomalies that have been reported in association with exstrophy are clinically insignificant, such as duplex ureters. In 462 children who had renal ultrasounds only 1.5% had an anomaly that could affect renal function.⁵¹⁴

Subsequent renal damage and renal failure are a consequence of the surgical management. Although older figures estimate renal damage at 15% to 20% for the initial reconstruction (or diversion), current figures are much better.⁵¹⁵

At birth, the mean estimated glomerular filtration rates (eGFR) are the same as in normal babies. There is then a dip, corresponding to the primary closure in the MSRE: from eight days old to 56 days the mean eGFR, corrected for surface area, does not increase while that of normal babies increases by about 50%

to 60%. Beyond 56 days the exstrophy babies begin to catch up and are not significantly different from normal by two years old.

When the same patients were reviewed at least one year after their bladder neck repair, there was still no difference from normal in the *mean* eGFR.⁵¹⁶ Unfortunately, the *mean* value obscured the fact that 20% of the kidneys were damaged, some quite seriously. Hydronephrosis was seen in two kidneys severely, five moderately and two mildly out of 44 kidneys at a mean age of 15 years. One patient had an eGFR of 61 mL/min/1.75m² which would almost put him in the high risk group for late end stage renal failure. DMSA scans were not done in these children so there is no information about scarring.⁵¹⁶

Similar results have been reported from Canada after major secondary surgery such as bladder neck closure or augmentation. In 57 patients at a mean age of 11.5 years, 18 (32%) had some hydronephrosis. DMSA showed renal scarring in 14 (27%). Damage was seen after all types of surgery regardless of whether or not a bladder neck closure was done. However, only one patient *without* hydronephrosis had scars. One developed mild renal failure and one required a renal transplant.⁵¹⁷

Although end stage renal failure is rare in patients with exstrophy, most series mention one or two cases. It is most unfortunate that it is usually a consequence of reconstructive surgery and infection, in spite of vigorous attempts to prevent it. The most important parts of the long term supervision are to control infection and to react promptly to even small signs of renal damage, especially hydronephrosis.

2. MANAGEMENT OF PERSISTING INCONTINENCE

Although the need for long-term care of children born with the major genitourinary anomalies has been advocated by some for many years, it is only recently that the need has been generally recognized. A process of transition from paediatrics, through adolescence and into adult life now is accepted as essential standard of care in the US and Europe.^{518,519,520}

2.1. Investigation

Complete objective evaluation of bladder function is particularly important in patients with exstrophy as the description by patients and parents is unreliable.⁵¹³

Urodynamic studies in adults are best done using a small co-axial suprapubic catheter. It is inserted under general anesthetic so that an endoscopic examination of the urethra and a measurement of the true bladder capacity can be made at the same time. Imaging during the urodynamic study which is done a day or two after the insertion gives good views of the outlet and its function. The studies can be repeated without the need to insert a new catheter. The volume

of the bladder measured under general anesthesia has some predictive value.

Validation of CMG findings in exstrophy is only available for children. Dave et al⁵²¹ investigated 31 children one year after a modified bladder neck reconstruction. Fifteen had satisfactory continence defined as a dry interval of two hours or more, no stress incontinence and no more than two episodes of nocturnal enuresis per week. The continent children had a better bladder capacity at 162 mL compared to 113 mL for those with poor continence or 55mL for the totally incontinent. End filling pressure was around 31 cmH₂O for the continent children vs 48 or 41 cm for the other two groups. Unstable detrusor contractions were seen in a third of the continent group and were associated with a lower than average bladder capacity and less good compliance than in the other continent children. As in other conditions of bladder abnormality, end filling pressures over 40 cm H₂O were associated with hydronephrosis (two thirds of patients).

A leak point pressure (LPP) of at least 10 cm H₂O is needed to generate bladder expansion. Despite a LLP over this level, some children still have severe dribbling incontinence because of detrusor over activity. Their bladders did not expand because the detrusor was constantly emptying it.⁵²²

The role of electromyography (EMG) of the sphincters has been reported but not correlated with management or outcomes.⁴⁹⁹ In Dave et al's⁵²¹ patients only 12 children voided with sustained detrusor contractions and only five voided effectively. Ten children had persistent EMG activity during voiding, but no other detectable neurological abnormality. Eight of them had significant residual urine volumes.

2.2. Medical Management

The near normality of the detrusor innervation at least in infants born with exstrophy, suggests that standard anti-muscarinic drugs should be effective for overactivity. Several reviews mention that oxybutynin or other anti-muscarinic agents can be used but without any data.

There have been no disease specific controlled trials, least of all in adults. In children, there has been an uncontrolled trial of imipramine using both clinical and urodynamic criteria to assess response. All of 17 children (mean age 7.9 years) had urodynamically proven detrusor overactivity, small poorly compliant bladders and incontinence. Imipramine 1.5-2.0mg/kg was given for a mean of 9.5 months. There was a 40% increase in bladder capacity and a 25% reduction in end filling pressure. Eleven of 17 children had a clinically significant improvement in continence; all of eight children with partial continence (1-2 hour dry interval by day but enuretic) became dry day and night with a dry interval of more than 2 hours. Three of nine children with severe incontinence improved.⁵²³ In an editorial comment on this paper, Gearhart⁵²⁴

stated that he used oxybutynin 0.5 mg/kg in combination with imipramine, which 'gave even better results'. No further data were given.

2.3. Bulking Agents for Bladder Outflow

The fixed bladder outflow resistance can be increased with injectable bulking agents. It does not matter which of the commercially available products is used but autologous fat does not seem to work. The only published results are in children. There is no standard technique of injection and the objective is to put in enough of the agent to produce visual occlusion of the bladder neck area using 2.5 to 7.5 mL.

In two recent series, 17% and 42% respectively became continent, though Alova et al⁵²⁵ in reviewing the literature, concluded that 50% of children became dry. Injections can be repeated but only one patient became dry beyond four attempts (he became dry after six injections).^{526,527} Best results are seen in those who are partially dry and have a bladder capacity above 70 mLs. It is important to note that in one of these series, two of 16 patients who were partially continent were rendered completely incontinent by the injections.⁵²⁷

2.4. Bladder Neck Reconstruction

There are few data on the outcomes of bladder neck reconstruction in adults with exstrophy, especially if done without augmentation. Occasional adult patients are included in series primarily on children.

In a group of older children (3.2 to 15.5 years) the group at the Hospital for Children, Great Ormond Street reported very modest results. There were 20 boys and ten girls most of whom had had several operations apart from the initial bladder neck reconstruction, including injection of bulking agents, augmentation and Mitrofanoff procedures and yet still remained wet. Sixty percent became dry by day (80% of girls and 50% of boys), but only 50% by night. None could void urethrally and only five could self-catheterize urethrally.⁵²⁸

The results in isolated epispadias are better with all of five patients (11 to 36 years old) becoming dry compared to two of four with exstrophy. All patients had failed previous injection of dextranomer (De-flux®) based agents and it was said that this did not compromise the bladder neck surgery.⁵²⁵

Bladder neck reconstruction without augmentation carries the additional risk that the bladder will expand but will develop instability and poor compliance. This will lead to hydronephrosis and renal deterioration. Grimsby et al⁵²⁹ have made the very important observation that there is a cumulative incidence of complications after bladder neck reconstruction without augmentation. Seventy percent of children had required further surgery for continence by seven years and the same percentage had new or worsening renal scarring up to ten years. Although none of the children had exstrophy, the observation remains valid – early

success is not a cure and may just be changing one problem for an even worse one.

2.5. Artificial Urinary Sphincters

The patient with exstrophy has, by definition, a reconstructed bladder neck and urethra. Such structures are not well suited to the support of an AUS cuff. It is also common for incontinent patients to carry a residual urine and so, with an AUS, would need to use CIC. Again, data on this procedure in adults with exstrophy are limited and often included in series of patients with different diagnoses. In one series of 112 patients without spina bifida, there were 12 with exstrophy and four with epispadias aged four to 17 years old. The AMS 880 AUS was used with 5.5 to 7.5 cm cuffs and 61–70 cm H₂O balloons. The cuff eroded in three of 12 exstrophy patients. Only four were dry and able to void spontaneously all of the time.⁵³⁰ Herndon et al⁵³¹ reported a 20% erosion rate in patients of any diagnosis who had had a bladder neck repair.

Various tissues and devices have been used to provide passive artificial outflow resistance. Pedicled gracilis muscle has been wrapped around the exstrophy urethra and gave continence in all of five children with CIC.⁵³² Lima et al⁵³³ described a silastic ring around the urethra which can be expanded by injecting saline through a sub-cutaneous port. In six of 12 patients the cuff eroded. The other six were dry, but one developed hydronephrosis and had to have the device deactivated. Five voided normally and the sixth who had had an augmentation previously, relied partially on CIC.

2.6. Bladder Augmentation

In childhood, the reported need for augmentation is 0% to 70%.⁵³⁴ Only a few patients will be able to void to completion from an augmented bladder, the majority requiring CIC. Follow-up urodynamic studies have compared the use of ileum as a patch and sigmoid colon as a patch or cup. The best reduction in detrusor pressure is achieved with a patch of ileum compared to sigmoid (mean decrease of 81% vs 27%).⁵³⁵ There was no significant difference in the volume achieved which is not surprising as it is only related to the size of augment applied.

In adults with incontinence, either new or persisting from childhood, full evaluation is essential. Augmentation will not create reliable continence if the bladder outflow is inadequate nor is it likely to permit spontaneous voiding: only one of seven adult patients with an augmented bladder in the series reported by Taskinen and Suominen could void.⁵¹² The patient has, therefore, to accept that CIC through one channel or another is the probable outcome. The ability to pass a catheter through the urethra must be checked before the augmentation is done. If it is not possible, the urethra will need to be adjusted to make it possible or a suprapubic catheterizable channel will be needed.

Similarly, if the outflow resistance is inadequate a plan is needed to strengthen it. However, a redo bladder neck repair at the same time as an augmentation has a low success rate, especially with a small bladder.

If the surviving bladder is very small and the outlet incompetent it may be better to abandon it altogether. Reconstruction can be done with isolated intestine and a supra pubic catheterizable stoma (see below).

The techniques of intestinal augmentation and the long-term consequences are beyond the scope of this chapter. The problems are well known, but to date no satisfactory alternative has been found and certainly not one that would dispense with need for CIC. It has proved possible to grow urothelial and muscle cells from fragments of exstrophy bladder and from mesenchymal (and other) stem cells.^{491,496} Clinically, several autografts and xenografts have been tried, most recently small intestinal submucosa, but have not produced reservoirs of useful size.⁵³⁶

2.7. Diversion

Even in the most prominent exstrophy centers diversion is sometimes needed. The only question is how many failed attempts to create a normally working bladder mandate some diversion from this ideal goal? In Baltimore, 91 of 704 children (13%) required such procedures. If it is correct that normal continence and voiding are not always preserved in adulthood, the number will rise.

There is a school of thought that the results of exstrophy reconstruction in the long run are so poor that early diversion should be the initial management.⁵³⁷ Gobet et al⁵³⁸ have reported good outcomes with up to 69 years of follow-up with a primary standard ureterosigmoidostomy. With the use of a de-tubularized rectal pouch, such as the Mainz II, and an understanding of the long-term complications continence rates of 95% day and night are reported.⁵³⁹ This could be the management of choice in countries with limited facilities for reconstruction.⁵⁴⁰ Surveillance for the development of anastomotic neoplasms from the tenth year after construction is mandatory.⁵⁴¹

At the simplest level, a catheterizable supra pubic stoma may be put into the bladder, usually with an augmentation. Ideally, the urethra is left open so that there are two channels for CIC. However, if the urethra cannot be made continent, it can be closed. In males the closure must be at bladder neck level so that antegrade ejaculation is possible. In an assessment of outcomes of this management 96% were reliably dry by day and 86% by night (82% of patients were adults at the time of review). The well-known complications of this type of diversion occurred in 39% including the need for redo of the bladder neck closure in one patient.⁵⁴²

If the remaining bladder is too small to be useful or has been removed, any of the standard continent diversions can be used. In females, there is a particular advantage in this because the reservoir can be put to

the side of the abdomen. This will usually, but not always, leave it clear of the uterus and out of harm's way during the C-section which is usually the safest means of delivery for those with exstrophy.⁵⁴³

A conduit diversion is only needed in the most exceptional circumstances such as uncontrolled hydro-nephrosis or non-compliance with CIC. In four of five patients described by Baradaran et al,⁵⁴⁴ reconstruction to a continent system was possible when the underlying problem had been corrected.

3. RECOMMENDATIONS

The published studies to date are retrospective case series with levels of evidence at best 3 with a Grade of Recommendation of C. The expert opinion of the Committee has resulted in the following recommendations regarding the evaluation and treatment of persisting incontinence in adulthood. **(C)**

Patients with exstrophy-epispadias complex should be evaluated and managed in specialized centers.

Persisting incontinence should be evaluated with urodynamics including measurement of bladder capacity and its treatment should be individualized based on urodynamic findings.

A universal definition of continence should be established.

Anti-muscarinic drugs are the first option for detrusor overactivity.

Bladder neck bulking agents may be effective but continence is unlikely to be achieved if 4 injections have failed.

Standard techniques for enlargement of a small or high-pressure bladder are appropriate.

Redo bladder neck reconstruction has a high failure rate and is very unlikely to allow complete, spontaneous voiding. Urethral CIC may be difficult or impossible.

AUS also has a poor outcome because of erosion, chronic retention and CIC difficulties.

Suprapubic continent diversion with or without augmentation and with or without bladder neck closure is the best choice for exstrophy patients with urethral failure. Rectal diversion (eg, a Mainz II pouch) should be considered especially in countries with limited medical facilities.

Life-long follow-up is mandatory in terms of continence, voiding efficiency, upper tract status and other urological complications. Appropriate transitional arrangements must be made to ensure that this is achieved.

Comparative studies, including quality of life and psychological assessment, should be undertaken if possible.

X. DETRUSOR OVERACTIVITY AND REDUCED BLADDER CAPACITY

1. REFRACTORY URGENCY INCONTINENCE AND IDIOPATHIC DETRUSOR OVERACTIVITY

The overactive bladder (OAB) syndrome refers to the symptoms of urgency, with or without urge incontinence, usually with frequency and nocturia.⁵⁴⁵ Detrusor overactivity (DO) indicates the urodynamic observation characterized by involuntary detrusor contractions during the filling phase that may be spontaneous or provoked. Idiopathic Detrusor Overactivity (IDO) exists when there is no defined cause. Neurogenic Detrusor Overactivity (NDO) is seen when there is a relevant neurological condition. Ahlberg et al⁵⁴⁶ found that 82% of patients initially considered idiopathic on careful searching actually had pathology potentially leading to the problem. Refractory OAB indicates OAB symptoms that have failed conservative and medical management.

Idiopathic detrusor overactivity is a normal situation early in life. Children have urgency incontinence as a stage in acquiring bladder control. The incidence of detrusor overactivity during mid-life years (20 to 60) has been estimated as 10%.⁵⁴⁷ In the asymptomatic elderly, detrusor overactivity once again becomes common, occurring in 50% of men over 70.⁵⁴⁸ In the symptomatic elderly, over 75 years old, it can reach 90% in men.⁵⁴⁹ DO may be a cause of severe storage symptoms such as frequency, nocturia, urgency and urgency incontinence. Conservative treatment of these symptoms such as bladder training and pharmacotherapy is discussed in other sections. Magnetic stimulation via a variety of techniques has been reported as a noninvasive treatment of DO.^{550,551} Bradshaw et al⁵⁵² demonstrated an effect on cystometry with magnetic stimulation and found an improvement in urodynamic parameters but no consistent change in OAB symptoms. Almeida et al⁵⁵³ in a prospective urodynamic controlled study of 91 women with UI, found an improvement on DO only in patients with initial bladder contractions greater than 15 cm H₂O. There are no other specific data available.⁵⁵⁴ The use of intravesical neuromodulatory drugs such as capsaicin and resiniferatoxin was extended to DO of non-neurologic origin after the suggestion that its etiology involved the enhancement of the C-fiber mediated spinal micturition reflex⁵⁵⁵ and emerged as a minimally invasive procedure: the results are shown in Table 10.^{556,557,558,559,560,561,562,563}

TABLE 10. Intravesical Capsaicin and Resiniferatoxin for Detrusor Overactivity (Males and Females)

Authors	N	Improvement	Duration of Effect	Drug and Dose	Side Effects
Cruz et al ⁵⁵⁶	3 IDO (total of 16 including 3 males)	71% continence (overall total of 14) and 21% improvement	Up to 18 months	Capsaicin 125 mL of 30% alcohol in saline containing 1 mM	Intense burning sensation
Kuo ⁵⁵⁷	13 IDO (41 total)	5 (38.5%)	2 to 9 months	RTX 10 mL of 100 nM RTX in 10% ethanol for 40 min	
	18 previous TURP	11 (61.1%)	Average 5 months		
Kuo ⁵⁶¹	23 (19 ended)	11 of 19 (58%)		10 nM RTX weekly 3 to 4 times	4 withdrew due to side effects. Significant worsening of emptying
Kuo et al ⁵⁶²	17 IDO	Vehicle 2 (9) 22% RTX 5 (8) 63%	6 months	Vehicle or 4 weekly 10 nM RTX	Randomized double blind placebo controlled. 6 withdrew after first instillation
Liu and Kuo ⁵⁶⁷	28	14 (50%)		10 nM RTX weekly for 4 weeks	Transient receptor potential vanilloid subfamily 1 overexpressed in the responders

Authors	N	Improvement	Duration of Effect	Drug and Dose	Side Effects
Palma et al ⁵⁶⁸	25 females with idiopathic urgency incontinence	10 (40%) disappearance of urgency incontinence	1 month evaluation only	50 nM RTX	No mention of retention
Rios et al ⁵⁶³	58 females with IDO	43% RTX 35% Placebo vehicle improvement equal ($P=0.439$)	1 month first evaluation	50 nM RTX or 10% ethanol saline solution	Randomized double-blind placebo controlled
Silva et al ⁵⁶⁰	13 IDO (2 men, 11 women) (12 incontinent)	11 improved (91%) in incontinence 3 (25%) dry	3 months follow-up	100 mL 50 nM RTX solution 10% ethanol in saline for 30 minutes	No retention or other problems
Silva et al ⁵⁶⁸	17 IDO (out of 23)	Vehicle 9 (39%) RTX 14 (60%)	Pre-test with vehicle only followed by RTX	Vehicle followed by 100 mL 50 nM RTX (patients enrolled in 2005)	No separation of NDO and IDO
Yokoyama et al ⁵⁶⁵	10 (4 men)	5 (2 dry) 50%	3 months follow-up	100 mL 50 nM RTX for 30 minutes	Neurometer before and at 30 days

IDO = idiopathic detrusor overactivity, RTX = resiniferatoxin, TURP = transurethral resection of prostate

NDO = neurogenic detrusor activity

In spite of promising and controversial results, it is still considered experimental and more clinical studies are necessary for it to be licensed,⁵⁶⁴ but recent publications on this subject could not be found. The mechanism of action is still under study. The mean bladder perception threshold is increased only in patients with clinical improvement.⁵⁶⁵ The complexity of the mechanism is demonstrated by the presence of vanilloid receptors not only on sensory fibers but also in bladder urothelium and smooth muscle cells⁵⁶² and by ineffectiveness in treating OAB from idiopathic causes or suprapontine lesions with no vanilloid-sensitive fiber-mediated reflex.⁵⁶⁶ It has been suggested that over expression of transient receptor potential vanilloid subfamily 1 in the bladder predicts the response.⁵⁶⁷ A well designed double-blind placebo controlled study revealed no difference between placebo ethanol 10% saline solution and 50 nM resiniferatoxin, nevertheless both treatments showed improvement in symptoms of women with IDO.⁵⁶³ Some placebo-controlled studies either did a quasi randomization⁵⁶⁸ or did not explain how it was done.⁵⁶² Patients with increased bladder sensation without DO presented some improvement in symptoms in a small non placebo controlled series.⁵⁶⁹ There are no recent clinical series published and at present time and the use of resiniferatoxin has been restricted to animal studies.^{570,571} **(Levels of evidence 1 – 4; Grade of recommendation D, two level 1 studies have contradictory conclusions).**^{562,567} For symptoms that are refractory to conventional means, 3 interventional treatments have been reported: botulinumtoxin-A detrusor injections, neuromodulation, and bladder augmentation. Attempts to determine the effectiveness of

management among individuals with different pathophysiologic profiles found no trends in treatment efficacy according to any sub-type of bladder overactivity.⁵⁷² A prospective study comparing satisfaction in patients that underwent onabotulinumtoxin injections or augmentation cystoplasty (AC) was favorable to AC, but the conclusion was weakened due to no randomization.⁵⁷³

1.1. Botulinum Toxin A Injection in the Bladder

The minimal invasiveness of this method makes it very attractive but long-term results in IDO are lacking Table

11.^{574,575,576,577,578,579,580,581,582,583,584,585,586,587,588,589,590}

The effects of its use are still not fully recognized,^{591,592} with possible systemic consequences,^{593,594,595} such as generalized muscle weakness in a number of patients treated for neurogenic bladder overactivity, and the development of resistance to the drug.^{596,597,598} The FDA conducted a safety review of botulinum toxin products and issued a report that included a “Boxed Warning” highlighting the possibility of life-threatening distant spread of the toxin, a Risk Evaluation and Mitigation Strategy (REMS) with a medication guide to help patients understand the risks and benefits, and changes to the established drug names to reinforce individual potency and lack of interchangeability of the different products and to prevent medication error.⁵⁹⁹ Most of the initial experience comes from its use in neurogenic bladders.^{600,601,602,603}

TABLE 11. Botulinum Toxin A Detrusor Injection Results

Authors	N	Type of Patients	Dose	Punctures (N)	Results	Comments
Harper et al ⁵⁷⁴ Level 3	13 men 26 women	Neurogenic and idiopathic origin (not described separately)	200 idiopath 300 neurog	20 to 30 sparing the trigone flex cysto.	Increase max bladder volume 174 to 589 mL	
Loch et al ⁵⁷⁵	30	Neurogenic and idiopathic	200 U	20 injections sparing the trigone	Significant improvement in 67% of the patients ≥ residual urge	No description of gender or whether NDO
Radziszewski et al ⁵⁷⁶ Level 3	6 women 6 men	Only idiopathic	Up to 300 U	10-15 injections sparing the trigone	1 months follow-up 100% success no residual	Short follow-up inexact criterion of success
Rackley et al ⁵⁸⁹ Level 3	18 women	IDO	200-300 U (Botox)	Each 100 U in 1 cc saline, 0.1 cc injections	Improvement 40% frequency 30% urgency	6 months follow-up
Rapp et al ⁵⁷⁷ Level 3	29 women 6 men	6 neurogenic	300 U	30 injections including trigone	34% resolution 26% improvement	40% failure
Kuo ⁵⁷⁸ Level 3	12 women 18 men	12 neurogenic	200 U	40 injections sparing the trigone	26% resolution 46% improvement	26% failure
Chancellor et al ⁵⁷⁹ Level 2/3	2 men 8 women	Only idiopathic	100-300 U	20-30 injections only in bladder base and trigone	80% improvement	Control group-11 neurogenic with 73% improvement
Rajkumar et al ⁵⁸⁵ Level 3	15 women	IDO	300 U (Botox)	30 mL – 30 injections	93% improvement	Not randomized prospective study 6 patients with PVR > 130 mL
Popat et al ⁵⁸⁴ Level 3	31 (18 women and 13 men)	IDO	200 U (Botox)	20 mL – 20 injections	57% dry at 4 months	19% needed CISC
Kessler et al ⁵⁹⁰ Level 3	11 (no gender information – 8 men in total of 22 patients)	IDO	300 U (Botox)	30 mL – 30 injections sparing the trigone	91% dry 5 months duration	Prospective study comparing IDO with NDO 4 high PVR with CSIC (36%)
Werner et al ⁵⁷⁶ Level 3	26 women	Only IDO	100 U (Botox)	30 mL – 30 injections	65% dry at 12 weeks 60% dry at 36 weeks	36 weeks follow-up

Authors	N	Type of Patients	Dose	Punctures (N)	Results	Comments
Schmid et al ⁵⁸² Level 3	23 men 77 women	Only IDO	100 U (Botox)	30 mL – 30 injections	88% improved 8% poor results	12 weeks follow-up, 4% urinary retention
Kuschel et al ⁵⁸¹ Level 3	26 (only women)	Only IDO with incontinence	100 U (Botox)	30 mL – 30 injections	11/26 improved (42%), 4 no need further treatment	2-year follow-up, 3 complications (1 no response and 2 high PVR)
Jeffery et al ⁵⁸⁰ Level 3	25 (only women)	Only IDO	500 U (Dysport)	20 mL – 20 injections	63% dry – 1 week, 32% dry – 3 months	Prospective first study with Dysport
Lee et al ⁵⁸³ Level 3	13 men 5 women	10 IDO and 8 NDO	50-200 U (NTX component of purified Type A neurotoxin)	20-40 injections including trigone indigocarmine together to check leak	89% improved	3 months follow-up, 6% retention with IC for 12 months
Sahai et al ⁵⁸⁸ Level 2	34 (16 BTX and 18 placebo), does not discriminate gender	Only IDO	200 U (Botox) or sale (as placebo)	20 mL – 20 injections	Normalization— <u>Frequency</u> – 36% BTX, 11% placebo <u>Urgency</u> – No difference <u>Incontinence</u> – 50% BTX, 0% placebo	12 weeks follow-up, randomized placebo controlled double blind trial, difficult voiding 75%, IC 38%
Kuo ⁵⁸⁶ Level 2	45 (gender not specified)	Only IDO	100 U (Botox)	Injections in detrusor, suburothelial or bladder base	Success 93% detrusor, 80% suburothelial, 67% bladder base	Prospective randomized 3 months, 4 retentions, 14 difficult void
Ghalayini & Al-Ghazo ⁵⁸⁷ Level 3	16	IDO	500 U (Dysport)	500 U diluted in 30 mL saline – 30 injections	80% of patients satisfied	Prospective study, 9 months follow-up, 1 retention and 4 with PVR > 120 mL – 5 ICath
Mohanty et al ⁹⁷⁷ Level 3	35 women	IDO	200 U (Botox)	20 mL – 20 injections sparing trigone	85.7% improvement, no adverse effects	Case series, no retentions
Kuschel et al ⁵⁸¹ Level 3	26 (women)	IDO	100 U (Botox)	30 mL – 30 injections	11 re-injections	Case series
Brubaker et al ⁶⁷⁷ Level 1	43 women (28 BTX and 15 placebo)	IDO	200 U (Botox)	20-30 injections, sparing trigone	Study stopped—43% (12 pts) with large PVR	Randomized double blind placebo controlled

Authors	N	Type of Patients	Dose	Punctures (N)	Results	Comments
Flynn et al ⁹⁷⁸ Level 2	22 women (7 placebo and 15, 2 does of Botox)	IDO	200 or 300 U (Botox)	10 injections, sparing trigone	6 weeks results only – (improvement) 26% PVR > 200 mL, 18% infection	Randomized double blind placebo controlled (immediate results)
Sahai et al ⁶⁷⁴ Level 1	34 (both sexes)	IDO	200 U (Botox) (16 pts) or placebo (18 pts)	20 mL with 20 injections	QoL improved with Botox	Randomized double blind placebo controlled
Lie et al ⁹⁷⁹ Level 3	9 women 10 men	IDO	200 U (onabotulinumtoxinA)	20 mL, 20 sites sparing trigone	More efficacious in female	Case series, 5.2% retention
Dmochowski et al ⁶⁷⁶ Level 1	313, randomized to 6 groups (both sexes)	IDO	Placebo and Botox 50, 100, 150, 200, 300 U	20 injections of 0.5 cc, sparing trigone	All benefits but placebo and 50 U groups, 100 U best result (14.5% PVR > 200 mL)	Randomized double blind placebo controlled
Granese et al ⁹⁸⁰ Level 3	68 women	IDO	100 U (Botox)	20 sites, sparing trigone	All with objective and subjective improvement	35% required IC (residual > 100 mL)
Dowson et al ⁹⁸¹ Level 3	100	OAB and IDO	Botox most 200 U	20 sites, up to 10 injections	47% discontinued treatment	IC 35%, UTI 21% (include cases from Sahai et al, 2009)
Kanagarajah et al ⁶²⁹ Level 3	5 men 27 women	IDO without urodynamic detrusor overactivity	Botox? 100 or 150 U	10 to 15 sites	84% improved more than 50% of symptoms	5 UTI, 3 IC
El-Azab et al ⁵⁷³ Level 3	13 men 18 women	IDO	Botox 100 or 200 U (16) or bladder augmentation (15)	20 injections sparing trigone or 20 cm ileal segment augment	More satisfaction with AC than with oBTX therapy	No randomized and different doses
Shakeri et al ⁶⁴⁰ Level 3	15 women 15 men	NDO (12), IDO (18)	500 U (Dysport)	20 injections sparing trigone	Satisfaction in 58% IDO and 77% NDO	1 UTI in each group
Abeywickrama et al ⁶¹² Level 3	33 women	Only IDO, repeated injections	Dysport initial 500 U, 3 or more injections	20 sites injections sparing trigone	Sustained improvement maintained in all injections	2 UTI and IC, 750 U next injection if return < 6 months
Abdelwahab et al ⁹⁸² Level 1	63 women 17 men	Idiopathic OAB	Botox randomized 100 or 200 U	20 sites injections	At 6 months, comparable results	More dysuria and UTI in the 200 U group

NDO = neurogenic detrusor activity, IDO = idiopathic detrusor overactivity, PVR = postvoid residual

CISC = clean intermittent self-catheterization, NTX = neurotoxins, IC = intermittent catheterization

BTX = Botulinum toxin type A (Botox), QoL = quality of life, OAB overactive bladder, UTI = urinary tract infection

In 2011, OnabotulinumtoxinA was first approved by countries in North and South America and Europe for treatment of urinary incontinence in people with neurologic conditions as spinal cord injury or multiple sclerosis. Lately, approval was extended to idiopathic detrusor overactivity. Information about its use in children is scarce.⁶⁰⁴ DasGupta et al⁶⁰⁵ published a systematic review on its use in children. They found 225 children in ten peer-reviewed publications with 165 pediatric patients with neurogenic overactivity (6 studies), 21 patients with idiopathic overactivity (1 study) and 39 patients with voiding dysfunction (3 studies). Only 11 male children with idiopathic OAB were included, limiting conclusions on this subject. Blackburn et al⁶⁰⁶ reported the use of Dysport in 27 pediatric patients 6 to 16 years, being only 7 males. They concluded for efficacy in a dosage of 15 iu/kg.

A randomized study comparing the results of botulinum toxin (BTx)-A injections to intravesical resiniferatoxin in NDO showed superior clinical and urodynamic benefit with the use of botulinum toxin.⁶⁰³ The need for reinjections seems to be overcome by the significant improvement in quality of life of these patients,^{607,608,609} nevertheless discontinuation has been reported to be up to 63% after 36 months of treatment.⁶¹⁰ Malde et al⁶¹¹ conducted a retrospective telephone interview on 72 patients regarding satisfaction after treatment. Among them, only 49 continued to receive injections and 57% would consider BTx-A a lifelong management option. In general, there is an impression that efficacy after multiple reinjections seems to be maintained.^{612,613,614} Cost-effectiveness with botulinum toxin A in patients with detrusor overactivity is becoming an important issue with its increasingly widespread use.⁶¹⁵ The number of BTx treatments in the UK has increased dramatically from around 50 in 2000 to 4088 in 2010, making costs an important matter to be considered.^{616,617,618} A 3-year cumulative cost analysis of BTx vs augmentation cystoplasty favored botulinum toxin injections,⁶¹⁹ but longer follow up may change this. The use of BTx-B (Myobloc – RimabotulinumtoxinB) is less efficient, with duration of action of about 10 weeks.⁶²⁰

The optimal site of injections, including or not including the trigone, is still under debate.⁶²¹ In 2007, Kuo⁵⁸⁶ published a study comparing the injections into the detrusor, suburothelial area, and bladder base, with the last location improving urgency but not increasing capacity. In 2011, Kuo⁶²² did a single blind, randomized, parallel, actively controlled trial testing 100 U of OnabotulinumtoxinA with patients assigned to receive injection into one of the three following sites: bladder body, 100 U; bladder body, 75 U plus trigone, 25 U; and bladder base, 50 U and trigone, 50 U. He concluded that the injections are a safe and effective treatment for IDO regardless of the injection sites. Manecksha et al⁶²³ performed a study with 500 U of AbobotulinumtoxinA in 22 patients randomized to trigone-included or trigone-sparing detrusor injections. Benefits of trigone included injections were superior to trigone sparing injections for the treatment of refractory IDO and did not cause VUR in this study,

besides some question about the power of the study.⁶²⁴ A case series of 56 women with IDO underwent submucosa-only injection of 200 U of OnabotulinumtoxinA at 30 sites, showed success in 85.7% at 2 months and 54.3% at 12 months.⁶²⁵ Initial results of bladder instillation of 300 units of OnabotulinumtoxinA and 50 mL of 50% DMSO in aqueous solution in women with IDO, showed safety and some efficacy that merit further research.⁶²⁶ Many studies on idiopathic overactive bladder have been done in women.^{580,581,612} Data are still lacking on dose, concentration, site(s), numbers of injections, long-term efficacy and side effects though the manufacturer recommended dose of Onabotulinumtoxin A is 100 units divided in 20 injections within the bladder, sparing the trigone. Le Maux et al⁶²⁷ conducted animal experiments showing similar inhibiting effects of aboBoNTA despite the number of sites injected, but this conclusion needs clinical confirmation. Administration of BoNTA through liposome encapsulated formulations is also beginning to show some therapeutic potential.⁶²⁸ Attempts to determine whether poor responders could be predicted from preoperative urodynamic parameters showed only a very high maximal detrusor pressure over 110 cm H₂O as an unfavorable predictor when using 200 units.⁵⁸⁸ Kanagarajah et al⁶²⁹ showed good outcomes in patients with OAB without urodynamic detrusor overactivity, proposing the need for further studies in this situation. Studies in women suggest a longer duration of action than its mere motor-nerve blocking potency can explain.⁵⁸¹ Therefore, a dual mechanism of action has been proposed. In addition to binding to cholinergic terminals, it might also affect afferent nerve transmission, thereby decreasing urgency.^{630,631} Kuo⁶³² evaluated retrospectively the results of 100 U OnabotulinumtoxinA injection in 174 patients (89 males). Patients who had sensory effects had significantly greater long-term success rates compared to those with motor effects alone. He concluded that improvement of urgency severity seems to be significantly associated with the long-term success of BoNT-A treatment for IDO. There are five commonly marketed forms of BTx-A: Botox (Allergan Pharmaceuticals, Irvine, CA, USA), now referred to as OnabotulinumtoxinA, Dysport (Ipsen Biopharm Ltd., Wrexham, UK), referred to as AbobotulinumtoxinA, Xeomin® (Merz Pharma, Frankfurt am Main, Germany), referred to as IncobotulinumtoxinA, Prosigne® (Lanzhou Biological Products Institute, Lanzhou, China), and Neuronox (Medy-tox, South Korea) which currently does not have a known non-proprietary names. The FDA Import Alert 65-02 from October 6, 2015 stated that the following were the only U.S. licensed botulinum toxin products at that time: Botox, Dysport, Myobloc and Xeomin. Botox and Dysport require different doses to achieve similar results, in a proportion of approximately 1:3.^{633,634} Other forms of BTx-A do not have enough data in urology to be considered for this report, including Xeomin (IncobotulinumtoxinA) (Merz, Germany), Prosigne (Lanzhou Institute of Biological Products, China),⁶³⁵ and Neuronox (Medy-tox, South

Korea). They have different constituents and excipients, different complex sizes, and they are stored under nonequivalent situation, making immediate comparison inappropriate.⁶³⁶ AbobotulinumtoxinA for refractory IDO was published in 2007 with similar results to OnabotulinumtoxinA.⁵⁸⁰ Recently, a series of 22 patients with IDO underwent injection of 500 U of AbobotulinumtoxinA and were randomized to injections including or excluding the trigone.⁶²³ Similar results were obtained regarding side effects (18% retention and no reflux) with the trigone-included group showing better results. Another large case series of 234 patients either with various types of neurogenic bladder dysfunction (NBD) or IDO underwent respectively 500 U and 250 U of AbobotulinumtoxinA including 57 men with IDO. Success was 91% for NBD and 93% for IDO, with 12% retention only in the male patients.⁶³⁷ In a study using a type A neurotoxin, produced in a medical school laboratory and purified by a procedure using a lactose gel column, Lee et al⁵⁸³ reported improvements in 89% of patients treated for incontinence due to IDO and NDO. Malki et al⁵³⁸ retrospectively reviewed cases with doses switched from 300 to 200 U, maintaining 79% of effectiveness. Only 9% (all NDO) reverted back to receiving 300U. Mangera et al⁶³⁹ did a systematic review on management of lower urinary tract diseases comparing OnabotulinumtoxinA and AbobotulinumtoxinA. They identified good-quality studies for OnabotulinumtoxinA in adults and lack of such studies for AbobotulinumtoxinA, although this does not imply that OnabotulinumtoxinA is more effective than AbobotulinumtoxinA. Recently, the use of AbobotulinumtoxinA in a small series of IDO and NDO, showed satisfaction in 58% and 77% respectively.⁶⁴⁰ A new series with AbobotulinumtoxinA has been published since them.⁶¹² Many studies with botulinum toxin detrusor injection use different outcome measures for results and are variable in reporting the presence of residual urine and the need for intermittent catheterization, but 6-75% of cases may develop a high post void residual urine.^{581,583,585,588} A retrospective study looking at risk factors for adverse events in a series of 217 patients treated with OnabotulinumtoxinA showed an overall 63.3% success, with male gender, base line PVR \geq 100 mL and dosage >100 U as predictors of urinary retention or difficulty voiding. Liao and Kuo⁶⁴¹ reviewed 61 frail elderly patients submitted to 100 U onabotulinumtoxinA because of IDO, among their large group of patients. Frail elderly was defined as age greater than 65 years and 3 or more of certain criteria, including unintentional weight loss, self-reported exhaustion, weakness, slow walking speed and/or low physical activity. Large post-void residual urine volume (greater than 150 mL) was significantly higher in the frail elderly group than in the other groups (60.7% vs 39.7%, $P=0.018$). Besides being an alternative for treatment of refractory DO, currently available data do not support superiority of any specific treatment plan, and therapy options should be tailored to the specific patient and physician preference.⁶⁴² Higher doses such as 200 units in IDO re-

sulted in incomplete emptying, necessitating intermittent catheterization in 6 out of 16 patients (37.5%) in one study.⁵⁸⁸ Sahai suggests a careful follow up of the patients after the injections, starting IC in symptomatic patients if post void residual urine is more than 100-150 mL.⁶⁴³ Many reports do not separate genders and mix neurogenic and idiopathic etiologies. A large number of publications are reviews of the literature.^{614,644,645,646,647,648,649,650,651,652,653,654,655,656,657,658,659,660,661,662,663,664,665,666,667,668,669,670,671,672,673} There is a randomized double blind OnabotulinumtoxinA placebo controlled trial showing favorable difference against saline injections for frequency and incontinence, but not for urgency.⁵⁸⁸ Quality of life analysis showed improvement even with the occurrence of 38% of urinary retention.⁶⁷⁴ In a dose-finding randomized double blind placebo controlled study with a total of 313 IDO patients of both sexes, all OnabotulinumtoxinA dosages (50-300 U) were better than placebo, but the 100 and 150 U dosages were best in regard to the balance between efficacy and side effects.^{675,676} In women, a placebo controlled randomized study with 200U of OnabotulinumtoxinA for IDO showed a 60% clinical response, but was terminated early due to 43% of patients having increased PVR.⁶⁷⁷ Point-counterpoint about the use of BTx-A as a first or second line treatment for OAB^{678,679,680,681} favors a first approach for oral medications. The knowledge of long term effectiveness and costs will better clarify this point.

CONCLUSIONS

- **Efficacy of botulinum toxin A for IDO: level 1 of evidence, Grade of recommendation A** (for OnabotulinumtoxinA). Fewer studies for AbobotulinumtoxinA and the lack of studies for other A toxins do not allow similar recommendation.
- **Dosage of botulinum toxin A for IDO:** between 100 and 150 U (for OnabotulinumtoxinA). No studies for other types. **Level 1 of evidence; Grade of recommendation A.**
- **Location of injection:** the majority of studies use 20 or 30 injections, and spare the trigone (Table 11). Alternative sites such as submucosal or including the trigone, have **levels 2 and 3 of evidence. Grade of recommendation C.**
- **Predictability of complications:** Risk factors for retention or difficulty voiding are: male gender, baseline PVR \geq 100mL and a dosage >100 U, **frail elderly population. Level 3 of evidence; Grade of recommendation C** (for OnabotulinumtoxinA – for other types, no conclusion possible).

The committee cautions that although the efficacy and safety of botulinum toxin A for IDO has been established there are still gaps in the available data. Its use in men remains not as widely reported as its use in woman; the issue of voiding difficulty and the need

for intermittent catheterization has not been addressed in men. Furthermore the recommendations cannot be extended to other toxins due to lack of studies.

1.2. Electrical Stimulation and Neurostimulation

Electrical stimulation of the genital area was first used to control incontinence due to DO of different etiologies on an empirical basis.⁶⁸² Later, it was suggested that reflex sphincteric contraction induced by electrical stimulation can promote an inhibitory effect on detrusor activity, thus suppressing DO.⁶⁸³ Many studies of external electrical stimulation for bladder inhibition of idiopathic urgency incontinence have been published, mainly in female patients^{684,685,686,687,688,689,690,691} The results vary from 45% to 85% success, with a mean of 38%, and 26% improved. Electrodes implanted in the pelvic floor, have not yielded good results.⁶⁸⁹

Sacral neurostimulation has been reported as an alternative therapy for urgency incontinence, urinary retention, chronic pelvic pain, and for simultaneous urinary and fecal incontinence.⁶⁹² Good results utilizing sacral neurostimulation in neurogenic bladder dysfunction were published as early as 1991.^{693,694} The working mechanism of neurostimulation in the treatment of lower tract dysfunction is still unknown.^{695,696} A suggested mechanism is somatic afferent inhibition of sensory processing in the spinal cord,^{697,698} therefore, it may be a centrally acting treatment modality different from botulinum toxin, which is an end-organ therapy that specifically targets the bladder.⁶⁹⁹

Long-term results suggest a sustained effect on restoring voiding in appropriately selected cases, but a revision rate up to 42% at 5-year follow up remains a problem.⁷⁰⁰ The largest sacral neurostimulation database reported noted an overall patient satisfaction with treatment of between 60-80% and loss of efficacy was the major problem, occurring in 17% of patients⁷²⁵. The 14-year revision rate from a single center was 39%, which decreased by up to one-third after the introduction of design improvements such as the tined lead.⁷⁰¹ In this group, the main reason for revision was loss of efficacy in 58.5% of cases. Battery change was necessary in 8% of patients and the mean battery life was 101.8 months. On-demand stimulation as suggested by Orlemans et al⁷⁰² may improve this revision rate. Its use in refractory idiopathic urgency incontinence has been limited to mostly women. Bosch and Groen⁷⁰³ presented results of chronic implantation in 15 women and 3 men, with an average age of 46 years. Significant improvements in voiding frequency, average voided volume, number of incontinence episodes and number of pads used were found, with no deterioration in response to stimulation with time. However, with subsequent experience in 14 men only 2 patients had a partial response and the rest ultimately failed.⁷⁰⁴ Shaker and Hassouna⁷⁰⁵ implanted 18 patients with

refractory urinary urgency incontinence, but only 2 were in men. Groen, Bosch and van Mastrigt⁷⁰⁶ reviewed 33 implanted women and found no effect on urethral resistance and bladder contraction strength as consequence of the depressant effect of sacral (S3) nerve neuromodulation on detrusor overactivity. Groenendijk et al⁷⁰⁷ in a retrospective study for the Sacral Nerve Stimulation Study Group, reported urodynamic aspects of 111 patients implanted, but only 8 men were included. They found a better result on urgency incontinence in patients without DO. The difference was not significant. This tendency was also found by South et al⁷⁰⁸ in 67 women implanted. Clinical or urodynamic values to predict the outcome of sacral nerve stimulation have been difficult to define. Evaluation of 19 women suggested that urethral instability seemed to be a good parameter to predict a favourable outcome.⁷⁰⁹

Some studies do not specify the etiology of the DO and neurogenic and non-neurogenic causes are grouped together.⁷⁰⁵ Some reports focus on technical or specific aspects of the procedure and the same patients may be included in different publications.^{707,710,711,712} Implantation in children may be feasible in selected cases^{713,714} and poorer results are expected in older women. The outcome in older men is unknown since there are no reports.

Table 12^{590,700,715,716,717,718,719,720,721,722,723,724,725} shows recent studies.

Some reports are literature reviews^{696,726,727,728} or detail technical modifications.^{729,730} There is one systematic review on efficacy and safety of sacral nerve stimulation for urgency incontinence, but 13 of the articles analyzed are abstracts and it is also difficult to ascertain whether the same patients are included in different publications.⁷³¹

There are some publications with level 1^{715,716} or 2^{704,718,719} evidence and with a grade of recommendation of B. However, due to relatively few men in the clinical trials, and poor results in one of the prospective trials, its general applicability to men with urgency incontinence may be limited. The scenario remains unchanged after about 26,000 patients implanted.⁷³² In a recent review, Apostolidis⁷³³ concluded that further research is needed to improve patient selection, identify prognostic factors, clarify the mechanism of action, and reduce complications and revision rates. Smits et al⁷³⁴ studied 20 patients who had discontinued BTx-A because of lack of efficacy (3 had success with Botox but preferred a more permanent solution) and later underwent sacral neuromodulation. Fourteen patients had a successful trial and were implanted and at one year 79% of these patients were satisfied with the treatment. **(Use of neurostimulation for treatment of refractory urinary urgency incontinence in non-neurogenic patients - Level of evidence 3. Grade of recommendation C).**

TABLE 12. Neuromodulation for Treatment of Refractory Urgency Incontinence Due to Detrusor Activity (Both Sexes)

Authors	N	Success (Dry)	Improved	Control Group (N)	Study and Comments
Schmidt et al ⁷¹⁵	34	47%	29%	42	Prospective randomized
Weil et al ⁷¹⁶	21	56%	19%	23	Prospective randomized
Bosch et al ⁷¹⁷	34 women 6 men	38% 16%	21% 16%		Prospective longitudinal
Siegel et al ⁷¹⁸	41	46%	19%		Prospective cohort
van Kerrebroeck et al ⁷⁰⁰	105 (at 5 years-gender not specified)		58% UI 40% frequency		5 year follow-up (non-randomized)
Grunewald et al ⁷¹⁹	18	39%	33%		Prospective
Aboseif et al ⁷²⁰	5 men 38 women	77%			Not clear about etiology
Hedlund et al ⁷²¹	13	61.5%			2 men included, both dry
Kessler et al ⁵⁹⁰	91 (71 with UI)		70%		Average follow-up 2 years. Gender not specifically discriminated (about 13% males)
Groen et al ⁷²³	60 women	15%	62%		Longitudinal study, 5 year follow-up
Chartier-Kastler et al ⁷²⁴	1170 OAB		85%		Multicenter prospective observational, 85% females
Davis et al ⁷²⁵	172		77%		8% complication

UI = urgency incontinence, OAB = overactive bladder

1.3. Surgical Treatment by Detrusor Myectomy and Augmentation

Previously used treatments of surgical bladder denervation, open bladder transection, cystolysis, endoscopic phenol injections, hydrostatic bladder distention did not yield good results.

Bladder autoaugmentation or detrusor myectomy has been reported as an alternative to augmentation in neurogenic and non-neurogenic dysfunction. Table 13^{735,736,737,738} shows results of this treatment in patients with non-neurogenic detrusor overactivity. There are few long-term results available.⁷³⁷ The use of a silastic intravesical balloon as a scaffold after myectomy seems to improve results in neurogenic patients, but was not tested in IDO.⁷³⁹ Additional and longer-term experience is still required to properly assess this procedure. **(Level of evidence 3; grade of recommendation C-D)**

Enterocystoplasty results are detailed in Table 14,^{736,740,741,742,743,744,745,746} which includes both male and female patients. Some publications are not clear about the type of surgery specifically done in IDO and about the gender. Good results vary from 58% to 88%, with an average of 77%. Approximately 10 to 75% of patients require intermittent catheterization for bladder emptying. Ileum was the most frequently used bowel segment followed by sigmoid colon, although no scientific reason for the use of any particular segment was given. The surgery, as reported in other sections, has a significant complication rate and should be considered carefully when applying it to these patients. A study of 40 patients with neurogenic and idiopathic OAB showed sustained good results with a medium follow up of 13 years.⁷⁴⁷ **(Level of evidence 3; grade of recommendation C)**

TABLE 13. Detrusor Myectomy for Treatment of Refractory Urgency Incontinence Due to Detrusor Overactivity (Both Sexes)

Author	Idiopathic Detrusor Overactivity	Good Results
Aslam et al ⁷³⁸	18	10
Kumar et al ^{737b}	24	19
Leng et al ⁷³⁶	8	7
Swami et al ^{735a}	17	12
TOTAL	67	48 (71.6%)

^ashort-term follow-up

^blonger term follow-up of the same series, 45% required IC

TABLE 14. Enterocystoplasty for Treatment of Refractory Urgency Incontinence Due to Detrusor Overactivity (Both Sexes)

Author	Detrusor Overactivity	Good or Moderate Result	Bowel Segment
Blaivas et al ⁷⁴⁶	9	9	Ileocecal segment and ileum
Bramble ⁹⁸³	15	13	2 ileum 13 colon
Edlund et al ⁷⁴⁵	25	19	
Hasan et al ⁷⁴⁰	35	19	46 ileum 2 colon
Leng et al ⁷³⁶	2	2	
McInerney et al ⁷⁴¹	50	44	
Mundy & Stephenson ⁷⁴⁴	40	30	Ileum
Sethia et al ⁷⁴³	11	9	Ileum
TOTAL	187	145 (78%)	

2. REDUCED BLADDER CAPACITY

Fibrosis of the wall produces a low-volume low-compliant bladder, leading to diminished functional capacity. Symptoms of frequency and nocturia occur as a result of progressive decrease in bladder volume, but urinary incontinence may also be the consequence of a very small capacity, especially if accompanied by urethral weakness. The diagnosis can be suggested by the micturition chart, and confirmed by urodynamics. The causes can be congenital or acquired. Acquired causes include multiple surgeries, inflammatory processes (chronic cystitis, interstitial cystitis, tuberculosis, schistosomiasis, and chemical cystitis) or following radiation.

Bilharzial contracted bladder is a problem that is primarily limited to endemic areas in Africa and the Middle East. Schistosoma haematobium migrates to the veins of the vesical and pelvic plexuses, where the female begins to lay eggs, promoting an initial inflammatory response. As a result, granulomatous lesions

form in the lamina propria. Mucosal reactions vary from hyperplasia to polypoid cystitis. A contracted bladder occurs in 2% of cases.⁷⁴⁸ Bladder augmentation seems to offer reasonable results in these cases.

Similarly, small fibrotic bladders due to other etiologies can be treated successfully with enterocystoplasty. The results of this surgery are presented in Table 15.^{746,749,750,751,752,753,754,755,756,757 758,759,760,761,762,763,764,765,766,767,768,769,770,771,772,773,774,775,776} The results are similar in all etiologies except for radiation. The poorer results after radiation may be due to other tissue damage in the surgical area. New conformal techniques for radiotherapy may improve results in the future, so that the need for augmentation cystoplasty decreases. A new cause for reduced bladder capacity is the long-term ketamine abuse leading to bladder inflammation and volume reduction in about one third of patients.⁷⁷⁷ The treatment outcome of augmentation enterocystoplasty was better than those patients with conservative treatment.

TABLE 15. Enterocystoplasty Results for Reduced Bladder Capacity

Authors	Bilharziasis Cystitis		Tuberculous Cystitis		Radiation Cystitis		Unknown Cause	
	Total	Success	Total	Success	Total	Success	Total	Success
Smith et al ⁷⁴⁹	---	---	7	4	9	3	12	7
Kerr et al ⁷⁵⁰	---	---	12	12	---	---	---	---
Zinman and Libertino ⁷⁵¹	---	---	2	2	1	?	1	1
Dounis et al ⁷⁵²	---	---	31	27	---	---	1	1
Lunghi et al ⁷⁵³	---	---	15	15	4	4	3	3
Shawket and Muhsen ⁷⁵⁴	8	8	---	---	---	---	---	---
Whitmore and Gittes ⁷⁵⁵	---	---	7	7	---	---	2	1
Chan et al ⁷⁵⁶	---	---	---	---	---	---	10	9
Shirley et al ⁷⁵⁷	---	---	10	10	4	2	---	---
Goodwin et al ⁷⁵⁸	---	---	3	2	---	---	3	3
Winter and Goodwin ⁷⁵⁹	---	---	1	1	3	1	---	---
Fall and Nilsson ⁷⁶⁰	---	---	1	1	---	---	1	1
Goldwasser and Webster ⁷⁶¹	---	---	---	---	---	---	7	7
Weinberg et al ⁷⁶²	---	---	2	2	1	1	1	1
Novak ⁷⁶³	---	---	11	11	---	---	---	---
Sayegh and Dimmette ⁷⁶⁴	2	0	---	---	---	---	---	---
Beduk et al ⁷⁶⁵	---	---	---	---	---	---	1	1
Kuo ⁷⁶⁶	---	---	---	---	1	1	---	---
Kawamura et al ⁷⁶⁷	---	---	---	---	---	---	1	1
Hradec ⁷⁶⁸	---	---	---	---	27	23	---	---
el Otmany et al ⁷⁷⁰	---	---	1	1	---	---	---	---
Yamada et al ⁷⁷¹	---	---	1	1	---	---	---	---
Miyano et al ⁷⁷²	---	---	---	---	---	---	1	1
Blaivas et al ⁷⁴⁶	---	---	---	---	3	2	3	3
de Figueiredo et al ⁷⁷³	---	---	25	20	---	---	---	---
Yashi et al ⁷⁷⁴	---	---	---	---	1	1	---	---
Lima et al ⁷⁷⁵	---	---	7	7	---	---	---	---
Singh et al ⁷⁷⁶	---	---	28	28	---	---	---	---
TOTAL	10	8 (80%)	164	151 (92%)	54	39 (72%)	48	40 (85%)

Almost all of these studies do not distinguish bowel segments or separate males from females in reporting results. Therefore, it is not possible to correlate

any particular aspect with the chance of success or failure. However, overall the results seem reasonably

good with the exception of patients who have undergone radiation. (Level of evidence 3; Grade of recommendation B).

XI. URETHROCUTANEOUS AND RECTOURETHRAL FISTULAE

Urethrocutaneous or rectourethral fistula may have congenital, inflammatory, neoplastic or traumatic origins. It is important to recognize the varying etiologies because each type may require a different surgical strategy. All reports except one are retrospective case series. The report by Shakespeare et al⁷⁷⁸ is from a prospectively collected database of patients treated with radiotherapy for prostate cancer. They noted that some of the men who had undergone brachytherapy had a biopsy of the anterior rectal wall by gastroenterologists prior to developing the fistula. They recommended that the anterior rectal wall not be biopsied in patients with a history of prostate brachytherapy unless there was a high clinical suspicion of malignancy (Level of evidence 3; grade of recommendation C).

1. URETHROCUTANEOUS FISTULA (UCF)

1.1. Acquired UCF

Hidden foreign bodies have been described as a rare cause of both strangulation of the glans penis and UCF. Tash and Eid⁷⁷⁹ presented the case of a 30-year-old man who developed a UCF and penile shaft necrosis after a condom broke during intercourse. Neither the patient nor several physicians could identify the retained ring of condom, which had been buried under newly epithelialized skin. He underwent removal of the foreign body under general anesthesia, followed 5 months later by a formal UCF repair.

Urethroperineal fistula, as a complication of open perineal prostate cryosurgery, occurs as an immediate perioperative complication in 10.7%.⁷⁸⁰ Thomas et al⁷⁸¹ retrospectively evaluated 250 patients after radical perineal prostatectomy and revealed only one (0.4%) urethroperineal fistula. Fahal et al⁷⁸² published an unusual complication of mycetoma. The patient had an infection with *Actinomyces madurae* that involved abdominal wall, perineum and urethra. This resulted in urinary extravasation with a UCF.

1.2. Management of UCF

The diagnosis of UCF is made by physical examination, retrograde urethrography (Figure 6), urethros-copy, fistulography, urethral ultrasound or color Doppler imaging. Urethral sonography provides additional information about any involvement of the surrounding tissue, location of vessels and associated abnormalities such as a periurethral abscess.⁷⁸³ Treatment of UCF usually requires urethroplasty techniques with modifications involving fistula excision and multiple layer closure.⁷⁸⁴ (Level of evidence 3; Grade of recommendation C)



Figure 6. Voiding cystourethrogram after incision.

2. RECTOURETHRAL FISTULA (RUF)

Culp and Calhoon⁷⁸⁵ described five basic groups of RUF according to the etiology: congenital, iatrogenic, traumatic, neoplastic, and inflammatory. This classification is the most current, even today over 50 years later.

2.1. Congenital RUF

Endo et al⁷⁸⁶ described the results of the Japanese Study Group of Anorectal Anomalies (JSGA) to determine the relative incidence of specific types of these anomalies in Japan. They included discussion of RUF regarding the relationship between the fistula levels and the blind end of the rectum, low type deformity, rare types, and associated anomalies. A total of 1,992 patients (1,183 boys and 809 girls) registered from

1976 to 1995 were analyzed according to the pathogenesis of anorectal malformation in the field of molecular genetics. They reported that more than 20% of RUF should be categorized as intermediate or low deformity from the position of the rectal pouch. A significant preponderance of Down's syndrome in the deformities without fistulae suggests that investigation of associated anomalies and congenital diseases may provide further insights. The purpose of Rintala's study was to compare the long-term outcome of sacroperineal-sacroabdominoperineal pull-through (SP-SAP) to that of posterior sagittal anorectoplasty (PSARP). In boys with high anorectal anomalies, PSARP was superior to SP-SAP pull-through in terms of long-term bowel function and fecal continence.⁷⁸⁷

In 2011, the German network for congenital uro-rectal malformations evaluated postoperative urological complications in 267 patients with anorectal malformations (recto-urethral fistula in 21 cases). According to type of operation, the highest number of postoperative urologic problems was reported after abdominosacroperineal pull-through.⁷⁸⁸

2.2. Acquired RUF

Acquired RUF may occur after pelvic trauma, surgery of the prostate or rectum, pelvic cancer, radiation (either external beam or brachytherapy), cryosurgery, prostatic hyperthermia, prostatic high intensity focused ultrasound (HIFU), inflammatory bowel disease affecting rectum, or rarely prostatic inflammation. Lorán et al⁷⁸⁹ reported a patient with a RUF after a repeat transrectal prostate biopsy.

Benčekroun and co-workers⁷⁹⁰ report a series of 11 RUF observed over a 25-year period. The etiologies were surgical trauma (5 cases), fracture of the pelvis (2 cases), inflammatory lesions (3 cases), and one fistula was congenital. Colostomy was performed in two patients, surgical closure of the fistula was performed in seven patients: abdominoperineal (3 cases), perineal (2 cases), transperitoneal (1 case) or by transanosphincteric incision (1 case).

In 1972, Smith and Veenema⁷⁹¹ reported their 20-year experience with 160 patients undergoing radical retropubic prostatectomy (RRP) with an incidence of 15 rectal injuries. Only four fistulas developed in this group.

Roberts et al⁷⁹² published a series of 11,452 men who underwent open (RRP) or laparoscopic (LRP) radical prostatectomy. Rectal injury occurred in 18 men—12 in the RRP group (0.12%) and six in the LRP group (0.47%). When recognized intraoperatively and primarily repaired, rectourethral fistula was prevented in 87.5% of men. Primary repair performed with vascularized tissue interposition prevented rectourethral fistula development. In men with unrecognized rectal injury, the rectourethral fistula tended to persist and eventually required delayed surgical repair. Thomas et al⁷⁹³ reported that rectourethral fistulas developed in 13 of 2,447 patients (0.53%) after RP. In seven of

13 patients (54%) a rectal lesion was primarily closed at radical prostatectomy.

With conservative management in three patients, all three healed spontaneously. None of these patients had fecaluria. Three of the nine patients (33%) experienced spontaneous fistula closure after temporary colostomy and transurethral catheterization. In this group, six patients (67%) required additional surgical fistula closure, which was successful in all. Surgical fistula closure (1) without colostomy in presence of fecaluria failed.

The most common single cause of RUF in the series of 23 male patients published by Tiptaft et al⁷⁹⁴ was a fracture of the pelvis and iatrogenic causes (two cases after transurethral prostatic surgery, two cases after open prostatectomy, and three cases after urethral instrumentation. Noldus et al⁷⁹⁵ reported 23 (3.9%) rectal injuries during 589 RRP and cystoprostatectomy procedures. Eastham and Scardino⁷⁹⁶ summarized the incidence of rectal injury during RRP in 3834 patients with an average of 0.7% (range 0.2-2.9%). The incidence of RUF, as an immediate perioperative complication of open perineal prostate surgery, is 1.4 %.

Nyam et al⁷⁹⁷ reviewed records of all patients who were diagnosed with RUF between January 1981 and December 1995 and 16 males were identified. All patients were interviewed by telephone for follow-up. The mean age was 68 years and the mean follow-up was 80 months. Adenocarcinoma of the prostate in 15 patients and recurrent transitional cell carcinoma of the bladder in one patient were the underlying malignant diseases. Nine patients had had a RRP with two fistulas after radiation, two after brachytherapy, and three after a combination of radiation and brachytherapy. One patient formed a fistula after cystectomy and dilation of a stricture. This heterogeneous group of patients received multiple therapies including initial colostomy (7 patients), transanal repair (2 patients), parasacral repair (2 patients), transperineal repair (2 patients), coloanal anastomosis (3 patients), and muscle transposition (3 patients). Four of the patients required a permanent stoma.

Badalament et al⁷⁹⁸ managed one patient (0.4%) with a urethrorectal fistula after cryoablation therapy for prostate cancer. Zippe⁷⁹⁹ reviewed preliminary results of prostate cryosurgery and reported a 2 to 5% incidence of RUF. Porter et al⁷⁸⁰ found a 2.5% rate of RUF in 210 patients after TRUS-guided prostate cryosurgery and no urethroperineal fistulae. Ismail et al⁸⁰⁰ reported the experience of using salvage targeted cryoablation of the prostate (TCAP) in 100 patients for the recurrence after radiotherapy. The mean follow-up was 33.5 months and RUF occurred in 1%.

Montorsi et al⁸⁰¹ reported a RUF after transrectal prostatic hyperthermia (43°C) in patients with advanced prostatic cancer after multiple treatment sessions. The fistula was cured after a urethral catheter was left in place for one month. Kleinberg et al⁸⁰² summarized results of 31 patients with stage T1 or T2

prostatic carcinoma following CT guided transperineal I125 implants and reported that only one patient developed a prostaticorectal fistula that was managed with an ileal conduit.

Fengler and Abcarian⁸⁰³ published their experience of eight patients with RUF in the course of treatment of prostate cancer (3 fistulae after radiation therapy alone, 3 after prostatectomy and 2 after both surgery and radiation therapy). Larson et al⁸⁰⁴ evaluated 5719 patients after radiation for prostate cancer. Ten had documented RUF. Lane et al⁸⁰⁵ treated 21 men with RUF following primary external beam radiotherapy and one after adjuvant external beam radiation therapy for prostate cancer. Time from the last radiation treatment to fistula presentation was 6 months to 20 years. Four patients underwent proctectomy with permanent fecal and urinary diversion. Successful fistula closure was achieved in the 9 patients who underwent urethral reconstruction. Chrouser et al⁸⁰⁶ identified a total of 51 patients with a history of external beam radiation for prostate cancer that subsequently had a urinary fistula. Of 20 patients meeting inclusion criteria, 30% received external beam RT alone, 30% received brachytherapy and 40% had received combined external beam RT/brachytherapy. Most fistulas (80%) were from the rectum to the urinary tract with an average diameter of 3.2 cm. Of patients with rectal fistulas 81% had a history of rectal stricture, urethral stricture, rectal biopsy, rectal argon beam therapy or transurethral prostate resection after radiation. All patients with rectourethral fistulas who achieved symptomatic resolution required urinary and fecal diversion.

Shakespeare et al⁷⁷⁸ reviewed the potential factors in fistula development and identified three cases (0.2%) of RUF among 1455 patients treated with prostate brachytherapy (BT), occurring at 19-27 months following BT. All these patients had BT monotherapy and had been investigated with endoscopy and low rectal biopsy. They concluded that gastrointestinal specialists should not perform biopsy of the anterior rectum in patients who have had BT unless there is a very high clinical suspicion of malignancy. Marguet et al⁸⁰⁷ described 6 cases of RUF in patients treated with BT plus external beam radiotherapy for localized prostate cancer and subsequent rectal biopsies or rectal surgery. Four patients underwent hyperbaric oxygen therapy, which failed. Three patients underwent fecal diversion with gracilis interposition flaps, and two underwent pelvic exenteration. They also concluded that biopsy of rectal ulcers in the clinical setting of combined radiotherapy should not be performed.

Chang et al⁸⁰⁸ published a case of prostatic malakoplakia masquerading as a rectal tumor due to formation of a fistulous tract to the rectal muscular layers. Cools et al⁸⁰⁹ reported a very uncommon type of fistula between the large bowel and the prostatic urethra due to Crohn's disease. Felipetto et al⁸¹⁰ described a prostaticutaneous fistula as a complication of pseudomonas prostatitis.

Transrectal high-intensity focused ultrasound (HIFU) destroys prostate cells by coagulative necrosis of the tissue. Recent reports of efficacy also include morbidity. Rebillard et al⁴⁵² reported RUF in 0-3% in a review involving 37 articles/abstracts.

Netsch et al⁸¹¹ reported a retrospective analysis of 363 patients with PCa who underwent HIFU. A total of 8 patients (2.2%) developed RUF. The occurrence after 1 HIFU session was 1.17%, after salvage HIFU 4.5% and after repeated HIFU sessions was markedly elevated (13.63%). Spontaneous closure of RUF did not occur.

Buckley et al⁸¹² concluded that there has been a major shift in the cause of RUF from primarily surgical to approximately 50% resulting from radiation/ ablation therapy. Surgically induced RUFs typically are small, located in bladder neck/trigonal region and can be closed primarily. Radiation/ablation induced fistula are large (>2 cm), involve the prostatic urethra and are fibrotic often requiring a combination of onlay grafting and interposition muscle flap for closure. The anterior, perineal sphincter-sparing approach may be the optimal approach for closure of most RUF (simple or complex). Lacarriere et al⁸¹³ noted that the use of radiotherapy had a major impact on its prognosis. The flap, which seemed to have the best results, was the gracilis muscle flap.

Hanna et al⁸¹⁴ reviewed outcomes after surgical treatment of RUF in irradiated and nonirradiated patients. Patients who had irradiated RUF underwent more complex operative repairs, including gracilis interposition flaps (38%) and pelvic exenterations (19%), whereas nonirradiated patients most commonly underwent a York-Mason repair (50%). There were no statistically significant differences in RUF or in post-operative and functional outcomes. Only 55% of irradiated patients had their stoma reversed vs 91% in the nonirradiated group.

Beddy et al⁸¹⁵ examined whether choice of operation and results of surgery for RUF in 50 patients are influenced by prior radiotherapy. Radiation was received by patients for prostate or rectal cancer, and other patients developed a fistula following prostatectomy, Crohn's disease or pelvic fracture (without radiation). Prior to definitive surgery, 30 patients underwent fecal diversion and 37 underwent urinary diversion. Definitive surgery was approached predominantly abdominally in irradiated patients and perineally in nonirradiated patients successful primary fistula repair was more frequent in the nonirradiated group compared with the irradiated group. Permanent colostomy and urinary diversion were more often required in irradiated patients.

Linder et al⁸¹⁶ also evaluated the impact of pelvic radiation (BT, external beam radiation) and ablative therapy (cryotherapy or high intensity focused ultrasound) on the surgical repair of RUF. Patients with prior radiation/ablation were significantly more likely to require permanent colostomy and permanent urinary diversion as part of fistula management.

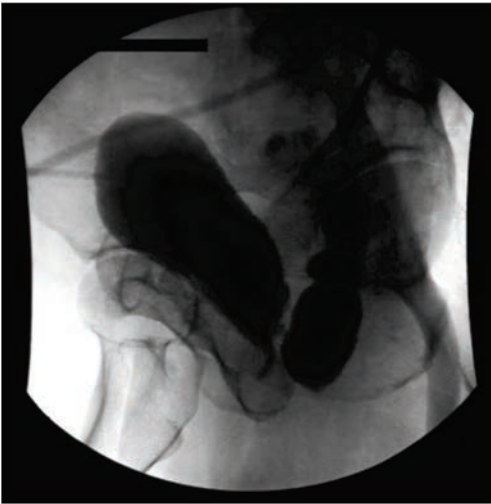

Figure 7. Cystogram demonstrates a rectourethral fistula that occurred after a laparoscopic radical prostatectomy

RUF following laparoscopic radical prostatectomy in 10 patients was reported by Chun et al.⁸¹⁷ Spontaneous healing of the fistula was noted in 6 patients following diversion (urinary ± fecal diversion).

2.3. Diagnosis of RUF

RUF may be strongly suspected from the patient's history (fecaluria, abnormal urethral discharge, pneumaturia, leakage of urine from the rectum during micturition). Rectal examination, proctoscopy, careful urethroscopy, intraurethral injection of methylene blue dye, radiopaque contrast agent placed into the bladder and then voided usually appears in the rectum on X-ray, are the most important diagnostic steps (Figure 7).^{783,818}

Sa et al⁸¹⁹ evaluated the value of three-dimensional spiral computed tomography/cysto-urethrography (CTCUG) in diagnosing posterior urethral strictures associated with RUF. The accuracy in determining the RUF was higher with CTCUG (93%) than with conventional urethrography (71%).URFs.

2.4. Therapy of RUF

Small fistulae may resolve spontaneously with urinary and/or fecal diversion. Therefore, an initial trial of conservative therapy is reasonable. Selected patients with chronic fistulas who are poor surgical candidates may also be managed conservatively with antibiotics, pads and symptomatic care. Timing of repair is often individualized, mainly according to the etiology, delay in diagnosis, size of fistula, whether it is the first or subsequent repairs, and the general condition of patient.

Diversion of urine (suprapubic cystostomy) is generally recommended as well as correction of any urethral stricture distal to the fistula. Fecal diversion, with colostomy is used by some as a mandatory part of double diversion or selectively by others.⁷⁹³ Gibbons⁸²⁰ stressed the need for a diverting colostomy for 3-4 months.

However, as surgeons obtained more experience, bowel preparations became standardized, and effective antibiotics were developed, and the enthusiasm for colostomy diminished. Currently, colostomy is recommended in circumstances where antibiotics alone cannot control the inflammation and infection associated with the fistula or when the fistula involves radiated tissue. Low residue diet is also useful for healing. Suitable drainage (perineal and urethral splinting) is stressed.

2.5. SURGICAL APPROACHES

Surgical management for rectourinary fistulas remains a reconstructive challenge. Two-layer closure of the urethra and rectum with suture lines at right angles and with interposition of soft tissue (eg, omentum,⁸²¹ gracilis muscle,⁸²² or scrotal flap⁸²³) has been described. Surgical approaches include transabdominal, transvesical, or direct exposure of the RUF.

There are only a few guidelines to direct the surgeon to the most successful and least morbid technique. Rivera et al⁸²⁴ staged RUF as: stage I, low (less than 4 cm from anal verge and nonirradiated); stage II, high (more than 4 cm from anal verge and nonirradiated); stage III, small (less than 2 cm irradiated fistula); stage IV, large (more than 2 cm irradiated fistula); and stage V, large (ischial decubitus fistula). Diverting colostomy was performed for stages III to V 6 weeks before definitive therapy. Some of the patients in addition to the RUF will also have urethral strictures that have to be managed. Reconstruction of both aspects to restore functional anatomy is possible with complex reconstructions.⁸²⁵

Hechenbleikner et al⁸²⁶ searched MEDLINE (PubMed, Ovid) and the Cochrane Library by using the term RUF. All studies were retrospective. Of the 569 records identified, 26 articles were included. Four hundred sixteen patients were identified, including 169 (40%) who had previous pelvic irradiation and/or ablation. Most patients (90%) underwent 1 of 4 categories of repair: transanal (5.9%), transabdominal (12.5%), transsphincteric (15.7%), and transperineal (65.9%). Tissue interposition flaps, predominantly gracilis muscle, were used in 72% of repairs. The fistula was successfully closed in 87.5%. Overall permanent fecal and/or urinary diversion rates were 10.6% and 8.3%. Most high-volume centers (>25 patients) performed transperineal repairs with tissue flaps in 100% of cases.

TABLE 16. Surgical Approaches to Rectourethral Fistulas

Approach	Author, Year	N
PERINEAL	Young, 1926 ⁸²⁷	11
	Lewis, 1947 ⁸²⁸	13
	Goodwin, 1958 ⁸²⁹	22
	Culp & Calhoon, 1964 ⁷⁸⁵	20
	Smith & Veenema, 1972 ⁷⁹¹	4
	Youssef, 1999 ⁷⁸⁹ (<i>perineal dartos flap</i>)	12
	Benckekroun, 1999 ⁷⁹⁰	11
	Ng, 2004 ⁸³¹ (<i>buccal graft</i>)	27
	Pratap, 2006 ⁸³²	8
	Samplaski, 2011 ⁸³³	13
	Selph, 2015 ⁸³⁴	6
	Voelzke, 2013 ⁸³⁵	23
POSTERIOR – SAGITTAL	Kilpatrick & Thompson, 1962 ⁸³⁶	6
POSTERIOR – TRANSSPHINCTERIC	Stephenson, 1996 ⁸³⁷	15
	Kilpatrick & Mason, 1969 ⁸³⁸	7
	Culp & Calhoon, 1964 ⁷⁸⁵	20
	Fengler & Abcarian, 1997 ⁸⁰³	8
	Fournier, 1996 ⁸³⁹	1
	Bukowski, 1995 ⁸⁴⁰	7
	Dal Moro, 2006 ⁸⁴¹	7
	Erickson, 2006 ⁸⁴²	1
	Lorente, 2011 ⁸⁴³	10
	Pera, 2008 ⁸⁴⁴	5
	Rouanne, 2011 ⁸⁴⁵	10
	Kyrklund, 2014 ⁸⁴⁶	34
	Forest, 2014 ⁸⁴⁷	17
	Alam, 2014 ⁸⁴⁸	18
Pfalzgraf, 2014 ⁸⁴⁹	17	
TRANSANAL	Vose, 1949 ⁸⁵⁰	4
	Parks & Motson, 1983 ⁸⁵¹	1
	Tiptaft, 1983 ⁷⁹⁴	3
	Noldus, 1997 ⁷⁹⁵	5
	Culkin, 2003 ⁸⁵²	5
COMBINED (<i>posterior transsphincteric anterior rectal wall advancement</i>)	al-Ali, 1997 ⁸¹⁸	16
	Joshi, 2011 ⁸⁵³	5
	Keller, 2015 ⁸⁵⁴	30
ANTERIOR TRANSANORECTAL (ASTRA)	Geceleter, 1973 ⁸⁵⁵	19
	Venable, 1989 ⁸²³	1

Approach	Author, Year	N
	Zinman, 2003 ⁸⁵⁶	22
ENDOSCOPIC	Wilbert, 1996 ⁸⁵⁷	2
	Bardari, 2001 ⁸⁵⁸	1
	Pigalarga, 2011 ⁸⁵⁹	1

The surgical approaches including the numbers of reported patients are listed in Table 16.^{785,790,791,794,795,803,818,823,827,828,829,830,831,832,833,834,835,836,837,838,839,840,841,842,843,844,845,846,847,848,849,850,851,852,853,854,855,856,857,858,859}

2.5.1 Perineal Approach

In 1926, Young⁸²⁷ dissected the rectum away from sphincters, divided the fistula, closed the urethra, and mobilized the rectum further cephalad in such a fashion as to pull the affected rectum caudally out of the anus where it was then transected and discarded, suturing the proximal rectum to the anal skin. Subsequently Lewis,⁸²⁸ in 1947, described suturing the levator muscle fibers together in the anterior midline when possible.

Goodwin et al⁸²⁹ reported a series of 22 RUF approached perineally. They extensively mobilized the rectum posteriorly and the bladder anteriorly through wide perineal exposure allowing interposition of the levator ani muscles between the urinary tract and rectum. Singh et al⁸⁶⁰ described the management of a

ineal access without rectal or sphincteric transgression. An example of a preoperative and postoperative urethrogram is in Figure 8. Pratap et al⁸³² described a simultaneous perineal and abdominal approach in a series of 8 patients with traumatic perineal injuries who had both complex urethral disruptions and RUF.

Samplaski et al⁸³³ reported transperineal repair with gracilis muscle interposition in 13 patients with complex RUFs of varying etiologies. One patient developed recurrence. They demonstrated low morbidity, high success rates, and reasonable bowel and bladder function postoperatively.

Selph et al⁸³⁴ confirmed that patients who require placement of an AUS after a perineal RUF repair seem to fare just as well as patients who undergo primary AUS implantation with no increased rate of complications postoperatively.

Voelzke et al⁸³⁵ divided the fistula cohort of 23 patients into 2 groups, including postoperative and energy ablative fistulas, respectively. They recommended rectal sphincter preserving transperineal repair as a successful surgical method to repair postop-

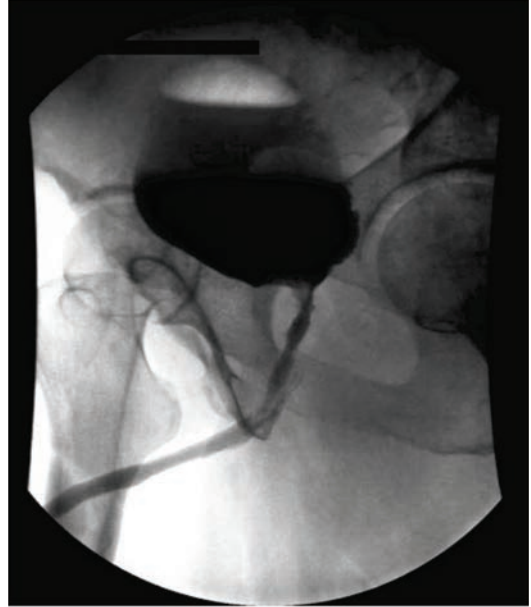
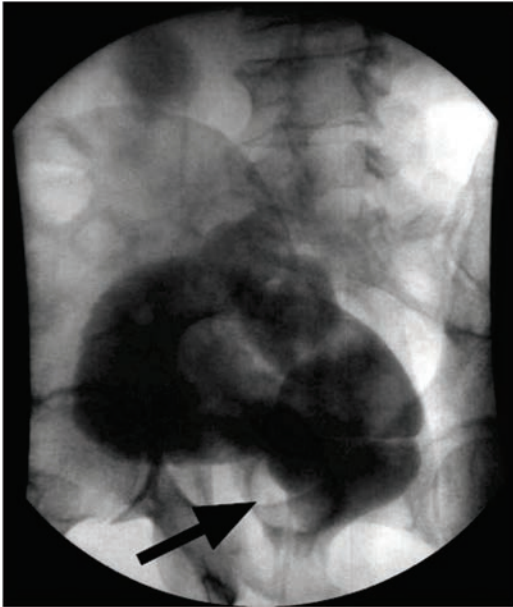

Figure 8.A. Cystogram demonstrates RUF caused by a TURP. Negative shadow from Foley catheter is seen in the bladder. **B.** Retrograde urethrogram after transperineal closure of RUF.

delayed post-traumatic RUF repaired via transper-

erative and energy ablative rectourethral fistulas. An interposition muscle flap should be considered in the

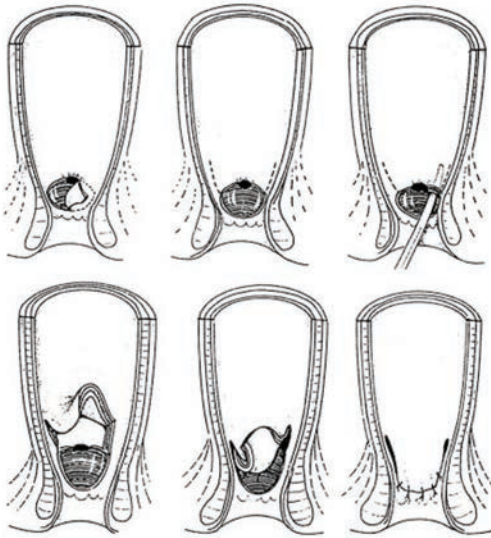

Figure 9. Rectourethral fistula repair. Full thickness rectal wall is mobilized to close in a “vest over pants” technique to close the fistula.

setting of energy ablative rectourethral fistulas to increase successful outcomes.

2.5.2 Posterior Sagittal Approach

Kraske in 1885⁸⁶¹ described a posterior midline incision extending to the left paramedian aspect of the coccyx and sacrum that involved partial removal of the sacrum in addition to coccygectomy. His method did not involve division of the sphincters, but rather sweeping the rectum laterally to ultimately facilitate resection and reanastomosis of a tumor-bearing rectal segment, thereby preserving fecal continence. In 1962, Kilpatrick and Thompson⁸³⁶ used this approach when the rectum was completely mobilized circumferentially proximal and distal to the fistula. The RUF was then divided, sparing as much as possible on the urethral aspect. The rectal part of the fistula was excised and closed in two layers, and the urethra was repaired and stented with a catheter.

2.5.3 Posterior (Parasacrococcygeal) Transsphincteric Approach

In 1969, Kilpatrick and Mason⁸³⁸ updated this method and advocated a more radical method of dividing the rectal sphincters to give direct access to the RUF. The procedure (the York-Mason approach) is simpler than some complicated transabdominal or transperineal approaches to RUF. It is still used because it allows direct visualization of the fistula via parasacrococcygeal (transsphincteric) incision especially to fistulae in the mid to lower rectum.⁸⁰³ After the skin incision the mucocutaneous junction is marked with sutures and the internal sphincter is exposed. Division of the sphincter mechanism and posterior rectal wall allows exposure of the fistula. Each sphincter muscle is tagged with color-coded sutures. The next step of

this procedure is the incision around fistula, followed by excision of the fistulous tract exposing the catheter in the prostatic urethra. The undermining of rectal wall allows sufficient mobilization.

After closure of the prostatic urethra it is recommended that the full-thickness rectal wall flaps close in a “vest over pants” technique (Figure 9). It is important to make sure that the suture lines do not overlie each other. The procedure is completed by suture of the rectal wall and approximation of the sphincter muscles (Figure 10). Fengler and Abcarian⁸⁰³ reported healing of RUF in all of 8 patients with the York-Mason approach. Bukowski et al⁸⁴⁰ managed 7 acquired recurrent RUF (3 after prostatectomy, 3 after trauma and 1 after perineal abscess) using York-Mason technique and a similar experience was described by Fournier et al⁸³⁹ in the management of a case of the urethroprostatic-rectal fistula after a gunshot wound.

Stephenson and Middleton⁸³⁷ modified the York-Mason repair and reported their experience with posterior sagittal, transanal, transrectal repair of RUF in 15 patients. The transsphincteric, transanal surgical approach provides many advantages, including easy access and identification of the fistula tract, good surgical exposure, adequate resection back to well vascularized tissue, and access to several vascularized

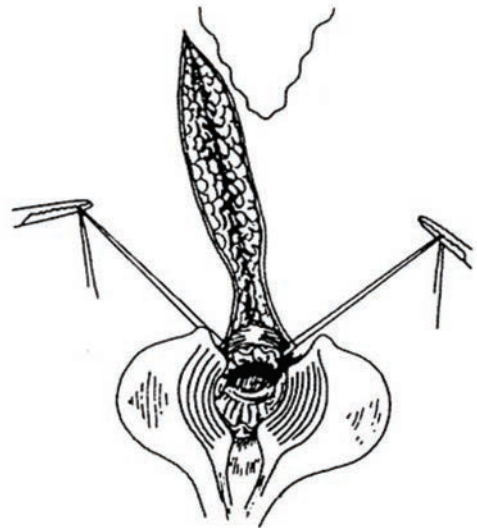

Figure 10. York-Mason approach to a rectourethral fistula via a parasacrococcygeal (transsphincteric) incision. Sutures are used to mark the sphincters. The speculum has been placed at the bottom of the incision and the anterior rectal wall is visible.

flaps for interposition between the repaired urinary and gastrointestinal tracts.

Culkin⁸⁵² reported preliminary experience with the transsphincteric, transanal surgical approach to correct acquired urethrorectal fistula in five men. Mean patient age was 56.6 years (range 37 to 72). The etiology was surgical (radical prostatectomy) in 3 cases, traumatic in 1 and idiopathic in 1. The time from the diagnosis of urethrorectal fistula to surgery was 4 weeks to 4 years. Five men underwent excision and closure of a urethrorectal fistula with diverting colostomy. In 4 men (80%) urinary continence subsequently returned with adequate sphincter tone, while in 1 (20%) with perineal trauma and active proctitis the fistula recurred 6 weeks after surgery.

Dal Moro et al⁸⁴¹ reviewed a 15-year experience using the York-Mason posterior sagittal transrectal approach to iatrogenic RUF in 7 patients. In one patient with Crohn's disease the fistula recurred 11 years after the first surgery. The colostomy remained in place only in one patient with Crohn's disease and in another with ulcerative rectocolitis.

Erickson et al⁸⁴² reported a novel surgical technique used to repair a rectourethral fistula associated with two short-segment urethral strictures located in the anterior and posterior segments of the urethra in a patient with prior unsuccessful repairs. The anterior urethral stricture was reconstructed with a ventral onlay of buccal mucosa in the exaggerated lithotomy position. In a modified prone position, the rectourethral fistula was repaired using the transrectal transsphincteric (York-Mason) technique and the posterior urethral stricture with a radial forearm fasciocutaneous free flap which was anastomosed to the inferior gluteal artery and vein. The coexistence of a rectourethral fistula and distal urethral stricture requires simultaneous repair, because the urethral pressure from the distal obstruction may compromise fistula closure. Lorente et al⁸⁴³ reported early successful closure in 10 patients with the posterior transsphincteric York-Mason technique, with good recovery of urinary and fecal continence. Pera et al⁸⁴⁴ reported on 5 patients successfully treated after RP with the York Mason technique.

They reported minor morbidity and no impairment of continence.

Rouanne et al⁸⁴⁵ reported 10 male patients with RUF due to radical prostatectomy who underwent York Mason repair between 1998 and 2009. All patients initially received both a urinary and a bowel diversion as the first step of the treatment. The second step consisted of a modification of the York Mason technique in which the approach began with a parasacro-coccygeal incision extending from the coccyx to the anal verge. The mean time from surgery to York Mason repair was 15 (range, 4-42) months.

Kyrklund et al⁸⁴⁶ aimed to define the long-term bowel functional outcomes following PSARP (posterior sagittal anorectoplasty) for RUF. They used validated

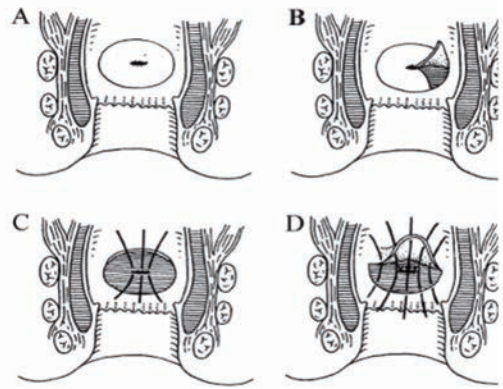

Figure 11. Transanal repair of rectourethral fistula.

A. Elliptical incision of rectal mucosa around the fistula.

B. Denudation of the rectal mucosa.

C. Fistula closed with absorbable suture.

D. Rectal mucosal flap sutured with absorbable suture.

Bowel Function Score (BFS) questionnaires mailed out to patients. Approximately one third of 34 respondents reported voluntary bowel movements (VBMs) and complete continence and 24% were reliant on antegrade continence enema (ACE) wash-outs, and 1 patient had a colostomy. Their results suggest that in the long-term, functional symptoms remain highly prevalent among patients treated for RUF with PSARP. However, the majority can be expected to achieve social continence.

Forest et al⁸⁴⁷ retrospectively analyzed the data of 17 patients treated surgically for RUF with the York Mason technique between 2000 and 2012. All patients had a bowel diversion before surgery. They observed four recurrences of RUF (23.5%).

Alam et al⁸⁴⁸ from India prospectively reviewed the records of all the patients who developed RUF. A total of 18 patients were included and in all cases faecal and urinary diversion were done preoperatively. In 8 patients repair of fistula was done through the perineal approach where excision of the fistulous tract with anastomotic urethroplasty and repair of rectal wound was performed. Out of these 8 patients tunica vaginalis flap was applied in 3 and dartos pedicle flap in 5 cases; in the remaining 6 patients transrectal York-Mason repair was done. No patient developed urinary or faecal incontinence. Transrectal York-Mason repair is easier to do with less morbidity and complication while perineal approach with graft interposition may be done in cases where anastomotic urethroplasty is needed along with fistula repair.

Pfalzgraf et al⁸⁴⁹ assessed fistula recurrence rate and health-related quality of life (HRQL) after repair in a

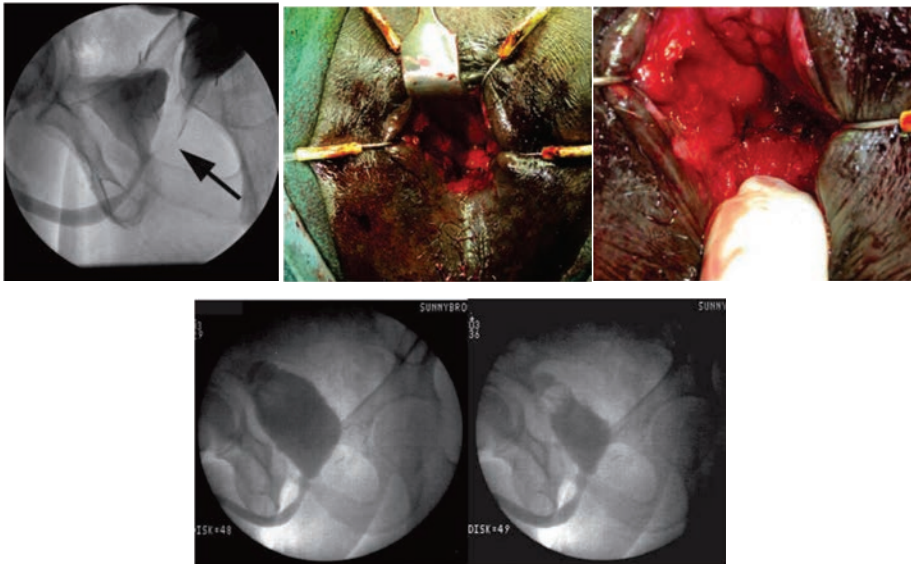

Figure 12.

A. Retrograde urethrogram of a 55 year-old man who underwent a radical prostatectomy. He complained of fecaluria and urine per rectum. This shows urethral contrast in the rectum through a rectourethral fistula (Black arrow).

B. Intraoperative photograph of transanal rectourethral fistula repair. The anus is held open by the ring retractor to permit direct access to the fistula.

C. Intraoperative view of the rectal mucosal sutures in the rectourethral fistula repair.

D. Retrograde urethrogram 3 months after transanal rectourethral fistula repair. There is no contrast entering the rectum from the urethra. The patient's suprapubic tube was removed and his colostomy was reversed.

retrospective study of 17 patients treated for RUF after RP between 1993 and 2008. Fistula closure was abdominal in 10 patients, perineal in five and combined abdominal and perineal in two, some with tissue interposition. Perineal or abdominal fistula repair yields excellent success rates and high patient satisfaction.

Transanal Approach

Parks and Motson⁸⁵¹ popularized the addition of a full thickness local flap of anterior rectal wall as an adjunct to fistula repair through the intact anal canal (Figure 11⁸⁶² and Figure 12). They modified the transanal technique by denuding the rectal mucosa lateral and distal to the fistula, and mobilized the rectal wall away from Denonvilliers' fascia proximal to the fistula for four centimeters. Tiptaft et al⁷⁹⁴ also used a special anal retractor for this surgery.

With the Latzko procedure the RUF is closed in three layers with absorbable suture. A transurethral catheter is placed for 3 weeks. Noldus et al⁷⁹⁵ reported 23 patients (3.9%) with rectal injury during 589 RP and cystoprostatectomies. Of these 23 patients, 12 developed a RUF. Seven fistulas closed spontaneously with prolonged catheter drainage. The remaining 5

fistulas were all successfully closed with the transanal Latzko procedure.

Al-Ali et al⁸¹⁸ treated 30 men with RUF caused by war wounds. He used the method of posterior transsphincteric anterior rectal wall advancement as the treatment of choice. Double diversion (end sigmoid colostomy and suprapubic cystostomy) for one month was performed in all patients. Double diversion alone resulted in 'spontaneous' RUF healing in 47% of patients but 53% required reconstruction. Early repair was recommended for large fibrous fistulas. Undiversion was done after two months when the urethra and anorectal canals were normal.

Joshi et al⁸⁵³ successfully used a rectal advancement flap in five patients with RUF.

Keller et al⁸⁵⁴ introduced an algorithm-based treatment approach for RUF. Selective fecal diversion is possible, and the majority of patients who require definitive intervention can be treated with a transanal or transperineal (endorectal, dartos, or gracilis) approach. Only six patients (20%) required permanent urinary diversion or drainage catheters, but long-term urinary dysfunction is frequent. Healing rate was 90% and recurrence rate 0%.

2.5.4 Anterior Transsphincteric, Transanal Surgical Approach (ASTRA)

In 1973, Gecelter⁸⁵⁵ performed a midline perineal incision to gain access to the urinary tract after placing the patient in exaggerated lithotomy position. The anal sphincter was incised anteriorly, tag sutures carefully placed, and the rectal incision was carried to the fistulous tract, which was excised and repaired in multiple layers with transposition of tissue as available. Castillo et al⁸⁶³ reviewed their first 110 consecutive laparoscopic extraperitoneal radical prostatectomies and reported 3 RUF. Only one was cured with conservative management. The other 2 patients were repaired by ASTRA.

2.5.5 Endoscopic Approach

Wilbert et al⁸⁵⁷ reported two patients with RUF who were repaired endoscopically transanally. The patients were positioned prone and the rectoscope mounted to the operating table was inserted into the rectum. The fistula was visualized and the opening excised to the level of the perirectal tissues with cautery. The rectal wall was mobilized full thickness with scissors and closed primarily in two layers with a microscope. The patient was then placed in lithotomy position and the urethral side of the fistula was coagulated and injected with fibrin.

Bardari et al⁸⁵⁸ used cyanoacrylic biological glue to close one prostatico-perineal fistula complicating an abdominoperineal resection of rectum and one persistent neobladder-ileal fistula. The biologic sealant was administered endoscopically through an open-ended 6F urethral catheter. Quinlan et al⁸⁶⁴ presented the case of an iatrogenic fistula in a 71-year-old man treated by a transanal endoscopic microsurgical (TEM) approach, without recourse to a stoma. Bochove-Overgaauw et al⁸⁶⁵ reported successful repair of 1 of 2 RUF with transanal endoscopic microsurgery (TEM): the RUF occurred after laparoscopic radical prostatectomy. Pigalarga et al⁸⁵⁹ described a case of successful repair of iatrogenic RUF through a multidisciplinary approach consisting of cystoscopy, urethral stent placement, colonoscopy, and transanal endoscopic microsurgery assisted rectal advancement flap.

2.5.6 Other Modifications

Youssef et al⁸³⁰ successfully treated 12 male patients who presented with RUF from 1990 to 1997 using the perineal subcutaneous dartos flap procedure. The RUF resulted from crush pelvic injury in 6 cases, gunshot wounds in 2, and post prostatectomy in 4. The fistula was associated with a urethral stricture in 4 cases. A perineal approach was used and combined with a transsymphyseal approach in the 4 patients with posterior urethral stricture. They interposed a subcutaneous dartos flap as a tissue flap between the repaired rectum and urethra. No leakage or perineal collection developed and there was no fistula recurrence. Follow-up ranged from 9 to 42 months. This technique of a perineal subcutaneous dartos flap may

fulfill the principles for successful repair of RUF. Varma et al⁸⁶⁶ also concluded that dartos muscle interposition is a straightforward technique that can result in successful fistula repair, but should not be used in immune-compromised patients or after radiation therapy.

Felipetto et al⁸¹⁰ used human fibrin sealant (Tissucol) to close a prostatico-cutaneous fistula (as a complication of pseudomonas prostatitis). Venkatesh and Ramanujam⁸⁶⁷ prospectively studied the efficacy of autologous fibrin glue for closure of recurrent anorectal fistulas. Overall success rate was 60% however patients with acquired immunodeficiency syndrome who had fistulas associated with the urinary tract failed to respond. Verriello et al⁸⁶⁸ used fibrin sealant (Quixil) to inject it into the fistula tract and a rectal mucosal flap was used to close the internal opening. The fistula healed in few weeks, and the patient remained symptom free after 1 year of follow-up. Chirica et al⁸⁶⁹ reported their experience with coloanal sleeve anastomosis (Soave procedure) as a salvage procedure for complex rectourinary fistulas after radical prostatectomy or following anterior resection for rectal cancer after radiochemotherapy. All eight patients had a temporary ileostomy, which was successfully reversed in 7. Lesser et al⁸⁷⁰ reported a case of radiation and salvage cryoablation induced RUF after treatment of prostate cancer which was successfully repaired with a combined endorectal advancement flap with an Alloderm graft.

Muhlmann et al⁸⁷¹ compared techniques of rectal mucosal advancement flaps (RMAF) and fistula plugs (FP) used to manage complex anal fistulas. The results of treatment of complex anal fistulas are disappointing. The choice of operation of either a RMAF or a FP did not alter the poor healing rates of about one third of patients in each group.

Gonzales-Contreras et al⁸⁷² treated the RUF after radical prostatectomy with interposition of the gracilis muscle. Eight weeks after surgery and with colostomy closed, no evidence of recurrence was detected.

Chen et al⁸⁷³ gained a high success rate in the treatment of complex rectovaginal fistulas and RUF by the technique of the gracilis muscle transposition and postoperative salvage wound irrigation-suction.

Yo et al⁸⁷⁴ also treated the recurrent RUF in a man after anoplasty for anorectal malformation during early infancy. They used a gracilis muscle flap approximately 30 cm long which was harvested from the left thigh, brought into the deepest part between the separated rectum and urethra through a subcutaneous tunnel and affixed there.

Iwamoto et al⁸⁷⁵ introduced a successful novel operative technique of a RUF with a pedicled vastus lateralis musculofascial flap. A first attempt failed to close the fistula utilizing the transanal rectal flap advancement technique.

Solomon et al⁸⁷⁶ described a new perineal approach using the medial aspect of the puborectalis muscles

as a double-breasted rotational interposition flap to repair the RUF.

Ganio et al⁸⁷⁷ achieved the closure of the RUF in all 11 patients by the repair of using a bulbocavernosus muscle graft.

Lee et al⁸⁷⁸ presented a novel minimally invasive procedure: robotic-assisted laparoscopic segmental resection with rectoanal anastomosis for the management of difficult RUFs.

2.6. Summary

A review of recent literature shows an increasing number of papers describing UCF or RCF

treatment. The vast majority of available studies are retrospective cases and case series (level 3 evidence). There are many causes of these fistulas described in the literature but there is a lack of valid epidemiologic data about the incidence of UCF and RUF. The aim of the surgical approach is the closure of all types of fistulas. While spontaneous closure and success with a one-stage procedure has been reported, most cases to date involve 3 stages (double diversion, closure technique, and undiversion). An endoscopic approach using biological sealants is promising. Only a few urologists and general surgeons have gained wide experience in the management of UCF or RUF, and the management of these difficult conditions should remain in the hands of experts working in tertiary referral centres. No single procedure has yet proved to be best or universally applicable. Conservative treatment is generally ineffective in the management of large RUF. Surgical intervention offers symptomatic relief and improved quality of life in most patients. Regardless of complexity, rectourethral fistulas have an initial closure rate approaching 90% when the transperineal approach is used. Permanent fecal and/or urinary diversion should be a last resort in patients with devastated, nonfunctional fecal and urinary systems.

All reports are still only retrospective case series (**Level of evidence 3; grade of recommendation C**).

XII. THE ARTIFICIAL URINARY SPHINCTER (AUS)

Different devices designed to control urinary incontinence in the male began to be developed in the middle of the 18th century.⁸⁷⁹ The gold standard today is the artificial urinary sphincter (AUS) designed by F.B. Scott, W.E. Bradley, and G.W. Timm in 1973.⁸⁸⁰ The original model underwent a number of modifications, but the basic principle remains the same. It consists of a fluid filled hydraulic system with a cuff around the urethra, a pressure regulating balloon and an activating device, the pump, placed in the scrotum (AMS 800TM Urinary Control System, Boston Scientific, Marlborough, MA, USA). In recent years a competing model (ZSI 375, Zephyr Surgical Implants, Geneva,

Switzerland) where the reservoir is incorporated into the pump in the scrotum has become available,⁸⁸¹ though a recent publication reports disappointing results.⁸⁸²

1. AVAILABILITY AND COST

The use of the AUS has increased dramatically since its introduction in 1975 when 90 AUS devices were implanted until 2008 when 4818 procedures were done, with 61% implanted for PPI.^{883,884} In 2005, just over 10% of US urologists perform AUS surgery with the vast majority (92%) performing 5 or fewer surgeries a year and there were only 8 surgeons who implanted 21 or more AUS devices per year.⁸⁸⁴ A recent study evaluating American Board of Urology case logs from 2003 to 2013 demonstrated that of those surgeons logging at least one AUS case the median number of AUS surgeries done over a 6 month period by those applying or recertifying for certification was 1.⁸⁸⁵ The top 4% in that cohort logged a median of 8 cases over the 6 month period. This group performed 29% (652) of all AUS placements logged.

The results of an e-mail survey among urologists and gynecologists were previously published in the 3rd ICI, whereby members of the International Continence Society asking them if the AUS was available in their country; and if so, what was the price of the device (in US dollars). About 10% of the members responded by email from 31 countries. The high price in some countries at the time (Georgia, Hong-Kong, Romania and Saudi Arabia) precluded its use. Very few gynecologists implant the sphincter, probably since the majority of patients receiving the device are male.

2. INDICATIONS

The indication for AUS placement is for the *treatment of SUI that is persistently bothersome despite 6-12 months of active conservative management*. A recent ICS Consensus Conference recommended that patients with bothersome severe symptoms can be offered an AUS 6 months postoperatively while those with improving symptoms, even at 12 months, can at surgeon discretion still be observed.⁸⁸⁶ As the most common cause of SUI in men is iatrogenic injury during prostate cancer surgery, it follows that the most common indication for AUS is post-prostatectomy incontinence (PPI). The use of the AUS for the treatment of PPI varies regionally. For example, within the United States, state-by-state use of the AUS ranges from 1% to 10% of all RRP patients, with an average of 6% of RRP patients ultimately undergoing AUS implantation.⁸⁸⁷

Previous radiotherapy to the pelvis is not a contraindication for AUS placement in males,⁸⁸⁸ as the ultimate outcome seems to be similar in men whether or not they have received radiation therapy,⁸⁸⁹ although a higher incidence of urethral atrophy, erosion and infection requiring surgical revision has been reported

in irradiated patients compared to those not irradiated (41% vs 11%). These patients should be counselled about this higher need for revision.⁸⁸⁶ Despite this observation, long term continence and patient satisfaction appear not to be adversely affected in the irradiated male patient.⁸⁸⁹

The compressive effect of the AUS is temporarily relieved when the patient squeezes the scrotal pump, transferring fluid from the urethral cuff to the pressure-regulating balloon. Subsequently, the bladder can then empty either by bladder contraction and/or by abdominal straining. Accordingly, patients voiding with the Valsalva maneuver because of an underactive or neurologically acontractile bladder, do not seem to be at an increased risk of complications.⁸⁹⁰ It should also be noted that patients with previous anti-incontinence procedures show a significantly higher explantation rate.⁸⁹¹

Clinical experience suggests that enterocystoplasty or gastrocystoplasty can be done simultaneously with the implantation of the AUS.^{892,893} However, AUS placement at the time of cystoplasty is associated with earlier infections, especially during the first 3 years postoperatively.⁸⁹⁴ In the long-term (> 3 years) the infection rate is the same whether the AUS is implanted after or at the time of cystoplasty. AUS can also be successfully implanted in patients after bladder substitution,⁴⁷¹ and in those with locally recurrent prostate cancer with a relatively good prognosis,⁸⁹⁵ or those with severe post-radical prostatectomy anastomotic stricture in whom a stent has been placed previously.⁴⁸³

Finally, advanced age is not a contraindication to AUS placement. A retrospective analysis by O'Connor and colleagues⁸⁹⁶ of a cohort of men over age 75, revealed excellent success rates, with 21 of 29 men (72%) achieving successful continence. Revision rate was 14% at an average of 5 years follow-up, with 14% requiring explantation, and 21% requiring device deactivation due to deterioration in overall health precluding proper use of the AUS at an average of 47 months after placement. A recent analysis by Ziegelmann et al⁸⁹⁷ demonstrated that patients over 80 years of age were more likely to experience device erosion or infection compared to a reference group of patients under 60. Nevertheless the overall device failure rate was noted to be low and the AUS was recommended for the appropriately selected and counselled octogenarian. A study by Raup et al⁸⁹⁸ evaluating a similar population noted that those with intact cognition and manual dexterity did very well with an AUS, but cautioned that those with impaired cognition or manual dexterity showed a statistically significant increased rate of overall failure.

3. SURGICAL TECHNIQUES

Preoperative prophylactic antibiotics should be administered within 60 minutes of skin incision and UTIs should be treated preoperatively. Patients can be positioned in either lithotomy or supine – lithotomy is preferred for perineal approach while supine is preferred if a trans-scrotal approach is to be performed. An appropriate scrub should be performed -chlorhexidine-alcohol has been shown to be superior to povidine-iodine.⁸⁸⁶

The original technique of implantation is illustrated in Figure 13. The cuff of the sphincter is placed around the bulbar urethra via a midline perineal incision, while the pressure regulating balloon and the scrotal pump are inserted via a separate inguinal incision. The inguinal incision is carried through the fascia, above the level of the ligament and an area in the pre-vesical space is bluntly cleared. The pressure-regulating balloon is placed there and filled with 23 cc of saline or contrast after which the fascia is closed. A tunnel is made under Scarpa's fascia into the scrotum deep to the dartos fascia where a pocket for the pump is developed. The cuff tubing is transferred from the perineum to the inguinal incision after which the excess tubing is cut off and the appropriate connections are made with the quick connect system.

Another surgical approach has been described using a single, upper transverse scrotal incision which allows the placement of all 3 components of the system, the cuff, the pump in a scrotal pouch, and the reservoir behind the fascia transversalis.³⁶³ Alternatively, the pressure-regulating balloon may be placed through a separate inguinal incision, with the cuff and control pump placed via a single trans-scrotal incision, with the connections among scrotal pump, balloon reservoir, and urethral cuff tubing made in the usual inguinal incision. While the trans-scrotal approach potentially minimizes the invasiveness of the AUS surgery, by limiting the surgical approach to a single incision,³⁶³ a few reports have revealed that surgical success might be diminished compared with perineal cuff placement and abdominal balloon reservoir placement.^{899,900} A multicenter retrospective study by Henry et al⁹⁰⁰ of 158 patients operated on at 4 centers noted that in patients treated with a perineal vs trans-scrotal AUS the perineal group had a completely dry rate of 44%, vs 28% in the scrotal group ($P<0.03$) and had much higher rates of "social continence" as well. Thus, the perineal approach for initial artificial urinary sphincter implantation appears to control male stress incontinence better than the trans-scrotal approach.

Figure 13. Artificial Sphincter Technique

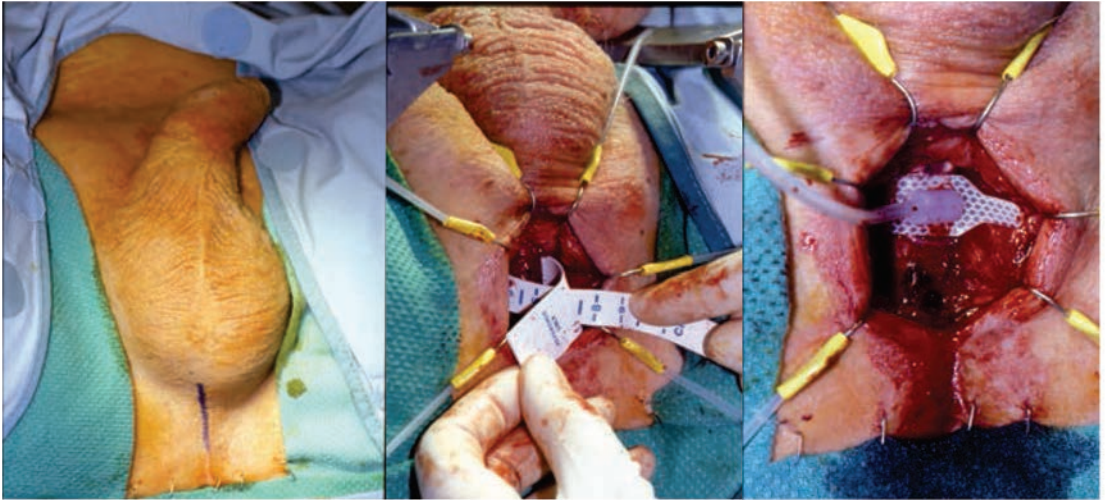

A. With the patient in lithotomy position, a perineal incision is made behind the scrotum to expose the bulbar urethra.

B. The urethra is mobilized circumferentially within the bulbospongiosus muscle and the measuring tape is used to obtain the cuff size.

C. The belt-like cuff is positioned around the urethra.



D. A right lower quadrant (RLQ) abdominal incision is made and the extraperitoneal space is entered lateral to the rectus muscle for insertion of the reservoir.

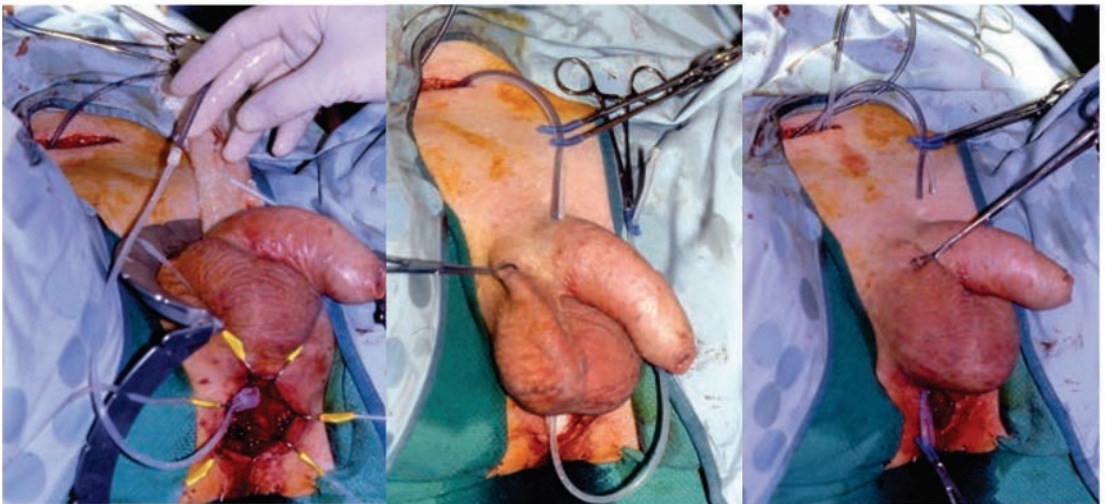

E.

F.

G.

Figure 13. Artificial Sphincter Technique

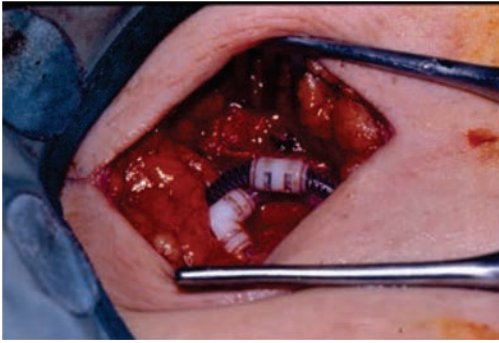

H. Connectors are placed to join the tubes from the cuff and reservoir to the corresponding tubes from the pump in the RLQ incision.

The trans-scrotal approach appears particularly useful for simultaneous placement of an AUS and inflatable penile prosthesis through a single incision, with Kendirci and colleagues⁹⁰¹ reporting a urethral erosion rate of 9%, an overall revision rate of 14%, and a social continence rate of 100% in 22 patients at 17 months average follow-up. Sellers et al⁹⁰² recommend the simultaneous surgery for cost-efficacy. They demonstrated a \$7,000 cost savings when both devices were implanted simultaneously through a scrotal approach, compared to staged implantation with 2 separate surgeries.

Recent experience with the relatively new 3.5 cm cuff has demonstrated significant efficacy, however men who with a history of radiation experienced a significantly increased risk of erosion (21%).⁹⁰³

A very well done concise review of pertinent surgical details (as well as indications and trouble-shooting) has recently been published by the 2015 ICS AUS Consensus Group⁸⁸⁶ and is worth reviewing.

4. COMPLICATIONS

Complications following implantation of the AUS can be divided into the categories of incontinence, erosion and/or infection, and unusual complications. While the number of AUS procedures performed varies geographically throughout the world. Certain “centers of excellence” perform substantially more procedures than do community hospitals.⁸⁸⁷ However, the total number of procedures done in a given center does not seem to be a determining risk factor for complications. Comparable erosion/infection rates have been reported from centers with fewer than 50 or more than 100 cases.³²⁶ This suggests that erosion and infection may be more closely related to the physiologic state of the host rather than the experience of the surgical team, provided standard precautions are strictly applied. Nevertheless, as experience with the AUS has grown the overall revision rate has reportedly decreased.⁸⁸⁴

4.1. Incontinence

Incontinence following implantation of an AUS can result from (1) alteration in bladder function, (2) atrophy of the urethra, or (3) mechanical failure of the device. These causes may co-exist.

4.1.1 Alteration in Bladder Function

Lai and Boone³⁰⁷ noted that based on postoperative patient symptoms and the need for anticholinergic medication up to 23% of men undergoing AUS for PPI can develop denovo OAB. UDS were not repeated postoperatively to define the bladder changes associated with this.

Alteration in bladder function has been reported principally in patients with neurogenic bladder dysfunction, especially in children.^{904,905,906,907,908,909} These changes include de novo involuntary detrusor contractions, decrease in bladder compliance, and the development of a high-pressure system, causing incontinence, hydronephrosis and ultimately renal failure. Modifications in detrusor behavior (including its consequences on the upper urinary tract) occur in up to 57% of cases.^{904,905,906,907,908,910,911,912,913,914,915} It should be pointed out, however, that there has never been a published report of hydronephrosis following implantation of an AUS for incontinence after prostatectomy.⁹¹⁶ While the ideal candidates for sphincter implantation are those with a low pressure, relaxed, and compliant bladder but an incompetent urethral sphincter⁹¹³ data described earlier demonstrated that even those with “unfavourable” urodynamic factors may have a good outcome after AUS placement.⁶²

4.1.2 Atrophy of the Urethra

Urethral atrophy may occur at the cuff site secondary to long-term mechanical compression of the periurethral and urethral tissues. However, some authors do not mention it as a possible cause of AUS failure.^{404,916,917} About 4 months following implantation, cuff efficiency diminishes, presumably because pressure atrophy occurs in every patient to some extent.⁹¹⁸ The incidence of urethral atrophy leading to revision varies from 3% to

9.3%.^{292,298,301,914,919,920,921,922} Atrophy can be lessened with nocturnal deactivation of the cuff.⁹²³

However, a recent study from a very experienced center argues that urethral atrophy does not occur.⁹²⁴ They reviewed 50 consecutive patients with recurrent incontinence after AUS placement who had the device explanted. In 31 a specific cause for malfunction of the AUS device was noted. In the other 19 where no specific cause was found 14 had the device replaced with a new, but same size cuff and pressure regulating balloon. Of those 14, 12 were successful without any cuff downsizing. They hypothesize that material failure of the cuff or balloon, likely because of age and the resulting inability to generate the appropriate pressure is the cause of failure and that urethral atrophy does not exist. In fact in 6 patients in whom the restrictive fibrous sheath around the cuff was excised, the urethral circumference was noted to immediately return to normal.

4.2. Mechanical Failure

This includes perforation of one of the components with loss of fluid from the system, air bubbles or organic debris within the system causing inadequate function of the pump, disconnection of the tubes, or kinking of the tubes. Introduction of “kink-free” tubing has virtually eliminated this last complication. The incidence of these complications varies widely and ranges from 0%⁹²⁰ to 52.5%³⁰⁸ with the longest follow-up. In this latter study, the cuff seemed to be the most vulnerable part of the system (22 cuff failures in 18 patients, most of them occurring during the first 2 to 3 years following implantation), followed by pump failure (6 times in 4 patients). Blockage is an exceptional event, occurring only once in 61 patients followed from 10 to 15 years.³⁰⁸ In a publication from Baylor,³⁰¹ chronicling a 13-year experience with the AUS, mechanical failure occurred at an average of 68.1 months postoperatively. An unusual mechanical complication has been reported. The locking tab became



Figure 14. Pump erosion.

"Courtesy of Drs Luis Augusto Seabra Rios and Márcio Augusto Averbek and by permission of Urologia Essencial"

displaced distally into the cycling portion of the cuff preventing the fluid from flowing into the cuff surrounding the urethra.⁹²⁵

4.3. EROSION AND/OR INFECTION

Erosion and infection are two major complications that almost invariably necessitate removal of the prosthesis (Figure 14 and Figure 15). Their incidence may be reported separately, or more commonly as a single complication. The incidence of these complications varies from 0% to 24.6%.^{292,404,907,913,914,919,920,921,922,926,927} Most recent large series report an incidence of infection and erosion generally less than 8%.^{60,300,301,313,916,917,928,929} As would be expected, the highest incidence has been reported with the longest follow-up (10-15 years).²⁹² Lai and colleagues³⁰¹ from Baylor reported that erosion occurred at an average of 19.8 months postoperatively rather than in the perioperative period. Previous surgery⁹³⁰ at the site of cuff placement increases the risk of erosion. This, however, may be decreased by delayed cuff activation.⁹³¹ A study by Lai et al⁹³² noted that patients undergoing a “secondary” implant (after a prior explant for erosion or infection) had a four-fold higher erosion rate compared to “virgin” cases. Some authors, however, did not find an increased incidence of complications when a new cuff was implanted at the site where several months before a cuff has been removed for infection or erosion.⁹³³ Other risk factors include urethral catheterization and urethral endoscopic manipulations with an activated sphincter in place.⁹³⁴ This point is important and it is crucial that patients with an AUS understand that if they are to have a catheter placed they should ask their physician to have a urologist deactivate the AUS first.



Figure 15. AUS Infection

"Courtesy of Drs Luis Augusto Seabra Rios and Márcio Augusto Averbek and by permission of Urologia Essencial"

A likely etiology of early erosion is intra-operative laceration of the urethra when dissecting it from the corpora cavernosa, where a difficult anatomical plane exists. Intraoperative recognition of urethral injury can be facilitated by retrograde perfusion sphincterometry

using a flexible cystoscope.³⁹ While recognition of a urethral injury may alert the surgeon to the necessary termination of the procedure, urethral erosion may still occur without a known urethral laceration.⁹³⁵

As mentioned above, while the majority of authors consider previous radiotherapy a risk factor for increased infection and erosion, it is not a contraindication to implantation of an AUS in the male patient with PPI.^{291,293,315,397,889,917,936} Overall patient satisfaction is similar in those who have been irradiated, compared to those who have not been.^{291,302,889} Furthermore, the degree of satisfaction does not diminish with an increased number of surgical revisions.^{306,937}

4.4. Rare Complications

Several unusual and rare complications have been reported in the literature, such as the intravesical migration of the reservoir with secondary stone formation in the bladder,⁹³⁸ or a giant urethral diverticulum at the site of a previously removed cuff because of erosion and urinary extravasation.⁹³⁹

5. DURABILITY OF AUS COMPONENTS

When defining durability of one of the components or the AUS as a whole, one should distinguish between explantation of the device due to device malfunction (e.g. leak in one of the components) or complications caused by an otherwise properly functioning sphincter unit (e.g. cuff erosion, infection at the site of implantation, etc.). This distinction is rarely made in the literature. Durability of a device is defined as time elapsed during which no mechanical problem alters the normal function of the device. This should exclude the second group from further analysis.

There are very few references in the literature pertaining to the length of time a device functioned normally before its removal due to mechanical failure. In a multicenter trial, for neurogenic bladders, conducted in France,⁹¹⁴ the authors mention that the "mean operational life" of the sphincter was 56 months (range 3-118 months). Haab et al²⁹⁸ analyzed 68 patients and noted that the mechanical failure rate dropped from 44.4% to 12.4% since modifications were made to the device, mainly the cuff component. Survival time of these components was not provided. Similar conclusions can be drawn from a series from the Mayo Clinic³⁰⁴ where the modification of the cuff design (narrower back) resulted in a substantial drop of the reoperation rate at 5 years. In the "narrow back" group 17% (31/184) required reoperation. In that cohort, non-mechanical failure decreased from 17% to 9% and mechanical failure decreased from 21% to 8% following introduction of the narrow back cuff.³⁰⁴ Mean time to reoperation was 26.2 months (mean 2-68 months). Using Kaplan-Meier statistical analysis for this group of patients, the overall 5-year expected product survival was 75%. Another recent report from

the Mayo Clinic noted that of 1082 patients with a primary AUS implantation, with a median follow-up of 4.1 years, 32.1% required secondary surgery.⁹⁴⁰ Of 338 revision surgeries, 89 were for device infection and/or erosion, 131 for device malfunction, 89 for urethral atrophy and 29 for pump malposition or tubing complications. Of interest, while infection and/or erosion occurred at a median of 2 years from implantation, device malfunctions and urethral atrophy occurred at 4.5 and 4.7 years respectively. Overall device survival was 74% at 5 years, 57% at 10 years and 41% at 15 years. In Lai's report regarding Baylor's 13-year experience with the AUS, only 6% of devices failed mechanically, at an average of 68.1 months, with 75% of patients requiring no revisions at 5 years.³⁰¹ In a review, Venn et al⁴⁰⁴ analyzed the outcome of 100 patients in whom an artificial urinary sphincter was implanted for more than 10 years. Thirty-six percent of them still had the original sphincter and were continent at a median follow-up of 11 years. The bulbar cuff, as compared to the bladder neck cuff provided a slightly better continence rate at 10 years, 92% and 84%, respectively. The lowest erosion rate occurred with the bulbar cuff. Device survival rate at 10 years was 66% in this series.

In a series of 30 boys with spina bifida, Spiess et al⁹⁴¹ found that the mean lifetime of all AUS was 4.7 years, with no statistically significant difference in sphincter survival of those inserted at the bladder neck or the bulbous urethra (4.6 and 4.9 years, respectively). A sharp drop was observed at 100 months with only 8.3% of the original sphincters still functioning beyond this point. In a series of 35 adolescents with neurogenic voiding dysfunction implanted with a bladder neck cuff over an 11-year period, with an average follow-up of 5.5 years, Lopez Pereira and colleagues⁹⁴² reported a 20% mechanical failure rate, with an additional 8.6% erosion rate. Adverse bladder storage changes developed in 31.8% of patients, who thereby required augmentation cystoplasty. However, continence was achieved in 91.4% of individuals.

In other series, the global long-term (2-7.7 years) revision rate, for any of the above mentioned reasons varies between 16% and 50%.^{300,301,305,306,530,937,942,943,944} In Webster's report⁹³⁷ of 554 implantations over a 10 year period, (i.e. performed since the 1987 device modification), he noted a mechanical failure rate of only 31/554 (5.5%). Non-mechanical failure was 88/554 (15.9%), with 63/554 (11.3%) due to urethral atrophy and 21/554 (3.8%) due to cuff erosion. Of the total cohort, 21.4% required at least one revision surgery, while 78.6% did not. Of those 119 patients who required re-operation, 76.5% required no further treatment (similar to the non-reoperation rate of the initial cohort), while 23.5% required reoperation for either mechanical or non-mechanical failure. Five-year durability of the AUS following primary or secondary implantation was comparable, with 80% for the initial placement, and 88% following revision surgery. Similarly, continence status was comparable, with 90% of primary and 82% of revision patients achieving 0-1 pad per day urinary

control. Patients with neurological deficits seem to have a higher risk of non-mechanical failure and the overall continence rate may be lower compared to non-neurologic patients.³⁶

6. DIAGNOSTIC PROCEDURES RELATED TO ARTIFICIAL SPHINCTER FAILURE

The diagnostic evaluation of urinary incontinence after the placement of the AUS is critical for the management of these patients and represents a challenging problem for the urologist. Several diagnostic and management algorithms have been proposed, some

relatively simple, others more complex.^{36,37,315,326,915,945,946,947} Figure 16 shows an algorithm to investigate and treat the male patient with a previously functioning AUS who becomes incontinent.

Physical examination should exclude infection at the site of the cuff or the scrotal/labial pump (Figure 12). Difficulty compressing the pump suggests tube kinking, fluid loss or an obstructed system. Loss of fluid from the system may be suggested by the inability of the pump to appropriately refill after just one or two pumps.

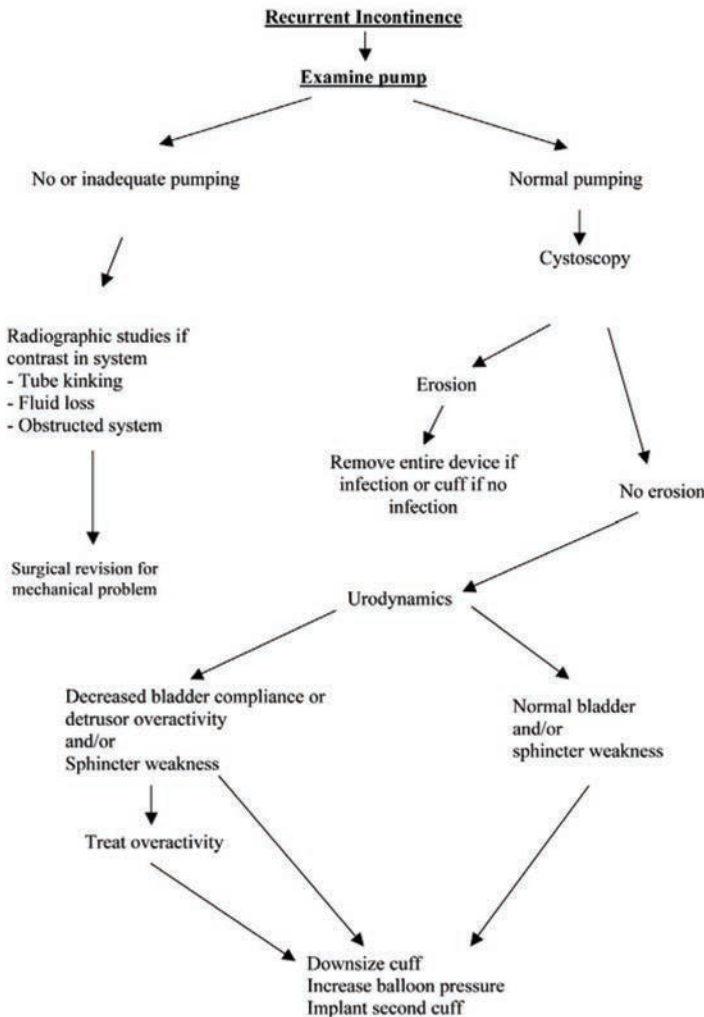

Figure 16. Algorithm for managing incontinence after AUS placement.

Plain x-rays of the abdomen or pelvis may show fluid loss, if the system is filled with radio-opaque solution

(Figure 1).^{948,949} Alternatively, sonography of the pressure-regulating balloon may show volume loss.



Figure 17. Endoscopic view of AUS cuff erosion into the bulbar urethra. The patient had undergone radiation after radical prostatectomy.

One should obtain a baseline plain film after the primary implantation when the reservoir is filled with contrast for subsequent comparison as radiographic imaging of the balloon does not detect changes until at least 50% of its volume has been lost.¹⁹ Cystometrograph or complete urodynamic study will demonstrate changes in bladder behavior following insertion of the AUS as described above. Cystourethrography could eventually demonstrate a urethral diverticulum at the site of previous cuff erosion. Endoscopy will disclose any urethral erosion by the cuff (Figure 17).

Retrograde perfusion sphincterometry has been reported to diagnose the loss of compressive pressure in the urethral cuff.³⁶ It is done by infusing fluid from the meatus in a retrograde fashion. If the AUS cuff is functional and the urethral is intact there should be no flow when the pressure equals the AUS balloon pressure. This technique can also be used intraoperatively to detect urethral perforation or to adjust the pressure in the cuff.³⁹ This seems to be more useful than urethral pressure profile (UPP).⁹¹¹

Intraoperative electrical testing, using an ohmmeter^{927,946} has been described to determine the site of fluid leakage from the system. This test can be helpful to avoid the need to change the whole system, and allow replacement of the leaking part only.

7. TREATMENT OF COMPLICATIONS

As outlined above, complications directly related to the presence of an artificial sphincter can be divided into categories: de novo OAB (which is typically treated as OAB), urethral atrophy, and/or mechanical failure, and infection/erosion. The treatment of these complications deserves comment, as no detailed reference can be found in the literature dealing exclusively with the treatment of these complications.

7.1. Atrophy of the Urethra

Several therapeutic options exist to increase cuff pressure around the atrophied urethral wall: changing the balloon reservoir for one generating a higher pressure, downsizing the cuff diameter,^{19,293,950} or increasing the amount of fluid in the system. The most common approach is downsizing of the cuff. Another approach consists of placing the cuff inside the corporal tunica albuginea on the dorsal aspect of the urethra (transcorporal). This allows a safer mobilization of the urethra and adds some supplementary bulk of tissue to the circumference of the urethra, possibly decreasing the risk of erosion.³¹¹ It should be mentioned, however, that there is a risk of reduced erectile function with this technique. The vast majority of such patients, however, already suffer from erectile dysfunction secondary to the prostate cancer surgery. As noted earlier however, some have recently suggested that “urethral atrophy” does not exist and that mechanical or material failure is typically responsible and that the cuff and balloon can simply be replaced with same size new components.⁹²⁴

The implantation of a double-cuff AMS 800 had a recent period of increased popularity, as a primary procedure in the totally or severely incontinent patient,^{312,951} or as a salvage procedure, by adding a second cuff, following a failed previous single cuff.^{309,310,951} Dimarco's group³¹⁰ and others showed excellent results with the addition of a second urethral cuff, placed 1.5–2.0 cm distal to the primary cuff. Alternatively, a circumurethral wrap of an organic bulking agent can be fitted, with subsequent placement of the AUS cuff over the biologic external urethral bulking agent.⁹⁵² Early reports of primary double cuff placement did not demonstrate any significant increase in morbidity with the double-cuff as compared with the single cuff system³¹² and patient satisfaction also seemed to be higher³¹³ at an average of 21-41 months follow-up. However, O'Connor et al³¹⁴ recently described their experience with 28 men who underwent double cuff placement and in contrast to an earlier report of theirs found that with longer follow-up there was no difference in continence between those men and 28 who underwent single cuff placement. In addition, those who had the double cuff placement had a higher rate of additional surgery due to complications.

7.2. Mechanical Failure

As with any device, mechanical failure can be expected with the AMS 800 AUS. The treatment involves surgical replacement of the failed component and reconnecting the system. A recent study from the Mayo Clinic that retrospectively reviewed outcomes after repair of mechanical failures noted a trend toward better outcomes if all components were replaced instead of just one component.⁹⁵³

7.3. Infection

With overt infection the accepted treatment option is removal of the entire device and appropriate antibiotics. A second system can be subsequently implanted with equally good results.⁹³¹ It has been demonstrated, however, that immediate reimplantation of a new AUS after the removal of an infected, but not eroded, prosthesis can be a valid option with an overall success rate of 87%.⁹⁵⁴ In 2007, AMS introduced the InhibiZone-coated AUS (rifampin and minocycline hydrochloride coating).⁹⁵⁵

7.4. Erosion

In cases of urethral cuff erosion, the “offending” cuff must be removed. No clear guidelines exist whether removal of the whole system is superior to removal of the cuff alone but it must be assessed for infection and if present the whole device should be removed. However, the recent AUS consensus panel noted that the decision to remove the cuff exclusively or the entire device mainly depends on time since AUS implantation⁸⁸⁶. In the immediate perioperative period (less than 6 weeks) erosion is likely the result of an unrecognized urethral injury and should be treated with cuff removal and preservation of the remaining AUS por-

tions (in the absence of evidence of infection). Erosions occurring years after surgery may require removal of the entire device. When in doubt remove the entire system. Reservoir erosion into the bladder has been described following the removal of an eroded cuff.⁹³⁸ Furthermore, it is not known whether it is necessary to allow the urethra to heal over a catheter vs surgical repair. Most though would leave a catheter to allow for spontaneous healing, with the expectation that the urethra will re-epithelialize and permit reimplantation in the future⁹⁵⁶ (after 4-6 months).

Some have advocated for the placement of sutures to re-approximate the urethral defect, known as abbreviated urethroplasty (AU), to facilitate healing and expedite time-to-reimplantation. Another option, especially for erosions accounting for >50% of the urethral circumference, would be to excise the cuff capsule, circumferentially dissect and debride the urethral margins, and mobilize the urethra sufficiently to allow a more formal primary urethral anastomosis.

Rozanski et al⁹⁵⁷ compared stricture outcomes in patients with artificial urinary sphincter cuff erosion managed with and without synchronous urethral repair. In this retrospective case-series two cohorts of patients were evaluated (in situ urethroplasty vs Foley catheter only). Of the 26 artificial urinary sphincter cuff erosion cases identified 13 underwent in situ urethroplasty while 13 did not. Mean patient age was 73 years (range 61 to 83) with a mean follow-up of 24 months (range 8 to 69). The rate of urethral stricture formation after AUS explantation was significantly reduced among patients treated with in situ urethroplasty (5 of 13, 38%) compared to those treated with Foley catheter only (11 of 13, 85%; $P=0.047$). Performing the ISU did not add significant time to the operative procedure, averaging an additional 8 minutes. Those treated with in situ urethroplasty underwent significantly fewer procedures per patient before AUS replacement (0.4 vs 1.1, $P=0.004$) and had a much higher rate of eventually undergoing secondary AUS implantation (7 of 13, 54% vs 2 of 13, 15%, $P=0.04$) compared to those with cuff erosion treated with Foley catheter only.

Chertack et al⁹⁵⁶ retrospectively reviewed medical records of patients treated for AUS cuff erosion from 2005 to 2015, in order to examine cuff erosion intraoperative management methods: Foley catheter placement, AU, or mobilization with primary urethral anastomosis (PA). Seventy-five patients with a median age of 77 years (72-83) were treated for AUS cuff erosion. Fifty-two underwent Foley placement, 8 AU, and 15 PA. Mean follow-up was 13 months (0-106). Severe erosions were more common in the PA group than Foley or AU (100% vs 37%, 100% vs 38%, $P<0.001$, $P<0.001$, respectively). Severe erosions treated with Foley were more likely to develop strictures than mild erosions (38% vs 5%, $P=0.009$). Tandem cuff patients treated with Foley were more likely to develop diverticuli than single cuff patients (33% vs 4%, $P=0.016$). There was no difference in probability

of reimplantation between PA and Foley or AU (63% vs 69%, 63% vs 33%, $P=0.748$, $P=0.438$, respectively). The authors concluded that Foley catheter placement alone may represent suboptimal management for severe or tandem cuff erosions due to increased risk of urethral complications.

When a new cuff is placed it should be positioned away from the erosion site. In case of the erosion of one of the cuffs of a double system, removal of the eroded cuff can successfully convert a double-cuff system into a single cuff system.⁹⁵⁸ It is logical that intraoperative urethral injury may precipitate cuff erosion if unrecognized.

8. CONSENSUS PROTOCOL FOR FOLLOW-UP OF PATIENTS WITH AUS

As complications continue to be seen for years after implantation,⁹⁵⁹ it is helpful to have a structured follow-up plan. However, no standardized recommendations are available in the literature.

The consensus upon which the members of this subcommittee agreed and which is based on expert opinion are as follows:

1. Perioperative antibiotics are required. Gram-negative enteric bacteria and Staphylococcus epidermidis are the most frequently encountered microorganisms in infected prostheses.⁹³⁴
2. Hospital stay should be kept to a minimum.
3. Urethral catheters, if inserted, should be withdrawn within 24-48 hours of surgery and the preoperative continence management continued.
4. The sphincter device should not be activated immediately postoperatively. In the initial period scrotal edema and pain prevent patients from manipulating the pump adequately. When this subsides after 6 to 8 weeks the device can be activated. Earlier activation may also be acceptable. Irradiated patients may benefit from a longer initial period of deactivation, up to 12 weeks.²⁹³ Nocturnal deactivation should be considered in high-risk patients.²⁹²
5. Patients are reviewed at 3 months after activation to ensure the device is working adequately, and to assess the continence status.
6. Long-term follow-up is different in the neurogenic and non-neurogenic patient. With time, alteration in bladder function may jeopardize renal function in the neurogenic patients. Periodic ultrasound evaluation of the upper urinary tract and monitoring of renal function is essential. If changes occur, urodynamic studies should be done to rule out detrusor overactivity. In non-neurogenic patients, periodic ultrasound may not be necessary.

- When changes in the continence status occur diagnostic procedures depicted in the algorithm above should be considered.

(Level of evidence 3; Grade of recommendation B-C)

XIII. NEW TECHNOLOGIES UNDER EVALUATION

1. INTRODUCTION

Despite the advances in the surgical treatment of post-prostatectomy urinary incontinence (PPUI), both slings and AUSs present limitations in terms of continence rates and complications. With greater than 100,000 prostatectomies performed per year with a 9%-20% risk of incontinence, treatment of PPUI is a common clinical issue treated by urologists.¹⁵⁴ This context makes room for the development of new technologies and minimally invasive treatments.

2. FLOWSECURE ARTIFICIAL URINARY SPHINCTER (RBM-MED)

The FlowSecure sphincter is a one-piece device consisting of two reservoirs placed in the paravesical space, a cuff that surrounds the urethra and a control pump with a self-sealant port that is placed in patient's scrotum.⁹⁶⁰ The first reservoir regulates resting urethral pressure and the other relieves stress pressure during intra-abdominal pressure increases. During bladder filling the cuff connected to the pressure regulating reservoir compresses and keeps the bulbar urethra closed at low pressure. When intra-abdominal pressure rises, the stress relief balloon provides additional pressure to the cuff to maintain continence. The fluid pressure of the prosthesis may be regulated by injecting or removing saline through the self-sealing port in the control pump located in patient's scrotum.⁹⁶¹ When the patient wishes to void he presses the control pump until good urine flow is achieved. In this way the cuff is emptied by moving the fluid from it to the pressure-regulating reservoir. Redirection of fluid flow and filling of the cuff is recovered when compression of the pump stops.⁹⁶²

The main potential advantage of the FlowSecure device over the AUS 800 is that while the latter exerts a high constant pressure over the urethra, the former causes an immediate increase in urethral pressure only when there is a sudden increase of intra-abdominal pressure. During the deactivated portion the cuff returns to the initial low pressure below 40 cm H₂O, thus minimizing the danger of urethral erosion.⁹⁶²

Knight et al⁹⁶³ presented 9 male patients (mean age 66 years) with urodynamically proven stress inconti-

nence due to radical prostatectomy treated with implantation of a FlowSecure sphincter. All 9 patients tolerated the surgery well and were followed for a minimum of 12 months. Two devices had to be removed for technical reasons. The mean leakage for the remaining 7 patients prior to implantation was 771 ± 658mL. Twelve months later the leakage was statistically significantly reduced to 52 ± 36 mL ($P < 0.05$). Four patients required additional pressurization to achieve optimal continence and this was carried out without complication. Despite the promising initial results, no further series on PPUI are available in PUBMED. Further studies will be needed to define the role of this sphincter in the management of PPUI.

3. PERIURETHRAL CONSTRICTOR (SILIMED)

The Periurethral Constrictor (PUC) is a one-piece, two-part device. It is comprised of a constrictor cuff linked by a 20 cm silicone tube to a valve, which is elliptical in shape and rounded at the edges. The device was initially designed for implantation in pediatric patients to treat deficient bladder sphincter function.⁹⁶⁴ The adjustable cuff is implanted around the bladder neck through a suprapubic approach or around the bulbous urethra through a perineal incision.⁹⁶⁵ The injection port is designed to accommodate a fine Huber needle and is usually placed in the scrotum or in the subcutaneous space between the umbilicus and the iliac crest.⁹⁶⁶

A limited number of studies with controversial results have been published for using PUC in PPUI.⁹⁶² Schiavini et al⁹⁶⁷ retrospectively studied 30 patients with PPUI and PUC implantation for a mean period of 42.1 months. In 22 patients (73.3%) the devices were functional leading to a good continence result. In 7 patients the device was removed due to cuff erosion (4 patients, 13.3%) and infection (3 patients, 10%).⁹⁶⁷ In contrast, Lima et al. presented a study with 82.2-month mean follow-up, reporting higher device removal rates (41.07%).⁹⁶⁵ The average time between surgery and the removal of the device was 22.6 months. The most frequent complication was urethral erosion in 15 patients (26.78%). Other complications were mechanical malfunction in 5 (8.9%), urethral stenosis in 3 (5.3%), urinary fistula in 2 (3.5%), infection in 2 (3.5%), and persistent urinary tract infection in 1 case (1.7%). In patients in whom the device was not removed (33), only 17 from them were continent, representing an overall success rate of 30.35%.

While the simplicity and the low cost of the PUC are attractive the high removal rates and mechanical malfunctions are concerning.

4. ZSI 375 (ZEPHYR SURGICAL IMPLANTS)

The ZSI 375 device is a one-piece device consisting of an adjustable cuff, which is connected by a tube to a pump and a pressure-regulating tank. It has no abdominal reservoir. In comparison to the AUS 800, potential advantages of the ZSI 375 include reduced cost, and the possibility to re-adjust the cuff in case of postoperative urethral atrophy.⁹⁶² However, there are only a limited number of publications in the literature, showing conflicting results.

Staerman et al⁹⁶⁸ evaluated 36 patients who underwent a ZSI 375 device placement. The median (range) follow-up was 15.4 (6-28) months. No patient experienced bladder overactivity, chronic urinary retention, or any other adverse effect after device activation. Complications leading to device removal arose in four patients (one case of erosion, three cases of infection). Social continence (0 or 1 pad/day) was achieved in 28/36 patients (78%) at 3 months and 26/36 patients (73%) at 6 months after device activation.

Kretschmer et al⁹⁶⁹ conducted a multicentric study to assess ZSI 375 efficacy and safety in men with stress urinary incontinence. Thirteen patients underwent implantation of a ZSI375 artificial urinary sphincter device between 2010 and 2012 in three international continence referral centers. There were no intraoperative complications. Median follow-up was 13.5 months. In this period, four device defects (30.8 %) were observed, being the main cause for device explantation, followed by device infection (15.4 %), non-resolvable pain (7.7 %), and urethral erosion (7.7 %). Overall explantation rate was 61.5 %. Mean time-to-explantation was 279 ± 308 days. There was no significant influence of previous irradiation or previous invasive incontinence therapy ($P=0.587$ and $P=0.685$, respectively). Mean daily pad usage decreased from 5.8 ± 1.5 to 2.4 ± 2.1 ($P=0.066$). One patient (7.7 %) did not use any pads. Social continence (0-1 pads) was achieved in only 15.4 % of the patients.

5. AROYO (GT UROLOGICAL)

The Aroyo device is a one-piece pre-connected system consisting of a reservoir, one-push pump and urethral cuff. The purported advantage of this device is the ability of the patient to push on the reservoir located in the lower quadrant to briefly increase the cuff pressure during periods of increased abdominal pressure (a cough for instance) and the fact that the pump only requires one push to open the cuff. A single study reporting positive 12 month outcomes was presented at the ICS in 2015 but further published data is lacking.⁹⁷⁰

6. STEM CELLS

The use of stem cells has been studied and reported on in females with SUI. Currently two studies looking at stem cells for male stress urinary incontinence are listed on clinicaltrials.org as enrolling patients.⁹⁷¹ One evaluating the use of autologous adipose derived regenerative cells is run through Nagoya University and the other utilizing autologous muscle derived stem cells is run through Cook Myosite. While the use of stem cells to treat male SUI is very attractive data collection and evaluation are still in the early stages and its use outside of a clinical trial cannot be recommended

XIV.SUMMARY AND RECOMMENDATIONS

1. EVALUATION AND RECOMMENDATIONS

Prior to surgery a basic patient evaluation should consist of history and physical examination, urinalysis and postvoid residual urine (Level of evidence 1-2: grade of recommendation A).

- A voiding diary is helpful to assess functional capacity and total urine output (Level of evidence 1-2: grade of recommendation B).
- Pad tests may be useful in certain circumstances, and pad use is a reasonable surrogate to a formal pad test (Level of evidence 1-2: grade of recommendation B).
- Blood testing (BUN, creatinine, glucose) is recommended if compromised renal function is suspected or if polyuria or poor urinary concentrating ability (in the absence of diuretics) is documented.
- Additional testing with cystoscopy and appropriate imaging of the urinary tract may be helpful in guiding therapy—this depends to a large degree on the type of incontinence and presumed etiology (Level of evidence 2-3: grade of recommendation B).
- The committee felt that multichannel urodynamics may be useful prior to invasive treatment for incontinence—this depends to a large degree on the type of incontinence and presumed etiology. (Level of evidence 3: grade of recommendation C).

2. INCONTINENCE POST-PROSTATECTOMY FOR BPO AND

POST-RADICAL PROSTATECTOMY FOR PROSTATE CANCER

After a period of conservative management, which may also be from 6 to 12 months (Level of evidence 3-4; grade of recommendation C):

- The artificial sphincter is the preferred treatment for properly selected men who have moderate to severe stress incontinence after radical prostatectomy as the AUS has the longest record of safety and efficacy. The AUS has been reported extensively for men with moderate to severe incontinence. This recommendation relates exclusively to the AMS 800 as newer devices do not have a similar evidence base or experience (Level of evidence 2-3; grade of recommendation A)
- Male slings are an acceptable surgical approach with several-year follow-up data supporting their safety and efficacy in men with mild to moderate degrees of PPI. They are associated with a low rate of urinary retention, infection, urethral erosion, and urethral atrophy. Adjustable slings do not appear to have a higher efficacy rate compared to nonadjustable slings, but have a higher reoperation rate, typically for readjustment. (Level of evidence 3; grade of recommendation C)
- Injectable agents, even with repeated application, have a low success rate and should only be used when more effective treatments are contraindicated. (Level of evidence 3-4; grade of recommendation C)
- Adjustable balloons have also been reported, but have a higher complication rate than do the AUS and male sling. (Level of evidence 3; grade of recommendation D [no recommendation possible])

3. INCONTINENCE FOLLOWING EXTERNAL BEAM RADIATION FOR PROSTATE CANCER

- The artificial sphincter is most widely used but radiation may be a risk factor for an increase in complications. (Level of evidence 3; grade of recommendation B).
- Slings generally have a lower success rate in radiated patients than in those who have not had radiation. (Level of evidence 3; grade of recommendation C).
- Injectable agents have a low level of efficacy in radiated patients. (Level of evidence 3-4; grade of recommendation C).

- Adjustable balloons have not been successful in the setting of radiation. (Level of evidence 3; grade of recommendation D [not recommended]).

4. INCONTINENCE FOLLOWING PELVIC TRAUMA

(Level of evidence 3; grade of recommendation C)

- The artificial sphincter is the most widely reported treatment for stress incontinence.
- Lower urinary tract reconstruction has also been reported on a limited basis.

5. INCONTINENCE IN ADULT EPISPADIAS EXSTROPHY COMPLEX

(Level of evidence 3; grade of recommendation C)

- Patients should be treated in centers of excellence.
- A patient-directed approach should be taken.
- The choices include further bladder neck reconstructive surgery, bladder neck closure, bladder reconstruction or diversion with bowel.
- The data are insufficient for a specific recommendation.
- Arrangements for transition between the pediatric and adult urologist are standard.
- Life-long follow-up is mandatory in terms of continence, voiding efficiency, upper tract status and other urological complications

6. REFRACTORY URGENCY INCONTINENCE AND DETRUSOR OVERACTIVITY

- BTx-A bladder injection is a minimally invasive treatment with efficacy (Level of evidence 1-2; grade of recommendation B). This is valid for onabotulinumtoxin—other types of BTx do not have the same recommendation grade.
- Neurostimulation is a treatment option with success reported in a limited number of male patients. (Level of evidence 3; grade of recommendation C).
- Detrusor myectomy has also been reported to be successful in a small number of male patients. (Level of evidence 3; grade of recommendation C).

- Augmentation cystoplasty is potentially successful in controlling symptoms but may be associated with unacceptable side effects. (Level of evidence 3; grade of recommendation C).
- Urinary diversion is a final option. (Level of evidence 3; grade of recommendation C).

7. REDUCED CAPACITY BLADDER

- Augmentation cystoplasty has been successful in most etiologies. Efficacy post-radiation therapy is diminished. (Level of evidence 3; grade of recommendation B).

8. URETHROCUTANEOUS FISTULA AND RECTOURETHRAL FISTULA

(Level of evidence 3; grade of recommendation C)

- Etiologic factors causing acquired urethrocutaneous or rectourethral fistulae are demonstrated by clinical, endoscopic and imaging studies.
- Similar diagnostic maneuvers are applied to rectourethral fistulae.
- In those that do not close with or without temporary urinary and fecal diversion, surgical reconstruction may be carried out.
- Surgical reconstruction is applied in the majority of cases.
- Most repairs are now carried out after prior urinary and fecal diversion.
- Various techniques are available for closure and can be done in collaboration with colorectal surgeons.

9. MANAGEMENT OF AUS COMPLICATIONS

(Level of evidence 3; grade of recommendation C).

- Incontinence may result from alteration in bladder function, urethral atrophy, or mechanical malfunction.
- Reported therapeutic options for recurrent urinary incontinence due to urethral atrophy include: change of the balloon reservoir for one generating a higher pressure; downsizing the cuff diameter (most common approach); increasing the amount of fluid in the system; transcorporal cuff and double-cuff implantation.
- Infection and/or erosion of components demand surgical removal of all or part of the prosthesis.
- Compared to primary urethral repair techniques, a Foley catheter placement alone may represent

suboptimal management for severe cuff erosions due to increased risk of urethral complications. (Level of evidence 3, grade of recommendation C)

- A treatment algorithm is presented to aid in management and in follow-up of patients.

10. NEW TECHNOLOGIES

(Level of evidence C; grade of recommendation D)

- Tissue engineering has not been widely reported in males apart from isolated reports of preliminary studies.^{972,973}
- A number of new artificial sphincter devices and slings are being evaluated. Currently, the number of patients implanted and studies with reported outcomes are relatively limited.

11. FUTURE RESEARCH DIRECTIONS

- New technologies, bulking agents, sling materials, prosthetic devices, neuromodulation devices and stem cell based treatments should continue to be evaluated.
- Accuracy in reporting of early research results is mandatory.
- Mechanisms of post-prostatectomy incontinence and device effects need further research.

12. CLINICAL TRIAL RECOMMENDATIONS

- Randomized trials (AUS and slings).
- Standardized workup and outcome measures including QoL.
- Evaluation of the role of urodynamics in the workup.
- Complete reporting of complications and outcomes especially those of slings.
- Standardized definitions of cure/improved/unchanged/worse.
- Reporting of procedures to salvage failures.
- Long-term results (>2 years).
- Standardized reporting of durability.

REFERENCES

1. Bhindi B, Mamdani M, Kulkarni GS, Finelli A, Hamilton RJ, Trachtenberg J, Zlotta AR, Evans A, van der Kwast TH, Toi A, Fleshner NE. Impact of U.S. Preventative Services Task Force recommendations against prostate specific antigen screening on prostate biopsy and cancer detection rates. *J Urol*. 2015 May;193(5):159-24.
2. Li J, Berkowitz Z, Hall IJ. Decrease in prostate cancer testing following the US Preventative Services Task Force (USPSTF) recommendations. *J Am Board Fam Med*. 2015 Jul-Aug;28(4):491-3.
3. Srivastava A, Grover S, Sooriakumaran P, Joneja J, Tewari AK. Robotic-assisted laparoscopic prostatectomy: a critical analysis of its impact on urinary continence. *Curr Opin Urol* 2011;21:185-94
4. Anderson CB, Elkin EB, Atoria CL, Eastham JA, Scardino PT, Touijer K. The diffusion of minimally invasive radical prostatectomy in the United States: a case study of the introduction of new surgical devices. *Prostate Cancer Prostatic Dis* 2015 Mar;18(1):74-80.
5. Nam RK, Herschorn S, Loblaw DA, et al. Population based study of long-term rates of surgery for urinary incontinence after RP for prostate cancer. *J Urol* 2012;188:502-6.
6. Kumar A, Litt ER, Ballert KN, Nitti VW. Artificial urinary sphincter vs male sling for post-prostatectomy incontinence--what do patients choose? *J Urol* 2009;181:1231-5.
7. Herschorn S, Brushini H, Comiter CV, Goldman HB, Grise P, Hanus T, Woodhouse, C.. Surgical Treatment of Urinary Incontinence in Men. In: Abrams P, Cardozo L, Khoury AE, Wein A, eds. *Incontinence: Fifth International Consultation*. Paris: Health Publications Ltd.; 2013:1229-1307
8. Blaivas JG, Zayed AA, Labib KB. The bulbocavernosus reflex in urology: a prospective study of 299 patients. *J Urol* 1981;126:197-9.
9. Griffiths DJ, McCracken PN, Harrison GM, Gormley EA. Relationship of fluid intake to voluntary micturition and urinary incontinence in geriatric patients. *Neurourol Urodyn* 1993;12:1-7.
10. Wyman JF, Choi SC, Harkins SW, Wilson MS, Fantl JA. The urinary diary in evaluation of incontinent women: a test-retest analysis. *Obstet Gynecol* 1988;71:812-7.
11. Schick E, Jolivet-Tremblay M, Dupont C, Bertrand PE, Tessier J. Frequency-volume chart: the minimum number of days required to obtain reliable results. *Neurourol Urodyn* 2003;22:92-6.
12. Cornu JN, Sèbe P, Ciofu C, Peyrat L, Beley S, Tligui M, Lukacs B, Traxer O, Cussenot O, Haab F. The AdVance transobturator male sling for postprostatectomy incontinence: clinical results of a prospective evaluation after a minimum follow-up of 6 months. *Eur Urol*. 2009 Dec; 56(6):923-7.
13. Groutz A, Blaivas JG, Chaikin DC, Resnick NM, Engleman K, Anzalone D, Bryzinski B, Wein AJ. Noninvasive outcome measures of urinary incontinence and lower urinary tract symptoms: a multicenter study of micturition diary and pad tests. *J Urol*. 2000 Sep;164(3 Pt 1):698-701.
14. Mouritsen L, Berild G, Hertz J. Comparison of different methods for quantification of urinary leakage in incontinent women. *Neurourol Urodyn* 1989;8:579-87.
15. Starer P, Libow LS. The measurement of residual urine in the evaluation of incontinent nursing home residents. *Arch Gerontol Geriatr* 1988;7:75-81.
16. Diokno AC, Brown MB, Brock BM, Herzog AR, Normolle DP. Clinical and cystometric characteristics of continent and incontinent noninstitutionalized elderly. *J Urol* 1988;140:567-71.
17. Fantl JA, Newman D, Colling J, al. e. Urinary incontinence in adults: acute and chronic management. Clinical Practice Guideline, No 2., Rockport,MD: U.S. Department of Health and Human Services. Public Health Service, Agency for Health Care Policy and Research; 1996 March, 1996. Report No.: AHCPR Publication No 96-0682.
18. Foote J, Yun S, Leach GE. Postprostatectomy incontinence. Pathophysiology, evaluation, and management. *Urol Clin North Am* 1991;18:229-41.
19. Petrou SP, Williams HJ, Young PR. Radiographic imaging of the artificial urinary sphincter pressure regulating balloon. *J Urol* 2001;165:1773-5.
20. Leach GE, Yip CM. Urologic and urodynamic evaluation of the elderly population. *Clin Geriatr Med* 1986;2:731-55.
21. Goode PS, Locher JL, Bryant RL, Roth DL, Burgio KL. Measurement of postvoid residual urine with portable transabdominal bladder ultrasound scanner and urethral catheterization. *Int Urogynecol J Pelvic Floor Dysfunct* 2000;11:296-300.

22. Richter S, Hag'ag R, Shalev M, Nissenkorn I. [Measuring residual urine by portable ultrasound scanner]. *Harefuah* 1999;137:93-5.
23. Strasser H, Frauscher F, Helweg G, Colleselli K, Reissigl A, Bartsch G. Transurethral ultrasound: evaluation of anatomy and function of the rhabdosphincter of the male urethra. *J Urol* 1998;159:100-4; discussion 4-5.
24. McGuire EJ, Fitzpatrick CC, Wan J, et al. Clinical assessment of urethral sphincter function. *J Urol* 1993;150:1452-4.
25. Schick E. Objective assessment of resistance of female urethra to stress. A scale to establish degree of urethral incompetence. *Urology* 1985;26:518-26.
26. Smith AL, Ferlise VJ, Wein AJ, Ramchandani P, Rovner ES. Effect of A 7-F transurethral catheter on abdominal leak point pressure measurement in men with post-prostatectomy incontinence. *Urology* 2011;77:1188-93.
27. Bump RC, Elser DM, Theofrastous JP, McClish DK. Valsalva leak point pressures in women with genuine stress incontinence: reproducibility, effect of catheter caliber, and correlations with other measures of urethral resistance. Continence Program for Women Research Group. *Am J Obstet Gynecol* 1995;173:551-7.
28. Decter RM, Harpster L. Pitfalls in determination of leak point pressure. *J Urol* 1992;148:588-91.
29. Flood HD, Alevizatos C, Liu JL. Sex differences in the determination of abdominal leak point pressure in patients with intrinsic sphincter deficiency. *J Urol* 1996;156:1737-40.
30. Faerber GJ, Vashi AR. Variations in Valsalva leak point pressure with increasing vesical volume. *J Urol* 1998;159:1909-11.
31. Haab F, Dmochowski R, Zimmern P, Leach GE. [The variability of the leakage pressure threshold due to exertion "the Valsalva Leak Point Pressure" as a function of the filling volume of the bladder]. *Prog Urol* 1997;7:422-5.
32. Theofrastous JP, Cundiff GW, Harris RL, Bump RC. The effect of vesical volume on Valsalva leak-point pressures in women with genuine stress urinary incontinence. *Obstet Gynecol* 1996;87:711-4.
33. Petrou SP, Kollmorgen TA. Valsalva leak point pressure and bladder volume. *Neurourol Urodyn* 1998;17:3-7.
34. Swift SE, Utrie JW. The need for standardization of the valsalva leak-point pressure. *Int Urogynecol J Pelvic Floor Dysfunct* 1996;7:227-30.
35. McCormack M, Pike J, Kiruluta G. Leak point of incontinence: a measure of the interaction between outlet resistance and bladder capacity. *J Urol* 1993;150:162-4.
36. Leach GE. Incontinence after artificial urinary sphincter placement: the role of perfusion sphincterometry. *J Urol* 1987;138:529-32.
37. Wang Y, Hadley HR. Management of persistent or recurrent urinary incontinence after placement of artificial urinary sphincter. *J Urol* 1991;146:1005-6.
38. Comiter CV, Sullivan MP, Yalla SV. Retrograde leak point pressure for evaluating postRP incontinence. *Urology* 1997;49:231-6.
39. Choe JM, Battino BS, Bell TE. Retrograde perfusion sphincterometry with a flexible cystoscope: method of troubleshooting the AMS 800. *Urology* 2000;56:317-9.
40. Comiter CV, Nitti V, Elliot C, Rhee E. A new quadratic sling for male stress incontinence: retrograde leak point pressure as a measure of urethral resistance. *J Urol* 2012;187:563-8.
41. Horstmann M, Fischer I, Vollmer C, et al. Pre- and postoperative urodynamic findings in patients after a bulbourethral composite suspension with intraoperative urodynamically controlled sling tension adjustment for postprostatectomy incontinence. *Urology* 2012;79:702-7.
42. Beck R, Fowler C. Clinical neurophysiology in the investigation of genitourinary tract dysfunction. In: Rushton DN, ed. *Handbook of Neurourology*. New York: Marcel Dekker; 1994:151-80.
43. Brown MC, Sutherst JR, Murray A, Richmond DH. Potential use of ultrasound in place of X-ray fluoroscopy in urodynamics. *Br J Urol* 1985;57:88-90.
44. Bidair M, Tiechman JM, Brodak PP, Juma S. Transrectal ultrasound urodynamics. *Urology* 1993;42:640-4; discussion 4-5.
45. Manieri C, Carter SS, Romano G, Trucchi A, Valenti M, Tubaro A. The diagnosis of bladder outlet obstruction in men by ultrasound measurement of bladder wall thickness. *J Urol* 1998;159:761-5.
46. Blatt AH, Titus J, Chan L. Ultrasound measurement of bladder wall thickness in the assessment of voiding dysfunction. *J Urol* 2008;179:2275-8; discussion 8-9.
47. Ozawa H, Chancellor MB, Ding YY, Nasu Y, Yokoyama T, Kumon H. Noninvasive urodynamic evaluation of bladder outlet obstruction using Doppler ultrasonography. *Urology* 2000;56:408-12.

48. Abrams P. Detrusor instability and bladder outlet obstruction. *Neurourol Urodyn* 1985;4:317-28.
49. Dikranian AH, Chang JH, Rhee EY, Aboseif SR. The male perineal sling: comparison of sling materials. *J Urol* 2004;172:608-10.
50. Fischer MC, Huckabay C, Nitti VW. The male perineal sling: assessment and prediction of outcome. *J Urol* 2007;177:1414-8.
51. Migliari R, Pistolesi D, Leone P, Viola D, Trovarelli S. Male bulbourethral sling after RP: intermediate outcomes at 2 to 4-year followup. *J Urol* 2006;176:2114-8; discussion 8.
52. Hubner WA, Schlarp OM. Adjustable continence therapy (ProACT): evolution of the surgical technique and comparison of the original 50 patients with the most recent 50 patients at a single centre. *Eur Urol* 2007;52:680-6.
53. Rehder P, Gozzi C. Transobturator sling suspension for male urinary incontinence including post-RP. *Eur Urol* 2007;52:860-6.
54. Fassi-Fehri H, Badet L, Cherass A, et al. Efficacy of the InVance male sling in men with stress urinary incontinence. *Eur Urol* 2007;51:498-503.
55. Lebret T, Cour F, Benchetrit J, et al. Treatment of postprostatectomy stress urinary incontinence using a minimally invasive adjustable continence balloon device, ProACT: results of a preliminary, multicenter, pilot study. *Urology* 2008;71:256-60.
56. Imamoglu MA, Tuygun C, Bakirtas H, Yigitbasi O, Kiper A. The comparison of artificial urinary sphincter implantation and endourethral macroplastique injection for the treatment of postprostatectomy incontinence. *Eur Urol* 2005;47:209-13.
57. John H. Bulbourethral composite suspension: a new operative technique for post-prostatectomy incontinence. *J Urol* 2004;171:1866-70; discussion 9-70.
58. Schaal CH, Costa RP, Sala FC, Vanni AP, Cortez JP. Longitudinal urethral sling with prepubic and retropubic fixation for male urinary incontinence. *Int Braz J Urol* 2004;30:307-11; discussion 12.
59. Thiel DD, Young PR, Broderick GA, et al. Do clinical or urodynamic parameters predict artificial urinary sphincter outcome in post-RP incontinence? *Urology* 2007;69:315-9.
60. Trigo Rocha F, Gomes CM, Mitre AI, Arap S, Srougi M. A prospective study evaluating the efficacy of the artificial sphincter AMS 800 for the treatment of postRP urinary incontinence and the correlation between preoperative urodynamic and surgical outcomes. *Urology* 2008;71:85-9.
61. Ballert KN, Nitti VW. Association between detrusor overactivity and postoperative outcomes in patients undergoing male bone anchored perineal sling. *J Urol* 2010;183:641-5.
62. Lai HH, Hsu EI, Boone TB. Urodynamic testing in evaluation of postRP incontinence before artificial urinary sphincter implantation. *Urology* 2009;73:1264-9.
63. Hu JC, Elkin EP, Pasta DJ, et al. Predicting quality of life after radical prostatectomy: results from CaPSURE. *J Urol* 2004;171:703-7; discussion 7-8.
64. Rodriguez E, Jr., Skarecky DW, Ahlering TE. Post-robotic prostatectomy urinary continence: characterization of perfect continence vs occasional dribbling in pad-free men. *Urology* 2006;67:785-8.
65. Krupski TL, Saigal CS, Litwin MS. Variation in continence and potency by definition. *J Urol* 2003;170:1291-4.
66. Olsson LE, Salomon L, Nadu A, et al. Prospective patient-reported continence after laparoscopic radical prostatectomy. *Urology* 2001;58:570-2.
67. Du Moulin MF, Hamers JP, Ambergen AW, Janssen MA, Halfens RJ. Prevalence of urinary incontinence among community-dwelling adults receiving home care. *Res Nursing & Health* 2008;31:604-12.
68. Coyne KS, Zhou Z, Thompson C, Versi E. The impact on health-related quality of life of stress, urge and mixed urinary incontinence. *BJU Int* 2003;92:731-5.
69. Wilt TJ, MacDonald R, Rutks I, Shamlivan TA, Taylor BC, Kane RL. Systematic review: comparative effectiveness and harms of treatments for clinically localized prostate cancer. *Annals Int Med* 2008;148:435-48.
70. Johansson E, Steineck G, Holmberg L, et al. Long-term quality-of-life outcomes after radical prostatectomy or watchful waiting: the Scandinavian Prostate Cancer Group-4 randomised trial. *Lancet Onc* 2011;12:891-9.
71. Wallerstedt A, Carlsson S, Nilsson AE, et al. Pad use and patient reported bother from urinary leakage after radical prostatectomy. *J Urol* 2012;187:196-200.

72. Litwin MS, Pasta DJ, Yu J, Stoddard ML, Flanders SC. Urinary function and bother after radical prostatectomy or radiation for prostate cancer: a longitudinal, multivariate quality of life analysis from the Cancer of the Prostate Strategic Urologic Research Endeavor. *J Urol* 2000;164:1973-7.
73. Liss MA, Osann K, Canvasser N, et al. Continence definition after radical prostatectomy using urinary quality of life: evaluation of patient reported validated questionnaires. *J Urol* 2010;183:1464-8.
74. Penson DF, McLerran D, Feng Z, et al. 5-year urinary and sexual outcomes after radical prostatectomy: results from the prostate cancer outcomes study. *J Urol* 2005;173:1701-5.
75. Begg CB, Riedel ER, Bach PB, et al. Variations in morbidity after radical prostatectomy. *N Engl J Med* 2002;346:1138-44.
76. Steineck G, Helgesen F, Adolfsson J, et al. Quality of life after radical prostatectomy or watchful waiting. *N Engl J Med* 2002;347:790-6.
77. Stanford JL, Feng Z, Hamilton AS, et al. Urinary and sexual function after radical prostatectomy for clinically localized prostate cancer: the Prostate Cancer Outcomes Study. *JAMA* 2000;283:354-60.
78. Kielb S, Dunn RL, Rashid MG, et al. Assessment of early continence recovery after radical prostatectomy: patient reported symptoms and impairment. *J Urol* 2001;166:958-61.
79. Sebesta M, Cespedes RD, Luhman E, Optenberg S, Thompson IM. Questionnaire-based outcomes of urinary incontinence and satisfaction rates after radical prostatectomy in a national study population. *Urology* 2002;60:1055-8.
80. Lepor H, Kaci L. The impact of open radical retropubic prostatectomy on continence and lower urinary tract symptoms: a prospective assessment using validated self-administered outcome instruments. *J Urol* 2004;171:1216-9.
81. Madalinska JB, Essink-Bot ML, de Koning HJ, Kirkels WJ, van der Maas PJ, Schroder FH. Health-related quality-of-life effects of radical prostatectomy and primary radiotherapy for screen-detected or clinically diagnosed localized prostate cancer. *J Clin Oncol* 2001;19:1619-28.
82. Deliveliotis C, Protogerou V, Alargof E, Varkarakis J. Radical prostatectomy: bladder neck preservation and puboprostatic ligament sparing--effects on continence and positive margins. *Urology* 2002;60:855-8.
83. Harris MJ. Radical perineal prostatectomy: cost efficient, outcome effective, minimally invasive prostate cancer management. *Eur Urol* 2003;44:303-8; discussion 8.
84. Maffezzini M, Seveso M, Taverna G, Giusti G, Benetti A, Graziotti P. Evaluation of complications and results in a contemporary series of 300 consecutive radical retropubic prostatectomies with the anatomic approach at a single institution. *Urology* 2003;61:982-6.
85. Hofmann T, Gaensheimer S, Buchner A, Rohloff R, Schilling A. An unrandomized prospective comparison of urinary continence, bowel symptoms and the need for further procedures in patients with and with no adjuvant radiation after radical prostatectomy. *BJU Int* 2003;92:360-4.
86. Ruiz-Deya G, Davis R, Srivastav SK, A MW, Thomas R. Outpatient radical prostatectomy: impact of standard perineal approach on patient outcome. *J Urol* 2001;166:581-6.
87. Augustin H, Pummer K, Daghofer F, Habermann H, Primus G, Hubmer G. Patient self-reporting questionnaire on urological morbidity and bother after radical retropubic prostatectomy. *Eur Urol* 2002;42:112-17.
88. Rassweiler J, Seemann O, Schulze M, Teber D, Hatzinger M, Frede T. Laparoscopic vs open radical prostatectomy: a comparative study at a single institution. *J Urol* 2003;169:1689-93.
89. Jacobsen NE, Moore KN, Estey E, Voaklander D. Open vs laparoscopic radical prostatectomy: a prospective comparison of postoperative urinary incontinence rates. *J Urol* 2007;177:615-9.
90. Anastasiadis AG, Salomon L, Katz R, Hoznek A, Chopin D, Abbou CC. Radical retropubic vs laparoscopic prostatectomy: a prospective comparison of functional outcome. *Urology* 2003;62:292-7.
91. Sacco E, Prayer-Galetti T, Pinto F, et al. Urinary incontinence after radical prostatectomy: incidence by definition, risk factors and temporal trend in a large series with a long-term follow-up. *BJU Int* 2006;97:1234-41.
92. Krambeck AE, DiMarco DS, Rangel LJ, et al. Radical prostatectomy for prostatic adenocarcinoma: a matched comparison of open retropubic and robot-assisted techniques. *BJU Int* 2009;103:448-53.
93. Rocco B, Matei DV, Melegari S, et al. Robotic vs open prostatectomy in a laparoscopically naive centre: a matched-pair analysis. *BJU Int* 2009;104:991-5.

94. Boris RS, Kaul SA, Sarle RC, Stricker HJ. Radical prostatectomy: a single surgeon comparison of retropubic, perineal, and robotic approaches. *Can J Urology* 2007;14:3566-70.
95. Di Pierro GB, Baumeister P, Stucki P, Beatrice J, Danuser H, Mattei A. A prospective trial comparing consecutive series of open retropubic and robot-assisted laparoscopic radical prostatectomy in a centre with a limited caseload. *Eur Urol* 2011;59:1-6.
96. Reynolds WS, Shikanov SA, Katz MH, Zagaja GP, Shalhav AL, Zorn KC. Analysis of continence rates following robot-assisted radical prostatectomy: strict leak-free and pad-free continence. *Urology* 2010;75:431-6.
97. Choi JM, Nelson CJ, Stasi J, Mulhall JP. Orgasm associated incontinence (climacturia) following radical pelvic surgery: rates of occurrence and predictors. *J Urol* 2007;177:2223-6.
98. Patel VR, Coelho RF, Palmer KJ, Rocco B. Periurethral suspension stitch during robot-assisted laparoscopic radical prostatectomy: description of the technique and continence outcomes. *Eur Urol* 2009;56:472-8.
99. Noguchi M, Kakuma T, Suekane S, Nakashima O, Mohamed ER, Matsuoka K. A randomized clinical trial of suspension technique for improving early recovery of urinary continence after radical retropubic prostatectomy. *BJU Int* 2008;102:958-63.
100. Laviqueur-Blouin H, Noriega AC, Valdivieso R, Hueber PA, Bienz M, et al: Predictors of early continence following robot-assisted RP. *CUAJ* 2015;9:E94-97.
101. Moore KN, Truong V, Estey E, Voaklander DC. Urinary incontinence after radical prostatectomy: can men at risk be identified preoperatively? *J Wound Ostomy Continence Nurs* 2007;34:270-9.
102. Wei JT, Dunn RL, Marcovich R, Montie JE, Sanda MG. Prospective assessment of patient reported urinary continence after radical prostatectomy. *J Urol* 2000;164:744-8.
103. Majoros A, Bach D, Keszthelyi A, Hamvas A, Romics I. Urinary incontinence and voiding dysfunction after radical retropubic prostatectomy (prospective urodynamic study). *Neurourol Urodyn* 2006;25:2-7.
104. Khan Z, Mieza M, Starer P, Singh VK. Post-prostatectomy incontinence. A urodynamic and fluoroscopic point of view. *Urology* 1991;38:483-8.
105. Horie S, Tobisu KI, Fujimoto H, Doi N, Kakizoe T. Urinary incontinence after non-nerve-sparing radical prostatectomy with neoadjuvant androgen deprivation. *Urology* 1999;53:561-7.
106. Catalona WJ, Carvalhal GF, Mager DE, Smith DS. Potency, continence and complication rates in 1,870 consecutive radical retropubic prostatectomies. *J Urol* 1999;162:433-8.
107. Eastham JA, Kattan MW, Rogers E, et al. Risk factors for urinary incontinence after radical prostatectomy. *J Urol* 1996;156:1707-13.
108. Zincke H, Oesterling JE, Blute ML, Bergstralh EJ, Myers RP, Barrett DM. Long-term (15 years) results after radical prostatectomy for clinically localized (stage T2c or lower) prostate cancer. *J Urol* 1994;152:1850-7.
109. Leandri P, Rossignol G, Gautier JR, Ramon J. Radical retropubic prostatectomy: morbidity and quality of life. Experience with 620 consecutive cases. *J Urol* 1992;147:883-7.
110. Novara G, Ficarra V, D'Elia C, et al. Evaluating urinary continence and preoperative predictors of urinary continence after robot assisted laparoscopic radical prostatectomy. *J Urol* 2010;184:1028-33.
111. Yang BS, Ye DW, Peng JY, et al. [Analysis of risk factors for urinary continence after radical prostatectomy]. *Zhonghua Yi Xue Za Zhi* 2011;91:2239-42.
112. Steiner MS, Morton RA, Walsh PC. Impact of anatomical radical prostatectomy on urinary continence. *J Urol* 1991;145:512-4; discussion 4-5.
113. Young MD, Weizer AZ, Silverstein AD, et al. Urinary continence and quality of life in the first year after radical perineal prostatectomy. *J Urol* 2003;170:2374-8.
114. Lepor H, Kaci L, Xue X. Continence following radical retropubic prostatectomy using self-reporting instruments. *J Urol* 2004;171:1212-5.
115. Mohamad BA, Marszalek M, Brossner C, et al. Radical prostatectomy in Austria: a nationwide analysis of 16,524 cases. *Eur Urol* 2007;51:684-8; discussion 9.
116. Rogers CG, Su LM, Link RE, Sullivan W, Wagner A, Pavlovich CP. Age stratified functional outcomes after laparoscopic radical prostatectomy. *J Urol* 2006;176:2448-52.
117. Nilsson AE, Schumacher MC, Johansson E, et al. Age at surgery, educational level and long-term urinary incontinence after radical prostatectomy. *BJU Int* 2011;108:1572-7.
118. van Roermund JG, van Basten JP, Kiemeneij LA, Karthaus HF, Witjes JA. Impact of obesity on surgical outcomes following open radical prostatectomy. *Urol Int* 2009;82:256-61.

119. Wolin KY, Luly J, Sutcliffe S, Andriole GL, Kibel AS. Risk of urinary incontinence following prostatectomy: the role of physical activity and obesity. *J Urol* 2010;183:629-33.
120. Jonler M, Madsen FA, Rhodes PR, Sall M, Messing EM, Bruskewitz RC. A prospective study of quantification of urinary incontinence and quality of life in patients undergoing radical retropubic prostatectomy. *Urology* 1996;48:433-40.
121. Lowe BA. Comparison of bladder neck preservation to bladder neck resection in maintaining postprostatectomy urinary continence. *Urology* 1996;48:889-93.
122. Pierorazio PM, Spencer BA, McCann TR, McKiernan JM, Benson MC. Preoperative risk stratification predicts likelihood of concurrent PSA-free survival, continence, and potency (the trifecta analysis) after radical retropubic prostatectomy. *Urology* 2007;70:717-22.
123. Loeb S, Smith ND, Roehl KA, Catalona WJ. Intermediate-term potency, continence, and survival outcomes of radical prostatectomy for clinically high-risk or locally advanced prostate cancer. *Urology* 2007;69:1170-5.
124. Gray M, Petroni GR, Theodorescu D. Urinary function after radical prostatectomy: a comparison of the retropubic and perineal approaches. *Urology* 1999;53:881-90; discussion 90-1.
125. Weldon VE, Tavel FR, Neuwirth H. Continence, potency and morbidity after radical perineal prostatectomy. *J Urol* 1997;158:1470-5.
126. Gacci M, Carini M, Simonato A, et al. Factors predicting continence recovery 1 month after radical prostatectomy: results of a multicenter survey. *Int J Urol* 2011;18:700-8.
127. Poon M, Ruckle H, Bamshad BR, Tsai C, Webster R, Lui P. Radical retropubic prostatectomy: bladder neck preservation vs reconstruction. *J Urol* 2000;163:194-8.
128. Srougi M, Nesrallah LJ, Kauffmann JR, Nesrallah A, Leite KR. Urinary continence and pathological outcome after bladder neck preservation during radical retropubic prostatectomy: a randomized prospective trial. *J Urol* 2001;165:815-8.
129. Pick DL, Osann K, Skarecky D, Narula N, Finley DS, Ahlering TE. The impact of cavernosal nerve preservation on continence after robotic radical prostatectomy. *BJU Int* 2011;108:1492-6.
130. Nandipati KC, Raina R, Agarwal A, Zippe CD. Nerve-sparing surgery significantly affects long-term continence after radical prostatectomy. *Urology* 2007;70:1127-30.
131. Burkhard FC, Kessler TM, Fleischmann A, Thalmann GN, Schumacher M, Studer UE. Nerve sparing open radical retropubic prostatectomy--does it have an impact on urinary continence? *J Urol* 2006;176:189-95.
132. Kadono Y, Ueno S, Kadomoto S, Iwamoto H, Takezawa Y, et al: Use of preoperative factors including urodynamic evaluations and nerve-sparing status for predicting urinary continence recovery after robot-assisted RP: nerve-sparing technique contributes to the reduction of postprostatectomy incontinence. *Neurourol Urodyn* 2015 Sep 9. doi: 10.1002/nau.22877. [Epub ahead of print]
133. Wille S, Heidenreich A, Hofmann R, Engelman U. Preoperative erectile function is one predictor for post prostatectomy incontinence. *Neurourol Urodyn* 2007;26:140-3; discussion 4.
134. Thorsteinsdottir T, Stranne J, Carlsson S, et al. LAPPRO: a prospective multicentre comparative study of robot-assisted laparoscopic and retropubic radical prostatectomy for prostate cancer. *Scand J Urol Nephrol* 2011;45:102-12.
135. Ficarra V, Novara G, Fracalanza S, et al. A prospective, non-randomized trial comparing robot-assisted laparoscopic and retropubic radical prostatectomy in one European institution. *BJU Int* 2009;104:534-9.
136. Salomon L, Sebe P, De La Taille A, et al. Open vs laparoscopic radical prostatectomy: Part II. *BJU Int* 2004;94:244-50.
137. Asimakopoulos AD, Pereira Fraga CT, Annino F, Pasqualetti P, Calado AA, Mugnier C: Randomized comparison between pure laparoscopic and robot-assisted laparoscopic nerve-sparing RP. *J Sex Med.* 2011;8:1503-12.
138. Ficarra V, Novara G, Rosen RC, et al. Systematic review and meta-analysis of studies reporting urinary continence recovery after robot-assisted RP. *Eur. Urol.* 2012;62:405-17.
139. Novara G, Ficarra V, Rosen RC, et al. Systematic review and meta-analysis of perioperative outcomes and complications after robot-assisted RP. *Eur. Urol.* 2012;62:431-52.
140. Novara G, Ficarra V, Mocellin S, et al. Systematic review and meta-analysis of studies reporting oncologic outcome after robot-assisted RP. *Eur. Urol.* 2012;62:382-404.
141. Ficarra V, Novara G, Ahlering TE, et al. Systematic review and meta-analysis of studies reporting potency rates after robot-assisted RP. *Eur. Urol.* 2012;62:418-30.

142. Shao IH, Chou CY, Huang CC, Lin CF, Chang YS, et al: A specific cystography pattern can predict postprostatectomy incontinence. *Ann Surg Oncol* 2015;Suppl 3:1580-6.
143. Olgin G, Alsayouf M, Han D, Li R, Lioghtfoot M, et al: Postoperative cystogram findings predict incontinence following robot-assisted RP. *J Endourol* 12: 1460-3, 2014.
144. Suardi N, Scattoni V, Briganti A, Salonia A, Naspro R, Gallina A, et al. Nerve-sparing radical retropubic prostatectomy in patients previously submitted to holmium laser enucleation of the prostate for bladder outlet obstruction due to benign prostatic enlargement. *Eur Urol*. 2008 Jun;53(6):1180-5. Epub 2007 Jul 23.
145. Hollenbeck BK, Lipp ER, Hayward RA, Montie JE, Schottenfeld D, Wei JT. Concurrent assessment of obstructive/irritative urinary symptoms and incontinence after radical prostatectomy. *Urology* 2002;59:389-93.
146. Groutz A, Blaivas JG, Chaikin DC, Weiss JP, Verhaaren M. The pathophysiology of post-radical prostatectomy incontinence: a clinical and video urodynamic study. *J Urol* 2000;163:1767-70.
147. Ficazzola MA, Nitti VW. The etiology of post-radical prostatectomy incontinence and correlation of symptoms with urodynamic findings. *J Urol* 1998;160:1317-20.
148. Bruschini H, Simonetti R, Antunes AA, Srougi M. Urinary incontinence following surgery for BPH: the role of aging on the incidence of bladder dysfunction. *International Braz J Urol* 2011;37:380-6; discussion 7.
149. Porena M, Mearini E, Mearini L, Vianello A, Giannantoni A. Voiding dysfunction after radical retropubic prostatectomy: more than external urethral sphincter deficiency. *Eur Urol* 2007;52:38-45.
150. Giannantoni A, Mearini E, Di Stasi SM, et al. Assessment of bladder and urethral sphincter function before and after radical retropubic prostatectomy. *J Urol* 2004;171:1563-6.
151. Giannantoni A, Mearini E, Zucchi A, et al. Bladder and urethral sphincter function after radical retropubic prostatectomy: a prospective long-term study. *Eur Urol* 2008;54:657-64.
152. Coakley FV, Eberhardt S, Kattan MW, Wei DC, Scardino PT, Hricak H. Urinary continence after radical retropubic prostatectomy: relationship with membranous urethral length on preoperative endorectal magnetic resonance imaging. *J Urol* 2002;168:1032-5.
153. Van Kampen M, De Weerd W, Van Poppel H, et al. Prediction of urinary continence following radical prostatectomy. *Urol Int* 1998;60:80-4.
154. Hammerer P, Huland H. Urodynamic evaluation of changes in urinary control after radical retropubic prostatectomy. *J Urol* 1997;157:233-6.
155. Hakimi AA, Faleck DM, Agalliu I, Rozenblit AM, Chernyak V, Ghavamian R. Preoperative and intraoperative measurements of urethral length as predictors of continence after robot-assisted radical prostatectomy. *J Endourol* 2011;25:1025-30.
156. Pfister C, Cappelletti O, Dunet F, Bugel H, Grise P. Assessment of the intrinsic urethral sphincter component function in postprostatectomy urinary incontinence. *Neurourol Urodyn* 2002;21:194-7.
157. Bader P, Hugonnet CL, Burkhard FC, Studer UE. Inefficient urethral milking secondary to urethral dysfunction as an additional risk factor for incontinence after radical prostatectomy. *J Urol* 2001;166:2247-52.
158. John H, Sullivan MP, Bangerter U, Hauri D, Yalla SV. Effect of radical prostatectomy on sensory threshold and pressure transmission. *J Urol* 2000;163:1761-6.
159. Comiter CV, Sullivan MP, Yalla SV. Correlation among maximal urethral closure pressure, retrograde leak point pressure, and abdominal leak point pressure in men with postprostatectomy stress incontinence. *Urology* 2003;62:75-8.
160. Mendoza P, Sharma S, Lee DI. Techniques to improve urinary incontinence following robot-assisted RP. In: Hemal AK, Menon M (eds). *Robotics in Genitourinary Surgery*. Springer-Verlag, London, 2011; 341-60.
161. Greco KA, Meeks JJ, Wu S, Nadler RB. Robot-assisted RP in men aged > or = 70 years. *BJU Int*. 2009;104:1492-5.
162. Mendiola FP, Zorn KC, Mikhail AA et al. Urinary and sexual function outcomes among different age groups after robot-assisted laparoscopic prostatectomy. *J. Endourol*. 2008 22:519-24.
163. Rodriguez E Jr, Skarecky DW, Ahlering TE. Post-robotic prostatectomy urinary continence: characterization of perfect continence vs occasional dribbling in pad-free men. *Urology* 2006;67:785-8.
164. Lee DJ, Cheetham P, Badani KK. Predictors of early urinary continence after robotic prostatectomy. *Can J Urol*. 2010;17:5200-5.
165. Novara G, Ficarra V, D'elia C, et al. Evaluating urinary continence and pre-operative predictors of urinary continence after robot assisted laparoscopic RP. *J Urol*. 2010;184:1028-33.

166. Van Kampen M, De Weerdts W, Van Poppel H, De Ridder D, Feys H, Baert L. Effect of pelvic-floor re-education on duration and degree of incontinence after radical prostatectomy: a randomised controlled trial. *Lancet* 2000;355:98-102.
167. Parekh AR, Feng MI, Kirages D, Bremner H, Kaswick J, Aboseif S. The role of pelvic floor exercises on post-prostatectomy incontinence. *J Urol* 2003;170:130-3.
168. Franke JJ, Gilbert WB, Grier J, Koch MO, Shyr Y, Smith JA, Jr. Early post-prostatectomy pelvic floor biofeedback. *J Urol* 2000;163:191-3.
169. Wille S, Sobottka A, Heidenreich A, Hofmann R. Pelvic floor exercises, electrical stimulation and biofeedback after radical prostatectomy: results of a prospective randomized trial. *J Urol* 2003;170:490-3.
170. Ribeiro LH, Prota C, Gomes CM, et al. Long-term effect of early postoperative pelvic floor biofeedback on continence in men undergoing radical prostatectomy: a prospective, randomized, controlled trial. *J Urol* 2010;184:1034-9.
171. Moore KN, Griffiths D, Hughton A. Urinary incontinence after radical prostatectomy: a randomized controlled trial comparing pelvic muscle exercises with or without electrical stimulation. *BJU Int* 1999;83:57-65.
172. Burgio KL, Stutzman RE, Engel BT. Behavioral training for post-prostatectomy urinary incontinence. *J Urol* 1989;141:303-6.
173. Meaglia JP, Joseph AC, Chang M, Schmidt JD. Post-prostatectomy urinary incontinence: response to behavioral training. *J Urol* 1990;144:674-6.
174. Hunter KF, Moore KN, Cody DJ, Glazener CM. Conservative management for postprostatectomy urinary incontinence. *Cochrane Database Syst Rev* 2004;CD001843.
175. Glazener C, Boachie C, Buckley B, et al. Urinary incontinence in men after formal one-to-one pelvic-floor muscle training following radical prostatectomy or transurethral resection of the prostate (MAPS): two parallel randomised controlled trials. *Lancet* 2011;378:328-37.
176. Collado Serra A, Rubio-Briones J, Puyol Payas M, Iborra Juan I, Ramon-Borja JC, Solsona Narbon E. Postprostatectomy established stress urinary incontinence treated with duloxetine. *Urology* 2011;78:261-6.
177. McGuire EJ, Appell RA. Transurethral collagen injection for urinary incontinence. *Urology* 1994;43:413-5.
178. Aboseif SR, O'Connell HE, Usui A, McGuire EJ. Collagen injection for intrinsic sphincteric deficiency in men. *J Urol* 1996;155:10-3.
179. Cummings JM, Boullier JA, Parra RO. Transurethral collagen injections in the therapy of post-radical prostatectomy stress incontinence. *J Urol* 1996;155:1011-3.
180. Sanchez-Ortiz RF, Broderick GA, Chaikin DC, et al. Collagen injection therapy for post-radical retropubic prostatectomy incontinence: role of Valsalva leak point pressure. *J Urol* 1997;158:2132-6.
181. Smith DN, Appell RA, Rackley RR, Winters JC. Collagen injection therapy for post-prostatectomy incontinence. *J Urol* 1998;160:364-7.
182. Klutke JJ, Subir C, Andriole G, Klutke CG. Long-term results after antegrade collagen injection for stress urinary incontinence following radical retropubic prostatectomy. *Urology* 1999;53:974-7.
183. Tiguert R, Gheiler EL, Gudziak MR. Collagen injection in the management of post-radical prostatectomy intrinsic sphincteric deficiency. *Neurourol Urodyn* 1999;18:653-8.
184. Cespedes RD, Leng WW, McGuire EJ. Collagen injection therapy for postprostatectomy incontinence. *Urology* 1999;54:597-602.
185. Gomes CM, Broderick GA, Sanchez-Ortiz RF, Preate D, Jr., Rovner ES, Wein AJ. Artificial urinary sphincter for post-prostatectomy incontinence: impact of prior collagen injection on cost and clinical outcome. *J Urol* 2000;163:87-90.
186. Comiter CV. The male sling for stress urinary incontinence: a prospective study. *J Urol* 2002;167:597-601.
187. Onur R, Singla A. Comparison of bone-anchored male sling and collagen implant for the treatment of male incontinence. *Int J Urol* 2006;13:1207-11.
188. Bugel H, Pfister C, Sibert L, Cappele O, Khalaf A, Grise P. [Intraurethral Macroplastic injections in the treatment of urinary incontinence after prostatic surgery]. *Prog Urol* 1999;9:1068-76.
189. Kylmala T, Tainio H, Raitanen M, Tammela TL. Treatment of postoperative male urinary incontinence using transurethral macroplastique injections. *J Endourol* 2003;17:113-5.
190. Lee SW, Kang JH, Sung HH, Jeong SU, Lee YS. Treatment of outcomes of transurethral macroplastique injection for postprostatectomy incontinence. *KJU* 55:182-9, 2014
191. Poon SA, Silberstein JL, Sav-age C, Maschino AC, Lowrance WT, Sandhu JS. Surgical practice patterns for male urinary incontinence: analysis of case logs from certifying American urologists. *J Urol* 2012;188:205-10.

192. Kim PH, Pinheiro LC, Atoria CL, Eastham JA, Sandhu JS, Elkin EB: Trends in the use of incontinence procedures after RP: a population based analysis. *J Urol*. 2013;189:602-8.
193. Page KV, Keagan PE, Atiemo K, Coldy JD, McClinton S: Urethral injection therapy for urinary incontinence in women. *Cochrane Database Syst Rev*, Feb 15, 2012.
194. Lightner DJ, Fox J, Klinge C. Cystoscopic injections of dextranomer hyaluronic acid into proximal urethra for urethral incompetence: efficacy and adverse outcomes. *Urology* 2010;75:1310-4.
195. Hurtado EA, McCrery RJ, Appell RA. Complications of ethylene vinyl alcohol copolymer as an intraurethral bulking agent in men with stress urinary incontinence. *Urology* 2008;71:662-5.
196. Secin FP, Martinez-Salamanca JI, Eilber KS. [Limited efficacy of permanent injectable agents in the treatment of stress urinary incontinence after radical prostatectomy]. *Arch Esp Urol* 2005;58:431-6.
197. Mitterberger M, Marksteiner R, Margreiter E, et al. Myoblast and fibroblast therapy for post-prostatectomy urinary incontinence: 1-year followup of 63 patients. *J Urol* 2008;179:226-31.
198. Strasser H, Marksteiner R, Margreiter E, et al. Transurethral ultrasonography-guided injection of adult autologous stem cells vs transurethral endoscopic injection of collagen in treatment of urinary incontinence. *World J Urol* 2007;25:385-92.
199. Kleinert S, Horton R. Retraction—autologous myoblasts and fibroblasts for treatment of stress urinary incontinence: a randomised controlled trial. *Lancet* 2008;372:789-90.
200. Strasser H, Marksteiner R, Margreiter E, et al. Autologous myoblasts and fibroblasts vs collagen for treatment of stress urinary incontinence in women: a randomised controlled trial. *Lancet* 2007;369:2179-86.
201. Nikolavsky D, Chancellor MB. Stem cell therapy for stress urinary incontinence. *Neurourol Urodyn* 2010;29 Suppl 1:S36-41.
202. Gerullis H, Eimer C, Georgas E, Homburger M, El-Baz AG, et al: Muscle-derived cells for treatment of iatrogenic sphincter damage and urinary incontinence in men. *Sci World J* 2012;2012:898535.
203. Kaufman JJ. A new operation for male incontinence. *Surg Gynecol Obstet* 1970;131:295-9.
204. Kaufman JJ. Treatment of post-prostatectomy urinary incontinence using a silicone gel prosthesis. *Br J Urol* 1973;45:646-53.
205. Kaufman JJ. Surgical treatment of post-prostatectomy incontinence: use of the penile crura to compress the bulbous urethra. *J Urol* 1972;107:293-7.
206. Gudziak MR, McGuire EJ, Gormley EA. Urodynamic assessment of urethral sphincter function in post-prostatectomy incontinence. *J Urol* 1996;156:1131-4; discussion 4-5.
207. Kielb SJ, Clemens JQ. Comprehensive urodynamics evaluation of 146 men with incontinence after radical prostatectomy. *Urology* 2005;66:392-6.
208. Klingler HC, Marberger M. Incontinence after radical prostatectomy: surgical treatment options. *Curr Opin Urol* 2006;16:60-4.
209. Schaeffer AJ, Clemens JQ, Ferrari M, Stamey TA. The male bulbourethral sling procedure for post-radical prostatectomy incontinence. *J Urol* 1998;159:1510-5.
210. Clemens JQ, Bushman W, Schaeffer AJ. Questionnaire based results of the bulbourethral sling procedure. *J Urol* 1999;162:1972-6.
211. Clemens JQ, Bushman W, Schaeffer AJ. Urodynamic analysis of the bulbourethral sling procedure. *J Urol* 1999;162:1977-81; discussion 81-2.
212. Stern JA, Clemens JQ, Tiplitsky SI, Matschke HM, Jain PM, Schaeffer AJ. Long-term results of the bulbourethral sling procedure. *J Urol* 2005;173:1654-6.
213. Migliari R, Pistolesi D, De Angelis M. Polypropylene sling of the bulbar urethra for post-radical prostatectomy incontinence. *Eur Urol* 2003;43:152-7.
214. Xu YM, Zhang XR, Sa YL, Chen R, Fei XF. Bulbourethral composite suspension for treatment of male-acquired urinary incontinence. *Eur Urol* 2007;51:1709-14; discussion 15-6.
215. Wadie BS. Retropubic bulb-ourethral sling for post-prostatectomy male incontinence: 2-year followup. *J Urol*. 2010 Dec;184(6):2446-51.
216. Madjar S, Jacoby K, Giberti C, et al. Bone anchored sling for the treatment of post-prostatectomy incontinence. *J Urol* 2001;165:72-6.
217. Comiter CV. The male perineal sling: intermediate-term results. *Neurourol Urodyn* 2005;24:648-53.
218. Ullrich NF, Comiter CV. The male sling for stress urinary incontinence: urodynamic and subjective assessment. *J Urol* 2004;172:204-6.
219. Onur R, Rajpurkar A, Singla A. New perineal bone-anchored male sling: lessons learned. *Urology* 2004;64:58-61.

220. Rajpurkar AD, Onur R, Singla A. Patient satisfaction and clinical efficacy of the new perineal bone-anchored male sling. *Eur Urol* 2005;47:237-42; discussion 42.
221. Giberti C, Gallo F, Schenone M, Cortese P. The bone-anchor sub-urethral sling for the treatment of iatrogenic male incontinence: subjective and objective assessment after 41 months of mean follow-up. *World J Urol* 2008;26:173-8.
222. Carmel M, Hage B, Hanna S, Schmutz G, Tu le M. Long-term efficacy of the bone-anchored male sling for moderate and severe stress urinary incontinence. *BJU Int* 2010;106:1012-6.
223. Palma PC, Dambros M, Thiel M, et al. Readjustable transobturator sling: a novel sling procedure for male urinary incontinence. *Urol Int* 2004;73:354-6.
224. Comiter CV, Rhee EY. The 'ventral urethral elevation plus' sling: a novel approach to treating stress urinary incontinence in men. *BJU Int* 2008;101:187-91.
225. Rehder P, Freiin von Gleissen-thal G, et al. The treatment of postprostatectomy incontinence with the retroluminal transobturator repositioning sling (Advance): lessons learnt from accumulative experience. *Arch. Esp. Urol.* 2009;62:860-70.
226. De Ridder D, Rehder P. The AdVance male sling: anatomic features in relation to mode of action. *Eur. Urol. Supp.* 2011;10:383-9.
227. Rapp DE, Reynolds WS, Lucioni A, Bales GT. Surgical technique using AdVance sling placement in the treatment of post-prostatectomy urinary incontinence. *Int Braz J Urol* 2007;33:231-5; discussion 6-7.
228. Li H, et al. Therapeutic durability of the male transobturator sling: midterm patient reported outcomes. *J. Urol.* 2012;187:1331-5.
229. Rehder P, Haab F, Cornu JN, et al. Treatment of postprostatectomy male urinary incontinence with the transobturator retroluminal repositioning sling suspension: 3-year follow-up. *Eur. Urol.* 2012;62(1):140-5.
230. Mascle L, Descazeud A, Rob-ertg G, Bernhard JC, Bensadoun H, et al: Multi-center study of Advance suburethral sling for treatment of post-operative urinary incontinence of male. *Prog Urol* 2015 5:249-55.
231. Serra AC, Folkersma LR, Dominguez-Escrig JL, Gomez Ferrer A, Ru-bio-Briones J, Narbon ES: AdVance/AdVance XP transobturator male slings: preoperative degree of incontinence as predictor of surgical outcome. *Urology.* 2013 May;81(5):1034-9.
232. Kowalik CG, De Long JM, Mourzino AP: The advance transobturator male sling for post-prostatectomy incontinence: subjective and objective outcomes with 3 years followup. *Neurourol Urodyn,* 2015;34:251-4.
233. Grise P, Vautherin R, Njinou-Nginkeu B, Bochereau G, Lienhart J, Saussine C. I-STOP TOMS transobturator male sling, a minimally invasive treatment for post-prostatectomy incontinence: continence improvement and tolerability. *Urology* 2012;79:458-63.
234. Yiu R, Butow Z, Parisot J, Lingombet O, Augustin D, et al: Update on 2-year outcomes of the TOMS transobturator male sling for the treatment of male stress urinary incontinence. *Neurourol Urodyn* 2016;35(1):44-7.
235. de Leval J, Waltregny D. The inside-out transobturator sling: a novel surgical technique for the treatment of male urinary incontinence. *Eur Urol* 2008;54:1051-65.
236. Leruth J, Waltregny D, de Leval J. The inside-out transobturator male sling for the surgical treatment of stress urinary incontinence after radical prostatectomy: midterm results of a single-center prospective study. *Eur Urol* 2012;61:608-15.
237. Welk BK, Herschorn S. The male sling for post-prostatectomy urinary incontinence: a review of contemporary sling designs and outcomes. *BJU Int.* 2011;109:328-44.
238. Rehder P, Mitterberger MJ, Pichler R, Kerschbaumer A, Glodny B. The 1-year outcome of the transobturator retroluminal repositioning sling in the treatment of male stress urinary incontinence. *BJU Int.* 2010;106:1668-72.
239. Cornu JN, Sebe P, Ciofu C, Peyrat L, Cussenot O, Haab F. Mid-term evaluation of the transobturator male sling for post-prostatectomy incontinence: focus on prognostic factors. *BJU Int.* 2011;108:236-40.
240. Bauer RM, Mayer ME, May F, Gratzke C, Buchner A, Solianik I, Bastian PJ, Stief CG, Gozzi C. Complications of the AdVance transobturator male sling in the treatment of male stress urinary incontinence. *Urology* 2010;75:1494-8.
241. Comiter CV, Rhee EY, Tu LM, et al: The virtue sling – a new quadratic sling for postprostatectomy incontinence- results of a multinational clinical trial. *Urology* 2014; 84:433-8.
242. McCall AN, Rivera ME, Elliott DS. Long-term Follow-up of the Virtue Quadratic Male Sling. *Urology.* 2016;93:213-6.

243. Moreno Sierra J, Victor Romano S, Galante Romo I, Barrera Ortega J, Salinas Casado J, Silmi Moyano A. [New male sling "Argus" for the treatment of stress urinary incontinence]. *Arch Esp Urol* 2006;59:607-13.
244. Sousa-Escandon A, Rodriguez Gomez JI, Uribarri Gonzalez C, Marques-Queimadelos A. Externally readjustable sling for treatment of male stress urinary incontinence: points of technique and preliminary results. *J Endourol* 2004;18:113-8.
245. Krause J, Tietze S, Behrendt W, Nast J, Hamza A. Reconstructive surgery for male stress urinary incontinence: Experiences using the ATOMS® system at a single center. *GMS Interdiscip Plast Reconstr Surg DGPW*. 2014;3:Doc15
246. Romano SV, Metrebian SE, Vaz F, et al. An adjustable male sling for treating urinary incontinence after prostatectomy: a phase III multicentre trial. *BJU Int* 2006;97:533-9.
247. Romano SV, Metrebian SE, Vaz F, et al. [Long-term results of a phase III multicentre trial of the adjustable male sling for treating urinary incontinence after prostatectomy: minimum 3 years]. *Actas Urol Esp* 2009;33:309-14.
248. Hubner WA, Gallistl H, Rutkowski M, Huber ER. Adjustable bulbourethral male sling: experience after 101 cases of moderate-to-severe male stress urinary incontinence. *BJU Int* 2011 Mar;107(5):777-82.
249. Bochove-Overgaauw DM, Schrier BP. An adjustable sling for the treatment of all degrees of male stress urinary incontinence: retrospective evaluation of efficacy and complications after a minimal followup of 14 months. *J Urol* 2011;185:1363-8.
250. Dalpiaz O, Knopf HJ, Orth S, Griese K, Aboulsorour S, Truss M. Mid-term complications after placement of the male adjustable suburethral sling: a single center experience. *J Urol* 2011;186:604-9.
251. Tuygun C, Imamoglu A, Gucuk A, Goktug G, Demirel F. Comparison of outcomes for adjustable bulbourethral male sling and artificial urinary sphincter after previous artificial urinary sphincter erosion. *Urology* 2009;73:1363-7.
252. Bauer RM, Rutkowski M, Kretschmer A, Casuscelli J, Stief CG, Huebner W: Efficacy and complications of the adjustable sling system ArgusT for male incontinence: results of a prospective center study. *Urology* 85:316-320, 2015
253. Sousa-Escandon A, Cabrera J, Mantovani F, et al: Adjustable suburethral sling (male remeex system) in the treatment of male stress urinary incontinence: a multicentric European study. *Eur Urol* 2007; 52:1473-9.
254. Navalon Verdejo P, Pallas Costa Y, Ordonez Dominguez F, et al. Our experience in the treatment of male stress urinary incontinence with the male Remeex system. *Arch Esp Urol* 2010;63:432-9.
255. Jimenez Parra JD, Cebrian Lostal JL, Hualde Alfaro A, et al. [REMEEX(R) system for the treatment of male urinary stress incontinence: our experience]. *Actas Urol Esp* 2010;34:802-5.
256. Krause J, Tietze S, Behrendt W, Nast J, Hamza A: Reconstructive surgery for male stress urinary incontinence: experiences using the ATOMS system at a single center. *GMS Interdiscip Plast Reconstr Surg DGPW* 2014; Dec 17;3:Doc15.
257. Thuroff JW, Hohenfellner M, Schultz-Lampel D. Die Harninkontinenz des Mannes. Faszienzügelplastik zur Therapie der Streßinkontinenz. *Akt Urol* 1992;23:149.
258. Cespedes RD, Jacoby K. Male slings for post-prostatectomy incontinence. *Tech Urol* 2001;7:176-83.
259. Castle EP, Andrews PE, Itano N, Novicki DE, Swanson SK, Ferrigni RG. The male sling for post-prostatectomy incontinence: mean followup of 18 months. *J Urol* 2005;173:1657-60.
260. Gallagher BL, Dwyer NT, Gaynor-Krupnick DM, Latini JM, Kreder KJ. Objective and quality-of-life outcomes with bone-anchored male bulbourethral sling. *Urology* 2007;69:1090-4.
261. Chung E, Smith P, Malone G, Cartmill R: Adjustable vs non-adjustable male sling for post-prostatectomy urinary incontinence: a prospective clinical trial comparing patient choice, clinical outcomes and satisfaction rate with a minimum follow up of 24 months. *Neurourology Urodyn* 2016 Apr;35(4):482-6.
262. Guimaraes M, Oliveira R, Pinto R, et al. Intermediate-term results, up to 4 years, of a bone-anchored male perineal sling for treating male stress urinary incontinence after prostate surgery. *BJU Int* 2009;103:500-4.
263. Athanasopoulos A, Konstantinopoulos A, McGuire E. Efficacy of the InVance male sling in treating stress urinary incontinence: a three-year experience from a single centre. *Urol Int* 2010;85:436-42.
264. Harris SE, Guralnick ML, O'Connor RC: Urethral erosion of transobturator male sling. *Urology* 2009 Feb;73(2):443 e19-20.

265. Trost L, Elliott DS: Male stress urinary incontinence: a review of surgical treatment options and outcomes. *Adv Urol* 2012;2012:287489.
266. Comiter CV, Rhee EY, Tu LE, Herschorn S, Nitti VW: The virtue sling – a new quadratic sling for postprostatectomy incontinence – results of a multinational clinical trial. *Urology* 2014;84:433-9.
267. Mahdy A, Elmissiry M, Ghoniem G. Recurrent stress urinary incontinence after dislodged screws in patient with bone-anchored suburethral sling. *Urology* 2008;72:1185 e11-3.
268. Cornu JN, Sebe P, Ciofu C, Peyrat L, Cussenot O, Haab F. Mid-term evaluation of the transobturator male sling for post-prostatectomy incontinence: focus on prognostic factors. *BJU Int* 2011;108:236-40.
269. Bauer RM, Mayer ME, May F, et al. Complications of the AdVance transobturator male sling in the treatment of male stress urinary incontinence. *Urology* 2010;75:1494-8.
270. Gill BC, Swartz MA, Klein JB, et al. Patient perceived effectiveness of a new male sling as treatment for post-prostatectomy incontinence. *J Urol* 2010;183:247-52.
271. Cornel EB, Elzevier HW, Putter H. Can advance transobturator sling suspension cure male urinary postoperative stress incontinence? *J Urol* 2010;183:1459-63.
272. Rehder P. Re: Can advance transobturator sling suspension cure male urinary postoperative stress incontinence?: E. B. Cornel, H. W. Elzevier and H. Putter *J Urol* 2010;183:1459-1463. *J Urol* 2010;184:1575-6; author reply 6-7.
273. Soljanik I, Becker AJ, Stief CG, Gozzi C, Bauer RM. Repeat retourethral transobturator sling in the management of recurrent postprostatectomy stress urinary incontinence after failed first male sling. *Eur Urol* 2010;58:767-72.
274. Martinez EJ, Zuckerman JM, Henderson K, Edwards B, McCammon K. Evaluation of salvage male transobturator sling placement following recurrent stress urinary incontinence after failed transobtura-tor sling. *Urology* 2015;85:478-82.
275. Berger AP, Strasak A, Seitz C, Rein P, Hobisch A. Single institution experience with the transobturator sling suspension system AdVance(R) in the treatment of male urinary incontinence: mid-term results. *International Braz J Urol* 2011;37:488-94.
276. Bauer RM, Mayer ME, Gratzke C, et al. Prospective evaluation of the functional sling suspension for male postprostatectomy stress urinary incontinence: results after 1 year. *Eur Urol* 2009;56:928-33.
277. Gozzi C, Becker AJ, Bauer R, Bastian PJ. Early results of transobturator sling suspension for male urinary incontinence following radical prostatectomy. *Eur Urol* 2008;54:960-1.
278. Soljanik I, Gozzi C, Becker AJ, Stief CG, Bauer RM: Risk factors of treatment failure after retourethral transobturator male sling. *World J Urol* 2012;30:201-6.
279. Torrey, R. et al. Radiation history affects continence outcomes after advance transobturator sling placement in patients with post-prostatectomy incontinence. *Urology* 2013;82:713-7.
280. Bauer RM, Mayer M, Gratzke C et al: UP-1.189: Functional retourethral sling for male stress urinary incontinence after RP and adjuvant radiotherapy: are the results as good as in patients without radiotherapy? *Urology* 2009;74(4):S230.
281. Comiter CV Surgery insight: surgical management of postprostatectomy incontinence – the artificial urinary sphincter and male sling. *Nat. Clin. Pract. Urol* 2007;4:615-24.
282. Barnard J, van Rij S, Westenberg AM. A Valsalva leak point pressure of > 100 cm H₂O is associated with greater success in AdVance sling placement for the treatment of post-prostatectomy urinary incontinence. *BJU Int* 2014 Nov;114 Suppl 1:34-7.
283. Bauer RM, et al. Impact of the 'repositioning test' on postoperative outcome of retroluminal transobturator male sling implantation. *Urol Int* 2013;90:334-8.
284. Cornu JN, et al. The AdVance transobturator male sling for postprostatectomy incontinence: clinical results of a prospective evaluation after a minimum follow-up of 6 months. *Eur Urol* 2009;56:923-7.
285. Bauer RM, et al. Mid-term results for the retroluminal transobturator sling suspension for stress urinary incontinence after prostatectomy. *BJU Int.* 2011;108:94-8.
286. Giberti C, Gallo F, Schenone M, Cortese P, Ninotta G. The bone anchor suburethral synthetic sling for iatrogenic male incontinence: critical evaluation at a mean 3-year followup. *J Urol* 2009;181:2204-8.

287. The management of lower urinary tract symptoms in men. National Clinical Guidelines Centre at the Royal College of Physicians 2010. (Accessed June 7, 2016 <http://www.ncbi.nlm.nih.gov/books/NBK65073/>.)
288. Leach GE, Trockman B, Wong A, Hamilton J, Haab F, Zimmern PE. Post-prostatectomy incontinence: urodynamic findings and treatment outcomes. *J Urol* 1996;155:1256-9.
289. Davidson PJ, van den Ouden D, Schroeder FH. Radical prostatectomy: prospective assessment of mortality and morbidity. *Eur Urol* 1996;29:168-73.
290. Perez LM, Webster GD. Successful outcome of artificial urinary sphincters in men with post-prostatectomy urinary incontinence despite adverse implantation features. *J Urol* 1992;148:1166-70.
291. Gomha MA, Boone TB. Artificial urinary sphincter for post-prostatectomy incontinence in men who had prior radiotherapy: a risk and outcome analysis. *J Urol* 2002;167:591-6.
292. Montague DK. The artificial urinary sphincter (AS 800): experience in 166 consecutive patients. *J Urol* 1992;147:380-2.
293. Martins FE, Boyd SD. Artificial urinary sphincter in patients following major pelvic surgery and/or radiotherapy: are they less favorable candidates? *J Urol* 1995;153:1188-93.
294. Fleshner N, Herschorn S. The artificial urinary sphincter for post-radical prostatectomy incontinence: impact on urinary symptoms and quality of life. *J Urol* 1996;155:1260-4.
295. Mottet N, Boyer C, Chartier-Kastler E, Ben Naoum K, Richard F, Costa P. Artificial urinary sphincter AMS 800 for urinary incontinence after radical prostatectomy: the French experience. *Urol Int* 1998;60 Suppl 2:25-9; discussion 35.
296. Madjar S, Gousse AE, Lambert MM, Fishman IJ. Artificial urinary sphincter implantation for radical prostatectomy urinary incontinence: which factors influence patient satisfaction? *BJU Int* 2000;86 (suppl. 3):121.
297. Klijn AJ, Hop WC, Mickisch G, Schroder FH, Bosch JL. The artificial urinary sphincter in men incontinent after radical prostatectomy: 5 year actuarial adequate function rates. *Br J Urol* 1998;82:530-3.
298. Haab F, Trockman BA, Zimmern PE, Leach GE. Quality of life and continence assessment of the artificial urinary sphincter in men with minimum 3.5 years of followup. *J Urol* 1997;158:435-9.
299. Goldwasser B, Furlow WL, Barrett DM. The model AS 800 artificial urinary sphincter: Mayo Clinic experience. *J Urol* 1987;137:668-71.
300. Kim SP, Sarmast Z, Daignault S, Faerber GJ, McGuire EJ, Latini JM. Long-term durability and functional outcomes among patients with artificial urinary sphincters: a 10-year retrospective review from the University of Michigan. *J Urol* 2008;179:1912-6.
301. Lai HH, Hsu EI, Teh BS, Butler EB, Boone TB. 13 years of experience with artificial urinary sphincter implantation at Baylor College of Medicine. *J Urol* 2007;177:1021-5.
302. Litwiller SE, Kim KB, Fone PD, White RW, Stone AR. Post-prostatectomy incontinence and the artificial urinary sphincter: a long-term study of patient satisfaction and criteria for success. *J Urol* 1996;156:1975-80.
303. Kuznetsov DD, Kim HL, Patel RV, Steinberg GD, Bales GT. Comparison of artificial urinary sphincter and collagen for the treatment of postprostatectomy incontinence. *Urology* 2000;56:600-3.
304. Elliott DS, Barrett DM. Mayo Clinic long-term analysis of the functional durability of the AMS 800 artificial urinary sphincter: a review of 323 cases. *J Urol* 1998;159:1206-8.
305. Clemens JQ, Schuster TG, Konnak JW, McGuire EJ, Faerber GJ. Revision rate after artificial urinary sphincter implantation for incontinence after radical prostatectomy: actuarial analysis. *J Urol* 2001;166:1372-5.
306. Gousse AE, Madjar S, Lambert MM, Fishman IJ. Artificial urinary sphincter for post-radical prostatectomy urinary incontinence: long-term subjective results. *J Urol* 2001;166:1755-8.
307. Lai HH, Boone TB. Implantation of artificial urinary sphincter in patients with post-prostatectomy incontinence, and preoperative overactive bladder and mixed symptoms. *J Urol* 2011;185:2254-9.
308. Fulford SC, Sutton C, Bales G, Hickling M, Stephenson TP. The fate of the 'modern' artificial urinary sphincter with a follow-up of more than 10 years. *Br J Urol* 1997;79:713-6.
309. Brito CG, Mulcahy JJ, Mitchell ME, Adams MC. Use of a double cuff AMS800 urinary sphincter for severe stress incontinence. *J Urol* 1993;149:283-5.
310. DiMarco DS, Elliott DS. Tandem cuff artificial urinary sphincter as a salvage procedure following failed primary sphincter placement for the treatment of post-prostatectomy incontinence. *J Urol* 2003;170:1252-4.

311. Guralnick ML, Miller E, Toh KL, Webster GD. Transcortical artificial urinary sphincter cuff placement in cases requiring revision for erosion and urethral atrophy. *J Urol* 2002;167:2075-8; discussion 9.
312. Kowalczyk JJ, Spicer DL, Mulcahy JJ. Erosion rate of the double cuff AMS800 artificial urinary sphincter: long-term followup. *J Urol* 1996;156:1300-1.
313. O'Connor RC, Gerber GS, Avila D, Chen AA, Bales GT. Comparison of outcomes after single or double-cuff artificial urinary sphincter insertion. *Urology* 2003;62:723-6.
314. O'Connor RC, Lyon MB, Guralnick ML, Bales GT. Long-term follow-up of single vs double cuff artificial urinary sphincter insertion for the treatment of severe postprostatectomy stress urinary incontinence. *Urology* 2008;71:90-3.
315. Manunta A, Guille F, Patard JJ, Lobel B. Artificial sphincter insertion after radiotherapy: is it worthwhile? *BJU Int* 2000;85:490-2.
316. Hird AF, Radomski SB: Artificial urinary sphincter erosion after RP in patients treated with and without radiation. *Can Urol Assoc J* 2015 9:E354-8.
317. Hoy NY, Rourke KF: Artificial urinary sphincter outcomes in the "fragile ure-thra" *Urology* 2015;86:618-24.
318. Ajay D, Zhang H, Gupta S, et al: The artificial urinary sphincter is superior to a secondary transobturator male sling in cases of a primary sling failure. *J Urol* 2015;194:1028-42.
319. Hoy NY, Rourke KF: Stemming the tide of mild to moderate post-prostatectomy incontinence: A retrospective comparison of transobturator male slings and the artificial urinary sphincter. *Can Urol Assoc J* 2014;7-8:273-7.
320. Lim B, Kim A, Song M, et al: Comparing Argus sling and artificial urinary sphincter in patients with moderate post-prostatectomy incontinence. *J Exerc Rehabil* 2014;10:337-42.
321. Galli S, Simonato A, Bozzola A, et al. Oncologic outcome and continence recovery after laparoscopic radical prostatectomy: 3 years' follow-up in a "second generation center". *Eur Urol* 2006;49:859-65.
322. Colombo R, Naspro R, Salonia A, et al. Radical prostatectomy after previous prostate surgery: clinical and functional outcomes. *J Urol* 2006;176:2459-63; discussion 63.
323. Schneider T, Sperling H, Rossi R, Schmidt S, Rubben H. Do early injections of bulking agents following radical prostatectomy improve early continence? *World J Urol* 2005;23:338-42.
324. Jones JS, Vasavada SP, Abdelmalak JB, et al. Sling may hasten return of continence after radical prostatectomy. *Urology* 2005;65:1163-7.
325. McConnell JD, Barry MJ, Bruskewitz RC, et al. Benign prostatic hyperplasia: diagnosis and treatment. Clinical practice guidelines, No. 8. Rockville, MD: Agency for Health Care Policy and Research, Public health service, US Department of Health and Human Services; 1994. Report No.: AHCPR Publication No.94-0582.
326. Herschorn S, Boccon-Gibod L, Bosch JL, et al. Surgical treatment of urinary incontinence in men. In: Abrams P, Khoury S, Wein A, eds. First International Consultation on Urinary Incontinence. Plymouth, U.K.: Health Publications Ltd.; 1999:691-729.
327. Herschorn S, Bosch JL, Bruschini H, Hanus T, Low A, Schick E. Surgical treatment of urinary incontinence in men. In: Abrams P, Cardozo L, Khoury S, Wein A, eds. Second International Consultation on Incontinence. Plymouth, U.K.: Health Publications Ltd.; 2002:785-821.
328. Results of the Treatment Outcome Analyses. American Urological Association Education and Research Inc., 2010. (Accessed September 1, 2012, at http://www.auanet.org/content/clinical-practice-guidelines/clinical-guidelines/main-reports/bph-management/chap_3_ResultsTreatmentOutcomesAnalyses.pdf.)
329. Wendt-Nordahl G, Bucher B, Hacker A, Knoll T, Alken P, Michel MS. Improvement in mortality and morbidity in transurethral resection of the prostate over 17 years in a single center. *J Endourol* 2007;21:1081-7.
330. Guideline on the Management of Benign Prostatic Hyperplasia (BPH). American Urological Association, 2003. (Accessed at <http://www.auanet.org/guidelines/bph.cfm>.)
331. Wasson JH, Reda DJ, Bruskewitz RC, Elinson J, Keller AM, Henderson WG. A comparison of transurethral surgery with watchful waiting for moderate symptoms of benign prostatic hyperplasia. The Veterans Affairs Cooperative Study Group on Transurethral Resection of the Prostate. *N Engl J Med* 1995;332:75-9.
332. Kaplan SA, Te AE. Transurethral electrovaporization of the prostate: a novel method for treating men with benign prostatic hyperplasia. *Urology* 1995;45:566-72.
333. Orandi A. Transurethral incision of prostate (TUIP): 646 cases in 15 years--a chronological appraisal. *Br J Urol* 1985;57:703-7.
334. Saporta L, Aridogan IA, Erlich N, Yachia D. Objective and subjective comparison of transurethral resection, transurethral incision and balloon dilatation of the prostate. A prospective study. *Eur Urol* 1996;29:439-45.

335. Sparwasser C, Riehm M, Knes J, Madsen PO. [Long-term results of transurethral prostate incision (TUIP) and transurethral prostate resection (TURP). A prospective randomized study]. *Urologe A* 1995;34:153-7.
336. Results of the Treatment Outcomes Analyses. American Urological Association Education and Research Inc., 2003. (Accessed October 10, 2010, at http://www.auanet.org/content/clinical-practice-guidelines/clinical-guidelines/archived-guidelines/chapt_3_appendix.pdf.)
337. Tubaro A, Carter, S., Hind, A., Vicentini, C., Mi-ano, L. A prospective study of the safety and efficacy of suprapubic trans-vesical prostatectomy in patients with benign prostatic hyperplasia. *J Urol* 2001;166:172.
338. Serretta V, Morgia, G., Fondacaro, L., Curto, G., Lo bianco, A., Pirri-tano, D., Melloni, D., Orestano, F., Motta, M., Pavone-Macaluso, M.: Open prostatectomy for benign prostatic enlargement in southern Europe in the late 1990s: a contemporary series of 1800 interventions. *Urology* 2002; 60: 623.
339. Kuntz R, Ahyai S, Lehrich K et al: Transurethral holmium laser enucleation of the prostate vs transurethral electrocautery resection of the prostate: a randomized prospective trial in 200 patients. *J Urol* 2004; 172: 1012.
340. Tan A, Gilling P, Kennett K et al: A randomized trial comparing holmium laser enucleation of the prostate with transurethral resection of the prostate for the treatment of bladder outlet obstruction secondary to benign prostatic hyperplasia in large glands (40 to 200 grams). *J Urol* 2003;170:1270.
341. Cornu JN, Ahyai S, Bachmann A, de la Rosette J, Gilling P, Gratzke C, et al. A Systematic Review and Meta-analysis of Functional Outcomes and Complications Following Transurethral Procedures for Lower Urinary Tract Symptoms Resulting from Benign Prostatic Obstruction: An Update. *Eur Urol*. 2015 Jun;67(6):1066-96.
342. Gilling PJ, Mackey M, Cresswell M, Kennett K, Kabalin JN, Fraundorfer MR. Holmium laser vs transurethral resection of the prostate: a randomized prospective trial with 1-year followup. *J Urol* 1999;162:1640-4.
343. Das A, Kennett K, Fraundorfer M, Gilling P. Holmium laser resection of the prostate (HoLRP): 2-year follow-up data. *Tech Urol* 2001;7:252-5.
344. Tan A, Liao C, Mo Z, Cao Y. Meta-analysis of holmium laser enucleation vs transurethral resection of the prostate for symptomatic prostatic obstruction. *Br J Surg* 2007;94:1201-8.
345. Gupta N, Sivaramakrishna, Kumar R, Dogra PN, Seth A. Comparison of standard transurethral resection, transurethral vapour resection and holmium laser enucleation of the prostate for managing benign prostatic hyperplasia of >40 g. *BJU Int* 2006;97:85-9.
346. Kuntz RM, Ahyai S, Lehrich K, Fayad A. Transurethral holmium laser enucleation of the prostate vs transurethral electrocautery resection of the prostate: a randomized prospective trial in 200 patients. *J Urol* 2004;172:1012-6.
347. Montorsi F, Naspro R, Salonia A, et al. Holmium laser enucleation vs transurethral resection of the prostate: results from a 2-center, prospective, randomized trial in patients with obstructive benign prostatic hyperplasia. *J Urol* 2004;172:1926-9.
348. Tan AH, Gilling PJ, Kennett KM, Frampton C, Westenberg AM, Fraundorfer MR. A randomized trial comparing holmium laser enucleation of the prostate with transurethral resection of the prostate for the treatment of bladder outlet obstruction secondary to benign prostatic hyperplasia in large glands (40 to 200 grams). *J Urol* 2003;170:1270-4.
349. Vavassori I, Valenti S, Naspro R, et al. Three-year outcome following holmium laser enucleation of the prostate combined with mechanical morcellation in 330 consecutive patients. *Eur Urol* 2008;53:599-604.
350. Geavlete B, Georgescu D, Multescu R, Stanescu F, Jecu M, Geavlete P. Bipolar plasma vaporization vs monopolar and bipolar TURP-A prospective, randomized, long-term comparison. *Urology* 2011;78:930-5.
351. Tasci AI, Ilbey YO, Luleci H, et al. 120-W GreenLight laser photoselective vaporization of prostate for benign prostatic hyperplasia: mid-term outcomes. *Urology* 2011;78:134-40.
352. Nam JK, Kim HW, Lee DH, Han JY, Lee JZ, Park SW. Risk Factors for Transient Urinary Incontinence after Holmium Laser Enucleation of the Prostate. *World J Mens Health*. 2015 Aug;33(2):88-94.
353. Health Quality Ontario. Energy delivery systems for treatment of benign prostatic hyperplasia: an evidence-based analysis. *Ont Health Technol Assess Ser*. 2006;6(17):1-121.
354. Rigatti L, Naspro R, Salonia A, Centemero A, Ghezzi M, Guazzoni G et al. Urodynamics after TURP and HoLEP in uro-dynamically obstructed patients: are there any differences at 1 year of follow-up? *Urology* 2006; 67(6):1193-8.

355. Wilson LC, Gilling PJ, Williams A, Kennett KM, Frampton CM, Westenberg AM, Fraundorfer MR. A randomised trial comparing holmium laser enucleation vs transurethral resection in the treatment of prostates larger than 40 grams: results at 2 years. *Eur Urol*. 2006 Sep;50(3):569-73.
356. Westenberg A, Gilling P, Kennett K, Frampton C, Fraundorfer M. Holmium laser resection of the prostate vs transurethral resection of the prostate: results of a randomized trial with 4-year minimum long-term followup. *J Urol* 2004; 172(2):616-9.
357. Shingleton WB, Farabaugh P, May W. Three-year follow-up of laser prostatectomy vs transurethral resection of the prostate in men with benign prostatic hyperplasia. *Urology* 2002; 60(2):305-8.
358. Bachmann A, Tubaro A, Barber N, d'Ancona F, Muir G, Witzsch U, Grimm MO, Benejam J, Stolzenburg JU, Riddick A, Pahernik S, Roelink H, Ameye F, Saussine C, Bruyère F, Loidl W, Larner T, Gogoi NK, Hindley R, Muschter R, Thorpe A, Shrotri N, Graham S, Hamann M, Miller K, Schostak M, Capitán C, Knispel H, Thomas JA. A Europe-wide multicenter randomized noninferiority trial comparing 180 W GreenLight XPS laser vaporization and transurethral resection of the prostate for the treatment of benign prostatic obstruction: 12-month results of the GOLIATH study. *J Urol*. 2015 Feb;193(2):570-8.
359. Pereira-Correia JA, de Moraes Sousa KD, Santos JB, de Moraes Perpétuo D, Lopes-da-Silva LF, Krambeck RL, et al. GreenLight HPS™ 120-W laser vaporization vs transurethral resection of the prostate (<60 mL): a 2-year randomized double-blind prospective urodynamic investigation. *BJU Int*. 2012 Oct;110(8):1184-9.
360. Pedriali FR, Gomes CS, Spires L, et al. Is pilates as effective as conventional pelvic floor muscle exercises in the conservative treatment of post-prostatectomy urinary incontinence? A randomised controlled trial. *Neurourol Urodyn*. 2015 Mar 21. doi: 10.1002/nau.22761. [Epub ahead of print].
361. Filocamo MT, Li Marzi V, Del Popolo G, Cecconi F, Villari D, Marzocco M, Nicita G. Pharmacologic treatment in post-prostatectomy stress urinary incontinence. *Eur Urol* 2007;51(6):1559-64.
362. Scott FB. The artificial urinary sphincter: experience in adults. *Urol Clin North Am* 1989;16:105.
363. Wilson SK, Delk JR, 2nd, Henry GD, Siegel AL. New surgical technique for sphincter urinary control system using upper transverse scrotal incision. *J Urol* 2003;169:261-4.
364. Faerber GJ, Richardson TD. Long-term results of transurethral collagen injection in men with intrinsic sphincter deficiency. *J Endourol* 1997;11:273-7.
365. Westney OL, Bevan-Thomas R, Palmer JL, Cespedes RD, McGuire EJ. Transurethral collagen injections for male intrinsic sphincter deficiency: the University of Texas-Houston experience. *J Urol* 2005;174:994-7.
366. Frangenheim P. Zur operativen Behandlung der Inkontinenz der männlichen Harnröhre. *Verh Dtsch Ges Chir* 1914;43:149.
367. Godbole P, Mackinnon AE. Expanded PTFE bladder neck slings for incontinence in children: the long-term outcome. *BJU Int* 2004;93:139-41.
368. Ullrich NF, Comiter CV. The male sling for stress urinary incontinence: 24-month followup with questionnaire based assessment. *J Urol* 2004;172:207-9.
369. Lawton CA, Won M, Pilepich MV, Asbell SO, et al. Long-term treatment sequelae following external beam irradiation for adenocarcinoma of the prostate: analysis of RTOG studies 7506 and 7706. *Int J Radiat Oncol Biol Phys* 1991;21(4):935-9.
370. Perez CA, Lee HK, Georgiou A, Lockett MA. Technical factors affecting morbidity in definitive irradiation for localized carcinoma of the prostate. *Int J Radiat Oncol Biol Phys* 1994;28:811-9.
371. Shipley WU, Zietman AL, Hanks GE, Coen JJ, et al. Treatment related sequelae following external beam radiation for prostate cancer: a review with an update in patients with stages T1 and T2 tumor. *J Urol* 1994;152(5 Pt 2):1799-1805.
372. Weil MD, Crawford ED, Cornish P, Dzingle W, Stuhr K, Pickett B, Roach M 3rd. Minimal toxicity with 3-FAT radiotherapy of prostate cancer. *Semin Urol Oncol* 2000;18(2):127-32.
373. Hanlon AL, Watkins Bruner D, Peter R, Hanks GE. Quality of life study in prostate cancer patients treated with three-dimensional conformal radiation therapy: comparing late bowel and bladder quality of life symptoms to that of the normal population. *Int J Radiat Oncol Biol Phys* 2001;49:51-9.
374. Sandhu AS, Zelefsky MJ, Lee HJ, Lombardi D, Fuks Z, Leibel SA. Long-term urinary toxicity after 3-dimensional conformal radiotherapy for prostate cancer in patients with prior history of transurethral resection. *Int J Radiat Oncol Biol Phys* 2000;48(3):643-7.

375. Scalliet PG, Remouchamps V, Curran D, Ledent G, Wambersie A, Richard F, van Cangh P. Retrospective analysis of results of p(65)+Be neutron therapy for treatment of prostate adenocarcinoma at the cyclotron of Louvain-la-Neuve. Part II: Side effects and their influence on quality of life measured with QLQ-C30 of EORTC. *Int J Radiat Oncol Biol Phys* 2004;58(5):1549-61.
376. Fransson P, Bergstrom P, Lofroth PO, Widmark A. Prospective evaluation of urinary and intestinal side effects after BeamCath stereotactic dose-escalated radiotherapy of prostate cancer. *Radiother Oncol* 2002;63:239-48.
377. Ponholzer A, Brossner C, Struhal G, Marszalek M, Madersbacher S. Lower urinary tract symptoms, urinary incontinence, sexual function and quality of life after radical prostatectomy and external beam radiation therapy: real life experience in Austria. *World J Urol* 2006;24:325-30.
378. Miller DC, Sanda MG, Dunn RL, Montie JE, Pimenetel H, Sandler HM, McLaughlin WP, Wei JT. Long-term outcomes among localized prostate cancer survivors: health-related quality-of-life changes after radical prostatectomy, external radiation, and brachytherapy. *J Clin Oncol* 2005;23(12):2772-80.
379. Budäus L, Bolla M, Bossi A, Cozzarini C, Crook J, Widmark A, Wiegel T. Functional outcomes and complications following radiation therapy for prostate cancer: a critical analysis of the literature. *Eur Urol* 2012;61(1):112-27.
380. Yu JB, Cramer LD, Herrin J, Soulos PR, Potosky AL, Gross CP. Stereotactic body radiation therapy vs intensity-modulated radiation therapy for prostate cancer: comparison of toxicity. *J Clin Oncol* 2014;32(12):1195-201.
381. Halpern J.A., Sedrakyan A, Hsu WC, Mao J, Dasvich TJ, Nguyen PL, Golden EB, Kang J, Hu JC. Use, complications, and costs of stereotactic body radiotherapy for localized prostate cancer. *Cancer* 2016;122(16):2496-504.
382. Jonler M, Ritter MA, Brinkmann R, Messing EM, Rhodes PR, Bruskewitz RC. Sequelae of definitive radiation therapy for prostate cancer localized to the pelvis. *Urology* 1994;44(6):876-82.
383. Green N, Treible D, Wallack H. Prostate cancer: post-irradiation incontinence. *J Urol* 1990;144:307-9.
384. Lee WR, Schultheiss TE, Hanlon AL, Hanks GE. Urinary incontinence following external-beam radiotherapy for clinically localized prostate cancer. *Urology* 1996;48:95-9.
385. Ishiyama H, Hirayama T, Jhaveri P, Satoh T, Paulino AC, Xu B, Butler EB, The BS. Is there an increase in genitourinary toxicity in patients treated with transurethral resection of the prostate and radiotherapy? A systematic review. *Am J Clin Oncol* 2014;37(3):297-304.
386. Liu M., Pickles T, Berthelet E, Agranovich A, Kwan W, et al. Urinary incontinence in prostate cancer patients treated with external beam radiotherapy. *Radiother Oncol* 2005;74(2):197-201.
387. Petrovich Z., Lieskovsky G, Langholz B, Bochner B, Formenti S, Streeter O, Skinner DG. Comparison of outcomes of radical prostatectomy with and without adjuvant pelvic irradiation in patients with pathologic stage C (T3N0) adenocarcinoma of the prostate. *Am J Clin Oncol* 1999;22(4):323-31.
388. Petrovich Z, Lieskovsky G, Langholz B, Jozsef G, Streeter OE Jr, Skinner DG. Postoperative radiotherapy in 423 patients with pT3N0 prostate cancer. *Int J Radiat Oncol Biol Phys* 2002;53(3):600-9.
389. Fontaine E, Ben Mouelli S, Thomas L, Otmezguine Y, Beurton D. Urinary continence after salvage radiation therapy following radical prostatectomy, assessed by a self-administered questionnaire: a prospective study. *BJU Int* 2004;94:521-3.
390. Petroski RA, Warlick WB, Herring J, Donahue TF, Sun L, Smith CV, Connelly RR, McLeod DG, Moul JW External beam radiation therapy after radical prostatectomy: efficacy and impact on urinary continence. *Prostate Cancer Prostatic Dis* 2004;7(2):170-7.
391. Sowerby RJ, Gani J, Yim H, Radomski SB, Catton C. Long-term complications in men who have early or late radiotherapy after radical prostatectomy. *Can Urol Assoc J* 2014;8(7-8):253-8.
392. Ornstein DK, Oh J, Herschman JD, Andriole GL. Evaluation and management of the man who has failed primary curative therapy for prostate cancer. *Urol Clin North Am* 1998;25:591-601.
393. Rogers E, Ohori M, Kassabian VS, Wheeler TM, Scardino PT. Salvage radical prostatectomy: outcome measured by serum prostate specific antigen levels. *J Urol* 1995;153:104-10.
394. Nguyen PL, D'Amico AV, Lee AK, Suh WW. Patient selection, cancer control, and complications after salvage local therapy for post-radiation prostate-specific antigen failure: a systematic review of the literature. *Cancer* 2007;110:1417-28.

395. Matei DV, Ferro M, Jereczek-Fossa BA, Renne G, Crisan N, Bottero D, Mazzarella C, Terracciano D, Autorino R, DeCobelli O. Salvage radical prostatectomy after external beam radiation therapy: a systematic review of current approaches. *Urol Int* 2015;94(1):373-82.
396. Cozzarini C, Fiorino C, Da Pozzo LF, Algoni F, Berardi G, Bolognesi A, et al. Clinical factors predicting late severe urinary toxicity after post-operative radiotherapy for prostate carcinoma: a single-institute analysis of 742 patients. *Int J Radiat Oncol Biol Phys* 2012;82(1):191-9.
397. Wang Y, Hadley HR. Experiences with the artificial urinary sphincter in the irradiated patient. *J Urol* 1992;147:612-3.
398. Gundian JC, Barrett DM, Parulkar BG. Mayo Clinic experience with the AS800 artificial urinary sphincter for urinary incontinence after transurethral resection of prostate or open prostatectomy. *Urology* 1993;41:318-21.
399. Sathianathen NJ, McGuigan SM, Moon DA. Outcomes of artificial urinary sphincter implantation in the irradiated patient. *BJU Int* 2014;113:636-41.
400. Rivera ME, Linder BJ, Ziegelmann MJ, Viers BR, Rangel LJ, Elliott DS. The impact of prior radiation therapy on artificial urinary sphincter device survival. *J Urol* 2016;195(4P1):1033-7.
401. Bates AS, Martin RM, Terry TR. Complications following artificial urinary sphincter placement after radical prostatectomy and radiotherapy: a meta-analysis. *BJU Int* 2015;116:623-33.
402. Raj GV, Peterson AC, Webster GD. Outcomes following erosions of the artificial urinary sphincter. *J Urol* 2006;175:2186-90.
403. Wang R, McGuire EJ, He C, Faerber GJ, Latini JM. Long-term outcomes after primary failures of artificial urinary sphincter implantation. *Urology* 2012;79:922-8.
404. Venn SN, Greenwell TJ, Mundy AR. The long-term outcome of artificial urinary sphincters. *J Urol* 2000;164:702-6.
405. Bevan-Thomas R, Westney OL, Cespedes RD. Long-term follow-up of periurethral collagen injections for male intrinsic deficiency. *J Urol* 1999;161:257.
406. Griebing TL, Kreder KJ Jr, Williams RD. Transurethral collagen injection for treatment of postprostatectomy urinary incontinence in men. *Urology* 1997;49:907-12.
407. Elsergany R, Ghoniem GM. Collagen injection for intrinsic sphincteric deficiency in men: a reasonable option in selected patients. *J Urol* 1998;159:1504-6.
408. Martins FE, Bennett CJ, Dunn M, Filho D, Keller T, Lieskovsky G. Adverse prognostic features of collagen injection therapy for urinary incontinence following radical retropubic prostatectomy. *J Urol* 1997;158(5):1745-9.
409. Torrey R, Rajeshuni N, Ruel N, Muldrew S, Chan K. Radiation history affects continence outcomes after advance transobturator sling placement in patients with post-prostatectomy incontinence. *Urology* 2013;82:713-7.
410. Bauer RM, Soljanik I, Fullhase C, Buchner A, May F, Stief CG, Gozi C. Results of the Advance transobturator male sling after radical prostatectomy and adjuvant radiotherapy. *Urology* 2011;77(2):474-9.
411. Habashy D, Losco G, Tse V, Collins R, Chan L. Mid-term outcomes of a male retro-urethral, transobturator synthetic sling for treatment of post-prostatectomy incontinence: Impact of radiotherapy and storage dysfunction. *Neurourol Urodyn* 2016 Jul 26. [Epub ahead of print]
412. Zuckerman JM, Tisdale B, McCammon K. Advance male sling in irradiated patients with stress urinary incontinence. *Can J Urol* 2011;18:6013-7.
413. Kretschmer A, Grabbert M, Sommer A, Stief CG, Bauer RM. Mid-term outcome after AdvanceXP male sling implantation. *BJU Int* 2016 Feb 25. [Epub ahead of print]
414. Hoda MR, Primus G, Fischereeder K, Von Heyden B, Mohammed N, Schmid N, et al. Early results of a European multicentre experience with a new self-anchoring adjustable transobturator system for treatment of stress urinary incontinence in men. *BJU Int* 2013;111(2):296-303.
415. Gregori A, Romano AL, Scieri F, et al. Transrectal ultrasound-guided implantation of Adjustable Continence Therapy (ProACT): surgical technique and clinical results after a mean follow-up of 2 years. *Eur Urol* 2010;57:430-6.
416. Kocjancic E, Crivellaro S, Ranzoni S, Bonvini D, Gontero P, Frea B. Adjustable Continence Therapy for the treatment of male stress urinary incontinence: a single-centre study. *Scand J Urol Nephrol* 2007;41:324-8.
417. Beyer C, Priestly JB. Biochemical disease-free survival following 1-125 prostate implantation. *Int J Radiat Oncol Biol Phys* 1995;32:254 (abstr.).
418. Blasko JC, Ragde H, Grimm PD. Transperineal ultrasound-guided implantation of the prostate: morbidity and complications. *Scand J Urol Nephrol Suppl* 1991;137:113-8.

419. Stock RG, Stone NN, Dewyngaert JK. PSA findings and biopsy results following interactive ultrasound guided transperineal brachytherapy for early stage prostate cancer. In: Proceedings of the American Radium Society 78th Annual Meeting; 1995; Paris, France; 1995. p. 58.
420. Wallner K, Roy J, Zelefsky M, Fuks Z, Harrison L. Fluoroscopic visualization of the prostatic urethra to guide transperineal prostate implantation. *Int J Radiat Oncol Biol Phys* 1994;29:863-7.
421. Kaye KW, Olson DJ, Payne JT. Detailed preliminary analysis of 125iodine implantation for localized prostate cancer using percutaneous approach. *J Urol* 1995;153:1020-5.
422. Blasko JC, Ragde H, Luse RW, Sylvester JE, Cavanagh W, Grimm PD. Should brachytherapy be considered a therapeutic option in localized prostate cancer? *Urol Clin North Am* 1996;23:633-50.
423. Hu K, Wallner K. Urinary incontinence in patients who have a TURP/TUIP following prostate brachytherapy. *Int J Radiat Oncol Biol Phys* 1998;40:783-6.
424. Benoit RM, Naslund MJ, Cohen JK. Complications after prostate brachytherapy in the Medicare population. *Urology* 2000;55:91-6.
425. Merrick GS, Butler WM, Lief JH, Dorsey AT. Temporal resolution of urinary morbidity following prostate brachytherapy. *Int J Radiat Oncol Biol Phys* 2000;47:121-8.
426. Crook J, Lukka H, Klotz L, Bestic N, Johnston M. Systematic overview of the evidence for brachytherapy in clinically localized prostate cancer. *CMAJ* 2001;164(7):975-81.
427. Talcott JA, Clark JA, Stark PC, Mitchell SP. Long-term treatment related complications of brachytherapy for early prostate cancer: a survey of patients previously treated. *J Urol* 2001;166:494-9.
428. Bottomley D, Ash D, Al-Qaisieh B, et al. Side effects of permanent I125 prostate seed implants in 667 patients treated in Leeds. *Radiother Oncol* 2007;82:46-9.
429. Barkati M, Williams SG, Foroudi F, et al. High-dose-rate brachytherapy as a monotherapy for favorable-risk prostate cancer: a Phase II trial. *Int J Radiat Oncol Biol Phys* 2012;82:1889-96.
430. Mock S, Leapman M, Stock RG, Hall SJ, Stone NN. Risk of urinary incontinence following post-brachytherapy transurethral resection of the prostate and correlation with clinical and treatment parameters. *J Urol* 2013;190:1805-10.
431. Petit JH, Gluck C, Kiger WS 3rd, Laury Henry D, Karasiewicz C, Talcott JA, Berg S, Holupka EJ, Kaplan ID. Androgen deprivation-mediated cy-toreduction before interstitial brachytherapy for prostate cancer does not abrogate the elevated risk of urinary morbidity associated with larger initial prostate volume. *Brachytherapy* 2007;6(4):267-71.
432. Zaid UB, McAninch JW, Glass AS, Cinman NM, Breyer BN. Presentation, management, and outcomes of complications following prostate cancer therapy. *Translational andrology and urology* 2014;3:150-5.
433. Grills IS, Martinez AA, Hollander M, Huang R, Goldman K, Chen PY, Gustafson, GS. High dose rate brachytherapy as prostate cancer monotherapy reduces toxicity compared to low dose rate palladium seeds. *J Urol* 2004;171(3):1098-104.
434. Zilli T, Benz E, Dipasquale G, Rouzaud M, Miralbell R. Reirradiation of prostate cancer local failures after previous curative radiation therapy: long-term outcome and tolerance. *Int J Radiat Oncol Biol Phys* 2016 May 28. [Epub ahead of print].
435. Shinohara K, Connolly JA, Presti JC, Jr., Carroll PR. Cryosurgical treatment of localized prostate cancer (stages T1 to T4): preliminary results. *J Urol* 1996;156:115-20.
436. Bahn DK, Lee F, Solomon MH, Gontina H, Klionsky DL, Lee FT, Jr. Prostate cancer: US-guided percutaneous cryoablation. Work in progress. *Radiology* 1995;194:551-6.
437. Cox RL, Crawford ED. Complications of cryosurgical ablation of the prostate to treat localized adenocarcinoma of the prostate. *Urology* 1995;45:932-5.
438. Wieder J, Schmidt JD, Casola G, vanSonnenberg E, Stainken BF, Parsons CL. Transrectal ultrasound-guided transperineal cryoablation in the treatment of prostate carcinoma: preliminary results. *J Urol* 1995;154:435-41.
439. Cohen JK, Miller RJ, Rooker GM, Shuman BA. Cryosurgical ablation of the prostate: two-year prostate-specific antigen and biopsy results. *Urology* 1996;47:395-401.
440. Coogan CL, McKiel CF. Percutaneous cryoablation of the prostate: preliminary results after 95 procedures. *J Urol* 1995;154:1813-7.
441. Sosa ER, Martin T, Lynn K. Cryosurgical treatment of prostate cancer: a multicenter review of compilations. *J Urol* 1996;155:361.

442. Long JP, Fallick ML, LaRock DR, Rand W. Preliminary outcomes following cryosurgical ablation of the prostate in patients with clinically localized prostate carcinoma. *J Urol* 1998;159:477-84.
443. Pisters LL, von Eschenbach AC, Scott SM, et al. The efficacy and complications of salvage cryotherapy of the prostate. *J Urol* 1997;157:921-5.
444. Derakhshani P, Neubauer S, Braun M, Zumbe J, Heidenreich A, Engelmann U. Cryoablation of localized prostate cancer. Experience in 48 cases, PSA and biopsy results. *Eur Urol* 1998;34:181-7.
445. Long JP, Bahn D, Lee F, Shinohara K, Chinn DO, Macaluso JN, Jr. Five-year retrospective, multi-institutional pooled analysis of cancer-related outcomes after cryosurgical ablation of the prostate. *Urology* 2001;57:518-23.
446. de la Taille A, Hayek O, Benson MC, et al. Salvage cryotherapy for recurrent prostate cancer after radiation therapy: the Columbia experience. *Urology* 2000;55:79-84.
447. Robinson JW, Donnelly BJ, Coupland K, et al. Quality of life 2 years after salvage cryosurgery for the treatment of local recurrence of prostate cancer after radiotherapy. *Urol Oncol* 2006;24:472-86.
448. Dhar N, Ward JF, Cher ML, Jones JS. Primary full-gland prostate cryoablation in older men (> age of 75 years): results from 860 patients tracked with the COLD Registry. *BJU Int* 2011;108:508-12.
449. Siddiqui KM, Billia M, Al-Zahrani A, Williams A, Goodman C, Arifin A, Violette P, Bauman G, Chil JL. Long-term oncologic outcomes of salvage cryoablation for radio-recurrent prostate cancer. *J Urol* 2016 May 6. [Epub ahead of print].
450. Izawa JI, Ajam K, McGuire E, Scott S, von Eschenbach AC, Skibber J, Pisters LL. Major surgery to manage definitively severe complications of salvage cryotherapy for prostate cancer. *J Urol* 2000;164(6):1978-81.
451. Chapelon JY, Margonari J, Vernier F, Gorry F, Ecochard R, Gelet A. In vivo effects of high-intensity ultrasound on prostatic adenocarcinoma Dunning R3327. *Cancer Res* 1992;52(22):6353-7.
452. Rebillard X, Soulie M, Chartier-Kastler E, et al. High-intensity focused ultrasound in prostate cancer; a systematic literature review of the French Association of Urology. *BJU Int* 2008;101:1205-13.
453. Siddiqui KM, Billia M, Arifin A, Li F, Violette P, Chin JL. Pathologic, oncologic and functional outcomes of a prospective registry of salvage high intensity focused ultrasound ablation for radio-recurrent prostate. *J Urol* 2016 Jul 12. [Epub ahead of print].
454. Cordeiro ER, Cathelineau X, Thüroff S, Marberger M, Crouzet S, de la Rosette JJ. High-intensity focused ultrasound (HIFU) for definitive treatment of prostate cancer. *BJU Int* 2012;110(9):1228-42.
455. Dickinson L., Arya M, Afzal N, Cathcart P, Charman SC, Cornaby A, Hindley RG, Lewi H, McCartan N, Moore CM, et al. Medium-term outcomes after whole-gland high-intensity focused ultrasound for the treatment of nonmetastatic prostate cancer from a multicentre registry cohort. *Eur Urol* 2016 Mar 4. [Epub ahead of print].
456. Alcini E, Racioppi M, D'Addessi A, Menchinelli P, Grasseti F, Alcini A. Bladder replacement by detubularized ileal loop: 10 years of experience using a personal technique. *Br J Urol* 1996;77:688-93.
457. Cancrini A, De Carli P, Pompeo V, et al. Lower urinary tract reconstruction following cystectomy: experience and results in 96 patients using the orthotopic ileal bladder substitution of Studer et al. *Eur Urol* 1996;29:204-9.
458. Elmajian DA, Stein JP, Skinner DG. Orthotopic urinary diversion: the Kock ileal neobladder. *World J Urol* 1996;14:40-6.
459. Studer UE, Danuser H, Hochreiter W, Springer JP, Turner WH, Zingg EJ. Summary of 10 years' experience with an ileal low-pressure bladder substitute combined with an afferent tubular isoperistaltic segment. *World J Urol* 1996;14:29-39.
460. Benson MC, Seaman EK, Olsson CA. The ileal ureter neobladder is associated with a high success and a low complication rate. *J Urol* 1996;155:1585-8.
461. Abol-Enein H, Ghoneim MA. Further clinical experience with the ileal W-neobladder and a serous-lined extramural tunnel for orthotopic substitution. *Br J Urol* 1995;76:558-64.
462. Rogers E, Scardino PT. A simple ileal substitute bladder after radical cystectomy: experience with a modification of the Studer pouch. *J Urol* 1995;153:1432-8.
463. Hautmann RE, Miller K, Steiner U, Wenderoth U. The ileal neobladder: 6 years of experience with more than 200 patients. *J Urol* 1993;150:40-5.

464. Hautmann RE, de Petriconi R, Gottfried HW, Kleinschmidt K, Mattes R, Paiss T. The ileal neobladder: complications and functional results in 363 patients after 11 years of followup. *J Urol* 1999;161:422-7.
465. Steven K, Poulsen AL. The orthotopic Kock ileal neobladder: functional results, urodynamic features, complications and survival in 166 men. *J Urol* 2000;164:288-95.
466. Abol-Enein H, Ghoneim MA. Functional results of orthotopic ileal neobladder with serous-lined extramural ureteral reimplantation: experience with 450 patients. *J Urol* 2001;165:1427-32
467. Carrion R, Arap S, Corcione G, et al. A multi-institutional study of orthotopic neobladders: functional results in men and women. *BJU Int* 2004;93:803-6.
468. Nieuwenhuijzen JA, de Vries RR, Bex A, et al. Urinary diversions after cystectomy: the association of clinical factors, complications and functional results of four different diversions. *Eur Urol* 2008;53:834-42.
469. Yadav SS, Gangkak G, Mathur R, Yadav RG, Tomar V. Long-term functional, urodynamic, and metabolic outcome of a modified orthotopic neobladder created with a short ileal segment: our 5-year experience. *Urology* 2016;94:167-72.
470. Clifford TG, Shah SH, Bazargani ST, Mirandi G, Cai J, Wayne K, Dialadat H, Schuckman AK, Daneshmand S. Prospective evaluation of continence following radical cystectomy and orthotopic urinary diversion using a validated questionnaire. *J Urol* 2016 May 30. [Epub ahead of print].
471. O'Connor RC, Kuznetsov DD, Patel RV, Galocy RM, Steinberg GD, Bales GT. Artificial urinary sphincter placement in men after cystectomy with orthotopic ileal neobladder: continence, complications, and quality of life. *Urology* 2002;59:542-5.
472. Simma-Chiang V, Ginsberg DA, Teruya KK, Boyd SD. Outcomes of artificial urinary sphincter placement in men after radical cystectomy and orthotopic urinary diversions for the treatment of stress urinary incontinence: the University of Southern California experience. *Urology* 2012;79:1397-401.
473. Vainrib M, Simma-Chiang V, Boyd SD, Ginsberg DA. Potential risk factors and outcomes of artificial urinary sphincter placement after radical cystectomy and orthotopic neobladder urinary diversion. *Neurourol Urodyn* 2013;32:1010-3.
474. Cerqueira M, Xambre L, Silva V, Santos R, Lages R, Prisco R, Carreira F. [Bulbourethral sling. The experience of our service]. *Actas Urol Esp* 2005;29(4):401-7.
475. Tchetgen MB, Sanda MG, Montie JE, Faerber GJ, English S. Collagen injection for the treatment of incontinence after cystectomy and orthotopic neobladder reconstruction in women. *J Urol* 2001;163:212 (Abstr).
476. Herschorn S, Thijssen A, Radomski SB. The value of immediate or early catheterization of the traumatized posterior urethra. *J Urol* 1992;148:1428-31.
477. Kotkin L, Koch MO. Impotence and incontinence after immediate realignment of posterior urethral trauma: result of injury or management? *J Urol* 1996;155:1600-3.
478. Raj GV, Peterson AC, Toh KL, Webster GD. Outcomes following revisions and secondary implantation of the artificial urinary sphincter. *J Urol* 2005;173:1242-5.
479. Mundy AR, Andrich DE. Pelvic fracture-related injuries of the bladder neck and prostate: their nature, cause and management. *BJU Int* 2010;105:1302-8 .
480. Iselin CE, Webster GD. The significance of the open bladder neck associated with pelvic fracture urethral distraction defects. *J Urol* 1999;162:347-51.
481. Jayanthi VR, Churchill BM, McLorie GA, Khoury AE. Concomitant bladder neck closure and Mitrofanoff diversion for the management of intractable urinary incontinence. *J Urol* 1995;154:886-8.
482. Meulen T, Zambon JV, Janknegt RA. Treatment of anastomotic strictures and urinary incontinence after radical prostatectomy with urolume wallstent and AMS 800 artificial sphincter. *J Endourol* 1999;13:517-20.
483. Elliott DS, Boone TB. Combined stent and artificial urinary sphincter for management of severe recurrent bladder neck contracture and stress incontinence after prostatectomy: a long-term evaluation. *J Urol* 2001;165:413-5.
484. Adamakis I, Fragkiadis E, Katafigiotis I, Koursounas G, Stravodimos K, Constantinides CA. A two staged treatment procedure for the difficult to treat bladder neck contractures with concomitant incontinence. In the search of a solution to a complex problem. *Arch Ital Urol Androl* 2015;87(3):233-7.

485. Simonato A, Gregori A., Lissiani A, Carmignani G. Two-stage transperineal management of posterior urethral strictures or bladder neck contractures associated with urinary incontinence after prostate surgery and endoscopic treatment failures. *Eur Urol* 2007;52:1499-504.
486. Patil MB, Hannoun D, Reyblat P, Boyd SD. Total bladder and posterior urethral reconstruction: salvage technique for defunctionalized bladder with recalcitrant posterior urethral stenosis. *J Urol* 2015;193:1649-54.
487. Palmer DA, Buckley JC, Zinman LN, Vanni AJ. Urethroplasty for high risk, long segment urethral strictures with ventral buccal mucosa graft and gracilis muscle flap. *J Urol* 2015;193:902-5.
488. Hipp J, Andersson K-E, Kwon TG, Kwak EK, Yoo J, Atala A. Microarray analysis of exstrophic human bladder smooth muscle. *Br J Urol Int* 2008; 101:100-5.
489. Shapiro E, Jeffs RD, Gearhart J, Lepor H. Muscarinic cholinergic receptors in bladder exstrophy: insights into surgical management. *J Urol* 1985; 134:308-10.
490. Rosch W, Christl A, Strauss B, Schrott KM, Neuhuber WL. Comparison of preoperative innervation pattern and postre-constructive urodynamics in the exstrophy-epispadias complex. *Urol Int* 1997;59(1):6-15.
491. Suson KD, Stec AA, Gearhart JP, Shimoda LA. Transforming growth factor-beta1 mediates migration in cultured human control and exstrophy bladder smooth muscle cells. *J Urol* 2012;188(4 Suppl):1528-33.
492. Suson KD, Stec AA, Shimoda LA, Gearhart JP. Initial characterization of ex-strophy bladder smooth muscle cells in cul-ture. *J Urol* 2012;188(4 Suppl):1521-7.
493. Orsola A, Estrada CR, Nguyen HT, Retik AB, Freeman MR, Peters CA et al. Growth and stretch response of human ex-strophy bladder smooth muscle cells: molec-ular evidence of normal intrinsic function. *Br J Urol Int* 2004;95:144-8.
494. Lais A, Paolucci N, Ferro F, Bosman C, Boldrini R, Caione P. Morphomet-ric analysis of smooth muscle in the exstro-phy-epispadias complex. *J Urol* 1996;156(2 Pt 2):819-21.
495. Puri A, Mishra K, Sikdar S, Unni KE, Jain AK. Vesical preservation in patients with late bladder exstrophy referral: histolog-ical insights into functional outcome. *J Urol* 2014;192(4):1208-14.
496. Wu R, Liu G, Bharadwaj S, Zhang Y. Isolation and myogenic differentia-tion of mesenchymal stem cells for urologic tissue engineering. *Methods Mol Biol* 2013;1001:65-80.
497. Stec AA, Pannu HK, Tadros YE, Sponsellar PD, Fishman EK, Gearhart JP. Pelvic floor anatomy in classic bladder ex-strophy using 3-dimensional computerized tomography: initial insights. *J Urol* 2001;166:1444-9.
498. Varma KK, Mammen A, Kolar Venkatesh SK. Mobilization of pelvic muscula-ture and its effect on continence in classical bladder exstrophy: a single-center experi-ence of 38 exstrophy repairs. *J Pediatr Urol* 2015;11(2):87-5.
499. Borer JG, Gargollo PC, Kinna-mon DD, Bauer SB, Khoshbin S, Hendren WH et al. Bladder growth and development after complete primary repair of bladder exstrophy in the newborn with comparison to the staged approach. *J Urol* 2005;174:1553-8.
500. Gearhart JP, Yang A, Leonard MP, Jeffs RD, Zerhouni EA. Prostate size and configuration in adults with bladder exstro-phy. *J Urol* 1993;149:308-10.
501. Lloyd JC, Spano SM, Ross SS, Wiener JS, Routh JC. How dry is dry? A re-view of definitions of continence in the con-temporary exstrophy/epispadias literature. *J Urol* 2012;188(5):1900-4.
502. Trendelenberg F. The treatment of ectopia vesicae. *Ann Surg* 1906;44:281-9.
503. Borer JG, Vasquez E, Canning DA, Kryger JV, Mitchell ME. An initial report of a novel multi-institutional bladder exstrophy consortium: a collaboration focused on pri-mary surgery and subsequent care. *J Urol* 2015;193(5 Suppl):1802-7.
504. Ben-Chaim J, Binyamini Y, Segev E, Sofer M, Bar-Yosef Y. Can classic bladder exstrophy be safely and successfully reconstructed at a low volume center? *J Urol* 2016; 195(1):150-4.
505. Prasad MM, Marks A, Vasquez E, Yerkes EB, Cheng EY. Published surgical success rates in pediatric urology--fact or fic-tion? *J Urol* 2012;188(4 Suppl):1643-7.
506. Oesterling JE, Jeffs RD. The importance of a successful initial bladder clo-sure in the surgical management of classical bladder exstrophy: analysis of 144 patients treated at the Johns Hopkins Hospital be-tween 1975 and 1985. *J Urol.* 1987;137(2):258-62.
507. Grady RW, Mitchell ME. Com-plete primary repair of exstrophy. *J Urol* 1999;162:1415-20.

508. Gargollo P, Hendren WH, Diamond DA, Pen-nison M, Grant R, Rosoklija I et al. Bladder neck reconstruction is often nec-essary after com-plete primary repair of ex-strophy. *J Urol* 2011;185(6 Suppl):2563-71.
509. Jarzebowski AC, McMullin MD, Grover SR, Southwell BR, Hutson JM. The Kelly technique of bladder exstrophy repair: continence, cos-mesis and pelvic organ pro-lapse outcomes. *J Urol* 2009;182:1802-6.
510. Woodhouse CRJ, Redgrave NG. Late failure of the reconstructed exstro-phy bladder. *Br J Urol* 1996;77:590-2.
511. Gupta AD, Goel SK, Wood-house CR, Wood D. Examining long-term outcomes of bladder ex-strophy: a 20-year fol-low-up. *BJU Int* 2014;113(1):137-41.
512. Taskinen S, Suominen JS. Lower urinary tract symptoms (LUTS) in pa-tients in adulthood with bladder exstrophy and epispadias. *BJU Int* 2013;111(7):1124-9.
513. Yerkes EB, Adams MC, Rink RC, Pope JC, Brock JW. How well do patients with exstrophy actually void? *J Urol* 2000;164:1044-7.
514. Stec AA, Baradaran N, Gearhart JP. Congeni-tal renal anomalies in patients with classic blad-der exstrophy. *Urology* 2012;79(1):207-9.
515. Turner WR, Ransley P, Wil-liams DI. Patterns of renal damage in the management of vesical exstrophy. *J Urol* 1980;124:412-6.
516. Schaeffer AJ, Stec AA, Bara-daran N, Gearhart JP, Mathews RI. Preserva-tion of renal function in the modern staged repair of classic bladder exstrophy. *J Pediatr Urol* 2013;9(2):169-73.
517. Bolduc S, Capolicchio G, Upadhyay J, Bagli DJ, Khoury AE, McLorie GA. The fate of the up-per urinary tract in ex-strophy. *J Urol* 2002;168(6):2579-82.
518. Cooley WC, SagermanPJ. Sup-ported the health care transition from ado-lescence to adulthood in the medical home. *Pediatrics* 2011;128(1):182-200.
519. Viner RM. Adolescents' health needs: the same the world over. *Arch Dis Child* 2013;98(1):2.
520. Szymanski KM, Misseri R, Whit-tam B, Large T, Cain MP. Current opinions regarding care of the mature pediatric urolo-gy patient. *J Pediatr Urol* 2015;11(5):251.e1-4.
521. Dave S, Grover VP, Agarwala S, Mitra DK, Bhatnagar V. Cystometric evaluation of recon-structed classical bladder exstrophy. *BJU Int* 2001;88(4):403-8.
522. Hollowell JG, Hill PD, Duffy PG, Ransley PG. Bladder function and dysfunc-tion in exstrophy and epispadias. *Lancet* 1991;338:926-8.
523. Dave S, Grover VP, Agarwala S, Mitra DK, Bhatnagar V. The role of imipramine therapy in bladder exstrophy after bladder neck recon-struction. *BJU Int* 2002;89(6):557-60.
524. Gearhart JP. The role of imipra-mine therapy in bladder exstrophy after blad-der neck recon-struction: Editorial comment. *BJU Int* 2002;89(6):560-1.
525. Alova I, Margaryan M, Verkarre V, Bernuy M, Lortat JS, Lottmann HB. Out-come of conti-nence procedures after failed endoscopic treat-ment with dextranomer-based implants (DEFLUX®). *J Pediatr Urol* 2012;8(1):40-6.
526. Burki T, Hamid R, Ransley PG, Mushtaq I, Duffy PG. Injectable polydime-thylsiloxane for treating incontinence in chil-dren with the ex-strophy-epispadias complex: long-term results. *BJU Int* 2006;98(4):849-53.
527. Shah BB, Massanyi EZ, Dicarlo H, Shear D, Kern A, Baradaran N et al. Role of urethral bulk-ing agents in epispadias-exstrophy complex patients. *J Pediatr Urol* 2014; 10(1):176-180.
528. Burki T, Hamid R, Duffy P, Ransley P, Wilcox D, Mushtaq I. Long-term followup of patients af-ter redo bladder neck reconstruction for bladder exstrophy com-plex. *J Urol* 2006;176(3):1138-41.
529. Grimsby GM, Menon V, Schlomer BJ, Baker LA, Adams R, Gargollo PC et al. Long-term out-comes of bladder neck reconstruction without augmentation cysto-plasty in children. *J Urol* 2016;195(1):155-61.
530. Ruiz E, Puigdevall J, Moldes J, et al. 14 years of experience with the artificial urinary sphincter in children and adolescents without spina bi-fida. *J Urol* 2006;176:1821-5.
531. Herndon CD, Rink RC, Shaw MB, Simmons GR, Cain MP, Kaefer M et al. The Indiana ex-perience with artificial urinary sphincters in chil-dren and young adults. *J Urol* 2003;169(2):650-4.
532. Gershbaum MD, Stock JA, Hanna MK. Gracilis muscle sling for select incontinent "bladder ex-strophy cripples". *J Urol* 2001;165(6 Pt 2):2422-4.
533. Lima SV, Araujo LA, Vilar FO. Further experi-ence with the periurethral ex-pander: a new type of artificial sphincter. *Br J Urol* 1997; 80(3):460-462.
534. Woodhouse CRJ, North A, Gearhart J. Stand-ing the test of time: a long term outcome of re-construction of the exstro-phy bladder. *World J Urol* 2006;24:244-9.

535. Rodo JS, Caceres FA, Lerena JR, Rossy E. Bladder augmentation and artificial sphincter implantation: urodynamic behavior and effects on continence. *J Pediatr Urol* 2008;4(1):8-13.
536. Schaefer M, Kaiser A, Stehr M, Beyer HJ. Bladder augmentation with small intestinal submucosa leads to unsatisfactory long-term results. *J Pediatr Urol* 2013;9(6 Pt A):878-83.
537. Hohenfellner R, Stein R. Primary urinary diversion in patients with bladder exstrophy. *Urology* 1996;48:828-30.
538. Gobet R, Weber D, Horst M, Yamamoto S, Fischer J. Long term followup (37-69 years) in patients with bladder exstrophy treated with ureterosigmoidostomy: psychosocial and psychosexual outcomes. *J Urol* 2010;182:1819-23.
539. Fisch M, Wammack R, Muller SC, Hohenfellner R. The Mainz pouch 2 (sigmoid-rectum pouch). *J Urol* 1993;149:258-63.
540. Alemu MH. Mainz II pouch: continent urinary diversion, for bladder extrophy epispadia complex and irreparable VVF: a 5 year comprehensive retrospective analysis. *Ethiop Med J* 2010;48(1):57-62.
541. Cairns SR, Scholefield JH, Steel RJ, et al. Guidelines for colorectal cancer screening and surveillance in moderate and high risk groups (update from 2002). *Gut* 2010 May;59(5):668-89.
542. Kavanagh A, Afshar K, Scott H, MacNeily AE. Bladder neck closure in conjunction with enterocystoplasty and Mitrofanoff diversion for complex incontinence: closing the door for good. *J Urol* 2012;188(4 Suppl):1561-5.
543. Deans R, Banks F, Liao LM, Wood D, Woodhouse C, Creighton SM. Reproductive outcomes in women with classic bladder exstrophy: an observational cross-sectional study. *Am J Obstet Gynecol* 2012; 206(6):496.
544. Baradaran N, Stec A, Wang MH, Cervellione RM, Luskin J, Gearhart JP. Urinary diversion in early childhood: indications and outcomes in the exstrophy patients. *Urology* 2012;80(1):191-5.
545. Abrams P, Cardozo L, Fall M, et al. The standardisation of terminology of lower urinary tract function: report from the Standardisation Subcommittee of the International Continence Society. *Neurourol Urodyn* 2002;21:167-78.
546. Ahlberg J, Edlund C, Wikkelso C, Rosengren L, Fall M. Neurological signs are common in patients with urodynamically verified "idiopathic" bladder overactivity. *Neurourol Urodyn* 2002;21:65-70.
547. Turner-Warwick R. Observations upon techniques for reconstruction of the urethral meatus, the hypospadiac glans deformity and the penile urethra. *Urol Clin North Am* 1979;6:643-55.
548. Abrams P. Bladder instability: concept, clinical associations and treatment. *Scand J Urol Nephrol Suppl* 1984;87:7-12.
549. Malone-Lee JG. New data on urodynamics in the symptomatic elderly. *Neurourol Urodyn* 1990;9:409.
550. Takahashi S, Kitamura T. Overactive bladder: magnetic vs electrical stimulation. *Curr Opin Obstet Gynecol* 2003;15:429-33.
551. Quek P. A critical review on magnetic stimulation: what is its role in the management of pelvic floor disorders? *Curr Opin Urol* 2005;15:231-5.
552. Bradshaw HD, Barker AT, Radley SC, Chapple CR. The acute effect of magnetic stimulation of the pelvic floor on involuntary detrusor activity during natural filling and overactive bladder symptoms. *BJU Int* 2003;91:810-3.
553. Almeida FG, Bruschini H, Srougi M. Urodynamic and clinical evaluation of 91 female patients with urinary incontinence treated with perineal magnetic stimulation: 1-year followup. *J Urol* 2004;171:1571-4.
554. Gilling PJ, Wilson LC, Westenberg AM, et al. A double-blind randomized controlled trial of electromagnetic stimulation of the pelvic floor vs sham therapy in the treatment of women with stress urinary incontinence. *BJU Int* 2009;103:1386-90.
555. Chai TC, Gray ML, Steers WD. The incidence of a positive ice water test in bladder outlet obstructed patients: evidence for bladder neural plasticity. *J Urol* 1998;160:34-8.
556. Cruz F, Guimaraes M, Silva C, Rio ME, Coimbra A, Reis M. Desensitization of bladder sensory fibers by intravesical capsaicin has long lasting clinical and urodynamic effects in patients with hyperactive or hypersensitive bladder dysfunction. *J Urol* 1997;157:585-9.
557. Kuo HC. Effectiveness of intravesical resiniferatoxin for anticholinergic treatment refractory detrusor overactivity due to nonspinal cord lesions. *J Urol* 2003;170:835-9.
558. Palma PCR, Thiel M, Riccetto CLZ, Dambros M, Miyaoka R, Rodriguez Netto Jr N. Resiniferatoxin for detrusor instability refractory to anticholinergics. *Int Brazilian J Urol* 2004;30:53-8.

559. Rios M, Mattos J, D., Panhoca R, al. e. Intravesical resiniferatoxin for the treatment of idiopathic detrusor overactivity in women: a randomized double-blind placebo controlled study. *Neurourol Urodyn* 2004;23:Abstr.
560. Silva C, Ribeiro MJ, Cruz F. The effect of intravesical resiniferatoxin in patients with idiopathic detrusor instability suggests that involuntary detrusor contractions are triggered by C-fiber input. *J Urol* 2002;168:575-9.
561. Kuo HC. Multiple intravesical instillation of low-dose resiniferatoxin is effective in the treatment of detrusor overactivity refractory to anticholinergics. *BJU Int* 2005;95:1023-7.
562. Kuo HC, Liu HT, Yang WC. Therapeutic effect of multiple resiniferatoxin intravesical instillations in patients with refractory detrusor overactivity: a randomized, double-blind, placebo controlled study. *J Urol* 2006;176:641-5.
563. Rios LA, Panhoca R, Mattos D, Jr., Srugi M, Bruschini H. Intravesical resiniferatoxin for the treatment of women with idiopathic detrusor overactivity and urgency incontinence: A single dose, 4 weeks, double-blind, randomized, placebo controlled trial. *Neurourol Urodyn* 2007;26:773-8.
564. Cruz F, Dinis P. Resiniferatoxin and botulinum toxin type A for treatment of lower urinary tract symptoms. *Neurourol Urodyn* 2007;26:920-7.
565. Yokoyama T, Nozaki K, Fujita O, Nose H, Inoue M, Kumon H. Role of C afferent fibers and monitoring of intravesical resiniferatoxin therapy for patients with idiopathic detrusor overactivity. *J Urol* 2004;172:596-600.
566. Fowler CJ. Bladder afferents and their role in the overactive bladder. *Urology* 2002;59:37-42.
567. Liu HT, Kuo HC. Increased expression of transient receptor potential vanilloid subfamily 1 in the bladder predicts the response to intravesical instillations of resiniferatoxin in patients with refractory idiopathic detrusor overactivity. *BJU Int* 2007;100:1086-90.
568. Silva C, Silva J, Castro H, et al. Bladder sensory desensitization decreases urinary urgency. *BMC Urology* 2007;7:9.
569. Apostolidis A, Gonzales GE, Fowler CJ. Effect of intravesical Resiniferatoxin (RTX) on lower urinary tract symptoms, urodynamic parameters, and quality of life of patients with urodynamic increased bladder sensation. *Eur Urol* 2006;50:1299-305.
570. Saitoh C, Chancellor MB, de Groat WC, Yoshimura N. Effects of intravesical instillation of resiniferatoxin on bladder function and nociceptive behavior in freely moving, conscious rats. *J Urol* 2008;179:359-64.
571. Cruz CD, Charrua A, Vieira E, Valente J, Avelino A, Cruz F. Intrathecal delivery of resiniferatoxin (RTX) reduces detrusor overactivity and spinal expression of TRPV1 in spinal cord injured animals. *Exp Neurol* 2008;214:301-8.
572. Hanna-Mitchell AT, Kashyap M, Chan WV, Andersson KE, Tannenbaum C. Pathophysiology of Idiopathic Overactive Bladder and the Success of Treatment: A Systematic Review from ICI-RS 2013. *Neurourol Urodyn* 2014; 33:611-7.
573. El-Azab AS, Moeen AM. The satisfaction of patients with refractory idiopathic overactive bladder with onabotulinumtoxinA and augmentation cystoplasty. *Arab J Urol* 2013;11:344-49.
574. Harper M, Popat RB, Dasgupta R, Fowler CJ, Dasgupta P. A minimally invasive technique for outpatient local anaesthetic administration of intradetrusor botulinum toxin in intractable detrusor overactivity. *BJU Int* 2003;92:325-6.
575. Loch A, Loch T, Osterhage J, al. e. Botulinum-A toxin detrusor injection in the treatment of non-neurogenic and neurologic cases of urge incontinence. *Eur Urol Suppl* 2003;2:172.
576. Radziszewski P, Borkowski A. Botulinum toxin type A intravesical injections for intractable bladder overactivity. *Eur Urol Suppl* 2002;1:174.
577. Rapp DE, Lucioni A, Katz EE, O'Connor RC, Gerber GS, Bales GT. Use of botulinum-A toxin for the treatment of refractory overactive bladder symptoms: an initial experience. *Urology* 2004;63:1071-5.
578. Kuo HC. Urodynamic evidence of effectiveness of botulinum A toxin injection in treatment of detrusor overactivity refractory to anticholinergic agents. *Urology* 2004;63:868-72.
579. Chancellor MB, O'Leary M, Erickson J, al. e. Successful use of bladder botulinum toxin injection to treat refractory overactive bladder. *J Urol* 2003;169 (suppl.):351 (Abstr. DP50).
580. Jeffery S, Fynes M, Lee F, Wang K, Williams L, Morley R. Efficacy and complications of intradetrusor injection with botulinum toxin A in patients with refractory idiopathic detrusor overactivity. *BJU Int* 2007;100:1302-6.
581. Kuschel S, Werner M, Schmid DM, Faust E, Schuessler B. Botulinum toxin-A for idiopathic overactivity of the vesical detrusor: a 2-year follow-up. *Int Urogynecol J Pelvic Floor Dysfunct* 2008;19:905-9.

582. Schmid DM, Saueremann P, Werner M, et al. Experience with 100 cases treated with botulinum-A toxin injections in the detrusor muscle for idiopathic overactive bladder syndrome refractory to anticholinergics. *J Urol* 2006;176:177-85.
583. Lee JC, Yokoyama T, Hwang HJ, et al. Clinical application of Clostridium botulinum type A neurotoxin purified by a simple procedure for patients with urinary incontinence caused by refractory detrusor overactivity. *FEMS Immunol Med Microbiol* 2007;51:201-11.
584. Popat R, Apostolidis A, Kalsi V, Gonzales G, Fowler CJ, Dasgupta P. A comparison between the response of patients with idiopathic detrusor overactivity and neurogenic detrusor overactivity to the first intradetrusor injection of botulinum-A toxin. *J Urol* 2005;174:984-9.
585. Rajkumar GN, Small DR, Mustafa AW, Conn G. A prospective study to evaluate the safety, tolerability, efficacy and durability of response of intravesical injection of botulinum toxin type A into detrusor muscle in patients with refractory idiopathic detrusor overactivity. *BJU Int* 2005;96:848-52.
586. Kuo HC. Comparison of effectiveness of detrusor, suburothelial and bladder base injections of botulinum toxin a for idiopathic detrusor overactivity. *J Urol* 2007;178:1359-63.
587. Ghalayini IF, Al-Ghazo MA. Intradetrusor injection of botulinum-A toxin in patients with idiopathic and neurogenic detrusor overactivity: urodynamic outcome and patient satisfaction. *Neurourol Urodyn* 2007;26:531-6.
588. Sahai A, Khan MS, Dasgupta P. Efficacy of botulinum toxin-A for treating idiopathic detrusor overactivity: results from a single center, randomized, double-blind, placebo controlled trial. *J Urol* 2007;177:2231-6.
589. Rackley R, Abdelmalak J. Urologic applications of botulinum toxin therapy for voiding dysfunction. *Curr Urol Rep* 2004;5:381-8.
590. Kessler TM, Danuser H, Schumacher M, Studer UE, Burkhard FC. Botulinum A toxin injections into the detrusor: an effective treatment in idiopathic and neurogenic detrusor overactivity? *Neurourol Urodyn* 2005;24:231-6.
591. Apostolidis A, Popat R, Yiangou Y, et al. Decreased sensory receptors P2X3 and TRPV1 in suburothelial nerve fibers following intradetrusor injections of botulinum toxin for human detrusor overactivity. *J Urol* 2005;174:977-82; discussion 82-3.
592. Giannantonio A, Conte A, Far-fariello V, Proietti S, Vianello A, Nardicchio V, Santonic G, Aman-tinic C. Onabotulinumtoxin-A intradetrusorial injections modulate bladder expression of NGF, TrkA, p75 and TRPV1 in patients with detrusor overactivity. *Pharmacol Res* 2013;68:118-24.
593. Wyndaele JJ, Van Dromme SA. Muscular weakness as side effect of botulinum toxin injection for neurogenic detrusor overactivity. *Spinal Cord* 2002;40:599-600.
594. Sinha D, Karri K, Arunkalaivanan AS. Applications of Botulinum toxin in urogynaecology. *Eur J Obstet Gynecol Reprod Biol* 2007;133:4-11.
595. De Laet K, Wyndaele JJ. Adverse events after botulinum A toxin injection for neurogenic voiding disorders. *Spinal Cord* 2005;43:397-9.
596. Pistolesi D, Selli C, Rossi B, Stampacchia G. Botulinum toxin type B for type A resistant bladder spasticity. *J Urol* 2004;171:802-3.
597. Reitz A, Schurch B. Botulinum toxin type B injection for management of type A resistant neurogenic detrusor overactivity. *J Urol* 2004;171:804; discussion -5.
598. Herschorn S, Gajewski J, Ethans K, et al. Efficacy of botulinum toxin A injection for neurogenic detrusor overactivity and urinary incontinence: a randomized, double-blind trial. *J Urol* 2011;185:2229-35.
599. Information for Healthcare Professionals: OnabotulinumtoxinA (marketed as Botox/Botox Cosmetic), AbobotulinumtoxinA (marketed as Dysport) and RimabotulinumtoxinB (marketed as Myobloc). 2011. (Accessed July 20, 2012, at <http://www.fda.gov/Drugs/DrugSafety/Post-marketDrugSafetyInformationforPatientsandProviders/DrugSafetyInformationforHealthcareProfessionals/ucm174949.htm>).
600. Denys P, Even-Schneider A, Thiry Escudie I, Ben Smail D, Ayoub N, Chartier-Kastler E. [Efficacy of botulinum toxin A for the treatment of detrusor hyperreflexia]. *Ann Readapt Med Phys* 2003;46:326-8.
601. Schulte-Baukloh H, Michael T, Sturzebecher B, Knispel HH. Botulinum-a toxin detrusor injection as a novel approach in the treatment of bladder spasticity in children with neurogenic bladder. *Eur Urol* 2003;44:139-43.
602. Riccabona M, Koen M, Schindler M, et al. Botulinum-A toxin injection into the detrusor: a safe alternative in the treatment of children with myelomeningocele with detrusor hyperreflexia. *J Urol* 2004;171:845-8; discussion 8.

603. Giannantoni A, Di Stasi SM, Stephen RL, Bini V, Costantini E, Porena M. Intravesical resiniferatoxin vs botulinum-A toxin injections for neurogenic detrusor overactivity: a prospective randomized study. *J Urol* 2004;172:240-3.
604. Schurch B, Corcos J. Botulinum toxin injections for paediatric incontinence. *Curr Opin Urol* 2005;15:264-7.
605. DasGupta R, Murphy FL. Botulinum toxin in paediatric urology: a systematic literature review. *Pediatr Surg Int* 2009;25:19-23.
606. Blackburn SC, Jones C, Bedoya S, Steinbrecher HA, Malone PS, Griffin SJ. Intravesical botulinum type-A toxin (Dysport) in the treatment of idiopathic detrusor overactivity in children. *J Pediatr Urol* 2013;9:750-3.
607. Kalsi V, Apostolidis A, Popat R, Gonzales G, Fowler CJ, Dasgupta P. Quality of life changes in patients with neurogenic vs idiopathic detrusor overactivity after intradetrusor injections of botulinum neurotoxin type A and correlations with lower urinary tract symptoms and urodynamic changes. *Eur Urol* 2006;49:528-35.
608. Game X, Khan S, Panicker JN, et al. Comparison of the impact on health-related quality of life of repeated detrusor injections of botulinum toxin in patients with idiopathic or neurogenic detrusor overactivity. *BJU Int* 2011;107:1786-92.
609. Khan S, Kessler TM, Apostolidis A, et al. What a patient with refractory idiopathic detrusor overactivity should know about botulinum neurotoxin type a injection. *J Urol* 2009;181:1773-8.
610. Mohee A, Khan A, Harris N, Eardley I. Long-term outcome of the use of in-travesical botulinum toxin for the treatment of overactive bladder (OAB). *BJU Int* 2012;111:106-13.
611. Malde S, Dowson C, Fraser O, Watkins J, Khan MS, Dasgupta P, Sahai A. Patient experience and satisfaction with Onabotulinumtoxin A for refractory overactive bladder. *BJU Int* 2015;116:443-9.
612. Abeywickrama L, Arunkalaivan-an A, Quinlan M. Repeated botulinum toxin type A (Dysport®) injections for women with intractable detrusor overactivity: a prospective outcome study. *Int Urogynecol J* 2014;25:601-5.
613. Veeratterapillay R, Harding C, Teo L, Vasdev N, Abroaf A, Dorkin TJ, Pickard RS, Hasan T, Thorpe AC. Discontinuation rates and inter-injection interval for repeated intravesical botulinum toxin type A injections for detrusor overactivity. *Int J Urol* 2014;21:175-8.
614. Santos-Silva A, da Silva CM, Cruz F. Botulinum toxin treatment for bladder dysfunction. *Int J Urol* 2013;20:956-2.
615. Kalsi V, Popat RB, Apostolidis A, et al. Cost-consequence analysis evaluating the use of botulinum neurotoxin-A in patients with detrusor overactivity based on clinical outcomes observed at a single UK centre. *Eur Urol* 2006;49:519-27.
616. Biers SM, Venn SN, Greenwell TJ. The past, present and future of augmentation cystoplasty. *BJU Int* 2012;109:1280-93.
617. Leong RK, de Wachter SG, Joore MA, van Kerrebroeck PE. Cost-effectiveness analysis of sacral neuromodulation and botulinum toxin A treatment for patients with idiopathic overactive bladder. *BJU Int* 2011;108:558-64.
618. Siddiqui NY, Amundsen CL, Visco AG, Myers ER, Wu JM. Cost-effectiveness of sacral neuromodulation vs intravesical botulinum A toxin for treatment of refractory urge incontinence. *J Urol* 2009;182:2799-804.
619. Watanabe JH, Campbell JD, Ravelo A, Chancellor MB, Kowalski J, Sullivan SD. Cost analysis of interventions for antimuscarinic refractory patients with overactive bladder. *Urology* 2010;76:835-40.
620. Hirst GR, Watkins AJ, Guerrero K, et al. Botulinum toxin B is not an effective treatment of refractory overactive bladder. *Urology* 2007;69:69-73.
621. Karsenty G, Elzayat E, Delapparent T, St-Denis B, Lemieux MC, Corcos J. Botulinum toxin type a injections into the trigone to treat idiopathic overactive bladder do not induce vesicoureteral reflux. *J Urol* 2007;177:1011-4.
622. Kuo HC. Bladder base/trigone injection is safe and as effective as bladder body injection of onabotulinumtoxinA for idiopathic detrusor overactivity refractory to antimuscarinics. *Neurourol Urodyn* 2011;30:1242-8.
623. Manecksha RP, Cullen IM, Ahmad S, et al. Prospective randomised controlled trial comparing trigone-sparing vs trigone-including intradetrusor injection of abobotulinumtoxinA for refractory idiopathic detrusor overactivity. *Eur Urol* 2012;61:928-35.
624. Mouracade P. Letter to the Editor. *Eur Urol* 2012; e 41.
625. Onyeka BA, Shetty A, Ilangovan K, Saxena A. Submucosal injections of botulinum toxin A in women with refractory idiopathic detrusor overactivity. *Int J Gynaecol Obstet* 2010;110:68-9.

626. Petrou SP, Parker AS, Crook JE, Rogers A, Metz-Kudashick D, Thiel DD. Botulinum a toxin/dimethyl sulfoxide bladder instillations for women with refractory idiopathic detrusor overactivity: a phase 1/2 study. *Mayo Clin Proc* 2009;84:702-6.
627. Le Maux AH, Pignol B, Behr-Roussel D, Blachon JL, Chabrier PE, Compagnie S, Picaut P, Bernabé J, Giuliano F, Denys P. Does reduction of number of intra-detrusor injection sites of aboBoNTA (Dysport®) impact efficacy and safety in a rat model of neurogenic detrusor overactivity? *Toxins* 2015;7:5462-71.
628. Jiang YH, Liao CH, Kuo HC. Current and potential urological applications of botulinum toxin A. *Nat Rev Urol* 2015;12: 519-33.
629. Kanagarajah P, Ayyathurai R, Caruso DJ, Gomez C, Gous AE. Role of botulinum toxin-A in refractory idiopathic overactive bladder patients without detrusor overactivity. *Int Urol Nephrol* 2012;44:91-7.
630. Smith CP, Radziszewski P, Borkowski A, Somogyi GT, Boone TB, Chancellor MB. Botulinum toxin a has antinociceptive effects in treating interstitial cystitis. *Urology* 2004;64:871-5; discussion 5.
631. Apostolidis A, Dasgupta P, Fowler CJ. Proposed mechanism for the efficacy of injected botulinum toxin in the treatment of human detrusor overactivity. *Eur Urol* 2006;49:644-50.
632. Kuo HC. Reduction of urgency severity is associated with long-term therapeutic effect after intravesical onabotulinumtoxin A injection for idiopathic detrusor overactivity. *Neurourol Urodyn* 2011;30:1497-502.
633. Sahai A, Dowson C, Khan MS, Dasgupta P. Re: Efficacy and complications of intradetrusor injection with botulinum toxin A in patients with refractory idiopathic detrusor overactivity. *BJU Int* 2008;101:515-6; author reply 6-7.
634. Wohlfarth K, Schwandt I, Wegner F, et al. Biological activity of two botulinum toxin type A complexes (Dysport and Botox) in volunteers: a double-blind, randomized, dose-ranging study. *J Neurology* 2008;255:1932-9.
635. Gomes CM, Castro Filho JE, Rejowski RF, et al. Experience with different botulinum toxins for the treatment of refractory neurogenic detrusor overactivity. *Int Braz J Urol* 2010;36:66-74.
636. Shenot PJ, Mark JR. Intradetrusor OnabotulinumtoxinA injection: How I do it? *Can J Urol* 2013;20:6649-55.
637. Alloussi SH, Lang C, Eichel R, et al. Videodynamic changes of botulinum toxin A in patients with neurogenic bladder dysfunction (NBD) and idiopathic detrusor overactivity (IDO) refractory to drug treatment. *World J Urol* 2012;30:367-73.
638. Malki M, Mangera A, Reid S, Inman R, Chapple C. What is the feasibility of switching to 200IU OnabotulinumtoxinA in patients with detrusor overactivity who have previously received 300IU? *Cent European J Urol* 2014;67:35-40.
639. Mangera A, Andersson KE, Apostolidis A, et al. Contemporary management of lower urinary tract disease with botulinum toxin A: a systematic review of botox (onabotulinumtoxinA) and dysport (abobotulinumtoxinA). *Eur Urol* 2011;60:784-95.
640. Shakeri S, Mohammadian R, Aminsharifi A, Ariafar A, Vaghedashti J, Yazdani M, Yadollahi M, Emadmarvasti V, Ba-harikhoob A. Success rate and patients' satisfaction following intradetrusor dysport injection in patients with detrusor overactivity: a comparative study of idiopathic and neurogenic types of detrusor overactivity. *Urol J* 2014;11:1289-95.
641. Liao CH, Kuo HC. Increased risk of large postvoid residual urine and decreased long-term success rate after intravesical OnabotulinumtoxinA injection for refractory idiopathic detrusor overactivity. *J Urol* 2013;189:1804-10.
642. Smaldone MC, Chancellor MB. Neuromodulation vs neurotoxin for the treatment of refractory detrusor overactivity: for neurotoxin. *Nat Clin Pract Urol* 2008;5:120-1.
643. Sahai A. A prospective study to evaluate the safety, tolerability, efficacy and durability of response of intravesical injection of botulinum toxin type A into detrusor muscle in patients with refractory idiopathic detrusor overactivity. *BJU Int* 2006;97:413.
644. Nitti VW. Botulinum toxin for the treatment of idiopathic and neurogenic overactive bladder: state of the art. *Rev Urol* 2006;8:198-208.
645. Patel AK, Patterson JM, Chapple CR. The emerging role of intravesical botulinum toxin therapy in idiopathic detrusor overactivity. *Int J Clin Pract Suppl* 2006:27-32.
646. Casanova N, McGuire E, Fenner DE. Botulinum toxin: a potential alternative to current treatment of neurogenic and idiopathic urinary incontinence due to detrusor overactivity. *Int J Gynaecol Obstet* 2006;95:305-11.
647. Patel AK, Patterson JM, Chapple CR. Botulinum toxin injections for neurogenic and idiopathic detrusor overactivity: A critical analysis of results. *Eur Urol* 2006;50:684-709

648. Patterson JM, Chapple CR. Botulinum toxin in urinary incontinence. *Curr Opin Urol* 2006;16:255-60.
649. Dmochowski R, Sand PK. Botulinum toxin A in the overactive bladder: current status and future directions. *BJU Int* 2007;99:247-62.
650. Apostolidis A, Fowler CJ. The use of botulinum neurotoxin type A (BoNTA) in urology. *J Neural Transm* 2008;115:593-605.
651. Ho MH, Lin LL, Haessler AL, Bhatia NN. Intra-vesical injection of botulinum toxin for the treatment of overactive bladder. *Curr Opin Obstet Gynecol* 2005;17:512-8.
652. Kim DK, Thomas CA, Smith C, Chancellor MB. The case for bladder botulinum toxin application. *Urol Clin North Am* 2006;33:503-10, ix.
653. MacDonald R, Fink HA, Huckabay C, Monga M, Wilt TJ. Botulinum toxin for treatment of urinary incontinence due to detrusor overactivity: a systematic review of effectiveness and adverse effects. *Spinal Cord* 2007;45:535-41.
654. Smith CP, Somogyi GT, Chancellor MB, Appell RA. A case for botulinum toxin-A in idiopathic bladder overactivity. *Curr Urol Rep* 2004;5:432-6.
655. Gomez CS, Kanagarajah P, Gousse A. The use of botulinum toxin a in idiopathic overactive bladder syndrome. *Curr Urol Rep* 2010;11:353-9.
656. Magera A, Chapple CR. Use of botulinum toxin in the treatment of lower urinary tract disorders. Current status. *Arch Esp Urol* 2010;63:829-41.
657. Amend B, Castro-Diaz D, Chartier-Kastler E, et al. [Second-line therapy of idiopathic detrusor overactivity. Sacral neuromodulation and botulinum toxin A]. *Urologe A* 2010;49:245-52.
658. Chancellor MB. Ten years single surgeon experience with botulinum toxin in the urinary tract; clinical observations and research discovery. *Int Urol Nephrol* 2010;42:383-91.
659. da Silva CM, Cruz F. Has botulinum toxin therapy come of age: what do we know, what do we need to know, and should we use it? *Curr Opin Urol* 2009;19:347-52.
660. Shaban AM, Drake MJ. Botulinum toxin treatment for overactive bladder: risk of urinary retention. *Curr Urol Rep* 2008;9:445-51.
661. Apostolidis A, Dasgupta P, Denys P, et al. Recommendations on the use of botulinum toxin in the treatment of lower urinary tract disorders and pelvic floor dysfunctions: a European consensus report. *Eur Urol* 2009;55:100-19.
662. Schmid DM, Roy S, Sulser T, Scheiner D. Prospects and limitations of treatment with botulinum neurotoxin type A for patients with refractory idiopathic detrusor overactivity. *BJU Int* 2008;102 Suppl 1:7-10.
663. Magera A, Apostolidis A, Andersson KE, Dasgupta P, Giannantonio A, Roehrborn C, Novara G, Chapple C. An up-dated systematic review and statistical comparison of standardised mean outcomes for the use of botulinum toxin in the management of lower urinary tract disorders. *Eur Urol* 2014;65:981-90.
664. Orasanu B, Mahajan ST. The use of botulinum toxin for the treatment of overactive bladder syndrome. *Indian J Urol* 2013;29:2-11.
665. Seth J, Khan MS, Dasgupta P, Sahai A. Botulinum toxin—what urologic uses does the data support? *Curr Urol Rep* 2013;14:227-34.
666. Seth JH, Dowson C, Khan MS, Panicker JN, Fowler CJ, Dasgupta P, Sahai A. Botulinum toxin-A for the treatment of overactive bladder: UK contributions. *J Clin Urol* 2013;6(2):77-83.
667. Chancellor MB, Elovic E, Es-quenazi A, Naumann M, Segal KR, Schiavo G, Smith CP, Ward AB. Evidence-based review and assessment of botulinum neurotoxin for the treatment of urologic conditions. *Toxicon* 2013; 67:129-40.
668. Kuo YC, Kuo HC. Botulinum toxin injection for lower urinary tract dysfunction. *Int J Urol* 2013;20:40-55.
669. Leicht W, Hampel C, Thüroff J. Botulinum toxin vs sacral neuromodulation for idiopathic detrusor overactivity. *Urologe* 2012;51:348-51.
670. Yokoyama T, Chancellor MB, Oguma K, Yamamoto Y, Suzuki T, Kumon H, Naga Ai. Botulinum toxin type A for the treatment of lower urinary tract disorders. *Int J Urol* 2012;19:202-15.
671. Jiménez-Cidrea MA, Arlandis-Guzmán S, en representación el Grupo Español para el uso de Toxina Botulínica en Urología (ALLURA). OnabotulinumtoxinA en vejiga hiperactiva: Recomendaciones de consenso basadas en la evidencia. *Actas Urol Esp.* 2015. <http://dx.doi.org/10.1016/j.acuro.2015.04.001>.
672. Wadie BS. Management of refractory OAB in the non-neurogenic patient. *Curr Urol Rep* 2014;15:438-43.
673. Duthie JB, Vincent M, Herbison GP, Wilson DI, Wilson D. Botulinum toxin injections for adults with overactive bladder syndrome. *Cochrane Database Syst Rev* 2011;12: CD005493.

674. Sahai A, Dowson C, Khan MS, Dasgupta P. Improvement in quality of life after botulinum toxin-A injections for idiopathic detrusor overactivity: results from a randomized double-blind placebo-controlled trial. *BJU Int* 2009;103:1509-15.
675. Rovner E, Kennelly M, Schulte-Baukloh H, Zhou J, Haag-Molkenteller C, Dasgupta P. Urodynamic results and clinical outcomes with intradetrusor injections of onabotulinumtoxinA in a randomized, placebo-controlled dose-finding study in idiopathic overactive bladder. *Neurourol Urodyn* 2011;30:556-62.
676. Dmochowski R, Chapple C, Nitti VW, et al. Efficacy and safety of onabotulinumtoxinA for idiopathic overactive bladder: a double-blind, placebo controlled, randomized, dose ranging trial. *J Urol* 2010;184:2416-22.
677. Brubaker L, Richter HE, Visco A, et al. Refractory idiopathic urge urinary incontinence and botulinum A injection. *J Urol* 2008;180:217-22.
678. Carr LK. Botulinum toxin A should not be first-line therapy for overactive bladder. *Can Urol Assoc J* 2011;5(3):204-5.
679. Steele SS. Moving beyond ineffective medication for OAB. *Can Urol Assoc J* 2011;5(3):206.
680. Steele SS. Botulinum toxin A: First-line therapy for idiopathic detrusor overactivity. *Can Urol Assoc J* 2011;5(3):207-9.
681. Carr LK. More data are needed to use BTX A as first-line treatment. *Can Urol Assoc J* 2011;5(3):209.
682. Godec C, Cass AS, Ayala GF. Electrical stimulation for incontinence. Technique, selection, and results. *Urology* 1976;7:388-97.
683. Tanagho E. Concepts of neuromodulation. *Neurourol Urodyn* 1993;12:487-8.
684. Trsinar B, Kraij B. Maximal electrical stimulation in children with unstable bladder and nocturnal enuresis and/or daytime incontinence: a controlled study. *Neurourol Urodyn* 1996;15:133-42.
685. Primus G, Kramer G. Maximal external electrical stimulation for treatment of neurogenic or non-neurogenic urgency and/or urge incontinence. *Neurourol Urodyn* 1996;15:187-94.
686. Fall M. Does electrostimulation cure urinary incontinence? *J Urol* 1984;131:664-7.
687. McGuire EJ, Zhang SC, Horwinski ER, Lytton B. Treatment of motor and sensory detrusor instability by electrical stimulation. *J Urol* 1983;129:78-9.
688. Siegel SW, Richardson DA, Miller KL, et al. Pelvic floor electrical stimulation for the treatment of urge and mixed urinary incontinence in women. *Urology* 1997;50:934-40.
689. Merrill DC. The treatment of detrusor incontinence by electrical stimulation. *J Urol* 1979;122:515-7.
690. Nakamura M, Sakurai T, Tsujimoto Y, Tada Y. Bladder inhibition by electrical stimulation of the perianal skin. *Urol Int* 1986;41:62-3.
691. Nakamura M, Sakurai T, Sugao H, Sonoda T. Maximum electrical stimulation for urge incontinence. *Urol Int* 1987;42:285-7.
692. Caremel R, Damon H, Ruffion A, et al. Can sacral neuromodulation improve minor incontinence symptoms in doubly incontinent patients successfully treated for major incontinence symptoms? *Urology* 2012;79:80-5.
693. Dijkema HE, Weil EH, Mijs PT, Janknegt RA. Neuromodulation of sacral nerves for incontinence and voiding dysfunctions. Clinical results and complications. *Eur Urol* 1993;24:72-6.
694. Schmidt RA. Treatment of unstable bladder. *Urology* 1991;37:28-32.
695. van der Pal F, Heesakkers JP, Bemelmans BL. Current opinion on the working mechanisms of neuromodulation in the treatment of lower urinary tract dysfunction. *Curr Opin Urol* 2006;16:261-7.
696. Daneshgari F, Moy ML. Current indications for neuromodulation. *Urol Clin North Am* 2005;32:37-40, vi.
697. Leng WW, Chancellor MB. How sacral nerve stimulation neuromodulation works. *Urol Clin North Am* 2005;32:11-8.
698. Keppene V, Mozer P, Chartier-Kastler E, Ruffion A. [Neuromodulation in the management of neurogenic lower urinary tract dysfunction]. *Prog Urol* 2007;17:609-15.
699. Nakib N, Siegel S. Neuromodulation vs neurotoxin for the treatment of refractory detrusor overactivity: for neuromodulation. *Nat Clin Pract Urol* 2008;5:118-9.
700. van Kerrebroeck PE, van Voskuilen AC, Heesakkers JP, et al. Results of sacral neuromodulation therapy for urinary voiding dysfunction: outcomes of a prospective, worldwide clinical study. *J Urol* 2007;178:2029-34.
701. Al-zahrani AA, Elzayat EA, Gajewski JB. Long-term outcome and surgical interventions after sacral neuromodulation implant for lower urinary tract symptoms: 14-year experience at 1 center. *J Urol* 2011;185:981-6.

702. Oerlemans DJ, van Voskuilen AC, Marcelissen T, Weil EH, de Bie RA, Van Kerrebroeck PE. Is on-demand sacral neuromodulation in patients with OAB syndrome a feasible therapy regime? *Neurourol Urodyn* 2011;30:1493-6.
703. Bosch JL, Groen J. Sacral (S3) segmental nerve stimulation as a treatment for urge incontinence in patients with detrusor instability: results of chronic electrical stimulation using an implantable neural prosthesis. *J Urol* 1995;154:504-7.
704. Bosch JL, Groen J. Disappointing results of neuromodulation in men with urge incontinence due to detrusor instability. *Neurourol Urodyn* 1997;16:347-9.
705. Shaker HS, Hassouna M. Sacral nerve root neuromodulation: an effective treatment for refractory urge incontinence. *J Urol* 1998;159:1516-9.
706. Groen J, Ruud Bosch JL, van Mastrigt R. Sacral neuromodulation in women with idiopathic detrusor overactivity incontinence: decreased overactivity but unchanged bladder contraction strength and urethral resistance during voiding. *J Urol* 2006;175:1005-9.
707. Groenendijk PM, Lycklama a Nyeholt AA, Heesakkers JP, et al. Urodynamical evaluation of sacral neuromodulation for urge urinary incontinence. *BJU Int* 2008;101:325-9.
708. South MM, Romero AA, Jamison MG, Webster GD, Amundsen CL. Detrusor overactivity does not predict outcome of sacral neuromodulation test stimulation. *Int Urogynecol J Pelvic Floor Dysfunct* 2007;18:1395-8.
709. Groenendijk PM, Heesakkers JP, Lycklama ANAA. Urethral instability and sacral nerve stimulation—a better parameter to predict efficacy? *J Urol* 2007;178:568-72.
710. Hassouna MM, Siegel SW, Nyeholt AA, et al. Sacral neuromodulation in the treatment of urgency-frequency symptoms: a multicenter study on efficacy and safety. *J Urol* 2000;163:1849-54.
711. Edlund C, Hellstrom M, Peeker R, Fall M. First Scandinavian experience of electrical sacral nerve stimulation in the treatment of the overactive bladder. *Scand J Urol Nephrol* 2000;34:366-76.
712. Herbison GP, Arnold EP. Sacral neuromodulation with implanted devices for urinary storage and voiding dysfunction in adults. *Cochrane Database Syst Rev* 2009:CD004202.
713. Humphreys MR, Vandersteen DR, Slezak JM, et al. Preliminary results of sacral neuromodulation in 23 children. *J Urol* 2006;176:2227-31.
714. McAchran SE, Daneshgari F. Sacral neuromodulation in the older woman. *Clin Obstet Gynecol* 2007;50:735-44.
715. Schmidt RA, Jonas U, Oleson KA, et al. Sacral nerve stimulation for treatment of refractory urinary urge incontinence. Sacral Nerve Stimulation Study Group. *J Urol* 1999;162:352-7.
716. Weil EH, Ruiz-Cerda JL, Eerdmans PH, Janknegt RA, Bemelmans BL, van Kerrebroeck PE. Sacral root neuromodulation in the treatment of refractory urinary urge incontinence: a prospective randomized clinical trial. *Eur Urol* 2000;37:161-71.
717. Bosch JL, Groen J. Sacral nerve neuromodulation in the treatment of patients with refractory motor urge incontinence: long-term results of a prospective longitudinal study. *J Urol* 2000;163:1219-22.
718. Siegel SW, Catanzaro F, Dijkema HE, et al. Long-term results of a multicenter study on sacral nerve stimulation for treatment of urinary urge incontinence, urgency-frequency, and retention. *Urology* 2000;56:87-91.
719. Grunewald V, Hofner K, Thon WF, Kuczyk MA, Jonas U. Sacral electrical neuromodulation as an alternative treatment option for lower urinary tract dysfunction. *Restor Neurol Neurosci* 1999;14:189-93.
720. Aboseif S, Tamaddon K, Chalfin S, Freedman S, Kaptein J. Sacral neuromodulation as an effective treatment for refractory pelvic floor dysfunction. *Urology* 2002;60:52-6.
721. Hedlund H, Schultz A, Talseth T, Tonseth K, van der Hagen A. Sacral neuromodulation in Norway: clinical experience of the first three years. *Scand J Urol Nephrol Suppl* 2002:87-95.
722. Roupert M, Chartier-Kastler E, Almeras C, Ayoub N, Haertig A, Richard F. Sacral neuromodulation for refractory detrusor overactivity in women with an artificial urinary sphincter. *J Urol* 2004;172:236-9.
723. Groen J, Blok BF, Bosch JL. Sacral neuromodulation as treatment for refractory idiopathic urge urinary incontinence: 5-year results of a longitudinal study in 60 women. *J Urol* 2011;186:954-9.
724. Chartier-Kastler E, Ballanger P, Belas M, et al. [Sacral neuromodulation with InterStim system: Results from the French national register]. *Prog Urol* 2011;21:209-17.
725. Davis T, Makovey I, Guralnick ML, O'Connor RC. Sacral neuromodulation outcomes for the treatment of refractory idiopathic detrusor overactivity stratified by indication: Lack of anticholinergic efficacy vs in-tolerability. *Can Urol Assoc J* 2013;7(5-6):176-8.

726. Abrams P, Blaivas JG, Fowler CJ, et al. The role of neuromodulation in the management of urinary urge incontinence. *BJU Int* 2003;91:355-9.
727. Hussain Z, Harrison SC. Neuromodulation for lower urinary tract dysfunction--an update. *ScientificWorldJournal* 2007;7:1036-45.
728. Oerlemans DJ, van Kerrebroeck PE. Sacral nerve stimulation for neuromodulation of the lower urinary tract. *Neurourol Urodyn* 2008;27:28-33.
729. Diokno AC, Leu PB, Konstandt DB. A simplified method of implanting a neuromodulator device. *J Urol* 2003;169:1466-9.
730. Spinelli M, Malaguti S, Giardiello G, Lazzeri M, Tarantola J, Van Den Hombergh U. A new minimally invasive procedure for pudendal nerve stimulation to treat neurogenic bladder: description of the method and preliminary data. *Neurourol Urodyn* 2005;24:305-9.
731. Brazzelli M, Murray A, Fraser C. Efficacy and safety of sacral nerve stimulation for urinary urge incontinence: a systematic review. *J Urol* 2006;175:835-41.
732. Van Kerrebroeck PE, Marcelissen TA. Sacral neuromodulation for lower urinary tract dysfunction. *World J Urol* 2012;30:445-50.
733. Apostolidis A. Neuromodulation for intractable OAB. *Neurourol Urodyn* 2011;30:766-70.
734. Smits MA, Oerlemans D, Marcelissen TA, Van Kerrebroeck PE, De Wachter SG. Sacral neuromodulation in patients with idiopathic overactive bladder after initial botulinum toxin therapy. *J Urol*. 2013; 190:2148-52.
735. Swami KS, Feneley RC, Hammonds JC, Abrams P. Detrusor myectomy for detrusor overactivity: a minimum 1-year follow-up. *Br J Urol* 1998;81:68-72.
736. Leng WW, Blalock HJ, Fredriksson WH, English SF, McGuire EJ. Enterocystoplasty or detrusor myectomy? Comparison of indications and outcomes for bladder augmentation. *J Urol* 1999;161:758-63.
737. Kumar SP, Abrams PH. Detrusor myectomy: long-term results with a minimum follow-up of 2 years. *BJU Int* 2005;96:341-4.
738. Aslam MZ, Agarwal M. Detrusor myectomy: Long-term functional outcomes. *Int J Urol* 2012;19:1099-102.
739. Rocha FT, Bruschini H, Figueiredo JA, et al. Use of an inflatable silicone balloon improves the success rate of bladder autoaugmentation at long-term followup. *J Urol* 2011;185:2576-81.
740. Hasan ST, Marshall C, Robson WA, Neal DE. Clinical outcome and quality of life following enterocystoplasty for idiopathic detrusor instability and neurogenic bladder dysfunction. *Br J Urol* 1995;76:551-7.
741. McInerney PD, DeSouza N, Thomas PJ, Mundy AR. The role of urodynamic studies in the evaluation of patients with augmentation cystoplasties. *Br J Urol* 1995;76:475-8.
742. Bramble F. The clam cystoplasty. *Br J Urol* 1990;66:337-41.
743. Sethia KK, Webb RJ, Neal DE. Urodynamic study of ileocystoplasty in the treatment of idiopathic detrusor instability. *Br J Urol* 1991;67:286-90.
744. Mundy AR, Stephenson TP. "Clam" ileocystoplasty for the treatment of refractory urge incontinence. *Br J Urol* 1985;57:641-6.
745. Edlund C, Peeker R, Fall M. Clam ileocystoplasty: successful treatment of severe bladder overactivity. *Scand J Urol Nephrol* 2001;35:190-5.
746. Blaivas JG, Weiss J, Desai P, Flisser AJ, Stember D, Stahl P. Long-term followup of augmentation enterocystoplasty and continent diversion in patients with benign disease. *J Urol* 2005;173:1631-4.
747. Cheng KC, Kan CF, Chu PS, Man CW, Wong BT, Ho LY, Au WH. Augmentation cystoplasty: Urodynamic and metabolic outcomes at 10-year follow-up. *Int J Urol* 2015;22:1149-54.
748. Shokeir AA, Ibrahim AM, Hamid MY, Shalaby MA, Hussein HE, Badr M. Urinary bilharziasis in upper Egypt. I. A clinicopathological study. *East Afr Med J* 1972;49:298-311.
749. Smith RB, van Cangh P, Skinner DG, Kaufman JJ, Goodwin WE. Augmentation enterocystoplasty: a critical review. *J Urol* 1977;118:35-9.
750. Kerr WK, Gale GL, Peterson KS. Reconstructive surgery for genitourinary tuberculosis. *J Urol* 1969;101:254-66.
751. Zinman L, Libertino JA. Technique of augmentation cecocystoplasty. *Surg Clin North Am* 1980;60:703-10.
752. Dounis A, Abel BJ, Gow JG. Cecocystoplasty for bladder augmentation. *J Urol* 1980;123:164-7.
753. Lunghi F, Nicita G, Selli C, Rizzo M. Clinical aspects of augmentation enterocystoplasties. *Eur Urol* 1984;10:159-63.
754. Shawket TN, Muhsen J. Treatment of bilharzial-contracted bladder by ileocystoplasty or colcystoplasty. *J Urol* 1967;97:285-7.

755. Whitmore WF, 3rd, Gittes RF. Reconstruction of the urinary tract by cecal and ileocecal cystoplasty: review of a 15-year experience. *J Urol* 1983;129:494-8.
756. Chan SL, Ankenman GJ, Wright JE, McLoughlin MG. Cecocystoplasty in the surgical management of the small contracted bladder. *J Urol* 1980;124:338-40.
757. Shirley SW, Mirelman S. Experiences with colcystoplasties, cecocystoplasties and ileocystoplasties in urologic surgery: 40 patients. *J Urol* 1978;120:165-8.
758. Goodwin WE, Turner RD, Winter CC. Results of ileocystoplasty. *J Urol* 1958;80:461-6.
759. Winter CC, Goodwin WE. Results sigmoidocystoplasty. *J Urol* 1958;80:467-72.
760. Fall M, Nilsson S. Volume augmentation cystoplasty and persistent urgency. *Scand J Urol Nephrol* 1982;16:125-8.
761. Goldwasser B, Webster GD. Augmentation and substitution enterocystoplasty. *J Urol* 1986;135:215-24.
762. Weinberg AC, Boyd SD, Lieskovsky G, Ahlering TE, Skinner DG. The hemi-Kock augmentation ileocystoplasty: a low pressure anti-refluxing system. *J Urol* 1988;140:1380-4.
763. Novak R. [Surgical treatment of contracted tuberculous bladder]. *Plucne Bolesti Tuberk* 1969;21:109-14.
764. Sayegh ES, Dimmette RM. The fibrotic contracted urinary bladder associated with schistosomiasis and chronic ulceration: a clinicopathological study including treatment. *J Urol* 1956;75:671-9.
765. Beduk Y, Anafarta K, Baltaci S, Adsan O, Iskit N. Urinary tract reconstruction in a patient with urethral stricture, contracted bladder and erectile impotence. *Int Urol Nephrol* 1994;26:173-8.
766. Kuo HC. Clinical outcome and quality of life after enterocystoplasty for contracted bladders. *Urol Int* 1997;58:160-5.
767. Kawamura S, Kumasaka K, Noro K, Aoki H, Kubo T, Abe T. [A case of replacement ileocystoplasty for contracted bladder]. *Hinyokika Kiyo* 1991;37:1049-52.
768. Hradec EA. Bladder substitution: indications and results in 114 operations. *J Urol* 1965;94:406-17.
769. Lima SV, Araujo LA, Montoro M, Maciel A, Vilar FO. The use of demucosalized bowel to augment small contracted bladders. *Br J Urol* 1998;82:436-9.
770. el Otmany A, Hamada H, al Bouzidi A, et al. [Squamous cell carcinoma in an augmentation of the ilial bladder for tuberculosis]. *Prog Urol* 1999;9:534-6.
771. Yamada Y, Takenaka A, Gotoh K, Yamanaka N. Augmentation ileocystoplasty and ileal ureter replacement for distal ureteral cancer in a patient with a contracted bladder. *Int J Urol* 1999;6:475-8.
772. Miyano G, Yamataka A, Okada Y, et al. Sigmoidocolocystoplasty for augmentation of iatrogenic small capacity bladder caused by direct injury to the bladder during inguinal hernia repair: long-term follow-up. *Pediatr Surg Int* 2004;20:61-4.
773. de Figueiredo AA, Lucon AM, Srougi M. Bladder augmentation for the treatment of chronic tuberculous cystitis. Clinical and urodynamic evaluation of 25 patients after long term follow-up. *Neurourol Urodyn* 2006;25:433-40.
774. Yashi M, Muraishi O, Kobayashi Y, Tokue A. Gastrocystoplasty in a woman with radiation-induced ureteral obstruction and low-compliance bladder. *Urol Int* 1998;61:55-7.
775. Lima SV, Araujo LA, Vilar Fde O, Lima RS, Lima RF. Nonsecretory intestinocystoplasty: a 15-year prospective study of 183 patients. *J Urol* 2008;179:1113-6.
776. Singh V, Sinha RJ, Sankhwar SN, Sinha SM. Reconstructive surgery for tuberculous contracted bladder: experience of a center in northern India. *Int Urol Nephrol* 2011;43:423-30.
777. Jhang JF, Birder LA, Chancel-Ior MB, Kuo HC. Patient characteristics for different therapeutic strategies in the management ketamine cystitis. *Neurourol Urodyn*. 2016 Mar 21. doi: 10.1002/nau.22996. [Epub ahead of print].
778. Shakespeare D, Mitchell DM, Carey BM, et al. Recto-urethral fistula following brachytherapy for localized prostate cancer. *Colorectal Dis* 2007;9:328-31.
779. Tash JA, Eid JF. Urethrocutaneous fistula due to a retained ring of condom. *Urology* 2000;56(3):508.
780. Porter AT, Littrup P, Grignon D, al. e. Radiotherapy and Cryotherapy for Prostate Cancer. In: Walsh PC, Retik AB, Vaughan Jr ED, Wein AJ, eds. *Campbell's Urology*. 7th ed. Philadelphia: W.B. Saunders Co.; 1998:2605-6.
781. Thomas R, Davis R, Ahuja S. Toward out-patient radical prostatectomy: a cost effective cost management of patients with localized prostate cancer. *BJU Int* 1997;80:261.

782. Fahal AH, Sharfi AR, Sheik HE, el Hassan AM, Mahgoub ES. Internal fistula formation: an unusual complication of mycetoma. *Trans R Soc Trop Med Hyg* 1996;90:550-2.
783. Chiou RK, Anderson JC, Tran T, Patterson RH, Wobig R, Taylor RJ. Evaluation of urethral strictures and associated abnormalities using high-resolution and color Doppler ultrasound. *Urology* 1996;47:102-7.
784. Blandy JP, Singh M. Fistulae involving the adult male urethra. *Br J Urol* 1972;44:632-43.
785. Culp OS, Calhoon HW. A variety of rectourethral fistulas: experiences with 20 cases. *J Urol* 1964;91:560-71.
786. Endo M, Hayashi A, Ishihara M, et al. Analysis of 1,992 patients with anorectal malformations over the past two decades in Japan. Steering Committee of Japanese Study Group of Anorectal Anomalies. *J Pediatr Surg* 1999;34:435-41.
787. Rintala RJ, Lindahl HG. Posterior sagittal anorectoplasty is superior to sacroperineal-sacroabdominoperineal pull-through: a long-term follow-up study in boys with high anorectal anomalies. *J Pediatr Surg* 1999;34:334-7.
788. Maerzheuser S, Jenetzky E, Zwink N, Reutter H, Bartels E, Grasshoff-Derr S, Holland-Cunz S, Hosie S, Schmiedeke E, Schwarzer N, Szychalski N, Goetz G, Schmidt D. German network for congenital uro-rectal malformations: first evaluation and interpretation of postoperative urological complications in anorectal malformations. *Pediatr Surg Int*. 2011, 7(10):1085-9
789. Loran OB, Veliev EI, Sokolov EA, Dadashev EO, Guspanov RI. Rectourethral fistula after repeat transrectal prostate biopsy. *Urology* 2013, 82(3):118-9.
790. Benchekroun A, Lachkar A, Soumana A, et al. [Urethrorectal fistula. Report of 11 cases]. *Ann Urol (Paris)* 1999;33:93-6.
791. Smith AM, Veenema RJ. Management of rectal injury and rectourethral fistulas following radical retroperitoneal prostatectomy. *J Urol* 1972;108:778-9.
792. Roberts WB, Tseng K, Walsh PC, Han M. Critical appraisal of management of rectal injury during radical prostatectomy. *Urology* 2010;76:1088-91.
793. Thomas C, Jones J, Jager W, Hampel C, Thuroff JW, Gillitzer R. Incidence, clinical symptoms and management of rectourethral fistulas after radical prostatectomy. *J Urol* 2010;183:608-12.
794. Tiptaft RC, Motson RW, Costello AJ, Paris AM, Blandy JP. Fistulae involving rectum and urethra: the place of Parks's operations. *Br J Urol* 1983;55:711-5.
795. Noldus J, Graefen M, Huland H. An old technique for a new approach for repair of rectourinary fistulas. *J Urol* 1997;157(Suppl):1547.
796. Eastham JA, Scardino PT. Radical prostatectomy. In: Walsh PC, Retik AB, Vaughan Jr ED, Wein AJ, eds. *Campbell's Urology*. 7th ed. Philadelphia: W.B. Saunders Co.; 1997:2547-64.
797. Nyam DC, Pemberton JH. Management of iatrogenic rectourethral fistula. *Dis Colon Rectum* 1999;42:994-7.
798. Badalament RA, Bahn DK, Kim H, Kumar A, Bahn JM, Lee F. Patient-reported complications after cryoablation therapy for prostate cancer. *Urology* 1999;54:295-300.
799. Zippe CD. Cryosurgery of the prostate: techniques and pitfalls. *Urol Clin North Am* 1996;23:147-63.
800. Ismail M, Ahmed S, Kastner C, Davies J. Salvage cryotherapy for recurrent prostate cancer after radiation failure: a prospective case series of the first 100 patients. *BJU Int* 2007;100:760-4.
801. Montorsi F, Guazzoni G, Bergamaschi F, et al. Transrectal prostatic hyperthermia and advanced prostatic cancer: Clinical results of one year follow up. *Acta Urol Ital* 1992;6 (Suppl. 6):471-4.
802. Kleinberg L, Wallner K, Roy J, et al. Treatment-related symptoms during the first year following transperineal 125I prostate implantation. *Int J Radiat Oncol Biol Phys* 1994;28:985-90.
803. Fongler SA, Abcarian H. The York Mason approach to repair of iatrogenic rectourinary fistulae. *Am J Surg* 1997;173:213-7.
804. Larson DW, Chrouser K, Young-Fadok T, Nelson H. Rectal complications after modern radiation for prostate cancer: a colorectal surgical challenge. *J Gastrointest Surg* 2005;9:461-6.
805. Lane BR, Stein DE, Remzi FH, Strong SA, Fazio VW, Angermeier KW. Management of radiotherapy induced rectourethral fistula. *J Urol* 2006;175:1382-7.
806. Chrouser KL, Leibovich BC, Sweat SD, et al. Urinary fistulas following external radiation or permanent brachytherapy for the treatment of prostate cancer. *J Urol* 2005;173:1953-7.
807. Marguet C, Raj GV, Brashears JH, et al. Rectourethral fistula after combination radiotherapy for prostate cancer. *Urology* 2007;69:898-901.

808. Chang KM, Lee RC, Chiu AW, Wang JH, Chiang H. Malakoplakia of the prostate forming a fistulous tract to rectum: a case report. *Zhonghua Yi Xue Za Zhi (Taipei)* 1996;58:439-43.
809. Cools P, Vanderputte S, Van der Stighelen Y, Colemont L, Denis B. Rectourethral fistula due to Crohn's disease. *Acta Urol Belg* 1996;64:47-8.
810. Felipetto R, Vigano L, Cecchi M, Florentini L, Minervini R. Use of fibrin sealant in the treatment of prostatic cutaneous fistula in a case of *Pseudomonas* prostatitis. *Int Urol Nephrol* 1995;27:563-5.
811. Netsch C, Bach T, Gross E, Gross AJ. , Rectourethral fistula after high-intensity focused ultrasound therapy for prostate cancer and its surgical management. *Urology*.2011, 77(4):999-1004.
812. Buckley JC. Complications after radical prostatectomy: anastomotic stricture and rectourethral fistula. *Curr Opin Urol* 2011;21:461-4.
813. Lacarriere E, Suaud L, Caremel R, Rouache L, Tuech JJ, Pfister C. [Rectourethral fistulae: diagnosis and management. Review of the literature]. *Prog Urol* 2011;21:585-94.
814. Hanna JM, Turley R, Castleberry A, Hopkins T, Peterson AC, Mantyh C, Migaly J. Surgical management of complex rectourethral fistulas in irradiated and nonirradiated patients. *Dis Colon Rectum*.2014;57(9):1105-12.
815. Beddy D, Poskus T, Umbreit E, Larson DW, Elliott DS, Dozois EJ. Impact of radiotherapy on surgical repair and outcome in patients with rectourethral fistula. *Colorectal Dis*. 2013;15(12):1515-20.
816. Linder BJ, Umbreit EC, Larson D, Dozois EJ, Thapa P, Elliott DS. Effect of prior radiotherapy and ablative therapy on surgical outcomes for the treatment of rec-tourethral fistulas. *J Urol*. 2013;190(4):1287-91
817. Chun L, Abbas MA. Rec-tourethral fistula following laparoscopic radical prostatectomy. *Tech Coloproctol*. 2011;15(3):297-300.
818. al-Ali M, Kashmoula D, Saoud IJ. Experience with 30 posttraumatic rectourethral fistulas: presentation of posterior transsphincteric anterior rectal wall advancement. *J Urol* 1997;158:421-4.
819. Sa YL, Xu YM, Feng C, Ye XX, Song LJ. Three-dimensional spiral computed tomographic cysto-urethrography for post-traumatic complex posterior urethral strictures associated with urethral-rectal fistula. *J Xray Sci Tech*. 2013;21(1):133-9
820. Gibbons RP. Radical perineal prostatectomy. In: Walsh PC, Retik AB, Vaughan Jr ED, Wein AJ, eds. *Campbell's Urology*. 7th ed. Philadelphia: W.B. Saunders Co.; 1997:2589-603.
821. Turner-Warwick R. The use of the omental pedicle graft in urinary tract reconstruction. *J Urol* 1976;116:341-7.
822. Ryan JA, Jr., Beebe HG, Gibbons RP. Gracilis muscle flap for closure of rectourethral fistula. *J Urol* 1979;122:124-5.
823. Venable DD. Modification of the anterior perineal transanorectal approach for complicated prostatic urethrorectal fistula repair. *J Urol* 1989;142:381-4.
824. Rivera R, Barboglio PG, Hellinger M, Gousse AE. Staging rectourinary fistulas to guide surgical treatment. *J Urol* 2007;177:586-8.
825. Elliott SP, McAninch JW, Chi T, Doyle SM, Master VA. Management of severe urethral complications of prostate cancer therapy. *J Urol* 2006;176:2508-13.
826. Hechenbleikner EM, Buckley JC, Wick EC. Acquired rectourethral fistulas in adults: a systematic review of surgical re-pair techniques and outcomes. *Dis Colon Rectum*.2013 56(3):374-83
827. Young HH. Repair of rectourethral fistula. In: Young HH, Davis DM, eds. *Young's Practice of Urology*. Philadelphia: W.B. Saunders Co.; 1926:582.
828. Lewis LG. Repair of rectourethral fistulas. *J Urol* 1947;57:1173-81.
829. Goodwin WE, Turner RD, Winter CC. Rectourinary fistula: principles of management and a technique of surgical closure. *J Urol* 1958;80:246-54.
830. Youssef AH, Fath-Alla M, El-Kassaby AW. Perineal subcutaneous dartos pedicled flap as a new technique for repairing urethrorectal fistula. *J Urol* 1999;161:1498-500.
831. Ng L, Sorcini A, Mourtzinou A, et al. Management of the complex rectourinary fistula with buccal mucosal patch graft and muscle flap support. *J Urol* 2004;17 Suppl 4:62.
832. Pratap A, Agrawal CS, Pandit RK, Sapkota G, Anchal N. Factors contributing to a successful outcome of combined abdominal transpubic perineal urethroplasty for complex posterior urethral disruptions. *J Urol* 2006;176:2514-7.
833. Samplaski MK, Wood HM, Lane BR, Remzi FH, Lucas A, Angermeier KW. Functional and quality-of-life outcomes in patients undergoing transperineal repair with gracilis muscle interposition for complex rectourethral fistula. *Urology* 2011;77:736-41.

834. Selph JP, Madden-Fuentes R, Peterson AC, Webster GD, Lentz AC. Long-term artificial urinary sphincter outcomes following a prior rectourethral fistula repair. *Urology*. 2015;86(3):608-12.
835. Voelzke BB, McAninch JW, Breyer BN, Glass AS, Garcia-Aguilar J. Transperineal management for postoperative and radiation rectourethral fistulas. *J Urol*. 2013;189(3):966-71.
836. Kilpatrick FR, Thompson HR. Postoperative rectoprostatic fistula and closure by Kraske's approach. *Br J Urol* 1962;34:470-4.
837. Stephenson RA, Middleton RG. Repair of rectourinary fistulas using a posterior sagittal transanal transrectal (modified York-Mason) approach: an update. *J Urol* 1996;155:1989-91.
838. Kilpatrick FR, Mason AY. Postoperative rectoprostatic fistula. *Br J Urol* 1969;41:649-54.
839. Fournier R, Traxer O, Lande P, Tuech JJ, Vergos M. [Posterior trans-anal-sphincter approach in the management of urethro-prostate-rectal fistula]. *J Urol (Paris)* 1996;102:75-8.
840. Bukowski TP, Chakrabarty A, Powell IJ, Frontera R, Perlmutter AD, Montie JE. Acquired rectourethral fistula: methods of repair. *J Urol* 1995;153:730-3.
841. Dal Moro F, Mancini M, Pinto F, Zanovello N, Bassi PF, Pagano F. Successful repair of iatrogenic rectourinary fistulas using the posterior sagittal transrectal approach (York-Mason): 15-year experience. *World J Surg* 2006;30:107-13.
842. Erickson BA, Dumanian GA, Sisco M, Jang TL, Halverson AL, Gonzalez CM. Rectourethral fistula associated with two short segment urethral strictures in the anterior and posterior urethra: single-stage reconstruction using buccal mucosa and a radial forearm fasciocutaneous free flap. *Urology* 2006;67:195-8.
843. Lorente JA, Bielsa O, Rijo E, Frances A, Pera M, Arango O. Experience in the treatment of rectourethral fistulae after radical prostatectomy. *Arch Esp Urol* 2011;64:517-23.
844. Pera M, Alonso S, Pares D, et al. [Treatment of a rectourethral fistula after radical prostatectomy by York Mason posterior trans-sphincter exposure]. *Cirurgia Espanola* 2008;84:323-7.
845. Rouanne M, Vaessen C, Bitker MO, Chartier-Kastler E, Roupert M. Outcome of a modified York Mason technique in men with iatrogenic urethrorectal fistula after radical prostatectomy. *Dis Colon Rectum*. 2011;54(8):1008-13.
846. Kyrklund K, Pakarinen MP, Koi-vusalo A, Rintala RJ. Long-term bowel functional outcomes in rectourethral fistula treated with PSARP: controlled results after 4-29 years of follow-up: a single-institution, cross-sectional study. *J Pediatr Surg*. 2014;49(11):1635-42.
847. Forest S, Fassi Fehri H, Gla-chant S, Colombel M, Crouzet S, Ravier E, Gelet A, Martin X. [Management of rec-tourethral fistulas with the York Mason pro-cedure: surgical techniques and outcomes]. [French] *Prog Urol*. 2014;24(5):276-81.
848. Alam MM, Awal MA, Rasul MA, Rahman MM, Naser MF, Salam MA, Rahman MA. Surgical management of rectourethral fis-tula in different situations. *Mymensingh Med J*. 2014;23(1):75-80.
849. Pfalzgraf D, Isbarn H, Reiss P, Meyer-Moldenhauer WH, Fisch M, Dahlem R. Outcomes after recto-anastomosis fistula re-pair in patients who underwent radical pros-tatectomy for prostate cancer. *BJU Int*. 2014,113(4):568-73.
850. Vose SN. A technique for repair of recto-urethral fistula. *J Urol* 1949;61:790-4.
851. Parks AG, Motson RW. Peranal repair of rectoprostatic fistula. *Br J Surg* 1983;70:725-6.
852. Culkin DJ, Ramsey CE. Urethrorectal fistula: transanal, transsphincteric approach with locally based pedicle interposition flaps. *J Urol* 2003;169:2181-3.
853. Joshi HM, Vimalachandran D, Heath RM, Rooney PS. Management of iatrogenic rectourethral fistula by transanal rectal flap advancement. *Colorectal Dis* 2011;13(8):918-20.
854. Keller DS, Aboseif SR, Lesser T, Abbass MA, Tsay AT, Abbas MA. Algorithm-based multidisciplinary treatment approach for rectourethral fistula. *Int J Colorectal Dis* 2015;30(5):631-8.
855. Gecelter L. Transanorectal approach to the posterior urethra and bladder neck. *J Urol* 1973;109:1011-6.
856. Zinman L. The challenge of the complex rectourethral fistula: algorithm of management. *AUA News* 2003:47-8.
857. Wilbert DM, Buess G, Bichler KH. Combined endoscopic closure of rectourethral fistula. *J Urol* 1996;155:256-8.
858. Bardari F, D'Urso L, Muto G. Conservative treatment of iatrogenic urinary fistulas: the value of cyanoacrylic glue. *Urology* 2001;58:1046-8.

859. Pigalarga R, Patel NM, Rezac C. Transanal endoscopic microsurgery-assisted rectal advancement flap is a viable option for iatrogenic rectourethral fistula repair: a case report. *Tech Coloproctol* 2011;15:209-11.
860. Singh I, Mittal G, Kumar P, Gangas R. Delayed post-traumatic prostatic-urethrorectal fistula: transperineal rectal sparing repair - point of technique. *Int J Urol* 2006;13:92-4.
861. Kraske P. Zur Extirpation hochsitzender Mastdarmkrebs. *Verh Dtsch Ges Chir* 1885;14:464-74.
862. Hata F, Yasoshima T, Kitagawa S, et al. Transanal repair of rectourethral fistula after a radical retropubic prostatectomy: report of a case. *Surg Today* 2002;32:170-3.
863. Castillo OA, Bodden E, Vitagliano G. Management of rectal injury during laparoscopic radical prostatectomy. *Int Braz J Urol* 2006;32:428-33.
864. Quinlan M, Cahill R, Keane F, Grainger R, Butler M. Transanal endoscopic microsurgical repair of iatrogenic recto-urethral fistula. *Surgeon* 2005;3:416-7.
865. Bochove-Overgaauw DM, Beerlage HP, Bosscha K, Gelderman WA. Transanal endoscopic microsurgery for correction of rectourethral fistulae. *J Endourol* 2006;20:1087-90.
866. Varma MG, Wang JY, Garcia-Aguilar J, Shelton AA, McAninch JW, Goldberg SM. Dartos muscle interposition flap for the treatment of rectourethral fistulas. *Dis Colon Rectum* 2007;50:1849-55.
867. Venkatesh KS, Ramanujam P. Fibrin glue application in the treatment of recurrent anorectal fistulas. *Dis Colon Rectum* 1999;42:1136-9.
868. Verriello V, Altomare M, Masiello G, Curatolo C, Balacco G, Altomare DF. Treatment of post-prostatectomy rectourethral fistula with fibrin sealant (Quixil) injection: a novel application. *Tech Coloproctol* 2010;14:341-3.
869. Chirica M, Parc Y, Tiret E, Dehni N, McNamara D, Parc R. Coloanal sleeve anastomosis (Soave procedure): the ultimate treatment option for complex rectourinary fistulas. *Dis Colon Rectum* 2006;49:1379-83.
870. Lesser T, Aboseif S, Abbas MA. Combined endorectal advancement flap with Alloderm graft repair of radiation and cryoablation-induced rectourethral fistula. *Am Surg* 2008;74:341-5.
871. Muhlmann MD, Hayes JL, Merrie AE, Parry BR, Bissett IP. Complex anal fistulas: plug or flap? *ANZ J Surg* 2011;81(10):720-4.
872. Gonzalez-Contreras QH, Bahe-na-Aponte JA, Salinas-Aragon E, Jimenez-Gonzalez A, Gonzalez-Longoria G. Interposition of gracilis muscle for rectourethral fistula repair: case report. *Cir Cir* 2011;79(4):343-5.
873. Chen XB, Wang YX, Jiang H, Liao DX, Yu JH, Luo CH. Salvage irrigation-suction in gracilis muscle repair of complex rectovaginal and rectourethral fistulas. *World J Gastroenterol* 2013;19(39):6625-9.
874. Yo T, Kanematsu A, Hanasaki T, Nakanishi Y, Togo Y, Suzuki T, Higuchi Y, Nojima M, Yamamoto S, Okuyama H. An adult case of transperineal repair of congenital rec-tourethral fistula using gracilis muscle flap in-terposition. *Hinyokika Kyo* 2015;61(7):289-92.
875. Iwamoto Y, Kanda H, Tsujii M, Toiyama Y, Yamada Y, Soga N, Arima K, Sudo A, Kusunoki M, Sugimura Y. Pedicled vastus lateralis musculofascial flap as a new technique for repairing rectourethral fistula after radical prostatectomy. *Microsurgery* 2011;31(7):564-7.
876. Solomon MJ, Tan KK, Bromilow RG, Wong JC. Bilateral puborectalis interposition repair of rectourethral fistula. *Dis Colon Rectum* 2014;57(1):133-9.
877. Ganio E, Martina S, Novelli E, Sandru R, Clerico G, Realis Luc A, Trompetto M. Transperineal repair with bulbocavernosus muscle interposition for recto-urethral fistula. *Colorectal Dis*. 2013;15(3):138-43.
878. Lee KH, Lee MR, Pigazzi A. Robotic-assisted laparoscopic segmental resection with recto-anal anastomosis: a new approach for the management of complicated rectourethral fistula. *Tech Coloproctol* 2013;17(5):585-7.
879. Madjar S, Raz S, Gousse AE. Fixed and dynamic urethral compression for the treatment of post-prostatectomy urinary incontinence: is history repeating itself? *J Urol* 2001;166:411-5.
880. Scott FB, Bradley WE, Timm GW. Treatment of urinary incontinence by implantable prosthetic sphincter. *Urology* 1973;1:252-9.
881. Staerman F, C GL, Leon P, Leclerc Y. ZSI 375 artificial urinary sphincter for male urinary incontinence: a preliminary study. *BJU Int* 2013;111(4 Pt B):E202-6.
882. Kretschmer A, Hüscher T, Thomsen F, Kronlachner D, et al. Efficacy and safety of the ZSI375 artificial urinary sphincter for male stress urinary incontinence: lessons learned. *World J Urol* 2016 Feb 25. [Epub ahead of print]
883. Matsushita K, Chughtai BI, Maschino AC, Lee RK, Sandhu JS. International variation in artificial urinary sphincter use. *Urology* 2012;80:667-72.

884. Lee R, Te AE, Kaplan SA, Sandhu JS. Temporal trends in adoption of and indications for the artificial urinary sphincter. *J Urol* 2009;181:2622-7.
885. Oberlin DT, Liu JS, Hofer MD, Milose J, Matulewicz RS, Flury SC, Morey AF, Gonzalez CM. An analysis of case logs from American urologists in the treatment of Peyronie's disease. *Urology* 2016;87:205-9.
886. Biardeau X, Aharony S, AUA Consensus Group, Campeau L, Corcos J. Artificial urinary sphincter: report of the 2015 Consensus Conference. *Neurourol Urodyn* 2016 Apr;35 Suppl 2;S8-S24.
887. Reynolds WS, Patel R, Msezane L, Lucioni A, Rapp DE, Bales GT. Current use of artificial urinary sphincters in the United States. *J Urol* 2007;178:578-83.
888. Montague DK, Angermeier KW, Paolone DR. Long-term continence and patient satisfaction after artificial sphincter implantation for urinary incontinence after prostatectomy. *J Urol* 2001;166:547-9.
889. Walsh IK, Williams SG, Mahendra V, Nambirajan T, Stone AR. Artificial urinary sphincter implantation in the irradiated patient: safety, efficacy and satisfaction. *BJU Int* 2002;89:364-8.
890. Gomha MA, Boone TB. Voiding patterns in patients with post-prostatectomy incontinence: urodynamic and demographic analysis. *J Urol* 2003;169:1766-9.
891. ter Meulen PH, Zambon V, Kessels AG, van Kerrebroeck PE. Quality of life, functional outcome and durability of the AMS 800 artificial urinary sphincter in patients with intrinsic sphincter deficiency. *Urol Int* 2003;71:55-60.
892. Gonzalez R, Nguyen DH, Koleilat N, Sidi AA. Compatibility of enterocystoplasty and the artificial urinary sphincter. *J Urol* 1989;142:502-4.
893. Abdel-Azim MS, Abdel-Hakim AM. Gastrocystoplasty in patients with an areflexic low compliant bladder. *Eur Urol* 2003;44:260-5.
894. Catto JW, Natarajan V, Tophill PR. Simultaneous augmentation cystoplasty is associated with earlier rather than increased artificial urinary sphincter infection. *J Urol* 2005;173:1237-41.
895. Grein U, Meyer WW. Local recurrent cancer after radical prostatectomy and incontinence. Is the artificial urinary sphincter a useful therapeutic option? *Urol Int* 2001;66:9-12.
896. O'Connor RC, Nanigian DK, Patel BN, Guralnick ML, Ellison LM, Stone AR. Artificial urinary sphincter placement in elderly men. *Urology* 2007;69:126-8.
897. Ziegelmann MJ, Linder BJ, Rivera ME, Viers BR, Rangel LJ, Elliott DS. Outcomes of artificial urinary sphincter placement in octogenarians. *Intl J of Urol* 2016 May;23(5):419-23.
898. Raup VT, Eswara JR, Marshall SD, Vetter J, Brandes SB. Artificial urinary sphincters for treatment of urinary incontinence in elderly males. *Urol Int.* 2016;97(2):1-5.
899. Stone AR, Nguyen M, Tse V. Letter, re: New surgical technique for sphincterurinary control system using upper transverse scrotal incision. *J Urol* 2003;170:550-1.
900. Henry GD, Graham SM, Cleves MA, Simmons CJ, Flynn B. Perineal approach for artificial urinary sphincter implantation appears to control male stress incontinence better than the transscrotal approach. *J Urol* 2008;179:1475-9.
901. Kendirci M, Gupta S, Shaw K, et al. Synchronous prosthetic implantation through a transscrotal incision: an outcome analysis. *J Urol* 2006;175:2218-22.
902. Sellers CL, Morey AF, Jones LA. Cost and time benefits of dual implantation of inflatable penile and artificial urinary sphincter prosthetics by single incision. *Urology* 2005;65:852-3.
903. Simhan J, Morey AF, Singla N, Tausch TJ, Scott JF, Lemack GE, Roehrborn CG. .5cm artificial sphincter cuff erosion occurs predominantly in irradiated patients. *J Urol* 2015 Feb;193(2):593-7.
904. Murray KH, Nurse DE, Mundy AR. Detrusor behaviour following implantation of the Brantley Scott artificial urinary sphincter for neuropathic incontinence. *Br J Urol* 1988;61:122-8.
905. Light JK, Pietro T. Alteration in detrusor behavior and the effect on renal function following insertion of the artificial urinary sphincter. *J Urol* 1986;136:632-5.
906. Bauer SB, Reda EF, Colodny AH, Retik AB. Detrusor instability: a delayed complication in association with the artificial sphincter. *J Urol* 1986;135:1212-5.
907. Roth DR, Vyas PR, Kroovand RL, Perlmutter AD. Urinary tract deterioration associated with the artificial urinary sphincter. *J Urol* 1986;135:528-30.
908. Bitsch M, Nerstrom H, Nordling J, Hald T. Upper urinary tract deterioration after implantation of artificial urinary sphincter. *Scand J Urol Nephrol* 1990;24:31-4.
909. Churchill BM, Gilmour RF, Khoury AE, McLorie GA. Biological response of bladders rendered continent by insertion of artificial sphincter. *J Urol* 1987;138:1116-9.

910. Scott FB, Fishman IJ, Shabsigh R. The impact of the artificial urinary sphincter in the neurogenic bladder on the upper urinary tracts. *J Urol* 1986;136:636-42.
911. Warwick DJ, Abrams P. The perineal artificial sphincter for acquired incontinence--a cut and dried solution? *Br J Urol* 1990;66:495-9.
912. O'Flynn KJ, Thomas DG. Artificial urinary sphincter insertion in congenital neuropathic bladder. *Br J Urol* 1991;67:155-7.
913. Aprikian A, Berardinucci G, Pike J, Kiruluta G. Experience with the AS-800 artificial urinary sphincter in myelodysplastic children. *Can J Surg* 1992;35:396-400.
914. Simeoni J, Guys JM, Mollard P, et al. Artificial urinary sphincter implantation for neurogenic bladder: a multi-institutional study in 107 children. *Br J Urol* 1996;78:287-93.
915. Ghoniem GM, Lapeyrolerie J, Sood OP, Thomas R. Tulane experience with management of urinary incontinence after placement of an artificial urinary sphincter. *World J Urol* 1994;12:333-6.
916. Montague DK, Angermeier KW. Postprostatectomy urinary incontinence: the case for artificial urinary sphincter implantation. *Urology* 2000;55:2-4.
917. Petrou SP, Elliott DS, Barrett DM. Artificial urethral sphincter for incontinence. *Urology* 2000;56:353-9.
918. Bosch JL. The contemporary role of the artificial urinary sphincter. *Curr Opin Urol* 2000;10:219-23.
919. Fishman IJ, Shabsigh R, Scott FB. Experience with the artificial urinary sphincter model AS800 in 148 patients. *J Urol* 1989;141:307-10.
920. Light JK, Reynolds JC. Impact of the new cuff design on reliability of the AS800 artificial urinary sphincter. *J Urol* 1992;147:609-11.
921. Leibovich BC, Barrett DM. Use of the artificial urinary sphincter in men and women. *World J Urol* 1997;15:316-9.
922. Marks JL, Light JK. Management of urinary incontinence after prostatectomy with the artificial urinary sphincter. *J Urol* 1989;142:302-4.
923. Elliott DS, Barrett DM, Gohma M, Boone TB. Does nocturnal deactivation of the artificial urinary sphincter lessen the risk of urethral atrophy? *Urology* 2001;57:1051-4.
924. Bugeja S, Ivaz SL, Frost A, Andrach DE, Mundy AR. Urethral atrophy after implantation of an artificial urinary sphincter: fact or fiction? *BJU Int* 2016 Apr;117(4):669-76.
925. Smith DN, Fralick R, Appell RA. Incontinence after placement of a sphincter. *Urology* 1997;50:974.
926. Nurse DE, Mundy AR. One hundred artificial sphincters. *Br J Urol* 1988;61:318-25.
927. Webster GD, Sihelnik SA. Troubleshooting the malfunctioning Scott artificial urinary sphincter. *J Urol* 1984;131:269-72.
928. Flynn B, Webster GD. New advances in the treatment of post-prostatectomy incontinence. *Grand Rounds in Urology* 2003;3:9-15.
929. Hussain M, Greenwell TJ, Venn SN, Mundy AR. The current role of the artificial urinary sphincter for the treatment of urinary incontinence. *J Urol* 2005;174:418-24.
930. Decter RM, Roth DR, Fishman IJ, Shabsigh R, Scott FB, Gonzales ET, Jr. Use of the AS800 device in exstrophy and epispadias. *J Urol* 1988;140:1202-3.
931. Motley RC, Barrett DM. Artificial urinary sphincter cuff erosion. Experience with reimplantation in 38 patients. *Urology* 1990;35:215-8.
932. Lai HH, Boone TB. Complex artificial urinary sphincter revision and reimplantation cases--how do they fare compared to virgin cases? *J Urol* 2012;187:951-5.
933. Frank I, Elliott DS, Barrett DM. Success of de novo reimplantation of the artificial genitourinary sphincter. *J Urol* 2000;163:1702-3.
934. Martins FE, Boyd SD. Postoperative risk factors associated with artificial urinary sphincter infection-erosion. *Br J Urol* 1995;75:354-8.
935. Petrou SP, Thiel DD, Elliot DS, Broderick GA, Wehle MJ, Young PR. Does indigo carmine prevent early artificial urinary sphincter cuff erosion? *Can J Urol* 2006;13:3195-8.
936. Lai HH, Smith CP, Teh BS, Butler EB, Boone TB. Pelvic radiotherapy does not increase the complication rates of artificial urinary sphincter implantation. *Int J Radiat Oncol Biol Phys* 2003;57:S273.
937. Webster GD, Sherman ND. Management of male incontinence following artificial urinary sphincter failure. *Curr Opin Urol* 2005;15:386-90.
938. Bartoletti R, Gacci M, Travaglini F, Sarti E, Selli C. Intravesical migration of AMS 800 artificial urinary sphincter and stone formation in a patient who underwent radical prostatectomy. *Urol Int* 2000;64:167-8.
939. Laungani RG, Angermeier KW, Montague DK. Giant urethral diverticulum in an adult male: a complication of the artificial urinary sphincter. *J Urol* 2003;170:1307-8.

940. Linder BJ, Rivera ME, Ziegelmann MJ, Elliott DS. Long-term outcomes following artificial urinary sphincter placement: an analysis of 1082 cases at Mayo Clinic. *Urology* 2015 Sep;86(3):602-7.
941. Spiess PE, Capolicchio JP, Kiruluta G, Salle JP, Berardinucci G, Corcos J. Is an artificial sphincter the best choice for incontinent boys with Spina Bifida? Review of our long term experience with the AS-800 artificial sphincter. *Can J Urol* 2002;9:1486-91.
942. Lopez Pereira P, Somoza Ariba I, Martinez Urrutia MJ, Lobato Romero R, Jaureguizar Monroe E. Artificial urinary sphincter: 11-year experience in adolescents with congenital neuropathic bladder. *Eur Urol* 2006;50:1096-101.
943. Dalkin BL, Wessells H, Cui H. A national survey of urinary and health related quality of life outcomes in men with an artificial urinary sphincter for post-radical prostatectomy incontinence. *J Urol* 2003;169:237-9.
944. Patki P, Hamid R, Shah PJ, Craggs M. Long-term efficacy of AMS 800 artificial urinary sphincter in male patients with urodynamic stress incontinence due to spinal cord lesion. *Spinal Cord* 2006;44:297-300.
945. Herschorn S, Boccon-Gibod L, Bosch JL, et al. Surgical treatment of urinary incontinence in men. In: Abrams P, Khoury S, Wein A, eds. *First International Consultation on Urinary Incontinence*. Plymouth, UK: Health Publication Ltd; 1999:691-729.
946. Kreder KJ, Webster GD. Evaluation and management of incontinence after implantation of the artificial urinary sphincter. *Urol Clin North Am* 1991;18:375-81.
947. Wahl GR. Urinary incontinence after radical prostatectomy. *Semin Urol Oncol* 2000;18:66-70.
948. Taylor GA, Lebowitz RL. Artificial urinary sphincters in children: radiographic evaluation. *Radiology* 1985;155:91-7.
949. Lorentzen T, Dorph S, Hald T. Artificial urinary sphincters. Radiographic evaluation. *Acta Radiol* 1987;28:63-6.
950. Barrett DM, Licht MR. Implantation of the artificial genitourinary sphincter in men and women. In: Walsh PC, Retik AB, Vaughan Jr ED, Wein AJ, eds. *Campbell's Urology*. 7th ed. Philadelphia: W.B. Saunders Co.; 1998:1121-34.
951. Kabalin JN. Addition of a second urethral cuff to enhance performance of the artificial urinary sphincter. *J Urol* 1996;156:1302-4.
952. Rahman NU, Minor TX, Deng D, Lue TF. Combined external urethral bulking and artificial urinary sphincter for urethral atrophy and stress urinary incontinence. *BJU Int* 2005;95:824-6.
953. Linder BJ, Viers BR, Ziegelmann MJ, Rivera ME, Rangel LJ, Elliott DS. Artificial urinary sphincter mechanical fail-ures-is it better to replace the entire device or just the malfunctioning component? *J Urol* 2016 May;195(5):1523-8.
954. Bryan DE, Mulcahy JJ, Simmons GR. Salvage procedure for infected noneroded artificial urinary sphincters. *J Urol* 2002;168:2464-6.
955. Magera JS, Jr., Elliott DS. Tandem transcorporal artificial urinary sphincter cuff salvage technique: surgical description and results. *J Urol* 2007;177:1015-9.
956. Chertack N, Chaparala H, An-germeier KW, Montague DK, Wood HM. Foley or fix: a comparative analysis of reparative procedures at the time of explantation of artificial urinary sphincter for cuff erosion. *Urology* 2016 Apr;90:173-8.
957. Rozanski AT, Tausch TJ, Ramirez D, Simhan J, Scott JF, Morey AF. Immediate urethral repair during explantation prevents stricture formation after artificial urinary sphincter cuff erosion. *J Urol* 2014 Aug;192(2):442-6.
958. Bell BB, Mulcahy JJ. Management of cuff erosion of the double cuff artificial urinary sphincter. *J Urol* 2000;163:85-6.
959. Hajivassiliou CA. A review of the complications and results of implantation of the AMS artificial urinary sphincter. *Eur Urol* 1999;35:36-44.
960. Craggs MD, Chaffey NJ, Mundy AR. A preliminary report on a new hydraulic sphincter for controlling urinary incontinence. *J Med Eng Technol*. 1991;15(2):58-62.
961. García-Montes F. [FlowSecure artificial urinary sphincter for the treatment of stress urinary incontinence after radical prostatectomy]. *Arch Esp Urol*. 2009;62(10):845-50.
962. Vakalopoulos I, Kampantais S, Laskaridis L, Chachopoulos V, Koptsis M, Toutziaris C. New artificial urinary sphincter devices in the treatment of male iatrogenic incontinence. *Adv Urol*. 2012;2012:439372.
963. Knight SL, Susser J, Greenwell T, Mundy AR, Craggs MD. A new artificial urinary sphincter with conditional occlusion for stress urinary incontinence: preliminary clinical results. *Eur Urol*. 2006;50(3):574-80.

964. Lima SV, Araújo LA, Vilar FO, Kummer CL, Lima EC. Combined use of enterocystoplasty and a new type of artificial sphincter in the treatment of urinary incontinence. *J Urol*. 1996;156(2 Pt 2):622-4.
965. Lima RS, Barros EG, Souza CA, de O Vilar F, Lima SV. Periurethral constrictor: late results of the treatment of post prostatectomy urinary incontinence. *Int Braz J Urol*. 2011;37(4):483-7.
966. de O Vilar F, Araújo LA, Lima SV. Periurethral constrictor in pediatric urology: long-term followup. *J Urol*. 2004;171(6 Pt 2):2626-8.
967. Schiavini JL, Damião R, de Resende Júnior JA, Dornas MC, et al. Treatment of post-prostate surgery urinary incontinence with the periurethral constrictor: a retrospective analysis. *Urology*. 2010 Jun;75(6):1488-92.
968. Staerman F, G-Llorens C, Leon P, Leclerc Y. ZSI 375 artificial urinary sphincter for male urinary incontinence: a preliminary study. *BJU Int*. 2013 Apr;111(4 Pt B):E202-6.
969. Kretschmer A, Hüsck T, Thomsen F, Kronlachner D, Pottek T, et al. Efficacy and safety of the ZSI375 artificial urinary sphincter for male stress urinary incontinence: lessons learned. *World J Urol*. 2016 Feb 25. [Epub ahead of print].
970. Zachoval R, Krhut J, Stejskal J, Mika D, Oelke M. Efficacy and safety of a new adjustable artificial urinary sphincter (Aroyo™) for the treatment of male stress urinary incontinence: relief I study with 12 months follow-up. <http://www.ics.org/Abstracts/Publish/241/000205.pdr>.
971. ClinicalTrials.gov web site. Search terms male and incontinence. Accessed July 26, 2016.
972. Yamamoto T, Gotoh M, Hattori R, et al. Periurethral injection of autologous adipose-derived stem cells for the treatment of stress urinary incontinence in patients undergoing radical prostatectomy: report of two initial cases. *Int J Urol* 2010;17:75-82.
973. Sumino Y, Hirata Y, Hanada M, Akita Y, Sato F, Mimata H. Long-term cryopreservation of pyramidalis muscle specimens as a source of striated muscle stem cells for treatment of post-prostatectomy stress urinary incontinence. *Prostate* 2011 Aug 1;71(11):1225-30.
974. Claudon P, Spie R, Bats M, Saint F, Petit J. [Male stress urinary incontinence: medium-term results of treatment by sub-urethral bone anchored sling InVance]. *Prog Urol* 2011;21:625-30.
975. Martinez-Salamanca JI, Espinós EL, Moncada I, Portillo LD, Carballido J. Management of end-stage erectile dysfunction and stress urinary incontinence after radical prostatectomy by simultaneous dual implantation using a single trans-scrotal incision: surgical technique and outcomes. *Asian J Androl*. 2015;17(5):792-6.
976. Werner M, Schmid DM, Schussler B. Efficacy of botulinum-A toxin in the treatment of detrusor overactivity incontinence: a prospective non-randomized study. *Am J Obstet Gynecol* 2005;192:1735-40.
977. Mohanty NK, Nayak RL, Alam M, Arora RP. Role of botulinum toxin-A in management of refractory idiopathic detrusor overactive bladder: Single center experience. *Indian J Urol* 2008;24:182-5.
978. Flynn MK, Amundsen CL, Perevich M, Liu F, Webster GD. Outcome of a randomized, double-blind, placebo controlled trial of botulinum A toxin for refractory overactive bladder. *J Urol* 2009;181:2608-15.
979. Lie KY, Wong MY, Ng LG. Botulinum toxin a for idiopathic detrusor overactivity. *Ann Acad Med Singapore* 2010;39:714-5.
980. Granese R, Adile G, Gugliotta G, Cucinella G, Saitta S, Adile B. Botox for idiopathic overactive bladder: efficacy, duration and safety. Effectiveness of subsequent injection. *Arch Gynecol Obstet* 2012;286:923-99.
981. Dowson C, Watkins J, Khan MS, Dasgupta P, Sahai A. Repeated botulinum toxin Type A injections for refractory overactive bladder: medium-term outcomes, safety profile, and discontinuation rates. *Eur Urol* 2012; 61:8 3 4-9.
982. Abdelwahab O, Sherif H, Soliman T, Elbarky I, Eshazly A. Efficacy of botulinum toxin type A 100 Units vs 200 units for treatment of refractory idiopathic overactive bladder. *Int Bras J Urol* 2015;41 (6): 1132-40.
983. Bramble FJ. The treatment of adult enuresis and urge incontinence by enterocystoplasty. *Br J Urol* 1982;54:693-6.

SURGERY FOR URINARY INCONTINENCE IN WOMEN

Chair

Eric Rovner (US)

Members

Stavros Athanasiou (Greece)

Myung-Soo Choo (Korea)

Michel Cosson (France)

Roger Dmochowski (US)

Alex Gomelsky (US)

Cristiano Gomes (Brazil)

Ash Monga (UK)

Charles Nager (US)

Roy Ng (Singapore)

Peter Sand (US)

Hikaru Tomoe (Japan)

CONTENTS

ABBREVIATIONS	1743	6. Previous Continence Surgery.....	1819
INTRODUCTION	1744	7. Concomitant Hysterectomy	1820
Search Strategy.....	1744	8. Severity and Duration of Symptoms .	1820
I. SURGERY FOR STRESS URINARY INCONTINENCE (SUI)	1745	9. OAB and Stress Incontinence	1820
1. Traditional BN PVS	1745	10. Urethral Occlusive Forces	1821
2. Colposuspension	1757	11. Summary	1821
3. Midurethral Sling.....	1761	V. CLINICAL TRIAL OUTCOMES USED IN UI RESEARCH	1821
4. Urethral Bulking Agents	1792	1. History of SUI Measures	1821
5. Artificial urinary sphincter for women.....	1800	2. Patient Reported Outcomes.....	1821
6. Stem Cell Technologies.....	1801	3. Composite Measures.....	1822
7. Other Surgery for Female SUI	1804	4. Survival Analysis Reporting for SUI Outcomes -Once a Failure, Always a Failure.....	1822
II. SURGERY FOR NON-NEUROGENIC UII	1807	5. Success Rates are Dependent on the Rigor of the Assessment	1822
1. Sacral Neurostimulation (SNS)	1807	6. Mixed incontinence as a Confounder	1822
2. Percutaneous Tibial Nerve Stimulation (PTNS).....	1813	7. Global Measures	1823
3. Augmentation (Enlargement) Cystoplasty.....	1815	8. Summary	1823
III. URETHRAL DIVERTICULA	1817	9. Recommendations	1823
1. UD and Urinary Incontinence	1817	VI. RESEARCH RECOMMENDATIONS	1823
2. Preoperative Assessment Including Urodynamics	1817	1. General	1823
3. UD and Stress Urinary Incontinence .	1817	2. Stress Urinary Incontinence	1825
4. UD and UII	1818	3. Urgency Urinary Incontinence.....	1825
5. Summary.....	1818	4. Urethral Diverticula	1826
6. Recommendations	1818	REFERENCES	1827
IV. CONFOUNDING VARIABLES	1818		
1. Age	1818		
2. Race	1819		
3. Obesity.....	1819		
4. Psychiatric Illness.....	1819		
5. Physical Activity.....	1819		

SURGERY FOR URINARY INCONTINENCE IN WOMEN

ERIC ROVNER (US)

STAVROS ATHANASIOU (GREECE), MYUNG-SOO CHOO (KOREA), MICHEL COSSON (FRANCE),
ROGER DMOCHOWSKI (US), ALEX GOMELSKY (US), CRISTIANO GOMES (BRAZIL),
ASH MONGA (UK), CHARLES NAGER (US), ROY NG (SINGAPORE), PETER SAND (US),
HIKARU TOMOE (JAPAN)

ABBREVIATIONS

AC	Augmentation Cystoplasty	I-QoL	Incontinence-Quality of Life Questionnaire
ACT	Adjustable Continence Therapy	IQR	Interquartile Range
AE	Adverse Event	ISC	Intermittent Self Catheterization
ANV	Actual Number of Nightly Voids	ISD	Intrinsic Sphincter Deficiency
aPVS	Autologous Pubovaginal Sling	KHQ	Kings Health Questionnaire
ARF	Autologous Rectus Fascia	LPP	Leak Point Pressure
ASC	Adult Stem Cells	LUTS	Lower Urinary Tract Symptoms
AUASS	American Urological Association Symptom Score	MDSC	Mesoderm Derived Stem Cells
AUS	Artificial Urinary Sphincter	MMK	Marshall Marchetti Krantz
BMI	Body Mass Index	MRI	Magnetic Resonance Imaging
BN	Bladder Neck	MUCP	Maximal Urethral Closure Pressure
BTX-A	OnabotulinumtoxinA	MUI	Mixed Urinary Incontinence
CI	Confidence Interval	MUS	Midurethral Sling
CST	Cough Stress Test	NASHA-dx	Non-Animal Stabilized Hyaluronic Ac-Id/Dextranomer
CT	Computed Tomography	NBCi	Nocturnal Bladder Capacity Index
DO	Detrusor Overactivity	OAB	Overactive Bladder
EL	Evidence Level	OABSS	Overactive Bladder Symptom Score
ES	Electrical Stimulation	OR	Odds Ratio or Operating Room
FDA	Food and Drug Administration	PAHG	Polyacrylamide Hydrogel
FSFI	Female Sexual Function Index	PDMS	Polydimethylsiloxane Elastomer
GRA	Global Response Assessment	POP	Pelvic Organ Prolapse
ICTOT	Industry Created Transobturator Tape	PTFE	Polytetrafluoroethylene
IIQ	Incontinence Impact Questionnaire	PVDF	Polyvinylidene Fluoride
IIT	Intention to Treat	PVS	Pubovaginal Sling
IPG	Implantable Pulse Generator	PFMT	Pelvic Floor Muscle Training
		PGII	Patient Global Impression of Improvement
		PNE	Peripheral Nerve Evaluation

PP	Polypropylene or per Protocol
PRO	Patient Reported Outcomes
PTNS	Percutaneous Tibial Nerve Stimulation
RCT	Randomized Controlled Trial
RFA	Radio Frequency Ablation
RP	Retropubic
RR	Relative Risk
QoL	Quality of Life
SCTOT	Self Created Transobturator Tape
SIMS	Single Incision Mini-Sling
SMT	Standard Medical Therapy
SNS	Sacral Nerve Stimulation
SPARC	Supra Pubic Arc Sling
SS	Sample Size
SUI	Stress Urinary Incontinence
TO	Transobturator
TOT	Transobturator Tape
TVT	Tension Free Vaginal Tape
TVT-O	Tension Free Vaginal Tape-Obturator
UD	Urethral Diverticula
UDI	Urogenital Distress Inventory
UF	Urgency Frequency
UI	Urinary Incontinence
UITN	Urinary Incontinence Treatment Network
UR	Urinary Retention
USI	Urinary Stress Incontinence
UTI	Urinary Tract Infection
UUI	Urgency Urinary Incontinence
VAS	Visual Analog Scale
VDM-PDMS	Vinyldimethyl-Terminated Polydime-Thylsiloxane Polymer
VLPP	Valsalva Leak Point Pressure
WMD	Weighted Means Difference
WHO	World Health Organization

INTRODUCTION

This chapter aims to update the current status of surgical interventions for non-neurogenic female urinary incontinence. The structure is built upon prior versions, most notably that of the ICI-5 published in 2013

with the intent of building upon these previously presented data. However, given the vast amount of literature produced since the prior version, it was necessary to re-organise and expand several sections. This includes most notably considerable new data on MUSs including PVS, TO and single-incision mini-slings. In addition, new portions of the chapter include a section on the biology of implanted mesh as well as a section on evolving stem cell technology for urinary incontinence. Finally, as compared to prior editions of this book, there are several areas which are not covered in this chapter including urinary incontinence in association with vaginal prolapse, and chemodenervation, which will be covered by the other committees elsewhere.

Within the reorganisation of the chapter, we have tried to minimise overlap between comparative studies as much as possible. For example, studies comparing a particular MUS vs. colposuspension will be covered in only one of the two relevant sections.

SEARCH STRATEGY

As in prior editions, material collected for this chapter was based on electronic searches of Medline, EMBASE, Cinhal, Cochrane Database of Systematic Reviews and the NICE website (www.nice.org.uk). Review papers were separately searched for additional references not identified by initial database search. Individual papers were then selected from these searches for inclusion where appropriate. Search terms included; Urinary incontinence: stress, mixed, urge. Surgical procedures: minimally invasive, urogenital, gynaecologic, urologic, urinary tract, urethra, vagina, bladder, colposuspension, vesicourethral or urethrovesical, colpourethrosuspension, Burch, Marshall-Marchetti-Krantz, paravaginal, obturator, surgical mesh, sling, bladder, surgical or synthetic, or biological or autologous; tape; urethra, suburethra, midurethra, transurethral, pubovesical; PVS, suprapubic; pubovaginal, implant; Prostheses: injections; bulking agents, Contigen; collagen; Macroplastique, silicones; microparticulate; hyaluronic acid; carbon particles; polytetrafluoroethylene; biocompatible materials; urinary sphincter, artificial.

Finally, we would like to acknowledge the overwhelming and tremendous contributions to this chapter made by the previous authors and committee members from prior Consultations. This includes the prior Chairs, Dr. ARB Smith and Dr. Roger Dmochowski. Our chapter is built on the framework set up by these individuals and truly represents an update to their prior work. Furthermore, we would like to acknowledge the considerable contribution from Dr. Sandy Hanssens in this version with her assistance to Dr. Cosson. And finally we are extremely grateful to Edna Johnson from Vanderbilt University for her editorial support.

I. SURGERY FOR STRESS URINARY INCONTINENCE (SUI)

1. TRADITIONAL BN PVS

The term 'traditional' sling procedure is used here, in line with the terminology used in the latest Cochrane review. (1). This is done mainly to distinguish open sling procedures typically placed at the region of the BN from the newer, minimally-invasive mid-urethral sling (MUS) procedures.

Sling procedures came into prominence in the beginning of the twentieth century. In 1907, Giordano transplanted gracilis muscle and wrapped it around the urethra. (2) Soon thereafter, other autologous tissues were transplanted under the urethra to provide additional support: pyramidalis (3), levator ani (4) rectus fascia (5), gracili (6), and bulbocavernosus muscle and fat (7). While it was hypothesised that the transplanted muscle would retain its contractility and act as a neo-sphincter to prevent SUI, these procedures compressed the urethra and created a partial obstruction. Complications such as recurrent cystitis, urethral sloughing, and fistula formation were common.

The modern autologous BN sling exists mainly due to the work of Aldridge in the 1940's and McGuire and Blaivas in the latter part of the twentieth century. (8-10). The majority of sling procedures have involved a combined abdominovaginal approach, although procedures performed entirely through an abdominal approach have been described. Suspended, or 'sling on a string,' methods have been developed in order to reduce the invasiveness of the procedure and to shorten the length of sling material. These shorter slings can also vary in length, from a "mid-length" sling (7-10 cm) to a "patch" sling (2-4 cm).

Sling materials may vary widely and individual materials may have only a modest effect on initial sling efficacy. However, these materials may considerably affect the long-term outcomes of sling procedures and the associated morbidity. Materials may be synthetic or biological. The latter include autografts (rectus fascia, fascia lata, round ligament, dermis, vaginal skin, and gracilis, levator, and rectus muscles), cadaveric allografts (fascia, dermis, and dura mater) and xenografts (porcine dermis and small intestinal submucosa, bovine dermis and pericardium).

Case series of autologous rectus fascial (ARF) sling were reviewed within the systematic review underlying the NICE guidance on urinary incontinence (11). Ten series including a total of 1280 women were considered. Studies had a mean or median duration of follow-up between 2 and 6 years, while in three studies, maximum follow-up of 15–18 years was reported.

Subjective cure rates ranged from 26% to 97% (median 81%); and cure rates that included subjective and objective elements ranged from 73% to 95%. Satisfaction rates of 86% and 92% were reported in two studies.

Synthetic sling materials have included nylon, polyethylene, polytetrafluoroethylene (PTFE), and polypropylene. On occasion, these polymers have been 'enhanced' with synthetic or biologic coatings in an attempt to improve their biocompatibility profiles. Many additional variations in the technique have been described, although it is unclear which of these materially influence the outcome. Several case series have published outcomes for polyethylene and PTFE slings with short-term cure rates typically in the 80-90% range, depending on the definition [EL=3]. Vaginal extrusion, erosion, and sinus formation have been common with these materials. Since the last ICI review, there have been no additional studies published and the number of these procedures performed appears to have waned significantly in favour of polypropylene MUSs.

Both biological and synthetic sling materials are analysed together in the Cochrane review (1) although these were considered separately in the systematic review underlying the NICE guidance on urinary incontinence (1, 11). NICE has also published a non-systematic review of biological sling procedures under its Interventional Procedures Programme. The most recent Cochrane review included 26 RCTs (or quasi-randomised trials) describing a total of 2284 women of whom 1287 were treated with suburethral traditional slings. Sample sizes ranged from 20 to 655 participants. Several of these trials are available only in abstract form and remain unpublished as full peer-reviewed papers. Owing to the significant number of recent meeting abstracts about surgical procedures for SUI, only full publications have been included in this section. Additional studies have been included, but the majority of these are case-control studies and have a relatively low level of evidence.

There have been no new trials identified that compared traditional suburethral sling operation vs. no treatment, sham operation, conservative management (e.g. pelvic floor muscle training, electrical stimulation, cones, biofeedback), anterior repair, laparoscopic PVS suspension, or artificial urinary sphincter (1). One trial studied patients with MUI treated with oxybutynin or surgery (12). The type of surgery was selected according to Valsalva leak point pressure (VLPP): those women with VLPP <90 cm H₂O underwent an ARF sling and those with VLPP ≥ 90cm H₂O underwent Burch colposuspension. The results for the surgically managed group were similar to that in the subgroup having slings. The study suggested that slings are significantly better for treating MUI than oxybutynin.

Table 1: Traditional sling vs Bulking Agent

Author	RCT	Sling	Comparat or	N/N (n1/n2)	F/U	Cure; effect size	EL	Comments
Corcos, 2005	Yes	ARF/Col po	Bovine Collagen	133 (67:66)	12m	55% vs. 52% ; p=ns 72% vs. 53% ; p=sig	2	ITT analysis Per protocol with verbal update No differences in SF-36, IIQ
Maher, 2005	Yes	ARF	Macro-plastique	45/45 (22:23)	6m	81% vs. 9%; p=sig	2	Silicone injected transurethrally

Results were analysed in terms of patient reported incontinence within one year (RR 0.18; 95% CI 0.08 to 0.43). Fewer women had persistent UII after the sling surgery (RR 0.29; 95% CI 0.09 to 0.94).

1.1. Traditional sling vs. bulking agent (Table 1)

One RCT compared ARF sling with a single periurethral silicone injection in women with SUI secondary to ISD (MUCP ≤20 cm H2O) in whom conservative treatment had failed (13). At 6 months, no significant differences were seen between groups in subjective cure (1-hour pad test) or satisfaction, QOL (UDI-6, IIQ). Significantly more women undergoing sling surgery were objectively cured on the basis of urodynamic assessment (81% vs. 9%; p=0.0001), but duration of the procedure, catheterisation, inpatient stay, and time to return to normal activities were significantly longer in the sling group. A telephone survey of two thirds of the women at 5 years found no statistically significant differences between groups in urinary symptoms or in satisfaction with surgery, although fewer women in the silicone bulking group were satisfied (29% vs. 69%) (n=45). The average cost per patient for the Macroplastique (including re-operations) was significantly greater (AU\$4410) than for the sling (AU\$3500) (P < 0.0001). [EL=2].

Open continence surgery (a suspension procedure in 46% and ARF sling in 54%) was compared with periurethral collagen in women with SUI or MUI in an additional RCT (14). Notably, collagen is no longer commercially available as a bulking agent. The collagen group received an average of 9.7 mL of collagen in 2.9 injections per patient. As in the previous study, there were no significant differences in patient satisfaction or QOL (SF-36, IIQ) between groups at 1 year. Using ITT analysis, there was no significant difference in continence rates at 1 year (52% collagen, 55% surgery). If only the 89% of women who underwent the randomised intervention were considered, the continence rate with surgery was significantly higher (72% vs. 53%; p=0.01). The incidence of adverse effects was significantly higher in the surgery group: urinary retention 13% vs. 2%, transient voiding difficulty 36% vs. 17%, UTI 6% vs. 0% (n = 133). [EL=2]

A recent metaanalysis (15) combined the results for the previous studies and suggested that the objective

recurrence rate of periurethral bulking agents is significantly higher in comparison with the traditional slings (OR: 6.35, 95% CI: 0.18, 222.85). Furthermore, lower subjective recurrence rate was observed among patients undergoing traditional sling procedures in comparison with those undergoing bulking agents, although this trend was not statistically significant (OR: 2.02, 95% CI: 0.99, 4.12). Moreover, patients undergoing injection of bulking agents experienced a lower rate of voiding dysfunctions in comparison to the sling group (OR: 0.23, 95% CI: 0.11, 0.48). Urinary tract infections were less common in the bulking agent group although the difference did not reach statistical significance (OR: 0.30, 95% CI: 0.07, 1.33) [EL=1/2]

1.2. Traditional sling vs. colposuspension (Table 2)

Nine randomised or quasi-randomised trials were identified from the literature. Six of the trials compared suburethral slings with open abdominal PVS suspension (16-21) while two trials reported the long-term outcomes (22, 23) and another reported the complications of the aforementioned trial (24) One additional trial compared sub urethral slings with the Stamey transvaginal needle suspension (25). The Cochrane review systematically evaluated the six trials comparing suburethral slings with open PVS suspension and an additional trial that was only published in abstract form (1)

One RCT compared duramater sling with open colposuspension in 72 women with recurrent SUI after vaginal hysterectomy and at least one previous anterior repair (17). At a minimum follow-up of 32 months, the combined objective and subjective cure rates were 92% after duramater sling compared with 86% after colposuspension. While both were common, significantly more women in the sling group developed postoperative voiding difficulty or urinary retention (29% vs 11%).

More women in the colposuspension group developed a postoperative rectocele (13%). Bladder perforation and de novo urgency were common in both groups. The time to spontaneous voiding was significantly longer in the sling group (12.4 days vs 6.4 days) (n = 72). [EL=1/2].

Table 2: Traditional Sling vs Colposuspension

Author	RCT	Sling	Comparator	N/N (n1/n2)	F/U	Cure; effect size	EL	Comments
Henriksson, 1978	Quasi	Zoedler, Vaginal	MMK	30/30 (15:15)	3m	100% vs. 100% (o)	2	Quasi-RCT: by alternation; No ss calculation; analysis not clear if ITT
Hilton, 1989	Yes	Porcine Dermis	Stamey	20/20 (10/10)	3m 24m	90% vs. 80% (o) 92% vs. 86% (s)	2	Included only SUI w/vaginal narrowing unsuitable for colposuspension
Enzelsberger, 1996	Yes	Dura Mater	Colpo	72/72 (36:36)	32-48m	92% vs. 86% (s)	2	All patients had recurrent SUI after failed incontinence surgery; no ss calculation; analysis not clear if ITT
Sand, 2000	Yes	Gore-Tex	Colpo	36/37 (17:19)	3m	100% vs. 90% (o); p-ns	2	No ITT analysis 2 (12%) slings partial resection due to erosion
Culligan, 2003				28 (13:15)	33-116m (Mean 72.6m)	100% vs. 85% (o); p-ns 84% vs. 93% (s); p=ns		
Demirci, 2001	Quasi	ARF	Colpo	34/46 (17:17)	12m	94% vs. 88% (0); RR 2.0; 95% CI 0.20, 20.04	2	Quasi RCT by alternation; no ss calculation; analysis not clear if ITT
Bai, 2005	Yes	ARF	Burch	61/61 (28:33)	6m 12m	92.8% vs. 90.9% (s+o); p-ns 92.8% vs. 87.8% (s+o); p-sig	2	No ss calculation; minimal details about randomization; some disparities between text and tables
Albo, 2007 Chai, 2009	Yes	ARF	Colpo	520/655 (326:329)	24m	SUI cure: 47% vs. 38% (s+o); p-sig Overall cure: 66% vs. 49% (s+o); p-sig	1	50% concomitant surgery for POP; 79% outcome assessment at 24m (265:255); postoperative UTIs, voiding and storage symptoms higher in ARF group
Brubaker, 2012	Yes	ARF	Colpo	357/482 (183:174)	60m	Overall cure: 30.8% vs 24.1% (s+o) p-sig		Participants enrolled more likely to be incontinent (85.5%) compared with those who were continent (52.2%), irrespective of assigned surgical group (p <0.0001).

Three trials compared ARF sling with open colposuspension. In a small trial alternating 17 women with primary USI (type/II) each to ARF and colposuspension, ARF had similar effectiveness to colposuspension at 12 months follow up by objective measures (94% vs. 88%) (19). In a second trial randomising women to ARF, colposuspension, and TVT, ARF was significantly superior to colposuspension at 12 months (92.8% vs. 87.8%) using a subjective and objective definition of cure (20). The significant difference in the two procedures was not evident at 6 months follow-up (92.8% vs. 90.9%). Finally, the Urinary Incontinence Treatment Network conducted the Stress Incontinence Surgical Treatment Efficacy Trial (SISTER), (21) a randomised trial comparing outcomes from Burch colposuspension versus autologous fascial sling. Overall 655 women were randomized and 79% of participants (265:255) were available for the 24-month outcome assessment. ARF was significantly superior to colposuspension both in its cure of SUI (47% vs. 38%) and overall incontinence cure (66% vs. 49%) at 24 months. Fifty percent of the women underwent concomitant surgery for pelvic organ prolapse (POP). The low success rates reported can be explained by the stringent criteria applied to define success, including no self-reported symptoms of SUI, less than 15g pad weight in 24 hours, no incontinence documented in a 3-day voiding diary, a negative urinary stress test on physical examination, and no retreatment for urinary incontinence. The findings on efficacy were not modified by performance of concomitant surgery for POP. Although highly effective for SUI, the PVS was accompanied by higher rates of urinary tract infection, urgency incontinence (27% vs 20%, $P = 0.04$), voiding dysfunction (14% vs. 2%, $p < 0.001$), and need for surgical revision to improve voiding when compared with traditional colposuspension. [EL=1]

A further study by the same group was undertaken to assess in more detail the complications data in SISTER trial (24). Subjects undergoing concomitant surgeries had a significantly higher serious adverse events (SAE) rate (14.2% vs 7.3%, $p = 0.01$) and AE rate (60.5% vs. 48%, $p < 0.01$) compared to subjects undergoing continence surgery alone. Women undergoing ARF sling had a higher percentage of postoperative UTIs within the first six weeks of follow-up ($p < 0.01$), voiding and storage urinary symptoms. Intermittent self-catheterization (ISC) increased the rate of cystitis by 17% and 23% in the Burch and sling groups, respectively. [EL=1]

The same group of researchers presented the long term results (more than 5 years postoperatively) (22). Women who completed the SISTER trial were asked to participate in a long term prospective observational study with the aim to characterise continence, satisfaction, and AEs at least 5 years after a Burch urethropexy or fascial sling. Urinary continence status was assessed yearly for a minimum of five years postoperatively. Continence was defined as no urinary leakage on a three-day voiding diary and no self-reported stress incontinence symptoms (telephone or

mail contact) AND no stress incontinence surgical re-treatment. Incontinent participants were more likely to enroll in the follow-up study than continent patients (85.5% vs. 52.2%), regardless of surgical group ($p < 0.0001$). Overall the continence rates were lower in the Burch urethropexy group than in the fascial sling group ($p = 0.002$). The continence rates at five years were 24.1% (95% CI 18.5% to 29.7%) compared to 30.8% (24.7% to 36.9%), respectively. Satisfaction at 5 years was related to continence status and higher in women undergoing a sling (83% vs. 73%, $p = 0.04$). Satisfaction declined over time ($P = 0.001$) and remained higher in the sling group ($p = 0.03$). The two groups had similar AE rates (10% Burch vs. 9% sling) and similar numbers of participants with AEs (23 Burch vs. 22 sling). [EL=1]

Two small RCTs evaluated an expanded polytetrafluoroethylene patch sling (PTFE; GoreTex®) and open colposuspension in women with USI with low pressure urethra (MUCP < 20cm H₂O) and urethral hypermobility. The second trial provided the long-term subjective and objective outcomes of the same group of patients

(18, 23). Although the groups were different at baseline in terms of the proportion with DO (DO) (95% colposuspension vs. 41% sling), cure rates with PTFE were not significantly different from open colposuspension at 3 months (objective 100% vs. 90%) and at 2.5 years (objective 100% vs. 85%; subjective 84% vs. 93%) ($n = 36$). No significant differences were found between groups in hospital stay or time to catheter removal. [EL=2]

In the Cochrane review, trials comparing rectus fascia with other materials heavily weighted the comparison of different types of sling (1). Furthermore, the results of the most recent, and by far the largest and most rigorous RCT of colposuspension and ARF sling heavily weighted the results of the analysis (21). This trial randomised 655 women of whom 520 were assessed at 24 months, while the next largest trial randomised 72 women (17). The summary statistic, combining urodynamic and symptom only diagnosis, showed a lower incontinence rate with sling procedures (RR 0.75; 95% CI 0.62 to 0.90) for a follow-up from 1-5 years. The data from the trials where women all had urodynamic SUI showed no significant difference in urinary incontinence after one year (RR 0.72, 95% CI 0.31 to 1.67). Data beyond five years were provided by only one trial (23), and there was no statistically significant difference between the groups, but with very wide confidence intervals (RR 2.31; 95% CI 0.24 to 22.62). There was an inadequate number of studies to support a metaanalysis of objective cure. AEs in general (47% vs. 63% ($p < 0.001$)) and voiding difficulty in particular (14% vs. 2%, $p < 0.001$, RR 6.08; 95% CI 3.10 to 11.95.) were more common in sling group (24). Women in the colposuspension group had their catheters removed earlier (Mean difference :8 days; 95% CI 6.8 to 9.2). However, it is unclear if this was due to the procedures themselves or differences in hospital policies. There was no statistical

significant difference of de novo urge symptoms or DO between the two procedures [EL=1].

Only one small trial (10 women in each group) is available to allow comparison between sling (porcine dermis) and needle suspension (Stamey) in a group of women unsuitable for abdominal colposuspension because of vaginal narrowing secondary to either previous interventions or atrophic change (25). Although there were no differences in objective cure rates at 3 or 24 months, perioperative complications (RR 4.50; 95% CI 1.28 to 15.81) and length of hospital stay (RR 13.00; 95% CI 5.00 to 21.00) favored the needle suspension procedure (n=20). [EL=2]

A recent Cochrane review (26) assessed the results of the open Burch Colposuspension. In a subgroup analysis of studies comparing traditional slings and open colposuspension showed better effectiveness with traditional slings in the medium and long term (RR 1.35; 95% CI 1.11 to 1.64 from one to five years follow up, RR 1.19; 95% CI 1.03 to 1.37).

1.3. ARF vs. other traditional slings (Table 3)

Our review identified 3 RCTs and 2 quasi-RCT comparing one type of traditional sling with another (27-31), with an additional RCT providing long-term outcomes of one of the aforementioned studies (32). The remainder were cohort and case control studies.

ARF and vaginal wall slings were compared in one RCT and two non-randomised retrospective studies (29, 33, 34). All of these trials were considered to be of poor quality. The RCT reported high subjective cure, and satisfaction rates (80–100%) for both procedures, with median follow-up of 7 months and minimum follow-up of only 3 months (n = 26) (29) [EL=2]. The non-randomised studies reported similar 'success rates' with both interventions, ranging from 80% to 97% with follow-up of 21 months and 70 months versus 45 months (n=232, n=79) (33, 34) [EL=2/3]. Other than the proportions of patients requiring intermittent catheterisation after surgery (2% in the ARF group and 0% in the vaginal wall group), no additional differences were noted in rates of other postoperative complications (e.g. voiding and storage dysfunction, wound infection and seroma formation, and bladder or urethral injury).

One RCT compared two techniques of fascial sling in 168 women with urodynamic stress incontinence (USI), 89% of whom had had prior continence surgery (28). Women underwent a standard fascial sling procedure or a 'sling on a string' (a shorter sling mounted on each end with a nylon thread) (28). At 1 year, subjective cure rates were 84% using both techniques. Satisfaction and changes in IIQ scores were also similar in both groups, whereas improvements in UDI scores were greater with the standard approach (adjusted for differences in baseline UDI data). A further evaluation of women in this study was reported at 5 to 7 years of follow-up (32). There were no significant differences in symptoms of SUI or UUI between

groups, with 40%-53% vs. 36%-51% reporting SUI in a sensitivity analysis. [EL=1]

Eight non-randomised studies compared the outcomes of autologous and allograft slings in a total of 859 women with SUI (35-37) (38-42) while one additional study also compared both interventions with a xenograft material (porcine dermis) (43). All were retrospective reviews, each with differences in duration of follow-up for the interventions evaluated (between 1 month and 3 years), with dropout rates of 4% to 34%. Additionally, between 16% and 82% in different studies underwent other concomitant surgeries, and all of these studies were considered to be of poor quality. [EL=3]. Four of these studies compared autologous with allograft (cadaveric) fascia lata. Three reported similar results for all outcomes (subjective cure, satisfaction, and UDI-6, IIQ-7 and SEAPI scores) (35, 36, 41), while the fourth study reported significantly higher cure rates in the autologous group (40) [EL=3]

In three studies that compared autologous rectus fascia or fascia lata with allograft fascia lata, two found a significantly higher cure rate in the autologous group (37, 43) the other found no significant differences in cure rate, although satisfaction rates were higher in the autologous group after 2 years follow-up (38). In the study with a xenograft arm, cure rates were significantly higher with autograft material (43). The study comparing ARF to cadaveric dermis found no significant difference in subjective cure rates at a mean follow-up of 18 months and 13 months, respectively (42) [EL=3].

One RCT compared the porcine dermis sling vs. ARF (sling on a string technique) and tension-free vaginal tape (TVT), a RP MUS (44). Women recruited had primary SUI. It should be noted that the ARF and porcine dermis slings were placed at the midurethra rather than the BN, but suspended above the rectus fascia like traditional slings. The primary outcome was patient-reported improvement rates at 6 months and 1 year. At 6 months, the porcine dermis arm had significantly poorer improvement rates (73%) than TVT (92%) and ARF (95%), and, at 1 year, only 61% of the porcine dermis slings remained as improved, vs. 93% and 90% of the TVT and ARF arms, respectively. At 1 year, women undergoing porcine dermis slings had significantly lower dry rates (22%) as compared to TVT (55%) and ARF slings (48%), respectively. Subsequently, the porcine dermis arm was suspended following interim analysis.

There was no difference in success rates between the TVT and ARF arms.

Table 3: Traditional Sling vs Traditional Sling

Author	RCT	Sling	Comparator	N/N (n1/n2)	F/U	Cure; effect size	E L	Comments
Kaplan, 1996	No	ARF	Vaginal Wall	79 (43:39)	6-51 m (Mean 21.4m)	84% vs. 89% (s+o)	3	9%o vs. 94% satisfied or very satisfied
Barbalias, 1997	Yes	ARF	Gore-Tex	48/48 (32:16)	6m & 30m	81% vs. 88%(s-6m) 65% vs. 88%(s-12m)	2	computer randomisation 2:1 No baseline data reported per treatment group, no analysis of results
Wright, 1998	No	AFL	CFL	92 (33:59)	1-28m (Mean 11.5m)	SEAPI improvemen; p-ns	3/4	
Brown, 2000 O'Reilly, 2002	No	AFL	CFL	167 (46:121)	44m:12m (Mean)	90% vs. 85% (s)	3	High satisfaction rates in both groups; an additional 8 women experienced failure at 4-13m F/U
Choe, 2000	Quasi	PTFE MycroMesh	Vaginal Wall	40/40 (20:20)	12-27m	95% vs. 75% (s+o; mean 22m)	2	
Lucas, 2000 Guerrero, 2007	Yes	ARF (20cm)	ARF (8-10cm)	165/168 (81:84)	12m 25-60m (Mean 42m) 61-89m (Mean 74m)	68-84% vs. 70-80% on sensitivity analysis (s); p-ns 47-60% vs. 49-64% (s); p=ns 29-62% vs. 44-57% (s); p=sig on ITT analysis only	1	ss calculated; cure ranges reflect ITT, per protocol, and best possible % cure
Kuo, 2001	Quasi	ARF	Prolene	50 (24:26)	Median 23-24m	91.6% vs. 92.3 (s); p-ns	2	ss not calculated
Maher, 2001	No	ARF	ARF & Vicryl Mesh	51 (24:27)	Mean 8m:5m	58% vs. 85% (s); p-sig 50% vs. 52% (o); p-ns	3	
Soergel, 2001	No	ARF	CFL	45:50 (33:12)	3-6m	69.7% vs. 16.7%(o);p=sig	3/4	
Flynn, 2002	No	ARF/AFL	CFL	134/140 (71/63)	24m	77% vs. 71%o (o-pad test); p-ns	3	
Viseshsindh, 2003	Yes	ARF	Vaginal Wall	26/26 (15:11)	3-12m	93% vs. 100%; p-ns	2	Lack of details regarding randomization, analysis of results
Almeida, 2004	No	AFL	CFL	60 (30:30)	22-44m (Mean 33-36m)	40% vs. 70%; p-sig	3/4	

Table 3: Traditional Sling vs Traditional Sling

Author	RCT	Sling	Comparat or	N/N (n1/n2)	F/U	Cure; effect size	E L	Comments
Rodrigues, 2004	No	ARF	Vaginal Wall	232 (128:104)	Mean 70.3m: 44.9m	93.7% vs. 79.8% (s; SUI cure rate) 73.4% vs. 61.5% (s; no SUI + no storage/ voiding dysfunction)	3	No statistical comparison between cures
MoBride, 2005	No	AFL	CFL	47/71 (39:32)	24m	100% vs. 58.3% (o-CST); p=sig	3/4	Subjective indices criteria similar
Simsiman, 2005	No	ARF	Porcine Dermis	241 (78:83:80)	12m	87% vs. 54% vs. 64% (o); p-sig for ARF	3	
Giri, 2006	No	ARF	Porcine Dermis	94/101 (46/48)	36m	80.4% vs. 54% (s; cure + improved);P=sig	3	
Morgan, 2007	No	ARF	Porcine Dermis	111 (81:30)	Mean 24m:25m	Symptom severity higher for Porcine Dermis; p-sig	3	
Onur, 2008	No	ARF	Cadaver Dermis	49 (25:24)	Mean 18m:13m	84% vs. 79% (s; cure+ improved); p-ns	3/4	
Wilson, 2008	No	ARF	Bovine Dermis	85 (48:37)	12m	81.3% vs. 83.8% (s+o; SUI cure); p-ns 60.4% vs. 54.1% (s; global cure); p-ns	3/4	Significant demographic differences between groups
Winckler, 2010	No	ARF	Bovine Dermis	85 (48:37)	12m	81.3% vs. 83.8% (s+o; SUI cure); p-ns 60.4% vs. 54.1% (s; global cure); p-ns	3/4	

One in five women in the porcine dermis arm had surgery for SUI by 1 year, but none had undergone additional surgery in the other arms. [EL=1/2].

One non-randomised trial compared porcine dermis sling vs. ARF (45), a second compared porcine dermis sling vs. both ARF and TVT(46), and a third trial mentioned earlier compared porcine dermis vs. both ARF and allograft slings (43). At a follow-up of 36 months, the subjective success rate (cure and improved) after ARF sling was significantly higher than porcine dermis sling (80.4% vs. 54%) (45). Women undergoing porcine dermis slings were found to have significantly higher postoperative symptom severity than women undergoing either ARF sling or TVT (46). Objective cure rates after ARF were significantly higher (87%) than either porcine dermis sling (54%) or cadaveric fascia lata (64%) (43) [EL=2/3]

A quasi-RCT compared an ARF sling with a self-fashioned polypropylene mesh sling placed at the BN (31). At a median follow-up of approximately 24 months, cure and satisfaction rates were similar but operating time and hospital stay were significantly shorter in the polypropylene sling group. Delayed voiding and wound pain occurred in more women in the ARF sling group. No other significant differences were seen between groups in complications (e.g. haematoma, dysuria, de novo urgency or UUI) (n=50). [EL=2] A second, retrospective, non-randomised trial found no significant difference in subjective cure rate (81% vs. 88.9%) in women undergoing ARF and polypropylene mesh (Marlex) slings (47). It should be noted that both slings in this study were placed at the midurethra but tied without tension above the rectus fascia as in the traditional BN sling. Interestingly, vaginal extrusion rates and rates of surgical intervention for extrusion were not significantly different between ARF and Marlex slings. [EL=3]

One RCT compared ARF and PTFE slings in women with type III SUI, 92% of whom had had previous continence surgery (27). Combined objective and subjective cure rates at 6 months follow-up were 81% and 88%, respectively. No complications were reported in the ARF sling group; however, recurrent UTI and de novo DO were very common with PTFE (n= 48). In 2 patients there was an erosion of the urethra and the Goretex sling had to be removed 3.5 years later. [EL = 1] A quasi-randomised comparison of a MycroMesh patch sling (PTFE mesh impregnated with silver diacetate and chlorhexidine) with vaginal wall sling gave no statistical analysis, but found combined subjective and objective cure in 95% vs. 75% at mean follow-up of 22 months. Complications reported were wound infection, UTI, bleeding, vaginitis and transient de novo UUI (30) [EL=2] Again, the need for sling removal was common, reported in up to 31% (median 8%) in a review of case series within the systematic review underlying the NICE guidance on UI (11)[EL=3].

A retrospective cohort study compared an ARF sling with one reinforced with polyglactin mesh in women with USI, one-third of whom also had UUI (n=51)

(48). Follow-up differed between groups and, overall, no clear difference was seen between groups in success rates. As with most studies, results depended on the definition of success used. No significant differences were noted between groups in terms of complications (e.g. wound infection, incisional hernia, voiding dysfunction, and de novo DO). [EL=3]

A small, non randomised trial compared ARF to bovine dermis sling (n=85) (49). Patients were allocated to material by institution and all had ISD (VLPP≤60 cm H2O), advanced age, and/or recurrent SUI after previous anti-incontinence surgery. At 12 months follow-up, the SUI-specific cure rates (consisting of subjective stress SEAPI domain and negative cough stress test) and global cure rates (consisting of SEAPI composite score and visual analog score) were not significantly different between the two slings. QOL indices (UDI-6, IIQ-7) were significantly improved in both groups. There were significant differences in several preoperative demographic variables between the groups.

In the Cochrane review of traditional BN slings, there were six studies comparing one type of sling to another (1) including four published trials in their statistical comparison (27-29, 32) as well as two trials in abstract form. A total of 379 women studied after 12 months showed no statistically significant difference in incontinence rates (RR 0.89; 95% CI 0.72 to 1.10). However, results reported improvement after one year in favour of the traditional ARF sling (RR 0.33; 95% CI 0.17 to 0.64). The incontinence rate after five years was reported in only one trial (28) and showed no statistically significant difference between different lengths of the autologous material used (RR 1.17; 95% CI 0.86 to 1.59). There was significant heterogeneity in the incidence of perioperative complications between groups in two trials, which was attributed more to complications with the use of Gore-Tex in one trial (RR 0.05; 95% CI 0.00 to 0.80, (27). In the other trial, there was no statistically significant difference between two biological slings (RR1.14, 95% CI 0.78 to 1.66, (28). No statistically significant difference was found in assessment of the following AEs, reported in only one trial : bladder perforation (RR 0.69; 95% CI 0.12 to 4.03), UTI (RR 1.73; 95% CI 0.66 to 4.54), de novo DO or urge symptoms (RR 3.11; 95% CI 0.65 to 14.97), and voiding dysfunction (RR 1.16; 95% CI 0.65 to 2.07).

1.4. Traditional sling vs. MUS (Tables 4 and 5)

Our review identified 17 trials that addressed the comparison between traditional sling operations and MUS operations. Eight RCTs compared traditional slings placed at the BN with the RP MUS (Table 4) (20, 50-56) and 3 additional RCTs provided long-term outcomes of aforementioned studies (44, 57, 58).

Table 4: Traditional Sling vs RP MUS

Author	RCT	Sling	Comparator	N/N (n1/n2)	F/U	Cure; effect size	E L	Comments
Arunkalaivanan, 2003	Yes	Porcine Dermiss	TVT	128/142 (74:68)	Median 12m	89% vs. 85% (s); p=ns	2	No ss calculation
Abdel-Fattah, 2004				(68:60)	Median 36m	82.4% vs. 88.3% (s); p=ns	2	90.1% response rate to questionnaire at 36m
Hung, 2004	No	Prolene	TVT	80 (57:23)	Mean 20m:23m	93% vs. 91.3% (o); p=ns 68.8% vs. 77.4% (s); p=ns	3	TVT better than prolene at BMK27.3 kg/m'
Bai, 2005	Yes	ARF	TVT	59/59 (28:31)	6m 12m	92.8% vs. 90.3% (s+o); p=ns 92.8% vs. 87.0% (s+o); p=sig	2	No ss calculation; minimal details about randomization; some disparities between text and tables
Wadie, 2005	Yes	ARF	TVT	53/53 (25:28)	6m	92% vs. 92.9% (o-1 week); p=ns	2	No ss calculation; may be underpowered; cure determined at first F/U visit because of results of interim analysis; UDI-6, IIQ-7 significantly decreased at 24m
Wadie, 2010				63/75 (39:24)	24m (median 54m)	93.7% vs. 95.2% (s+o); p=ns	2	No ss calculation; may be underpowered; cure determined at first F/U visit because of results of interim analysis; UDI-6, IIQ-7 significantly decreased at 24m
Kondo, 2006	Yes	ARF	TVT	60/63 (29:31)	24m	66.7% vs. 82.6% (s); p=ns 47.6% vs. 69.6% (o); p=ns	2	Subjects for analysis reduced to 21 in ARF group & 23 in TVT group
Morgan, 2007	No	ARF	TVT	143 (81:62)	Mean 24m: 18m	Similar symptom severity; p=ns	3	
Basok, 2008	Yes	CFL	IVS	139 (67:72)	12m	79% vs. 70.8% (o); p=ns 82% vs. 87.5% (s); p=ns	2	Method of randomization not stated; 67% had MUI; significantly higher persistent UUI and de novo DO for CFL
Jeon, 2008	No	PVS	TVT	181 (87:94)	24m 84m	87.3% vs. 86.9% (s+o); p=ns 59.1% vs. 55.1% (s+o); p=ns	3	Retrospective; complication rates similar at 24m
Sharifiaghdas, 2008	Yes	ARF	TVT	61/100 (36:25)	12m (mean 39m)	75% vs. 76% (o-pad weight); p=ns	2	No ss calculation; 39% dropped out by 12m; no details

Table 4: Traditional Sling vs RP MUS (continued)

Author	RCT	Sling		Comparator	N/N (n1/n2)	F/U	Cure; effect size	E L	Comments
									about randomization; subjective cure (IIQ) similar
Amaro,2009	Yes	ARF		TVT	41/41 (21/20)	12m 36m	57% vs. 65% (s); p=ns 55% vs. 63% (s); p=ns	2	No statistical difference in satisfaction, KHQ domains, de novo urgency; op time shorter for TVT
Trabuco, 2009	No	ARF		Uretex	242/290 (79:163)	36m	Survival rate free of SUI: 73.8% vs. 87.9% (s); p=ns	2	RR for SUI after ARF=1.8x higher than Uretex at 36m; satisfaction lower in ARF group, voiding dysfunction higher
Guerrero, 2010A (Lucas, 2004 in abstract form)	Yes	ARF	Porcine Dermis	TVT	189/201 (73/45/71) 182/201 (67/46/69)	6m 12m	95% vs. 73% vs. 92% (s; improved); p=sig, PD vs. others 48% vs. 22% vs. 55% (s; dry); p=sig, PD vs. others	2	SS performed, but porcine dermis arm suspended following interim analysis at 12m
Khan 2013	Yes				162/201 61/38/63	10 years	75.4%; 58% 73% (s cured 50.8% vs 15.7% vs 31.7% (s; dry) p=sig		
Mock 2015]	No	ARF		RP-MUS Top-down	91/110	13.8m	75.8 vs 80.9% p=ns	3	SUI, CST positive no POP Surgery on patients informed choice

One of the trials (51) was only available as an abstract and 3 studies were non-randomised case-control or cohort studies (46, 59, 60). Two RCTs compared a traditional ARF sling to a TO MUS (Safyre-t) (Table 5) (61, 62). Finally, a non-randomised trial compared PVSs (material not stated) with TVT and TO MUS (63). Six RCTs compared ARF sling with TVT and reported on a total of 463 patients (20, 51, 56); (52, 54, 55). Three of the studies were recently updated at a longer-term follow-up (44, 58, 64). Cure rates at 12-36 months (subjective +/- objective) varied widely depending on definition and were 47%-95% for both ARF and TVT.

Although a statistical difference was not observed at 6 months, one trial (20) showed a significant difference in subjective + objective cure rate at 12 months favoring TVT (92.8% vs. 87%). This trial also had a colposuspension arm, which had a 12 month cure rate of 88%. [EL=2]. The remainder five RCTs did not reveal a statistical difference in cure rates (subjective or objective) between ARF and TVT. [EL=1/2].

Another trial randomised 201 women with clinically and urodynamically confirmed SUI to TVT, ARF (sling on a string) or Pelvicol™ sling (44, 51). At 6 months the Pelvicol™ arm had poorer improvement rates (73%) than TVT (92%)/ARF (95%); $P = 0.003$. At 1 year only 61% of the Pelvicol slings remained as improved, versus 93% of TVTs and 90% of ARFs ($P < 0.001$). Following interim analysis the Pelvicol™ arm was suspended due to the significant poorer results. There was no difference in the success rates between TVT and ARF. ARF took longer to do (54 minutes versus 35 minutes for TVT/ 36 minutes for Pelvicol) and had higher intermittent self catheterisation rates (9.9 versus 0% Pelvicol /TVT 1.5%). Hospital stay was shortest for TVT (2 days). [EL=2]

In order to assess long term efficacy, participants were assessed by postal questionnaires or via a telephone interview (64) In all, 162 (80.6%) women were available for follow-up with a median (range) duration of 10 (6.6–12.6) years. 'Success' rates for TVT, AFS and Pelvicol™ were 73%, 75.4% and 58%, respectively. Comparing the 1- and 10-year 'success' rates, there was deterioration from 93% to 73% ($P < 0.05$) in the TVT arm and 90% to 75.4% ($P < 0.05$) in the AFS arm; 'dry' rates were 31.7%, 50.8% and 15.7%, respectively. Overall, the 'dry' rates favoured AFS when compared with Pelvicol ($P < 0.001$) and TVT ($P = 0.036$). The re-operation rate for persistent SUI was 3.2% (two patients) in the TVT arm, 13.1% (five) in the Pelvicol arm, while none of the patients in the AFS arm required further intervention. [EL=2]

A non randomised prospective comparative study examined the efficacy and complications of ARF and MUS in surgically naïve women with SUI. A total of 201 women were given the option between a PVS and an MUS (top-down). Ninety-one women (45%) underwent ARF and 110 underwent MUS (55%). The

two groups were comparable on the baseline characteristics. At a median follow-up of 13.8 months the cure rate in the ARF group (75.8%) was not statistically significant different from that in the MUS group (80.9%) De novo urinary urgency incontinence appeared in 16.7% of the PVS group and 33.3% of the MUS group (non significant). Complications and voiding difficulty were similar between the groups (4.4% in ARF vs 2.7% in MUS)(65) [EL=2]

One RCT found no statistical difference in objective and subjective cure rates at 12 months after cadaveric fascia lata slings and the intravaginal slingplasty (IVS), a multifilament, polypropylene MUS (53) [EL=2]

One non-randomised trial that also included a porcine dermis arm found no statistical difference between ARF slings and TVT (46). Symptom severity, as assessed by validated questionnaire, was not significantly different between the ARF sling and TVT groups. [EL=2/3].

Two randomized studies compared the porcine dermis sling with PVS tape (TVT) (50, 51) The first RCT comparing porcine dermis sling with TVT found no significant differences in operating time, hospital stay, complication rates, or subjective cure at 1 year (85% vs. 89%) (50), nor in cure (88% vs. 82%) or satisfaction at 3 years, assessed by mailed questionnaire (77% vs. 80%) (57) [EL=1]. The other study (44, 51) compared 3 treatment arms (ARF, porcine dermis sling-Pelvicol™, and TVT). At 1 year only 61% of the Pelvicol™ slings remained as improved, versus 93% of TVTs and 90% of AFSs ($P < 0.001$). It is not clear why the first study (50) found comparable results between porcine dermis and TVT, whereas the 3-arm trial found such significantly poorer results after porcine dermis to require the premature curtailment of recruitment (44, 51).

The non-randomised trial mentioned in the previous section (46) that included a porcine dermis arm, found that symptom severity was significantly higher in the porcine dermis group than in the other 2 groups of ARF and TVT. [EL=2/3]

A retrospective study compared traditional ARF sling, TVT, and the TO MUS (63). Overall complication rates were not significantly different between the sling groups. At 2 years postoperatively, the cumulative cure rates of the traditional sling, TVT, and TO MUS groups were significantly different (87.3% vs. 86.7% vs. 34.9%, respectively; $p < 0.0001$).

The risk of treatment failure in women who received TO MUS was 4.6 times higher than in women who underwent traditional sling. The 7-year cumulative cure rates of traditional sling and TVT groups were 59.1% and 55.1%, respectively. [EL=2/3]. Another retrospective cohort study of 242 women who underwent ARF ($n = 79$) or midurethral ($n = 163$) sling found that women with rectus fascia slings were more likely to report any leakage of urine ($P = .04$) and were

Table 5: Traditional Sling vs TO MUS

Author	RCT	Sling	Comparator	N/N (n1/n2)	F/U	Cure; effect size	EL	Comments
Silva-Filho, 2006	Yes	ARF	Safyre-t	20 (10:10)	6m	39g vs. 8.4g (o; pad weight); p=sig	2	Mean operating time & hospital stay significantly shorter in Safyre group
Jeon, 2008	No	PVS	TO MUS TVT	159 (87:72)	24m	87.3% vs. 34.9% (s+o); p=sig	3	Retrospective; complication rates similar at 24m; RR treatment failure of TO MUS=4.6x higher than ARF
Tcherniakovsky, 2009	Yes	ARF	Safyre-t	41/41 (20:21)	12m	95% vs. 90.5% (s+o); p=ns	2	Randomization technique not stated; no ss calculation

13 times more likely to require urethrolysis ($P < .001$) than patients with MUSs. Patient satisfaction was lower in the rectus fascia sling group compared with the MUS group ($P = .01$). (60) [EL=3]

Two small RCTs compared ARF sling to Safyre-t TO MUS (61, 62). At a follow-up of 12 months, subjective + objective cure rates were not statistically different (95% vs. 90.5%) in one trial (62), while higher pad weight at 6 months was observed for the ARF group in another trial (39g vs. 8.4g) (61) [EL=2]

The Cochrane database identified 12 trials that addressed the comparison between traditional sling procedures and minimally invasive, MUS operations. (1). Ten of these studies have been summarized in our assessment and 2 studies were only in abstract form. (8, 20, 44, 50, 53-55, 58, 62, 63). Data on incontinence after the first year were available from four RCTs (20, 44, 50, 54). Incontinence was reported by 31.6% of those women in the traditional sling and 25.3% of those in the MUS groups. This was not statistically significant (RR 1.23; 95% CI 0.91 to 1.66). This translates to 311 per 1000 women being incontinent after a traditional sling compared with 253 per 1000 after a MUS. Improvement after a year was addressed by two trials (44, 50) and there was no statistically significant difference between the two types of sling (RR 1.30; 95% CI 0.57 to 2.94).

Pooled data from 3 trials (50, 54, 62) showed a statistically significant higher risk of perioperative complications after traditional sling operations (RR 1.59; 95% CI 1.03 to 2.44). Seven RCTs (20, 50, 54, 55); (66) (abstract only); (58, 62) reported bladder perforation. There were more perforations after MUS procedures, but this did not reach statistical significance (RR 0.62; 95% CI 0.34 to 1.11) and the confidence interval was wide. The combined results from 3 trials showed less de novo urgency symptoms after MUS (RR 3.13; 95% CI 0.96 to 10.24) but this did not reach statistical significance and the confidence interval was wide. However, 3 trials showed that development of de novo DO was significantly less after MUS operations (RR 3.21; 95% CI 1.29 to 8.03). This was principally due to the higher weighting given to the largest trial (53). The combined results from 5 trials showed that more women had postoperative voiding dysfunction after traditional slings than after MUS (RR 1.60; 95% CI 0.94 to 2.71) but this did not quite

reach statistical significance and the confidence interval was wide. More women in the traditional sling group required release of sling (9% versus 2%), reported in two trials (RR 3.67; 95% CI 0.95 to 14.22) but again this was not statistically significant. There was no statistically significant difference in urinary retention up to 6 weeks (RR 5.51; 95% CI 0.68 to 44.63) from one trial and vaginal erosion (RR 0.35; 95% CI 0.02 to 8.10) based on one trial.

Summary

Only a few new studies have emerged on traditional slings since the 5th edition.

AFS (autologous fascial sling) is the most widely evaluated biological sling and is an effective and durable treatment for SUI. [EL=1].

There is little short term difference in efficacy between biological slings using autograft or allograft (EL=2/3) and synthetic slings and biological slings placed at the BN. However, those studies that find a difference between biological materials for sling all favor autologous materials [EL=2].

As compared to AFS, AEs may be more common following the use of synthetic materials as 'traditional' (BN) sling procedures (exposure, erosion, etc.) [EL=3].

In comparison to other procedures:

AFS is more durable than injectable bulking agents as a treatment for SUI (EL=2/3)

AFS (BN slings) are as effective as MUS in the short term [EL=1] however OR time and LOS are significantly shorter with MUS

AFS is modestly more effective than colposuspension at mid-long term (EL= 1/2) albeit with a higher rate of early postoperative voiding dysfunction. The limited data available suggest that the overall rates of late surgical complications are similar after sling and colposuspension; however, the pattern of complications may vary.

Due to the variability and somewhat unique array of complications associated with each procedure, as well as the relatively low incidence of short term and long term complications overall, and the relatively

small number of comparative trials with a complete accounting of all complications between AFS, biological materials, MUS, and colposuspension, there is an insufficient database on which to recommend or differentiate these procedures on the basis of AEs/complications alone.

Recommendations

Autologous fascial sling (AFS) is recommended as an effective treatment for female stress urinary incontinence, which has longevity for both primary and redo surgery. [Grade A]

2. COLPOSUSPENSION

2.1. Open Colposuspension

Open PVS colposuspension is a surgical treatment which involves lifting the tissues near the BN and proximal urethra in the area behind the anterior pubic bones to correct deficient urethral closure. Since its introduction by Goebell, Stroekl, and Frangenheim in 1910, various alternative techniques have been described. The Marshall-Marchetti- (67) and the Burch procedures (68, 69) are two traditional approaches that have had long-term success rates in restoring continence.

2.1.1 Marshall-Marchetti-Krantz (MMK) Procedure

There were no new RCTs involving the MMK procedure and therefore no new recommendations since the 2009 edition of the ICI-3 book.

Although short-term results indicate comparable cure rates to colposuspension, there is limited evidence that longer-term outcome is poorer following MMK [EL=1], and declines further over time [EL=3]. The previous edition of this consultation found no reason to support the continued use of MMK over colposuspension; there is no new evidence to indicate a change in this view.

Recommendation

The MMK Procedure is not recommended for the treatment of SUI. [Grade A]

2.1.2 Burch Colposuspension

There have been only two newly published randomised trials since the 2009 edition of the ICI-3 book, which are one comparing open colposuspension with TVT procedure (70) and one with TO MUS procedure. (71)

In common with previous systematic review supported by meta-analysis, (26) the combined results from the various studies show open colposuspension to have comparable subjective and objective outcomes to both traditional sling procedures and to the newer minimally invasive midurethral PVS sling pro-

cedures; it has better outcomes than anterior colporrhaphy, BN needle suspension and MMK procedure [EL=1].

Open colposuspension has been shown to be an effective surgical treatment for stress urinary incontinence. In common with other procedures there is some loss of efficacy with time.

Recommendations

Open Burch PVS colposuspension can be recommended as an effective treatment for primary and recurrent stress urinary incontinence, which has longevity. [Grade A]

Open Burch colposuspension can be considered for those women in whom an open abdominal procedure is required concurrently with surgery for SUI. [Grade D]

2.2. Laparoscopic/Robotic Colposuspension

Laparoscopic minimally invasive approaches to PVS was introduced by Vancaille and Schuessler in 1991, as an alternative technique of open colposuspension that features the advantages of reduced pain, a shorter length of hospitalisation, and a more expedient return to activity while avoiding the morbidity associated with the open PVS colposuspension.

2.2.1 Laparoscopic versus Open Colposuspension (Table 6)

The Cochrane review of laparoscopic colposuspension includes details of 22 RCTs that include laparoscopic colposuspension (72), 14 more than their initial review (34). Of these 22 trials, ten compared laparoscopic colposuspension with open colposuspension (18, 61, 73-80).

Eight of the ten studies comparing laparoscopic colposuspension with open colposuspension were included along with eight retrospective cohort studies in a recently published meta-analysis (43).

One RCT compared laparoscopic colposuspension (81) with open colposuspension and one RCT compared different techniques of laparoscopic colposuspension. In addition, two publications with longer-term follow-up (37) or cost-effectiveness data (82) were added.

We identified two RCTs (83, 84), which were included in the Cochrane review of open colposuspension.

Table 6: Published level 1 & 2 evidence relating to laparoscopic colposuspension

Study references	Type	Comparator	N/N(n1:n2)	FU	Cure(obj or sub)/ effect size	EL	Comments
85	RCT	Transperitoneal vs. extraperitoneal	22 (?:?)	1-12m	92% (s+o)	2	Mixture of suturing/stapling techniques outcomes not separately evaluable
74	RCT	Sutures vs. mesh/staples	69/69(25:34)	1y	91% vs. 94%: RR 0.97: 95% CI 0.85, 1.11	2	
86	RCT	Open colpo	92/92 (46:46)	6m	80% vs. 95%: p= 0.044(o)	2	Part preference, part randomised: sample size calculation req'd 152.
87,88,89,90	RCT	2 single bite vs. 1 double bite sutures	161/?(83:78)	1y	83% vs. 58%: p<0.001	2	Enrollment curtailed early after interim analysis
91	RCT	Sutures vs. mesh/staples	53/60 (27:26)	1 & 3y	89% vs. 75 % (o-at 1y) 70% vs.42% (o-at 2y) 58% vs.38% (o-at 3y):p<0.05	2	Only completers analysed in 2001 paper: ITT used in 3 year follow-up
92	RCT	Open colpo	74/74 (34:40)	18m	88% vs. 85%: p=ns (0+s)	2	No ss calculation
93	RCT	TVT	68/79 (31:37)	1Y	87% vs.89% RR 0.98: 95% CI 0.82, 1.16	2	270 approached: 79 randomised. Study designed to examine costs.
94	RCT	Open colpo	90/90 (47:43)	1y	85% vs. 86%: p=ns (o)	2	15% vs. 37% underwent concomitant hysterectomy
95	RCT	TVT	46/46(23:23)	3-24m	83% vs. 83%; RR1.00; 95% CI 0.77, 1.60 (s+o)	2	No information on randomisation; no allowance for variation in FU
96,97,98	RCT	TVT	121/128 (51:70)	1y	57% vs. 86% (95% for CI for diff. 1.27,43.9); p=0.000(o)	2	Lap. Colpo with mesh. SS calculation required 176.
99	RCT	TVT	71/72 (35:36)	12-43m 12-88m	97% vs 81% (0-at median 18m) 43% vs 52% (s-at median 65m)	2	SS 130; recruitment stopped early because of slow recruitment. 63 (88) FU at 1y; 33(46%) at 2y
100	RCT	Open colpo Lap colpo(mesh)	184/211 (49:63:72)	1y	90% vs. 92% vs. 63% (o) p<0.05 open vs.mesh	2	Unclear randomisation; all pts randomised to Burch or lap colpo(mesh) also included in separate multi-centre study [265]. Only completers analysed.

Table 6: Published level 1 & 2 evidence relating to laparoscopic colposuspension (continued)

Study references	Type	Comparator	N/N(n1:n2)	FU	Cure(obj or sub)/ effect size	EL	Comments
101	RCT	Open colpo	52/52 (26:26)	3-24m	81% vs. 81%; p=ns	2	Many concurrent procedures- varied between groups
102,103	RCT	Open colpo	242/291 (144:147)	2y	80 vs.70% (o)	1	5 had no op., & 12 changed op, after randomis'n. Objective data on 83&
104	RCT	Open colpo	164/200 (766:88)	3-5y	72% vs. 78%; p= 0.22 (o at 6m) 69% vs. 80%; p= 0.38(s at 2y)	2	Telephone interview at 3-5y; results similar to 24 m
16	RCT	TVT	121/128	5 yr	78% vs 94% p<0.028	2	Valpas et al, 2015 (105)

One is only an abstract (83). They reported shorter operative times with open colposuspension, by 15-30 minutes and a longer hospital stay after open compared to laparoscopic colposuspension. Tuygun also reported that the time to catheter removal or the time to return to normal activities was longer in the open colposuspension group.

Studies included in the Cochrane review had different lengths of follow-up, although eight studies had follow-up in the region 6 to 18 months. In comparison with open colposuspension they found subjective cure rates to range from 58% to 96% in the open and 62% to 100% in the laparoscopic group within the 18 months follow up, with a non-significant 5% lower relative subjective cure rate for laparoscopic colposuspension (RR 0.95, 95% CI 0.90 to 1.00)(72) [EL=1]. The two studies with follow-up at five years or beyond unfortunately remain unpublished and available in abstract form only. Both these studies were relatively small, and their results are inconsistent, one finding better subjective outcome from the laparoscopic procedure (80), and one favouring the open procedure (79); the methodology of this latter study in particular has been questioned [EL=2].

Overall, the objective cure rate as judged by cough stress testing or pad test within 18 months was statistically significantly lower following laparoscopic colposuspension (RR 0.91, 95%CI 0.86 to 0.96) [EL=1]. Between 18 months and five years there was no significant difference (RR 1.01, 95%CI 0.88 to 1.16); again however, there was heterogeneity with one small trial greatly favouring open procedure (79) and the other favouring laparoscopic(80) [EL=2]. When objective cure was judged by urodynamic investigations there was a significantly higher success rate following open colposuspension (RR 0.91, 95%CI 0.85 to 0.99).

2.2.2 Laparoscopic Colposuspension vs. Other Techniques

Eight trials have compared laparoscopic colposuspension with minimally invasive mid-urethral slings(4, 106-110).

In comparison with minimally invasive mid-urethral slings there was no statistically significant difference in subjective cure rates within 18 months (RR 0.91, 95% CI 0.80 to 1.02) [EL=1]. The definition of objective cure varied widely between studies, although overall the objective cure rate was higher for minimally invasive mid-urethral slings than laparoscopic colposuspension (RR 0.92, 95% CI 0.85 to 0.99) [EL=1]. (for addition information on laparoscopic colposuspension vs. MUS, please see section on RP MUS)

Although laparoscopic colposuspension is regarded as a less invasive operation than the open colposuspension, the mid-urethra tape procedures had significantly shorter operating time (<0.001), hospital stay (<0.001) and time for resuming normal activity (<0.01

-0.001) as compared to the laparoscopic colposuspension.

2.2.3 Different Techniques of Laparoscopic Colposuspension

Different aspects of the laparoscopic technique have been compared including one vs. two sutures (111), sutures vs. mesh (86, 112, 113) and transperitoneal vs. extraperitoneal approach to laparoscopy(114).

Two sutures on either side of the BN resulted in higher subjective (RR 1.37, 95% CI 1.14 to 1.64) and objective (RR 1.42, 95% CI 1.14 to 1.77) cure rates as compared to one [285] [EL=2].

When comparing sutures and mesh to secure para-urethral support, sutures resulted in a higher subjective (RR 1.28, 95% CI 1.11 to 1.47) and objective (RR 1.20, 95%CI 1.07 to 1.35) cure rate than mesh (74, 86, 112, 113) [EL=1].

The transperitoneal versus extraperitoneal study reported above employed different techniques (sutures vs mesh) and therefore gives little insight into the value of either approach given the superior results obtained with sutures.

The use of glue or fibrin sealants has not been reported outside small case series.

2.2.4 Complications of Laparoscopic Colposuspension

Bladder, ureteric and vascular injuries are recognised complications of colposuspension. The Cochrane review reported 21 bladder injuries among 521 laparoscopic procedures (compared with 10 among 507 open procedures) and two studies reported obturator vein lacerations. However, when compared with the traditional open colposuspension, the laparoscopic group was found to have significantly fewer postoperative complications (RR 0.74, 95% CI 0.58–0.96) with lower estimated blood losses and shorter duration of catheterisation.

Longer operating times are a significant disadvantage of the laparoscopic approach (73, 76, 83, 84); however, women have reported significantly less pain, (79, 115-117) shorter hospital admissions, faster recoveries and quicker return to normal activities. (91, 93), (102),(86),(62, 70, 118, 119) (83),(84).

2.2.5 Longevity of Laparoscopic Colposuspension

A long-term review of women who had undergone laparoscopic colposuspension more than 10 years previously(60, 120) compared the results with a group of women who had open colposuspension. Subjective cure rates deteriorated over time from 71% and 67% at 6 months to 52% and 36% at 10 years for the laparoscopic and open procedures, respectively. Vaipas updated their previous study comparing TVT with laparoscopic colposuspension (109), and showed that both objective and subjective cure rates were significantly higher in the TVT group (94%,

64%) than in the laparoscopic mesh colposuspension group (78%, 51%) (105).

The conclusion from the Cochrane review was that the available evidence suggests that laparoscopic colposuspension may be as effective as open colposuspension two years postoperatively (72). The systematic review specific to laparoscopic colposuspension and TVT™ concluded that the evidence so far appears to favour the latter as the minimal access technique of choice for USI (121). In both cases however the authors indicated that the place of laparoscopic colposuspension in clinical practice could not be clearly defined without further long term results.

It should also be noted that much of the published research in this area is from individuals with enthusiasm and skill in laparoscopic surgery; their results should not necessarily be seen as being generalizable to the urogynecological/urological community at large. The NICE guidance includes amongst its recommendations that laparoscopic colposuspension is not recommended as a routine procedure for the treatment of SUI in women, but that the procedure should be performed only by an experienced laparoscopic surgeon working in a multidisciplinary team with expertise in the assessment and treatment of UI (122, 123); this same point is emphasised in the meta analysis from Tan and colleagues [275] [EL=4].

Summary

Laparoscopic colposuspension shows comparable subjective and objective outcome to open colposuspension in the short to medium term; longer term outcomes are unknown [EL=2].

Limited evidence suggests that the subjective outcome from laparoscopic colposuspension is similar to the TVT™, however the objective outcome is poorer. (EL=2)

Recommendations

Laparoscopic colposuspension can only be recommended for the surgical treatment of SUI in women by surgeons with appropriate training and expertise. (Grade C)

Women should be advised about the limited evidence available about the long term durability of laparoscopic colposuspension. (Grade C)

3. MIDURETHRAL SLING

3.1. Retropubic MUS

The tension-free vaginal tape (TVT) procedure for treatment of female PVS was first introduced by Ulmsten, et al. in 1996(124). The development of the TVT operation was an attempt to support the middle portion of the urethra, instead of restoring anatomy and correcting urethral hyper-mobility at the BN. The idea of supporting the “mid-urethra” has been derived

from the results of several research projects conducted during the last thirty years. The work of Zacharin in 1968 and DeLancey in 1994 had already shown that the pubourethral ligaments inserted at the mid-urethra and that the urogenital diaphragm also was closer to the middle portion of the urethra than the BN(125, 126). In 1978, Owman et al. found that the most densely innervated portion of the urethra was the middle part and Huisman in 1983 showed in histological studies that the mid-urethra had the most abundant vascularisation(127). Additionally, Westby et al. in 1982 showed in radiographic studies how the urine stream was interrupted at the mid-urethra on holding in continent women and Asmussen et al. in 1983 showed that the maximal urethral closure pressure was situated at the midurethra(128, 129). It quickly became apparent that focusing on the mid-urethra might bring improvement in the performance of incontinence surgery.

Prospective observational cohort studies revealed that placing a macroporous, monofilament polypropylene tape at the mid urethra resulted in cure rates between 80-90 % in primary cases of SUI (123, 124, 130-132), in recurrent cases (133, 134), in mixed incontinence cases (133), and in an unselected group of women including primary, recurrent and mixed incontinence as well as women with ISD(132). Since those initial reports of success, several groups have reported long-term outcomes exceeding 5 years (107, 135-138) and 10 years after the TVT procedure (139, 140). A variety of follow-up regimens and definitions of success reveal that the effects of the TVT on resolution of SUI are durable over the long-term.

Since the last ICI review was conducted, the literature regarding the TVT and other RP MUS procedures has expanded at an almost exponential pace. As an example, 16 RCTs comparing MUS to other procedures were available for review. The number of RCTs and large cohort studies now available significantly exceeds the previous review, and, unless otherwise mentioned, only fully-published studies have been included herein.

3.1.1 RP MUS vs. No Treatment (Table 7a)

No recent trial has compared RP MUS and no treatment. A multicentre, prospective RCT performed by Campeau et al. enrolled 69 elderly females who initially consented to be randomised to either undergo immediate TVT surgery or to wait for 6 months before submitting to the same surgery (control group). (141) The main outcomes measured at every visit (pre-randomisation, 8-12 weeks and 6 months) consisted of the Incontinence-Quality of Life (I-QOL) Questionnaire, the Patient Satisfaction Questionnaire and the Urinary Problems Self-assessment Questionnaire. The analysis included 31 patients in the immediate surgery group and 27 subjects in the control group. Perioperative complications in the immediate surgery group were bladder perforation (22.6%), urinary retention (12.9%), urinary tract infection (3.2%) and de novo urgency (3.2%). At 6 months, the mean scores

on each questionnaire were significantly in favour of the TVT group. [EL=1/2]

3.1.2 RP MUS vs. Pelvic Floor Muscle Training (PFMT)

Pelvic floor muscle training (PFMT) with or without biofeedback is a recognised and effective treatment for various pelvic floor conditions, including SUI, UUI, and pelvic pain.

Since ICI-5, Labrie et al. published a multicentre RCT which included 215 women in the surgery group and 202 women in the physiotherapy group. At 1 year, a total of 49.0% of women in the physiotherapy group and 11.2% of women in the surgery group crossed over to the alternative treatment. In an intention-to-treat analysis, at 1 year, there was higher rates of subjective improvement (90.8% versus 64.4% (absolute difference, 26.4 percentage points; 95% [CI], 18.1 to 34.5), subjective cure (85.2% vs 53.4% (AD, 31.8 pp; 95% CI, 22.6 to 40.3) and objective cure (76.5% vs 58.8% (AD, 17.8 pp; 95% CI, 7.9 to 27.3) in women in the surgery group compared with women in the physiotherapy group (Lot 1). A post hoc per-protocol analysis showed that women who crossed over to the surgery group had outcomes similar to those of women initially assigned to surgery and that both these groups had outcomes superior to those of women who did not cross over to surgery.

3.1.3 RP MUS vs. Bulking Agents

No trial comparing bulking agents to MUS slings was found.

3.1.4 RP MUS vs. Open Colposuspension (Table 7b)

Since the ICI-5 review, only two additional studies have been published comparing TVT and open colposuspension. (142, 143) While El-Din Shawki 2012 reported outcomes, we were not able to include the data in the review because they did not specify how the participants were allocated across the three treatment groups. For Trabuco 2014, only the abstract was available and the trial has not been included in this review.

Three of the studies from ICI-5 compared TVT with open colposuspension (70, 144, 145). In a nonrandomised trial with significant failed-to-complete-follow-up, McCracken et al. found no difference in subjective success rates via questionnaire between colposuspension and TVT at 5 to 10 years. [30] In an RCT randomising 49 women to TVT or colposuspension, Tellez Martinez-Fornes found no significant difference in subjective success rates (cured/improved) between the 2 procedures at follow-up periods of 6, 12, and 36 months.(70) In a retrospective, nonrandomised trial comparing 105 women who underwent TVT with 81 women who underwent MMK, the authors found that while the short-term success rate of the MMK was 89%, the rate fell to 68.2% at 5 years and 32% at 10 years. (145) In comparison, the short-term success rate of the TVT was statistically similar

to the MMK (90%) but decreased only to 84.3% at 5 years. Women who underwent TVT also experienced shorter operative time, less blood loss, and shorter hospital stay. [EL=3]

A systematic review and meta-analysis comparing open colposuspension and sling procedures was published in the Cochrane Database(146). Twenty-two trials compared suburethral slings (traditional slings or trans-vaginal tape or TO tape) and open colposuspension, involving a total of 2343 women (slings procedures n=1254, vs. open colposuspension n=1089). The authors of this review acknowledged the discrepancy of the data which was attributed to the different types of sling operations performed. There were non-significant differences in long-term patient reported cure rate (RR 1.11; 95% CI 0.97 to 1.27) and in objective cure rate (RR 0.70; 95% CI 0.30 to 1.64). Six trials involved traditional (BN) suburethral sling procedures, 12 trials used RPMUS, 3 trials TO MUS and one trial did not specify whether the TVT or TO MUS procedure was the approach taken.

The operative time (18.06 ; 95%CI 14.67 to 21.46) and the hospitalisation stay (MD (Mean difference) 3.99; 95%CI 3.71 to 4.28) were shorter with TVT as compared to open colposuspension. The time for catheter removal was shorter in the TVT group compared with the open colposuspension (RR 4.51; 95%CI 3.05 to 5.97).

There was no significant difference in the perioperative complication rates between colposuspension and TVT (RR 1.11; 95% CI 0.66 to 1.87). There was no significant difference between these two groups in the number of de novo urgency symptoms or urgency incontinence (RR1.28 ; 95%CI 0.65 to 2.50) or for de novo DO (RR 1.28 ; 95%CI 0.71 to 2.32). However, there was a nearly 40% lesser risk of developing voiding difficulties after open colposuspension as compared to sling procedures (RR 0.41; 95% CI 0.26 to 0.67). Trials which focused on TVT however, showed no significant difference in the risk of voiding dysfunction between the two groups (RR 0.66 ; 95%CI 0.06 to 7.09). Women had a higher risk of developing new or recurrent prolapse when undergoing open PVS colposuspension compared to those undergoing sling procedures (RR 1.85; 95% CI 1.25 to 2.75).

There was a lower risk of bladder perforation (RR 0.20; 95% CI 0.08 to 0.49) and vascular injury in open colposuspension compared to TVT.

Table 7a: Studies comparing RP MUSs with no treatment and pelvic floor muscle training

Author	RPMUS	Comparator	No. Patients	F/U	Power calculation	# Lost to F/U	% Cure	Significance	LE	Notes
RP MUS vs. No treatment										
Campeau, 2007* (141)	TVT	-	31/27	6m	Yes	0/20	N/A	0.0001	1	Favors TVT
RP MUS vs. pelvic floor muscle training (PFMT)										
Labrie, 2013	TVT	PFMT	215/202	12m	Yes	19/28	90.8/64.4 (subjective improvement)	yes	1	
							85.2/53.4 (subjective cure)	yes		
							76.5/58.8 (objective cure)	yes		

Table 7b: Studies comparing RP MUSs with open colposuspension (OC)

Author	RPMUS	Comparator : OC	No. Patients	F/U	Power calculation	# Lost to F/U	% Cure	Significance	LE	Notes
RP MUS vs. Open Colposuspension (OC)										
Ward, 2002* (147)	TVT	OC	175/169	6m	Yes	N/A	66/57 (o)	No	1	
Ward, 2004* (148)				24m		19/26	63/51 (o)	No	1	
Ward, 2008* (149)				60m		103/120	81/90 (o) 91/90 (s)	No	1/2	>50% lost to F/U
Liapis, 2002* (150)	TVT	OC	36/35	24m	No	N/A	84/86 (o)	No	2	
Wang, 2003* (151)	TVT	OC	49/49	22m	No	N/A	82/76 (o) 92/93 (s)	No	2	
Bai, 2005* (20)	TVT	OC	31/33	12m	No	0/0	87/87.4 (s)	No	2	
El-Barky, 2005* (152)	TVT	OC	25/25	3-6m	No	0/0	72/72 (s)	No	2	
McCracken, 2007 * (144)	TVT	OC	40/45	1.5-3m	No	8/14	88.5/92 (s)	No	3/4	
				60-120m		17/22	77/70 (s)			
Tellez Martinez- Fornes, 2009* (70)	TVT	OC	24/25	6m	No	3/1	76.2/87.5 (s)	No	2	Success=cure + improved
				12m		1/1	78.3/87.5 (s)			
				36m		3/2	77.3/91.3 (s)			
Wu, 2010* (145)	TVT	OC	105/81	12m	No	0/0	90/89.5 (o)	-	3	No statistical comparison performed
				60m			84.3/68.2 (o)			
				120m			-/32 (o)			

3.1.5 RP MUS vs. Laparoscopic Colposuspension (Table 7c)

Since ICI-5, there are no additional trials published comparing RP MUS and laparoscopic colposuspension. Four of the 12 RCTs in ICI-4 comparing RP MUS with traditional incontinence procedures compared TVT with laparoscopic colposuspension. (87, 94, 96, 98) Two additional trials were added for ICI-5 (119, 153) as well as an update of the Paraiso et al. study (99). The Cochrane review included 5 fully-published manuscripts (87, 94, 96, 98, 153) along with 2 abstracts. (154).

In the studies comparing TVT or Supra Pubic Arc Sling (SPARC; a monofilament polypropylene MUS placed through a top-down approach) with laparoscopic colposuspension objective cure was assessed by a pad test in 2 of the 6 studies (87, 96), and by a cough-stress test in 3 of the studies (94, 96, 98). The criteria for cure or improvement were unclear in the study by Foote et al. (153). The trial by Valpas et al. with the greatest number of patients enrolled showed a significantly higher objective and subjective cure rate in the TVT group than in the laparoscopic colposuspension group ($p < 0.0001$), (96) while the other studies showed similar cure rates for both procedures ranging between 72.9% and 96.8% in the TVT groups and between 58.8% and 87% in the laparoscopic colposuspension groups. It was thought that the Valpas et al. trial may have shown a significant difference in outcomes in favour of TVT due to a difference in laparoscopic technique (using mesh rather than sutures to perform colposuspension). (154) In their trial, Paraiso et al. performed postoperative multichannel urodynamic studies in 32 laparoscopic Burch colposuspension and 31 TVT patients. This showed a higher rate of urodynamic stress incontinence at 1 year in the laparoscopic Burch colposuspension group, 18.8% versus 3.2% ($p = 0.056$). (98) There was a significant improvement in the number of incontinent episodes per week and in UDI and IIQ scores in both groups at 1 and 2 years after surgery ($p < 0.001$). However, postoperative subjective symptoms of incontinence (stress, urge, and any urinary incontinence) were reported significantly more often in the laparoscopic Burch colposuspension group than in the TVT group ($p < 0.04$ for each category). At long-term follow-up of the previous study, Jelovsek et al. confirmed that the TVT has similar efficacy to the laparoscopic Burch for the treatment of SUI. (99) While not always bothersome, the authors cited a substantial number of women in either group who had some degree of incontinence 4 to 8 years after surgery. Although laparoscopically-performed colposuspension is regarded as a less-invasive operation than the open colposuspension the MUS procedures had significantly shorter operating time, hospital stay, and time for resuming normal activity as compared to laparoscopic colposuspension. [EL=2]

As with the studies comparing open colposuspension with MUS, the conclusions of studies comparing MUS with laparoscopic colposuspension may be limited

due to underpowering. Dean et al. performed a systematic review of laparoscopic colposuspension ($n = 264$) and TVT ($n = 290$) which included 7 trials. (155) There was no statistically significant difference in the reported subjective cure rate between laparoscopic colposuspension and TVT within 18 months (RR 1.12, 95% CI 0.98 to 1.29). However, within the same time period, the overall objective cure rate was statistically significantly higher for TVT (RR 1.16, 95% CI 1.07 to 1.25). There were no significant differences between the two procedures with regards to perioperative complications, de novo DO, voiding dysfunction, procedural costs and QoL scores. The authors confirmed that the TVT procedure was quicker to perform and was associated with a shorter hospital stay. [EL=1/2]

A systematic review by Novara et al. evaluated open and laparoscopic colposuspensions together with RP MUS. (156) Women receiving MUS had significantly higher overall (OR 0.61; 95% CI 0.46 to 0.82, $p = 0.00009$) and objective (OR 0.38; 95% CI 0.25 to 0.57, $p < 0.0001$) cure rates than those receiving colposuspension. A clinical and economic subanalysis of the Valpas et al. study suggested that over a follow-up period of 1 year the TVT is more cost-effective than laparoscopic mesh colposuspension as a primary treatment for female SUI. [103] ??[49][EL=1/2]

3.1.6 RP MUS vs. Traditional Sling

This comparison is addressed in the section on traditional PVSs.

3.1.7 RP MUS vs. Other RP MUS (Table 7d)

The favourable results obtained with the TVT operation have resulted in several modifications of the procedure and the use of different tape materials. These PVS modifications have not been evaluated satisfactorily clinically and only 6 randomised studies comparing these with the TVT have been published.

The meta-analysis by Novara et al. did not differentiate between different types of RP MUS procedures. (156) In ICI-5, 4 non-randomised studies compared TVT with SPARC. (157-160) In the Dietz et al., study (TVT vs. SPARC), there were no significant differences for subjective cure/improvement, patient satisfaction, or symptoms of incontinence. (157) The cough-stress test was positive in 8 of 37 women who underwent SPARC compared to 4 of 69 TVT patients ($p = 0.019$). The TVT had a more negative effect ($p = 0.001$) on postoperative voiding. In the Gandhi et al. study, 107 of 122 women returned for objective postoperative evaluation after surgery. (158)

The TVT procedure was associated with higher subjective (86% vs. 60%, $p = 0.001$) and objective (95% vs. 70%, $p < 0.001$) SUI cure rates, while there was no difference between the TVT and SPARC groups in the resolution of subjective and objective UUI.

Table 7c: Studies comparing RP MUSs with laparoscopic colposuspension (LC)

Author	RPMUS	Comparator : LC	No. Patients	F/U	Power calculation	# Lost to F/U	% Cure	Significance	LE	Notes
RP MUS vs. Laparoscopic Colposuspension (LC)										
Persson, 2002* (92)	TVT	LC	28/32	12m	Yes	2/2	89/87 (o) 57/52 (s)	No	1	
Ustun, 2003* (94)	TVT	LC	23/23	3m	No	0/0	82.6/82.6 (o) 82.6/82.6 (s)	No	2	
Paraiso, 2004* (98) Jelovsek, 2008* (99)	TVT	LC	36/36	12m	Yes	8/6	97/81 (o)	0.056	1	Trends to TVT
				12-88m (Median 65m)		74% had F/U 48-96m	52/42 (s)	No	2	Cure=no reported incontinence
Valpas, 2004* (96)	TVT	LC	70/51	12m	Yes	6/4	85.7/56.9 (o) 82/58 (s)	0.001	1	Favors TVT
Foote, 2006* (153)	SPARC	LC	49/48	27m	Yes	10/10	77.4/81.4 (s)	No	2	
Tong, 2008* (119)	TVT	LC	67/30	9m (Mean)	No	0/0	95.5/86.5 (s)	No	3	

Table 7d: Studies comparing RP MUS with other RP MUS

Author	RPMUS	Comparator : RP MUS	No. Patients	F/U	Power calculation	# Lost to F/U	% Cure	Significance	LE	Notes
RP MUS vs. RP MUS										
Rechberger, 2003* (164)	TVT	IVS	50/50	4-18m	No	0/0	88/80 (s+o)	No	2	
Dietz, 2004* (157)	TVT	SPARC	69/37	1-18m	No	0/0	94.2/78.4 (o)	0.019	3	Favors TVT
Andonian, 2005* (165)	TVT	SPARC	43/41	12m	Yes	0/0	95/83 (o) IIQ (s)	No	1	
Lim, 2005* (166)	TVT	IVS/SPARC	65/65/65	1.5-3m	No	4/5/4	87.9/81.5/72.4 (o) 78.5/67.7/64.6 (o; ITT)	No	1/2	
Tseng, 2005* (122)	TVT	SPARC	31/31	24-30m (Median 25m)	Yes	0/0	87.1/80.7 (o)	No	2	0% vs. 12.9% bladder puncture (p=0.112)
Gandhi, 2006* (158)	TVT	SPARC	73/49	>1.5m (Median ~4m)	No	0/0	86/60 (s) 95/70 (o)	0.001	3	Favors TVT; short F/U
Kim, 2006* (159)	TVT	SPARC	62/62	12m	No	20/14	91.7/100 (o)	No	2/3	Satisfaction rate similar
Lord, 2006* (167)	TVT	SPARC	147/154	1.5m	Yes	0/0	97.3/97.4 (o)	No	1	Short F/U
							87.1/76.5 (s)	0.03		Favors TVT
Meschia, 2006* (168)	TVT	IVS	95/95	24m	Yes	3/8	85/72 (o) 87/78 (s)	No	1	
Yoon, 2007* (162)	TVT	IRIS	32/34	12m	No	0/0	96.9/88.2 (s+o)	No	2/3	

Table 7d: Studies comparing RP MUS with other RP MUS (continued)

Author	RPMUS	Comparator : RP MUS	No. Patients	F/U	Power calculation	# Lost to F/U	% Cure	Significance	LE	Notes
				36m			90.6/85.3 (s+o)			
Agarwala, 2008* [64]	TVT	Lynx	48/48	-	No	0/0	94/92 (s) 96/94 (o)	No	2	Consecutively assigned to sling
Paick, 2008* (160)	TVT	SPARC	72/22	6m	No	0/0	95.8/90 (s+o; SUI) 81.9/86.4 (s+o; MUI)	No	3/4	
Prien-Larsen*, (169)	TVT	IVS	103/213	3m	No		98/86 (o) 82/79 (s)	<0.03 (o) No (s)	3	Objective cure favors TVT; 0% vs. 11.8% vaginal extru- sion
				12m			95/86 (o) 79/81 (s)			
				60m			94/80 (o) 74/71 (s)			
Thubert 2016* (170)	TVT	TVT-Exact	49/49	12m	No	0/0	80.0 / 82.0 (s)	No	1	

Kim et al. found no difference in objective cure rates at 1 year of follow-up and complication rates were similarly low. (159) Paick et al. found no significant difference in cure of SUI or cure of all incontinence between TVT and SPARC at 6 months. (160) [EL=3/4]. Notably, SPARC is no longer commercially available as of 2016.

In ICI-5, two studies compared TVT against other PVS midurethral MUS procedures. Agarwala found no difference in subjective (94% vs. 92%) and objective (96% vs. 94%) cure rates in 96 women consecutively assigned to TVT or to Lynx mid-urethral sling (Boston Scientific; monofilament polypropylene), respectively. (161) Yoon et al. compared TVT to the IRIS (Innovative Replacement of Incontinence Surgery) with a follow-up of 3 years. (162) The instrument of the IRIS system is comprised of a nondisposable metal handle to which two metal needles can be attached. The needles have an outer diameter of 5-6 mm and the non-absorbable polypropylene tape, which is 11 mm wide and 450 mm long with a plastic sheath cover, is fixed to the needles. The tape of the IRIS system is polypropylene monofilament mesh (Trex; Meadox Medicals, Oakland, NJ/Boston Scientific, NJ, U.S.A.), and the diameter of the pore size is greater than 75 μ m such as the tape of TVT. Success rate encompassing both objective and subjective criteria were not statistically different between the 2 procedures at 12 and 36 months. Likewise, the incidence of perioperative complications and postoperative voiding dysfunction was not statistically different. [EL=3]

A recent Cochrane systematic review and meta-analysis of mid-urethral sling operations compared the PVS bottom-to-top approach to the PVS top-to-bottom approach (163). Five trials were included, including a total of 636 women.

The subjective cure rate within 12 months was significantly higher with the bottom-to-top approach (TVT) compared with the top-to-bottom approach (SPARC) (RR 1.10, 95%CI 1.01 to 1.19), while the objective cure rate was similar (RR 1.06, 95%CI 0.97 to 1.17). At one year follow-up, there was no statistically significant difference in the mean IIQ scores for quality of life (-4.6; 95% CI: -7.5 to 16.7).

There were no significant differences between the 2 groups for the duration of operation (RR -2.15, 95% CI -4.68 to 0.38), length of hospital stay (RR -0.03, 95% CI -0.37 to 0.30), or postoperative de novo urgency symptoms (RR 0.84, 95% CI 0.52 to 1.34). With the bottom-to-top approach, there were fewer bladder or urethral perforations (RR 0.55, 95% CI 0.31 to 0.98), less voiding dysfunction (RR 0.40, 95% CI 0.18 to 0.90), and fewer vaginal tape erosions (RR 0.27, 95% CI 0.08 to 0.95). There were no data reported on the need for further treatment.

3.1.8 RP MUS vs. Single-Incision Mini-Slings (SIMS) (Table 7e)

Single-incision mini-slings (SIMS) have emerged as an additional option for the woman with SUI. These procedures theoretically require minimal anesthesia and may be performed, in some instances, under local anesthetic. A recent systematic review and meta-analysis of SIMS and RP MUS procedures was published in the Cochrane Database. (171) Five studies were included, comparing TVT-Secur (n=X) to bottom-to-top RP MUS. No trials compared single-incision slings to top-to-bottom RP MUS. Four trials involved one type of mini-sling: TVT-Secur. One of the trials (Andrada Hamer 2012) was stopped at interim analysis (2 months) because of poor efficacy and high complication rates associated with the TVT-Secur. A total of 573 women were included (RPMUS n=281, vs. SIMS n=292). The meta-analysis reported no significant difference in patient reported cure rate when comparing SIMS with RPMUS (RR 1.38, 95% CI 0.55 to 3.46). RPMUS were associated with significantly higher objective cure rates when compared to SIMS (RR 4.44, 95% CI 2.06 to 9.56). Quality of life was statistically better in the PVS group. A shorter operation time was associated with SIMS (RR -17.33 95% CI -32.09 to -2.57) but there was no significant difference in the length of inpatient stay between the two procedures (RR -0.10 95% CI -0.69 to 0.49). SIMS had a higher risk of de novo urgency compared with RPMUS (RR 2.39, 95% CI 1.25 to 4.56).

There were no significant differences between the two groups for the other complications: operative blood loss (-16.60 95% CI -34.41 to -1.21), major vascular or visceral injury (RR 3.23 95% CI 0.13 to 77.90), vaginal wall perforation (RR 1.02 95% CI 0.07 to 15.89, not estimable), bladder or urethral perforation (RR 0.45 95% CI 0.15 to 1.38), urinary retention or need for catheterisation (RR 0.87 95% CI 0.38 to 1.99), infection related to use of synthetic mesh (RR 2.00 95% CI 0.22 to 17.89), vaginal mesh exposure (RR 1.37 95% CI 0.23 to 8.16), mesh extrusion into bladder or urethra (RR 0.76 95% CI 0.19 to 3.01), long-term pain (not estimable), dyspareunia (RR 2.90 95% CI 0.32 to 26.30), new-onset DO (RR 0.89 95% CI 0.13 to 5.98), repeat stress incontinence surgery (RR 2.34 95% CI 0.79 to 6.92) or need for any other additional or new surgical procedure to treat exposure (RR 1.18 95% CI 0.29 to 4.74). The authors concluded that the overall results demonstrated that TVT-Secur was considerably inferior to PVS slings for the treatment of women with stress incontinence. This product has already been withdrawn from clinical use. Six additional studies comparing TVT and SIMS were published since the last Cochrane review. (171) Five of them are randomised trials (172) (LE (Level of evidence) 3/4); (173) (LE 2); (174-176) (LE 2); and one was a retrospective trial (172).

Table 7e: Studies comparing RP MUSs with single incision mini slings (SIMS)

Author	RPMUS	Comparator	No. Patients	F/U	Power calculation	# Lost to F/U	% Cure	Significance	LE	Notes
RP MUS vs. Mini Slings										
Andraden Hamer 2013 (177)	TVT	TVT Secur	62/61	12m	yes	61/60	98/80 (o) 94/71 (s)	yes	1	stopped at interim analysis (2months) because of poor efficacy and complications rates with the TVT-Secur
Barber 2012 (178)	TVT	TVT Secur	129/127	24m	yes	-	60.6/55.8	no	1	include women with concomittant prolapse (concomittant surgery)
Ross 2014(173)	TVT	TVT Secur	34/40	12m	yes	6/7	89/82	no	2	stopped because of poor recruitment
Madsen 2014 (172)	TVT Align	MiniArc	183/141	22.9/ 18.6	no	74/48	35.8/23.7 (o) 69.7/60.2 (s)	yes	3/4	retrospective study
Basu 2013 (175)	TVT	MiniArc	33/38	36	yes	7/3	91/47.4	yes	2	
Naumann 2013(176)	TVT	MiniArc and Ajust	75/75	6m	no	0/0	88/84 (o) 96/89.3 (s)	yes	2	the aim of the study was to evaluate the effect of surgical precedure for SUI on sexual function

Excepting the Ross et al. trial, which was small, all of these studies are in demonstrate inferiority of the SIMS procedures (Table 7e).

3.1.9 RP MUS vs. TO MUS (Table 7f)

A unique complication of the RP MUS procedures has been inadvertent puncture of PVS and, on occasion, intra-abdominal viscera or neurovascular structures. The most common organ punctured is the bladder and the rates of puncture have varied between 0.8% and 21 % in different studies (179). Two systematic registries on the rates of complications associated with the TVT operation have been published, one from Finland including the first 1455 operations performed nation-wide and one from Austria including 2795 operations (106, 180). The rates of bladder perforation were 3.8% and 2.7%, respectively. In an effort to minimise the incidence and morbidity of bladder injuries, Delorme in 2001 introduced a modified tape procedure in which the tape was brought to support the mid-urethra from inside the thighs through the obturator foramina on both sides ('outside-in')(181). De Leval further modified the outside-in TO MUS procedure to be an 'inside-out' procedure, now called the tension-free vaginal tape-obturator (TVT-O)(182).

The comparison between the PVS and TO MUS procedures has been the subject of numerous publications over the last few years. ICI-5 reported the results of 2 Cochrane systematic reviews(154, 156) . The two reviews did not show any difference for the subjective cure rate between the two procedures. However, the objective cure rate was significantly higher when using the PVS route(154). Moreover, in one of these reviews [48], a statistically significant difference in favour of TVT was shown when comparing objective continence rates between TVT and inside-out TO MUS (OR: 0.71; 95% CI OR: 0.52 to 0.96; p= 0.03), whereas no difference was found comparing TVT to outside-in TO MUS (OR: 0.90; 95% CI OR: 0.66to 1.22; p= 0.51). Sensitivity analyses limited to studies of higher methodological quality showed only a nonstatistically significant trend in favour of TVT with regard to objective cure rate (OR: 0.74; 95% CI OR: 0.54 to 1.01; p= 0.05).

With regard to complications, bladder or vaginal perforations, and postoperative haematoma were significantly more common following RP MUS (156). The rates of vaginal extrusion were slightly higher following TO MUS in one of these reviews(156), possibly due to the use of ObTape, a device removed from the market due to a high risk of erosion and extrusion, however, there were no statistically significant differences in the second review (154).

There was no significant difference between the 2 groups in the need for repeat incontinence surgery, postoperative DO, de novo urgency and urgency incontinence(154, 156). There was a significantly higher occurrence of groin pain (12%) in women with a TO approach compared with a higher incidence of suprapubic pain in women with a PVS sling. However,

postoperative voiding dysfunction occurred significantly less frequently in the TO route group (4% versus 7%, RR 0.63, 95% CI 0.44 to 0.89) in one of these reviews(156) but with no difference noted in the second one(156).

In ICI-5, one other RCT trial compared PVS and TO MUS(149). This was a multicentre, randomised equivalence trial with the primary outcome being objective and subjective success at 12 months. A total of 597 women were randomly assigned to a study group and 565 (94.6%) completed the 12-month assessment. The objective and the subjective cure rates were significantly higher in the RP group. The rates of voiding dysfunction requiring surgery was higher in the RP group (2.7% versus 0% ,p = 0.004) and the rate of neurological symptoms were higher in the TO group (4.0% versus 9.4%, p = 0.01). There were no significant differences between groups in postoperative urgency incontinence, satisfaction with the results of the procedure, or quality of life. Thus, the success rates met the predetermined criteria for equivalence of the 2 procedures. [EL=1]

In ICI-5, numerous additional, non-randomised trials published in peer-reviewed literature. [100-118] The majority of these concluded that there is no statistically significant difference in subjective or objective outcome measures between PVS and TO MUS procedures. As concluded in the RCTs, postoperative complications are more common in the RP MUS group. [EL=3/4]

A recent Cochrane systematic review and meta-analysis of mid-urethral sling operations compared TO MUS and RP MUS(163). Fifty-five trials with a total of 8652 women were included, with a sample size ranging from 20 to 597. The meta-analysis reported non-significant differences in subjective cure rate at 12 months (RR 0.98, 95%CI 0.96 to 1.00) ranging from 62% to 98% in the TO MUS group, and from 71% to 97% in the RP MUS group. Short-term objective cure was similar in the 2 groups (RR 0.98, 95% CI 0.96 to 1.00). Long-term subjective cure was also similar between the groups (RR 0.95, 95% CI 0.80 to 1.12). The rate of bladder perforation was lower after TO MUS compared with RP MUS (RR 0.13, 95% CI 0.08 to 0.20). Major vascular/visceral injury (RR 0.33 95% CI 0.19 to 0.55), mean operating time (RR -7.54 95% CI -9.31 to -5.77), operative blood loss (RR -6.49 95% CI -12.33 to -0.65) and length of hospital stay (RR -0.25 95% CI -0.59 to -0.09) were lower with the TO approach. Postoperative voiding dysfunction was less frequent following TO MUS (RR 0.53, 95% CI 0.43 to 0.65). There were no significant difference in de novo urgency and urgency urinary incontinence between the 2 groups (RR 0.98, 95% CI 0.82 to 1.17). Groin pain was higher in the TO MUS group (RR 4.12, 95% CI 2.71 to 6.27) whereas suprapubic pain was lower (RR 0.29, 95% CI 0.11 to 0.78); both being of short duration. There was no significant difference in vaginal tape erosion/exposure/extrusion (RR 1.13, 95% CI 0.78 to 1.65) or bladder or urethral erosion (RR 0.34, 95% CI 0.01 to 8.13) between the 2 groups.

Repeat incontinence surgery in the long term was more likely with the TO approach as compared to PVS. (RR 8.79, 95% CI 3.36 to 23.00). At 24-month follow-up, there were no significant differences in sexual function or in dyspareunia between the two groups.

Ten additional RCTs compared PVS and trans-obturator approaches (183) (LoE (Level of evidence) 1), (184) (LE 1), (185) (LE 1), (186) (LE 3), (187) (LE 3), (188) (LE 3), (189) (LE 1), (190) (LE 3), (191) (LE 1) and (192) (LE 2)). There was no significant difference between the objective and the subjective cure rates in these studies. In Albo 2012, 253 women underwent TVT and 263 TO. At 24 months, the subjective (55.7% versus 48.3%, 95% CI for difference of 7.4% : -0.7, 15.5%) and the objective cure rates (77.3 versus 72.3%, 95% CI for difference of 5.1% : -2.0, 12.1%) were similar. In another study, Bellaster included 24 women in the TVT group and 37 in the TO group. There was no difference for the subjective cure rates between these groups.

In Costantini 2016, there were no differences for the objective cure rate. The Kaplan–Meier survival curve showed that the continence rate decreased for up to 25 months after surgery, with stabilisation thereafter for the TVT group while continuing to drop in the TO MUS group, with no inter-group difference. The patients in both groups were highly satisfied at long-term follow-up. The Brennan 2015 study is subset of original RCT by Ross 2009. TO and RP MUS were grouped together in this analysis. The probability of objective cure remained significantly higher for non-obese women than obese women ($p=0.018$, RR 1.26, 95% CI 1.04–1.52), after controlling for MUS type. Surgery type was not significantly associated with cure ($p=0.492$, RR 0.95, 95% CI 0.83–1.10). In Kenton 2015, the authors made a per protocol analysis; RP MUS treatment success rate was 7.9% greater than TO MUS (95% CI -1.4 to 17.2), and did not meet the prespecified criteria for equivalence of 12% in the original trial or 15% in the current study. However, the CI included 0%, indicating that success rates also cannot be considered different from one another. Treatment failures were primarily due to SUI symptoms only, while others were due to SUI symptoms and surgical retreatment, as well as surgical retreatment only.

Cavkaytar 2015 is a non-randomised, prospective observational study; in both groups, postoperative Q-tip values were significantly reduced, but postoperative urethral mobility was more frequent in the TO MUS group. In Bohlin 2015, authors conducted an observational study; pre-, peri- and postoperative (8 weeks and 1 year) data were retrieved from the Swedish National Register for Gynecological Surgery of MUS procedures (PVS procedures, $n=4.539$; TO procedures, $n=1.769$) performed between January 2006 and December 2011; multiple logistic regression analyses were performed between the outcome variables and BMI and smoking, presented as adjusted odds ratios (adjOR) with 95 % CI; subjective 1-year

cure rate was 87.4 % for all MUS procedures (88.3 % with the PVS technique and 85.2 % with the TO technique ($p=0.002$); preoperative daily urinary leakage and urgency were more common with increasing BMI, but surgery reduced symptoms in all BMI groups; lower cure rate was seen in women with a BMI >30 (0.49; CI 0.33–0.73), in diabetics (0.50; CI 0.35–0.74) and women aged >80 years (0.18; CI 0.06–0.51); perioperative complications were more common in the PVS group (4.7 % vs 2.3 % in the TO group, $p=0.001$) and in women with BMI <25 . Smoking did not influence any of the outcome variables.

Jeong 2014 was a retrospective study; when dividing women by the route of approach, the success rates in the TO approach became worse with increasing BMI ($P=0.037$, linear by linear association), while those in the RP approach were not different according to the BMI groups ($P=0.06$, linear by linear association); the satisfaction rates were not different among the BMI groups in either approach; in the multivariate logistic regression models, only the presence of preoperative MUI (clinically-defined) was identified as a risk factor for treatment failure in all patients.

Laurikainen 2014 is a 60-month update of Palva K, Rinne K, Aukee P, et al. There were no differences between the groups (TVT and TVT-O). In the Zyczynski 2014 study, there were no statistical differences in the objective and the subjective cure rate. The total incidence of complications was 13.4% for the TVT, 9.3% for the TO MUS and 8.6% for the modified TO MUS (sig higher for TVT)(190)

Summary

RP MUS has demonstrated equal or superior efficacy compared to other procedures for female SUI (LE=1/2).

RP vs. colposuspension:

RP MUS is at least as effective as open colposuspension in the short and medium term, and may be superior to laparoscopic colposuspension although most studies are small and underpowered (EL=1/2). Overall the rate of complications of RP MUS and colposuspension are similar between procedures. However, the rates of specific complications (e.g. bladder perforation, need for subsequent POP surgery, etc.) differ between the procedures. RP MUS is associated with a shorter operative time and hospital stay. (EL=1/2)

RP MUS vs. TO MUS:

Overall, PVS and TO MUS procedures perform equally at a short term follow-up of 6 to 12 months. (EL= 1/2). There are insufficient data to make conclusions regarding the long term comparable efficacy of these procedures.

Table 7f: Studies comparing RP MUSs with TO MUSs (t

Author	RP MUS	Comparator	No. Patients	F/U	Power calculation	# Lost to F/U	% Cure	Significance	LE	Notes
RP MUS vs. TO MUS										
Ansquer, 2004* (193)	TVT	TOT?	25/24	1m	No	0/0	80/83 (s)	No	3/4	
Mellier, 2004* (194)	TVT	Monarc	90/85	6w	No	0/0	91/95 (s)	No	3	
Enzelsberger, 2005* (195)	TVT	TO MUS	52/53	12m	No	0/0	86/84 (o)	No	1/2	
Kim, 2005*	Sparc	Monarc	22/21	6m	No	0/0	81.8/80.9 (s+o)	No	2	
Wang A, 2006*	Sparc	Monarc	31/31	6-14m (Median 9m)	Yes	2/0	Significant improvement in pad weight for both	No	2	Cure rate never mentioned
Liapis, 2006* (196)	TVT	TVT-O	46/43	12m	No	0/0	89/90 (o) 73.9/76.7 (s)	No	1/2	
Morey, 2006* (197)	TVT, Sparc	Monarc, ObTape	350/154	6m	No	0/0	85.6/89.4 (o)	No	3	
Andonian, 2007* (198)	TVT	TO MUS	80/78	12m	Yes	0/0	86/83 (o)	No	1	
Darai, 2007* (199)	I-Stop	I-Stop	42/46	3m	Yes	0/0	90.5/89.1 (s+o)	No	2	
				6-12m			88.5/86.5 (s+o)			
Falkert, 2007* (200)	TVT	TO MUS	56/49	12m	No	0/0	90/96 (o)	No	3	
	TVT	TVT-O		2m	Yes	0/0	98.5/95.4 (o)	No	1	ITT analysis not significantly different

Table 7f: Studies comparing RP MUSs with TO MUSs (continued)

Author	RP MUS	Comparator	No. Patients	F/U	Power calculation	# Lost to F/U	% Cure	Significance	LE	Notes
Laurikainen, 2007* (201) Rinne, 2008* (202), Palva, 2010* (203)			136/131	12m		2/0	95.5/93.1 (o) 90/93 (s)			
				36m		5/5	94.6/89.5 (o)			
Lee, 2007*	TVT	TVT-O	60/60	12m	No	0/0	86.8/86.8 (s+o)	No	2	Quasi-RCT (alternation)
Meschia, 2007* (204)	TVT	TVT-O	114/117	6m (Median)	Yes	6/7	92/89 (o) 92/87 (s)	No	1	
Neuman, 2007* [104]	TVT	TVT-O	75/75	6m	No	0/0	97.3/98.7 (s)	No	3	
Paick, 2007* [105]	TVT	TO MUS	252/212	6m	Yes	0/0	92.1/84.9 (s+o)	0.015	2	Favors TVT
Porena, 2007* (205)	TVT	ObTape	73/75	12m	Yes	3/0	71.4/77.3 (o)	No	1	
Sola, 2007* (82)	TVT	TVT-O	76/98	3m	No	0/0	96/100 (s)	No	3	~80% each group additional surgery
Zhu, 2007* (206)	TVT	TVT-O	28/27	22m	No	0/0	92.6/92.9 (s)	No	2	All had concomitant prolapse surgery
Zullo, 2007* (207)	TVT	TVT-O	35/37	12m	Yes	0/0	91/89 (o)	No	1/2	
Araco, 2008*	TVT	TVT-O	120/120	12m	Yes	12/20	100/66 (o) (severe SUI)	0.001	1	Favors TVT for severe SUI
							100/100 (o) (mild SUI)	No		

Table 7f: Studies comparing RP MUSs with TO MUSs (continued)

Author	RP MUS	Comparator	No. Patients	F/U	Power calculation	# Lost to F/U	% Cure	Significance	LE	Notes
Barber, 2008* (208)	TVT	Monarc	88/82	12m	Yes	2/6	58.8/62.3 (s)	0.006	1	Monarc not inferior to TVT
Barry, 2008*	TVT	Monarc	107/80	3m	Yes	25/22	86.6/72.4 (s) 79.3/84.5 (o)	No	1/2	Short F/U
Charalambous, 2008*	TVT	TVT-O	265/50	12m	No	0/0	87/94 (not stated)	No	3	
Jeon, 2008* (63)	TVT	Iris	61/60	3m	No	0/0	96.7/95 (s+o)	No	3	
				6m			90.2/91.7 (s+o)			
				12m			88.5/88.3 (s+o)			
Long, 2008*	TVT	TVT-O	53/29	36m/14m	No	0/0	92.5/79.3 (s) 94.3/86.2 (o)	No	3/4	
Paick, 2008* (160)	TVT	TO MUS	72/50	6m	No	0/0	95.8/94 (SUI) 81.9/82 (all incontinence)	No	3/4	
Paick, 2008*	Sparc	TO MUS	22/50	6m	No	0/0	90/94 (SUI) 86.4/82 (all incontinence)	No	3/4	
Schierlitz, 2008* (110)	TVT	Monarc	82/82	6m	Yes	15/11	79/55 (o)	0.004	1	Favors TVT; all women w/ISD
Wang W, 2008 *	TVT	TVT-O	35/34	14.5m (Mean)	No	0/0	88.6/85.3 (s)	No	2	
Aniuliene, 2009*	TVT	TVT-O	114/150	12m	No	0/0	94.6/94.6 (s)	No	2	Vague criteria for "effectiveness"
Gungorduk, 2009*	TVT	Safyre-t	180/120	12m	No	0/0	93.9/82.5 (s+o)	0.0002	3	Favors TVT
				48m		-	78.3/52.5 (s+o)	0.0001		

Table 7f: Studies comparing RP MUSs with TO MUSs (continued)

Author	RP MUS	Comparator	No. Patients	F/U	Power calculation	# Lost to F/U	% Cure	Significance	LE	Notes
Houwert, 2009* (209)	TVT	TVT-O Monarc	214/173	12m	Yes	0/0	82/75 (s)	No	2/3	
Hsiao, 2009*	TVT	Monarc	61/60	12m	No	0/0	82/78.3 (s+o)	No	3	
Karateke, 2009*	TVT	TVT-O	81/83	12-16m	Yes	2/1	88.9/86.7 (s+o)	No	1	
Rapp, 2009*	Sparc	Monarc	107/43	12m	No	10/4	29/41 (s; dry) 76/77 (s; success)	No	3	
Rechberger, 2009* (210)(Rechberger, 2007† abstract only)	IVS-02	IVS-04	269/268	18m	Yes	68/71	75.1/74.1 (s)	No	1	
Reich, 2009*	TVT	TVT-O	120/120	3m	No	0/0	85/77 (s+o)	No	2/3	
Ross, 2009	TVT	Obtryx	105/94	12m	Yes	18/10	77/81 (o)	No	1	TO MUS palpable in 80% (vs. 27% TVT group)
Wang W, 2009* (211) Wang W, 2011* (212)	TVT	TVT-O	160/155	6m	No	6/9	93.5/91.1 (o)	No	1/2	
				12m		45/37	89.6/89.8 (o)			
				24m		82/68	87.2/86.2 (o)			
				36m		125/125	82.9/83.3 (o)			
Castillo-Pino*, 2010 (213)	TVT	Safyre-t	55/49	12m	No	0/0	74.5/77.6 (o)	No	3	
				24m			81.8/83.7 (s+o)			

Table 7f: Studies comparing RP MUSs with TO MUSs (continued)

Author	RP MUS	Comparator	No. Patients	F/U	Power calculation	# Lost to F/U	% Cure	Significance	LE	Notes
Deffieux, 2010*; (Deffieux, 2007* abstract only) (137)	TVT	TVT-O	75/74	6m	Yes	3/3	88/91 (s+o)	No	1	
				12m		6/5	89/88 (s+o)			
				24m		8/9	83/83 (s+o)			
Duckett, 2010* (214)	TVT	TO MUS	34/34	6w/6m/12m	No	0/0	100/70.6 (no repeat surgery)	Yes	3	All had DO; OR 10.1, 95% CI 2.6 to 38.2 for TO MUS to have additional surgery
George, 2010* (215)	TVT	Uretex-TO	76/73	24m	No	0/0	97.3/94.5 (s+o)	No	3	
Krofta, 2010* (216)	TVT	TVT-O	141/147	12m	No	0/0	90.1/88.4 (o) 84.7/80.9 (s)	No	1	
Richter, 2010* (217)	TVT	TVT-O Monarc	298/299	12m	Yes	17/15	80.8/77.7 (o) 62.2/55.8 (s)	No	1	Per protocol analysis
Tanuri, 2010* (117)	Safyre-rp	Safyre-t	10/20	12m	No	1/1	88.8/84.2 (o) 88.8/85 (s)	No	2	
Wang F, 2010* (218)	TVT	TO MUS	70/70	12m	No	0/0	90/91.4 (s) 92.8/91.4 (o)	No	1/2	
Teo, 2011* (Teo, 2007* abstract only)	TVT	TVT-O	66/61	6m	Yes	7/8	78/83 (o) 81.4/77.4 (s)	No	1	ITT analysis NS at both F/U intervals; trial stopped early (leg pain w/TVT-O)
				12m		25/32	80.5/86.2 (o) 85.4/89.7 (s)			
Zyczkowski, 2014 (190)	TVT	TO MUS/m TOT	142/129/256	6m	No		91.5/93/93.3 (s)	no	3	
							96.4/96.1/94.4 (o)			

Table 7f: Studies comparing RP MUSs with TO MUSs (continued)

Author	RP MUS	Comparator	No. Patients	F/U	Power calculation	# Lost to F/U	% Cure	Significance	LE	Notes
Laurikainen, 2014 (189)	TVT	TVT-O	136/132	60+ m	Yes	5/9	84.7/86.2 (o)	no	1	
							94.2/91.7 (s)			
Jeong, 2014 (188)	RP MUS	TO MUS	74/169	36+ m	No	0/0	72 (o+s), 16.9 (Cure+impr)	no	3	
Bohlin, 2015 (187)	RP MUS	TO MUS	4539/1769	12m	No		88.3/85.2	Yes	3	
Costantini, 2016 (183)	TVT	ObTape	44/51	75+ m	Yes	4/4	87.5/70.2 (o)	no	1	
							75/59.6 (s)			
Brennand, 2015 (184)	Non-obese	Obese	136/61	12m	Yes	25/3	85.6/67.8 (o)	Yes	1	Postop UII: 37.1% (obese) vs. 61% (non-obese) (Sig); complication rates similar
							85.5/70.7 (s)			
Kenton, 2015 (185)	RP MUS	TO MUS	298/299	60m	Yes	7/6	51.3/43.4	yes*	1	Per protocol analysis; did not meet criteria for equivalence; 40 women experienced 52 nonserious AEs and 6 had serious AE requiring surgical, endoscopic, or radiological intervention

Table 8a: Long-term Outcomes of Single Arm Studies of TO MUS

Author	MUS	N (reported)	F/U	# Lost To F/U	% Objective Cure	% Subjective Cure	AEs	Notes
Costantini, 2009(222)	Out in TO MUS	65	46m med (36-82)	6	74.4% VLPP>60 65% VLPP≤60	-	-	-
Liapis, 2010 (223)	TVT-O	74	48-52m	6	82.4%	81%	9 UTI, 13 ↑PVR, 2 extrusion, 13 leg pain	-
	TVT-O+AC	41			80.5%	76%		
Heinonen, 2013(224)	Out in TO MUS	139	6.5y mean	52	89%	83%	-	MUI patients less satisfied
Chun, 2014 (225)	Out in TO MUS	129	7.1y med	-	87.1%		-	-
	TVT-O	86			66.7%			
Lienhart, 2014 (226)	I-Stop (out in)	131	7y	-	-	72%	0.3% extrusion	80% satisfied
Yonguc, 2014 (227, 228)	Out in TO MUS ¹	126	61.2m mean (55-82)	12	87.3%	65.9% (higher for SUI vs. MUI)	1 UTI, 5 groin pain, 2 extrusion, 2 retention	73% satisfied (higher for SUI vs. MUI)
Toz, 2015 (229)	Safyre T ² (out in)	153	96m	-	77.6%	77.6%	-	-
Lo, 2016 (230)	Monarc (out in)	56	80.3m med (78-83)	4	89.3%	87.5%	None	-
Pereira, 2016 (231)	TVT-O (obese)	72	48m	50	95%		2 extrusion, 1 retention	KHQ similarly improved for each BMI group
	TVT-O (non-obese)	96		63	95.8%		2 extrusion	

Key:

MUS: midurethral sling; **N:** number; **F/U:** follow-up; **AEs:** AEs; **TO MUS:** transobturator midurethral sling; **m:** months; **y=years;** **med:** median; **VLPP:** valsalva leak point pressure; **UTI:** urinary tract infection; **PVR:** post-void residual; **MUI:** mixed urinary incontinence; **SUI:** stress urinary incontinence; **KHQ:** King's Health Questionnaire; **BMI:** body-mass index.

- Two types of outside-in TO MUS used: Heine Medizin® urethral support system, Germany, and I-STOP® CL Medical, France.
- Safyre T®, Promedon, Argentina.

The rate of complications, including bladder puncture postoperative voiding dysfunction, and haematoma formation are higher for the RP MUS as compared to the TO approach whereas thigh discomfort is more common with the TO approach. [EL=1/2]. The overall rate of vaginal MUS erosion is no different between these techniques. (EL=1/2)

Surgical approach for RP MUS (top-down vs. bottom-up):

RP MUS appears to be somewhat more efficacious when being placed from 'bottom-up' as compared to an 'top-down' approach (LE=2). But only limited long term "up-down" data exists (LE=2) Intraoperative and postoperative AEs are less common with the 'bottom-up' approach. (EL=1/2)

Recommendations

RP MUS is recommended as an effective and durable treatment for stress urinary incontinence. [Grade A]

3.2. TO MUS

Owing to trocar passage through the PVS space, inadvertent puncture of PVS and, infrequently, intra-abdominal viscera or neurovascular structures comprises a unique complication of the PVS slings, and RP MUS in particular. (106, 219-221)

In an effort to minimise the incidence and morbidity of bladder injuries, a novel modified MUS procedure was introduced in which the tape was brought to support the mid-urethra from inside the thighs through the obturator foramina bilaterally (181). De Leval further modified the outside-in TO MUS procedure to be an inside-out procedure, now called the tension-free vaginal tape-obturator (TVT-O™; Gynecare, Ethicon, Somerville, NJ, USA)(182).

The materials used for TO MUS have continued to be modified to decrease risk of erosion, extrusion and infection. Today, nearly all of the commercially-available synthetic TO MUS products are made of Amid type I polypropylene mesh and have an extrusion and erosion rate well below 5%.

The TO technique has since gained immense popularity, owing to its reproducible results and low rates of complications. The "outside-in" and "inside-out" methods of insertion continue to be the major division in the classification of surgical outcomes and complications.

3.2.1 Long-Term Outcomes of TO MUS

Long-term outcomes are rapidly emerging for the TO MUS and several case series have reached mean or median follow-up periods ≥ 48 months (Table 8a).

Despite wide variations in objective and subjective definitions of success, both the outside-in and inside-out TO MUS are associated with good long-term outcomes (Level 3b/4). The conclusions should be interpreted with caution since all of the available data are from single-institution, retrospective cohort studies.

3.2.2 Trials Comparing TO MUS and Other Slings

A Cochrane systematic review recently compiled randomised controlled trials (RCT) comparing TO MUS vs. other procedures. (163) The review assessed 81 trials that included 12,113 women. The outcome analysis between the PVS and TO MUS is the most studied comparison of two procedures in the SUI literature. To minimise redundancy, the discussion of this comparison is covered in the section on RP MUS. Likewise, the comparison between TO MUS and single-incision mini slings (SIMS) will be covered in the section on SIMS. What follows is an evaluation of the existing literature comparing the TO MUS to other surgical procedures. Studies and analyses previously covered in ICI-5 will be summarized, while new literature will be covered in greater detail.

3.2.2.1 TO "Inside-Out" Approach vs. "Outside-In" Approach

Nine trials in the Cochrane review compared the inside-out approach with the outside-in approach. (209, 232-239) The study by Hassan et al. was reported only as an abstract, while the other eight trials were reported as full articles. An additional trial appeared in a trials registry, but, to date, there has been no additional information provided by the authors (240). Median sample sizes was 110 (range 74 to 341). Five studies included women with MUI [But and Faganelj, 2008; Lee et al., 2008; Abdel-Fattah et al., 2010; Park et al, 2012; Scheiner et al., 2012], and two trials included women who had undergone previous incontinence surgery [Abdel-Fattah et al., 2010; Scheiner et al., 2012]. The trial by Scheiner et al. included women with POP as well as women undergoing concomitant pelvic surgery. Median follow-up was 12 months (range 3-36 months). The outcomes of the initial trial by Abdel-Fattah et al. (235) have since been updated in several additional reports. (241-246) The most recent Cochrane review has added an additional five trials to the previous version, that included four trials of small size

3.2.2.1.1 Objective and Subjective Outcomes

There were no statistically significant differences in either short-term (≤ 12 months) subjective cure rates (6 studies, 759 women; RR 1.0, 95% CI 0.96 to 1.06) or subjective cured and improved rates (5 studies, 732 women; RR 1.02, 95% CI 0.97 to 1.08). Similarly, there were no statistically significant differences in either medium-term subjective cure rates (2 studies, 235 women; RR 1.06, 95% CI 0.91 to 1.23) or subjective cured and improved rates (2 studies, 399 women; RR 1.00, 95% CI 0.90 to 1.11). No trials have thus far published long-term data. There were no statistically significant differences in short-term objective cure (6 studies, 745 women; RR 0.99, 95% CI 0.95 to 1.04) or cured plus improved rate (RR 1.00, 95% CI 0.95 to 1.07) between the two groups.

In a recently-published, secondary analysis of a single-blind RCT, 83 of 341 women (24%) with MUI were randomised to outside-in (Aris®, Coloplast, Denmark, n=42) or inside-out (TVT-O, n=41) TO MUS (247). The primary outcome was patient-reported success rate, defined as very much improved/much improved on the Patient Global Impression of Improvement (PGI-I), while secondary outcomes included improvement in QoL, impact on preoperative urgency/UUI, and repeat surgery for SUI. A total of 66 women completed 3-year follow-up. The patient reported success rate was 73.8% with no significant differences between the groups (OR 1.035, 95% CI 0.342-3.134, p=0.951). Overall, 34 (50.1%) and 26 women (56.5%) reported cure of preoperative urgency/UUI, respectively, while 52 women (86.7%) had a clinically significant improvement in QoL (≥ 18 points in total Kings Health Questionnaire (KHQ) score) compared to baseline. In each group, two women underwent further continence surgery.

A recent systematic review and meta-analysis of inside-out vs. outside-in TO tapes summarised five RCTs and three cohort studies (248). As in the Cochrane Review, there was no significant difference in short-term subjective cure/improvement (OR 1.25, 95% CI 0.78 to 1.99, p=0.35) or in objective cure/improvement (OR 1.66, 95% CI 0.8 to 3.43, p=0.17) between the two groups. Meta-analysis of cohort studies confirmed similar results.

3.2.2.1.2 Perioperative and Postoperative Complications

There were no statistically significant differences between the two groups in terms of: duration of operation in minutes, (4 studies, 481 women; MD 0.52, 95% CI 1.09 to 2.13); operative blood loss in mL (3 studies, 255 women; MD 1.11, 95% CI -6.01 to 8.22); length of hospital stay in days (2 studies, 190 women; MD -0.77, 95% CI -2.54 to 0.99); and, time to return to normal activity in weeks (1 study, 100 women; MD -0.60,

95% CI -1.80 to 0.60). The following table summarizes the perioperative and postoperative complications from the Cochrane Review (Table 8)(163).

As in the Cochrane Review, Madhuvrata et al. concluded that vaginal angle injuries (vaginal perforation) were significantly higher with the outside-in route (OR 0.14, 95% CI 0.05 to 0.41, p=0.0003), while groin/thigh pain (OR 1.42, 95% CI 0.94 to 2.13, p=0.10) and de novo urgency (OR 1.46, 95% CI 0.63 to 3.36, p=0.38) were not significantly higher with the inside-out route. [35] Meta-analysis of cohort studies confirmed these findings.

3.2.2.1.3 Impact on QoL

Five of the ten trials in the Cochrane Review assessed QoL using validated questionnaires(163). In the trial by Houwert et al., there was significant postoperative improvement in IIQ-7 and UDI-6 scores compared to scores obtained preoperatively within each group, but no significant postoperative differences between the two groups (42 women; MD 16.54, 95% CI 4.84 to 28.24)(209). But and Faganelj assessed QoL with IIQ and UDI questionnaires and visual analog score (VAS), but reported no results(232). Lee et al. used a validated Korean version of the Incontinence QoL (I-QoL) and showed improvements within the groups, but with no significant postoperative differences between the groups(233). Scheiner et al. used the KHQ and found no significant difference between the groups at baseline and postoperatively, but noted improvement following surgery compared to baseline scores in all domains(238). Abdel-Fattah et al. used the KHQ, Birmingham Bowel and Urinary Symptoms Questionnaire, Pelvic Organ Prolapse/Urinary Incontinence Sexual Questionnaire (PISQ-12), PGI-I and the short form of the ICIQ to assess QoL(235). Overall, there was statistically significant postoperative improvement in total scores, as well as in each of the nine domains of the KHQ. There was no significant postoperative difference in any of the QoL scores between the two routes.

Table 8b: Perioperative and postoperative complications (from Cochrane)

Category	Incidence	# Studies	N	RR	CI	Significant
Vaginal Perforation	7.39%	3	541	0.25	0.12-0.53	Yes: less w/inside-out
Voiding Dysfunction	5.53%	8	1121	1.74	1.06-2.88	Yes: less w/outside-in
Overall Perioperative Complications		2	214	1.30	0.23-7.51	No
Major Vascular/ Visceral Injury		4	622	0.71	0.23-2.19	No
Bladder Perforation		6	794	0.38	0.07-1.92	No
De Novo Urge/ UUI		3	357	1.01	0.46-2.20	No
Detrusor Overactivity (DO)		1	114	0.87	0.27-2.84	No
Vaginal Extrusion		7	1087	0.42	0.16-1.09	No
Groin/Thigh Pain	9.2% vs. 8%	6	837	1.15	0.75-1.76	No

Key: N: number of patients; RR: relative risk; CI: 95% confidence interval

3.2.2.1.4 Impact on Sexual Function

Three trials in the Cochrane Review evaluated postoperative sexual function following inside-out and

outside-in TO MUS(163, 209, 235, 237). There was significant improvement in PISQ-12 scores following

surgery (improved sexual function compared to baseline), but no significant difference between the two groups at follow-up. Rates of de novo dyspareunia following surgery were extremely low, with evidence of symptom resolution by 24 months of follow-up.

Several recent retrospective cohort studies have added to the information available regarding postoperative sexual function in these women. Forty-eight of the 62 women returning a follow-up questionnaire following inside-out or outside-in TO MUS were sexually active before and after surgery(249). The frequency and appreciation of intercourse, extent of sexuality, and the frequency of leakage during intercourse were not significantly different after surgery. Fifteen women (31.2%) reported an improvement in intercourse satisfaction while five (10.4%) complained of sexual function deteriorating after the TO MUS. Of the 62 women, ten (16.1%) were dissatisfied with the surgical outcome because of persistent or recurrence of SUI (6) and a deterioration of intercourse satisfaction after surgery (4). Partner discomfort remained unchanged. Narin et al. administered the self-reported libido scoring system (LSS) in 59 sexually-active women preoperatively and six months after outside-in TO MUS(250). Two parameters of the LSS, orgasm and who starts the sexual activity, increased at a statistically significant rate following surgery. Kamalak et al. used the Female Sexual Function Index (FSFI) in 30 women before and three months after TO MUS(251). There was a statistically significant improvement in libido (desire), arousal, lubrication, orgasm and satisfaction. A reduction of urinary leakage during sexual activity was also seen.

Finally, the Nine Questions Regarding Sexual Functioning (NSF-9) questionnaire was administered before TO MUS to 34 sexually active women and repeated at the 3-month, 6-month, 12-month follow-up visits and annually thereafter (252). Scores in all domains of sexual function were significantly improved after surgery. The frequency improved in 24 women (70.5%), lubrication improved in 12 (57.1%), orgasm improved in 21 (67.1%), pain improved in 14 (70%), and, in leaking patients, sexual satisfaction improved in 85.7%, while in non-leaking patients improvement was seen in 40%. Sexual relations were not satisfactory in 26 women (76.4%) before surgery; however, of these, 21 (80%) had improved sexual satisfaction after surgery. De novo urgency and dyspareunia developed in one and two patients, respectively.

Summary

Ten RCTs in the Cochrane Review totaling 1199 women compared the TO inside-out approach with the outside-in approach (Level 1/2). Evidence from the ten trials, two of which reported medium-term data, showed no significant difference between the two approaches in regards to objective and subjective cure and cured/improved rates. Likewise, the rates of the majority of perioperative and postoperative var-

iables and complications were not significantly different between approaches. The only exceptions were voiding dysfunction, where higher rates were reported in the inside-out group, and vaginal perforation, which had higher rates in the outside-in group. Despite this, there was no resultant increase in the rate of tape erosion. Postoperative improvement in QoL and sexual function was observed with each approach, regardless of the outcome measure employed. The addition of a contemporary update of one of the RCTs (247) and several cohort studies has not served to alter these conclusions.

Recommendations

Since both approaches (outside-in and inside-out) to TO sling are associated with similar outcomes and overall incidence of AEs, the choice of surgical technique in those individuals undergoing a TO MUS should be based on other factors such as professional judgement and experience.. Grade A/B

3.2.2.2 TO MUS vs. BN PVS

A Cochrane Review identified two trials in which a TO MUS was compared with a traditional BN sling (1). Silva-Filho et al. randomized 20 women to aPVS or Safyre outside-in TO MUS(61). The Safyre consists of a polypropylene suburethral portion held between polydimethylsiloxane self-anchoring columns. Pre- and postoperative quantification of the severity of incontinence and QoL was done by pad test and KHQ, respectively. While mean operating time (21.1 vs. 69.5 minutes; $p<0.001$) and hospital stay (28.8 vs. 44.4 hours; $p<0.001$) were shorter in the Safyre group, the postoperative pad test (39.4 vs. 8.4 g; $p=0.01$) was in favour of the autologous sling. Likewise, improvement in KHQ was significantly higher in the autologous sling group. Tcherniakovski et al. randomised 21 women to TO MUS and 20 patients to PVS sling(62). At 12 months of follow-up, the success rates were 90.5% (19/21) and 95% (19/20), respectively, with fewer overall complications observed in the TO MUS group.

In an additional retrospective cohort trial 203 women who underwent TO MUS were compared with 260 women who received autologous rectus fascia (ARF) slings (253). Both groups were statistically similar with regard to age, parity, BMI, number of previous gynaecological surgeries, and anti-incontinence therapies. After 12 months, women in the TO MUS group had a higher subjective efficacy rate compared to those in the ARF sling group (94% vs. 88%, $p<0.05$). However, this difference was no longer statistically significant at 24-month follow-up (88.7% vs. 84.6%, $p=0.20$). The TO MUS was associated with fewer overall postoperative complications (14.1% vs. 25.6%, $p<0.05$) and similar intraoperative complication rates (1.15% vs. 2.3%, $p=0.22$).

Summary

The available data from two small RCTs and a retrospective trial suggest that overall outcomes after autologous BN slings and TO MUS are similar (Level 2b/3) at short to medium terms. These conclusions should be interpreted with caution owing to the small numbers of women recruited in the RCTs.

Recommendation

The surgeon may offer either TO MUS or autologous fascial sling to the index patient. (Grade B/C)

3.2.2.3 One Method of TO MUS Insertion vs. Another (Via Same Route)

Five trials in the Cochrane Review compared different TO outside-in approaches (240): Monarc vs. TO MUS (254); TO MUS vs. adjustable TO MUS(255); TO MUS vs. TO MUS with two-point fixation sutures (256); and, synthetic TO MUS vs. biological TO MUS(257, 258). Four additional trials compared TO inside-out approaches: TVT-O vs. shorter TVT-O and less lateral dissection (259); TVT-O vs. TVT-O plus Ingleman-Sundberg (IS) bladder denervation procedure(260); TVT-O vs. TVT-O with less dissection (261); and, TVT-O vs. self-tailored TVT-O mesh (262).

Other than the synthetic vs. biological TO MUS comparison which was addressed in two small trials, the remaining comparison groups included only a single small trial. For all outcomes measured in each trial, there were no statistically significant differences reported, with the exception of the study by Juang et al. (260) In this study, 96 women with MUI were randomised to TVT-O plus IS (Ingleman Sundberg) (n=49) and to TVT-O alone (n=47). The primary outcome measure was objective assessment of surgical outcomes, and the secondary outcome measure was warning time. Objective cure rate was statistically in favor of TVT-O plus IS (84.8% vs. 62.8%; p=0.019). Furthermore, a significant increase in warning time was observed in the TVT-O plus IS group (from 3.9 to 9.4 min; p=0.006), but the increase in warning time within the TVT-O alone group was not statistically significant (from 4.3 to 4.5 min; p=0.695). The short-term objective cure rates between synthetic and biological TO MUS were not significantly different (RR 1.03, 95% CI 0.94 to 1.14). The trials by Paparella et al. and Tommaselli et al. revealed that the PISQ-12 scores decreased after the procedure in both groups, indicating improved sexual function after surgery. (257, 261) No significant differences were observed between groups after the procedures.

Two additional, retrospective cohort studies have addressed different TO MUS from the same approach. A hand-made outside-in MUS (polypropylene monofilament; n=41) was compared with a commercially-available, outside-in TO MUS (n=61) [Ciftci et al., 2015]. (263) Age, menopausal status, and BMI were similar for both groups. There was no significant difference in 1-year success rates between the groups

(p=0.319); however, the rate of vaginal extrusion (p=0.016) was significantly lower in the commercially-available MUS group. Likewise, a self-created TO MUS (SCTOT; n=67) was compared with the standard, industrially-created TO MUS (ICTOT; n=47) (264). The IIQ-7, UDI-6, ICIQ-SF, and OAB symptom score (OABSS) were recorded. Cure was defined as a negative CST and no need for additional surgery. At 18-month follow-up, objective cure was achieved in 56 women (83.5%) in the SCTOT group and in 40 women (85.1%) in the ICTOT group (p>0.05). There was a significant improvement in IIQ-7, UDI-6, ICIQ5-SF, and OABSS in both groups. Improvement was better in the group with pure SUI than in patients with MUI, but this difference was not significant. The post-operative infection rates were 7-10% and not significantly different between groups. De novo OAB symptoms occurred in four women (5.9%) in the SCTOT group and three (6.3%) in the ICTOT group.

Summary

Despite several design or procedural modifications to TO MUS inserted via the same route, there was no difference in the efficacy, surgical outcomes or occurrence of AEs. These conclusions should be interpreted with caution owing to the small numbers of trials evaluating each comparison and short term follow-up. (Level 2b/3)

3.2.2.4 Other Materials Used for TO MUS

Linder and Elliott evaluated 33 consecutive women that underwent autologous rectus fascia TO MUS. (265) Patients were seen at three months postoperatively and mailed a questionnaire at least one year after surgery for further follow-up. Outcomes were measured by ICIQ-FLUTS. When isolated sling placement was performed, 88% (15/17) were outpatient procedures. Median follow-up was 14.9 months (IQR 3.6, 18.7), during which five patients underwent repeat anti-incontinence surgery. For those without retreatment, 25/28 (89%) completed ICIQ-FLUTS at last follow-up. Compared to preoperative scores, patients who completed ICIQ-FLUTS questionnaires at 1-year or greater (n=18) showed significant improvement in all domains: frequency (p=0.007), voiding (p=0.02) and incontinence (p=0.004), and in QoL related to frequency (p=0.008), voiding (p=0.002) and incontinence (p=0.01). Among those who completed questionnaires both at 3-month and at least 1 year after surgery (N=17), there was no significant deterioration in ICIQ-FLUTS scores. Overall retreatment-free survival rate was 92% at 1 year. No patients suffered severe (Clavien III-V) complications or required sling release.

Sabadell et al. compared the efficacy and safety of polyvinylidene fluoride (PVDF) TO MUS to polypropylene (PP) MUS. (266) A PVDF sling was used in 23 women and a comparison group was randomly selected among all women treated with a PP sling in a 1:4 ratio (n=92). The median follow-up was 24.6 months in the PP group and 21.3 months in the PVDF

group. The survival functions showed a higher incidence of failures in the PP group, primarily because of obstructive symptoms. However, the differences were not statistically significant (HR of failure 4.31; 95% CI 0.56 to 33.05). Complication rates did not differ between the two groups; however, more cases of voiding dysfunction were observed in the PP group.

Summary

Little can be concluded regarding alternative materials for TO MUS slings from two, short term retrospective cohort studies. (Level 4)

3.2.2.5 TO MUS in Special Populations

Several risk factors for failure of anti-incontinence surgery, in general, have been assessed in the literature. Several of these (obesity, ISD, presence of MUI, and previous MUS failure) are addressed below in the context of TO MUS procedures.

3.2.2.5.1 Obese Women

Obesity, defined as a BMI ≥ 30 kg/m², and its relationship to TO MUS outcomes has been evaluated in several studies. The results, thus far, have been mixed. Pereira et al. found no difference in 48-month, objective cure rates between obese (n=72) and non-obese women (n=96) undergoing TO MUS (95% vs. 95.8%, respectively). (231) The cumulative incidence of complications was, likewise, not significantly different between BMI groups. On the other hand, Heinonen et al. noted that women with BMI >30 kg/m² had significantly higher scores on the IIQ-7 (p<0.01), UDI-6 (p<0.01), VAS (p<0.001), UISS (p<0.01), and DIS (p<0.001), than those with BMI <30 kg/m². (224) Likewise, in the study by Jeong et al., success rates were lower for women with higher BMI measurements. (188) This was a retrospective assessment of 243 women, of whom 69.5% underwent one of three TO MUS procedures: TVT-O, Monarc, and SMESH (WooRhi Medical, Namyangju, Korea). The mean follow-up was 58.4 months (range 36-101) and 30.5% were of normal weight, 51% were overweight, and 18.5% were obese. It must be noted that the BMI cutoffs for the Asian population were used (normal weight (18.5-23 kg/m²), overweight (23.1-27.4 kg/m²), and obese (≥ 27.5 kg/m²). Cure was defined as absence of subjective complaint of leakage and negative CST, while improvement was defined as rare subjective leakage and satisfaction, regardless of the CST. The cured/improved rates after the transobturator MUS decreased as BMI increased: 94.3%, 88.6%, and 78.6%, for normal weight, overweight, and obese groups, respectively (p=0.037). Notably MONARC is no longer commercially available as of 2016.

3.2.2.5.2 Intrinsic Sphincter Deficiency (ISD; Low MUCP and/or Low VLPP)

As with evaluating obesity as a risk factor for TO MUS failure, the findings for lower leak point or closure pressures have been inconsistent. In the study by

Costantini et al., the overall objective cure rates (dry) were 74.4% for patients with VLPP >60 cm H₂O and 65% in those ≤ 60 cm H₂O (p<0.654). (222) The overall objective cure rates were 75% for patients with MUCP >40 cm H₂O and 68.6% in those ≤ 40 cm H₂O. Finally, the overall objective cure rates were 82.4% for patients with MUCP >40 cm H₂O and VLPP >60 cm H₂O and 69.2% in those with MUCP ≤ 40 cm H₂O and VLPP ≤ 60 cm H₂O (p<0.956). No significant differences were recorded for women with MUI. In a RCT comparing PVS and TO MUS from the same group, 95/145 (65.5%) of the patients had a VLPP >60 cm H₂O and the remaining 50 (34.5%) had a VLPP ≤ 60 cm H₂O. (267) The objective cure rates were 75.8% for patients with VLPP >60 cm H₂O and 72% for those with VLPP ≤ 60 cm H₂O (p<0.619). No significant differences in objective cure rates emerged when patients were stratified for preoperative VLPP and matched for either TO or RP MUS. Thus, no difference was seen for those with lower VLPP/MUCP compared to higher VLPP/MUCP.

Ryu et al. reported on 204 women who underwent TVT-O, with cure defined as absence of objective and subjective SUI. (268)[59] The numbers of women with Stamey grades I, II, and III were 99 (48.5%), 84 (41.2%), and 21 (10.3%), respectively. A total of 30 (14.7%), 87 (42.6%), and 87 patients (42.6%) had VLPP ≤ 60 , $60 < VLPP \leq 90$, and VLPP >90 cm H₂O, respectively. Preoperative VLPP was not significantly different according to preoperative I-QoL or change in I-QoL after surgery; however, I-QoL after surgery improved in patients with a high preoperative Stamey grade (p=0.001). In this study, VLPP was not a factor related to surgical outcome from the MUS; however, Stamey grade was important for predicting subjective QoL and improved incontinence-related QoL after surgery.

On the other hand, at a mean follow-up of 8.1 (range 6-12) months after a Monarc MUS, 56/70 (80%) women with urodynamically diagnosed SUI and urethral hypermobility were continent based on a CST and subjective report (269). The median VLPP at 150 mL (VLPP₁₅₀) in the failures and successes was not different (p=0.12). However, the median VLPP at cystometric capacity (VLPP_{cap}) in the failures was 32 cm H₂O vs. 71 cm H₂O in the successes (p<0.001). Also, the median MUCP in the failures was 20 cm H₂O and 45 cm H₂O in the successes (p<0.001). No correlation existed between the degree of urethral hypermobility, as measured by the cotton swab test, and surgical success (p=0.17). Using a combined model, the cutoff values of VLPP_{cap} >60 cm H₂O and MUCP >40 cm H₂O were the most predictive of surgical success, revealing a sensitivity of 83% (0.55, 0.95) and specificity of 79% (0.67, 0.88).

3.2.2.5.3 Recurrent SUI

From a multivariate analysis of potential preoperative risk factors for failure of TO MUS, Abdel-Fattah et al. found that a history of previous incontinence surgery was the only independent risk factor based both on

the patient-reported and objective outcome. (235) Van Baelen and Delaere reported retrospectively on 21 women who underwent repeat TO MUS procedure after failed MUS treatment (TVT in five, TO MUS in 16). (270) At a mean of 16 months, physician-determined cure and improvement were achieved in 55% and 15% of patients, respectively. Subjective cure and improvement based on the ICIQ was seen in 53% and 5%, respectively. Additionally, a Cochrane Review attempted to summarize the data regarding different types of MUS procedures for recurrent SUI after failure of primary surgical therapy. (271) Twelve studies were identified, but all were excluded from group analysis because they did not meet eligibility criteria. Thus, there were no data to recommend or refute any of the different management strategies for recurrent or persistent SUI after failed MUS surgery.

While there are sparse data to support or refute the use of TO MUS in recurrent SUI, recent surveys suggest that this approach may not be the reoperative procedure of choice for female pelvic medicine subspecialists. A pretested, web-based survey designed to explore assessment and surgical management was sent to IUGA members. (272) A total of 385 participants opened the survey and 331 eligible responses were obtained. The type of previous surgery, urodynamic findings, and surgeon's preference/experience were considered to be the most important factors in choosing the type of surgical management. RP MUS was the preferred surgical option in most of the clinical scenarios with urethral bulking agents being more popular in the absence of urethral hypermobility after a failed RP MUS.

Likewise, a recent update of two UITN trials suggests that any MUS, in general, may not be preferred in cases of recurrent SUI. (273) A secondary analysis of the SISTER and ToMUS trials compared the retreatment-free survival rates by initial surgical procedure. Half of the women in the SISTER trial met inclusion criteria for this analysis (329/655, 174 Burch and 155 fascial sling), as did 444/597 (74%) of subjects in ToMUS (221 TO MUS (TMUS), and 223 RP MUS (RMUS)). Types of surgical retreatment included autologous fascial sling (19), bulking agent (18), and synthetic sling (1). Five-year retreatment free survival rates (and standard errors) were 87% (3%), 96% (2%), 97% (1%), and 99% (0.7%) for Burch, autologous fascial sling, TMUS, and RMUS groups respectively ($p < 0.0001$). In these cohorts, 6% of women after standard anti-incontinence procedures were retreated within five years, mostly with injection therapy or autologous fascial sling. Not all women with recurrent SUI chose surgical retreatment.

3.2.2.5.4 Women with MUI

Although Jeong et al. found that cured/improved rates after the TO MUS decreased as BMI increased, in their multivariate model, only the presence of preoperative MUI was proven to be the risk factor for treatment failure after the TO approach (OR 6.39, $p = 0.003$). (188) The percentage of women with MUI

was higher in obese women than in non-obese women undergoing the TO MUS. However, it also appears that OAB symptoms improve after the TO MUS. Habibi et al. evaluated 87 women with stress-predominant MUI one year after undergoing TVT-O. (274) Prospective assessment included 3-day bladder diary, Urgency Perception Score (UPS), ICIQ-FLUTS, and IIQ-7. At 1-year follow-up, subjective cure of SUI was 78% and significant point improvements (vs. baseline) in mean daily pad use (2.5 to 0.9, $p < 0.05$) and mean incontinence episodes (3.6 to 0.7, $p < 0.05$) were seen. Mean questionnaire scores for UUI significantly improved from 2.0 to 1.0 ($p < 0.001$), with 32% and 31% of patients reporting cure and improvement of UUI, respectively. Similarly, mean UPS score improved from 10.1 to 6.7 ($p < 0.001$). Eighty-two percent of the women did not require anticholinergics over the 1-year follow-up period and urgency outcomes were associated with improvements in QoL.

Finally, Lee et al. evaluated OAB symptoms, especially nocturia, in 237 women with MUI after outside-in TO MUS. (275) Of these, 86 (36.4%) had preoperative nocturia. Women with neurogenic DO and those who were being treated with anticholinergics and anti-diuretic hormones were excluded, leaving 70 subjects for analysis. TO MUS treatment resulted in an overall significant improvement in OAB symptoms including nocturia. Frequency-volume charts revealed that TO MUS treatment significantly decreased the actual number of nightly voids (ANV) and the nocturnal bladder capacity index (NBCi) in the entire cohort. However, in a subgroup of women with nocturnal polyuria, there was no significant change in ANV or NBCi after the sling operation. Correlation analysis of the whole cohort revealed that the postoperative changes in NBCi correlated positively with postoperative changes in ANV.

Summary (TO MUS in special populations)

Currently available data are insufficient to make conclusions regarding the utility of the TO MUS in the obese population, those women with ISD or MUI, or those undergoing reoperation for recurrent or persistent SUI after definitive MUS. (LE= 3/4) Likewise, no Level 1 data is available to recommend the TO MUS vs. other anti-incontinence procedures for these special populations.

Summary

TO MUS demonstrates similar efficacy vs. other procedures (aPVS, colposuspension, RP MUS, SIMS) at short to medium term (LE= 1/2) however long term RCT data are lacking vs. these procedures.

Both approaches (outside-in vs. inside-out) to TO MUS are associated with similar short/medium term efficacy outcomes. (LE=1) However, vaginal wall perforation is higher with the outside-in approach and voiding dysfunction is higher with inside-out approach.

Recommendation

TO MUS may be offered as an effective treatment for SUI with appropriate counseling regarding its current limitations including unique AEs, and limited long term RCT data regarding durability. (Grade B)

3.3. Single Incision Mini-Slings (SIMS)

The single incision mini slings (SIMS) have been developed in an attempt to further reduce the morbidity associated with continence surgery and to provide an outpatient or office procedure to treat PVS(276, 277). The blind passage of needles, during TVT and TO MUS procedures, through the PVS space or the obturator foramen respectively is associated with a small risk of vascular, nerve or visceral injury (278). The shorter SIMS is thought to minimise this risk while maintaining the efficacy of these predicate procedures. The concept of the single incision sling is not novel. Smith presented a small series of SIMS in 1987 using porcine dermis. However this was a xenograft sling procedure which demonstrated poor long term cure rates which could have been attributed to in-vivo degradation.

The first commercially available mid-urethral single incision sling, TVT-Secur (Gynaecare), was launched in 2006 with no published human trial data. However 5 of the 7 trials of TVT-Secur found it to be inferior to TVT or TVT-O. Several different outcome measures were reported in these 7 trials, making it difficult to compare the trials directly. Two of these trials were stopped prematurely following an interim analysis which demonstrated TVT-Secur results to be significantly less effective than the comparator MUS (Table 9). Hamer et al (279) also reported concerns about the morbidity associated with TVT-Secur. They reported three significant complications in 67 cases, one hemorrhage 1000ml, one urethral perforation and one perforation of the bladder. Based on these reports, TVT-Secur was withdrawn from the market by the manufacturer, having been shown to have poor clinical outcomes at the midterm follow-up (280). (Table 9)

In the meantime, additional SIMSs were launched with different anchoring mechanisms in the obturator foramen. All are made of type I polypropylene mesh however the length and anchoring mechanisms are variable. The method of insertion is either U shaped, inserted in the same manner as the TVT or the H "hammock" insertion of the TO MUS. Three trials compared MiniArc to MUS, two found no significant difference between MiniArc and obturator tapes however the third trial by Basu et al (281) reported a considerably worse outcome for MiniArc compared to TVT, 9 out of the 37 patients who underwent the MiniArc subsequently had a TVT (Table 2). Notably, MiniArc is no longer commercially available as of 2016.

After excluding RCTs evaluating TVT-Secur, updated meta-analysis of RCT comparing SIMS to standard MUS was reported by Mostafa et al. in 2014. A total

26 RCTs (n=3308) were included. There was no evidence of significant differences between SIMS and MUS in patient-reported cure rate (RR:0.94; 95% CI, 0.88-1.00) and objective cure rates (RR:0.98; 95% CI, 0.94-1.01) at a mean follow-up of 18.6 months (282).

Afterwards 8 more trials have been published including 1581 women (Table 10). Three RCTs compared MiniArc to MUS, 3 compared Ajust to MUS, 1 compared Fixation single incision sling to MUS and 1 compared to Contasure to MUS. Three RCTs of MiniArc found it to be not inferior to MUS and 3 RCTs of Ajust reported that there was no difference for subjective and objective outcome from MUS.

One of the reasons for the development of SIMS is to reduce the morbidity of continence surgery. Hence trial design should include an assessment of morbidity, including perforation, hemorrhage, chronic pain and voiding difficulty. The meta-analysis showed that SIMS had significantly lower postoperative pain (weighted means difference [WMD]: -2.94; 95% CI, -4.16 to -1.73) and earlier return to normal activities (WMD:-50.8; 95% CI, -9.59 to -0.56 and WMD: -7.20; 95% CI -12.43 to -1.98, respectively) (282). Recent RCTs (Table 2) also reported that there was no significant difference for postoperative complications and SIMS was superior with respect to postoperative pain.

Nambiar et al. (171) have published the Cochrane review of SIMS which will enable ongoing assessment of data. Due to the considerable variation in the anchoring mechanisms of each type of SIMS, data from one device cannot be extrapolated to another. Palomba et al. reported a 2014 update of their trial comparing three SIMS procedures at 24 months. Subjective cure rates were not statistically different between the Ajust, MiniArc and TVT-Secur and similar patients in each group received a second anti-incontinence procedure for SUI (174). There is a need for further RCT comparing with various SIMS.

Summary

Several trials report that SIMS (except TVT-Secur) are not inferior to standard MUS in the short to mid-term (longest data 24-36 months). (LE=2) These procedures may be associated w/ less pain, but similar AEs compared to standard MUS. Rates of postoperative pain favor SIMS in the short-term, but appear to be similar with longer follow-up.

Recommendations

SIMS is an option for some individuals with SUI after appropriate counseling including the lack of long term RCT data (Grade B)

3.4. Other considerations with synthetic mesh: Host Response and the Risk of

Tumorigenesis with Polypropylene Mesh

While the United States Food and Drug Administration has stated in their 2013 report that the safety and efficacy of MUSs has been well established in clinical trials that followed patients for up to one year (299) some authors have questioned the potential for these materials to induce a harmful immunogenic, inflammatory and possibly malignant response in host tissues. (300, 301) Evaluation of the potential impact of implanted biografts is difficult to separate from the host's normal response to surgical wounding.

3.4.1 The Impact of Biografts on Wound Healing After Sling Placement

Any surgical incision or tissue trauma is associated with a normal cascade of events that is triggered in mammalian tissues as a response to the injury. Initially, a cascade of hemostasis, inflammation, proliferation, and remodeling will occur over time with the generation of scar tissue.(302) The quality of the scar tissue and its integration into the surrounding tissues will vary based on numerous host characteristics including the presence of pre-existing immunological disease, history of smoking, obesity, medications, age, and diabetes, among others. The presence of prolapse itself has been shown to potentially influence wound healing during vaginal reconstructive surgery. Jackson and colleagues(303) showed an association between prolapse and a reduction in total collagen and decreased collagen solubility with an increase in matrix metalloproteinase 9 activity leading to a fourfold increase in collagen turnover in those women with prolapse compared to controls.

With implantation of a polypropylene mesh sling, the normal healing cascade is impacted to some degree by the host's response to a foreign body with a separate cascade of seven overlapping phases including: injury, protein adsorption, acute inflammation, chronic inflammation, foreign body reaction, the formation of granulation tissue and encapsulation. It is now clear that the characteristics of implanted mesh may have a profound effect on the host's response to implanted materials, and more specifically, mesh used for vaginal reconstruction such as slings. Use of lightweight, loosely woven, monofilament, polypropylene sling mesh with large pores will be better incorporated into the vaginal and periurethral tissues than heavier weight multifilamentous mesh with small interstices. Pascual et al.(304) looked at the effect of pore size and mesh weight on collagen formation and the tensile strength of a healing abdominal wound. They compared four different types of polypropylene mesh and found that large pore, lighter weight mesh showed more rapid incorporation with Type III collagen and faster conversion to the stronger Type I collagen compared to heavier meshes. The most porous lightweight mesh achieved the greatest tensile strength in a short term model.

During the acute and chronic inflammation phase of the foreign body reaction, a matrix forms around the

sling that is rich in cytokines, growth factors and chemoattractants. This leads to histamine-mediated phagocyte recruitment and mast cells coming into the wound along the graft. Their release of histamine and interleukin enhances neutrophil activity and then monocytes and lymphocytes become active in the chronic phase of inflammation and lead to the formation of foreign body giant cells.(305, 306) The cytokines and growth factors influence the activity of macrophages and fibroblast proliferation that leads to tissue ingrowth into the sling. Cytokine responses and leukocyte adherence from cells adhering to hydrophobic materials, like polypropylene, are more marked than when cells are in contact with hydrophilic materials.(307) Rechberger and colleagues(210) examined the affect of increased cytokines on the risk for sling exposure through the vagina. They found that women with mesh exposure had higher interferon levels preoperatively compared those women whose slings healed normally. These data suggest that pre-existing systemic inflammation may play an adverse role in wound healing after sling placement but that there is no evidence for an enhanced local inflammatory response leading to systemic immunological symptoms. Moalli and colleagues concluded that the foreign body reaction and inflammation surrounding polypropylene mesh implants is largely limited to the immediate area of the implant with no evidence for a systemic inflammatory response. Further knowledge of the influence of polypropylene on wound healing and the presence of risk factors for impaired wound healing will be important to further reduce the low risk of poor healing when polypropylene is used for anti-incontinence and prolapse surgery.

3.4.2 Tumorigenesis in Animals with Biografts

Tumorigenesis in laboratory animals after implant placement has been demonstrated. Ostergard and Azadi have questioned whether these animal data would extend to humans having polypropylene grafts implanted through the vagina. They present data on studies showing induction of sarcomas in mice with polypropylene coated transponder chips(308) and sarcomas induced in rats that had radiated polypropylene discs implants.(309) But Witherspoon et al. showed no tumor induction in mice over two years who had monofilament polypropylene hernia mesh implanted.(310) The absence of tumorigenesis following implantation of a loosely woven polypropylene mesh in a rodent model is likely due to the "Oppenheimer effect".

Table 9. Summary of the data on TVT-Secur

Author	N	F/U (months)	% Objective cure		% Subjective cure		Year	% lost FU	EL
			TVT-S	SMUS	TVT-S	SMUS			
Author	N	F/U (months)	% Objective cure		% Subjective cure		Year	% lost FU	EL
			TVT-S	SMUS	TVT-S	SMUS			
Oliveira et al. (283)	90	12			67 v 87 v 83 TVT-S v MiniArc v TVT-O		2010	12	2
Tommaselli et al. (261)	84	12	83.8	81.6 TVT-O			2010	10.7	2
Hinoul et al. (284)	194	12	84	98	76	92	2011	17.5	1
Hola et al. (285)	142(86)	3	52.8	97.4 TVT-O			2011		2
Hamer et al. (279)	308(133)	2			71	92	2011	1.6	2
Wang et al. (212)	106	12	67.7 v 91.7 v 93.8 TVT-S v TVT-O v TVT				2011	3.7	2
Abdelwahab, et al(286)	60	9			90	93	2010	0	2

Table 10. Summary of the data on SIMS except TVT-Secur

Author	N	F/U (months)	% Objective cure		% Subjective cure		Year	% lost FU	EL
			TVT-S	SMUS	TVT-S	SMUS			
De Ridder D et al. (287)	90	24			85 Monarc	82 MiniArc	2010	0	2
Basu et al. (281)	71	0	MiniArc v TVT USI OR 7.58 (CI 2.7-24.7)		OR 8.14 (2.7-24.7)		2010	0	2
Amat et al. (288)	158	12	87.5 Contasure-Needleless	90.0 TVT-O	87.3 TVT-O	75.4 Contasure-Needleless	2011	16.4	2
Schellart et al. (289)	193	12	89 MiniArc	91 Monarc	83	86	2014	10.3	2
Jurakova et al. (290)	93	12	90.0 Fixation SIS	87.0 TO MUS	93.2	91.3	2015	3.2	2
Martinez et al. (291)	257	36	88.9 Contasure-Needleless	84.7 TVT-O	90.7	95.4	2015	7.0	2
Lee JK et al. (292)	225	12	94.4 MiniArc	96.7 Monarc	92.2	94.2	2015	14.0	2
Schellart et al. (293)	193	24	93 MiniArc	94 Monarc	84	89	2015	16.5	2
Schweitzer et al. (294)	156	12	90.8 Ajust	88.6 TO MUS	77.2	72.9	2015	30.7	3
Schellart et al. (295)	193	24	93 MiniArc	94 Monarc	84	89	2016	28.4	2

Table 10. Summary of the data on SIMS except TVT-Secur

Author	N	F/U (months)	% Objective cure		% Subjective cure		Year	% lost FU	EL
			TVT-S	SMUS	TVT-S	SMUS			
Xin X et al. (296)	368	12	97.2 Ajust	90.7 TVT-O	94.4	90.7	2016	2.1	2
Masata J et al. (297)	96	12	89.8 Ajust	87.2 TVT-O	89.8	91.5	2016	5	2
Jurakova et al. (298)	93	12	90.9 Ophira	87.0 TOT	93.2	91.3	2016	3.2	2

Oppenheimer showed that the surface characteristics of an implant are important in tumorigenesis. They showed that while inert materials (glass and inert metals) implanted as discs and sheets might induce sarcomas, the powder and porous forms of these materials would not induce cancers in the same species. This would explain why smooth sheets and discs of polypropylene would induce sarcomas but polypropylene mesh would not. So while the WHO in 1999 listed smooth sheets of polypropylene as possibly carcinogenic (Category 2b), Williams stresses that at the Lyon meeting of the WHO many products were placed in the 2b category because there was no hard evidence that they were not carcinogenic and the WHO felt it was prudent to say that smooth sheets of polypropylene were possibly carcinogenic.(311) It has been suggested that a biofilm induced inflammatory response around an implanted polypropylene mesh sling might be an inductive factor in carcinogenesis. This might lead to genomic instability and mutagenesis. However, Weber et al. were unable to find any genomic instability in a rat model of animals with preneoplastic and neoplastic tumors.(312)

It is important to recognise that tumorigenesis in rodents is common and very rare in humans. Therefore, whether or not the processes that ultimately result in carcinogenesis in rodents are relevant in humans is unknown and suggesting that such a relationship exists is purely speculative. Moalli and colleagues bring up the potential absurdity of directly translating animal research data to human clinical care in referencing the article by Moore and Palmer in 1977, reported in the *Journal of the American Medical Association* entitled "Money causes cancer: ban it".(313) They found that implanting metal coins into rats caused 60% to develop sarcomas within 16 months.

3.4.3 Tumorigenesis in Humans with Biografts

Peer reviewed scientific literature on the subject of mesh induced carcinogenesis in humans is lacking. Ostergard and Azadi stress that we may not be seeing associated malignancies in humans because the induction time for malignancy is quite long in humans and estimated to be 15 to 20 years- but may be as long as 40 years. This suggestion does warrant long term diligence but must be balanced against the clear advantages brought to the clinical arena in the last two decades by the MUS as compared to prior procedures for female SUI.

Williams, in his review, brings up data that shows that even when humans have been exposed to potential carcinogens, the risk for malignancy remains very low. For example, while product liability law suits in the later 20th century flourished asserting that silicone leaking into the breast tissue would be carcinogenic, careful scientific review has shown no greater incidence of cancer, death from cancer or negative impact on breast cancer survival in women who received these silicone implants.(314) Even Trilucent

™breast implants that had a filler of polyunsaturated fatty acids in a silicone elastomer shell did not induce cancers or any local or systemic markers of cancer. This was in spite of the fact that lipids had a tendency to degrade the silicone elastomer shell allowing some of the lipid filler to leak into the tissues. It is known that when these fatty acids undergo lipid peroxidation when exposed to body fluids that it leads to the formation of aldehydes, including malondialdehyde. The malondialdehyde is known to be mutagenic and carcinogenic in animals but no humans developed cancers in 4 years of study. This was in spite of peroxidation in the tissue.(315)

King et al(316) specifically examined the malignant potential of polypropylene MUSs in a single centre study of 2361 such slings performed at their institution between 2004 and 2013. With an average follow-up of 42 months and as long as 122 months they noted that 2 of the 2361 women had developed a single bladder and a vaginal cancer felt to be unrelated to the sling placement. The bladder cancer was a high grade urothelial cell carcinoma that occurred 4 years after a TO MUS with no bladder perforation. The vaginal cancer was anatomically separate from the sling at the apex and was associated with human papilloma virus. The overall incidence was 0%.

In 2014, Birolini et al.(317) reported on two cases of mesh-related squamous cell carcinomas of the abdominal wall associated with long term mesh infections for 6 and 24 years. The mesh was a polyester mesh and the authors concluded that it was the long term infection with poorly incorporated mesh that led to the evolution of these malignancies and that this was not related to the material. More recently, Lin et al(318) reported a case of clear cell carcinoma alongside an exposed midurethral polypropylene sling. She presented with retention 10 years after placement of an inside-out TO MUS. She had no history of intrauterine diethylstilbestrol. She initially had a tender and indurated anterior vaginal wall with a 1cm mesh exposure in the right vaginal sulcus and she had a mesh excision two weeks later. But two months after excision she was noted to have friable vaginal tissue under the distal 3 cm of the urethra. Biopsy revealed a poorly differentiated high-grade clear cell carcinoma. The authors considered that the inflammation caused by the sling exposure could have been related but recognise that there is nothing in the literature to support that mesh causes cancer in humans.

In an editorial comment on this case report, Dwyer reported another case of a squamous cell carcinoma proximate to a RP MUS discovered as a 3 cm paraurethral mass 14 months after placement of the sling.(319) These authors concluded that the exposed mesh was likely just an incidental finding in a patient with clear cell carcinoma. They remark that this is the first case in 20 years of MUSs where a malignancy has been found proximate to a MUS. Tens of millions of patients have undergone surgery with polypropylene mesh or sutures in the past 60 years without prior reports of, or an association with clear

cell cancer. Goldman and Dwyer also recognised that animal studies had only identified the potential for sarcomas. Williams suggests that with exposure in over 100 million humans to all types of implantable medical devices with more than a billion implant-years of observation one would expect that tumors would develop in proximity to the implant but the evidence to date does not support this(315).

Review of the literature shows that there is little evidence of an association between the implantation of polypropylene mesh MUSs and tumorigenesis in humans. The data also show that trying to extrapolate experimental data from rodents on inflammatory and oncologic induction in humans is misguided. While it is clear that we need to be vigilant in looking for cases of malignancy in subjects with implantable mesh we need to be careful not to frighten women who are considering having a MUS with excessive concern and anxiety about the neoplastic potential of these implants.

3.4.4 Degradation of Mesh in Vivo

Legal proceedings have suggested that polypropylene mesh may fracture in vivo and cause harm. This has been suggested because of the cracked appearance of explanted mesh. However, Ong and colleagues (320) have recently shown that this may be an artifact due to the formalin fixation process and inadequate mesh cleaning. Careful cleaning of the explanted mesh with distilled water, sodium hypochlorite and Proteinase K shows that cracked flaking material seen on explanted mesh was from inadequate cleaning and could be washed away leaving clean, smooth, unoxidized and non-degraded polypropylene fibers. Analysis of the flaking material shows it contains magnesium, phosphorous and calcium indicative of the adsorbed protein coating on the polypropylene and not disruption of the fibers themselves. The authors concluded that in vivo degradation of polypropylene mesh is a myth.

Summary

A causative relationship between the implantation of MUSs with loosely woven polypropylene MUSs and the development of systemic inflammation or aberrant host response has not been proven in humans. (EL=4)

A causative relationship between the implantation of MUSs with loosely woven polypropylene MUSs and the development malignancy (oncogenesis) has not been proven in humans.(EL=4)

Recommendation

The option of utilizing loosely woven polypropylene MUS for the treatment of SUI should NOT be limited or impacted by the risk of subsequent development of tumorigenesis or systemic inflammation (Grade D)

4. URETHRAL BULKING AGENTS

One of the mechanisms for stress continence is reliant on effective coaptation of the urethra during increases in intra-abdominal pressure. If the “water-tight seal” is inadequate, SUI results. Urethral bulking agents are designed to address defective coaptation and may be injected either transurethral or periurethral in a retrograde fashion, using either direct cystoscopic, ultrasonographic, or implanter-guided device implantation. The procedure may be performed under local, regional, or general anesthesia. Device implantation optimally occurs in the mid- to-proximal urethra, and strategic planning for reinjection at some point after initial injection is warranted. Clinical trials have defined specific injection schedules (usually three injections) as part of trial therapeutic algorithms; however, the optimal injection technique has yet to be standardised.

4.1. Available Agents

Due to manufacturing cessation, bovine collagen (Contigen®) was already obsolete by the ICI-5 compilation. Its inclusion in this chapter is strictly as a comparison (control) group. Currently available agents include: calcium hydroxyl apatite (Coaptite®), carbon coated zirconium beads (Durasphere®), polydimethylsiloxane elastomer (PDMS; Macroplastique®), polyacrylamide hydrogel (PAHG; Bulkamid®), and Urolastic (Urogyn BV, Nijmegen, The Netherlands), a new bulking agent that consists of vinyl dimethyl terminated PDMS, tetrapropoxysilane cross-linking agent, platinum vinyltetramethyl siloxane complex catalyst, and titanium dioxide radiopacifying agent. Additionally, limited data has been published regarding non-animal stabilised hyaluronic acid/dextranomer (NASHA-dx; Zuidex®). Polytetrafluoroethylene (Polytef paste) continues to be available in some International sites. In the Cochrane Review, women treated with NASHA-dx appeared to have significantly higher rates of injection site complications (16% with NASHA-dx vs. 0% with bovine collagen; RR 37.78, 95% CI 2.34 to 610) and this product has now been withdrawn from the U. S. market. (321) It remains available for injection therapy to address vesicoureteral reflux. Its inclusion in this chapter is for completeness only. Recent experience with adult stem cells for SUI treatment will be covered in the section “Stem cell technologies for SUI”

4.2. Outcomes

4.2.1 Cohort Studies

Mohr et al. reported a large series of 514 women treated with various forms of bulking therapy (bovine collagen, NASHA-dx, ethylene vinyl alcohol (no longer marketed,) and PAHG). (322) Outcomes were reported using standardized pad tests, visual analogue score (VAS) for severity of incontinence, and Kings Health Questionnaire (KHQ). Sixty-one

women were lost to follow-up. At one year post-implantation, pad testing was negative in 73.2% of women and there was statistical improvement in both pad weight and VAS for each of the agents used. Re-injection was permitted six weeks after initial injection.

4.2.2 Carbon-coated Zirconium Beads

No new studies of periurethral carbon-coated zirconium beads were located from ICI-5.

4.2.3 Calcium Hydroxyl Apatite

From 2011-2013, 60 women underwent one (30%), two (63%) or three (7%) periurethral calcium hydroxylapatite injections performed by a single surgeon. (323) Thirty-seven patients provided questionnaires and 38 provided pad counts, all with a mean age of 75 years. The overall American Urological Association Symptom Score (AUASS), AUASS QOL, and overall Michigan Incontinence Symptom Index (M-ISI) scores improved in 67.6%, 54.8%, and 61.3 % respectively (4.5 ± 7.9 , 1.3 ± 1.7 and 5.5 ± 8.6 respectively). The M-ISI bother score improved in 44.8 % with a mean improvement of 0.5 ± 2.9 , but did not reach significance. There was a 1.7 ± 3.7 decrease in the mean number of pads used daily after the procedure ($p = 0.006$) and 19 % experienced transient urinary retention.

4.2.4 Polydimethylsiloxane Elastomer (PDMS)

Ghoniem et al. evaluated the 24-month outcomes in women treated with PDMS in a multicenter study. (324) The participants were culled from a RCT comparing polydimethylsiloxane vs. bovine collagen (325), and included those women achieving initial treatment success (defined as ≥ 1 Stamey grade improvement 12 months from baseline). Outcome measures were Stamey grade, PGI-I, Physician Assessment of Improvement, 1-hour pad weight, Incontinence Quality of Life (I-QoL) scores, and safety assessment. At 24 months, 56 of 67 patients (84%) had sustained success from their 12-month visit, of whom 45 of 67 (67%) were dry (Stamey grade 0). Of the dry patients at 12 months, 33 of 38 (87%) maintained cure at 24 months. Also, 12 of 29 patients (41%) considered improved at 12 months were dry at 24 months. Overall I-QoL scores and all subscales showed statistically significant improvement from baseline ($p < 0.001$). Mean pad weight was 24 g at baseline and 4 g at 12- and 24-month follow-up. Patient and physician assessments rated 85% of patients dry or markedly improved 24 months after the last treatment.

Ghoniem and Miller performed a systematic review of the scientific literature from 1990 to 2010 to quantitatively summarise the safety and effectiveness of PDMS. (326) A total of 958 patients from 23 cohorts were eligible for inclusion and were analyzed. Random-effects models were used to estimate the improvement and cure rates following treatment at three

time periods: short-term (<6 months), mid-term (6-18 months), and long-term (>18 months). Improvement rates were 75% [95% CI, 69 to 81] in the short-term, 73% (9% CI, 62 to 83) in the mid-term, and 64% (95% CI, 57 to 71) in the long-term. Cure/dry rates were 43% (95% CI, 33 to 54), 37% (95% CI, 28 to 46), and 36% (95% CI, 27 to 46) over the same follow-up periods, respectively. Higher study reinjection rates were associated with improved long-term SUI outcomes. Safety events associated with injection included retention, irritative voiding symptoms, dysuria, and urinary tract infection.

4.2.5 Polyacrylamide Hydrogel (PAHG)

The use of PAHG in women with SUI or MUI has been reported in several recent cohort studies. At 12-month follow-up, 47 of 135 women (35%) underwent repeat injection (327). The overall subjective response rate was 66% and incontinence episodes per 24 hours decreased from a baseline of 3 to 0.7. Additionally, pad weight decreased from 29 g at baseline to 4 g at the end of the trial. ICIQ demonstrated overall improvement in QoL. At 24-month follow-up in this cohort, 64% maintained subjective improvement (vs. 67% at 12 months)(328). The overall decrease in incontinence episodes and pad weights, as well as improvement in QoL indices, remained stable from the 12-month evaluation.

From 2006 to 2011, 256 women underwent bulking with PAHG and were assessed at least annually with QoL and ICIQ questionnaires(329). Eighty-two percent reported cure/significant improvement at three months and the high satisfaction rate (via both VAS and ICIQ scores) was maintained at a median follow up of 38 months. There were no reported adverse reactions and no significant safety concerns.

In a single-centre, prospective study, 80 women with severe SUI had PAHG bulking between June 2010 and October 2011(330). Before and after treatment, QoL was assessed with the Patient Global Impression of Severity (PGI-S), ICIQ-SF, and PGI-I. At a mean follow-up of 18.6 ± 5.3 months, 60% of women had improvement and no patient had worsening of PGI-I after injection. The ICIQ -SF score improved from 17 ± 2.84 before injection to 13 ± 5.52 after surgery, with a significant 30% decrease ($P < 0.00001$). The reinjection rate was 29%. The complication rate was 16% (17/108): 11 cases of transient postoperative retention, two cases of cystitis, and four episodes of dysuria. There were no abscesses or infection at the injection site.

Recently, 24 of 25 women who underwent PAHG injection eight years earlier were contacted (331). Fifteen had had no further treatment, seven underwent MUS placement, and two had been re-injected with PAHG. Eleven women attended for objective examination and all non-attenders were interviewed by telephone. In 44%, SUI was subjectively cured or much improved, with a positive outcome according to the KHQ. Objectively, all patients had visible PAHG deposits on vaginal ultrasonography. No local adverse

reactions were seen in the vaginal mucosa and the results of staged MUS were reportedly unaffected by previous bulking.

Finally, a systematic review of the MEDLINE (1966-2015), Scopus (2004-2015), POPLINE (1974-2015) and ClinicalTrials.gov (2008-2015) databases was performed to assess efficacy and AE profile of PAHG bulking (332). Observational studies, prospective, retrospective, and RCTs were included. Eight studies which enrolled a total of 767 women were included. In order to achieve adequate efficacy, 186/767 women (24.3%, range 12-35%) required reinjection. The most frequent adverse effects were pain at the site of injection (4-14%) and UTIs (3-7%). Both the number of incontinence episodes/24 h and the number of mL/24 h were significantly reduced one year following treatment. Likewise, QoL was significantly improved.

4.2.6 Vinylidimethyl-terminated Polydimethylsiloxane Polymer (VDM-PDMS)

A prospective, cohort study included 20 women who underwent VDM-PDMS periurethral injections under local anesthesia (333). The injection procedure was repeated after six weeks, when indicated. Patients were evaluated for efficacy and safety parameters at six weeks, three months, and 12 months after therapy. Thirteen patients (65%) received one injection each (overall average of 2.1 mL), while seven received a second injection. Nineteen women completed the 12-month follow-up. The mean Stamey grade significantly decreased from 1.9 at baseline to 0.4 at 12 months ($p < 0.001$). While none of the patients were dry at baseline, 68% were dry at 12 months. The mean number of incontinence episodes significantly decreased from 6/day at baseline to 1.6/day at visit IV ($p < 0.001$). Pad weight reduced from 20.2 g to 7.8 g at one year. The mean I-QoL score significantly increased from 51 at baseline to 76 at visit #4 ($p < 0.001$). Six women (30%) developed minor complications related to the injection procedure.

The 19 women completing 12-month follow-up in the study above were invited for the 24-month follow-up study (334). Four of the 18 women who responded to the correspondence reported removal of the VDM-PDMS implant at another facility. The explanation for this removal was painful intercourse in one woman and less than optimal dryness in three. The overall objective improvement in continence status at 24-months was 66% compared to the 89% at the 12-month follow-up. The 1-hour pad weight test showed >50% reduction in pad weight in 66% of patients compared to 84% at the 12-month follow-up. AEs reported were UTI in one woman, local genital infection with erosion into the vagina in one, painful intercourse in two, and urgency in four.

4.2.7 Adjustable Continence Therapy (ACT®)

The ACT device consists of two balloons each attached to an injectable port placed in the labia majora.

The port enables postoperative adjustment in balloon coaptation pressure.

A review of the PubMed database yielded eight studies that were published between 2007 and 2013. (335) The mean follow-up of these studies was 1-6 years. The mean age of the patients ranged between 62 and 73 years, and 40-100% of the patients had already been treated surgically for their SUI. A significant reduction in the number of pads used per day was observed after ACT® balloon placement, with improvement of short pad tests from 49.6 to 77.3 g preoperatively to 11.2-25.7 g after balloon placement. Fifteen to 44% of patients considered that their SUI had been cured, and 66-78.4% of the patients were satisfied with the result. No major complication was reported; however, the explantation rate was 18.7-30.8%. Quality of life was significantly improved.

More recently, a single-centre retrospective study reported on 52 women who underwent ACT balloon placement between 2000 and 2013, with 64.5% performed under local anesthesia. (336) Among these women, 35 (67.3%) had already undergone previous surgery for SUI. Clavien grade I-II early post-operative complications occurred in five (9.6 %) patients. Median follow-up was 10.5 months (IQR 3-24.25) with 11 women (21.1 %) lost to follow-up. At last follow-up, seven patients (13.5%) were subjectively continent after the first implantation and 13 (25%) had an >80% improvement rate (10 patients after first implantation, two after second implantation, and one after third implantation). Four patients (7.7%) found the procedure unsuccessful even after several consecutive implantations. Ten patients (19.2%) reported a partial result and were still having successive balloon inflations. Explantation occurred in 22 patients, caused by infection, erosion or balloon migration. In intention-to-treat analysis, the failure rate was 42.3%.

4.3. Method and Location of Injection

A Cochrane Review identified 14 trials (excluding one that was subsequently withdrawn from publication and not included in this analysis) including 2004 women; however, the Review has not been updated since ICI-5(321). The limited data available were not suitable for meta-analysis because they all came from separate trials. Trials were small and generally of moderate quality. The Cochrane Analysis concluded that there was no difference in periurethral vs. transurethral manner of delivery, although there was a non-significant trend towards higher early complications with periurethral injection. Additionally, weak evidence supports mid-urethral injection resulting in improved patient satisfaction compared to BN injection.

4.4. RCTs Comparing Bulking Agents

A RCT enrolling 247 women compared PDMS (n=122) and bovine collagen (control group; n=125) (325). Repeat injection was allowed at three months after initial delivery for persistent incontinence. Efficacy was determined at one year post last injection

using Stamey grade scoring, pad weight change, and Urinary Incontinence Quality of Life Scale. At one year post-treatment, 61.5% of women who received PDMS had improved by one Stamey grade vs. 48% of controls. The dry/cure rate at one year was 36.9% in the PDMS group vs. 24.8% in the control group ($p < 0.05$). One hour pad weight change was 25.4 mL from baseline in the PDMS group vs. 28 mL in the control group ($p = 0.64$). Both groups had improvement in QoL assessment (28.7% and 26.4%, respectively; $p = 0.49$).

The Zuidex Study Group performed a prospective 2:1 randomised trial of NASHA-dx vs. bovine collagen in 344 women at 23 North American sites (337). Outcomes at 12 months from last treatment failed to demonstrate that NASHA-dx was equivalent to bovine collagen in the primary outcome, which was the proportion of women who achieved a 50% reduction in urinary leakage on CST (84% in the bovine collagen group vs. 65% of NASHA-dx).

A single-blind, randomised, prospective, 33-centre, 2-arm parallel study of PAHG vs. bovine collagen had follow-up to one year (338). At baseline, women underwent CST, pad weight, bladder diaries, and QoL questionnaires. After randomisation, patients could receive up to three injections at 1-month intervals. At the last visit Valsalva leak point pressure was measured. Of the 345 women 229 were randomized to PAHG and 116 were randomised to bovine collagen. At 12 months, a $\geq 50\%$ decrease in leakage and incontinence episodes was seen in 53.2% and 55.4% of patients who received PAHG and collagen, respectively. At 12 months, 47.2% of patients with PAHG and 50% with collagen reported zero SUI episodes, while 77.1% and 70%, respectively, considered themselves cured or improved. Major AEs were rare in each group.

The Cochrane analysis concluded that all bulking agents appeared to provide similar overall improvements as compared to bovine collagen. (321) Eight trials compared different agents and all results had wide confidence intervals. Silicone particles, calcium hydroxyl apatite, ethylene vinyl alcohol, carbon spheres and NASHA-dx gave improvements which were not shown to be more or less efficacious than bovine collagen. Finally, a recent systematic review that included only RCTs has been published (339). The primary outcomes were clinical and urodynamic parameters. Initially, 942 studies were identified; however, only 14 eligible trials fulfilled the prerequisites. Altogether, the review included 1814 patients from trials of eight different types of bulking agents and confirmed the findings of the Cochrane Review. The most common complications of the bulking agents were urinary retention and UTI. The authors cautioned that the lack of adequate studies, the heterogeneous populations studied, the wide variety of materials used, and the lack of long-term follow-up limit guidance of practice.

4.5. Bulking Agents vs. Surgery

In the two trials in the Cochrane Review that compared injection therapy with surgical management, better overall objective cure was obtained after surgery vs. injection (RR 4.77, 95% CI 1.96 to 11.64; and RR 1.69, 95% CI 1.02 to 2.79). (321) Of note, the latter trial data did not reach statistical significance if an intention-to-treat analysis was used.

A recent review assessed the objective and subjective outcomes of bulking agents in comparison with MUS, Burch colposuspensions, and PVSS for SUI (15). A PubMed and Medline search yielded three studies evaluating bulking agents in comparison with other surgical approaches for either primary or recurrent SUI. Two of these studies were RCTs evaluating the use of bulking agents vs. other surgical procedures for the treatment of primary SUI. The remaining article was a retrospective cohort study that compared the effectiveness and safety of repeat MUS with urethral bulking after failed MUS. The combined results of all analyses showed that the objective recurrence rate of bulking is significantly higher in comparison with other surgical procedures. Similar findings were observed when considering separately the treatment for primary or recurrent SUI. Furthermore, lower subjective recurrence rate was observed among patients undergoing other surgical treatment in comparison with those undergoing bulking agents; however, this trend was not statistically significant. As may be expected, women undergoing injection of bulking agents experienced a lower rate of voiding dysfunctions in comparison to surgery group.

4.6. Role of Bulking in Special Populations

4.6.1 Bulking in the Elderly

Twenty consecutive women with a mean age 84.5 years (range 80-87) were prospectively enrolled to undergo PAHG injection (340). All subjects were evaluated at baseline and re-evaluated at six-month intervals after treatment. A statistically significant decrease in the number of pads was observed at the 24-month follow-up ($p = 0.0002$). Physical examination showed a statistically significant lack of, or reduction in, urine loss with CST ($p = 0.0163$). Urodynamic findings showed an increase in VLPP, MUCP, and functional urethral length. IIQ-7 showed a statistically significant improvement in QoL ($p = 0.0001$). Patient satisfaction assessed with the VAS and PGI-I respectively produced evaluations of "satisfied" and "much improved" even after 24 months.

Table 11: Bulking Agents: Cohort Studies

Lead Author(s)	Year	Injectable	N (initial)	N (reported)	F/U	Injections	Objective Outcome	Subjective Improvement	Complications
Mohr (322)	2013	Collagen NASHA-dx EVA PAHG	312 54 104 44	453 (61 lost to FU)	12m	Med 1 Range (1-3) Permitted at 6w	73.2% [\leq 2g on 2h pad test]	(S) VAS (S) general health & role limitation KHQ domains	3.2% 5.6% 5.7% 0%
Griffin (323)	2016	Ca-HA	60	44 (37 had quest & 38 pad #)	169d (32-499)	1 (18, 30%) 2 (38, 63%) 3 (4, 7%)	(S) ↓ (mean 1.7) in pad #	(S) AUASS, AUASS QOL, M-ISI	19% transient urinary retention
Ghoniem (324, 325)	2010	PDMS	75	67	24m	49% reinjection at 3m	67% Stamey Grade=0 79% \geq 50% ↓ vol on 1h pad test	85% dry or v. improved PGI-I (S) I-QOL	NR
Ghoniem & Miller (326)(Systematic Review)	2013	PDMS	-	958 (24 studies)	-	30% reinjection (17 studies)	Short-term: 75% improved, 43% cure Mid-term: 73% improved, 37% cure Long-term: 64% improved, 36% cure		7% transient urinary retention 3% UTIs, 50% transient dysuria; 45% transient hematuria
Lose (327)	2010	PAHG	135	94 (per protocol)	12m	35% reinjection	(S) ↓ incont episodes (3→0.7) (S) ↓pad wt (29→4g)	24% cured; 66% cure + improved; (S) ICIQ improvement	88/96 AEs not-serious; 32 TRAEs: 10 UTI, 2 retention; 2 hematuria, 1 injection-site rupture
Toosz-Hobson (328)	2012	PAHG	135	86 (per protocol)	24m	35% reinjection	Improvement in incont episodes, pad wt sustained	ICIQ, VAS improvement sustained 94% sustained subj success	16 new non-serious AEs No new emptying difficulties at 24m
Pai & Al-Singary (329)	2015	PAHG	256		3m min 38m med	18 (7%) reinjection	(S) ↓ incont episodes, pad wt	82% cure/signif improved at 3m 43% cure at 3m (S) ICIQ, VAS improvement	2 worse storage symptoms, 4 acute cystitis, 1 retention No abscesses
Beraru (330)	2014	PAHG	80	80	18.6 mean	29% reinjection	-	60% improved PGI-I (S) ↓ICIQ-SF	16%: 11 retention, 2 cystitis, 4 dysuria No abscesses

Lead Author(s)	Year	Injectable	N (initial)	N (reported)	F/U	Injections	Objective Outcome	Subjective Improvement	Complications
Mouritsen (331)	2014	PAHG	25	24 (interview) 11 (exam)	8y	2 (8%) reinjection	-	15 (62.5%) no additional surgery during FU 6/15 cured, 4/15 improved + satisfied	1 stranguria, 7 recurrent cystitis
Kasi (332) (systematic review)	2016	PAHG	-	767 (8 studies)	1-50m	186 (24.3%) reinjection	(S) ↓ incont episodes, pad wt	(S) QOL improvement	4-14% pain, 3-7% UTIs
Zajda & Farag (333)	2013	VDM-PDMS	20	19	12m	1 (13, 65%) 2 (7, 35%) at 6w	(S) ↓ incont episodes, pad wt	68% dry (Stamey 0) 89% ↓ Stamey grade (S) ↑ I-QoL	6 (30%): 1 small hematoma, 3 retention, 2 dyspareunia; 1 implant removal
Zajda & Farag (334)	2015	VDM-PDMS	20	18	24m	1 (13, 65%) 2 (7, 35%) at 6w	(S) ↓ incont episodes, pad wt	45% dry (Stamey 0) 66% ↓ Stamey grade	1 UTI, 1 vaginal erosion, 2 dyspareunia, 4 urgency; 4 implant removals

Key:

EVA: Ethylene vinyl alcohol;

Ca-HA: calcium hydroxyl apatite

VDM-PDMS: vinyl dimethyl-terminated polydimethylsiloxane polymer

4.6.2 Recurrent SUI

Several studies have indicated that bulking agents represent a viable option for treating persistent or recurrent SUI after failed primary surgery. Hansen et al. queried the Danish National Patient Registry to identify women who had undergone first-time synthetic MUS from 1998 through 2007. (341) The outcome was repeat surgery with any subsequent procedure code for urinary incontinence within a 5-year period of the first procedure. A total of 5,820 women (mean age 55.4±12.1 years) underwent a primary synthetic MUS, and 354 (6%) underwent reoperation. The first-choice treatment for reoperation was another synthetic MUS (45.5%) followed by urethral injection therapy (36.7%) and miscellaneous operations (13.8%). PVSs (2.8%) and Burch colposuspension (1.1%) were seldom used. A secondary analysis of the UITN SISTER and ToMUS trials of women who underwent primary SUI treatment was assessed for retreatment-free survival rates by initial surgical procedure (273). Half of the women in the SISTER trial met inclusion criteria for this analysis (329/655, 174 Burch and 155 fascial sling), as did 444/597 (74%) of subjects in ToMUS (221 TO and 223 PVS). Types of surgical retreatment included autologous fascial sling (339), synthetic sling (321), and bulking agent (338).

Studies evaluating individual bulking agents have demonstrated some success with injection for recurrent SUI. In a retrospective study of 23 women who had received therapy with PDMS or carbon-coated zirconium beads after a failed MUS, the authors noted a cure rate of 34.8% at a median follow-up of 10 months and improvement in secondary outcomes (342). Overall, 92% of these patients reported benefit from therapy and the authors reported no complications. Another observational study included 60 patients who underwent PAHG injection after a failed MUS (343). Patients were considered cured based on a negative CST, <2 g urine loss on 1-hr pad test, and a VAS score improved by ≥90%. Women considered improved were those with the loss of only a few drops of urine on CST and 2-10 g urine loss on 1-hr pad test, or a reduction of >50% compared with preoperative urine loss and a VAS score improved by ≥75%. The volume of PAHG injected ranged from 1-3 mL. Cured/improved rates were 93.3% (56/60), 88.3% (53/60), and 83.6% (46/55) at 1, 6, and 12 months, respectively. Those with MUI had UUI resolution rates of 36.8%, 47.4%, and 38.9%, respectively. Voiding dysfunction rates were 13.3% (8/60), 8.3% (5/60), and 1.8% (1/55) at 1, 6, and 12 months, respectively, while UTI rates were 5% (3/60), 11.7% (7/60), and 3.6% (2/55), respectively. Other AEs were short-term and/or observed in <4% of patients.

Another retrospective study described outcomes in 52 women who underwent PAHG, 40 of whom had failed previous anti-incontinence surgery (344). Cure

was evaluated by VAS (0-100 (dry)) and a 5-point Likert scale. A negative CST was observed in 19.6% of women at a mean follow-up of 22 months. Subjective assessment by the ICIQ-UI SF questionnaire showed that 15.7% of patients were completely dry, while 45.1% of patients were dry or improved. The mean VAS score was 51.3, and, on the Likert scale, the cure effect was evaluated as 5 or 4 ("cured" or "improved") in 54.9% of patients.

An open multicentre study of VDM-PDMS recruited 105 women from three tertiary gynecological clinics, 91 of whom had recurrent SUI (345). At each follow-up visit, CST and 1-hour pad test were performed. Objective success rate after 12 months in those women with recurrent SUI was 59.3%, compared with 71.4% of patients treated for primary SUI.

While bulking may be considered and used for recurrent SUI, the outcomes following injection therapy appear to be inferior to repeat sling surgery. A retrospective cohort study of women within the Kaiser Permanente Southern California Medical Group who underwent a MUS from 2008-2011 assessed the outcomes following either MUS or urethral bulking for recurrent SUI (346). The primary outcome was either subjective failure defined by SUI or objective failure defined as a positive CST, urodynamic SUI, or retreatment for SUI. Secondary outcomes included perioperative complications and AEs. Of 6,914 MUS performed, 165 women underwent a repeat procedure for recurrent SUI, including 98 MUS and 67 urethral bulking. Of those 165, there were 11 failures (11.2%) in the MUS group and 26 (38.8%) in the urethral bulking group ($p=0.004$). There were no differences in perioperative complications or AEs between the groups. In multivariable logistic regression, risk of failure was significantly higher in those undergoing urethral bulking compared with those undergoing MUS (OR 3.49, 95% CI 1.34-9.09, $p=0.01$).

Finally, an electronic database search was performed (1980-2014) using the keywords: stress urinary incontinence, failure, recurrence, and treatment (347). The search was restricted to female patients and currently-used surgical procedures, including studies with five or more cases. The authors found that the pooled objective cure rate for urethral bulking in recurrent SUI was 38% (95% CI ±10.7), compared to 66.2% (95% CI ±4) for repeat MUS and 79.3% (95% CI ±6.54) for PVSs.

4.6.3 Radiation-Associated Incontinence

A multicentre prospective trial enrolled a total of 46 women with severe SUI who underwent PAHG (348). Group A consisted of 24 women with previous pelvic radiotherapy for a gynecological malignancy, while Group B consisted of 22 women without previous radiotherapy. At a mean follow-up of 12.4 months, complete continence was achieved in 25% of patients in group A and in 36.4% of patients in group B. Significantly reduced urinary leakage was observed in

both groups ($p=0.0164$ in group A and $p=0.0002$ in group B). Total scores in the ICIQ decreased by 5.2 in group A ($p=0.0000$) and 6.36 in group B ($p=0.0001$). The scores for the Total Patient Perception of Bladder Condition decreased by 1.54 in group A ($p=0.0001$) and 2.59 in group B ($p=0.0000$), with a significant difference between groups ($p=0.0224$). No clinically significant changes in urodynamic parameters were observed and no severe AEs were noted.

4.6.4 Neurogenic SUI

SUI related to a relevant neurologic condition can be considered neurogenic SUI. A systematic review of the published literature from Pub Med and Web of Science was undertaken for studies describing surgical treatment of neurogenic SUI between 1990 and 2013 (349). Thirty studies were identified, all with Level 3 evidence. None of the studies followed a RCT design, so the quality of evidence is modest. Three primary surgical procedures were used in 29 of 30 studies: artificial urinary sphincter (AUS), urethral slings, and urethral bulking agents. One study used a ProACT device. AUS was considered more successful than urethral bulking agents ($77 \pm 15\%$ vs. $27 \pm 20\%$, $p=0.002$). Urethral bulking agents reported higher failures than urethral sling procedures ($49 \pm 16\%$ vs. $21 \pm 19\%$, $p=0.016$) and AUS ($21 \pm 19\%$ vs. $10 \pm 11\%$, $p<0.002$).

A retrospective cohort study reported outcomes in 22 children (16 females, 6 males) who had NASHA-dx injections from January 2001 to June 2011 for persistent incontinence from either the BN (7), Mitrofanoff (10), or both (5) (350). Median age at injection was 13 years (range 4-21). All patients had adequate bladder capacity and compliance on maximized medical therapy before injection. "Success" was defined as either "continence" (daytime dry interval >3 hours) or "improvement" (daytime dry interval >2 hours). Children underwent an average of 1.6 injection sessions per patient with an average of 2.6 mL of NASHA-dx per session. At a median follow-up of 72 months (range 4-104), 19 (86.4%) patients had successful results (16 continent, 3 improved). For those incontinent from BN, 42% became continent after 1, 75% after 2, and 83% after 3 injections, for a success rate of 91% (10 continent, 1 improved). For those incontinent from Mitrofanoff, 20% became continent after 1, and 73% after 2 injections, for a success rate of 86% (11 continent, 2 improved).

4.7. Complications

As mentioned in several studies above, bulking therapy is infrequently associated with severe complications. The most frequent AE in the trial by Lose et al. was UTI in 10 women. (327) Occasionally, the injectables themselves cause unique complications. Malabarey and Walter described a case of urinary retention and a large firm para-urethral vaginal mass as a complication of periurethral collagen injections three years before presentation. (351) The patient was

managed successfully with complete surgical resection of the mass and subsequent, recurrent SUI was managed using a rectus fascial sling. Likewise, Crites et al. reported a single case of bladder mass post bovine collagen injection which required transurethral resection for improvement of symptoms. (352) Kumar et al. reported a pseudo-diverticulum of the urethra due to an encysted collagen implant. (353) The use of PAHG has also been linked to a periurethral abscess which required surgical drainage (354).

Of note, NASHA-dx was associated with injection site sterile abscesses in 8.4% of patients, injection site mass in 4.4%, and pseudo cyst formation in 2.2% of patients (337). Irritative voiding symptoms and injection site pain were more common with NASHA-dx than with bovine collagen. Additionally, Lightner et al. reported a single-institution retrospective case series of 35 women with ISD who underwent implantation with NASHA-dx. (355) Four of these women developed pseudo abscess formation requiring multiple operative interventions. It must be noted that the NASHA-dx was the only bulking agent injected using the implaner device, a template used to position four syringes (0.7 mL each) in the urethra. Furthermore, the bulking agent was not injected under direct visual control and the volume injected was typically large, potentially accounting for some of the abscesses and other complications.

Summary

Limited Level 1 information has emerged regarding bulking therapy since compilation and publication of ICI-5. While bulking agents provide a treatment option for primary SUI, optimal results may be obtained with repeated injections as effect wanes with time.

The few RCTs that exist (Level 2b/3) suggest that outcomes are similar regardless of bulking agent used, with no single bulking agent demonstrating superiority to bovine collagen.

There appears to be no difference in outcomes whether the transurethral or paraurethral technique is used. Likewise, there appears to be no difference in outcomes whether the bulking was performed at the BN or the midurethra (Level 2b).

Limited data suggest that bulking is inferior to surgical therapy for both primary and recurrent SUI (Level 3b/4).

Limited, non-randomised data suggest some benefit of bulking therapy in special populations, such those women with SUI following pelvic irradiation (Level 4).

Overall complication rates associated with bulking agents continue to be relatively low (Level 2b/3b/4); however, the long-term implications of permanent bulking agents in the periurethral milieu is unknown.

Recommendations

Bulking agents should not be offered as first-line therapy for those women desiring a “one-time” durable solution for primary or recurrent SUI (Grade B).

Bulking therapy is an option for selected individuals with SUI (e.g. poor candidates for anti-incontinence surgery or those desiring an office-based, minimally-invasive procedure) after appropriate counseling regarding lack of long term durability (Grade B)

Bulking agents may be offered to women as first-line therapy for recurrent or persistent SUI following anti-incontinence surgery, although these outcomes are likely inferior to repeat anti-incontinence surgery in the long term (Grade C).

5. ARTIFICIAL URINARY SPHINCTER FOR WOMEN

The artificial urinary sphincter has been used to treat some female individuals with SUI for several decades. It has been used as a salvage procedure, for patients with special circumstances (e.g. neurogenic sphincter dysfunction, etc.), and as a primary procedure in some centres.

In the 5th Edition there were 13 publications on AUS in women performed vaginally, abdominally and laparoscopically from 2007 to 2012. Nine of these will be shared in this 6th Edition.

Roupret, et al., (356) reported 12 women who underwent laparoscopic insertion of an artificial sphincter over a 2 year period, 11 of whom had undergone previous procedures. After a variable period of activation ranging from 4 to 14 weeks, with a mean follow-up of 12.1 month (range 5.2 to 27 months) incontinence was cured in 88% of the women. Complications included the need for open conversion in 2 patients, 2 bladder injuries, 2 vaginal injuries with an overall complication rate of 25%.

Mandron, et al., (357) reported their experience with 25 patients undergoing laparoscopic AUS implantation over four years. No cases required open conversion and the authors reported only an intraoperative complication, of vaginal perforation. Five of the patients developed urinary retention which required re-catheterisation of less than 4 weeks. At a mean follow-up of 26.1 months, two patients failed due to vaginal erosion and required removal of the AUS. Overall, 23 patients reported continence, either total (19) or social (minimal pad use) (4).

Vayleux, et al., (358) reported an analysis of 215 women undergoing sphincter implantation over a 22 year period. 88% of women had undergone previous treatment for incontinence. 73.5% of the patients were considered continent (0 to 1 pad use) and 170 (79%) were satisfied at follow-up. The revision rate in this group was 15.3% after a mean interval of 8.47 years. 15 explantations (7% of total) were performed.

The major risk factor for intraoperative complications was a history of smoking (10.7%). Multivariate analysis revealed age to be the major risk factor for failure (odds ratio 2.46), which occurred in 23.7% of the subjects. In addition, pelvic radiotherapy was also associated with failure (4.37 odds ratio).

The largest long term analysis was published by Costa, et al. (359) Over a 20 year period, 376 devices were implanted in 344 women. At mean follow-up of 9.6 years, 85.6% of patients were fully continent (no incontinence), 8.8 were socially incontinent (occasional incontinence episode) and 5.6% were incontinent (defined as one pad or more incontinence). 3, 5 and 10 year device survival rates by Kaplan-Meier analysis were 92%, 88.6% and 69.2%. Mean mechanical survival time was 176 months (14.7 years). The authors identified three factors for AUS survival including number of previous incontinent procedures, presence of associated neurogenic disease, and simultaneous augmentation procedure.

Chung, et al., (360) reviewed 29 patients in whom AUS was implanted after failed anti-incontinence procedures. 5 (17%) of those patients required explantation of the device either due to erosion or infection. In addition, 13 revisions were performed with device malfunction accounting for 95% of those cases. Overall survival analysis revealed 90% malfunction of the device at less than 100 months from the time of implant. There was a significant decrease in pad use noted in the trials and overall continence rates (no pad use) were 70% in this study.

Other additional device modifications have included the use of a larger implanted cuff (greater than 8cm). Revaux, et al., (361) reported 50 women who underwent implantation with a large cuff device over a 23 year period, of whom 86% had undergone previous incontinence procedures. At a mean follow-up of eight years, 34 women had complete resolution of their incontinence (68%). Factors that were associated with device survivability included less than two pregnancies, urethral closure pressure higher than 19cm of H₂O and a cuff size equivalent to 8 cm.

Several consensus statements regarding use of the artificial urinary sphincter have been published. Chartier-Kastler, et al., (362) noted a higher risk of erosion and revision rates in women after multiple previous procedures. The authors concluded that the AUS should be implanted at high volume specialist centres with appropriate knowledge and experience in the management of complex cases of incontinence.

Richard, et al., (363) reported the recommendations of the committee in Women's Urology and Pelviperineology of the French Association of Urology. This guideline recommended avoidance of patients who had not had multiple prior procedures and where a well standardised technique performed by surgeons with regular experience and sufficiently long deactivation after implantation, long term monitoring as key aspects for device success.

Lovatsis, et al., (364) summarised the guidelines for the evaluation of treatment of urinary incontinence for the Society of Obstetricians and Gynaecologists of Canada. The authors concluded that the AUS was an option in patients with significantly decreased dexterity and mobility (recommendation of III-C).

Since the 5th Edition, there were five publications: two on long-term functional outcomes, two on robotic-assisted laparoscopic approach and the last on a retrospective comparison of robot-assisted and open approaches which would be summarised in this 6th Edition.

Phe, et al., (365) studied 34 women retrospectively with ISD who underwent an AUS between 1994 and 1992. Their median age at surgery was 56.5 (IQR 50-64.7) years and the median follow-up was 17 (IQR 12-19) years. The 10-, 15- & 20-year survival rates without explantation were 80, 80 & 74% respectively. The 10-, 15- & 20-year survival rate of the device without revision were 79, 65 & 40% respectively. After 20 years of follow-up, 11 (61%) women still had successful outcome.

Phe, et al.,(366) reported the long-term functional outcomes of AUS implantation in 26 female adult neurological patients suffering from ISD between 1984 and 2011. Their median age was 49.2 years (IQR 28.5–59.7) and at the end of the median follow-up time of 7.5 years (IQR 3.9–23.8), 15 patients (57.7%) still had their primary AUS. The AUS was explanted in five women because of infection or erosion. Survival rates, using Kaplan-Meier curves, without AUS explantation were 90%, 84%, 84%, and 74% at 5, 10, 15, 20 years, respectively. Survival rates without AUS revision were 75%, 51%, 51%, and 51% at 5, 10, 15, 20 years, respectively. 71.4% of patients with AUS were continent. When considering the 26 initial patients, including the patients in whom the AUS was explanted, the continence rate was 57.7%.

Fournier, et al., (367) reported the initial results of six women with ISD who underwent a robotic-assisted AUS implantation between 2012 and 2013. The mean age was 65 ± 9.6 years. Five patients had previous surgery for incontinence. The mean duration of follow-up was 14.3 months. A transperitoneal approach with a lateral positioning of the robotic arms was performed. The cuff implantation, positioning of the reservoir, and the pump were carried out similarly to the laparoscopic technique. Operative time, intraoperative occurrence of injuries of the bladder or vagina, postoperative complications, and continence (pad per day) were assessed. The robotic-assisted AUS implantation was feasible in all cases without intraoperative injury and 1 grade 1 postoperative complication. Mean operative time, postoperative bladder catheterisation, and hospitalisation time were 210 ± 32 minutes, 7 days, and 6 days, respectively. At the end of the follow-up, 83% of cases were fully continent.

Biardeau, et al., (368) reported the feasibility and short-term outcomes of a robot-assisted laparoscopic

approach for AUS implantation in 11 women with stress urinary incontinence. The authors reported successful AUS implantation in 8 of 11 patients (72.7%), with a complete continence rate of 87.5% (7 of 8 patients) after a mean follow-up of 17.6 (interquartile range 10.8-26) months. However the intraoperative complication was 36.4% (4 of 11, of which 2 each were bladder and vaginal injuries) and similar rate of post-operative complications (2 each of minor and major).

Peyronnet B, et al., (369) retrospectively compared the robot-assisted and open approaches of AUS implantation in 24 women with SUI. Twenty-four women were assessed: 16 in the open group and eight in the robot-assisted group. Three patients had neurogenic stress urinary incontinence. Most patients had undergone previous procedures for urinary incontinence (15 in the open group and seven in the robotic group). Mean operative time was similar in both groups (214 vs. 211 min; p=0.90). Postoperative complications rate was lower in the robot-assisted group (25 vs. 75 %; p=0.02). There was a trend toward a lower intraoperative complication rate (37.5 vs. 62.5 %; p=0.25), decreased blood loss (17 ml vs. 275 ml; p=0.22), and shorter length of stay (3.5 vs. 9.3 days; p=0.09) in the robot-assisted group. Continence rates were comparable in both groups (75 vs. 68.8 %; p=0.75). Three AUS explantations were needed in the open group (18.8 %) compared with one in the robot-assisted group (12.5 %; p=0.70).

Summary

There is a paucity of data regarding the use of AUS in women with SUI (EL=3)

Although short term efficacy of the AUS in females is satisfactory, durability in the long term is unproven (EL=3).

The procedure has a high rate of complications and surgical revision (EL=3).

Recommendations

AUS for female SUI should be limited only to highly selected individuals usually with recurrent SUI and only with appropriate counseling regarding the likely need for revision over time and the lack of long term RCT data (Grade C).

6. STEM CELL TECHNOLOGIES

The use of stem cell modalities for the treatment of urinary incontinence and bladder dysfunction has been proposed for more than a decade. (370-373) Basic and clinical science reports of stem cell use for the indication of PVS(SUI) or DO based incontinence (OAB) are extant and indicate potential utility for both of these indications. Varying types of stem cell populations have been utilised for these indications as delineated below. For purposes of this discussion, the literature and evidence will be surveyed for the indication of SUI in women only.

As a premise, stem cells are categorised by their differentiation capabilities. The term embryonic stem cell incorporates the concept of totipotentiality of the cells. (374) Adult stem cells, in contradistinction, are pluripotent and/or multipotent and cannot undergo differentiation into as many different cell types as embryonic cells. Generally, adult stem cells are specific for unique tissues based upon their derivation. Stem cells have been found in a variety of tissues. Cells from these unique sources are somewhat similar in phenotypic expression and cellular characteristics dependent on the cell source. Stem cells are thought to have local beneficial effects in host tissues including the ability to alter immune function, release paracrine factors and to be capable of proliferation. (375) Key surface inclusion (including CD73, and $\alpha\beta 1$ integrin), exclusion (such as CD45) and intracellular markers (for example vimentin and Pax 7) contribute to the unique local effects that these cells induce in host tissues. Vascular endothelial growth factor (VEGF) has been noted to promote host tissue incorporation of expanded stem cells. (376) Additionally exogenous materials such as microbeads (377) or calcium alginate gels (378), nanoparticles (379), or polyglycolic acid (380) have all been posited to benefit cell viability.

There are six common cell types that have been evaluated for the indication of female SUI inclusive of embryonic, muscle derived (satellite cells), bone marrow derived (381), mesenchymal, adipose, urinary and human umbilical cord blood types. Also human amniotic fluid stem cells (hAFSCs) have been proposed as an alternative source. (382, 383) Other potential stem cell sources do exist in the mammalian systems but have yet to be studied extensively for purposes of the indication of stress urinary incontinence. Pluripotent stem cells (PSC) have been proposed as a potential contributor of smooth and skeletal sphincter components. (384)

The actual mode of effectiveness of stem cell injection for urinary incontinence is as yet unspecified. There is some evidence of cell fusion into the host tissue, although this has not been definitively proven. There may also be benefits of stem cells by release of local factors which stimulate injured and uninjured host tissue to respond more effectively. Cytokines may actually upregulate the functional activity of normal cells. These include hepatocyte growth factor (HGF), insulin-like growth factor (IGF-1), IGF-2, and basic fibroblast growth factor (bFGF), transforming growth factor- β (TGF- β 1), and platelet derived growth factor (PDGF). (385) Actual cellular differentiation into different cell types is controversial as there is some evidence of stem cell differentiation into myoblast lines on the basis of studies done in cardiac smooth muscle. (382) Also, in the case of SUI, the injected volume of viable cells may produce a bulking effect similar to other biologic and synthetic agents but with durability conveyed by viable cell persistence.

After extraction, all stem cells are post treated by a process known as an expansion in which either as progenitor cells or by incubation in differentiation media, either smooth muscle cells or myoblasts (if from striated muscle) are derived which then further develop into multinucleated myofibers. (386) The route of administration of stem cells into the urethra has been performed by either transurethral or periurethral injection technique. There is also some recent evidence of improved deposition of cell load when an ultrasound aided injection technique is used. (387)

Most of the data that is extant in clinical trials are reported in small, uncontrolled, non-randomised settings.

6.1. Clinical Trials

Several of the stem cell concepts have resulted in clinical trials. In a pilot study, five patients were treated with ASCs combined with bovine collagen gel and saline. (388) Prior to the treatment, the ASCs were isolated from subcutaneous fat and expanded for three weeks followed by transurethral injection via cystoscope. Patients were followed-up at 3, 6, and 12 months after the injections. The primary objective and subjective endpoints were CST and validated questionnaires, respectively. After six months, one of five patients had a negative CST with 500 mL in the bladder. At one year, the CST was negative with three patients, two of whom were satisfied with the treatment and did not wish further treatment for SUI. Validated questionnaires showed some subjective improvement in all five patients.

A total of 20 and 15 women with uncomplicated and complicated SUI, respectively, received intraurethral injections of minced autologous skeletal muscle tissue and were followed for one year (389). Efficacy was assessed by the number of leakage episodes in a 3-day diary and by ICIQ-SF scores. Cure was defined as zero leaks in 3 days plus an ICIQ-SF score of 5 or less, while improvement was defined as simultaneous decreases in each outcome measure. Significant reductions were observed in each group in the mean number of leakages ($p < 0.01$) and in ICIQ-SF scores ($p < 0.001$). In the uncomplicated group, cure and improvement were observed in 25% and 63% of patients, and in the complicated group they were noted in 7% and 57%, respectively. No voiding dysfunction developed and only minor AEs were reported.

Autologous muscle derived cells have also been evaluated in a feasibility study for intrasphincteric injection (390). A total of 38 women in whom SUI had not improved with conservative therapy underwent intrasphincter injection of low doses (1, 2, 4, 8 or 16×10^6) or high doses (32, 64 or 128×10^6) of autologous muscle derived cells obtained from biopsies of their quadriceps femoris. All patients could elect a second treatment of the same dose after 3-month follow-up. Assessments were made at one, three, six, and 12 months after the last treatment. The primary end

point was the incidence and severity of AEs. In addition, changes in SUI severity were evaluated by pad test, incontinence diary, and QoL surveys. Of the 38 patients 33 completed the study. Treatment related complications were limited to minor events such as pain/bruising at the biopsy and injection sites. Of those patients who received two injections and were eligible for analysis, a higher percentage of those in the high dose vs. the low dose group experienced a 50% or greater reduction in pad weight (88.9%, 8 of 9 vs. 61.5%, 8 of 13), had a 50% or greater reduction in diary reported stress leaks (77.8%, 7 of 9 vs. 53.3%, 8 of 15) and had 0-1 leaks during a 3-day period (88.9%, 8 of 9 vs. 33.3%, 5 of 15) at final follow-up.

A 12-month safety and efficacy update was recently published (391). Pooled data from two phase I/II studies with identical patient selection criteria and outcome measures were analyzed. Patients received intrasphincter injection of 10 (16), 50 (16), 100 (24) or 200×10⁶ (24) autologous muscle derived cells for urinary sphincter repair. A total of 80 patients underwent injection and 72 completed diaries and pad tests at 12-month follow-up. As with the feasibility study, no AEs attributed to autologous muscle derived cells were reported. Likewise, higher dose groups tended to have greater percentages of patients with at least a 50% reduction in stress leaks and pad weight at 12-month follow-up. All dose groups had statistically significant improvement in UDI-6 and IIQ-7 scores compared to baseline.

Strangel-Wojcikiewicz et al recently reported two year follow up demonstrating safety and 50 % resolution of incontinence. (392)

Autologous myoblasts have also been injected into the external urethral sphincter under ultrasound-guidance followed by electrical stimulation (ES) as a possible 2-step treatment for SUI (393). Autologous myoblasts isolated from the biceps muscle were injected into the external urethral sphincter of 38 females followed by postoperative ES to enhance cell integration. The effects of the myoblast injections followed by an ES cycle were compared to those of a preoperative ES cycle undergone by the same patients. No serious AEs or complications were noted and the procedure was well tolerated. Compared with the objective and subjective measurements collected after the preoperative ES cycle, the corresponding measurements obtained after a second ES cycle six weeks postoperatively indicated considerable improvement. CST was negative for 29 (78.4%) of the patients and 5 (13.5%) and 29 (78.4%) considered their SUI cured and improved, respectively. Additional improvement or a plateau was observed at three and six months postoperatively, and was not negatively influenced by discontinuation of injection therapy(387). Of the patients, 23.7% considered their SUI cured and 52.6% reported improvement at six months, while 95% would recommend this treatment to others.

In 2013, Aref-Adib, assessed the current evidence for the use of stem cell therapy for stress urinary incontinence. Overall, they found eight studies that met inclusion criteria (7 observational and one randomised). The outcomes, as reported in these various trials varied from urodynamic to quality of life improvement outcomes. Additionally, there were limited radiographic assessments using urethral ultrasound done in the reported trials. Additionally, three studies noted increases in rhabdosphincter function and structure with two suggesting increases in the EMG activity. Unfortunately, these authors found the data to be somewhat limited due to lack of durability and inconsistent quality of reporting. Of the included articles, seven of eight used autologous mesoderm derived stem cells (MDSC) and one used umbilical cord derived stem cells. Follow-up in those trials ranged from 1.5 to 24 months and the trials included from 8 to 123 patients. Only one was randomized. Of note, complications were minimal. Interestingly, when done, urethral ultrasound revealed increase in sphincter thickness and contractility after stem cell injection. (394)

In the most recent assessment of the extant literature, Pokrywczynska et al again note inconsistencies in outcomes reporting and follow up. (395) They identified 16 articles which met inclusion criteria which included 383 female patients and noted that mean cure and improvement rates over a 12-month follow-up were 37.2 ± 29.7% and 33.1 ± 14.3% (of included patients). Cell types included; myoblasts, muscle-derived stem cells (MDSCs), and fibroblasts (most common). Less commonly, adipose-derived regenerative cells, cord blood stem cells and total nucleated cells (TNCs) and platelets were used. The number of cells used for the trials was noted to range between 0.6 million to 1020 million cells with some studies suggesting higher cell numbers to be associated with improved outcomes. (391)

In studies where only cells were implanted as compared to those where implantation together with a bulking agent (collagen or adipose) was performed, cure rates over 12-month follow-up was lower ($p < 0.001$) for the cell only patient (21.7 ± 8.9%) compared to the cell-bulking agent combination (60.8 ± 36%). No serious AEs or major complications were reported. The most common AEs were; exacerbation of incontinence, short term urinary retention, injection site pain, and urinary tract infection.(391)

Notably, a randomised Phase III regulatory trial evaluating muscle derived stem cells is in progress in North America currently.

6.2. Other Technology

A macro/nanogel composed of in situ forming gelatin-based macrogels and self-assembled heparin-based nanogels served as an injectable and bioactive bulking material for SUI (396). The hybrid hydrogels were prepared via enzymatic reaction in the presence of horseradish peroxidase and hydrogen peroxide. Incorporating a growth factor (GF)-loaded heparin

nanogel into a gelatin gel matrix enabled the hybrid gel matrix to release GF continuously up to 28 days. The hydrogel composites stimulated the regeneration of the urethral muscle tissue surrounding the urethral wall and promoted the recovery of their biological function when injected in vivo.

Plasmid DNA (pDNA; encoding for bFGF) complex-loaded poly(DL-lactic-co-glycolic acid) (PLGA)/Pluronic F127 mixture dispersed with polycaprolactone (PCL) microspheres was prepared as an injectable bioactive bulking (397). This thought was that this agent may provide bulking effect (via the PCL microspheres) and allow stimulation of the defective periurethral tissues around (via synthesis of bFGF from cells or tissues transfected by the pDNA complex). From in vitro experiments, the pDNA complex incorporated in the bulking agent was released in a sustained manner over 84 days ($\geq 80\%$ of the initial loading amount). The pDNA complex was effectively transfected into fibroblasts and the cells were continuously producing the target protein, bFGF. From the in vivo study using hairless mice and Sprague-Dawley rats, it was confirmed that the pDNA complex released from the bulking agent is transfected into surrounding cells/tissue, and the cells/tissues synthesised sufficient bFGF to regenerate smooth muscle with biological function around the urethra.

Summary

It is clear that the science of stem cell use for the indication of SUI continues to evolve. Current evidence is limited by a lack of comparator arms or other study design flaws. Additionally, the optimal cell type, injection method, and final administration characteristics for cell transfer (inclusive of volume of viable cells) remain areas for improvement and study.

Recommendation

The use of stem cell technology for the treatment of female SUI remains investigational, and such therapy should not be offered to individuals with primary or recurrent SUI except in the setting of clinical trials. (Grade D)

7. OTHER SURGERY FOR FEMALE SUI

7.1. Transurethral Radiofrequency Collagen Denaturation

Radiofrequency ablation (RFA) is a method of heating tissue that can cause tissue ablation and necrosis (higher temperatures) or denatured protein (lower temperatures, 65°C to 75°C)(398). In the treatment of female urinary incontinence low-level radiofrequency energy has been used for localized collagen denaturation of the BN and proximal urethra for the treatment of female stress urinary incontinence.

In 2005, Novasys Medical received US Food and Drug Administration (FDA) clearance to market transurethral radiofrequency collagen denaturation under the trade name *Recessa*® in the United States. More recently, the device used to perform this procedure has been marketed under the trade name *Lyrette*® by the Verathon Company (lyretterf.com)(399). Perceived or potential advantages of this procedure are that it can be done in the office setting with the patient under local anesthesia or intravenous sedation, without imaging, in less than one hour.

7.1.1 Mechanism of Action

The low levels of radiofrequency energy at 65°C are thought to create localised microscopic collagen denaturation sites within the BN and proximal urethra without creating strictures, fibrosis, significant tissue necrosis, gross shrinkage, or neurovascular injury. The denatured collagen results in reduced dynamic compliance of the surrounding untreated tissue(400).

In a preclinical porcine study employing transurethral RF, Valsalva leak point pressure was higher in the treatment group receiving 24 foci of RF energy at 65°C as compared to controls at 8 weeks ($P = 0.06$)(400).

7.1.2 Outcomes

The Cochrane review(401) included only one small sham-controlled randomized trial of 173 women with (402). In this study, 110 women underwent transurethral radiofrequency collagen denaturation in the treatment arm and 63 underwent sham treatment in the control arm. Mean participant age was 50 years (range 22 to 76 years), and mean duration of SUI was eight years (range one to 49 years). All participants were treated with the same type of radiofrequency probe (Novasys Medical, Inc., Newark, California) and one of two similar radiofrequency generators (Novasys Medical, Inc.; CuronMedical, Inc., Fremont, California).

In this study, 48% of the treatment arm subjects and 44% of the sham treatment arm subjects demonstrated ≥ 10 point I-QOL score improvement at 12 months ($P = 0.7$). However, in a subgroup analysis, 74 percent of women suffering from moderate to severe SUI experienced ≥ 10 point I-QOL score improvement at 12 months following RF micro-remodeling versus 50% of women who underwent sham treatment ($P = 0.03$).

The Cochrane review concluded that transurethral radiofrequency collagen denaturation was not associated with an increase in the number of women with an I-QOL score improvement greater than or equal to 10 points at 12 months when compared with sham treatment in an analysis of available data (RR 1.11, 95% CI 0.77 to 1.62; participants = 142). Therefore, the Cochrane review concluded that evidence is insufficient to show whether the procedure improves disease-specific quality of life. [EL=4] The Cochrane

review evaluation downgraded the quality of the evidence by two levels to low because of the high risk of bias and imprecision. Furthermore, the number of women reporting UI symptoms after intervention was not reported in this paper.

In a sub-analysis of this study, Leihan showed that Menopausal status and HRT demonstrated no impact on the quality of life improvement experienced by women with moderate-to-severe SUI who underwent RF tissue micro-remodeling(403).

Appell et al. also showed that women who underwent RF micro-remodeling demonstrated an increase in mean LPP at 12 months (13.2 ± 39.2 cmH₂O), while women who underwent sham treatment demonstrated a reduction in mean LPP at 12 months (-2.0 ± 33.8 cmH₂O), and the difference in mean LPP change between the two arms was statistically significant ($P = 0.02$).(402)

7.1.3 Long Term Results

A summary of prospective trials of transurethral radiofrequency collagen denaturation is presented in Table 1(403-409). An early 12-month study(404) examined the use of four different timing and placement methods for the delivery of radiofrequency energy. Cure rates ranged from 22% to 67%, with reductions in episode frequency from 67% to 89% of patients. The longest follow-up period described was 3 years(405, 406) Appell et al. reported that 56% of women who underwent radiofrequency collagen denaturation continued to report a 50% or greater reduction in SUI episode frequency(405).

In a single-armed original cohort study by Elser et al (407). , 45% of patients were considered dry, with 29% experiencing no leaks and 16% leaking less than 1 gram on a standardized in-office pad weight test. Additionally, 69% of women experienced a 50% or greater reduction in leakage, and 71% reported improvements on quality of life measures. A follow-up report from the same study revealed that 61.7% of evaluated patients continued to experience at least a 50% reduction in SUI leaks at 18 months(408) , and showed that mean I-QOL score improved 17 points from baseline ($P = .0004$), while mean UDI-6 score improved (decreased) 19 points ($P = .0005$) at 36 months(406).

7.1.4 Complications

Appel, et al showed that dysuria occurred in 9.1% of actively treated participants and in 1.6% of sham-treated participants (RR 5.73, 95% CI 0.75 to 43.70), and dry OAB was more common in the transurethral radiofrequency collagen denaturation arm (7.3% vs 3.2%), but this finding was not statistically significant(402). Urinary tract infection was observed to occur equally in both groups (4.5% vs 4.8%). However, the Cochrane review concluded that evidence is insufficient to show whether the procedure causes serious AEs or other AEs in comparison with sham treatment.

Summary

There is only one small sham-controlled randomized trial of transurethral radiofrequency collagen denaturation. [EL=2/3] Evidence is insufficient to show whether the procedure improves disease-specific quality of life. Evidence is also insufficient to show whether the procedure causes serious AEs or other AEs in comparison with sham treatment, and no evidence was found for comparison with any other method of treatment for UI. There is a need for further prospective randomized assessments of this treatment.

Recommendation

There is insufficient evidence to recommend this procedure as a treatment for female SUI (Grade D)

7.2. Transvaginal and Transurethral Laser Treatment

Non-invasive laser applications utilising applied cooling have been successfully exploited for skin resurfacing (thermal denaturation and shrinkage of collagen for tissue remodeling), hair removal, tattoo removal, and treatment of vascular birthmarks (410). Erbium:YAG ($\lambda=2.94$ mm) and CO₂ ($\lambda=10.6$ mm) skin resurfacing lasers have recently been applied in gynecology for sub-ablative resurfacing of atrophic vaginal tissue in post-menopausal women, and for treatment of female SUI. Short-term studies appear have been published for vaginal rejuvenation.

7.2.1 Mechanism of Action

Laser energy to achieve heat pulsing (i.e., temporarily increasing the temperature) of collagen is thought to improve collagen structure and initiate neocollagenesis. As a result of the temperature increase, intermolecular cross-links that stabilize collagen triple-helix structure are broken, which leads to the shrinkage of collagen fibrils and improvement in tissue firmness (411). Therefore, laser-mediated heat pulsing of the endopelvic fascia and pelvic floor tissue could represent an effective non-surgical method for treating female urinary incontinence and other disorders resulting from diminished pelvic floor support.

7.2.2 Outcomes

There are only a few original cohort studies with short-term results and there are no randomised control trials. Ogrinc et al (412) reported a prospective, single centre, non-randomised, pilot study of transvaginal Er:YAG laser treatment in 175 women with newly diagnosed SUI (66% of women) and MUI (34%). They used a 2940nm Er:YAG laser (SP Spectro, Fotona®, Slovenia) set in "smooth mode" (fluence 10.0 J/cm²; four pulses per packet, packet pulse duration is 250 ms; spot size 7mm; repetition rate 1.6 Hz) which enables non-ablative, thermal-only operation. At one-year-follow-up, Incontinence Severity Index decreased 2.6 ± 1.0 points in patients diagnosed with mild UI before the treatment, 3.6 ± 1.4 points in those with moderate UI, for 5.7 ± 1.8 points in those

with severe UI and 8.4 ± 2.6 in those with very severe UI ($P < 0.001$, paired samples t-test)[EL=4]. Fistonc et al (411) conducted a pilot clinical study recruiting 31 women with SUI. The procedure was performed with a 2940 nm Er:YAG laser (XS Dynamis, Fotona®, Slovenia), based on the pulsing sequence designed to achieve deep heating of the vaginal mucosa to around 60 °C. The International Consultation on Incontinence Questionnaire-Urinary Incontinence Short Form (ICIQ-UI SF) score was decreased on average by 6.3 points after 1 month, by 5.3 points after 2 months, and by 5.1 points 6 months after treatment[EL=4]. In this study, no serious AEs were observed or reported throughout the course of laser treatment and the follow-up period. All patients experienced a sensation of warmth or teasing during treatment. Most patients reported increased vaginal discharge in the next few days after the procedure and slight vulval oedema, which disappeared within 48 h after the treatment.

Summary

Evidence is insufficient to evaluate the efficacy and AEs.

There is a need for further prospective randomised assessments and long-term follow up data for this treatment. [EL=4].

Recommendation

There is insufficient evidence to recommend this procedure as a treatment for female SUI (Grade D)

7.3. Intravesical Pressure Attenuation Device

7.3.1 Mechanism of Action

The Vesair™ Device (Solace Therapeutics, Framingham, MA, USA) is an intravesical pressure attenuation device which is a novel approach to the treatment of female SUI. As opposed to treatments for SUI which are directed toward improving urethra/bladder outlet closure (slings, colposuspension, bulking agents, etc.), this intravesically placed balloon device works by attenuating intravesical/intraabdominal explosive forces without having a direct effect on the outlet.

After intravesical placement, the polyurethane balloon filled is filled with 15 or 30 ml of air with liquid perfluorocarbons sealing the balloon. Because gas is more compressible than water, the intravesical balloon floats near the dome of the bladder and attenuates the rapid intravesical pressure increases from rises in abdominal pressure to decrease SUI episodes.

7.3.2 Outcomes

The Vesair™ device has been studied in two prospective, single-blind, randomized, sham-controlled trials in North America¹ and Europe(413, 414).

The North American trial recruited 166 women with SUI in a 2:1 randomisation scheme for a 6 month trial with replacement of the balloon device every 90 days (413). This trial had a very high withdrawal rate (31%). The primary outcome variable was a reduction in one Stamey grade. This was not achieved in the intent to treat (ITT) population with only 28.6% of the women with the active device having a reduction of one Stamey grade at 6 months versus 22.2% in the sham arm ($p=0.455$). Data for Stamey grade reduction was significantly different between the cohorts in the per protocol (PP) analysis [40.9% of active device patients versus 22.4% of controls ($p=0.046$)]. A secondary composite outcome variable of a 50% reduction in pad weight and improvement in the patient impression of improvement scale was achieved by 50.8% of patients versus 16.3% of the controls ($p < 0.001$) in the ITT population. Three day voiding diaries showed a significant reduction in incontinence episode frequency in the device group from 4.4 to 2.5 episodes/day (43.2%) versus 5.4 to 4.1 episodes/day (24.1%) in the control group ($p < 0.001$).

However, the active device group had a very high rate of AEs complicating its usage with 88.4% having at least one AE. Most common were symptomatic UTIs in 29.5% in the device group versus 9.3% in the sham group. The women with devices in their bladders also had urgency and hypertonic bladder in 18.7%, hematuria in 17%, dysuria in 11.6%, pelvic pain in 10.7%, UUI in 8.9% and bladder pain in 8% versus <2% in controls. The balloon ruptured in 8% of women and was voided out. Eight percent withdrew from the trial because of discomfort with the device and 4% because of urinary tract infections.

The European trial (414) was somewhat similar to the North American trial with a modified thicker balloon that was inflated with 30 ml of air (instead of 15 ml) with assessments over only 3 months in a smaller cohort. A proprietary delivery instrument further protected the urethra during insertion and removal of the device. Participants were given prophylactic antibiotics during instrumentation to prevent UTIs. These modifications led to lower AE rates and study withdrawals. They recruited only 63 women with 41 randomised to receive the intravesical balloon and 22 were in the sham arm. The outcome variables were different from the North American trial with the composite outcome of a $\geq 50\%$ decrease in office pad testing and a ≥ 10 point increase in the incontinence quality of life survey (I-QOL) as the primary outcome and secondary outcomes of incontinence episode frequency and the patient global impression of improvement (PGII). Significant differences were found in the composite outcome with 63% of women in the active device group reaching this goal compared to only 31% in the sham group ($p=0.02$). Pad weight increases ≤ 1 gram on the office pad test (dryness) was found in 41.6% of the subjects with the intravesical balloon versus none in the control group ($p < 0.001$). The PGII improvement was significantly better in patients than controls ($p=0.025$). The overall AE rate was reduced to 44% but the trial was only 3 months

in length. The symptomatic UTI incidence was only 7.3% but hematuria was frequent in 9.8% and dysuria occurred in 14.6% of women in the intravesical balloon group. Ten of the 41 women (24%) withdrew from the 3 month study prematurely because of AEs.

Examination of some of the removed balloons microscopically and chemically showed deposition of calcium oxalate on the balloon surface in the 6 month study group but not in the 3 month study group.

Summary

Based on these data the Vesair™ intravesical balloon appears to be efficacious in a selected population at short term followup (LE=2). However, the frequently seen AEs and patient acceptability may limit its clinical utility.

Recommendation

There is insufficient evidence to recommend this procedure as a treatment for female SUI (Grade C)

II. SURGERY FOR NON-NEUROGENIC UUI

1. SACRAL NEUROSTIMULATION (SNS)

1.1. Sacral (Interstim®)

SNS was developed in the early 1980s by Tanagho and Schmidt.(415, 416) They demonstrated that continuous stimulation of the sacral root S3 with an electrode connected to an implanted pulse generator could modulate detrusor and sphincter activity and improve LPP.(417) InterStim® Therapy (Medtronic, Minneapolis, MN, USA) is licensed by the US Food and Drug Administration (FDA) for the treatment of urinary urge incontinence (UI) since 1997 and for urgency-frequency (UF) and chronic non-obstructive urinary retention (UR) since 1999. SNS is a potential treatment for other forms of bladder dysfunction and has been used for disorders such as chronic pelvic pain and interstitial cystitis as well as for faecal incontinence.(418-421)

The mechanism of action of SNS is not completely understood. The therapeutic benefits of SNS may arise from the effects of electrical stimulation on afferent and efferent nerve fibers connecting the pelvic viscera and the spinal interneurons to the central nervous system. Although it is referred to as a “restorative” therapy for patients with various voiding dysfunctions refractory to conservative measures, compelling evidence of permanent remodeling, reinnervation or alteration of pathways in the central or peripheral nervous systems in humans following successful therapy is lacking. SNS seems to predominantly in-

fluence sacral afferents and modulate spinal cord reflexes and brain centers involved in lower urinary tract function.(422-424)

Continual improvements in SNS have been introduced and it is now a minimally invasive technique. Briefly, an electrode is implanted in the S3 foramen and connected to an implantable pulse generator (IPG). The patient undergoes a test phase lasting for days to weeks to determine whether SNS has provided a relevant benefit. If the results of the test phase are positive, the IPG is implanted in the upper buttocks. The introduction of the tined-lead electrode enabled a less invasive percutaneous implantation that is associated with lesser migration rates.(425-427)

The test phase of SNS may also be performed by peripheral nerve evaluation (PNE) using a temporary electrode or by staged implantation of a permanent, tined-lead electrode. Because PNE may underestimate treatment effect and result in significant false-negative rates, most physicians utilise the staged implantation of a tined-lead for the first stage.(428-430)

1.2. Efficacy

1.2.1 SNS vs No Therapy

At the time of the last ICI review, outcomes of SNS for UI and UF were based on a small number of studies that randomized patients to active or delayed therapy as well as numerous prospective and retrospective case series. Schmidt and coworkers (1999) reported on SNS therapy in 76 patients with refractory UI from 16 centers worldwide randomized to active or delayed therapy (control group) during the study period of 6 months.(431) Daily incontinence episodes and use of pads/diapers were significantly reduced in the stimulation compared to the delay group. Of the 34 patients receiving active SNS therapy, 16 (47%) were completely dry and an additional 10 (29%) demonstrated more than 50% reduction in incontinence episodes. Patients returned to baseline levels of incontinence when stimulation was inactivated. Hassouna and colleagues (2000) reported the outcomes of SNS for refractory UF in 51 patients randomised from 12 centers during an initial 6-month period that was extended to 2 years.(432) Outcomes at 6 months in the active SNS group showed improvement in the number of daily voids (16.9 ± 9.7 to 9.3 ± 5.1), volume voided (118 ± 74 mL to 226 ± 124 mL), degree of urgency (rank score of 2.2 ± 0.6 to 1.6 ± 0.9), and SF-36 quality of life (QOL) measures. At 6 months after implantation, stimulators in the active group were turned off and urinary symptoms returned to baseline values. After reactivation of SNS, sustained efficacy was documented at 12 and 24 months.

A Cochrane review from 2009 (433) examined the evidence of the effects of SNS in the treatment of UI, UF and UR. Eight RCTs were considered eligible and were included in the analysis. At 6 months follow-up, SNS was found to be superior to no treatment for all indications with highly significant improvements in all

the outcomes measured (leakage episodes, number of voids, rating of urgency, pad usage, bladder capacity). Both the SF-36 mental and physical scales favoured the immediate implant group but the results were not statistically significantly different between the treatment and no treatment groups. The review concluded that SNS can be of benefit in selected patients with OAB and chronic non-obstructive UR. (Level of evidence 2)

1.2.2 SNS vs Medical Therapy:

The InSite trial is an ongoing two-phase study including a prospective, multi-centre, randomised clinical trial comparing SNS to standard medical therapy (SMT) consisting of anticholinergic medication for patients with refractory mild to moderate symptoms of OAB including urinary urge incontinence (UI) and/or urgency-frequency (UF), within a six-month follow-up period (430). The primary hypothesis of the randomised portion of the study was that SNS is superior to SMT in OAB patients for whom at least one medication had been tried, but other pharmacologic agents were still available. The second phase is a prospective long-term evaluation of the safety and efficacy of SNS, which was an FDA mandated requirement to evaluate the cumulative five year rate of AEs (AEs) including need for surgery, rates of infection and lead migration as well as therapeutic success and QOL. Investigators have published results for one (434) and three years (427) of follow-up. The primary outcome measure of the randomized phase of the study was OAB therapeutic success, which was determined using voiding diaries collected at the 6-month follow-up visit. Success was defined for patients with UI and UF as a $\geq 50\%$ improvement in average leaks/day or voids/day from baseline or a return to normal voiding frequency (<8 voids/day), respectively. Additional objectives were to compare QOL, impact on sexual function and depressive symptoms between groups using the ICI Modular Questionnaire (ICIQ)-OABqol, the ICIQ—Male/Female Lower Urinary Tract Symptoms-Sex, and the Beck Depression Inventory II. Overall, 147 subjects were randomised (70 to SNS and 77 to SMT); 93% were female and mean age was 58. Subjects randomised to SNS underwent a staged procedure using the InterStim requiring a 14-day test stimulation period. If successful test stimulation was demonstrated, the neurostimulator was implanted. Of the 70 subjects randomised to SNS, 59 underwent test stimulation and 51/59 (86%) received a full system implant. The primary intent to treat analysis showed OAB therapeutic success was significantly greater in the SNS group (61%) than in the SMT group (42%; $P = 0.02$). In the as treated analysis, OAB therapeutic success was 76% for SNS and 49% for SMT ($P = 0.002$). Complete continence was almost doubled in the SNS group (39% vs 21% in the SMT group; $P=0.06$) which also showed significant improvements in QOL versus the SMT group (all $P < 0.001$). SNS females had a greater improvement in sexual function and a greater improvement in depression compared to SMT. The device-related AE rate was 30.5% and the medication-related AE rate was

27.3%, none of which were serious. The most common device-related AE's in SNS subjects were undesirable change in stimulation in 10.2% (6/59), implant site pain 8.5% (5/59), lead migration/ dislodgment 3.4% (2/59), and implant site infection 3.4% (2/59). For the 51 SNS subjects with full system implant, the 6-month post-implant surgical intervention rate was 3.9% (2/51). The most common OAB medication-related events were constipation in 9.1%, drug toxicity in 6.5% and dry mouth in 5.2%. (Level of evidence 1)

1.2.3 SNS vs OnabotulinumtoxinA (BTX-A)

1.2.3.1 Efficacy

The use of BTX-A has been approved by the FDA for use in patients with refractory idiopathic OAB. SNS is more invasive but offers long-term efficacy whereas treatment with BTX-A injections is less invasive but needs to be repeated on a less than a year basis in order to provide sustained efficacy. Each treatment modality has its own range of possible AEs.

The ROSETTA Trial (Refractory OAB: Sacral Neuromodulation vs Botulinum Toxin Assessment) is an ongoing RCT comparing SNS versus intradetrusor injection of 200 U BTX in women with refractory OAB.(435) Results for 6 months follow-up were presented during the AUA Meeting in San Diego (May/2016). A total of 386 women were randomly assigned and 369 were treated, including 364 who were available for the primary outcome analyses. Mean age in the study cohort was approximately 63 years, and more than 80% of both treatment groups rated themselves as severely or very severely incontinent. In the SNS group, women underwent a two-stage procedure. The rate of clinical response — defined as a reduction of at least 50% in urgent urinary incontinence episodes on a 3-day bladder diary — was similar in the injection and neurostimulation groups (83% vs 84%). This was measured at 1 month in the injection group and during the test phase in the neurostimulation group.

In both the intention to treat and clinical responder, primary outcome analyses, the BTX group reported significantly greater mean reduction in daily UUI episodes per day compared to the neurostimulation group. In the intention-to-treat analysis at 6 months, the change in the mean number of daily incontinence episodes from baseline was -3.9 in the injection group and -3.3 episodes/day in the SNS group; $P = .01$.

More patients in the injection group than in the SNS group achieved complete symptom resolution at 6 months (20% vs 4%; $P < .0001$) and a reduction of at least 75% in episodes per day (46% vs 26%; $P = .0002$).

OAB symptom bother scores, measured with the OAB Questionnaire Short Form, were significantly better in both groups after treatment, but the change from baseline was greater in the injection group than in the SNS group (-46.71 vs -38.5 ; $P = .002$).

Treatment satisfaction was better in the injection group than in the neurostimulation group ($P = .01$), as was endorsement, assessed with the OAB Satisfaction of Treatment Questionnaire ($P = .0009$).

1.2.3.2 Adverse Events

At 6 months, the rate of urinary tract infection was higher in the injection group than in the neurostimulation group (35% vs 11%; $P < .0001$).

In addition, in the injection group, intermittent catheterisation was required by 8% of patients at 1 month, by 4% at 3 months, and by 2% at 6 months. In the neurostimulation group, 3% of patients required surgical revision or removal.

An important drawback of this study is the fact that it used a 200 U dose of onabotulinum toxin A but the FDA-approved dose is 100 U. Longer term follow-up will be necessary to better understand how these treatment modalities differ in the treatment of refractory OAB.

(Level of evidence 1)

The use of SNS in patients who discontinued BTX-A treatment has been evaluated by Smits et al, who reported on a group of 14 patients who had discontinued BTX-A treatment due to lack of efficacy (85%) or the desire for a more permanent treatment (15%).(436) At one year post-implant, 11 of 14 patients (79%) reported satisfaction with treatment.

(Level of evidence 4)

1.3. Testing procedure: PNE vs Staged

The application of the two-stage procedure using the permanent tined lead appears to be superior to the percutaneous PNE technique. (437), in a retrospective case control study, the authors examined urodynamic and clinical outcomes of the two different testing techniques and found that permanent quadripolar electrodes led to significant differences in the overall response rate (81.8% versus 47.6%) and urodynamic parameters (max detrusor pressure, bladder capacity) compared to the PNE. This has to be balanced against the cost implications (e.g. the permanent electrodes are several times the cost of the cheaper PNE wires) and invasiveness (e.g. the staged or tined lead approach requires 2 anesthetics: one for lead implantation, and if successful, a second anesthetic for IPG implant, whereas the PNE is done under local anesthesia). In a recent study (438) 41 of 76 (54%) patients who failed to respond to PNE were subsequently tested with the tined lead or staged procedure.. Of those, 18 (44%) were implanted with a neurostimulator after a successful response suggesting that the tined lead procedure is a more sensitive screening tool. At 53-month follow-up, 12 of these patients (67%) had a successful outcome, which was not statistically different from the success rate in patients with a positive response to an initial PNE test.

The response rate to PNE as compared to the 1st stage tined-lead placement test (FSTLP) was compared in a prospective single centre study.(428) One hundred patients with refractory idiopathic OAB or non-obstructive UR, screened with both PNE and FSTLP. The positive response rate on PNE was 47%. FSTLP showed a 69% positive response rate, which was negatively related to age. The 22% gain in positive response was statistically significant ($p < 0.001$) and positively associated with female gender and younger age. This study also suggests that the FSTLP may be a more sensitive screening method than PNE. (LE=2)

1.4. Use of Computed Tomography (CT) for Lead Placement

In an attempt to improve the efficacy and accuracy of neuromodulator lead placement into the S3 foramen, investigators have evaluated alternative imaging techniques as compared to fluoroscopic guidance. Amoroso et al used CT with the patient in the prone position to identify the location of S3 foramina and guide electrode placement.(439) Thirty patients underwent PNE under CT guidance. Electrode placement through the S3 foramen was successful at the first attempt in 36/38 attempts (8 patients had bilateral PNE test). Two cases required several attempts. In one patient who had a nonconsolidated sacral fracture, CT guidance enabled insertion of the electrode inside the only practicable foramen, which would probably not have been possible under fluoroscopic guidance. A positive response to the PNE was obtained in 18/30 patients (60%). The procedure lasted about 45 minutes. Other authors successfully used CT guidance for lead placement in small case series and recommend that it should be considered especially in patients with an altered anatomy in the sacral region.(440-443) (Level of evidence 4)

1.5. Unilateral vs Bilateral SNS

A retrospective study by Pham et al. (444) compared the success of the bilateral to unilateral neuromodulator lead placement in 124 patients undergoing screening for permanent placement of sacral neurostimulation. Fifty-five (44%) patients underwent unilateral stage I lead placement and 69 (56%) received bilateral S3 leads. Successful stage I trials were reported in 32/55 (58%) and 53/69 (76%) of unilateral and bilateral cohorts, respectively ($P = 0.03$). There was no difference in wound infection or other complications.

In a prospective randomised crossover trial, Scheepens et al investigated 33 patients who underwent bilateral implantation of a temporary test lead.(445) Patients were randomly assigned to start with bilateral or unilateral stimulation. Eight patients were excluded due to lead migration. Of the 25 patients included in the analysis, 12 patients had UI and 13 had urinary retention. A significant and comparable improvement of symptoms was seen during the test stimulation for both the bilateral and unilateral stimulation. Two patients with urinary retention only

started voiding to completion during bilateral stimulation. The authors concluded that bilateral is in general not superior to unilateral SNS but a few individuals may have improved results with bilateral stimulation.

A recent randomized single-blinded crossover study failed to demonstrate superior results with bilateral SNS compared to unilateral stimulation for faecal incontinence.(446)

(Level of evidence 2/3)

1.6. SNS and Different Programming Parameters

A crossover study evaluated the effect of three different stimulator settings on OAB symptoms and AEs.(447) Patients in this study had an SNS implant with a tined lead for at least three months prior to the start of the study. Twelve women were randomised to one of three rate-setting sequences: 5.2, 14, and 25 Hz. Each rate setting was tested for 1 week in every subject. Rate had a significant effect on the number of incontinent episodes ($P < 0.001$) and number of pad changes ($P = 0.039$) with more incontinent episodes in the 5.2-Hz setting compared to the 14- and 25-Hz settings ($P < 0.04$) for both measurements. The number of AEs was similar across the three rate settings with programming-related AEs lowest in the 14 Hz group.

Hoen et al evaluated the effect of intermittent SNS (iSNS) in OAB patients.(448) In this prospective cohort study, 19 women who had received a SNS implant for refractory UI for a minimum of 6 months, had their neurostimulator programmed to 8 hr "on" and 16 hr "off" per day, for 12 weeks. Prior to iSNS, data were collected during no SNS and continuous SNS (cSNS). Twelve (63%) patients showed an improvement of >50% of incontinence episodes during iSNS compared to pre-SNS, of which seven (37%) had an improvement of > 90%. iSNS was superior to pre-SNS in incontinence episodes/24 hr, voiding episodes/24 hr and voided volume. The UDI-6 and the IIQ-7 scores were also improved during iSNS compared to pre-SNS. No difference was demonstrated between iSNS and cSNS, indicating that iSNS could be a cost-effective alternative prolonging battery life of the IPG. (Level of evidence 3)

1.7. Long Term Results for OAB

The long-term results of SNS have been addressed by several case studies. It is important to highlight that most studies reporting on long term data refer to older SNS technology and it is possible that with the newer techniques used, efficacy and complication/re-intervention rates will improve.

De Groen et al (449) evaluated the long-term results of SNS in 60 patients with refractory UI. Patients were assessed prospectively at regular intervals for at least 5 years after implantation. The success rate gradually decreased from 52 patients (87%) at 1 month to 37 (62%) at 5 years. Complete continence persisted in 15% of patients. The analysis was extended to the 41

patients who passed the 10-year follow-up. At least 25 of these women (61%) were still on active SNS. The 10-year success rates did not appear to be different from the 5-year results suggesting that a deterioration of the results is observed during the first 5 years, which stabilised thereafter. A total of 57 AEs occurred in 32 (53%) patients, the majority of those being related to hardware failure and pain or discomfort at various sites. A total of 23 reoperations, including 2 explantations, were done in 15 patients (25%). Different long-term studies evaluated the same groups of OAB patients and reported that, at 5 years post-surgery, greater than 50% improvement was achieved by 68% of those with UI and 56% of those with UF (450-452).

A number of retrospective studies reported on the long term efficacy of SNS for different urological conditions. Peeters et al reported on 217 patients with a mean follow-up of 47 months.(453) The success and cure rates for UI were 70% and 20%, and for UF were 68% and 33%, respectively. In those with unsuccessful outcome, the mean time to failure was 24.6 months after implantation. At least one re-intervention was needed in 88 (41%) patients, most of which (47%) were performed within the first two years of follow up.

In the InSite study, an ongoing multicentre prospective study, authors evaluated the success rates of SNS at 12 (434) and 36 months (427). A total of 340 subjects went through test stimulation and 272 were implanted with SNS. Of these, 91% were female with a mean age of 57 years. UI subjects had an average of 3.1 leaks/day. The completers analysis included all subjects with diary data at baseline and 12 or 36 months and showed a sustainable effect of SNS through 36 months, with a mean reduction of 2.2 leaks/day after 12 months and 2.3 leaks/day after 36 months ($P < 0.0001$). Subjects showed significant improvements from baseline in all measures of ICIQ-OABqol and 80% reported improved changes in their urinary symptom interference at 12 and 36 months.

Device-related AE's occurred in 16% (56/340) of subjects during test stimulation, 30% (82/272) of subjects 12 months post-implant and 47% (127/272) after 36 months. The most frequent AE types reported were undesirable change in stimulation (49/272, 18%), implant site pain (34/272, 13%), and therapeutic product ineffective (16/272, 6%). Lead migrations were reported in 4% of subjects (12/272), with the majority occurring between 12 and 24 months post-implant. Implant site infections were reported in 4% of implanted subjects (10/272), with half reported between the implant procedure and 3 months post-implant. Surgical interventions related to the neurostimulator, lead, or chronic extension were experienced in 32% of subjects (86/272) after implant. The rate of device replacement was 20% (55/272) and device revision was 4% (11/272). Surgical interventions due to battery replacement occurred in 11% (29/272) of subjects, and 93% (27/29) of these neurostimulators were assessed to be within the expected longevity

ranges based on the set parameters of the device. In total, 13% (34/272) of subjects underwent permanent explant. The top reason for permanent explant was due to an AE (8%). Other reasons were lack and/or loss of efficacy in 3% (9/272), subject's need for magnetic resonance imaging and "other". (Level of evidence 2)

Although the medium/long-term clinical efficacy of SNS has been demonstrated by several case series, its impact on patient satisfaction and improvement of QOL has not been clearly defined bearing in mind that there are technical problems and adverse effects requiring constant medical attention and surgical revisions in a significant proportion of patients. Leong et al (454) examined the long-term satisfaction of patients with an implanted SNS for various medical indications such as OAB syndrome, non-obstructive UR, combined OAB and UR, and pelvic pain. Overall, 275 patients received a postal questionnaire regarding satisfaction and experiences with the system, such as side effects, complications, burden, impact on sexuality and defecation changes. The response rate was 75% (207 patients) with a median post-implantation period 77 months (range 12 to 214). The patient satisfaction rate was high at 90% and significantly related to the perceived clinical effect and 85% of all explanted cases (13 patients) were considered as failures. Satisfaction had no direct relationship with patient age, gender, duration of therapy or type of complaint for which SNS was offered, but was lower in patients with more than 1 pelvic floor comorbidity. The patient's attitude towards yearly follow-up and the ability to use the programmer was positively related to the degree of satisfaction. Overall 40% reported having some limitations or concerns with SNS such as exclusion from MRI and passing through metal detectors. Most patients perceived regular pain (56%) and discomfort (40%). (Level of evidence 3)

1.8. Effect of SNS on Sexual Function

The effect of SNS on female sexual function (FSF) has been investigated in a number of studies. Lombardi et al have recently reviewed nine studies that investigated the impact on sexual response when the aim of the SNS was to resolve urinary symptoms mainly due to OAB (seven studies) or fecal incontinence.(455) Most women included were of menopausal age. Three studies included sexually inactive women. Post-SNS follow-up varied from 3 to 36 months. Meta-analysis of efficacy results was not possible due to the heterogeneity of the sexual and pelvic dysfunctions. The most specific questionnaire assessing FSF was the Female Sexual Function Index (FSFI), which was used in six studies. During follow-up women showed statistically significant improvement in at least one FSFI domain compared to baseline. In one study significant improvement in the FSFI pain domain was exclusively detected in women with neurological disease. Two studies, however, using the questionnaire to screen for sexual dysfunction did not find any statistically significant differences after SNS. Authors concluded that available data were

still insufficient to definitely assert the positive effect of SNS on FSF.

In the InSite study, FSF was investigated as a secondary outcome measure. Women who underwent SNS had a greater improvement in sexual function based on the Female LUTS-sex questionnaire than those treated with SMT after 6, 12 and 36 months.(427, 430, 434) (Level of evidence 1-2)

1.9. Predictors of Outcomes

Authors have investigated a number of possible predictors of success for SNS in OAB patients, including age, severity of incontinence, obesity, prior medication use, previous spinal surgery, urodynamic findings and other.

Davis et al showed comparable success rates at the testing phase for patients who presented for SNS because of lack of medication efficacy versus intolerable medication side effects (70% and 71% respectively).(456)

Yazdany et al also reported on testing phase success in a group of patients with severe incontinence (mean 10.4 episodes/day); the authors note that patients with >10 incontinence episodes per day were more likely to have a successful stage I trial compared to those with less than 5 episodes/day.(457)

Levin (2012) reported on the impact of obesity on stage I success rates.(458) Of 149 patients, 80 (53.7%) were obese (BMI mean 37.3) and 69 (46.3%) were non-obese (BMI mean 25.6). The overall stage I success rate was 81% and the success rates for non-obese patients (83%) was comparable to rates for obese patients (78%).

Peters et al. evaluated the impact of age on the outcomes of SNS.(459) They analysed urologic diagnosis, rate of IPG placement, complications, and revisions from medical records of adults enrolled in a prospective observational study. Urge incontinence was predominant in the older groups and more patients <40 years had IC/PBS. A total of 266 patients had a sacral lead placed. In this group, the rate of IPG implant (89-90%) and explant (9.3-13%) did not vary between different age groups (<40 years, 40-64 and >=65) but there was a tendency for higher complication rates in younger patients (23% vs. 15% vs. 8.5%, respectively; P= 0.08). Angioli et al reported their results of SNS in patients older than 65 years (mean patient age 76 years).(460) At 12 months post-implant, 27.8% of patients reported improvement and 55.5% of patients reported complete success with cessation of UUI episodes. Overall, UUI episodes decreased from mean 6.3/day to mean 0.5/day. Incontinence episodes, frequency, nocturia, and number of pads used daily also significantly decreased. All subscales of the OAB-q were significantly improved.

Peters et al evaluated predictors of reoperation after SNS in a single centre retrospective study.(461) Of a total of 407 patients, 134 (33%) had at least one re-

operation over a median follow-up of 28.9 months, including 78/407 (19%) revisions and 56/407 (14%) explantations. The most common reason for reoperation was lack and/or loss of efficacy (65%). On multivariate analysis, only longer follow-up ($P = 0.0011$; OR 1.048; CI 1.019, 1.078) and having a complication ($P < 0.0001$; OR 23.2; CI 11.47, 46.75) were significant predictors of reoperations. (LE=3)

The role of urodynamics as a predictor of outcome for SNS has been evaluated by different authors. Groenendijk et al reported on 111 patients with UI undergoing permanent SNS after a successful PNE test of whom 67 had, and 44 did not have, DO on urodynamics. (462) Both groups improved bladder volumes at first sensation of filling and at maximum fill volume compared with baseline. Resolution of DO post treatment occurred in 51% of patients, however the success in those patients was not significantly different from those with persistent DO. Interestingly patients with UI and no DO had a higher rate of clinical success (73%) than those with UI and DO (61%), although this did not reach statistical significance.

South et al had similar results evaluating 104 patients with refractory UI who underwent SNS test stimulation and compared responders to the test stimulation and non-responders. (463) There was no relationship between the presence or absence of DO and the likelihood for test stimulation success.

Drossaerts et al. explored the predictive role of conventional and ambulatory urodynamics for SNS outcome. (464) Over a period of more than ten years, 98 patients who performed conventional and ambulatory urodynamics and underwent SNS test were evaluated. They found similar success rates for SNS in patients with storage dysfunction according to either conventional-UDS or ambulatory-UDS. However, conventional-UDS overestimated the amount of patients diagnosed with hypocontractile or acontractile bladder, for whom SNS success rates were 67 % and 35 %, respectively. According to ambulatory-UDS diagnosis, success rates for patients with reduced bladder contractility were much lower, with 32 and 17 %, respectively for hypocontractile and acontractile bladder. (LE= 3)

1.10. Magnetic Resonance Imaging (MRI) Recommendations

MRI is a relative contraindication for patients who may be considering or who have an implantable electrical stimulation device. Magnetic fields produce currents in neuroelectrodes and heating of the leads has been demonstrated in vivo and in vitro. (465, 466) Whereas the clinical significance of the small temperature changes observed in the leads is questionable, the potential exists to produce nerve damage, and the magnetic field may change the generator itself. (467) There is limited evidence that MRI may be performed with no harm to the patient based on few case reports or small case series that have reported on the use of MRI under very specific conditions. (468, 469)

For patients who have InterStim devices in place, current manufacturer recommendations advocate removal of the device in preparation for elective MRI. (470) The only exception are patients who received the new models of Interstim II, who may be eligible to have MRI examinations of the head only. However, the manufacturer indicates that it must be performed under specific conditions. Before ordering a head MRI for a patient with a SNS system, it is important to certify his eligibility with the manufacturer support team or review the MRI Guideline for the Interstim Neuromodulation Systems. (Level of evidence 5)

1.11. Pregnancy

Electrical stimulation has the potential to induce teratogenicity or abortion and SNS has been considered contraindicated in pregnant women. However, whether electrical stimulation can cause abortion or malformation is not known. Wang and Hassouna (471) reported no adverse effects of electrical stimulation on pregnant rats. They counseled that termination of pregnancy is not advised for prospective mothers when electrical stimulation has been performed unknowingly in early pregnancy. Women with electrical stimulation devices for pelvic health conditions who become pregnant should turn off their devices during pregnancy. (Level of evidence 5)

1.12. Neurostimulation with Pudendal Nerve stimulation

Neurostimulation techniques other than SNS have been used for the treatment of different urological conditions with varying techniques and results.

Pudendal nerve efferent activation directed toward the urethral sphincter is an important mechanism for the control of bladder contractions. In addition, many of the sensory afferent nerve fibers contained in the sacral spinal nerves originate in the pudendal nerve. Thus, the pudendal nerve fibers are important targets for neuromodulating the inhibitory reflex on the micturition reflex. (472-476)

Pudendal nerve stimulation has been used with different techniques to treat numerous pelvic floor function impairments such as urinary and/or fecal incontinence, urinary retention and constipation. Spinelli and associates (477) modified existing SNS technology and adapted it to pudendal nerve stimulation. They performed a staged procedure similar to that of sacral neurostimulation (SNS) to place tined leads near the pudendal nerve, using neurophysiological guidance that allowed accurate pudendal nerve stimulation through either a perineal or posterior approach. Few trials using pudendal neurostimulation have been reported for patients with neurogenic voiding dysfunction (477), interstitial cystitis (478) and non neurogenic voiding dysfunction (479). Despite the good results reported, studies are based on small patient samples with short term follow up. (Level of evidence 3/4)

Summary

There is limited evidence for long term efficacy for SNS beyond 12-36 months.(LE = 2)

Maintenance of therapeutic effect requires reprogramming and surgical revision rate in a substantial number of patients. (LE= 2)

Preoperative predictors of optimal patient response to this invasive therapy remain unclear except for a positive response to PNE or staged implant (LE=2)

Recommendations

SNS is an effective therapy for selected individuals with urgency/frequency and UUI refractory to behavioural therapy and oral medications (Grade B).

Patients should be counseled regarding the potential for AEs, need for long term monitoring and intervention/adjustment of the implant, and additional surgeries to maintain favourable therapeutic effects. (Grade B)

2. PERCUTANEOUS TIBIAL NERVE STIMULATION (PTNS)

2.1. Mechanism of Action

The exact mechanism of action of PTNS on bladder function is unclear but it is thought to be mediated through the retrograde stimulation of the sacral nerve plexus. The posterior tibial nerve is a peripheral nerve with mixed sensory and motor fibers. It originates from spinal roots L4 through S3, which also contribute directly to sensory and motor control of the urinary bladder and pelvic floor. Current literature suggests that a plastic reorganisation of the cortical network triggered by peripheral neurostimulation could be a mechanism of action of PTNS.(480)

Based on translational findings of the traditional Chinese practice of using acupuncture points over the common peroneal or posterior tibial nerve to inhibit bladder activity, McGuire and associates (1983) used transcutaneous stimulation of the common peroneal or posterior tibial nerve for inhibition of DO.(481) PTNS (Urgent PC, Cogentix Medical) as approved by the FDA currently consists of weekly 30-minute stimulation treatments provided by insertion of a small-gauge stimulating needle approximately 5 cm cephalad from the medial malleolus and just posterior to the margin of the tibia with the grounding electrode pad placed on the medial surface of the calcaneus. Treatment usually consists of 12 weekly PTNS sessions followed by additional maintenance sessions.(482)

2.2. Efficacy

Recent studies have shown, with level of evidence I, that PTNS can effectively improve OAB symptoms (frequency, urgency, nocturia, and incontinence) and quality of life with no serious AEs in patients with refractory OAB. The 2015 AUA/SUFU Guideline

Amendment for Diagnosis and Treatment of OAB (Non-Neurogenic) in Adults (483) recommends PTNS as a 3rd line treatment option for refractory OAB.

2.2.1 PTNS vs Placebo (Sham Device)

Peters et al in a multicentre, double-blind, RCT (SUMiT trial) compared the efficacy of PTNS to sham through 12 weeks of therapy.(484) A total of 220 adults with OAB were randomized 1:1 to 12 weeks of treatment with weekly PTNS or sham therapy. In the sham group, a Streitberger placebo needle was used to simulate the location and sensation of PTNS needle electrode insertion. In addition, two active TENS surface electrodes were placed and sham stimulation was performed. Patients were evaluated by OAB and QoL questionnaires as well as 3-day voiding diaries before treatment and at week 13. At 13 weeks follow-up there was moderate or marked improvement in overall bladder symptoms in 54.5%(60/110) and 20.9% (23/110) of subjects respectively (p<0.001). All individual symptoms such as frequency, nighttime voids, voids with moderate to severe urgency and UUI episodes were significantly improved from baseline to 13 weeks for the PTNS group compared to the sham group. This was also confirmed on voiding diaries. There were no serious AEs, with 4% (5/110) reporting bleeding and discomfort at the needle site, one case of ankle bruising, and one with leg tingling.

In a double-blind RCT, Finazzi-Agro et al randomised 35 patients that did not respond to anticholinergics into PTNS or a control group.(485) The control group (17 patients) received an original placebo treatment using a 34 gauge needle placed in the medial part of the gastrocnemius muscle and stimulated for 30 seconds. Patients were considered to be responders if they had a reduction in UI episodes greater than 50%. After 12 weeks of weekly treatments, 71% (12/17) in the PTNS group and 0% (0/12) in the placebo group were considered responders (p < 0.001). The number of UI episodes and voids, voided volume, and I-QoL score significantly improved only in the PTNS group. (Level of evidence 2/3)

2.2.2 PTNS vs Antimuscarinics

A multicentre RCT showed comparable efficacy of PTNS to medical treatment (OrBIT trial).(486) A total of 100 adults with OAB (urinary frequency > 8 times/day) were randomized 1:1 to 12 weeks of treatment with weekly PTNS or to 4 mg daily extended-release tolterodine. Voiding diaries and an OAB questionnaire were completed at baseline and at the end of therapy. Global response assessments (GRA) were completed by subjects and investigators after 12 weeks of therapy. At 12 weeks, 79.5% (35/44) of the PTNS and 54.8% (23/42) of the tolterodine patients considered themselves to be cured or improved (p=0.01). Urinary frequency, UI episodes, urgency severity, nighttime voids, voided volume and QoL improved significantly in both groups.

A long-term follow-up of the OrBIT Trial evaluated the durability of PTNS benefits.(487) Patients who were randomised to weekly PTNS in the OrBIT trial were offered an additional 9 months of treatment with assessments at 6 and 12 months from baseline. A total of 33 PTNS responders continued therapy with 32 and 25 subjects completing 6 and 12 months of therapy, respectively. Subjects received a mean of 12.1 treatments at various intervals during an average of 263 days, with a mean of 21 days (median 17) between treatments. Sustained improvement was shown with 94% (30/32) of patients continuing periodic treatment considering themselves to be cured or improved at 6 months and 96% (24/25) at 12 months follow-up. OAB questionnaire symptom severity was significantly improved from 12 weeks to 12 months as well as from 6 to 12 months (both $p < 0.01$). No serious AEs were reported. (LE= 2)

In a recent RCT, Preyer et al randomised 36 patients with OAB to 3 months treatment with PTNS weekly or tolterodine 2mg twice a day.(488) Micturition frequency did not decline significantly in either group. QoL scores showed improvement over time compared to baseline measurements but no significant differences between treatment groups ($p=0.07$). UI episodes/day significantly declined during therapy in both groups comparably ($p=0.89$). PTNS had fewer side effects than tolterodine ($p=0.04$).

In a randomised controlled crossover study, Vecchioni-Scaldazza et al divided 40 women in two groups – A) 20 patients received solifenacin succinate (SS) 5mg/day for 40 days, then went on a 3 month wash-out period followed by PTNS (twice a week for 30 minutes for a total of 6 weeks); B) 20 patients received PTNS, then went on a 3 month washout period followed by the same SS therapy.(489) Micturition diary, OAB Questionnaire Short Form and Patient Perception of Intensity of Urgency Scale were used to assess patients and were completed before and after each treatment. A reduction in the number of daily micturitions, episodes of nocturia and urge incontinence were found with both SS and PTNS in all groups, but PTNS showed greater effectiveness than SS. PTNS also showed a greater effect in patient perception of urgency and QoL. (Level of evidence 2)

2.2.3 Systematic Reviews and Meta-Analyses

Six systematic reviews (490-495) of which two provided meta-analysis (494, 495) concluded PTNS improves OAB symptoms with success rates varying from 37% to 100%. Definition of success was variable across studies. Overall, these reviews showed that PTNS is better than sham procedures or placebo with minimal AEs (painful sensation during procedure without interfering with it and minor bleeding at insertion site) and comparable to antimuscarinics.

Burton et al in a meta-analysis of four RCTs where PTNS was compared to placebo demonstrated that all studies favour PTNS over sham procedures, with overall risk ratio of 7.02 (95% CI of 1.69–29.17).(494) PTNS treated patients were seven times more likely

to be successful in treatment when compared to placebo treated patients. Compared to antimuscarinic treatment, PTNS showed comparable efficacy results. Wibisono et al also provided a meta-analysis with similar results, based on four RCTs comparing PTNS to sham procedures.(495) When PTNS was compared to antimuscarinics both groups showed significant reduction of symptoms with no significant difference. (Level of evidence 1)

2.2.4 Functional assessment

Musco et al in an observational prospective study assessed female sexual dysfunction (FSD) in patients with dry OAB.(498) They completed the FSFI to assess sexuality, the OAB short-form questionnaire and a 24-hour bladder diary at baseline and at the end of the PTNS treatment, 3 months later. Twenty-one women were considered to have FSD. FSFI domains showed significant improvement in FSD symptoms. Women without FSD at baseline also reported statistically significant improvement in their sexual function based on FSFI scores. (LE=3)

2.3. Long Term Data / Maintenance Therapy

Peters et al reported outcomes in patients that met the primary effectiveness end point of the SUmIT trial and were willing to enroll in a 36 month protocol, the STEP (Sustained Therapeutic Effects of Percutaneous Tibial Nerve Stimulation) Study.(482) A total of 29 patients completed the 36 month protocol receiving a median of 1.1 treatments/month. At 3 years, 77% (95% CI 64-90) of patients maintained moderate or marked improvement in OAB symptoms. Median voids/day decreased from 12.0 to 8.7, nighttime voids decreased from 2.7 to 1.7 and UI episodes/day decreased from 3.3 to 0.3 (all $p < 0.0001$), when compared to baseline numbers. All QoL parameters improved when compared to baseline through all 3 years (all $p < 0.0001$). No serious AEs were reported.

Yoong et al (496) reported a long-term (2 years) follow-up of 23 women from a previous study (497) who had a positive response to PTNS treatment. Patients in this follow-up study were instructed to contact the hospital to undergo maintenance PTNS treatment whenever they felt it was required. At 2 years from the beginning of the treatment, patients were assessed with diaries and the IIQ-7 and were compared to baseline and initial response to treatment at 6 weeks. Urinary frequency, UI, nocturia, pad use, and IIQ-7 scores were comparable to those recorded after initial responses to treatment at 6 weeks. Patients received a median of 8.4 treatments/year and median time between treatments was 64.3 days. Only one patient reported hypoaesthesia in the toe lasting 4 months. (LE=2)

Summary

PTNS shows efficacy in the treatment of OAB with no serious AEs in the short/mid term (LE=2)

There is limited evidence for long term efficacy.(LE = 2)

PTNS is superior to no therapy/sham, and at least as effective as drug. (LE=2)

Recommendations

PTNS is an effective therapy for selected individuals with refractory OAB who are willing to comply with the PTNS protocol in the short/mid term. (Grade B)

Patients should be counselled regarding the need for frequent office visits during the initial treatment phase as well as the likelihood in needing maintenance treatments, and the lack of long term data as a stand-alone treatment and vs. other therapies. (Grade B).

3. AUGMENTATION (ENLARGEMENT) CYSTOPLASTY

Augmentation cystoplasty (AC), has been used for many years with varying degrees of success for refractory DO and related incontinence.

3.1. Enterocystoplasty

Enterocystoplasty is the main form of AC and involves a segment of the bowel that is removed from continuity with the fecal stream, detubularised, and patched into the bisected bladder. This method increases bladder capacity and decreases bladder pressure caused by uninhibited detrusor contractions. Virtually any portion of the GI tract can be utilised for enterocystoplasty, and each segment has its own unique favourable properties as well as inherent complications.(499-503)

Other than idiopathic OAB, indications for enterocystoplasty include mainly small capacity bladders due to fibrosis, tuberculosis, radiation, chronic infection or neurogenic DO (NDO).(500, 501, 504, 505) AC has been used as a last resort in cases of refractory OAB. With the introduction of third line therapies such as SNS and the intradetrusor injection BTX-A, there has been a dramatic decline in the use of AC and only one addition to the literature for idiopathic OAB since the publication of the 5th International Consultation on Incontinence (see below).

3.1.1 Efficacy and safety:

At present there is no RCT published to compare the efficacy and safety of AC with other methods. The 2015 AUA/SUFU Guideline Amendment for Diagnosis and Treatment of OAB (Non-Neurogenic) in Adults recommend that AC should only be considered in extremely rare cases. (483)

In a recent study, El-Azab et al (506) compared patient satisfaction with AC versus intradetrusor injection of BTX. A total of 31 patients were allocated to each treatment group based on personal preference, including 16 for BTX (nine men and 7 women) and 15 for AC (four men and eleven women). In a short-term follow-up of six months, significant improvements in LUTS and QoL were observed after both treatments

based on the UDI-6, IIQ-7 and OAB-Sat questionnaires. Improvements in symptoms and QoL were greater in patients who underwent AC. Those undergoing AC had worse scores in the UDI-6 question regarding difficulty for voiding (1.7 vs 0.81 for the BTX group; $p=0.004$). Four (26.7%) patients required CIC after AC and two in the BTX group. The need for repeat treatments to maintain symptom control was the primary reason for dissatisfaction in those who received BTX. (LE= 4)

Apart from the inherent risks of open, laparoscopic or robotic abdominal surgery associated with bowel and bladder anastomoses, AC carries several distinct long-term risks. The risks of this surgery include kidney or bladder infections, new-onset recurrent UTIs, metabolic derangements, mucus production, and, in rare cases, bladder tumours.(507, 508) As a segment of bowel is used for AC, the available absorptive surface area of the bowel is reduced, and the incorporation of bowel segments into the urinary tract may have metabolic consequences.(509) Hyperchloraemic metabolic acidosis can occur if ileal and/or colon segments are used, as well as malabsorption of vitamin B12 and bile acid after the use of ileal segments. Blackburn et al demonstrated a reduction in serum B12 level with time following ileocystoplasty in 44% of their patients at 7-year follow-up and recommended that these patients should have their B12 levels measured in the long term.(510)

There has been concern about the incidence of secondary malignancies that may develop as a long-term consequence of bladder augmentation. The carcinogenesis pathway is still not clearly understood but several factors are involved. In a recent study, Biard-eau et al systematically reviewed the evidence regarding the risk of malignancy after AC. The probability to develop a malignant tumour after AC ranged from 0 to 5.5% and the estimated incidence ranged from 0 to 272.3 per 100,000 patients/year. Adenocarcinoma was the commonest (51.6%) histological type. Malignant lesions predominantly occurred at the entero-urinary anastomosis (50%). The mean latency period was 19 years and most tumours were diagnosed more than 10 years after AC (90%). Long-term surveillance by cystoscopy is still controversial because of its lack of efficiency. Tumours were often diagnosed at an advanced stage within surveillance protocols, because of urinary tract related symptoms (64.1%). The authors recommended that studies regarding carcinogenesis and surveillance strategies should be performed to develop a more efficient follow-up protocol and allow early diagnosis. The authors cautioned that the level of evidence of the studies was usually poor and results should be interpreted with caution. (LE=4)

3.1.2 Other Evidence:

The conclusions of recent reviews on the role of AC indicate that the overwhelming predominance of literature is dedicated to AC in patients with a neurogenic bladder.(503, 511) The few reports in the literature

that have examined the results of AC in adults with idiopathic OAB are case series (LOE=4). Since the publication of the 5th International Consultation on Incontinence, there has been only one addition to the AC literature for iOAB. The studies differ in several ways. Most include both males and females, and some include patients with NDO. Additionally, length of follow-up differs widely and success definitions may be different and inconsistently reported. Outcome measures have included mostly non-validated questionnaires and subjective patient assessments. Furthermore, continence rates must also be considered with caution, since many procedures are combined with bladder outlet surgeries.

Several variations on the standard AC have been described, most of which were applied to children or adult patients with neurogenic DO or contracted bladders. These include novel bowel options such as urothelium lined seromuscular colocolostomy and an appendicular-based caecal flap (512-514). Techniques using robotic assisted laparoscopic surgery (RALS) and laparoendoscopic single site (LESS) procedures have also been introduced and have further added to the surgical options for AC.(515-519) While the initial results are encouraging, long-term outcomes are uniformly absent. Overall, due to its invasive nature and potential for long-term adverse effects, AC is considered to be one of the last choices of treatment in refractory IDO cases.(483)

Summary

There have been no randomised controlled trials, double blind or sham-controlled trials or long-term cohort studies which have examined the effects of enterocystoplasty for the treatment of idiopathic OAB. (LE=4)

Recommendations

Enterocystoplasty for idiopathic OAB should only be considered in rare cases where other therapies have been deemed unsuccessful or are not applicable. (GRADE D)

Patients undergoing enterocystoplasty should be counselled regarding the potential life altering changes postoperatively (e.g. need for self catheterisation, etc.) and the need for long term follow-up. (GRADE D)

3.2. Autoaugmentation

Initially described by Cartwright and Snow, auto augmentation of the bladder was developed as an alternative option to AC, especially in children with neurogenic DO.(520, 521) Auto augmentation may be performed by incision (detrusor myotomy) or excision (detrusor myectomy) of a portion of the detrusor muscle and may also be named as vesicomatomy (522) or detrusorectomy (523). Either technique aims to create an iatrogenic bladder mucosal “bulge” or pseudodiverticulum and an increase in the storage capacity of the bladder with a concomitant decrease in stor-

age pressures. The advantages of detrusor auto augmentation over enterocystoplasty is the avoidance of complications related to the use of bowel in the urinary tract including malignancy, mucous formation, stones, surgical morbidity related to opening and re-anastomosis of the GI tract, and metabolic acidosis.(505, 524, 525)

3.2.1 Evidence

There have been no randomised controlled trials, double blind trials or cohort studies which have examined the effects of auto-augmentation as a treatment for non-neurogenic DO incontinence.

There are few studies on auto-augmentation in the adult non-neurogenic population and there have been no additions to the literature since the publication of the 5th International Consultation on Incontinence.

One small study of 5 patients with urgency incontinence showed promising results in all patients at the initial postoperative visit, but clinical deterioration and failure occurred in 4 of the 5 patients at three months follow-up.(522) Mean bladder capacity increased but mean volume to first involuntary bladder contraction decreased. Four of the 5 patients continued to have involuntary bladder contractions on cystometry. One additional retrospective study including 61 patients with NDO and IDO compared detrusor myectomy to AC.(526) Comparable clinical success was reported for the two procedures; however, there was a 22% incidence of serious complications in the 27 patients undergoing AC, compared to only 3% of the 33 patients undergoing detrusor myectomy. (LE= 4)

In an attempt to improve long-term outcomes with this procedure and create a biological “backing” and blood supply for the pseudodiverticulum, a number of variations of this procedure have been described. These variations have included the use of demucosalised bowel segments, stomach, peritoneum and rectus abdominis muscle.(524, 527-531) Additionally, the use of an inflatable balloon placed in the bladder for 2 weeks after auto-augmentation improved long-term capacity and compliance.(532) Long-term follow-up demonstrating favourable clinical results with these variations is lacking. This technique is no longer considered as an option for surgical management of DO.

Summary

There have been no randomised controlled trials, double blind or sham-controlled trials or long-term cohort studies which have examined the efficacy and safety of autoaugmentation for the treatment of adult idiopathic OAB. (LE=4)

Recommendation

Autoaugmentation is not recommended as a therapy for adult idiopathic OAB.

(GRADE D)

III. URETHRAL DIVERTICULA

Urethral diverticulum (UD) is an outpouching of the urethral lumen into the surrounding periurethral connective tissue. This is a relatively rare condition with an annual incidence of 17.9/1,000,000 in a recent study(533). UD are thought to arise from repeated obstruction, infection and subsequent rupture of periurethral glands into the urethral lumen, resulting in an epithelialised cavity that communicates with the urethra(534, 535). Iatrogenic damage to the urethra may also play a role, as up to 20% of women with urethral diverticula are noted to have a history of prior urethral surgery, dilation, or traumatic delivery(534, 536). Iatrogenic UD formation associated with MUS has also been reported(537-539).

1. UD AND URINARY INCONTINENCE

Although the presentation of UD is often non-specific and variable, these lesions can be associated with voiding dysfunction and urinary incontinence. One recent series reported stress urinary incontinence (SUI) occurring in 60% of patients with UD(540). Other presentations include vaginal mass, irritative LPP, and recurrent urinary tract infections(540, 541). Up to 20% of patients lack symptoms, with UD being an incidental finding on imaging.

A UD is most often located at the level of the midurethra. This location often overlaps with the external sphincter, however UD may also extend proximally toward the BN in the vicinity of the proximal sphincter mechanism. This morphology may, in part, explain the association between UD and SUI in some individuals with potentially more proximal lesions at risk for postoperative SUI (542). Alternatively, some patients may have pre-existing SUI unrelated to the UD, or may simply have post-void dribbling and paradoxical incontinence due to urine accumulation in the UD during normal voiding with subsequent discharge of the accumulated urine in the UD out through the urethral meatus upon movement.

UD may also be associated with bladder outlet obstruction due to the mass effect of the UD, urinary retention, or irritative LPP including urgency and urgency incontinence (543). Pain and dysuria associated with UD may also result in acquired voiding dysfunction.

Surgical treatment of UD may also be associated with urinary incontinence. Although resolution of UI may occur following surgical excision UD, either as a result of elimination of post-void dribbling/paradoxical incontinence, reconstruction of a damaged sphincter mechanism during UD repair, or concomitant anti-incontinence surgery (e.g. sling), de novo UI may also occur. Certain features seen on preoperative imaging may predict for recurrence of UD postoperatively or postoperative complications such as de novo or

persistent SUI. Risk factors for de novo SUI may include the size of the diverticulum (>30 mm), more proximal location (542, 544), and wide excision (544). Another important cause of UI postoperatively from urethral diverticulectomy surgery is iatrogenic urethrovaginal fistula, which may occur in up to 6% of cases (534, 536, 541, 542, 544, 545).

2. PREOPERATIVE ASSESSMENT INCLUDING URODYNAMICS

Careful history, physical examination, and appropriate diagnostic studies are often pursued in the evaluation of the suspected UD. Cystourethroscopy will most commonly reveal the ostia of the UD in the dorsolateral midurethral segment. Imaging modalities including ultrasound, voiding cystourethrography, CT, and MRI have a role in defining the anatomy of the UD and, perhaps, planning surgical intervention.

Pressure flow urodynamics may have a role in the preoperative assessment of patients with UD and co-existing voiding dysfunction or urinary incontinence (546-549). Urodynamics may evaluate for co-existing detrusor dysfunction or document the presence or absence of SUI or obstruction prior to repair. Approximately 50% of women with UD will demonstrate SUI on urodynamic evaluation (550, 551).

Urethral pressure profilometry has also been utilised by some authors in the assessment or diagnosis of UD noting a biphasic pattern, or pressure drop at the level of the lesion during the study (547, 549, 552).

Videourodynamics may be helpful in differentiating SUI from paradoxical UI due to fluid accumulation in the UD. In addition, resting and straining images obtained during fluoroscopic imaging may document an open BN at rest, suggesting a compromised proximal sphincter mechanism in some patients. This may be a consideration in some patients with an extensive UD at the level of the midurethra and potential implications for postoperative incontinence due to compromise of both sphincter mechanisms.

3. UD AND STRESS URINARY INCONTINENCE

Patients with symptomatic, bothersome SUI in association with UD can be offered simultaneous anti-incontinence surgery. Although historical series have shown good results with concomitant BN suspension (551), more contemporary series have utilized pubovaginal fascial slings in patients with UD and SUI with satisfactory outcomes (553-556). Midurethral synthetic slings are not recommended as a concomitant, anti-incontinence procedure at the time of urethral diverticulectomy (557). Synthetic material adjacent to a fresh suture line following diverticulectomy in the setting of potentially infected urine may place

the patient at higher risk for subsequent urethral erosion and vaginal extrusion of the sling material, as well as urethrovaginal fistula formation and foreign body granuloma formation (EL=4).

Significant postoperative de novo SUI may occur in 7-16% of individuals undergoing urethral diverticulectomy surgery without a concomitant anti-incontinence procedure (542, 544, 558). However, Lee et al. noted at least some de novo SUI in 49% of patients following urethral diverticulectomy, the majority of which was minor and did not require additional therapy (559). Only 10% of these individuals underwent a subsequent SUI operation. UD may mask SUI due to mass effect especially when the UD is proximal and greater than 3 cm in size(560). De novo SUI may arise from the extensive suburethral or circumferential dissection required for a large UD, and the more proximal UD location may compromise the urethral sphincter BN anatomical support and the sphincter mechanism (542). Alternatively, large UD at the BN may cause obstruction (543), and occult SUI may be unmasked after removing the obstructing UD (561). Nickels et al. report de novo SUI in 1/11 (9.1%) after complex UD repair and 1/32 (3.1%) after simple UD repairs, noting a significantly higher rate of concomitant PV sling with complex repairs (541).

4. UD AND UUI

Stav et al. reported rates of storage symptoms decreased significantly postoperatively from 60% to 16% following UD surgery (542). Other series with long term follow-up, however, have demonstrated rates of postoperative urgency of 54% (545), and de novo urgency incontinence in 36% of patients (544). Such symptoms postoperatively may herald UD persistence, UD recurrence, or de novo urethral obstruction.

5. SUMMARY

The evidence pertaining to UD and urinary incontinence consists of retrospective, small- to medium-size case series with limited follow-up demonstrating that urinary incontinence and other voiding dysfunction is significantly associated with this condition (Evidence Level=3).

6. RECOMMENDATIONS

Patients with UD should be carefully questioned and investigated for co-existing voiding dysfunction and urinary incontinence. (Grade C)

Following appropriate counselling, bothersome SUI can be addressed at the time of urethral diverticulectomy with concomitant non-synthetic sling (Grade C)

Patients should be counselled regarding the possibility of de novo or persistent LUTS including urinary incontinence despite technically successful urethral diverticulectomy. (Grade C)

IV. CONFOUNDING VARIABLES

The purpose of this review is to update the previous report on confounding variables published in the 5th consensus report. A Medline search from 2012 along with any updates from NICE guidelines and from Cochrane were examined. The subdivision of variables is consistent with the previous report and serves as an update although some of the previous prose has been included in this update.

1. AGE

The previous report highlighted the data from Medicare Australia examining (562) stress incontinence procedures from 1994 – 2009. The number of procedures performed for SUI doubled in the three year period after the introduction of midurethral tapes. Over the 15 year period there was an 87% increase in procedures performed in women over 55 years old compared to a 1% increase in younger women.

Although less commonly performed both PVSs and colposuspension remain efficacious procedures for stress urinary incontinence. The Stress Incontinence Surgical Treatment Efficacy study investigated the effect of age on both perioperative and postoperative outcome of both procedures in 659 women (563). The older group (mean age 69.7 years) were compared with a younger group (mean age 49.4 years). Overall older women took longer to return to normal activities (50 vs 42 days; p=0.05) but there were no difference in return to normal voiding. The older group were more likely to have a positive stress test at follow up (OR 3.7;95%CI: 1.70-7.97; p=0.001), less subjective improvement in both stress and urgency symptoms and were also more likely to require repeat surgery (OR 3.9; 95%CI: 1.30-11.48).

Toozs- Hobson et al (564) have recently published data collected from the British Society of Urogynaecology database to assess the impact of age on success rates and insertion complications of suburethral tapes used as primary procedures using the Patient Global Impression of Improvement (PGII) as the primary endpoint. 7600 cases were identified of which 757 were performed on women over 70 years of age and 119 on women over 80 years. Approximately 80% were PVS and 20% TO procedures. Short follow up was available for 54% of cases. The PGII remained high in all age groups but did decrease with age with 90% of women under 50 scoring highly to 70% of women over 80 scoring highly. Short term voiding was seen more frequently in the older group but there was no other increase in complications with age. Other studies have also confirmed increased short term voiding difficulty (110).

Malek et al (565) conducted a retrospective cohort study of women undergoing primary MUS surgery comparing women 70 years or older (mean age 75.4+ 4.5) with those under 70 years (mean age 56.2 +- 9.4) . Multivariable analysis revealed no difference in SUI failure rates (adjusted OR 1.7 95%CI 0.9-3.1). Women under 70 demonstrated greater improvement in the impact of urinary symptoms and women 70 and over had greater persistence of UUI.

The actual published information on surgery for stress incontinence in older women is quite sparse. A systematic review published in 2014(566) searched the literature from 1966 to October 2013.They included randomised controlled trials and prospective non-randomised studies. The population examined included those 65 years or older and they looked at sling procedures, bulking agents, artificial sphincters, onabotulinum toxin A injections and sacral neuromodulation. Only five studies fulfilled the inclusion criteria and they were all studying suburethral slings. Persistent SUI after surgery varied between 5.2 and 17.6%. One study evaluating quality of life showed significant improvement after surgery. Complication rates varied between 1-26% - mainly bladder perforation, short term voiding difficulties and de novo UUI.

2. RACE

There have been no new relevant publications since the last report. A large epidemiological study examined 129 778 women who underwent continence surgery in the United States in 2003(567) and found an overall rate of 12 surgical procedures per 10 000 women. The figure was 10 per 10 000 (95% CI: 7-12) in white women and dropped to 3 per 10 000 (95% CI: 0-9) and 6 per 10 000 (95% CI: 0-13) in women of other ethnicity. A further analysis of the Stress Incontinence Surgical Treatment Efficacy Trial in 654 women following colposuspension or PVS comparing Hispanic with non-Hispanic white and non-Hispanic black women showed no difference in any of the urinary incontinence measures investigated(563) .

The function of the continence mechanism has also been compared in a cross sectional population based study of 335 black and white women aged 35-64 years classified as continent (n=137), stress incontinent (n=102) and urge incontinent (n=96)(568). When comparing black women to white women the maximum urethral closure pressure(MUCP) was 22% higher (68.0 vs 55.8 cm H₂O p<0.0001).

3. OBESITY

There is considerable evidence suggesting obesity is linked with increasing severity of incontinence and weight loss (particularly that associated with bariatric surgery) can reduce incontinence. The evidence on the effect of obesity on surgical outcomes is less comprehensive. Older studies largely examining mid urethral tape procedures suggested no effect of BMI on

outcome (569). Brennan et al (184) evaluated the impact of BMI >30 on objective and subjective outcomes 12 months after MUSs. 182 women were enrolled into a randomised trial of TVT vs TO MUS. There was no difference in outcomes between the two surgical approaches. Objective cure was defined as <1g urine loss on a one hour pad test. The cure for non obese women was 85.6% vs 67.8% for the obese group (p=0.006, risk difference 17.8%, 95%CI 4.2-31.4%). There was also a 15% difference in subjective outcomes in the obese women (85.8% vs 70.7%). Karaman et al (570) used the same definition of obesity and retrospectively compared 328 non obese women with 294 obese women who had undergone RP MUSs. After they had controlled for concomitant pelvic surgery the success rates were similar for both groups (76.9% vs 73.7%) with no difference in complication rates. Berger et al(571) also compared 56 obese vs 100 non obese women undergoing PVS TVT and found a higher rate of short term complaints of SUI but by 2 months the failure rates were the same.

Two recent studies have looked at the impact of obesity on TO slings. Pereira et al (231) in a retrospective analysis of 122 obese and 159 non obese women found no difference in short and up to 4 year cure rates (95%vs 95.8%) with no difference in complication rates. Yonguc et al (572) had a series of 32 women all with BMI >35kg/m² with good success rates and low complication rates at three year follow up.

Waltz et al (573) published a systematic review pooling data from 13 studies comparing obese and non obese women and stress incontinence surgery outcomes at a minimum 12 month follow up. The subjective success was 76.4% and 74.7% and objective cure was 83.3% and 79.2%of non obese and obese women respectively. There was no significant difference in complications except non obese women were more likely to have bladder perforation.

4. PSYCHIATRIC ILLNESS

There have been no new relevant publications since the last report.

5. PHYSICAL ACTIVITY

There have been no new relevant publications since the last report.

6. PREVIOUS CONTINENCE SURGERY

Traditionally it has been believed that “redo” surgery for stress incontinence is associated with poorer outcomes the primary surgery. The numbers of colposuspension operations whether open or laparoscopic and fascial slings have diminished with the advent

and establishment of MUSs. The majority of recent studies examine the role of these MUSs when previous continence surgery has failed. This section will update on the more recent studies and the reader is referred to the ICI 5 document to read about older studies.

Lo et al (574) examined the records of 24 women who had undergone repeat MUS surgery. They used a mixture of transobturator, PVS and single incision slings and reported 79.2% objective and 75% subjective success rates. ISD and low MUCP predicted failure.

A Dutch study (575) identified from a retrospective cohort 242 women having primary surgery and 197 women having repeat surgery. All women had predominant stress incontinence. The overall success rate for primary surgery at a median 205 days follow up was 86% and 79% for recurrent surgery the complication rates were the same for both groups. Gaddi et al (346) reported on the failures of 6914 MUSs performed between 2008-2011. 165 women had repeat surgery for recurrent SUI 98 had repeat MUSs and 67 had urethral bulking. There were 11 failures in the MUS group and 26 failures in the bulking group (11.2% vs 38.8%). The complication rates were similar.

Agur et al (576) carried out a literature search from 1945- 2013. Data were available for a total of 350 women in 10 randomised controlled trials having had surgery for recurrent SUI with a mean follow up of 18.1 months. They concluded that there was no difference between the PVS tape or TO approaches as the two most studied procedures. One trial showed no difference between PVS TVT and colposuspension. Nikolopoulos et al (347) carried out a systematic review but allowed pooling of data for small studies even with as little as five cases. Their pooled analysis shows objective cure rates for recurrent stress urinary incontinence treated with colposuspension of 76% (95%CI +-5.04). For MUSs the success rate was 66.2%(95% CI +/-4) and was higher for the PVS as compared to TO approach. PVSs had a success rate of 79.3%(95%CI+- 6.5).

7. CONCOMITANT HYSTERECTOMY

There have been no new relevant publications since the last report.

8. SEVERITY AND DURATION OF SYMPTOMS

There have been no new relevant publications since the last report.

9. OAB AND STRESS INCONTINENCE

Previous reports have suggested that women with MUI are more likely to have persistent urgency incontinence after surgery for stress urinary incontinence and may also be predisposed to higher rates of failure of surgery for stress urinary incontinence.

Lee et al(577) investigated 358 with SUI and another 598 women who had SUI and urgency but not UUI who underwent MUSs with a mean follow up of 50 months. Women who developed de novo urgency(dU) or denovo UUI(dUUI) were compared with those that did not. dU occurred in 27.7% (99/358) and DUUI occurred in 13.7%(82/598) of women at long term follow up after MUS. Pre-existing DO, history of prior incontinence or prolapse surgery and concomitant apical prolapse surgery were important predictors of dU and dUUI following MUSs.

Gleason et al (578) compared the outcomes of MUS surgery in women with either pure stress urinary incontinence(SUI) or mixed urinary incontinence (MUI) using the Urinary Distress Inventory (UDI-6) subscale of the Pelvic Floor Distress Inventory(PFDI-20) and the Urinary Impact Questionnaire(UIQ-7). Five hundred and thirty four women completed baseline and follow up questionnaires. The mean follow up time was 35 months (Standard Deviation (SD) 15 months) and women with MUI had a significantly lower success rate compared to those with SUI alone (64 vs 85%, $p<0.001$). Abdel-Fattah et al (23) performed a secondary analysis of 83 women with MUI of a total population of 341 women who had been randomised to either (247) the "outside in" or "inside out" TO tape and found no difference in patient reported success rates using the Patient Global Impression of Improvement(PGI-I).

In another secondary analysis (579)(24) the authors examined data from three multicentre urinary incontinence surgical trials of women with stress predominant MUI assigned to Burch colposuspension, autologous fascial sling or PVS or TO MUSs. Significant improvements in Urinary Distress Inventory-Irritative scores were reported by all surgical groups 1 year after surgery. Improvements were similar between MUS groups at 1 year(65.5% compared with 70.7%, $p=.32$;odds ratio (OR) 0.83, 95% CI 0.57-1.20 for PVS compared with TO) and this persisted at 5 year follow up. More women reported OAB symptom improvement after Burch compared with PVS (67.9% compared with 56.6%, $p=0.01$; OR 1.59, 95% CI 1.10-2.31 for Burch compared with sling) at five years. The pre-op use of anticholinergics or urodynamic parameters was not predictive of OAB change.

10. URETHRAL OCCLUSIVE FORCES

There have been no new relevant publications since the last report. In the previous report the role of urethral mobility and intrinsic deficiency on outcome has been investigated in two studies. The first of these investigated 134 women following TO tape insertion. Overall 86% reported subjective cure and 14% of persistent symptoms. Median preoperative urethral mobility was significantly lower amongst treatment failures compared to those women who were cured (40 (10-60) degrees vs 50 (10-90) degrees ; $p=0.0049$). In addition women with preoperative mobility < 45 degrees were at least four times more likely to report incontinence when compared to those with >45 degrees mobility (29.4% vs 6.9%; RR 4.29; 95% CI 1.59-11.60; $p=005$)(580).

A prospective 2 year study of 65 women has also found that ISD with a fixed urethra is associated with a poorer objective outcome at 24 months following TO MUS when compared to intrinsic deficiency and urethral hypermobility and hypermobility alone (66.7% vs 87.5% and 96.6% respectively) (581).

11. SUMMARY

More studies are needed that are adequately powered to examine confounding variables as the primary outcome measure. Most if not all studies reporting on confounding variables are secondary analyses of studies examining success rates of surgical procedures for SUI. Therefore the levels of evidence are generally low at 3/4

Older women have similar outcomes after MUS surgery for SUI as their younger counterparts but have higher rates of short term voiding difficulty and de novo UUI. EL 3/4

Obesity does not adversely affect the outcome of MUS surgery for SUI with no increase in complication rates. EL 3/4

Prior failed SUI procedures does not appear to adversely affect outcome of subsequent surgery for SUI if ISD and low MUCP are excluded. EL 3/4

V. CLINICAL TRIAL OUTCOMES USED IN UI RESEARCH

There is no single measure that adequately measures SUI surgery outcomes. Outcome measures for SUI surgery remain non-standardised in clinical trials because of several factors unique to the condition or the treatment of the condition. Unlike cancer treatments with a readily defined outcome, or even prolapse surgeries where an anatomic outcome can be objectively assessed, SUI is a quality of life

condition whose presence, absence, or severity remains difficult to measure. Furthermore, the surgical treatment of SUI can improve or worsen other LUTS. Because we do not have a standard definition of success that is used in all studies, success rates from one study of one procedure cannot be compared to another study of a different procedure. Our best data for success comes from randomised trials where the same outcome criteria are applied to the same population and only then can 2 different surgeries be compared.

1. HISTORY OF SUI MEASURES

Outcome assessments can be broken down into subjective and objective measures. Early reports of SUI surgical outcomes were subjective. Often they were nothing more than surgeons asking the patient at the post-operative appointment if they were better. Of course, both the patient who decided to have the surgery, and the surgeon who did the surgery, were invested in the outcome and consequently success rates greater than 95% were not uncommon. This physician-reported subjective outcome measure was justifiably criticized. In one of the first systematic reviews of SUI surgery by Jarvis in 1994 he noted that subjective assessment of cure may be satisfactory in clinical practice, but it is clearly unsatisfactory for scientific assessment. (582) When the AUA SUI Guidelines Panel published their systematic review in 1997 they noted the paucity of clinical studies that met minimal criteria for good science in the conduct of clinical studies and reporting results. (583) The panel recommended 5 year outcomes with specific outcome measures including history/questionnaire, physical exam, diary, pad test, post void residual urine determination, and an assessment of complications/morbidity, including urinary retention, and de novo urgency.(583) Ten years later when Rovner et al reviewed the literature no articles met all criteria, but most complied with at least half of the recommendations. (584) Most SUI studies now report both subjective and objective measures and most of the Cochrane reviews of SUI surgery outcomes compare subjective and objective outcomes. Objective parameters typically include stress tests, pad tests, voiding diaries, urodynamic studies and the advantages and disadvantages of these measures are included in Table 12. Over time urodynamic studies have been used less commonly as an SUI surgical treatment outcome measure because of the limitations outlined in the table.

2. PATIENT REPORTED OUTCOMES

While many of the subjective self-reported measures can be considered "patient reported", the concept of true Patient Reported Outcomes (PRO) is more complex and encompasses a more global assessment. PRO's measure patient impressions in a more global context by encompassing 4 domains: 1) Symptoms,

2) Functioning, 3) General Health Perception and 4) HRQOL. The use of PRO's has gained acceptance as noted by the fact that most research funding sponsors, industry, and regulatory agencies now require inclusion of outcome measures that include the patient's perspective. The NIH recently established the Patient Reported Outcomes Measurement Information System (PROMIS) for women with urinary incontinence.(585) The International Consultation on Incontinence has adopted the use of PRO's and established the ICI Modular Questionnaire (ICIQ) Project that includes the assessment of a wide spectrum of urinary, bowel and vaginal symptoms along with their impact on HRQOL. Table 13 demonstrates PRO measures which have received an A grade from the ICI for female SUI outcomes from prior Consultations.

3. COMPOSITE MEASURES

No single instrument is universally accepted by all investigators. There are deficiencies with any single subjective or objective SUI research outcome measure. Therefore multiple measures are often reported and this makes definitive conclusions difficult. For this reason, especially with the advent of clinical trial networks, investigators have increasingly used composite outcomes (Table 14). While providing more comprehensive assessments, composite outcomes often create a stricter definition of success and lower success rates especially if all of the components of the composite must be satisfied. Because a provider may not always agree with the choice of measures used as a composite, investigators should also consider reporting the results of the individual components of the composite measure. An example of the reporting of individual composite components is shown in Figure 1.

4. SURVIVAL ANALYSIS REPORTING FOR SUI OUTCOMES -ONCE A FAILURE, ALWAYS A FAILURE

When assessing outcomes it is important to determine if the study used a survival type analysis (typically reported on a Kaplan-Meier graph which follows patients over time) or just assessed the patient at one specific postoperative time point. In these survival analysis types of studies an assumption is made that once a patient reports incontinence she will continue to have incontinence and she is considered a failure for the course of the study. Because of the waxing and waning nature of SUI symptoms, this may not fit the natural history of SUI symptoms. Survival analysis reporting will lead to lower success rates than single time reporting and may not be consistent with the patient's reported outcome.

5. SUCCESS RATES ARE DEPENDENT ON THE RIGOR OF THE ASSESSMENT

Further complicating the issue of outcome assessment is that few of our SUI treatments ever make a woman completely dry and therefore successful outcome rates decline with the rigor of the assessment. An example of both a rigorous outcome measure and a survival analysis approach is the UITN's randomised trial of Burch vs PVS which was criticized for low overall success rates of less than 50% in both arms. (21) In this study a composite measure was used which included administering a 3 day diary, a 24 hour pad test and a 15 question incontinence survey (MESA) every 6 months for 2 years. Any positive response during any assessment resulted in a failure for the duration of the study. In this study with composite rigorous assessments and survival analysis methodology, the low overall success rates of less than 50% were inconsistent with patient satisfaction rates of 78 and 86% in the 2 groups. (21)

If the definition of SUI surgical success is too rigorous outcomes will not meet face validity. In 2001, the NIH defined cure of stress urinary incontinence as: (1) resolution of the stress incontinence symptoms; (2) resolution of the sign (negative full bladder cough stress test, performed under the same conditions as before treatment); and (3) no new symptoms or side effects which could include new urinary symptoms such as urinary urgency, frequency, urge incontinence, with or without urodynamic changes of DO (detrusor instability); change in sexual function; development or worsening of POP; adverse effect on bowel function; onset of urinary tract infections; surgical complications, etc.(586) As Hilton noted in an editorial, if this definition was applied to the very well done United Kingdom TVT RCT, cure rates in the 2 arms would be 6 and 9%!(587)

6. MIXED INCONTINENCE AS A CONFOUNDER

Many patients undergoing stress incontinence surgery also have urgency incontinence (mixed incontinence) and this urgency component may get worse, remain the same, or improve after SUI surgeries. SUI surgery failures are often the result of worsening or de novo urgency incontinence. The true "pure" SUI patient is rare. In support of this, in the SISTeR trial where all women were reported to have pure or predominant SUI for study inclusion, the range of women with mixed incontinence ranged from 8.3% if mixed incontinence required DO on urodynamic studies to as high as 93.3% if they reported affirmatively to any urgency incontinence question. (588) Because inclusion criteria for studies vary and the amount of mixed incontinence in the populations vary, one study cannot be compared to another study. The effect of any

particular type of surgery on mixed incontinence varies and this is the reason why validated comprehensive measures of bladder function may be the best instruments to assess the outcomes of SUI surgery.

Quality of Life measures. If SUI is a quality of life condition, ideally we would have a quality of life tool that would capture changes with our intervention. Global quality of life instruments (like the SF-36 or SF-12) are not sensitive to SUI interventions and incontinence specific QOL instruments are recommended. The incontinence specific quality of life instruments that have received an ICI Grade A recommendation are shown in Table 13 and include the: ICIQ FLUTS, IIQ, IIQ-7, I-QOL, and LIS.

Stress-Specific vs Bladder Specific.

Any instrument that is stress-specific may give results about the surgery's effect on stress incontinence but may not give an overall accurate assessment of what the surgery did for overall bladder storage and emptying LUTS (urgency, frequency, urgency incontinence, or voiding difficulties). Therefore an overall bladder assessment tool is recommended for measuring SUI surgical outcomes. Patient reported bladder outcomes with ICI Grade A recommendations are shown in Table 13 and include the: ICIQ-UISF, ISS, KHQ, UISS, PPBC, UDI, and UDI-6.

7. GLOBAL MEASURES

Another outcome measure that has recently gained popularity is the patient global impression of severity (PGIS) and the patient global impression of improvement (PGI-I). Use of such global assessment instruments provides a single response which is easy for the patient and clinician to understand.(589) Furthermore, the measurement is all encompassing since the subject takes success and complications into account when responding. The PGI-I was part of the composite primary outcome in the UITN randomised trial evaluating preoperative urodynamics. (590)

Table 12: Female SUI Objective Outcome Measures

Measure	Advantages	Disadvantages
Stress test	Noninvasive or minimally invasive Inexpensive Specific for stress incontinence A positive test is predictive for urodynamic stress incontinence (590, 591)	Should be standardised (position and volume)
Pad test (1 hr or 24 hr)	Quantitative	Not SUI specific Can be burdensome to patient and investigator
Voiding diary (3 day or 7 day)	Can differentiate stress from urgency events.	Burdensome to patient
Urodynamics	Can detect urodynamic stress incontinence and DO	Invasive, uncomfortable, expensive

8. SUMMARY

The last two decades has seen a massive expansion in the field of stress urinary incontinence (SUI) research. While initially criticised for poor quality research, significant advances have been made especially in the development of clinical trial networks that have allowed large scale multisite surgical studies necessary for high quality studies. We have also seen a maturation of outcome tools including validated patient reported outcome instruments. The standard clinical trial for SUI now is a prospective randomised comparative efficacy trial using patient reported outcomes as a component of the primary outcome.

9. RECOMMENDATIONS

Patient reported outcomes using ICI Grade A bladder symptom and incontinence-specific quality of life instruments should be utilized in stress incontinence clinical trials (Grade D).

A cough stress test standardised to bladder volume and patient position provides an objective assessment of stress continence outcomes (Grade D).

Composite measures address inadequacies of any individual stress outcome measure, but rates with these measures are often lower than any individual measure so the components should also be reported. (Grade D)

VI. RESEARCH RECOMMENDATIONS

1. GENERAL

It is becoming clear that there is not a single optimal intervention for all patients with SUI or UUI. Future high quality research is required to clarify the place of each SUI and UUI intervention for the individual patient, and establish the optimal materials and approach to the index and non-index UI patient.

		Not sensitive for urgency incontinence
Need for repeat surgery	Identifies the worst failures	Uncommon outcome Not sensitive for less severe outcomes.

Table 13: Female SUI Patient Reported Outcomes with ICI Grade A Recommendations

Tool	Measures	Items
ICIQ FLUTS	QOL, Treatment outcome	34
ICIQ-UI SF	Symptoms and impact	4
IIQ (Incontinence Impact Questionnaire)	Impact of UI on HRQOL	30
IIQ-7	Short version of IIQ	7
I-QOL (Incontinence QOL)	Incontinence specific QOL	22
ISS (Incontinence Symptom Severity Index)	Severity of storage and voiding symptoms	8
KHQ (ICIQ-LUTSqol) King's Health Questionnaire	Symptoms impact of LUTS	21
LIS (Leicester Impact scale)	LUTS QOL	21
UISS (Urinary Incontinence Severity Score)	Severity and impact of UI	10
LUSQ (Leicester Urinary Symptom Questionnaire)	Presence and severity of storage abnormalities	10
PGI-I (Patient Global Impression of Improvement)	Symptom bother	1
PGI-S (Patient Global Impression of Severity)	Symptom bother	1
PPBC (Patient Perception of Bladder Condition)	Impression of bladder condition	1
UDI (Urogenital Distress Inventory)	Symptom bother related to UI	19
UDI-6	Symptom bother related to UI/LUTS	6

Table 14: Examples of Composite Primary Outcomes used in RCT's of SUI Surgery with more than 200 Subjects.

1 st author, year (ref)	Surgery	Composite Outcome
Ward, 2002 (147)	TVT vs. Burch	No USI and Negative pad test
Albo, 2007 (21)	Fascial sling vs Burch	Negative pad test and No UI on 3 day diary and Negative cough stress test and No self-reported SUI on MESA and No SUI retreatment
Barber, 2008 (208)	PVS vs. TO	Abnormal bladder function defined by presence of Incontinence symptoms of any type Positive cough stress test Retreatment of SUI Elevated PVR
Rinne, 2008 (202)	TVT vs TVT-O	Objective Negative stress test Negative pad test Subjective condition-specific quality of life questionnaires and general health by the EQ-5D questionnaire.
Wang W, 2009 (211)	TVT vs TVT-O	Negative cough test Negative pad test Reduction by 50% of incontinence episodes
Krofta , 2010 (216)	TVT vs. TVT-O	Objective Negative stress test Negative pad test Subjective No leakage on questionnaire
Richter, 2010 (217)	PVS vs TO	Objective Negative stress test Negative pad test

		No SUI retreatment Subjective No self- reported SUI symptoms No UI on 3 day diary
Nager, 2012 (590)	UDS vs No UDS	70% reduction in UDI and PGI-I of much better or very much better

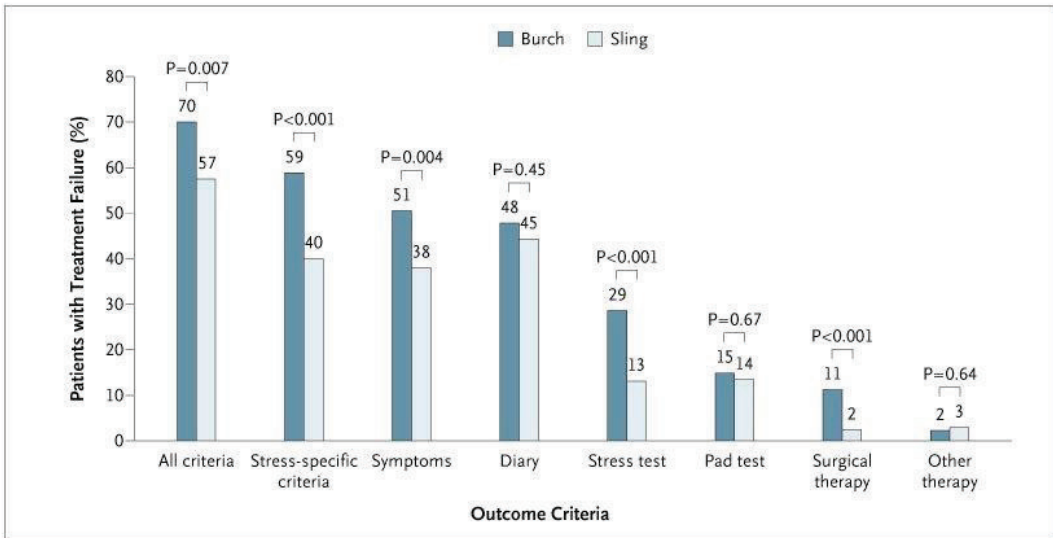

Figure 1. Proportion of Subjects with Treatment Failure at 2 years according to different criteria in the UITN randomized trial comparing Burch vs. Autologous sling. (21)

Future studies should systematically record in a standard, quantifiable, and reproducible manner (e.g. Clavien-Dindo, etc.) all AEs and complications associated with each of the interventions for UI.

Future studies should utilise appropriate outcome measures to better understand and address the broader effects of UI interventions with respect to health economics in individuals, populations, payers, and health care systems.

2. STRESS URINARY INCONTINENCE

Studies should investigate the subpopulations and characteristics of patients (e.g. urethral function, medical comorbidities, BMI, vaginal atrophy, POP, etc.) in whom each of the interventions for SUI is the optimal choice.

As the use of foreign and synthetic materials for the treatment of SUI evolves and expands (mesh, bulking agents, stem cells, etc.), a better understanding of the long-term implications of these implanted materials is needed.

3. URGENCY URINARY INCONTINENCE

Prospective randomised trials comparing third line treatments for refractory OAB/UII are needed, especially with respect to the long term efficacy, complications and cost of these interventions.

The role and efficacy of third line therapies in combination with each other (e.g. SNS and BTX) as well as in combination with other non-invasive therapies (e.g. medications) is unknown.

The mechanism of action of the SNS, and PTNS remains unknown.

Optimal patient selection for each of the third line therapies is undefined.

The role and efficacy of third line therapies such as SNS and PTNS is unknown in the non-refractory OAB patient who declines other therapy (e.g. behavioral therapy and/or pharmacological therapy).

The long term impact of the newer SNS technology currently used in terms of durability and complications is not defined as the current data in the literature is limited to older SNS devices.

The role of different programming settings in SNS and PTNS for different urological conditions is not well understood.

The optimal long term maintenance regimen for PTNS is unknown.

Alternatives to enlargement cystoplasty for refractory patients are lacking despite initial enthusiasm for tissue engineering.

4. URETHRAL DIVERTICULA

There is a need for prospective, assessment of LPP, including urinary incontinence with respect to surgical and non-surgical management of these patients.

REFERENCES

1. Rehman H, Bezerra CC, Bruschini H, Cody JD. Traditional suburethral sling operations for urinary incontinence in women. *Cochrane Database Syst Rev*. 2011;1.
2. Hohenfelner R & Petrie E. *Sling procedure in surgery*: Springer-Verlag: Berlin.; 1986. p. 105-13. p.
3. Goebel R. Zur operativen Beseitigung der Angelborenen incontinenz vesicae. *Zeitschrift fur gynakologisch Urologie*, 1910;2:187-90.
4. Squier J. Post-operatiave urinary incontinence: urethroplastic operation. 1911;79:868.
5. Frangenheim P. Zur operativen Behandlung der Inkontinenz der mannlichen Harnroehre. *Verhandlunge [der] Tagung. Deutsche Gesellschaft fur Chirurgie*. 1914;43:149-58.
6. Deming C. Transplantation of fascia for relief of urinary stress incontinence. *J Am Medical Association*, 1926;86:822-5.
7. Martius H. Sphincter-und Harnrohrplastik aus dem Musculus Bulbocavernosus. *Der Chirurg Zeitschrift fur alle Gebeite der operative Medizin*, 1929;1:769-73.
8. Aldridge A. Transplantation of fascia for relief of urinary stress incontinence. *Amer J of Obstetrics and GYN*. 1942;44:398-411
9. McGuire EJ. Pubovaginal sling procedure for stress incontinence. *J Urol*, 1978.
10. Blaivas JG, Jacobs BZ. Pubovaginal fascial sling for the treatment of complicated stress urinary incontinence. *The Journal of urology*. 1991;145(6):1214-8.
11. NICE Ws, National Collaborating Centre for women's and children's health. *Urinary incontinence in women: the management of urinary incontinence in women*. 2013.
12. Osman T. Stress incontinence surgery for patients presenting with mixed incontinence and a normal cystometrogram. *BJU international*. 2003;92(9):964-8.
13. Maher CF, O'Reilly BA, Dwyer PL, Carey MP, Cornish A, Schluter P. Pubovaginal sling versus transurethral Macroplastique for stress urinary incontinence and intrinsic sphincter deficiency: a prospective randomised controlled trial. *BJOG*. 2005;112(6):797-801.
14. Corcos J, Collet JP, Shapiro S, Herschorn S, Radomski SB, Schick E, et al. Multicenter randomized clinical trial comparing surgery and collagen injections for treatment of female stress urinary incontinence. *Urology*. 2005;65(5):898-904.
15. Leone Roberti Maggiore U, Bogani G, Meschia M, Sorice P, Braga A, Salvatore S, et al. Urethral bulking agents versus other surgical procedures for the treatment of female stress urinary incontinence: a systematic review and meta-analysis. *Eur J Obstet Gynecol Reprod Biol*. 2015;189:48-54.
16. Henriksson L, Ulmsten U. A urodynamic evaluation of the effects of abdominal urethrocystopexy and vaginal sling urethroplasty in women with stress incontinence. *Am J Obstet Gynecol*. 1978;131(1):77-82.
- 17.ENZELSBERGER H, HELMER H, SCHATTEN C. Comparison of Burch and Lyodura sling procedures for repair of unsuccessful incontinence surgery. *Obstet Gynecol*. 1996;88(2):251-6.
18. Sand PK, Winkler H, Blackhurst DW, Culligan PJ. A prospective randomized study comparing modified Burch retropubic urethropexy and suburethral sling for treatment of genuine stress incontinence with low-pressure urethra. *Am J Obstet Gynecol*. 2000;182(1 Pt 1):30-4.
19. Demirci F, Yucel O. Comparison of pubovaginal sling and burch colposuspension procedures in type I/II genuine stress incontinence. *Arch Gynecol Obstet*. 2001;265(4):190-4.
20. Bai SW, Sohn WH, Chung DJ, Park JH, Kim SK. Comparison of the efficacy of Burch colposuspension, pubovaginal sling, and tension-free vaginal tape for stress urinary incontinence. *Int J Gynaecol Obstet*. 2005;91(3):246-51.
21. Albo ME, Richter HE, Brubaker L, Norton P, Kraus SR, Zimmern PE, et al. Burch colposuspension versus fascial sling to reduce urinary stress incontinence. *N Engl J Med*. 2007;356(21):2143-55.
22. Brubaker L, Richter HE, Norton PA, Albo M, Zyczynski HM, Chai TC, et al. 5-year continence rates, satisfaction and adverse events of burch urethropexy and fascial sling surgery for urinary incontinence. *The Journal of urology*. 2012;187(4):1324-30.
23. Culligan PJ, Goldberg RP, Sand PK. A randomized controlled trial comparing a modified Burch procedure and a suburethral sling: long-term follow-up. *Int Urogynecol J Pelvic Floor Dysfunct*. 2003;14(4):229-33; discussion 33.
24. Chai TC, Albo ME, Richter HE, Norton PA, Dandreo KJ, Kenton K, et al. Complications in women undergoing Burch colposuspension versus autologous rectus fascial sling for stress urinary incontinence. *The Journal of urology*. 2009;181(5):2192-7.

25. Hilton P. A clinical and urodynamic study comparing the Stamey bladder neck suspension and suburethral sling procedures in the treatment of genuine stress incontinence. *Br J Obstet Gynaecol.* 1989;96(2):213-20.
26. Lapitan MC, Cody JD. Open retropubic colposuspension for urinary incontinence in women. *Cochrane Database Syst Rev.* 2016;2:CD002912.
27. Barbalias G, Liatsikos E, Barbalias D. Use of slings made of indigenous and allogenic material (Goretex) in type III urinary incontinence and comparison between them. *Eur Urol.* 1997;31(4):394-400.
28. Lucas M E, Stephenson T., A randomised study to assess and compare the clinical effectiveness of two surgical techniques for the treatment of stress urinary incontinence in women. Cardiff, The Wales Office of Research and Development for Health and Social Care. 2000.
29. Viseshsindh W, Kochakarn W, Waikakul W, Roongruangsilp U, Siripornpinyo N, Viseshsindh V. A randomized controlled trial of pubovaginal sling versus vaginal wall sling for stress urinary incontinence. *Journal of the Medical Association of Thailand = Chotmaihet thanghaet.* 2003;86(4):308-15.
30. Choe JM, Ogan K, Battino BS. Antimicrobial mesh versus vaginal wall sling: a comparative outcomes analysis. *The Journal of urology.* 2000;163(6):1829-34.
31. Kuo HC. Comparison of video urodynamic results after the pubovaginal sling procedure using rectus fascia and polypropylene mesh for stress urinary incontinence. *The Journal of urology.* 2001;165(1):163-8.
32. Guerrero K, Watkins A, Emery S, Wareham K, Stephenson T, Logan V, et al. A randomised controlled trial comparing two autologous fascial sling techniques for the treatment of stress urinary incontinence in women: short, medium and long-term follow-up. *Int Urogynecol J Pelvic Floor Dysfunct.* 2007;18(11):1263-70.
33. Kaplan SA, Santarosa RP, Te AE. Comparison of fascial and vaginal wall slings in the management of intrinsic sphincter deficiency. *Urology.* 1996;47(6):885-9.
34. Rodrigues P, Hering F, Meler A, Campagnari JC, D'Império M. Pubo-fascial versus vaginal sling operation for the treatment of stress urinary incontinence: a prospective study. *Neurourol Urodyn.* 2004;23(7):627-31.
35. Wright EJ, Iselin CE, Carr LK, Webster GD. Pubovaginal sling using cadaveric allograft fascia for the treatment of intrinsic sphincter deficiency. *The Journal of urology.* 1998;160(3 Pt 1):759-62.
36. Brown SL, Govier FE. Cadaveric versus autologous fascia lata for the pubovaginal sling: surgical outcome and patient satisfaction. *The Journal of urology.* 2000;164(5):1633-7.
37. Soergel TM, Shott S, Heit M. Poor surgical outcomes after fascia lata allograft slings. *Int Urogynecol J Pelvic Floor Dysfunct.* 2001;12(4):247-53.
38. Flynn BJ, Yap WT. Pubovaginal sling using allograft fascia lata versus autograft fascia for all types of stress urinary incontinence: 2-year minimum followup. *The Journal of urology.* 2002;167(2 Pt 1):608-12.
39. O'Reilly KJ, Govier FE. Intermediate term failure of pubovaginal slings using cadaveric fascia lata: a case series. *The Journal of urology.* 2002;167(3):1356-8.
40. Almeida SH, Gregorio E, Grando JP, Rodrigues MA, Fraga FC, Moreira HA. Pubovaginal sling using cadaveric allograft fascia for the treatment of female urinary incontinence. *Transplantation proceedings.* 2004;36(4):995-6.
41. McBride AW, Ellerkmann RM, Bent AE, Melick CF. Comparison of long-term outcomes of autologous fascia lata slings with Suspend Tuto-plast fascia lata allograft slings for stress incontinence. *Am J Obstet Gynecol.* 2005;192(5):1677-81.
42. Onur R, Singla A, Kobashi KC. Comparison of solvent-dehydrated allograft dermis and autograft rectus fascia for pubovaginal sling: questionnaire-based analysis. *Int Urol Nephrol.* 2008;40(1):45-9.
43. Simsiman AJ, Powell CR, Stratford RR, Menefee SA. Suburethral sling materials: best outcome with autologous tissue. *Am J Obstet Gynecol.* 2005;193(6):2112-6.
44. Guerrero KL, Emery SJ, Wareham K, Ismail S, Watkins A, Lucas MG. A randomised controlled trial comparing TVT, Pelvicol and autologous fascial slings for the treatment of stress urinary incontinence in women. *BJOG.* 2010;117(12):1493-502.
45. Giri SK, Hickey JP, Sil D, Mabadeje O, Shaikh FM, Narasimhulu G, et al. The Long-Term Results of Pubovaginal Sling Surgery Using Acellular Cross-Linked Porcine Dermis in the Treatment of Urodynamic Stress Incontinence. *The Journal of urology.* 2006;175(5):1788-93.
46. Morgan DM, Dunn RL, Fenner DE, Faerber G, DeLancey JOL, McGuire EJ, et al. Comparative analysis of urinary incontinence severity after autologous fascia pubovaginal sling, pubovaginal sling and tension-free vaginal tape. *The Journal of urology.* 2007;177(2):604-8; discussion 8-9.

47. Winckler JA, Ramos JGL, Dalmolin BM, Winckler DC, Doring M. Comparative study of polypropylene and aponeurotic slings in the treatment of female urinary incontinence. *Int braz j urol.* 2010;36(3):339-47.
48. Maher C, Carey M, Dwyer P, Moran P. Pubovaginal or vicryl mesh rectus fascia sling in intrinsic sphincter deficiency. *International Urogynecology Journal.* 2001;12(2):111-6.
49. Wilson CM, Williams BJ, Bilello S, Gomelsky A. Bovine dermis: a novel biologic substitute for autologous tissue in sling surgery. *Int Urogynecol J Pelvic Floor Dysfunct.* 2008;19(12):1671-6.
50. Arunkalaivanan AS, Barrington JW. Randomized trial of porcine dermal sling (Pelvicol implant) vs. tension-free vaginal tape (TVT) in the surgical treatment of stress incontinence: a questionnaire-based study. *Int Urogynecol J Pelvic Floor Dysfunct.* 2003;14(1):17-23; discussion 1-2.
51. Lucas M E, Alan W & Kathy W. Failure of porcine xenograft sling in a randomised controlled trial of three sling materials in surgery for stress incontinence. . *International Continence Society & International Urogynecological Association Paris, France.* 2004.
52. Amaro JL, Yamamoto H, Kawano PR, Barros G, Gameiro MOO, Agostinho AD. Clinical and quality-of-life outcomes after autologous fascial sling and tension-free vaginal tape: a prospective randomized trial. *Int Braz J Urol.* 2009;35(1):60-6; discussion 6-7.
53. Basok EK, Yildirim A, Atsu N, Basaran A, Tokuc R. Cadaveric fascia lata versus intravaginal slingplasty for the pubovaginal sling: surgical outcome, overall success and patient satisfaction rates. *Urologia internationalis.* 2008;80(1):46-51.
54. Kondo A, Isobe Y, Kimura K, Kamihira O, Matsuura O, Gotoh M, et al. Efficacy, safety and hospital costs of tension-free vaginal tape and pubovaginal sling in the surgical treatment of stress incontinence. *The journal of obstetrics and gynaecology research.* 2006;32(6):539-44.
55. Sharifiaghdas F, Mortazavi N. Tension-free vaginal tape and autologous rectus fascia pubovaginal sling for the treatment of urinary stress incontinence: a medium-term follow-up. *Med Princ Pract.* 2008;17(3):209-14.
56. Wadie BS, Edwan A, Nabeeh AM. Autologous fascial sling vs polypropylene tape at short-term followup: a prospective randomized study. *The Journal of urology.* 2005;174(3):990-3.
57. Abdel-Fattah M, Barrington JW, Arunkalaivanan AS. Pelvicol pubovaginal sling versus tension-free vaginal tape for treatment of urodynamic stress incontinence: a prospective randomized three-year follow-up study. *Eur Urol.* 2004;46(5):629-35.
58. Wadie BS, Mansour A, El-Hefnawy AS, Nabeeh A, Khair AA. Minimum 2-year follow-up of mid-urethral slings, effect on quality of life, incontinence impact and sexual function. *Int Urogynecol J.* 2010;21(12):1485-90.
59. Hung MJ, Liu FS, Shen PS, Chen GD, Lin LY, Ho ES. Analysis of two sling procedures using polypropylene mesh for treatment of stress urinary incontinence. *Int J Gynaecol Obstet.* 2004;84(2):133-41.
60. Trabuco EC, Klingele CJ, Weaver AL, McGree ME, Lightner DJ, Gebhart JB. Medium-term comparison of continence rates after rectus fascia or midurethral sling placement. *Am J Obstet Gynecol.* 2009;200(3):300.e1-6.
61. Silva-Filho AL, Candido EB, Noronha A, Triginelli SA. Comparative study of autologous pubovaginal sling and synthetic transobturator (TOT) SAFYRE sling in the treatment of stress urinary incontinence. *Arch Gynecol Obstet.* 2006;273(5):288-92.
62. Tcherniakovsky M, Fernandes CE, Bezerra CA, Del Roy CA, Wroclawski ER. Comparative results of two techniques to treat stress urinary incontinence: synthetic transobturator and aponeurotic slings. *Int Urogynecol J Pelvic Floor Dysfunct.* 2009;20(8):961-6.
63. Jeon M-J, Jung H-J, Chung S-M, Kim S-K, Bai S-W. Comparison of the treatment outcome of pubovaginal sling, tension-free vaginal tape, and transobturator tape for stress urinary incontinence with intrinsic sphincter deficiency. *Am J Obstet Gynecol.* 2008;199(1):76.e1-4.
64. Khan ZA, Nambiar A, Morley R, Chapple CR, Emery SJ, Lucas MG. Long-term follow-up of a multicentre randomised controlled trial comparing tension-free vaginal tape, xenograft and autologous fascial slings for the treatment of stress urinary incontinence in women. *BJU international.* 2015;115(6):968-77.
65. Mock S, Angelle J, Reynolds WS, Osborn DJ, Dmochowski RR, Gomelsky A. Contemporary comparison between retropubic midurethral sling and autologous pubovaginal sling for stress urinary incontinence after the FDA advisory notification. *Urology.* 2015;85(2):321-5.
66. Song YF, Huang HJ, Xu B, Hao L. [Comparative study of tension-free vaginal tape and fascia lata for stress urinary incontinence]. *Zhonghua Fu Chan Ke Za Zhi.* 2004;39(10):658-61.

67. Marshall VF, Marchetti AA, Krantz KE. The correction of stress incontinence by simple vesicourethral suspension. *Surgery, gynecology & obstetrics*. 1949;88(4):509-18.
68. Burch JC. Urethrovaginal fixation to Cooper's ligament for correction of stress incontinence, cystocele, and prolapse. *Am J Obstet Gynecol*. 1961;81:281-90.
69. Burch JC. Cooper's ligament urethrovesical suspension for stress incontinence. Nine years' experience--results, complications, technique. *Am J Obstet Gynecol*. 1968;100(6):764-74.
70. Tellez Martinez-Fornes M ea. A three year follow-up of a prospective open randomized trial to compare tension-free vaginal tape with Burch colposuspension for treatment of female stress urinary incontinenc. . *Actas urologicas Espanolas*. 2009;33(10):1088-96.
71. Bandarian M, Ghanbari Z, Asgari A. Comparison of transobturator tape (TOT) vs Burch method in treatment of stress urinary incontinence. *Journal of obstetrics and gynaecology : the journal of the Institute of Obstetrics and Gynaecology*. 2011;31(6):518-20.
72. Roderick T, Paul M, Christopher M, Douglas T. Urethral retro-resistance pressure: association with established measures of incontinence severity and change after midurethral tape insertion. *Neurourol Urodyn*. 2009;28(1):86-9.
73. Roovers JP, Oelke M. Clinical relevance of urodynamic investigation tests prior to surgical correction of genital prolapse: a literature review. *Int Urogynecol J Pelvic Floor Dysfunct*. 2007;18(4):455-60.
74. Ross J. Two techniques of laparoscopic Burch repair for stress incontinence: a prospective, randomized study. *J Am Assoc Gynecol Laparosc*. 1996;3(3):351-7.
75. Ross S, Robert M, Swaby C, Dederer L, Lier D, Tang S, et al. Transobturator tape compared with tension-free vaginal tape for stress incontinence: a randomized controlled trial. *Obstet Gynecol*. 2009;114(6):1287-94.
76. Schierlitz L, Dwyer PL, Rosamilia A, Murray C, Thomas E, De Souza A, et al. Effectiveness of tension-free vaginal tape compared with transobturator tape in women with stress urinary incontinence and intrinsic sphincter deficiency: a randomized controlled trial. *Obstet Gynecol*. 2008;112(6):1253-61.
77. Schraffordt Koops SE, Bisseling TM, Heintz AP, Vervest HA. Prospective analysis of complications of tension-free vaginal tape from The Netherlands Tension-free Vaginal Tape study. *Am J Obstet Gynecol*. 2005;193(1):45-52.
78. Sevestre S, Ciofu C, Deval B, Traxer O, Amarenco G, Haab F. Results of the tension-free vaginal tape technique in the elderly. *Eur Urol*. 2003;44(1):128-31.
79. Shah AD, Kohli N, Rajan SS, Hoyte L. Surgery for stress urinary incontinence in the United States: does race play a role? *Int Urogynecol J Pelvic Floor Dysfunct*. 2008;19(8):1085-92.
80. Shao Y, He HC, Shen ZJ, Zhou WL. Tension-free vaginal tape retropubic sling for recurrent stress urinary incontinence after Burch colposuspension failure. *Int J Urol*. 2011;18(6):452-7.
81. Skriapas K, Poulakis V, Dillenburg W, de Vries R, Witzsch U, Melekos M, et al. Tension-free vaginal tape (TVT) in morbidly obese patients with severe urodynamic stress incontinence as last option treatment. *Eur Urol*. 2006;49(3):544-50.
82. Sola V, Pardo J, Ricci P, Guiloff E, Chiang H. TVT versus TVT-O for minimally invasive surgical correction of stress urinary incontinence. *Int Braz J Urol*. 2007;33(2):246-52; discussion 53.
83. Stangel-Wojcikiewicz K. Laparoscopic Burch colposuspension compared to laparotomy for treatment urinary stress incontinence (Abstract number 121). *Neurourology and Urodynamics*. 2008;27(7):714.
84. Tuygun C BH, Erogulu M, et al. Comparison of two different surgical approaches in the treatment of stress urinary incontinence: Open an laparoscopic Burch colposuspensions. . *Turk Uroloji Dergisi*. 2006;32(2):248-53.
85. Wallwiener D, et al. Endoscopic retropubi colposuspension: "Retziusscopy" versus laparoscopy - a reasonable enlargement of the operative spectrum in the management of recurrent stress incontinence? . *Endosc Surg Allied Technol*. 1995;3(2-3):115-8.
86. Su TH, Wang KG, Hsu CY, Wei HJ, Hong BK. Prospective comparison of laparoscopic and traditional colposuspensions in the treatment of genuine stress incontinence. *Acta obstetrica et gynecologica Scandinavica*. 1997;76(6):576-82.
87. Persson J, Wolner-Hanssen P. Laparoscopic Burch colposuspension for stress urinary incontinence: a randomized comparison of one or two sutures on each side of the urethra. *Obstet Gynecol*. 2000;95(1):151-5.
88. Piccione T ea. Different techniques of laparoscopic Burch colposuspension. *Italian Journal of Gynaecology & Obstetrics*. 2001;13(1):10-3.

89. Zullo F, Palomba S, Piccione F, Morelli M, Arduino B, Mastrantonio P. Laparoscopic Burch colposuspension: a randomized controlled trial comparing two transperitoneal surgical techniques. *Obstet Gynecol.* 2001;98(5 Pt 1):783-8.
90. Zullo F, Morelli M, Russo T, Iuzzolino D, Palomba S. Two techniques of laparoscopic retropubic urethropexy. *J Am Assoc Gynecol Laparosc.* 2002;9(2):178-81.
91. Fathy H, El Hao M, Samaha I, Abdallah K. Modified Burch colposuspension: laparoscopy versus laparotomy. *J Am Assoc Gynecol Laparosc.* 2001;8(1):99-106.
92. Persson J, Teleman P, Eten-Bergquist C, Wolner-Hanssen P. Cost-analyses based on a prospective, randomized study comparing laparoscopic colposuspension with a tension-free vaginal tape procedure. *Acta obstetrica et gynecologica Scandinavica.* 2002;81(11):1066-73.
93. Cheon WC, Mak JH, Liu JY. Prospective randomised controlled trial comparing laparoscopic and open colposuspension. *Hong Kong Med J.* 2003;9(1):10-4.
94. Ustun Y, Engin-Ustun Y, Gungor M, Tezcan S. Tension-free vaginal tape compared with laparoscopic Burch urethropexy. *J Am Assoc Gynecol Laparosc.* 2003;10(3):386-9.
95. Valpas A, Kivela A, Penttinen J, Kauko M, Kujansuu E, Tomas E, et al. Tension-free vaginal tape and laparoscopic mesh colposuspension in the treatment of stress urinary incontinence: immediate outcome and complications--a randomized clinical trial. *Acta obstetrica et gynecologica Scandinavica.* 2003;82(7):665-71.
96. Valpas A, Kivela A, Penttinen J, Kujansuu E, Haarala M, Nilsson CG. Tension-free vaginal tape and laparoscopic mesh colposuspension for stress urinary incontinence. *Obstet Gynecol.* 2004;104(1):42-9.
97. Valpas A, Rissanen P, Kujansuu E, Nilsson CG. A cost-effectiveness analysis of tension-free vaginal tape versus laparoscopic mesh colposuspension for primary female stress incontinence. *Acta obstetrica et gynecologica Scandinavica.* 2006;85(12):1485-90.
98. Paraiso MF, Walters MD, Karram MM, Barber MD. Laparoscopic Burch colposuspension versus tension-free vaginal tape: a randomized trial. *Obstet Gynecol.* 2004;104(6):1249-58.
99. Jelovsek JE, Barber MD, Karram MM, Walters MD, Paraiso MF. Randomised trial of laparoscopic Burch colposuspension versus tension-free vaginal tape: long-term follow up. *BJOG.* 2008;115(2):219-25; discussion 25.
100. Ankardal M, Milsom I, Stjerndahl JH, Engh ME. A three-armed randomized trial comparing open Burch colposuspension using sutures with laparoscopic colposuspension using sutures and laparoscopic colposuspension using mesh and staples in women with stress urinary incontinence. *Acta obstetrica et gynecologica Scandinavica.* 2005;84(8):773-9.
101. Ustun Y, Engin-Ustun Y, Gungor M, Tezcan S. Randomized comparison of Burch urethropexy procedures concomitant with gynecologic operations. *Gynecologic and obstetric investigation.* 2005;59(1):19-23.
102. Kitchener HC, Dunn G, Lawton V, Reid F, Nelson L, Smith AR, et al. Laparoscopic versus open colposuspension--results of a prospective randomised controlled trial. *BJOG.* 2006;113(9):1007-13.
103. Dumville JC, Manca A, Kitchener HC, Smith AR, Nelson L, Torgerson DJ, et al. Cost-effectiveness analysis of open colposuspension versus laparoscopic colposuspension in the treatment of urodynamic stress incontinence. *BJOG.* 2006;113(9):1014-22.
104. Carey MP, Goh JT, Rosamilia A, Cornish A, Gordon I, Hawthorne G, et al. Laparoscopic versus open Burch colposuspension: a randomised controlled trial. *BJOG.* 2006;113(9):999-1006.
105. Valpas A, Ala-Nissila S, Tomas E, Nilsson CG. TVT versus laparoscopic mesh colposuspension: 5-year follow-up results of a randomized clinical trial. *Int Urogynecol J.* 2015;26(1):57-63.
106. Kuuva N, Nilsson CG. A nationwide analysis of complications associated with the tension-free vaginal tape (TVT) procedure. *Acta obstetrica et gynecologica Scandinavica.* 2002;81(1):72-7.
107. Song PH, Kim YD, Kim HT, Lim HS, Hyun CH, Seo JH, et al. The 7-year outcome of the tension-free vaginal tape procedure for treating female stress urinary incontinence. *BJU international.* 2009;104(8):1113-7.
108. Stav K, Dwyer PL, Rosamilia A, Lee J. Long-term outcomes of patients who failed to attend following midurethral sling surgery--a comparative study and analysis of risk factors for non-attendance. *Aust N Z J Obstet Gynaecol.* 2010;50(2):173-8.
109. Stav K, Dwyer PL, Rosamilia A, Schierlitz L, Lim YN, Chao F, et al. Repeat synthetic mid urethral sling procedure for women with recurrent stress urinary incontinence. *The Journal of urology.* 2010;183(1):241-6.

110. Stav K, Dwyer PL, Rosamilia A, Schierlitz L, Lim YN, Lee J. Midurethral sling procedures for stress urinary incontinence in women over 80 years. *Neurourol Urodyn.* 2010;29(7):1262-6.
111. Stav K, Dwyer PL, Rosamilia A, Schierlitz L, Lim YN, Lee J. Risk factors of treatment failure of midurethral sling procedures for women with urinary stress incontinence. *Int Urogynecol J.* 2010;21(2):149-55.
112. Sivaslioglu AA, Unlubilgin E, Keskin HL, Gelisen O, Dolen I. The management of recurrent cases after the Burch colposuspension: 7 years experience. *Arch Gynecol Obstet.* 2011;283(4):787-90.
113. Summitt R. Randomised comparison of laparoscopic and transabdominal Burch urethropexy for the treatment of genuine stress incontinence. (abstract only). *Obstet Gynecol.* 2000;94(4).
114. Summitt R. Randomized comparison of laparoscopic and transabdominal burch urethropexy for the treatment of genuine stress incontinence. *Obstet Gynecol.* 2000;95(4).
115. Carey M. Laparoscopic versus open colposuspension: a prospective multi-centre randomised single-blinded comparison (abstract only). *Neurourol Urodyn.* 2000;19(4):379-406.
116. Burton G. A three year prospective randomised urodynamic study comparing open and laparoscopic colposuspension(abstract only). *Neurourol Urodyn.* 1997;16(5):353-4
117. Tanuri AL, Feldner PC, Jr., Bella ZI, Castro RA, Sartori MG, Girao MJ. [Retropubic and transobturator sling in treatment of stress urinary incontinence]. *Rev Assoc Med Bras (1992).* 2010;56(3):348-54.
118. Teo R, Moran P, Mayne C, Tincello D. Randomized trial of tension-free vaginal tape and tension-free vaginal tape-obturator for urodynamic stress incontinence in women. *The Journal of urology.* 2011;185(4):1350-5.
119. Tong JL, Zhu L, Lang JH. [Effects of laparoscopic Burch colposuspension and tension-free vaginal tape in treatment of female stress urinary incontinence: a comparative study]. *Zhonghua Yi Xue Za Zhi.* 2008;88(45):3192-4.
120. Barr S, Reid FM, North CE, Hosker G, Smith AR. The long-term outcome of laparoscopic colposuspension: a 10-year cohort study. *Int Urogynecol J Pelvic Floor Dysfunct.* 2009;20(4):443-5.
121. Trabuco EC, Klingele CJ, Weaver AL, McGree ME, Lightner DJ, Gebhart JB. Preoperative and postoperative predictors of satisfaction after surgical treatment of stress urinary incontinence. *Am J Obstet Gynecol.* 2011;204(5):444 e1-6.
122. Tseng LH, Wang AC, Lin YH, Li SJ, Ko YJ. Randomized comparison of the suprapubic arc sling procedure vs tension-free vaginal taping for stress incontinent women. *Int Urogynecol J Pelvic Floor Dysfunct.* 2005;16(3):230-5.
123. Ulmsten U, Falconer C, Johnson P, Jomaa M, Lanner L, Nilsson CG, et al. A multicenter study of tension-free vaginal tape (TVT) for surgical treatment of stress urinary incontinence. *Int Urogynecol J Pelvic Floor Dysfunct.* 1998;9(4):210-3.
124. Ulmsten U, Henriksson L, Johnson P, Varhos G. An ambulatory surgical procedure under local anesthesia for treatment of female urinary incontinence. *Int Urogynecol J Pelvic Floor Dysfunct.* 1996;7(2):81-5; discussion 5-6.
125. Zacharin RF. The anatomic supports of the female urethra. *Obstet Gynecol.* 1968;32(6):754-9.
126. DeLancey J. Structural support of the urethra as it relates to stress urinary incontinence: the hammock hypothesis. *Am J Obstet Gynecol.* 1994;170(6):1713-201.
127. Huisman AB. Aspects on the anatomy of the female urethra with special relation to urinary continence. *Contributions to gynecology and obstetrics.* 1983;10:1-31.
128. Westby M, Asmussen M, Ulmsten U. Location of maximum intraurethral pressure related to urogenital diaphragm in the female subject as studied by simultaneous urethrocystometry and voiding urethrocytography. *Am J Obstet Gynecol.* 1982;144(4):408-12.
129. Asmussen M, Ulmsten U. On the physiology of continence and pathophysiology of stress incontinence in the female. *Contributions to gynecology and obstetrics.* 1983;10:32-50.
130. Nilsson CG. The tensionfree vaginal tape procedure (TVT) for treatment of female urinary incontinence. A minimal invasive surgical procedure. *Acta obstetrica et gynecologica Scandinavica Supplement.* 1998;168:34-7.
131. Ulmsten U, Johnson P, Rezapour M. A three-year follow up of tension free vaginal tape for surgical treatment of female stress urinary incontinence. *Br J Obstet Gynaecol.* 1999;106(4):345-50.

132. Nilsson CG, Kuuva N. The tension-free vaginal tape procedure is successful in the majority of women with indications for surgical treatment of urinary stress incontinence. *BJOG*. 2001;108(4):414-9.
133. Rezapour M, Ulmsten U. Tension-Free vaginal tape (TVT) in women with mixed urinary incontinence--a long-term follow-up. *Int Urogynecol J Pelvic Floor Dysfunct*. 2001;12 Suppl 2:S15-8.
134. Kuuva N, Nilsson CG. Tension-free vaginal tape procedure: an effective minimally invasive operation for the treatment of recurrent stress urinary incontinence? Gynecologic and obstetric investigation. 2003;56(2):93-8.
135. Ankardal M, Heiwall B, Lausten-Thomsen N, Carnelid J, Milsom I. Short- and long-term results of the tension-free vaginal tape procedure in the treatment of female urinary incontinence. *Acta obstetrica et gynecologica Scandinavica*. 2006;85(8):986-92.
136. Doo CK, Hong B, Chung BJ, Kim JY, Jung HC, Lee KS, et al. Five-year outcomes of the tension-free vaginal tape procedure for treatment of female stress urinary incontinence. *Eur Urol*. 2006;50(2):333-8.
137. Deffieux X, Donnadiu AC, Porcher R, Gerlaise A, Frydman R, Fernandez H. Long-term results of tension-free vaginal tape for female urinary incontinence: follow up over 6 years. *Int J Urol*. 2007;14(6):521-6.
138. Chene G, Amblard J, Tardieu AS, Escalona JR, Viallon A, Fattouh B, et al. Long-term results of tension-free vaginal tape (TVT) for the treatment of female urinary stress incontinence. *Eur J Obstet Gynecol Reprod Biol*. 2007;134(1):87-94.
139. Nilsson CG, Palva K, Rezapour M, Falconer C. Eleven years prospective follow-up of the tension-free vaginal tape procedure for treatment of stress urinary incontinence. *Int Urogynecol J Pelvic Floor Dysfunct*. 2008;19(8):1043-7.
140. Olsson I, Abrahamsson AK, Kroon UB. Long-term efficacy of the tension-free vaginal tape procedure for the treatment of urinary incontinence: a retrospective follow-up 11.5 years post-operatively. *Int Urogynecol J*. 2010;21(6):679-83.
141. Campeau L, Tu LM, Lemieux MC, Naud A, Karsenty G, Schick E, et al. A multicenter, prospective, randomized clinical trial comparing tension-free vaginal tape surgery and no treatment for the management of stress urinary incontinence in elderly women. *Neurourol Urodyn*. 2007;26(7):990-4.
142. El-Din Shawki H KH, El-Moghazy D, et al. The role of transobturator vaginal tape (TVT-O) and some traditional surgical interventions in the management of female genuine stress urinary incontinence--randomized controlled trial. *International Journal of Gynaecology and Obstetrics* 2012;119:S337.
143. Trabuco E KC, Blandon R, et al. A randomized comparison of incontinence procedures performed concomitantly with abdominal sacrocolpopexy: the Burch versus mid-urethral sling trial (Abstract number 689). *Neurology and Urodynamics* 2014;33(6):1005.
144. McCracken GR, Henderson NA, Ashe RG. Five year follow-up comparing tension-free vaginal tape and colposuspension. *The Ulster medical journal*. 2007;76(3):146-9.
145. Wu JY, He HC, Chen SW, Jin XD, Zhou YX. Surgical therapies of female stress urinary incontinence: experience in 228 cases. *Int Urogynecol J*. 2010;21(6):645-9.
146. Lapitan MC, Cody JD. Open retropubic colposuspension for urinary incontinence in women. *Cochrane Database Syst Rev*. 2012(6):CD002912.
147. Ward K, Hilton P. Prospective multicentre randomised trial of tension-free vaginal tape and colposuspension as primary treatment for stress incontinence. *BMJ*. 2002;325(7355):67.
148. Ward KL, Hilton P, Uk, Ireland TVTTG. A prospective multicenter randomized trial of tension-free vaginal tape and colposuspension for primary urodynamic stress incontinence: two-year follow-up. *Am J Obstet Gynecol*. 2004;190(2):324-31.
149. Ward KL, Hilton P, Uk, Ireland TVTTG. Tension-free vaginal tape versus colposuspension for primary urodynamic stress incontinence: 5-year follow up. *BJOG*. 2008;115(2):226-33.
150. Liapis A, Bakas P, Creatsas G. Burch colposuspension and tension-free vaginal tape in the management of stress urinary incontinence in women. *Eur Urol*. 2002;41(4):469-73.
151. Wang AC, Chen MC. Comparison of tension-free vaginal taping versus modified Burch colposuspension on urethral obstruction: a randomized controlled trial. *Neurourol Urodyn*. 2003;22(3):185-90.
152. El-Barky E, El-Shazly A, El-Wahab OA, Kehinde EO, Al-Hunayan A, Al-Awadi KA. Tension free vaginal tape versus Burch colposuspension for treatment of female stress urinary incontinence. *Int Urol Nephrol*. 2005;37(2):277-81.

153. Foote AJ, Maughan V, Carne C. Laparoscopic colposuspension versus vaginal suburethral slingplasty: a randomised prospective trial. *Aust N Z J Obstet Gynaecol.* 2006;46(6):517-20.
154. Ogah J, Cody JD, Rogerson L. Minimally invasive synthetic suburethral sling operations for stress urinary incontinence in women. *Cochrane Database Syst Rev.* 2009(4):CD006375.
155. Dean N, Herbison P, Ellis G, Wilson D. Laparoscopic colposuspension and tension-free vaginal tape: a systematic review. *BJOG.* 2006;113(12):1345-53.
156. Novara G, Artibani W, Barber MD, Chapple CR, Costantini E, Ficarra V, et al. Updated systematic review and meta-analysis of the comparative data on colposuspensions, pubovaginal slings, and midurethral tapes in the surgical treatment of female stress urinary incontinence. *Eur Urol.* 2010;58(2):218-38.
157. Dietz HP, Foote AJ, Mak HL, Wilson PD. TVT and Sparc suburethral slings: a case-control series. *Int Urogynecol J Pelvic Floor Dysfunct.* 2004;15(2):129-31; discussion 31.
158. Gandhi S, Abramov Y, Kwon C, Beaumont JL, Botros S, Sand PK, et al. TVT versus SPARC: comparison of outcomes for two midurethral tape procedures. *Int Urogynecol J Pelvic Floor Dysfunct.* 2006;17(2):125-30.
159. Kim WT, Kim KT, Kim JW, Choe JH, Lee JS, Seo JT. Comparative Study of the Tension-Free Vaginal Tape (TVT) Procedure and the Suprapubic Arc Sling (SPARC) Procedure for Treating Female Stress Urinary Incontinence: a 1-Year Follow-Up. *Korean J Urol.* 2006;47(4):397-401.
160. Paick JS, Oh SJ, Kim SW, Ku JH. Tension-free vaginal tape, suprapubic arc sling, and transobturator tape in the treatment of mixed urinary incontinence in women. *Int Urogynecol J Pelvic Floor Dysfunct.* 2008;19(1):123-9.
161. Agarwala N. A randomized comparison of two synthetic mid-urethral tension-free slings. *Uro-Today International Journal.* 2008;1(4).
162. Yoon CJ, Jung HC. Three-year outcomes of the innovative replacement of incontinence surgery procedure for treatment of female stress urinary incontinence: comparison with tension-free vaginal tape procedure. *J Korean Med Sci.* 2007;22(3):497-501.
163. Ford AA, Rogerson L, Cody JD, Ogah J. Mid-urethral sling operations for stress urinary incontinence in women. *Cochrane Database Syst Rev.* 2015(7):CD006375.
164. Rechberger T, Rzezniczuk K, Skorupski P, Adamiak A, Tomaszewski J, Baranowski W, et al. A randomized comparison between monofilament and multifilament tapes for stress incontinence surgery. *Int Urogynecol J Pelvic Floor Dysfunct.* 2003;14(6):432-6.
165. Andonian S, Chen T, St-Denis B, Corcos J. Randomized clinical trial comparing suprapubic arch sling (SPARC) and tension-free vaginal tape (TVT): one-year results. *Eur Urol.* 2005;47(4):537-41.
166. Lim YN, Muller R, Corstiaans A, Dietz HP, Barry C, Rane A. Suburethral slingplasty evaluation study in North Queensland, Australia: the SUSPEND trial. *Aust N Z J Obstet Gynaecol.* 2005;45(1):52-9.
167. Lord HE, Taylor JD, Finn JC, Tsokos N, Jeffery JT, Atherton MJ, et al. A randomized controlled equivalence trial of short-term complications and efficacy of tension-free vaginal tape and suprapubic urethral support sling for treating stress incontinence. *BJU international.* 2006;98(2):367-76.
168. Meschia M, Pifarotti P, Bernasconi F, Magatti F, Viganò R, Bertozzi R, et al. Tension-free vaginal tape (TVT) and intravaginal slingplasty (IVS) for stress urinary incontinence: a multicenter randomized trial. *Am J Obstet Gynecol.* 2006;195(5):1338-42.
169. Prien-Larsen JC, Hemmingsen L. Long-term outcomes of TVT and IVS operations for treatment of female stress urinary incontinence: monofilament vs. multifilament polypropylene tape. *Int Urogynecol J Pelvic Floor Dysfunct.* 2009;20(6):703-9.
170. Thubert T, Canel V, Vinchant M, Wigniolle I, Fernandez H, Deffieux X. Bladder injury and success rates following retropubic mid-urethral sling: TVT EXACT vs. TVT. *Eur J Obstet Gynecol Reprod Biol.* 2016;198:78-83.
171. Nambiar A, Cody JD, Jeffery ST. Single-incision sling operations for urinary incontinence in women. *Cochrane Database Syst Rev.* 2014;6:CD008709.
172. Madsen AM, El-Nashar SA, Woelk JL, Klingele CJ, Gebhart JB, Trabuco EC. A cohort study comparing a single-incision sling with a retropubic midurethral sling. *Int Urogynecol J.* 2014;25(3):351-8.
173. Ross S, Tang S, Schulz J, Murphy M, Goncalves J, Kaye S, et al. Single incision device (TVT Secur) versus retropubic tension-free vaginal tape device (TVT) for the management of stress urinary incontinence in women: a randomized clinical trial. *BMC Res Notes.* 2014;7:941.

174. Palomba S, Falbo A, Oppedisano R, Torella M, Materazzo C, Maiorana A, et al. A randomized controlled trial comparing three single-incision minislings for stress urinary incontinence. *Int Urogynecol J*. 2014;25(10):1333-41.
175. Basu M, Duckett J. Three-year results from a randomised trial of a retropubic mid-urethral sling versus the Miniarc single incision sling for stress urinary incontinence. *Int Urogynecol J*. 2013;24(12):2059-64.
176. Naumann G, Steetskamp J, Meyer M, Laterza R, Skala C, Albrich S, et al. Sexual function and quality of life following retropubic TVT and single-incision sling in women with stress urinary incontinence: results of a prospective study. *Arch Gynecol Obstet*. 2013;287(5):959-66.
177. Andrada Hamer M, Larsson PG, Teleman P, Bergqvist CE, Persson J. One-year results of a prospective randomized, evaluator-blinded, multicenter study comparing TVT and TVT Secur. *Int Urogynecol J*. 2013;24(2):223-9.
178. Barber MD, Weidner AC, Sokol AI, Amundsen CL, Jelovsek JE, Karram MM, et al. Single-incision mini-sling compared with tension-free vaginal tape for the treatment of stress urinary incontinence: a randomized controlled trial. *Obstet Gynecol*. 2012;119(2 Pt 1):328-37.
179. Wang AC. The techniques of trocar insertion and intraoperative urethrocytoscopy in tension-free vaginal taping: an experience of 600 cases. *Acta obstetrica et gynecologica Scandinavica*. 2004;83(3):293-8.
180. Tamussino KF, Hanzal E, Kolle D, Ralph G, Riss PA, Austrian Urogynecology Working G. Tension-free vaginal tape operation: results of the Austrian registry. *Obstet Gynecol*. 2001;98(5 Pt 1):732-6.
181. Delorme E. [Transobturator urethral suspension: mini-invasive procedure in the treatment of stress urinary incontinence in women]. *Prog Urol*. 2001;11(6):1306-13.
182. de Leval J. Novel surgical technique for the treatment of female stress urinary incontinence: transobturator vaginal tape inside-out. *Eur Urol*. 2003;44(6):724-30.
183. Costantini E, Kocjancic E, Lazzeri M, Giannantoni A, Zucchi A, Carbone A, et al. Long-term efficacy of the trans-obturator and retropubic mid-urethral slings for stress urinary incontinence: update from a randomized clinical trial. *World journal of urology*. 2016;34(4):585-93.
184. Brennand EA, Tang S, Williamson T, Birch C, Murphy M, Robert M, et al. Twelve-month outcomes following midurethral sling procedures for stress incontinence: impact of obesity. *BJOG*. 2015;122(12):1705-12.
185. Kenton K, Stoddard AM, Zyczynski H, Albo M, Rickey L, Norton P, et al. 5-year longitudinal followup after retropubic and transobturator mid urethral slings. *The Journal of urology*. 2015;193(1):203-10.
186. Cavkaytar S, Kokanali MK, Guzel AI, Ozer I, Aksakal OS, Doganay M. Comparison of TVT and TOT on urethral mobility and surgical outcomes in stress urinary incontinence with hypermobile urethra. *Eur J Obstet Gynecol Reprod Biol*. 2015;190:36-40.
187. Bohlin KS, Ankardal M, Pedroletti C, Lindkvist H, Milsom I. The influence of the modifiable lifestyle factors body mass index and smoking on the outcome of mid-urethral sling procedures for female urinary incontinence. *Int Urogynecol J*. 2015;26(3):343-51.
188. Jeong SJ, Lee HS, Lee JK, Jeong JW, Lee SC, Kim JH, et al. The long-term influence of body mass index on the success rate of mid-urethral sling surgery among women with stress urinary incontinence or stress-predominant mixed incontinence: comparisons between retropubic and transobturator approaches. *PLoS One*. 2014;9(11):e113517.
189. Laurikainen E, Valpas A, Aukee P, Kivela A, Rinne K, Takala T, et al. Five-year results of a randomized trial comparing retropubic and transobturator midurethral slings for stress incontinence. *Eur Urol*. 2014;65(6):1109-14.
190. Zyczkowski M, Nowakowski K, Kuczmik W, Urbanek T, Kaletka Z, Bryniarski P, et al. Tension-free vaginal tape, transobturator tape, and own modification of transobturator tape in the treatment of female stress urinary incontinence: comparative analysis. *Biomed Res Int*. 2014;2014:347856.
191. Albo ME, Litman HJ, Richter HE, Lemack GE, Sirls LT, Chai TC, et al. Treatment success of retropubic and transobturator mid urethral slings at 24 months. *The Journal of urology*. 2012;188(6):2281-7.
192. Ballester M, Bui C, Frobert JL, Grisard-Anaf M, Lienhart J, Fernandez H, et al. Four-year functional results of the suburethral sling procedure for stress urinary incontinence: a French prospective randomized multicentre study comparing the retropubic and transobturator routes. *World journal of urology*. 2012;30(1):117-22.
193. Ansquer Y, Marcollet A, Yazbeck C, Salomon L, Poncelet C, Thoury A, et al. The suburethral sling for female stress urinary incontinence: a retropubic or obturator approach? *J Am Assoc Gynecol Laparosc*. 2004;11(3):353-8.

194. Mellier G, Benayed B, Bretones S, Pasquier JC. Suburethral tape via the obturator route: is the TOT a simplification of the TVT? *Int Urogynecol J Pelvic Floor Dysfunct.* 2004;15(4):227-32.
195. Enzelsburger H HR, et al. TVT versus TOT-A prospective randomized study for the treatment of female stress urinary incontinence at a followup of 1 years. *Geburtshilfe and Frauenheilkunde.* 2005;65:506-11.
196. Liapis A, Bakas P, Christopoulos P, Giner M, Creatsas G. Tension-free vaginal tape for elderly women with stress urinary incontinence. *Int J Gynaecol Obstet.* 2006;92(1):48-51.
197. Morey AF, Medendorp AR, Noller MW, Mora RV, Shandera KC, Foley JP, et al. Transobturator versus transabdominal mid urethral slings: a multi-institutional comparison of obstructive voiding complications. *The Journal of urology.* 2006;175(3 Pt 1):1014-7.
198. Andonian S, St-Denis B, Lemieux MC, Corcos J. Prospective clinical trial comparing Obtape and DUPS to TVT: one-year safety and efficacy results. *Eur Urol.* 2007;52(1):245-51.
199. Darai E, Frobert JL, Grisard-Anaf M, Lienhart J, Fernandez H, Dubernard G, et al. Functional results after the suburethral sling procedure for urinary stress incontinence: a prospective randomized multicentre study comparing the retropubic and transobturator routes. *Eur Urol.* 2007;51(3):795-801; discussion -2.
200. Falkert A, Seelbach-Gobel B. TVT versus TOT for surgical treatment of female stress urinary incontinence. *Int J Gynaecol Obstet.* 2007;96(1):40-1.
201. Laurikainen E, Valpas A, Kivela A, Kalliola T, Rinne K, Takala T, et al. Retropubic compared with transobturator tape placement in treatment of urinary incontinence: a randomized controlled trial. *Obstet Gynecol.* 2007;109(1):4-11.
202. Rinne K, Laurikainen E, Kivela A, Aukee P, Takala T, Valpas A, et al. A randomized trial comparing TVT with TVT-O: 12-month results. *Int Urogynecol J Pelvic Floor Dysfunct.* 2008;19(8):1049-54.
203. Palva K, Rinne K, Aukee P, Kivela A, Laurikainen E, Takala T, et al. A randomized trial comparing tension-free vaginal tape with tension-free vaginal tape-obturator: 36-month results. *Int Urogynecol J.* 2010;21(9):1049-55.
204. Meschia M, Bertozzi R, Pifarotti P, Baccichet R, Bernasconi F, Guercio E, et al. Peri-operative morbidity and early results of a randomised trial comparing TVT and TVT-O. *Int Urogynecol J Pelvic Floor Dysfunct.* 2007;18(11):1257-61.
205. Porena M, Costantini E, Frea B, Giannantoni A, Ranzoni S, Mearini L, et al. Tension-free vaginal tape versus transobturator tape as surgery for stress urinary incontinence: results of a multicentre randomised trial. *Eur Urol.* 2007;52(5):1481-90.
206. Zhu L, Lang J, Hai N, Wong F. Comparing vaginal tape and transobturator tape for the treatment of mild and moderate stress incontinence. *Int J Gynaecol Obstet.* 2007;99(1):14-7.
207. Zullo MA, Plotti F, Calcagno M, Marullo E, Palaià I, Bellati F, et al. One-year follow-up of tension-free vaginal tape (TVT) and trans-obturator suburethral tape from inside to outside (TVT-O) for surgical treatment of female stress urinary incontinence: a prospective randomised trial. *Eur Urol.* 2007;51(5):1376-82; discussion 83-4.
208. Barber MD, Kleeman S, Karram MM, Paraiso MF, Walters MD, Vasavada S, et al. Transobturator tape compared with tension-free vaginal tape for the treatment of stress urinary incontinence: a randomized controlled trial. *Obstet Gynecol.* 2008;111(3):611-21.
209. Houwert RM, Renes-Zijl C, Vos MC, Vervest HA. TVT-O versus Monarc after a 2-4-year follow-up: a prospective comparative study. *Int Urogynecol J Pelvic Floor Dysfunct.* 2009;20(11):1327-33.
210. Rechberger T, Jankiewicz K, Adamiak A, Miotla P, Chrobak A, Jerzak M. Do preoperative cytokine levels offer a prognostic factor for polypropylene mesh erosion after suburethral sling surgery for stress urinary incontinence? *Int Urogynecol J Pelvic Floor Dysfunct.* 2009;20(1):69-74.
211. Wang W, Zhu L, Lang J. Transobturator tape procedure versus tension-free vaginal tape for treatment of stress urinary incontinence. *Int J Gynaecol Obstet.* 2009;104(2):113-6.
212. Wang YJ, Li FP, Wang Q, Yang S, Cai XG, Chen YH. Comparison of three mid-urethral tension-free tapes (TVT, TVT-O, and TVT-Secur) in the treatment of female stress urinary incontinence: 1-year follow-up. *International Urogynecology Journal.* 2011;22(11):1369-74.
213. Castillo-Pino E, Sasson A, Pons JE. Comparison of retropubic and transobturator tension-free vaginal implants for the treatment of stress urinary incontinence. *Int J Gynaecol Obstet.* 2010;110(1):23-6.
214. Duckett JR, Basu M. TVT vs TOT: a case controlled study in patients with mixed urodynamic stress incontinence and detrusor overactivity. *Int Urogynecol J.* 2010;21(7):763-6.

215. George S, Begum R, Thomas-Philip A, Thirumalakumar L, Sorinola O. Two-year comparison of tension-free vaginal tape and transobturator tape for female urinary stress incontinence. *Journal of obstetrics and gynaecology : the journal of the Institute of Obstetrics and Gynaecology*. 2010;30(3):281-4.
216. Krofta L, Feyereisl J, Otcenasek M, Velebil P, Kasikova E, Krcmar M. TVT and TVT-O for surgical treatment of primary stress urinary incontinence: prospective randomized trial. *Int Urogynecol J*. 2010;21(2):141-8.
217. Richter HE, Albo ME, Zyczynski HM, Kenton K, Norton PA, Sirls LT, et al. Retropubic versus transobturator midurethral slings for stress incontinence. *N Engl J Med*. 2010;362(22):2066-76.
218. Wang F, Song Y, Huang H. Prospective randomized trial of TVT and TOT as primary treatment for female stress urinary incontinence with or without pelvic organ prolapse in Southeast China. *Arch Gynecol Obstet*. 2010;281(2):279-86.
219. Brink DM. Bowel injury following insertion of tension-free vaginal tape. *S Afr Med J*. 2000;90(5):450, 2.
220. Kobashi KC, Govier FE. Perioperative complications: the first 140 polypropylene pubovaginal slings. *The Journal of urology*. 2003;170(5):1918-21.
221. Meschia M, Busacca M, Pifarotti P, De Marinis S. Bowel perforation during insertion of tension-free vaginal tape (TVT). *Int Urogynecol J Pelvic Floor Dysfunct*. 2002;13(4):263-5; discussion 5.
222. Costantini E, Lazzeri M, Giannantoni A, Bini V, del Zingaro M, Porena M. Preoperative MUCP and VLPP did not predict long-term (4-year) outcome after transobturator mid-urethral sling. *Urologia internationalis*. 2009;83(4):392-8.
223. Liapis A, Bakas P, Creatsas G. Efficacy of inside-out transobturator vaginal tape (TVTO) at 4 years follow up. *Eur J Obstet Gynecol Reprod Biol*. 2010;148(2):199-201.
224. Heinonen P, Ala-Nissila S, Raty R, Laurikainen E, Kiilholma P. Objective cure rates and patient satisfaction after the transobturator tape procedure during 6.5-year follow-up. *J Minim Invasive Gynecol*. 2013;20(1):73-8.
225. Chun JY, Song M, Yoo DS, Han JY, Hong B, Choo MS. A Comparative Study of Outside-In and Inside-Out Transobturator Tape Procedures for Female Stress Urinary Incontinence: 7-Year Outcomes. *Low Urin Tract Symptoms*. 2014;6(3):145-50.
226. Lienhart J, Vautherin R, Grisard-Anaf M, Frobert JL. [Seven-year follow-up of 331 I-Stop transobturator sling cases in female urinary incontinence treatment]. *Prog Urol*. 2014;24(12):750-6.
227. Yonguc T, Gunlusoy B, Degirmenci T, Kozacioglu Z, Bozkurt IH, Arslan B, et al. Are the outcomes of transobturator tape procedure for female stress urinary incontinence durable in long-term follow-up? *Int Urol Nephrol*. 2014;46(7):1295-300.
228. Yonguc T, Aydogdu O, Bozkurt IH, Degirmenci T, Polat S, Sen V, et al. Long-term outcomes of transobturator tape procedure in women with stress and mixed urinary incontinence: 5-year follow-up. *Minerva Urol Nefrol*. 2016;68(5):444-50.
229. Toz E, Balsak D, Basogul N, Ozdemir AA, Okay G, Apaydin N, et al. Outcomes of Transobturator Tape Surgery with Safyre T(R) Slings for Female Stress Urinary Incontinence after 96 Months of Follow-Up. *Gynecologic and obstetric investigation*. 2015.
230. Lo TS, Jaili S, Tan YL, Wu PY. Five-year follow-up study of Monarc transobturator tape for surgical treatment of primary stress urinary incontinence. *Int Urogynecol J*. 2016.
231. Pereira I, Valentim-Lourenco A, Castro C, Martins I, Henriques A, Ribeirinho AL. Incontinence surgery in obese women: comparative analysis of short- and long-term outcomes with a transobturator sling. *Int Urogynecol J*. 2016;27(2):247-53.
232. But I, Faganelj M. Complications and short-term results of two different transobturator techniques for surgical treatment of women with urinary incontinence: a randomized study. *Int Urogynecol J Pelvic Floor Dysfunct*. 2008;19(6):857-61.
233. Lee KS, Choo MS, Lee YS, Han JY, Kim JY, Jung BJ, et al. Prospective comparison of the 'inside-out' and 'outside-in' transobturator-tape procedures for the treatment of female stress urinary incontinence. *Int Urogynecol J Pelvic Floor Dysfunct*. 2008;19(4):577-82.
234. Liapis A, Bakas P, Creatsas G. Monarc vs TVT-O for the treatment of primary stress incontinence: a randomized study. *Int Urogynecol J Pelvic Floor Dysfunct*. 2008;19(2):185-90.
235. Abdel-Fattah M, Familusi A, Ramsay I, Ayansina D, Mostafa A. Preoperative determinants for failure of transobturator tapes in the management of female urodynamic stress incontinence. *Int J Gynaecol Obstet*. 2010;110(1):18-22.

236. Chen Z, Chen Y, Du GH, Yuan XY, Wu J, Zeng XY, et al. Comparison of three kinds of mid-urethral slings for surgical treatment of female stress urinary incontinence. *Urologia*. 2010;77(1):37-41; discussion 2.
237. Park YJ, Kim DY. Randomized controlled study of MONARC(R) vs. tension-free vaginal tape obturator (TVT-O(R)) in the treatment of female urinary incontinence: comparison of 3-year cure rates. *Korean J Urol*. 2012;53(4):258-62.
238. Scheiner DA, Betschart C, Wiederkehr S, Seifert B, Fink D, Perucchini D. Twelve months effect on voiding function of retropubic comparison with outside-in and inside-out transobturator midurethral slings. *Int Urogynecol J*. 2012;23(2):197-206.
239. Hassan S AH. Randomized comparative study between inside-out transobturator tape and outside-in transobturator tape for urodynamic stress incontinence *Neurology and Urodynamics*. 2013;32(7):777.
240. A P. Randomized controlled trial of transvaginal tension-free vaginal tape-obturator (TVT-O) versus Monarc in treatment of urodynamic stress incontinence. . ISRCTN (<http://isrctn.org/ISSRCTN71562338>) 2006 (:ISRCTN71562338: srincont62312). 2006.
241. Abdel-fattah M, Ramsay I, Pringle S, Hardwick C, Ali H. Evaluation of transobturator tapes (E-TOT) study: randomised prospective single-blinded study comparing inside-out vs. outside-in transobturator tapes in management of urodynamic stress incontinence: short term outcomes. *Eur J Obstet Gynecol Reprod Biol*. 2010;149(1):106-11.
242. Abdel-Fattah M, Ramsay I, Pringle S, Hardwick C, Ali H, Young D, et al. Randomised prospective single-blinded study comparing 'inside-out' versus 'outside-in' transobturator tapes in the management of urodynamic stress incontinence: 1-year outcomes from the E-TOT study. *BJOG*. 2010;117(7):870-8.
243. Abdel-Fattah M, Ramsay I, Pringle S, Hardwick C, Ali H, Young D, et al. Evaluation of transobturator tension-free vaginal tapes in management of women with recurrent stress urinary incontinence. *Urology*. 2011;77(5):1070-5.
244. Abdel-fattah M, Mostafa A, Young D, Ramsay I. Evaluation of transobturator tension-free vaginal tapes in the management of women with mixed urinary incontinence: one-year outcomes. *Am J Obstet Gynecol*. 2011;205(2):150 e1-6.
245. Mostafa A, Madhuvrata P, Abdel-Fattah M. Preoperative urodynamic predictors of short-term voiding dysfunction following a transobturator tension-free vaginal tape procedure. *Int J Gynaecol Obstet*. 2011;115(1):49-52.
246. Abdel-Fattah M, Mostafa A, Familusi A, Ramsay I, N'Dow J. Prospective randomised controlled trial of transobturator tapes in management of urodynamic stress incontinence in women: 3-year outcomes from the Evaluation of Transobturator Tapes study. *Eur Urol*. 2012;62(5):843-51.
247. Abdel-Fattah M, Hopper LR, Mostafa A. Evaluation of transobturator tension-free vaginal tapes in the surgical management of mixed urinary incontinence: 3-year outcomes of a randomized controlled trial. *The Journal of urology*. 2014;191(1):114-9.
248. Madhuvrata P, Riad M, Ammembal MK, Agur W, Abdel-Fattah M. Systematic review and meta-analysis of "inside-out" versus "outside-in" transobturator tapes in management of stress urinary incontinence in women. *Eur J Obstet Gynecol Reprod Biol*. 2012;162(1):1-10.
249. Sentilhes L, Berthier A, Caremel R, Loisel C, Marpeau L, Grise P. Sexual function after transobturator tape procedure for stress urinary incontinence. *Urology*. 2008;71(6):1074-9.
250. Narin R, Nazik H, Narin MA, Aytan H, Api M. An evaluation of the effects of the transobturator tape procedure on sexual satisfaction in women with stress urinary incontinence using the libido scoring system. *ISRN Obstet Gynecol*. 2013;2013:627671.
251. Kamalak Z, Kosus A, Hizli F, Kosus N, Hizli D, Kafali H. Does quality of female sexual function improve after a transobturator tape procedure? *Journal of obstetrics and gynaecology : the journal of the Institute of Obstetrics and Gynaecology*. 2014;34(6):512-4.
252. Paul F, Rajagopalan S, Doddamani SC, Mottemmal R, Joseph S, Bhat S. Effect of midurethral sling (transobturator tape) surgery on female sexual function. *Indian J Urol*. 2015;31(2):120-4.
253. Brito LG, Rodrigues HL, Carvalho MA, Magnani PS, Lopes AH, Sabino-de-Freitas MM. Comparison of the efficacy and safety of surgical procedures utilizing autologous fascial and transobturator slings in patients with stress urinary incontinence. *J Reprod Med*. 2013;58(1-2):19-24.

254. Cho S LS, Kim K, et al A sequential comparison of postoperative voiding pattern and uroflowmetry between two transobturator midurethral tape procedures (Monarc(trademark) and TOT (trademark) (Abstract number 750). Joint Meeting of the International Continence Society (ICS) and the International Urogynecological Association; August 23-27, 2010; Toronto, Canada2010.
255. Elbadry M SA, Gabre A. Adjustable versus ordinary trans-obturator tape fo rfemale stress incontinence...is there a difference? A randomized trial (aBstract number MP7509). *The Journal of urology*. 2014;191(4 Suppl !):2876.
256. Rechberger T, Futyra K, Jankiewicz K, Adamiak A, Bogusiewicz M, Bartuzi A, et al. Tape fixation: an important surgical step to improve success rate of anti-incontinence surgery. *The Journal of urology*. 2011;186(1):180-4.
257. Paparella R, Marturano M, Pelino L, Scarpa A, Scambia G, La Torre G, et al. Prospective randomized trial comparing synthetic vs biological out-in transobturator tape: a mean 3-year follow-up study. *Int Urogynecol J*. 2010;21(11):1327-36.
258. Ugurlucan FG, Erkan HA, Onal M, Yalcin O. Randomized trial of graft materials in transobturator tape operation: biological versus synthetic. *Int Urogynecol J*. 2013;24(8):1315-23.
259. de Leval J, Thomas A, Waltregny D. The original versus a modified inside-out transobturator procedure: 1-year results of a prospective randomized trial. *Int Urogynecol J*. 2011;22(2):145-56.
260. Juang CM, Yu KJ, Chou P, Yen MS, Twu NF, Horng HC, et al. Efficacy analysis of trans-obturator tension-free vaginal tape (TVT-O) plus modified Ingelman-Sundberg procedure versus TVT-O alone in the treatment of mixed urinary incontinence: a randomized study. *Eur Urol*. 2007;51(6):1671-8; discussion 9.
261. Tommaselli GA, Formisano C, Di Carlo C, Fabozzi A, Nappi C. Effects of a modified technique for TVT-O positioning on postoperative pain: single-blind randomized study. *Int Urogynecol J*. 2012;23(9):1293-9.
262. Zhang Y, Jiang M, Tong XW, Fan BZ, Li HF, Chen XL. The comparison of an inexpensive-modified transobturator vaginal tape versus TVT-O procedure for the surgical treatment of female stress urinary incontinence. *Taiwan J Obstet Gynecol*. 2011;50(3):318-21.
263. Ciftci S, Ozkurkcugil C, Ustuner M, Yilmaz H, Yavuz U, Gulecen T. Comparison of transobturator tape surgery using commercial and hand made slings in women with stress urinary incontinence. *Urol J*. 2015;12(2):2090-4.
264. Ignjatovic I, Potic M, Basic D, Dinic L, Medojevic N, Laketic D, et al. Self-created transobturator tape treatment of stress urinary incontinence without prior urodynamic investigation. *Eur J Obstet Gynecol Reprod Biol*. 2014;182:76-80.
265. Linder BJ, Elliott DS. Autologous Transobturator Urethral Sling Placement for Female Stress Urinary Incontinence: Short-term Outcomes. *Urology*. 2016;93:55-9.
266. Sabadell J, Larrain F, Gracia-Perez-Bonfils A, Montero-Armengol A, Salicru S, Gil-Moreno A, et al. Comparative study of polyvinylidene fluoride and polypropylene suburethral slings in the treatment of female stress urinary incontinence. *The journal of obstetrics and gynaecology research*. 2016;42(3):291-6.
267. Costantini E LM, Giannantoni A, et al Preoperative Valsalva Leak Point Pressure May not Predict Outcome of Mid-Urethral Slings. Analysis from a Randomized Controlled Trial of Retropubic versus Transobturator Mid-Urethral Slings. *Int Braz J Urol*. 2008;34(1):73-83.
268. Ryu JG, Yu SH, Jeong SH, Yun BH, Yu HS, Kim SO, et al. Transobturator tape for female stress urinary incontinence: preoperative valsalva leak point pressure is not related to cure rate or quality of life improvement. *Korean J Urol*. 2014;55(4):265-9.
269. Guerette NL, Bena JF, Davila GW. Transobturator slings for stress incontinence: using urodynamic parameters to predict outcomes. *Int Urogynecol J Pelvic Floor Dysfunct*. 2008;19(1):97-102.
270. Van Baelen AA, Delaere KP. Repeat transobturator tape after failed mid-urethral sling procedure: follow-up with questionnaire-based assessment. *Urologia internationalis*. 2009;83(4):399-403.
271. Bakali E, Buckley BS, Hilton P, Tincello DG. Treatment of recurrent stress urinary incontinence after failed minimally invasive synthetic suburethral tape surgery in women. *Cochrane Database Syst Rev*. 2013(2):CD009407.
272. Giarenis I, Thiagamoorthy G, Zacche M, Robinson D, Cardozo L. Management of recurrent stress urinary incontinence after failed midurethral sling: a survey of members of the International Urogynecological Association (IUGA). *Int Urogynecol J*. 2015;26(9):1285-91.
273. Zimmern PE, Gormley EA, Stoddard AM, Lukacz ES, Sirls L, Brubaker L, et al. Management of recurrent stress urinary incontinence after burch and sling procedures. *Neurourol Urodyn*. 2016;35(3):344-8.

274. Habibi JR, Petrossian A, Rapp DE. Effect of Transobturator Midurethral Sling Placement on Urgency and Urge Incontinence: 1-Year Outcomes. *Female Pelvic Med Reconstr Surg.* 2015;21(5):283-6.
275. Lee SK, Kang HW, Kim WT, Kim YJ, Yun SJ, Lee SC, et al. Impact of transobturator tape treatment on overactive bladder symptoms, particularly nocturia, in patients with mixed urinary incontinence. *Korean J Urol.* 2014;55(8):520-6.
276. Presthus JB, Van Drie D, Graham C. MiniArc single-incision sling in the office setting. *J Minim Invasive Gynecol.* 2012;19(3):331-8.
277. Khandwala S, Jayachandran C. TVT-Secur in office sling procedure under local anesthesia: a prospective 2-year analysis. *Female Pelvic Med Reconstr Surg.* 2012;18(4):233-8.
278. Novara G, Galfano A, Boscolo-Berto R, Secco S, Cavalleri S, Ficarra V, et al. Complication rates of tension-free midurethral slings in the treatment of female stress urinary incontinence: A systematic review and meta-analysis of randomized controlled trials comparing tension-free midurethral tapes to other surgical procedures and different devices. *European Urology.* 2008;53(2):288-309.
279. Andrada Hamer M, Larsson PG, Teleman P, Eten-Bergqvist C, Persson J. Short-term results of a prospective randomized evaluator blinded multicenter study comparing TVT and TVT-Secur. *Int Urogynecol J.* 2011;22(7):781-7.
280. Cornu JN, Sebe P, Peyrat L, Ciofu C, Cussenot O, Haab F. Midterm prospective evaluation of TVT-Secur reveals high failure rate. *Eur Urol.* 2010;58(1):157-61.
281. Basu M, Duckett J. A randomised trial of a retropubic tension-free vaginal tape versus a minisling for stress incontinence. *Bjog-Int J Obstet Gy.* 2010;117(6):730-5.
282. Mostafa A, Lim CP, Hopper L, Madhuvrata P, Abdel-Fattah M. Single-Incision Mini-Slings Versus Standard Midurethral Slings in Surgical Management of Female Stress Urinary Incontinence: An Updated Systematic Review and Meta-analysis of Effectiveness and Complications. *European Urology.* 2014;65(2):402-27.
283. Oliveira R, Botelho F, Silva P, Resende A, Silva C, Dinis P, et al. Exploratory study assessing efficacy and complications of TVT-O, TVT-Secur, and Mini-Arc: results at 12-month follow-up. *Eur Urol.* 2011;59(6):940-4.
284. Hinoul P, Vervest HAM, den Boon J, Venema PL, Lakeman MM, Milani AL, et al. A Randomized, Controlled Trial Comparing an Innovative Single Incision Sling With an Established Transobturator Sling to Treat Female Stress Urinary Incontinence. *J Urology.* 2011;185(4):1356-62.
285. Hota LS, Hanaway K, Hacker MR, Disciullo A, Elkadry E, Dramitinos P, et al. TVT-Secur (Hammock) versus TVT-Obturator: a randomized trial of suburethral sling operative procedures. *Female Pelvic Med Reconstr Surg.* 2012;18(1):41-5.
286. Abdelwahab O SI, Al-Adl AM. Tension-Free Vaginal Tape versus Secure Tension-Free Vaginal Tape in Treatment of Female Stress Urinary Incontinence. *Current Urology.* 2010;4(2):93-8.
287. De Ridder D, Berkers J, Deprest J, Verguts J, Ost D, Hamid D, et al. Single incision mini-sling versus a transobturator sling: a comparative study on MiniArc and Monarc slings. *Int Urogynecol J.* 2010;21(7):773-8.
288. Amat ITL, Martinez Franco E, Lailla Vicens JM. Contasure-Needleless compared with transobturator-TVT for the treatment of stress urinary incontinence. *Int Urogynecol J.* 2011;22(7):827-33.
289. Schellart RP, Rengerink KO, Van der Aa F, Lucot JP, Kimpe B, de Ridder DJMK, et al. A Randomized Comparison of a Single-incision Midurethral Sling and a Transobturator Midurethral Sling in Women with Stress Urinary Incontinence: Results of 12-mo Follow-up. *European Urology.* 2014;66(6):1179-85.
290. Jurakova M, Huser M, Belkov I, Janku P, Hudecek R, Stourac P, et al. Prospective randomized comparison of the transobturator mid-urethral sling with the single-incision sling among women with stress urinary incontinence: 1-year follow-up study. *Int Urogynecol J.* 2015.
291. Martinez Franco E, Amat Tardiu L. Contasure-Needleless(R) single incision sling compared with transobturator TVT-O(R) for the treatment of stress urinary incontinence: long-term results. *Int Urogynecol J.* 2015;26(2):213-8.
292. Lee JK, Rosamilia A, Dwyer PL, Lim YN, Muller R. Randomized trial of a single incision versus an outside-in transobturator midurethral sling in women with stress urinary incontinence: 12 month results. *Am J Obstet Gynecol.* 2015;213(1):35 e1-9.

293. Schellart RP, Rengerink KO, Van der Aa F, Lucot JP, Kimpe B, Dijkgraaf MG, et al. A randomised comparison of single-incision versus traditional transobturator midurethral sling in women with stress urinary incontinence: results of a 24-month follow-up. *Int Urogynecol J*. 2015.
294. Schweitzer KJ, Milani AL, van Eijndhoven HWF, Gietelink DA, Hallensleben E, Cromheecke GJ, et al. Postoperative Pain After Adjustable Single-Incision or Transobturator Sling for Incontinence A Randomized Controlled Trial. *Obstetrics and Gynecology*. 2015;125(1):27-34.
295. Schellart RP, Oude Rengerink K, Van der Aa F, Lucot JP, Kimpe B, Dijkgraaf MG, et al. A randomised comparison of single-incision versus traditional transobturator midurethral sling in women with stress urinary incontinence: results of a 24-month follow-up. *Int Urogynecol J*. 2016;27(6):871-7.
296. Xin X, Song Y, Xia ZJ. A comparison between adjustable single-incision sling and tension-free vaginal tape-obturator in treating stress urinary incontinence. *Archives of Gynecology and Obstetrics*. 2016;293(2):457-63.
297. Masata J, Svabik K, Zvara K, Hubka P, Toman A, Martan A. Comparison of the efficacy of tension-free vaginal tape obturator (TVT-O) and single-incision tension-free vaginal tape (Ajust) in the treatment of female stress urinary incontinence: a 1-year follow-up randomized trial. *Int Urogynecol J*. 2016.
298. Jurakova M, Huser M, Belkov I, Janku P, Hudecek R, Stourac P, et al. Prospective randomized comparison of the transobturator mid-urethral sling with the single-incision sling among women with stress urinary incontinence: 1-year follow-up study. *Int Urogynecol J*. 2016;27(5):791-6.
299. Administration. USFaD. Considerations about surgical mesh for SUI. [Available from: [http://www.fda.gov/Medical Devices/Products and Medical Procedures/Implants and Prosthetics/UroGyn Surgical Mess/ucm345219.htm](http://www.fda.gov/Medical Devices/Products and Medical Procedures/Implants and Prosthetics/UroGyn Surgical Mesh/ucm345219.htm)].
300. Patel H, Ostergard DR, Sternschuss G. Polypropylene mesh and the host response. *Int Urogynecol J*. 2012;23(6):669-79.
301. Ostergard DR, Azadi A. To mesh or not to mesh with polypropylene: does carcinogenesis in animals matter? *Int Urogynecol J*. 2014;25(5):569-71.
302. Moalli P, Brown B, Reitman MT, Nager CW. Polypropylene mesh: evidence for lack of carcinogenicity. *Int Urogynecol J*. 2014;25(5):573-6.
303. Jackson SR, Avery NC, Tarlton JF, Eckford SD, Abrams P, Bailey AJ. Changes in metabolism of collagen in genitourinary prolapse. *Lancet*. 1996;347(9016):1658-61.
304. Pascual G, Rodriguez M, Gomez-Gil V, Garcia-Honduvilla N, Bujan J, Bellon JM. Early tissue incorporation and collagen deposition in lightweight polypropylene meshes: bioassay in an experimental model of ventral hernia. *Surgery*. 2008;144(3):427-35.
305. Gorbet MB, Sefton MV. Biomaterial-associated thrombosis: roles of coagulation factors, complement, platelets and leukocytes. *Biomaterials*. 2004;25(26):5681-703.
306. Tang L, Jennings TA, Eaton JW. Mast cells mediate acute inflammatory responses to implanted biomaterials. *Proc Natl Acad Sci U S A*. 1998;95(15):8841-6.
307. Brodbeck WG, Voskerician G, Ziats NP, Nakayama Y, Matsuda T, Anderson JM. In vivo leukocyte cytokine mRNA responses to biomaterials are dependent on surface chemistry. *J Biomed Mater Res A*. 2003;64(2):320-9.
308. Blanchard KT, Barthel C, French JE, Holden HE, Moretz R, Pack FD, et al. Transponder-induced sarcoma in the heterozygous p53+/- mouse. *Toxicol Pathol*. 1999;27(5):519-27.
309. Vollmar J, Ott G. [Experimental tumor induction by plastics from a surgical point of view]. *Langenbecks Arch Klin Chir Ver Dtsch Z Chir*. 1961;298:729-35.
310. Witherspoon P, Bryson G, Wright DM, Reid R, O'Dwyer PJ. Carcinogenic potential of commonly used hernia repair prostheses in an experimental model. *Br J Surg*. 2004;91(3):368-72.
311. Williams DF. Carcinogenicity of implantable materials: experimental and epidemiological evidence. *Int Urogynecol J*. 2014;25(5):577-80.
312. Weber A SA, Springer E , et al. Biomaterial-induced sarcomagenesis is not associated with microsatellite instability. *Virchows Arch*. 2009;454(2):195-201.
313. Moore GE, Palmer WN. Money causes cancer: ban it. *JAMA*. 1977;238(5):397.
314. Deapen D. Breast implants and breast cancer: a review of incidence, detection, mortality, and survival. *Plast Reconstr Surg*. 2007;120(7 Suppl 1):70S-80S.
315. Williams GM, Caldwell J, Armstrong D, Bartsch H, Bevan R, Browne RW, et al. Multicenter study to assess potential hazards from exposure to lipid peroxidation products in soya bean oil from Trilucent breast implants. *Regul Toxicol Pharmacol*. 2009;53(2):107-20.

316. King AB, Zampini A, Vasavada S, Moore C, Rackley RR, Goldman HB. Is there an association between polypropylene midurethral slings and malignancy? *Urology*. 2014;84(4):789-92.
317. Birolini C, Minossi JG, Lima CF, Utiyama EM, Rasslan S. Mesh cancer: long-term mesh infection leading to squamous-cell carcinoma of the abdominal wall. *Hernia*. 2014;18(6):897-901.
318. Lin HZ, Wu FM, Low JJ, Venkateswaran K, Ng RK. A first reported case of clear cell carcinoma associated with delayed extrusion of midurethral tape. *Int Urogynecol J*. 2016;27(3):377-80.
319. Goldman HB, Dwyer PL. Polypropylene mesh slings and cancer: An incidental finding or association? *Int Urogynecol J*. 2016;27(3):345-6.
320. Thames SF, White JB, Ong KL. The myth: in vivo degradation of polypropylene-based meshes. *Int Urogynecol J*. 2016.
321. Kirchin V, Page T, Keegan PE, Atiemo K, Cody JD, McClinton S. Urethral injection therapy for urinary incontinence in women. *Cochrane Database Syst Rev*. 2012(2):CD003881.
322. Mohr S, Siegenthaler M, Mueller MD, Kuhn A. Bulking agents: an analysis of 500 cases and review of the literature. *Int Urogynecol J*. 2013;24(2):241-7.
323. Griffin MA, Janosek-Albright KJ, Diaz-Insua M, Elshatanoufy S, Atiemo HO. Quality of life outcomes in peri-urethral calcium hydroxylapatite injection. *Int Urogynecol J*. 2016.
324. Ghoniem G, Corcos J, Comiter C, Westney OL, Herschorn S. Durability of urethral bulking agent injection for female stress urinary incontinence: 2-year multicenter study results. *The Journal of urology*. 2010;183(4):1444-9.
325. Ghoniem G, Corcos J, Comiter C, Bernhard P, Westney OL, Herschorn S. Cross-linked polydimethylsiloxane injection for female stress urinary incontinence: results of a multicenter, randomized, controlled, single-blind study. *The Journal of urology*. 2009;181(1):204-10.
326. Ghoniem GM, Miller CJ. A systematic review and meta-analysis of Macropastique for treating female stress urinary incontinence. *Int Urogynecol J*. 2013;24(1):27-36.
327. Lose G, Sorensen HC, Axelsen SM, Falconer C, Lobodasch K, Safwat T. An open multicenter study of polyacrylamide hydrogel (Bulkamid(R)) for female stress and mixed urinary incontinence. *Int Urogynecol J*. 2010;21(12):1471-7.
328. Toozs-Hobson P, Al-Singary W, Fynes M, Tegerstedt G, Lose G. Two-year follow-up of an open-label multicenter study of polyacrylamide hydrogel (Bulkamid(R)) for female stress and stress-predominant mixed incontinence. *Int Urogynecol J*. 2012;23(10):1373-8.
329. Pai A, Al-Singary W. Durability, safety and efficacy of polyacrylamide hydrogel (Bulkamid((R))) in the management of stress and mixed urinary incontinence: three year follow up outcomes. *Cent European J Urol*. 2015;68(4):428-33.
330. Beraru A, Droupy S, Wagner L, Soustelle L, Muyschondt C, Ben Naoum K, et al. [Efficacy of periurethral injections of polyacrylamide hydrogel (Bulkamid((R))) and quality of life of patients with urinary incontinence due to sphincter deficiency (IUE-IS)]. *Prog Urol*. 2014;24(8):501-10.
331. Mouritsen L, Lose G, Moller-Bek K. Long-term follow-up after urethral injection with polyacrylamide hydrogel for female stress incontinence. *Acta obstetrica et gynecologica Scandinavica*. 2014;93(2):209-12.
332. Kasi AD, Pergialiotis V, Perrea DN, Khunda A, Doumouchtsis SK. Polyacrylamide hydrogel (Bulkamid(R)) for stress urinary incontinence in women: a systematic review of the literature. *Int Urogynecol J*. 2016;27(3):367-75.
333. Zajda J, Farag F. Urolastic-a new bulking agent for the treatment of women with stress urinary incontinence: outcome of 12 months follow up. *Adv Urol*. 2013;2013:724082.
334. Zajda J, Farag F. Urolastic for the treatment of women with stress urinary incontinence: 24-month follow-up. *Cent European J Urol*. 2015;68(3):334-8.
335. Phe V, Nguyen K, Roupret M, Cardot V, Parra J, Chartier-Kastler E. A systematic review of the treatment for female stress urinary incontinence by ACT(R) balloon placement (Uromedica, Irvine, CA, USA). *World journal of urology*. 2014;32(2):495-505.
336. Billault C, Chartier-Kastler E, Roupret M, Robain G, Phe V. Functional outcomes of adjustable continence therapy (ACT) balloons in women aged >80 years and suffering from stress urinary incontinence caused by intrinsic sphincter deficiency. *World journal of urology*. 2015;33(11):1897-903.
337. Lightner D, Rovner E, Corcos J, Payne C, Brubaker L, Drutz H, et al. Randomized controlled multisite trial of injected bulking agents for women with intrinsic sphincter deficiency: mid-urethral injection of ZuideX via the Implacer versus proximal urethral injection of Contigen cystoscopically. *Urology*. 2009;74(4):771-5.

338. Sokol ER, Karram MM, Dmochowski R. Efficacy and safety of polyacrylamide hydrogel for the treatment of female stress incontinence: a randomized, prospective, multicenter North American study. *The Journal of urology*. 2014;192(3):843-9.
339. Matsuoka PK, Locali RF, Pacetta AM, Baracat EC, Haddad JM. The efficacy and safety of urethral injection therapy for urinary incontinence in women: a systematic review. *Clinics (Sao Paulo)*. 2016;71(2):94-100.
340. Vecchioli-Scaldazza CV, Smaali C, Morosetti C, Azizi B, Giannubilo W, Ferrara V. Polyacrylamide hydrogel (bulkamid(R)) in female patients of 80 or more years with urinary incontinence. *Int Braz J Urol*. 2014;40(1):37-43.
341. Hansen MF, Lose G, Kesmodel US, Gradel KO. Repeat surgery after failed midurethral slings: a nationwide cohort study, 1998-2007. *Int Urogynecol J*. 2016;27(7):1013-9.
342. Lee HN, Lee YS, Han JY, Jeong JY, Choo MS, Lee KS. Transurethral injection of bulking agent for treatment of failed mid-urethral sling procedures. *Int Urogynecol J*. 2010;21(12):1479-83.
343. Zivanovic I, Rautenberg O, Lobodasch K, von Bunau G, Walser C, Viereck V. Urethral bulking for recurrent stress urinary incontinence after midurethral sling failure. *Neurourol Urodyn*. 2016.
344. Martan A, Masata J, Svabik K, Krhut J. Transurethral injection of polyacrylamide hydrogel (Bulkamid((R))) for the treatment of female stress or mixed urinary incontinence. *Eur J Obstet Gynecol Reprod Biol*. 2014;178:199-202.
345. Futyma K, Miotla P, Galczynski K, Baranowski W, Doniec J, Wodzislawska A, et al. An Open Multicenter Study of Clinical Efficacy and Safety of Urolastic, an Injectable Implant for the Treatment of Stress Urinary Incontinence: One-Year Observation. *Biomed Res Int*. 2015;2015:851823.
346. Gaddi A, Guaderrama N, Bassiouni N, Bechuk J, Whitcomb EL. Repeat midurethral sling compared with urethral bulking for recurrent stress urinary incontinence. *Obstet Gynecol*. 2014;123(6):1207-12.
347. Nikolopoulos KI, Betschart C, Doumouchtsis SK. The surgical management of recurrent stress urinary incontinence: a systematic review. *Acta obstetrica et gynecologica Scandinavica*. 2015;94(6):568-76.
348. Krhut J, Martan A, Jurakova M, Nemec D, Masata J, Zvara P. Treatment of stress urinary incontinence using polyacrylamide hydrogel in women after radiotherapy: 1-year follow-up. *Int Urogynecol J*. 2016;27(2):301-5.
349. Farag F, Koens M, Sievert KD, De Ridder D, Feitz W, Heesakkers J. Surgical treatment of neurogenic stress urinary incontinence: A systematic review of quality assessment and surgical outcomes. *Neurourol Urodyn*. 2016;35(1):21-5.
350. Riachy E, Defoor WR, Reddy PP, Alam S, Noh PH, Sheldon C, et al. Endoscopic treatment with dextranomer/hyaluronic acid for persistent incontinence after continent urinary reconstruction. *J Endourol*. 2015;29(2):137-40.
351. Malabarey O, Walter JE. Collagenoma and voiding dysfunction as complications of periurethral bulking. *Int Urogynecol J*. 2015;26(7):1077-8.
352. Crites MA, Ghoniem GM. Bladder mass "collagenoma". *Int Urogynecol J*. 2011;22(5):621-3.
353. Kumar D, Kaufman MR, Dmochowski RR. Case reports: periurethral bulking agents and presumed urethral diverticula. *Int Urogynecol J*. 2011;22(8):1039-43.
354. Gopinath D, Smith AR, Reid FM. Periurethral abscess following polyacrylamide hydrogel (Bulkamid) for stress urinary incontinence. *Int Urogynecol J*. 2012;23(11):1645-8.
355. Lightner DJ, Fox J, Klingele C. Cystoscopic injections of dextranomer hyaluronic acid into proximal urethra for urethral incompetence: efficacy and adverse outcomes. *Urology*. 2010;75(6):1310-4.
356. Roupret M, Misrai V, Vaessen C, Cardot V, Cour F, Richard F, et al. Laparoscopic approach for artificial urinary sphincter implantation in women with intrinsic sphincter deficiency incontinence: a single-centre preliminary experience. *Eur Urol*. 2010;57(3):499-504.
357. Mandron E, Bryckaert PE, Papatsoris AG. Laparoscopic artificial urinary sphincter implantation for female genuine stress urinary incontinence: technique and 4-year experience in 25 patients. *BJU international*. 2010;106(8):1194-8; discussion 8.
358. Vayleux B, Rigaud J, Luyckx F, Karam G, Glemain P, Bouchot O, et al. Female urinary incontinence and artificial urinary sphincter: study of efficacy and risk factors for failure and complications. *Eur Urol*. 2011;59(6):1048-53.
359. Costa P, Poinas G, Ben Naoum K, Bouzoubaa K, Wagner L, Soustelle L, et al. Long-term results of artificial urinary sphincter for women with type III stress urinary incontinence. *Eur Urol*. 2013;63(4):753-8.

360. Chung E, Navaratnam A, Cartmill RA. Can artificial urinary sphincter be an effective salvage option in women following failed anti-incontinence surgery? *Int Urogynecol J*. 2011;22(3):363-6.
361. Revaux A, Roupret M, Seringe E, Misrai V, Cour F, Chartier-Kastler E. Is the implantation of an artificial urinary sphincter with a large cuff in women with severe urinary incontinence associated with worse perioperative complications and functional outcomes than usual? *Int Urogynecol J*. 2011;22(10):1319-24.
362. Chartier-Kastler E, Van Kerrebroeck P, Olianas R, Cosson M, Mandron E, Delorme E, et al. Artificial urinary sphincter (AMS 800) implantation for women with intrinsic sphincter deficiency: a technique for insiders? *BJU international*. 2011;107(10):1618-26.
363. Richard F, Committee on Women's U, pelviperineology FAoU. [Guidelines for the treatment of non-neurological urinary incontinence in women using the artificial urinary sphincter]. *Prog Urol*. 2010;20 Suppl 2:S155-60.
364. Lovatsis D, Easton W, Wilkie D, Society of O, Gynaecologists of Canada Urogynaecology C. Guidelines for the evaluation and treatment of recurrent urinary incontinence following pelvic floor surgery. *J Obstet Gynaecol Can*. 2010;32(9):893-904.
365. Phe V, Leon P, Granger B, Denys P, Bitker MO, Mozer P, et al. Stress urinary incontinence in female neurological patients: long-term functional outcomes after artificial urinary sphincter (AMS 800TM) implantation. *Neurourol Urodyn*. 2016.
366. Phe V, Benadiba S, Roupret M, Granger B, Richard F, Chartier-Kastler E. Long-term functional outcomes after artificial urinary sphincter implantation in women with stress urinary incontinence. *BJU international*. 2014;113(6):961-7.
367. Fournier G, Callerot P, Thoulouzan M, Valeri A, Perrouin-Verbe MA. Robotic-assisted laparoscopic implantation of artificial urinary sphincter in women with intrinsic sphincter deficiency incontinence: initial results. *Urology*. 2014;84(5):1094-8.
368. Biardeau X, Rizk J, Marcelli F, Flamand V. Robot-assisted laparoscopic approach for artificial urinary sphincter implantation in 11 women with urinary stress incontinence: surgical technique and initial experience. *Eur Urol*. 2015;67(5):937-42.
369. Peyronnet B, Vincendeau S, Tondut L, Bensalah K, Dampousse M, Manunta A. Artificial urinary sphincter implantation in women with stress urinary incontinence: preliminary comparison of robot-assisted and open approaches. *Int Urogynecol J*. 2016;27(3):475-81.
370. Dissaranan C, Cruz MA, Couri BM, Goldman HB, Damaser MS. Stem cell therapy for incontinence: where are we now? What is the realistic potential? *Current urology reports*. 2011;12(5):336-44.
371. Lee C, Chermansky CJ, Damaser MS. Translational approaches to the treatment of benign urologic conditions in elderly women. *Current opinion in urology*. 2016;26(2):184-92.
372. Tran C, Damaser MS. The potential role of stem cells in the treatment of urinary incontinence. *Therapeutic advances in urology*. 2015;7(1):22-40.
373. Vaegler M, Lenis AT, Daum L, Amend B, Stenzl A, Toomey P, et al. Stem cell therapy for voiding and erectile dysfunction. *Nature reviews Urology*. 2012;9(8):435-47.
374. Lin CS, Lue TF. Stem cell therapy for stress urinary incontinence: a critical review. *Stem cells and development*. 2012;21(6):834-43.
375. Eberli D, Aboushwareb T, Soker S, Yoo JJ, Atala A. Muscle precursor cells for the restoration of irreversibly damaged sphincter function. *Cell transplantation*. 2012;21(9):2089-98.
376. Wu S, Wang Z, Bharadwaj S, Hodges SJ, Atala A, Zhang Y. Implantation of autologous urine derived stem cells expressing vascular endothelial growth factor for potential use in genitourinary reconstruction. *The Journal of urology*. 2011;186(2):640-7.
377. Liu G, Pareta RA, Wu R, Shi Y, Zhou X, Liu H, et al. Skeletal myogenic differentiation of urine-derived stem cells and angiogenesis using microbeads loaded with growth factors. *Biomaterials*. 2013;34(4):1311-26.
378. Du XW, Wu HL, Zhu YF, Hu JB, Jin F, Lv RP, et al. Experimental study of therapy of bone marrow mesenchymal stem cells or muscle-like cells/calcium alginate composite gel for the treatment of stress urinary incontinence. *Neurourol Urodyn*. 2013;32(3):281-6.
379. Jin M, Chen Y, Zhou Y, Mei Y, Liu W, Pan C, et al. Transplantation of bone marrow-derived mesenchymal stem cells expressing elastin alleviates pelvic floor dysfunction. *Stem cell research & therapy*. 2016;7(1):51.

380. Wang Y, Shi GW, Wang JH, Cao NL, Fu Q. Adipose-derived stem cells seeded on polyglycolic acid for the treatment of stress urinary incontinence. *World journal of urology*. 2016.
381. Yu A, Campeau L. Bone marrow mesenchymal stem cell therapy for voiding dysfunction. *Current urology reports*. 2015;16(7):49.
382. Chung E. Stem-cell-based therapy in the field of urology: a review of stem cell basic science, clinical applications and future directions in the treatment of various sexual and urinary conditions. *Expert opinion on biological therapy*. 2015;15(11):1623-32.
383. Zhou S, Zhang K, Atala A, Khoury O, Murphy SV, Zhao W, et al. Stem Cell Therapy for Treatment of Stress Urinary Incontinence: The Current Status and Challenges. *Stem cells international*. 2016;2016:7060975.
384. Wang Z, Wen Y, Li YH, Wei Y, Green M, Wani P, et al. Smooth Muscle Precursor Cells Derived from Human Pluripotent Stem Cells for Treatment of Stress Urinary Incontinence. *Stem cells and development*. 2016;25(6):453-61.
385. Amend B, Vaegler M, Fuchs K, Mannheim JG, Will S, Kramer U, et al. Regeneration of degenerated urinary sphincter muscles: improved stem cell-based therapies and novel imaging technologies. *Cell transplantation*. 2015;24(11):2171-83.
386. Aicher WK, Hart ML, Stallkamp J, Klunder M, Ederer M, Sawodny O, et al. Towards a Treatment of Stress Urinary Incontinence: Application of Mesenchymal Stromal Cells for Regeneration of the Sphincter Muscle. *Journal of clinical medicine*. 2014;3(1):197-215.
387. Blaganje M, Lukanovic A. Ultrasound-guided autologous myoblast injections into the extrinsic urethral sphincter: tissue engineering for the treatment of stress urinary incontinence. *Int Urogynecol J*. 2013;24(4):533-5.
388. Kuismanen K, Sartoneva R, Haimi S, Mannerstrom B, Tomas E, Miettinen S, et al. Autologous adipose stem cells in treatment of female stress urinary incontinence: results of a pilot study. *Stem cells translational medicine*. 2014;3(8):936-41.
389. Gras S, Klarskov N, Lose G. Intraurethral injection of autologous minced skeletal muscle: a simple surgical treatment for stress urinary incontinence. *The Journal of urology*. 2014;192(3):850-5.
390. Carr LK, Robert M, Kultgen PL, Herschorn S, Birch C, Murphy M, et al. Autologous muscle derived cell therapy for stress urinary incontinence: a prospective, dose ranging study. *The Journal of urology*. 2013;189(2):595-601.
391. Peters KM, Dmochowski RR, Carr LK, Robert M, Kaufman MR, Sirls LT, et al. Autologous muscle derived cells for treatment of stress urinary incontinence in women. *The Journal of urology*. 2014;192(2):469-76.
392. Stangel-Wojcikiewicz K, Jarocho D, Piowar M, Jach R, Uhl T, Basta A, et al. Autologous muscle-derived cells for the treatment of female stress urinary incontinence: a 2-year follow-up of a Polish investigation. *Neurourol Urodyn*. 2014;33(3):324-30.
393. Blaganje M, Lukanovic A. Intrasphincteric autologous myoblast injections with electrical stimulation for stress urinary incontinence. *Int J Gynaecol Obstet*. 2012;117(2):164-7.
394. Aref-Adib M, Lamb BW, Lee HB, Akinnawo E, Raza MM, Hughes A, et al. Stem cell therapy for stress urinary incontinence: a systematic review in human subjects. *Arch Gynecol Obstet*. 2013;288(6):1213-21.
395. Pokrywczynska M, Adamowicz J, Czapiewska M, Balcerczyk D, Jundzill A, Nowacki M, et al. Targeted therapy for stress urinary incontinence: a systematic review based on clinical trials. *Expert opinion on biological therapy*. 2016;16(2):233-42.
396. Park KM, Son JY, Choi JH, Kim IG, Lee Y, Lee JY, et al. Macro/Nano-gel composite as an injectable and bioactive bulking material for the treatment of urinary incontinence. *Biomacromolecules*. 2014;15(6):1979-84.
397. Choi SJ, Oh SH, Kim IG, Chun SY, Lee JY, Lee JH. Functional recovery of urethra by plasmid DNA-loaded injectable agent for the treatment of urinary incontinence. *Biomaterials*. 2013;34(20):4766-76.
398. Lukban j TP, Crisell M, et al Transurethral Radiofrequency Collagen Denaturation in the Treatment of Mild to Moderate Female Stress Urinary incontinence: Twelve-Month Interim Analysis (Abstract). *J Urology*. 2014;191(4S):e402-3.
399. Davila GW. Nonsurgical outpatient therapies for the management of female stress urinary incontinence: long-term effectiveness and durability. *Adv Urol*. 2011;2011:176498.
400. Edelstein PS. A preclinical study of nonsurgical radiofrequency collagen remodeling for the treatment of stress urinary incontinence. *Expert Rev Med Devices*. 2006;3(6):743-8.
401. Kang D, Han J, Neuberger MM, Moy ML, Wallace SA, Alonso-Coello P, et al. Transurethral radiofrequency collagen denaturation for the treatment of women with urinary incontinence. *Cochrane Database Syst Rev*. 2015(3):CD010217.

402. Appell RA, Juma S, Wells WG, Lenihan JP, Klimberg IW, Kanellos A, et al. Transurethral radiofrequency energy collagen micro-remodeling for the treatment of female stress urinary incontinence. *Neurourol Urodyn*. 2006;25(4):331-6.
403. Lenihan JP. Comparison of the quality of life after nonsurgical radiofrequency energy tissue micro-remodeling in premenopausal and postmenopausal women with moderate-to-severe stress urinary incontinence. *Am J Obstet Gynecol*. 2005;192(6):1995-8; discussion 9-2001.
404. Sotomayor M, Bernal GF. Twelve-month results of nonsurgical radiofrequency energy micro-remodeling for stress incontinence. *Int Urogynecol J Pelvic Floor Dysfunct*. 2005;16(3):192-6; discussion 6.
405. Appell RA, Singh G, Klimberg IW, Graham C, Juma S, Wells WG, et al. Nonsurgical, radiofrequency collagen denaturation for stress urinary incontinence: retrospective 3-year evaluation. *Expert Rev Med Devices*. 2007;4(4):455-61.
406. Elser DM, Mitchell GK, Miklos JR, Nickell KG, Cline K, Winkler H, et al. Nonsurgical transurethral radiofrequency collagen denaturation: results at three years after treatment. *Adv Urol*. 2011;2011:872057.
407. Elser DM, Mitchell GK, Miklos JR, Nickell KG, Cline K, Winkler H, et al. Nonsurgical transurethral collagen denaturation for stress urinary incontinence in women: 12-month results from a prospective long-term study. *J Minim Invasive Gynecol*. 2009;16(1):56-62.
408. Elser DM, Mitchell GK, Miklos JR, Nickell KG, Cline K, Winkler H, et al. Nonsurgical transurethral collagen denaturation for stress urinary incontinence in women: 18-month results from a prospective long-term study. *Neurourol Urodyn*. 2010;29(8):1424-8.
409. Sand PK, Owens GM, Black EJ, Anderson LH, Martinson MS. Cost effectiveness of radiofrequency microremodeling for stress urinary incontinence. *Int Urogynecol J*. 2014;25(4):517-23.
410. Hardy LA, Chang CH, Myers EM, Kennelly MJ, Fried NM. Computer simulations of thermal tissue remodeling during transvaginal and transurethral laser treatment of female stress urinary incontinence. *Lasers Surg Med*. 2016.
411. Fistonc N, Fistonc I, Gustek SF, Turina IS, Marton I, Vizintin Z, et al. Minimally invasive, non-ablative Er:YAG laser treatment of stress urinary incontinence in women--a pilot study. *Lasers Med Sci*. 2016;31(4):635-43.
412. Ogrinc UB, Sencar S, Lenasi H. Novel minimally invasive laser treatment of urinary incontinence in women. *Lasers Surg Med*. 2015;47(9):689-97.
413. Rovner ES, Dmochowski RR, Leach GE, Jayne C, Snyder JA. A randomized, controlled clinical trial of a novel intravesical pressure attenuation device for the treatment of stress urinary incontinence. *The Journal of urology*. 2013;190(6):2243-50.
414. Wyndaele JJ, De Wachter S, Tommaselli GA, Angioli R, de Wildt MJ, Everaert KC, et al. A randomized, controlled clinical trial of an intravesical pressure-attenuation balloon system for the treatment of stress urinary incontinence in females. *Neurourol Urodyn*. 2016;35(2):252-9.
415. Tanagho EA, Schmidt RA. Bladder pacemaker: scientific basis and clinical future. *Urology*. 1982;20(6):614-9.
416. Tanagho EA, Schmidt RA, Orvis BR. Neural stimulation for control of voiding dysfunction: a preliminary report in 22 patients with serious neuropathic voiding disorders. *The Journal of urology*. 1989;142(2 Pt 1):340-5.
417. Schmidt RA, Bruschini H, Tanagho EA. Feasibility of inducing micturition through chronic stimulation of sacral roots. *Urology*. 1978;12(4):471-7.
418. Laviana A, Jellison F, Kim JH. Sacral neuromodulation for refractory overactive bladder, interstitial cystitis, and painful bladder syndrome. *Neurosurg Clin N Am*. 2014;25(1):33-46.
419. Powell CR, Kreder KJ. Long-term outcomes of urgency-frequency syndrome due to painful bladder syndrome treated with sacral neuromodulation and analysis of failures. *The Journal of urology*. 2010;183(1):173-6.
420. Chiarioni G, Palsos OS, Asteria CR, Whitehead WE. Neuromodulation for fecal incontinence: an effective surgical intervention. *World J Gastroenterol*. 2013;19(41):7048-54.
421. Rosen A, Taragano L, Condrea A, Sidi A, Ron Y, Ginath S. Effects of Sacral Neuromodulation on Urinary and Fecal Incontinence. *Isr Med Assoc J*. 2015;17(6):351-5.
422. Yoshimura N, de Groat WC. Neural control of the lower urinary tract. *Int J Urol*. 1997;4(2):111-25.
423. Leng WW, Chancellor MB. How sacral nerve stimulation neuromodulation works. *Urol Clin North Am*. 2005;32(1):11-8.

424. Malaguti S, Spinelli M, Giardiello G, Lazzeri M, Van Den Hombergh U. Neurophysiological evidence may predict the outcome of sacral neuromodulation. *The Journal of urology*. 2003;170(6 Pt 1):2323-6.
425. Marcelissen TA, Leong RK, de Bie RA, van Kerrebroeck PE, de Wachter SG. Long-term results of sacral neuromodulation with the tined lead procedure. *The Journal of urology*. 2010;184(5):1997-2000.
426. Spinelli M, Sievert KD. Latest technologic and surgical developments in using InterStim Therapy for sacral neuromodulation: impact on treatment success and safety. *Eur Urol*. 2008;54(6):1287-96.
427. Siegel S, Noblett K, Mangel J, Griebing TL, Sutherland SE, Bird ET, et al. Three-year Follow-up Results of a Prospective, Multicenter Study in Overactive Bladder Subjects Treated With Sacral Neuromodulation. *Urology*. 2016.
428. Leong RK, De Wachter SG, Nieman FH, de Bie RA, van Kerrebroeck PE. PNE versus 1st stage tined lead procedure: a direct comparison to select the most sensitive test method to identify patients suitable for sacral neuromodulation therapy. *Neurourol Urodyn*. 2011;30(7):1249-52.
429. Amend B, Khalil M, Kessler TM, Sievert KD. How does sacral modulation work best? Placement and programming techniques to maximize efficacy. *Current urology reports*. 2011;12(5):327-35.
430. Siegel S, Noblett K, Mangel J, Griebing TL, Sutherland SE, Bird ET, et al. Results of a prospective, randomized, multicenter study evaluating sacral neuromodulation with InterStim therapy compared to standard medical therapy at 6-months in subjects with mild symptoms of overactive bladder. *Neurourol Urodyn*. 2015;34(3):224-30.
431. Schmidt RA, Jonas U, Oleson KA, Janknegt RA, Hassouna MM, Siegel SW, et al. Sacral nerve stimulation for treatment of refractory urinary urge incontinence. Sacral Nerve Stimulation Study Group. *The Journal of urology*. 1999;162(2):352-7.
432. Hassouna MM, Siegel SW, Nyeholt AA, Elhilali MM, van Kerrebroeck PE, Das AK, et al. Sacral neuromodulation in the treatment of urgency-frequency symptoms: a multicenter study on efficacy and safety. *The Journal of urology*. 2000;163(6):1849-54.
433. Herbison GP, Arnold EP. Sacral neuromodulation with implanted devices for urinary storage and voiding dysfunction in adults. *Cochrane Database Syst Rev*. 2009(2):CD004202.
434. Noblett K, Siegel S, Mangel J, Griebing TL, Sutherland SE, Bird ET, et al. Results of a prospective, multicenter study evaluating quality of life, safety, and efficacy of sacral neuromodulation at twelve months in subjects with symptoms of overactive bladder. *Neurourol Urodyn*. 2016;35(2):246-51.
435. Amundsen CL, Richter HE, Menefee S, Komesu YM, Arya LA, Gregory WT, et al. Sacral Neuromodulation versus OnabotulinumtoxinA for Refractory Overactive Bladder. *J Urology*. 2016;195(4S):e949.
436. Smits MA, Oerlemans D, Marcelissen TA, Van Kerrebroeck PE, De Wachter SG. Sacral neuromodulation in patients with idiopathic overactive bladder after initial botulinum toxin therapy. *The Journal of urology*. 2013;190(6):2148-52.
437. Bannowsky A, Wefer B, Braun PM, Junemann KP. Urodynamic changes and response rates in patients treated with permanent electrodes compared to conventional wire electrodes in the peripheral nerve evaluation test. *World journal of urology*. 2008;26(6):623-6.
438. Marcelissen T, Leong R, Serroyen J, van Kerrebroeck P, de Wachter S. Is the screening method of sacral neuromodulation a prognostic factor for long-term success? *The Journal of urology*. 2011;185(2):583-7.
439. Amoroso L, Pelliccioni G, Ghiselli R, Scarpino O, Saba V, Ricci S. Sacral-neuromodulation CT-guided. *Radiol Med*. 2005;109(4):421-9.
440. Goos M, Ruf G, Jargon D, Trummer C, Thomusch O, Gruneberger J, et al. [CT-guided electrode placement for sacral nerve stimulation in the treatment of faecal incontinence (cSNS)]. *Zentralbl Chir*. 2014;139 Suppl 2:e63-7.
441. Meissnitzer T, Trubel S, Posch-Zimmermann R, Meissnitzer MW. CT-Guided Lead Placement for Selective Sacral Neuromodulation to Treat Lower Urinary Tract Dysfunctions. *AJR Am J Roentgenol*. 2015;205(5):1139-42.
442. Chung CP, Neese PA, Le HK, Bird ET. Computed tomography-guided S3 lead placement for sacral neuromodulation. *Int Urogynecol J*. 2013;24(2):349-51.
443. Castillo J, Cristobal L, Alonso J, Martin R, Suarez D, Martinez MA, et al. Sacral nerve stimulation lead implantation in partial sacral agenesis using intraoperative computerised tomography. *Colorectal Dis*. 2016.
444. Pham K, Guralnick ML, O'Connor RC. Unilateral versus bilateral stage I neuromodulator lead placement for the treatment of refractory voiding dysfunction. *Neurourol Urodyn*. 2008;27(8):779-81.

445. Scheepens WA, de Bie RA, Weil EH, van Kerrebroeck PE. Unilateral versus bilateral sacral neuromodulation in patients with chronic voiding dysfunction. *The Journal of urology*. 2002;168(5):2046-50.
446. Duelund-Jakobsen J, Buntzen S, Lundby L, Sorensen M, Laurberg S. Bilateral compared with unilateral sacral nerve stimulation for faecal incontinence: results of a randomized, single-blinded crossover study. *Colorectal Dis*. 2015;17(12):1085-93.
447. Peters KM, Shen L, McGuire M. Effect of Sacral Neuromodulation Rate on Overactive Bladder Symptoms: A Randomized Crossover Feasibility Study. *Low Urin Tract Symptoms*. 2013;5(3):129-33.
448. LA TH, Groen J, Scheepe JR, Blok BF. Intermittent sacral neuromodulation for idiopathic urgency urinary incontinence in women. *Neurourol Urodyn*. 2015.
449. Groen J, Blok BF, Bosch JL. Sacral neuromodulation as treatment for refractory idiopathic urge urinary incontinence: 5-year results of a longitudinal study in 60 women. *The Journal of urology*. 2011;186(3):954-9.
450. Siegel SW, Catanzaro F, Dijkema HE, Elhilali MM, Fowler CJ, Gajewski JB, et al. Long-term results of a multicenter study on sacral nerve stimulation for treatment of urinary urge incontinence, urgency-frequency, and retention. *Urology*. 2000;56(6 Suppl 1):87-91.
451. Janknegt RA, Hassouna MM, Siegel SW, Schmidt RA, Gajewski JB, Rivas DA, et al. Long-term effectiveness of sacral nerve stimulation for refractory urge incontinence. *Eur Urol*. 2001;39(1):101-6.
452. van Kerrebroeck PE, van Voskuilen AC, Heesakkers JP, Lycklama a Nijholt AA, Siegel S, Jonas U, et al. Results of sacral neuromodulation therapy for urinary voiding dysfunction: outcomes of a prospective, worldwide clinical study. *The Journal of urology*. 2007;178(5):2029-34.
453. Peeters K, Sahai A, De Ridder D, Van Der Aa F. Long-term follow-up of sacral neuromodulation for lower urinary tract dysfunction. *BJU international*. 2014;113(5):789-94.
454. Leong RK, Marcelissen TA, Nieman FH, De Bie RA, Van Kerrebroeck PE, De Wachter SG. Satisfaction and patient experience with sacral neuromodulation: results of a single center sample survey. *The Journal of urology*. 2011;185(2):588-92.
455. Lombardi G, Finazzi Agro E, Del Popolo G. Sacral neuromodulation and female sexuality. *Int Urogynecol J*. 2015;26(12):1751-7.
456. Davis T, Makovey I, Guralnick ML, O'Connor RC. Sacral neuromodulation outcomes for the treatment of refractory idiopathic detrusor overactivity stratified by indication: Lack of anticholinergic efficacy versus intolerability. *Can Urol Assoc J*. 2013;7(5-6):176-8.
457. Yazdany T, Bhatia N, Nguyen J. Determining outcomes, adverse events, and predictors of success after sacral neuromodulation for lower urinary disorders in women. *Int Urogynecol J*. 2011;22(12):1549-54.
458. Levin PJ, Wu JM, Siddiqui NY, Amundsen CL. Does obesity impact the success of an InterStim test phase for the treatment of refractory urge urinary incontinence in female patients? *Female Pelvic Med Reconstr Surg*. 2012;18(4):243-6.
459. Peters KM, Killinger KA, Gilleran J, Boura JA. Does patient age impact outcomes of neuro-modulation? *Neurourol Urodyn*. 2013;32(1):30-6.
460. Angioli R, Montera R, Plotti F, Aloisi A, Montone E, Zullo MA. Success rates, quality of life, and feasibility of sacral nerve stimulation in elderly patients: 1-year follow-up. *Int Urogynecol J*. 2013;24(5):789-94.
461. Peters KM, Killinger KA, Gilleran JP, Bartley J, Wolfert C, Boura JA. Predictors of reoperation after sacral neuromodulation: A single institution evaluation of over 400 patients. *Neurourol Urodyn*. 2015.
462. Groenendijk PM, Lycklama a Nyeholt AA, Heesakkers JP, van Kerrebroeck PE, Hassouna MM, Gajewski JB, et al. Urodynamic evaluation of sacral neuromodulation for urge urinary incontinence. *BJU international*. 2008;101(3):325-9.
463. South MM, Romero AA, Jamison MG, Webster GD, Amundsen CL. Detrusor overactivity does not predict outcome of sacral neuromodulation test stimulation. *Int Urogynecol J Pelvic Floor Dysfunct*. 2007;18(12):1395-8.
464. Drossaerts J, Rademakers K, van Koeveeringe G, Van Kerrebroeck P. The value of urodynamic tools to guide patient selection in sacral neuromodulation. *World journal of urology*. 2015;33(11):1889-95.
465. Martin ET. Can cardiac pacemakers and magnetic resonance imaging systems co-exist? *Eur Heart J*. 2005;26(4):325-7.
466. Roguin A, Zviman MM, Meiningner GR, Rodrigues ER, Dickfeld TM, Bluemke DA, et al. Modern pacemaker and implantable cardioverter/defibrillator systems can be magnetic resonance imaging safe: in vitro and in vivo assessment of safety and function at 1.5 T. *Circulation*. 2004;110(5):475-82.

467. Gimbel JR, Kanal E. Can patients with implantable pacemakers safely undergo magnetic resonance imaging? *J Am Coll Cardiol*. 2004;43(7):1325-7.
468. Alsyouf M, Keheila M, Marinone M, Blackburn A, Staack A. Magnetic resonance imaging of the ankle performed on an InterStim patient. *Can J Urol*. 2016;23(1):8168-70.
469. Chermansky CJ, Krlin RM, Holley TD, Woo HH, Winters JC. Magnetic resonance imaging following InterStim(R): an institutional experience with imaging safety and patient satisfaction. *Neurourol Urodyn*. 2011;30(8):1486-8.
470. MRI Guidelines for InterStim Therapy neurostimulation systems 2012 [Available from: http://manuals.medtronic.com/wcm/groups/mdtcom_sg/@emanuals/@era/@neuro/documents/documents/contrib_214172.pdf].
471. Wang Y, Hassouna MM. Electrical stimulation has no adverse effect on pregnant rats and fetuses. *The Journal of urology*. 1999;162(5):1785-7.
472. Yoo PB, Woock JP, Grill WM. Bladder activation by selective stimulation of pudendal nerve afferents in the cat. *Exp Neurol*. 2008;212(1):218-25.
473. Yoo PB, Woock JP, Grill WM. Somatic innervation of the feline lower urinary tract. *Brain Res*. 2008;1246:80-7.
474. Woock JP, Yoo PB, Grill WM. Activation and inhibition of the micturition reflex by penile afferents in the cat. *Am J Physiol Regul Integr Comp Physiol*. 2008;294(6):R1880-9.
475. Peng CW, Chen JJ, Cheng CL, Grill WM. Role of pudendal afferents in voiding efficiency in the rat. *Am J Physiol Regul Integr Comp Physiol*. 2008;294(2):R660-72.
476. Peng CW, Chen JJ, Cheng CL, Grill WM. Improved bladder emptying in urinary retention by electrical stimulation of pudendal afferents. *J Neural Eng*. 2008;5(2):144-54.
477. Spinelli M, Malaguti S, Giardiello G, Lazzeri M, Tarantola J, Van Den Hombergh U. A new minimally invasive procedure for pudendal nerve stimulation to treat neurogenic bladder: description of the method and preliminary data. *Neurourol Urodyn*. 2005;24(4):305-9.
478. Peters KM, Feber KM, Bennett RC. A prospective, single-blind, randomized crossover trial of sacral vs pudendal nerve stimulation for interstitial cystitis. *BJU international*. 2007;100(4):835-9.
479. Peters KM, Feber KM, Bennett RC. Sacral versus pudendal nerve stimulation for voiding dysfunction: a prospective, single-blinded, randomized, crossover trial. *Neurourol Urodyn*. 2005;24(7):643-7.
480. Finazzi-Agro E, Rocchi C, Pachatz C, Petta F, Spera E, Mori F, et al. Percutaneous tibial nerve stimulation produces effects on brain activity: study on the modifications of the long latency somatosensory evoked potentials. *Neurourol Urodyn*. 2009;28(4):320-4.
481. McGuire E, Morrissey S, Zhang S, Horwinski E. Control of reflex detrusor activity in normal and spinal injured non-human primates. *The Journal of urology*. 1983;129(1):197-9.
482. Peters KM, Carrico DJ, Wooldridge LS, Miller CJ, MacDiarmid SA. Percutaneous tibial nerve stimulation for the long-term treatment of overactive bladder: 3-year results of the STEP study. *The Journal of urology*. 2013;189(6):2194-201.
483. Gormley EA, Lightner DJ, Faraday M, Vasavada SP. Diagnosis and treatment of overactive bladder (non-neurogenic) in adults: AUA/SUFU guideline amendment. *The Journal of urology*. 2015;193(5):1572-80.
484. Peters KM, Carrico DJ, Perez-Marrero RA, Khan AU, Wooldridge LS, Davis GL, et al. Randomized trial of percutaneous tibial nerve stimulation versus Sham efficacy in the treatment of overactive bladder syndrome: results from the SUMiT trial. *J Urol*. 2010;183(4):1438-43.
485. Finazzi-Agro E, Petta F, Sciobica F, Pasqualetti P, Musco S, Bove P. Percutaneous tibial nerve stimulation effects on detrusor overactivity incontinence are not due to a placebo effect: a randomized, double-blind, placebo controlled trial. *J Urol*. 2010;184(5):2001-6.
486. Peters KM, MacDiarmid SA, Wooldridge LS, Leong FC, Shobeiri SA, Rovner ES, et al. Randomized trial of percutaneous tibial nerve stimulation versus extended-release tolterodine: results from the overactive bladder innovative therapy trial. *J Urol*. 2009;182(3):1055-61.
487. MacDiarmid SA, Peters KM, Shobeiri SA, Wooldridge LS, Rovner ES, Leong FC, et al. Long-term durability of percutaneous tibial nerve stimulation for the treatment of overactive bladder. *J Urol*. 2010;183(1):234-40.
488. Preyer O, Umek W, Laml T, Bjelic-Radicic V, Gabriel B, Mittlboeck M, et al. Percutaneous tibial nerve stimulation versus tolterodine for overactive bladder in women: a randomised controlled trial. *Eur J Obstet Gynecol Reprod Biol*. 2015;191:51-6.

489. Vecchioli-Scaldazza C, Morosetti C, Berouz A, Giannubilo W, Ferrara V. Solifenacin succinate versus percutaneous tibial nerve stimulation in women with overactive bladder syndrome: results of a randomized controlled crossover study. *Gynecologic and obstetric investigation*. 2013;75(4):230-4.
490. Gaziev G, Topazio L, Iacovelli V, Asimakopoulos A, Di Santo A, De Nunzio C, et al. Percutaneous Tibial Nerve Stimulation (PTNS) efficacy in the treatment of lower urinary tract dysfunctions: a systematic review. *BMC Urol*. 2013;13:61.
491. Moosdorff-Steinhauser HF, Berghmans B. Effects of percutaneous tibial nerve stimulation on adult patients with overactive bladder syndrome: a systematic review. *Neurourol Urodyn*. 2013;32(3):206-14.
492. Biemans JM, van Balken MR. Efficacy and effectiveness of percutaneous tibial nerve stimulation in the treatment of pelvic organ disorders: a systematic review. *Neuromodulation : journal of the International Neuromodulation Society*. 2013;16(1):25-33; discussion
493. Levin PJ, Wu JM, Kawasaki A, Weidner AC, Amundsen CL. The efficacy of posterior tibial nerve stimulation for the treatment of overactive bladder in women: a systematic review. *Int Urogynecol J*. 2012;23(11):1591-7.
494. Burton C, Sajja A, Latthe PM. Effectiveness of percutaneous posterior tibial nerve stimulation for overactive bladder: a systematic review and meta-analysis. *Neurourol Urodyn*. 2012;31(8):1206-16.
495. Wibisono E, Rahardjo HE. Effectiveness of Short Term Percutaneous Tibial Nerve Stimulation for Non-neurogenic Overactive Bladder Syndrome in Adults: A Meta-analysis. *Acta medica Indonesiana*. 2015;47(3):188-200.
496. Yoong W, Shah P, Dadswell R, Green L. Sustained effectiveness of percutaneous tibial nerve stimulation for overactive bladder syndrome: 2-year follow-up of positive responders. *Int Urogynecol J*. 2013;24(5):795-9.
497. Yoong W, Ridout AE, Damodaram M, Dadswell R. Neuromodulative treatment with percutaneous tibial nerve stimulation for intractable detrusor instability: outcomes following a shortened 6-week protocol. *BJU international*. 2010;106(11):1673-6.
498. Musco S, Serati M, Lombardi G, Lumi E, Parisi AI, Del Popolo G, et al. Percutaneous Tibial Nerve Stimulation Improves Female Sexual Function in Women With Overactive Bladder Syndrome. *The journal of sexual medicine*. 2016;13(2):238-42.
499. Duel BP, Gonzalez R, Barthold JS. Alternative techniques for augmentation cystoplasty. *The Journal of urology*. 1998;159(3):998-1005.
500. Niknejad KG, Atala A. Bladder augmentation techniques in women. *Int Urogynecol J Pelvic Floor Dysfunct*. 2000;11(3):156-69.
501. Gough DC. Enterocystoplasty. *BJU international*. 2001;88(7):739-43.
502. Reyblat P, Ginsberg DA. Augmentation cystoplasty: what are the indications? *Current urology reports*. 2008;9(6):452-8.
503. Reyblat P, Ginsberg DA. Augmentation enterocystoplasty in overactive bladder: is there still a role? *Current urology reports*. 2010;11(6):432-9.
504. Goldwasser B, Webster GD. Augmentation and substitution enterocystoplasty. *The Journal of urology*. 1986;135(2):215-24.
505. Greenwell TJ, Venn SN, Mundy AR. Augmentation cystoplasty. *BJU international*. 2001;88(6):511-25.
506. El-Azab AS, Moeen AM. The satisfaction of patients with refractory idiopathic overactive bladder with onabotulinumtoxinA and augmentation cystoplasty. *Arab J Urol*. 2013;11(4):344-9.
507. Herschorn S, Hewitt RJ. Patient perspective of long-term outcome of augmentation cystoplasty for neurogenic bladder. *Urology*. 1998;52(4):672-8.
508. Biardeau X, Chartier-Kastler E, Roupret M, Phe V. Risk of malignancy after augmentation cystoplasty: A systematic review. *Neurourol Urodyn*. 2015.
509. Stein R, Schroder A, Thuroff JW. Bladder augmentation and urinary diversion in patients with neurogenic bladder: non-surgical considerations. *J Pediatr Urol*. 2012;8(2):145-52.
510. Blackburn SC, Parkar S, Prime M, Healiss L, Desai D, Mustaq I, et al. Ileal bladder augmentation and vitamin B12: levels decrease with time after surgery. *J Pediatr Urol*. 2012;8(1):47-50.
511. Shreck E, Gioia K, Lucioni A. Indications for Augmentation Cystoplasty in the Era of OnabotulinumtoxinA. *Current urology reports*. 2016;17(4):27.
512. Gonzalez R, Ludwikowski B, Horst M. Determinants of success and failure of seromuscular colcystoplasty lined with urothelium. *The Journal of urology*. 2009;182(4 Suppl):1781-4.

513. Jung HJ, Lee H, Im YJ, Lee YS, Hong CH, Han SW. Prerequisite for successful surgical outcome in urothelium lined seromuscular colocolocystoplasty. *The Journal of urology*. 2012;187(4):1416-21.
514. Shakeri S, Aminsharifi A, Jahanabadi Z. Application of appendicular-based cecal flap for less invasive augmentation cystoplasty: a novel technique. *Urologia internationalis*. 2009;83(3):271-6.
515. Gundeti MS, Kojima Y, Haga N, Kiriluk K. Robotic-assisted laparoscopic reconstructive surgery in the lower urinary tract. *Current urology reports*. 2013;14(4):333-41.
516. Murthy P, Cohn JA, Selig RB, Gundeti MS. Robot-assisted Laparoscopic Augmentation Ileocystoplasty and Mitrofanoff Appendicovesicostomy in Children: Updated Interim Results. *Eur Urol*. 2015;68(6):1069-75.
517. Rey D, Oderda M, El Helou E, Robbiani J, Lopez L, Piechaud PT. Feasibility of robotic double Yang-Monti ileal conduit with bladder augmentation: surgical technique. *Urology*. 2013;82(2):480-4.
518. Laydner HK, Pedrosa JA, Khanna R, Isac W, Stein RJ. LESS pyeloplasty & other reconstructive procedures. *Arch Esp Urol*. 2012;65(3):329-35.
519. Noguera RJ, Astigueta JC, Carmona O, De Andrade RJ, Luis S, Cuomo B, et al. Laparoscopic augmentation enterocystoplasty through a single trocar. *Urology*. 2009;73(6):1371-4.
520. Cartwright PC, Snow BW. Bladder autoaugmentation: partial detrusor excision to augment the bladder without use of bowel. *J Urol*. 1989;142(4):1050-3.
521. Cartwright PC, Snow BW. Bladder autoaugmentation: early clinical experience. *J Urol*. 1989;142(2):505-8.
522. ter Meulen PH, Heesakkers JP, Janknegt RA. A study on the feasibility of vesicomatomy in patients with motor urge incontinence. *Eur Urol*. 1997;32(2):166-9.
523. Veenboer PW, Nadorp S, de Jong TP, Dik P, van Asbeck FW, Bosch JL, et al. Enterocystoplasty vs detrusorectomy: outcome in the adult with spina bifida. *The Journal of urology*. 2013;189(3):1066-70.
524. Dewan PA. Autoaugmentation demucosalized enterocystoplasty. *World journal of urology*. 1998;16(4):255-61.
525. Appell RA. Surgery for the treatment of overactive bladder. *Urology*. 1998;51(2A Suppl):27-9.
526. Leng WW, Blalock HJ, Fredriksson WH, English SF, McGuire EJ. Enterocystoplasty or detrusor myectomy? Comparison of indications and outcomes for bladder augmentation. *The Journal of urology*. 1999;161(3):758-63.
527. Dewan PA, Stefanek W. Autoaugmentation gastrocystoplasty: early clinical results. *Br J Urol*. 1994;74(4):460-4.
528. Close CE. Autoaugmentation gastrocystoplasty. *BJU international*. 2001;88(7):757-61.
529. Oge O, Tekgul S, Ergen A, Kendi S. Urothelium-preserving augmentation cystoplasty covered with a peritoneal flap. *BJU international*. 2000;85(7):802-5.
530. Perovic SV, Djordjevic ML, Kekic ZK, Vukadinovic VM. Bladder autoaugmentation with rectus muscle backing. *J Urol*. 2002;168(4 Pt 2):1877-80.
531. Shekarriz B, Upadhyay J, Demirbilek S, Barthold JS, Gonzalez R. Surgical complications of bladder augmentation: comparison between various enterocystoplasties in 133 patients. *Urology*. 2000;55(1):123-8.
532. Rocha FT, Bruschini H, Figueiredo JA, Machado MG, Gomes CM, Mascarenhas F, et al. Use of an inflatable silicone balloon improves the success rate of bladder autoaugmentation at long-term followup. *J Urol*. 2011;185(6 Suppl):2576-81.
533. El-Nashar SA, Bacon MM, Kim-Fine S, Weaver AL, Gebhart JB, Klingele CJ. Incidence of female urethral diverticulum: a population-based analysis and literature review. *Int Urogynecol J*. 2014;25(1):73-9.
534. Crescenze IM, Goldman HB. Female Urethral Diverticulum: Current Diagnosis and Management. *Current urology reports*. 2015;16(10):71.
535. Huffman JW. The detailed anatomy of the para-urethral ducts in the adult human female. *Am J Obstet Gynecol*. 1948;55(1):86-101.
536. Reeves FA, Inman RD, Chapple CR. Management of symptomatic urethral diverticula in women: a single-centre experience. *Eur Urol*. 2014;66(1):164-72.
537. Hammad FT. TVT can also cause urethral diverticulum. *Int Urogynecol J Pelvic Floor Dysfunct*. 2007;18(4):467-9.
538. Mahdy A, Elmissiry M, Ghoniem GM. Urethral diverticulum after tension-free vaginal tape procedure: case report. *Urology*. 2008;72(2):461 e5-6.
539. Athanasopoulos A, McGuire EJ. Urethral diverticulum: a new complication associated with tension-free vaginal tape. *Urologia internationalis*. 2008;81(4):480-2.

540. Baradaran N, Chiles LR, Freilich DA, Rames RA, Cox L, Rovner ES. Female Urethral Diverticula in the Contemporary Era: Is the Classic Triad of the "3Ds" Still Relevant? *Urology*. 2016;94:53-6.
541. Nickles SW, Ikwuezunma G, MacLachlan L, El-Zawahry A, Rames R, Rovner E. Simple vs complex urethral diverticulum: presentation and outcomes. *Urology*. 2014;84(6):1516-9.
542. Stav K, Dwyer PL, Rosamilia A, Chao F. Urinary symptoms before and after female urethral diverticulectomy--can we predict de novo stress urinary incontinence? *The Journal of urology*. 2008;180(5):2088-90.
543. Ockrim JL, Allen DJ, Shah PJ, Greenwell TJ. A tertiary experience of urethral diverticulectomy: diagnosis, imaging and surgical outcomes. *BJU international*. 2009;103(11):1550-4.
544. Ljungqvist L, Peeker R, Fall M. Female urethral diverticulum: 26-year followup of a large series. *The Journal of urology*. 2007;177(1):219-24; discussion 24.
545. Ingber MS, Firoozi F, Vasavada SP, Ching CB, Goldman HB, Moore CK, et al. Surgically corrected urethral diverticula: long-term voiding dysfunction and reoperation rates. *Urology*. 2011;77(1):65-9.
546. Adelowo A, Dessie S, Rosenblatt PL. The role of preoperative urodynamics in urogynecologic procedures. *J Minim Invasive Gynecol*. 2014;21(2):217-22.
547. Bhatia NN, McCarthy TA, Ostergard DR. Urethral pressure profiles of women with urethral diverticula. *Obstet Gynecol*. 1981;58(3):375-8.
548. Reid RE, Gill B, Laor E, Tolia BM, Freed SZ. Role of urodynamics in management of urethral diverticulum in females. *Urology*. 1986;28(4):342-6.
549. Summitt RL, Jr., Stovall TG. Urethral diverticula: evaluation by urethral pressure profilometry, cystourethroscopy, and the voiding cystourethrogram. *Obstet Gynecol*. 1992;80(4):695-9.
550. Bass JS, Leach GE. Surgical treatment of concomitant urethral diverticulum and stress incontinence. *Urol Clin North Am*. 1991;18(2):365-73.
551. Ganabathi K, Leach GE, Zimmern PE, Dmochowski R. Experience with the management of urethral diverticulum in 63 women. *The Journal of urology*. 1994;152(5 Pt 1):1445-52.
552. Wagner U, Debus-Thiede G, Christ F. [Significance of the urethral pressure profile in the diagnosis of urethral diverticulum]. *Geburtshilfe Frauenheilkd*. 1986;46(7):456-8.
553. Romanzi LJ, Groutz A, Blaivas JG. Urethral diverticulum in women: diverse presentations resulting in diagnostic delay and mismanagement. *The Journal of urology*. 2000;164(2):428-33.
554. Enemchukwu E, Lai C, Reynolds WS, Kaufman M, Dmochowski R. Autologous Pubovaginal Sling for the Treatment of Concomitant Female Urethral Diverticula and Stress Urinary Incontinence. *Urology*. 2015;85(6):1300-3.
555. Faerber GJ. Urethral diverticulectomy and pubovaginal sling for simultaneous treatment of urethral diverticulum and intrinsic sphincter deficiency. *Tech Urol*. 1998;4(4):192-7.
556. Swierzewski SJ, 3rd, McGuire EJ. Pubovaginal sling for treatment of female stress urinary incontinence complicated by urethral diverticulum. *The Journal of urology*. 1993;149(5):1012-4.
557. Dmochowski RR, Blaivas JM, Gormley EA, Juma S, Karram MM, Lightner DJ, et al. Update of AUA guideline on the surgical management of female stress urinary incontinence. *The Journal of urology*. 2010;183(5):1906-14.
558. Han DH, Jeong YS, Choo MS, Lee KS. Outcomes of surgery of female urethral diverticula classified using magnetic resonance imaging. *Eur Urol*. 2007;51(6):1664-70.
559. Lee UJ, Goldman H, Moore C, Daneshgari F, Rackley RR, Vasavada SP. Rate of de novo stress urinary incontinence after urethral diverticulum repair. *Urology*. 2008;71(5):849-53.
560. Blaivas JG, Flisser AJ, Bleustein CB, Panagopoulos G. Periurethral masses: etiology and diagnosis in a large series of women. *Obstet Gynecol*. 2004;103(5 Pt 1):842-7.
561. Patel AK, Chapple CR. Female urethral diverticula. Current opinion in urology. 2006;16(4):248-54.
562. Lee J, Dwyer PL. Age-related trends in female stress urinary incontinence surgery in Australia - Medicare data for 1994-2009. *Aust N Z J Obstet Gynaecol*. 2010;50(6):543-9.
563. Richter HE, Goode PS, Brubaker L, Zyczynski H, Stoddard AM, Dandreo KJ, et al. Two-year outcomes after surgery for stress urinary incontinence in older compared with younger women. *Obstet Gynecol*. 2008;112(3):621-9.
564. Toozs-Hobson P, Devani P, Pick J, Moran PA, Assassa P, Burton C. Does age affect the outcome of suburethral tape surgery? The importance of national registries in answering bigger questions. *Int Urogynecol J*. 2016;27(10):1541-5.

565. Malek JM, Ellington DR, Jauk V, Szychowski JM, Parden AM, Richter HE. The effect of age on stress and urgency urinary incontinence outcomes in women undergoing primary midurethral sling. *Int Urogynecol J*. 2015;26(6):831-5.
566. Franzen K, Andersson G, Odeberg J, Midlov P, Samuelsson E, Stenzelius K, et al. Surgery for urinary incontinence in women 65 years and older: a systematic review. *Int Urogynecol J*. 2015;26(8):1095-102.
567. Shah AD, Kohli N, Rajan SS, Hoyte L. Racial characteristics of women undergoing surgery for pelvic organ prolapse in the United States. *Am J Obstet Gynecol*. 2007;197(1):70 e1-8.
568. DeLancey JO, Fenner DE, Guire K, Patel DA, Howard D, Miller JM. Differences in continence system between community-dwelling black and white women with and without urinary incontinence in the EPI study. *Am J Obstet Gynecol*. 2010;202(6):584 e1- e12.
569. Rechberger T, Futyma K, Jankiewicz K, Adamiak A, Bogusiewicz M, Skorupski P. Body mass index does not influence the outcome of anti-incontinence surgery among women whereas menopausal status and ageing do: a randomised trial. *Int Urogynecol J*. 2010;21(7):801-6.
570. Karaman U, Campbell KJ, Frilot CF, 2nd, Gomelsky A. The impact of obesity on outcomes and complications after top-down retropubic midurethral sling. *Neurourol Urodyn*. 2016.
571. Berger AA, Zhan T, Montella JM. The Role of Obesity in Success and Complications in Patients Undergoing Retropubic Tension-Free Vaginal Tape Surgery. *Female Pelvic Med Reconstr Surg*. 2016;22(3):161-5.
572. Yonguc T, Aydogdu O, Bozkurt IH, Degirmenci T, Gunlusoy B, Sen V, et al. Do severe obese patients with stress urinary incontinence benefit from transobturator tape procedure? 3-year surgical outcome. *Can Urol Assoc J*. 2015;9(7-8):E546-50.
573. Weltz V, Guldberg R, Lose G. Efficacy and perioperative safety of synthetic mid-urethral slings in obese women with stress urinary incontinence. *Int Urogynecol J*. 2015;26(5):641-8.
574. Lo TS, Pue LB, Tan YL, Wu PY. Risk factors for failure of repeat midurethral sling surgery for recurrent or persistent stress urinary incontinence. *Int Urogynecol J*. 2016;27(6):923-31.
575. van der Doelen MJ, Withagen MI, Vierhout ME, Heesakkers JP. Results of primary versus recurrent surgery to treat stress urinary incontinence in women. *Int Urogynecol J*. 2015;26(7):997-1005.
576. Agur W, Riad M, Secco S, Litman H, Madhuvrata P, Novara G, et al. Surgical treatment of recurrent stress urinary incontinence in women: a systematic review and meta-analysis of randomised controlled trials. *Eur Urol*. 2013;64(2):323-36.
577. Lee JK, Dwyer PL, Rosamilia A, Lim YN, Polyakov A, Stav K. Which women develop urgency or urgency urinary incontinence following midurethral slings? *Int Urogynecol J*. 2013;24(1):47-54.
578. Gleason JL, Parden AM, Jauk V, Ballard A, Sung V, Richter HE. Outcomes of midurethral sling procedures in women with mixed urinary incontinence. *Int Urogynecol J*. 2015;26(5):715-20.
579. Zyczynski HM, Albo ME, Goldman HB, Wai CY, Sirls LT, Brubaker L, et al. Change in Overactive Bladder Symptoms After Surgery for Stress Urinary Incontinence in Women. *Obstet Gynecol*. 2015;126(2):423-30.
580. Minaglia S, Urwitz-Lane R, Wong M, Ozel B. Effectiveness of transobturator tape in women with decreased urethral mobility. *J Reprod Med*. 2009;54(1):15-9.
581. Haliloglu B, Karateke A, Coksuer H, Peker H, Cam C. The role of urethral hypermobility and intrinsic sphincteric deficiency on the outcome of transobturator tape procedure: a prospective study with 2-year follow-up. *Int Urogynecol J*. 2010;21(2):173-8.
582. Jarvis GJ. Surgery for genuine stress incontinence. *Br J Obstet Gynaecol*. 1994;101(5):371-4.
583. Leach GE, Dmochowski RR, Appell RA, Blaivas JG, Hadley HR, Luber KM, et al. Female Stress Urinary Incontinence Clinical Guidelines Panel summary report on surgical management of female stress urinary incontinence. The American Urological Association. *The Journal of urology*. 1997;158(3 Pt 1):875-80.
584. Rovner ES, Wright CJ, Messer H. Adherence to the 1997 American Urological Association guidelines for the surgical treatment of stress urinary incontinence. *Urology*. 2008;71(2):239-42.
585. Sung VW, Marques F, Rogers RR, Williams DA, Myers DL, Clark MA. Content validation of the patient-reported outcomes measurement information system (PROMIS) framework in women with urinary incontinence. *Neurourol Urodyn*. 2011;30(4):503-9.

586. Weber AM, Abrams P, Brubaker L, Cundiff G, Davis G, Dmochowski RR, et al. The standardization of terminology for researchers in female pelvic floor disorders. *Int Urogynecol J Pelvic Floor Dysfunct*. 2001;12(3):178-86.
587. Hilton P. Trials of surgery for stress incontinence--thoughts on the 'Humpty Dumpty principle'. *Bjog*. 2002;109(10):1081-8.
588. Brubaker L, Stoddard A, Richter H, Zimmern P, Moalli P, Kraus SR, et al. Mixed incontinence: comparing definitions in women having stress incontinence surgery. *Neurourol Urodyn*. 2009;28(4):268-73.
589. Yalcin I, Bump RC. Validation of two global impression questionnaires for incontinence. *Am J Obstet Gynecol*. 2003;189(1):98-101.
590. Nager CW, Brubaker L, Litman HJ, Zyczynski HM, Varner RE, Amundsen C, et al. A randomized trial of urodynamic testing before stress-incontinence surgery. *N Engl J Med*. 2012;366(21):1987-97.
591. Videla FL, Wall LL. Stress incontinence diagnosed without multichannel urodynamic studies. *Obstet Gynecol*. 1998;91(6):965-8.

PELVIC ORGAN PROLAPSE SURGERY

Chair

Christopher Maher (Australia)

Members

Kaven Baessler (Germany)
Matthew Barber (USA)
Cecilia Cheon (Hong Kong)
Esther Consten (Netherlands)
Kevin Cooper (UK)
Xavier Deffieux (France)
Viviane Dietz (Netherlands)
Robert Gutman (USA)
Jan van Iersel (Netherlands)
Vivian Sung (USA)
Renaud DeTayrac (France)

Consultant

Charles Nager (USA)

CONTENTS

LIST OF ABBREVIATIONS	1858	VI. POSTERIOR PROLAPSE SURGERY	1907
I. EPIDEMIOLOGY	1859	2. Midline Plication (Traditional Posterior Colporrhaphy).....	1908
1. Incidence and prevalence of Pelvic Organ Prolapse (POP).....	1859	3. Site-specific Posterior Vaginal Repair	1909
2. Incidence and Prevalence of Pelvic Organ Prolapse Surgery.....	1860	4. Graft (absorbable) or Mesh (permanent) Augmentation of Posterior Vaginal Repair	1910
II. OUTCOME ASSESSMENT	1861	5. Sacral Colpopexy with Extension of Mesh Posteriorly.....	1911
1. Outcome Assessment: Anatomy.....	1862	6. Transanal Repair of Rectocele	1912
2. Outcome Assessment: Symptoms ...	1862	7. Ventral Rectopexy	1912
3. Outcome Evaluation: Quality of Life ...	1863	8. Ventral Mesh Rectopexy Morbidity ...	1913
4. Outcome Assessment: Reoperation..	1863	9. Biological Graft Rectopexy.....	1913
III. ANTERIOR COMPARTMENT SURGERY	1865	10. Rectocele as an Indication for Ventral Mesh Rectopexy	1914
1. Native tissue repairs	1865	11. Combined Vaginal and Rectal Prolapse	1915
2. Synthetic Grafts in Anterior Compartment Surgery	1869	VII. PELVIC ORGAN PROLAPSE SURGERY AND BLADDER FUNCTION	1923
3. Biological Grafts in Anterior Compartment Surgery	1871	1. Continent Women Undergoing POP Surgery:.....	1924
4. Recurrent Anterior Prolapse	1873	2. Stress Urinary Incontinent Women Undergoing POP Surgery:	1925
IV. SURGICAL TREATMENT OF UTEROVAGINAL PROLAPSE	1874	3. Overactive Bladder Symptoms.....	1930
1. Patient Selection	1874	4. Voiding Problems	1930
2. Native Tissue Hysteropexy Procedures	1875	VIII. PELVIC ORGAN PROLAPSE SURGERY AND SEXUAL FUNCTION	1931
3. Mesh Hysteropexy Procedures	1878	1. Sexual Function After Prolapse Surgery Without Mesh	1931
4. Sacral hysteropexy	1879	2. Sexual Function After Prolapse Surgery with Mesh	1931
5. Hysterectomy risks	1882	IX. COMPLICATIONS AND METHODS OF PREVENTION	1933
V. APICAL PROLAPSE SURGERY	1885	1. Reoperation after Vaginal Surgery....	1934
1. Sacrospinous Ligament Suspension (SSLS).....	1885	2. Reoperation after Abdominal Surgery.....	1937
2. Uterosacral Ligament Suspension (USLS).....	1890	3. Vaginal Mesh Exposure	1937
3. Transvaginal Mesh Apical Prolapse.	1894		
4. Sacral Colpopexy	1898		
5. Obliterative Procedures: LeFort Colpocleisis, Total Colpocleisis	1906		

4.	Visceral (bladder, rectum) Mesh Exposure.....	1940
5.	Infectious Complication.....	1940
6.	Pelvic Pain	1940
7.	Methods of Prevention.....	1942
8.	Prevention Methods for Vaginal Mesh Surgery	1943
9.	Prevention Methods for Abdominal Sacral colpopexy.....	1945
X.	RISK FACTORS RECURRENT PROLAPSE	1946
<hr/>		
1.	Patient Characteristics	1946
2.	Surgeon Characteristics.....	1948
XI.	ECONOMICS OF PROLAPSE SURGERY	1950
<hr/>		
1.	SUMMARY OF SURGICAL TREATMENT OF PELVIC ORGAN PROLAPSE	1953
	REFERENCES	1957

PELVIC ORGAN PROLAPSE SURGERY

CHRISTOPHER MAHER (AUSTRALIA)

KAVEN BAESSLER (GERMANY), MATTHEW BARBER (USA), CECILIA CHEON (HONG KONG), ESTHER CONSTEN (NETHERLANDS), KEVIN COOPER (UK), XAVIER DEFFIEUX (FRANCE), VIVIANE DIETZ (NETHERLANDS), ROBERT GUTMAN (USA), JAN VAN IERSEL (NETHERLANDS), VIVIAN SUNG (USA), RENAUD DETAYRAC (FRANCE)

LIST OF ABBREVIATIONS

AC	Anterior Colporrhaphy	OAB	Overactive Bladder
ACOG	American College Obstetrics and Gynecology	ODS	Obstructed Defecation Syndrome
ASC	Abdominal Sacral Colpopexy	PE	Polyester
ASH	Abdominal Sacral Hysteropexy	PFDI	Pelvic Floor Distress Inventory
AUGS	American Urogynecologic Society	PFMT	Pelvic Floor Muscle Training
BMI	Body Mass Index	PGI-I	Patients global Impression of Improvement
BSO	Bilateral Salpingo-Oophorectomy	PISQ	Pelvic Organ Prolapse/Incontinence Sexual Questionnaire
CCCS	Cleveland Clinic Continence Score	POP	Pelvic Organ Prolapse
CCIS	Cleveland Clinic Incontinence Score	POPQ	Pelvic Organ Prolapse Quantification
DVT	Deep Venous Thrombosis	PP	Polypropylene
ERP	External Rectal Prolapse	RCT	Randomised Controlled Trial
FDA	Food and Drug Administration	RSC	Robotic Sacral Colpopexy
FISI	Fecal Incontinence Severity Index	RSC	Robotic Sacral Colpopexy
FSFI	Female Sexual Function Index	RVMR	Robotic Ventral Mesh Rectopexy
HRQOL	Health-related quality of life	SBO	Small Bowel Obstruction
HVS	High Volume Surgeon	SIS	Small Intestine Submucosa
ICS	International Continence Society	SSLS	Sacrospinous ligament suspension
IIQ	Incontinence Impact Questionnaire	SSPH	Sacrospinous Hysteropexy
IRP	Internal Rectal Prolapse	SUI	Stress Urinary Incontinence
IUGA	International Urogynaecology Association	TAH	Total Abdominal Hysterectomy
IVS	Intravaginal Slingplasty	TFS	Tissue Fixation System
LSC	Laparoscopic Sacral Colpopexy	TLH	Total Laparoscopic Hysterectomy
LSH	Laparoscopic Sacral Hysteropexy	TVH	Total Vaginal Hysterectomy
LVMR	Laparoscopic Ventral Mesh Rectopexy	TVL	Total Vaginal Length
LVS	Low Volume Surgeon	TVM	Trans-vaginal mesh
		UDI	Urinary Distress Inventory

USLS	Uterosacral ligament suspension
VMH	Vaginal Mesh Hysteropexy
VRS	Vaginal Reconstructive Surgery

I. EPIDEMIOLOGY

Pelvic organ prolapse (POP) is a common problem affecting up to 50% of parous women and between 6-20% of women will have undergone a surgical correction for pelvic organ prolapse by the age of 80.^{1,2} Prolapse surgery is an increasingly important aspect of gynaecological practice due to our ageing population, and already prolapse surgery is performed at least as frequently as continence surgery and, the operating and admission times are at least three times greater than for continence surgery. Given the increasing time and resources that will be required for POP surgery in the future it is paramount that we perform effective, durable, cost effective interventions with minimal morbidity. This chapter serves to outline and summarise the information relating to POP surgery reported in the English-language scientific literature after searching PubMed, Medline, Cochrane library and Cochrane database of systematic reviews, published up to July 2016.

1. INCIDENCE AND PREVALENCE OF PELVIC ORGAN PROLAPSE (POP)

There is a lack of epidemiological studies of the natural history, incidence and prevalence of POP.

It is widely accepted that 50% of women will develop

prolapse but only 10-20% of those seek evaluation for their condition.³ In the current literature, the overall prevalence of POP varies significantly depending upon the definition utilised, ranging from 3-50% (Table 1). Where POP is defined, and graded on symptoms the prevalence is 3-6% as compared to 41-50% when based on examination, as mild prolapse on examination is common and frequently asymptomatic.³⁻⁶ On examination anterior compartment prolapse is the most frequently reported site of prolapse and is detected twice as often as posterior compartment defects and three times more commonly than apical prolapse.^{7,8} Following hysterectomy 6-12% of women will develop vaginal vault prolapse^{9,10} and in two-thirds of these cases multi-compartment prolapse is present.¹¹

There is little knowledge about the natural history of POP. The reported incidence for cystocele is around 9 per 100 women-years, 6 per 100 women-years for rectocele and 1.5 per 100 women-years for uterine prolapse.⁷ Some data show that there is a 1-year incidence of POP of 26% and a 3-years incidence of 40% with regression rates of 21% and 19%, respectively. In general, older parous women are more likely to develop new or progressive POP than to show regression. Over a three year period 11% of the women aged over 65 had prolapse progression of more than 2 cm whilst only 2.7% had a regression by the same amount.¹²

Luber has shown in a large demographic study that the peak incidence of symptoms attributed to prolapse is between ages of 70 to79 whilst POP symptoms are still relatively common in women of younger age.

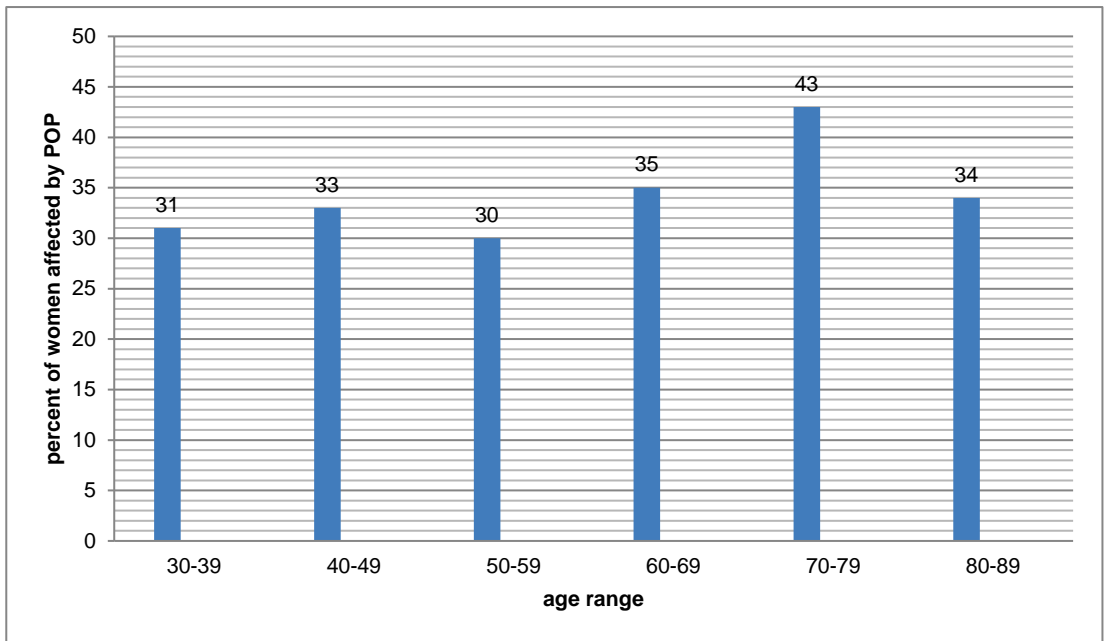

Figure 1. Shows the distribution of POP among women seeking care, US 2000 (Modified Luber 2001¹³)

Demographic changes including an ageing population have significant implications for the future planning of women's health services. Wu et al¹⁴ have predicted that by 2050 the number of women suffering from symptomatic POP in the United States will increase at minimum by 46% (from 3.3 up to 4.9 million women and in a "worst-case scenario" up to

200% or 9.2 million women with POP. These figures were based upon population growth statistics in the United States however models that evaluate the impact of decreasing parity and increasing elective caesarean section rates are required to more accurately predict future rates of POP.

Table 1. Prevalence and Incidence of Pelvic Organ Prolapse

Study	Definition	Prevalence	Incidence	Country
Rorveit, 2007	Symptom-based	5.7%		US
Nygaard, 2008	Symptom-based	2.9%		US
Hendrix, 2002	WHI-Study, Examination	Any prolapse: 41.1% Cystocele: 34.3% Rectocele: 18.6% Uterine: 14.2%		US
Swift, 2003	Examination	6.4% stage 0 43.3% stage 1 47.7% stage 2 2.6% stage 3		US
Handa, 2004	WHI-Study, Examination	Cystocele: 24.6% Rectocele: 12.9% Uterine: 3.8%		US
Nygaard, 2004	Examination	2.3% stage 0 33% stage 1 63% stage 2 1.9% stage 3		US
Bradley, 2007	Examination	23.5 - 49.9%	26%/1 year 40%/3 year	US
Maccharoni, 1999	Examination	Vault-prolapse: 12%		Italy
Aigmueller, 2009	Examination	Vault-prolapse: 6-8%		Austria

Adapted: Sung and Hampton 2009¹⁵

2. INCIDENCE AND PREVALENCE OF PELVIC ORGAN PROLAPSE SURGERY

Both incidence and prevalence for prolapse surgery increase with age. Women older than 80 years are currently the fastest growing segment of the population. The estimated lifetime risk of an American woman undergoing at least one surgical intervention by the age of 80 was frequently reported as 6.3%.¹ More recently the estimated lifetime risk of prolapse has been reported at 13.7% in the USA¹⁶, 18.7% in Denmark¹⁷ and 19% in Western Australia.² Also the reoperation rate reported by Olsen et al was 29.2% rate however, a more recent, prospective study showed a significantly lower reoperation rate of only 13% at 5 years, which may be explained by improved surgical procedures.¹⁸

Not only is there significant variation in the reported lifetime risk of prolapse surgery there is also wide variation in the rate at which surgical interventions for

pelvic organ prolapse are performed. Haya et al¹⁹ demonstrated significant variation in the rates and types of surgical interventions for prolapse in 2012 in various countries in the Organisation for Economic Co-operation and Development (OECD). The rate of prolapse procedures were five times higher in the USA (2.6/1000 women) as compared to Switzerland (0.5/1000 women). There was also very significant variation in the type of interventions undertaken. Transvaginal mesh for anterior compartment prolapse were used eight times more frequently in Germany (26%) than in England (3.3%). Sacral colpopexy was employed 13 times more frequently in France (66%) than in Sweden (5%) for apical vaginal prolapse. Such large variation in rate and types of surgery performed for pelvic organ prolapse maybe explained by a variety of factors including women's preferences, cultural and demographic variables, access to healthcare professionals, health professional training and a lack of clear consensus guidelines on the surgical management of prolapse. The lack of consistency in the rates and types of surgical intervention for pelvic organ prolapse needs further evaluation and ensures difficulty in the allocation of health

care resources for future planning for pelvic organ prolapse.

The annual incidence for POP surgery is stated to be between 1.5 and 1.8 cases per 1000 women-years with the incidence peaking in women between 60-69 years.^{20, 21} Shah et al²¹ also demonstrated a peak incidence in 70 year old women however surprisingly

high numbers of younger women were also undergoing surgical treatments reflecting a similarity in the prolapse symptoms reported in younger women by Luber 2001¹³ (Figure 2). Wu et al found the annual incidence of prolapse surgery increased linearly with age and peaked at 72 years of age at 4.3 cases per 1000 women.¹⁶

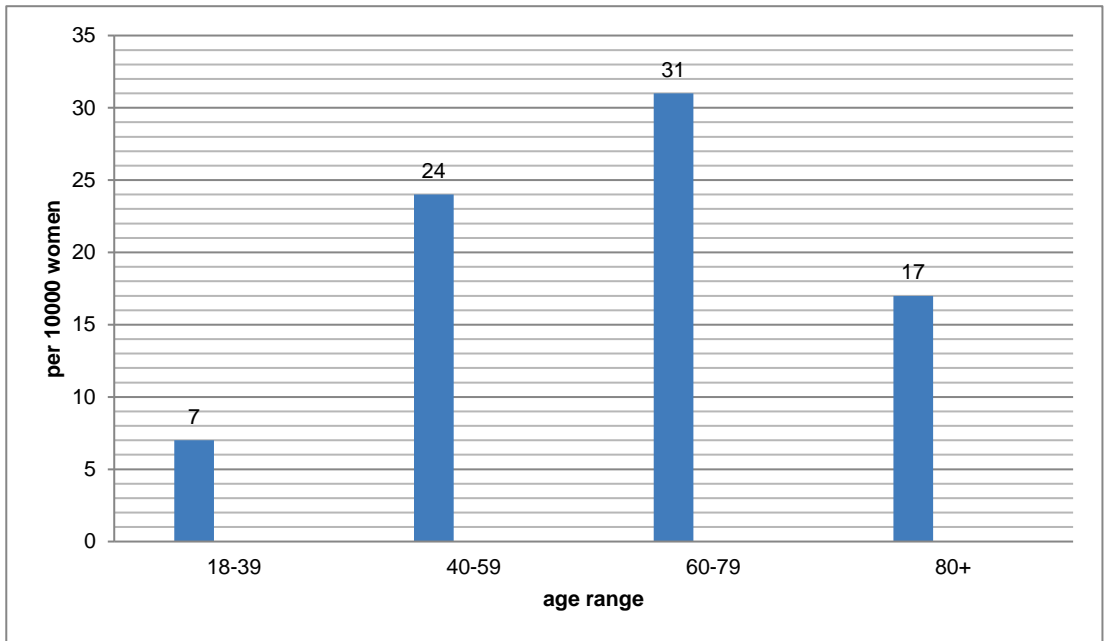

Figure 2. Shows the surgical treatment for POP/ rate per 10000 women (2003)

In the US, POP is thought to be the leading cause for more than 200,000 surgical procedures per year (22.7 per 10,000 women) with 25% undergoing re-operations at a total annual cost of more than 1 billion dollars.²⁰⁻²³ Also of note during a nine-year period (1996 – 2005) the ambulatory costs related to pelvic floor disorder increased by 40% and if these figures are extrapolated to POP surgery the total annual cost would be over 1.4 billion dollars. While it has been predicted that due to our aging populations the rate and cost of surgery for prolapse will rise by as much as 40%, counter-intuitively some studies are in fact demonstrating decreasing rates of surgical interventions for prolapse. In Denmark, the lifetime risk of prolapse surgery by age of 80 decreased from 26.9% in 1978 to 18.7% in 2008.¹⁷ Over a similar time period in Washington state USA, the rate of surgery for pelvic organ prolapse decreased from 2.1 in 1987 to 1.4 per 1000 women aged 20-84 years in 2009.²⁴ The authors eloquently linked the decrease in the rate of inpatient prolapse surgery to higher rates of caesarean section and lower rates of instrumental delivery during the same time period. Further detailed modelling of factors that will impact on future rates of POP in the community are required so that services can be provided to match the future demands of POP surgical interventions.

II. OUTCOME ASSESSMENT

Pelvic organ prolapse, like all pelvic floor disorders, is a multidimensional phenomenon and “success” of treatment is often difficult to define. Historically, most studies evaluating the treatment of pelvic organ prolapse have focused exclusively on anatomic success without considering other important areas such as symptoms, vaginal compliance, quality of life, or socioeconomic outcomes. For an individual patient, the most important outcome of a surgical procedure is the relief of her symptoms and improvement in her quality of life²⁵, yet until recently these areas have largely been ignored. Fortunately, over the last 15 years, measures to evaluate POP have improved; there is now an internationally-accepted and reliable assessment of the anatomic support of the uterus and vagina (POPQ) and a number of valid, reliable and responsive symptom questionnaires and condition-specific HRQOL instruments.²⁶⁻³¹ A recent joint report from the International Continence Society (ICS) and International Urogynaecology Association (IUGA) recommended that the following outcomes be reported in studies of POP surgery: Objective (e.g. POPQ), Patient reported outcomes (particularly the presence or absence of vaginal bulge symptoms), Satisfaction,

Quality of Life, and Perioperative data (e.g. operative time, hospital stay, etc.).³² A careful report of short- and long-term complications are also essential to properly weigh the risk-benefit ratio of each procedure.

1. OUTCOME ASSESSMENT: ANATOMY

The Pelvic Organ Prolapse Quantification system (POPQ), introduced in 1996, is the international standard for describing female pelvic organ support.²⁸ The POPQ allows a reproducible and reliable description of the support of the anterior, posterior and apical vaginal segments using precise measurements to a fixed reference point, the hymen, and established criteria for “staging” the various levels of pelvic organ support from good support (POPQ Stage 0 or I) to almost complete lack of support (POPQ Stage IV).²⁸ The POPQ system has proved a valuable measurement tool that over the last 15 years has improved our understanding of POP and allowed a reliable assessment of the anatomical success of POP surgeries. However, there remain several critical challenges in the anatomical assessment of POP surgery.

First, it is difficult to establish dichotomous anatomical outcome criteria for success and failure, especially in the absence of symptoms. Traditionally researchers have defined surgical success using the NIH satisfactory anatomic outcome (POP-Q Stage 0-1) and defined surgical failure as POPQ stage 2 or greater. More recently it is suggested that these anatomic definitions are too strict as over 75% of women presenting for annual gynaecological examinations without symptoms of pelvic organ prolapse would not meet the definition of “optimal anatomic outcome” and almost 40% would not meet the definition of “satisfactory anatomic outcome”.^{5, 33} Thus, a substantial number of women considered “surgical failures” by these definitions would be within the normal distribution of vaginal support for parous women. The hymen maybe a more clinically relevant anatomic threshold for surgical success and some researchers have begun defining anatomic failure after surgery as POP that extends beyond the hymen.^{25, 34-37}

Second, the five-level staging system of the current POP-Q (Stages 0-IV) may be insufficient to discriminate among clinically important groups of women with POP, placing virtually all such women into Stage II or III. While the staging may facilitate comparisons, it may not describe sufficient detail as the individual POP-Q measurements provide. A third area of uncertainty is whether or not apical prolapse should be considered by the same anatomic standards as prolapse of the anterior or posterior vaginal wall.

The recent joint committee of IUGA/ICS on the terminology of female pelvic organ prolapse evaluated these points and elected to leave the POP-Q staging

unchanged.³⁸ The decision was based on the principle that POP-Q was developed to address uniform anatomical reporting which it has undoubtedly achieved. POP-Q classification was never designed to replicate subjective outcome and anatomical outcome remain vitally important to surgeons when evaluating, undertaking surgical interventions and reporting these interventions. The division of Stage II prolapse into Stage IIa (-1cm to hymen) and Stage IIb (hymen to +1cm) was also considered. The committee felt the subdivision of Stage II prolapse in POP-Q classification would be open to significant observer and inter-observer error as each subgroup has a range of only 1cm, and would further complicate a grading system already criticised for being too complicated. An alternative proposal to classify Stage II as extending to the hymen and Stage III beyond the hymen was also rejected. The committee remained open to further evaluation of all aspects of terminology relating to female pelvic organ prolapse.

Controversy also surrounds the impact that the observer recording the anatomical outcomes has upon reported success rates. Traditionally in the retrospective assessment of anterior compartment trials the reported success rates ranged from 80-100%.³⁹⁻⁴² However, prospective assessment of similar surgical interventions utilising similar definitions of success under the auspices of randomised controlled trials report significantly lower success rate ranging from 37-64%.^{43, 44} Further variation is also reported in prospective evaluations of prolapse staging depending upon whether the assessor is blinded to the surgical intervention. Antosh et al⁴⁵ demonstrated that the recurrence rate in a RCT comparing native tissue and transvaginal mesh repairs was significantly higher when performed by a blinded versus unblinded assessor at the 3 months (68 versus 53%) and at 1 year (57 versus 43%). Finally, it is not uncommon for authors with financial conflict of interest related to the commercial products being evaluated reporting the outcomes of surgical interventions, which further increases the risk of reporting bias.

2. OUTCOME ASSESSMENT: SYMPTOMS

Women seeking care for POP often have concurrent pelvic symptoms. Ellkermann et al found that in 237 women evaluated for POP 73% reported urinary incontinence, 86% reported urinary urgency and/or frequency, 34-62% reported voiding dysfunction and 31% complained of faecal incontinence.⁴⁶ The evaluation of a patient with vaginal prolapse requires a comprehensive review of the full spectrum of pelvic floor symptoms and an assessment of how these symptoms affect their quality of life. The most valid way of measuring the presence, severity, and impact of pelvic floor symptoms on a patient’s activities and well-being is through the use of psychometrically robust self-administered questionnaires.²⁶⁻³¹

We have gained an improved understanding of the relationship between pelvic organ support and the development of symptoms. Most symptoms often attributed to POP have at best weak to moderate correlations with worsening pelvic organ support, however, the one symptom that is almost consistently acknowledged by patients with advanced POP is the presence of a vaginal bulge that can be seen or felt.^{6, 46-49} The absence of vaginal bulge symptoms post-operatively has a significant relationship with a patient's assessment of overall improvement and improvement in quality of life after surgery, while anatomic success alone does not and ensures that symptom of vaginal bulge remains an important outcome assessment of POP surgery.²⁵

3. OUTCOME EVALUATION: QUALITY OF LIFE

Health-related quality of life (HRQOL) refers to a person's total sense of well-being and considers multiple dimensions including (but not limited to) their social, physical, and emotional health. Measures of HRQOL can be classified into two types: generic and condition-specific. Generic HRQOL instruments are used to assess quality of life in a broad range of illness or populations while condition-specific measures are designed to measure the impact of a specific disease on HRQOL. Women with advanced POP (Stage III-IV) have decreased generic and condition-specific HRQOL compared to women with nor-

mal vaginal support.⁵⁰ It is recommended that investigators describe the impact of POP surgical treatment on HRQOL. Most studies that have assessed condition-specific HRQOL after POP surgery have demonstrated a significant improvement post-operatively. Improvements in generic HRQOL after POP surgery have been seen in some studies but not others. Maher et al reported significant improvements in condition-specific and generic QOL after SSLF, similar to that after abdominal sacrocolpopexy.⁵¹ The CARE trial reported significant improvements in condition-specific quality of life following sacrocolpopexy at three months and two years.^{52, 53} Barber et al demonstrated significant improvements in generic and condition-specific HRQOL in a prospective cohort of elderly women receiving vaginal surgery for POP and demonstrated similar improvements in women undergoing reconstructive surgery and those receiving colpoceleisis.⁵⁴ While some of these condition-specific HRQOL incorporate assessment of sexual function³¹ specific validated questionnaires on sexual function are available and provide a discreet and reproducible method for evaluating sexual health. The Pelvic Organ Prolapse/Incontinence Sexual Questionnaire (PISQ)⁵⁵ and the Female Sexual Function Index (FSFI)⁵⁶ are two questionnaires frequently used. The joint ICS/IUGA paper on reporting outcomes after prolapse surgery has also recommended authors report the sexual function status of all individual participants pre and post intervention as seen in Figure 3.³²

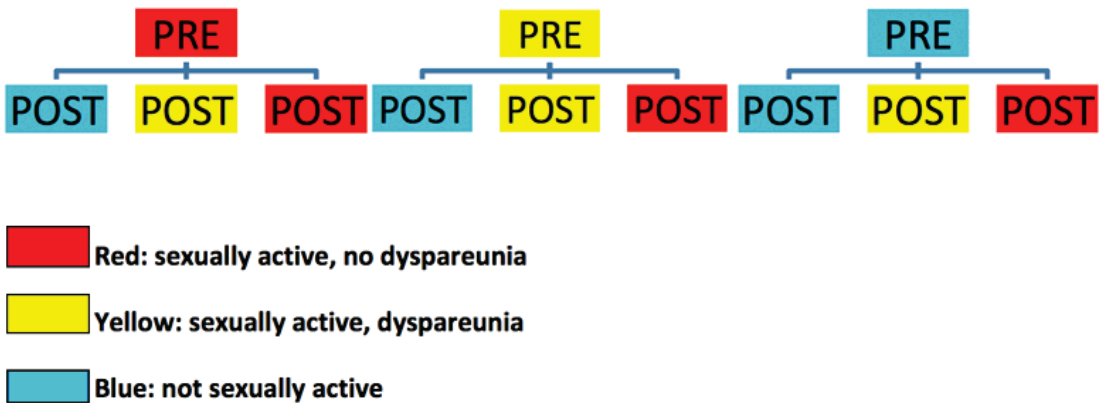

Figure 3. Describes colour coordinated approach to systematically recording pre-and post-intervention sexual function outcomes from Toozs-Hobson 2012³²

4. OUTCOME ASSESSMENT: REOPERATION

Reoperation after POP surgery for recurrence is an important measure of procedure efficacy. It is important to realise that reoperation rates are likely to represent the “tip of the iceberg” in terms of un-

successful surgical outcomes as many women with recurrence of symptomatic prolapse may not elect to undergo another operation, nonetheless the repeat surgery for recurrent POP is an undesirable outcome that should, in most cases, be considered a surgical failure. The rates of reoperation after POP surgery vary widely in the literature, in large part because of varying definitions and timeframes. Olsen et al using administrative data from a large U.S. healthcare sys-

tem reported a lifetime reoperation rate of 29.2%.¹ Importantly, this study included both POP and stress incontinence surgery and did not distinguish between reoperation for incontinence or POP in their report. Moreover, the authors did not distinguish between reoperation for POP in the same compartments originally operated versus the development of new POP in a new segment of the vagina (“de novo POP”). More recently several investigators have looked specifically at the issue of site-specific recurrence with reoperation rates ranging from 3.4%-9.7%.^{57, 58} In a meta-analysis of 258 studies evaluating reoperation rates after apical prolapse repairs, Diwadkar et al, reported a reoperation rate of 3.9% (95% CI 3.5-4.4%) for traditional vaginal vault suspensions (sacrospinous ligament suspension and uterosacral vault suspensions) after a mean of 32 months, 2.3% (95% CI 1.9-2.7%) for sacrocolpopexy with a mean follow-up of 26 months and 1.3% (95% CI 1.0-1.7%) after transvaginal mesh procedures at a mean follow-up of 17 months.⁵⁹ Notably, the total reoperation rate if one includes reoperations for recurrent POP and for complications was highest in the transvaginal mesh group (8.5%).⁵⁹

In order to provide some clarity for future studies reporting reoperation rates after POP surgery, the joint ICS/IUGA report on reporting outcomes after prolapse surgery has proposed the following standardised terminology for POP surgery studies³²:

Primary surgery for POP is the first procedure required for the treatment of POP in any compartment.

Further surgery gives a global figure for the number of subsequent procedures the patient undergoes directly or indirectly relating to the primary surgery. This is subdivided into:

a. Primary prolapse surgery/different site: A prolapse procedure in a new site/compartment following previous surgery in a different compartment (e.g. anterior repair following previous posterior repair).

b. Repeat surgery: is a repeat operation for prolapse arising from the same site. Where combinations of procedures arise, e.g. new anterior repair plus further posterior repair these should be reported separately i.e. repeat posterior repair and primary anterior repair.

c. Surgery for complications: e.g. mesh exposure or extrusion or pain or patient compromise e.g. haemorrhage (see complications section).

d. Surgery for non-prolapse related conditions: e.g. subsequent surgery for stress urinary incontinence or faecal incontinence.

4.1. Defining Treatment Success

The definition of success substantially affects treatment success rates following POP surgery.²⁵ Since the publication of the NIH Workshop recommendations, considerable variability in defining treatment success still persists in studies evaluating surgery for prolapse. A number of trials define success as POP-

Q stage 0 or I consistent with the Workshop’s “satisfactory anatomic outcome” definition with one reporting success rates as low as 30% using standard surgical techniques.^{44, 60} Some have used the Baden-Walker prolapse grading system rather than the POP-Q system.⁵¹ Other studies have used a combination of anatomic criteria and the presence or absence of symptoms to define treatment success.⁶⁰⁻⁶² Such variability makes it difficult to compare study results. Moreover, there are many unknowns, including clinical relevance of these definitions or how different outcome definitions might affect the comparison between treatment arms within a study.

The joint ICS/IUGA paper on reporting outcomes after prolapse surgery³² has recommended reporting subjective outcome (presence or absence of vaginal bulge), objective outcomes (POP-Q), validated reliable and responsive symptom questionnaires (bladder, bowel, prolapse, sexual function), condition-specific HRQOL instruments, and clearly defined reoperation rates. Complications relating to mesh and native tissue repairs should be reported using tools such as IUGA/ICS classification system for prosthesis/graft complication⁶³ or the Clavien-Dindo classification.⁶⁴ The reporting of these single outcome measures individually rather than as composite measures, allows more ready and reliable comparison in meta-analysis.

CONCLUSION

The committee made the following points:

- Significant variation is reported in the rates and types of interventions performed for pelvic organ prolapse. Such variation requires further analysis and standardisation of guidelines for the surgical management of prolapse maybe helpful. (GoR C) should be reported as levels of evidence 1-4 and based on that.
- Early evidence of decreasing rates of surgical intervention for prolapse over the last 30 years are unexpected and require further evaluation. (GoR C)
- Anatomical outcomes reported should include all POP-Q points and staging utilising traditional definition of success. Assessment should be prospective and assessors blinded as to the surgical intervention performed if possible and without any conflict of interest related to the assessment undertaken. (GoR C)
- Subjective success post-operatively should be defined as absence of vaginal bulge. (GoR C)
- Functional outcomes are best reported using valid, reliable and responsive symptom questionnaires and condition-specific HRQOL instruments. (GoR C) Grades of recommendation A-D
- Sexual function is best reported utilising validated condition specific HRQOL that assess sexual function or validated sexual function ques-

tionnaires such as the Pelvic Organ Prolapse/Incontinence Sexual Questionnaire (PISQ) or the Female Sexual Function Index(FSFI). The sexual activity status of all study participants should be reported pre-and post-operatively under the following categories: sexually active without pain, sexually active with pain or not sexually active. (GoR C)

- Prolapse surgery should be defined as primary surgery, and repeat surgery sub-classified as primary surgery different site, repeat surgery, complications related to surgery and surgery for non-prolapse related conditions. (GoR C)

III.ANTERIOR COMPARTMENT SURGERY

Ahlfelt stated in 1909 that the only remaining problem in plastic gynaecology was the permanent cure of cystocele and now more than a century later this problem persists.⁶⁵ Following high reported objective failure rates and reoperation rates after native tissue repairs and the success of mesh tapes in continence surgery and mesh utilised abdominally at sacral colpopexy, the last decade has seen both a rapid uptake and subsequent decline of transvaginal permanent meshes utilisation in the management of anterior compartment prolapse.

1. NATIVE TISSUE REPAIRS

Historically anterior colporrhaphy (AC) was the standard procedure in the management of anterior compartment prolapse with objective success rates ranging from 80-100% in retrospective series.³⁹⁻⁴² White⁶⁶ as early as 1912 demonstrated the importance of paravaginal defects in anterior compartment prolapse. Richardson⁶⁷ in 1976 described a series of defects in the pubocervical fascia explaining why no single repair should be applied indiscriminately to all with anterior compartment defects. He also advocated the abdominal paravaginal repair which has a 75-97% success rate for cystoceles reported in case series (Table 2).⁶⁷⁻⁷¹ The surgical technique of the laparoscopic paravaginal repair is well described however little information is available on the efficacy of this approach. Shull⁷² also reported on the safety and efficacy of the vaginal paravaginal repair in 1994. Although the success rates of the vaginal paravaginal

repair for cystoceles in case series vary from 67 – 100%^{66, 72-76} significant complications have been reported recently. Mallipeddi⁷⁵ reported on complications in a series of 45 including: 1 bilateral ureteric obstruction, 1 retropubic haematoma requiring surgery, 2 vaginal abscesses, 2 transfusions. In a series of 100 women Young⁷⁶ reported 21 major complications and a 16% transfusion rate.

No randomised control studies have evaluated the abdominal or vaginal paravaginal repair in isolation. Benson et al⁷⁷ and Maher et al⁷⁸ have reported RCTs on upper vaginal prolapse comparing abdominal sacral colpopexy and vaginal sacrospinous colpopexy. Abdominal paravaginal repair was performed in the abdominal group if required and an anterior colporrhaphy with or without vaginal paravaginal laterally. Both authors reported the abdominal group to have a statistically lower rate of post-operative anterior vaginal prolapse than the vaginal group.

Raz et al⁷⁹ popularised the needle suspension type procedure for cystocele and reported success rates in case series may vary from 90-98%.⁸⁰⁻⁸² The addition of polyglactin mesh to the repair appears to have little impact on the success.⁸³ [160] Dmochowski et al⁸⁴ reported a lower success rate using a stricter outcome definition of success.

Goldberg et al⁸⁵ reported results from a case control study of women with cystocele and stress urinary incontinence. He suggested that the addition of the pubovaginal sling to the anterior colporrhaphy significantly reduced the recurrence rate of cystocele from 42% in the control group to 19% in the anterior colporrhaphy and sling group (P<0.05).

The role of adequate apical support has long been thought to be important in reducing the recurrence rate of AC used for Delancey Level 11 defects. Recently, Eilber et al⁸⁶ demonstrated that 10 years after an AC, the reoperation rate for prolapse could be reduced by nearly half, from 20.2% to 11.3% by performing an apical suspending procedure at the time of AC. Unfortunately, this message is not reflected in clinical practice. In a sample of just over 1500 hysterectomies performed for vaginal prolapse in Michigan in the 17 months from January 2013 only 25% underwent some form of colpopexy at the time of surgery.⁸⁷

Table 2. Anterior Vaginal Wall Prolapse Procedures.

Author	Year	No.	Follow-up	Success Rate
Anterior Colporrhaphy				
Stanton ⁴¹	1982	54	up to 2yrs	85%
Macer ³⁹	1978	109	5-20yrs	80%
Walter ⁴²	1982	76	1.2yrs	100%

Author	Year	No.	Follow-up	Success Rate
Porges 40	1994	388	2.6yrs	97%
Colombo 88	2000	33 AC 35 colposuspension	8-17yrs 8-17yrs	97% 66%
Sand 43	2001	70 AC 73 AC& vicryl mesh	1yr 1yr	57% 75% No mesh complications
Weber 44	2001	57 AC 26 AC+ vicryl mesh	23 months 23 months	37% 42% No mesh complications
Abdominal Paravaginal Repair				
White 66	1912	19	up to 3yrs	100%
Shull 72	1994	62	0.6yrs	67%
Grody 73	1995	72	0.5-3yrs	99%
Elkins 74	2000	25	0.5-3yrs	92%
Mallipeddi 75	2001	45	0.6yrs	97%
Young 76	2001	100	11 months	78%
Morse 89	2007	27 VPVR 86 AC	13 24	54% 45%
Abdominal Paravaginal Repair				
Richardson 67	1976	60	1.7yrs	97%
Richardson 68	1981	213	0.5-6yrs	95%
Shull 69	1989	149	0.5-4yrs	95%
Bruce 70	1999	27 APR& sling 25 APR	17 months 17 months	93% 76%
Scotti 71	1998	40	39 months	97%
Sling Type Support				
Raz 79	1989	107 AC & needle	2 yrs	98%
Raz 80	1991	50	2.8yrs	90%
Gardy 81	1991	58 AC & needle	2 yrs	95%
Benirzi 82	1996	36 AC & vaginal wall sling	17 months	95%
Dmochowski 84	1997	47 Raz type	47 months	43%
Cross 90	1997	36 AC & sling	20 months	92%
Safir 83	1999	112 Raz + polyglactin mesh	21 months	92%
Goldberg 85	2001	53 AC& sling 90 AC	1 yr. 1yr	81% 58%

Abbreviations: APR: Abdominal paravaginal repair, AC: Anterior colporrhaphy Definition varies between authors

In line with our surgical colleagues from early 2000's there has been a move towards the use of prostheses to augment native tissue repair in reconstructive gynaecology. This movement took much of its impetus from two early papers. Firstly, Olsen et al¹ reported a reoperation of 29% following prolapse and or continence surgery and Weber⁴⁴ reported a 70% failure

rate of native tissue anterior compartment repair. Recent re-evaluation of the Olsen's same demographic 10 years later revealed a significantly lower reoperation rate of 17%⁹¹ and the reader should be cautious in making conclusions even from these data as the surgical interventions performed in 1995 are not representative of interventions performed today. More importantly, Weber et al⁴⁴ and Sand et

al⁴³ in randomised control trials reported the anterior colporrhaphy to be successful in the management of cystocele in only 30% and 57% respectively. Recent re-analysis of data from Weber's paper using the hymen as the threshold for objective success reported considerably better outcomes with only 10% of subjects developing anatomic recurrence beyond the

hymen, 5% of subjects developing symptomatic recurrence and reoperations less than 1% at 23 months follow-up.⁹²

During the decade between these initial and subsequent publications surgeons introduced a plethora of biological and mesh grafts to improve the outcomes of anterior compartment prolapse surgery.

Table 3. Synthetic Meshes Utilised Anterior Compartment Surgery

Author	Year	Type	No	Review (Months)	Success Rate (%)	Complication
Julian ⁹³	1996	Marlex Control	12 12	24	100 66	25% mesh erosion, infection
Nicita ⁹⁴	1998	Prolene	44	14	100	3 uterine prolapse
Flood ⁹⁵⁾	1998	Marlex	142	38	100	3 mesh erosions
Migliari ⁹⁶	1999	Mixed fibre	15	23	93	
Migliari ⁹⁷	2000	Polypropylene	12	20	75	
Natale ⁹⁸	2000	Polypropylene	138	19	97	13 mesh erosions, 9 dyspareunia, 1 haematoma
Sand ⁴³	2001	Polyglactin AC	73 70	12	75 57	no mesh complications
Weber ⁴⁴	2001	Polyglactin mesh AC	26 57	23 23	42 37	no mesh complications
Salvatore ⁹⁹	2002	Prolene	32	17	87	13% mesh erosions
de Tayrac ¹⁰⁰	2006	Polypropylene	55	37	89	9.1% mesh erosion, 5.5% mesh shrinkage 16.7% dyspareunia
de Tayrac ¹⁰⁰	2007	Low weight coated polypropylene	32	13	93	6.3% erosion, 12.8% de novo dyspareunia
Sivaslioglu ¹⁰¹	2007	RCT: low weight, self-styled polypropylene Site specific vicryl AC 4	43 42	12 12	91 72	6.9% mesh erosions 4.6% de novo dyspareunia
Nguyen ¹⁰²	2008	RCT Armed Polypropylene Perigee AC	38 38	12 12	89% 55%	5% Erosion 9% dyspareunia 16% dyspareunia 5% reoperations 1 tape, 1 POP
Carey ¹⁰³	2009	RCT repair with polypropylene gynemesh augmentation	69	12	81%	6.5% mesh erosion 0 reoperation prolapse
		Ant & post colporrhaphy	70	12	66%	Denovo dyspareunia equal both groups
Nieminen ¹⁰⁴	2010	RCT low weight self-styled armed polypropylene AC	104 97	36 36	87 59	19% erosions 24% reoperations 6 POP, 5tapes, 14 mesh exposure 19% reoperation 10 POP 9 tapes

Author	Year	Type	No	Review (Months)	Success Rate (%)	Complication
Vollebregt ¹⁰⁵	2011	RCT polypropylene Avulta Bard	56	12	91%	4% mesh exposure 0 reoperations POP Baseline dyspareunia resolved 20% Denovo dyspareunia 15% rectocele 10% Denovo dyspareunia 9% 5% reoperations POP, denovo rectocele 10% Baseline dyspareunia resolved 80%
		Vicryl AC	58		41%	
El-Nazier ¹⁰⁶	2012	AC Self-styled polypropylene Gynecare Ethicon	20 21	12	70% 95%	No difference between groups operating time, blood loss, in-patient time 5% mesh erosion
Menefee ¹⁰⁷	2011	AC Self-styled Polypropylene mesh	32 36	24	87% 96%	No reoperation prolapse either group 14% Mesh erosion
Turgal ¹⁰⁸	2013	AC Polypropylene mesh kit Parieten Sofradim	20 20	12	75% 95%	Denovo SUI 5% each group Mesh erosion 15%
Delroy ¹⁰⁹	2013	AC Polypropylene mesh kit Nazca Promedon	39 40	12	56% 82%	5% Mesh exposure
De Tayrac ¹¹⁰	2013	AC Polypropylene mesh kit Ugtex, Sofradim	82 80	12	64% 89%	2.8% reoperation prolapse 9.5% Mesh erosion, 1 patient re-operated dyspareunia
Tamanini ¹¹¹	2014	AC Polypropylene mesh kit Nazca Promedon	55 45	24	64% 76%	No reoperation prolapse either group 16.2% Reoperation rate in mesh group
Gupta ¹¹²	2014	AC Self-Styled Polypropylene Mesh (vypro JnJ)	54 52	12	100% 100%	Optimal or satisfactory outcome 100% in both groups. Operating time and blood loss greater in the mesh group High rate of blood transfusion in both groups
Lamblin ¹¹³	2014	AC Polypropylene Armed Mesh Perigee AMS	35 33	24	84% 100%	6% Mesh erosion
Rudnicki ¹¹⁴	2014	AC Polypropylene Mesh Kit Avulta Bard	79 82	36	41% 91%	14.7% Mesh erosion

Abbreviations: AC: Anterior colporrhaphy

2. SYNTHETIC GRAFTS IN ANTERIOR COMPARTMENT SURGERY

As seen in Table 3 as early as 1996 Julian et al⁹³ demonstrated in a prospective case control study that in women who had undergone at least 2 previous vaginal repairs, the overlaying of a Marlex (Bard) mesh to the anterior colporrhaphy reduced the recurrence rate of cystocele from 33% to 0%. The Marlex mesh was associated with a mesh erosion rate of 25%. Flood et al⁹⁵ in a retrospective review of 142 women with Marlex mesh augmentation of anterior colporrhaphy demonstrated a 100% success rate for cystoceles at 3.2 years and a mesh erosion rate of only 2%.

Absorbable meshes are an attractive option as an augmenting material as they offer the increased strength during the early healing phase without the long-term complications of permanent mesh and have been evaluated in two randomised controlled trials. Weber et al⁴⁴ in a randomised control trial compared the anterior colporrhaphy [33], ultra-wide anterior colporrhaphy [24] or anterior colporrhaphy with absorbable polyglactin (Vicryl) 910 mesh [26] in the management of cystocele. The study size was too small to detect small differences in efficacy or adverse events. However, at a mean follow-up of nearly two years the groups had similar proportions of women experiencing satisfactory or optimal anatomic results, 30%, 46% and 42% respectively.

Sand et al⁴³ in a larger RCT allocated cystoceles to anterior colporrhaphy alone (n=70) and to anterior colporrhaphy plus polyglactin mesh underlay (n=73). At one year the success rate in the mesh group was 75% and significantly greater than the 57% success rate in the anterior repair group alone (P=0.02). Concurrent paravaginal defect was present in 11 women and concomitant paravaginal repair was significantly associated with a lower recurrence of cystocele overall (P=0.02).

The 2016 Cochrane review on anterior compartment prolapse reported on three trials that evaluated the effects of using absorbable polyglactin (Vicryl) mesh inlay to augment prolapse repair^{43, 44, 115}. There were insufficient data for analysis on awareness of prolapse and reoperation for prolapse. There was no difference in the rate of recurrent anterior wall prolapse between the groups (RR 0.82, 95% CI 0.57 to 1.18). The authors concluded there was little advantage to utilising an absorbable mesh as opposed to anterior colporrhaphy for anterior compartment prolapse.

The 2016 Cochrane review also reported on 16 trials evaluating nearly 2000 women comparing anterior colporrhaphy with permanent polypropylene mesh for anterior compartment prolapse. The meta-analysis demonstrated some advantages and disadvantages

to the utilisation of polypropylene mesh and the Summary of Findings table is reproduced in Table 4¹¹⁶. Moderate quality evidence demonstrated that awareness of prolapse (RR 0.56, 95% CI 0.43 to 0.73), recurrent anterior wall prolapse (RR 0.34, 95% CI 0.25 to 0.46) and reoperation for prolapse (RR 0.44, 95% CI 0.24 to 0.46) were significantly less common following mesh repair as compared to AC.

There were no differences between the groups in terms of quality of life outcomes or rates of dyspareunia. However, the transvaginal polypropylene mesh group had higher rates of reoperation rate for mesh exposure, stress urinary incontinence or prolapse (RR 1.62, 95% CI 1.15 to 2.28), prolapse in the apical or posterior compartment (RR 1.85, 95% CI 1.01 to 3.37) and at POP-Q point Bp (MD 0.53, 95% CI 0.10 to 0.95,) as compared to AC. The operating time (MD 17.9 mins, 95% CI 10.0 to 25.8), rate of transfusion (RR 2.37, 95% CI 1.32 to 4.24), cystostomy (RR 4.65, 95% CI 1.22 to 17.77) and de novo stress urinary incontinence (RR 1.55, 95% CI 1.02 to 2.35) were higher after transvaginal polypropylene mesh as compared to AC. The mesh erosion rate after polypropylene mesh was 11.5% and 7% underwent surgical correction for the mesh exposure¹¹⁶.

More recently the majority of the polypropylene mesh products evaluated in this meta-analysis have been voluntarily withdrawn by the manufacturers in the face of ongoing litigation. The products with trade-name Ugtex and Paritiene (Sofradem, France) and Nazca (Promedon, Argentina) remain available in some countries.

Newer light-weight transvaginal polypropylene mesh products that have been introduced to decrease the complication rate, specifically mesh erosion. Altman et al¹¹⁷ reported a multi-centre prospective case series evaluating 207 women with apical prolapse undergoing Uphold (Boston Scientific, USA) pelvic floor system and reported a subjective success rate of 90% at one year. The reoperation rate for mesh exposure was 1.3%. Similarly, De Tairac et al found at 3-years, in 79 women with grade 3-4 cystocele, an anatomic success rate of 95%, a satisfaction rate of 98% and a mesh exposure rate of 1.3% using a light-weight (28 g/m²) polypropylene mesh (Surgimesh® Prolapse Xlight, Aspide Medical, France).¹¹⁸ Despite the current negative sentiment surrounding transvaginal mesh these newer lightweight mesh products require further evaluation.

One anomaly remains challenging from the Cochrane 2016 meta-analysis of grafts versus native tissue repairs for vaginal prolapse. Only one case of reoperation for dyspareunia or pain was reported in the nearly 1000 cases of transvaginal mesh evaluated¹¹⁶. However, pain and dyspareunia were leading causes of adverse events that triggered the 2011 FDA warnings on the safety of transvaginal mesh.¹¹⁹ In series reporting on re-intervention after transvaginal mesh pain and dyspareunia are the leading indicator for reoper-

ation and at a rate equal to higher than mesh exposure.¹²⁰⁻¹²² These findings raise the possibility that pain and dyspareunia following transvaginal mesh re-

viewed in the Cochrane review maybe under-reported and possibly only identified in trials with longer-term evaluation.

Table 4. Summary of Findings Tables comparing Anterior Colporrhaphy and Polypropylene Mesh for Anterior Compartment Prolapse. Reproduced from the 2016 Cochrane review on anterior compartment prolapse.

Outcomes	Anterior Repair (Colporrhaphy)	Polypropylene Mesh	Relative effect (95% CI)	No of Participants (studies)	Quality of the evidence (GRADE)
Awareness of prolapse	256 per 1000	143 per 1000 (110 to 187)	RR 0.56 (0.43 to 0.73)	974 (7 studies)	⊕⊕⊕⊖ moderate ¹
Repeat surgery – Prolapse	16 per 1000	7 per 1000 (4 to 13)	RR 0.44 (0.24 to 0.81)	1619 (12 studies)	⊕⊕⊕⊖ moderate ¹
Repeat surgery - Surgery for prolapse, SUI or mesh exposure	56 per 1000	91 per 1000 (64 to 128)	RR 1.62 (1.15 to 2.28)	1518 (12 studies)	⊕⊕⊕⊖ low ^{2,3}
Recurrent anterior compartment prolapse	406 per 1000	138 per 1000 (101 to 187)	RR 0.34 (0.25 to 0.46)	1481 (11 studies)	⊕⊕⊕⊖ moderate ¹
Apical or posterior compartment prolapse	93 per 1000	172 per 1000 (94 to 313)	RR 1.85 (1.01 to 3.37)	300 (2 studies)	⊕⊕⊕⊖ low ^{4,5}
Stress urinary incontinence (de novo)	86 per 1000	133 per 1000 (88 to 202)	RR 1.55 (1.02 to 2.35)	939 (6 studies)	⊕⊕⊕⊖ low ^{5,6}
De novo dyspareunia	36 per 1000	67 per 1000 (34 to 132)	RR 1.86 (0.94 to 3.66)	583 (8 studies)	⊕⊕⊕⊖ moderate ⁷

¹ Poor reporting: many studies failed to report method of allocation concealment and or rates of attrition bias

² poor reporting: adequate methods of allocation concealment or randomisation were not reported in 6 trials

³ If random effects model utilised difference not significant

⁴ One trial moderate data attrition and both participants and reviewers unblinded

⁵ Confidence interval compatible with benefit in the native tissue group or no effect

⁶ Blinding of participants or reviewers were not performed or not reported in most trials

⁷ Poor reporting: allocation concealment not reported in 3/8 and blinding of reviewers not performed or reported in 5/8

Table 5. Biological Grafts in Anterior Compartment Prolapse

Allgrafts

Author	Year	Graft	N	Months	Success rate	Complications
Cosson ¹²³	2001	Autologous vaginal patch	47	16	93%	None
Groutz ¹²⁴	2001	Cadaveric & Pubovaginal Sling	19	20	100%	None
Kobashi ¹²⁵	2002	Cadaveric Fascia lata & sling	132	12	87%	1 osteitis pubis
Chung ¹²⁶	2002	Cadaveric dermis	19	24	84%	1 infection removal
Clemons ¹²⁷	2003	Cadaveric dermis	33	18	59%	1 incision breakdown
Powell ¹²⁸	2004	Cadaveric fascia lata	58	24	81%	10% graft erosion 2 transfusions, 1 cystotomy 3 ureteral kinking
Frederick ¹²⁹	2005	Cadaveric fascia lata & sling	251	6	93%	1 osteitis pubis
Gandhi ¹³⁰	2005	RCT AC & fascia lata	76	13	82%	No graft complications

Author	Year	Graft	N	Months	Success rate	Complications
		(Tutoplasta) AC no graft	78	13	71%	
Ward ¹³¹	2007	Cadaveric dermis	39	24	42%	1 de novo dyspareunia No graft erosions

Xenografts

Lebouf ¹³²	2004	FDR & Pelvicol PDR	9 24	15 15	84% 100%	None None
Salomon ¹³³	2004	Porcine dermis transobturator	27	14	81%	1 graft r/o vaginal pain
Gomelsky ¹³⁴	2004	Porcine dermis	70	24	87%	None
Wheeler ¹³⁵	2006	Porcine dermis Uterosacral repair	28	18	50%	2% granulation tissue
Meschia ¹³⁶	2007	Porcine AC	98 103	12 12	93% 81%	1% vaginal extrusion
Handel ¹³⁷	2007	Porcine dermis Polypropylene AC	56 25 18	13 13 13	64% 96% 94%	21% vaginal extrusions 4% mesh erosion
Simsiman ¹³⁸	2006	Porcine graft	89	24	78%	17% erosions
Robles ¹³⁹	2007	Porcine dermis Polypropylene arm	90	8	85%	No complications
Guerrette ¹⁴⁰	2009	AC Bovine pericardium collagen	27 17	24	63% 77%	Reoperation POP surg 37% 23%
Hviid ¹⁴¹	2010	AC Porcine dermis graft	26 28	12	85% 93%	Recurrent POP Sur 8% 10%
Feldner ¹⁴²	2010	AC Porcine small intestine Submuosa	27 29	12	67% 86%	Dyspareunia 15% 25%
Natale ¹⁴³	2009	Porcine graft Self-styled polypropylene mesh	94 96	24	58% 72%	Mesh erosion 0 6.3%
Menefee ¹⁰⁷	2011	AC Vag paravaginal porcine dermis Vag paravaginal polypropylene	32 31 36	24	55% 52% 86%	Mesh erosion 0 4% 14%
Dahlgren ¹⁴⁴	2011	AC Porcine dermis graft	66 65	36	43% 38%	2% perineoplasty 4.4% graft erosion
Robert ¹⁴⁵	2014	AC Porcine small intestine submucosa	29 28	12	61% 57%	11% pelvic pain 13% pelvic pain

Variable definitions of success used.

3. BIOLOGICAL GRAFTS IN ANTERIOR COMPARTMENT SURGERY

Alternatively, to synthetic prosthetic grafts autologous

material may have a lower risk of host rejection or infection. Cosson¹²³ described an autologous 6-8cm long and 4cm wide vaginal patch suspended from the tendinous arches of the pelvic fascia and tucked under the anterior repair. The success rate (<grade 1 POP) was 93% at a mean follow-up of 16 months.

Allografts from post-mortem tissue banks have been

used for many years in orthopaedic surgery and decrease the risk associated with harvesting autologous rectus sheath or fascia lata. Cadaveric fascia lata with or without pubovaginal sling has been utilised to correct anterior compartment prolapse with a success rate varying from 81-100% with acceptable complication rates^{124, 125, 128, 129}. Gandhi et al have reported preliminary results of a randomised control trial comparing anterior colporrhaphy alone and augmented with fascia lata graft for cystoceles.¹³⁰ At 1 year they were not able to demonstrate that the addition of the fascial lata graft improved outcomes with the success rate after anterior colporrhaphy alone being 71% as compared to 82% in those augmented with the fascia lata graft (P=0.07). No complications were reported. Cadaveric dermis has been employed as a graft material in the anterior compartment with success rates varying from 42-84% at 2 years.^{126, 127, 131, 146} Concerns regarding prion transmission causing infectious diseases¹⁴⁷ or residual antigenicity¹⁴⁸ that may cause host graft reactions have encouraged the use of porcine or bovine xenografts as detailed in Table 4.

Leboeuf et al retrospectively reviewed 24 women with native tissue four corner defect repair (FDR) and 19 FDR with porcine dermis.¹⁴⁹ At 15 months the success rate was 100% in the FDR group and reduced to 84% if porcine dermis overlay was utilised. Wheeler et al reported on 36 women who all underwent high uterosacral vault suspension with anterior repair augmented with porcine dermis and at 17 months found a 50% recurrence rate.¹³⁵ The authors highlighted that despite the high objective failure rate greater than 90% of the women were satisfied or somewhat satisfied with the repair and 83% would undergo the surgery again. Handel et al retrospectively compared anterior colporrhaphy (n=18), porcine dermis (n=56) and polypropylene graft (n=24) in those with cystocele.¹³⁷ The success rate at 13 months was 94%, 64% and 96% respectively with a 21% rate of vaginal extrusion of the porcine dermis graft. Alternatively to these relatively disappointing results, a number of groups have reported satisfactory objective results utilising porcine dermis.^{134, 138}

Meschia et al in a multicentre randomised clinical trial compared the anterior colporrhaphy (n=103) and anterior colporrhaphy-augmented with 4x7cm piece of porcine dermis.¹⁵⁰ The success rate at 1 year was 93% in the anterior colporrhaphy with porcine graft overlay group as compared to 81% in anterior colporrhaphy alone group (P<0.001) with a 1% rate of graft erosion.

Hviid et al reported a smaller randomised controlled trial comparing polyglactin plication anterior colporrhaphy and porcine dermis 4x7cm graft at one year.¹⁴¹ The objective failure rate (defined as point Ba \geq 1) was 2/28 in the porcine dermis group as compared to 4/26 in the anterior colporrhaphy and was not significant. Guerette et al compared the anterior

colporrhaphy with (n=27) and without (n=17) bovine pericardium collagen matrix graft reinforcement and reported no difference on objective examination with success rate of 63% after the AC and 77% in the bovine pericardium collagen repair at 2 years.¹⁴⁰ The reoperation rate for prolapse was 37% in AC group and 23% in the bovine pericardium group. Denovo dyspareunia occurred in 5% following AC only. There was no difference in quality of life outcomes between the groups utilising Urinary Distress Inventory and Pelvic Organ Prolapse and Incontinence Sexual Questionnaire.

Feldner et al compared anterior colporrhaphy with 7x10cm small intestine submucosa (SIS) graft in a randomised control trial and demonstrated reduced operating time in AC group (30 versus 46min) as compared to SIS (p=0.02).¹⁴² The objective failure rate of 33% (9/27) was significantly higher after the AC versus 14% (4/29) in the SIS group. The dyspareunia rate was similar in both groups (AC 4/27 versus 5/20 SIS) and no reoperations were reported. Prolapse quality of life assessment (P-QOL) improved post-operatively in both groups with no significant difference between the groups. In another RCT, Natale_ et al compared polypropylene mesh (Gynemesh) with porcine dermis (Pelvicol). At two years, significantly fewer women had anterior vaginal wall recurrence in the mesh group 28% (27/96) versus to 44% (41/94) of the porcine graft group (RR 0.64, 95% CI 0.43 to 0.96). Mesh erosion was seen in 6.3% following mesh surgery. Although similar numbers of women reported dyspareunia (10 versus 12), the authors reported superior sexual activity outcomes in the porcine graft group as compared to polypropylene mesh (p = 0.03).¹⁴³

Finally, Menefee et al in a randomised control trial compared three operations, anterior colporrhaphy, vaginal paravaginal repair using porcine dermis graft and vaginal paravaginal with self-styled polypropylene mesh and also reported a higher objective success rate after the polypropylene mesh 86% (25/29) as compared to 52% (12/23) in the porcine dermis arm¹⁰⁷ and 53% (10/19) in the AC arm. The subjective failure rate was not significantly different and was 3.4%, 12% and 13% respectively. The graft erosion rate was 1/23 (4.3%) in the porcine dermis group and 4/29 (13.8%) in the mesh group.

In the 2016 Cochrane review on the surgical management of anterior compartment prolapse eight trials^{107, 130, 136, 140-142, 144, 145} compare AC (n=413) with various biological grafts (n=450). Porcine dermis (Pelvicol) was utilised in four trials (Dahlgren 2011; Hviid 2010; Menefee 2011; Meschia 2007), small intestine submucosa in Feldner 2010, Robert 2014, cadaveric fascia lata patch in Gandhi 2005 and bovine pericardium collagen in Guerette 2009. Meschia 2007 evaluated only primary anterior compartment prolapse and Dahlgren 2011 only included those who had at least one failed prior surgical intervention in the treated compartment. Hviid 2010 included those only with an-

terior compartment prolapse and concomitant surgery was excluded.

There were no differences detected between porcine dermis graft or small intestine submucosa and AC for the primary outcomes of awareness of prolapse, prolapse on examination and reoperation for prolapse.

When all biological grafts were analysed together biological grafts had similar outcomes to AC in awareness of prolapse and reoperation for prolapse, however the recurrent anterior prolapse rate on examination was less after biological graft repair as compared to anterior colporrhaphy (RR 0.74, 95% CI 0.55 to 0.99 n= 646, I²=29%, low quality evidence). The AC operating time was less than the biological graft procedure (MD -10.35, 95% CI -14.45 to -6.24).

4. RECURRENT ANTERIOR PROLAPSE

While many clinicians believe the primary role of polypropylene mesh may be in complex or high risk prolapse such as recurrent prolapse there is little evidence to support these proposals. Fayyad et al prospectively evaluated 36 women with recurrent anterior compartment prolapse and reported an objective success rate (less than stage 2 anterior compartment prolapse) of 47% with a mesh exposure rate of 19%.¹⁵¹

In a prospective multi-centre Dutch RCT trial women who had undergone prior prolapse surgery were randomised between native tissue repairs and tension free vaginal polypropylene mesh.¹⁵² Allocation concealment was not confirmed and neither patient, surgeon or assessor were blinded. Surgeons performed the reviews and all authors declared a financial relationship with the company manufacturing the commercial mesh product evaluated. Unfortunately, pre-operatively the two groups were significantly different pointing to a possible failure in the randomisation process which largely discredits the remaining findings of the manuscript.

The reported failure rate in the native tissue group using an unorthodox outcome definition (no prolapse in the treated compartment or reoperation) was 45% AC versus 9% mesh group at 1 year. Utilising the definition any grade 2 prolapse or subsequent prolapse surgery the failure rate was 66% in the conventional surgery group as compared to 49% (p=0.03) in the mesh group. The mesh exposure rate was 16.7% with 6% undergoing surgical intervention. Utilising Patients Global Impression of Improvement (PGII) and Urogenital Distress Inventory both groups had similar outcomes.

More recently Ow et al, retrospectively compared 237 women undergoing 185 native tissue repairs and 161 transvaginal mesh repairs (self-styled and mesh kits) for recurrent prolapse. The transvaginal mesh group had significantly lower rates of symptomatic prolapse,

prolapse on examination and reoperation for prolapse than the native tissue repairs. However, the mesh exposure rate (15% anterior, 21% posterior mesh) and reoperation for mesh exposure (anterior 9%, posterior 15%) were significant. There was no difference in the total reoperation rate between the groups (mesh 24%, NT 19%).¹⁵³

Data from these three trials demonstrate that in women with recurrent prolapse transvaginal mesh has significant advantages and disadvantages to native tissue repairs and this profile is similar to that described for primary repairs except the mesh exposure rates appear to be higher in recurrent prolapse surgery. The transvaginal mesh products evaluated in these trials have been removed from the market and of the newer transvaginal mesh products have not been evaluated in women with recurrent prolapse. This leads to the unanswered question to date, as to where sacral colpopexy fits in the treatment pathway for recurrent anterior compartment prolapse.

CONCLUSION

The following conclusion can be made regarding surgical interventions for anterior vaginal compartment repairs:

- Absorbable mesh augmentation of native tissue repair improves the anatomical outcome as compared to native tissue repair alone with no increased complication rate in meta-analysis of 2 RCTS. **(GoR B)**
- Biological grafts in meta-analysis have improved anatomical outcomes with no change in subjective outcomes as compared to native tissue repairs. **(GoR B)** Conflicting level one evidence supports porcine dermis graft (Meschia, Hviid, Menefee) and single RCT supports small intestine submucosa as graft material in anterior compartment prolapse surgery (Feldner). **(GoR B)**
- Consistent level one data support a superior anatomical outcome for Polypropylene mesh as compared to biological graft (Pelvicol) in the anterior compartment. Mesh exposure rate was significantly higher in the polypropylene mesh group. **(GoR A)**
- Consistent level one data demonstrate improved anatomical and subjective outcomes for polypropylene mesh as compared to anterior colporrhaphy. **(GoR A)** These outcomes did not translate into improved functional outcomes using validated questionnaires or a lower reoperation rate for prolapse. The mesh group was also associated with longer operating time, greater blood loss and higher rate of cystotomy, denovo stress urinary incontinence and prolapse of the apical or posterior vaginal compartment. The total reoperation rate was higher after the polypropylene mesh repair than the native tissue repair. The mesh extrusion rate was 11.5% with 7.0% requiring surgical correction. **(GoR B)**

- The risk benefit profile of transvaginal mesh as compared to native tissue repairs for recurrent vaginal prolapse is similar to primary prolapse, except for a higher rate of mesh exposures than reported after primary surgery. **(GoR C)**
- No conclusion can be reached on the safety or efficacy of the currently available transvaginal mesh for recurrent prolapse. **(GoR D)**

IV. SURGICAL TREATMENT OF UTEROVAGINAL PROLAPSE

It has been shown that defects in level 1 support, the uterosacral cardinal ligament complex, lead to uterine descent.¹⁵⁴ Despite the fact that most gynaecologists and pelvic reconstructive surgeons consider the uterus to be a passive structure in prolapse development, it is frequently removed during uterovaginal prolapse surgery. In fact, prolapse is one of the most commonly listed indications for hysterectomy.¹⁵⁵ As interest in uterine preservation increases it is important to critically evaluate the safety and efficacy of hysteropexy to determine if similar results can be achieved with uterine conservation compared to hysterectomy.

Queries of United States (US) women presenting for prolapse care suggest that 31-60% would choose uterine preservation assuming equal surgical efficacy.¹⁵⁵⁻¹⁵⁷ Women elect uterine preservation for a variety of reasons including the desire to preserve future fertility, that the uterus contributes to their sense of female identity and the wish to avoid hysterectomy perceived as a major surgery associated with significant risks. However, surveys have shown that many of the reasons for desiring uterine conservation have more to do with ovarian conservation. These include beliefs that removal of the uterus will worsen mood, relationships, quality of life, sex drive and result in weight gain.¹⁵⁶ Patient demographics have been associated with hysteropexy preferences. For example, college educated women were almost three times more likely to choose uterine conservation, and women living in the southern US were less likely to request uterine preservation (OR 0.17).¹⁵⁷ Whether it is cause or effect, a greater number of hysterectomies are performed in the US south compared to other geographic regions.¹⁵⁵ Each patient's interest in uterine conservation should be assessed during surgical planning. This can easily be accomplished by listing the patient's goals and preferences early on during the informed consent process.

Conservative management with a pessary is recommended for women with uterovaginal prolapse that are interested in future childbearing or uncertain about their reproductive plans. Due to limited data regarding risks associated with subsequent pregnancy and delivery, surgery should be reserved for those that cannot be managed with a pessary. We do not

know which type of hysteropexy is the safest with respect to fertility, pregnancy and delivery. We also do not know the impact of pregnancy and vaginal or caesarean delivery on postpartum pelvic support. Assuming pregnancy and delivery decreases the long-term success of the prolapse repair, native tissue vaginal or laparoscopic hysteropexy may be preferable as a temporising solution. This is based on the belief that future surgical management will likely be required for recurrent prolapse. This review focuses on women who have completed childbearing and are postmenopausal or practicing reliable contraception.

1. PATIENT SELECTION

Candidates for uterine conservation should be carefully considered and strict selection criteria applied to decrease the likelihood of subsequent hysterectomy, which may be more technically challenging. Most contraindications to hysteropexy are relative since the majority of cases (except LeFort colpocleisis) maintain access to the cervix and endometrial cavity for screening and sampling. Women at increased risk for endometrial, cervical or ovarian cancer and those with a personal history of oestrogen receptor positive breast cancer, especially those taking Tamoxifen should have their uterus, cervix and possibly ovaries removed at the time of prolapse repair. Hysteropexy should also be avoided in cases of uterine abnormalities listed in Table 6. Patients with recent postmenopausal bleeding even with a negative workup should probably undergo hysterectomy based on a 13% risk of unanticipated endometrial cancer or hyperplasia.¹⁵⁸ Premenopausal women and those without postmenopausal bleeding had low rates of endometrial pathology. The overall rate of endometrial cancer was 0.3% in this study (which study) and 0.8% in another large study.¹⁵⁹

During the consent process for post-menopausal women considering uterine preservation or hysterectomy, women should be informed of the lifetime risk of cervical (0.6%), uterine (2.7%), and ovarian cancer (1.4%).^{160, 161} While ovarian cancer is uncommon, the general late presentation of disease is associated with poor outcomes. Routine bilateral oophorectomy demonstrated a 10-fold decrease in the small risk of ovarian cancer without increased morbidity when results were stratified by age.^{162, 163} Furthermore in women who have completed their family and are considering prolapse surgery should be informed that bilateral salpingectomy may decrease the risk of ovarian cancer (OR 0.51, 95% CI 0.35-0.75).¹⁶⁴

Higher risk women with hereditary conditions (BRCA mutations, Lynch Syndrome) and obesity should consider hysterectomy with or without oophorectomy during prolapse repair. Table 6 list possible contraindications to uterine preservation and includes pre-operative cervical elongation. A prospective two-part study showed an almost 11-fold increased risk of failure in patients with cervical elongation undergoing sacrospinous hysteropexy. Success rates were 96-100%

after excluding patients with severe prolapse and performing partial trachelectomy for cervical elongation.¹⁶⁵ Other studies have shown similar high success rates using partial trachelectomy at the time of hysteropexy.^{166, 167} The majority of studies exclude women with menstrual disorders and abnormal uterine or cervical pathology. A recent study performed over 20 concomitant uterine/cervical procedures among 65 laparoscopic sacral hysteropexy subjects to correct abnormal pathology.¹⁶⁸ Procedures included 8 trachelectomy for cervical elongation, 5 cervical/endometrial polypectomy, 4 myomectomy/uterine artery occlusion, 2 cervical conisations for CIN 2 and 1 mesh excision. The relaxed exclusion criteria may be a factor that led to more symptomatic recurrences that required treatment (9 pessary, 1 surgery) in the hysteropexy group. This example illustrates the need for stringent selection criteria.

Table 6. Relative Contraindications to Uterine Preserving Surgery

Uterine abnormalities
Fibroids, adenomyosis, endometrial pathology sampling
Current or recent cervical dysplasia
Abnormal menstrual bleeding
Post-menopausal bleeding
Cervical elongation
Familial cancer BRAC1&2: ↑risk ovarian cancer and theoretical risk fallopian tube and serous endometrial cancer
Hereditary Non-Polyposis Colorectal Cancer (Lynch Syndrome): 60% lifetime risk endometrial cancer
Tamoxifen therapy
Obesity: up to 3-fold increased risk endometrial cancer ¹⁶⁹
Unable to comply with routine gynaecology surveillance

Hysteropexy Outcomes

A variety of hysteropexy techniques have been described to treat uterovaginal prolapse. Studies show short-term safety and efficacy with decreased blood loss, shorter operating time and more rapid recovery compared to hysterectomy. Although the quantity and quality of hysteropexy studies is growing, most studies lack controls and contain variable techniques and definitions of success. The primary purpose of this analysis is to compare hysteropexy and hysterectomy surgical outcomes for treatment of uterovaginal prolapse. Hysteropexy procedures can be subdivided into native tissue and mesh repairs. While apical or anatomic success is most commonly reported, a few studies used composite outcomes and most reported reoperation rates for prolapse. Mesh exposures have

also been included when applicable. Only studies containing a control or comparison hysterectomy group with an apical support procedure are included. Studies lacking controls as well as those that are unable to distinguish between hysteropexy and hysterectomy outcomes are excluded.

2. NATIVE TISSUE HYSTEROPEXY PROCEDURES

There are ostensibly three different types of native tissue repairs involving uterine conservation. For years, the Manchester procedure was considered to be a reasonable option; however, it has a limited role in modern gynaecological surgery and is essentially a repair for cervical elongation.¹⁷⁰ LeFort colpocleisis involves obliteration of the vaginal lumen and is an excellent option for a specific subset of women. Sacrospinous hysteropexy and uterosacral hysteropexy (vaginal, abdominal or laparoscopic) are the most commonly utilised native tissue procedures that preserve coital function.

LeFort (partial) colpocleisis

LeFort colpocleisis is the ultimate hysteropexy procedure due to high success and low morbidity in an older population with advanced prolapse and multiple medical comorbidities. It is reserved for women who are not sexually active and are not interested in preserving coital function. Shorter operating time, less blood loss and similar anatomic success was reported after LeFort compared to total colpocleisis.¹⁷¹ Hysterectomy should be reserved for uterine abnormalities identified preoperatively or concerns about difficulty evaluating subsequent vaginal bleeding. There are no studies comparing LeFort colpocleisis to vaginal hysterectomy/total colpocleisis. However, a recent decision analysis favoured LeFort colpocleisis over vaginal hysterectomy/total colpocleisis after balancing the risk of delayed endometrial cancer with hysterectomy complications plus the need for possible laparotomy.¹⁷²

Sacrospinous hysteropexy

Sacrospinous hysteropexy is performed by transfixing the cervix or uterosacral ligaments to the sacrospinous ligament using permanent or delayed absorbable suture. An initial RCT, reported more apical recurrences (21% vs. 3%, $p=0.03$), similarly frequent anterior recurrences (51% vs. 64%) and similar subjective improvement comparing sacrospinous hysteropexy ($n=37$) to vaginal hysterectomy with uterosacral suspension ($n=34$).¹⁷³ All three hysteropexy women with stage 4 prolapse had apical recurrences within one year. A recent RCT showed sacrospinous hysteropexy ($n=103$) to be non-inferior to vaginal hysterectomy with uterosacral suspension ($n=105$).¹⁷⁴ Success rates were 100% vs 96% for the primary composite outcome using the apex less than stage 2 as the threshold. Most of the recurrences occurred anteriorly. Another RCT comparing sacrospinous

hysteropexy to vaginal hysterectomy only reported sexual function outcomes using the Female Sexual Function Index-7.¹⁷⁵ There were no differences noted between groups and sexual function remained relatively unchanged with infrequent dyspareunia (5%). Transient buttock pain is a common complaint in up to 15% of patients and usually resolves without intervention.¹⁷⁴⁻¹⁷⁸ As mentioned previously, women with

cervical elongation should consider partial trachelectomy to improve apical cure.¹⁶⁵ No differences in anatomic success or symptomatic improvement were reported among four other prospective¹⁷⁶ and retrospective¹⁷⁷⁻¹⁷⁹ cohort studies. Combined analysis of data from Table 7 revealed similar high anatomic success (92 vs. 94%, $p = 0.20$) and a low reoperation rate (5%) for hysteropexy and hysterectomy.

Table 7. Sacrospinous Hysteropexy versus Hysterectomy and Native Tissue Repair

Author, Year	Study type and surgery	Review (months)	Success N (%) < stage/grade 2		Reoperation prolapse		Complications
			HP	Hyst	HP	Hyst	
Detollenaere, 2015 ¹⁸⁰	RCT SSHP vs TVH/USS	12	102/102 (100) *	96/100 (96) *	1/102 (1)	4/102 (4)	Death: 0 vs 1 (paralytic ileus, aspiration pneumonia) Reop bleeding: 0 vs 1 Buttock pain: 9% vs 0
Dietz, 2010 ¹⁷³	RCT SSHP vs TVH/USS	12	27/34 (79) **	30/31 (97) **	4/35 (11)	2/31 (6)	1 ureteral obstruction - TVH
Jeng, 2005 ¹⁷⁵	RCT SSHP vs TVH	6	MD	MD	MD	MD	Buttock pain 15%
Hefni, 2003 ¹⁷⁶	Prospective Cohort SSHP vs TVH/SSF	33	57/61 (94) ~	46/48 (96) ~	3/61 (5)	2/48 (4)	Buttock pain 3% vs 4% Hematoma 0 vs 6% – 1 reop to drain Transfusion 0 vs 4%
Van Brummen, 2003 ¹⁷⁸	Retrospective Cohort SSHP vs TVH	19	39/44 (89)	28/30 (93)	3/57 (5)	3/52 (6)	Hemorrhage: 2% vs 7% Nerve injury: 2% vs 0
Maher, 2001 ¹⁷⁷	Retrospective Cohort SSHP vs TVH/SSF	26 vs 33	20/27 (74)	21/29 (72)	2/27 (7)	2/29 (7)	Buttock pain 6% vs 3% Dyspareunia 7% vs 3%
Hefni, 2006 ¹⁸¹	Retrospective SSHP vs TVH/SSF	57	60/65 (92) ~	114/117 (97) ~	MD	MD	Buttock pain 7% Dyspareunia: 2 Rectal injury: 2 Transfusion: 1 Vault hematoma: 7 Reop bleeding: 3
Total			305/333 (92)	335/355 (94)	13/282 (5)	13/262 (5)	
P value			P = 0.20		P = 0.85		

Abbreviations: HP: hysteropexy, Hyst: hysterectomy, SSHP: sacrospinous hysteropexy, TVH: total vaginal hysterectomy, USLS: uterosacral suspension, SSLF: sacrospinous fixation, MD: missing data

* composite apex < stage 2, no prolapse symptoms, no apex reoperation

** apex < stage 2

~ composite apex < -6 cm, no prolapse symptoms, able insert 2 fingers without discomfort

Uterosacral hysteropexy

Uterosacral hysteropexy involves shortening or plicating the uterosacral ligaments with permanent or absorbable sutures placed vaginally, abdominally or laparoscopically. There are no RCTs comparing uterosacral hysteropexy to hysterectomy. A prospective cohort study comparing laparoscopic uterosacral hysteropexy (n=28) to total laparoscopic hysterectomy with uterosacral suspension (n=27) found similar anatomic success (79% vs. 78%).¹⁸² A retrospective cohort study comparing laparoscopic uterosacral hysteropexy (n=25) to age-matched vaginal hysterectomy prolapse repair (n=25) reported better symptomatic (92% vs. 80%) cure with fewer reoperations for recurrent prolapse (0 vs 3) following laparoscopic uterosacral hysteropexy.¹⁸³ A more recent retrospective cohort found lower anatomic success (47% vs. 63%) and more reoperations for recurrent prolapse

(28% vs. 21%) after laparoscopic uterosacral hysteropexy (n=104) compared to laparoscopic hysterectomy with uterosacral suspension (n=160).¹⁸³ Finally, a retrospective cohort comparing vaginal uterosacral hysteropexy (n=100) to vaginal hysterectomy with uterosacral suspension (n=100) reported similar outcomes with good apical (96% vs. 97%), anterior (87% vs. 94%) and posterior (98% vs. 100%) support.¹⁶⁷ Complications were rare for all of the studies with only two ureteric obstructions identified for over 500 uterosacral suspensions. Combined analysis from Table 8 revealed slightly better outcomes for uterosacral suspension with hysterectomy compared to hysteropexy for anatomic support (65% vs. 75%, p = 0.03) with no difference in reoperation (21% vs. 18%, p = 0.62). Overall success rates are extremely variable among the four studies with a single trial's results dominating the meta-analysis¹⁸⁴.

Table 8. Uterosacral Hysteropexy versus Hysterectomy with Uterosacral Suspension

Author, Year	Study type and surgery	Review (months)	Success N (%) < stage/grade 2		Reoperation prolapse		Complications
			HP	Hyst	HP	Hyst	
Romanzi, 2012 ¹⁶⁷	Retrospective Cohort VUSHP vs TVH/USS	24	59/68 (87)	91/97 (94)	MD	MD	Hemorrhage: 4 vs 3 Cystotomy: 0 vs 3 Ureteral obstruction: 0 vs 2 Rectal injury: 1 vs 1
Bedford, 2013 ¹⁸⁴	Retrospective Cohort LUSHP vs TLH or LAVH/LUSS	34 vs 22	49/104 (47)	100/160 (63)	29/104 (28)	33/160 (21)	Cystotomy: 1 Reoperation SBO: 1
Rosen, 2008 ¹⁸²	Prospective Cohort LUSHP vs TLH/LUSS	24	22/28 (79)	21/27 (78)	4/28 (14)	3/27 (11)	Dyspareunia: 1 each group
Diwan, 2006 ¹⁸³	Retrospective Cohort LUSHP vs TVH/McCall	7	MD	MD	0/25 (0)	3/25 (12) *	De novo dyspareunia: 2 vs 4
Total			130/200 (65)	212/284 (75)	33/157 (21)	39/212 (18)	
P value			P = 0.03		P = 0.62		

Abbreviations: HP: hysteropexy, Hyst: hysterectomy, VUSHP: vaginal uterosacral hysteropexy, TVH: total vaginal hysterectomy, USS: uterosacral suspension, LUSHP: laparoscopic uterosacral hysteropexy, TLH: total laparoscopic hysterectomy, LAVH: laparoscopic assisted vaginal hysterectomy, LUSS: laparoscopic uterosacral suspension, McCall: McCall culdoplasty, SBO: small bowel obstruction, MD: missing data * reoperation apical prolapse

3. MESH HYSTEROPEXY PROCEDURES

There are two main types of mesh hysteropexy procedures, vaginal mesh hysteropexy and sacral hysteropexy done abdominally or laparoscopically. Technique, graft type and configuration vary considerably for each of these procedures. Vaginal mesh repairs have generally declined due to concerns regarding mesh risks.¹⁹ The United States Food and Drug Administration (FDA) has reclassified vaginal mesh repairs for prolapse from class II, moderate-risk devices, to class III, high-risk devices. Manufacturers are now required to submit a premarket approval application with safety and efficacy data prior to marketing a new product or within 30 months for existing products. Anecdotally laparoscopic sacral hysteropexy is gaining popularity as a minimally invasive approach to uterine conservation with the potential for increased durability, although long-term data are lacking for this procedure.

Vaginal mesh hysteropexy

Vaginal mesh hysteropexy is performed with vaginal placement of mesh into the anterior wall with uterine conservation. In order to be a hysteropexy procedure, a concomitant apical support procedure must be performed such as a sacrospinous or uterosacral ligament suspension. Level 1 evidence demonstrates improved anterior wall support with the addition of vaginal mesh.¹⁸⁵ Thus, the addition of anterior mesh has the potential to decrease rates of anterior recurrences seen with other hysteropexy repairs. Early anterior mesh kits did not include apical support unless a concomitant posterior mesh kit with apical support was inserted or a separate apical support procedure was performed. These products are no longer commercially available and have been replaced by trocar-less

anterior mesh kits that are anchored into the sacrospinous ligament via an anterior approach. Notably, most of the second generation anterior and posterior mesh kits are no longer commercially available.

The only RCT comparing vaginal mesh hysteropexy (Uphold) to vaginal hysterectomy native tissue repair recently completed enrolment of 180 women. The Pelvic Floor Disorders Network published the rationale for and design of this trial with 36 to 60 month outcomes underway.¹⁸⁶ Three retrospective cohort studies compared vaginal mesh hysteropexy to vaginal hysterectomy with vaginal mesh repair using Perigee/Apogee (American Medical Systems, Minnetonka, MN, USA), Total Prolift (Ethicon, Somerville, NJ, USA) and Posterior Intravaginal Slingplasty (Tyco Healthcare, Norwalk, CT, USA).^{166, 187, 188} All showed high anatomical success (91-100%) with no differences between groups. The first retrospective series using Uphold involved 115 consecutive cases that were all performed by the surgeon that developed the device.¹⁸⁹ Anatomical success was 98% versus 96% for the 53 hysteropexy and 24 vaginal hysterectomy procedures. Combined analysis from Table 9 showed no difference in anatomical support (95% vs. 96%, $p = 0.94$), but more mesh exposures in the hysterectomy group (6% vs. 14%, $p = 0.02$). These findings are consistent with an early Prolift study that reported a 5-fold increased odds of mesh exposure with concomitant hysterectomy.¹⁹⁰ Thus, there may be a benefit for uterine conservation at the time of vaginal mesh repair for uterovaginal prolapse to decrease mesh exposure risks. The only study that included reoperations for prolapse found more reoperations (5% vs. 0) in the hysteropexy group when using total Prolift.¹⁸⁸ Currently 3 of the 4 devices used in Table 4 are no longer commercially available and no comparative data exist for surgeons that fashion their own vaginal mesh implants.

Table 9. Vaginal Mesh Hysteropexy versus Vaginal Hysterectomy and Vaginal Mesh Repair

Author, Year	Study type and surgery	Review (months)	Success N (%) < stage 2		Complications	Mesh exposure N (%)	
			HP	Hyst		HP	Hyst
Chu, 2011 ¹⁸⁷	Retrospective Cohort (Perigee/Apogee) VMHP vs TVH/VMR	9	50/52 (96)	39/39 (100)	Abnormal sensation: 3 vs 3 Transfusion: 0 vs 1	2/52 (4)	5/39 (13)
Neuman, 2007 ¹⁹¹	Retrospective Cohort (post IVS) VMHP vs TVH/VMR	29	32/35 (91) *	42/44 (95) *	None	4/35 (11)	6/44 (14)
Vu, 2012 ¹⁸⁹	Retrospective (Uphold) VMHP vs TVH/VMR	12	52/53 (98)	22/24 (96)	Left labial numbness: 1	1/53 (2)	2/24 (8)
Huang, 2015 ¹⁸⁸	Retrospective Cohort (Total Prolift)	30	74/78 (95)	23/24 (96)	Dyspareunia: 1 vs 0 Vaginal pain: 2 vs 0	6/78 (8)	5/24 (21)

Author, Year	Study type and surgery	Review (months)	Success N (%) < stage 2		Complications	Mesh exposure N (%)	
			HP	Hyst		HP	Hyst
	VMHP vs TVH/VMR				Vaginal infection: 0 vs 2 Reop mesh exposure: 2 vs 3		
TOTAL			208/218 (95)	126/131 (96)		13/218 (6)	18/131 (14)
P value			P = 0.94			P = 0.02	

Abbreviations: HP: hysteropexy, Hyst: hysterectomy, VMHP: vaginal mesh hysteropexy, TVH: total vaginal hysterectomy, VMR: vaginal mesh repair, post IVS: posterior intravaginal slingplasty

* < stage 3

4. SACRAL HYSTEROPEXY

Sacral hysteropexy typically involves the attachment of at least one graft from the cervix and uterus to the anterior longitudinal ligament near the sacral promontory. This is an abdominal procedure that can be performed via an open, laparoscopic or robotic approach. A variety of graft materials, configurations and operative techniques have been described. The most common technique involves a single polypropylene mesh strap extending posteriorly from the sacrum to the uterus. The graft then bifurcates and the two smaller arms are passed through windows in the broad ligament and secured to the anterior cervix. The length of graft extension down the anterior and posterior vaginal walls as well as the use of a second mesh strap varies and may explain differences in anterior wall recurrences and development of cervical elongation. Some studies use a single anterior graft attached to the proximal anterior vaginal wall similar to sacral colpopexy.

The graft bifurcates and the arms are passed through windows in the broad ligament and anchored into a posterior graft if present or directly into the anterior longitudinal ligament. The majority of studies compare sacral hysteropexy to hysterectomy and sacral colpopexy with a few studies using native tissue controls.

One RCT comparing abdominal sacral hysteropexy (n=41) to vaginal hysterectomy with uterosacral suspension (n=41) found similar subjective and anatomical outcomes. However, the hysteropexy subjects underwent more planned or performed reoperations (22% vs. 2%).¹⁹² Similarly to this, a recent pilot RCT comparing laparoscopic sacral hysteropexy (n=40) to vaginal hysterectomy with uterosacral suspension (n=39) demonstrated that while apical support and total vaginal length were superior in the laparoscopic hysteropexy group, 21% of the hysteropexy group required additional anterior colporrhaphy compared to none in the vaginal hysterectomy group.¹⁹³ The laparoscopic approach had a longer operating time however blood loss, admission and recovery time were reduced compared to the vaginal hysterectomy group. A retrospective cohort compared abdominal sacral hysteropexy (n=35) to abdominal hysterectomy with sacral colpopexy (n=63) or uterosacral suspension (n=70).¹⁹⁴ In this cohort, sacral hysteropexy had superior anatomical success (100% vs. 74%) over hysterectomy and uterosacral suspension. For the combined native tissue comparisons in Table 10, sacral hysteropexy had similar anatomical success (80% vs. 69%, p = 0.14), however the planned and performed reoperations were higher after the sacrohysteropexy (21% vs 10%, p = 0.05).

Table 10. Sacral Hysteropexy versus Hysterectomy and Uterosacral Suspension

Author, Year	Study type and surgery	Review (mo.)	Success N (%) < stage 2		Reoperation prolapse (includes planned reoperation)		Complications	Mesh exposure N (%)	
			HP	Hyst	HP	Hyst		HP	Hyst
Roovers, 2004 ¹⁹²	RCT ASHP vs TVH/USS	12	26/41 (63)	25/41 (61)	9/41 (22)	1/41 (2)	Transfusion: 1 vs 2 Bowel injury: 0 vs 1 Vault abscess: 2 vs 0	2/41 (5)	n/a

Author, Year	Study type and surgery	Review (mo.)	Success N (%) < stage 2		Reoperation prolapse (includes planned reoperation)		Complications	Mesh exposure N (%)	
			HP	Hyst	HP	Hyst		HP	Hyst
							Reop: 3 (hernia, 2 infected implants) vs 1 (vaginal stricture)		
Jeon, 2008 ¹⁹⁴	Retrospective Cohort ASHP vs TAH/USS	36	35/35 (100)	52/70 (74)	MD	MD	Ureteral obstruction:0 vs 1 SBO: 0 vs 1	0/35	n/a
Rahmanou, 2014 ¹⁹³	RCT LSHP vs TVH/USS	12	MD	MD	8/40 (8)	7/39 (18)	None	0/40	n/a
Total			61/76 (80)	77/111 (69)	17/81 (21)	8/80 (10)		2/116 (2)	n/a
P value			P = 0.14		P = 0.05				

Abbreviations: HP: hysteropexy, Hyst: hysterectomy, ASHP: abdominal sacral hysteropexy, TVH: total vaginal hysterectomy TAH: total abdominal hysterectomy, LSHP: laparoscopic sacral hysteropexy, USS: uterosacral suspension, SBO: small bowel obstruction, MD: missing data

There are no RCTs comparing sacral hysteropexy to hysterectomy and sacral colpopexy. Two prospective cohort studies showed similar high success (91% vs. 92% and 100% each group) with no reoperations for recurrent prolapse comparing abdominal sacral hysteropexy to total abdominal hysterectomy plus sacral colpopexy.^{195, 196} Retrospective cohort studies also showed similar anatomical success (100% vs. 95%) comparing abdominal^{196, 197} and laparoscopic¹⁶⁸ sacral hysteropexy to hysterectomy plus sacral colpopexy.^{197, 198} Re-operation (n=1) and pessary use (n=9) were higher (15% vs. 0) following laparoscopic hysteropexy.¹⁶⁸ A small pilot prospective cohort is the only study comparing laparoscopic sacral hysteropexy (n=15) to laparoscopic supracervical hysterectomy and sacral colpopexy (n=30).¹⁹⁹ They reported lower anatomical cure in the hysteropexy group (27% vs. 67%) despite complete resolution of

prolapse symptoms and no reoperation in either group. Combined analysis in Table 11 reveals no difference in anatomical success rates (84% vs 90%, p = 0.06); however, there were significantly more reoperations for prolapse in the hysteropexy group compared to hysterectomy group (7% vs 0, p < 0.01). There were fewer mesh exposures (0 vs. 7%, p < 0.01) for hysteropexy compared to total hysterectomy and no mesh exposures among the 30 laparoscopic supracervical hysterectomy procedures. Myers et al retrospectively reported on women two years after total versus supracervical hysterectomy with robotic sacral colpopexy and demonstrated a higher rate of recurrent stage 2 or greater prolapse after the subtotal hysterectomy as compared to total hysterectomy ((41.9 % vs 20.0 %, p = 0.03; OR 2.8, 95 % CI, 1.07-7.7).²⁰⁰

Table 11. Sacral Hysteropexy versus Hysterectomy and Sacral Colpopexy

Author, Year	Study type and surgery	Review (mo.)	Success N (%) < stage 2		Reoperation prolapse		Complications	Mesh exposure N (%)	
			HP	Hyst	HP	Hyst		HP	Hyst
Costantini, 2005 ¹⁹⁵	Prospective Cohort ASHP vs TAH/SCP	51	31/34 (91) *	35/38 (92) *	0/34 (0)	0/38 (0)	Hematoma: 2 vs 4 Transfusion: 2 vs 2	0/34	3/38 (8)
Costantini, 2013 ¹⁹⁶	Prospective Cohort ASHP vs TAH/SCP	12	32/32 (100) **	36/36 (100) **	0/32 (0)	0/36 (0)	MD	MD	MD

Author, Year	Study type and surgery	Review (mo.)	Success N (%) < stage 2		Reoperation prolapse		Complications	Mesh exposure N (%)	
			HP	Hyst	HP	Hyst		HP	Hyst
Jeon, 2008 ¹⁹⁸	Retrospective Cohort ASH vs TAH/SCP	36	35/35 (100)	60/63 (95)	MD	MD	Abscess: 0 vs 2 Ureteral obstruction: 0 vs 1 SBO: 0 vs 3	0/35	5/63 (8)
Bai, 2005 ¹⁹⁷	Retrospective Cohort ASHP vs TAH/SCP	12	10/10 (100) ^	18/19 (95) ^	MD	MD	Transfusion: 3 vs 5 Wound dehiscence and closure: 0 vs 2	0/10	3/19 (16)
Costantini, 1998 ²⁰¹	Retrospective ASHP vs TAH/SCP	32	7/7 (100)	8/9 (89)	MD	MD	DVT/PE: 2 Femoral neuropathy: 1 Incisional hernia: 2	0/7	0/9
Pan, 2015 ¹⁶⁸	Retrospective Cohort LSHP vs TLH/LSCP	33	47/65 (72) ~	30/34 (88) ~	10/66 (15) †	0/34 (0) †	None	0/65	0/34
Gracia, 2015 ¹⁹⁹	Prospective Cohort LSHP vs LSH/LSCP	12	4/15 (27)	20/30 (67)	0/15(0)	0/30 (0)	Bladder injury: 0 vs 2	0/15	0/30
Total			166/198 (84)	207/229 (90)	10/147 (7)	0/138		0/166	TAH+ TLH 11/163 (7) LSH 0/30
P value			P = 0.06		P = 0.002			P = 0.0004 for TAH	

Abbreviations: HP: hysteropexy, Hyst: hysterectomy, ASHP: abdominal sacral hysteropexy, TAH: total abdominal hysterectomy, SCP: sacral colpopexy, LSHP: laparoscopic sacral hysteropexy, TLH: total laparoscopic hysterectomy, LSCP: laparoscopic sacral colpopexy, LSH: laparoscopic supracervical hysterectomy, MD: missing data

* < stage 2 plus apex < -6 cm

** apex < -6 cm

^ < stage 1

~ < stage 1 and at least 3 cm above hymen

† reoperation prolapse or pessary use

Hysteropexy Comparative Studies

There are limited data to help guide surgical planning and choice of hysteropexy for patients interested in uterine preservation. Our composite outcomes (Tables 8-12) are useful for comparing hysteropexy to hysterectomy, but should be viewed with caution when comparing the various hysteropexy procedures. For example, it would be inaccurate to claim that sacrospinous hysteropexy is superior to uterosacral hysteropexy based on the total success rates from Tables 2 and 3. While there appears to be a large difference in outcomes for the two procedures, they have not been compared to each other directly using similar outcome criteria. There are no RCT's published comparing different types of hysteropexy procedures. A multi-centre RCT (LAVA-trial) is under-

way in the Netherlands comparing laparoscopic sacral hysteropexy with vaginal sacrospinous hysteropexy and a methods paper has been published for this trial.²⁰²

A retrospective cohort study evaluated outcomes for 240 hysteropexies performed at a single academic institution over a 9-year period.²⁰³ There were 61 vaginal mesh hysteropexies using Prolift and Uphold. There were 43 laparoscopic and 27 robotically assisted laparoscopic plus 15 abdominal sacral hysteropexy procedures. The remainder were native tissue hysteropexy. Mesh exposures occurred in 2% of vaginal mesh repairs and 2.4% of combined laparoscopic, robotic and abdominal sacral hysteropexy procedures. Length of follow-up differed between groups (6 to 22 months) with additional baseline differences noted. Prolapse recurrence, defined as

bulge symptoms and POP-Q > stage 1, was observed in 12%. Recurrence rates were similar between vaginal mesh and non-mesh repairs (10% vs 12%, $p = 0.71$) as well as laparoscopic mesh and non-mesh repairs (23% vs 10%, $p = 0.07$). Another retrospective cohort compared laparoscopic ($n=54$) and open ($n=57$) sacral hysteropexy repairs.²⁰⁴ Aside from longer operative time and blood loss with open abdominal surgery, there were no differences in satisfaction (94% vs. 91%), anatomical success (POP-Q < stage 3: 96% vs. 98%), reoperation (4% vs. 2%) and mesh exposure (0 vs. 5%).

A recent prospective multi-centre cohort study compared laparoscopic sacral hysteropexy using anterior and posterior mesh straps ($n=64$) to vaginal mesh hysteropexy using Uphold ($n=61$).²⁰⁵ There was no difference at 1 year in composite cure (72% vs 74%, $p=0.27$) using validated outcome measurements/POP-Q. Composite cure was defined as no prolapse beyond the hymen, apex above the mid vagina, no symptoms and no reoperation or pessary use. There were only two reoperations for recurrent prolapse, both in the vaginal group. Mesh exposure rates were 2.7% for laparoscopic and 6.6% for vaginal hysteropexy. Satisfaction was 95% for both groups and symptoms resolved in 90-95%.

5. HYSTERECTOMY RISKS

Most providers recognise that hysterectomy is a relatively safe procedure with low risks of severe morbidity. The most common injuries that occur during pelvic reconstructive surgery involve the urinary tract. These injuries are often preventable or recognised with routine cystoscopy and repaired prior to leaving the operating room. Most hysterectomies performed for prolapse involve small uteri, especially in postmenopausal women, leading to short operative times for this portion of the procedure. If we assume similar success with hysteropexy and hysterectomy, risks of hysteropexy and subsequent hysterectomy, which may be more challenging, must be weighed against concomitant hysterectomy risks. This section reviews some of the risks that may be encountered when hysterectomy is performed at the time of urogenital prolapse repair.

Premature ovarian failure

Performance of a hysterectomy alone or at the time of prolapse repair (native tissue or mesh) may have a negative impact on ovarian function in premenopausal women. Two large prospective cohort studies showed an increased risk of earlier onset of menopause in women undergoing hysterectomy compared to nonsurgical controls, even with conservation of both ovaries.^{206, 207} There was an approximately 2-fold increased risk of undergoing menopause over a 5-year time period with hysterectomy alone. The risk increased to almost 3-fold with removal of one ovary.²⁰⁶ While this may not be a major factor in peri- and postmenopausal women, it must be considered

during surgical planning for premenopausal women.

Mesh exposure

Total hysterectomy at the time of sacral colpopexy has been shown to increase mesh exposure rates when compared to hysteropexy or supracervical hysterectomy. In Tables 9 and 11, mesh exposure risks were 6% versus 14% for vaginal mesh repairs and 0 versus 7% for sacral colpopexy. Even with a decline in rates of vaginal mesh repair, laparoscopic sacral colpopexy with or without robotic assistance is becoming increasingly popular for the treatment of primary uterovaginal prolapse. This is based on the assumption that it will provide better anatomical support with more durable outcomes. However, evidence favouring sacral colpopexy as the best prolapse repair is largely founded on studies involving surgical management of post-hysterectomy vault prolapse. Many providers have extrapolated these results to primary uterovaginal prolapse despite a lack of good quality data and consensus. In a recent review of over 125,000 robotic or laparoscopic sacral colpopexy in the US between 2009 and 2011, nearly 50% of cases involved concomitant hysterectomy.²⁰⁸ Thus, to further evaluate the data on sacral colpopexy and uterine prolapse, we compared mesh exposure rates for studies describing results with no hysterectomy (post-hysterectomy or hysteropexy), total hysterectomy and subtotal (supracervical) hysterectomy. Procedures were further subdivided into open and laparoscopic sacral colpopexy. Mesh exposure rates were 3.5-fold higher ($p < 0.0001$) after a sacral colpopexy with concomitant total hysterectomy (7.2%) compared to no hysterectomy (2.2%). The differences in mesh exposure rates between sacral colpopexy with hysterectomy versus no hysterectomy were greater for open procedures (9.3% vs 2.3%, $p < 0.0001$) compared to laparoscopic repairs (5.9% to 2.1%, $p < 0.0001$). Many of the open repairs used grafts other than polypropylene, such as polytetrafluoroethylene (Teflon) and polyethylene (Mersilene, some Marlex), which have been shown to increase the risk of mesh exposure.²⁰⁹ The rate of mesh exposure was significantly lower with sacral colpopexy and supracervical hysterectomy (0.7%).

If hysterectomy was considered at the time of sacral colpopexy techniques for graft attachment to the vagina may also play a role. Three studies included in Table 12 contain subjects that underwent total vaginal hysterectomy or laparoscopic assisted vaginal hysterectomy with vaginal attachment of the mesh at sacral colpopexy.^{210-212 58,59,60} Two of these studies revealed a 2 to 4-fold decreased rate of mesh exposure (14% vs 32% and 3% vs 14%) with vaginal attachment of mesh compared to laparoscopic attachment of the vaginal portion of the mesh with concomitant total hysterectomy during laparoscopic sacral colpopexy.^{211, 212} A third study showed a low rate of mesh exposure (1.6% vs 1.7%) comparing total vaginal hysterectomy with vaginal attachment to laparoscopic supracervical hysterectomy at the time of lap-

aroscopic sacral colpopexy.²¹³ One potential explanation for the decreased rate of mesh exposure with vaginal compared to laparoscopic attachment is less vaginal cuff manipulation and disruption during the

laparoscopic portion of the case. More long-term prospective data are needed to determine the role of vaginal attachment at the time of sacral colpopexy.

Table 12. Rate of mesh exposures at sacral colpopexy with and without total and subtotal hysterectomy

Author, Year	Follow-up (months)	SCP surgery	Mesh	No hysterectomy Cuff intact	Total hysterectomy	Subtotal hysterectomy	P value
Jeon, 2008 ¹⁹⁸	36	Open	Teflon Marlex(PP)	0/35	5/63		
Jeon, 2009 ¹⁹⁴	66	Open	Teflon Marlex(PP)	0/31	4/26		
Cundiff, 2008 ^{209*}	24	Open	Mersilene(PE) PP Gorotex	8/239	12/83		
Wu, 2006 ²¹⁴	15	Open	Gorotex Mersilene PP	10/212	7/101		
Costantini, 2005 ^{195*}	51	Open	Marlex(PP)	0/34	3/38		
Bai, 2005 ¹⁹⁷	12	Open	Synthetic mesh	0/20	3/19		
Bensiger, 2005 ²¹⁵	12	Open	PP	0/35	4/49	0/37	
Brizzolara, 2003 ²¹⁶	35	Open	80% PP 20% allografts	0/64	1/60		
Culligan, 2002 ²¹⁷	24	Open	Synthetic mesh	3/234	3/11		
Ginath, 2013 ²¹⁸	7	Open	PP	2/82		1/195	
Total for Open SCP				23/986 (2.3%)	42/450 (9.3%)	1/232 (0.4%)	<0.0001
Stepanian, 2008 ²¹⁹	12	Lap	PP	2/272	3/130		
Tan Kim, 2011 ²²⁰	15	Lap ±RA	PP	5/110	13/57*	1/21	
Osmundsen, 2012 ²²¹	3	RA Lap	PP		8/49	0/31	
Warner, 2012 ²¹²	6	Lap	PP	1/95	9/187*	0/92	
Crane, 2014 ²²²	2	RA Lap	PP	6/118	3/79	0/33	
Myers, 2016 ²²³	12	RA Lap	PP		3/40	1/43	
Pan, 2015 ¹⁶⁸	33	Lap	PP	0/65	0/34		
Gracia, 2015 ^{199*}	12	Lap	PP	0/15		0/30	
Nosti, 2016 ²¹³	9	Lap ±RA	PP		2/123**	1/59	
Total for Lap SCP				14/675 (2.1%)	41/699 (5.9%)	3/309 (1%)	<0.0001

Author, Year	Follow-up (months)	SCP surgery	Mesh	No hysterectomy Cuff intact	Total hysterectomy	Subtotal hysterectomy	P value
Total				37/1661 (2.2%)	83/1149 (7.2%)	4/541 (0.7%)	<0.0001

Abbreviations: PP: polypropylene, PE: polyester, Lap: Laparoscopic, RA: robotic assisted, SCP: Sacral Colpopexy, MD: missing data

*A portion of these cases involves vaginal attachment of the mesh

**All of these cases involve vaginal attachment of the mesh

*** Denotes prospective trial. All other retrospective

Spread of unanticipated malignancy

There are insufficient data to compare laparoscopic sacral hysteropexy and laparoscopic supracervical hysterectomy and sacral colpopexy. Cervical conservation appears to decrease mesh exposure risk when hysterectomy is performed with sacral colpopexy (Table 12). A common concern with laparoscopic supracervical hysterectomy involves the spread of unanticipated pathology associated with electronic power morcellation. On April 17, 2014, The U.S. FDA issued a safety communication discouraging the use of laparoscopic uterine power morcellation in hysterectomy and myomectomy for the treatment of uterine fibroids due to the “risk of spreading unsuspected cancerous tissue, notably uterine sarcomas beyond the uterus”.²²⁴ The American College of Obstetricians and Gynecologists (ACOG)²²⁵ in May 2014. The FDA later issued an updated guidance communication November 24, 2014 recommending that manufacturers of power morcellators include a boxed warning with product labelling safety statements. This included the following contraindications: 1) removal of suspected fibroids in peri- or post-menopausal patients and 2) gynaecologic surgery with tissue known or suspected of malignancy. This prompted many manufacturers to withdraw their products from the market for fear of litigation. Many hospitals placed an immediate ban on laparoscopic power morcellation, while a smaller number of institutions crafted policies to permit usage under strict guidelines.

In women with fibroids, the risk of undiagnosed leiomyosarcoma is between 1:350 to 1:500 according to the FDA and ACOG.^{224, 225} The prognosis is poor with

this condition, and intraperitoneal spread of tissue may worsen the prognosis. This risk is presumably much lower in women without fibroids. Since the majority of women undergoing prolapse surgery do not have fibroids, the American Urogynecologic Society (AUGS) issued the following comments in a position statement.²²⁶ “After appropriate preoperative evaluation, supracervical hysterectomy facilitated by power morcellation use during mesh sacrocolpopexy is a reasonable procedure. The decision to perform power morcellation during a supracervical hysterectomy for a minimally invasive mesh sacrocolpopexy should include a discussion between the physician and the patient of the risks and benefits during the informed consent process”. So, what is the true risk of unanticipated pathology and cancer in a population undergoing prolapse surgery? Table 13 includes data from several studies reporting the rate of unanticipated pathology and malignancy at the time of hysterectomy for prolapse repair. The studies were retrospective and evaluated low risk patients excluding cases involving preoperative symptoms of postmenopausal bleeding or abnormal findings on screening. The overall rates were low with only 1.8% unanticipated pathology, the majority of which were endometrial hyperplasia, and 0.3% of endometrial cancer. There were no cases of sarcoma identified during prolapse surgery. Consequently, for low risk women, it is reasonable to perform laparoscopic power morcellation during prolapse repair after obtaining adequate informed consent.

Table 13. Risk of unanticipated pathology and malignancy during hysterectomy for prolapse

Reference	Number prolapse cases	Total unanticipated pathology N (%)	Endometrial Cancer	Sarcoma
Frick, 2010 ¹⁵⁸	644	17 (2.6)	2 (0.3)	0
Andy, 2014 ²²⁷	324	3 (0.9)	0	0
Ackenbom, 2016 ²²⁸	1196	10 (0.8)	3 (0.3)	0
Renganathan, 2010 ¹⁵⁹	517		4 (0.8)	0
Grigoriadis, 2015 ²²⁹	333	14 (4.2) *	0	0

Reference	Number prolapse cases	Total unanticipated pathology N (%)	Endometrial Cancer	Sarcoma
Ouldamer, 2014 ²³⁰	853		4 (0.5)	0
Bojahr, 2015 ²³¹	635			0
Total	4502	44/2497 (1.8)	13/3867 (0.3)	0/4502

*includes 1 case of cervical cancer (0.3%)

CONCLUSION

There are numerous options for primary treatment of uterovaginal prolapse. The following are evidence based guidelines regarding uterine preservation.

- Hysteropexy is reasonable in women undergoing surgery for uterovaginal prolapse without contraindications to uterine preservation. However long-term data are limited and the need for subsequent hysterectomy unknown. **(GoR C)**
- LeFort colpocleisis is preferred over vaginal hysterectomy and total colpocleisis when there is no specific indication for hysterectomy and no interest in preserving coital function. **(GoR D)**
- Consistent Level one and two evidence reveal no differences in outcomes comparing sacrospinous hysteropexy to vaginal hysterectomy with native tissue prolapse repair with the exception of a single small RCT showing a higher risk of apical recurrence for hysteropexy patients with advanced prolapse. **(GoR C)**
- Vaginal hysterectomy with apical suspension has a lower rate of reoperation for prolapse when compared to sacrohysteropexy. **(GoR B)**
- The data are not supportive of transvaginal mesh and hysterectomy for uterine prolapse. Consistent Level two evidence shows no difference in anatomical success comparing vaginal mesh hysteropexy to hysterectomy; however, the mesh exposure rate was significantly higher after hysterectomy than hysteropexy (14% vs. 6). **(GoR C)**
- The data are inconclusive comparing sacral hysteropexy and sacral colpopexy with hysterectomy due to a higher reoperation rate for prolapse in the hysteropexy group and a higher rate of mesh exposure in the hysterectomy group **(GoR D)**
- Consistent Level two evidence supports low mesh exposure rates when sacral colpopexy is performed without hysterectomy or with supracervical hysterectomy. Rates are increased three to five-fold with total hysterectomy and sacral colpopexy. **(GoR B)**
- If total hysterectomy is considered with sacral colpopexy, in preliminary studies vaginal attach-

ment of the mesh may have a lower mesh exposure rate than laparoscopic attachment of the vaginal portion of the mesh in early Level three evidence. **(GoR C)**

- Level three evidence reveals low rates of unanticipated pathology (1.8%) and endometrial cancer (0.3%) with no cases of sarcoma identified during laparoscopic supracervical hysterectomy with power morcellation in women with low risk of malignancy and dysplasia undergoing prolapse surgery. **(GoR C)**

V. APICAL PROLAPSE SURGERY

While anterior vaginal prolapse is most common, loss of apical support is usually present in women with prolapse that extends beyond the hymen.^{232, 233} There is growing recognition that adequate support for the vaginal apex is an essential component of a durable surgical repair for women with advanced prolapse.²³⁴⁻²³⁶ There is a strong correlation between anterior vaginal prolapse and apical descent seen on anatomical studies.^{237, 238} While recognition of apical defects is one of the biggest challenges in the preoperative evaluation of pelvic support defects, surgical correction of the apex has several good options with relatively high success rates. Apical suspension procedures can broadly be separated into those performed transvaginally and those performed abdominally. Abdominal procedures, predominantly sacrocolpopexy, can be performed via laparotomy or using conventional laparoscopic or robotically assisted-laparoscopic techniques. Although precise estimates are not available, most studies suggest that the vaginal approach is most common with 80-90% of procedures being performed through this route^{1, 20, 22, 60}[FDA]. Transvaginal apical suspension procedures include both non-mesh (native tissue) procedures and mesh repairs. The individual woman's surgical history and goals, as well as her individual risks for surgical complications, prolapse recurrence and de novo symptoms affect surgical planning and choice of procedure for apical POP.

1. SACROSPINOUS LIGAMENT SUSPENSION (SSLs)

One of the most popular and widely reported native tissue transvaginal procedures for correcting apical prolapse is the SSLs. First described in 1958²³⁹, this

procedure suspends the vaginal apex to the sacrospinous ligament either unilaterally or bilaterally, typically using an extraperitoneal approach. Observational series and clinical trials suggest that while apical recurrence after SSLS is uncommon (0.6% to 19%), recurrence of anterior vaginal prolapse is more problematic (3.7% to 28.5%) (Table 14). A meta-analysis by Morgan et al found an overall failure rate at any site of 28.8% (95% CI 18.4%-36.3%) with failure of the anterior segment seen in 21.3% (17-3-25.3%), apical segment of 7.2% (95% CI 4.0 – 10.4%) and posterior segment of 6.3% (95%CI 4.2-8.4%). Whether the relatively high rate of anterior vaginal prolapse recurrence seen with SSLS is due to the posterior deflection of the vaginal axis, as many authors suggest,^{61, 77, 240, 241} or simply represents a general predilection of anterior support to fail after pelvic reconstructive surgery remains unknown.²⁴² Reoperation rates after SSLS range from 1.3% to 37%, with all but three series reporting rates less than 9% (Table 14).

Maier et al demonstrated significant improvements in condition-specific and generic QOL after SSLS, similar to that after abdominal sacral colpopexy.⁷⁸ A meta-analysis of randomised and observational studies found a pooled average for failure to provide relief of prolapse symptoms after SSLS of 10.3% (95% CI 4.4-16.2%).²⁴³ The pooled average for failure to provide patient satisfaction after SSLS in this analysis was 13% (95% CI 7.4%-18.6%).²⁴³ Although infrequent, serious complications associated with SSLS include buttock pain and sacral/ pudendal neurovascular injury. Unilateral buttock/gluteal pain occurs in 3-15% of patients and typically resolves within 6 weeks after surgery.^{122, 244} In one multi-centre trial, neurological pain requiring medical or surgical intervention occurred in 12.4% immediately after SSLS and persisted in 4.3% at 4-6 weeks after surgery.²⁴⁴ In a review of 22 studies that included 1229 SSLS procedures, three patients (0.2%) had life-threatening haemorrhage from sacral or pudendal vascular injury and the overall transfusion rate was 2%.²⁴⁵

Table 14. Outcomes of Sacrospinous ligament suspension (SSLS) procedures.

First Author, Year (year)	Study Design	No	Mean Follow-up Mo. (range)	Definition of Anatomic Success*	Anatomic success –all segments	Anatomic recurrence by segment	Reoperation for prolapse
Morley, (1988) ¹¹	retrospective	92	51.6 (1-132)	Not defined	90%	Apex 4% Anterior 6%	4 (5%)
Imparato, (1992) ²⁴⁶ [53]	retrospective	155	Not stated	Not defined	90.3%	Not reported	None reported
Shull, (1992) ²⁴¹	retrospective	81	(24 – 60)	Grade 0-1	82%	Apex 4% Anterior 12% Posterior 1%	4 (5%)
Pasley, (1995) ²⁴⁷	retrospective	144	35 (6-83)	Asymptomatic and above hymen	85.4%	Apex 5.6% Anterior 7.6% Posterior 1.4%	2 (1.3%)
Benson, (1996) ⁷⁷	RCT SSLS vs ASC	42	30 (12-66)	Vaginal walls above hymen or apical descent less than 50% length [#]	67%	Apex 12% Anterior 28.5% Posterior 2.3%	14 (37%)
Paraiso, (1996) ⁶¹	retrospective	243	76. (1-190)	Grade 0 or asymptomatic grade 1	79.7% at 5 years	Apex 4.9% Anterior 15.9% Posterior 4.9%	11 (4.5%)
Penalver, (1998) ²⁴⁸	retrospective	160	40 (18-78)	'any symptomatic descent'	85%	Apex 6% Anterior 6% Posterior 2.5%	11 (6.8%)
Colombo, (1998) ²⁴⁰	retrospective	62	83 (48-108)	Grade 0-1	74%	Apex 8% Anterior 14% Posterior 3%	0 (0%)
Meschia, (1999) ²⁴⁹	retrospective	91	43 (12-86)	Grade 0-1	85%	Apex 4% Anterior 13% Posterior 9%	None reported
Sze, (1997) ²⁵⁰	retrospective	75	24 (3-72)	above hymen	71%	A Anterior 21% Other 8%	7 (12.9%)
Lantzsch, (2001) ²⁵¹	retrospective	123	58 (6 – 108)	Not defined	87%	Apex 3.5% Anterior 8% Posterior 1.6%	2 (1.6%)

First Author, Year (year)	Study Design	No	Mean Follow-up Mo. (range)	Definition of Anatomic Success*	Anatomic success –all segments	Anatomic recurrence by segment	Reoperation for prolapse
Lovatsis, (2001) ²⁵²	Retrospective	293	(12-30)	At or beyond the introitus	97%	Apex 3% Anterior NR Posterior NR	3%
Cruikshank, (2003) ²⁵³	Prospective cohort	695	43 (6 – 60)	Reoperation for recurrence	89.4%	Apex 5.1%	105 (15%)
Niemenen, (2003) ²⁵⁴	Retrospective	138	24	POPQ Stage 2 or greater	78.7%	Apex 4.9% Anterior 11.5% Posterior NR	NR
Maher, (2004) ⁷⁸	RCT SSLS vs. ASC	48	22 (6-58)	Grade 0-1	69%	Apex 19% Anterior 14% Posterior 7%	3 (6.3%)
Hefni, (2006) ¹⁸¹	Prospective	305	57 (24-84)	Vaginal vault at least 6 cm distal to hymen	96%	Apex 4% Anterior 13% Posterior 0%	NR
Toglia, (2008) ²⁵⁵	Retrospective	64	26.5 (1-72)	Apex above introitus and no reoperation	78%	Apex 9% Anterior 17% Posterior 0%	2 (3%)
Aigmuller, (2008) ²⁵⁶	Prospective	55	84 (24-180)	Above the hymen	64%	Apex 7% Anterior 29% Posterior 5%	5 (9%)
Chou, (2010) ²⁵⁷	Retrospective	76	36 (12-60)	Grade 0	91%	Apex 5.3% Anterior 3.7% Posterior NR	4 (5.3%)
Larsen, (2013) ²⁵⁸	Retrospective	242	96 +/- 20	At or above hymen	86%	Apex 0.6% Anterior 13.6% Posterior 1.2%	NR
Qatawneh, (2013) ²⁵⁹	Retrospective	114	40	Stage 0-1	77%	Apex 11% Anterior 23% Posterior 10%	3 (2.6%)
Leone Roberti Maggoire, (2013) ²⁶⁰	Retrospective	86	36	Stage 0-1	88-86%	NR	NR

First Author, Year (year)	Study Design	No	Mean Follow-up Mo. (range)	Definition of Anatomic Success*	Anatomic success –all segments	Anatomic recurrence by segment	Reoperation for prolapse
Barber, (2014) ²⁴⁴	RCT SSLS vs ULS	186	24	Absence of: 1)apical descent 1/3 into vaginal canal, 2) anterior or posterior prolapse beyond hymen 3) bothersome vaginal bulge symptoms and 4) retreatment	63.1%	Apex 2% Anterior 13.1% Posterior 3.3%	4 (2.6%)
Mothes, (2015) ²⁶¹	Retrospective	110	14+/-7	Apex Stage 0 or 1	94.5%	Apex 5.5% Anterior 8.3%	NR

* Prospective and Retrospective cohorts with n >50 published since 1985 and SSLS arms of 3 RCTs comparing SSLS to Abdominal sacrocolpopexy (ASC) and 1 trial comparing SSLS to ULS;**POP staging systems, if used, are indicated as 'grade' for Baden-walker^{236, 262} or 'stage' for POPQ; # optimal and satisfactory outcomes combined; NR, not reported

2. UTEROSACRAL LIGAMENT SUSPENSION (USLS)

The USLS was first described by Miller²⁶³ in 1927 and later popularised by Shull in the late 1990s. The USLS suspends the vaginal apex to the proximal remnants of the uterosacral ligaments using an intraperitoneal surgical approach. This procedure restores the vagina to its normal axis, avoiding the retroflexion associated with SSSL. The current evidence supporting the use of USLS is limited primarily to uncontrolled retrospective case-series and evaluation of these data confirm a mean objective success rate of 85% (range 48-96%) and mean reoperation rate for prolapse of 5.8% (range 0-12%) (Table 15). A meta-analysis performed by Margulies et al found pooled rates of anatomical success (POP-Q Stage 0-1) of 81.2% (95%CI 67.5-94.5%) for the anterior segment, 98.3% (95% CI 95.7-100%) for the apical segment and 87.4% (95% CI, 67.5%-94.5%) for the posterior segment.²⁶⁴ Post-operative prolapse symptoms were reported in 5 of 11 studies in this review and were relieved in 82-100% of patients. These promising results are balanced against ureteric kinking/injury rate of 1%-11% with this procedure.²⁶⁴ A review of 700 consecutive vaginal prolapse surgeries found intraoperative ureteric kinking/injury of 5.9% directly attributable to USLS. However, 87% were identified at cystoscopy before the completion of the index surgery and corrected by removing suspension sutures intraoperatively with no long-term consequence to the patient.²⁶⁵ Only three of 355 USLS (0.9%) performed in this series required additional procedures to relieve or correct ureteric obstruction or injury. A retrospective review of over 900 patients receiving ULS found an overall adverse event rate of 31.2% with 20.3% being attributed to peri-operative urinary tract infection.²⁶⁶ Rates of pulmonary and cardiac events were 2.3% whereas the rate of ileus and small bowel obstruction were less than 0.5%. The intraoperative bladder injury rate was 1%. There were no intraoperative ureteric injuries; however, 4.5% of cases were complicated by ureteric kinking, all of which were resolved without subsequent sequelae with intraoperative suture removal with or without replacement of the vault suspension stitches.²⁶⁶ Margulies et al identified 10 studies including a total of 820 women that reported on perioperative complications of USLS.²⁶⁴ The ureteric reimplantation rate in this series was only 0.6%. Blood transfusions were reported in 1.3%, cystotomy in 0.1%, and bowel injury in 0.2%.

While the USLS is traditionally performed using an intraperitoneal approach, Dwyer and Fatton have described an extraperitoneal variant of the USLS.^{267, 268} In their series of 123 consecutive women undergoing an extraperitoneal ULS, 93 also received anterior and/or posterior synthetic mesh. The overall anatomical success (POP-Q stage 0 – 1) at a mean follow-up of 2 years (range 6 mo. – 5 years) was 85.5% with apical success of 95.4%.²⁶⁸ The reoperation rate for recurrent prolapse was 7%. Urethral injury occurred

in only 1.7%, however the blood transfusion rate was 4.9% and the rate of mesh exposure was 19.3%.

Abdominal and laparoscopic USLS techniques have also been described. Lowenstein et al reported a retrospective review of 107 women who underwent prolapse surgery that included an abdominal USLS.²⁶⁹ In the 75 patients who completed one year follow-up, 12% reported recurrent or persistent prolapse symptoms and 7% had an anatomical failure (POP-Q stage 2 or greater). Complications were relatively few however erosion of the apical sutures (expanded PTFT, Gore-Tex) occurred in 9% at an average time of 56 months (range 3-75 mo.).²⁶⁹ Two retrospective comparisons between vaginal and laparoscopic USLS procedure both found no significant differences in perioperative morbidity or anatomical or subjective outcomes.^{270, 271}

Table 15. Outcomes of transvaginal uterosacral vault suspension procedures.

First Author	Year	No. of Pts.	Mean Follow-up Months (range)	Definition of anatomic success*	Anatomic success –all segments	Anatomic Recurrence by Segment	Reoperation for prolapse
Jenkins ²⁷²	1997	50	(6-48)	Not defined	48/50 96%	Anterior 4%	NR
Comiter ²⁷³	1999	100	17 (6.5-35)	Grade 0-1	96/100 96%	Apex 4%	4/100 (4%)
Barber ⁶²	2000	46	15.5 (3.5-40)	Stage 0/1 or Stage 2 without symptoms	41/46 90%	Apex 5% Anterior 5% Posterior 5%	3/46 (6.5%)
Shull ²⁷⁴	2000	289	Not stated	Grade 0-1	275/289 95%	Apex 1% Anterior 3.5% Posterior 1.4%	NR
Karram ²⁷⁵	2001	168	21.6 (6 -36)	Grade 0-1	148/168 88%	Apex 1% Anterior or posterior 11%	11/168(5.5%)
Amundsen ²⁷⁶	2003	33	28 (6-43)	Stage 0 or 1	27/33 82%	Apex 6% Posterior 12%	NR
Silva ²³	2006	72	61.2 (42-90)	Symptomatic Stage 2 or greater	61/72 85%	Apex 3% Anterior 7% Posterior 14%	2/72 (3%)
Antovska ²⁷⁷	2006	32	25 (9-42)	Stage 0 or 1	NR	Apex 0% Anterior	NR
Wheeler ¹³⁵	2007	35	24 (0-46)	Stage 0 apical prolapse	28/35 80%	Apex 20%	0/0 (0%)
De Boer ^{278#}	2009	48	12	Stage 0-1	23/48 48%	Apex 4.2% Anterior 47.9% Posterior 14.6%	NR
Doumaouchtsis ²⁷⁹	2011	42	60	Grade 0 of vaginal vault	36/84 84.6%	Apex 15.4%	5/42 (11.9%)
Wong ²⁸⁰	2011	57	12	Apical stage 0-1	4/57 93%	NR	1/57 (1.8%)
Cunjian ²⁸¹	2012	31	14 +/- 6	Stage 0-1	31/31 100%	NR	NR
Edenfield ²⁸²	2013	219	14 (8.5-26.5)	Beyond the hymen or retreatment	54/219 24.7%	Apical 8.7% Anterior 17.4% Posterior 6.8%	33/219 (15%)

First Author	Year	No. of Pts.	Mean Follow-up Months (range)	Definition of anatomic success*	Anatomic success –all segments	Anatomic Recurrence by Segment	Reoperation for prolapse
Barber (Optimal Trial)# ²⁴⁴	2014	188	24	Absence of: 1)apical descent 1/3 into vaginal canal, 2)anterior or posterior prolapse beyond hymen 3) bothersome vaginal bulge symptoms and 4) retreatment	100/155 64.5%	Apical 2% Anterior 12.9% Posterior 1.9%	5/161 (3.1%)
Unger ²⁶⁶	2015	983	6.9	Beyond hymen	875/983 89%	NR	3.4%
Rondini# ²⁸³	2015	56	12	Apex Stage 0 or 1	46/56 82%	Apex 18% Anterior 34% Posterior 6.3%	10/56 (17%)

*Includes retrospective and prospective cohorts of intraperitoneal transvaginal USLS and one RCT comparing ULS to SSLS and one RCT comparing ULS with mesh to sacrocolpopexy. *POP staging systems, if used, are indicated as 'grade' for Baden-walker or 'stage' for POPQ. #Includes only subjects who underwent USLS; NR, not reported*

Sacrospinous Ligament Suspension versus Uterosacral Ligament Suspension

In 2014, the NICHD Pelvic Floor Disorders Network reported the results of the OPTIMAL trial whose primary objective was to compare the safety and efficacy of the SSLS to USLS in women with uterine or post hysterectomy apical prolapse.²⁴⁴ To date, this is the only randomised trial to have compared these two commonly performed procedures. Success was defined as a composite outcome measurement and included the absence of: a) descent of the vaginal apex more than one third of the vaginal canal; b) anterior or posterior vaginal wall descent beyond the hymen, c) bothersome vaginal bulge symptoms as reported by the Pelvic Floor Distress Inventory and d) retreatment with surgery or a pessary. A total of 374 patients were randomised (188 ULS and 186 SSLF) from 9 U.S. centres. Two years after surgery, there was no statistical difference between the two groups for the composite outcome (ULS 64.5% vs SSLF 63.1%; adj. OR 1.1 95% CI 0.7 to 1.7). Additionally, bothersome vaginal bulge symptoms were seen in 18%, anterior or posterior prolapse beyond the hymen in 17.5% and retreatment with pessary or surgery 5.1% two years post-operatively with no differences between groups. Neurological pain requiring medical, behavioural or surgical intervention was higher in the SSLS group (12.4% vs 6.9%, $p = 0.49$) and persisted to 4-6 weeks in more participants (4.3% vs 0.5%). Intraoperative

ureteric obstruction was noted in five patients (3.2%) in the USLS group and none in the SSLF.

Mayo/McCall's Culdoplasty

Like the USLS, the Mayo/McCall's culdoplasty uses the proximal uterosacral ligaments to suspend the vaginal apex. The major difference is that with the Mayo/McCall procedure the uterosacral ligaments are plicated in the mid-line to obliterate the posterior cul-de-sac. While commonly performed, data describing the outcomes for this procedure are limited (Table 16). Colombo and Milani retrospectively compared the outcomes of a modified-McCall's culdoplasty to the SSLS ($n = 62$ in each group).²⁴⁰ Recurrence after the McCall's culdoplasty (Baden-Walker Grade ≥ 2) was 15% 4 to 9 years after surgery and not significantly different from the SSLS group. Recurrent anterior vaginal prolapse occurred less frequently in the McCall's group than the SSLS group (6% vs. 21%, $p = .04$; OR 4.1 (95% CI 1.3 to 14.2))²⁴⁰ A large retrospective series of 693 women from the Mayo clinic described an 82% satisfaction rate on subjective follow-up with few complications.²⁸⁴ The rate of subsequent prolapse repair in this population was 5.2%. A retrospective case series of 411 women undergoing Mayo culdoplasty found that a more dorsal "deep" placement of sutures through the uterosacral ligaments reduced the incidence of ureteric obstruction compared to other published series.²⁸⁵

Table 16. Mayo/McCall's culdoplasty.

Author	Year	No. of Pts.	Mean Follow-up (range)	Post-operative \geq grade/stage 2 –all segments	Post-operative \geq grade/stage 2 by segment	Reoperation for prolapse
Webb ²⁸⁴	1998	693	(6 – 144)	NR	NR	5.2%
Colombo ^{240*}	1998	62	84 (48-108)	15%	Apex – 5% Anterior – 7% Posterior – 14%	0%
Montella ²⁸⁶	2005	51	12	NR	Apex – 3% Anterior – NR Posterior – 7%	7.8%
Koyama ^{287**}	2005	21	26	NR	Apex – 5% Anterior – 19% Posterior 5%	14%

* excludes SSLS group; ** excludes Inmon group

Levator Myorrhaphy

Francis and Jeffcoate described their retrospective series using levator myorrhaphy, in which a wide mid-line plication of the levator ani muscles is performed to which the vaginal cuff is fixed, in 1961.²⁸⁸ A large sponge pack in the rectum is used to avoid over plication and bowel dysfunction. Five of 35 women responding to the questionnaire had transient ureteric complications, one requiring reoperation. Seventeen women were quite satisfied, while six were dissatisfied. Natale et al compared the levator myorrhaphy to the USLS in a randomised clinical trial of 229 women with stage 2-4 prolapse.²⁸⁹ All women

received a hysterectomy and all received placement of polypropylene mesh in the anterior vaginal segment. Anatomical success was not significantly different between groups. The mean total vaginal length was significantly shorter after levator myorrhaphy (7.9 cm vs. 8.9 cm, $p = .04$). Urinary, bowel and sexual function did not differ between groups post-operatively. Intraoperative ureteric obstruction was less common in the levator myorrhaphy group (0% vs. 7.9%); however all cases of ureteric obstruction in the USLS group were corrected intraoperatively with suture removal/replacement with no additional interventions required.²⁸⁹ Other complications

including mesh erosion were similar between groups.

Iliococcygeus Fascia Fixation

There are no randomised trials that support the use of this procedure. Several case series have provided some information. Shull reported that apical support was optimal in 39/42 (83%) of patients, but eight others had apical or other defects.²⁹⁰ Meeks and colleagues reported a 96% objective cure in 110 women followed up to 13 years.²⁹¹ In a retrospective case-control study, Maher and colleagues reported similar subjective (91% vs 94%) and objective (53% vs 67%) cure rates with iliococcygeus fixation (n=50) compared to sacrospinous fixation (n=78).²⁹² A prospective cohort of 44 subjects receiving iliococcygeous fixation followed up for a median of 68.8 (range 60-92) months provides the longest-term data on this procedure.²⁹³ Objective success (POP-Q stage 0 or 1) and subjective success (patient global impression of improvement < 2) were both 84%. Preoperative stage 4 vault prolapse was an independent predictor of failure (OR 8.8; 95% CI 1.3-9.4).²⁹³

meshes for apical prolapse from prospective and retrospective cohorts ranges from 87-100% for monofilament polypropylene meshes with mesh erosion rates varying from 0-15% (Table 18). Notably, mesh exposure rates for more recently introduced non-trocar mesh devices (Elevate, AMS; Uphold, Boston Scientific) are generally lower than those noted with older devices (0 to 5.7%) based on the limited data available.

3. TRANSVAGINAL MESH APICAL PROLAPSE

Multiple commercially available transvaginal mesh devices have been marketed to correct apical prolapse, often designed to support both anterior and apical or anterior, apical and posterior vaginal segments. Since the 2011 FDA Public Health Notification on surgical mesh for pelvic organ prolapse, many of these devices are no longer marketed. The Cochrane Collaboration identified six randomised trials comparing native tissue vaginal repairs with transvaginal polypropylene mesh for apical prolapse in 589 women.²⁹⁴ In all six of these trials, the native tissue repair included a SSLF or USLS and the mesh was polypropylene (Four trials monofilament weave (Prolift, Ethicon) and two trials multifilament weave). No significant differences in anatomical outcomes, vaginal bulge symptoms, repeat surgery for prolapse, dyspareunia or post-operative stress urinary incontinence were noted between groups. The average rate of mesh exposure after transvaginal mesh was 18% and surgery for mesh exposure was required in 9.5%. Most of the evaluated transvaginal apical mesh products have been removed from the market and the newer lighter mesh products have not yet been evaluated in a RCT. The Cochrane Collaboration authors concluded that the implication for clinical practice is that while the newer mesh products may be as anatomically beneficial with a lower complication rate than their preceding mesh products this has not been rigorously evaluated and these products should be used cautiously until level one comparative data become available.²⁹⁴ A summary of trials comparing native tissue vaginal repair with monofilament mesh repair is in Table 17. Success rates of transvaginal

Table 17. Randomised Trials Comparing Native Tissue Repair Versus Monofilament Transvaginal Mesh for Apical Prolapse

Author	Year	Group (N)	Mean Follow-up (Mos)	Objective Success rate (%)	Subjective Success rate (%)	Criteria for Objective (O) and Subjective (S) success*	Mesh exposure (%)	Comments
Sokol ^{295*}	2011	ULS (33)	14.7	66.2%	96%	O: Stage 0 or 1 S: Absence of bulge symptoms	NA	Reintervention in 15.6% of mesh group including 3 surgeries for prolapse recurrence and 2 for mesh exposure. None in ULS group
		Prolift (32)		70%	90%		15.6%	
Halaska ²⁹⁶	2012	SSLS (83)	12	60.6%	-	O: Stage 0 or 1 S: QOL scores	NA	Post-hysterectomy vault prolapse only. Significant improvement in QOL questionnaires in both groups with no difference between groups.
		Prolift (85)		83.1%	-		20.8%	
Svabik ²⁹⁷	2014	SSLS (34)	12	38.2%	-	O: Above hymen on POPQ or bladder descent less than 10mm below symphysis pubis on translabial US S: Pelvic Organ Distress Inventory Score (POPDI)	NA	Unilateral or bilateral levator avulsion required for inclusion. Significant improvement in POPDI with no difference between groups
		Prolift (36)		97.2%	-		8.3%	
De Silveira ²⁹⁸	2015	SSLS (90)	12	Anterior 70.4% Apical 84% Posterior 91.4%	-	O: less than or equal to hymen S: P-QOL (Portuguese version)	NA	Significant improvements in P-QOL with no difference between groups. Overall rate of reoperation in the native vaginal tissue repair group was 3.7 % (3 patients with recurrence) and in the mesh group was 7.9 % (2 patients with recurrence, 3 with exposure, 1 with wound dehiscence, and 1 with extrusion into the rectum)
		Prolift (94)		Anterior 86.4% Apical 92% Posterior 97.7%	-		20%	

Table 18. Outcomes from prospective and retrospective cohorts of transvaginal mesh kits used for apical repairs

Author	Year	Type	No.	Follow-up weeks	Success rate	Complications
Abdel Fattah ³⁰⁰	2008	Apogee AMS*	38	12	95% (36/38)	Blood loss>400mls1, erosion 4, Dyspareunia 1, rectal injury 1
Gaurder-Burmester ³⁰¹	2007	Apogee AMS	48	52	100%	
Moore ³⁰²	2012	Anterior/Apical Elevate AMS	60	57	92%	No extrusions
Stanford ³⁰³	2015	Anterior/Apical Elevate AMS	142	104	93.8-100%	Mesh exposure 4.9% in those with prior hysterectomy and 13.8% with concurrent hysterectomy
Rapp ³⁰⁴	2014	Anterior/Apical Elevate AMS	42	136	90%	Mesh exposure 5%, leg pain 3%, urinary retention 13%
Lo ³⁰⁵	2015	Anterior/Apical Elevate AMS	65	24	97%	No mesh exposures noted, de novo stress incontinence 16%
Marschke ³⁰⁶	2015	Anterior/Apical Elevate AMS	70	52	95.7%	Mesh exposure 5.7%
Vu ¹⁸⁹	2012	Uphold, Boston Scientific	115	12.1	96%	Mesh exposure 2.6%, neurologic injury 1,
Letouzy ³⁰⁷	2015	Uphold, Boston Scientific	115	92	93%	8% denovo dyspareunia reoperation for mesh complications- 3.4%
Fatton ³⁰⁸	2007	Prolift, Ethicon†	88	25	93%	2 haematoma
Belot F ³⁰⁹	2005	Prolift Ethicon	277	Not stated	Not stated	Erosion 34/277
Abdel Fattah ³⁰⁰	2008	Prolift Ethicon	143	12	94%	1rectal injury, bladder injury
						16 vag erosion, 1 bladder erosion
Milani ³¹⁰	2009	Total vaginal mesh Prolift	46	52	91% (41/45)	15% mesh exposure 2 blood loss>500mls

Author	Year	Type	No.	Follow-up weeks	Success rate	Complications
McDermott ³¹¹	2011	Total vaginal mesh Prolift hysteropexy 24 Colpopexy 65	89	26-52	96%	10% mesh exposure 5% complications
Biertho ³¹²	2007	PIVS‡,(Tyco)	34	12	91%	1erosion 1 haemorrhage
Foote ³¹³	2007	PIVS (Tyco)	52	20	83%	Erosion 11/52
Matox ³¹⁴	2006	PIVS	21	7	37%	1 proctotomy 1 haematoma
Vardy ³¹⁵	2006	PIVS	98	3	99%	2 erosions
Neuman ¹⁹¹	2007	PIVS	140	120	99%	12 erosions
de Tayrac ³¹⁶	2007	PIVS	21	42	95%	2 haematomata
Lee ³¹⁷	2010	PIVS	32	52	100%	1 transfusion
Amrute ³¹⁸	2007	Polypropylene H shaped	76	123	95%	erosion, 2 dyspareunia

* American Medical System, Minnetonka MN, USA † Ethicon, Sommerville NJ, USA ‡ PIVS Posterior Intravaginal Slingplasty Tyco Healthcare Norwalk CT

4. SACRAL COLPOPEXY

Since its introduction by Lane in 1962³¹⁹, sacral colpopexy has proven to be an effective and durable technique for correcting apical prolapse. In 2010, approximately 34,000 sacral colpopexy's were performed in the U.S. representing 11% of all prolapse surgeries performed during that time period.¹¹⁹ Traditionally, sacrocolpopexy has been performed via a laparotomy (i.e. abdominal sacral colpopexy) but the use of minimally invasive approaches, both laparoscopic and robotic, has become the norm over the last decade. The 2016 Cochrane review identified six randomised trials comparing sacrocolpopexy to vaginal prolapse repair including three trials comparing abdominal sacral colpopexy (ASC) to SSLS^{77, 78, 320}, one trial comparing ASC to USLS²⁸³, one trial comparing laparoscopic sacral colpopexy (LSC) to transvaginal mesh repair³²¹ and one comparing abdominal or laparoscopic sacral colpopexy to ULS with mesh augmentation.^{[294} On meta-analysis, they concluded that overall a broad group of vaginal surgery with and without mesh is associated with higher risk of awareness of prolapse (RR 2.11 95% CI 1.1-4.2), recurrent prolapse on examination (RR 1.9 95% CI 1.3-2.7), repeat surgery for prolapse (RR 2.3 95% CI 1.2- 4.3), post-operative SUI (RR 1.9 95% CI 1.2-2.9) and dyspareunia (RR 2.5 95% CI 1.2- 5.5) when compared broadly with sacral colpopexy.²⁹⁴ A systematic review by the Society of Gynecologic Surgeons Systematic Review Group that included both randomised trials and cohort studies comparing sacral colpopexy with native tissue (non-mesh) vaginal repairs found improved anatomic outcomes with sacral colpopexy and no difference in reoperation rates or post-operative sexual function.³²² Adverse event data compiled from 79 studies found sacral colpopexy associated with a higher rate of ileus or small bowel obstruction (2.7% vs 0.2%, $p < .01$), mesh or suture complications (4.2% vs 0.4%, $p < .01$) and thromboembolic disease (0.6% vs 0.1%, $p = .03$).³²²

Abdominal sacral colpopexy (ASC)

Observational studies and clinical trials suggest that ASC is a highly effective procedure for apical prolapse. The success rate of ASC, when defined as lack of apical prolapse, ranges from 78-100% (Table 19). When success is defined as no recurrent prolapse in any segment the published success rates are 56-100%. A systematic review of ASC performed by Nygaard et al reported a median reoperation rate for recurrent prolapse of 4.4% (range 0 -18.2%) and for post-operative stress incontinence of 4.9% (range 1.2 -30.9%) and a mesh erosion rate of 3.4%.³²³ Subjects enrolled in the long-term follow-up (5-7 years) of the CARE trial (E-CARE), demonstrated objective failure rates of 24-48% depending upon the definition of failure and a cumulative mesh erosion rate of 10.5% by 7 years.³²⁴ Clinical trials demonstrate significant improvements in prolapse symptoms, urinary function

and quality of life after ASC.^{53, 78} There is Level 1 evidence that ASC has superior anatomical outcomes when compared to SSLS but this is balanced by longer operating time, longer recovery and higher cost.¹⁸⁵ A single trial has compared ASC (n=63) to USLS (n=61) and found ASC associated with greater anatomical success, fewer reoperations, greater post-operative complications but no difference in improvement in symptoms or quality of life.²⁸³

Beyond mesh erosion, reported complications of ASC are generally consistent with other major open pelvic surgeries. The systematic review by Nygaard et al reported that wound complications occurred in 4.6% (range 0.4% to 19.8%), haemorrhage or transfusion in 4.4% (.2% to 16.9%), cystotomy in 3.1% (0.4% to 15.8%), ureteral injury in 1.0% (0.8% to 1.9%), bowel injury in 1.6% (0.4% to 2.5%) and incisional hernia repair in 5% (0.4 to 11%)³²³. One in 20 women in the CARE trial experienced significant gastrointestinal morbidity after sacral colpopexy. Of 322 women in the study, 19 had symptoms of possible ileus or small bowel obstruction; of these, four had reoperation for small bowel obstruction, 11 were readmitted for medical management, and four had a prolonged initial hospitalisation for gastrointestinal symptoms.³²⁵ In long-term review after the CARE trial the subjective success rate gradually declined to 80% and the mesh exposure rate was 9.9%.³²⁴ The high rate of mesh exposure needs further clarification but may be explained by less than 40% of the original grafts utilised being monofilament polypropylene mesh.³²⁶

Abdominal sacral colpopexy (ASC) versus sacrospinous ligament suspension (SSLS)

To date, there are three RCTs that directly compare ASC to SSLS.^{51, 77, 78, 320} The 2013 Cochrane review on the surgical management of POP summarises these studies and concludes that these trials provide Level 1 evidence that there were no statistically significant differences in objective failure at any site (any pelvic organ prolapse RR 0.77, 95% CI 0.39 to 1.53), subjective failure (RR 0.53, 95% CI 0.25 to 1.09), reoperation for POP (RR 1.46, 95% CI 0.19 to 1.11) or patient satisfaction (RR 0.82, 95% CI 0.32 to 2.06).¹⁸⁵ However, ASC was superior to SSLS for the following outcomes: Prolapse \leq stage 2 (RR 0.29, 95% CI 0.09 to 0.97), recurrent vault prolapse (RR 0.23, 95% CI 0.07 to 0.77), post-operative stress urinary incontinence (RR 0.55, 95% CI 0.32 to 0.95) and less post-operative dyspareunia (RR 0.39, 95% CI 0.18 to 0.86). In contrast, ASC was associated with a longer operating time (Weighted Mean Difference (WMD) 21 minutes, 95% CI 12 to 30), longer time to recover (WMD 8.3 days, 95% CI 3.9 to 12.7) and was more expensive (WMD US \$1334, 95% CI 1027 to 1641) than SSLS.¹⁸⁵

Table 19. Abdominal Sacral Colpopexy outcomes.

Author	Year	Number of patients, (number lost to follow-up, if known)	Follow – up (months)	Success rate (%)	Criteria for success#	Comments
Addison ³²⁷	1985	56 (2)	39	96	Good vaginal vault suspension in a normal axis	Fascia lata was graft material used for patient with early recurrence 1 patient unimproved as a presacral haemorrhage prevented successful completion of the procedure
Baker ³²⁸	1990	59 (6)	6	100	No complaint of protrusion from the vagina	51/59 patients had post-operative records available, at which time all patients had a well-supported vagina
Snyder ³²⁹	1991	147 (15)	43	93 (108/116)	Lack of major long- term post-operative complications, restoration of functional vagina in the proper axis, and no recurrence of presenting symptoms with at least 6 months of follow-up	Graft attached to the entire length of the vagina in the rectovaginal septum
Imparato ²⁴⁶	1992	71 (8)	NS	78	Excellent, well- suspended vault on exam	50 had direct attachment of the vaginal apex to the anterior sacrum
				16	Good vault suspension, but asymptomatic vaginal “relaxation”	
Timmons ³³⁰	1992	163	33	99	Good vaginal vault support	The range of success is due to 4 different techniques which were compared
van Lindert ³³¹	1993	61	32	97	No recurrent vaginal prolapse	8 patients had preservation of the uterus
Grunberge ³³²	1994	62 (14)	75.6	94	No moderate vaginal vault prolapse on exam	42 patients had direct attachment of the vagina to the sacral promontory 12 had permanent “suture bridges” 8 had lyodura loops
Lecuru ^{333**}	1994	203	32.5	86.7-100	Anatomically good results	
				53.3-80.5	Functionally good results	

Author	Year	Number of patients, (number lost to follow-up, if known)	Follow – up (months)	Success rate (%)	Criteria for success#	Comments
Brubaker ³³⁴	1995	65 (0)	3	71	No anterior or apical prolapse	63/65 patients had abdominal anterior compartment repair at the time of the sacrocolpopexy
de Vries ³³⁵	1995	101 (29)	48	32	Fully cured (patient satisfaction based upon questionnaire)	Questionnaires sent to patients to evaluate pain, prolapse-related complaints and functional disorders. Patients indicated symptoms before surgery, >1 year after surgery, and >1 year after surgery
				39	Considerable improvement	
				29	No improvement	
Benson ⁷⁷	1996	40	60	58 (another 26% of patients had 'satisfactory' outcomes')	Patient asymptomatic, vaginal apex supported above the levator plate, no protrusion beyond the hymen	All patients had sacrocolpopexy and paravaginal repair. Results are from a RCT comparing sacrocolpopexy to sacrospinous suspension.
Hardiman ³³⁶	1996	80	47	99	No recurrent vault prolapse	
Sullivan ³³⁷	2001	236 (31)	64	100	No recurrence of vaginal or rectal prolapse	Total pelvic mesh repair involved attachment mesh strip between the perineal body and the sacrum, and then attaching two additional strips laterally to the pubis to support the vagina and bladder
				34%	Very satisfied	
				38%	Satisfied	
Occelli ³³⁸	1999	271 (54)	66	97.7	Cured for prolapse	
Patsner ³³⁹	1999	175 (0)	≥ 12	97	No "mesh failures"	
Sze ²⁵⁰	1999	56 (9)	23	81	No recurrent prolapse to or beyond the hymen	All 9 patients with recurrent prolapse were Symptomatic
Lo ³²⁰	1998	52 (not clear)	25	94	No prolapse > Stage II	Results are from a RCT comparing sacrocolpopexy to sacrospinous ligament suspension.
Collopy ³⁴⁰	2002	89 (0)	56.7	100	No recurrence of rectal or vaginal vault prolapse	All had concomitant culdoplasty
Culligan ²¹⁷	2002	245	61.2	85	Any POP-Q point ≥ 2	No apical failures observed

Author	Year	Number of patients, (number lost to follow-up, if known)	Follow – up (months)	Success rate (%)	Criteria for success#	Comments
Lefranc ³⁴¹	2002	85 (0)	126 (median)	90.6	No relapse of any prolapse	All patients without preoperative SUI had a prophylactic Burch procedure done
Lindeque ³⁴²	2002	262 (0)	≥ 16	99	No vaginal vault prolapse	1/3 failures due to graft detachment from vagina
Medina ³⁴³	2002	97 (1)	19	90	< Grade I prolapse	Aetiology of 1 failure was graft detachment from the vagina (aetiology of other 4 unknown)
Brizzolaro ²¹⁶	2003	124	36	98	No recurrent vault prolapse	
Podratz ³⁴⁴	1995	50(6)	70	70	Asymptomatic (including no incontinence) and durable repair by exam	
Hilger ³⁴⁵	2003	69(31)	164	74	Subsequent POP operation or a positive response to question 5 on the PFDI***	
Maher ⁷⁸	2004	47 (1)	24	76% objective 94% subjective	Objective: No POP beyond halfway point Subjective: No symptoms of POP	Results are from a RCT comparing sacrocolpopexy to sacrospinous ligament suspension.
Higgs ³⁴⁶	2005	148		97	No recurrent vault prolapse	24% required recurrent SUI surgery
				59.4	< Grade 1 prolapse	
				78	No prolapse symptoms	
Brubaker ⁵³	2008	322 (302)	24	56	< Stage 2 prolapse	CARE Trial 2 year follow-up; Reoperations for prolapse occurred in 6 (2%)
				98	≤ Stage 2 prolapse	
				95	POPQ point C within 2 cm of TVL	
Jeon ¹⁹⁴	2009	57	66 (60-108)	86	< Stage 2 prolapse	Major complication requiring reoperation or intensive care developed in 12 (21%)
Huebner ³⁴⁷	2009	78 (53)	NS	83	< Stage 2 prolapse	
Tate ³⁴⁸	2010	100 (58)	60	77	< Stage 2 prolapse	5-year follow-up of RCT comparing polypropylene to cadaveric fascia. Polypropylene demonstrated superior anatomic results (93% vs
				93	Symptoms of prolapse or bulging	

Author	Year	Number of patients, (number lost to follow-up, if known)	Follow – up (months)	Success rate (%)	Criteria for success#	Comments
						62%, p =.02) but no difference in symptomatic outcomes

**Prospective and Retrospective cohorts with $n \geq 50$ published since 1985, ASC arms of 3 RCTs comparing ASC to sacrospinous ligament suspension. #POP staging systems, if used, are indicated as 'grade' for Baden-walker or 'stage' for POP-Q*

NS = not stated; SUI = stress urinary incontinence; RPU = retropubic urethropexy; RCT=randomised clinical trial

***Only abstract reviewed (paper not in English)*

****Question 5 on the Pelvic Floor Distress Inventory – “Do you usually have a bulge or something falling out that you can see or feel in the vaginal area?”*

4.2. Laparoscopic sacral colpopexy (LSC)

The laparoscopic approach of sacral colpopexy has been adopted by many surgeons over the last decade as an alternative to ASC with the hopes of reproducing the high success rate of the ASC while decreasing the morbidity and delayed recovery associated with laparotomy. Multiple prospective and retrospective case series demonstrate acceptable short to mid-term success rates with mean objective success rate of 91% (range 60 -100%), subjective success rates of

79-98%³⁴⁹⁻³⁵¹ and mean reoperation rate of 5.6% (Table 20). Prospective studies demonstrate significant improvements in pelvic symptoms and quality of life after LSC.^{321, 352, 353} Most RCTs observed that laparoscopic sacral colpopexy is as effective as open abdominal procedure, with a reduced rate of intraoperative bleeding, hospitalisation and wound complications.^{354, 355} However, a recent RCT showed that LSC provides outcomes as good as those of open procedure for anatomical correction but not for anterior pelvic organ prolapse.³⁵⁶

Table 20. Describes outcomes for laparoscopic sacral colpopexy studies reporting greater 12 months review.

Author, year	n (mesh)	Success Rate	f.u. months	Total reoperation rate	Reoperation rate recurrence	Reoperation rate complication	Vaginal mesh exposure	Spondylo-discitis	de novo dyspareunia
Kenton, 2016357	33	MD	12	3/33	0/33	3/33	0/33	0/33	MD
Costantini, 2016356	60	60/60	41	3/60	0/60	3/60	3/60	0/60	1/60
Sarlos, 2014358	85	57/68	60	5/85	3/85	2/85	2/85	0/85	MD
Freeman, 2013354	25	24/25	12	1/25	1/25	0/25	0/25	0/25	MD
Perez, 2011359*	94	88/94	12	0/94	0/94	0/94	3/94	0/94	2/94
Maher, 201111	53	41/53	24	3/53	0/53	1/53	1/53	0/53	MD
Price, 201125	84	84/84	24	7/84	4/84	3/84	5/84	0/84	MD
Sergent, 201126 *	124	103/116	34	10/124	MD	3/124	4/116	1/124	1/85
Paraiso, 2011360	29	21/23	12	0/29	0/29	0/29	0/29	0/29	MD
Sabbagh, 2010 27**	186	122/132	60	8/186	2/186	6/186	5/132	0/132	9/170
Akladios, 2010361	48	46/48	16	8/48	0/48	2/48	1/48	0/48	MD
Granese, 200928	138	131/138	43	1/138	0/138	0/138	0/138	0/138	2/138
Sarlos, 200829	101	98/101	12	4/101	1/101	1/101	1/101	0/101	1/101
Deprest, 200930	65	43/65	33	7/65	0/65	7/65	7/65	0/65	MD
Claerhout, 200946	132	127/132	12	9/132	0/132	9/132	6/132	0/132	10/53
North, 2009362	22	22/22	27.5	1/22	0/22	1/22	1/22	0/22	0/12
Misrai, 2008363	43	37/43	48	3/43	1/43	2/43	2/43	0/43	MD

Author, year	n (mesh)	Success Rate	f.u. months	Total reoperation rate	Reoperation rate recurrence	Reoperation rate complication	Vaginal mesh exposure	Spondylo-discitis	de novo dyspareunia
Stepanian, 200831	402	380/402	12	14/402	0/402	11/402	5/402	0/402	4/402
Agarwala, 200734	74	74/74	24	2/74	0/74	2/74	1/74	MD	1/74
Rivoire, 200735*	114	100/114	33	14/114	7/114	7/114	7/114	1/114	0/114
Paraiso, 200536	56	MD	13	3/56	1/56	2/56	2/56	0/56	MD
Rozet, 200537*	363	348/363	14	13/363	7/363	6/363	3/363	1/363	MD
Ross, 200539	51	48/51	60	10/51	3/51	4/51	4/51	0/51	4/51
Higgs 2005349	103	39/66	60	15/103	11/103	4/103	6/103	0/103	MD
Gadonneix, 200440*	46	38/46	24	0/46	0/46	0/46	0/46	0/46	MD
Antiphon, 200441	108	75/100	16	10/108	5/108	0/108	0/108	1/108	MD
Cosson, 200242*	83	78/83	11	2/83	1/83	1/83	1/83	0/83	MD
Cherot 2001364	44	43/44	18	0/44	0/44	0/44	0/44	0/44	0/44
Total	2741	2303/2522 91%		156/2766 5.6%	47/2343 2.0%	80/2343 3.4%	70/2288 3.1%	4/2745 0.15%	35/1398 2.5%

Abbreviations: MD: missing data, all mesh monofilament polypropylene except * PE: polyester, PPS, monofilament polypropylene-dimethyl siloxane (silicone).

A retrospective study assessed the complication rates in 402 LSC cases.²¹⁹ This study compared patients who received concurrent laparoscopically-assisted vaginal hysterectomy with those that had previous hysterectomy. They showed no differences in intra- or perioperative complications and similar rates of mesh erosion between the two groups.²¹⁹ Overall the complication rates for this cohort were 0.75% for hematoma, 2.2% for ileus or small bowel obstruction, 1.5% for bladder injury, 0.75% for bowel injury and 0.25% ureteric injury. At 1 year, the overall mesh erosion rate was 1.2%. In contrast, Tan-Kim et al reported on a retrospective series of 188 minimally invasive sacrocolpopexy and found a significantly higher mesh exposure rate in those who received concurrent total vaginal hysterectomy (TVH) (23%) compared with those who were post-hysterectomy (5%) or received a supracervical hysterectomy (5%).²¹¹ TVH was found to be an independent risk factor for mesh erosion on multivariable regression analysis in this study (OR 5.67; 95% CI 2.88-17.10).

Despite the clinical advantages of a laparoscopic approach, adoption of LSC has been relatively limited

possibly related of the steep learning curve associated with attaining laparoscopic suturing and knot tying skills that are required to attach the mesh to the vagina and sacrum. Claerhout et al evaluated their learning curve in the first 206 cases performed by a single surgeon.³⁶⁵ Operating times declined rapidly during the first 30 procedures in this series and reached steady state (175 minutes) after 90 cases. Using a cumulative sum (CUSUM) approach to evaluate operative time and failures (laparotomy, complication or anatomic failures) they found that adequate learning occurred after 60 cases.³⁶⁵ Complication rates remained unchanged throughout this series. Other studies have shown a decrease in operating time after 15-24 cases.^{366, 367}

Robotic Sacral Colpopexy (RSC)

Because of the relatively long learning curve required for LSC, many surgeons have turned to robotic-assisted surgery in order to offer patients a minimally invasive approach to sacrocolpopexy. Robotic surgical systems have been developed with the goal

of facilitating technically difficult procedures by improving the surgeon's vision, dexterity and ergonomics. Limited data suggest that operating time and efficiency improves significantly after performing 20 RSCs.³⁶⁸ A systematic review of 27 studies including 1488 RSCs found that the robotic approach is associated with objective cure rates of 84%-100% and subjective cure rates of 92-95% with mesh erosion rates of 2% (range 0-8%)³⁶⁹ Overall, the post-operative complication rate in this meta-analysis was 11% (range 0-43%) with severe complications occurring in 2%.³⁶⁹ Conversion to open ASC occurred in <1% (range 0-5%).

Laparoscopic versus robotic sacral colpopexy

To date, two randomised trials have compared robotic to laparoscopic sacral colpopexy. Paraiso et al reported a single-centre, blinded randomised trial comparing RSC (n = 40) to LSC (n=38) in women with stage 2-4 post-hysterectomy vaginal prolapse. Patients undergoing a RSC experience longer operating time (mean difference + 67 minutes; 95% CI 43-89, p<.0001), increased post-operative pain up to six weeks following surgery and required longer use of non-steroidal anti-inflammatory medications (20 vs 11 days) compared with LSC. At one year, there was no difference between anatomical and quality of life measures between the two groups. Additionally, the cost of RSC was significantly higher (mean difference +\$1936; 95% CI \$417-\$3,454)³⁵² In 2014, Anger et al

conducted a multi-centre trial comparing 78 women with stage two or greater pelvic organ prolapse to RSC (n=40) or LSC (n=38) with a primary outcome of cost³⁷⁰. The robotic sacrocolpopexy group had higher initial hospital costs (\$19,616 compared with \$11,573, P<.001) and over six weeks, hospital costs remained higher for RSC (\$20,898 compared with \$12,170, P<.001). However, when excluding costs of robot purchase and maintenance there was no difference in hospital costs over 6 weeks (\$13,867 compared with \$12,170; P=.060). The robotic group had longer operating room times (202.8 minutes compared with 178.4 minutes, P=.030) and higher pain scores one week after surgery (3.5+/-2.1 compared with 2.6+/-2.2; P=.044). At one year, there were significant improvements in sexual activity, quality of life and symptoms improved in both groups with no differences between groups.³⁵⁷ No reoperations for mesh complications occurred in either group. In the majority of comparative studies RSC is associated with longer operating time but similar objective success and complication rates to LSC (Table 21).

Unger et al performed a retrospective analysis comparing perioperative adverse events in 406 women undergoing RSC and LSC. Rates of bladder injury (3.3% vs 0.4%, p = 0.04) and estimated blood loss greater than 500ml (2.5% vs 0%, p =.01) were higher in the robotic group.²⁶⁶ In contrast, a meta-analysis of six smaller studies found lower blood loss with RSC than LSC (50 vs 155ml, p<.001) but no difference in other rates of complications.³⁶⁹

Table 21. Comparison of laparoscopic (LSC) and robotic sacral colpopexy (RSC)

Author, Year	Design (follow-up mos)	Group	No. patients	Operating time mins	Blood loss mls	Objective Success Rate (%)	Complications (%)	Mesh exposure (%)
Paraiso, 2011 ³⁵²	RCT (12)	LSC	33	199	MD	91	12	0
		RSC	35	265	MD	88	43	6
Chan, 2011 ³⁷¹	Retrospective (RSC 16; LSC 39)	LSC	20	185	155	90	0	0
		RSC	16	230	131	93	12	0
Tan-Kim, 2011 ²²⁰	Retrospective (RSC 36; LSC 25)	LSC	61	206	85	80	MD	2
		RSC	43	281	86	90	MD	5
Seror, 2012 ³⁷²	Retrospective (RSC 15; LSC 18)	LSC	47	231	280	100	40	0
		RSC	20	128	55	95	30	0
Antosh, 2012 ³⁷³	Retrospective (3)	LSC	23	325	100	91	8	0
		RSC	65	334	50	87	MD	3
Awad, 2013 ³⁷⁴	Retrospective (3)	LSC	40	176	205	100	5	0
		RSC	40	186	48	100	5	0
Anger, 2014 ³⁷⁰	RCT (6)	LSC	38	178	106	MD	2.6	0
		RSC	40	202	85	MD	2.5	0
	Retrospective	LSC	232	215	114	92	8	0.8%

Author, Year	Design (follow-up mos)	Group	No. patients	Operating time mins	Blood loss mls	Objective Success Rate (%)	Complications (%)	Mesh exposure (%)
Mueller, 2016 ³⁵⁷		RSC	226	255	99	86	7	0.9%

Abbreviations: MD: missing data, RCT: randomized controlled trial, LSC: laparoscopic sacrocolpopexy, RSC: robotic sacrocolpopexy

Sacral colpopexy versus transvaginal mesh

Maher et al reported results from a randomised trial comparing laparoscopic sacral colpopexy (LSC) (n=53) to a total vaginal mesh (TVM) (Prolift, Ethicon, Sommerville NJ, USA) (n=55)³²¹. LSC was associated with longer operating time (mean difference +52 min (95% CI 41.5-62.6]), decreased hospital stay (mean difference -0.5 days (95% CI -.93 to -.10) and quicker return to normal activities (mean difference -5.3 days (95% CI -8.4 to -2.3). Two years after surgery, objective success (overall POP-Q Stage 0 or 1) was seen in 77% of the LSC group compared with only 43% of the TVM group, p < .001)³²¹. Also, reoperations were significantly higher in the TVM group (22%) than in the group that received LSC (5%, p =.006).

Sacral colpopexy with mesh versus biological grafts

Some surgeons have attempted to decrease mesh complications of sacral colpopexy by using biological materials instead of synthetic mesh. However, Level 1 evidence supports the superiority of polypropylene mesh to fascia lata for objective anatomical support following ASC.^{35, 348} A randomised trial of 106 women undergoing ASC compared polypropylene mesh to cadaveric fascia lata and found superior anatomical outcomes in those who received polypropylene at one year (success 91% vs. 68%, p = .007) and five years after surgery (93% vs. 62%, p =.02).^{35, 348} There were no differences in graft related complications overall between the two groups. Several retrospective case series support these data.³⁷⁵⁻³⁷⁷ While Level three evidence suggests that use of xenografts such as porcine dermis and small intestinal submucosa also have inferior anatomic success rates compared with polypropylene mesh³⁷⁸⁻³⁸⁰, a single randomised trial comparing polypropylene mesh to porcine dermis in women receiving LSC found no difference in objective or subjective outcomes at one year.³⁸¹

5. OBLITERATIVE PROCEDURES: LEFORT COLPOCLEISIS, TOTAL COLPOCLEISIS

Obliterative surgery, such as total colpocleisis (also called colpectomy/colpocleisis) or the LeFort partial colpocleisis, corrects POP by reducing the pelvic viscera back into the pelvis and closing off the vaginal

canal either in part or whole.³⁸² Obliterative procedures are less commonly performed in the Europe, Asia, and Australia compared to the United States, and are usually reserved for women who are elderly, medically compromised, and no longer sexually active.³⁸³ The purported advantages of obliterative surgery in this population are decreased operative time, decreased perioperative morbidity, and an extremely low prolapse recurrence risk. The obvious disadvantage is the elimination of the potential for vaginal intercourse. Preoperative counselling is essential when choosing between the obliterative and reconstructive options. A systematic review of colpocleisis published in 2006 noted colpocleisis appears to be nearly 100% effective for correcting pelvic organ prolapse.³⁸² However, a small cohort study of 47 elderly women undergoing LeFort colpocleisis found objective success to be 81% and symptomatic improvement at 91.5% with longer post-operative vaginal length and wider genital hiatus as risk factors for recurrence.³⁸⁴ Multiple cohort studies have found high rates of patient satisfaction and significant functional improvement with low rates of regret for loss of sexual function (0-4.3%).^{54, 171, 385-388}

Barber et al reported results from a multi-centre study of obliterative surgery using a prospective cohort design with a concurrent control group of age-matched women undergoing vaginal reconstructive surgery.⁵⁴ Despite permanent alterations in sexual function, significant improvements in bladder, bowel and prolapse symptoms as well as body image were noted after surgery with no differences between those who received colpocleisis and those who underwent reconstructive surgery. Additionally, significant and clinically important improvements were noted in bodily pain, vitality, social functioning, role-emotional, and mental health summary scales of the SF-36.⁵⁴ Another multi-centre prospective cohort of 90 women undergoing colpocleisis found significant improvement in pelvic floor symptoms and body image with high satisfaction and low levels of regret on validated questionnaires six months after surgery.³⁸⁷ Similarly, a retrospective cohort of women over age 65 by Murphy et al comparing women who underwent colpocleisis (n=45) and similar group women who underwent reconstructive surgery with transvaginal mesh (Prolift, Ethicon Women's Health and Urology) found that improvements in condition-specific quality of life and post-operative patient satisfaction were comparable between the two treatment groups.³⁸⁹

The Pelvic Floor Disorders Network has reported on a

large series of women undergoing colpopoiesis (n=153) with one year follow-up.³⁹⁰ All pelvic symptom scores and related bother significantly improved at three and 12 months, and 125 (95%) patients said they were either 'very satisfied' or 'satisfied' with the outcome of their surgery.³⁹⁰ Botherome stress and urgency incontinence were present before surgery in 54% and 41% of subjects respectively. Forty percent of subjects received a concurrent mid-urethral sling at the time of their colpopoiesis and the rates of bothersome stress and urgency incontinence one year after surgery were 14% and 15% respectively. Similarly, bothersome bowel symptoms were present in 77% of subjects at baseline. One year after surgery, the majority of bothersome bowel symptoms resolved, particularly obstructive and incontinence symptoms, and development of new bowel symptoms was uncommon (0-14%).³⁹¹

While obliterative procedures are predominantly performed in elderly, frail women who often have multiple co-morbidities, the rate of serious adverse events after this procedure appears to be low. In general, major complications due to performance of surgery on the elderly (e.g. cardiac, pulmonary and cerebrovascular complications) occur at a rate of approximately 2%.³⁸² Major complications due to the surgery itself (e.g. pyelonephritis, blood transfusion) occur at a rate of approximately 4%.³⁸² A systematic review of published series of colpopoiesis from 1966 to 2004 reported a surgical mortality rate of approximately 1 in 400 cases.³⁸² One complication that appears to be uniquely associated with obliterative surgery is development de novo rectal prolapse after surgery.^{392, 393} Collins et al in a retrospective cohort of 916 women undergoing vaginal POP surgery at one institution and found that the incidence of post-operative full-thickness rectal prolapse in women who were > or = 65 years old who underwent obliterative surgery was 3 of 74 (4.1%; 95% CI, 1.4-11), with an estimated odds ratio of 22 (95% CI, 2.3-196; P < .002) compared with women who were > or = 65 years old who underwent reconstructive surgery.³⁸²

CONCLUSIONS

- A single large RCT suggests ULS and SSLs have similar anatomical, functional and adverse event outcomes. (GoR B)
- Level one evidence suggests transvaginal mesh procedures do not improve anatomical outcomes, vaginal bulge symptoms, repeat surgery for prolapse, dyspareunia or post-operative stress urinary incontinence when compared to native tissue (non-mesh) vaginal apical repairs have a mesh exposure rate of 18% and surgery for mesh exposure is required in 9.5%. (GoR A)
- Level one evidence suggests that overall sacro-colpopexy is associated with lower risk of awareness of prolapse, recurrent prolapse on exami-

nation, repeat surgery for prolapse, post-operative SUI and dyspareunia when compared broadly with vaginal prolapse repairs with and without mesh augmentation. (GoR A)

- Level one evidence suggest ASC has a higher success rate as compared to SSLs with less SUI and post-operative dyspareunia. ASC had greater morbidity including operating time, inpatient stay, slower return to activities of daily living and higher cost. (GoR A)
- In a single RCT, ASC associated with greater anatomical success, fewer reoperations, greater post-operative complications than USLS but no difference in improvement in symptoms or quality of life. (GoR B)
- LSC is associated with lower blood loss, longer operating time and shorter hospital stay than ASC with no difference in objective or subjective cure rates. (GoR B)
- RSC is associated with longer operating times and greater cost than LCS with similar anatomic success and adverse events. (GoR B)
- ASC performed with polypropylene mesh has superior outcomes to fascia lata (GoR B)
- In a single RCT, LSC had a superior objective and subjective success rate and lower reoperation rate compared to polypropylene transvaginal mesh for vault prolapse (GoR B).
- Level three evidence suggest McCall culdoplasty, Iliococcygeus fixation and colpopoiesis are relatively safe and effective interventions. (GoR C)

VI. POSTERIOR PROLAPSE SURGERY

Surgery for Posterior Vaginal Wall Prolapse

Almost 200,000 women undergo prolapse surgery in the United States each year, with one-third to one-half including a posterior wall prolapse repair.²¹ Prolapse of the posterior vaginal wall may be secondary to the presence of rectocele, sigmoidocele, enterocele, or a combination of these. This section will focus on the current understanding of the posterior vaginal anatomy, pathophysiology and anatomic defects which contribute to posterior vaginal wall prolapse, and will update the previous ICI report regarding outcomes after surgical repair of rectocele.

Anatomy of the Posterior Vaginal Wall

The vagina is made up of fibromuscular tissue extending as a tube from the abdominal cavity to the perineal body. Support of the posterior vaginal wall includes a complex interaction of the vaginal tube, connective tissue support, and muscular support of

the pelvic floor.

The connective tissue support of the vagina can be divided into three levels based on work by DeLancey.¹⁵⁴ All three levels require evaluation when considering the surgical management of the posterior vaginal compartment. Level I includes the apical portion of the posterior vagina supported primarily by the cardinal-uterosacral ligaments, originating at the sacrum and inserting onto the posterior cervix and upper vagina.³⁹⁴ Level II includes support to the mid-section of the vagina, which is provided by the endopelvic fascia, attaching the lateral posterior vaginal wall to the aponeurosis of the levator ani muscles. The fibres of the endopelvic connective tissue extend from the lateral edge of the vaginal tube to the pelvic sidewall. The proximal half of the posterior vagina is supported by endopelvic attachment to the arcus tendinous fasciae pelvis.

Finally, Level III includes the distal support of the posterior vaginal wall and is primarily provided by the perineal body. This level of support has strong attachments to the levator ani complex and is thus less susceptible to pelvic pressure transmission that may cause prolapse: it imparts a physical barrier between the vagina and rectum.

The puborectalis muscle provides a sling of support, enclosing the genital hiatus. Typically, the puborectalis is in a state of chronic contraction and the anterior and posterior vaginal walls are in direct apposition. In normal defaecation, there would be no increased pressure or stress placed on the endopelvic fascial attachments, as the puborectalis muscle relaxes and any increased pressure on the posterior vaginal wall is equilibrated by the opposing anterior vaginal wall.

The rectovaginal space is the potential space between the vaginal tube and the rectum. It consists of areolar tissue, and allows the vagina and rectum to function independently. Histological studies have noted that there is no specific layer of "fascia" between these two structures.³⁹⁵

Disruption of this complex interplay of bony, muscular, and connective tissue support can result in posterior vaginal wall prolapse resulting in both physical discomfort as well as negative impact on a woman's functioning.

Surgical Repair of Posterior Vaginal Prolapse

Posterior vaginal prolapse can be associated with a bothersome vaginal bulge as well as emotional, sexual, and defaecatory dysfunction. Surgical treatment should be primarily driven by patient symptoms and bother. Of note, many patients may present with both defaecatory symptoms as well as posterior vaginal prolapse leading to the assumption that the prolapse is causing the problems. However, data are conflicting regarding the efficacy of posterior vaginal repair on improving defaecatory symptoms and the association is incompletely understood.^{396, 397}

Types of surgical repair for posterior vaginal prolapse include midline plication, site specific technique, graft/mesh augmentation of midline or site-specific repairs, transanal repair, ventral rectopexy, and sacral colpopexy in which mesh is extended to the distal portion of the posterior vaginal wall and/or perineum.

2. MIDLINE PLICATION (TRADITIONAL POSTERIOR COLPORRHAPHY)

Midline plication of the fibromuscularis in the posterior compartment, or posterior colporrhaphy, was introduced in the 19th century. Plication in the midline decreases the width of the posterior vagina wall, creates a shelf of support, theoretically increasing the strength of the fibromuscularis layer. Reported anatomical "success rates" of this technique range from 76-96% (Table 22). The vaginal epithelium of the posterior vaginal wall is incised in the midline and flaps are created by dissecting the vaginal epithelium off the underlying fibromuscularis layer. Plication of the fibromuscularis then starts proximally towards the hymen.

Of note, midline plication may include plication of the levator ani muscles as well. This can help to close the genital hiatus, although it is not a normal anatomical position of the levator muscles. This may overly constrict the vaginal calibre and cause post-operative pain and dyspareunia. Thus, in general levator plication has fallen out of favour especially in sexually active women.

Table 22. Midline plication or traditional posterior colporrhaphy

Study (year)	N	Review (Months)	Anatomic Cure (%)	Vaginal Bulge (%)	Vaginal Digitation (%)	Defaecatory Dysfunction (%)	Dyspareunia (%)
Arnold et al ³⁹⁸ Preoperative Post-operative	29 24		19/24(80)		20	9/24(36)	6/24(23)
Mellgren et al. ³⁹⁹ Preoperative	25 25	12	24/25(96)	21 4	50 0/25 (0)	8 2/25(8)	2/25(8)

Study (year)	N	Review (Months)	Anatomic Cure (%)	Vaginal Bulge (%)	Vaginal Digitation (%)	Defecatory Dysfunction (%)	Dyspareunia (%)
Post-operative							
Kahn et al ⁴⁰⁰ Preoperative Post-operative	231 171	42	130/171(76)	64 31	56/171(33)	4 19/171(11)	27/171(16)
Weber et al ^{401, (15)} Preoperative Post-operative	53 53	12					14/53(26)
Sand et al. ^{43 (16)} Preoperative Post-operative	70 67	12	67/70(90)				
Maher et al. ⁴⁰² Preoperative Post-operative	38 38	12	33/38(87)	100 5	100 6/38(16)	3 6/38 (16%)	37 2/38(5)
Abramov et al. ⁴⁰³ Preoperative Post-operative	183 183	>12	150/183(82)	100 4		17 33/183 (18)	8 31/183 (17)
Paraiso et al. ³⁶⁰ Preoperative Post-operative	37 28	17.5	24/28 (86%)			80 9/28 (32)	56 13/28(45)
Total			447/539 (83%)		61/234 (26%)	78/469 (17%)	95/522 (18%)

3. SITE-SPECIFIC POSTERIOR VAGINAL REPAIR

This technique is similar to the traditional posterior colporrhaphy, except for the plication step. After the epithelium is dissected off of the underlying connective tissue, discrete defects in the connective tissue are identified by the surgeon by placing a finger in the rectum. Any identified discrete breaks in the connective tissue are then approximated and closed using interrupted sutures. If there is remaining laxity after the site-specific repair, a midline plication can then be performed over the site-specific repairs. Levator plication is not performed. The mean anatomic success

Table 23. Site-specific posterior vaginal repair

Study (year)	N	Review (Months)	Anatomic Cure (%)	Vaginal Bulge (%)	Vaginal Digitation (%)	Defecatory Dysfunction (%)	Dyspareunia (%)
Cundiff et al ⁴⁰⁶							

rate is 83% (range 56-100%) with 18% post-operatively needing vaginal digitation to defecate and 18% experiencing post-operative dyspareunia (Table 23).

Abramov et al retrospectively compared the midline fascial plication and discrete site specific repair for rectoceles.⁴⁰⁴ They noted a significantly higher recurrence rate of rectoceles following the discrete site-specific repair 32% as compared to 13% following the midline fascial plication (P=0.015). The correction of the rectovaginal fascia defect that allows entrapment of faeces on straining in significant rectoceles may be too large to be repaired with the discrete approach⁴⁰⁵ and appears to be corrected by the more robust midline fascial plication.

Study (year)	N	Review (Months)	Anatomic Cure (%)	Vaginal Bulge (%)	Vaginal Digitation (%)	Defecatory Dysfunction (%)	Dyspareunia (%)
Preoperative Post-operative	69 61	12	50/61 (82%)	100 11/61(18)	39 11/61(18)	13 5/61(8)	29 12/61(19)
Porter et al ⁴⁰⁷ Preoperative Post-operative	125 72	6	59/72 (82)	38 10/72(14)	24 15/72/ (21)	24 15/72(21)	67 33/72(46)
Kenton et al ⁴⁰⁵ Preoperative Post-operative	66 46	12	41/46 (90)	86 4/46(9)	30 7/46(15)	30	28 4/46(8)
Glavind and Madsen ^{408 (23)} Preoperative Post-operative	67 67	3	67/67 (100)				12 2/67(3)
Singh et al ⁴⁰⁹ Preoperative Post-operative	42 33	18	30/33(92)	78 2/33(7)		9 2/33(5)	31 5/33(15)
Abramov et al ⁴⁰⁴ Preoperative Post-operative	124 124	>12	69/124 (56)	100 14/124(11)		15 24/124(19)	8 20/124(16)
Paraiso et al ⁴¹⁰ Preoperative Post-operative	37 27	17.5	21/23 (78)		58 6/27(21)		48 8/27(28)
Sung et al ⁴¹¹ Preoperative Post-operative	80 70	12	63/70 (90)	4/58(7%)	9/58 (15.5%)	12/57 (21)	4/57 (7)
Total			410/496 (83%)	45/394 (11.4%)	48/264 (18%)	58/347 (17%)	88/487 (18%)

4. GRAFT (ABSORBABLE) OR MESH (PERMANENT) AUGMENTATION OF POSTERIOR VAGINAL REPAIR

Graft or mesh can be used in the rectovaginal space. This is often combined with either a midline colporrhaphy or site-specific repair. Although there is variation in the surgical technique typically, after creating vaginal flaps, the dissection is extended laterally on both sides to the pelvic sidewall. A midline colporrhaphy or site-specific repair is then typically performed. The graft or mesh is then placed over the repair and anchored along the sidewall. The vaginal epithelium is then closed over the graft or mesh.

There are three comparative studies suggesting no difference in anatomical and quality of life outcomes when using synthetic absorbable mesh or biological graft compared to native tissue transvaginal repair, including two high quality randomised trials and one low-quality retrospective cohort study.⁴¹¹⁻⁴¹³ Graft-augmented repair outcomes are presented in Table 24.

Paraiso et al compared three techniques for rectocele repair in a prospective randomised trial.⁴¹⁰ Patients

were randomised to receive either a traditional repair (N=37), a site specific repair (N=37) or a site-specific repair augmented with porcine small intestine mucosa (N=32). All patients had Stage II or greater posterior vaginal wall prolapse at baseline. The objective anatomical failure rate was highest in the graft augmented group (12/26) at 1 year which was statistically significantly worse than the site-specific group (6/27) and traditional repair (4/28). There was no significant difference in subjective symptoms (worsening prolapse or colorectal symptoms) or dyspareunia between the three groups. (Note: native tissue data are presented in Table 23). No graft exposures were reported.

Sung et al conducted a double blind, multicentre randomised trial comparing native tissue repair (70) versus native tissue with porcine small intestine submucosal (SIS) graft (67) for symptomatic stage 2 rectocele.⁴¹¹ The native tissue repair involved either a midline plication or site specific repair at the surgeon's discretion, with the majority undergoing site-specific repair. In the graft group the native tissue repair was augmented with porcine SIS overlay. At one year, there was no difference between the groups in objective and subjective success rates or in resolution of defecatory symptoms. Post-operative dyspareunia

rates were not significantly different at 7% in the native tissue group and 12.5% graft group. (Note: native tissue data are presented in Table 23). No graft exposures were reported.

Grimes et al conducted a retrospective review of 193 posterior repairs performed between 2001-2008 from the Kaiser Permanente San Diego Pelvic Floor Database.⁴¹³ 124 (64%) native tissue (including 38% traditional colporrhaphy and 62% site-specific repair) and 69 (36%) graft augmentation procedures were included. Minimum follow up was approximately 12 months. Graft augmentation was at the discretion of the surgeon and included noncross-linked cadaveric dermis, cross-linked porcine dermis, and noncross-linked porcine dermis. Anatomical success was similar between native tissue vs. graft (Bp <-1, 86% vs. 80%). Post-operative splinting and incomplete evacuation was greater in the graft group compared to native tissue (splinting, 85% vs. 68%; p=0.04).

There was one comparative study evaluating patient-reported outcomes after native-tissue versus nonabsorbable mesh augmentation for isolated primary rectocele by Madsen et al.⁴¹⁴ The authors used prospective data from the Swedish National Register for Gynaecological Surgery, including 3988 women who underwent primary operation for rectocele between 2006-2014. 3908 women had a native-tissue repair and 80 had nonabsorbable mesh. No concurrent procedures were included and follow up was 12 months. The authors found no difference in vaginal bulge sensation (78% vs. 90% "cure" for native tissue vs. mesh), or feeling satisfied/very satisfied (74% vs. 70% native tissue vs. mesh). There was no statistically significant difference for de novo dyspareunia (33% vs. 10% for native tissue vs. mesh). Re-operation rate was 1.1% in both groups.

Table 24. Graft-augmented (absorbable) posterior vaginal repair

Author	N	Review (mo)	Anatomic cure (%)	Vaginal bulge (%)	Vaginal digitation (%)	Defecatory dysfunction (%)	Dyspareunia (%)
Paraiso et al (Paraiso 2006)	29	12 mo	14/26 (54%)	-	2/29 (7%)	5/24 (21%)	3 (6%)*
Sung et al (Sung 2012)	67	12 mo	59/67 (88%)	2/64 (3%)	6/62 (10%)	28/64 (44%)	7/56 (12.5%)
Grimes et al (Grimes 2012)	69	71 mo (median, range 9-80)	55/69 (80%)	-	35/41 (85%)	33/41 (80%)	5/23 (22%)
Total			128/162 (79%)		43/132 (33%)	66/129 (51%)	

*Uncertain denominator

5. SACRAL COLPOPEXY WITH EXTENSION OF MESH POSTERIORLY

The abdominal route has been employed in the correction of posterior vaginal wall prolapse when a co-existing apical defect requires surgery. The technique is a modification of sacral colpopexy with extension of the posterior mesh down to the distal posterior vaginal wall and or the perineal body. The procedure can

be performed through an abdominal incision, or through laparoscopic or robotic-assisted routes. The pre-sacral space is opened and the peritoneal dissection is extended posteriorly from the apex, entering the rectovaginal space. Dissection is continued to the perineal body. Mesh is then attached to the posterior vaginal wall distally and then attached to the anterior longitudinal ligament of the sacrum cephalad in a tension free fashion. The peritoneum is then typically closed over the mesh, burying it completely. A vaginal approach has also been described. Table 25 summarises a series of studies that have reported on extended posterior fixation of sacrocolpopexy mesh.

Table 25. Sacrocolpopexy with posterior mesh extension

Author	N	Follow Up	Success	Dyspareunia Pre-op	Post-op
Baessler K ⁴¹⁵	33	26 months	45%	39%	13%
Fox S. ⁴¹⁶	29	14 months	90%	38%	17%

Author	N	Follow Up	Success	Dyspareunia Pre-op	Post-op
Su K ⁴¹⁷	122	12 months	90%	-	-
Lyons ⁴¹⁸	20	12 months	80%	-	-
Marinkovic ⁴¹⁹	12	39 months	91%	29%	None

6. TRANSANAL REPAIR OF RECTOCELE

Three trials have evaluated transanal vs transvaginal repairs of rectoceles.⁴²⁰⁻⁴²² Each trial had slightly different inclusion criteria. Kahn included women who had symptoms of prolapse or impaired rectal evacuation with incomplete emptying on isotope defaecography and normal compliance on anorectal manometry⁴²⁰. Nieminen's included women with symptomatic rectoceles not responding to conservative therapy. Importantly women with compromised anal sphincter function and other symptomatic genital prolapse were excluded. In both trials the vaginal repair was performed by gynaecologists and the transanal repair by colorectal surgeons. In Kahn's trial the posterior vaginal wall repair was performed using levator plication and in Nieminen's trial the rectovaginal fascia was plicated. Farid's inclusion criteria required women to have a rectocele larger than 2 cm on defaecography with symptoms including digitation, incomplete evacuation, excessive straining and dyspareunia. Women with a compromised anal sphincter complex or recurrent prolapse, rectal prolapse, intussusception, or anismus were excluded. The surgery was performed within the surgery department and blinded examiners utilised defaecography, anal manometry, and a modified obstructed defaecation syndrome patient questionnaire to report outcomes.

Based on these three trials we can conclude that the results for transvaginal repair of rectocele are superior to transanal repair of rectocele, in terms of subjective and objective outcomes. In women with rectocele alone recurrent rectocele occurred in two out of 39 women in the vaginal group and seven out of 48 following the transanal repair, a difference that did not reach statistical significance. Post-operative enterocele was however significantly less common following vaginal surgery as compared to the transanal group.

Farid⁴²² reported on outcomes of three types of rectocele repair comparing transperineal repair to levatorplasty to transanal repair and noted conclusions similar to the two previously discussed trials. The size of the rectocele on defaecography was significantly smaller in the transperineal group (with or without levatorplasty) as compared to the transanal repair. Also functional outcome based on a modified obstruction defaecation syndrome patient questionnaire was better after transperineal repair compared to transanal repair.

Puigdollers et al reported results from a prospective cohort of women with rectocele and constipation who underwent surgery via either endorectal or a transperineal approach based on surgeon preference.⁴²³ At the end of one year the overall subjective improvement in constipation was reported in 43% ($p < 0.001$) and the need to splint decreased in 52% ($p = 0.001$).

Thornton et al⁴²⁴ reported in a single non-randomised study outcomes for a cohort of women with symptomatic rectocele who were treated laparoscopically (N=40) vs transanally (N=40). Level 2B evidence from this study supports the superiority of the transanal approach for symptom relief (55% vs 28%, $p < 0.02$) but lower post-operative dyspareunia rates (22% vs 36%) with the laparoscopic approach.

van Dam et al⁴²⁵ performed a combined transvaginal and transanal repair in 89 women who were evaluated at a follow up of 52 months. The anatomical success rate was 71% (defined as no persistent or recurrent rectocele on defaecography at six months). However, de novo dyspareunia was reported in 41% of women and there was a deterioration of faecal continence in seven patients.

7. VENTRAL RECTOPEXY

For rectal prolapse both perineal and abdominal procedures are described. While the transanal Delorme procedure has been performed for many years Level three evidence suggests that perineal approaches seem to be associated with a higher post-operative faecal incontinence and recurrence rate and therefore an abdominal procedure is preferred by most surgeons.⁴²⁶⁻⁴²⁸ In the search to reduce this high rate, laparoscopic ventral mesh rectopexy (LVMR) was introduced⁴²⁹ and mobilises just the anterior aspect of the rectum, and thereby the risk for autonomic nerve damage and associated dysmotility with impaired evacuation is minimised. The dissection is followed by a mesh suspension of the distal rectum to the sacral promontory, correcting the descent of the rectum and reinforcing the rectovaginal septum. Although no high quality comparative research exists so far, LVMR is being progressively performed internationally and proposed as the treatment of choice for rectal prolapse.⁴³⁰

To date, only one small randomised controlled trial (RCT) Emile et al. compared LVMR with Delorme's operation ($n = 25$ vs. 25) for ERP with mean follow-up of 18 ± 5 months (range, 9-30)⁴³¹. Baseline characteristics differed from the literature with a low mean age (39.7 years) and a high percentage of males

(38%). The trial demonstrated no difference between the groups in recurrent prolapse (16% Delormes, 8% LVMR) or difference in change in Wexner continence or constipation scores post-operatively. The Delormes procedure had a shorter operating time and longer admission stay than the LVMR. With a larger sample size, the non-significantly higher recurrent rectal prolapse rate after the Delorme procedure may become significant.

The vast majority of the current literature regarding LVMR comprises observational studies and often differ in patient selection and outcome measures. This heterogeneity makes it difficult to interpret the results. Most studies lack a systematic approach and follow-up is usually short.

Recurrence

Since the first description of LVMR, recurrence rates for external rectal prolapse (ERP) range between 1.5 to 15.4% (Table 26). Most recurrences are seen within 36 months' post-operatively, but not all studies demonstrate this time interval. Studies including all rectal prolapse syndromes as an indication for LVMR, report a recurrence rate of 2.6 to 14.3% (Table 2). Only three trials evaluated IRP as the indication for LVMR with recurrence ranging from 5.3 to 7.1%. Recurrence rates following RVMR are generally comparable to LVMR series (Table 2).

Functional Outcome

External rectal prolapse

External Rectal Prolapse (ERP) is considered a definitive indication for LVMR.⁴³² Functional outcome in rectal prolapse surgery is usually assessed with validated faecal incontinence and constipation scores. The LVMR articles included in this guideline either used the Cleveland Clinic Constipation Score (CCCS, range 0-30)⁴³³ Obstructed Defecation Syndrome (ODS) Score (range 0-31)⁴³⁴, Fecal Incontinence Severity Index (FISI, range 0-61)⁴³⁵ or the Cleveland Clinic Incontinence Score (CCIS, range 0-30)⁴³⁶. For all four grading systems, a decrease in score correlates with an improvement of symptoms. A median improvement in CCCS ranged from 4.8-11 points with between 52-84% reporting a general reduction of obstructed defecation complaints is noted following LVMR (Table 28). Post-operatively 50-93% of patients reported a reduction in faecal incontinence and an improved median FISI ranged from 12 to 36 points (Table 3). New-onset complaints are described in 4.8 to 17.6% of patients for obstructed defaecation and in 1.5 to 3.2% of patients for faecal incontinence (Table 28). The only robotic VMR study including patients with an ERP showed a mean CCCS gain of 3.2 points⁴³⁷.

Internal rectal prolapse

In general, for an Internal Rectal Prolapse (IRP) Oxford Grade 1 and 2 (recto-rectal intussusception) pelvic floor physiotherapy is indicated.⁴³⁸ Significant functional symptoms in combination with an Oxford

Grade 3 or 4 IRP (recto-anal intussusception) failing to conservative therapy, could be an indication for VMR.⁴³² Studies including patients with a symptomatic grade 3 or 4 IRP describe a median reduction of CCCS (range 3.1-9.0 points) and a reduction in obstructed defaecation complaints (range 55-86% of patients) (Table 28). Post-operatively between 20-92% reported a reduction in faecal incontinence with a median improved FISI ranging from 16 to 25 points as seen in Table 3. No, *de novo* faecal incontinence was described.

Median gain of CCIS was non-significantly equivalent between the two techniques. Functional results following RVMR are comparable to the literature on LVMR for various indications (Table 28).

8. VENTRAL MESH RECTOPEXY MORBIDITY

Multiple studies have been performed to assess the safety of LVMR. At present, thirty studies report a post-operative complication rate between 0-23.4% (Table 27). The vast majority of those complications were minor, as classified according to the Clavien-Dindo (CD) classification. Major complications following VMR are described from 0-7.7% with a mortality rate of 0-1.1%. In recent years, there was serious controversy about the use of permanent mesh in pelvic floor surgery. In 2015 Evans et al. combined data collated from prospective databases in five hospitals (2203 patients) and described an overall mesh erosion rate of 2% (42 synthetic, three biological) after a median of 23 months.⁴³⁹

Currently 34 observation studies (range median follow-up 3-74 months) mention mesh-related morbidity following LVMR with mesh complication rates from 0-6.7% and mesh erosion percentages between 0-3.7%.^{431, 439-457} Five studies (range median follow-up 3-24 months) evaluated robotic VMR and the rate of synthetic mesh-related complications was 0%.^{437, 458-461} Based on these figures, it appears that the concerns about mesh complications following a transvaginal mesh procedure are not applicable to the VMR.

9. BIOLOGICAL GRAFT RECTOPEXY

In 2008 and 2011 the US Food and Drug Administration (FDA) published official warnings for the use of mesh in POP surgery.⁴⁶² Although similar figures following an abdominal approach have never been described, an aversion to synthetic mesh in POP surgery was created. In the search for an alternative, biological meshes became more popular. To date, erosion rates and functional outcome following VMR for synthetic and biological mesh are comparable.⁴⁶³ The material characteristics of a biological mesh could in theory result in a higher recurrence rate. Currently, recurrence rates are quite comparable. One report, however, noted a high recurrence rate of 14% after 20 months of follow-up.⁴⁶⁴ Ogilvie et al published the

only (case-matched) study comparing biological with synthetic mesh for LVMR (n= 29 vs 29).⁴⁴⁷ No significant difference in mesh-related morbidity, functional outcome and recurrence after a median follow-up of 15.4 months was found. One article comparing LVMR with RVMR (34 vs 17) using biological mesh showed no mesh-related morbidity or recurrences in either cohort after 12 months.⁴⁶⁵ Functional outcome was approximately equivalent between the two groups.

10. RECTOCELE AS AN INDICATION FOR VENTRAL MESH RECTOPEXY

Rectocele has been described as an indication for VMR.^{280, 440, 443, 444, 446} As early as 2008 a Dutch group retrospectively reported on 16 women undergoing LVMR for obstructed defaecation syndrome. Many had an enterocele or rectocele preoperatively with 25% also having internal rectal prolapse.⁴⁶⁶ The mean operating time was 199 minutes and the mesh was secured to the anterior rectum and posterior vagina. Post-operative complications included two ileus, one of which required reoperation, one wound infection, 1 neurological injury to left leg, two incisional hernia and one infected mesh that was removed. The obstructed defaecation score was not significantly different post-operatively and in fact deteriorated in 75%. The authors reported the LVMR to be a feasible approach in selected patients, without identifying the group.

In 2011 Wong et al²⁸⁰ reported a retrospective case series on ventral rectopexy (n=38) for complex rectocele (defined as one or more of: rectocele greater than 3cm diameter on imaging, associated enterocele or internal rectal prolapse), with 12 months' review. The surgical technique was unorthodox for ventral rectopexy with "mesh secured to pelvic floor musculature on either side of the rectum, taking care not to place the sutures directly into the rectal wall". This single leaf procedure was performed in (14/38) and closely resembles a single leaf sacral colpopexy. The majority (24/38) actually underwent a classical dual leaf sacral colpopexy.⁴⁶⁷ The authors not surprisingly reported a significant reduction in vaginal prolapse symptoms, (45 to 5%) and dyspareunia (27 to 10%) results that have been well recognised in level one data on sacral colpopexy.⁴⁶⁸ There was no difference in post-operative scores for obstructed defaecation syndrome, Cleveland clinic incontinence score or Gastrointestinal quality of life score.

Formijne Jonkers et al retrospectively reported on 233 patients undergoing LVMR and who completed postal validated bowel function questionnaires.⁴⁴⁰ Indications for surgery were divided into three groups. Group one included external rectal prolapse (15%), group two internal rectal prolapse and or rectocele (68%) and group three internal rectal prolapse or rectocele and enterocele (17%). Sixty-four percent (n=150) completed the questionnaires which demon-

strated significant improvement in faecal incontinence and constipation scores post-operatively in all three subgroups. Unfortunately, it is not possible to determine how many of patients in groups two and three are included due to rectocele and how many due to internal rectal prolapse. Furthermore, the study methodology results in an overestimation of impact of the surgery. No attempt was made in the study methodology to account for the 36% that failed to respond and then persisted in including 233 patients in the post-operative review. These oversights in the study methodology served to overestimate the impact of the intervention. Thus, it is not possible to discern from this report if the LVMR is effective for rectocele.

Lauretta et al retrospectively described a modified laparoscopic ventral rectopexy for 30 women with external or internal prolapse and 26 for some degree of rectocele.⁴⁴⁴ At surgery the mesh was secured to both the anterior rectum and posterior vaginal wall. Pre- and post-operatively rectocele and internal prolapse were defined at proctography. At a median review of 14 months one patient had a suture erosion and one a recurrent rectal prolapse. Excellent functional outcomes were reported with constipation significantly improved in 93%, a significant reduction in the Altomare obstructed defaecation score and preoperative incontinence improved after the procedure in all patients affected. Unfortunately, no post-operative vaginal prolapse assessment or report of defaecography findings were reported and the reader is unable to determine if the functional outcomes reported are due to correction of the internal and or rectal prolapse or the possible correction of a rectocele.

A French group prospectively evaluated 33 patients undergoing a traditional LVMR for external rectal prolapse (n=20), rectocele and internal rectal prolapse (n=10), and rectocele (n=3)⁴⁴⁶. At median review of 42 months constipation was improved in 72% (13/18) and two patients (7 %) presented de novo constipation. The patients' Wexner score and quality of life improved significantly post-operatively and two patients developed recurrent rectocele (7%). Despite there being no pre or post-operative vaginal prolapse assessment recorded and that only three patients with rectocele alone were included, the authors concluded LVMR was an effective and safe treatment for external rectal prolapse and or rectocele.

Horisberger et al⁴⁴³ retrospectively evaluated 27 women undergoing LVMR for complex pelvic floor conditions including symptomatic rectocele (79%), enterocele (64%) and grade 1-2 rectal prolapse (43%). At 22 months significantly improved constipation scores and quality of life scores on the SF-12 questionnaire were demonstrated without improvement in Wexner Incontinence score. Over 50% of pre-operatively sexually active women reported a deterioration in sexual function and no post-operative assessment of vaginal prolapse was reported. Again, it is impossible to determine if the improvement in constipation scores are due to treatment of grade 1-2 rectal prolapse or correction of the rectocele.

Due to the significant heterogeneity of the included conditions the reader is unable to determine if the changes reported are due to correction of external and or internal rectal prolapse or due to correction of the rectocele. No trial has demonstrated that the LVMR or modifications employed are successful in correcting rectocele. One trial demonstrated that a procedure that more closely resembles a sacral colpopexy than ventral rectopexy, was successful in correcting vaginal prolapse symptoms with little impact upon functional bowel symptoms.

11. COMBINED VAGINAL AND RECTAL PROLAPSE

Logically women with rectal prolapse may also suffer vaginal prolapse and or bladder dysfunction. As early as 2007 Lim et al⁴⁶⁹ retrospectively reported on 29 women undergoing open combined mesh sacral colpopexy, ventral rectopexy and urinary continence surgery performed by urogynaecologist and colorectal surgeons working together for combined pelvic floor dysfunction. The authors demonstrated significant improvement in the validated Pelvic Floor Distress Inventory and in all three subscales including vaginal, urinary and rectal related symptoms. Three patients (10%) required reoperation, one for removal of mesh and two for recurrent vaginal prolapse.

More recently Van Iersel et al. prospectively describe 51 patients undergoing robotic ventral rectopexy, sacral colpopexy and urinary continence surgery as required performed in collaboration between colorectal and urogynaecology surgeons for combined vaginal and rectal prolapse.⁴⁶³ They demonstrated a significant improvement not only in faecal incontinence (Pescatori incontinence scale 4 vs 3, $p=0.002$) and constipation (73.3%, $p<0.0005$) but also in the Urinary Distress Inventory (27.8 vs 22.2; $p<0.0005$) and on sexual function (Pelvic Organ Prolapse/Urinary Incontinence Sexual Questionnaire score 31.8 vs 35.9; $p = 0.002$). Quality of life for bowel and bladder function ($p < 0.0005$) was also observed. Anatomical vaginal reconstruction was demonstrated by the simplified POP quantification $p < 0.0005$). One patient (2%) developed mesh erosion and a single recurrent rectocele was observed.

Table 26. Recurrence rates following LVMR and RVMR with synthetic mesh

Laparoscopic studies	n	FU (median)	Recurrence	Type of recurrence	Presentation of recurrence (months)
Indication ERP					
D'Hoore ⁴²⁹ 2004	42	61	2 (4.8%)	2 ERP	54, 91
Verdaasdonk ⁴⁷⁰ 2006 ^a	13	7	2 (15.4%)	2 ERP	-
Auguste ⁴⁵⁴ 2006	54	12	4 (7.4%)	3 ERP, 1 IRP	26 (7-54) ^b
D'Hoore ⁴⁷¹ 2006	109	-	5 (4.6%)	4 ERP, 1 enterocele	-
Cristaldi ⁴⁷² 2007	63	18	1 (1.7%)	ERP	-
Boons ⁴⁷³ 2010	65	19	1 (1.5%)	ERP	12
Wijffels ⁴⁷⁴ 2011	80	23	2 (2.5%)	2 ERP	6, 16
Faucheron ⁴⁷⁵ 2012	175	74/60 ^c	2 (3%) ^c	2 ERP	6, 24
Randall ⁴⁴⁸ 2014 ^d	190	29	9 (4.7%)	1 ERP, 8 IRP	25, 30, 31, 60 ^e
Gosselink ⁴⁴² 2015 ^f	41	12	1 (2.3%)	ERP	12
Tsunoda ⁴⁵³ 2016	31	25	3 (9.7%)	3 IRP	10, 17, 31
Emile ⁴³¹ 2016	25	18 ^g	2 (8%)	ERP	-
Chandra ⁴⁵⁶ 2016	15	22	0 (0%)	-	-
Indication IRP and/or rectocele					
Collinson ⁴⁷⁶ 2010	75	12	4 (5.3%)	4 IRP	-
Wong ²⁸⁰ 2011	84	29	6 (7.1%)	6 rectoceles	-
Gosselink ⁴⁴² 2015 ^f	50	12	3 (5.8%)	3 IRP	-
Indication both ERP and IRP and/or rectocele					
Lauretta ⁴⁴⁴ 2012	2 ERP, 28 IRP	13.9 ^g	1 (3.3%)	1 IRP	19
Formijne Jonkers ¹⁶ 2013	36 ERP, 197 IRP	30	6 (2.6%)	-	-
Badrek-Amoudi ¹⁸ 2013	11 ERP, 37 IRP	33	4 (8.3%)	4 IRP	22 (median)
Maggiori ¹⁹ 2013	33 ^h	42 ^g	2 (6.7%)	2 rectocele	11, 14
Mackenzie ²⁵ 2014	149 ERP, 487 IRP	21	60 (9.4%)	-	-

Laparoscopic studies	n	FU (median)	Recurrence	Type of recurrence	Presentation of recurrence (months)
Owais ⁶¹ 2014 ⁱ	18 ERP, 60 IRP	42	2 (2.9%)	2 IRP	-
Consten/van Iersel ⁴⁵⁷ 2015	242 ERP, 677 IRP	33.9/120 ^c	68 (14.3%) ^c	15 ERP, 53 IRP	24.1 (1–139.4) ^b
Tsunoda ⁴⁵² 2015	19 ERP, 25 IRP	26	2 (3.4%)	2 IRP	10, 15
Horisberger ⁴⁴³ 2016	12 ERP, 15 IRP	22	1 (3.7%)	ERP	2
Robotic vs. Laparoscopic – various indications					
De Hoog ⁴³⁷ 2009	20 ERP robot	23.4	4 (20%)	-	-
Wong ²⁸⁰ 2011	23 IRP lap 15 IRP robot	12	1 (4.3%) 1 (6.7%)	Rectocele Rectocele	3 7
Wong ⁴⁶¹ 2011	40 IRP lap 23 IRP robot	6	0 (0%) 0 (0%)	- -	- -
Mantoo ⁴⁶⁰ 2013 ^j	23 ERP, 51 IRP lap 12 ERP, 32 IRP robot	16 ^g	6 (8%) 3 (7%)	- -	- -
Mäkelä-Kaikkonen ⁴⁵⁸ 2014	14 ERP, 6 IRP lap 13 ERP, 7 IRP robot	3	1 (5%) 0 (0%)	- -	- -

^a One patient was excluded from further analysis, therefore n=13 instead of n=14 is used; ^b mean (range); ^c Recurrence percentage is KM estimate at 60 and 120 months of follow-up; ^d Study group included the first 44 cases from Slawik et al. ⁵⁵; ^e Only 4 time intervals are described; ^f The results of Gosselink et al. is displayed per indication; ^g Mean instead of median; ^h Of the 33 patients (ERP n = 20, n = 13 IRR) 3 lost to follow-up. For the remainder of patients, the surgical indication was not given; ⁱ Only men included; ^j A modified version of the D'Hoore rectopexy used; Lap: laparoscopic

Table 27. Conversion, intra- and post-operative complications following LVMR and RVMR with synthetic mesh

	n	Median FU (months)	Intra-operative complications	Conversion n	Post-operative complications			
Laparoscopic studies					Total	Minor (CD 1-2)	Major (CD 3-4)	Mortality (CD 5)
D'Hoore ⁴²⁹ 2004	42	61	0	2 (4.8%)	2 (4.8%)	2 (4.8%)	0	0
D'Hoore ⁴⁷¹ 2006	10 9	-	0	4 (3.7%)	8 (7.3%)	8 (7.3%)	0	0
Slawik ⁴⁷⁷ 2008	80	54	-	1 (1.3%)	7 (8.8%)	7 (8.8%)	0	0
van den Esscher ⁴⁶⁶ 2008	17	38 ^a	0	1 (5.9%)	4 (23.5%)	3 (17.6%)	1 (5.9%)	0

	<i>n</i>	Median FU (months)	Intra-operative complications	Conversion	Post-operative complications			
Boons ⁴⁷³ 2010	65	19	-	1 (1.5%)	11 (16.9%)	6 (9.2%)	5 (7.7%)	0
Collinson ⁴⁷⁶ 2010	75	12	0	1 (1.3%)	4 (5.3%)	3 (4%)	0	0
Wijffels ⁴⁷⁴ 2011	80	23	-	1 (1.3%)	10 (12.5%)	9 (11.3%)	1 (1.3%)	0
Wong ²⁸⁰ 2011 ^b	40	6	0	4 (10)	5 (12.5%)	5 (12.5%)	0	0
Wong ⁴⁶¹ 2011	84	29	4 (4.8%)	3 (3.6%)	3 (3.6%)	2 (2.4%)	1 (1.2%)	0
Lauretta ⁴⁴⁴ 2012	30	13.9 ^a	-	0	2 (7.7%)	0	2 (7.7%)	0
Faucheron ⁴⁷⁵ 2012	17 5	74/60 ^c	0	3 (1.7%)	8 (4.6%)	5 (2.9%)	3 (1.7%)	0
Formijne Jonkers ⁴⁴⁰ 2013	23 3	30	0	6 (2.6%)	11 (4.7%)	7 (3%)	4 (1.7%)	0
Badrek-Amoudi ⁴⁵⁵ 2013	48	33	-	0	9 (18.8%)	8 (16.7%)	1 (2.1%)	0
Maggiori ⁴⁴⁶ 2013	33	42 ^a	0	1 (3%)	0	0	0	0
Mantoo ⁴⁶⁰ 2013 ^b	74	16 ^d	0	3 (4.1%)	15 (20%)	15 (20%)	0	0
Mäkelä-Kaikkonen ⁴⁵⁸ 2014 ^b	20	3	0	0	1 (5%)	0	1 (5%)	0
Mackenzie ⁴⁴⁵ 2014	95 3	21	-	8 (1.3%)	63 (6.6%)	53 (5.6%)	8 (0.8%)	2 (0.2%)
Ogilvie ⁴⁴⁷ 2014	29	15.4	1 (3.4%)	0	3 (10.3%)	2 (6.9%)	1 (3.4%)	0
Randall ⁴⁴⁸ 2014	19 0	29	1 (0.5%)	5 (2.6%)	22 (11.6%)	11 (5.7%)	8 (4.2%)	2 (1.1%)
Owais ⁴⁷⁸ 2014	68	42	0	0	11 (16.2%)	10 (14.7%)	1 (1.5%)	0
Gosselink ⁴⁴² 2015	91	12	0	0	5 (5%)	4 (4.4%)	0	0
Tsunoda ⁴⁷⁹ 2015	26	16	0	0	2 (7.7%)	2 (7.7%)	0	0
Consten/van Iersel ²⁶ 2015	91 9	33.9/120 ^c	3 (0.3%)	20 (2.2%)	203 (23.4%)	153 (19.3%)	50 (4.1%)	1 (0.1%)
Tsunoda ⁴⁵³ 2016	31	25	0	0	2 (6.5%)	2 (6.5%)	0	0
Emile ⁴³¹ 2016	25	18 ^a	0	0	5 (20%)	5 (20%)	0	0

	<i>n</i>	Median FU (months)	Intra-operative complications	Conversion	Post-operative complications			
Chandra ⁴⁵⁶ 2016	15	22	1 (6.7%)	0	3 (20%)	3 (20%)	0	0
Robotic studies								
Wong ²⁸⁰ 2011 ^b	23	6	0	1 (4.3%)	1 (4.3%)	0	0	0
Mantoo ⁴⁶⁰ 2013 ^b	74	16 ^d	0	1 (2.3%)	5 (11%)	5 (11%)	0	0
Mäkelä-Kaikkonen ⁴⁵⁸ 2014 ^b	20	3	1 (5%)	0	1 (5%)	1 (5%)	0	0
Mäkelä-Kaikkonen ⁴⁵⁹ 2016	16	3	1 (6.3%)	0	2 (12.5%)	2 (12.5%)	0	0

^a Mean instead of median; ^b The results of Wong, Mantoo and Mäkelä-Kaikkonen et al. are displayed per technique; ^c Percentages are Kaplan-Meier estimates at 60 and 120 months of follow-up; ^d not specified whether mean of median was used. *n*: no. of patients, FU: follow-up; -: not specified of not applicable.

Table 28: Functional Results following LMVR and RVMR with synthetic mesh

Laparoscopic studies	<i>N</i>	Median FU (mo)	Improvement OD	P value	Improvement FI	P value	Median Gain CCCS	P value	Median gain CCIS	P value
Indication ERP										
D'Hoore ⁴²⁹ 2004	42	61	84.2%. <i>De novo</i> 4.8%	-	90.3%	-	-	-	13	<0.001
Auguste ⁴⁵⁴ 2006	54	12	70%. <i>De novo</i> 17.6%	-	72.4%	-	-	-	5.8 ^a	-
Verdaasdonk ⁴⁷⁰ 2006 ^b	13	7	66%	-	69%	-	-	-	-	-
Cristaldi ⁶³ 2007	63	18	78%	-	90%. <i>De novo</i> 3.2%	-	5	<0.0001	32 (FISI)	<0.0001
Boons ⁴⁷³ 2010	58 ^c	19	72%	-	83%. <i>De novo</i> 1.5%	-	5	< 0.0001	36 (FISI)	< 0.0001
Formijne Jonkers ⁴⁴⁰ 2013 ^d	36	30	57.9%	0.01	76.2%	<0.001	-	-	-	-
Randall ⁴⁴⁸ 2014	190	29	-	-	93%	-	-	-	8	< 0.0001
Gosselink ⁴⁴² 2015 ^d	41	12	-	-	50%	<0.01	4.8	<0.01	12 (FISI)	<0.01

Laparoscopic studies	N	Median FU (mo)	Improvement OD	P value	Improvement FI	P value	Median Gain CCCS	P value	Median gain CCIS	P value
Tsunoda ⁴⁵² 2015 ^{d,e}	19	12	52%	-	62%	-	7	<0.0001	23 (FISI)	<0.0001
Consten/van Iersel ²⁶ 2015 ^d	242	33.9	63.3%	<0.0001	73.2%	<0.0001	-	-	-	-
Tsunoda ⁴⁵³ 2016	31	12	-	-	-	-	5	0.005	22 (FISI)	<0.0001
Emile ⁴³¹ 2016	25	6	62.5%	-	75%	-	8.7	-	5	-
Chandra ⁴⁵⁶ 2016	15	22	-	-	-	-	11	< 0.001	24 (FISI)	0.007
Indication IRP and/or rectocele										
Collinson ⁴⁸⁰ 2009	30	3	83%	-	92%	-	9	<0.0001	25 (FISI)	<0.0001
Collinson ⁴⁷⁶ 2010	75	12	86%	-	85%	-	7	< 0.0001	20 (FISI)	<0.0001
Wong ⁴⁶¹ 2011	84	29	45%	< 0.001	20%	> 0.05	-	-	-	-
Formijne Jonkers ¹⁶ 2013 ^d	197	30	76.9%	< 0.001	65.4%	< 0.001	-	-	-	-
Gosselink ⁴⁴¹ 2013	72	12	-	-	-	-	5	< 0.001	16 (FISI)	<0.01
Gosselink ⁴⁴² 2015 ^d	50	12	-	-	48%	<0.01	3.1	<0.01	17 (FISI)	<0.01
Tsunoda ⁴⁵² 2015 ^{d,e}	25	12	55%	-	63%	-	6	<0.0001	22 (FISI)	<0.0001
Tsunoda ⁴⁷⁹ 2015	26	16	-	-	-	-	7	< 0.01	24 (FISI)	<0.01
Consten/van Iersel ⁴⁵⁷ 2015 ^d	242	33.9	61%	<0.0001	73.2%	<0.0001	-	-	-	-
Indication both ERP and IRP and/or rectocele										
van den Esschert ⁴⁶⁶ 2008	1 ERP, 16 IRP	38 ^a	-	-	-	-	+2.7 ^g (ODS)	0.091	-	-
Lauretta ⁴⁴⁴ 2012	2 ERP, 28 IRP	13.9 ^a	92.8%	-	85.7%	-	9.1 (ODS) ^a	<0.05	7.1 ^a	<0.05
Badrek-Amoudi ⁴⁵⁵ 2013	11 ERP, 37 IRP	33	68%	< 0.0001	-	-	17 (ODS) ^h	<0.0001	4	< 0.0001
Maggiori ⁴⁴⁶ 2013	33 ⁱ	42 ^a	72%. <i>De novo</i> 7%	-	90%	-	-	-	8	0.002
Mackenzie ⁴⁴⁵ 2014	149 ERP, 487 IRP	21	56.7% ^j . <i>De novo</i> 1.4%	0.119	89.7% ^k . <i>De novo</i> 1%	0.040	12 (ODS) ⁴⁰	-	8	-

Laparoscopic studies	N	Median FU (mo)	Improvement OD	P value	Improvement FI	P value	Median Gain CCCS	P value	Median gain CCIS	P value
Owais ^{47b} 2014 ^l	18 ERP, 50 IRP	42	82%	-	82%	-	12.5 (ODS)	< 0.001	4	< 0.001
Horisberger ⁴⁴³ 2016	12 ERP, 15 IRP	22	-	-	-	-	3 ^m	0.007	2	0.735
Robotic vs. Laparoscopic studies – various indications										
De Hoog ⁴³⁷ 2009 ^a	20 ERP R	23.4	-	-	-	-	3.2 ^a	-	-	-
Mantoo ⁴⁶⁰ 2013 ⁿ	23 ERP, 51 IRP L 12 ERP, 32 IRP R	16 ^a	-	-	-	-	6 (ODS) ^o 14 (ODS) ^o	0.004 0.004	4 ^p 4 ^p	0.604 0.604

^a Mean instead of median; ^b One patient excluded from further analysis, therefore n=13; ^c complete functional data in 58/65 patients; ^d Results of Formijne Jonkers et al., Gosselink et al., Tsunoda and Consten/van Iersel et al. are displayed per indication; ^e Postop. functional data were fulfilled in 44/59 patients; ^f preoperatively mean CCIS is given, postoperatively the median; ^g Mean ODS score was 2.7 higher after surgery meaning; ^h Pre- and postoperative ODS scores were available for n=36; ⁱ Of the 33 patients (ERP n=20, n=13 IRR) 3 lost to follow-up. For the rest the surgical indication was not given; ^j Based on n=602; ^k Based on n=276; ^l Only men included; ^m Herold obstipation score; ⁿ A modified version of D'Hoore rectopexy used; ^p estimation based on bar chart. OD: obstructed defecation, FI: faecal incontinence, ODS: obstructed defecation syndrome score, L: laparoscopic, R: robot. Based on expert opinion, the committee developed a treatment algorithm (Figure 4) for the management of women undergoing pelvic organ prolapse surgery and an associated array of bowels symptoms that frequently co-exist. The algorithm guides those with a rectocele with and without obstructed defaecation symptoms towards standard prolapse surgery as outlined in Figure 10. Those with faecal incontinence and obstructed defaecation without a rectocele, require colorectal evaluation and if due too internal or rectal prolapse maybe suitable for combined surgery for vaginal and rectal prolapse.

Figure 4. Prolapse surgery pathway and coexistent bowel symptoms

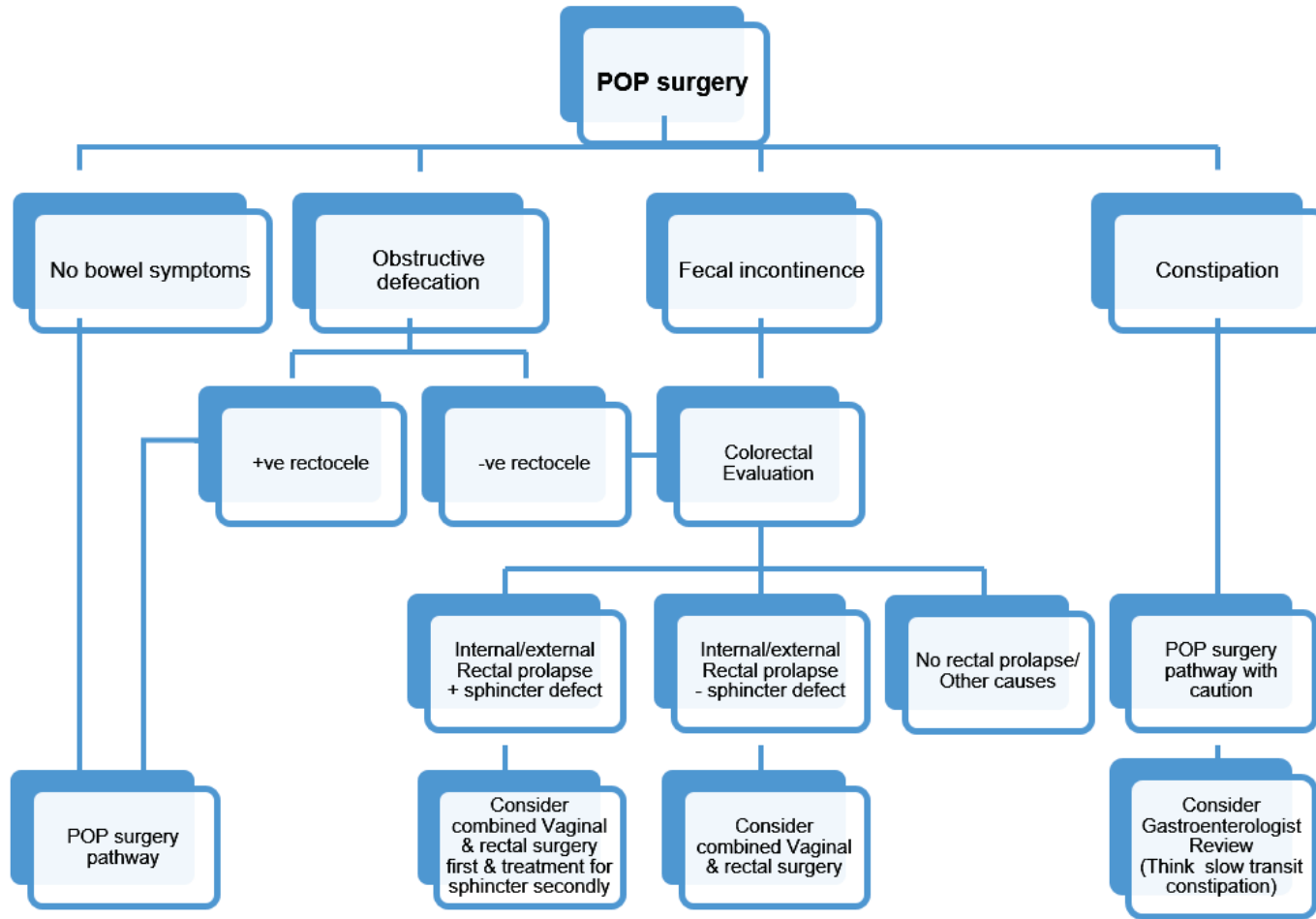

CONCLUSION

- Transvaginal repair of posterior vaginal wall defects includes midline fascial plication with or without levatorplasty or site-specific repair. Level one and two evidence suggest midline plication posterior repair without levatorplasty has superior objective outcomes as compared to site-specific posterior repair. **(GoR B)**
- Higher dyspareunia rate is reported when levatorplasty is performed. **(GoR C)**
- Transvaginal approach is superior to the transanal approach for repair of posterior wall prolapse. **(GoR A)**
- To date no study has shown any benefit to graft or mesh overlay or augmentation of a suture repair for posterior vaginal wall prolapse. **(GoR B)**
- While modified abdominal sacrocolpopexy results have been reported, data on how these results would compare to traditional transvaginal repair of posterior vaginal wall prolapse is lacking.
- The data comparing Delorme's procedure and VMR for external rectal prolapse are conflicting with a single RCT demonstrating no statistical difference, while level 3 data is supportive of VMR performed laparoscopically or robotically, with low rates of recurrent rectal prolapse and improved rates of faecal incontinence and constipation. **(GoR D)**
- VMR appears superior to other abdominal rectopexies (posterior mesh rectopexy, Ripstein, Orr-Loygue) with different rectal mobilisations to treat ERP in terms of functional outcome. **(GoE C)**
- LoE 3 supports ventral rectopexy for Oxford grade 3-4 internal rectal prolapse. The data is not conclusive regarding graft material or route of surgery **(GoR C)**
- No data demonstrates ventral rectopexy with or without graft attachment to the posterior vaginal wall is effective in management of rectocele. **(GoR D)**
- Limited level three evidence suggest that patients with combined rectal and vaginal prolapse benefit from colorectal surgeons and urogynaecologist collaborating closely. **(GoR C)**

VII. PELVIC ORGAN PROLAPSE SURGERY AND BLADDER FUNCTION

Patient-centred outcomes after POP surgery include bladder symptoms. Although many studies on surgery for POP focus on anatomical outcomes, persistent or de novo stress and urgency urinary incontinence as well as voiding symptoms are important issues to be discussed with the patient when counselling for a POP operation.

In women with stage II POP about 55% have concurrent stress urinary incontinence (SUI). This prevalence decreases with increasing POP stages to 33% in women with stage IV POP⁴⁸¹ and demonstrates that preoperatively, many women with advanced POP do not experience SUI. However, if the prolapse is reduced digitally or with the help of a pessary, sponge holder or speculum, SUI might be demonstrated in 10 to 80%.⁴⁸²⁻⁴⁸⁵ This type of SUI is termed occult, masked or latent SUI and is present when stress urinary incontinence is only demonstrable with the prolapse reduced in otherwise continent women. The importance of this finding remains ambiguous: the test itself is not optimal as it does not necessarily mimic prolapse surgery and may obstruct or put undue tension on the urethra.⁴⁸⁶ Although different techniques to reduce the prolapse have been described, a gold-standard has not been established.^{485, 486} Neither the speculum nor the pessary test to reduce the prolapse had acceptable positive predictive values to identify women in need of a concomitant continence procedure. The negative predictive values however were 92.5% (95%CI 90.3–1.00) and 91.1% (95%CI 88.5–99.7), respectively. Therefore, women with preoperatively negative tests for occult SUI are at low risk to develop SUI post-operatively.⁴⁸⁷ Reducing the prolapse may also restore normal voiding function during urodynamics.⁴⁸⁸

Women with occult SUI are at risk of developing SUI after POP repair. The Cochrane review on surgical management of POP found that new SUI symptoms were reported by 187 of 1280 women (15%) after prolapse surgery.⁴⁸⁹ The term de novo stress urinary incontinence is used to describe stress incontinence that develops following surgical correction of the prolapse, amongst women who were continent prior to surgery. De novo SUI might develop because POP surgery has unkinked the previously obstructed urethra.^{490, 491} De novo stress urinary incontinence is clearly disappointing to women and this outcome measure is considered in this review.

On the one hand POP surgery can lead to de novo SUI, on the other hand, preoperative SUI might be treated by prolapse repairs without an additional continence procedure.⁸⁸ Whether women with occult SUI should receive an additional continence procedure when the prolapse is repaired and which prolapse op-

eration would be best suitable to prevent symptomatic post-operative SUI remain debatable issues. The available evidence will be presented in this section of the chapter.

A third of women with Stage II or more POP experience difficulties emptying the bladder.⁴⁸¹ Voiding difficulties might disappear post-operatively because the obstruction caused by the prolapse has been corrected.⁴⁸⁸ In contrast, they might develop because of kinking of the urethra due the surgical technique. Studies assessing voiding dysfunction are summarised.

This section of the chapter assesses the effect of POP surgery on bladder function including stress urinary incontinence, overactive bladder and voiding dysfunction. In order to optimally evaluate pre-and post-operative bladder symptoms, only studies with standardised or validated pre-and post-operative outcome measures, more than 20 operated women and a follow up time of at least 12 months are included. The follow up time of 12 months does not apply to studies assessing voiding dysfunction.

1. CONTINENT WOMEN UNDERGOING POP SURGERY:

What is the risk of de novo SUI and is continence surgery required?

In women without stress incontinence preoperatively, which operation prevents post-operative SUI and will they benefit from an additional continence procedure? For symptomatically and clinically dry women an anterior native tissue repair yields better results than transobturator anterior mesh procedures. The overall cumulative de novo SUI rate after anterior repairs is 8% (44/559): In six RCT's^{152, 295, 492-495} de novo SUI was found in 31/455 (8%) women and in 13/104 (12%) women in two prospective studies.^{487, 496} After anterior armed mesh repairs the overall cumulative de novo SUI rate is significantly higher at 14% (142/1027; $p=0.0035$, chi-square) with a rate of 16% (105/660) in seven RCT arms,^{152, 295, 492, 493, 495, 497, 498} and 13% (65/493) in nine prospective or retrospective trials.^{104, 113, 151, 499-504}

Six RCT's directly compared anterior colporrhaphy (AC) and transobturator mesh procedures (mesh kits or self-fashioned) continent women and at 1 year found AC significantly reduced the risk of de novo SUI (RR 0.59 95%CI 0.39, 0.90; Fig. 5).^{152, 295, 492-495} Although all these trials employed quality of life and symptom questionnaires, different instruments were used and not reported in a way to include them in a meta-analysis.

Figure 5. De novo SUI: Forrest plot of six RCT's comparing anterior repair and transobturator mesh repairs.

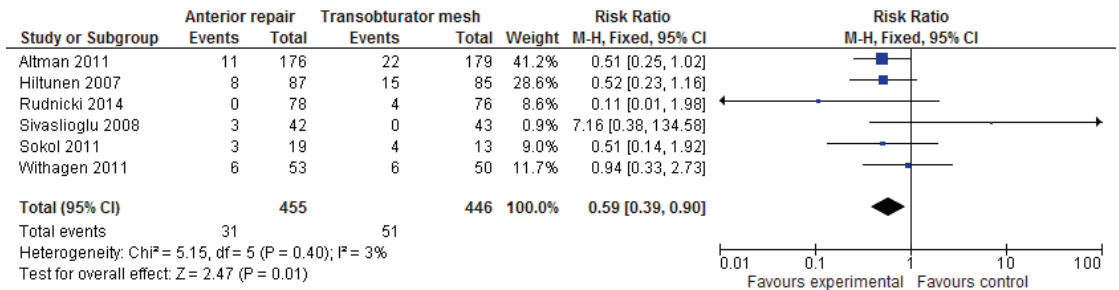

In a longer term follow up of Hiltunen et al's trial⁴⁹³, subsequently more women developed new SUI after anterior repair resulting in similar SUI rates after three years of 17% after both anterior repair (15/86) and transobturator mesh procedure (15/84).¹⁰⁴

Similar rates of de novo SUI occurred if the anterior compartment prolapse was repaired using a polypropylene transobturator mesh in 2/96 (2%) or a porcine dermis graft 1% (1/94).¹⁴³ New SUI was significantly more common after sacrospinous fixation and vaginal repairs compared with abdominal sacral colpopexy (8/24, 33% versus 2/22, 9% in a single RCT)⁷⁸, however, these data need to be reviewed cautiously as in

the sacral colpopexy group continent women preoperatively received paravaginal repairs which may be effective in limiting de novo SUI post-operatively. One trial considered concomitant sacrospinous fixation as a risk factor for de novo OAB, although this might only demonstrate the more severe POP which required more surgery.⁵⁰⁵

In the large multicentre randomised controlled CARE trial (Colpopexy and urinary reduction efforts), preoperatively continent women were randomly allocated to undergo sacral colpopexy with (n=157) or without colposuspension (n=165). Brubaker et al.

demonstrated at two years that Burch colposuspension, performed concomitantly with an abdominal sacrocolpopexy significantly reduced the risk of de novo SUI. Subjective SUI was reported by 38/147 (26%) after additional Burch colposuspension and by 63/155 women (41%) after sacrocolpopexy alone. However, objective testing yielded similar findings in the two groups: 11/116 (9%) and 9/134 women (7%), respectively, demonstrated SUI. The study was terminated prematurely because of the high post-operative SUI rate in women who did not receive concomitant Burch colposuspension and as a result of early termination was underpowered. Unfortunately, irregularities in study design create uncertainty regarding the study findings. Firstly, different and complicated definitions were used to categorise stress incontinence prior to and after the interventions that made it more difficult to be classified as stress continent post intervention than prior to the intervention. Secondly, while surgery was standardised for colposuspension neither the paravaginal repair nor sacral colpopexy was standardised with significant variations in use of

suture type and graft materials.^{53, 326}

After a follow up of 8 years, Costantini et al. in another smaller RCT reported contrary results with 9/31 women (29%) developing SUI after additional Burch colposuspension compared to 5/31 (16%) after sacrocolpopexy alone.^{506, 507}

Fig. 6 summarises these two RCT's in a meta-analysis.^{141, 508} Because of contrary outcomes resulting in significant heterogeneity, a random-effects model was used. According to this model, women do not benefit from Burch colposuspension in addition to abdominal sacral colpopexy. This is true for subjective de novo SUI (RR 0.96 95%CI 0.35, 2.62) and objective rates of de novo SUI (RR 1.56 95% CI 0.82, 2.95). Brubaker and colleagues differentiated between objective and subjective SUI whereas Costantini and colleagues used a composite definition of continence including voiding diary, stress test and reported symptoms.

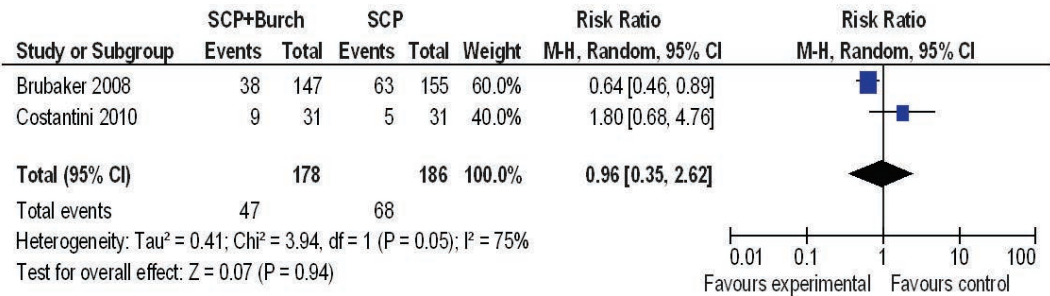

Figure 6. Meta-analysis of two RCT's looking at the effect of Burch colposuspension in addition to sacrocolpopexy. Presented are subjective rates of de novo SUI

In a retrospective study, Leruth et al assessed de novo SUI rates in continent women with a negative cough stress test with the prolapse reduced, who underwent laparoscopic sacral colpopexy.⁵⁰⁹ Of 45 women, 20 developed (44%) SUI.

32/33).⁸⁸

One recent randomised trial compared vaginal POP repairs with and without an additional mid-urethral tape in incontinent women.⁵⁰⁸ As expected, the concurrent continence procedure significantly increased SUI success rate (RR 2.73 95%CI 1.66, 4.49).

2. STRESS URINARY INCONTINENT WOMEN UNDERGOING POP SURGERY:

What kind of prolapse procedure and which continence surgery is required concomitantly in order to reduce post-operative SUI rates?

The cumulative success rate for SUI after anterior colporrhaphy in two randomised trial arms was 48% (19/40).^{88, 510} Colombo et al compared Burch colposuspension and anterior repair for the treatment of women with anterior vaginal wall prolapse and SUI. While women benefited more from Burch colposuspension with regards to SUI (cure of SUI 30/35, 86% versus 17/33, 52%), anterior repair better corrected the anterior prolapse (cure of cystocele 23/35 versus

Prospective studies employing transobturator mesh show a cumulative SUI success rate of 66% (77/117).^{500, 511, 512} Success rates appear considerably better if a mid-urethral tape is performed concomitantly (cumulative rate 299/326, 92%).^{151, 496, 504, 510, 513} Persisting or worsening SUI was described in 9/15 (60%) by Fayad et al¹⁵¹ who prospectively evaluated the role of transobturator polypropylene mesh in the management of recurrent prolapse. One retrospective study demonstrated lower success rates in incontinent women or women with occult SUI at 78% (69/89).⁴⁹⁹

Whether a mid-urethral tape (TVT) is inserted concomitantly or after three months did not result in significantly different success rates based on an "on-treatment" analysis of Borstad et al (83/87, 95% versus 47/53, 89% three months later). Twenty-seven/94

(29%) women were cured of SUI after prolapse surgery alone and did not require continence surgery.⁵¹¹

Costantini et al. 2008 compared abdominal sacrocolpopexy or sacrohysteropexy with and without concomitant Burch colposuspension in women with POP and SUI.⁵¹⁴ Similarly to their randomised trial in continent women, Burch colposuspension increased the post-operative SUI rate: 13/24 (54%) versus 9/23 (39%) were incontinent.⁵¹⁴ One retrospective trial assessed the effect of fascial sling, retropubic or transobturator mid-urethral tapes inserted at the time of abdominal sacral colpopexy⁵¹⁵: The transobturator sling was inferior with an SUI cure rate of 67% in comparison to 84% and 83%, respectively. A mid-urethral sling at the time of robotic sacral colpopexy in incontinent women performed similarly well at 80%. Be consistent sacrocolpopexy or sacral colpopexy

Should women with POP and occult SUI identified preoperatively undergo continence surgery at the time of POP surgery?

Four randomised trials assessed post-operative SUI rates in women who were symptomatically dry preoperatively.^{508, 516-518} After the addition of a retropubic mid-urethral sling to vaginal prolapse repairs (mainly anterior and posterior colporrhaphy) significantly fewer women complained of SUI (50/227, 22% versus 97/240, 40%). The meta-analysis of these four trials calculated that a concomitant TVT significantly improved post-operative SUI success rates (RR 3.04 95%CI 2.12- 4.37 Fig. 6). In three of the trials, all included women had occult SUI^{516, 519, 520}, whereas in Wei et al. study only 34% of the continent women demonstrated occult incontinence.⁵¹⁸

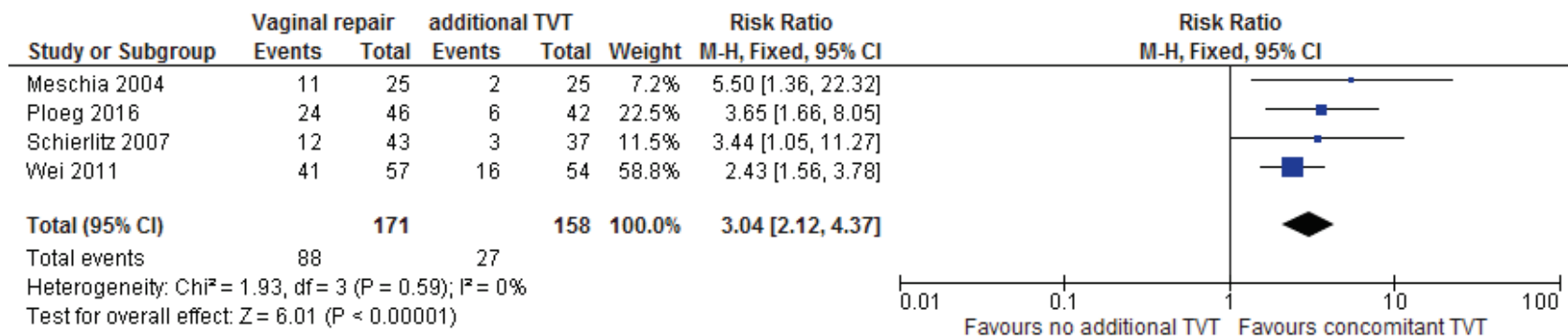

Figure 7. The addition of a mid-urethral sling to vaginal prolapse repairs in women without SUI significantly reduces the risk of post-operative SUI.

The data relating to performing continence surgery at the time of prolapse surgery are summarised in Figure 8 and demonstrate that women with pre-operative SUI and occult SUI benefit from concomitant prolapse and continence surgery. The evidence does not support the addition of routine continence surgery at the time of prolapse surgery in women without SUI or occult SUI.

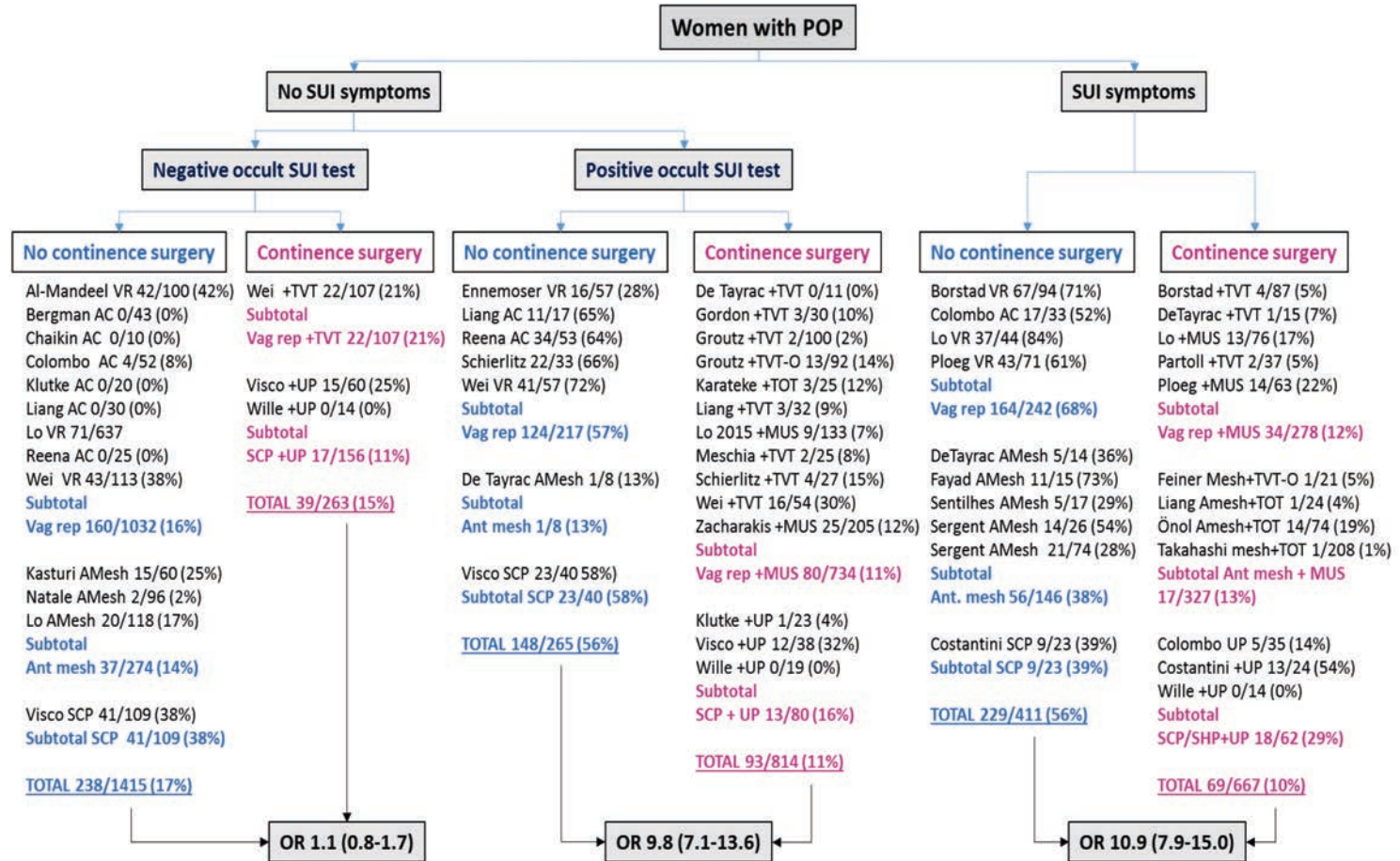

Figure 8. Postoperative SUI rates based on preoperative SUI symptoms, presence of occult SUI and POP surgery with or without an additional continence procedure.

Abbreviations: (AC=anterior colporrhaphy, VR= vaginal repairs, AMesh=anterior mesh, TVT=tension-free vaginal tape, TVT-O=tension-free vaginal tape-transobturator, TOT=transobturator tape, MUS=midurethral sling, UP=urethropexy, SCP=sacral colpopexy)

Based on data from Figure 8, a clinical flow diagram that has been developed to summarise the clinical pathway of women undertaking prolapse surgery based upon

continence symptoms and testing for occult stress incontinence (Figure 9).

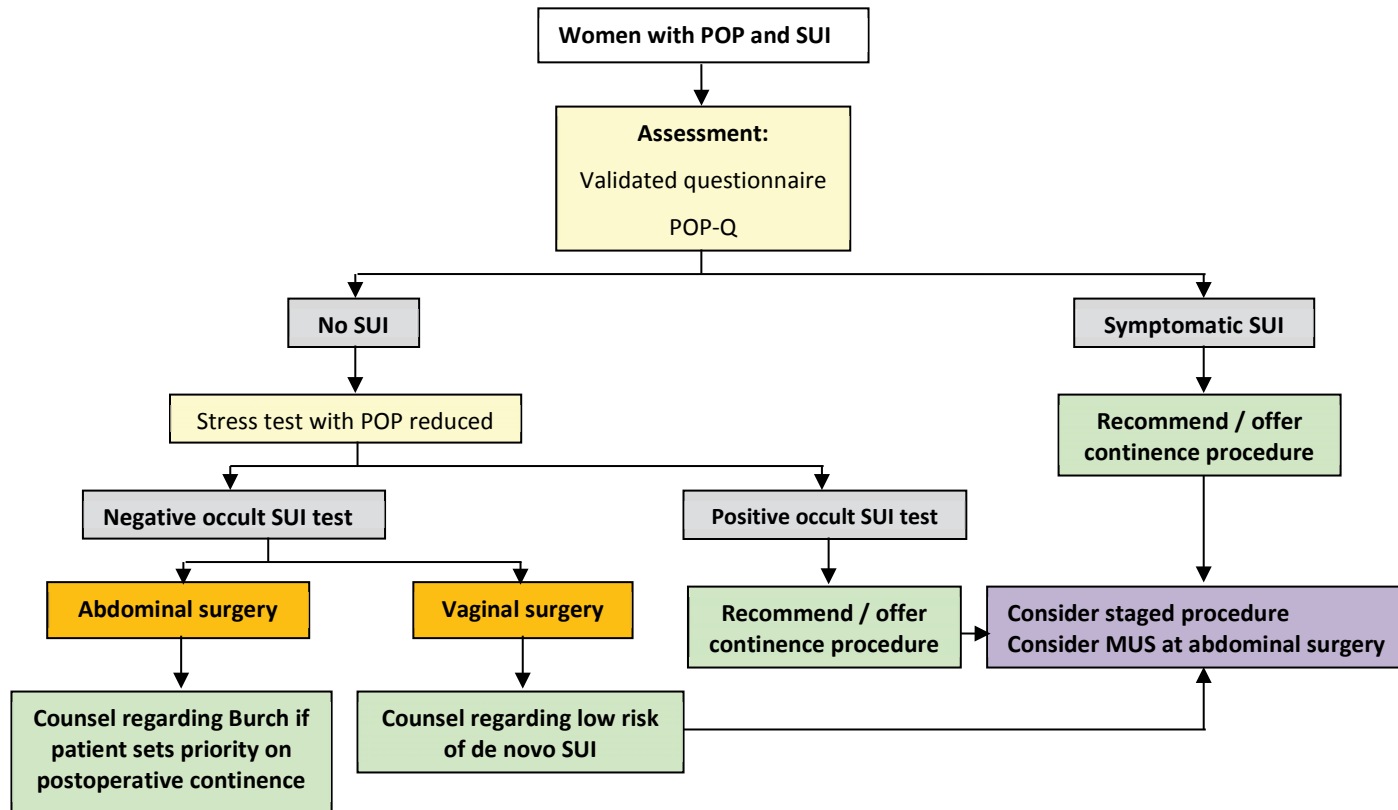

Figure 9. Flow chart of decision making based on incontinence symptoms and testing for occult SUI.

3. OVERACTIVE BLADDER SYMPTOMS

OAB symptoms may be associated with POP.⁴⁸¹ Therefore, prolapse surgery may cure or improve OAB but it may also result in new OAB symptoms. The Cochrane review on the surgical management of POP in 2013^{489, 521} calculated that new overactive bladder symptoms developed in 119 of 1005 (12%) women undergoing prolapse surgery.⁴⁶⁸ Whether women have been treated with anticholinergics e.g. post-operatively is not at all clear and numbers might in fact be higher. The cumulative rate of de novo OAB in women who underwent trans-obturator anterior mesh procedure is 8% (52/646),^{78, 185, 326, 516, 522-526} whereas it is 10% (7/71) in the few studies reporting data after anterior repair with or without mid-urethral tape.^{130, 516} This difference is not statistically significant ($p=0.4$). In one small trial in which all the women undergoing a variety of prolapse surgeries had pre-operative OAB, urgency incontinence resolved in 22/48 (46%) and persisted 26/48 (54%).⁵²²

Interestingly, in one retrospective study following transvaginal mesh (Prolift) and mid-urethral sling, the rate of persisting OAB was high at 78% (20/26) while the de novo rates similar to other studies at 14% (9/63).⁵¹² In contrast, other studies reported improved or cured OAB in 29% to 70% of women receiving anterior mesh repair and a mid-urethral tape.^{113, 505, 510} The reasons for these discrepancies remain open for discussion but may be due to different questionnaires and study designs.

In one RCT, Halaska et al. reported de novo overactive bladder in 7/97 (7%) after anterior Prolift, in 7/34 (21%) after anterior Prolift and sacrospinous fixation, in 8/84 (9%) after total prolapse and in 1/98 (1%) after posterior Prolift only.⁴⁹⁸ In another RCT, after vaginal sacrospinous fixation 6/29 women complained of OAB whereas after sacrocolpopexy 11/33 developed symptoms.⁷⁸ It is however unclear, which women had undergone e.g. additional procedures such as Burch colposuspension for SUI or paravaginal repairs that could contribute the OAB symptoms. Sacrocolpopexy with or without Burch colposuspension resulted in similar rates of de novo OAB (3/34 versus 2/32).⁵⁰⁷ Similarly, after vaginal POP surgery with or without mid-urethral sling OAB rates were not different (3/25 versus 1/25).⁵¹⁶

4. VOIDING PROBLEMS

The Cochrane review in 2013 noted new voiding dysfunction in 109 of 1209 (9%) women in 12 randomised trials with various prolapse surgeries with or without continence procedures.¹⁸⁵ However, voiding problems are rarely defined similarly enough and reported in a way that would allow cumulative and meta-analysis in a comparable follow up period.

After anterior repair, voiding dysfunction ranges from

0% to 37%.^{88, 130, 136, 152, 516, 526}

In their RCT Withagen et al. described significantly different temporary urinary retention rates in 5/97 (5%) compared with 15/93 (16%) after transobturator mesh repair ($p=0.008$).¹⁵² Anterior repair with or without concomitant vaginal POP surgery resulted in post-void residuals exceeding 150 ml in 27/126 (21%) in an RCT comparing transurethral and suprapubic catheterisation.⁵²⁶

After anterior mesh repair, voiding difficulties occur between 5% and 42%.^{51, 152, 321, 499, 527, 528} One study looked at post-operative urinary retention defined as the need to discharge the patient with an indwelling catheter because of a failed trial of void.⁵²⁶ Voiding dysfunction ranged from 34% (10/29) after isolated anterior mesh repair to 42% (30/71) cases after combined anterior and posterior repairs. After isolated posterior repair 8/42 (19%) developed urinary retention. At the 3-months follow up, there were no more voiding complaints.

If there are post-operative voiding problems with residuals exceeding 150 ml, clean intermittent catheterisation is superior to an indwelling catheter for three days regarding bacteriuria, urinary tract infection and length of catheterisation required according to one RCT⁵²⁹ and intermittent transurethral catheterisation is equivalent to a suprapubic catheter regimen.⁵²⁶ Insertion of a suprapubic catheter however resulted in more related complications including loss and blockage of the catheter and haematuria.⁵²⁶ Another RCT⁵³⁰ reported on the duration of post-operative urethral catheterisation between two and four days after anterior repair and found no differences in voiding dysfunction. This was confirmed by an RCT comparing two and five days of indwelling catheter placement. Longer hospital stay and more urinary tract infections were associated with the five days protocol.⁵³¹ Patients do not seem to benefit from post-operative urethral catheterisation beyond two days.^{530, 531}

CONCLUSION

There is significant heterogeneity in all aspects of prolapse surgery trials and the evaluation of bladder function that make interpretation of data challenging.

- Continent women undergoing anterior compartment POP surgery have a lower rate of de novo SUI after anterior repair than armed mesh procedures. **(GoR A)**
- Data are conflicting on whether colposuspension should be performed prophylactically in continent women undergoing sacral colpopexy. **(GoR C)**
- In continent women undergoing POP surgery with occult SUI the addition of continence surgery reduces the rate of post-operative SUI. **(GoR A)**
- In women with POP and SUI prolapse procedures alone (transobturator mesh and anterior

repair) are associated with low success rates for SUI. Concomitant continence procedures reduce the risk of post-operative SUI. **(GoR B)**

- Preoperative bladder overactivity may resolve in 40% undergoing POP surgery and denovo bladder overactivity occurs 12%. **(GoR C)**
- Urinary voiding dysfunction following any prolapse surgery is not uncommon and is usually temporary. Formal trial of void should be undertaken after prolapse surgery. **(GoR C)**
- Level one evidence demonstrates there is no need to leave an indwelling catheter beyond two days. Clean intermittent self-catheterisation is the preferred management of urinary retention as it has similar outcomes to supra-pubic catheters with fewer complications. **(GoR B)**

sexual function that provide a discreet and reproducible method for evaluating sexual health. The Pelvic Organ Prolapse/Incontinence Sexual Questionnaire (PISQ)⁵⁵ and the Female Sexual Function Index(FSFI)⁵⁶ are two questionnaires frequently used.

1. SEXUAL FUNCTION AFTER PROLAPSE SURGERY WITHOUT MESH

Overall, sexual function improves after prolapse surgery without Mesh.⁵³⁵⁻⁵³⁷ In three randomised controlled trials, sexual function was measured after sacrospinous hysteropexy and vaginal hysterectomy. No differences were found between the two groups.^{175, 538} Only the study of Detollenaere¹⁸⁰ used validated questionnaires, the PISQ-12. No differences were found between the two groups at one year follow up.

VIII. PELVIC ORGAN PROLAPSE SURGERY AND SEXUAL FUNCTION

2. SEXUAL FUNCTION AFTER PROLAPSE SURGERY WITH MESH

Sexual health is an essential component of a women's well-being. Female sexual dysfunction is defined as a sexual desire, sexual arousal, orgasm and /or sexual pain disorder which causes personal distress.⁵³² Up to 64% of sexually active women attending Urogynaecology clinic suffer from female sexual dysfunction.⁵³³ The data on sexual function after prolapse surgery are conflicting although in most cases sexual function will improve or remain the same.

Increasing data on sexual function after mesh repair are becoming available. Excellent randomised controlled trials on efficacy of mesh prolapse surgery have been published and while not all have utilised validated questionnaires on sexual function, most include data on dyspareunia. Data reported sexual function from level one studies comparing transvaginal mesh and native tissue repairs in the anterior compartment are summarised in Table 29. No differences in de novo dyspareunia, post-operative dyspareunia or PISQ scores were found.^{102, 104, 105, 492, 495, 539, 540} Most women improved or remained unchanged. In one study by Vollebregt¹⁰⁵, baseline dyspareunia disappeared more often after anterior colporrhaphy than after Mesh implant (80% vs 20%, p=0.018).

Apart from anatomical outcome, clinicians increasingly understand the importance of functional data after POP surgery. To measure sexual function, validated questionnaires on sexual function are necessary. Some validated quality of life and symptom questionnaires are inclusive of sexual function⁵³⁴ or there are dedicated questionnaires specifically for

Table 29: Sexual function data from RCT's comparing transvaginal mesh to native tissue repair in the anterior compartment

RCT	De novo dyspareunia		Post-operative dyspareunia		Post-operative PISQ score	
	Mesh	Native	Mesh	Native	Mesh	Native
Altman 2011 ⁴⁹²			8/110	2/101	33.1 +/- 6.7 35.1 (1.4)	32.2 +/- 7.2 35.0 (1.4)
Vollebregt 2011 ¹⁰⁵	3/20	2/21			FSFI	FSFI
Sivasliogly 2008 ⁴⁹⁵	2/43	0/42				
Ngyuyen 2008 ¹⁰²	2/22	4/26	2/23	2/23	33 +/- 3 34 +/-6	32+/-4 33 +/- 3
Sokol 2011 ⁵⁴¹	1/15	3/16			31	32
Gutman 2013 ⁵⁴²	2/14	1/11	7/14	6/11	34	35
Rudnicki 2014 ⁴⁹⁴	2/79	0/82			11.9 (5.5)	13.1 (5.6)

RCT	De novo dyspareunia		Post-operative dyspareunia		Post-operative PISQ score	
	Mesh	Native	Mesh	Native	Mesh	Native
2016 ¹¹⁴	2/79	0/82				
El-Nazer 2012 ⁵⁴³	0/18	1/17	3/18	4/17		
de Tayrac 2013 ⁵⁴⁴	3/13	1/14	6/22	5/24	5.3 change	6.6 change
Lamblin 2014 ¹¹³	1/33	1/35				
Delroy 2013 ¹⁰⁹			2/40	4/39		
Menefee 2011 ¹⁰⁷	2/28	3/24			No diff	No diff
Nieminen 2010 ¹⁰⁴	4/50	6/46				
Total	21/320 (6.5%)	19/318 (6.0%)	28/227 (12%)	23/215 (11%)	No difference	

For the posterior compartment and/or upper compartment, fewer RCT's were performed comparing native tissue repair to mesh repair. Paraiso et al compared three techniques (posterior colporrhaphy, site-specific repair and use of porcine small intestine sub mucosa).⁴¹² No differences in sexual outcome were found between the groups and PISQ scores improved after surgery in all three groups.

Data from RCT's comparing sexual function after prolapse surgery with mesh or native tissue repair in any compartment are collected in Table 30. No differences were found in the novo dyspareunia or PISQ scores.

Table 30: Sexual function data from RCT's comparing transvaginal mesh to native tissue repair in any compartment

RCT	De novo dyspareunia		Post-operative dyspareunia		Post-operative PISQ score	
	Mesh	Native	Mesh	Native	Mesh	Native
Carey 2009 ⁵³⁹	5/18	5/12	12/30	13/33	Change 6.9	Change 7.8
Milani 2011 ⁵⁴⁵	3/37	3/29	9/53	12/51	35+/- 5.7 34 +/- 6.7	31.5 +/-7.2 34.7 +/-5.7
Dos Reis Brandão da Silveira 2015 ²⁹⁸					QS-F no diff	QS-F no diff
	Total mesh	SSF	Total mesh	SSF	Total mesh	SSF
Halaska 2012 ⁴⁹⁸			6/79	2/72	33.44	36.53
Svabik 2014 ²⁹⁷			2/36	1/34	30.3 (9.52) 32.6 (6.26)	33.1 (6.31) 35.6 (5.07)
Lopes 2010 ⁵⁴⁶						
de Tayrac 2008 ⁵⁴⁷ SSF/PIVS					10.5 +/- 5.9 13.6 +/- 9.3	12.5 +/- 5.1 12.5 +/- 9.3
	SCP	SSF	SCP	SSF	SCP	SSF
Maher 2004 ⁷⁸			2/19	3/17		
Benson 1996 ⁷⁷						
Meschia 2004 ⁵¹⁶						
Rondini 2015 ⁵⁴⁸ (uterosacral suspension)					25 29.7	28 33.4

There is some evidence that light meshes, partly absorbable meshed or non-anchored meshes have less negative side effects on sexual function, however comparative studies or RCT's on this subject have not been performed.⁵⁴⁹⁻⁵⁵¹

In a recent Cochrane analyses¹¹⁶, mesh versus native tissue repair was compared for various outcome measurements, including dyspareunia. When any transvaginal permanent mesh versus native tissue repair was compared, data on dyspareunia showed de novo dyspareunia in 95 per 1000 women in the native tissue group compared to 88 per 1000 (55 to 140) in the mesh group. (RR 0.92 95% CI 0.58 to 1.47; 764 women, 11studies). In the subgroup analyses, anterior repair or multi-compartment repair, also no evidence of a significant difference was found.

Also, analyses on biological mesh and absorbable mesh were performed in this review but no data were available on dyspareunia in the absorbable mesh group. When biological mesh and native tissue repair were compared, de novo dyspareunia was 177 per 1000 of women for native tissue repair, 150 per 1000 (35 to 648) for biological mesh (RR0.85 95% CI 0.20 to 3.67, 1 study).¹¹⁶

Natale et al showed that the use of Porcine dermis graft (Pelvicol), compared to polypropylene mesh (Gynemesh) in the anterior compartment, was associated with an improvement in the PISQ scores.¹⁴³ Possibly, porcine dermis allows more flexibility to the anterior wall resulting in less pain, however this requires further evaluation. In four RCT's comparing anterior colporrhaphy to porcine skin graft or porcine small intestine submucosa mesh, no differences were found in dyspareunia and improvement on PISQ-12 scores.^{136, 144, 552, 553}

CONCLUSION

- With regard to the anterior compartment, the use of Mesh is neither associated with a worsening in sexual function nor with an increase of de novo dyspareunia compared to traditional anterior colporrhaphy. **(GoR B)**
- There is insufficient information to provide evidence based recommendation on sexual function after vaginal Mesh in the posterior compartment. **(GoR D)**
- There is insufficient information to provide evidence based recommendation on sexual function after new light or partially absorbable vaginal Meshes. **(GoR D)**
- It is essential to use validated questionnaires measuring sexual function in women before and after prolapse surgery. We also recommend reporting sexual activity and dyspareunia rates pre-and post-intervention in all patients.

IX. COMPLICATIONS AND METHODS OF PREVENTION

While pelvic reconstructive surgery for genital prolapse, with or without mesh, results in improved prolapse related symptoms and quality of life in most cases¹¹⁶ (Level 1) complications are inevitable.

In 2011, the IUGA (International Urogynecological Association) and the ICS (International Continence Society) published a specific classification of complications related to pelvic reconstructive surgery using prostheses.⁶³ That classification has been developed to encompass to all possible physical complications involving the use of a prosthesis or graft in a female pelvic floor surgical procedure. Both insertion complications (e.g. trocar related) and healing abnormalities are covered. Whilst this creates a large number of possible complication scenarios, appropriate organisation has still been possible by category (C), time (T) and site (S). A key advantage of a standardised classification is that all parties involved in female pelvic floor surgery will be referring to the same clinical issue. It has been shown in several studies that this classification can significantly add to clarity in reporting mesh related complications^{121, 554, 555}, even if training is necessary to optimise inter-observer reliability⁵⁵⁶, which has been criticised by others.⁵⁵⁷⁻⁵⁵⁹

Other classifications, such as Clavien-Dindo classification, have also been used.⁵⁶⁰ On a retrospective study of 438 patients who underwent anterior and posterior colporrhaphy, together with sacrospinous fixation for Level I defects in 269 patients and hysterectomy in 255 cases, authors have reported minor complications (Grade I) in 2.5%, Grade II complications in 13.2% and complications requiring surgical intervention as Grade IIIa in 0.9% and as Grade IIIb in 0.9% of patients. No Grade IV or V complications occurred.

Using the same complication classification after transvaginal mesh repair for prolapse Barski et al⁵⁶¹ performed a systematic review and reported much higher rates of complications than reported above for native tissue POP repairs. Eleven randomised controlled and nine prospective studies from 2008 to 2013 with 2,289 patients (most POP-Q ≥ II, median follow-up 12 months) were included. The total complication rate was 27% in anterior, 20% in posterior, and 40% in combined mesh repair group. Complications of at least Clavien-Dindo grade 3 (requiring surgical, endoscopic or radiological intervention) occurred in 8% anterior, 3.5% posterior, and 13% of combined mesh repairs. No differences were found for reoperation rates for POP in mesh repairs as compared to non-mesh repairs (two versus 3%).

1. REOPERATION AFTER VAGINAL SURGERY

Table 31 shows the reoperation rates after vaginal polypropylene mesh surgery versus native tissue repair for specific (linked to the mesh) complications from randomised controlled trials. The mean rate of reoperation for mesh-related complications was 6.6%, mainly for vaginal mesh exposure. The rate of reoperation for prolapse was similar in both the trans-vaginal mesh group and native tissue repair, 23/871 (2.6%) vs 33/861 (3.8%) ($p=0.16$) (Level 1), but follow-up was less than 36 months in the majority of trials.^{102, 104, 105, 111, 113, 114, 152, 299, 492, 495, 542, 544, 562, 563}

In a retrospective study of 524 Prolift mesh, with a median follow-up of 38 months (range, 15-63), global reoperation rate was 11.6%, including surgery for urinary incontinence (6.9%), mesh-related complications (3.6%), and prolapse recurrence (3%) (Level 4).⁵⁶⁴

To estimate the risk of repeat surgery for recurrent prolapse or mesh removal after vaginal mesh versus native tissue repair for anterior vaginal wall prolapse, Jonsson Funk et al. had utilised longitudinal, healthcare claims from 2005 to 2010 to identify women ≥ 18 years who underwent an anterior colporrhaphy with or without concurrent vaginal mesh. They identified 27,809 anterior prolapse surgeries with 49,658 person-years of follow-up. Of those, 6,871 (24.7%) included vaginal mesh. The 5-year cumulative risk of any repeat surgery was significantly higher for vaginal mesh versus native tissue (15.2 % vs 9.8 %, $p<0.0001$) with a 5-year risk of mesh revision/removal of 5.9%. The 5-year risk of surgery for recurrent prolapse was similar between vaginal mesh and native tissue groups (10.4 % vs 9.3 %, $p=0.70$) (Level 3). The use of mesh for anterior prolapse was associated with an increased risk of any repeat surgery, which was driven by surgery for mesh removal.⁵⁶⁵

In a study based on prospectively collected data from the Swedish National Register for Gynaecological Surgery, including 6247 anterior colporrhaphy and 356 non-absorbable mesh, reoperation rate within 12 months was higher in the mesh group, OR = 6.87 (CI 3.68-12.80) (Level 3).⁵⁶⁰

Table 31. Prevalence of reoperation after vaginal polypropylene mesh surgery vs native tissue repair (RCT with anterior mesh)

Author	Year	Number of mesh procedure and NTR (n/n)	Mesh / Surgical Technique	f.u. (months)	Vaginal exposure n (%)	Reoperation for vaginal exposure n (%)	Reoperation for mesh-related Complication (incl exposure) n (%)	Reoperation for POP recurrence No mesh vs Mesh n (%) / n (%)
Rudnicki 114	2016	70/68	Avaulta Plus® Collagen-coated PP / 4 arms TO	36	10 (14.7)	5 (7.4)	5 (7.4)	7 (10.3) / 0 (0)
Dos Reis Brandão da Silveira 298	2015	94/90	Prolift® / 4 arms TO	12	18 (20.5)	3 (3.4)	5 (5.6)	3 (3.7) / 2 (2.2)
Dias 562	2015	43/43	Nazca TC® / 2 arms TO + 2 prepubic arms	24	5 (13.5)	2 (4.7)	3 (8.1)	10 (30.3) / 3 (8.1)
Tamanini 111	2015	42/50	Nazca TC® / 2 arms TO + 2 prepubic arms	24	7 (16.4)	7 (16.4)	7 (16.4)	0 (0) / 0 (0)
Lamblin 113	2014	31/32	Perigee® / 4 arms TO	24	2 (6)	1 (3)	1 (3)	0 (0) / 0 (0)
Gutman 542	2013	25/26	Prolift® / 4 arms TO	36	5 (15.6)	3 (9.4)	3 (9.4)	0 (0) / 3 (11.5)
de Tayrac 544	2013	75/72	Ugytex® Collagen-coated PP / 4 arms TO	12	7 (9.5)	4 (5.3)	5 (7.6)	3 (4.5) / 2 (3)
Vollebregt 105	2011	61/64	Avaulta® / 4 arms TO	12	2 (4)	1 (2)	1 (2)	4 (7) / 3 (6)
Altman 492	2011	200/189	Prolift® / 4 arms TO	12	21 (11.5)	6 (3.2)	6 (3.2)	1 (0.5) / 0 (0)
Withagen 152	2011	93/97	Prolift® / 4 arms TO	12	14 (16.9)	5 (5)	5 (5)	4 (4.1) / 0 (0)
Iglesia 299	2010	32/33	Prolift® / 4 arms TO	10	5 (15.6)	3 (9)	3 (9)	0 (0) / 4 (6.5)

Author	Year	Number of mesh procedure and NTR (n/n)	Mesh / Surgical Technique	f.u. (months)	Vaginal exposure n (%)	Reoperation for vaginal exposure n (%)	Reoperation for mesh-related Complication (incl exposure) n (%)	Reoperation for POP recurrence No mesh vs Mesh n (%) / n (%)
Nieminen 104	2010	105/97	4 arms non TO	36	20 (19)	14 (13)	14 (13)	1 (1%) / 6 (5.8)
Nguyen 102	2008	37/38	4 arms TO	12	2 (5)	2 (5)	2 (5)	MD
Sivaslioglu 495	2008	45/45	4 arms TO	12	3 (6.9)	3 (6.9)	3 (6.9)	MD
Total	-	-	-	-	121/953 (12.7%)	59 (6.2%)	63 (6.6%)	33/861 vs 23/871 (p=0.16)

Abbreviations: NTR: native tissue repair, MD: missing data, PP: monofilament polypropylene

In the only randomised trial that had compared vaginal mesh surgery to laparoscopic sacrocolpopexy with a mean follow-up of 2-year Maher et al has also shown an increased rate of reoperation after vaginal mesh surgery (22% versus 5%, $p=0.006$)³²¹ (Level 2).

In the last Cochrane review¹¹⁶, 37 RCTs were selected (4023 women). The quality of the evidence ranged from very low to moderate. Awareness of prolapse at one to three years was less likely after mesh repair (relative risk (RR) 0.66, 95% confidence interval (CI) 0.54 to 0.81, 12 RCTs, $n = 1614$). Rates of repeat surgery for prolapse were lower in the mesh group (RR 0.53, 95% CI 0.31 to 0.88, 12 RCTs, $n = 1675$). More women in the mesh group required repeat surgery for the combined outcome of prolapse, stress incontinence, or mesh exposure (RR 2.40, 95% CI 1.51 to 3.81, 7 RCTs, $n = 867$). This suggests that if 5% of women require repeat surgery after native tissue repair, between 7% and 18% in the permanent mesh group will do so. Eight per cent of women in the mesh group required repeat surgery for mesh exposure. Permanent mesh was associated with a higher rate of bladder injury (RR 3.92, 95% CI 1.62 to 9.50, 11 RCTs, $n = 1514$). The risk-benefit profile means that transvaginal mesh has limited utility in primary surgery. While it is possible that in women with higher risk of recurrence the benefits may outweigh the risks, there is currently no evidence to support this position. The newer, lightweight transvaginal permanent meshes still available have not been evaluated within a RCT.

2. REOPERATION AFTER ABDOMINAL SURGERY

Recurrence rates following laparoscopic sacral colpopexy or hysteropexy range from 4 to 18% at 12-14 months of follow-up (Level 2). Mean rates of reoperation for prolapse recurrence and for de novo stress urinary incontinence after open abdominal sacral colpopexy are 2% and 5%, respectively (Level 3),^{35, 136, 194, 323, 566-568} Only preoperative stage 3 or 4 seems to be a significant risk factor for POP recurrence after surgery (Level 3).⁵⁶⁹ Although higher body mass index (BMI) is a risk factor for primary POP, it was not a significant risk factor for POP recurrence.

Table 20 demonstrates that the total reoperation rate for laparoscopic sacral colpopexy is 5.6%, with 3.4% representing complications and 2.0% representing reoperations for prolapse.^{219, 321, 350, 351, 353-356, 362, 363, 380, 566, 570-583} The rate of reoperation for recurrences after laparoscopic sacrocolpopexy is significantly higher with the use of porcine dermis grafts in comparison to polypropylene mesh.⁵⁸⁴ (Level 3)

Tijdink et al⁵⁸⁵ reported on the surgical management of 60 mesh complications following mesh prolapse surgery. Twelve followed sacral colpopexy and 48 vaginal mesh surgeries. Most women reported more

than one complication however the principle presentation requiring surgical intervention was pain in 77% (vaginal pain, dyspareunia or other chronic pain buttock, abdomen or thighs). They detected a distinct difference in symptoms related to mesh complications following transvaginal mesh and ASC. Vaginal pain and dyspareunia were the most commonly reported symptoms necessitating surgical intervention following transvaginal mesh and vaginal discharge and bleeding following ASC. Previous mesh excision procedures had been performed in 29% and complete mesh excision was required in 37% of cases. Perioperative complications occurred more frequently in those requiring complete excision of mesh. Furthermore, perioperative complications were more common in those who had undergone ASC as compared to vaginal mesh surgery (23% versus 1% $p=0.001$). Finally, recurrence of prolapse was significantly more likely if complete excision of the mesh was required and occurred in 29% as compared to 5% after partial excision of mesh. Resolution of preoperative symptoms was reported in 92% who underwent surgical management of mesh complications.

3. VAGINAL MESH EXPOSURE

Prevalence of vaginal mesh exposure after vaginal mesh surgery

It is difficult to know the exact rate of vaginal mesh exposure, as the definition of exposure is variable between studies and meshes used are different. Table 32 shows the rate of exposures after vaginal polypropylene mesh surgery in the 14 currently available randomised controlled trials, mainly with different kinds of four-arm trans-obturator meshes. In these trials, the mean rate of exposure was 12.7%, and the mean rate of reoperation for vaginal mesh exposure was 6.2% (Level 1).

According to the available literature, polypropylene collagen-coated mesh does not seem to give only advantage in comparison to classic non-absorbable mesh regarding the vaginal mesh exposure rate (Level 1)^{114, 118, 585, 586}. Furthermore, vaginal mesh exposure has also been reported as high as 6.9% with the use of biological implant⁵⁸⁷, even if others have found low rates using biological implants, between 0 to 1.4%.^{588, 589}

Contrarily, although there is no available RCT, ultra-light weight meshes (<30gr/m²) used with trans-obturator arms are associated with a low rate of mesh exposure (1.3%) at medium-term review (Level 4).¹¹⁸

Furthermore, several case series have reported a low rate of vaginal mesh exposure after anterior-apical single incision techniques, from 0 to 3.4% (Level 4)^{117, 118, 305, 307, 590, 591}, which was significantly lower in comparison to trans-obturator meshes⁵⁹², although there is no available RCT showing that these rates are due to the technique, rather than to the surgeons experience or the light-weight mesh.

Although there is a lack of evidence supporting the use of posterior mesh vaginally for rectocele or enterocele repair¹¹⁶, a few studies have reported a low vaginal mesh exposure rate in the posterior compartment, between 2 to 3.8%.^{593, 594}

More interestingly, few studies have reported vaginal mesh exposure rate in the long-term. In the study by Letouzey et al, who used the Gynemesh® on 63 patients with a mean follow-up of 6.5 years, the vaginal mesh exposure rate was 16% (10/63), all of which underwent surgical correction.⁵⁹⁵ In the study by Heionen et al, who used the Prolift® mesh on 140 patients with a mean follow-up of 7 years, the vaginal mesh exposure rate was 23% (32/140), even though most of these were small (less than 1cm in 25/36) and asymptomatic (24/32)⁵⁹⁶. In comparison Meyer et al, who used the Prolift® mesh as well, on 48/208 patients with a mean follow-up of 7 years (range 5.8 to 8.1), the vaginal mesh exposure rate was 6% (3/48).²²³

Prevalence of vaginal mesh exposure after abdominal surgery

Vaginal mesh exposure rate following laparoscopic sacral colpopexy or hysteropexy is 3% (mean, range 1-7%) (Table 20) (Level 2).^{219, 321, 350, 351, 353-356, 362, 363, 380, 566, 570-583, 365, 597, 598} Vaginal mesh exposure rates were comparable regardless the surgical approach (open, laparoscopic, robot-assisted) (Level 2).⁵⁹⁹ The risk of vaginal mesh exposure is significantly increased if hysterectomy is performed concomitantly (8.6%), in comparison to sacral colpopexy for post-hysterectomy prolapse (2.2 %) ($p<0.05$)⁶⁰⁰ (Level 2).

Risk factors of vaginal mesh exposure

Maher et al, have shown a non-significant increased rates of vaginal mesh exposure and reoperation for vaginal mesh exposure after vaginal mesh surgery in comparison to laparoscopic sacrocolpopexy (13% vs 2%, $p=0.07$ and 9% vs 2%, $p=0.11$, respectively)³²¹ (Level 2). However, that was not the primary endpoint of the study, and that study was underpowered for this parameter.

Younger age, higher parity, premenopausal status, diabetes mellitus, smoking, concomitant hysterectomy and surgery performed by a junior surgeon are significant risk factors for vaginal mesh exposure after female pelvic floor reconstructive surgery (Level 3).⁶⁰¹

Concerning vaginal mesh surgery, obesity (BMI>30 kg/m², OR=10.1) has been shown by some authors to be an independent risk factor for vaginal mesh exposure.⁶⁰² However, others have reported no difference in the rate of mesh exposure related to BMI, in a study on 200 patients with advanced pelvic organ prolapse treated by vaginal sacrospinous ligament fixation with anterior mesh repair as primary surgery with an exposure rate of 4.1% at a mean follow-up of 36 months.⁶⁰³ Furthermore, a recent paper on 201 patients with a mean mesh exposure rate of 8.5% at a

mean follow-up of 14 months has reported that the BMI may negatively correlate with exposure rates (12.9% for BMI less than 25 kg/m, 9.5% for BMI of 25 to 29.9 kg/m, 3.1% for BMI of 30 to 34.9 kg/m, and 0% for BMI greater than or equal to 35 kg/m).⁶⁰⁴

Smoking has also been shown to be an independent risk factor for mesh exposure after vaginal mesh surgery [OR=3.1 to 3.7].⁶⁰⁵⁻⁶⁰⁸ With regard to sacrocolpopexy, smoking [OR=5.2; 95%CI 1.7-16] is also an independent risk factor for vaginal mesh exposure.²⁰⁹

Current data on the impact of ageing on mesh complications are conflicting and no conclusion can be drawn.^{209, 551, 602, 609-611} In a recent study of 217 patients who underwent vaginal sacrospinous ligament fixation with anterior mesh repair for primary prolapse surgery, outcome measures were observed in cohorts of two age groups (<75 years and ≥75 years), with a mean follow-up of 34 and 36 months respectively. Although older women had significantly more preoperative comorbidities, perioperative complications showed no difference between the two groups.²²⁰ On the other hand, in a case-control study comparing mesh exposure requiring surgical revision (n=48) and controls who had no mesh exposures (n=48), the adjusted odds ratio of being one year older was 0.96 (95% CI 0.92-1.0) among women with mesh exposure.⁶⁰⁷ Overall, it has been shown that although the absolute risk of death is low, elderly women have a higher risk of mortality and morbidity following urogynaecology surgery.⁶¹² Among 264,340 women, increasing age was associated with a higher mortality risk per 1000 women (<60 years, 0.1; 60-69 years, 0.5 [OR 3.4; 95% CI 1.7-6.9]; 70-79 years, 0.9 [OR 4.9; 95% CI 2.2-10.9]; >80 years, 2.8 [OR 13.6; 95% CI 5.9-31.4]; $P<.01$) and a higher risk of complications per 1000 women (<60 years, 140; 60-69 years, 130; 70-79 years, 160; >80 years, 200 [OR 1.4; 95% CI 1.3-1.5]; $P<.01$). Furthermore, elderly women 80 years and over who underwent obliterative procedures had a lower risk of complications compared with those who underwent reconstructive procedures (17 vs 24.7%, $P<.01$).⁶¹²

Sexual activity has been reported to be a risk factor for vaginal mesh exposure after vaginal mesh surgery^{595, 610} (Level 3). However, this could simply reflect that those who are sexually active are more likely to identify a mesh exposure than those who are not.

A bleeding complication at the time of mesh implantation (excessive bleeding >500, post-operative haematoma requiring drainage or embolisation) has also been shown to be an independent risk factor for mesh exposure requiring reoperation after vaginal mesh surgery [OR=7.25, 95% CI 1.47-35.66].⁶⁰⁷

Parity greater than two has also been shown to be an independent risk factor for mesh exposure after vaginal mesh surgery [OR=2.64, 95% CI 1.07-6.51].⁶⁰⁶

No study has shown that the following are significantly associated with mesh exposure: diabetes

mellitus, corticosteroid use, immunosuppressive therapy, previous pelvic irradiation, history of previous mesh exposure, vaginal atrophy. However, many studies have shown that in other surgical specialties poorly controlled diabetes mellitus is a risk factor for post-operative infection. One study has reported that somatic inflammatory disease (mainly rheumatoid arthritis) is independent risk factor for mesh exposure after vaginal mesh surgery [25% (3/12) vs 7.6% (20/264), OR 5.11, 95% CI 1.17-22.23].⁶⁰⁶ Somatic inflammatory disease (rheumatoid arthritis, Sjögren's disease, lupus erythematosus) may by themselves influence wound healing but treatment is often accompanied by immunosuppressant medications which may prolong wound healing.

Treatment of vaginal mesh exposure after vaginal mesh surgery

Vaginal mesh exposure, both after vaginal mesh surgery or sacrocolpopexy is usually associated with vaginal discharge, and sometimes pain, dyspareunia, vaginal infection, and rarely abscess or cellulitis^{506, 613} (Level 3). The choice of treatment has to take into account the type of mesh implanted (need to obtain previous surgical records), clinical symptoms, location and size of exposure. All cases with abscess or cellulitis need an immediate reoperation to remove the maximum (if possible all) of the foreign material.

In cases of mesh exposure after vaginal mesh surgery, if there is no abscess or cellulitis, medical treatment is usually undertaken using local oestrogens and/or local antiseptic. However, medical treatment efficacy is low at 23.5% (Table 32) (Level 3.)^{190, 513, 608, 613-617}

Table 32. Efficacy of medical treatment for vaginal mesh exposure after vaginal mesh surgery.

Author, Year	Mesh	Efficacy of medical treatment
Cervigni Natale, 2011 ⁶¹⁵	PP coated collagen (AVAULTA)	3/21
Withagen, 2011 ¹⁵²	PP (PROLIFT)	3/14
Long, 2011 ⁶¹⁸	PP	3/14
Moore, 2010 ⁶¹⁶	PP (PERIGEE)	1/12
Feiner, 2010 ⁴⁹⁹	PP (PROLIFT)	6/10
Collinet, 2006 ¹⁹⁰	PP	9/34
Deffieux, 2006 ⁶¹³	PP (GYNEMESH ou GYNEMESH Soft)	7/34
Achtari, 2005 ⁶¹⁴	PP	4/14
Total		36/153 (23.5%)

Abbreviation: PP: polypropylene

After failure of medical treatment, a reoperation under local or general anaesthesia is generally performed, in order to remove the exposed portion of the mesh and to close the vaginal epithelium. Although technically difficult in some cases, mesh excision was safe with resolution of almost all presenting symptoms.^{120, 619} Conversely, for others, recurrence was reported in

up to 29% of patients with no change or worsening symptoms (recurrent discharge, persistent pelvic pain).⁶²⁰ Furthermore, up to 62% of treated patients could require multiple surgical procedures.^{621, 622} Efficacy of surgical excision for vaginal mesh exposure after vaginal mesh surgery is summarised Table 33.

Table 33. Efficacy of surgical excision for vaginal mesh exposure after vaginal mesh surgery.

Author, Year	Mesh	Efficacy of surgical treatment
Crosby, 2014 ⁶²³	Different mesh kits	53/56
Hansen, ⁶²⁰	Different mesh kits	2/3
Wong, 2013 ⁶²²	Different mesh kits	18/20
Firoozi, 2012 ¹²⁰	Different mesh kits (Prolift, Apogee/Perigee, Avaulta)	20/23
Total		93/102 (91.2%)

Abbreviation: PP: polypropylene, TVM: trans-vaginal mesh

A model to compare medical treatment and surgical excision has favoured surgical excision over conservative treatment in the initial management of mesh exposure following vaginal prolapse repair with synthetic mesh. However, in this model, the difference in Quality Adjusted Life Year (QALYs) between strategies was less than the Minimally Important Difference (MID). Therefore, the strategies are likely similar overall. Individual patient characteristics may ultimately drive clinical decision-making for this surgical complication.^{624, 625}

Furthermore, spontaneous evolution of asymptomatic (no vaginal discharge, no sexual problems) and small ($\leq 1\text{cm}^2$) mesh exposure in the long-term could be without specific complications, allowing expectant management (Level 4).⁶²⁶

In a study cohort consisting of 847 patients, Wong et al have reported 53 (6.2%) vaginal exposures after both vaginal (34/393, 8.7%) and abdominal surgery (19/454, 4%). Concerning treatment, permanent mesh exposures resolved most often after surgical excision (18/20, 90%) compared with office excision (6/14, 43%), vaginal estrogen (6/33, 18%), or expectant management (1/3, 33%) ($P < .001$) (Level 3).⁶²²

Treatment of vaginal mesh exposure after abdominal surgery

In cases of vaginal mesh exposure after sacrocolpopexy, most authors report reoperation by the vaginal approach as first line^{214, 219, 566}, because of the risk of spondylodiscitis and of the very low success rate of medical treatment ($< 15\%$).^{209, 219, 580, 627} When recurrence occurs after vaginal mesh excision, or in case of associated pelvic infection, total mesh removal by laparoscopy or laparotomy has been described^{628, 629} (Level 4).

4. VISCERAL (BLADDER, RECTUM) MESH EXPOSURE

There was no visceral mesh exposure reported in the randomised controlled trials after vaginal mesh surgeries, but follow-up was short. Late bladder or ureteric and rectal exposure have been reported after vaginal surgery (Level 4).^{596, 630, 631}

Visceral (bladder, rectum) mesh exposure have been reported rarely ($< 0.1\%$) following sacral colpopexy or hysteropexy (OS, LS, RALS) (Level 4).^{597, 598}

5. INFECTIOUS COMPLICATION

There is no clear definition of bacterial colonisation around a mesh or mesh infection. Consequently, the rate of infection is currently unknown.⁵⁹⁷ Some studies have reported up to 80% bacterial mesh colonisation.^{632, 633} However, the rate of relevant clinical infection (abscess, cellulitis, spondylodiscitis) does not seem to be more than 1%, after both sacrocolpopexy

(Level 4)⁶³⁴⁻⁶³⁷, or vaginal mesh surgery (Level 4).^{276, 638, 639}

In a cohort of 684 polypropylene mesh implanted vaginally (TVM procedure), the rates of pelvic abscess and cellulitis have been reported to occur in only 0.29% and 0.15%, respectively⁶⁴⁰ (Level 4).

One case of Actinomyces infection appearing five years after trocar-guided transvaginal mesh prolapse repair was recently reported.⁶⁴¹

Severe pelvic infection has also been described after native tissue repair, including total colpoceleisis.⁶⁴²

Spondylitis had been reported rarely following laparoscopic sacral colpopexy or hysteropexy. The prevalence of this complication ranges from 0.1 to 0.2% (see Table 3). Cases of spondylodiscitis have been reported following laparoscopic sacral colpopexy with tacks, but also with sutures and it is impossible to determine with certainty whether it is the mesh material itself, the sacral colpopexy system, the vaginal fixation system or the exposure which was the cause of, or promoted, the spondylitis (probably multifactorial in origin). Recent series have hypothesised that spondylitis following sacral colpopexy may sometimes be a graft rejection phenomenon (culture negative).⁶²⁸

Pelvic abscess has also been reported rarely following sacral colpo/hysteropexy.

6. PELVIC PAIN

Pelvic pain after vaginal surgery (with/without mesh, including mesh contraction)

The aetiology of chronic pelvic pain after vaginal mesh placement is variable, and the most significant causes include pelvic floor muscle spasm, pudendal neuralgia, and infection.⁶⁴³ Obturator muscles laceration with consequent oedema provoked by the mesh arm could also explain pain. In such cases, Magnetic Resonance Imaging (MRI) will look for obturator muscle hyper-intensity consistent with muscular oedema and pain could be helped by oral corticosteroids.⁶⁴⁴ The rate of polypropylene mesh-related pain reported ranges between 4 and 11% according to the definition used (Level 3)^{102, 104, 152, 299, 495, 513, 616, 640}. In the 2011 American FDA report regarding transvaginal mesh, vaginal pain and dyspareunia were the most common adverse events reported and vaginal pain and dyspareunia were also the most common indications for reoperation following transvaginal mesh in the report by Tijdink et al.⁵⁸⁵ These reports contrast with the common perception in the literature that mesh exposure is the commonest complication associated with transvaginal meshes and requires ongoing evaluation.

Mesh contraction is also a possible aetiology. Feiner et al defined mesh contraction as an adverse outcome following armed polypropylene mesh repair in which patients experience vaginal pain with move-

ment and dyspareunia and on examination have localised areas of prominent, tense and tender mesh under the vaginal epithelium.⁶⁴⁵ Mesh contraction assessed on ultrasound examination after anterior vaginal mesh repair may correlate with de novo OAB symptoms and vaginal pain. Of 103 patients who underwent Prolift anterior™ implantation, after 6 months' follow-up, mesh contraction occurred in 19.4% of patients presenting with de novo OAB symptoms, and 22.3% of patients reporting post-operative vaginal pain (Level 4).⁵⁹²

Pain before surgery has been shown to be a predictive factor for pain after surgery, with an OR of 3.2 (95% CI 1.2-8.4), in a prospective observational cohort study on 284 patients with a post-operative pain rate of 13% (35/275) (Level 3).⁶⁰⁸

Local pain around the mesh site could initially be treated conservatively with local injection using a combined steroid and local anaesthetic agent, as for groin pain after TVT⁶⁴⁶, but there is no evidence for vaginal mesh.

Although technically difficult in some cases, some authors have reported that purely transvaginal mesh excision appears to be safe with resolution of almost all presenting symptomatic, including pelvic pain¹²⁰, even if mesh removal was performed for painful mesh contraction, with a symptoms resolution rate of 93% (14/15) (Level 4).⁶⁴⁷ Contrarily, others have reported unsatisfactory outcomes after mesh removal. On 58 women who underwent mesh excision for multiple complaints, including pelvic pain in 22%, re-excision of residual mesh was necessary in 27 women (29%), and only 14 women (24%) were treated successfully, with complete resolution of all presenting symptoms.⁶⁴⁸

Pelvic pain after abdominal surgery

Pelvic or back pain is a rare condition (ranging from 1 to 2%) following laparoscopic sacral colpopexy or hysteropexy (Level 2)⁵⁹⁸ however, most did not assess lumbar/back pain before and after surgery and high rates of lower back pain are reported in the general population.⁶⁴⁹ Maher et al have reported a re-operation rate for mesh contraction significantly greater after vaginal mesh surgery than after laparoscopic sacral colpopexy (7% vs 0%, $p=0.05$)³²¹ (Level 2).

Other Complications

Other rare but severe complications have been described after pelvic organ prolapse surgery, such as massive haemorrhage after a trans-obturator mesh procedure, major vessel injury during sacral colpopexy, trocar hernia, bowel obstruction, urinary retention, ureteric complications and thrombo-embolism.

Post-operative haemorrhage or hematoma have been reported after native tissue repair, in 0.9% and 2.5% respectively.²⁶¹ In that study of 438 patients who underwent anterior and posterior colporrhaphy,

associated with sacrospinous fixation for level I defects in 269 patients and hysterectomy in 255 cases, gluteal hematomas occurred more commonly after sacrospinous fixation ($p = 0.019$) (Level 3), while concomitant hysterectomy was not associated with more complications.

Post-operative urinary retention has been described after both native tissue repair and vaginal mesh surgery. Urinary retention could be defined as a post-void residual over 150 ml more than 48 h after catheter removal.⁶⁵⁰ Posterior colporrhaphy has been shown to give more transient urinary retention than mid-urethral sling, in 32% vs 15% ($P = 0.03$), with longer bladder catheterisation (3.2 ± 0.9 vs 1.8 ± 0.4 days; $P = 0.007$), probably related to post-operative pain (Level 3).⁶⁵¹ Of 94 patients who underwent trans-obturator mesh ($n=32$) or anterior-apical mesh anchored to the sacrospinous ligament ($n=62$), with normal preoperative uroflowmetry and without concomitant mid-urethral sling, urinary retention occurred more frequently after the second technique [(17 (27 %) vs 2 (6.25 %), OR 5.7, 95% CI 1.2-26.3, $p=0.027$] (Level 3), with a trend towards more frequent hospital discharge with self-catheterisation [8 % (5) vs 3 % (1)]. This phenomenon could be explained by more injury to pelvic splanchnic nerves during the dissection of the sacrospinous ligament.⁶⁵⁰

Post-operative ureteric complications have also been described after both native tissue repair and vaginal mesh surgery. In a retrospective chart review of 983 women who underwent uterosacral colpopexy for uterovaginal and post-hysterectomy vault prolapse, the overall adverse event rate was 31.2% (95%CI, 29.2-38.6), which included 4.5% (95%CI, 3.4-6.0) of ureteric kinking requiring suture removal (Level 3).²⁶⁶ Ureteric kinking has also been reported with vaginal mesh surgery, and could be related to the traction of peri-ureteral tissue by the mesh arm [154]. In a study cohort consisted of 1,282 patients receiving 1,484 implants (847 synthetic mesh and 637 biologic grafts), Wong et al. have reported 59 (0.6%) ureteric injuries resulted from ureteric kinking during seven uterosacral ligament vaginal suspensions, one ureteric kinking during anterior implant placement, and one ureteric transection during sacrocolpopexy (Level 3).⁶²²

Concerning post-operative venous thrombo-embolism (within 30 days after surgery), in 13,023 women undergoing reconstructive pelvic surgery (including abdominal or vaginal surgery and sling), the incidence was 0.1% (Level 2) and the only specific predictor was length of stay (6.64 vs 3.22 days, $P<.001$). Information regarding thrombo-prophylaxis was not recorded in the database. Incidence was also increased in women undergoing other major surgical procedures, such as general, vascular, plastic or orthopedic surgeries (0.3%).⁶⁵²

Concerning laparoscopic sacral colpopexy, conversion to the open approach is rarely considered as a

complication. However, conversion rates range from 0.7 to 11% (mean 3%), according to the surgeons' experience (Level 3).^{365, 576, 598}

Mean bladder injury rate ranges from 0.6 to 2% during open or laparoscopic or robot-assisted sacral colpopexy or hysteropexy (Level 2).^{597, 598} Bladder injury may occur due to trocar placement, tissue dissection or suture placement. Injuries have been managed by immediate repair and extended duration of indwelling catheter. Mean bowel injury rate ranges from 0.07 to 1% (Level 2).^{597, 598}

Peri-operative blood loss is decreased using the laparoscopic approach when compared to the open approach (Level 2).^{597, 598} However, blood loss is limited (150-200ml) and the requirement of transfusion is rare (<1%), whatever the surgical route. Concomitant hysterectomy may increase blood loss.

Obstructed defecation is rarely reported (2%) following sacral colpopexy.⁵⁹⁸ Small bowel obstruction and port site hernia have been reported (0.2%) (Level 4).⁵⁹⁸

Vascular injuries are rare complications (<1%) of sacral colpopexy.⁵⁸³ Some cases are due to anatomical variations of the internal iliac veins in the presacral area

Very rare complications (<0.1%) of sacral colpopexy include vascular injuries due to anatomical variations of the internal iliac veins in the presacral area.⁶⁵³

Corneal abrasions have been rarely reported during pelvic reconstructive surgery.³⁷³ In this series, the prevalence of corneal abrasions was 2% following sacral colpopexy and 0.3% following vaginal surgery ($p=0.04$) (Level 3). However, the mean operative duration in the laparoscopic group was 312 min in this series. Furthermore, corneal abrasions did not occur in any patient with a total operating time less than 227 min. The amount of Trendelenburg was not recorded.

Fatalities occurred after vaginal surgery, open or laparoscopic sacrocolpopexy/hysteropexy. Concerning abdominal surgery, mortality rates ranged from 0.05 to 0.1 % (no difference between open and laparoscopic approach).⁵⁹⁷

7. METHODS OF PREVENTION

Prevention for both vaginal and abdominal approaches

Although there is no specific study in prolapse surgery, to demonstrate that cessation of smoking prior to surgery will decrease the post-operative complication rate (healing problems) in many other surgical specialties these data exist (Level 2). In a randomised controlled study on the effects of smoking cessation before surgery, including groin hernia repair using mesh, continued smoking up until the operation sig-

nificantly increased the risk of acquiring post-operative complications compared to those who stopped smoking four weeks before the operation.⁶⁵⁴

Reducing bleeding during surgery is important as both excessive bleeding >500 ml and post-operative hematoma requiring drainage or embolisation are independent risk factors for mesh exposure requiring reoperation after vaginal mesh surgery [OR=7.25, 95% CI 1.47-35.66].⁶⁰⁷

Many studies have shown, in other surgical specialties, that poorly controlled diabetes mellitus is a risk factor for post-operative infection.

Oestrogen therapy

Vaginal oestrogen application before and/or after pelvic organ prolapse surgery has been shown to improve the vaginal maturation index and increased vaginal epithelial thickness. However, no study has shown that the use of pre and/or post-operative application of oestrogen was associated with a decrease in vaginal mesh exposure rates (Level 3).⁶⁵⁵

Bowel preparation

One single-blind randomised trial has evaluated mechanical bowel preparation before reconstructive vaginal prolapse surgery (apical suspension and posterior colporrhaphy). Bowel preparation consisted of a clear liquid diet and two self-administered saline enemas the day before surgery ($n=75$). The patients in the control group are a normal diet ($n=75$). The bowel preparation group was less likely to report "complete" satisfaction compared with the control group (OR 0.11, 95% CI 0.04-0.35; $P<.001$) (Level 2). Abdominal fullness and cramping, fatigue, anal irritation, and hunger pains were greater in the bowel preparation group (all $P<.01$). Finally, preoperative bowel preparation conferred no benefit regarding surgeons' intraoperative assessment of the operative field (primary endpoint) (Level 2).⁶⁵⁶

Bowel preparation prior to sacral colpopexy is not routinely used in most series.

Antibiotic prophylaxis

There is no specific study on the use of antibiotic prophylaxis at the time of mesh reconstructive surgery for prolapse. However, most of studies report their use during pelvic organ prolapse surgery.^{104, 152} There are no data on the need to identify a urinary tract infection in the preoperative period nor to perform a vaginal bacteriological test or to use antiseptic or antibiotic meshes. Prolonged post-operative bladder catheterisation increases the risk of lower urinary tract infection (Level 3).⁵⁰¹

Mesh implantation and visceral injury

Although there is no comparative study, most of authors would consider the use of mesh after a rectal injury during dissection as a contraindication to mesh insertion, due to a perceived higher risk of mesh infection and subsequent recto-vaginal fistula⁶⁵⁷ (Level

4).

In the anterior compartment, a small series of five cases of recognised intra-operative bladder injury (out of 704 Trans-Vaginal Mesh procedures) has shown that mesh surgery was feasible without subsequent complications after appropriate bladder repair⁶⁵⁷ (Level 4). These data are limited and further evaluation is required.

Surgeon training

Regarding sacral colpopexy, is this laparoscopic? a learning curve has been shown, with a reduction of operative time and conversion rate over the first 80 procedures³⁶⁵ (Level 3). However, the incidence of severe complications does not seem to be related to the learning curve^{365, 366}.

The data regarding the impact of the learning curve for transvaginal meshes on the incidence of post-operative complications is conflicting. Some authors have reported that learning has a significant effect on the complication rate^{608, 658-660} while others did not^{308, 502}. For de Tayrac et al, 113 patients underwent bilateral anterior sacrospinous ligament suspension associated with anterior mesh, the risk of major complications (ureteric complications, vaginal infections, sciatic pain) was reduced by approximately 30% every ten procedures (HR = 0.71, 95% CI: 0.53–0.95) (Level 3)⁶⁵⁸. For Mowat et al, gynaecologists performing procedures approximately once a month or less were found to have higher rates of adverse outcomes in urogynaecology (RR 1.4, 95% CI 1.2-1.6), with higher rates of reoperation for mesh complications after mid-urethral sling procedures (RR 1.4, 95% CI 1.2-1.5).⁶⁶⁰

Convalescence recommendations

Current activity restrictions often placed on post-operative patients show substantial variations. Evidence-based guidelines and consensus are desirable. In France, mean recommended time until recommencement of sexual intercourse is four weeks following pelvic organ surgery. Mean recommended lifting restrictions range from four to six weeks.⁶⁶¹

8. PREVENTION METHODS FOR VAGINAL MESH SURGERY

Choose the right mesh for vaginal surgery

For vaginal mesh surgery, the use of non-absorbable synthetic meshes was associated with a reduced rate of short-term recurrences in comparison to the use of absorbable biological or synthetic meshes, for both primary and recurrent cases¹¹⁶ (Level 1). Contrarily, the use of absorbable biological or synthetic meshes was associated with a lower risk of vaginal mesh exposure and reoperation in comparison to non-absorbable synthetic meshes¹¹⁶ (Level 1).

Concerning the type of non-absorbable synthetic

mesh, the use of polyester was associated with an increased risk of vaginal exposure in comparison to polypropylene [33.3% vs 8.8%, $p < 0.03$]⁶⁶² (Level 4). Furthermore, the use of multifilament polypropylene was associated with a greater risk of vaginal exposure than monofilament polypropylene⁶⁶²[170] (Level 4), and the use of microporous monofilament polypropylene was associated with a greater risk of vaginal exposure than macroporous monofilament polypropylene⁶⁶³ (Level 4).

Composite polypropylene/polyglactin meshes do not seem to reduce the vaginal exposure rate [7.2% vs 6.9%, $p = 0.4$]⁶¹⁴ (Level 4). According to the available literature, polypropylene collagen-coated meshes do not seem to give an advantage in comparison with classic non-absorbable mesh regarding the vaginal mesh exposure rate^{111, 544, 586} (Level 4).

Contrarily, although there has been no RCT, several studies have shown that new ultra-light weight meshes (<30gr/m²) with trans-obturator arms or attached to the sacrospinous ligament were associated with low mesh exposure rate (0 to 3.4%) at medium-term (up to 36 months) (Level 4).^{117, 305, 307, 591}

Interest in mesh kits

The rate of intra-operative complications does not seem to be reduced by the use of a mesh kit rather than a self-prepared mesh⁶⁴⁰ (Level 4). However, the rate of vaginal mesh exposure was shown to be reduced by the use of the same mesh in a kit format (4.5% versus 11%, $p = 0.048$), in a retrospective study where the same surgeons had the experience of the technique with the self-prepared mesh before to use the kit⁶⁴⁰ (Level 4). On the other hand, mesh kits with anchoring fixation system could be responsible for serious complications related to migration of anchors⁶⁶⁴[173].

Only one small randomised controlled trial has compared commercial transvaginal mesh kits to self-styled mesh, however the techniques used were different (only the kit was trans-obturator)⁶⁶⁵ (Level 2).

Interest in smaller mesh

In a prospective observational cohort study, of 284 patients with an exposure rate of 12%, total mesh was an independent risk factor for vaginal mesh exposure, in comparison to anterior or posterior meshes (OR 3.0, 95% CI 1.2-7.0) (Level 3).⁶⁰⁸

Concomitant hysterectomy

Although several studies did not find any differences^{613, 666}, most of the studies have shown an increased rate of vaginal mesh exposure with concomitant vaginal hysterectomy^{187, 190, 191, 219, 551, 609, 667}. Meta-analysis demonstrates that the addition of hysterectomy to a transvaginal mesh surgery significantly ($p < 0.001$) increases the risk of mesh exposure from 5.0% (42/843) without hysterectomy as compared to 19.1% (124/650) with hysterectomy ($P < .001$) (Level 2) (Table 34).

Table 34. Comparison mesh exposure rate at transvaginal polypropylene mesh surgery with and without hysterectomy.

Author	Year	Number	Review months	Surgical technique	Mesh exposure hysterectomy n/N (%)	Mesh exposure no hysterectomy n/N (%)	p value
Huang ⁵⁹⁰	2015	102	26-32	Prolift PP mesh	5/24 (20.8)	6/78 (7.7)	0.124
Stanford ³⁰³	2015	142	24	Elevate PP mesh	4/29 (13.8)	4/112 (3.6)	0.094
El-Khawand ⁶⁰⁴	2014	201	14	Prolift, Avaulta, Uphold and custom arcus-to-arcus polyform PP mesh	16/68 (23.5)	1/133 (0.8)	<0.001
Vu ¹⁸⁹	2012	77	29	Uphold PP mesh	2/24 (8%)	1/53 (2)	
Chu ¹⁸⁷	2011	91	9	Perigee & apogee PP mesh	5/39 (12.8)	2/52 (3.8)	
Guillibert ⁶⁶⁷	2009	208	36	PP mesh	24/77 (31.2)	7/40 (17.5)	
Ganj ⁶⁰⁹	2009	127	18	PP mesh	6/21 (28.6)	7/106 (6.6)	
Neuman ¹⁹¹	2007	79	29	Posterior IVS multifilament	6/44 (13.6)	4/35 (11.4)	
Deffieux ⁶¹³	2007	138	32	Gynemesh PP mesh	20/103 (19.4)	7/35 (20)	
de Tayrac ⁵⁵¹	2007	143	10	Ugytex coated PP mesh	6/57 (10.5)	3/86 (3.5)	0.089
Collinet ¹⁹⁰	2006	277	2	Gynemesh Soft PP mesh	30/164 (18.3)	4/113 (3.5)	
Total					124/650 (19.1%)	42/843 (5.0%)	<0.001

Abbreviation: PP: polypropylene, IVS: posterior intravaginal slingplasty

Surgical incision

Although some authors recommend avoiding sagittal or inverted T colpotomy and trimming of excessive vaginal epithelium in order to reduce the rate of vaginal mesh exposure³⁰⁸, this has not been evaluated by other authors.

Vaginal sutures

Three studies have evaluated the type of sutures used for closure of the vaginal skin. The first two studies have matched women undergoing POP surgery with vaginal closure with multi-filament sutures with a cohort in which 2/0 monofilament sutures were used. In the first study, the multifilament suture group had significantly higher rates of offensive discharge ($p < 0.001$), vaginal bleeding ($p < 0.001$) and vaginal pain ($p = 0.004$) (Level 3). They were more likely to receive medical advice (0.007). However, patients in the multifilament group were no more likely to suffer

from a UTI ($p = 1.000$) or to be readmitted post-operatively ($p = 1.000$).⁶⁶⁸ In the second study, offensive vaginal discharge was also more common in the multifilament group (24% vs 12%; $p = 0.04$) (Level 3). However, there was no increased requirement to seek advice from a health professional (33% vs. 25%; $p = 0.27$) or to require antibiotics. Vaginal bleeding (10% vs. 5%; $p = 0.28$) and urinary infection (2% vs. 5%; $p = 0.44$) were statistically no more common in the multifilament group (Level 3)⁶⁶⁹. The third study has compared non-coated monofilament with triclosan-coated (antiseptic properties) monofilament sutures. Surgical site infections occurred in 3/78 (3.8%) in the first group versus 1/72 in the second group (1.4%), with no statistically significant difference ($P = 0.62$) (Level 3).⁶⁷⁰

Vaginal packing

Only one double-blind randomised study of 190

women undergoing vaginal hysterectomy and/or pelvic floor repair has evaluated the effect of vaginal packing following pelvic floor surgery with regard to post-operative pain, bleeding and infection. No statistically significant differences in the post-operative pain scores or secondary outcome measures were demonstrated. Incidence of haematoma formation (14.8 % no pack, 7.3 % pack, $p = 0.204$) was not statistically significant (Level 2). There were three clinically significant complications in the no pack group and none in the pack group. There is no evidence to suggest that packing increases pain scores or post-operative morbidity. A trend towards increased haematoma and significant complications was seen in the no pack group. Unfortunately, duration of inpatient stay was not recorded in that study. As vaginal packing does no harm and may be of some benefit, authors argued that packing should be recommended as routine clinical practice for vaginal surgery.⁶⁷¹

9. PREVENTION METHODS FOR ABDOMINAL SACRAL COLPOPEXY

Learning curve

Has been reported as a risk for recurrent prolapse.

Choice of surgical route for sacrocolpopexy

Most complications following sacral colpopexy occur irrespective of entry route. Most RCT's observed that laparoscopic sacral colpopexy is as effective as the open abdominal procedure, with a reduced rate of intraoperative bleeding, hospitalisation and wound complications.^{354, 355} However, a recent RCT showed that LSC provides outcomes as good as those of open sacral colpopexy for anatomical correction but not for anterior pelvic organ prolapse (Level 2).³⁵⁶ Robotic sacral colpopexy (RSC) and laparoscopic procedure had similar operative times, short-term anatomic cure rates, and length of hospital stay^{352, 370} (Level 2) however the robotic approach had longer operating time, greater post-operative pain and higher costs than LSC.⁵⁹⁹

In a recent systematic review, both the laparoscopic and robotic approaches were preferred to open access for sacral colpopexy. Indeed, similar anatomic/functional results have been observed (Level 2), but minimally invasive approach is associated with a decrease in blood loss and shorter length of hospital stay (Level 2).^{597, 599} However, overall complications rates are comparable in either approach.

Choose the right mesh for abdominal surgery

In a retrospective comparative study of open abdominal sacral colpopexy, Quiroz et al have shown that the short-term mesh-related complication rate was significantly higher with polypropylene than with porcine dermis [24/102 vs 12/134, $p=0.003$]³⁷⁹ (Level 3), however the prolapse recurrence rate using porcine dermis was higher [7/93 vs 0/105, $p = 0.004$].

Another study comparing fascia lata and polypropylene meshes with five-year review, has shown a long-term increased recurrence rate, but with no differences in the rate of complication³⁴⁸ (Level 2). Concerning LSC, in a prospective comparative non randomised study, Deprest et al have shown that recurrences at the level of anterior and apical compartment occur significantly more often when using a biograft, in comparison to polypropylene, 21% vs 3%, $p<0.01$ and 36% vs 19%, $p <0.05$, respectively (Level 3)³⁸⁰. Partially absorbable composite meshes (polyglactin + polypropylene) also seems to increase the risk of short-term recurrences (Level 4).⁶⁷²

The risk of vaginal mesh exposure seems to be higher with the use of polytetrafluoroethylene than with polypropylene meshes at ASC (15% vs 0%, $p=0.03$) (Level 4)¹⁹⁴[38] and 19% vs 5% (Level 2).²⁰⁹ Similar results were observed with the use of silicon-coated polyester (19% vs 0%, $p<0.05$) (Level 4).⁶⁷³

Choose the right fixation technique to the promontory, vaginal wall and levator ani

Most of authors perform a direct fixation to the vaginal wall using absorbable or non-absorbable sutures, and to the promontory using non-absorbable sutures (Level 3).^{350, 581, 582, 672}

Fewer authors use staples for the mesh fixation, both to the vaginal wall and to the levator ani muscle³⁶⁵, or tackers to the promontory.^{51, 321, 354} Spondylitis has been reported after both tackers⁶⁷⁴ and sutures^{350, 353, 581} are utilised to secure the graft to the promontory. Whatever the fixation material use for the vaginal wall, the main method of preventing the occurrence of vaginal mesh exposure seems to avoid breaching the vaginal epithelium (Level 4).⁵⁷⁹

Concomitant hysterectomy

The risk of vaginal mesh exposure is significantly increased in cases of sacrocolpopexy associated with concomitant total hysterectomy (8.6%), in comparison to 2.2% in those with previous hysterectomy, 1.5% at sacral hysterectomy and 1.7% subtotal hysterectomy⁶⁰⁰ (Level 4).

Peritoneal closure

Most of authors close the peritoneum after a sacrocolpopexy, both after open^{214, 219, 675} and laparoscopic approach.^{321, 350, 582} A recent review of 450 cases of laparoscopic and robotic sacrocolpopexy demonstrated a 1.8% rate of post-operative ileus or small bowel obstruction that were equally distributed between those with mesh that was and was not re-peritonealised⁶⁷⁶.

CONCLUSION

Pelvic organ prolapse reconstructive surgery is associated with rare but potentially severe complication, whatever the surgical approach and the use of mesh.

Preoperatively, patients should be informed that a mesh is considered a permanent implant; removal of mesh or correction of mesh-related complications may involve subsequent surgeries. Furthermore, complete removal of mesh may not be possible and additional surgeries may not fully correct some complications. Patients must also be informed of conservative and alternative surgical techniques.

Proposed Recommendations to Reduce the Rate of Complications

GoR A

Patients should be informed that transvaginal meshes have a higher reoperation rate than native tissue vaginal repairs.

GoR B

Concerning vaginal surgery:

- Bowel preparation prior to surgery is not recommended.
- If a synthetic mesh is placed by the vaginal route, it is recommended that a macroporous polypropylene monofilament mesh should be used.
- The use of polyester mesh is not recommended.

Concerning sacral colpopexy:

- The use of silicone-coated polyester, porcine dermis, fascia lata, and polytetrafluoroethylene meshes is not recommended.
- It is recommended to avoid total hysterectomy

GoR C

Whatever the surgical route:

- The first cases should be undertaken with the guidance of an experienced surgeon in the relevant technique.

Concerning sacrocolpopexy:

- Laparoscopic approach is recommended for sacral colpopexy
- The use of polyester (without silicone coating) or polypropylene meshes is recommended.
- Peritoneal closure is recommended to cover the meshes.

Expert Opinion

Whatever the surgical route:

- As with any surgery, cessation of smoking preoperatively is recommended.
- It is recommended to comply with the prevention of nosocomial infections.
- Antibiotic prophylaxis is recommended, regardless of the approach.

- Thromboembolic prophylaxis is recommended, regardless of the approach.
- It is recommended that preoperative urinary tract infections are identified and treated.
- It is recommended that the type and commercial name of mesh used in the operative report.

Concerning vaginal surgery:

- It is recommended that a non-absorbable synthetic mesh should not be inserted into the rectovaginal septum when a rectal injury occurs.
- The placement of a non-absorbable synthetic mesh into the vesicovaginal fascia may be considered after a bladder injury has been repaired if the repair is considered to be satisfactory.
- It is possible to perform a hysterectomy in association with the introduction of a non-absorbable synthetic mesh inserted vaginally but this is not recommended routinely.
- It is recommended to minimise the excision of vaginal tissue.
- Currently, there are not sufficient data to recommend the use of a mesh kit rather a self-prepared mesh.

X. RISK FACTORS RECURRENT PROLAPSE

While poor outcomes from prolapse surgery are difficult to succinctly define, knowledge of prognostic variables which could influence the outcome of surgery, along with incidences of failure and complications are invaluable information for both patient and surgeon. While the remainder of the chapter concentrates on procedural safety and efficacy in this section we seek to evaluate the impact of non-procedural factors such as patient and surgeon characteristics and peri-operative interventions on prolapse surgery outcomes.

1. PATIENT CHARACTERISTICS

Recurrent prolapse were most commonly reported in the anterior compartment^{274, 677} although in 10-year multivariate analysis of 374 American women by Denman et al this was not able to be confirmed.⁹¹ They identified prior pelvic organ prolapse or urinary incontinence (POPUI) surgery conferred a hazard ratio of 1.9 (95% CI, 1.1-3.2; P .018) for recurrent prolapse surgery. The abdominal approach was protective against reoperation compared with the vaginal approach (hazard ratio, 0.37; 95% CI, 0.17-0.83; P .02). No association was observed for age, vaginal parity, previous hysterectomy, body mass index, prolapse severity, ethnicity, chronic lung disease, smoking, oestrogen status, surgical indication, or anatomic

compartment.

Vergeldt et al completed a comprehensive systematic review evaluating 28 pre-determined risk factors for recurrent prolapse⁵⁶⁹ and after screening 7,500 relevant articles only five trials fulfilled predefined inclusion criteria⁶⁷⁷⁻⁶⁸¹ (POP recurrence defined as stage II or greater, at least one year review, native tissue repairs only and a multivariate analysis must have been undertaken). The only predictive factor for recurrent prolapse in all five papers was preoperative POP-Q stages III or IV prolapse although in Tegerstedt et al⁶⁸¹ only preoperative stage III, and not IV was a risk factor. Briefly, Weemhoff et al⁶⁷⁹ prospectively evaluated 156 women having vaginal repair of cystocele. Risk factors for anatomical recurrence were complete avulsion of puborectalis muscle (OR, 2.4; 95% CI, 1.3, 4.7), advanced preoperative stage (OR, 2.0; 95% CI, 1.0, 4.1), family history of prolapse (OR, 2.4; 95% CI, 1.2, 4.9), and sacrospinous ligament fixation (SSLF) (OR, 6.5; 95% CI, 2.0, 21.2). Salvatore identified 36 of an original 360 women who had undergone vaginal prolapse surgery and the only predictive factor for recurrence was initial stage III or IV prolapse (OR 2.4, 1.1–5.1 95% CI).⁶⁷⁸

Diez-Itza et al⁶⁷⁷ reported on a retrospective cohort of 134 women five years after prolapse surgery and while 42 (31.3%) had anatomical recurrence of the prolapse (gardenia), only 10 (7.4%) had prolapse related symptoms. Advanced preoperative prolapse (grade III–IV) of any compartment was associated with anatomical failure but not with symptomatic recurrence, (OR 3.93; 95% CI, 1.19–12.97). This study also suggested age under 60 years and weight over 65kg were additional prognostic factors for recurrence. Poor levator muscle contraction strength was not a risk factor for recurrent prolapse.

In a prospective observational study of 389 patients, age less than 60 years (OR 3.2; 95% CI, 1.6-6.4) and POP-Q stages III and IV, (OR 2.7; 95% CI, 1.3-5.3) were associated with greater risk for recurrent prolapse at one year⁶⁸⁰. No other prognostic variables were identified in this prospective observational study. Specifically, there was no difference in outcomes between the four Urogynaecologists. Concomitant Burch or sling for stress incontinence protected against recurrent anterior wall prolapse, but increased the risk of a posterior wall prolapse.

Diminished levator strength and wide genital hiatus are possible risk factors for recurrent prolapse. The data on levator muscle strength are conflicting. Diez-Itza et al⁶⁷⁷ demonstrated in multivariate analysis that decreased levator strength was not predictive of recurrent prolapse. However, in univariate analysis of 358 women five months after prolapse surgery, Vakili et al demonstrated diminished levator strength was associated with recurrent prolapse (35.8% versus 0%; $P = .017$) as was a genital hiatus 5 cm or greater (44.2% vs 27.8%; $P = .034$). Increasing levator con-

traction strength was associated with a decreased reoperation rate for pelvic floor disorders.⁶⁸² The theory of an enlarged genital hiatus being a risk factor for recurrent prolapse is supported by the retrospective univariate analysis by Medina et al⁶⁸³ which demonstrated a correlation for recurrent anterior compartment prolapse and genital hiatus measurement greater than 5cm. The rate of post-operative anterior vaginal wall prolapse was greater in patients with a wide genital hiatus compared with those with a normal genital hiatus (34.3% vs 10% respectively; OR 4.7 95% CI 1.0– 24.1).

As noted above Weemhoff confirmed after multivariate analysis that complete avulsion of the puborectalis muscle (USS confirmed) was a risk factor for objective recurrence of cystocele (OR, 2.3; 95% CI, 1.1, 4.8).⁶⁷⁹ Complete levator avulsion was also an independent risk factor for recurrent prolapse (OR 2.9 95% CI 1.8 to 4.9) in a second trial of 334 women evaluated with a mean review of 2.5 years (range 3 months to 6 years) after a variety of vaginal prolapse interventions.⁶⁸⁴ In a further trial with logistic regression analysis by the same group, they retrospectively evaluated 209 women, 2.2 years (range 3 months to 5.6 years) after a variety of anterior transvaginal mesh procedures. Levator avulsion was not a risk factor for symptomatic prolapse, POP-Q stage II prolapse, descent of Point Ba on examination, or mean bladder descent on ultrasound however it was a risk factor for cystocele diagnosed on ultrasound (OR 2.13 95% CI 1.04 to 4.39).⁶⁸⁵ More recently, in an evaluation of 287 women undergoing anterior colporrhaphy, after multivariate analysis levator defects were not an independent risk factor for recurrent prolapse OR 1.37 (0.8 to 2.34).⁶⁸⁶

A univariate analysis confirmed levator avulsion was a risk factor for symptomatic prolapse (RR 1.48 95% CI 1.08-1.91) in 165 women who had undergone prior continence and or prolapse surgery. The result was not significant for those undergoing only prior anterior colporrhaphy (RR 95% CI 0.95-1.95).⁶⁸⁷ The data from multivariate analysis are inconsistent in determining if pre-operative levator ani defects are a risk factor for recurrent prolapse.

While women with a positive family history are two to three times more likely to develop prolapse than women without a positive family history,^{688, 689} the evidence from multivariate analysis is conflicting in regard to recurrent prolapse.^{677, 679} It has also been demonstrated that women with reduced type 1 collagen and increased collagenolytic activity in vaginal tissue are predisposed to prolapse.^{690, 691} In a preliminary study, Khaja et al were not able to demonstrate a relationship between quality or type of collagen and outcome of anterior colporrhaphy.⁶⁹² Further evaluation of these risk factors is warranted.

2. SURGEON CHARACTERISTICS

Surgeon experience

The experience of the surgeon was not identified as an increased risk of vaginal prolapse recurrence following prolapse surgery in a multivariate analysis undertaken by Diez-Itza et al.⁶⁷⁷ A systematic review by Mowat et al of low versus high volume surgery (low defined as < than 12 procedures/year) found higher rates of complications for of all gynaecology procedures for low versus high volume surgeons. In the urogynaecology group, a single study reported that the LVS group had a higher rate of any complication (RR 1.4 95% CI 1.2-1.6). The evidence is of moderate to very low quality.⁶⁶⁰

Surgeon surgical volume was assessed in a retrospective analysis of all 5,488 vaginal mesh POP procedures performed by 368 surgeons in Ontario Canada, from 2002 to 2013. At 10-year review, the hazard of reoperation for complications was lower for patients of high-volume (>14 cases per annum) surgeons (3.0%, 145/3,001) compared with non- high volume surgeons (4.8%, 73/2,447), adjusted hazards ratio 0.59, 95% CI 0.40-0.86). In multivariable modelling, younger age, concomitant hysterectomy, blood transfusion, and increased medical comorbidity were all also associated with reoperation. Patients of high-volume surgeons were less likely to have a concurrent hysterectomy (32.5% versus 37.7%) and had a shorter post-operative stay in the hospital (median 2.0 versus 3 days).⁶⁹³ Overall, one in 20 women required a second surgery for a transvaginal mesh complication, after 10 years of follow-up and this risk was reduced by 41% for patients of high volume surgeons.

Surgeon learning curve

For total vaginal mesh (TVM) repair for POP, a significant surgeon learning curve was demonstrated in a multivariate analysis by Long et al.⁶⁹⁴ Women operated on during the surgeons first 50 cases were 11.93 times (95% CI: 1.79-240.1) more likely than subsequent women to develop a stage II POP-Q recurrence. A further retrospective study of 138 SSLF procedures also identified lower surgeon experience (< 20 cases) as a significant risk factor for recurrence (OR 2.7 95% CI 1.1 to 6.8) as compared to surgeon having performed > 20 cases.⁶⁹⁵

LSC requires the attaining of laparoscopic suturing and knot tying skills. Claerhout et al observed that LSC operative duration decreased rapidly during the first 30 procedures and reached steady state after 90 cases. However, complication rates remained unchanged throughout this learning curve series. Using a cumulative sum approach, they hypothesised that adequate learning occurred after 60 cases (Level 4).³⁶⁵ Akladios et al also observed that LSC operation duration decreased after 25 procedures.³⁶⁶ The complication rates were also low throughout this series and were not affected by learning curve. However,

this study analysed the learning curve of a senior urogynaecology surgeon who was initiated into this technique, and not the learning curve of a trainee. Kantartzis et al analysed the learning curves of the first 180 LSC done by four attending Urogynaecologist and observed that there was no significant difference in the rate of overall complications regardless of the number of prior procedures performed (Level 4)⁶⁹⁶. Mustafa et al (2012) observed that LSC operative time decreased considerably following the first 15 cases (Level 4).³⁶⁷

However, since complication rates associated with LSC are low, the published series cannot assess the effect of under-experience since the number of cases is few in each series. Furthermore, the complication rates are probably limited because of the supervision by a 'senior surgeon' during this learning curve. Prior training in laparoscopic suturing coincided with a short learning process for the phases requiring suturing.⁶⁹⁷ The most time-consuming step is the dissection of the vault, for which it took the trainee 31 procedures to achieve an operation time comparable to that of the teacher.⁶⁹⁷

Similarly, Morgan et al⁶⁹⁸ used multivariate analysis to look at the effect of surgeon case volume on use of apical colpopexy and cystoscopy and in the rate of intraoperative complications during hysterectomy for prolapse. Vaginal hysterectomy was undertaken for 78% of cases. Low (≤ 10 cases)-, intermediate (1-49 cases)-, and high (≥ 50 cases)-volume surgeon groups over a four-year period were established a priori. High-volume (OR, 0.42; 95% CI, 0.30-0.61) and low-volume (OR, 0.32; 95% CI, 0.15-0.66) surgeons were less likely than intermediate-volume surgeons to have intraoperative complications during vaginal hysterectomy for prolapse. The difference between high- and low-volume surgeons was not statistically significant (OR, 0.77; 95% CI, 0.5-1.2). The finding that intermediate-volume surgeons have the highest rates of intraoperative complications suggests a non-linear relationship between surgeon volume and avoidance of injury. The low volume surgeons however were far more likely to have a second experienced surgeon present for the case which could account for this. High volume surgeons were more likely to perform concomitant colpopexy and cystoscopy than intermediate or low volume surgeons.

A retrospective surgical database study by Sung et al⁶⁹⁹ demonstrated that for urogynaecological procedures low volume (<8 case per year) and intermediate volume (8-18 cases per year) had significantly higher rates of intraoperative complications (RR 1.36 and 1.24 respectively) than high volume surgeons (>18 cases per year). This was from the Nationwide Inpatient sample in the USA which represents a 20% stratified sample of US hospitals between 1998 and 2003.

Physiotherapy

Pelvic floor muscle training (PFMT) is often recom-

mended for women undergoing surgery for pelvic organ prolapse despite little evidence in the literature to support its routine use.

Jarvis et al⁷⁰⁰ randomised 60 women undergoing surgery for prolapse or incontinence and reported an improvement in urinary symptoms and quality of life in the women who received pre and post-operative pelvic floor muscle training (Jarvis et al). Follow up was only to 3 months' post operatively and the differences in outcomes could be explained by the fact that the treatment group underwent continence surgery (10/23, 44%) twice as frequently as the control group (6/27 22%).

In another Australian RCT by Frawley et al,⁷⁰¹ 51 women were allocated prolapse or continence surgery with and without supervised pre and post-operative pelvic floor exercises. No differences were detected at one year between the groups in Urogenital Distress Inventory (UDI) and the Incontinence Impact Questionnaire (IIQ) scores. Neither of the above trials reported effect on prolapse symptoms or need for re-treatment.

Pauls reported no benefit in a recent RCT (n=25 each group) comparing native tissue prolapse surgery with and without structured PFMT (one preoperative and five post-operative visits with expert pelvic floor therapist) at six-month review on a variety of outcomes including validated pelvic floor questionnaires and POP-Q staging. Quality of life and prolapsed, urinary and sexual function scores were improved equally in both groups reflecting the effect of the surgery and not the addition of a PFMT program.

In a slightly larger (n=28 in each group) multi-centre RCT, McClurg et al⁷⁰² compared prolapse surgery with and without structured PFMT (one preoperative, one phone call in week one and five post-operative

visits with a dedicated pelvic floor physiotherapist over a 12 week period). At six-month review of the whole available cohort no differences were detected between the two groups. Participant retention was problematic with less than 50% completing questionnaires and less than 20% completed examination at 12 months. At 12-month review at a single study site the treatment group had improved outcomes on the POP-SS and SF-12 scores. Unfortunately, the 12-month results do not include eligible participants from other sites which detracts from the validity of the trial.

In the largest randomised trial to date by Barber et al²⁴⁴, 374 women undergoing surgery to treat both apical vaginal prolapse and stress urinary incontinence were recruited and two-year follow-up rate was 84.5%. The intervention group underwent pelvic floor assessment and were taught PFMT two to four weeks pre-operatively and were re-assessed four times post operatively up to 12 weeks. Importantly this trial did include prolapse specific follow up assessment as well as urinary symptoms using UDI. No difference was found between behavioral therapy and pelvic floor muscle training and control group for urinary scores at six months [treatment difference -6.7 (95% CI -19.7, 6.2)], or prolapse scores at 24 months [treatment difference -8.0(95% CI -22.1, 6.1)] or anatomic success at 24 months. This trial differs from those by Frawley and Jarvis in that those supervising and teaching the behavioural package and PFMT were not interventional physiotherapists, but trained and certified clinicians.

These findings do not support the routine use of PFMT program for women undergoing repair for pelvic organ prolapse. Table 35 summarised data relating to possible risk factors for recurrent prolapse and the Grade of evidence supporting the finding.

Table 35. Risk factors for recurrent prolapse

Outcomes	Multivariate evidence	Risk quantification	GoR
Patient factors Age BMI/Weight (Kgs) Family history Stage 3-4 prolapse Prior Pelvic floor Surgery Levator defect Size Genital Hiatus Poor levator strength Levator defects Type collagen	<60 yrs. Conflicting Conflicting Yes Conflicting Conflicting data Not risk factor Conflicting data Not risk factor	OR 3.2-4.1 ^{677, 680} RR 2.0-3.9 ⁶⁷⁷⁻⁶⁷⁹	GoR B GoR A GoR C
Perioperative Factors Surgeon factors Less experienced Recurrent prolapse Complications HVS vs LVS Recurrent prolapse	 ↑ LVS No evidence No evidence	 2.7-11.9 ^{694, 695}	 GoR C

Outcomes	Multivariate evidence	Risk quantification	GoR
Complications <i>Perioperative Physio</i>	↑LVS Not protective	RR 1.4 to 2.4 ^{660, 698, 699}	GoR B GoR A

Abbreviation: BMI: body mass index, LVS: low volume surgeon, HVS: high volume surgeon,

CONCLUSION

The evidence suggests that:

- On multivariate analysis, only preoperative stage III and IV prolapse, prior prolapse or continence surgery and vaginal as compared to abdominal surgery are risk factors for recurrent prolapse after surgery. **(GoR B)**
- Level three data are conflicting on levator ani defects being a risk factor for recurrent prolapse. **(GoR D evidence)**
- Age less than 60 years, and genital hiatus greater than 5cm are possible risk factors for recurrent prolapse. **(GoR C)**
- Low volume surgeons are at increased risk of perioperative complications in prolapse surgery however the data on prolapse outcomes are inconclusive. **(GoR C evidence)**
- Limited level three evidence suggest that having a total vaginal mesh or sacrospinous colpopexy performed during the surgeons procedural learning phase increased the risk of recurrent prolapse. **(GoR C)**
- Consistent level one data demonstrate peri-operative pelvic floor muscle training does not improve prolapse surgery outcomes. **(GoR B evidence)**
- Further high quality research is needed to inform this important topic.

attention in order to decrease the burden on the countries studied.

Traditionally, Gynaecologist have based their decisions regarding surgical interventions upon the success rate, patient satisfaction, peri-operative morbidity and complications. With rising health care costs and in a setting of finite resources it is now imperative that clinicians include the financial costs of surgical interventions as a vital part of the decision-making process. Despite considerable consumable costs there is a scarcity of cost-effectiveness data on pelvic organ prolapse surgery. Hullfish et al. designed a study to compare the relative cost-effectiveness of treatment decision alternatives for post-hysterectomy POP.⁷⁰⁵ The authors used a Markov decision analysis model to assess and compare the relative cost-effectiveness of expectant management, use of a ring pessary and vaginal reconstructive surgery (VRS) and open or robotic sacral colpopexy to obtain months of quality adjusted life (QALY) over 1 year. Laparoscopy for prolapse and vaginal mesh kits were excluded as the authors do not utilise those two procedures at their institution and colpoclesis was excluded as the baseline case desired preservation of coital function. Only two decision alternatives were found to be cost-effective: pessary use and VRS. Pessary use achieved 10.4 quality-adjusted months at a cost of \$10,000 per patient. This cost includes all events for patients initially assigned to pessary use including costs for those patients who eventually underwent surgery within the 12-month time frame. The VRS alternative obtained 11.4 quality-adjusted months at \$15,000 per patient. Each of the other alternatives achieved fewer quality-adjusted months at greater cost.

XI. ECONOMICS OF PROLAPSE SURGERY

Despite the high prevalence and frequency of surgery for POP, there is little information on the costs of medical care for this condition. A study in the USA estimated that the direct costs of POP surgery were substantial, amounting to \$1,012 million (95% confidence interval \$775, 1,251 million) for a total of 226,000 patient surgical procedures during 1997.⁷⁰³ A European study showed that the number (rate) of admissions for POP surgery was 36,679 (1.14 per 1,000 women) in France, and 28,959 (1.13 per 1,000 women) in England during the year 2005.⁷⁰⁴ The total costs were €144,236,557, €83,067,825 and €81,030,907 in Germany, France and England respectively, which were also considered to be substantial, and required more

It is now recognised that women with advanced prolapse require adequate apical support to ensure durability of a simultaneous anterior and / or posterior correction.⁷⁰⁶ Options for correcting apical prolapse include: sacral colpopexy (ASC) which can be performed via a laparotomy or laparoscopically including robotically assisted laparoscopy, sacrospinous ligament fixation (SSLF), uterosacral ligament suspension, McCall's culdoplasty and levator myorrhaphy. A Cochrane meta-analysis of level 1 data comparing abdominal sacralcolpopexy (ASC) with sacrospinous fixation (SSLF) showed that ASC was superior in terms of recurrent vault prolapse, post-operative stress urinary incontinence (SUI) and post-operative dyspareunia. However, the downside of ASC includes longer operating time, longer recovery time, and increased inpatient cost.¹⁸⁵ Recently, Ohno et al used a decision analytic model to compare ASC to SSLF using TreeAge Pro (2013). Results showed

that ASC is more expensive than SSLF (\$13,988 vs \$11,950) but is more effective (QALY 1.53 vs 1.45) and is cost-effective (ICER \$24,574/ OALY) at 2 years.⁷⁰⁷ The additional costs incurred with ASC are justifiable owing to the improved outcome associated with ASC. However, if the cost of SSLF further decreases, or if the post-operative outcomes after SSLF improve, then ASC is no longer cost-effective. Limitations of the study include the lack of incorporation of the peri-operative complications like mesh erosion, wound complications etc. Evaluations extending the analysis to longer than two years are required.

Two cost-minimisation studies have evaluated the relative inpatient cost of robotic sacral colpopexy (RCS), laparoscopic sacral colpopexy (LSC) and ASC⁷⁰⁸, with both findings that the ASC was the least costly inpatient option. Patel reviewed 15 cases, 5 each of ASC, LSC and RCS performed in USA in 2008 (Patel et al., 2009). Results showed that ASC was the least expensive at \$13,149, LSC at \$19,308 and RCS the most expensive at \$24,161. Importantly, in this model there were no differences in length of stay and all procedures had long operating times, with the robotic procedure being over 2hr quicker than the laparoscopic procedures, which does not reflect common practice in the literature. Judd et al., using a decision model, estimated the hospital cost of ASC at \$5,792, LSC at \$7,353 and RCS at \$8,508 (excluding the cost of the robotic system).⁷⁰⁸ In this model, RCS and LSC became cost equivalent only when the robotic operating time was reduced to 149 min, robotic disposables were reduced to \$2,132 or laparoscopic disposables were increased to \$3,413. Both models of analysis only included inpatient care and may not reflect other benefits of the minimally invasive approach such as quicker recovery and possibly faster return to work.

Paraiso et al. performed an RCT comparing RSC (38) and LSC (40) for vault prolapse and reported the robotic group incurred significantly greater costs than the laparoscopic group (mean difference +\$1,936; 95% CI \$417-\$3,454; $P=0.008$).³⁵² Importantly, in this study the authors were experienced laparoscopic surgeons who had also completed the learning phase of the RSC. At that same time; Anger et al also randomised 78 women into laparoscopic and robotic group (Anger et al., 2014). The RSC group had higher initial hospital costs (\$19,616 compared with \$11,573, $p<0.001$) and over six weeks, hospital costs remained higher for RSC (\$20,898 compared with \$12,170, $p<0.001$). When costs of robot purchase and maintenance had been excluded, the difference would not be significant. Therefore, primary cost difference between RSC and LSC resulted from robot maintenance and purchase costs.

Over the last decade, both clinical efficacy and cost-efficiency of the mid-urethral sling in incontinence surgery has been demonstrated. Transvaginal mesh kits have been introduced to prolapse surgery in an attempt to replicate this benefit for the community. Unfortunately, a paucity of cost analysis data is available

for review. A study on the analysis of the cost-effectiveness of traditional anterior colporrhaphy (AC), non-kit mesh and commercial mesh kits for anterior vaginal prolapse repair showed that commercial mesh-kits are not cost-effective.⁷¹⁰ The authors included the estimated cost of managing recurrent prolapse and extrusions in the analytic model after performing a meta-analysis of 18 papers relating to anterior compartment repair to determine operating and admission time, recurrence rate and mesh extrusion rate for the three groups. The cost of non-kit mesh was \$3,380, AC was \$3,461 and mesh kits \$4,678. Non-kit mesh repair is cost-effective, compared with AC, if extrusion rates remain below 25%. One-way cost sensitivity analysis demonstrates that when the reoperation rate for AC reached 28%, the commercial mesh kits became cost-effective. The balance of the costs of AC and non-mesh kits depends significantly on recurrence and extrusion rates could be erosion or exposure? . Two-way cost sensitivity analysis demonstrated that if the reoperation rate of AC is below 20%, AC is more cost-effective even if the extrusion rate is 0%. When the reoperation rate of AC is 30% the non-mesh kit repair is the most effective option if the extrusion rate is less than 25%. At the same time, Jacklin et al also used a decision-analytic Markov model to compare the cost effectiveness of anterior repair augmented with synthetic mesh against non-mesh anterior repair⁷¹¹ and concluded that anterior augmented repair with mesh was relatively less cost-effective. Under base case assumptions at five years, the incremental cost-effectiveness ratio (ICER) for mesh-augmented anterior repairs was £15 million per OALY. This was mostly due to the extra costs associated with the price of the mesh, treating mesh erosion.

Maher and Connelly reported a cost minimisation analysis of an RCT comparing total vaginal mesh (TVM $n=55$) and LSC ($n=53$) in the management of vault prolapse at two years.⁷¹² Opportunity costs, defined as the economic costs to the women associated with recovery time were added to define the total economic cost. Mean total economic costs were significantly lower in the LSC group compared with the TVM (\$4,013.07, 95% CI 3,107.77-4,918.37). Labour costs were significantly greater for the LSC, reflecting that the operating time was twice as long as that of the TVM procedure. These higher labour costs were offset by lower consumable, inpatient, opportunity and reoperation costs for the LSC compared with the TVM. One-way cost analysis for the LSC and TVM demonstrates that cost equivalence would be achieved once the consumable cost reduced to zero, or the reoperation rate was zero in the TVM group or the operating time in the LSC was 130 min longer than that of the TVM. By using similar decision analysis model, Richardson et al compared the cost-effectiveness of three strategies for the use of a mid-urethral sling to prevent occult urinary incontinence in patients under-going abdominal sacral colpopexy.⁷¹³ They concluded that universal concomitant mid-ure-

thral sling is the most cost-effective prophylaxis strategy for occult stress urinary incontinence undergoing ASC.

In conclusion, despite the high prevalence and frequency of surgery for POP, there is little information relating to costs.

- Impact of rectocele repair on symptoms of obstructed defecation and faecal incontinence

CONCLUSIONS GoR

- The annual economic costs of POP surgeries are significant in United States and Europe and over the next decades will grow at twice the rate of population growth because of our aging population. **(GoR D)**
- Programs aimed at reducing the burden of this disease are needed. **(GoR D)**
- In a single institution study vaginal reconstructive surgery and pessary use were more cost-effective than expectant management, traditional ASC or RSC. **(GoR C)**
- In a single cost analysis study, ASC is cost-effective compared with SSLF for the repair of apical prolapse. **(GoR C)**
- Two studies have demonstrated that ASC incurs lower inpatient costs than LSC or RSC. **(GoR C)**
- LSC to incur lower inpatient costs than RSC, specifically relating to the lower operating time in the LSC group and costs from robot purchase and maintenance. **(GoR B)**
- Data from a meta-analysis of anterior vaginal compartment prolapse operations demonstrated that commercial mesh kits for anterior repair are less cost-effective than non-kit mesh and anterior colporrhaphy. **(GoR B)**

Future research recommendations

Significant further research is required in most areas of the surgical management of prolapse including but not limited to:

- Uterine prolapse and its various options
- Surgery for recurrent prolapse
- Identifying risk factors for recurrent prolapse
- Re-evaluation of prolapse quality of life questionnaires to ensure they are sensitive to change
- The utilisation and incorporation of tissue engineering in pelvic organ prolapse surgery
- Impact of POP surgery on bladder overactivity.
- Impact of POP surgery on urinary voiding dysfunction

1. SUMMARY OF SURGICAL TREATMENT OF PELVIC ORGAN PROLAPSE

Figure 10. Algorithm for the surgical management of pelvic organ prolapse

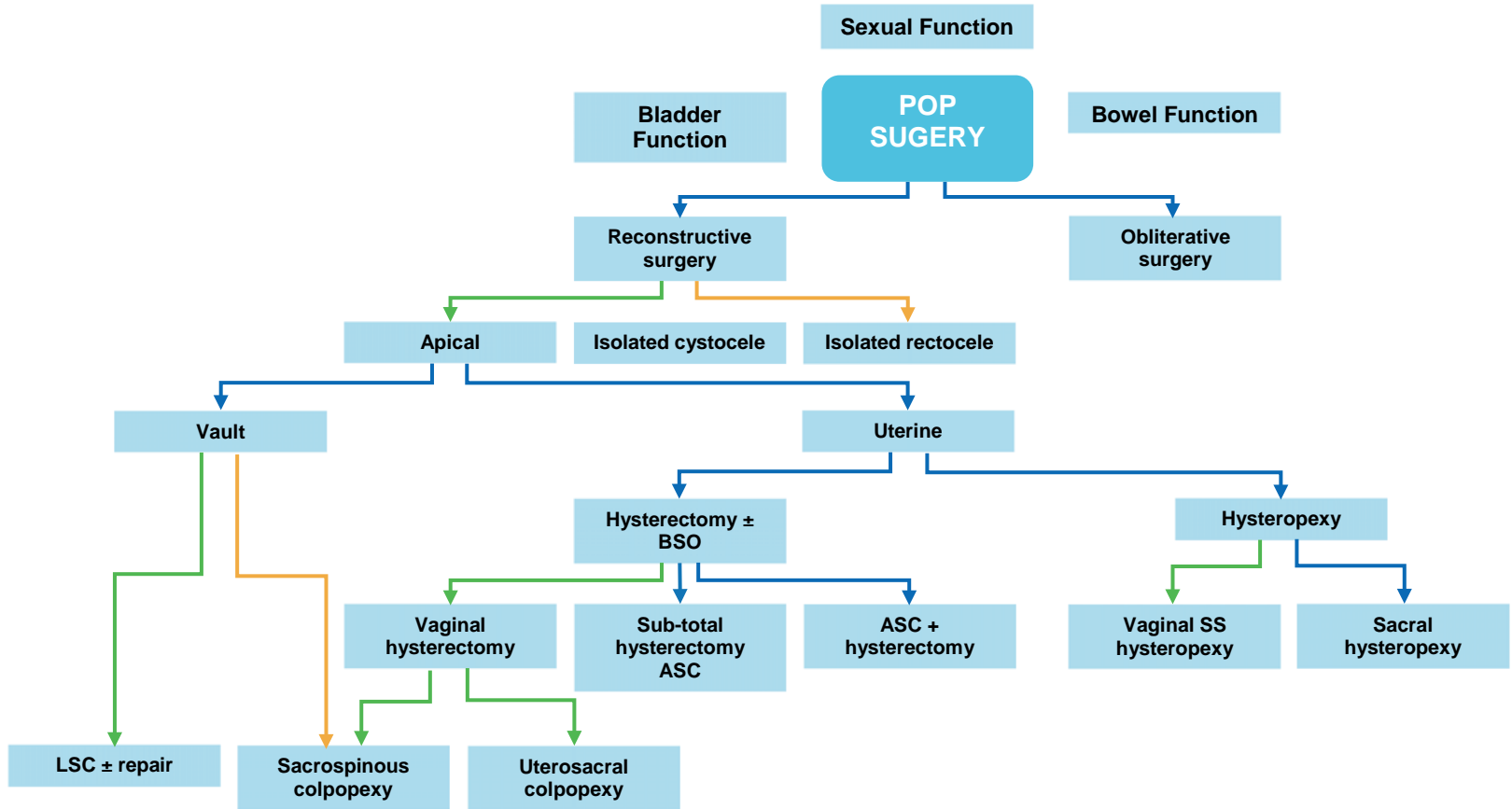

While the above text is significant in the evaluation of the surgical management of POP, the reader should note that no trial to date has reported a single intervention that has demonstrated superior outcomes to any other intervention using validated quality of life pelvic floor questionnaires. This indicates that either the interventions are not significantly different for the patients or that the questionnaires are not sensitive enough to detect change. Notwithstanding this problem, our committee has developed a treatment algorithm for the surgical management of prolapse (Figure 10). The committee recognises the algorithm is a guideline for both patients and clinicians and that patient's treatment is best individualised and recorded in open and transparent consultation and consent. The decisions that informed the algorithm are based on the findings in the report and the recommendations are summarised in Table 36.

The committee notes that prolapse surgery has undergone significant changes over the last four years with the removal of many commercial transvaginal mesh products from the market. Despite extensive criticism and concern raised by the general community regarding our unguarded optimism with the introduction of new surgical techniques and changes to regulatory pathways for new devices, as a group we continue to perform surgeries with little evidence as to their safety and efficacy. For example, many of the newer light weight mesh devices that are currently available have little supportive data and these products require significant further evaluation prior to be-

ing introduced into treatment pathways for the surgical management of prolapse.

A second example relates to the anecdotal perception that the performance of sacral colpopexy for uterine prolapse, that includes sacrohysteropexy, or supracervical or total hysterectomy and sacral colpopexy, is increasingly common. The confidence in surgical outcomes relating to sacral colpopexy is largely derived from post hysterectomy prolapse data and there is a paucity of data relating to these interventions. An interesting contradiction is emerging that while there is increasing data to support the performance of sacral colpopexy for post-hysterectomy prolapse, the limited early data available in this review suggest that neither sacrohysteropexy, nor supracervical or total hysterectomy and sacral colpopexy are superior to a variety of vaginal based interventions. The current evidence based algorithm points towards vaginal based native tissue interventions for primary uterine prolapse and reserving sacral colpopexy for post-hysterectomy and recurrent prolapse.

Innovation in the surgical management of pelvic organ prolapse remains vital to improving the outcomes of the women we are privileged to treat. There remains a simple obligation for clinicians and industry to work collaboratively and within the confines of appropriate national and local regulatory oversight to ensure that these new interventions are adequately evaluated prior to the wider introduction to the general market. These simple measures will help ensure that we are able to recapture the confidence of the community we serve.

Table 36. Recommendations for Surgical management of pelvic organ prolapse.

Treatment	GoR
Reconstructive Surgery	
<i>Isolated cystocele:</i>	
<ul style="list-style-type: none"> Anterior Colporrhaphy (AC) is generally recommended however permanent synthetic mesh could be considered for recurrent prolapse if women understand the risk/benefit profile 	A
<ul style="list-style-type: none"> Biological grafts offer no significant advantage over AC 	B
<i>Isolated rectocele:</i>	
<ul style="list-style-type: none"> Posterior Colporrhaphy (PC) is the procedure of choice 	B
<ul style="list-style-type: none"> Fascial plication superior to site specific posterior vaginal repair 	C
<ul style="list-style-type: none"> Levatorplasty associated with high rate of dyspareunia 	B
<ul style="list-style-type: none"> No evidence demonstrating benefit for synthetic or biological graft 	C
<ul style="list-style-type: none"> PC reduced prolapse with equal functional outcome compared to transanal approach 	B
<ul style="list-style-type: none"> No data demonstrates ventral rectopexy ± vaginal graft is effective for rectocele. 	D

Treatment	GoR
<ul style="list-style-type: none"> Those with combined rectal and vaginal prolapse benefit from colorectal & gynaecologist collaboration 	C
<i>Apical prolapse</i>	
<ul style="list-style-type: none"> Apical suspension at AC or PC significantly reduces the need for subsequent prolapse surgery 	B
<i>Vault prolapse (post hysterectomy)</i>	
<ul style="list-style-type: none"> Sacral colpopexy has significant anatomical and functional advantages when compared with a broad group of vaginal surgery (\pmmesh) 	A
<ul style="list-style-type: none"> Vaginal apical suspensions appropriate for those not suitable for SC (Delphi) 	C
<ul style="list-style-type: none"> Transvaginal apical mesh confers no advantage when compared to native tissue repairs 	A
<ul style="list-style-type: none"> Uterosacral & sacrospinous colpopexy have similar efficacy for apical prolapse 	B
<ul style="list-style-type: none"> Laparoscopic sacral colpopexy has advantages over both robotic and open approach however the learning curve with the laparoscopic approach is significant 	B
<i>Uterine prolapse</i>	
<ul style="list-style-type: none"> Relative contraindications to uterine preservation are listed in the Table 6. 	C
<ul style="list-style-type: none"> Salpingectomy \downarrow risk of ovarian Ca in women retaining ovaries at the time of hysterectomy 	B
<ul style="list-style-type: none"> BSO at hysterectomy in post-menopausal women \downarrow rate of ovarian Ca without \uparrow morbidity 	B
<ul style="list-style-type: none"> Vaginal hysteropexy is equally effective as vaginal hysterectomy with apical suspension and is associated with reduced blood loss and operating time 	B
<ul style="list-style-type: none"> Vaginal hysterectomy with apical suspension has a lower reoperation rate for prolapse than abdominal sacro-hysteropexy 	B
<ul style="list-style-type: none"> Sacro-hysteropexy has a \uparrow reoperation rate for prolapse than SC with hysterectomy 	C
<ul style="list-style-type: none"> Sacral colpopexy with hysterectomy is not recommended due to high rate of mesh exposure 	B
<ul style="list-style-type: none"> Supracervical hysterectomy has a lower rate of mesh exposure than hysterectomy & SC 	B
<ul style="list-style-type: none"> Supracervical hysterectomy has \uparrow rate of recurrent POP compared to SC & hysterectomy 	C
<ul style="list-style-type: none"> Although data is not complete, vaginal based apical suspensions should generally be considered for uterine prolapse reserving SC for recurrent or post hysterectomy prolapse 	C
<i>Prolapse surgery and lower urinary tract function</i>	
<ul style="list-style-type: none"> POP + SUI recommend POP and continence surgery 	A
<ul style="list-style-type: none"> POP + occult SUI recommend POP & continence surgery (consider staged procedure) 	B
<ul style="list-style-type: none"> POP without occult SUI does not require concomitant continence surgery. 	B
<ul style="list-style-type: none"> Data are lacking on the impact of POP surgery on bladder overactivity & voiding dysfunction 	D
<i>Risk factors for recurrent prolapse</i>	

Treatment	GoR
<ul style="list-style-type: none"> Age < 60 years 	C
<ul style="list-style-type: none"> Stage 3 or Stage 4 prolapse 	B
<ul style="list-style-type: none"> Preoperative widened genital hiatus or levator defects on USS: data are inconclusive 	D
<ul style="list-style-type: none"> Less experienced surgeons have higher rates of recurrent prolapse after transvaginal surgery 	C
<ul style="list-style-type: none"> Low volume surgeons have ↑ rate of complications compared to high volume surgeons 	B
<ul style="list-style-type: none"> Perioperative physiotherapy did not reduce the rate of recurrent prolapse 	A
Obliterative Surgery	
<ul style="list-style-type: none"> Effective low morbidity surgery for women not wishing to retain coital activity 	C

REFERENCES

1. Olsen AL, Smith VJ, Bergstrom JO, Colling JC, Clark AL. Epidemiology of surgically managed pelvic organ prolapse and urinary incontinence. *Obstetrics and gynecology*. 1997;89(4):501-6.
2. Smith FJ, Holman CD, Moorin RE, Tsokos N. Lifetime risk of undergoing surgery for pelvic organ prolapse. *Obstetrics and gynecology*. 2010;116(5):1096-100.
3. Phillips CH, Anthony F, Benyon C, AK. M. Collagen metabolism in the uterosacral ligaments and vaginal skin in women with uterine prolapse. *BJOG*. 2006;113:39-46.
4. Nygaard I, Barber MD, Burgio KL, Kenton K, Meikle S, Schaffer J, et al. Prevalence of symptomatic pelvic floor disorders in US women. *JAMA : the journal of the American Medical Association*. 2008;300(11):1311-6.
5. Samuelsson EC, Victor FT, Tibblin G, Svard-sudd KF. Signs of genital prolapse in a Swedish population of women 20 to 59 years of age and possible related factors. *American journal of obstetrics and gynecology*. 1999;180(2 Pt 1):299-305.
6. Swift SE, Tate SB, Nicholas J. Correlation of symptoms with degree of pelvic organ support in a general population of women: what is pelvic organ prolapse? *American journal of obstetrics and gynecology*. 2003;189(2):372-7; discussion 7-9.
7. Handa VL GE, Hendrix S, et al. . Progression and remission of pelvic organ prolapse: a longitudinal study of menopausal women. *Am J Obstet Gynecol*. 2004;190(1):27-32.
8. Hendrix S CA, Nygaard I, Aragaki A, Barnabei V, McTierman A. Pelvic organ prolapse in the Women's Health Initiative: gravity and gravidity. *Am J Obstet Gynecol* 2002;186:1160-6.
9. Aigmueller T DA, Hinterholzer S, Geiss I, Riss P. . An estimation of the frequency of surgery for posthysterectomy vault prolapsed. *Int Urogynecol J*. 2010;21:299-302.
10. Marchionni M BG, Checcucci V, et al.. 1999;44:679-684. True incidence of vaginal vault prolapse. Thirteen years experience. *J Reprod Med*. 1999;44:697-84.
11. Morley GW, DeLancey JO. Sacrospinous ligament fixation for eversion of the vagina. *American journal of obstetrics and gynecology*. 1988;158(4):872-81.
12. Bradley CS, Nygaard IE, Brown MB, Gutman RE, Kenton KS, Whitehead WE, et al. Bowel symptoms in women 1 year after sacrocolpopexy. *American journal of obstetrics and gynecology*. 2007;197(6):642 e1-8.
13. Luber KM BS, Choe JY. . The demographics of pelvic floor disorders: current observations and future projections. *Am J Obstet Gynecol*. 2001;184:1496-501.
14. Wu JM HA, Fulton RG, Myers ER. . *Obstet Gynecol* 2009 Dec;114(5):1278-83. Forecasting the prevalence of pelvic floor disorders in U.S. Women: 2010 to 2050. *Obstet Gynecol*. 2009;114(5):1278-83.
15. Sung VW, Hampton BS. Epidemiology of pelvic floor dysfunction. *Obstetrics & Gynecology Clinics of North America*. 2009;36(3):421-43.
16. Wu JM, Matthews CA, Conover MM, Pate V, Jonsson Funk M. Lifetime Risk of Stress Urinary Incontinence or Pelvic Organ Prolapse Surgery. *Obstetrics and gynecology*. 2014;123(6):1201-6.
17. Lowenstein E, Ottesen B, Gimbel H. Incidence and lifetime risk of pelvic organ prolapse surgery in Denmark from 1977 to 2009. *International urogynecology journal*. 2014.
18. Clark AL, Gregory T, Smith VJ, Edwards R. Epidemiologic evaluation of reoperation for surgically treated pelvic organ prolapse and urinary incontinence. *American Journal of Obstetrics & Gynecology*. 2003;189(5):1261-7.
19. Haya N, Baessler K, Christmann-Schmid C, de Tayrac R, Dietz V, Guldberg R, et al. Prolapse and continence surgery in countries of the Organization for Economic Cooperation and Development in 2012. *American journal of obstetrics and gynecology*. 2015;212(6):755 e1- e27.
20. Boyles SH, Weber AM, Meyn L. Procedures for pelvic organ prolapse in the United States, 1979-1997. *American journal of obstetrics and gynecology*. 2003;188(1):108-15.
21. Shah AD, Kohli N, Rajan SS, Hoyte L. The age distribution, rates, and types of surgery for pelvic organ prolapse in the USA. *Int Urogynecol J Pelvic Floor Dysfunct*. 2008;19(3):421-8.
22. Brown JS, Waetjen LE, Subak LL, Thom DH, Van den Eeden S, Vittinghoff E. Pelvic organ prolapse surgery in the United States, 1997. *American Journal of Obstetrics & Gynecology*. 2002;186(4):712-6.
23. Silva WA, Pauls RN, Segal JL, Rooney CM, Kleeman SD, Karram MM. Uterosacral ligament vault suspension: five-year outcomes. *Obstetrics and gynecology*. 2006;108(2):255-63.

24. Lisonkova S, Lavery JA, Ananth CV, Chen I, Muraca G, Cundiff GW, et al. Temporal trends in obstetric trauma and inpatient surgery for pelvic organ prolapse: An age-period-cohort analysis. *American journal of obstetrics and gynecology*. 2016.
25. Barber MD, Brubaker L, Nygaard I, Wheeler TL, 2nd, Schaffer J, Chen Z, et al. Defining success after surgery for pelvic organ prolapse. *Obstetrics and gynecology*. 2009;114(3):600-9.
26. Barber MD, Kuchibhatla MN, Pieper CF, Bump RC. Psychometric evaluation of 2 comprehensive condition-specific quality of life instruments for women with pelvic floor disorders. *American journal of obstetrics and gynecology*. 2001;185(6):1388-95.
27. Barber MD, Walters MD, Bump RC. Short forms of two condition-specific quality-of-life questionnaires for women with pelvic floor disorders (PFDI-20 and PFIQ-7). *American journal of obstetrics and gynecology*. 2005;193(1):103-13.
28. Bump RC, Mattiasson A, Bo K, Brubaker LP, DeLancey JO, Klarskov P, et al. The standardization of terminology of female pelvic organ prolapse and pelvic floor dysfunction. *American journal of obstetrics and gynecology*. 1996;175(1):10-7.
29. Digesu GA, Khullar V, Cardozo L, Robinson D, Salvatore S. P-QOL: a validated questionnaire to assess the symptoms and quality of life of women with urogenital prolapse. *Int Urogynecol J Pelvic Floor Dysfunct*. 2005;16(3):176-81; discussion 81.
30. Price N, Jackson SR, Avery K, Brookes ST, Abrams P. Development and psychometric evaluation of the ICIQ Vaginal Symptoms Questionnaire: the ICIQ-VS. *BJOG : an international journal of obstetrics and gynaecology*. 2006;113(6):700-12.
31. Baessler K, O'Neill SM, Maher CF, Battistutta D. A validated self-administered female pelvic floor questionnaire. *International urogynecology journal*. 2010;21(2):163-72.
32. Toozs-Hobson P, Freeman R, Barber M, Maher C, Haylen B, Athanasiou S, et al. An International Urogynecological Association (IUGA)/International Continence Society (ICS) joint report on the terminology for reporting outcomes of surgical procedures for pelvic organ prolapse. *International urogynecology journal*. 2012;23(5):527-35.
33. Swift S, Woodman P, O'Boyle A, Kahn M, Valley M, Bland D, et al. Pelvic Organ Support Study (POSST): the distribution, clinical definition, and epidemiologic condition of pelvic organ support defects. *American journal of obstetrics and gynecology*. 2005;192(3):795-806.
34. Chmielewski L, Walters MD, Weber AM, Barber MD. Reanalysis of a randomized trial of 3 techniques of anterior colporrhaphy using clinically relevant definitions of success. *Am J Obstet Gynecol*. 2011;205:69 e1-8.
35. Culligan PJ, Blackwell L, Goldsmith LJ, Graham CA, Rogers A, Heit MH, editors. A randomized controlled trial comparing fascia lata and synthetic mesh for sacral colpopexy. United States 2005.
36. Zyczynski HM, Carey MP, Smith AR, Gauld JM, Robinson D, Sikirica V, et al., editors. One-year clinical outcomes after prolapse surgery with nonanchored mesh and vaginal support device. United States 2010.
37. Sayer T, Lim J, Gauld JM, Hinoul P, Jones P, Franco N, et al. Medium-term clinical outcomes following surgical repair for vaginal prolapse with tension-free mesh and vaginal support device. *International urogynecology journal*. 2011.
38. Haylen BT, Maher CF, Barber MD, Camargo S, Dandolu V, Digesu A, et al. An International Urogynecological Association (IUGA) / International Continence Society (ICS) joint report on the terminology for female pelvic organ prolapse (POP). *International urogynecology journal*. 2016;27(2):165-94.
39. Macer GA. Transabdominal repair of cystocele, a 20 year experience, compared with the traditional vaginal approach. *American journal of obstetrics and gynecology*. 1978;131(2):203-7.
40. Porges RF, SW. S. Long-term analysis of the surgical management of pelvic support defects. *American journal of obstetrics and gynecology*. 1994;199(4):1518-28.
41. Stanton SL, Hilton P, Norton C, Cardozo L. Clinical and urodynamic effects of anterior colporrhaphy and vaginal hysterectomy for prolapse with and without incontinence. *Br J Obstet Gynaecol*. 1982;89(6):459-63.
42. Walter S, Olesen KP, Hald T, Jensen HK, Pedersen PH. Urodynamic evaluation after vaginal repair and colposuspension. *Br J Urol*. 1982;54(4):377-80.
43. Sand PK, Koduri S, Lobel RW, Winkler HA, Tomezsko J, Culligan PJ, et al. Prospective randomized trial of polyglactin 910 mesh to prevent recurrence of cystoceles and rectoceles. *American journal of obstetrics and gynecology*. 2001;184(7):1357-62.

44. Weber AM, Walters MD, Piedmonte MR, Ballard LA. Anterior colporrhaphy: a randomized trial of three surgical techniques. *American journal of obstetrics and gynecology*. 2001;185(6):1299-304.
45. Antosh DD, Iglesia CB, Vora S, Sokol AI. Outcome assessment with blinded versus unblinded POP-Q exams. *American journal of obstetrics and gynecology*. 2011;205(5):489 e1-4.
46. Ellerkmann RM, Cundiff GW, Melick CF, Nihira MA, Leffler K, Bent AE. Correlation of symptoms with location and severity of pelvic organ prolapse. *American journal of obstetrics and gynecology*. 2001;185(6):1332-7; discussion 7-8.
47. Bradley CS, Nygaard IE. Vaginal wall descensus and pelvic floor symptoms in older women. *Obstetrics and gynecology*. 2005;106(4):759-66.
48. Tan JS, Lukacz ES, Menefee SA, Powell CR, Nager CW. Predictive value of prolapse symptoms: a large database study. *Int Urogynecol J Pelvic Floor Dysfunct*. 2005;16(3):203-9; discussion 9.
49. Barber MD. Symptoms and outcome measures of pelvic organ prolapse. *Clin Obstet Gynecol*. 2005;48(3):648-61.
50. Jelovsek JE, Barber MD. Women seeking treatment for advanced pelvic organ prolapse have decreased body image and quality of life. *Am J Obstet Gynecol*. 2006;194(5):1455-61.
51. Maher CF, Qatawneh AM, Dwyer PL, Carey MP, Cornish A, Schluter PJ. Abdominal sacral colpopexy or vaginal sacrospinous colpopexy for vaginal vault prolapse: a prospective randomized study. *American journal of obstetrics and gynecology*. 2004;190(1):20-6.
52. Brubaker L, Cundiff GW, Fine P, Nygaard I, Richter HE, Visco AG, et al. Abdominal sacrocolpopexy with Burch colposuspension to reduce urinary stress incontinence. *N Engl J Med*. 2006;354(15):1557-66.
53. Brubaker L, Nygaard I, Richter HE, Visco A, Weber AM, Cundiff GW, et al. Two-year outcomes after sacrocolpopexy with and without burch to prevent stress urinary incontinence. *Obstetrics and gynecology*. 2008;112:49-55.
54. Barber MD, Amundsen CL, Paraiso MF, Weidner AC, Romero A, Walters MD. Quality of life after surgery for genital prolapse in elderly women: obliterative and reconstructive surgery. *Int Urogynecol J Pelvic Floor Dysfunct*. 2007;18(7):799-806.
55. Rogers RG, Kammerer-Doak D, Villarreal A, Coates K, Qualls C. A new instrument to measure sexual function in women with urinary incontinence or pelvic organ prolapse. *American journal of obstetrics and gynecology*. 2001;184(4):552-8.
56. Rosen R, Brown C, Heiman J, Leiblum S, Mes-ton C, Shabsigh R, et al. The Female Sexual Function Index (FSFI): a multidimensional self-report instrument for the assessment of female sexual function. *Journal of sex & marital therapy*. 2000;26(2):191-208.
57. Miedel A, Tegerstedt G, Morlin B, Hammarstrom M. A 5-year prospective follow-up study of vaginal surgery for pelvic organ prolapse. *International urogynecology journal and pelvic floor dysfunction*. 2008;19(12):1593-601.
58. Kapoor DS, Nemcova M, Pantazis K, Brockman P, Bombieri L, Freeman RM. Reoperation rate for traditional anterior vaginal repair: analysis of 207 cases with a median 4-year follow-up. *International urogynecology journal*. 2010;21(1):27-31.
59. Diwadkar GB, Barber MD, Feiner B, Maher C, Jelovsek JE. Complication and reoperation rates after apical vaginal prolapse surgical repair: a systematic review. *Obstetrics and gynecology*. 2009;113(2 Pt 1):367-73.
60. Brubaker L. Burch Colposuspension at the time of sacrocolpopexy in stress continent women reduces bothersome stress urinary symptoms: The CARE randomized trial. *J Pelvic Surg*. 2005;11(Supplement 1):S5.
61. Paraiso MF, Ballard LA, Walters MD, Lee JC, Mitchinson AR. Pelvic support defects and visceral and sexual function in women treated with sacrospinous ligament suspension and pelvic reconstruction. *American journal of obstetrics and gynecology*. 1996;175(6):1423-30.
62. Barber MD, Visco AG, Weidner AC, Amundsen CL, Bump RC. Bilateral uterosacral ligament vaginal vault suspension with site-specific endopelvic fascia defect repair for treatment of pelvic organ prolapse. *American journal of obstetrics and gynecology*. 2000;183(6):1402-10; discussion 10-1.
63. Haylen BT, Freeman RM, Swift SE, Cosson M, Davila GW, Deprest J, et al. An International Urogynecological Association (IUGA)/International Continence Society (ICS) joint terminology and classification of the complications related directly to the insertion of prostheses (meshes, implants, tapes) and grafts in female pelvic floor surgery. *Neurourology and urodynamics*. 2011;30(1):2-12.

64. Dindo D, Demartines N, Clavien PA. Classification of surgical complications: a new proposal with evaluation in a cohort of 6336 patients and results of a survey. *Annals of surgery*. 2004;240(2):205-13.
65. White GR. Cystocele. *JAMA : the journal of the American Medical Association*. 1909;853:1707-10.
66. White GR. An anatomic operation for the cure of cystocele. *Am J Obstet Dis Women Children*. 1912;65:286-90.
67. Richardson AC, Lyon JB, NL. W. A new look at pelvic relaxation. *American journal of obstetrics and gynecology*. 1976;126:568.
68. Richardson AC, Edmonds PB, Williams NL. Treatment of stress urinary incontinence due to paravaginal fascial defect. *Obstetrics and gynecology*. 1981;57(3):357-62.
69. Shull BL, Baden WB. A six-year experience with paravaginal defect repair for stress urinary incontinence. *American journal of obstetrics and gynecology*. 1989;160:1432-40.
70. Bruce RG, El Galley RE, Galloway NT. Paravaginal defect repair in the treatment of female stress urinary incontinence and cystocele. *Urology*. 1999;54(4):647-51.
71. Scotti RJ, Garely AD, Greston WM, Flora RF, Olson TR. Paravaginal repair of lateral vaginal wall defects by fixation to the ischial periosteum and obturator membrane. *American journal of obstetrics and gynecology*. 1998;179(6 Pt 1):1436-45.
72. Shull BL, Benn SJ, Kuehl TJ. Surgical management of prolapse of the anterior vaginal segment :An analysis of support defects, operative morbidity, and anatomical outcome. *American journal of obstetrics and gynecology*. 1994;171(1429-39).
73. Grody. M H, T., Nyirjesy. P, Kelley. L M, al e. Paraurethral fascial sling urethropexy and vaginal paravaginal defects cystopexy in the correction of urethrovesical prolapse. *Int Urogynecol J Pelvic Floor Dysfunct*. 1995;6:80-5.
74. Elkins. T E, Chesson. R R, Videla. F, al e. Transvaginal paravaginal repair. A useful adjunctive procedure at pelvic relaxation surgery. *J Pelvic Surg*. 2000;6:11-5.
75. Mallipeddi PK, Steele AC, Kohli N, Karram MM. Anatomic and functional outcome of vaginal paravaginal repair in the correction of anterior vaginal wall prolapse. *Int Urogynecol J Pelvic Floor Dysfunct*. 2001;12(2):83-8.
76. Young SB, Daman JJ, Bony LG. Vaginal paravaginal repair: one-year outcomes. *American journal of obstetrics and gynecology*. 2001;185(6):1360-6; discussion 6-7.
77. Benson JT, Lucente V, McClellan E. Vaginal versus abdominal reconstructive surgery for the treatment of pelvic support defects: a prospective randomized study with long-term outcome evaluation. *American journal of obstetrics and gynecology*. 1996;175(6):1418-21.
78. Maher CF, Qatawneh A, Dwyer P, Carey M, Cornish A, Schluter P. Abdominal sacral colpopexy or vaginal sacrospinous colpopexy for vaginal vault prolapse. A prospective randomized trial. *American journal of obstetrics and gynecology*. 2004;190:20-6.
79. Raz S, Klutke CG, Golomb J. Four-corner bladder and urethral suspension for moderate cystocele. *J Urol*. 1989;142:712-5.
80. Raz S, Little NA, Juma S, Sussman EM. Repair of severe anterior vaginal wall prolapse (grade IV cystourethrocele). *J Urol*. 1991;146(4):988-92.
81. Gardy M, Kozminski M, DeLancey J, Elkins T, McGuire EJ. Stress incontinence and cystoceles. *J Urol*. 1991;145(6):1211-3.
82. Benizri EJ, Volpe P, Pushkar D, Chevallier D, Amiel J, Sanian H, et al. A new vaginal procedure for cystocele repair and treatment of stress urinary incontinence. *J Urol*. 1996;156(5):1623-5.
83. Safir. M H, Gousse. A E, Rover. E S, Ginsberg DA, Raz S. 4-defect repair of grade 4 cystocele. *J Urol*. 1999;161:587-94.
84. Dmochowski RR, Zimmern PE, Ganabathi K, Sirls L, Leach GE. Role of the four-corner bladder neck suspension to correct stress incontinence with a mild to moderate cystocele. *Urology*. 1997;49(1):35-40.
85. Goldberg RP, Koduri S, Lobel RW, Culligan PJ, Tomezsko JE, Winkler HA, et al. Protective effect of suburethral slings on postoperative cystocele recurrence after reconstructive pelvic operation. *American journal of obstetrics and gynecology*. 2001;185(6):1307-12.
86. Eilber KS, Alperin M, Khan A, Wu N, Pashos CL, Clemens JQ, et al. Outcomes of vaginal prolapse surgery among female Medicare beneficiaries: the role of apical support. *Obstetrics and gynecology*. 2013;122(5):981-7.
87. Fairchild PS, Kamdar NS, Berger MB, Morgan DM. Rates of colpopexy and colporrhaphy at the time of hysterectomy for prolapse. *American journal of obstetrics and gynecology*. 2016;214(2):262.e1-7.

88. Colombo M, Vitobello D, Proietti F, Milani R. Randomised comparison of Burch colposuspension versus anterior colporrhaphy in women with stress urinary incontinence and anterior vaginal wall prolapse. *BJOG : an international journal of obstetrics and gynaecology*. 2000;107(4):544-51.
89. Morse AN, O'Dell KK, Howard AE, Baker SP, Aronson MP, Young SB. Midline anterior repair alone vs anterior repair plus vaginal paravaginal repair: a comparison of anatomic and quality of life outcomes. *International Urogynecology Journal And Pelvic Floor Dysfunction*. 2007;18(3):245-9.
90. Cross CA, Cespedes RD, McGuire EJ. Treatment results using pubovaginal slings in patients with large cystoceles and stress incontinence. *J Urol*. 1997;158(2):431-4.
91. Denman M GW, Boyles S, Smith V, Edwards R, Clark A. 2008;198:555. Reoperation rate 10 years after surgically managed pelvic organ prolapse and urinary incontinence. *American journal of obstetrics and gynecology*. 2008;198:555.
92. Chmielewski L, Walters MD, Weber AM, Barber MD. Reanalysis of a randomized trial of 3 techniques of anterior colporrhaphy using clinically relevant definitions of success. *American journal of obstetrics and gynecology*. 2011.
93. Julian TM. The efficacy of Marlex mesh in the repair of severe, recurrent vaginal prolapse of the anterior midvaginal wall. *American journal of obstetrics and gynecology*. 1996;175(6):1472-5.
94. Nicita G. A new operation for genitourinary prolapse. *J Urol*. 1998;160(3 Pt 1):741-5.
95. Flood CG, Drutz HP, Waja L. Anterior colporrhaphy reinforced with Marlex mesh for the treatment of cystoceles. *Int Urogynecol J Pelvic Floor Dysfunct*. 1998;9(4):200-4.
96. Migliari R, Usai E. Treatment results using a mixed fiber mesh in patients with grade IV cystocele. *J Urol*. 1999;161(4):1255-8.
97. Migliari R, De Angelis M, Madeddu G, Verdacchi T. Tension-free vaginal mesh repair for anterior vaginal wall prolapse. *European urology*. 2000;38(2):151-5.
98. Natale. F, Marziali. S, Cervigini. M. Tension-free cystocele repair(TCR): Longterm follow-up. *Int Urogynecol J Pelvic Floor Dysfunct*. 2000;11(suppl 1):S51.
99. Salvatore S, Soligo M, Meschia M, Luppino G, Piffarotti P, V. A. Prosthetic surgery for genital prolapse: functional outcome. *Neurourology and urodynamics*. 2002;21(4):296-7.
100. de Tayrac R, Devoldere G, Renaudie J, Villard P, Guilboud O, Eglin G, et al. prolapse repair by the vaginal route using a new protected low-weight polypropelene mesh; 1-year functional and anatomical outcome in prospective multicentre study. *Int Urogynecol J Pelvic Floor Dysfunct*. 2006;(epub ahead of print).
101. Sivaslioglu A, Unlubilgen E, Dolen I. A randomised comparison of polypropelene mesh surgery with site-specific surgery in treatment of cystocele. *International Urogynecology Journal And Pelvic Floor Dysfunction*. 2007;published online(19(4)):467-71.
102. Nguyen JN, Burchette RJ. Outcome after anterior vaginal prolapse repair: a randomized controlled trial. *Obstetrics and gynecology*. 2008;111(4):891-8.
103. Carey M, Slack M, Higgs P, Wynn-Williams M, Cornish A. Vaginal surgery for pelvic organ prolapse using mesh and a vaginal support device. *BJOG : an international journal of obstetrics and gynaecology*. 2008;115(3):391-7.
104. Nieminen K, Hiltunen R, Takala T, Heiskanen E, Merikari M, Niemi K, et al. Outcomes after anterior vaginal wall repair with mesh: a randomized, controlled trial with a 3 year follow-up. *American journal of obstetrics and gynecology*. 2010;203(3):235 e1-8.
105. Vollebregt A, Fischer K, Gietelink D, van der Vaart CH. Primary surgical repair of anterior vaginal prolapse: a randomised trial comparing anatomical and functional outcome between anterior colporrhaphy and trocar-guided transobturator anterior mesh. *BJOG : an international journal of obstetrics and gynaecology*. 2011;118(12):1518-27.
106. El-Nazer MA, Gomaa IA, Ismail Madkour WA, Swidan KH, El-Etriby MA. Anterior colporrhaphy versus repair with mesh for anterior vaginal wall prolapse: a comparative clinical study. *Archives of gynecology and obstetrics*. 2012;286(4):965-72.
107. Menefee SA, Dyer KY, Lukacz ES, Simsiman AJ, Luber KM, Nguyen JN. Colporrhaphy Compared With Mesh or Graft-Reinforced Vaginal Paravaginal Repair for Anterior Vaginal Wall Prolapse: A Randomized Controlled Trial. *Obstetrics and gynecology*. 2011;118:1337-44.
108. Turgal M, Sivaslioglu A, Yildiz A, Dolen I. Anatomical and functional assessment of anterior colporrhaphy versus polypropylene mesh surgery in cystocele treatment. *European journal of obstetrics, gynecology, and reproductive biology*. 2013;170(2):555-8.

109. Delroy CA, Castro Rde A, Dias MM, Feldner PC, Jr., Bortolini MA, Girao MJ, et al. The use of transvaginal synthetic mesh for anterior vaginal wall prolapse repair: a randomized controlled trial. *International urogynecology journal*. 2013;24(11):1899-907.
110. de Tayrac R, Cornille A, Eglin G, Guilbaud O, Mansoor A, Alonso S, et al. Comparison between trans-obturator trans-vaginal mesh and traditional anterior colporrhaphy in the treatment of anterior vaginal wall prolapse: results of a French RCT. *International urogynecology journal*. 2013;24(10):1651-61.
111. Tamanini JT, de Oliveira Souza Castro RC, Tamanini JM, Castro RA, Sartori MG, Girao MJ. A prospective, randomized, controlled trial of the treatment of anterior vaginal wall prolapse: medium term followup. *J Urol*. 2015;193(4):1298-304.
112. Gupta B, Vaid N, Suneja A, Guleria K, Jain S. Anterior vaginal prolapse repair: A randomised trial of traditional anterior colporrhaphy and self-tailored mesh repair. *S Afr JOG*. 2014;20(2):47-50.
113. Lamblin GG. A randomized controlled trial comparing anatomical and functional outcome between vaginal colposuspension and transvaginal mesh. *International urogynecology journal and pelvic floor dysfunction*. 2014;25(7):961-70.
114. Rudnicki M, Laurikainen E, Pogosean R, Kinne I, Jakobsson U, Teleman P. A 3-year follow-up after anterior colporrhaphy compared with collagen-coated transvaginal mesh for anterior vaginal wall prolapse: a randomised controlled trial. *BJOG : an international journal of obstetrics and gynaecology*. 2016;123(1):136-42.
115. Madhuvrata P GC, Boachie C, Allahdin S, Bain C. A randomised controlled trial evaluating the use of polyglactin (Vicryl) mesh, polydioxanone (PDS) or polyglactin (Vicryl) sutures for pelvic organ prolapse surgery: outcomes at 2 years. *Journal of Obstetrics and Gynaecology*. 2011;31(5):429-35.
116. Maher C, Feiner B, Baessler K, Christmann-Schmid C, Haya N, Marjoribanks J. Transvaginal mesh or grafts compared with native tissue repair for vaginal prolapse. *The Cochrane database of systematic reviews*. 2016;2:CD012079.
117. Altman D, Mikkola TS, Bek KM, Rahkola-Soisalo P, Gunnarsson J, Engh ME, et al. Pelvic organ prolapse repair using the Uphold Vaginal Support System: a 1-year multicenter study. *International urogynecology journal*. 2016.
118. de Tayrac R, Brouziyne M, Priou G, Devoldere G, Marie G, Renaudie J. Transvaginal repair of stage III-IV cystocele using a lightweight mesh: safety and 36-month outcome. *International urogynecology journal*. 2015;26(8):1147-54.
119. FDA. Urogynecologic Surgical Mesh: Update on the Safety and Effectiveness of Transvaginal Placement for Pelvic Organ Prolapse 2011 15/10/2013; (July 13,2011):[1-15 pp.]. Available from: <http://www.fda.gov/downloads/MedicalDevices/Safety/AlertsandNotices/UCM262760.pdf>.
120. Firoozi F, Ingber MS, Moore CK, Vasavada SP, Rackley RR, Goldman HB. Purely transvaginal/perineal management of complications from commercial prolapse kits using a new prostheses/grafts complication classification system. *J Urol*. 2012;187(5):1674-9.
121. Miklos JR, Chinthakanan O, Moore RD, Mitchell GK, Favors S, Karp DR, et al. The IUGA/ICS classification of synthetic mesh complications in female pelvic floor reconstructive surgery: a multicenter study. *International urogynecology journal*. 2016;27(6):933-8.
122. Unger CA, Abbott S, Evans JM, Jallad K, Mishra K, Karram MM, et al. Outcomes following treatment for pelvic floor mesh complications. *International urogynecology journal*. 2014;25(6):745-9.
123. Cosson M, Collinet P, Occelli B, Narducci F, Crepin G. The vaginal patch plastron for vaginal cure of cystocele. Preliminary results for 47 patients. *European journal of obstetrics, gynecology, and reproductive biology*. 2001;95(1):73-80.
124. Groutz A, Chaikin DC, Theusen E, Blaivas JG. Use of cadaveric solvent-dehydrated fascia lata for cystocele repair--preliminary results. *Urology*. 2001;58(2):179-83.
125. Kobashi KC, Leach GE, Chon J, Govier FE. Continued Multicenter Followup of Cadaveric Prolapse Repair With Sling. *The Journal of Urology*. 2002;168(5):2063-8.
126. Chung SY, Franks M, Smith CP, Lee J-Y, Lu S-H, Chancellor M. Technique of combined pubovaginal sling and cystocele repair using a single piece of cadaveric dermal graft. *Urology*. 2002;59(4):538-41.
127. Clemons JL, Myers DL, Aguilar VC, Arya LA. Vaginal paravaginal repair with an AlloDerm graft. *American journal of obstetrics and gynecology*. 2003;189(6):1612-8.
128. Powell CR, Simsman AJ, Menefee SA. Anterior Vaginal Wall Hammock With Fascia Lata for the Correction of Stage 2 or Greater Anterior Vaginal Compartment Relaxation. *The Journal of Urology*. 2004;171(1):264-7.

129. Frederick RW, Leach GE. CADAVERIC PROLAPSE REPAIR WITH SLING: INTERMEDIATE OUTCOMES WITH 6 MONTHS TO 5 YEARS OF FOLLOWUP. *The Journal of Urology*. 2005;173(4):1229-33.
130. Gandhi S, Goldberg RP, Kwon C, Koduri S, Beaumont JL, Abramov Y, et al. A prospective randomized trial using solvent dehydrated fascia lata for the prevention of recurrent anterior vaginal wall prolapse. *American journal of obstetrics and gynecology*. 2005;192(5):1649-54.
131. Ward RM, Sung VW, Clemons JL, Myers DL. Vaginal paravaginal repair with an AlloDerm graft: Long-term outcomes. *American journal of obstetrics and gynecology*. 2007;197(6):670.e1-e5.
132. Leboeuf L, Miles RA, Kim SS, Gousse AE. Grade 4 cystocele repair using four-defect repair and porcine xenograft acellular matrix (Pelvicol): Outcome measures using SEAPI. *Urology*. 2004;64(2):282-6.
133. Salomon LJ, Detchev R, Barranger E, Cortez A, Callard P, Darai E. Treatment of Anterior Vaginal Wall Prolapse with Porcine Skin Collagen Implant by the Transobturator Route: Preliminary Results. *European urology*. 2004;45(2):219-25.
134. Gomelsky A, Rudy D, Dmochowski R. Porcine dermis interposition graft for repair of high grade anterior compartment defects with or without concomitant pelvic organ prolapse procedures. *J Urol*. 2004;171(4):1581-4.
135. Wheeler TL, 2nd, Richter HE, Duke AG, Burgio KL, Redden DT, Varner RE. Outcomes with porcine graft placement in the anterior vaginal compartment in patients who undergo high vaginal uterosacral suspension and cystocele repair. *American journal of obstetrics and gynecology*. 2006;194(5):1486-91.
136. Meschia M, Pifarotti P, Bernasconi F, Magatti F, Riva D, Kocjancic E. Porcine skin collagen implants to prevent anterior vaginal wall prolapse recurrence: a multicenter, randomized study. *J Urol*. 2007;177(1):192-5.
137. Handel LN, Frenkl TL, Kim YH. Results of Cystocele Repair: A Comparison of Traditional Anterior Colporrhaphy, Polypropylene Mesh and Porcine Dermis. *The Journal of Urology*. 2007;178(1):153-6.
138. Simsiman AJ, Lubner KM, Menefee SA. Vaginal paravaginal repair with porcine dermal reinforcement: Correction of advanced anterior vaginal prolapse. *American journal of obstetrics and gynecology*. 2006;195(6):1832-6.
139. Robles JE, Rioja J, Saiz A, Brugarolas X, Rossell D, Zudaire JJ, et al. Anterior compartment prolapse repair with a hybrid biosynthetic mesh implant technique. *International Urogynecology Journal And Pelvic Floor Dysfunction*. 2007;18(10):1191-6.
140. Guerette NL, Peterson TV, Aguirre OA, Vandrie DM, Biller DH, Davila GW. Anterior repair with or without collagen matrix reinforcement: a randomized controlled trial. *Obstetrics and gynecology*. 2009;114(1):59-65.
141. Hviid U, Hviid TV, Rudnicki M. Porcine skin collagen implants for anterior vaginal wall prolapse: a randomised prospective controlled study. *Int Urogynecol J Pelvic Floor Dysfunct*. 2010;21(5):529-34.
142. Feldner PC, Jr., Castro RA, Cipolotti LA, Delroy CA, Sartori MG, Girao MJ. Anterior vaginal wall prolapse: a randomized controlled trial of SIS graft versus traditional colporrhaphy. *Int Urogynecol J Pelvic Floor Dysfunct*. 2010;21(9):1057-63.
143. Natale F, La Penna C, Padoa A, Agostini M, De Simone E, Cervigni M. A prospective, randomized, controlled study comparing Gynemesh, a synthetic mesh, and Pelvicol, a biologic graft, in the surgical treatment of recurrent cystocele. *Int Urogynecol J Pelvic Floor Dysfunct*. 2009;20(1):75-81.
144. Dahlgren E, Kjolhede P. Long-term outcome of porcine skin graft in surgical treatment of recurrent pelvic organ prolapse. An open randomized controlled multicenter study. *Acta obstetrica et gynecologica Scandinavica*. 2011;90(12):1393-401.
145. Robert MMDM, Girard IMD, Brennand EMD, Tang SB, Birch CMD, Murphy MMD, et al. Absorbable Mesh Augmentation Compared With No Mesh for Anterior Prolapse: A Randomized Controlled Trial. [Article]. *Obstetrics and gynecology*. 2014;123(2):288-94.
146. Behnia-Willison F, Seman EI, Cook JR, O'Shea RT, Keirse MJ. Laparoscopic paravaginal repair of anterior compartment prolapse. *Journal of minimally invasive gynecology*. 2007;14(4):475-80.
147. Simonds RJ, Homberg SD, RL. H. Transmission of human immunodeficiency virus type 1 from seronegative organ tissue donor. *N Engl J Med*. 1992;326:726-30.
148. Hathaway JK, Choe JM. Intact genetic material is present in commercially processed cadaver allografts used for pubovaginal slings. *J Urol*. 2002;168(3):1040-3.

149. Leboeuf L, Miles RA, AE. G. Grade 4 cystocele repair using 4-defect repair and porcine xenograft acellular matrix (Pelvicol). Outcome measures using SEAPI. *Urology*. 2004;64(2):282-6.
150. Meschia M, Pifarotti P, Bernasconi F, Magatti F, Riva D, Kocjancic E. Porcine skin collagen implants to prevent anterior vaginal wall prolapse recurrence: a multicenter, randomized study. *The Journal Of Urology*. 2007;177(1):192-5.
151. Fayyad AM, North C, Reid FM, Smith AR. Prospective study of anterior transobturator mesh kit (Prolift) for the management of recurrent anterior vaginal wall prolapse. *Int Urogynecol J Pelvic Floor Dysfunct*. 2011;22(2):157-63.
152. Withagen MI, Milani AL, den Boon J, Vervest HA, Vierhout ME. Trocar-guided mesh compared with conventional vaginal repair in recurrent prolapse: a randomized controlled trial. *Obstetrics and gynecology*. 2011;117(2 Pt 1):242-50.
153. Ow LL, Lim YN, Dwyer PL, Karmakar D, Murray C, Thomas E, et al. Native tissue repair or transvaginal mesh for recurrent vaginal prolapse: what are the long-term outcomes? *International urogynecology journal*. 2016.
154. DeLancey JO. Anatomic aspects of vaginal eversion after hysterectomy. *American journal of obstetrics and gynecology*. 1992;166(6 Pt 1):1717-24; discussion 24-8.
155. Wright JD, Herzog TJ, Tsui J, Ananth CV, Lewin SN, Lu YS, et al. Nationwide trends in the performance of inpatient hysterectomy in the United States. *Obstetrics and gynecology*. 2013;122(2 Pt 1):233-41.
156. Frick AC, Barber MD, Paraiso MF, Ridgeway B, Jelovsek JE, Walters MD. Attitudes toward hysterectomy in women undergoing evaluation for uterovaginal prolapse. *Female pelvic medicine & reconstructive surgery*. 2013;19(2):103-9.
157. Korbly NBMDa, Kassiss NCMDb, Good MMDOc, Richardson MLMDMPHd, Book NMMDe, Yip SMDf, et al. Patient preferences for uterine preservation and hysterectomy in women with pelvic organ prolapse. *American Journal of Obstetrics & Gynecology*. 2013;209(5):470e1-e6.
158. Frick AC, Walters MD, Larkin KS, Barber MD. Risk of unanticipated abnormal gynecologic pathology at the time of hysterectomy for uterovaginal prolapse. *American journal of obstetrics and gynecology*. 2010;202(5):507 e1-4.
159. Renganathan A, Edwards R, Duckett JR. Uterus conserving prolapse surgery--what is the chance of missing a malignancy? *International urogynecology journal*. 2010;21(7):819-21.
160. Pearce CL, Stram DO, Ness RB, Stram DA, Roman LD, Templeman C, et al. Population distribution of lifetime risk of ovarian cancer in the United States. *Cancer epidemiology, biomarkers & prevention : a publication of the American Association for Cancer Research, cosponsored by the American Society of Preventive Oncology*. 2015;24(4):671-6.
161. Siegel AL, Kim M, Goldstein M, Levey S, Ilbeigi P. High incidence of vaginal mesh extrusion using the intravaginal slingplasty sling. *The Journal Of Urology*. 2005;174(4 Pt 1):1308-11.
162. Jacoby VL, Grady D, Wactawski-Wende J, Manson JE, Allison MA, Kuppermann M, et al. Oophorectomy vs ovarian conservation with hysterectomy: cardiovascular disease, hip fracture, and cancer in the Women's Health Initiative Observational Study. *Archives of internal medicine*. 2011;171(8):760-8.
163. Parker WH, Feskanich D, Broder MS, Chang E, Shoupe D, Farquhar CM, et al. Long-term mortality associated with oophorectomy compared with ovarian conservation in the nurses' health study. *Obstetrics and gynecology*. 2013;121(4):709-16.
164. Yoon SH, Kim SN, Shim SH, Kang SB, Lee SJ. Bilateral salpingectomy can reduce the risk of ovarian cancer in the general population: A meta-analysis. *European journal of cancer (Oxford, England : 1990)*. 2016;55:38-46.
165. Lin TY, Su TH, Wang YL, Lee MY, Hsieh CH, Wang KG, et al. Risk factors for failure of transvaginal sacrospinous uterine suspension in the treatment of uterovaginal prolapse. *Journal of the Formosan Medical Association = Taiwan yi zhi*. 2005;104(4):249-53.
166. Neuman M, Lavy Y. Conservation of the prolapsed uterus is a valid option: medium term results of a prospective comparative study with the posterior intravaginal slingoplasty operation. *Int Urogynecol J Pelvic Floor Dysfunct*. 2007;18(8):889-93.
167. Romanzi LJ, Tyagi R. Hysteropexy compared to hysterectomy for uterine prolapse surgery: does durability differ? *International urogynecology journal*. 2012;23(5):625-31.
168. Pan K, Cao L, Ryan NA, Wang Y, Xu H. Laparoscopic sacral hysteropexy versus laparoscopic sacrocolpopexy with hysterectomy for pelvic organ prolapse. *International urogynecology journal*. 2016;27(1):93-101.

169. Jenabi E, Poorolajal J. The effect of body mass index on endometrial cancer: a meta-analysis. *Public health*. 2015;129(7):872-80.
170. Kalogirou D, Antoniou G, Karakitsos P, Kalogirou O. Comparison of surgical and postoperative complications of vaginal hysterectomy and Manchester procedure. *European journal of gynaecological oncology*. 1996;17(4):278-80.
171. FitzGerald MP, Elliott C, Brubaker L. New vs old: descriptors can affect patients' surgical preferences. *American journal of obstetrics and gynecology*. 2008;199:476 e1-3.
172. Jones KA, Zhuo Y, Solak S, Harmanli O. Hysterectomy at the time of colposcopy: a decision analysis. *International urogynecology journal*. 2016;27(5):805-10.
173. Dietz V, van der Vaart CH, van der Graaf Y, Heintz P, Schraffordt Koops SE. One-year follow-up after sacrospinous hysteropexy and vaginal hysterectomy for uterine descent: a randomized study. *Int Urogynecol J Pelvic Floor Dysfunct*. 2010;21(2):209-16.
174. Detollenaere RJ, den Boon J, Stekelenburg J, IntHout J, Vierhout ME, Kluivers KB, et al. Sacrospinous hysteropexy versus vaginal hysterectomy with suspension of the uterosacral ligaments in women with uterine prolapse stage 2 or higher: multicentre randomised non-inferiority trial. *BMJ : British Medical Journal*. 2015;351.
175. Jeng CJ, Yang YC, Tzeng CR, Shen J, Wang LR. Sexual functioning after vaginal hysterectomy or transvaginal sacrospinous uterine suspension for uterine prolapse: a comparison. *J Reprod Med*. 2005;50(9):669-74.
176. Hefni M, El-Toukhy T, Bhaumik J, Katsimanis E. Sacrospinous cervicocolpopexy with uterine conservation for uterovaginal prolapse in elderly women: an evolving concept. *American journal of obstetrics and gynecology*. 2003;188(3):645-50.
177. Maher CF, Cary MP, Slack MC, Murray CJ, Milligan M, Schluter P. Uterine preservation or hysterectomy at sacrospinous colpopexy for uterovaginal prolapse? *Int Urogynecol J Pelvic Floor Dysfunct*. 2001;12(6):381-4.
178. van Brummen HJ, van de Pol G, Aalders CI, Heintz AP, van der Vaart CH. Sacrospinous hysteropexy compared to vaginal hysterectomy as primary surgical treatment for a descensus uteri: effects on urinary symptoms. *Int Urogynecol J Pelvic Floor Dysfunct*. 2003;14(5):350-5; discussion 5.
179. Lo TS, Pue LB, Hung TH, Wu PY, Tan YL. Long-term outcome of native tissue reconstructive vaginal surgery for advanced pelvic organ prolapse at 86 months: Hysterectomy versus hysteropexy. *The journal of obstetrics and gynaecology research*. 2015;41(7):1099-107.
180. Detollenaere RJ, den BJ, Stekelenburg J, IntHout J, Vierhout ME, Kluivers KB, et al. Sacrospinous hysteropexy versus vaginal hysterectomy with suspension of the uterosacral ligaments in women with uterine prolapse stage 2 or higher: multicentre randomised non-inferiority trial. *BMJ : British Medical Journal*. 2015;351:h3717.
181. Hefni MA, El-Toukhy TA, editors. Long-term outcome of vaginal sacrospinous colpopexy for marked uterovaginal and vault prolapse. Ireland2006.
182. Rosen DM SA, Cario GM, Carlton MA, Chou D. . Is hysterectomy necessary for laparoscopic pelvic floor repair? . *Journal of minimally invasive gynecology*. 2008;15(6):729-34.
183. Diwan A RC, Strohsnitter WC, Weld A, Rosenblatt P, Kohli N. Laparoscopic uterosacral ligament uterine suspension compared with vaginal hysterectomy with vaginal vault suspension for uterovaginal prolapse. *Int Urogynecol J Pelvic Floor Dysfunct* 2006; 17(1): 79-83. Laparoscopic uterosacral ligament uterine suspension compared with vaginal hysterectomy with vaginal vault suspension for uterovaginal prolapse. *International urogynecology journal*. 2006;17(1):79-83.
184. Bedford ND, Seman EI, O'Shea RT, Keirse MJ. Effect of uterine preservation on outcome of laparoscopic uterosacral suspension. *Journal of minimally invasive gynecology*. 2013;20(2):172-7.
185. Maher C, Schmid C, Baessler K, Feiner B. Surgical management of pelvic organ prolapse in women. *Cochrane Database of Systematic Reviews (Online)*. 2013(issue 4):CD004014.
186. Nager CW, Zyczynski H, Rogers RG, Barber MD, Richter HE, Visco AG, et al. The Design of a Randomized Trial of Vaginal Surgery for Uterovaginal Prolapse: Vaginal Hysterectomy With Native Tissue Vault Suspension Versus Mesh Hysteropexy Suspension (The Study of Uterine Prolapse Procedures Randomized Trial). *Female pelvic medicine & reconstructive surgery*. 2016;22(4):182-9.
187. Chu LC, Chuang FC, Kung FT, Huang KH. Comparison of short-term outcomes following pelvic reconstruction with Perigee and Apogee systems: hysterectomy or not? *International urogynecology journal*. 2012;23(1):79-84.

188. Huang KH CF, Fu HC, Kung FT. J Obstet Gynaecol Res. Polypropylene mesh as an alternative option for uterine preservation in pelvic reconstruction in patients with uterine prolapse. The journal of obstetrics and gynaecology research. 2012;38(1):97-101.
189. Vu.MK, Letko J, Jirschele K, Gafni-Kane A, Nguyen A, & HD, et al. Minimal mesh repair for apical and anterior prolapse: initial anatomical and subjective outcomes. International urogynecology journal. 2012;23(12):1753-61.
190. Collinet P, Belot F, Debodinance P, Ha Duc E, Lucot J-P, Cosson M. Transvaginal mesh technique for pelvic organ prolapse repair: mesh exposure management and risk factors. International Urogynecology Journal And Pelvic Floor Dysfunction. 2006;17(4):315-20.
191. Neuman M LYIUJPFd-. Conservation of the prolapsed uterus is a valid option: medium term results of a prospective comparative study with the posterior intravaginal slingoplasty operation. International urogynecology journal. 2007;18(8):889-93.
192. Roovers J, van der Vaart C, van der Bom J, van Leeuwen J, Scholten P, Heintz A. A randomised controlled trial comparing abdominal and vaginal prolapse surgery: effects on urogenital function. BJOG : an international journal of obstetrics and gynaecology. 2004;111(1):50-6.
193. Rahmanou P, Price N, Jackson SR. Laparoscopic hysteropexy versus vaginal hysterectomy for the treatment of uterovaginal prolapse: a prospective randomized pilot study. International urogynecology journal. 2015;26(11):1687-94.
194. Jeon MJ, Moon YJ, Jung HJ, Lim KJ, Yang HI, Kim SK, et al. A long-term treatment outcome of abdominal sacrocolpopexy. Yonsei medical journal. 2009;50(6):807-13.
195. Costantini E, Mearini L, Bini V, Zucchi A, Mearini E, Porena M. Uterus preservation in surgical correction of urogenital prolapse. European urology. 2005;48(4):642-9.
196. Costantini E, Porena M, Lazzeri M, Mearini L, Bini V, Zucchi A. Changes in female sexual function after pelvic organ prolapse repair: role of hysterectomy. International urogynecology journal. 2013;24(9):1481-7.
197. Bai SW KE, Shin JS, Kim SK, Park KH, Lee DH. . Yonsei Med J 2005; 46(1): 112-8. A comparison of different pelvic reconstruction surgeries using mesh for pelvic organ prolapse patients. Yonsei medical journal. 2005;46(1):112-8.
198. Jeon MJ JH, Choi HJ, Kim SK, Bai SW. Int Urogynecol J Pelvic Floor Dysfunct 2008; 19(3): 351-5. Is hysterectomy or the use of graft necessary for the reconstructive surgery for uterine prolapse? . International urogynecology journal. 2008;19(3):351-5.
199. Gracia M, Perello M, Bataller E, Espuna M, Parellada M, Genis D, et al. Comparison between laparoscopic sacral hysteropexy and subtotal hysterectomy plus cervicopexy in pelvic organ prolapse: A pilot study. Neurourology and urodynamics. 2015;34(7):654-8.
200. Myers EM, Siff L, Osmundsen B, Geller E, Matthews CA. Differences in recurrent prolapse at 1 year after total vs supracervical hysterectomy and robotic sacrocolpopexy. International urogynecology journal. 2015;26(4):585-9.
201. Costantini E, Lombi R, Micheli C, Parziani S, Porena M. Colposacropey with Gore-tex mesh in marked vaginal and uterovaginal prolapse. European urology. 1998;34(2):111-7.
202. van IMN, Coolen AL, Detollenaere RJ, den Boon J, Bongers M, van de Pol G, et al. Hysteropexy in the treatment of uterine prolapse stage 2 or higher: a multicenter randomized controlled non-inferiority trial comparing laparoscopic sacrohysteropexy with vaginal sacrospinous hysteropexy (LAVA-trial, study protocol). BMC Women's Health. 2014;14:112.
203. Kow N, Goldman HB, Ridgeway B. Uterine Conservation During Prolapse Repair: 9-Year Experience at a Single Institution. Female pelvic medicine & reconstructive surgery. 2016;22(3):126-31.
204. Paek J, Lee M, Kim BW, Kwon Y. Robotic or laparoscopic sacrohysteropexy versus open sacrohysteropexy for uterus preservation in pelvic organ prolapse. International urogynecology journal. 2016;27(4):593-9.
205. Gutman RE, Rardin CR, Sokol ER, Matthews C, Park AJ, Iglesia CB, et al. Vaginal and laparoscopic mesh hysteropexy for uterovaginal prolapse: a parallel cohort study. American journal of obstetrics and gynecology. 2016.
206. Farquhar CM, Sadler L, Harvey SA, Stewart AW. The association of hysterectomy and menopause: a prospective cohort study. BJOG : an international journal of obstetrics and gynaecology. 2005;112(7):956-62.
207. Moorman PG, Myers ER, Schildkraut JM, Iversen ES, Wang F, Warren N. Effect of hysterectomy with ovarian preservation on ovarian function. Obstetrics and gynecology. 2011;118(6):1271-9.

208. Flack CK, Monn MF, Patel NB, Gardner TA, Powell CR. National Trends in the Performance of Robot-Assisted Sacral Colpopexy. *Journal of endourology / Endourological Society*. 2015;29(7):777-83.
209. Cundiff GW, Varner E, Visco AG, Zyczynski HM, Nager CW, Norton PA, et al. Risk factors for mesh/suture erosion following sacral colpopexy. *American journal of obstetrics and gynecology*. 2008;199(6):688 e1-5.
210. Nosti PAMD, Carter CMMD, Sokol AIMD, Tefera EMS, Iglesia CBMD, Park AJMD, et al. Transvaginal Versus Transabdominal Placement of Synthetic Mesh at Time of Sacrocolpopexy. *Female Pelvic Medicine & Reconstructive Surgery May/June*. 2016;22(3):151-5.
211. Tan-Kim J, Menefee SA, Lubner KM, Nager CW, Lukacz ES. Prevalence and risk factors for mesh erosion after laparoscopic-assisted sacrocolpopexy. *International urogynecology journal*. 2011;22(2):205-12.
212. Warner WB, Vora S, Hurtado EA, Welgoss JA, Horbach NS, von Pechmann WS. Effect of operative technique on mesh exposure in laparoscopic sacrocolpopexy. *Female pelvic medicine & reconstructive surgery*. 2012;18(2):113-7.
213. Nosti PA, Carter CM, Sokol AI, Tefera E, Iglesia CB, Park AJ, et al. Transvaginal Versus Transabdominal Placement of Synthetic Mesh at Time of Sacrocolpopexy. *Female pelvic medicine & reconstructive surgery*. 2016;22(3):151-5.
214. Wu JM, Wells EC, Hundley AF, Connolly A, Williams KS, Visco AG. Mesh erosion in abdominal sacral colpopexy with and without concomitant hysterectomy. *American Journal of Obstetrics & Gynecology*. 2006;194(5):1418-22.
215. Bensinger G, Lind L, Lesser M, Guess M, Winkler H. Abdominal sacral suspensions: analysis of complications using permanent mesh. *American journal of obstetrics and gynecology*. 2005;193(6):2094-8.
216. Brizzolara S, Pillai-Allen A. Risk of Mesh Erosion With Sacral Colpopexy and Concurrent Hysterectomy. *Obstetrics and gynecology*. 2003;102(2):306-10.
217. Culligan PJ, Murphy M, Blackwell L, Hammons G, Graham C, Heit MH. Long-term success of abdominal sacral colpopexy using synthetic mesh. *American journal of obstetrics and gynecology*. 2002;187(6):1473-80; discussion 81-2.
218. Ginath S, Garely AD, Condrea A, Vardy MD. Mesh erosion following abdominal sacral colpopexy in the absence and presence of the cervical stump. *International urogynecology journal*. 2013;24(1):113-8.
219. Stepanian AA, Miklos JR, Moore RD, Mattox TF. Risk of mesh extrusion and other mesh-related complications after laparoscopic sacral colpopexy with or without concurrent laparoscopic-assisted vaginal hysterectomy: experience of 402 patients. *Journal of minimally invasive gynecology*. 2008;15(2):188-96.
220. Tan-Kim J, Menefee S, Lubner K, Nager C, Lukacz E, Manodoro S, et al. Prevalence and risk factors for mesh erosion after laparoscopic-assisted sacrocolpopexy. *International urogynecology journal*. 2011;22(2):205-12.
221. Osmundsen BC, Clark A, Goldsmith C, Adams K, Denman MA, Edwards R, et al. Mesh erosion in robotic sacrocolpopexy. *Female pelvic medicine & reconstructive surgery*. 2012;18(2):86-8.
222. Crane AK, Geller EJ, Sullivan S, Robinson BL, Myers EM, Horton C, et al. Short-term mesh exposure after robotic sacrocolpopexy with and without concomitant hysterectomy. *Southern medical journal*. 2014;107(10):603-6.
223. Meyer I, McGwin G, Swain TA, Alvarez MD, Ellington DR, Richter HE. Synthetic Graft Augmentation in Vaginal Prolapse Surgery: Long-Term Objective and Subjective Outcomes. *Journal of minimally invasive gynecology*. 2016;23(4):614-21.
224. FDA. Food and Drug Administration. Quantitative assessment of the prevalence of unsuspected uterine sarcoma in women undergoing treatment of uterine fibroids: summary and key findings. 2014 [Available from: <http://www.fda.gov/downloads/MedicalDevices/Safety/AlertsandNotices/UCM393589.pdf>].
225. Gynecologists. ACoOa. Power Morcellation and Occult Malignancy in Gynecologic Surgery: A Special Report. May 2014 [Available from: Available at: <http://www.acog.org/About-ACOG/Announcements/FDA-Issues-Safety-Communication-on-Laparoscopic-Uterine-Power-Morcellation>].
226. AUGS. AUGS Position Statement: Laparoscopic Uterine Power Morcellation in Hysterectomy and Myomectomy FDA Safety Communication and ACOG Special Report. 2014 [Available from: <http://www.augs.org/index.php?mo=cm&op=ld&fid=810>].

227. Andy UU, Nosti PA, Kane S, White D, Lowenstein L, Gutman RE, et al. Incidence of unanticipated uterine pathology at the time of minimally invasive abdominal sacrocolpopexy. *Journal of minimally invasive gynecology*. 2014;21(1):97-100.
228. Ackenbom MF, Giugale LE, Wang Y, Shepherd JP. Incidence of Occult Uterine Pathology in Women Undergoing Hysterectomy With Pelvic Organ Prolapse Repair. *Female pelvic medicine & reconstructive surgery*. 2016.
229. Grigoriadis T, Valla A, Zacharakis D, Protopapas A, Athanasiou S. Vaginal hysterectomy for uterovaginal prolapse: what is the incidence of concurrent gynecological malignancy? *International urogynecology journal*. 2015;26(3):421-5.
230. Ouldamer L, Rossard L, Arbion F, Marret H, Body G. Risk of incidental finding of endometrial cancer at the time of hysterectomy for benign condition. *Journal of minimally invasive gynecology*. 2014;21(1):131-5.
231. Bojahr B, Tchatchian G, Waldschmidt M, Schollmeyer T, De Wilde RL. Laparoscopic Sacropexy: A Retrospective Analysis of Perioperative Complications and Anatomical Outcomes. *JLS : Journal of the Society of Laparoendoscopic Surgeons / Society of Laparoendoscopic Surgeons*. 2012;16(3):428-36.
232. Swift SE. The distribution of pelvic organ support in a population of female subjects seen for routine gynecologic health care. *American journal of obstetrics and gynecology*. 2000;183(2):277-85.
233. Delancey JO. Fascial and muscular abnormalities in women with urethral hypermobility and anterior vaginal wall prolapse. *American journal of obstetrics and gynecology*. 2002;187(1):93-8.
234. Shull BL. Pelvic organ prolapse: anterior, superior, and posterior vaginal segment defects. *American journal of obstetrics and gynecology*. 1999;181(1):6-11.
235. Toozs-Hobson P, Boos K, Cardozo L. Management of vaginal vault prolapse. *Br J Obstet Gynaecol*. 1998;105(1):13-7.
236. Eilber KSMD, Alperin MMD, Khan AMD, Wu NP, Pashos CLP, Clemens JQMDM, et al. Outcomes of Vaginal Prolapse Surgery Among Female Medicare Beneficiaries: The Role of Apical Support. *Obstetrics and gynecology*. 2013;122(5).
237. Rooney K, Kenton K, Mueller ER, FitzGerald MP, Brubaker L. Advanced anterior vaginal wall prolapse is highly correlated with apical prolapse. *American journal of obstetrics and gynecology*. 2006;195(6):1837-40.
238. Hsu Y, Chen L, Summers A, Ashton-Miller JA, DeLancey JO. Anterior vaginal wall length and degree of anterior compartment prolapse seen on dynamic MRI. *International urogynecology journal and pelvic floor dysfunction*. 2008;19(1):137-42.
239. Sederl J. Zur operation des prolapses der blind endigenden sheiden. *Geburtshilfe Frauenheilkd*. 1958;18:824-8.
240. Colombo M, Milani R. Sacrospinous ligament fixation and modified McCall culdoplasty during vaginal hysterectomy for advanced uterovaginal prolapse. *American journal of obstetrics and gynecology*. 1998;179(1):13-20.
241. Shull BL, Capen CV, Riggs MW, Kuehl TJ. Preoperative and postoperative analysis of site-specific pelvic support defects in 81 women treated with sacrospinous ligament suspension and pelvic reconstruction. *American journal of obstetrics and gynecology*. 1992;166(6 Pt 1):1764-8; discussion 8-71.
242. Weber AM, Richter HE. Pelvic organ prolapse. *Obstetrics and gynecology*. 2005;106(3):615-34.
243. Morgan DM, Rogers MA, Huebner M, Wei JT, Delancey JO, editors. Heterogeneity in anatomic outcome of sacrospinous ligament fixation for prolapse: a systematic review. *United States*2007.
244. Barber MD, Brubaker L, Burgio KL, Richter HE, Nygaard I, Weidner AC, et al. Factorial comparison of two transvaginal surgical approaches and of perioperative behavioral therapy for women with apical vaginal prolapse: The OPTIMAL Randomized Trial. *JAMA : the journal of the American Medical Association*. 2014;311(10):1023-34.
245. Sze EH, Karram MM. Transvaginal repair of vault prolapse: a review. *Obstetrics and gynecology*. 1997;89(3):466-75.
246. Imperato E, Aspesi G, Rovetta E, Presti M. Surgical management and prevention of vaginal vault prolapse. *Surg Gynecol Obstet*. 1992;175(3):233-7.
247. Pasley WW. Sacrospinous suspension: a local practitioner's experience. *American journal of obstetrics and gynecology*. 1995;173(2):440-5; discussion 5-8.
248. Penalver M, Mekki Y, Lafferty H, Escobar M, Angioli R. Should sacrospinous ligament fixation for the management of pelvic support defects be part of a residency program procedure? The University of Miami experience. *American journal of obstetrics and gynecology*. 1998;178(2):326-9.

249. Meschia M, Bruschi F, Amicarelli F, Pifarotti P, Marchini M, Crosignani PG. The sacrospinous vaginal vault suspension: Critical analysis of outcomes. *Int Urogynecol J Pelvic Floor Dysfunct.* 1999;10(3):155-9.
250. Sze EH, Kohli N, Miklos JR, Roat T, Karram MM. A retrospective comparison of abdominal sacrocolpopexy with Burch colposuspension versus sacrospinous fixation with transvaginal needle suspension for the management of vaginal vault prolapse and coexisting stress incontinence. *Int Urogynecol J Pelvic Floor Dysfunct.* 1999;10(6):390-3.
251. Lantzsch T, Goepel C, Wolters M, Koelbl H, Methfessel HD. Sacrospinous ligament fixation for vaginal vault prolapse. *Archives of gynecology and obstetrics.* 2001;265(1):21-5.
252. Lovatsis D, Drutz HP. Safety and efficacy of sacrospinous vault suspension. *International urogynecology journal and pelvic floor dysfunction.* 2002;13(5):308-13.
253. Cruikshank SH, Muniz M, editors. Outcomes study: A comparison of cure rates in 695 patients undergoing sacrospinous ligament fixation alone and with other site-specific procedures--a 16-year study. United States 2003.
254. Nieminen K, Huhtala H, Heinonen PK. Anatomic and functional assessment and risk factors of recurrent prolapse after vaginal sacrospinous fixation. *Acta obstetrica et gynecologica Scandinavica.* 2003;82(5):471-8.
255. Toglia MR, Fagan MJ, editors. Suture erosion rates and long-term surgical outcomes in patients undergoing sacrospinous ligament suspension with braided polyester suture. United States 2008.
256. Aigmueller T, Riss P, Dungal A, Bauer H. Long-term follow-up after vaginal sacrospinous fixation: patient satisfaction, anatomical results and quality of life. *International urogynecology journal and pelvic floor dysfunction.* 2008;19(7):965-9.
257. Chou LY, Chang DY, Sheu BC, Huang SC, Chen SY, Chang WC, editors. Clinical outcome of transvaginal sacrospinous fixation with the Veronikis ligature carrier in genital prolapse. Ireland 2010.
258. Larson KAMD, Smith TMD, Berger MBMD, Abernethy MMD, Mead S, Fenner DEMD, et al. Long-Term Patient Satisfaction With Michigan Four-Wall Sacrospinous Ligament Suspension for Prolapse. [Article]: *Obstetrics & Gynecology* November 2013;122(5):967-975.
259. Qatawneh A, Thekrallah F, Bata M, Al-Kazaleh F, Almustafa M, Abu-Kader I. Risk factors of surgical failure following sacrospinous colpopexy for the treatment of uterovaginal prolapse. *Archives of gynecology and obstetrics.* 2013;287(6):1159-65.
260. Leone Roberti Maggiore UMD, Ferrero SP, Salvatore S. Value of Urodynamics Before Stress Urinary Incontinence Surgery: A Randomized Controlled Trial. [Letter]: *Obstetrics & Gynecology* October 2013;122(4):904-905.
261. Mothes AR, Mothes HK, Radosa MP, Runnebaum IB. Systematic assessment of surgical complications in 438 cases of vaginal native tissue repair for pelvic organ prolapse adopting Clavien-Dindo classification. *Archives of gynecology and obstetrics.* 2015;291(6):1297-301.
262. Baden WF, Walker TA. Genesis of the vaginal profile: a correlated classification of vaginal relaxation. *Clin Obstet Gynecol.* 1972;15(4):1048-54.
263. Miller N. A new method of correcting complete inversion of the vagina. *Surg Gynecol Obstet.* 1927;44:550-4.
264. Margulies RU, Rogers MA, Morgan DM. Outcomes of transvaginal uterosacral ligament suspension: systematic review and metaanalysis. *American journal of obstetrics and gynecology.* 2010;202(2):124-34.
265. Gustilo-Ashby AM, Jelovsek JE, Barber MD, Yoo EH, Paraiso MF, Walters MD. The incidence of ureteral obstruction and the value of intraoperative cystoscopy during vaginal surgery for pelvic organ prolapse. *American journal of obstetrics and gynecology.* 2006;194(5):1478-85.
266. Unger CA, Walters MD, Ridgeway B, Jelovsek JE, Barber MD, Paraiso MF. Incidence of adverse events after uterosacral colpopexy for uterovaginal and posthysterectomy vault prolapse. *American journal of obstetrics and gynecology.* 2015;212(5):603.e1-7.
267. Dwyer PL, Fatton B. Bilateral extraperitoneal uterosacral suspension: a new approach to correct posthysterectomy vaginal vault prolapse. *International urogynecology journal and pelvic floor dysfunction.* 2008;19(2):283-92.
268. Fatton B, Dwyer PL, Ahtari C, Tan PK. Bilateral extraperitoneal uterosacral vaginal vault suspension: a 2-year follow-up longitudinal case series of 123 patients. *International urogynecology journal and pelvic floor dysfunction.* 2009;20(4):427-34.
269. Lowenstein L, Fitz A, Kenton K, FitzGerald MP, Mueller ER, Brubaker L, editors. Trans-abdominal uterosacral suspension: outcomes and complications. United States 2009.

270. Rardin CR, Ereksun EA, Sung VW, Ward RM, Myers DL. Uterosacral colpopexy at the time of vaginal hysterectomy: comparison of laparoscopic and vaginal approaches. *Journal of Reproductive Medicine*. 2009;54(5):273-80.
271. Turner LC, Lavelle ES, Shepherd JP. Comparison of complications and prolapse recurrence between laparoscopic and vaginal uterosacral ligament suspension for the treatment of vaginal prolapse. *International urogynecology journal*. 2015.
272. Jenkins VR, 2nd. Uterosacral ligament fixation for vaginal vault suspension in uterine and vaginal vault prolapse. *American journal of obstetrics and gynecology*. 1997;177(6):1337-43; discussion 43-4.
273. Comiter CV, Vasavada SP, Raz S. Transvaginal culdosuspension: technique and results. *Urology*. 1999;54(5):819-22.
274. Shull BL, Bachofen C, Coates KW, Kuehl TJ. A transvaginal approach to repair of apical and other associated sites of pelvic organ prolapse with uterosacral ligaments. *American journal of obstetrics and gynecology*. 2000;183(6):1365-73.
275. Karram M, Goldwasser S, Kleeman S, Steele A, Vassallo B, Walsh P. High uterosacral vaginal vault suspension with fascial reconstruction for vaginal repair of enterocele and vaginal vault prolapse. *American journal of obstetrics and gynecology*. 2001;185(6):1339-42; discussion 42-3.
276. Amundsen CL, Flynn BJ, Webster GD. Anatomical correction of vaginal vault prolapse by uterosacral ligament fixation in women who also require a pubovaginal sling. *J Urol*. 2003;169(5):1770-4.
277. Antovska SV, Dimitrov DG. Vaginosacral colpopexy (VSC)--a new modification of the Mc Call operation using vaginosacral ligaments as autologous sliding grafts in posthysterectomy vault prolapse. *Bratisl Lek Listy*. 2006;107(3):62-72.
278. de Boer TA, Milani AL, Kluivers KB, Withagen MI, Vierhout ME. The effectiveness of surgical correction of uterine prolapse: cervical amputation with uterosacral ligament plication (modified Manchester) versus vaginal hysterectomy with high uterosacral ligament plication. *International urogynecology journal and pelvic floor dysfunction*. 2009;20(11):1313-9.
279. Doumouchsis SK, Khunda A, Jeffery ST, Franco AV, Fynes MM. Long-term outcomes of modified high uterosacral ligament vault suspension (HUSLS) at vaginal hysterectomy. *International urogynecology journal*. 2011;22(5):577-84.
280. Wong MT, Abet E, Rigaud J, Frampas E, Lehur PA, Meurette G. Minimally invasive ventral mesh rectopexy for complex rectocele: impact on anorectal and sexual function. *Colorectal disease : the official journal of the Association of Coloproctology of Great Britain and Ireland*. 2011;13(10):e320-6.
281. Cunjian Y, Li L, Xiaowen W, Shengrong L, Hao X, Xiangqiong L. A retrospective analysis of the effectiveness of a modified abdominal high uterosacral colpopexy in the treatment of uterine prolapse. *Cell biochemistry and biophysics*. 2012;64(2):95-9.
282. Edenfield ALMD, Amundsen CLMD, Weidner ACMD, Wu JMMDMPH, George AMD, Siddiqui NYMDM. Vaginal Prolapse Recurrence After Uterosacral Ligament Suspension in Normal-Weight Compared With Overweight and Obese Women. [Article]: *Obstetrics & Gynecology* March 2013;121(3):554-559.
283. Rondini C, Braun H, Alvarez J, Urzua MJ, Villegas R, Wenzel C, et al. High uterosacral vault suspension vs Sacrocolpopexy for treating apical defects: a randomized controlled trial with twelve months follow-up. *International urogynecology journal*. 2015;26(8):1131-8.
284. Webb MJ, Aronson MP, Ferguson LK, Lee RA, editors. Posthysterectomy vaginal vault prolapse: primary repair in 693 patients. *United States*1998.
285. Aronson MP, Aronson PK, Howard AE, Morse AN, Baker SP, Young SB, editors. Low risk of ureteral obstruction with "deep" (dorsal/posterior) uterosacral ligament suture placement for transvaginal apical suspension. *United States*2005.
286. Montella JM, Morrill MY. Effectiveness of the McCall culdeplasty in maintaining support after vaginal hysterectomy. *International urogynecology journal and pelvic floor dysfunction*. 2005;16(3):226-9.
287. Koyama M, Yoshida S, Koyama S, Ogita K, Kimura T, Shimoya K, et al. Surgical reinforcement of support for the vagina in pelvic organ prolapse: concurrent iliococcygeus fascia colpopexy (Inmon technique). *International urogynecology journal*. 2005;16(3):197-202.
288. Frances W, Jeffcoate T. Dysparunia following vaginal operations. *J Obstet Gynaecol Br Commonw*. 1961;68:1-10.
289. Natale F, La Penna C, Padoa A, Agostini M, Panei M, Cervigni M. High levator myorrhaphy versus uterosacral ligament suspension for vaginal vault fixation: a prospective, randomized study. *Int Urogynecol J Pelvic Floor Dysfunct*. 2010;21(5):515-22.

290. Shull BL, Capen CV, Riggs MW, Kuehl TJ. Bilateral attachment of the vaginal cuff to iliococcygeus fascia: an effective method of cuff suspension. *American journal of obstetrics and gynecology*. 1993;168(6 Pt 1):1669-74; discussion 74-7.
291. Meeks GR, Washburne JF, McGehee RP, Wisner WL, editors. Repair of vaginal vault prolapse by suspension of the vagina to iliococcygeus (prespinous) fascia. United States 1994.
292. Maher CF, Murray CJ, Carey MP, Dwyer PL, Ugoni AM. Iliococcygeus or sacrospinous fixation for vaginal vault prolapse. *Obstetrics and gynecology*. 2001;98(1):40-4.
293. Serati M, Braga A, Bogani G, Leone Roberti Maggiore U, Sorice P, Ghezzi F, et al. Iliococcygeus fixation for the treatment of apical vaginal prolapse: efficacy and safety at 5 years of follow-up. *International urogynecology journal*. 2015;26(7):1007-12.
294. Maher C, Feiner B, Baessler K, Christmann-Schmid C, Haya N, Brown J. Surgery for women with apical vaginal prolapse. *Cochrane Database of Systematic Reviews*. 2016(10).
295. Sokol AI, Iglesia CB, Kudish BI, Gutman RE, Shveiky D, Bercik R, et al. One-year objective and functional outcomes of a randomized clinical trial of vaginal mesh for prolapse. *Am J Obstet Gynecol*. 2012;206(1):86-9.
296. Halaska M, Maxova K, Sottner O, Svabik K, Mlcoch M, Kolarik D. A multicentre randomized prospective controlled study comparing sacrospinous fixation and transvaginal mesh in the treatment of posthysterectomy vaginal vault prolapse. *American journal of obstetrics and gynecology*. 2012;207(301):e1-7.
297. Svabik K, Martan A, Masata J, El-Haddad R, Hubka P. Comparison of vaginal mesh repair with sacrospinous vaginal colpopexy in the management of vaginal vault prolapse after hysterectomy in patients with levator ani avulsion: a randomized controlled trial. *Ultrasound Obstet Gynecol*. 2014;43(4):365-71.
298. Dos Reis Brandao da Silveira S, Haddad JM, de Jarmy-Di Bella ZI, Nastri F, Kawabata MG, da Silva Carramao S, et al. Multicenter, randomized trial comparing native vaginal tissue repair and synthetic mesh repair for genital prolapse surgical treatment. *International urogynecology journal*. 2015;26(3):335-42.
299. Iglesia CB, Sokol AI, Sokol ER, Kudish BI, Gutman RE, Peterson JL, et al. Vaginal mesh for prolapse: a randomized controlled trial. *Obstetrics and gynecology*. 2010;116(2 Pt 1):293-303.
300. Abdel-Fattah M, Ramsay I. Retrospective multicentre study of the new minimally invasive mesh repair devices for pelvic organ prolapse. *BJOG : an international journal of obstetrics and gynaecology*. 2008;115(1):22-30.
301. Gauruder-Burmester A KP, Rohne J, Gronewold, M TR. Follow-up after polypropylene mesh repair of anterior and posterior compartments in patients with recurrent prolapse. *International urogynecology journal*. 2007;18:1059-64.
302. Moore RD, Mitchell GK, Miklos JR. Single-incision vaginal approach to treat cystocele and vault prolapse with an anterior wall mesh anchored apically to the sacrospinous ligaments. *International urogynecology journal*. 2012;23(1):85-91.
303. Stanford EJ, Moore RD, Roovers JP, VanDrie DM, Giudice TP, Lukban JC, et al. Elevate and Uterine Preservation: Two-Year Results. *Female pelvic medicine & reconstructive surgery*. 2015;21(4):205-10.
304. Rapp DE, King AB, Rowe B, Wolters JP. Comprehensive evaluation of anterior elevate system for the treatment of anterior and apical pelvic floor descent: 2-year followup. *J Urol*. 2014;191(2):389-94.
305. Lo TS, Tan YL, Cortes EF, Pue LB, Wu PY, Al-Kharabsheh A. Anterior-apical single-incision mesh surgery (SIMS): surgical and functional outcomes at 1 year. *Journal of minimally invasive gynecology*. 2015;22(1):50-6.
306. Marschke J, Hengst L, Schwertner-Tiepelmann N, Beilecke K, Tunn R. Transvaginal single-incision mesh reconstruction for recurrent or advanced anterior vaginal wall prolapse. *Archives of gynecology and obstetrics*. 2015;291(5):1081-7.
307. Letouzey V, Ulrich D, Balenbois E, Cornille A, de Tayrac R, Fatton B. Utero-vaginal suspension using bilateral vaginal anterior sacrospinous fixation with mesh: intermediate results of a cohort study. *International urogynecology journal*. 2015;26(12):1803-7.
308. Fatton B, Amblard J, Debodinance P, Cosson M, Jacquelin B. Transvaginal repair of genital prolapse: preliminary results of a new tension-free vaginal mesh (Prolift technique)--a case series multicentric study. *Int Urogynecol J Pelvic Floor Dysfunct*. 2007;18(7):743-52.
309. Belot F, Collinet P, Debodinance P, Ha Duc E, Lucot JP, Cosson M. Risk factors for prosthesis exposure in treatment of genital prolapse via the vaginal approach. *Gynecologie, obstetrique & fertilité*. 2005;33(12):970-4.

310. Milani AL, Withagen MI, Vierhout ME. Trocar-guided total tension-free vaginal mesh repair of post-hysterectomy vaginal vault prolapse. *Int Urogynecol J Pelvic Floor Dysfunct.* 2009;20(10):1203-11.
311. McDermott CD, Terry CL, Woodman PJ, Hale DS. Surgical outcomes following total Prolift: colpopexy versus hysteropexy. *The Australian & New Zealand journal of obstetrics & gynaecology.* 2011;51(1):61-6.
312. Biertho I, Dallemagne B, Dewandre JM, Markiewicz S, Monami B, Wahlen C, et al. Intravaginal slingplasty: short term results. *Acta Chir Belg.* 2004;104(6):700-4.
313. Foote AJ, Ralph J. Infracoccygeal sacropexy. *The Australian & New Zealand journal of obstetrics & gynaecology.* 2007;47(3):250-1.
314. Mattox TF, Moore S, Stanford EJ, Mills BB. Posterior vaginal sling experience in elderly patients yields poor results. *American journal of obstetrics and gynecology.* 2006;194(5):1462-6.
315. Vardy MD, Brodman M, Olivera CK, Zhou HS, Flisser AJ, Bercik RS. Anterior intravaginal slingplasty tunneller device for stress incontinence and posterior intravaginal slingplasty for apical vault prolapse: a 2-year prospective multicenter study. *American journal of obstetrics and gynecology.* 2007;197(1):104.e1-8.
316. de TR, Devoldere G, Renaudie J, Villard P, Guilbaud O, Eglin G. Prolapse repair by vaginal route using a new protected low-weight polypropylene mesh: 1-year functional and anatomical outcome in a prospective multicentre study. *Int Urogynecol J Pelvic Floor Dysfunct.* 2007;18(3):251-6.
317. Lee YS, Han DH, Lee JY, Kim JC, Choo MS, Lee KS. Anatomical and functional outcomes of posterior intravaginal slingplasty for the treatment of vaginal vault or uterine prolapse: a prospective, multicenter study. *Korean journal of urology.* 2010;51(3):187-92.
318. Amrute KV, Eisenberg ER, Rastinehad AR, Kushner L, Badlani GH. Analysis of outcomes of single polypropylene mesh in total pelvic floor reconstruction. *Neurourology and urodynamics.* 2007;26(1):53-8.
319. Lane F. Repair of posthysterectomy vaginal-vault prolapse. *Obstetrics and gynecology.* 1962;20:72-7.
320. Lo TS, Wang AC. Abdominal colposacropexy and sacrospinous ligament suspension for severe uterovaginal prolapse: a comparison. *J Gynecol Surg.* 1998;14:59-64.
321. Maher C, Feiner B, DeCuyper E, Nichlos C, Hickey K, O'Rourke P. Laparoscopic sacral colpopexy versus total vaginal mesh for vaginal vault prolapse: a randomized trial. *American journal of obstetrics and gynecology.* 2011;204(4):360 e1-7.
322. Siddiqui NY, Grimes CL, Casiano ER, Abed HT, Jeppson PC, Olivera CK, et al. Mesh sacrocolpopexy compared with native tissue vaginal repair: a systematic review and meta-analysis. *Obstetrics and gynecology.* 2015;125(1):44-55.
323. Nygaard IE, McCreery R, Brubaker L, Connolly A, Cundiff G, Weber AM, et al. Abdominal sacrocolpopexy: a comprehensive review. *Obstetrics and gynecology.* 2004;104(4):805-23.
324. Nygaard I, Brubaker L, Zyczynski HM, Cundiff G, Richter H, Gantz M, et al. Long-term outcomes following abdominal sacrocolpopexy for pelvic organ prolapse. *JAMA : the journal of the American Medical Association.* 2013;309(19):2016-24.
325. Whitehead WE, Bradley CS, Brown MB, Brubaker L, Gutman RE, Varner RE, et al. Gastrointestinal complications following abdominal sacrocolpopexy for advanced pelvic organ prolapse. *American journal of obstetrics and gynecology.* 2007;197:78 e1-7.
326. Brubaker L, Cundiff GW, Fine P, Nygaard I, Richter HE, Visco AG, et al., editors. *Abdominal sacrocolpopexy with Burch colposuspension to reduce urinary stress incontinence.* United States 2006.
327. Addison WA, Livengood CH, 3rd, Sutton GP, Parker RT, editors. *Abdominal sacral colpopexy with Mersilene mesh in the retroperitoneal position in the management of posthysterectomy vaginal vault prolapse and enterocele.* United States 1985.
328. Baker KR, Beresford JM, Campbell C. Colposacropexy with Prolene mesh. *Surg Gynecol Obstet.* 1990;171(1):51-4.
329. Snyder TE, Krantz KE. Abdominal-retroperitoneal sacral colpopexy for the correction of vaginal prolapse. *Obstetrics and gynecology.* 1991;77(6):944-9.
330. Timmons MC, Addison WA, Addison SB, Cavenar MG. Abdominal sacral colpopexy in 163 women with posthysterectomy vaginal vault prolapse and enterocele. Evolution of operative techniques. *J Reprod Med.* 1992;37(4):323-7.

331. van Lindert AC, Groenendijk AG, Scholten PC, Heintz AP. Surgical support and suspension of genital prolapse, including preservation of the uterus, using the Gore-Tex soft tissue patch (a preliminary report). *European journal of obstetrics, gynecology, and reproductive biology.* 1993;50(2):133-9.
332. Grunberger W, Grunberger V, Wierrani F. Pelvic promontory fixation of the vaginal vault in sixty-two patients with prolapse after hysterectomy. *J Am Coll Surg.* 1994;178(1):69-72.
333. Lecuru F, Taurelle R, Clouard C, Attal JP. [Surgical treatment of genito-urinary prolapses by abdominal approach. Results in a continuous series of 203 operations]. *Annales de chirurgie.* 1994;48(11):1013-9.
334. Brubaker L, editor. *Sacrocolpopexy and the anterior compartment: support and function.* United States1995.
335. de Vries MJ, vanDessel TH, Drogendijk AC, de Haas I, Huijkenhoven FJ. Short-term results and long-term patients' appraisal of abdominal colposacropey for treatment of genital and vaginal vault prolapse. . *European journal of obstetrics, gynecology, and reproductive biology.* 1995;59(35-8).
336. Hardiman PJ, Drutz HP, editors. *Sacrospinous vault suspension and abdominal colposacropey: success rates and complications.* United States1996.
337. Sullivan ES, Longaker CJ, Lee PY. Total pelvic mesh repair: a ten-year experience. *Diseases of the colon and rectum.* 2001;44(6):857-63.
338. Occelli B, Narducci F, Cosson M, Ego A, Decocq J, Querleu D, et al. [Abdominal colposacropey for the treatment of vaginal vault prolapse with or without urinary stress incontinence]. *Annales de chirurgie.* 1999;53(5):367-77.
339. Patsner B, editor. *Abdominal sacral colpopexy in patients with gynecologic cancer: report of 25 cases with long-term follow-up and literature review.* United States1999.
340. Collopy BT, Barham KA. Abdominal colpopexy with pelvic cul-de-sac closure. *Diseases of the colon and rectum.* 2002;45(4):522-6; discussion 6-9.
341. Lefranc JP, Atallah D, Camatte S, Blondon J, editors. *Longterm followup of posthysterectomy vaginal vault prolapse abdominal repair: a report of 85 cases.* United States2002.
342. Lindeque BG, Nel WS. *Sacrocolpopexy--a report on 262 consecutive operations.* *S Afr Med J.* 2002;92(12):982-5.
343. Medina CA, Pietro PA, Whitted RW, Penalver M. The use of dura mater allografts for abdominal sacral colpopexy. *J Pelvic Surg.* 2002;8:247-51.
344. Podratz KC, Ferguson LK, Hoverman VR, Lee RA, Symmonds RE. Abdominal sacral colpopexy for posthysterectomy vaginal vault descensus. . *J Pelvic Surg.* 1995;1:18-23.
345. Hilger WS, Poulson M, Norton PA, editors. *Long-term results of abdominal sacrocolpopexy.* United States2003.
346. Higgs P, Goh J, Krause H, Sloane K, Carey M, editors. *Abdominal sacral colpopexy: an independent prospective long-term follow-up study.* Australia2005.
347. Huebner M, Krzonkalla M, Tunn R, editors. *Abdominal sacrocolpopexy--standardized surgical technique, perioperative management and outcome in women with posthysterectomy vaginal vault prolapse.* Switzerland2009.
348. Tate SB, Blackwell L, Lorenz DJ, Steptoe M, Culligan P. Randomized trial of fascia lata and polypropylene mesh for abdominal sacrocolpopexy: 5-year follow-up. *International urogynecology journal.* 2010;22(2):137-43.
349. Higgs PJ, Chua HL, Smith AR, editors. *Long term review of laparoscopic sacrocolpopexy.* England2005.
350. Rivoire C, Botchorishvili R, Canis M, Jardon K, Rabischong B, Wattiez A, et al., editors. *Complete laparoscopic treatment of genital prolapse with meshes including vaginal promontofixation and anterior repair: a series of 138 patients.* United States2007.
351. Sarlos D, Brandner S, Kots L, Gygas N, Schaer G. Laparoscopic sacrocolpopexy for uterine and post-hysterectomy prolapse: anatomical results, quality of life and perioperative outcome-a prospective study with 101 cases. *International urogynecology journal and pelvic floor dysfunction.* 2008;19(10):1415-22.
352. Paraiso M, Jelovsek J, Frick A, Chen C, Barber M. Laparoscopic compared with robotic sacrocolpopexy for vaginal prolapse: a randomized controlled trial. *Obstetrics and gynecology.* 2011;118(5):1005-13.
353. Sergent F, Resch B, Loisel C, Bisson V, Schaal JP, Marpeau L. Mid-term outcome of laparoscopic sacrocolpopexy with anterior and posterior polyester mesh for treatment of genito-urinary prolapse. *European journal of obstetrics, gynecology, and reproductive biology.* 2011;156:217-22.

354. Freeman R, Pantazis K, Thomson A, Frappell J, Bombieri L, Moran P, et al. A randomised controlled trial of abdominal versus laparoscopic sacrocolpopexy for the treatment of post-hysterectomy vaginal vault prolapse: LAS study. *International urogynecology journal*. 2013;24:377-84.
355. Tyson MD, Wolter CE. A comparison of 30-day surgical outcomes for minimally invasive and open sacrocolpopexy. *Neurourology and urodynamics*. 2015;34(2):151-5.
356. Costantini E, Mearini L, Lazzeri M, Bini V, Nunzi E, di Biase M, et al. Laparoscopic Versus Abdominal Sacrocolpopexy: A Randomized, Controlled Trial. *J Urol*. 2016;196(1):159-65.
357. Mueller MG, Jacobs KM, Mueller ER, Abernethy MG, Kenton KS. Outcomes in 450 Women After Minimally Invasive Abdominal Sacrocolpopexy for Pelvic Organ Prolapse. *Female pelvic medicine & reconstructive surgery*. 2016.
358. Sarlos D, Aigmueller T, Schaer G. A technique of laparoscopic mesh excision from the bladder after sacrocolpopexy. *American journal of obstetrics and gynecology*. 2014.
359. Perez T, Crochet P, Descargues G, Tribondeau P, Soffray F, Gadonneix P, et al. Laparoscopic sacrocolpopexy for management of pelvic organ prolapse enhances quality of life at one year: a prospective observational study. *Journal of minimally invasive gynecology*. 2011;18(6):747-54.
360. Paraiso MF, Jelovsek JE, Frick A, Chen CC, Barber MD. Laparoscopic compared with robotic sacrocolpopexy for vaginal prolapse: a randomized controlled trial. *Obstetrics and gynecology*. 2011;118(5):1005-13.
361. Akladios CY, Dautun D, Saussine C, Baldauf JJ, Mathelin C, Wattiez A, editors. Laparoscopic sacrocolpopexy for female genital organ prolapse: establishment of a learning curve. Ireland 2010.
362. North CE, Ali-Ross NS, Smith AR, Reid FM, editors. A prospective study of laparoscopic sacrocolpopexy for the management of pelvic organ prolapse. England 2009.
363. Misrai V, Roupert M, Seringe E, Vaessen C, Cour F, Haertig A, et al. [Long-term results of laparoscopic sacral colpopexy for high-grade cystoceles]. *Progres en urologie : journal de l'Association francaise d'urologie et de la Societe francaise d'urologie*. 2008;18(13):1068-74.
364. Cheret A, Von Theobald P, Lucas J, Dreyfus M, Herlicoviez M, editors. [Laparoscopic promontofixation feasibility study in 44 patients]. France 2001.
365. Claerhout F, Roovers JP, Lewi P, Verguts J, De Ridder D, Deprest J. Implementation of laparoscopic sacrocolpopexy--a single centre's experience. *Int Urogynecol J Pelvic Floor Dysfunct*. 2009;20(9):1119-25.
366. Akladios CY, Dautun D, Saussine C, Baldauf JJ, Mathelin C, Wattiez A. Laparoscopic sacrocolpopexy for female genital organ prolapse: establishment of a learning curve. *European journal of obstetrics, gynecology, and reproductive biology*. 2010;149(2):218-21.
367. Mustafa S, Amit A, Filmar S, Deutsch M, Netzer I, Itskovitz-Eldor J, et al. Implementation of laparoscopic sacrocolpopexy: establishment of a learning curve and short-term outcomes. *Archives of gynecology and obstetrics*. 2012;286(4):983-8.
368. Geller EJ, Lin FC, Matthews CA. Analysis of robotic performance times to improve operative efficiency. *Journal of minimally invasive gynecology*. 2013;20(1):43-8.
369. Serati M, Bogani G, Sorice P, Braga A, Torella M, Salvatore S, et al. Robot-assisted sacrocolpopexy for pelvic organ prolapse: a systematic review and meta-analysis of comparative studies. *European urology*. 2014;66(2):303-18.
370. Anger J, Mueller E, Tarnay C, Smith B, Stroupe K, Rosenman A, et al. Robotic Compared With Laparoscopic Sacrocolpopexy: A Randomized Controlled Trial. *Obstetrics and gynecology*. 2014;123(1):5-12.
371. Chan SS, Pang SM, Cheung TH, Cheung RY, Chung TK. Laparoscopic sacrocolpopexy for the treatment of vaginal vault prolapse: with or without robotic assistance. *Hong Kong Med J*. 2011;17(1):54-60.
372. Seror J, Yates DR, Seringe E, Vaessen C, Bitterker MO, Chartier-Kastler E, et al. Prospective comparison of short-term functional outcomes obtained after pure laparoscopic and robot-assisted laparoscopic sacrocolpopexy. *World journal of urology*. 2012;30(3):393-8.
373. Antosh DD, Whyte T, Ezzell A, Chen BA, Sokol AI, Park AJ. Incidence of corneal abrasions during pelvic reconstructive surgery. *European journal of obstetrics, gynecology, and reproductive biology*. 2013;166(2):226-8.
374. Awad N, Mustafa S, Amit A, Deutsch M, Eldor-Itskovitz J, Lowenstein L. Implementation of a new procedure: laparoscopic versus robotic sacrocolpopexy. *Archives of gynecology and obstetrics*. 2013;287(6):1181-6.
375. FitzGerald MP, Mollenhauer J, Bitterman P, Brubaker L, editors. Functional failure of fascia lata allografts. United States 1999.

376. Flynn MK, Webster GD, Amundsen CL, editors. Abdominal sacral colpopexy with allograft fascia lata: one-year outcomes. United States 2005.
377. Gregory WT, Otto LN, Bergstrom JO, Clark AL. Surgical outcome of abdominal sacrocolpopexy with synthetic mesh versus abdominal sacrocolpopexy with cadaveric fascia lata. *International urogynecology journal and pelvic floor dysfunction*. 2005;16(5):369-74.
378. Claerhout F, De Ridder D, Van Beckevoort D, Coremans G, Veldman J, Lewi P, et al. Sacrocolpopexy using xenogenic acellular collagen in patients at increased risk for graft-related complications. *Neurourology and urodynamics*. 2010;29(4):563-7.
379. Quiroz LH, Gutman RE, Shippey S, Cundiff GW, Sanses T, Blomquist JL, et al. Abdominal sacrocolpopexy: anatomic outcomes and complications with Pelvicol, autologous and synthetic graft materials. *American journal of obstetrics and gynecology*. 2008;198(5):557.e1-5.
380. Deprest J, De Ridder D, Roovers JP, Werbroutck E, Coremans G, Claerhout F, editors. Medium term outcome of laparoscopic sacrocolpopexy with xenografts compared to synthetic grafts. United States 2009.
381. Culligan P, Salamon C, Priestley J, Shariati A. Porcine Dermis Compared With Polypropylene Mesh for Laparoscopic Sacrocolpopexy: A Randomized Controlled Trial. *Obstetrics and gynecology*. 2013;121(1):143-51.
382. Fitzgerald MP, Richter HE, Siddique S, Thompson P, Zyczynski H. Colpopoiesis: a review. *International urogynecology journal and pelvic floor dysfunction*. 2006;17(3):261-71.
383. Jelovsek JE, Maher C, Barber MD. Pelvic organ prolapse. *Lancet (London, England)*. 2007;369(9566):1027-38.
384. Krissi H, Aviram A, Eitan R, From A, Wiznitzer A, Peled Y. Risk factors for recurrence after Le Fort colpopoiesis for severe pelvic organ prolapse in elderly women. *International journal of surgery (London, England)*. 2015;20:75-9.
385. Hullfish KL, Bovbjerg VE, Steers WD. Colpopoiesis for pelvic organ prolapse: patient goals, quality of life, and satisfaction. *Obstetrics and gynecology*. 2007;110(2 Pt 1):341-5.
386. Vij M, Bombieri L, Dua A, Freeman R. Long-term follow-up after colpopoiesis: regret, bowel, and bladder function. *International urogynecology journal*. 2014.
387. Crisp CC, Book NM, Cunkelman JA, Tieu AL, Pauls RN. Body Image, Regret, and Satisfaction 24 Weeks After Colpopoiesis: A Multicenter Study. *Female pelvic medicine & reconstructive surgery*. 2016;22(3):132-5.
388. Reisenauer C, Oberlechner E, Schoenfisch B, Wallwiener D, Huebner M. Modified LeFort colpopoiesis: clinical outcome and patient satisfaction. *Archives of gynecology and obstetrics*. 2013;288(6):1349-53.
389. Murphy M, Sternschuss G, Haff R, van Raalte H, Saltz S, Lucente V, editors. Quality of life and surgical satisfaction after vaginal reconstructive vs obliterative surgery for the treatment of advanced pelvic organ prolapse. United States 2008.
390. Fitzgerald MP, Richter HE, Bradley CS, Ye W, Visco AC, Cundiff GW, et al. Pelvic support, pelvic symptoms, and patient satisfaction after colpopoiesis. *Int Urogynecol J Pelvic Floor Dysfunct*. 2008;19(12):1603-9.
391. Gutman RE, Bradley CS, Ye W, Markland AD, Whitehead WE, Fitzgerald MP. Effects of colpopoiesis on bowel symptoms among women with severe pelvic organ prolapse. *International urogynecology journal*. 2009;21(4):461-6.
392. Collins SA, Jelovsek JE, Chen CC, Gustilo-Ashby AM, Barber MD, editors. De novo rectal prolapse after obliterative and reconstructive vaginal surgery for urogenital prolapse. United States 2007.
393. von Pechmann WS, Mutone M, Fyffe J, Hale DS, editors. Total colpopoiesis with high levator plication for the treatment of advanced pelvic organ prolapse. United States 2003.
394. DeLancey JO. Structural anatomy of the posterior pelvic compartment as it relates to rectocele. *Am J Obstet Gynecol*. 1999;180(4):815-23.
395. Farrell SA, Dempsey T, Geldenhuis L. Histologic examination of "fascia" used in colporrhaphy. *Obstet Gynecol*. 2001;98(5 Pt 1):794-8.
396. Grimes CL, Tan-Kim J, Nager CW, Dyer KY, Menefee SA, Diwadkar GB, et al. Outcome measures to assess anatomy and function of the posterior vaginal compartment. *International urogynecology journal*. 2014;25(7):893-9.
397. Grimes CL, Lukacz ES. Posterior vaginal compartment prolapse and defecatory dysfunction: are they related? *International urogynecology journal*. 2012;23(5):537-51.
398. Arnold MW, Stewart WR, PS. A. Rectocele repair. Four year's experience. *Diseases of the colon and rectum*. 1990;33(684-7.).

399. Mellgren A, Anzen B, Nilsson BY, Johansson C, Dolk A, Gillgren P, et al. Results of rectocele repair. A prospective study. *Diseases of the colon and rectum*. 1995;38(1):7-13.
400. Kahn MA SS. Posterior colporrhaphy: its effects on bowel and sexual function. *Br J Obstet Gynaecol*. 1997;104:82-6.
401. Weber AM, Walters MD, Piedmonte MR. Sexual function and vaginal anatomy in women before and after surgery for pelvic organ prolapse and urinary incontinence. *American journal of obstetrics and gynecology*. 2000;182(6):1610-5.
402. Maher CF, Qatwneh A, Baessler K, Schluter P. Midline rectovaginal fascial plication for repair of rectocele and obstructed defecation. *Int Urogynecol J Pelvic Floor Dysfunct*. 2002;13(1):Abstract 166.
403. Abramov Y, Kwon C, Gandhi S, Goldberg R, P S. Long-term anatomic outcome of discrete site-specific defect repair versus standard posterior colporrhaphy for the correction of advanced rectocele: A 1 year follow-up analysis. *Neurourology and urodynamics*. 2003;22(5):520-1.
404. Abramov Y, Gandhi S, Goldberg RP, Botros SM, Kwon C, Sand PK. Site-specific rectocele repair compared with standard posterior colporrhaphy. *Obstetrics and gynecology*. 2005;105(2):314-8.
405. Kenton K, Shott S, Brubaker L. Outcome after rectovaginal fascia reattachment for rectocele repair. *American journal of obstetrics and gynecology*. 1999;181(6):1360-3.
406. Cundiff GW, Weidner AC, Visco AG, Addison WA, Bump RC. An anatomic and functional assessment of the discrete defect rectocele repair. *American journal of obstetrics and gynecology*. 1998;179(6 Pt 1):1451-6.
407. Porter WE, Steele A, Walsh P, Kohli N, M. K. The anatomic and functional outcomes of defect-specific rectocele repair. *American journal of obstetrics and gynecology*. 1999;181:1353-9.
408. Glavind K, Madsen H. A prospective study of the discrete fascial defect rectocele repair. *Acta obstetrica et gynecologica Scandinavica*. 2000;79(2):145-7.
409. Singh K, Cortes E, Reid WM. Evaluation of the fascial technique for surgical repair of isolated posterior vaginal wall prolapse. *Obstetrics and gynecology*. 2003;101(2):320-4.
410. Paraiso MFR, Barber MD, Muir TW, Walters MD. Rectocele repair: a randomized trial of three surgical techniques including graft augmentation. *American Journal Of Obstetrics And Gynecology*. 2006;195(6):1762-71.
411. Sung VW, Rardin CR, Raker CA, Lasala CA, Myers DL. Porcine subintestinal submucosal graft augmentation for rectocele repair: a randomized controlled trial. *Obstetrics and gynecology*. 2012;119(1):125-33.
412. Paraiso MF, Barber MD, Muir TW, Walters MD. Rectocele repair: a randomized trial of three surgical techniques including graft augmentation. *American journal of obstetrics and gynecology*. 2006;195(6):1762-71.
413. Grimes CL, Tan-Kim J, Whitcomb EL, Lukacz ES, Menefee SA. Long-term outcomes after native tissue vs. biological graft-augmented repair in the posterior compartment. *International urogynecology journal*. 2012;23(5):597-604.
414. Madsen LD, Nussler E, Kesmodel US, Greisen S, Bek KM, Glavind-Kristensen M. Native-tissue repair of isolated primary rectocele compared with nonabsorbable mesh: patient-reported outcomes. *International urogynecology journal*. 2016.
415. Baessler K, Schuessler B. Abdominal sacrocolpopexy and anatomy and function of the posterior compartment. *Obstetrics and gynecology*. 2001;97(5 Pt 1):678-84.
416. Fox SD, Stanton SL. Vault prolapse and rectocele: assessment of repair using sacrocolpopexy with mesh interposition. *BJOG : an international journal of obstetrics and gynaecology*. 2000;107(11):1371-5.
417. Su KC, Mutone MF, Terry CL, Hale DS. Abdominovaginal sacral colpoperineopexy: patient perceptions, anatomical outcomes, and graft erosions. *Int Urogynecol J Pelvic Floor Dysfunct*. 2007;18(5):503-11.
418. Lyons TL, Winer WK. Laparoscopic rectocele repair using polyglactin mesh. *The Journal of the American Association of Gynecologic Laparoscopists*. 1997;4(3):381-4.
419. Marinkovic SP, Stanton SL. Triple compartment prolapse: sacrocolpopexy with anterior and posterior mesh extensions. *BJOG : an international journal of obstetrics and gynaecology*. 2003;110(3):323-6.
420. Kahn MA, Stanton SL, Kumar D, SD F. Posterior colporrhaphy is superior to the transanal repair for treatment of posterior vaginal wall prolapse. *Neurourology and urodynamics*. 1999;18(4):70-1.

421. Nieminen K, Hiltunen KM, Laitinen J, Oksala J, Heinonen PK. Transanal or vaginal approach to rectocele repair: a prospective, randomized pilot study. *Diseases of the colon and rectum*. 2004;47(10):1636-42.
422. Farid M, Madbouly KM, Hussein A, Mahdy T, Moneim HA, Omar W. Randomized controlled trial between perineal and anal repairs of rectocele in obstructed defecation. *World J Surg*. 2010;34(4):822-9.
423. Puigdollers A, Fernandez-Fraga X, Azpiroz F. Persistent symptoms of functional outlet obstruction after rectocele repair. *Colorectal Dis*. 2007;9(3):262-5.
424. Thornton MJ, Lam A, King DW. Laparoscopic or transanal repair of rectocele? A retrospective matched cohort study. *Dis Colon Rectum*. 2005;48(4):792-8.
425. van Dam JH, Huisman WM, Hop WC, Schouten WR. Fecal continence after rectocele repair: a prospective study. *Int J Colorectal Dis*. 2000;15(1):54-7.
426. Fleming FJ, Kim MJ, Gunzler D, Messing S, Monson JR, Speranza JR. It's the procedure not the patient: the operative approach is independently associated with an increased risk of complications after rectal prolapse repair. *Colorectal disease : the official journal of the Association of Coloproctology of Great Britain and Ireland*. 2012;14(3):362-8.
427. Madiba TE, Baig MK, Wexner SD. Surgical management of rectal prolapse. *Archives of surgery (Chicago, Ill : 1960)*. 2005;140(1):63-73.
428. Schiedeck TH, Schwandner O, Scheele J, Farke S, Bruch HP. Rectal prolapse: which surgical option is appropriate? *Langenbeck's archives of surgery / Deutsche Gesellschaft für Chirurgie*. 2005;390(1):8-14.
429. D'Hoore A, Cadoni R, Penninckx F. Long-term outcome of laparoscopic ventral rectopexy for total rectal prolapse. *The British journal of surgery*. 2004;91(11):1500-5.
430. Gouvas N, Georgiou PA, Agalianos C, Tan E, Tekkis P, Derveniz C, et al. Ventral colpopexy for overt rectal prolapse and obstructed defaecation syndrome: a systematic review. *Colorectal disease : the official journal of the Association of Coloproctology of Great Britain and Ireland*. 2015;17(2):O34-46.
431. Emile SH, Elbanna H, Youssef M, Thabet W, Omar W, Elshobaky A, et al. Laparoscopic ventral mesh rectopexy versus Delorme's operation in management of complete rectal prolapse: a prospective randomized study. *Colorectal disease : the official journal of the Association of Coloproctology of Great Britain and Ireland*. 2016.
432. Mercer-Jones MA, D'Hoore A, Dixon AR, Lehur P, Lindsey I, Mellgren A, et al. Consensus on ventral rectopexy: report of a panel of experts. *Colorectal disease : the official journal of the Association of Coloproctology of Great Britain and Ireland*. 2014;16(2):82-8.
433. Agachan F, Chen T, Pfeifer J, Reissman P, Wexner SD. A constipation scoring system to simplify evaluation and management of constipated patients. *Diseases of the colon and rectum*. 1996;39(6):681-5.
434. Altomare DF, Spazzafumo L, Rinaldi M, Dodi G, Ghiselli R, Piloni V. Set-up and statistical validation of a new scoring system for obstructed defaecation syndrome. *Colorectal disease : the official journal of the Association of Coloproctology of Great Britain and Ireland*. 2008;10(1):84-8.
435. Rockwood TH, Church JM, Fleshman JW, Kane RL, Mavrantonis C, Thorson AG, et al. Fecal Incontinence Quality of Life Scale: quality of life instrument for patients with fecal incontinence. *Diseases of the colon and rectum*. 2000;43(1):9-16; discussion -7.
436. Jorge JM, Wexner SD. Etiology and management of fecal incontinence. *Diseases of the colon and rectum*. 1993;36(1):77-97.
437. de Hoog DE, Heemskerk J, Nieman FH, van Gemert WG, Baeten CG, Bouvy ND. Recurrence and functional results after open versus conventional laparoscopic versus robot-assisted laparoscopic rectopexy for rectal prolapse: a case-control study. *International journal of colorectal disease*. 2009;24(10):1201-6.
438. Wijffels NA, Collinson R, Cunningham C, Lindsey I. What is the natural history of internal rectal prolapse? *Colorectal disease : the official journal of the Association of Coloproctology of Great Britain and Ireland*. 2010;12(8):822-30.
439. Evans C, Stevenson AR, Sileri P, Mercer-Jones MA, Dixon AR, Cunningham C, et al. A Multicenter Collaboration to Assess the Safety of Laparoscopic Ventral Rectopexy. *Diseases of the colon and rectum*. 2015;58(8):799-807.

440. Formijne Jonkers HA, Poirier N, Draaisma WA, Broeders IA, Consten EC. Laparoscopic ventral rectopexy for rectal prolapse and symptomatic rectocele: an analysis of 245 consecutive patients. *Colorectal disease : the official journal of the Association of Coloproctology of Great Britain and Ireland*. 2013;15(6):695-9.
441. Gosselink MP, Adusumilli S, Gorissen KJ, Fourie S, Tuynman JB, Jones OM, et al. Laparoscopic ventral rectopexy for fecal incontinence associated with high-grade internal rectal prolapse. *Diseases of the colon and rectum*. 2013;56(12):1409-14.
442. Gosselink MP, Joshi H, Adusumilli S, van Onkelen RS, Fourie S, Hompes R, et al. Laparoscopic ventral rectopexy for faecal incontinence: equivalent benefit is seen in internal and external rectal prolapse. *Journal of gastrointestinal surgery : official journal of the Society for Surgery of the Alimentary Tract*. 2015;19(3):558-63.
443. Horisberger K, Rickert A, Templin S, Post S, Kienle P. Laparoscopic ventral mesh rectopexy in complex pelvic floor disorder. *International journal of colorectal disease*. 2016;31(5):991-6.
444. Lauretta A, Bellomo RE, Galanti F, Tonizzo CA, Infantino A. Laparoscopic low ventral rectocolpopexy (LLVR) for rectal and rectogenital prolapse: surgical technique and functional results. *Techniques in coloproctology*. 2012;16(6):477-83.
445. Mackenzie H, Dixon AR. Proficiency gain curve and predictors of outcome for laparoscopic ventral mesh rectopexy. *Surgery*. 2014;156(1):158-67.
446. Maggiori L, Bretagnol F, Ferron M, Panis Y. Laparoscopic ventral rectopexy: a prospective long-term evaluation of functional results and quality of life. *Techniques in coloproctology*. 2013;17(4):431-6.
447. Ogilvie JW, Jr., Stevenson AR, Powar M. Case-matched series of a non-cross-linked biologic versus non-absorbable mesh in laparoscopic ventral rectopexy. *International journal of colorectal disease*. 2014;29(12):1477-83.
448. Randall J, Smyth E, McCarthy K, Dixon AR. Outcome of laparoscopic ventral mesh rectopexy for external rectal prolapse. *Colorectal disease : the official journal of the Association of Coloproctology of Great Britain and Ireland*. 2014;16(11):914-9.
449. Samaranyake CB, Luo C, Plank AW, Merrie AE, Plank LD, Bissett IP. Systematic review on ventral rectopexy for rectal prolapse and intussusception. *Colorectal disease : the official journal of the Association of Coloproctology of Great Britain and Ireland*. 2010;12(6):504-12.
450. Smart NJ, Pathak S, Boorman P, Daniels IR. Synthetic or biological mesh use in laparoscopic ventral mesh rectopexy--a systematic review. *Colorectal disease : the official journal of the Association of Coloproctology of Great Britain and Ireland*. 2013;15(6):650-4.
451. Tranchart H, Valverde A, Goasguen N, Gravie JF, Mosnier H. Conservative treatment of intrarectal mesh migration after ventral laparoscopic rectopexy for rectal prolapse. *International journal of colorectal disease*. 2013;28(11):1563-6.
452. Tsunoda A, Ohta T, Kiyasu Y, Kusanagi H. Laparoscopic ventral rectopexy for rectoanal intussusception: postoperative evaluation with proctography. *Diseases of the colon and rectum*. 2015;58(4):449-56.
453. Tsunoda A, Takahashi T, Ohta T, Fujii W, Kusanagi H. New-onset rectoanal intussusception may not result in symptomatic improvement after laparoscopic ventral rectopexy for external rectal prolapse. *Techniques in coloproctology*. 2016;20(2):101-7.
454. Auguste T, Dubreuil A, Bost R, Bonaz B, Faucheron JL. Technical and functional results after laparoscopic rectopexy to the promontory for complete rectal prolapse. Prospective study in 54 consecutive patients. *Gastroenterologie clinique et biologique*. 2006;30(5):659-63.
455. Badrek-Amoudi AH, Roe T, Mabey K, Carter H, Mills A, Dixon AR. Laparoscopic ventral mesh rectopexy in the management of solitary rectal ulcer syndrome: a cause for optimism? *Colorectal disease : the official journal of the Association of Coloproctology of Great Britain and Ireland*. 2013;15(5):575-81.
456. Chandra A, Kumar S, Maurya AP, Gupta V, Gupta V, Rahul. Laparoscopic ventral mesh rectopexy for complete rectal prolapse: A retrospective study evaluating outcomes in North Indian population. *World journal of gastrointestinal surgery*. 2016;8(4):321-5.
457. Consten EC, van Iersel JJ, Verheijen PM, Broeders IA, Wolthuis AM, D'Hoore A. Long-term Outcome After Laparoscopic Ventral Mesh Rectopexy: An Observational Study of 919 Consecutive Patients. *Annals of surgery*. 2015;262(5):742-7; discussion 7-8.
458. Makela-Kaikkonen J, Rautio T, Klintrup K, Takala H, Vierimaa M, Ohtonen P, et al. Robotic-assisted and laparoscopic ventral rectopexy in the treatment of rectal prolapse: a matched-pairs study of operative details and complications. *Techniques in coloproctology*. 2014;18(2):151-5.

459. Makela-Kaikkonen J, Rautio T, Paakko E, Biancari F, Ohtonen P, Makela J. Robot-assisted versus laparoscopic ventral rectopexy for external, internal rectal prolapse and enterocele: a randomised controlled trial. *Colorectal disease : the official journal of the Association of Coloproctology of Great Britain and Ireland*. 2016.
460. Mantoo S, Podevin J, Regenet N, Rigaud J, Lehur PA, Meurette G. Is robotic-assisted ventral mesh rectopexy superior to laparoscopic ventral mesh rectopexy in the management of obstructed defaecation? *Colorectal disease : the official journal of the Association of Coloproctology of Great Britain and Ireland*. 2013;15(8):e469-75.
461. Wong MT, Meurette G, Rigaud J, Regenet N, Lehur PA. Robotic versus laparoscopic rectopexy for complex rectocele: a prospective comparison of short-term outcomes. *Diseases of the colon and rectum*. 2011;54(3):342-6.
462. FDA Safety Communication: UPDATE on Serious Complications Associated with Transvaginal Placement of Surgical Mesh for Pelvic Organ Prolapse. 2011.
463. van Iersel JJ, Paulides TJ, Verheijen PM, Lumley JW, Broeders IA, Consten EC. Current status of laparoscopic and robotic ventral mesh rectopexy for external and internal rectal prolapse. *World journal of gastroenterology*. 2016;22(21):4977-87.
464. Franceschilli L, Varvaras D, Capuano I, Ciangola CI, Giorgi F, Boehm G, et al. Laparoscopic ventral rectopexy using biologic mesh for the treatment of obstructed defaecation syndrome and/or faecal incontinence in patients with internal rectal prolapse: a critical appraisal of the first 100 cases. *Techniques in coloproctology*. 2015;19(4):209-19.
465. Mehmood RK, Parker J, Bhuvimanian L, Qasem E, Mohammed AA, Zeeshan M, et al. Short-term outcome of laparoscopic versus robotic ventral mesh rectopexy for full-thickness rectal prolapse. Is robotic superior? *International journal of colorectal disease*. 2014;29(9):1113-8.
466. van den Esschert JW, van Geloven AA, Vermulst N, Groenedijk AG, de Wit LT, Gerhards MF. Laparoscopic ventral rectopexy for obstructed defecation syndrome. *Surgical endoscopy*. 2008;22(12):2728-32.
467. Chevrot A, Droupy S, Linares E, de Tayrac R, Costa P, Wagner L. [Impact of laparoscopic sacrocolpopexy on symptoms, health-related quality of life and sexuality: A 3-year prospective study]. *Progres en urologie : journal de l'Association francaise d'urologie et de la Societe francaise d'urologie*. 2016.
468. Maher C, Feiner B, Baessler K, Adams E, Hagen S, Glazener C. Surgical management of pelvic organ prolapse in women. *The Cochrane database of systematic reviews*. 2010(4):CD004014.
469. Lim M, Sagar PM, Gonsalves S, Thekkinkattil D, Landon C. Surgical management of pelvic organ prolapse in females: functional outcome of mesh sacrocolpopexy and rectopexy as a combined procedure. *Diseases of the colon and rectum*. 2007;50(9):1412-21.
470. Verdaasdonk EG, Bueno de Mesquita JM, Stassen LP. Laparoscopic rectovaginalopexy for rectal prolapse. *Techniques in coloproctology*. 2006;10(4):318-22.
471. D'Hoore A, Penninckx F. Laparoscopic ventral recto(colpo)pey for rectal prolapse: surgical technique and outcome for 109 patients. *Surgical endoscopy*. 2006;20(12):1919-23.
472. Cristaldi M CR, Boons P, Cunningham C LI. . Laparoscopic anterior rectopexy: a new approach that still cures rectal prolapse, but also improves preoperative constipation without inducing new-onset constipation. *Diseases of the colon and rectum*. 2007;50:721.
473. Boons P, Collinson R, Cunningham C, Lindsey I. Laparoscopic ventral rectopexy for external rectal prolapse improves constipation and avoids de novo constipation. *Colorectal disease : the official journal of the Association of Coloproctology of Great Britain and Ireland*. 2010;12(6):526-32.
474. Wijffels N, Cunningham C, Dixon A, Greenslade G, Lindsey I. Laparoscopic ventral rectopexy for external rectal prolapse is safe and effective in the elderly. Does this make perineal procedures obsolete? *Colorectal disease : the official journal of the Association of Coloproctology of Great Britain and Ireland*. 2011;13(5):561-6.
475. Faucheron JL, Voirin D, Riboud R, Waroquet PA, Noel J. Laparoscopic anterior rectopexy to the promontory for full-thickness rectal prolapse in 175 consecutive patients: short- and long-term follow-up. *Diseases of the colon and rectum*. 2012;55(6):660-5.
476. Collinson R, Wijffels N, Cunningham C, Lindsey I. Laparoscopic ventral rectopexy for internal rectal prolapse: short-term functional results. *Colorectal disease : the official journal of the Association of Coloproctology of Great Britain and Ireland*. 2010;12(2):97-104.

477. Slawik S, Soulsby R, Carter H, Payne H, Dixon AR. Laparoscopic ventral rectopexy, posterior colporrhaphy and vaginal sacrocolpopexy for the treatment of recto-genital prolapse and mechanical outlet obstruction. *Colorectal disease : the official journal of the Association of Coloproctology of Great Britain and Ireland*. 2008;10(2):138-43.
478. Owais AE, Sumrien H, Mabey K, McCarthy K, Greenslade GL, Dixon AR. Laparoscopic ventral mesh rectopexy in male patients with internal or external rectal prolapse. *Colorectal disease : the official journal of the Association of Coloproctology of Great Britain and Ireland*. 2014;16(12):995-1000.
479. Tsunoda A, Takahashi T, Ohta T, Kusanagi H. Quality of life after laparoscopic ventral rectopexy. *Colorectal disease : the official journal of the Association of Coloproctology of Great Britain and Ireland*. 2015.
480. Collinson R, Cunningham C, D'Costa H, Lindsey I. Rectal intussusception and unexplained faecal incontinence: findings of a proctographic study. *Colorectal disease : the official journal of the Association of Coloproctology of Great Britain and Ireland*. 2009;11(1):77-83.
481. Slieker-ten Hove MC, Pool-Goudzwaard AL, Eijkemans MJ, Steegers-Theunissen RP, Burger CW, Vierhout ME. The prevalence of pelvic organ prolapse symptoms and signs and their relation with bladder and bowel disorders in a general female population. *Int Urogynecol J Pelvic Floor Dysfunct*. 2009;20(9):1037-45.
482. Reena C, Kekre AN, Kekre N. Occult stress incontinence in women with pelvic organ prolapse. *Int J Gynaecol Obstet*. 2007;97(1):31-4.
483. Sinha D, Arunkalaivanan AS. Prevalence of occult stress incontinence in continent women with severe genital prolapse. *Journal of obstetrics and gynaecology : the journal of the Institute of Obstetrics and Gynaecology*. 2007;27(2):174-6.
484. Haessler AL, Lin LL, Ho MH, Betson LH, Bhatia NN. Reevaluating occult incontinence. *Current opinion in obstetrics & gynecology*. 2005;17(5):535-40.
485. Ellstrom Engh AM, Ekeryd A, Magnusson A, Olsson I, Otterlind L, Tobiasson G. Can de novo stress incontinence after anterior wall repair be predicted? *Acta Obstet Gynecol Scand*. 2010;90(5):488-93.
486. Visco AG, Brubaker L, Nygaard I, Richter HE, Cundiff G, Fine P, et al. The role of preoperative urodynamic testing in stress-continent women undergoing sacrocolpopexy: the Colpopexy and Urinary Reduction Efforts (CARE) randomized surgical trial. *Int Urogynecol J Pelvic Floor Dysfunct*. 2008;19(5):607-14.
487. Ellstrom Engh AM, Ekeryd A, Magnusson A, Olsson I, Otterlind L, Tobiasson G. Can de novo stress incontinence after anterior wall repair be predicted? *Acta obstetrica et gynecologica Scandinavica*. 2011;90(5):488-93.
488. Romanzi LJ, Chaikin DC, Blaivas JG. The effect of genital prolapse on voiding. *J Urol*. 1999;161(2):581-6.
489. Maher C, Feiner B, Baessler K, Adams EJ, Hagen S, Glazener CM. Surgical management of pelvic organ prolapse in women. *The Cochrane database of systematic reviews*. 2010(4):CD004014.
490. Kenton K, Fitzgerald MP, Brubaker L. Striated urethral sphincter activity does not alter urethral pressure during filling cystometry. *American journal of obstetrics and gynecology*. 2005;192(1):55-9.
491. Mueller ER, Kenton K, Mahajan S, FitzGerald MP, Brubaker L. Urodynamic prolapse reduction alters urethral pressure but not filling or pressure flow parameters. *J Urol*. 2007;177(2):600-3.
492. Altman D, Vayrynen T, Engh ME, Axelsen S, Falconer C. Anterior colporrhaphy versus transvaginal mesh for pelvic-organ prolapse. *N Engl J Med*. 2011;364(19):1826-36.
493. Hiltunen R, Nieminen K, Takala T, Heiskanen E, Merikari M, Niemi K, et al. Low-weight polypropylene mesh for anterior vaginal wall prolapse: a randomized controlled trial. *Obstetrics and gynecology*. 2007;110(2 Pt 2):455-62.
494. Rudnicki M, Laurikainen E, Pogosean R, Kinne I, Jakobsson U, Teleman P. Anterior colporrhaphy compared with collagen-coated transvaginal mesh for anterior vaginal wall prolapse: a randomised controlled trial. *BJOG : an international journal of obstetrics and gynaecology*. 2014;121(1):102-10; discussion 10-1.
495. Sivaslioglu AA, Unlubigin E, Dolen I. A randomized comparison of polypropylene mesh surgery with site-specific surgery in the treatment of cystocele. *Int Urogynecol J Pelvic Floor Dysfunct*. 2008;19(4):467-71.
496. Hung MJ, Liu FS, Shen PS, Chen GD, Lin LY, Ho ES. Factors that affect recurrence after anterior colporrhaphy procedure reinforced with four-corner anchored polypropylene mesh. *Int Urogynecol J Pelvic Floor Dysfunct*. 2004;15(6):399-406; discussion

497. Ek M, Tegerstedt G, Falconer C, Kjaeldgaard A, Rezapour M, Rudnicki M, et al. Urodynamic assessment of anterior vaginal wall surgery: a randomized comparison between colporrhapty and transvaginal mesh. *Neurourology and urodynamics*. 2010;29(4):527-31.
498. Halaska M, Maxova K, Sottner O, Svabik K, Mlcoch M, Kolarik D, et al. A multicenter, randomized, prospective, controlled study comparing sacrospinous fixation and transvaginal mesh in the treatment of posthysterectomy vaginal vault prolapse. *Am J Obstet Gynecol*. 2012;207(4):301-7.
499. Feiner B, Gietelink L, Maher C. Anterior vaginal mesh sacrospinous hysteropexy and posterior fascial plication for anterior compartment dominated uterovaginal prolapse. *Int Urogynecol J Pelvic Floor Dysfunct*. 2010;21(2):203-8.
500. Kuribayashi M, Kitagawa Y, Narimoto K, Kawaguchi S, Konaka H, Namiki M. Postoperative voiding function in patients undergoing tension-free vaginal mesh procedure for pelvic organ prolapse. *International urogynecology journal*. 2011;22(10):1299-303.
501. Liang CC, Lee CL, Chang TC, Chang YL, Wang CJ, Soong YK. Postoperative urinary outcomes in catheterized and non-catheterized patients undergoing laparoscopic-assisted vaginal hysterectomy--a randomized controlled trial. *Int Urogynecol J Pelvic Floor Dysfunct*. 2009;20(3):295-300.
502. Sentilhes L, Sergent F, Resch B, Verspyck E, Descamps P, Marpeau L. Midterm follow-up of high-grade genital prolapse repair by the transobturator and infracoccygeal hammock procedure after hysterectomy. *European urology*. 2007;51(4):1065-72.
503. Sergent F, Resch B, Al-Khattabi M, Ricbourg A, Schaal JP, Marpeau L. Transvaginal mesh repair of pelvic organ prolapse by the transobturator-infracoccygeal hammock technique: long-term anatomical and functional outcomes. *Neurourology and urodynamics*. 2011;30(3):384-9.
504. Takahashi S, Obinata D, Sakuma T, Nagane Y, Sato K, Mochida J, et al. Tension-free vaginal mesh procedure for pelvic organ prolapse: a single-center experience of 310 cases with 1-year follow up. *International journal of urology : official journal of the Japanese Urological Association*. 2010;17(4):353-8.
505. Liang CC, Hsieh WC, Lin YH, Tseng LH. Predictors of persistent detrusor overactivity in women with pelvic organ prolapse following transvaginal mesh repair. *The journal of obstetrics and gynaecology research*. 2016;42(4):427-33.
506. Costantini E, Lazzeri M, Bini V, Del Zingaro M, Zucchi A, Porena M. Pelvic organ prolapse repair with and without prophylactic concomitant Burch colposuspension in continent women: a randomized, controlled trial with 8-year followup. *J Urol*. 2011;185(6):2236-40.
507. Costantini E, Zucchi A, Giannantoni A, Mearini L, Bini V, Porena M. Must colposuspension be associated with sacropexy to prevent postoperative urinary incontinence? *European urology*. 2007;51(3):788-94.
508. van der Ploeg J, van der Steen A, Oude Rengerink K, van der Vaart C, Roovers J. Prolapse surgery with or without stress incontinence surgery for pelvic organ prolapse: a systematic review and meta-analysis of randomised trials. *BJOG : an international journal of obstetrics and gynaecology*. 2014.
509. Leruth J, Fillet M, Waltregny D. Incidence and risk factors of postoperative stress urinary incontinence following laparoscopic sacrocolpopexy in patients with negative preoperative prolapse reduction stress testing. *International urogynecology journal*. 2013;24(3):485-91.
510. Onol FF, Tosun F, Guzel R, Boylu U, Kucuk EV, Gumus E. Minimum 1.5-year results of "surgeon-tailored" transvaginal mesh repair for female stress urinary incontinence and pelvic organ prolapse. *Urology*. 2012;80(2):273-9.
511. Borstad E, Abdelnoor M, Staff AC, Kulseng-Hanssen S. Surgical strategies for women with pelvic organ prolapse and urinary stress incontinence. *Int Urogynecol J Pelvic Floor Dysfunct*. 2010;21(2):179-86.
512. Wu CJ, Chuang FC, Chu LC, Kung FT, Huang KH, Wu MP. Concomitant trocar-guided transvaginal mesh surgery with a midurethral sling in treating advanced pelvic organ prolapse associated with stress or occult stress urinary incontinence. *Taiwanese journal of obstetrics & gynecology*. 2013;52(4):516-22.
513. Feiner B, Maher C. Vaginal mesh contraction: definition, clinical presentation, and management. *Obstetrics and gynecology*. 2010;115(2 Pt 1):325-30.
514. Costantini E, Lazzeri M, Bini V, Del Zingaro M, Zucchi A, Porena M. Burch colposuspension does not provide any additional benefit to pelvic organ prolapse repair in patients with urinary incontinence: a randomized surgical trial. *J Urol*. 2008;180(3):1007-12.

515. Osmundsen B, Gregory WT, Denman MA, Adams K, Edwards R, Clark A. Tension-Free Vaginal Tape Failure After Robotic Sacrocolpopexy and Tension-Free Vaginal Tape for Concomitant Prolapse and Stress Incontinence. *Female pelvic medicine & reconstructive surgery*. 2015;21(5):244-8.
516. Meschia M, Pifarotti P, Spennacchio M, Buonaguidi A, Gattei U, Somigliana E. A randomized comparison of tension-free vaginal tape and endopelvic fascia plication in women with genital prolapse and occult stress urinary incontinence. *American journal of obstetrics and gynecology*. 2004;190(3):609-13.
517. Schierlitz L, Dwyer PL, Rosamilia A, De Souza A, Murray C, Thomas E, et al. Pelvic organ prolapse surgery with and without tension-free vaginal tape in women with occult or asymptomatic urodynamic stress incontinence: a randomised controlled trial. *International urogynecology journal*. 2014;25(1):33-40.
518. Wei J, Nygaard I, Richter H, Brown M, Barber M, Xiao X, et al. Outcomes following vaginal prolapse repair and mid urethral sling (OPUS) trial--design and methods. *Clinical trials (London, England)*. 2009;6(2):162-71.
519. Schierlitz L, Dwyer P, Rosamilia A, Murray C, Thomas E, Taylor AW. A prospective randomised controlled study comparing vaginal prolapse repair with and without tension free vaginal tape (TVT) in women with severe pelvic organ prolapse and occult stress incontinence (Abstract number 114). *Neurourology and Urodynamics*. 2007;26(5):743-4.
520. van der Ploeg JM, Oude Rengerink K, van der Steen A, van Leeuwen JH, van der Vaart CH, Roovers JP, et al. Vaginal prolapse repair with or without a midurethral sling in women with genital prolapse and occult stress urinary incontinence: a randomized trial. *Int Urogynecol J*. 2016;27(7):1029-38.
521. Maher CM, Feiner B, Baessler K, Glazener CM. Surgical management of pelvic organ prolapse in women: the updated summary version Cochrane review. *International urogynecology journal*. 2011;22(11):1445-57.
522. Foster RT, Sr., Barber MD, Parasio MF, Walters MD, Weidner AC, Amundsen CL. A prospective assessment of overactive bladder symptoms in a cohort of elderly women who underwent transvaginal surgery for advanced pelvic organ prolapse. *American journal of obstetrics and gynecology*. 2007;197(1):82 e1-4.
523. Lamblin G, Van-Nieuwenhuysse A, Chabert P, Lebaill-Carval K, Moret S, Mellier G. A randomized controlled trial comparing anatomical and functional outcome between vaginal colposuspension and transvaginal mesh. *Int Urogynecol J*. 2014;25(7):961-70.
524. Natale F, La PC, Padoa A, Agostini M, De SE, Cervigni M. A prospective, randomized, controlled study comparing Gynemesh, a synthetic mesh, and Pelvicol, a biologic graft, in the surgical treatment of recurrent cystocele. *Int Urogynecol J Pelvic Floor Dysfunct*. 2009;20(1):75-81.
525. Moore RD, Miklos JR. Vaginal repair of cystocele with anterior wall mesh via transobturator route: efficacy and complications with up to 3-year followup. *Advances in urology*. 2009:743831.
526. Stekkinger E, van der Linden PJ. A comparison of suprapubic and transurethral catheterization on postoperative urinary retention after vaginal prolapse repair: a randomized controlled trial. *Gynecologic and obstetric investigation*. 2011;72(2):109-16.
527. Feiner B, O'Rourke P, Maher C. A prospective comparison of two commercial mesh kits in the management of anterior vaginal prolapse. *International urogynecology journal*. 2012;23(3):279-83.
528. Steinberg BJ, Finamore PS, Sastry DN, Holzberg AS, Caraballo R, Echols KT. Postoperative urinary retention following vaginal mesh procedures for the treatment of pelvic organ prolapse. *International urogynecology journal*. 2010;21(12):1491-8.
529. Hakvoort RA, Thijs SD, Bouwmeester FW, Broekman AM, Ruhe IM, Vernooij MM, et al. Comparing clean intermittent catheterisation and transurethral indwelling catheterisation for incomplete voiding after vaginal prolapse surgery: a multicentre randomised trial. *BJOG: an international journal of obstetrics and gynaecology*. 2011;118(9):1055-60.
530. Huang CC, Ou CS, Yeh GP, Der Tsai H, Sun MJ. Optimal duration of urinary catheterization after anterior colporrhaphy. *International urogynecology journal*. 2011;22(4):485-91.
531. Weemhoff M, Wassen MM, Korsten L, Serroyen J, Kampschoer PH, Roumen FJ. Postoperative catheterization after anterior colporrhaphy: 2 versus 5 days. A multicentre randomized controlled trial. *International urogynecology journal*. 2011;22(4):477-83.

532. Basson R, Berman J, Burnett A, Derogatis L, Ferguson D, Fourcroy J, et al. Report of the international consensus development conference on female sexual dysfunction: definitions and classifications. *J Urol*. 2000;163(3):888-93.
533. Pauls RN, Segal JL, Silva WA, Kleeman SD, Karram MM. Sexual function in patients presenting to a urogynecology practice. *Int Urogynecol J Pelvic Floor Dysfunct*. 2006;17(6):576-80.
534. Baessler K, O'Neill SM, Maher CF, Battistutta D, Baessler K, O'Neill SM, et al. A validated self-administered female pelvic floor questionnaire. *International Urogynecology Journal*. 2010;21(2):163-72.
535. Ghielmetti T, Kuhn P, Dreher EF, Kuhn A. Gynaecological operations: do they improve sexual life? *Eur J Obstet Gynecol Reprod Biol*. 2006;129(2):104-10.
536. Rogers RG, Kammerer-Doak D, Darrow A, Murray K, Qualls C, Olsen A, et al. Does sexual function change after surgery for stress urinary incontinence and/or pelvic organ prolapse? A multicenter prospective study. *Am J Obstet Gynecol*. 2006;195(5):e1-4.
537. Komesu YM, Rogers RG, Kammerer-Doak DN, Barber MD, Olsen AL. Posterior repair and sexual function. *Am J Obstet Gynecol*. 2007;197(1):101 e1-6.
538. Dietz V, van der Vaart CH, van der Graaf Y, Heintz P, Schraffordt Koops SE. One-year follow-up after sacrospinous hysteropexy and vaginal hysterectomy for uterine descent: a randomized study. *International urogynecology journal*. 2010;21(2):209-16.
539. Carey M, Higgs P, Goh J, Lim J, Leong A, Krause H, et al. Vaginal repair with mesh versus colporrhaphy for prolapse: a randomised controlled trial. *BJOG : an international journal of obstetrics and gynaecology*. 2009;116(10):1380-6.
540. Milani AL, Withagen MI, The HS, Nedelcu-van der Wijk I, Vierhout ME. Sexual function following trocar-guided mesh or vaginal native tissue repair in recurrent prolapse: a randomized controlled trial. *The journal of sexual medicine*. 2011;8(10):2944-53.
541. Sokol A, Iglesia C, Kudish B, Gutman R, Shveiky D, Bercik R, et al. One-year objective and functional outcomes of a randomized clinical trial of vaginal mesh for prolapse. *American journal of obstetrics and gynecology*. 2012;206(1):86e1-9.
542. Gutman RE, Nosti PA, Sokol AI, Sokol ER, Peterson JL, Wang H, et al. Three-year outcomes of vaginal mesh for prolapse: a randomized controlled trial. *Obstetrics and gynecology*. 2013;122(4):770-7.
543. El-Nazer M, Gomaa I, Ismail Madkour W, Swidan K, El-Etriby M. Anterior colporrhaphy versus repair with mesh for anterior vaginal wall prolapse: a comparative clinical study. *Archives of gynecology and obstetrics*. 2012;286:965-72.
544. de TR, Cornille A, Eglin G, Guilbaud O, Mansoor A, Alonso S, et al. Comparison between trans-obturator trans-vaginal mesh and traditional anterior colporrhaphy in the treatment of anterior vaginal wall prolapse: results of a French RCT. *Int Urogynecol J*. 2013;24(10):1651-61.
545. Milani AL, Withagen MI, The HS, Nedelcu-van der Wijk I, Vierhout ME. Sexual Function Following Trocar-guided Mesh or Vaginal Native Tissue Repair in Recurrent Prolapse: A Randomized Controlled Trial. *The journal of sexual medicine*. 2011.
546. Lopes ED, Lemos NL, Carramao SS, Lunardelli JL, Ruano JM, Aoki T, et al. Transvaginal polypropylene mesh versus sacrospinous ligament fixation for the treatment of uterine prolapse: 1-year follow-up of a randomized controlled trial. *Int Urogynecol J*. 2010;21(4):389-94.
547. de Tayrac R, Mathe ML, Bader G, Deffieux X, Fazel A, Fernandez H. Infracoccygeal sacropexy or sacrospinous suspension for uterine or vaginal vault prolapse. *International journal of gynaecology and obstetrics: the official organ of the International Federation of Gynaecology and Obstetrics*. 2008;100(2):154-9.
548. Rondini C BH, Alvarez J, Urzua M, Villegas R, Escobar M et al. . Prospective-randomised study comparing high uterosacral vault suspension vs abdominal sacral colpopexy for the correction of apical defects and vaginal vault prolapse. *International urogynecology journal*. 2013;22(Suppl 1):s87-8.
549. Zyczynski HM, Carey MP, Smith AR, Gauld JM, Robinson D, Sikirica V, et al. One-year clinical outcomes after prolapse surgery with nonanchored mesh and vaginal support device. *Am J Obstet Gynecol*. 2010;203(6):587 e1-8.
550. Milani AL, Hinoul P, Gauld JM, Sikirica V, van Drie D, Cosson M. Trocar-guided mesh repair of vaginal prolapse using partially absorbable mesh: 1 year outcomes. *American journal of obstetrics and gynecology*. 2011;204(1):74 e1-8.

551. de Tayrac R, Devoldere G, Renaudie J, Villard P, Guilbaud O, Eglin G. Prolapse repair by vaginal route using a new protected low-weight polypropylene mesh: 1-year functional and anatomical outcome in a prospective multicentre study. *Int Urogynecol J Pelvic Floor Dysfunct*. 2007;18(3):251-6.
552. Feldner PC, Jr., Delroy CA, Martins SB, Castro RA, Sartori MG, Girao MJ. Sexual function after anterior vaginal wall prolapse surgery. *Clinics (Sao Paulo)*. 2012;67(8):871-5.
553. Robert M, Girard I, Brennard E, Tang S, Birch C, Murphy M, et al. Absorbable mesh augmentation compared with no mesh for anterior prolapse: a randomized controlled trial. *Obstet Gynecol*. 2014;123(2 Pt 1):288-94.
554. Batalden RP, Weinstein MM, Foust-Wright C, Alperin M, Wakamatsu MM, Pulliam SJ. Clinical application of IUGA/ICS classification system for mesh erosion. *Neurourology and urodynamics*. 2016;35(5):589-94.
555. Skala C, Renezeder K, Albrich S, Puhl A, Laterza RM, Naumann G, et al. The IUGA/ICS classification of complications of prosthesis and graft insertion: a comparative experience in incontinence and prolapse surgery. *International urogynecology journal*. 2011;22(11):1429-35.
556. Haylen BT, Lee J, Maher C, Deprest J, Freeman R. Optimizing study design for interobserver reliability: IUGA-ICS classification of complications of prostheses and graft insertion. *International urogynecology journal*. 2014;25(6):751-4.
557. Goldman HB. SUI surgery at the time of vaginal POP repair: is a surgical algorithm possible or desirable? *Neurourology & Urodynamics*. 30(5):758-61.
558. Gowda M, Kit LC, Stuart Reynolds W, Wang L, Dmochowski RR, Kaufman MR. Interobserver variability when employing the IUGA/ICS classification system for complications related to prostheses and grafts in female pelvic floor surgery. *International urogynecology journal*. 2013;24(10):1671-8.
559. Tunitsky E, Abbott S, Barber MD. Interrater reliability of the International Continence Society and International Urogynecological Association (ICS/IUGA) classification system for mesh-related complications. *American journal of obstetrics and gynecology*. 2012;206(5):442.e1-6.
560. Nussler E, Kesmodel US, Lofgren M, Nussler EK. Operation for primary cystocele with anterior colporrhaphy or non-absorbable mesh: patient-reported outcomes. *International urogynecology journal*. 2015;26(3):359-66.
561. Barski D, Otto T, Gerullis H. Systematic Review and Classification of Complications after Anterior, Posterior, Apical, and Total Vaginal Mesh Implantation for Prolapse Repair. *Surgical technology international*. 2014;Xxiv.
562. Dias MM, de ACR, Bortolini MA, Delroy CA, Martins PC, Girao MJ, et al. Two-years results of native tissue versus vaginal mesh repair in the treatment of anterior prolapse according to different success criteria: A randomized controlled trial. *Neurourology and urodynamics*. 2016;35(4):509-14.
563. Silveira DRBd, Haddad JM, ZI dJ-DB, Nastri F, Kawabata MG, da Silva CS, et al. Multicenter, randomized trial comparing native vaginal tissue repair and synthetic mesh repair for genital prolapse surgical treatment. *Int Urogynecol J*. 2015;26(3):335-42.
564. de Landsheere L, Ismail S, Lucot JP, Deken V, Foidart JM, Cosson M. Surgical intervention after transvaginal Prolift mesh repair: retrospective single-center study including 524 patients with 3 years' median follow-up. *American journal of obstetrics and gynecology*. 2012;206(1):83.e1-7.
565. Jonsson Funk M, Visco AG, Weidner AC, Pate V, Wu JM. Long-term outcomes of vaginal mesh versus native tissue repair for anterior vaginal wall prolapse. *International urogynecology journal*. 2013;24(8):1279-85.
566. Claerhout F, De Ridder D, Roovers JP, Rommens H, Spelzini F, Vandenbroucke V, et al., editors. Medium-term anatomic and functional results of laparoscopic sacrocolpopexy beyond the learning curve. Switzerland2009.
567. Elneil S, Cutner AS, Remy M, Leather AT, Toozs-Hobson P, Wise B. Abdominal sacrocolpopexy for vault prolapse without burial of mesh: a case series. *BJOG : an international journal of obstetrics and gynaecology*. 2005;112(4):486-9.
568. Handa VL, Zyczynski HM, Brubaker L, Nygaard I, Janz NK, Richter HE, et al. Sexual function before and after sacrocolpopexy for pelvic organ prolapse. *American journal of obstetrics and gynecology*. 2007;197(6):629.e1-6.
569. Vergeldt TF, Weemhoff M, IntHout J, Kluivers KB. Risk factors for pelvic organ prolapse and its recurrence: a systematic review. *International urogynecology journal*. 2015;26(11):1559-73.
570. Agarwala N, Hasiak N, Shade M, editors. Laparoscopic sacral colpopexy with Gynemesh as graft material--experience and results. United States2007.

571. Antiphon P, Elard S, Benyoussef A, Fofana M, Yiou R, Gettman M, et al., editors. Laparoscopic promontory sacral colpopexy: is the posterior, recto-vaginal, mesh mandatory? *Netherlands*2004.
572. Bruyere F, Rozenberg H, Abdelkader T. [Laparoscopic sacral colpopexy: an attractive approach for prolapse repair]. *Progres en urologie : journal de l'Association francaise d'urologie et de la Societe francaise d'urologie*. 2001;11(6):1320-6.
573. Coolen AL, van Oudheusden AM, van Eindhoven HW, van der Heijden TP, Stokmans RA, Mol BW, et al. A Comparison of Complications between Open Abdominal Sacrocolpopexy and Laparoscopic Sacrocolpopexy for the Treatment of Vault Prolapse. *Obstetrics and gynecology international*. 2013;2013:528636.
574. Cosson M, Rajabally R, Bogaert E, Querleu D, Crepin G. Laparoscopic sacrocolpopexy, hysterectomy, and burch colposuspension: feasibility and short-term complications of 77 procedures. *JSLs : Journal of the Society of Laparoscopic Surgeons / Society of Laparoscopic Surgeons*. 2002;6(2):115-9.
575. Descargues G, Collard P, Grise P. [Surgical management of pelvic organ prolapse in women: laparoscopic or vaginal sacrocolpopexy?]. *Gynecologie, obstetrique & fertilité*. 2008;36(10):978-83.
576. Gadonneix P, Ercoli A, Salet-Lizee D, Cotelle O, Bolner B, Van Den Akker M, et al. Laparoscopic sacrocolpopexy with two separate meshes along the anterior and posterior vaginal walls for multicompartiment pelvic organ prolapse. *The Journal of the American Association of Gynecologic Laparoscopists*. 2004;11(1):29-35.
577. Granese R, Candiani M, Perino A, Romano F, Cucinella G. Laparoscopic sacrocolpopexy in the treatment of vaginal vault prolapse: 8 years experience. *European journal of obstetrics, gynecology, and reproductive biology*. 2009;146(2):227-31.
578. Grynberg M, Dedecker F, Staerman F. [Laparoscopic sacral colpopexy: comparison of non-resorbable prosthetic tape (Mersuture) and a SIS collagen matrix (Surgisis ES)]. *Progres en urologie : journal de l'Association francaise d'urologie et de la Societe francaise d'urologie*. 2005;15(4):751-5; discussion 5.
579. Paraiso MF, Walters MD, Rackley RR, Melek S, Hugney C. Laparoscopic and abdominal sacral colpopexies: a comparative cohort study. *American journal of obstetrics and gynecology*. 2005;192(5):1752-8.
580. Price N, Slack A, Jackson SR. Laparoscopic sacrocolpopexy: an observational study of functional and anatomical outcomes. *International urogynecology journal*. 2011;22(1):77-82.
581. Ross JW, Preston M, editors. Laparoscopic sacrocolpopexy for severe vaginal vault prolapse: five-year outcome. *United States*2005.
582. Rozet F, Mandron E, Arroyo C, Andrews H, Cathelineau X, Mombet A, et al., editors. Laparoscopic sacral colpopexy approach for genitourinary prolapse: experience with 363 cases. *Netherlands*2005.
583. Sabbagh R, Mandron E, Piussan J, Brychaert PE, Tu le M. Long-term anatomical and functional results of laparoscopic promontofixation for pelvic organ prolapse. *BJU international*. 2010;106(6):861-6.
584. Deprest J, De Ridder D, Roovers JP, Werbrouck E, Coremans G, Claerhout F. Medium term outcome of laparoscopic sacrocolpopexy with xenografts compared to synthetic grafts. *J Urol*. 2009;182(5):2362-8.
585. Tijdink MM, Vierhout ME, Heesakkers JP, Withagen MIJ. Surgical management of mesh-related complications after prior pelvic floor reconstructive surgery with mesh. *International urogynecology journal*. 2011;22(11):1395-404.
586. Lo TS, Tan YL, Khanuengkitkong S, Dass AK, Cortes EF, Wu PY. Assessment of collagen-coated anterior mesh through morphology and clinical outcomes in pelvic reconstructive surgery for pelvic organ prolapse. *Journal of minimally invasive gynecology*. 2014;21(5):753-61.
587. Le Long E, Rebibo JD, Caremel R, Grise P. Efficacy of Pelvisoft(R) Biomesh for cystocele repair: assessment of long-term results. *International braz j urol : official journal of the Brazilian Society of Urology*. 2014;40(6):828-34.
588. Madhu C, Cooke J, Harber P, Holmes D. Functional outcomes of posterior vaginal wall repair and prespinous colpopexy with biological small intestinal submucosal (SIS) graft. *Archives of gynecology and obstetrics*. 2014;290(4):711-6.
589. Mahdy A, Karp D, Davila GW, Ghoniem GM. The outcome of transobturator anterior vaginal wall prolapse repair using porcine dermis graft: intermediate term follow-up. *International braz j urol : official journal of the Brazilian Society of Urology*. 2013;39(4):506-12.
590. Huang KH, Huang LY, Chu LC, Chuang FC, Wu MP, Kung FT. Evaluation of the single-incision Elevate system to treat pelvic organ prolapse: follow-up from 15 to 45 months. *International urogynecology journal*. 2015;26(9):1341-6.

591. Su TH, Lau HH, Huang WC, Hsieh CH, Chang RC, Su CH. Single-incision mesh repair versus traditional native tissue repair for pelvic organ prolapse: results of a cohort study. *International urogynecology journal*. 2014;25(7):901-8.
592. Rogowski A, Bienkowski P, Tarwacki D, Szafarowska M, Samochowicz J, Sienkiewicz-Jarosz H, et al. Retrospective comparison between the Prolift and Elevate anterior vaginal mesh procedures: 18-month clinical outcome. *International urogynecology journal*. 2015;26(12):1815-20.
593. Mourtialon P, Letouzey V, Eglin G, de Tayrac R. Transischioanal trans-sacrospinous ligament rectocele repair with polypropylene mesh: a prospective study with assessment of rectoanal function. *International urogynecology journal*. 2013;24(1):81-9.
594. Nguyen JN, Jakus-Waldman SM, Walter AJ, White T, Menefee SA. Perioperative complications and reoperations after incontinence and prolapse surgeries using prosthetic implants. *Obstetrics and gynecology*. 2012;119(3):539-46.
595. Letouzey V, Deffieux X, Gervaise A, Mercier G, Fernandez H, de Tayrac R. Trans-vaginal cystocele repair using a tension-free polypropylene mesh: more than 5 years of follow-up. *European journal of obstetrics, gynecology, and reproductive biology*. 2010;151(1):101-5.
596. Heinonen P, Aaltonen R, Joronen K, Ala-Nissila S. Long-term outcome after transvaginal mesh repair of pelvic organ prolapse. *International urogynecology journal*. 2016;27(7):1069-74.
597. De Gouveia De Sa M, Claydon LS, Whitlow B, Dolcet Artahona MA. Laparoscopic versus open sacrocolpopexy for treatment of prolapse of the apical segment of the vagina: a systematic review and meta-analysis. *International urogynecology journal*. 2016;27(1):3-17.
598. Lee RK, Mottrie A, Payne CK, Waltregny D. A review of the current status of laparoscopic and robot-assisted sacrocolpopexy for pelvic organ prolapse. *European urology*. 2014;65(6):1128-37.
599. De Gouveia De Sa M, Claydon LS, Whitlow B, Dolcet Artahona MA. Robotic versus laparoscopic sacrocolpopexy for treatment of prolapse of the apical segment of the vagina: a systematic review and meta-analysis. *International urogynecology journal*. 2016;27(3):355-66.
600. Gutman R, Maher C. Uterine-preserving prolapse surgery. *International urogynecology journal*. 2013;24(11):1803-13.
601. Deng T, Liao B, Luo D, Shen H, Wang K. Risk factors for mesh erosion after female pelvic floor reconstructive surgery: a systematic review and meta-analysis. *BJU international*. 2016;117(2):323-43.
602. Araco F, Gravante G, Sorge R, Overton J, De Vita D, Primicerio M, et al. The influence of BMI, smoking, and age on vaginal erosions after synthetic mesh repair of pelvic organ prolapses. A multicenter study. *Acta obstetrica et gynecologica Scandinavica*. 2009;88(7):772-80.
603. Lo TS, Tan YL, Khanuengkitkong S, Dass AK. Surgical outcomes of anterior trans-obturator mesh and vaginal sacrospinous ligament fixation for severe pelvic organ prolapse in overweight and obese Asian women. *International urogynecology journal*. 2013;24(5):809-16.
604. El-Khawand D, Wehbe SA, O'Hare PG, 3rd, Arunachalam D, Vakili B. Risk factors for vaginal mesh exposure after mesh-augmented anterior repair: a retrospective cohort study. *Female pelvic medicine & reconstructive surgery*. 2014;20(6):305-9.
605. Araco F, Gravante G, Piccione E, Araco F, Gravante G, Piccione E. Bladder erosion after 2 years from cystocele repair with type I polypropylene mesh. *International urogynecology journal*. 2009;20(6):731-3.
606. Elmer C, Altman D, Engh ME, Axelsen S, Vayrynen T, Falconer C. Trocar-guided transvaginal mesh repair of pelvic organ prolapse. *Obstetrics and gynecology*. 2009;113(1):117-26.
607. Gold KP, Ward RM, Zimmerman CW, Biller DH, McGuinn S, Slaughter JC, et al. Factors associated with exposure of transvaginally placed polypropylene mesh for pelvic organ prolapse. *International urogynecology journal*. 2012;23(10):1461-6.
608. Withagen MI, Vierhout ME, Hendriks JC, Kluivers KB, Milani AL. Risk factors for exposure, pain, and dyspareunia after tension-free vaginal mesh procedure. *Obstetrics and gynecology*. 2011;118(3):629-36.
609. Ganj FA, Ibeanu OA, Bedestani A, Nolan TE, Chesson RR. Complications of transvaginal monofilament polypropylene mesh in pelvic organ prolapse repair. *Int Urogynecol J Pelvic Floor Dysfunct*. 2009;20(8):919-25.
610. Kaufman Y, Singh SS, Alturki H, Lam A. Age and sexual activity are risk factors for mesh exposure following transvaginal mesh repair. *International urogynecology journal*. 2011;22(3):307-13.

611. Nosti PA, Lowman JK, Zollinger TW, Hale DS, Woodman PJ. Risk of mesh erosion after abdominal sacral colpoperineopexy with concomitant hysterectomy. *American journal of obstetrics and gynecology*. 2009;201(5):541 e1-4.
612. Sung VW, Weitzen S, Sokol ER, Rardin CR, Myers DL. Effect of patient age on increasing morbidity and mortality following urogynecologic surgery. *American journal of obstetrics and gynecology*. 2006;194(5):1411-7.
613. Deffieux X, de Tayrac R, Huel C, Bottero J, Gervaise A, Bonnet K, et al. Vaginal mesh erosion after transvaginal repair of cystocele using Gynemesh or Gynemesh-Soft in 138 women: a comparative study. *Int Urogynecol J Pelvic Floor Dysfunct*. 2007;18(1):73-9.
614. Acharti C, Hiscock R, O'Reilly BA, Schierlitz L, Dwyer PL. Risk factors for mesh erosion after transvaginal surgery using polypropylene (Atrium) or composite polypropylene/polyglactin 910 (Vypro II) mesh. *Int Urogynecol J Pelvic Floor Dysfunct*. 2005;16(5):389-94.
615. Cervigni M, Natale F, La Penna C, Saltari M, Padoa A, Agostini M. Collagen-coated polypropylene mesh in vaginal prolapse surgery: an observational study. *European journal of obstetrics, gynecology, and reproductive biology*. 2011;156(2):223-7.
616. Moore RD, Beyer RD, Jacoby K, Freedman SJ, McCammon KA, Gambla MT. Prospective multicenter trial assessing type I, polypropylene mesh placed via transobturator route for the treatment of anterior vaginal prolapse with 2-year follow-up. *Int Urogynecol J Pelvic Floor Dysfunct*. 2010;21(5):545-52.
617. Westermann LB, Brown A, Long JB. Delayed presentation of an enterocutaneous fistula after tension-free vaginal tape sling. *Female pelvic medicine & reconstructive surgery*. 2011;17(5):258-9.
618. Long CY, Hsu CS, Wu MP, Lo TS, Liu CM, Tsai EM. Comparison of the changes in sexual function of premenopausal and postmenopausal women following transvaginal mesh surgery. *The journal of sexual medicine*. 2011;8(7):2009-16.
619. Crosby RD, Kolotkin RL, Williams GR. Defining clinically meaningful change in health-related quality of life. *J Clin Epidemiol*. 2003;56(5):395-407.
620. Hansen BL, Dunn GE, Norton P, Hsu Y, Nygaard I. Long-term follow-up of treatment for synthetic mesh complications. *Female pelvic medicine & reconstructive surgery*. 2014;20(3):126-30.
621. Abbott S, Unger CA, Evans JM, Jallad K, Mishra K, Karram MM, et al. Evaluation and management of complications from synthetic mesh after pelvic reconstructive surgery: a multicenter study. *American journal of obstetrics and gynecology*. 2014;210(2):163.e1-.e8.
622. Wong KSMD, Nguyen JNMD, White TMD, Menefee SAMD, Walter AJMD, Krulewicz CJCNMFP, et al. Adverse Events Associated With Pelvic Organ Prolapse Surgeries That Use Implants. [Article]. *Obstetrics and gynecology*. 2013;122(6):1239-45.
623. Crosby EC, Abernethy M, Berger MB, Delancey JO, Fenner DE, Morgan DM. Symptom resolution after operative management of complications from transvaginal mesh. *Obstetrics and gynecology*. 2014;123(1):134-9.
624. Skoczylas LC, Shepherd JP, Smith KJ, Lowder JL. Managing mesh exposure following vaginal prolapse repair: a decision analysis comparing conservative versus surgical treatment. *International urogynecology journal*. 2013;24(1):119-25.
625. Zucchi A, Lazzeri M, Porena M, Mearini L, Costantini E. Uterus preservation in pelvic organ prolapse surgery. *Nature reviews Urology*. 2010;7(11):626-33.
626. Deffieux X, Thubert T, de Tayrac R, Fernandez H, Letouzey V. Long-term follow-up of persistent vaginal polypropylene mesh exposure for transvaginally placed mesh procedures. *International urogynecology journal*. 2012;23(10):1387-90.
627. Lowman JK, Woodman PJ, Nosti PA, Bump RC, Terry CL, Hale DS. Tobacco use is a risk factor for mesh erosion after abdominal sacral colpoperineopexy. *American journal of obstetrics and gynecology*. 2008;198(5):561 e1-4.
628. Api M, Kayatas S, Boza A. Spondylodiscitis following sacral colpopexy procedure: is it an infection or graft rejection? *European journal of obstetrics, gynecology, and reproductive biology*. 2015;194:43-8.
629. Quiroz LH, Gutman RE, Shippey S, Cundiff GW, Sanses T, Blomquist JL, et al., editors. Abdominal sacrocolpopexy: anatomic outcomes and complications with Pelvicol, autologous and synthetic graft materials. *United States*2008.
630. Huffaker RK, Shull BL, Thomas JS. A serious complication following placement of posterior Prolift. *Int Urogynecol J Pelvic Floor Dysfunct*. 2009;20(11):1383-5.
631. Karateke A, Cam C, Ayaz R. Unilateral hydroureteronephrosis after a mesh procedure. *Journal of minimally invasive gynecology*. 2010;17(2):232-4.

632. Boulanger L, Boukerrou M, Rubod C, Collinet P, Fruchard A, Courcol RJ, et al. Bacteriological analysis of meshes removed for complications after surgical management of urinary incontinence or pelvic organ prolapse. *Int Urogynecol J Pelvic Floor Dysfunct*. 2008;19(6):827-31.
633. Vollebregt A, Troelstra A, van der Vaart CH. Bacterial colonisation of collagen-coated polypropylene vaginal mesh: are additional intraoperative sterility procedures useful? *Int Urogynecol J Pelvic Floor Dysfunct*. 2009;20(11):1345-51.
634. Akl MN, Long JB, Giles DL, Cornella JL, Pettit PD, Chen AH, et al. Robotic-assisted sacrocolpopexy: technique and learning curve. *Surgical endoscopy*. 2009;23(10):2390-4.
635. de Tayrac R, Letouzey V. Basic science and clinical aspects of mesh infection in pelvic floor reconstructive surgery. *International urogynecology journal*. 2011;22(7):775-80.
636. Donnez O, Squifflet J, Jadoul P, Donnez J. Complete mesh expulsion as a complication of vaginally assisted laparoscopic cervicosacropexy with subtotal hysterectomy: a case report. *Journal of minimally invasive gynecology*. 2009;16(2):212-5.
637. Walid MS, Agarwala N, Heaton RL. Laparoscopic removal of infected mesh colposacropexy. *Archives of gynecology and obstetrics*. 2009;280(1):103-6.
638. Chen CC, Hijaz A, Drazba JA, Damaser MS, Daneshgari F. Collagen remodeling and suburethral inflammation might account for preserved anti-incontinence effects of cut polypropylene sling in rat model. *Urology*. 2009;73(2):415-20.
639. Lewicky-Gaupp C, McGuire EJ, Fenner DE. Multiple perineal abscesses and sinus tracts as a complication of vaginal mesh. *Int Urogynecol J Pelvic Floor Dysfunct*. 2009;20(9):1137-9.
640. Caquant F, Collinet P, Debodinance P, Berrocal J, Garbin O, Rosenthal C, et al. Safety of Trans Vaginal Mesh procedure: retrospective study of 684 patients. *The journal of obstetrics and gynaecology research*. 2008;34(4):449-56.
641. Masata J, Dunder P, Martan A. Actinomyces infection appearing five years after trocar-guided transvaginal mesh prolapse repair. *International urogynecology journal*. 2014;25(7):993-6.
642. McCluskey TC, Stany MP, Hamilton CA. Pyocolpos presenting as a large pelvic mass after total colpopoiesis. *American journal of obstetrics and gynecology*. 2015;212(1):113.e1-2.
643. Gyang AN, Feranec JB, Patel RC, Lamvu GM. Managing chronic pelvic pain following reconstructive pelvic surgery with transvaginal mesh. *International urogynecology journal*. 2014;25(3):313-8.
644. Sartore A, Zennaro F, Banco R. An unusual long-term complication of transobturator polypropylene mesh. *Archives of gynecology and obstetrics*. 2014;290(6):1273-4.
645. Feiner B, Jelovsek JE, Maher C. Efficacy and safety of transvaginal mesh kits in the treatment of prolapse of the vaginal apex: a systematic review. *BJOG : an international journal of obstetrics and gynaecology*. 2009;116(1):15-24.
646. Duckett JR, Jain S. Groin pain after a tension-free vaginal tape or similar suburethral sling: management strategies. *BJU international*. 2005;95(1):95-7.
647. Jeffery ST, Nieuwoudt A. Beyond the complications: medium-term anatomical, sexual and functional outcomes following removal of trocar-guided transvaginal mesh. A retrospective cohort study. *International urogynecology journal*. 2012;23(10):1391-6.
648. Lee D, Dillon B, Lemack G, Gomelsky A, Zimmermann P. Transvaginal mesh kits-how "serious" are the complications and are they reversible? *Urology*. 2013;81(1):43-8.
649. Vieillefosse S, Thubert T, Dache A, Hermieu JF, Deffieux X. Satisfaction, quality of life and lumbar pain following laparoscopic sacrocolpopexy: suture vs. tackers. *European journal of obstetrics, gynecology, and reproductive biology*. 2015;187:51-6.
650. Rusavy Z, Rivaux G, Fattouh B, Cayrac M, Boileau L, de Tayrac R. Voiding difficulties after vaginal mesh cystocele repair: does the perivesical dissection matter? *International urogynecology journal*. 2013;24(8):1385-90.
651. Book NM, Novi B, Novi JM, Pulvino JQ. Postoperative voiding dysfunction following posterior colporrhaphy. *Female pelvic medicine & reconstructive surgery*. 2012;18(1):32-4.
652. Mueller MG, Pilecki MA, Catanzarite T, Jain U, Kim JY, Kenton K. Venous thromboembolism in reconstructive pelvic surgery. *American journal of obstetrics and gynecology*. 2014;211(5):552.e1-6.
653. Lazarou G RS, Cui N, Zormpa M. Variant iliocaval confluence discovered during sacrocolpopexy. *Obstetrics and gynecology*. 2011;117(pt 2):436-7.

654. Lindstrom D, Sadr Azodi O, Wladis A, Tonnesen H, Linder S, Nasell H, et al. Effects of a perioperative smoking cessation intervention on postoperative complications: a randomized trial. *Annals of surgery*. 2008;248(5):739-45.
655. Rahn DD, Ward RM, Sanses TV, Carberry C, Mamik MM, Meriwether KV, et al. Vaginal estrogen use in postmenopausal women with pelvic floor disorders: systematic review and practice guidelines. *International urogynecology journal*. 2015;26(1):3-13.
656. Ballard AC, Parker-Autry CY, Markland AD, Varner RE, Huisingh C, Richter HE. Bowel preparation before vaginal prolapse surgery: a randomized controlled trial. *Obstetrics and gynecology*. 2014;123(2 Pt 1):232-8.
657. Jacquetin B, Fatton B, Rosenthal C, Clave H, Debodinance P, Hinoul P, et al. Total transvaginal mesh (TVM) technique for treatment of pelvic organ prolapse: a 3-year prospective follow-up study. *International urogynecology journal*. 2010;21(12):1455-62.
658. de Tayrac R, Faillie JL, Gaillet S, Boileau L, Triopon G, Letouzey V. Analysis of the learning curve of bilateral anterior sacrospinous ligament suspension associated with anterior mesh repair. *European journal of obstetrics, gynecology, and reproductive biology*. 2012;165(2):361-5.
659. Dwyer PL, O'Reilly BA. Transvaginal repair of anterior and posterior compartment prolapse with Atrium polypropylene mesh. *BJOG : an international journal of obstetrics and gynaecology*. 2004;111(8):831-6.
660. Mowat A, Maher C, Ballard E. Surgical outcomes for low-volume vs high-volume surgeons in gynecology surgery: a systematic review and meta-analysis. *American journal of obstetrics and gynecology*. 2016;215(1):21-33.
661. Deffieux X, Thubert T, de Tayrac R, Fernandez H, Amarenco G, Jousse M, et al. [Convalescence recommendations after incontinence and pelvic organ prolapse surgery: A study of opinions among French surgeons]. *Journal de gynécologie, obstétrique et biologie de la reproduction*. 2011;40(1):29-35.
662. Sentilhes L, Berthier A, Sergent F, Verspyck E, Descamps P, Marpeau L, et al. Sexual function in women before and after transvaginal mesh repair for pelvic organ prolapse Infracoccygeal sacropexy reinforced with posterior mesh interposition for apical and posterior compartment prolapse.
663. Baessler Kaven, Alan D. Hewson, Ralf Tunn, Bernhard Schuessler, Maher CF. Severe Mesh Complications Following Intravaginal Sling-plasty. *Obstetrics and gynecology*. 2005;106:713-6.
664. Atherton MJ, Daborn JP, Tsokos N, Jeffery JT, Yin MJ. Complications associated with tissue anchor migration after vaginal surgery using the tissue fixation system - a case series. *The Australian & New Zealand journal of obstetrics & gynaecology*. 2012;52(1):83-6.
665. Finamore PS, Echols KT, Hunter K, Goldstein HB, Holzberg AS, Vakili B. Risk factors for mesh erosion 3 months following vaginal reconstructive surgery using commercial kits vs. fashioned mesh-augmented vaginal repairs. *International urogynecology journal*. 2010;21(3):285-91.
666. Huang LY, Chu LC, Chiang HJ, Chuang FC, Kung FT, Huang KH. Medium-term comparison of uterus preservation versus hysterectomy in pelvic organ prolapse treatment with Prolift mesh. *International urogynecology journal*. 2015;26(7):1013-20.
667. Guillibert F, Chene G, Fanget C, Huss M, Sefert P, Chauleur C. [Risk factors of mesh exposure after transvaginal repair of genital prolapse]. *Gynecologie, obstétrique & fertilité*. 2009;37(6):470-5.
668. Patil A, Duckett J. Short-term complications after vaginal prolapse surgery: do suture characteristics influence morbidity? *Journal of obstetrics and gynaecology : the journal of the Institute of Obstetrics and Gynaecology*. 2012;32(8):778-80.
669. Mizon G, Duckett J. The effect of suture characteristics on short-term morbidity after vaginal prolapse surgery. *Journal of obstetrics and gynaecology : the journal of the Institute of Obstetrics and Gynaecology*. 2015;35(6):625-7.
670. Hedde-Parison A, Minchella A, Bastide S, Cornille A, Fatton B, de Tayrac R. [Surgical site infections in vaginal prolapse surgery]. *Progres en urologie : journal de l'Association française d'urologie et de la Société française d'urologie*. 2013;23(17):1474-81.
671. Thiagamoorthy G, Khalil A, Cardozo L, Srikrishna S, Leslie G, Robinson D. The value of vaginal packing in pelvic floor surgery: a randomised double-blind study. *International urogynecology journal*. 2014;25(5):585-91.
672. Granese R, Candiani M, Perino A, Romano F, Cucinella G, editors. Laparoscopic sacrocolpopexy in the treatment of vaginal vault prolapse: 8 years experience. Ireland2009.

673. Govier FE, Kobashi KC, Kozlowski PM, Kuznetsov DD, Begley SJ, McGonigle KF, et al. High complication rate identified in sacrocolpopexy patients attributed to silicone mesh. *Urology*. 2005;65(6):1099-103.
674. Cosson M, Narducci F, Querleu D, Crepin G. [Experimental use of laparoscopic material: report of a case of spondylodiscitis after laparoscopic sacropexy with Taker]. *Annales de chirurgie*. 2001;126(6):554-6.
675. Culligan PJ, Blackwell L, Goldsmith LJ, Graham CA, Rogers A, Heit MH. A randomized controlled trial comparing fascia lata and synthetic mesh for sacral colpopexy. *Obstetrics and gynecology*. 2005;106(1):29-37.
676. Kenton K, Mueller ER, Tarney C, Bresee C, Anger JT. One-Year Outcomes After Minimally Invasive Sacrocolpopexy. *Female pelvic medicine & reconstructive surgery*. 2016.
677. Diez-Itza I, Aizpirtarte I, Becerro A. Risk factors for the recurrence of pelvic organ prolapse after vaginal surgery: a review at 5 years after surgery. *Int Urogynecol J Pelvic Floor Dysfunct*. 2007;18(11):1317-24.
678. Salvatore S, Siesto G, Serati M. Risk factors for recurrence of genital prolapse. *Current opinion in obstetrics & gynecology*. 2010;22(5):420-4.
679. Weemhoff M, Vergeldt TF, Notten K, Serroyen J, Kampschoer PH, Roumen FJ. Avulsion of puborectalis muscle and other risk factors for cystocele recurrence: a 2-year follow-up study. *International urogynecology journal*. 2012;23(1):65-71.
680. Whiteside JL, Weber AM, Meyn LA, Walters MD. Risk factors for prolapse recurrence after vaginal repair. *American journal of obstetrics and gynecology*. 2004;191(5):1533-8.
681. Tegerstedt G, Hammarstrom M. Operation for pelvic organ prolapse: a follow-up study. *Acta obstetrica et gynecologica Scandinavica*. 2004;83(8):758-63.
682. Vakili B, Zheng YT, Loesch H, Echols KT, Franco N, Chesson RR. Levator contraction strength and genital hiatus as risk factors for recurrent pelvic organ prolapse. *American journal of obstetrics and gynecology*. 2005;192(5):1592-8.
683. Medina CA, Candiotti K, Takacs P. Wide genital hiatus is a risk factor for recurrence following anterior vaginal repair. *International journal of gynaecology and obstetrics: the official organ of the International Federation of Gynaecology and Obstetrics*. 2008;101(2):184-7.
684. Rodrigo N, Wong V, Shek KL, Martin A, Dietz HP. The use of 3-dimensional ultrasound of the pelvic floor to predict recurrence risk after pelvic reconstructive surgery. *The Australian & New Zealand journal of obstetrics & gynaecology*. 2014;54(3):206-11.
685. Wong V, Shek K, Rane A, Goh J, Krause H, Dietz HP. Is levator avulsion a predictor of cystocele recurrence following anterior vaginal mesh placement? *Ultrasound in obstetrics & gynecology : the official journal of the International Society of Ultrasound in Obstetrics and Gynecology*. 2013;42(2):230-4.
686. Vergeldt TF, van Kuijk SM, Notten KJ, Kluivers KB, Weemhoff M. Anatomical Cystocele Recurrence: Development and Internal Validation of a Prediction Model. *Obstetrics and gynecology*. 2016;127(2):341-7.
687. Model AN, Shek KL, Dietz HP. Levator defects are associated with prolapse after pelvic floor surgery. *European journal of obstetrics, gynecology, and reproductive biology*. 2010;153(2):220-3.
688. Lince SL, van Kempen LC, Vierhout ME, Kluivers KB. A systematic review of clinical studies on hereditary factors in pelvic organ prolapse. *International urogynecology journal*. 2012;23(10):1327-36.
689. Slieker-ten Hove MCP, Pool-Goudzwaard AL, Eijkemans MJC, Steegers-Theunissen RPM, Burger CW, Vierhout ME. Symptomatic pelvic organ prolapse and possible risk factors in a general population. *American Journal of Obstetrics & Gynecology*. 2002(2):184.e1-e7.
690. Cartwright R, Kirby AC, Tikkinen KAO, Mangera A, Thiagamoorthy G, Rajan P, et al. Systematic review and metaanalysis of genetic association studies of urinary symptoms and prolapse in women. *American Journal of Obstetrics & Gynecology*. 2015;212(2):199.e1-e24.
691. Jackson SR, Avery NC, Tarlton JF, Eckford SD, Abrams P, Bailey AJ. Changes in metabolism of collagen in genitourinary prolapse. *Lancet (London, England)*. 1996;347(9016):1658-61.
692. Khaja A, Winlove P, Waterfield M, Oriolowo A, Adekanmi OA, Freeman RM. Is anatomical failure following anterior vaginal repair associated with weak native vaginal tissues? A biomechanical and immunohistochemical study. *International urogynecology journal*. 2014;25(2):181-7.
693. Kelly EC, Winick-Ng J, Welk B. Surgeon Experience and Complications of Transvaginal Prolapse Mesh. *Obstetrics and gynecology*. 2016.

694. Long CY, Lo TS, Wang CL, Wu CH, Liu CM, Su JH. Risk factors of surgical failure following transvaginal mesh repair for the treatment of pelvic organ prolapse. *European journal of obstetrics, gynecology, and reproductive biology*. 2012;161(2):224-7.
695. Nieminen K, Huhtala H, Heinonen PK. Anatomic and functional assessment and risk factors of recurrent prolapse after vaginal sacrospinous fixation. *Acta obstetrica et gynecologica Scandinavica*. 2003;82:471-8.
696. Kantartzis K, Sutkin G, Winger DG, Wang L, Shepherd JP. Introduction of laparoscopic sacral colpopexy to a fellowship training program *International urogynecology journal*. 2013;24:1877-81.
697. Claerhout F, Verguts J, Werbrouck E, Veldman J, Lewi P, Deprest J. Analysis of the learning process for laparoscopic sacrocolpopexy: identification of challenging steps. *International urogynecology journal*. 2014;25(9):1185-91.
698. Morgan DMMD, Pulliam SMD, Adam RAMD, Swenson CMD, Guire KMS, Kamdar NMS, et al. Analysis of High-, Intermediate-, and Low-Volume Surgeons When Performing Hysterectomy for Uterovaginal Prolapse. *Female Pelvic Medicine & Reconstructive Surgery* January/February. 2016;22(1):43-50.
699. Sung VW, Rogers ML, Myers DL, Clark MA. Impact of hospital and surgeon volumes on outcomes following pelvic reconstructive surgery in the United States. *American journal of obstetrics and gynecology*. 2006;195(6):1778-83.
700. Jarvis SK, Hallam TK, Lujic S, Abbott JA, Vancaillie TG. Peri-operative physiotherapy improves outcomes for women undergoing incontinence and or prolapse surgery: results of a randomised controlled trial. *The Australian & New Zealand journal of obstetrics & gynaecology*. 2005;45(4):300-3.
701. Frawley HC, Phillips BA, Bo K, Galea MP. Physiotherapy as an adjunct to prolapse surgery: an assessor-blinded randomized controlled trial. *Neurourology and urodynamics*. 2010;29(5):719-25.
702. McClurg D, Hilton P, Dolan L, Monga A, Hagen S, Frawley H, et al. Pelvic floor muscle training as an adjunct to prolapse surgery: a randomised feasibility study. *International urogynecology journal*. 2014;25(7):883-91.
703. Subak LL, Waetjen LE, van den Eeden S, Thom DH, Vittinghoff E, Brown JS. Cost of pelvic organ prolapse surgery in the United States. *Obstetrics and gynecology*. 2001;98(4):646-51.
704. Subramanian D, Szwarcensztein K, Mauskopf JA, Slack MC. Rate, type, and cost of pelvic organ prolapse surgery in Germany, France, and England. *European journal of obstetrics, gynecology, and reproductive biology*. 2009;144(2):177-81.
705. Hullfish KL, Trowbridge ER, Stukenborg GJ. Treatment strategies for pelvic organ prolapse: a cost-effectiveness analysis. *International urogynecology journal*. 2011;22(5):507-15.
706. Barber MD, Maher C. Apical prolapse. *International urogynecology journal*. 2013;24(11):1815-33.
707. Ohno MS, Richardson ML, Sokol ER. Abdominal sacral colpopexy versus sacrospinous ligament fixation: a cost-effectiveness analysis. *International urogynecology journal*. 2016;27(2):233-7.
708. Judd JP, Siddiqui NY, Barnett JC, Visco AG, Havrilesky LJ, Wu JM. Cost-minimization analysis of robotic-assisted, laparoscopic, and abdominal sacrocolpopexy. *Journal of minimally invasive gynecology*. 2010;17(4):493-9.
709. Patel M, O'Sullivan D, Tulikangas PK. A comparison of costs for abdominal, laparoscopic, and robot-assisted sacral colpopexy. *International urogynecology journal and pelvic floor dysfunction*. 2009;20(2):223-8.
710. Murray S, Haverkorn RM, Lotan Y, Lemack GE. Mesh kits for anterior vaginal prolapse are not cost effective. *Int Urogynecol J Pelvic Floor Dysfunct*. 2011;22(4):447-52.
711. Jacklin P, Duckett J. A decision-analytic Markov model to compare the cost-utility of anterior repair augmented with synthetic mesh compared with non-mesh repair in women with surgically treated prolapse. *BJOG : an international journal of obstetrics and gynaecology*. 2013;120(2):217-23.
712. Maher CF, Connelly LB. Cost minimization analysis of laparoscopic sacral colpopexy and total vaginal mesh. *American Journal of Obstetrics & Gynecology*. 2012;206(5):433.e1-7.
713. Richardson ML, Elliott CS, Shaw JG, Comiter CV, Chen B, Sokol ER. To sling or not to sling at time of abdominal sacrocolpopexy: a cost-effectiveness analysis. *J Urol*. 2013;190(4):1306-12.

ASSESSMENT AND CONSERVATIVE MANAGEMENT OF FAECAL INCONTINENCE AND QUALITY OF LIFE IN ADULTS

Chairs

D.J. Bliss (USA)
T. Mimura (Japan)

Members

B. Berghmans (Netherlands)
A. Bharucha (USA)
G. Chiarioni (Italy)
A. Emmanuel (UK)
Y. Maeda (UK)
M. Northwood (Canada)
C. Peden-Mcalpine (USA)
H. Rafiee (UK)
Todd Rock-Wood (USA)
G. Santoro (Italy)
S. Taylor (UK)
W. Whitehead (USA)

CONTENTS

ABREVIATIONS	1996	VII. DIET AND FLUID INTAKE	2020
I. INTRODUCTION	1997	1. Lactose, Yogurt, Sorbitol, Fructose, Caffeine, and Alcohol	2021
II. DEFINITIONS	1997	2. What's New about Diet and Fluid Intake in the Current Review?	2021
1. New Definitions of Bowel Incontinence	1997	3. Prebiotics, Probiotics, Synbiotics	2021
III. CLINICAL ASSESSMENT OF FAECAL INCONTINENCE	1998	4. Dietary Fibre	2021
1. History	1998	5. What is New about Probiotics and Dietary Fibre in the Current Review?	2022
2. Subtypes of Faecal Incontinence	1999	6. Summary of Current Evidence on Dietary Fibre and Probiotics	2023
3. Risk Factors	1999	VIII. BOWEL MANAGEMENT AND RETRAINING PROGRAMMES, RECTAL EVALUATION, AND TRANSANAL IRRIGATION	2027
4. Physical Examination	2000	1. What is New in the Current Review?	2027
5. Anoscopy and Proctoscopy	2000	IX. COMBINATION THERAPIES	2028
6. Vaginal Examination	2001	1. What is New about Combination Therapies in the Current Review?	2028
7. What is New about Clinical Assessment in the Current Review?	2001	X. MEDICATION TREATMENT OF FAECAL INCONTINENCE	2029
IV. SPECIALISED TESTING	2001	1. Goals	2029
1. Anorectal Manometry	2001	2. What is New about Medication Treatment in the Current Review?	2030
2. Endoanal Ultrasound Imaging	2003	XI. PELVIC FLOOR MUSCLE EXERCISES, BIOFEEDBACK, AND ELECTRICAL STIMULATION	2034
3. Defaecography	2006	1. Background	2034
4. Magnetic Resonance Imaging (MRI) ..	2009	2. What is New in the Current Review?	2036
5. Clinical Neurophysiological Testing ..	2011	3. Summary of Current Evidence for Pelvic Floor Muscle Exercises, Biofeedback, and Electrical Stimulation	2047
V. FAECAL INCONTINENCE SYMPTOM SEVERITY SCALES	2012	XII. QUALITATIVE RESEARCH ON THE EXPERIENCE OF FAECAL INCONTINENCE AND QUALITY OF LIFE	2048
1. Description of Scales	2012	1. Criteria for Evaluation of Qualitative Studies	2048
2. Assessing Clinically Important Differences in Symptom Severity	2013		
3. Blending Symptom Severity and Quality of Life Scales	2014		
VI. EDUCATION AND LIFESTYLE CHANGE	2017		
1. What is New About Education and Lifestyle Changes in the Current Review?	2018		

2.	What is New in the Current Review? .	2049
3.	Levels of Evidence for Qualitative Studies	2049
4.	Grades of Recommendation for Qualitative Studies	2049
5.	The Experience of Faecal Incontinence and Quality of Life.....	2049
6.	Living with Faecal Incontinence Related to Relationships	2050
7.	Living with Faecal Incontinence Related to Time and Planning	2051
8.	Living with Faecal Incontinence Related to Bodily Symptoms, Self Esteem, and Body Image.....	2052
9.	Living with Faecal Incontinence Related to Sexuality	2053
10.	Living with Faecal Incontinence Related to Dietary Issues	2054
XIII.	SUMMARY OF KEY RESEARCH RECOMMENDATIONS	2055
XIV.	ALGORITHM	2055
	REFERENCES	2067
	APPENDIX 1	2083

ASSESSMENT AND CONSERVATIVE MANAGEMENT OF FAECAL INCONTINENCE AND QUALITY OF LIFE IN ADULTS

D. Bliss (USA), T. Mimura (Japan)

B. Berghmans (Netherlands), A. Bharucha (USA), G. Chiarioni (Italy), A. Emmanuel (UK), Y. Maeda (UK), M. Northwood (Canada), C. Peden-Mcalpine (USA), H. Rafiee (UK), Todd Rock-Wood (USA), G. Santoro (Italy), S. Taylor (UK), W. Whitehead (USA)

ABBREVIATIONS

AI	Anal Incontinence	IASD.D.2	Incontinence-Associated Skin Damage and Severity Instrument, version D.2
ANS	Autonomic Nervous System	IBD	Inflammatory Bowel Disease
ARA	Anorectal Angle	ICIQ-B	International Consultation of Incontinence Questionnaire for Bowel
BF	Biofeedback	LA	Levator Ani
CCFI	Cleveland Clinic Fecal Incontinence Score	LARS	Lower Anterior Resection
CN-EMG	Concentric Needle Electromyography	LUTS	Lower Urinary Tract Symptoms
DRESS	Digital Rectal Examination Scoring System	LVR	Laparoscopic Ventral Rectopexy
EAS	External Anal Sphincter	MCID	Minimum Clinically Important Difference
EAUS	Endoanal Ultrasound	MEPS	Motor Evoked Potentials
EMG	Electromyography	MES	Mucosal Electrosensitivity
ES	Electrical Stimulation of the Anal Mucosa	MR	Magnetic Resonance
EVUS	Endovaginal Ultrasound	MRI	Magnetic Resonance Imaging
FI	Fecal Incontinence	NIDDK	National Institute of Diabetes and Digestive Kidney Diseases
FICA	Fecal Incontinence and Constipation Assessment	OASIS	Obstetric Anal Sphincter Injury
FIQL	Fecal Incontinence Quality of Life Scale	PFMT	Pelvic Floor Muscle Training
FISI	Fecal Incontinence Severity Index	PNTML	Pudendal Nerve Terminal Motor Latency
FISS	Fecal Incontinence Symptom Severity Scale	PTNS	Percutaneous Tibial Nerve Stimulation
HRM	High Resolution Manometry	QOL	Quality of Life
IAS	Internal Anal Sphincter	RCOG	Royal College of Obstetricians and Gynaecologists
		RCT	Randomized Clinical Trial
		SEPS	Somatosensory Evoked Potentials
		SF-EMG	Single Fibre Electromyography

SLT	Sacral Latency Test
SNS	Sacral Nerve Stimulation
SP	Symphysis Pubis
TNS	Tibial Nerve Stimulation
TPUS	Transperineal Ultrasound
TTNS	Transcutaneous Tibial Nerve Stimulation
US	Ultrasound
3D	Three-Dimensional
3T	Triple Therapy

I. INTRODUCTION

Faecal incontinence affects all age groups of adults and both sexes. It is often distressing and embarrassing, lowers quality of life, decreases one's sense of health and well-being, and interferes with social interactions and intimacy [1-5]. Faecal incontinence increases risk of skin damage from inflammation and dysfunction of epidermal skin layers [6] (See Chapter 17) and pressure injury [7]. Conservative management of faecal incontinence is recommended in the absence of acute traumatic anal sphincter rupture or a major defect in the external anal sphincter confirmed by endosonograph in the presence of gross faecal leakage (See algorithm). Patients with these problems should be referred for surgical evaluation. Reduction of faecal incontinence severity, especially frequency of leakage, is a goal of therapy for many individuals when complete cure may not be attainable [1].

This chapter provides an updated review of evidence from studies about the assessment, conservative management, and influence of faecal incontinence on quality of life assessed by qualitative methods in adults. Assessment of the aetiology and severity of faecal incontinence can enable subsequent appropriate management. A new topic included in this review is faecal incontinence symptom severity scales, which are used in research studies and as part of clinical assessment. Conservative management refers to a variety of non-operative interventions that are aimed to improve faecal incontinence or prevent worsening of its severity. The committee recommends conservative management in the clear majority of patients before considering surgical treatments because these conservative approaches are comparatively inexpensive, have considerably less risk for morbidity, and may be sufficient for some patients.

In each section of this chapter, recommendations for practice made by the committee at the 5th ICI in 2012 are included and the main findings of that review are summarised. Recommendations for practice from the 5th ICI are compared to any new recommendations based on current evidence. For the current review, literature databases relevant to each topic (e.g., CINHAL, EMBASE, Medline/Ovid, PubMed, Web of

Science, and Cochrane Systematic Reviews) were searched for studies in the English language from January 2011 to December 2015, assisted by a librarian as needed. For some topics, the start date may have been modified, depending on the literature included in the past review. The terms used in comprehensive literature search strategies are listed in Appendix 1. Studies of adults in institutional settings such as hospitals and long-term care/nursing homes were excluded. Assessment and management of incontinence of adults in these settings, as well as in children and those with neurogenic incontinence are covered by other ICI committees and chapters. Faecal incontinence is the primary outcome measure of interest in this review. In rare instances, when the body of literature was small and it was not possible to distinguish faecal from anal incontinence, studies about anal incontinence may have been included in the review. Committee members examined the list of citations and abstracts yielded from the electronic search strategy and potentially relevant papers were retrieved in full text. Full-length studies, systematic reviews, and meta-analyses were reviewed. Reference lists in articles were examined and relevant articles obtained.

New information from studies during the recent literature search period is emphasised and added to Tables of study details. Recommendations for practice and research from the 5th ICI in 2012 were re-evaluated considering new evidence and revised as needed. Updated recommendations for research are presented.

II. DEFINITIONS

The definitions of anal incontinence (AI) versus faecal incontinence (FI) in the previous consultations were

"Anal incontinence is the involuntary loss of flatus, liquid or solid stool that is a social or hygienic problem."

"Faecal incontinence is the involuntary loss of liquid or solid stool that is a social or hygienic problem."

1. NEW DEFINITIONS OF BOWEL INCONTINENCE

The definitions of both anal and faecal incontinence have been revised. Definitions of other types of bowel incontinence have been added.

- Anal incontinence is the involuntary loss of faeces and/or flatus and/or mucus.
- Faecal incontinence is the involuntary loss of faeces.
- Flatus incontinence is the involuntary loss of rectal gas or flatus.
- Mucus incontinence is the involuntary loss of mucus only (without faeces).

The terms and definition of faecal incontinence and anal incontinence are not synonymous. As before, the committee recommends that whichever definition is used in studies and publications, the conceptual and operational definition be made explicit and used in a consistent manner. It is recommended that scores of anal incontinences severity allow for separate quantification of faecal incontinence severity to facilitate comparison with findings of studies of faecal incontinence and to expand the body of our knowledge. Similarly, quantifying the severity of flatus or mucus incontinence separately if relevant is optimal. The choice of which definition to use depends on the outcome of interest and scientific and clinical judgement. The prevalence of the different types of bowel incontinence and the percentage of anal incontinence that the different types constitute are not fully known. Use of these definitions in research studies will enable collection of these data. This committee acknowledges that the degree of bothersomeness, embarrassment, or distress associated faecal or anal incontinence is subjective and may influence a patient's treatment seeking.

III. CLINICAL ASSESSMENT OF FAECAL INCONTINENCE

Faecal continence is maintained by complex mechanisms and relies on several different factors, including stool consistency, anal sphincter function, anorectal sensation, intra-rectal pressure, rectal capacity and compliance, colonic function, and cognitive processes [8,9]. The aetiology of faecal incontinence is usually multifactorial, and therefore clinical assessment with detailed history and anorectal physical examination is essential to evaluate these factors for its initial management. When the initial management of faecal incontinence fails to improve symptoms sufficiently, specialised examinations such as endoanal ultrasonography and defaecography can be used to assess the causes of faecal incontinence. Further testing results assist the selection of appropriate treatment in a stepwise manner [9,10].

Recommendations for Practice for Initial Clinical Assessment of Faecal Incontinence from the 5th ICI

- Perform a baseline assessment including a focused medical history, a general physical examination, and an anorectal examination with inspection of perianal skin (Recommendation Grade B-C).
- Several conditions should be specifically assessed for in the history and physical examination, as they may be amenable to definitive treatment, including rectal prolapse, haemorrhoids, faecal loading, potentially treatable causes of diarrhoea (e.g., inflammatory bowel disease and irritable bowel syndrome, infection, adenomata),

acute anal sphincter injury, and acute disc prolapse/cauda equina syndrome (Recommendation Grade B).

- Conduct a digital rectal examination (Recommendation Grade C).
- Perform a proctoscopy (Recommendation Grade B).

1. HISTORY

History gathering requires sensitivity but health professionals must be aware that most patients prefer clinicians (physicians, nurse practitioners, continence nurse specialists, physiotherapists, etc.) to ask them directly about faecal incontinence [11,12] (Level of Evidence 3). More than two thirds of women with faecal incontinence do not seek care voluntarily [13], while men take longer than women before asking for treatment [14]. The aims of history taking and examination are to identify conditions that are amenable to management and to characterize symptoms so that they might be reduced.

In taking a history, assessing the impact of faecal incontinence on quality of life (See Section XII-Qualitative Research on the Experience of Faecal Incontinence and Quality of Life), the patient's goals of treatment [1], and symptom severity [15] are important in planning care (Level of Evidence 4) as well as for engaging the patient in the plan (Level of Evidence 3). There are several scoring systems or questionnaires that have been used to assess symptom severity of anal incontinence including the Cleveland Clinic Fecal Incontinence Score (CCFI) [16], Fecal Incontinence Severity Index (FISI) [17], Fecal Incontinence Symptom Severity Score [4,18], and St Mark's Score [19]. Additionally, the Faecal Incontinence Quality of Life Scale (FIQL) [20] and Modified Manchester Health Questionnaire [21] evaluate faecal or anal incontinence specific quality of life (QOL), and the Bowel version of the International Consultation on Incontinence questionnaire (ICIQ-B) [5,22,23] assesses anal incontinence severity and QoL (See Section XII-Qualitative Research on the Experience of Faecal Incontinence and Quality of Life and Chapter 5-B). Use of valid and reliable measures is recommended and essential in research. In clinical practice, questionnaires that are short, simple, and easy to use are often preferred

- The history consists of data on daily bowel habits, the nature of the incontinence, past surgical & obstetric history, co-morbidities and current medication, including laxatives. Daily bowel habits include bowel frequency and stool consistency. Stool consistency can be quantified with Bristol stool form scale [24]. A simpler, shorter stool consistency classification used for faecal incontinence developed by Bliss and col-

leagues, shown to have good validity and reliability, is also available [25,26] (Level of Evidence 3).

- The onset and duration of the symptoms should be asked, and the nature of the incontinence includes the subtype (e.g. passive), frequency, amount, and consistency of the incontinent leakage as well as the presence of urgency [9,27] (Level of Evidence 4).
- The timing of the faecal incontinence, such as post-defaecation, during the night, versus any time is important as faecal incontinence is not always associated with a bowel movement. Leakage of faeces can occur immediately before or in between bowel movements [28] (Level of evidence 3). Nocturnal faecal incontinence occurs uncommonly and is most frequently encountered in patients with neurogenic disorders, faecal impaction, low anterior resection syndrome, post-restorative proctocolectomy, diabetes mellitus and Scleroderma [9] (Level of Evidence 4).

2. SUBTYPES OF FAECAL INCONTINENCE

The types of bowel incontinence are anal, faecal, flatus or mucus (See Section II.1-New Definitions of Bowel Incontinence for definitions). Differentiating the type as well as subtype of faecal incontinence, if possible, may help identify an aetiology of faecal incontinence[15]. Subtypes of faecal incontinence are passive, urge, and functional faecal incontinence. Passive faecal incontinence is the involuntary leakage of faeces without forewarning. A small amount of soiling and seepage between the buttocks or on a small pad or underwear are symptoms of minor passive faecal incontinence. Passive faecal incontinence is frequently related to internal anal sphincter dysfunction, while urge faecal incontinence is often associated with external anal sphincter dysfunction [29,30] (Level of Evidence 3). Urge faecal incontinence is the inability to defer defaecation once the urge is perceived for long enough to reach a toilet. However, as distances to a toilet will vary, this is an inconsistent and uncontrolled condition. Faecal incontinence associated with the urgency to defecate has also been observed to be associated with reduced rectal capacity and with increased rectal sensitivity [18,31]. Functional faecal incontinence is due to limitations in mobility, manipulating clothing, or toileting ability or delayed assistance with toileting. With regards to urinary incontinence, functional incontinence is also referred to as dependent [32] incontinence. Fonda and Abrams [32] propose that a subtype of urinary incontinence is contained incontinence, which is urine leakage contained in an absorbent pad or appliance. This definition has some relevance to faecal incontinence which may be managed with absorbent products or an appliance such as an anal pouch (see Chapter 20).

Faecal incontinence is not always caused by sphincter dysfunction. Urge faecal incontinence can occur, for example, in patients with irritable bowel syndrome who have a strong external anal sphincter, whilst passive faecal incontinence might occur as over-flow incontinence in those with faecal impaction in the rectum who have a functionally and structurally intact internal anal sphincter. Minor passive faecal incontinence after defaecation can also occur, and is typically related to internal anal sphincter dysfunction or poor “snapping shut” (i.e., closure) of the external anal sphincter after defaecation[33] (Level of Evidence 4).

3. RISK FACTORS

The history of faecal incontinence should include questioning about its risk factors, which could be associated with its potential etiology. (See Chapter 1 for more information about faecal incontinence risk factors).

- Dietary history – include intake of caffeine (Level of Evidence 4) and sorbitol (Level of Evidence 3) as they may stimulate GI transit or diarrhoea [34-36].
- Medication - overdose or abuse of laxatives could cause chronic diarrhoea leading to faecal incontinence, particularly in the elderly [37] (Level of Evidence 4). Anti-anginal and antihypertensive medications (for example, calcium channel blockers and adrenergic alpha-1 receptor antagonists) may reduce internal anal sphincter tone [38], and magnesium containing antacids may provoke diarrhoea [16,36] (Level of Evidence 3).
- Co-morbidities – risk factors for faecal incontinence include diabetes mellitus, irritable bowel syndrome, constipation (particularly faecal impaction with overflow), benign anal disease (haemorrhoids, fistula, anal warts), scleroderma, neurogenic disorders (spinal cord injury or lesions), multiple sclerosis, stroke and dementia [8,9,39] (Level of Evidence 4).
- Obstetric history- vaginal delivery could cause anal sphincter disruption, tear, and/or pudendal neuropathy. Risk factors for obstetric anal sphincter disruption include primiparous delivery, use of forceps, birth weight > 4 kg, occipital-posterior position at delivery, and prolonged second stage of labour [22,40,41] (Level of Evidence 3).
- Surgical history - particularly anal fissure surgery (sphincterotomy or anal stretch), haemorrhoidectomy, fistula surgery and low anterior resection [42-44] (Level of Evidence 3). Cholecystectomy could cause post-cholecystectomy diarrhoea, leading to faecal incontinence [44] (Level of Evidence 3).

- History of pelvic radiation - due to risk of radiation prostatitis (that can cause decreased rectal compliance) and internal anal sphincter radiation damage[45] (Level of Evidence 4).
- Symptoms of other pelvic floor problems (urinary incontinence and pelvic organ prolapse), which have similar risk factors [44,46,47] (Level of Evidence 3).
- Rectal tumour or mass – if palpable, colonoscopy is required.
- Resting tone - indicative of internal anal sphincter function.
- Voluntary and reflex squeeze pressure – indicative of external anal sphincter function and potential function, respectively. The latter is elicited most commonly by asking the patient to cough while assessing sphincter tone - a cough causes a reflex near-maximal external sphincter contraction.

4. PHYSICAL EXAMINATION

4.1. General, Perianal, and Digital Rectal Examination

Examination is focused on the detection of evidence of faecal incontinence and identifying its causes, if possible. True faecal incontinence must be differentiated from conditions that cause discharge or seepage of mucus such as prolapsing external haemorrhoids, fistulae, and low rectal or anal tumours as well as from poor perineal hygiene. Physical examination should include inspection of underclothing for soiling and staining by stool, pus, or mucus. Perianal skin should be examined for signs of irritation such as erythema, rash, and excoriation [48]. The Incontinence-Associated Skin Damage and Severity Instrument, version D.2 for use with light to dark toned skin (IASD.D.2), is a validated and useful tool to assess inflammatory damage of the upper skin layers resulting from faecal incontinence [49,50] (Level of Evidence 2) (See chapter 17). Perianal inspection should also include attempts to identify a patulous anus or one which gapes on gentle traction of the anal verge and/or a “keyhole” deformity of the anal canal which suggests a persisting sphincter defect. Inspection may reveal scars from previous episiotomies, or obstetric tears. Abnormalities at the anal verge from previous surgery or a gaping anus suggestive of marked loss of function may be present.

4.2. Perianal inspection should identify the following [8,9] (Level of Evidence 4):

- Scars from previous surgery or obstetric injury
- Perianal disease - prolapsing haemorrhoids, fistula, anal warts
- Presence of sensory deficits – numbness on the perianal skin
- Absence of perineal body - suggestive of obstetric trauma; at its worst this may manifest as a cloacal deformity

4.3. Digital Rectal Examination Should Assess the Following[8,9,51] (Level of Evidence 4):

- Rectal contents - if faecal impaction is present, this could explain incontinence.

- Function of the puborectalis muscle (palpable at the anorectal junction) - assessed by asking the patient to squeeze the sphincter at which time the puborectalis should push the examiner’s finger anteriorly.
- Regional sphincter defects - detected as asymmetry.
- Paradoxical puborectalis contraction - this may be valuable in assessing constipated patients to identify paradoxical contraction as a cause of retained stool, and hence overflow incontinence [52].

The evaluation by the digital rectal examinations is reasonably correlated with anal canal manometry for resting pressure [51,53-55] and squeeze pressure [51,53,55,56] (Level of Evidence 3), although there are some conflicting data [57]. Orkin et al.[51] have developed and proposed the digital rectal examination scoring system (DRESS) to describe anal sphincter tone on digital rectal examination. The DRESS score uses a scale of 0 to 5 for both resting and squeeze pressures, ranging from 0 = no discernible pressure to 5 = extremely tight and 3 = normal. It was demonstrated that DRESS correlates very well with anal manometry pressures for both resting and squeeze pressure (Level of Evidence 3). Therefore, experienced clinicians can reliably use the digital rectal examination to assess the anal sphincter strength. However, anal inspection and digital rectal examination is not accurate enough to identify small to moderate external anal sphincter defects, requiring further diagnostic work-up such as endoanal ultrasonography in select patients [55,58] (Level of Evidence 3).

If rectal prolapse is suspected by history of mass prolapse per anus or perianal discomfort on straining or walking, but cannot be confirmed by Valsalva manoeuvre on a couch, the patient should be asked to sit on a commode and attempt defaecation - the perineum should then be inspected for evidence of a rectal mucosal or full thickness prolapse on straining.

5. ANOSCOPY AND PROCTOSCOPY

Anoscopy and proctoscopy with a rigid instrument or flexible sigmoidoscopy are bedside examinations of

value in excluding potentially treatable causes of faecal incontinence: anorectal tumours or polyps, haemorrhoids[8] and solitary rectal ulcer syndrome - a functional disorder of evacuation, in which repeated straining at stool and or rectal self-digitalisation may result in an ulcerated area of the anterior rectal wall [59] (Level of Evidence 4).

6. VAGINAL EXAMINATION

Vaginal examination using a Simms speculum may show a rectocele, cystocele and/or uterine prolapse, all of which may contribute to developing faecal incontinence [60,61] (Level of Evidence 4). Physiological and complementary radiological tests are used to confirm clinical suspicion and provide objective data on the function of the anorectum. Pelvic floor dysfunction is a complex problem and multiple tests may be needed based on initial findings and complexity of the planned intervention.

7. WHAT IS NEW ABOUT CLINICAL ASSESSMENT IN THE CURRENT REVIEW?

- Experienced clinicians can reliably use the digital rectal examination to assess the anal sphincter strength. The digital rectal examination scoring system (DRESS) [51] is a useful tool to describe anal sphincter tone on digital rectal examination.
- The Incontinence Associated Skin Damage and Severity Instrument (IASD.D.2) is a validated, reliable, and useful tool to assess the severity of superficial skin irritation resulting from faecal incontinence and promote treatment [49,50].

Current Recommendations for Practice for Clinical Assessment

- Perform a baseline assessment including a focused medical history, a general physical examination, and an anorectal examination with inspection of perineal skin (Recommendation Grade C).
- Try to differentiate the type of faecal incontinence (passive and/or urge, or functional), which can help identify its etiology (Recommendation Grade C).
- Several conditions should be specifically assessed for in the history and physical examination, as they may be amenable to definitive treatment, including anorectal tumour, rectal prolapse, haemorrhoids, faecal loading, potentially treatable causes of diarrhoea (e.g., inflammatory bowel disease, infection and irritable bowel syndrome), acute anal sphincter injury, and spinal cord disorders (e.g., spinal cord injury and cauda equina syndrome) (Recommendation Grade C).

- Conduct a digital rectal examination to assess the strength of the internal and external anal sphincter as well as puborectal muscle (Recommendation Grade B).
- Perform anoscopy and proctoscopy to exclude potentially treatable causes of faecal incontinence (e.g., anorectal tumours, haemorrhoids, inflammatory bowel disease) (Recommendation Grade C).
- Further diagnostic work-up such as anorectal manometry, endoanal ultrasonography and defaecography are required, when the initial management fails to improve symptoms Sufficiently (Recommendation Grade C).
- Assess and manage skin damage associated with faecal incontinence (Recommendation Grade C).

Current Recommendations for Research for Clinical Assessment

- Establish the best way for clinicians to ask patients directly about faecal incontinence.
- Characterise the faecal incontinence in men, who are less studied although according to the epidemiological studies both sexes are equally affected.

IV. SPECIALISED TESTING

1. ANORECTAL MANOMETRY

1.1. Indications

Anorectal manometry measures the pressures in the anal canal and the distal rectum. This test serves as one of the most accepted and used investigations to measure the function of the internal anal sphincter and the external anal sphincter. Evaluation of the sphincter function in patients with faecal incontinence is the primary indication for manometry. In addition, measurement of rectal sensation is also an important component of the testing [62-64] (Level of Evidence 2).

1.2. Recommendations for Practice for Anorectal Manometry from the 5th ICI

- Anorectal manometry can objectively assess anal sphincter function in patients with faecal incontinence (Recommendation Grade C).
- Focused expertise to perform manometry is required; each centre/laboratory should establish its own control values for anorectal manometry and check for reproducibility of the test (Recommendation Grade B).

1.3. Equipment and Testing

Anorectal manometry can be performed with different types of catheters, including solid state and water perfused [65]. The diameter of the probe is variable but should not exceed 5-6 mm. The probe usually includes sensors (typically fewer than 6) radially distributed to measure several pressures at each level. Any manipulation of the rectum, such as digital rectal examination or administration of an enema prior to a test should be followed by a minimum of 5 minutes of rest to allow sphincter activity to return to baseline.

Traditional technique has been stationary pull-through as this technique avoids the reflex sphincter contraction. The stationary pull-through measures the resting pressure and the squeeze increase at 6, 5, 4, 3, 2, and 1 cm from the anal verge by extracting the probe in increments of 1 cm from the rectum to the anal verge. Allowing a waiting period of 30 seconds between each measurement minimises artifacts. A pull-through can also be performed by automated withdrawal. Because normal values are strongly affected by technique as well as age and sex, and it is advisable to compare findings in patients with normal values determined with the same technique.

1.4. High Resolution Manometry

In the last decade, the development of high resolution manometry (HRM) has offered another option to investigate anorectal function in detail. A high-resolution catheter has up to 256 circumferentially distributed pressure sensors which extend over the entire length of the anal canal, allowing a greater definition of the function of the sphincter complex and removing the need for a stationary pull-through [66,67]. The pressures measured by HRM are generally well correlated with pressure measurements by a water-perfused catheter but the values are higher than those measured with conventional catheters [67,68]. High resolution manometry has become the gold-standard investigation in studying oesophageal function and standardised between hospitals using the Chicago classification [69] yet the take up in evaluation of anorectal function and standardisation has been slow. The British Society of Gastroenterology guideline for HRM was published in 2015 [70]. There is an ongoing international consensus process to standardise anorectal manometry procedure.

1.5. Anal Resting Pressure

The anal resting tone is a composite pressure generated by the internal anal sphincter (55%), external anal sphincter (30%) and the anal cushions (15%)[71]. The patient needs to be relaxed; otherwise there may be contributory effects of the external anal sphincter. Anal resting pressure is defined as the difference between the intra-anal canal pressure at rest and the atmospheric pressure or the intrarectal pressure [72]. There is some radial asymmetry in pressures in the different parts of the anal canal and there-

fore the pressures are normally expressed as the average of readings obtained at a single level of the anal canal. The length of the anal canal with higher pressure is normally called the high-pressure zone.

Patients with faecal incontinence usually have a lower anal resting tone than continent patients or normal controls, but this is not a reliable marker on its own [73]. The degree of faecal incontinence will not only depend on the anal sphincter tone, since there are many other factors (i.e., stool consistency, rectal compliance, etc.) that play an important role. Age, sex and parity also affect sphincter pressure profile [74,75]. In general, older people and women with faecal incontinence have lower sphincter pressures, but the association of lower sphincter pressure with age and female gender is also seen in normal subjects[76]. Defined values for the normal range of anal resting tone pressures are being generated for some groups [66,77,78].

1.6. Squeeze Increments

The squeeze increase of the anal canal pressure is generated by contraction of the external anal sphincter and puborectalis which can be calculated as the increase in pressure from the anal canal resting pressure during maximal anal squeeze. The squeeze increment is usually measured in the high-pressure zone. Decreased squeeze pressures are frequently correlated with injuries in the external anal sphincter, neurological damage or just poor patient compliance/voluntary control [62,79].

The fatiguability of the external anal sphincter can be estimated by measuring the patients' ability to sustain the squeeze effort over time. The squeeze duration (endurance squeeze pressure or increment) is often reduced in patients with incontinence. Pressure change during cough can be measured and termed involuntary squeeze pressure or increment, which indicates potential pressures that could be generated by the external anal sphincter and puborectalis.

1.7. Recto-Anal Inhibitory Reflex

Rectal distension or attempted defaecation results in an inhibition the tonic activity of the internal anal sphincter and relaxation of this muscle. Presence of an intact internal anal sphincter is dependent on an intact myenteric plexus and it is usually impaired in patients with intrinsic neuropathy such as Hirschsprung's disease and in some neuropathic conditions such as multiple sclerosis. The value of recto-anal inhibitory reflex testing in patients with faecal incontinence is limited.

1.8. Rectal Sensation and Compliance

Rectal sensation (and rectal compliance) can be measured by intermittent balloon distension in the distal rectum and simultaneously monitoring the patient's response. The first sensation, the first urge and the maximal tolerable volume are usually recorded.

Rectal compliance can also be assessed by measuring the pressure and volume relationship when a balloon is inflated in the rectum but this is mostly used as a tool in research settings.

Reduced sensory threshold levels of the rectum (rectal hypersensitivity) in patients with faecal incontinence could indicate a presence of urge faecal incontinence and increased frequency of defaecation, whereas incontinent patients with increased sensory threshold levels (rectal hyposensitivity) may suffer from overflow incontinence.

1.9. What is New about Anorectal Manometry in the Current Review?

- Development of high resolution manometry has generated more detailed profiles of sphincter function. There are ongoing efforts to establish its value in clinical practice.

Current Recommendations for Practice for Anorectal Manometry

- Recommendations for Practice from the 5th ICI continue to be supported (See section IV.1.2-Specialized Testing-Recommendations for Practice for Anorectal Manometry from the 5th ICI).

Current Recommendations for Research for Anorectal Manometry

- Assess normal values for anorectal manometry in large healthy control samples spanning all ages to serve as comparisons for abnormalities in faecal incontinence.
- Assess capability of anorectal physiology testing, including HRM, results on predicting outcomes of conservative/medical and/ or surgical treatments for faecal incontinence
- Evaluate the utility of high resolution manometry in the assessment of patients with faecal incontinence and whether HRM adds information to improves clinical decision making or is better than non-high resolution manometry.
- Assess if anorectal manometry can be performed in a more physiological position (e.g. sitting) and if this provides more clinically meaningful values.

2. ENDOANAL ULTRASOUND IMAGING

Summary of Studies from the 5th ICI

Endoanal ultrasound (EAUS) is established as an important part of a colorectal diagnostic work-up [80]

and has been recommended as the gold standard investigation to identify anal sphincter injury by the International Urogynecological Association/ International Continence Society joint report [81]. EAUS is usually performed with high multi-frequency (9-16 MHz), 360° rotational mechanical probe or radial electronic probe (frequency: 5-10 MHz)[80]. High-resolution three-dimensional (3D) EAUS provides better visualisation performance by multiplanar reconstruction and rendering of the 3D data volume[81].With EAUS, the anal canal is divided into three levels of assessment. The upper level corresponds to the hypoechoic sling of the puborectalis muscle and the concentric hypoechoic ring of the internal anal sphincter (IAS). In males, the deep part of the external anal sphincter (EAS) is also identified at this level. The middle level corresponds to the superficial EAS (concentric band of mixed echogenicity), the conjoined longitudinal layer, the IAS, and the transverse peronei muscles. The lower level corresponds to the subcutaneous part of the EAS [82].

2.1. Endoanal Ultrasonography in Faecal Incontinence

EAUS is currently the gold standard for the morphological assessment of the anal canal in faecal incontinence and is a simple, well-tolerated and inexpensive technique. Most studies revealed high accuracy in identifying sphincter defects. EAUS can differentiate between incontinent patients with intact anal sphincters and those with sphincter lesions (defects, scarring, thinning, thickening, and atrophy) due to vaginal delivery or anal surgery (i.e., haemorrhoidectomy, fistula surgery or sphincterotomy) [82].

Tears are defined by an interruption of the circumferential fibrillar echo texture. Scarring is characterized by loss of normal architecture, with an area of amorphous texture that usually has low reflectivity. Number, circumferential (radial angle in degrees or in hours of the clock site) and longitudinal (proximal, distal or full length) extension of the defect should be reported.

3D EAUS is currently largely used and accepted for sphincter evaluation in faecal incontinence, improving diagnostic accuracy and knowledge of physiological and pathological sphincter alterations. It allows measurement of length, thickness, and the area of sphincter defect in the sagittal and coronal planes in addition to the volume of sphincter damage [82]. Two scoring systems have been proposed to define the severity of the sphincter damage [83,84]. Both systems have demonstrated good correlation between the extent of sphincter defect and the degree of faecal incontinence. EAUS has an important role in detecting clinically occult anal sphincter injuries after vaginal delivery [22]. Faecal incontinence related to occult sphincter lesions is likely to occur even in an elderly population of women who experienced vaginal deliveries earlier in life (late-onset faecal incontinence)[85]. US imaging is useful to evaluate the result of treatments

(e.g. sphincteroplasty, bulking agents, injections) [86,87].

2.2. Alternative Ultrasound Modalities (Transperineal and Endovaginal) in Faecal Incontinence

Transperineal US (TPUS) is performed with conventional convex transducers (main frequency between 3 and 6 MHz, field of view at least 70°) applied in the perineum between the mons pubis and the anal margin[80]. Perineal ultrasound provides an overall assessment of all anatomical structures in the midsagittal plane (bladder, urethra, vaginal walls, anal canal and rectum) between the posterior surface of the symphysis pubis (SP) and the posterior part of the levator ani (LA). Imaging is usually performed at rest, on maximal Valsalva manoeuvre and on pelvic floor muscle contraction (dynamic assessment). 3D TPUS is performed with volumetric probes. The most important clinical application is the assessment of LA injuries [88]. The disconnection of the muscle from its insertion on the inferior pubic ramus and the pelvic sidewall, a consequence of overstretching during the second stage of labour, is defined as LA avulsion [89,90].

3D endovaginal ultrasound (EVUS) is performed with high multi-frequency (9-16 MHz), 360° rotational mechanical probe. The pelvic floor is divided into four levels of assessment [91]. At level I, the bladder base and the inferior third of the rectum are visualized. Level II corresponds to the bladder neck, the intramural region of the urethra and the anorectal junction. Level III corresponds to the midurethra and the upper third of the anal canal. Level IV corresponds to the perineal muscles, the perineal body, the distal urethra and the middle and distal third of the anal canal. 3D EVUS provides information on the levator ani and levator hiatus integrity.

Summary of Evidence from the 5th ICI

- EAUS is an integral part in the investigation of faecal incontinence (Level of Evidence 2).

Recommendations for Practice for Endoanal Ultrasonography from the 5th ICI

- EAUS is an important part in the assessment of patients with faecal incontinence to define the presence of anal sphincter injuries (Recommendation Grade A).
- Pelvic floor ultrasound may define combined conditions, i.e., perineal descent, rectal intussusception, enterocele, all of which may play a role in faecal incontinence (Recommendation Grade C).

2.3. What is New about Endoanal Ultrasonography in the Current Review?

2.4. Endoanal Ultrasonography and Obstetric Anal Sphincter Injury (OASIS)

Obstetric anal sphincter injury (OASIS) is a term used to define trauma to the perineum during vaginal childbirth that includes third- (injury to perineum involving the anal sphincter complex – EAS and IAS) and fourth-degree tears (injury to perineum involving the anal sphincter complex and anal epithelium). When the diagnosis of OASIS is obtained from EAUS evaluation within 2 months of delivery, the incidence of any degree of anal sphincter defect in primiparous women is reported to be as high as 27% -35%. Between 4% -8.5% of multiparous women have a new sphincter defect [92]. When women sustain an OASIS, they are at increased risk of developing faecal incontinence either immediately following childbirth or later in life. The true prevalence of faecal incontinence related to OASIS may be underestimated. The reported rates of faecal incontinence following the primary repair of OASIS range between 15% and 61%, with a mean of 39%[92].

There is some evidence to suggest that EAUS performed after vaginal birth and before the tear has been repaired could lead to improved primary repair of the IAS and EAS resulting in reduced rates of faecal incontinence and improved quality of life for women. One randomised trial of 752 primiparous women compared clinical examination (routine care), to the use of EAUS prior to perineal repair. EAUS was associated with a reduction in the rate of severe faecal incontinence at greater than six months postpartum (risk ratio RR 0.48) (Level of Evidence 2) [93]. More high quality randomised controlled trials are needed before the routine use of EAUS on the labour ward can be supported. Cost and training required to implement EAUS should be considered.

Data are controversial for asymptomatic patients. There are no cost-benefit studies of EAUS in this setting, nor any data on whether asymptomatic patients could benefit from it. Currently, there is no recommendation about screening women later after vaginal delivery for occult sphincter defects. EAUS may have a role after perineal repair in the evaluation of residual injury and in the management of subsequent pregnancies [94]. There are no systematic reviews or randomised controlled trials to suggest the best method of follow-up after OASIS.

Studies show a high frequency of endosonographic sphincter defects after primary repairs in between 54% -93% of women [95,96]. These data emphasize the importance of adequate repair of OASIS and demonstrates that repair can be difficult or underestimated. The current guidelines of the United Kingdom Royal College of Obstetricians and Gynecologists (RCOG) do not make recommendations about using EAUS for confirming a complete primary repair

(COG Guideline, 2007). According to this guideline, if a woman is experiencing faecal incontinence at follow-up after repair, referral to EAUS should be considered. A persistent ultrasound-detected defect in the anal sphincter muscles after OASIS is associated with faecal incontinence [97]. Reconstruction of the entire length of the EAS is crucial. Incontinence after primary repair of OASIS is related to relative length of reconstructed EAS and to the extent of the ultrasonographic defects demonstrated by 3D-EAUS [98] (Level of Evidence 3). In a prospective study that assessed at long term the function and morphology of the anal sphincters and the pelvic floor after primary repair of OASIS, women who experienced deterioration of continence over time following repair had a significantly shorter anterior EAS at 3D-EAUS. EAS length correlated with increased severity of faecal incontinence [99].

A decision about the mode of delivery of pregnancy after OASIS based on symptoms, anal manometry, and EAUS helps in preserving anal sphincter function and avoiding unnecessary Caesarean sections [100] (Level of Evidence 2 Recommendation Grade B). In a descriptive study on a cohort of women who had OASIS from 2006 to 2013, vaginal delivery was recommended to asymptomatic women with normal investigations (EAUS and anal manometry) and elective Caesarean section was recommended for women with faecal symptoms, anal sphincter defects of more than 30° or low resting or incremental anal pressures. Caesarean section was done in 22 women and 28 women delivered vaginally. Worsening of faecal incontinence symptoms and reduction in anal pressures were not observed in the planned vaginal delivery or elective Caesarean section groups. There were no new sphincter defects or recurrent OASIS in any of the women in the study group.

EAUS can be useful to select patients with faecal incontinence that could benefit from rehabilitation. Therapy may be less effective in patients with sphincter lesions, and there is a linear relationship between post-rehabilitative scores of faecal incontinence severity and severity of sphincter defects [101]. Currently, there is no evidence to support the use of real time elastography in the evaluation of faecal incontinence. There was an absence of a correlation in elastogram colour distributions of the IAS and EAS with major clinical and functional parameters; elastography does not seem to provide additional information in the diagnostic workup of faecal incontinence [102].

2.5. Alternative Ultrasound Modalities (Transperineal and Endovaginal) in Faecal Incontinence

TPUS and EVUS have been recently evaluated as alternative imaging modalities for the investigation of sphincter integrity in faecal incontinence [80,103-106] (Level of Evidence 3). Advantages of these procedures include the availability of commonly used transducers, absence of distortion of the anal canal, better

patient acceptability and possibility for functional studies [107]. Currently there are limited studies that directly compare these techniques with EAUS [108,109]. Although the sensitivity for the detection of sphincter defects ranges from 44% for EVUS to 50% for TPUS, these modalities can be used in combination with EAUS, to provide additional information on pelvic floor muscles and levator hiatus damage. In a prospective, observational study, defects of the pubo-visceral muscle (PVM) were identified with 3D-EVUS in 27% of women with faecal incontinence who had undergone vaginal delivery. Severity of incontinence was related to the extent of damage of the PVM and to the enlargement of the levator hiatus [110]. These findings were not confirmed in a retrospective study where worsening of levator ani deficiency among patients with major faecal incontinence, did not reach statistical significance [111].

TPUS may be used as screening modality for the detection of occult anal sphincter injuries after vaginal delivery (Level of Evidence 2, Recommendation Grade B). In a prospective, randomised controlled trial, the occult tear rate increased from 3.5% (clinically detected) to 11.5% by US technique [112]. Future studies should focus on technique standardisation and method as well on the predictive value of both EVUS and TPUS compared with EAUS in the detection of sphincter defects.

2.6. Endoanal Ultrasonography in Anorectal Surgery

Haemorrhoidectomy, fistulectomy or fistulotomy, anal dilatation, or internal lateral sphincterotomy can cause faecal incontinence, due to anal sphincter injury. Clinical severity of faecal incontinence after anorectal surgery is related to EAUS features. More frequently, in patients with higher clinical severity score the IAS is always affected and thicker [113] (Level of Evidence 3). EAUS has been used to select the surgical treatment in patients with faecal incontinence and to assess the clinical efficacy of the treatment. In a multicentre observational study on the implantation of prostheses in patients with faecal incontinence, EAUS was used preoperatively to select cases (either intact sphincters or IAS lesions extending for less than 60° of the anal circumference), intraoperatively to perform the implants into the intersphincteric space and postoperatively to evaluate the results of surgery and complications (prostheses dislodgement) [114,115].

3D-EAUS can be used to quantify how much sphincter can be safely divided during fistulotomy. In a prospective, consecutive study, a strong correlation was found between preoperative 3D-EAUS measurements of fistula height with intraoperative and postoperative 3D-EAUS measurements of IAS and EAS division. Fistulotomy limited to the lower two thirds of the EAS is associated with excellent continence and cure rates [116] (Level of Evidence 3).

2.7. Current Summary of Evidence about Endoanal Ultrasonography

- Compared with clinical examination (routine care), the use of EAUS prior to perineal repair of OASIS is associated with a reduction in the rate of severe faecal incontinence at greater than six months postpartum (Level of Evidence 2).
- Incontinence after primary repair of OASIS is related to relative length of reconstructed EAS and to the extent of the ultrasonographic defects demonstrated by 3D-EAUS (Level of Evidence 3).
- Clinical severity of faecal incontinence after anorectal surgery is related with EAUS features (Level of Evidence 3).

Current Recommendations for Practice for Endoanal Ultrasound Imaging

- Decision about the mode of delivery of pregnancy after OASIS based on symptoms, anal manometry and EAUS helps in preserving anal sphincter function and avoiding unnecessary Caesarean sections (Recommendation Grade B).
- TPUS and EVUS represent alternative imaging modalities for the investigation of sphincter integrity in faecal incontinence (Recommendation Grade C).
- TPUS may be used to screen for occult anal sphincter injuries after vaginal delivery (Recommendation Grade B).
- 3D-EAUS can be used to quantify how much sphincter can be safely divided during fistulotomy (Recommendation Grade C).

Current Recommendations for Research for Endoanal Ultrasound Imaging

- Evaluate the role of levator ani damage, visualised with pelvic floor ultrasound, on faecal incontinence symptoms and therapy results.
- Further characterise and standardise the utility of pelvic floor ultrasound in the clinical assessment of patients with faecal incontinence and if it adds extra information useful for clinical decision-making.
- Assess if pelvic floor ultrasound during rehabilitation provides more effective treatments for patients.

3. DEFAECOGRAPHY

3.1. Introduction

Defaecography, also referred to as evacuation proctography, is the radiological assessment of the voluntary rectal evacuation of semi-solid contrast material, and provides information on both static and dynamic anorectal structure and function. It is widely used in the diagnosis and management of obstructed defaecation, but the technique has been less often utilized in the assessment of faecal incontinence until the advent of laparoscopic ventral rectopexy (LVR) [117]. LVR improves faecal incontinence through the anatomical correction of rectal intussusception (internal rectal prolapse) [118-120] (Level of Evidence 3), although some studies have reported conflicting data.

Rao [121] did not include defaecography in commonly performed diagnostic tests in faecal incontinence in an evidenced-based summary, and an American Gastroenterological Association Medical Position Statement [16] concluded that defaecography was not of established value in patients with faecal incontinence. Even in the recent guidelines from the American College of Gastroenterology in 2014 [9] and the American Society of Colon and Rectal Surgeons in 2015 [8], defaecography is not included in the diagnostic testing for faecal incontinence (Level of Evidence 4).

On the other hand, defaecography was used by 56% of physicians in the routine diagnostic work-up of patients with faecal incontinence in a Dutch study [122]. Defaecography is also mentioned, albeit briefly, in recent review papers for the management of faecal incontinence [61,123] (Level of Evidence 4). There were several studies reporting that surgical correction of rectal intussusception [14] or rectocele [15] resulted in improved faecal incontinence. Since D'Hoore et al. [117] reported on the LVR technique for the treatment of total rectal prolapse, several studies have demonstrated that LVR is also effective in improving faecal incontinence in patients with high-grade rectal intussusception [118-120,124] (Level of Evidence 3). A consensus meeting on ventral rectopexy has reported that symptomatic high-grade rectal intussusception and complex rectocele are relative indications for ventral rectopexy after the failure of maximal conservative therapies in patients with obstructed defaecation and/or faecal incontinence [125] (Level of Evidence 4). There has been a controversy regarding the correlation between symptoms and defaecographic findings. Abnormal findings from defaecography can be seen in many normal subjects without any anorectal symptoms [126,127], whilst there is some convincing evidence that rectal intussusception is associated with obstructed defaecation and faecal incontinence [128-131] (Level of Evidence 3).

Since LVR has been shown to be effective in the treatment of faecal incontinence in patients with rectal intussusception and complicate rectocele, the role of defaecography has become more important in diagnosing these conditions, although some concerns remain regarding mesh-associated complications caused by this operation[132].

Recommendations for Practice for Defaecography from the 5th ICI

- Defaecography is of limited value and not always utilized in the diagnosis and management of faecal incontinence. (Recommendation Grade B).
- Defaecography can be useful in the diagnosis and management of faecal incontinence by measuring perineal descent and ARA, evaluating involuntary leakage of the contrast material as well as diagnosing rectal intussusception and rectocele (Recommendation Grade B).

3.2. Examination Technique

There are no universally agreed standard methods of defaecography. Usually, a viscous barium contrast material is injected into the rectum of the patient in the left decubitus position. The semisolid contrast material can be made by mixing barium with flour, oatmeal or mashed potato, whilst ready-made barium paste can be utilized in countries where it is commercially available. The volume of the injected material is either fixed at around 150 ml or up to the volume at which the patient feels the urge to defaecate. A radiopaque marker can be placed close to the anus, pubic symphysis and the apex of the coccyx to facilitate interpretation. Barium contrast in the vagina facilitates interpretation of enterocele and prolapse in the anterior and middle compartments.

During the procedure, the patient sits on a commode attached to the footboard of the fluoroscopy table and lateral views of the film are taken at rest and maximum squeeze before rapid film sequences are taken during evacuation, followed by a film taken after the completion of the evacuation at maximum straining. The sequential films are usually by a video recording: cinedefaecography.

3.3. Parameters Studied at Defaecography

The anorectal junction is the distally tapered point of the rectal contrast column caused by posterior impression of the puborectal muscle. The anorectal angle (ARA) is measured by the angle between the line along the anal canal and the axis of the rectum. Normal subjects should be able to evacuate more than two thirds of rectal contrast material within 30 seconds. In addition to assessing rectal evacuation, defaecography can reveal rectal intussusception, rectocele, sigmoidocele and enterocele

Rectal intussusception is defined as the invagination of the rectal wall into itself and the degree of rectal

intussusception can be classified by Oxford classification [133]. Rectocele is defined as the outpouching of the anterior rectal wall beyond the normally expected anterior rectal wall at straining. Sigmoidocele and enterocele are defined as the herniation of the lining of the peritoneum by the sigmoid colon or the small bowel, respectively, into the rectovaginal septum and may push on the anterior rectal wall. Dobben et al.[134] reported good reproducibility for enterocele, rectocele and their severity grading as well as fair to moderate reproducibility for rectal intussusception in a prospective assessment of inter-observer agreement for defaecography in faecal incontinence (Level of Evidence 2).

3.4. Clinical Utility of Defaecography

Defaecography can be useful in the diagnosis and management of faecal incontinence by measuring perineal descent and ARA, evaluating involuntary leakage of the contrast material as well as diagnosing rectal intussusception and rectocele. Perineal descent may be a sign of the weak pelvic floor muscles and possible pudendal neuropathy, which may be associated with faecal incontinence. An obtuse ARA implies weakening of the puborectal muscle and possibly the entire pelvic floor muscles. In a study by Piloni et al.[135], the mean ARA at rest differed significantly between patients with faecal incontinence and those without (Level of Evidence 3). The normal range of ARA, however, is wide and some patients with normal ARA are incontinent to stool, whilst some with abnormally obtuse ARA are continent.

Continent subjects with normal anal sphincter function can easily retain the contrast material in the rectum while sitting on a commode. The involuntary leakage of the material during its injection or on sitting before evacuation indicates weak anal sphincters. This finding can be utilised to evaluate whether patients are incontinent to semisolid stool or not when their complaints are equivocal. In a study by Savoye-Collet et al.[136], 24 out of 50 women with faecal incontinence showed a leakage of barium paste in upright position during defaecography (Level of Evidence 4). The finding of involuntary leakage is beneficial in evaluating the surgical outcomes by performing defaecography before and after the operation. Rao et al. [72] reported a significant correlation between the continence score and the finding of the involuntary leakage on defaecography performed before and after dynamic graciloplasty (Level of Evidence 3). This finding also can be utilised as a pre-operative evaluation for stoma closure to predict faecal continence in patients with diverting stoma after surgery such as intersphincteric resection of the rectum or restorative proctocolectomy [137].(Level of Evidence 4).

Karasick [138] stated that the major indication for performing defaecography in patients with faecal incontinence is to diagnose rectal intussusception. Collin-

son et al.[133] performed defaecography in 40 patients whose faecal incontinence could not be explained by anorectal physiology and endoanal ultrasound, and recto-anal intussusception was observed in 63% of the patients. Surgical correction of rectal intussusception has been shown to improve faecal incontinence, indicating a possibility that rectal intussusception can be a cause of faecal incontinence [118-120] (Level of Evidence 3). Gosselink et al. [118] performed LVR in 72 patients with faecal incontinence associated with high-grade rectal intussusception not responding to maximal medical treatment, and the median Fecal Incontinence Severity Index score significantly improved 1 year after surgery. Tsunoda et al. [120] performed LVR in 21 patients with faecal incontinence associated with high-grade rectal intussusception; a reduction of at least 50% of the Fecal Incontinence Severity Index score was achieved in 14 (67%).

The possible mechanisms of faecal incontinence in rectal intussusception are thought to be the intermittent activation of rectoanal inhibitory reflex by the redundant mucosa and the faecal trapping in the rectum allowing post-defecatory leakage [133]. Harmston et al.[129] demonstrated a significant reduction in the mean maximum resting pressure with increasing grade of rectal intussusception, concluding that the effect of rectal intussusception on continence occurs mainly through a reduction of internal anal sphincter tone (Level of Evidence 3).

It is more controversial whether a rectocele can cause faecal incontinence. Collinson et al.[133] claimed that one of its mechanisms is faecal trapping in the rectum that allows post-defaecatory leakage to occur. Formijne et al.[139] performed LVR in patients with combined rectocele and enterocele, and the proportion of patients with faecal incontinence significantly decreased from 63% to 18% after surgery (Level of Evidence 3). However, when Wong et al.[124] performed LVP in 84 patients with symptomatic complex rectocele, there was no significant improvement in faecal incontinence whilst vaginal discomfort and obstructed defaecation symptoms improved significantly (Level of Evidence 3).

3.5. Magnetic Resonance Defaecography

Magnetic resonance (MR) defaecography can also provide information on both static and dynamic anorectal structure and function. It has advantages over conventional defaecography in the avoidance of radiation exposure as well as its ability to evaluate other pelvic organs including vagina, uterus, bladder and small intestine[140,141]. Its disadvantage is that it is often performed in the supine position and is not physiological. MR defaecography with an open-configuration may solve this problem [142], but is expensive and still not widely available. The supine position of MR defaecography, however, might have another advantage over conventional defaecography in patients with faecal incontinence. One of the problems in performing defaecography in these patients is that

those with weak anal sphincters have problems retaining the semisolid contrast material in the rectum when seated on a commode. It might be easier for them to hold the contrast material in supine position than sitting on a commode, and its evacuation in the supine position might be enough for the diagnosis of rectal intussusception and rectocele in patients with faecal incontinence, contrary to those with obstructed defaecation.

3.6. What is New about Defaecography in the Current Review?

Defaecography has become more important in the diagnosis and management of faecal incontinence, since the advent of laparoscopic ventral rectopexy, which has been shown to improve faecal incontinence through the anatomical correction of rectal intussusception and/or complex rectocele.

Current Recommendations for Practice for Defaecography

- Defaecography can be useful in the diagnosis and management of faecal incontinence by measuring perineal descent and anorectal angle (Recommendation Grade C), evaluating involuntary leakage of the contrast material (Recommendation Grade B), as well as diagnosing rectal intussusception and rectocele (Recommendation Grade B).
- Defaecography might be performed in patients with faecal incontinence, when their symptoms cannot be explained by anorectal physiology and endoanal ultrasound, and rectal intussusception and/or rectocele are suspected from symptoms (post-defaecatory passive faecal incontinence) and anorectal examinations (Recommendation Grade B).
- Defaecography is recommended in patients with faecal incontinence, who have failed to maximum conservative therapies, and are possible candidates for laparoscopic ventral rectopexy (Recommendation Grade B).

Current Recommendations for Research for Defaecography

- Identify patients with rectal intussusception and/or rectocele, who would most benefit from ventral rectopexy by combining symptoms, clinical characteristics and defaecographic findings.
- Identify the best methods and interpretations of magnetic resonance defaecography at supine position in the diagnosis of rectal intussusception and rectocele.

4. Magnetic Resonance Imaging (MRI)

MRI is a non-ionizing radiation technique which can provide high resolution images through the anal canal and pelvic floor. More recently it has also been used for proctographic studies (See section above). The role of MRI in assessing faecal incontinence is growing, although, in general, it remains second line behind endoanal ultrasound for the evaluation of anal sphincter integrity. It has a long-established superiority over ultrasound for quantifying pelvic floor and anal sphincter muscle quality, and delineating the presence of atrophy. The more recent literature suggests its role is particularly developing in specialist situations where anatomy is complex or deranged, for example in congenital disorders or following surgery. The clinical significance of pelvic floor pubo-visceralis injury detected with MRI is also under investigation. MRI is also increasingly employed as a research tool to investigate the pathophysiology and mechanisms of defaecation.

Recommendations for Practice for MRI from the 5th ICI

- The place for MRI assessment of anal sphincters is limited (Recommendation Grade D).
- Patients with faecal incontinence after repeated anorectal surgeries may benefit from assessment with MRI (Recommendation Grade C).
- Patients with possible, but not proven, external sphincter defect on ultrasound may benefit from further assessment with MRI (Recommendation Grade C).

Overview and Summary of MRI from the 5th ICI

There is evidence that magnetic resonance imaging (MRI) is accurate in detecting external anal sphincter defects potentially suitable for repair in patients presenting with faecal incontinence [143-156] (Level of Evidence 2). MRI can be performed with endoluminal coils or surface phased-array coils placed external to the patient. The spatial resolution of MRI is less than that of endoanal ultrasound and, in general, experience with the technique is less. Accuracy for external anal sphincter defects is therefore reported to be slightly below that of endoanal ultrasound [157-161]. There is good evidence that the longer-term functional outcome following sphincteroplasty for obstetric-related external anal sphincter defects is inferior in those with neuropathy-associated external anal sphincter atrophy [162-167]. MRI has higher accuracy in identifying external anal sphincter atrophy compared with endoanal ultrasound [166,167] (Level of Evidence 2).

4.1. Normal Anal Sphincter Anatomy at MRI

Anal sphincter anatomy is best depicted on high resolution angled T2-weighted images which maximise the contrast between muscle and adjacent fat. It is possible to measure muscle volume and length on the resulting images which may have some clinical utility. For example, in a series of 100 healthy volunteers, age- and sex-related differences are demonstrable on endoanal MRI [168], women have a significantly shorter external anal sphincter than men.

4.2. Anal Sphincter Defects on MRI

Akin to endoanal ultrasound, external anal sphincter defects manifest as discontinuity in the normal intermediate signal muscle structure, often with associated low signal fibrosis. An advantage of MRI is multiplanar image acquisition which facilitates evaluation of the sphincter complex in multiple orientations, improving diagnostic accuracy. Secondary changes to the architecture of adjacent structures (for example, the longitudinal muscle and perianal fat) may provide supportive evidence of a sphincter tear. One pitfall of MRI evaluation of the anal sphincter complex is that variations in normal anatomy may be misdiagnosed as sphincter defects by the unwary.

The internal anal sphincter is typically of higher signal than the external sphincter on T2 weighted images and defects manifest as either discontinuity or thinning, again with replacement of the normal smooth muscle by fibrous tissue. Internal anal sphincter defects are often found in combination with external anal sphincter defects, especially in women presenting with incontinence following obstetric sphincter tear. Solitary internal anal sphincter defects are more common in iatrogenic cases of incontinence.

The ability of MRI to detect anal sphincter injury has been addressed by several studies. In general, those reporting higher accuracy have utilized an endoanal coil, although large scale comparisons with surface coils are lacking. An accuracy of 95% has been reported for external sphincter tears [145,148,153].

4.3. Anal Sphincter Atrophy at MRI

The ability of MRI to accurately detect external sphincter atrophy has been demonstrated in a number of studies[144,145,148,165] (Level of Evidence 2). For example, in a study of 25 women undergoing surgical external sphincter repair, Briel et al.[148] compared pre-operative MRI evaluation of sphincter atrophy with histological analysis of full thickness muscle biopsies. Atrophy on MRI was defined as muscle thinning or fatty replacement. Against the histopathological reference, MRI achieved a sensitivity of 89% and specificity of 94% for sphincter atrophy. Importantly, the same group reported a clear association between external sphincter atrophy on MRI and significantly poorer outcome following external sphincter repair [165], emphasizing the clinical importance of this observation. The work also showed atrophy could only be detected on MRI and not using endoanal ultrasound.

4.4. What is New about MRI in the Current Review

4.4.1 Mechanistic Studies

The complex anatomy of the external anal sphincter has been further elucidated by novel MRI techniques including diffusion tensor imaging, fibre tracking and spin-tag MRI [169]. Using these sequences, Mittal et al. demonstrated a purse-string morphology of the external anal sphincter on contraction, with decussation of muscle fibres within the perineal body to the contralateral transverse perineal and bulbospongiosus muscles. This new understanding could potentially question the fundamental premise behind lateral episiotomy and overlapping sphincteroplasty, as both these surgical techniques assume that the external sphincter is a circular muscle.

4.4.2 Sphincter Atrophy

In a retrospective cohort study of 158 women with pelvic floor symptoms undergoing external phased array coil MRI, Kessels et al.[170] reported a correlation between severe EAS atrophy and faecal incontinence, as well as a link between the severity of EAS atrophy and increasing age and BMI (Level of Evidence 3). There was however no statistically significant correlation between the presence of sphincter defects and faecal incontinence.

4.4.3 Sphincter and Pelvic Floor Injury

The ability of MRI detected sphincter injury to predict symptoms has been reported in a few studies. In a nested case control study of 68 women with faecal incontinence and 68 matched controls, Bharucha [171] reported that IAS injury detected on endoanal MRI was an independent risk factor for incontinence (Level of Evidence 2). However, neither external sphincter nor puborectalis injury was itself an independent risk factor. A retrospective cohort study in 189 women with pelvic floor dysfunction [172] found no correlation between pubovisceral muscle avulsions detected on MRI and symptoms of faecal incontinence, although there was a correlation with symptoms of pelvic organ prolapse and an inverse correlation with symptoms of obstructed defaecation (Evidence Level 3). A retrospective study in 119 women undergoing external phased array coil MRI and anal manometry [173] found that a patulous anal canal (which cannot be identified with endoanal MRI) was associated with more severe anal injury as documented by reduced squeeze pressure increment (Level of Evidence 3).

4.4.4 Post-Surgical Sphincter Evaluation

In a prospective study, 29 patients who had undergone 3rd- 4th degree obstetric sphincter injury reconstruction underwent MRI and 3D ultrasound, along with 30 controls [99]. There was a significant correlation between anterior EAS length (measured on 3D ultrasound) and the severity of faecal incontinence in the post-surgical patients, but no association with

MRI parameters including sphincter defects or atrophy (Level of Evidence 3).

How et al.[174] retrospectively reviewed the morphology of the pelvic floor in 30 patients who had undergone staging MRI scans for rectal cancer, and found a correlation between the thickness of the puborectalis sling and the incidence of faecal incontinence after anterior resection. A cut off thickness of 3.5mm had the best predictive ability suggesting this assessment could be used to help predict functional outcome following surgery (Level of Evidence 3).

MRI has also been found to be useful in assessing patients with defaecatory dysfunction after surgical correction of anorectal malformations, both in children [175,176] and adults[177]. An increased anorectal angle, misdirection of the neorectum and peritoneal fat herniation between the neorectum and striated muscle complex are associated with an increased incidence of faecal incontinence. MRI is superior to endoanal ultrasound in demonstrating the amount and quality of any residual external sphincter (Level of Evidence 2).

4.5. Role of MRI in the Assessment of Faecal Incontinence

MRI is an accurate alternative to endoanal ultrasound for detection of anal sphincter injuries, when the latter is not available. MRI is superior to EAUS for evaluating external sphincter atrophy which is associated with symptoms of faecal incontinence and can predict poorer outcomes after surgical repair of sphincter defects. MRI can provide additional information over EAUS in patients with congenital anorectal malformations, and after surgical interventions.

Current Recommendations for Practice for MRI

- Endocoil MRI has high accuracy for detecting anal sphincter injury but is second line after endoanal ultrasound (Recommendation Grade C).
- Patients with faecal incontinence may benefit from assessment with MRI, particularly those with anorectal malformations and/or previous anal sphincter surgery (Recommendation Grade C).
- MRI is superior to endoanal ultrasound for assessing external sphincter atrophy, which may correlate with symptoms of faecal incontinence and predicts poorer outcome after anal sphincter repair (Recommendation Grade C).

Current Recommendations for Research for MRI

- The impact of MRI detected sphincter and pelvic floor muscle atrophy on the outcomes of emerging therapeutic interventions, for example, sacral nerve stimulation (SNS).
- Use of advanced MRI sequence technology to further define the functional anatomy of the anal

canal and pelvic floor and the impact of this on surgical techniques.

5. CLINICAL NEUROPHYSIOLOGICAL TESTING

5.1. Introduction

The clinical use of neurophysiological testing in patients presenting with incontinence has a long history, but appears to be diminishing in practice because of improvements in clinical sphincter imaging and as a result of the understanding that some neurophysiological parameters have only minimal influence on decision-making [178,179]. Despite the rise of sacral neuromodulation in the selective management of incontinent patients, there is no clear guideline for specific predictive neurophysiological testing [180,181], relegating its specific use in complicated cases of incontinence secondary to particular neurological diseases and following spinal injury. A recent consensus paper suggested that neurophysiological testing should be performed in all incontinent patients who either have reduced anal pressure with no obvious explanation or who have a neurological disease although this is not supported by any references [182].

Recommendations for Practice from the 5th ICI

- Neurophysiological testing is of limited value in the assessment of patients with faecal incontinence (Recommendation Grade C).
- Pudendal nerve terminal motor latency (PNTML) may be useful in the perioperative assessment of patients before sphincteroplasty or sacral nerve stimulation (Recommendation Grade C).
- Neurophysiologic testing may be useful in the assessment of patients with possible pudendal neuralgia (Recommendation Grade D).
- Concentric needle electromyography (CN-EMG) may have a specific role when ultrasonography and/or MRI imaging is equivocal (Recommendation Grade D).

5.2. Types of Neurophysiological Testing for Faecal Incontinence

The following are the typically described neurophysiological test modalities in faecal incontinence:

- Electromyography (EMG)
- Pudendal terminal motor latency (PNTML)
- Sacral latency test (SLT)
- Somatosensory evoked potentials (seps) of pudendal nerve
- Motor evoked potentials (meps)

- Anorectal reflex assessment
- Autonomic nervous system (ANS) testing

Somatic motor testing assesses the somatic nervous system responsible for skeletal muscle motor innervation plus sensory innervation from cutaneous sites to the muscle spindles. This testing incorporates all forms of electromyography (EMG), PNTML studies, motor nerve conduction studies, and motor evoked potentials. Somatosensory testing includes somatosensory evoked potentials and sensory neurography. ANS testing assesses the ANS which provides motor innervation to the viscera and other end-organs and which assess its visceral afferent pathways at peripheral, spinal and supraspinal levels.

5.2.1 Electromyography

In the past the specific use of this EMG technology in faecal incontinence was for the differentiation of patients with potential voluntary sphincter defects from those without sphincter defects thought to be reparable but who had an attendant presumptive neurological cause for their incontinence. CN-EMG is performed with single-use needles employed at multiple sites. Inherent differences exist at rest in sphincter musculature when compared with peripheral (non-sphincteric) musculature showing basal resting activity whereas non-sphincter musculature is electrically silent [183,184]. The technique can help identify neurogenic from myopathic causes of anal sphincter dysfunction [185]. There is no correlation between severity of EMG findings and degree of incontinence [186]. Denervation is diagnosed as a reduction in the number of continuously firing low-threshold MUPs. CN-EMG has disappeared with improved accurate sphincter imaging; however, it may have a specific place in those patients where ultrasonography and/or MR imaging is equivocal.

Single Fibre EMG (SF-EMG) has a smaller recording surface with a pickup of activity from a smaller muscle volume than that recorded with CN-EMG, recording generally 1-3 single muscle fibres from the same MU. Surface EMG has no value in assessing neurogenic aspects of sphincter function (but may be used as part of biofeedback therapy)[18].

5.2.2 Pudendal Nerve Conduction Testing

Pudendal nerve conduction testing measures the nerve conduction velocity in the pudendal nerve as latency time between direct stimulation of the pudendal nerve and EAS contraction. There is a customised (Dantec Electronic Tonsbaaken 16-18 DK-2740 Skovlunde, Denmark) St. Mark's electrode that has been designed. Prolongation of the pudendal nerve terminal motor latency (PNTML) is common after vaginal delivery and with aging [187-189]. The technique tends to underestimate the degree of pudendal neuropathy since the latency measured reflects the function of the most rapidly conducting nerve fibres[73]. Unlike needle EMG, it does not show direct neurological damage.

It has been suggested that the delay in PNTML is associated with a worse overall prognosis of external anal sphincter repair for patients presenting with faecal incontinence [162-164], although there is little available evidence to suggest that PNTML measurement alters specific surgical decision-making or outcomes after surgery [190]. In addition, the measurement is influenced by body habitus and clinician factors [191,192]. There is little available evidence that the presence or extent of a pudendal neuropathy correlates with objective incontinence [179] or with the specific response to biofeedback therapy with or without the presence of an external anal sphincter defect [193].

5.2.3 Sensory System Testing

Anorectal sensitivity plays a significant role in the defaecation process and in maintaining faecal continence. Variation in anorectal sensibility is also important in pain disorders and in irritable bowel syndrome. Basic sensory testing of light touch and pinprick and sensation of bladder filling is standard. The ano-cutaneous sensation of the perianal area and in the anal canal below the dentate line is conveyed by the efferent fibres of the pudendal nerve (S2-S4) [194].

5.2.4 Anal Mucosal Electrosensitivity

Anal mucosal electrosensitivity (MES) testing was originally described independently by Roe et al. [195] and Sigel [196] using two electrodes with a constant square wave of current with variable intensity. It is unknown precisely which receptors are involved in this standardised and reproducible response [197]. Incontinent patients invariably have a high MES whereas patients with anal sphincter defects, (with or without faecal incontinence), show an increased MES with the highest values found in patients with a combined internal anal sphincter and external anal sphincter defect.

Current Recommendations for Practice for Neurophysiological Testing

- Neurophysiological testing is of limited value in the assessment of patients with faecal incontinence (Recommendation Grade C).
- PNTML is not useful in the preoperative assessment of patients before sphincteroplasty or sacral nerve stimulation. (Recommendation Grade C).
- CN-EMG may have a specific role when ultrasonography and/or MR imaging is equivocal (Recommendation Grade D).

Current Recommendations for Research for Neurophysiological Testing

- Assess reproducibility of testing of anorectal sensation on predicting outcome of surgical and conservative/medical treatment for faecal incontinence in large patient samples.

V. FAECAL INCONTINENCE SYMPTOM SEVERITY SCALES

1. DESCRIPTION OF SCALES

There are over 20 scales for rating the severity of faecal or anal incontinence. Many scales were developed prior to 1992, are rarely used and have been reviewed elsewhere [198]; these are not included in this review. Subsequently, six other scales; the instrument developed by Pescatori and Wexner [16,198], which is also known as the Cleveland Clinic incontinence score, the Vaizey or St. Marks incontinence score [19], the Faecal Incontinence Severity Index by Rockwood et al. [20], Modified Manchester Health Questionnaire [21,199], and the Faecal Incontinence and Constipation Assessment (FICA) symptom severity instrument [4,18,200] now referred to as the Faecal Incontinence Symptom Severity Scale (FISS) have been developed and used in clinical studies to rate the severity of faecal or anal incontinence. More recent instruments, the Bowel version of the International Consultation on Incontinence modular questionnaire (ICIQ-B) [5,23] and the Revised Faecal Incontinence Scale [201], have been developed and validated but not been widely used in clinical studies. These eight scales are summarised in Table 16-1.

None of the scales provide a measure of the severity of faecal incontinence only. Three scales score the severity of anal incontinence and, in five scales, the severity of anal incontinence is combined with a score of the impact of anal incontinence on lifestyle. Use of these instruments typically relies on patient recall as they are not part of a daily diary.

All of these instruments contain an assessment of frequency of different types of rectal leakage suggesting that frequency is considered one of the most important dimensions of incontinence severity. Some scales assess additional issues related to incontinence, such as rectal urgency, amount or volume of leakage, or use of perineal protective products (e.g., pads). Three scales, Vaizey, FICA [FISS], and ICIQ-B include a measure of rectal/ defaecation urgency [4,18,19,23]. The Vaizey scale [19] evaluates urgency with a question that asks about the "lack of ability to defer defaecation for 15 minutes" for which 2 response options are provided; weekly or daily. However, clinical observations suggest that this question may not accurately discriminate between people who have and do not have urgency because most people with severe urgency have a few, perhaps 5 minutes, at most to reach the toilet.

Population-based studies from the Rochester Epidemiology Project defined urgency as the need to “rush to the toilet” often (>25% of time) or usually (>75% of time) because of an “urgent need to empty the bowels” [18]. Through an initial survey followed by a case-control study that included a two-week daily bowel diary, this study observed that bowel disturbances are the most important factors associated with faecal incontinence and for incontinent bowel movements in women with faecal incontinence [4,18,44,202,203]. Rectal/ defaecation urgency was an independent and the strongest factor associated with faecal incontinence even after adjusting for other bowel disturbances.

Urgency is a distressing symptom [204]. Patients with more severe urge faecal incontinence report greater use of pads [205]. Urgency is associated with loose stools, increased rectal sensitivity [18,205], and reduced rectal capacity (i.e., a smaller reservoir) [18]. Nonetheless, the time required for measuring the inability to reach a toilet before leakage occurs is not standardised and patients’ estimates and sense of being rushed may vary greatly.

A recent state of the science summary emanating from a workshop organized by the U.S. National Institute of Diabetes and Digestive and Kidney Diseases (NIDDK), National Institutes of Health [15], emphasised the importance of considering the amount/volume of leakage when characterizing the severity of faecal incontinence. When the amount of leakage was greater, the impact on quality of life was worse [202]. Only one scale, the FISS, incorporates the amount of leakage into the assessment of anal incontinence severity, with a question that categorises the “usual leakage” as staining, a moderate amount (i.e., requiring change of underwear), and a large bowel movement (i.e., requiring change of all clothes) [4,18,44,202,203]. Conceivably, a matrix defined by amount*frequency, which assesses the amount of leakage for each consistency of faeces leaked (e.g., solid or liquid) may more comprehensively characterise the severity of faecal incontinence. This type of matrix scoring of faecal incontinence severity was used by Bliss et al. [28] in summarizing data from a stool diary in a clinical trial of fibre supplementation for the treatment of faecal incontinence. Using this assessment for anal incontinence would comprise four options for type of leakage (i.e, solid and liquid faeces, flatus, and mucus) and three for amount/volume (e.g., small, moderate, and large) requiring 12 items. The challenge is to develop measures that are comprehensive and useful for clinical practice and research but are not overly burdensome.

The current anal incontinence severity scoring systems assume that leakage of solid and liquid stools is equivalent. However, the FISI study observed that patients and physicians have different perspectives of severity; loss of liquid and solid stool was the worst for patients and physicians respectively [17]. Patients with faecal incontinence are able to reliably distinguish solid from loose/liquid stools [27,28]. Some

measures (e.g., Wexner [16] and Vaizey [19] scales) consider the use of pads when characterising severity. However, use of these measures may conceivably reflect not only the severity of anal incontinence but also fastidiousness regarding one’s sense of hygiene. Finally, the relationship between symptom severity and anorectal functions (e.g., anal resting and squeeze pressures) has not been established.

2. ASSESSING CLINICALLY IMPORTANT DIFFERENCES IN SYMPTOM SEVERITY

Recent clinical trials have considered a 50% or greater reduction in the number of days or episodes of faecal incontinence recorded with bowel diaries as the primary endpoint [206,207]. On the other hand, it has been suggested that a 50% reduction does “not constitute a clinically meaningful improvement from the patient’s perspective, mainly because the degree of improvement does little to allay the anxiety of the patient that an accident may occur at any time” [208]. In accepting this assumption, it is necessary to ascertain whether a statistically significant change in the frequency of faecal incontinence is also clinically significant [209]. One way to accomplish this is to assess the minimum clinically important difference (MCID), which is the smallest change detected by an instrument that is associated with a clinically meaningful change[210]. The MCID can be identified with distribution-based ($\frac{1}{2}$ of standard deviation of the population mean at baseline,[211] and the effect size (mean change /standard deviation at baseline or an anchor based approach [209]. These anchor-and distribution-based approaches [210] have been used to estimate the MCID for the FISI, FISS, and Modified Manchester Health Questionnaire [212,213]. Based on the 0.5 SD threshold, the improvement in FISS exceeded the MCID in 75% and 83% of patients in whom the faecal incontinence frequency declined by 50– 74% and $\geq 75\%$ respectively [213].

A few practical issues pertaining to assessment of the MCID deserve emphasis. First, the distribution-based MCID (e.g., $0.5 \times SD$, effect size) can be readily calculated. The SD is not a universal value but is unique for each study. The anchor-based methods require additional data to be collected at all follow-up assessments. This may be as simple as adding one additional item to the “post” measurement (for e.g., a global rating of better/worse for the time period between baseline and post measurement.) While MCID represents a step in the right direction and current methods have demonstrated a utility relative to identify meaningful ‘day-to-day’ life changes for a person with faecal incontinence, we have to be more cautious if considering them “Clinically Important.” None of the methods rely on a clinical gold standard to determine the amount of change that is clinically significant as defined by a gold standard. These methods rely on either distributional properties ($1/2$ standard

deviation, MCID) or other self-reported assessments (anchor based) to identify meaningful change, not clinical indicators. These two questions may be considered as the anchor for assessing the MCID:

1. Over the past <period of time> please rate whether or not the frequency of bowel accidents has become: Much Less Frequent, Moderately Less Frequent, Somewhat Less Frequent, Somewhat More Frequent, Moderately More Frequent, Much More Frequent.
2. Thinking about the bowel accidents you have had over the past <period of time> do you think that you are getting: Much Better, Moderately Better, Somewhat Better, Somewhat Worse, Moderately Worse, Much Worse.

3. BLENDING SYMPTOM SEVERITY AND QUALITY OF LIFE SCALES

Faecal and anal incontinence can have a devastating impact on quality of life (QOL), which can be evaluated by generic or disease-specific instruments [214]. Some symptom severity scales also include typically one [16,19,201], sometimes more [23] questions related to impact of faecal incontinence on lifestyle and QOL. The alternative approach is to use dedicated instruments with more questions that provide a more refined assessment of the impact of faecal or anal incontinence on QOL (e.g., Faecal Incontinence Quality of Life Scale and modified Manchester Health Questionnaire, and FICA QOL scale) [4,20,21]. There is a significant correlation between symptom severity and QOL in faecal and anal incontinence [4,17] (See Qualitative Research section below). The Pelvic Organ Prolapse/Incontinence Sexual Questionnaire - IUGA Revised is validated in women with faecal incontinence, allowing for measurement of sexual function with a condition-specific measure [215].

Bowel diaries are widely used to record bowel habits and track the severity of faecal or anal incontinence. Bowel diaries are less prone to recall bias than questionnaires. They not only quantify faecal or anal incontinence but also the relationship of episodes of incontinence to bowel habits, e.g., whether episodes of faecal or anal incontinence are related to liquid or formed stools or preceded by urgency [203]. These features are useful for guiding therapy. However, maintaining daily bowel diaries entails more work for patients and more analysis. With advancements in digital technology, mobile “apps”, internet, and telephone-based daily reporting of symptoms will likely be increasingly used in future.

In summary, the severity of faecal or anal incontinence is based on the symptoms evaluated by a standardised and validated questionnaires. A scale that scores the severity of faecal incontinence only is lacking and development is needed. The assessment of anal incontinence severity is currently comprised of

four domains (i.e., frequency and type of leakage, amount, and rectal/defaecation urgency). Not all anal incontinence questionnaires incorporate all four domains. At present, a 50% or greater reduction in the number of days or episodes of faecal incontinence is a primary outcome measure in therapeutic trials. In one study, this outcome measure reflects a clinically important difference as measured by the minimal clinically important difference in 75% of patients[213].

Recommendations for Research for Symptom Severity Scales

- Develop an instrument offering a severity score for faecal incontinence only (separate from that of anal incontinence and from quality of life measures).
- Evaluate the addition of weighting the scoring of the consistency of leaked faeces (e.g., liquid vs. solid) in faecal or anal incontinence severity scales.
- Further studies are necessary to ascertain whether use, size, or number of pads is an indication of faecal or anal incontinence severity, hygiene preference, affordability, or a coping mechanism that mediates the relationship between severity and QoL.
- Evaluate the role of behavioural/coping factors (e.g., staying near a toilet, ability to respond to urgency) in faecal or anal incontinence severity. Develop measures for including the effects of these factors in faecal incontinence severity scales.
- If rectal/defaecation urgency is to be used as an item in faecal or anal incontinence severity scales, a way to standardize and measure urgency is necessary.

Table 16-1. Instruments for Rating Severity of Faecal or Anal Incontinence and Their Quality

Scale Name Reference	Content included in score and Type of Score (AI, FI or Blended with Impact on QOL)	Inclusion of Urgency or Amount/Volume of Faecal Leakage*	Construct Validity	Criterion Validity	Internal Consistency†	Test-Retest Reliability	Responsiveness
Pescatori[198]	Frequency of leakage of solid and liquid faeces, flatus, and flatus AI score	Urgency - Amount/Volume -	A(19)	B	B	A(19)	B
Wexner[16]	Frequency of leakage of solid and liquid faeces, flatus, pad use and lifestyle restriction AI QOL impact score	Urgency- Amount/Volume -	A(19,201)	A(216)	A(201)	A(19)	A(217)
St Mark's Incontinence Score[19]	Frequency of leakage of solid and liquid faeces, flatus, and altered lifestyle Presence of urgency (inability to delay defaecation), needing to wear a pad or anal plug, or use of constipating medication AI score	Amount/Volume -	A(201)	A(218)	A(201)	A**	A(218)
FIS[17]	Frequency of leakage of solid faeces, liquid faeces, flatus, and mucus AI score	Urgency - Amount/Volume -	B	A	B	A(21)	A(206)
FICA [FISS] [4,18,200]	Frequency of incontinence, type/amount of leakage (flatus only, small or large amount of faeces), number of pads changed, presence of urgency AI score		A	A	A	A	A(219)
Modified Manchester Health Questionnaire[21,199]	Frequency of: urgency, leaking faeces in various conditions (e.g., coughing and sneezing, walking), leaking solid or liquid faeces, flatus, not wiping clean, and effects on various activities (physical activity, sexual relations, etc) AI QOL impact score	Urgency Amount/Volume -	A(21)	A(21)	A(21)	A(21)	A(21)

Scale Name Reference	Content included in score and Type of Score (AI, FI or Blended with Impact on QOL)	Inclusion of Urgency or Amount/Volume of Faecal Leakage*	Construct Validity	Criterion Validity	Internal Consistency†	Test-Retest Reliability	Responsiveness
ICIQ-B[5,23]	In the Bowel Control section: Frequency of: ability to control solid faeces, liquid faeces, mucus, and flatus, frequency of needing to wear a pad, frequency of leakage in between bowel movements, frequency of unpredictability of incontinence In other sections: frequency of urgency, and using medication to stop leakage along with usual bowel pattern and impact on lifestyle AI QOL impact score	Amount/Volume -	A	A	A	A	B
Revised Faecal Incontinence Scale[201]	Frequency of leakage of solid faeces, liquid feces, urgency, needing to change underwear and needing to alter lifestyle FI QOL impact score	Urgency - Amount/Volume -	A	B	A	B	A

QOL refers to Quality of Life.

"A" refers to attributes that have been partly or adequately validated. "B" refers to attributes that have not been validated.

* Items which are not incorporated in the instrument are indicated by a - sign

†Internal consistency has been evaluated with Cronbach's α coefficient, which may not provide the most appropriate assessment of this characteristic

**For cells with an "A" rating that do not include a citation, the citation is provided in the row heading.

VI. EDUCATION AND LIFESTYLE CHANGE

Faecal incontinence Education, Weight Loss, Smoking, Medication Side Effects, Toilet Facilities, and Complementary Therapies

In community-living adults, conservative management of faecal incontinence relies on patient participation and self-management or caregiver-assistance [220]. A number of self-management strategies for faecal incontinence have been identified including lifestyle changes such as modification of diet and eating patterns, learning the location of public toilets, planning the timing of social events, public outings, and taking anti-diarrhoeal medications, preparing kits of cleansing supplies and clothing changes [221-224]. These strategies often rely on trial and error or borrowing recommendations for other gastro-intestinal problems [221,222]. Many patients with faecal incontinence or their caregivers lack understanding about how the bowel functions, how it may be altered in some disease processes such as dementia, or how lifestyle practices might influence defaecation [12]; therefore, expert opinion supports educating patients and caregivers about these topics [220]. Furthermore, self-management of health practices and caregiving for faecal incontinence are influenced by knowledge and attitudes as well as stigma and cultural taboos. Associations of lifestyle changes such as weight loss and smoking cessation with improvements in urinary incontinence and an association between obesity and faecal incontinence in middle to older aged women have led to suggestions for similar changes to reduce faecal incontinence [226-228].

Recommendations for Practice for Faecal Incontinence Education and Lifestyle Change from the 5th ICI

- Educate the patient (Recommendation Grade B/C) and their carer about faecal incontinence and normal bowel function (Recommendation Grade C).
- Assess medication side effects and consider alternatives if they include diarrhoea and faecal incontinence (Recommendation Grade C).
- Make available appropriate toilet facilities and convenient toilet access especially for people with disabilities (Recommendation Grade C).
- No recommendation about use of complementary therapies can be made due to lack of evidence (Recommendation Grade D).

There is insufficient evidence to recommend or discourage most lifestyle modifications either for the prevention or treatment of faecal incontinence. Interventions

such as education and environmental modification such as easier toilet access pose few risks of harm to patients, and therefore are encouraged.

Summary of Studies about Faecal Incontinence Education and Lifestyle Change from the 5th ICI

Nurse-led education and advice about conservative faecal incontinence management alone or as part of a combined intervention that added exercises and/or biofeedback reduced frequency of faecal incontinence [229]. Nurse-led education and advice addressed diet modification, medication titration, and bowel retraining and was as effective as the combination therapies in reducing faecal incontinence (Level of Evidence 1).

Caregivers of people with dementia, over half of whom had some degree of faecal incontinence, increased their knowledge scores after receiving a videotape and information booklet about maintaining bowel control in those with dementia [230]. It is not known if the improved knowledge resulted in less faecal incontinence.

Faecal incontinence did not resolve in obese women with dual (faecal and urinary incontinence) on a non-surgical weight loss programme [231] (Level of Evidence 3). Results of two studies of decreases in faecal incontinence after weight loss following bariatric surgery for morbid obesity are conflicting [232,233] (Level of Evidence 3). Faecal incontinence after bariatric surgery decreased in the study of women [232].

Nicotine is thought to slow upper gut motility and increase total transit time [234], but it can reduce recto-sigmoid transit time [235]. This colonic effect is associated with a sense of defaecation urgency and anecdotal reports that cigarette smoking promotes the initiation of defaecation. However, epidemiological studies have shown no association of smoking and faecal incontinence [236-238] (Level of Evidence 3). No studies of the effects of smoking cessation on faecal incontinence were found.

Liquid stool consistency and diarrhoea, which are common side effects of many medications, exacerbate faecal incontinence [28,36,239]. A thorough review of prescribed medications as well as of over-the-counter and herbal preparations taken by persons with faecal incontinence can identify the unintended side-effect of faecal incontinence. Change or discontinuation of the medications/preparations is recommended when possible (Level of Evidence 4).

Continence is promoted by sitting well-supported, leaning forward somewhat with feet slightly raised to enable appropriate use of abdominal effort if needed [240]. An environment with lack of privacy such as with commode use in the home [241,242] or physical or social obstacles, especially for individuals with physical or mental disabilities, may impair the ability to maintain continence. Environmental obstacles include toilet facilities that are too few or distant, inac-

cessible due to stairs, needing to obtain a key, requiring money to access, or having no public access [243]. Other obstacles are clothing that is difficult to manipulate, a commode that is too high, low, or unstable, or a wheel chair with arms that are difficult to remove. No studies were found examining the effect of modifying the physical or social environment to reduce faecal incontinence.

A review of complementary mind-body therapies for functional gastrointestinal disorders, i.e., diarrhoea (but not faecal incontinence) and constipation suggested there were some positive outcomes but recommendations for their effectiveness and could not be made [244]. Therapies included yoga, hypnotherapy, cognitive therapy, and biofeedback, and about one-third of studies used patients with inflammatory bowel syndrome. The use of cognitive therapy for managing incontinence has been proposed but not studied [245]. No studies of the use of acupuncture, reflexology, homeopathy or other complimentary therapeutic approach for faecal incontinence were found.

Summary of Evidence on Education and Lifestyle Interventions for Faecal Incontinence from the 5th ICI

- Educating patients and caregivers about their bowel function and faecal incontinence may improve faecal incontinence (Level of Evidence 5).
- Weight loss without surgery did not reduce faecal incontinence (Level of Evidence 3) and findings about the benefit of weight loss after bariatric surgery for morbid obesity were inconsistent (Level of Evidence 3).
- Smoking was not associated with faecal incontinence (Level of Evidence 3) and there were no studies of the effects of smoking cessation on faecal incontinence.
- Medication side effect of diarrhoea may cause faecal incontinence (Level of Evidence 4).
- Environmental barriers in public facilities or private homes increase the risk of faecal incontinence; environmental modifications may promote continence (Level of Evidence 5).

1. WHAT IS NEW ABOUT EDUCATION AND LIFESTYLE CHANGES IN THE CURRENT REVIEW?

1.1. Education About Faecal Incontinence

There was one observational study supporting the need for educating patients and caregivers about fae-

cal incontinence. One new experimental study investigated the effectiveness of a mnemonic to assist women receiving counselling for faecal incontinence to recall the lifestyle-related therapies that they were to perform. Bliss et al. [12] described the health literacy needs of caregivers related to managing incontinence and preventing skin problems in their care recipients with Alzheimer's disease or dementia (Level of Evidence 3). From focus groups and interviews of 48 family and friend caregivers with culturally diverse backgrounds, three main areas of incontinence literacy needs were identified: knowledge, skills, and attitudes. For example, caregivers sought information about the risk of and reasons for incontinence in dementia, therapies other than using absorbent products, understanding many over-the-counter products available for skin care and types of absorbent products, and trustworthy resources. Caregivers were interested in improving skills for managing incontinence, preventing incontinence associated skin problems, and lessening resistance of care recipients to those strategies. Almost all caregivers expressed a desire for incontinence to be framed as a health versus behavioural problem and saw a need for greater public awareness and empathy so the stigma associated with incontinence would be less. Results can guide the selection of educational topics for patients with faecal incontinence and their caregivers [12] (Level of Evidence 3).

A series of educational and supportive materials for clinicians to provide their patients were developed from this study and are available free via the webpage of the Nursing Committee of the International Continence Society (ICS) [246] or the first author of the study [12]. A continence product advisor website [247] to assist in selecting absorbent products has also been developed from a collaboration of ICS, International Consultation on Incontinence, University College of London and University of Southampton.

In teaching counselling-naïve women about faecal incontinence management [248], randomized women with faecal incontinence to a standard counselling group or counselling and use of a mnemonic to assist them to recall the types of lifestyle therapies that they were to perform. The mnemonic was RELIEF: routine lifestyle and routine bowel habits, exercise, live, lmodium, effort, and fibre and food diary. At two months following counselling, there was no difference in recall of faecal incontinence treatments between groups. The group using the mnemonic had higher (better) scores on the Manchester Health Questionnaire however. Results show that although education about faecal incontinence increases knowledge, the effectiveness of different teaching strategies needs to be evaluated (Level of Evidence 2).

1.2. Weight Loss

Several recent studies investigating weight loss and faecal incontinence were found. Two studies were observations [249,250], one was a secondary analysis [231], and one study had a one-group, pre-post

design [228]. Findings by Bussen et al. [249] add to observations of the association between faecal incontinence and weight in women. In a retrospective review of women evaluated at a coloproctological clinic, being overweight or obese was identified in 26% of 98 women presenting with faecal incontinence compared to 9% of 98 control women with outlet obstruction (Level of Evidence 3).

Ellington et al. [250] described anorectal manometry findings in women with faecal incontinence grouped by weight (normal, overweight, or obese) in a retrospective review of medical records. Women with faecal incontinence who were obese had higher baseline anal resting tone and squeeze pressures compared to those with normal weight (Level of Evidence 3). The authors concluded that obese women have a lower threshold to leakage with pressure increases (Level of Evidence 3).

In a secondary analysis of 338 overweight and obese females completing an experimental programme of weight loss and maintenance for urinary incontinence using dietary fibre [231], examined whether there would be a decrease in anal incontinence at 6, 12, or 18 months. Although there was an overall combined decrease in anal incontinence in 13% of women, the change was not significantly different from that of the control group receiving education. In comparing women with and without improvement of anal incontinence, those who showed a decrease in anal incontinence had a lower weight and BMI at baseline, but total caloric intake after 18 months did not differ between the groups. A decrease in lower urinary tract symptoms (LUTS) was associated with lesser anal incontinence severity in all women. In 33 women with incontinence of liquid faeces, an increase of 10 g of dietary fibre and a decrease in LUTS were associated with less anal incontinence. Limitations of this study included using an untested modification of the FISI score to measure anal incontinence and the lack of adjusting for baseline anal incontinence severity in the analysis (Level of Evidence 2).

Scozzari et al. [228] compared the presence and severity of anal incontinence before and after bariatric surgery in 32 obese women. At 15.6 months after surgery, the women lost about 40 kg on average. However, the presence of anal incontinence increased 12.5% postoperatively but this was not a statistically significant change from baseline. The increased anal incontinence was attributed mainly to incontinence of flatus. The mean Wexner score of anal incontinence severity differed by only 0.1 before and after surgery and was not statistically significantly different. Limitations of this study were lack of a power analysis for its sample size, no comparison treatment and therefore no random assignment was possible, and inability to describe/quantify faecal incontinence separately from flatus incontinence (Level of Evidence 2).

1.3. Complementary Therapies

A survey of patients utilizing a biofeedback service revealed that a variety of complementary therapies

were used for bowel problems [251]. The most common therapies for bowel problems were the use of herbal medicines (n=27) or acidophilus/probiotics (n=26). Other therapies included acupuncture, massage, homeopathy, kinesiology, relaxation therapy, reflexology, and traditional Chinese medicine. Of the 93 survey respondents, 31% were being treated for faecal incontinence, but use of complementary therapies for faecal incontinence was not specified. Users considered complementary therapies safe, natural, and providing them with some control over their health feeling that conventional treatment had failed them or was not available (Level of Evidence 3).

A case report describes naturopathic treatment of faecal incontinence, urgency and soft stools in a 44 year-old woman with multiple sclerosis [252]. Her first treatment consisted of an herbal preparation (Parex, Health World LTD) considered antimicrobial and a probiotic (Probiotic Ultra flora LGG (*Lactobacillus rhamnosus*, (Health World LTD))). The second treatment consisted of a different herbal mixture and Instamine, a bioceutical containing Aloe vera, Ulmus rubra, Citrus bioflavonoids, apple pectin, Pisacia lentiscus, glutamine and *Curcuma longa*. After six weeks, the patient reported no faecal incontinence, fewer liquid stools and less urgency, albeit outcomes were not quantified before or after treatment (Level of Evidence 4).

There is one case report of the occurrence of faecal incontinence in a middle-aged woman with multiple sclerosis after receiving bilateral needling of trigger-point acupuncture ("dry needling") for a painful musculoskeletal condition [253]. Acupuncture was administered in spinal, gluteal and occipital areas (Level of Evidence 4).

Current Recommendations for Practice for Faecal Incontinence Education and Lifestyle Change

- Educate patients their caregiver about bowel function and alterations in disease states, faecal incontinence, and available therapies (Recommendation Grade B/C).
- Weight loss may be recommended for better health in general but no recommendation can be made regarding faecal incontinence due to inconsistent evidence of improvement (Recommendation Grade B).
- Inform patients using complementary therapies to do so with caution as there is minimal evidence of their effects and some may result in worsening of faecal incontinence (Recommendation Grade C).
- Recommendations for practice regarding medication side effects, smoking and toilet access are similar to the 5th ICI:
 - Consider alternatives to medications if possible when faecal incontinence is a side effect (Recommendation Grade C).

- Improve access to toilet facilities especially for those with disabilities (Recommendation Grade C).
- Smoking cessation is recommended for better health in general but no recommendation can be made regarding benefit for reducing faecal incontinence due to a lack of studies showing association (Recommendation Grade D).

Current Recommendations for Research for Faecal Incontinence Education and Lifestyle Change

- Develop and evaluate innovative gender and culturally appropriate educational strategies for increasing patient and caregiver health literacy about bowel function and preventing or managing faecal incontinence.
- Randomized controlled trials on the effectiveness of weight loss in reducing faecal incontinence especially in moderately obese patients using non-surgical interventions are needed.
- Randomized controlled trials on the effectiveness of smoking cessation in reducing faecal incontinence are recommended.
- Evaluate the impact of environmental modifications including better toilet access in reducing faecal incontinence.
- Evaluate the individual or additive effect of various lifestyle changes and contribution of complementary therapies in reducing faecal incontinence.

VII. DIET AND FLUID INTAKE

Background

Some individuals with faecal incontinence believe the severity of their faecal incontinence is related to dietary intake and can be altered by modifying the type and amount of their food and drink and when they eat.

Community-living individuals with faecal incontinence, more so in women than men, report that they manipulate their diet and eating patterns as part of their self-management strategies to reduce faecal incontinence [222,254,255] (Level of Evidence 3). Dietary modifications most often restrict intake of certain foods (for example, fried or spicy foods, caffeine-containing beverages and chocolate, or foods that increased flatus such as cabbage); however, some foods are purposively eaten as a therapy to decrease faecal incontinence (for example, yogurt) [222]. Skipping meals is also a common strategy to manage faecal incontinence [221,222].

Some community-living individuals report increasing fluid intake especially when faecal incontinence is loose or liquid to prevent dehydration or subsequent constipation. Nutritional deficiencies and subsequent poor health are concerns of dietary modification in persons at high risk for malnutrition. In comparing diet intake of 39 community-living individuals with faecal incontinence with 39 age and sex matched controls with normal bowel function [34], reported there were no significant differences in the intake of total kilocalories, protein, fat, dietary fibre, caffeine, or lactose. The group with faecal incontinence had a significantly greater intake of carbohydrates, manganese, and vitamin B1 compared with the control group. The percentages of the RDA for calcium and vitamin D were less for the group with faecal incontinence (84%± 6% and 56% ±8%, respectively) than controls (90% ± 8% and 69% ± 11%) but differences were not statistically significant (Level of Evidence 3).

Recommendations for Practice for Diet and Fluids from the 5th ICI

- Patients should be asked about dietary restrictions and meal skipping to assess nutritional impact especially in groups who may be at higher risk for malnutrition (Recommendation Grade C).
- Soluble dietary fibre is recommended for the management of faecal incontinence especially when stool consistency is loose or liquid (Recommendation Grade B).

- Soluble dietary fibre is recommended as part of a combination therapy involving rectal/ transanal irrigation (Recommendation Grade B).
- No recommendations about the use of dietary fibre as an adjuvant to antispasmodic medications can be made because evidence is conflicting and study methods vary in quality (Recommendation Grade B).

1. LACTOSE, YOGURT, SORBITOL, FRUCTOSE, CAFFEINE, AND ALCOHOL

Background

Several diet components may induce alterations of normal gastrointestinal function resulting in faecal incontinence. In individuals with a deficiency of the intestinal enzyme, lactase, hydrolysis and absorption of the disaccharide lactose is reduced. Consumption of lactose creates an osmotic shift of water into the small intestinal lumen which can increase transit. In the large intestine, lactose is fermented by colonic bacteria resulting in flatulence, distension, diarrhoea, and possibly faecal incontinence. Malabsorption of fructose and sorbitol results in osmotic diarrhoea and faecal incontinence similar to lactose. Caffeine, of which coffee is a popular source, induces a desire to defecate in some individuals [256-260]. Chronic alcohol consumption accelerates gastric emptying and small bowel transit in animal studies.[261-263] Excessive alcohol consumption leads to injury of cells in the small intestine, reduced sodium and water absorption, and bacterial overgrowth, which may contribute to loose stools, diarrhoea, and faecal incontinence [264].

Summary of of Studies about Intake of Diet, Fluid, Lactose, Yogurt, Sorbitol, Fructose, Caffeine, and Alcohol from the 5th ICI

- Studies about diet and faecal incontinence are observational and have not measured the effectiveness of diet modification on faecal incontinence in a controlled manner.
- There were no studies assessing the effect of reducing lactose, sorbitol, or fructose intake on faecal incontinence..
- Regular consumption of coffee is not associated with faecal incontinence in elderly men and women [238] (Level of Evidence 3). No studies examining caffeine restriction to improve faecal incontinence were found.
- There were no studies in which alcohol was restricted to reduce faecal incontinence.

2. WHAT'S NEW ABOUT DIET AND FLUID INTAKE IN THE CURRENT REVIEW?

Two observational studies examining the effects of fluid or serum levels of Vitamin D were found. In one study, women with urinary incontinence were surveyed about their fluid intake or restriction and bothersome bowel symptoms [265]. There were no associations between faecal incontinence of solid or liquid faeces and the volume of daily fluid intake or the behaviour of restricting fluid (Level of Evidence 3). Fluid intake by women with bothersome flatus incontinence was less than those with no bother from flatus incontinence.

As Vitamin D is important for normal muscle function, serum Vitamin D levels were compared in 31 women with faecal incontinence or 81 female controls with normal bowel function referred to a tertiary care centre for faecal incontinence or gynaecological care, respectively [266]. Women with faecal incontinence had significantly lower serum total Vitamin D levels (29.2 ± 12.3 ng/ml) (mean \pm sd) than controls (35 ± 14.1). The authors concluded that Vitamin D deficiency may contribute to faecal incontinence in women (Level of Evidence 3).

3. PREBIOTICS, PROBIOTICS, SYNBIOTICS

Background

A prebiotic is diet ingredient that is not digested by human enzymes in the small intestine and stimulates the growth or activity of bacteria in the colon. Dietary fibre, fructo-oligosaccharides and galacto-oligosaccharides are prebiotics. A probiotic is a food supplement containing live non-pathogenic and non-toxic microbial organisms, such as Bifidobacteria and lactobacilli, which have the potential to modify the profile microbes in the colon. Yogurt which has active microbial cultures is a probiotic. A synbiotic refers to a product containing a prebiotic and probiotic. In the previous reviews, there were no studies examining the use of probiotics or synbiotics to treat faecal incontinence.

4. DIETARY FIBRE

Background

Dietary fibre is the non-starch, polysaccharide component of plant cell walls and lignin that resists digestion by human intestinal enzymes[267]. Faecal incontinence is associated with low dietary fibre intake (Level of Evidence 1). Overweight women with faecal incontinence were 2.5 times as likely to have a low fibre intake (≤ 10 g/d) than those without faecal incontinence.

tinence [231]. On the other hand, if a higher fibre intake increases flatus, faecal incontinence might worsen. Bliss et al. [268] showed that flatus increased over time in individuals with faecal incontinence taking one of three supplements of 16 g of dietary fibre/day as well as a placebo supplement. The self-reported severity of flatus did not significantly differ among the groups.

Summary of Evidence about Dietary Fibre and Faecal Incontinence from the 5th ICI

In two non-experimental studies, a staged intervention in which dietary fibre was the initial treatment, reduced faecal incontinence [269,270]. In one of these studies, 46% of women taking a supplement of methylcellulose followed by the antitomotility medication loperamide as needed were cured of faecal incontinence while none in the control group receiving no intervention was cured [269]. In the second study [270], faecal soiling resolved in 24% of patients after psyllium supplementation alone, in 48% who added rectal/transanal irrigation to psyllium supplementation, and in 2% in those who added cholestyramine to psyllium supplementation transanal irrigation.

In one randomized clinical trial [27], supplementation with one of two soluble dietary fibres of moderate fermentability (psyllium) or high fermentability (gum arabic) was compared to placebo (See Table 16-2). The percentage of incontinent stools was significantly lower in those taking the fibre supplements than the placebo (Level of Evidence 1). The percentage of stools that had a loose/liquid consistency was also significantly lower in the fibre groups [27].

Another randomised clinical trial investigated two combination treatments: one treatment consisted of loperamide, a diet advice sheet describing a high vs. low fibre diet, and a fibre supplement, and the other treatment used loperamide and a placebo supplement [271]. There was no additional benefit of a dietary fibre supplement and diet advice sheet over use of the antitomotility medication in reducing incontinence of flatus, mucus or solid or liquid stool (Level of Evidence 1).

5. WHAT IS NEW ABOUT PROBIOTICS AND DIETARY FIBRE IN THE CURRENT REVIEW?

A case report [252] in which a probiotic (*Lactobacillus rhamnosus*) was included as part of a naturopathic therapy for faecal incontinence is described in the section on complementary therapies (Level of Evidence 4).

Two new randomised clinical trials investigating the effects of dietary fibre on faecal incontinence were conducted. Both studies showed a reduction in faecal incontinence from consumption of psyllium fiber, one

using a higher dose of psyllium [28] and the other a lower dose [28,272]. Bliss et al. [28] compared three soluble dietary fibre supplements of 16 g total fibre/day and a placebo supplement on the frequency of faecal incontinence in community-living adults. The supplements were carboxy- methylcellulose, psyllium, and gum arabic and had low, medium, and high fermentability. There was a 14-day baseline period and a 32-day treatment period during which the fibre amount was increased over six days. The primary outcome of faecal incontinence frequency was reported daily on a diary for 14 days at the end of each period. Secondary measures of all subjects were wet and dry stool weights, the water content and total fibre content, adverse symptom severity, and quality of life (FIQL score). In 52 randomly selected subjects, gel formation and water-holding capacity of stools was also measured.

In the intent-to-treat analysis, data from 206 adults with faecal incontinence of loose/liquid faeces who were randomly assigned to a group were analysed; 189 subjects completed the protocol. Both the intent-to-treat and per protocol analyses showed that faecal incontinence frequency significantly decreased after supplementation with psyllium fibre compared to placebo (Level of Evidence 1). The percent change of faecal incontinence in the psyllium group was 51%. Faecal incontinence severity, measured by a severity index of frequency, consistency, and amount, significantly decreased in the psyllium group (Level of Evidence 1). The fermentability of psyllium was moderate [273] and a gel formed in stool during psyllium supplementation only suggesting a mechanism of psyllium's effect in faecal incontinence. Secondary measures did not differ among groups.

The severity of adverse symptoms, including flatus, was small and did not differ among groups ingesting dietary fibre or placebo [268] (Level of Evidence 1). Those withdrawing from the study were more likely to experience bloating or a feeling or fullness and emotional upset from symptoms. Strengths of the study included blinding of subjects, pre-prepared supplements with a known amount of fibre, monitoring dietary intake with a food diary and adherence with appearance of a dye in faeces, and using a longitudinal analysis that adjusted for baseline faecal incontinence and faecal dietary fibre content. Limitations included self-report measures of faecal incontinence and use of a diary and faecal incontinence severity index whose parts had not all been tested for validity and reliability, not double-blinded, some lab measures only on a subsample.

Markland et al. [272] examined the effectiveness and tolerance of loperamide (2 mg) versus a supplement of psyllium fibre in a cross-over design with a two-week washout period. Subjects (68% male) were patients at clinics at veterans' hospitals who were randomly assigned to take loperamide first then psyllium for 4 weeks each or psyllium then loperamide after a two-week baseline period. The dose of loperamide

was 2 mg/day and that of psyllium was 3.4 mg/day, but these could be titrated depending on effects. The primary outcome of faecal incontinence frequency was reported daily on a diary for 7 days during each period. Secondary measures were anal incontinence severity (FISI score), quality of life (MMHQ), adverse symptoms, and impression of improvement for all subjects, and anorectal manometry for a subset of 26 subjects. There was no significant difference in faecal incontinence between treatment groups (Level of Evidence 1).

Within each treatment group, faecal incontinence frequency significantly decreased from baseline during the first treatment period for both treatments, but did not significantly change after the crossover to the other treatment (Level of Evidence 1). No differences were found between groups for secondary measures. Anal incontinence severity (FISI) scores improved in both groups as did quality of life after the second treatment and subjects' impressions of improvement. Loperamide users complained of constipation and headache and one serious adverse occurred in this group.

Most anorectal manometry measures did not differ between treatment groups except transit time increased with loperamide after the second intervention. A supplement of low dose psyllium was as effective as loperamide in reducing faecal incontinence frequency and was associated with fewer side effects (Level of Evidence 1). Strengths of the study were its double-blinding and use of a longitudinal analysis. Limitations were self-report measures, use of a stool diary untested for validity and reliability, potential error due to subjects needing to prepare part of their supplement, possible unmeasured cross-over effects, a non-equivalent baseline period, and attrition during the washout period.

6. SUMMARY OF CURRENT EVIDENCE ON DIETARY FIBRE AND PROBIOTICS

- Two new randomized clinical trials showed that a supplement of moderately fermentable, soluble dietary fibre (i.e., psyllium) reduced the frequency of faecal incontinence (Level of Evidence 1).
- A supplement of a low amount of psyllium fibre (3.4 mg/day) was as effective as a low dose of loperamide (2 mg/day) in reducing faecal incontinence (Level of Evidence 1).
- Gel formation in faeces may be a mechanism by which psyllium dietary fibre exerts its effect in faecal incontinence (Level of Evidence 1).
- The severity of adverse symptoms of dietary fibre supplementation up to 16 g total fibre/day are small on average but tolerance may be more individual (Level of Evidence 1).

Current Recommendations for Practice on Diet and Fluids

- Patients should be asked about dietary restrictions and meal skipping to assess nutritional impact, especially in groups who may be at higher risk for malnutrition (Recommendation Grade C).
- Soluble dietary fibre with moderate fermentability such as psyllium is recommended for the management of faecal incontinence; starting with a lower fibre amount and assessing its effect then increasing to a higher amount if needed is suggested (Recommendation Grade A).
- Supplementation with psyllium fibre, especially when a low dose is used, is recommended as an alternative rather than an adjuvant to antimotility medication as a therapy for faecal incontinence as their effects may be similar (Recommendation Grade B).
- Soluble dietary fibre with moderate fermentability is recommended as part of a combination therapy involving transanal irrigation (Recommendation Grade B).

Current Recommendations for Research on Diet and Fluids

- Because dietary fibres differ in their chemical composition and properties, future studies are recommended to determine the optimal type and amount of fibre to use for faecal incontinence.
- The extent to which modifying usual diet including specific foods, caffeine, and alcohol and eating patterns can reduce faecal incontinence or augment other behavioural interventions, such as pelvic floor muscle exercises or bowel training, needs further study.
- More research is needed about the role of Vitamin D in the management of faecal incontinence.

2024 **Table 16-2. Randomised Trials Using Dietary Fibre to Manage Faecal Incontinence**

Study and Country	Design and Sample	Intervention and Outcomes	Findings	Strengths	Limitations
Markland et al. 2015[272] USA	Double-blind, randomised, cross-over design 80 veterans with faecal incontinence or liquid or solid stool at least weekly for 3 months	Random assignment to loperamide (2 mg/day) first then a supplement of psyllium fibre (3.4 mg/day) or psyllium first then loperamide for 4 weeks each with a 2 week washout and a 2 week non-equivalent baseline period Faecal incontinence frequency was reported daily on a diary for 7 days during each period	No significant difference in faecal incontinence between treatment groups. Within each treatment group, faecal incontinence frequency significantly decreased from baseline during the first treatment period for both treatments, but did not significantly change after the crossover to the other treatment.	Double-blind, and used a longitudinal analysis	Use of a stool diary untested for validity and reliability, potential error due to subjects needing to prepare part of the supplement, possible unmeasured cross-over effects, non-equivalent baseline period, and attrition during the washout.
Bliss et al. 2014[28] USA	Single-blind, randomised, placebo controlled, parallel groups 206 community-living adults with at least 2 episodes of faecal incontinence of loose/liquid stools in 2 weeks	One of 3 dietary fibre supplements, carboxymethylcellulose, psyllium, or gum arabic, (16 g total fibre/day) or placebo for 32 days each Faecal incontinence frequency was reported daily on a diary for 14 days at the end of each period	Both the intent-to-treat and per protocol analyses showed that faecal incontinence frequency significantly decreased after supplementation with psyllium fibre compared to placebo. The percent change of faecal incontinence in the psyllium group was 51%	Blinding of subjects, pre-prepared supplements with a known amount of fibre, monitoring dietary intake with a food diary and adherence with appearance of a dye in faeces, and a longitudinal analysis that adjusted for baseline values	Use of a diary and faecal incontinence severity index whose parts had not all been tested for validity and reliability; not double blinded; lab measures only on a subsample

Study and Country	Design and Sample	Intervention and Outcomes	Findings	Strengths	Limitations
Lauti et al. 2008[271] Australia	Double-blind, randomised, cross-over design using blocks of 10 63 adults with incontinence of mucus, or liquid or formed stools. started study, and 47 subjects (91% female) completed the study Treatment A n= 31 and treatment B n= 32 49 crossed-over Treatment A = 27 and B = 22	Treatment A: self-titrated dose of loperamide (starting at 2 mg twice/d), 1 teaspoon of a food thickener containing starch, maltodextrin, and locust bean gum twice/d, and a diet advice sheet about a low-fibre residue diet. Treatment B: same self-titrated dose of loperamide, one teaspoon of psyllium fibre in water twice/d, and a diet advice sheet about a high and low fiber residue diet. Treatments were for 6 weeks each Primary measure was self-reported anal incontinence for the last 4 weeks of each treatment using the FISl. Secondary clinical measures were FIQL and SF-36, a measure of general health.	67% of treatment A fibre and 73% of treatment B fibre were taken. The mean difference in the FISl score between treatments was not statistically significant.	A power analysis was used for sample size calculation. Independent pharmacists dispensed the treatments. The interval for data collection during both treatments was the same. 75% of subjects completed the study protocol and reasons for attrition were reported.	Period and sequence effects were not reported prior to combining all subjects on Treatments A or B for analysis. Attrition resulted in low statistical power. There was no theoretical or physiological rationale for use of dietary fibre for leakage of mucus or solid stools. Subjects mixed their own fibre supplements and intake was not controlled. Doses of the anti-motility medication and suppositories for constipation were uncontrolled.

Study and Country	Design and Sample	Intervention and Outcomes	Findings	Strengths	Limitations
Bliss et al. 2001[27] USA	Randomised, parallel-group, placebo-controlled, single blind trial Subjects, statistician, lab technician, and subjects' clinicians were blinded. 39 adults (79% female) with faecal incontinence of loose or liquid stool at least weekly. A block scheme resulted in equal numbers (n=13) in each group. Groups' characteristics were comparable at baseline.	Intervention: soluble dietary fibre supplements mixed into fruit juices: 7.1g of psyllium/d, 21.5 g of gum arabic/d, or placebo (0.2 g pectin/d). Supplements taken for 31 days in addition to usual diet Faecal incontinence reported daily on a stool diary for 8 d in baseline and supplement periods Primary measure was the proportion of incontinent stools. Secondary clinical measures were stool consistency and frequency, and flatulence reported daily Secondary lab measures were stool wet and dry weights, % of water, pH, total fibre content, water-holding capacity of stool solids, and faecal short chain fatty acids.	Proportion of incontinent stools in psyllium or gum arabic groups was significantly lower than placebo. Percent of loose or liquid stools in psyllium and gum arabic groups was significantly lower than placebo. The water-holding capacity of stool solids was highest for the psyllium group. No significant differences among the groups in other measures.	Sample size was based on a power analysis. Data collection period was equal during baseline and supplement periods. Control of concomitant treatments. Supplements were pre-mixed and ready-to-take. 95% of subjects completed the study and reasons for attrition were reported.	Details of the procedures for random assignment and allocation concealment were not provided. Although adequately powered, small group sizes reduce generalizability of findings.

VIII. BOWEL MANAGEMENT AND RETRAINING PROGRAMMES, RECTAL EVALUATION, AND TRANSANAL IRRIGATION

Summary from the 5th ICI

Expert opinion supports the importance of attempting to establish a regular, predictable pattern of bowel elimination using patient teaching and adherence to a routine [274,275] (Level of Evidence 4). Because peristaltic contractions of the colon that are associated with defaecation increase in frequency following awakening from sleep and following meals [276,277], the period after breakfast is considered the best time for scheduled defaecation. Bowel management, bowel habit retraining, or toileting programmes have been tested for their effectiveness for faecal incontinence mainly in adults with neurogenic faecal incontinence or in those in long-term care institutions. The possibility of managing faecal incontinence through bowel habit training by community-living adults with normal cognitive function is relatively unexplored.

As the sensation of a strong urge to defecate is associated with some forms of faecal incontinence, some biofeedback protocols aim to modify altered rectal sensory thresholds as discussed below. Some patients, mainly those with passive faecal incontinence or incomplete evacuation of the rectum, are advised to use laxatives, suppositories, enemas, or transanal irrigation (also called rectal irrigation) to empty the rectum and reduce the risk of faecal incontinence. No studies examining the use of laxatives or suppositories to treat faecal incontinence in adults with non-neurogenic faecal incontinence were found.

Irrigation of the lower bowel via the rectum has been used for many years to manage both faecal incontinence and constipation by patients with neurogenic bowel problems such as spinal cord damage, spina bifida, multiple sclerosis, stroke etc. [278,279] Antegrade irrigation is possible after surgical construction of a portal into the intestine. Observational studies [118,165,270,279] have shown that transanal irrigation reduced faecal incontinence in 47% to 61% of patients (Level of Evidence 3). Patients discontinuing transanal irrigation complained of the time required, difficulties with the irrigating procedure, incontinence of irrigation fluid later in the day, lack of benefit, and bothersome symptoms. Transanal irrigation was included as part of a staged intervention for faecal incontinence by patients who still had faecal incontinence after consuming 3.25 g psyllium fibre per day and high fibre diet [270]. Patients whose faecal incontinence continued added cholestyramine. Faecal soiling resolved in 24% of patients consuming psyllium alone, 48% of patients who added transanal irrigation

to psyllium supplementation, and 2% who added cholestyramine to the other treatments (Level of Evidence 2).

Recommendations for Practice for Bowel Training Rectal Evacuation, and Transanal Irrigation from the 5th ICI

- Attempt to establish a bowel habit routine (Recommendation Grade C).
- No recommendation can be made about establishing a toileting schedule for non-institutionalized adults due to a lack of studies (Recommendation Grade D).
- Urgency resistance training is possibly useful for defaecation urgency (Recommendation Grade D).
- Transanal irrigation is recommended for patients who do not respond to other conservative therapies and as part of a combined approach of therapies (Recommendation Grade C).

1. WHAT IS NEW IN THE CURRENT REVIEW?

In the current review, one study [280] described the use and evaluation of a mini-irrigation system (Qufora®, MBH International A/S, Allerød, Denmark) by 50 adults with passive faecal incontinence (n=11), incomplete rectal evacuation during defaecation (n=35) or both (n=4) undergoing biofeedback therapy. The mini irrigation system consists of a hand-held bulb used to draw up and deliver tap water through a cone at the other end that is inserted into the rectum while sitting on the toilet. Thirty-six patients (72%) reported on a questionnaire completed at their clinic that they irrigated less than once a day, 11 patients (22%) irrigated once per day, and three (6%) irrigated more than once a day. More than half of the patients (n=29 58%) thought their symptoms improved while using the system, two patients thought their symptoms completely resolved, whereas 14 (34%) did not think the irrigation system helped, and one patient said their symptoms worsened. The rate of faecal incontinence was not measured daily before or during use of the irrigation system. Only 14 patients 28% thought that using irrigation system was uncomfortable. Eighteen patients (36%) said they would continue using the irrigation system as designed (Level of Evidence 2).

In a long-term prospective observational study [281], the effectiveness of transanal irrigation was assessed in patients who received sphincter-saving anterior resection for rectal cancer and developed a combination of faecal incontinence and defaecation difficulty. Ten patients had received pre-operative radiotherapy. All patients had tried other conservative measures (dietary counselling, loperamide, or an

anal plug). The Peristeen® irrigation system (Coloplast A/S, Humblebak, Denmark) which consists of a rectal catheter with a balloon, bag with a screw top for water, pump for activating the balloon and flushing water, and a control unit for regulating water, was used. Five patients irrigated less than once per day, and nine patients (64%) irrigated daily. After an average of 29 months using transanal irrigation, the Cleveland Clinic Score for anal incontinence decreased from 17 (15-20 (median (range))) to 5 (4-9) ($p < .01$). The total number of defaecations per day significantly decreased from 8 (1-4) to 1 (1-2) after using transanal irrigation. Transanal irrigation also resulted in a significant decrease in defaecations during the night from 3 (2-5) to 0 (0).

Median scores on all domains (Lifestyle, Coping/Behaviour, Depression/Self-perception, and Embarrassment) of the Fecal Incontinence Quality of Life Scale significantly improved after using transanal irrigation (Level of Evidence 3). Adverse symptoms included minor rectal bleeding in four patients and transient abdominal pain after irrigation in three patients.

Patton and Lubowski [282] reported a retrospective case series of use of an indwelling antegrade continence enema for 2 to 5.5 years by 54 patients with constipation, faecal incontinence, or other elimination difficulties from a variety of aetiologies. Six patients had incontinence and two had constipation and incontinence but results for those with faecal incontinence were not reported separately.

Lyons [283] instituted group sessions for teaching and supporting patients using transanal irrigation. She observed that the groups helped patients feel that they were not alone in needing to use transanal irrigation and were a cost-effective means to providing psychosocial support and improve patients' skills in the procedure (Level of Evidence 2).

Current Recommendations for Practice for Bowel Training and Rectal Evacuation or Irrigation

- Attempt to establish a bowel habit routine (Recommendation Grade C).
- No recommendation can be made about establishing a toileting schedule for non-institutionalized adults due to a lack of studies (Recommendation Grade D).
- Urgency resistance training is possibly useful for defaecation urgency; urgency resistance training is part of some biofeedback regimens (See Section XI Pelvic Floor Muscle Exercises, Biofeedback, and Electrical Stimulation). (Recommendation Grade C).
- Evacuation of the rectum using a suppository or enema in patients with passive faecal incontinence or incomplete rectal evacuation is possibly useful (Recommendation Grade D).

- Transanal irrigation is recommended for patients with passive faecal incontinence, incomplete rectal evacuation, or faecal incontinence with defaecation difficulty who do not respond to other conservative therapies (Recommendation Grade C).
- Consider group sessions as a way of teaching and supporting patients performing transanal irrigation (Recommendation Grade D).

Current Recommendations for Research for Bowel Training and Rectal Evacuation or Irrigation

- Randomised clinical trials of transanal irrigation are needed.
- Research is needed in all areas of bowel habit training and rectal evacuation.

IX. COMBINATION THERAPIES

Summary from The 5th ICI

Faecal incontinence may be the result of a complex combination of alterations in normal anatomy and physiology, stool consistency, gut motility, colonic microorganism environment, emotional and psychological status, and access to toilet facilities. Many patients use a combined approach, for example, adjusting diet, medications, lifestyle, and pelvic floor muscle function. Studies of combinations of interventions are addressed by the main topic of the intervention in the respective section above when possible. A limitation of these studies is that the contribution of the individual components to the overall effect or the effect of the order of components has not been determined and remains unknown.

1. WHAT IS NEW ABOUT COMBINATION THERAPIES IN THE CURRENT REVIEW?

A study by Sjothol et al. [284] which compared biofeedback to treatment with loperamide and stool bulking agents, isphagula and sterculia, then to both therapies combined in a randomised crossover design is addressed in the section on biofeedback therapy.

Collins et al. [285] performed a retrospective study in which patients treated for anal incontinence or constipation were classified into three groups: those receiving (1) defaecatory techniques and biofeedback, (2) dietary advice and education about medications and suppositories, and (3) rectal irrigation and anal plugs. Anal incontinence was graded in 231 patients with

anal incontinence before and after treatment using St. Mark's score. There was a decrease in the median St. Mark's score from 10 of a possible 24 (5-14) to 4 (1-6) (median (interquartile range)). However, the results were not reported by the type of treatment (Level of Evidence 3).

X. MEDICATION TREATMENT OF FAECAL INCONTINENCE

1. GOALS

With the recognition that severity is subjective, treatment should be allocated according to symptom profile and patient lifestyle. The goals of this section are to identify the drugs and other conservative/medical interventions that have been used to treat faecal incontinence and to evaluate the evidence regarding their efficacy (See Table 16-3). Drugs can be combined for synergistic effect, helping reduce individual doses; loperamide plus codeine phosphate and loperamide plus amitriptyline are examples. The conservative/ medical management of faecal incontinence has focused exclusively on three mechanisms:

1. Reduction of diarrhoea. Diarrhoea is consistently found to be a strong risk factor for faecal incontinence.
2. Increasing resting anal canal pressure. Low resting anal canal pressure is a risk factor for passive faecal incontinence, and is commonly seen following some types of anorectal surgery (e.g., ileal pouch procedures, sphincterotomy, abdomino-perineal pull-through for imperforate anus).
3. Treatment or prevention of constipation. Constipation is frequently found to be a risk factor for faecal incontinence, especially in children and the elderly [286].

Recommendations for Clinical Practice for Drug Treatment of Faecal Incontinence from the 5th ICI

- Treat faecal incontinence with diarrhoea with anti-diarrhoeal medication. (Recommendation Grade C); titrate the dose to individual response (Recommendation Grade C).
- We are unable to recommend sphincter modifying drugs (Recommendation Grade D).

Summary of Evidence on Medication Treatment for Faecal Incontinence from the 5th ICI

Treatment of Diarrhoea-Associated Faecal Incontinence with Antidiarrhoeal Drugs, Loperamide and Diphenoxylate

Loperamide (synthetic opioid with μ -agonist activity) is the most studied drug specifically for diarrhoea-associated faecal incontinence. The mechanism of action is slowing of gut transit, increasing fluid reabsorption and reducing secretion, as well as directly increasing resting anal pressure. There were 9 studies in adult subjects [133,149,287] and 3 studies in children [126,288,289].

- Due to design, sample size and case selection, a methodologically sound meta-analysis is not feasible.
- Loperamide improves continence by reducing diarrhoea, being superior to codeine and diphenoxylate in this respect.
- Syrup formulation offers the opportunity of finer dose-titration to avoid constipation.
- Tolerance does not seem to develop with chronic use.
- Diphenoxylate, a natural opioid, is usually combined with atropine to reduce abuse potential and can cause anticholinergic effects.
- Codeine phosphate is another opiate derivative. Clinical effects are like those of loperamide, but it is harder to titrate and adverse effects (nausea and tolerance) become prominent with time.

Palmer [290] compared loperamide (average of 4.6mg/day) to codeine (average of 103mg/day) and diphenoxylate (average of 12.5mg/day) in 30 patients with diarrhoea, of whom 19 had faecal incontinence. Loperamide significantly decreased stool frequency, improved stool consistency, and showed a trend for less faecal incontinence. Effect was like codeine and superior to diphenoxylate.

Fox et al. [291] undertook a double-blind placebo-controlled cross-over trial of loperamide in 10 obese subjects taking orlistat with resulting faecal incontinence. Loperamide significantly decreased soiling and faecal incontinence and increased resting anal canal pressure.

Lahti et al. [271] conducted a double-blind cross-over trial comparing loperamide plus fibre supplementation to loperamide with a low fibre placebo supplement in 63 patients. Both groups showed a significant improvement in faecal incontinence, but the addition of fibre to loperamide did not increase benefit.

Sze and Hobbs [151,269] investigated the additional benefit of loperamide over methylcellulose in an open controlled, study of 69 patients. Combination therapy "cured" 46% with a tendency towards constipation (which was modified by dose reduction).

Other Antidiarrhoeal Drugs

Santoro et al. [292] carried out an uncontrolled study of amitriptyline 20 mg at bedtime, in 18 patients with faecal incontinence of whom 3 reported improvement and 13 became constipated.

Sucralfate is a formulation of aluminium hydroxide used primarily for the treatment of peptic ulcers. A large randomised controlled trial showed no significant benefit for diarrhoea [135] and a worsening of faecal incontinence [138] in patients with radiotherapy-induced symptoms.

Bharucha and Fletcher [219] undertook a 4-week trial of clonidine showing a modest reduction of stool frequency and improvement of faecal incontinence.

Adrenoceptor Agonists

Phenylephrine gel, an alpha-1 adrenergic agonist, has been investigated for the treatment of passive faecal incontinence [178,179,181,293,294]. Two studies failed to show any benefit [178,179,181] and two others [178,179,293,294] suggested a modest benefit. The clinical utility of phenylephrine gel seems limited, and the topical preparation was associated with local discomfort. L-erythro methoxamine gel, an alpha-1 adrenoceptor agonist like phenylephrine, was shown to increase internal anal sphincter resting pressure [180,183].

Valproate Sodium

This gamma-amino butyric acid transaminase inhibitor increases anal canal resting pressure. It was compared to placebo in two randomised placebo-controlled studies of post-operative patients and found to improve rectal physiology and faecal incontinence [184,187].

Drug Treatment of Constipation-Associated Faecal Incontinence

Constipation-associated faecal incontinence, sometimes referred to as “overflow incontinence” [295]. It is more common in children, nursing home residents, and in patients with spinal cord injury. Chapter 11 deals specifically with faecal incontinence in the frail elderly where more detail can be found. No studies of treating constipation-associated faecal incontinence in community, independent-living adults with medications were found in 2012 or the current review.

2. WHAT IS NEW ABOUT MEDICATION TREATMENT IN THE CURRENT REVIEW?

Two studies on loperamide for faecal incontinence showed benefit of the drug alone or in combination with standard medical therapy or biofeedback. Judah et al. [284] undertook an open controlled study of biofeedback with loperamide and fibre supplementation in 57 patients. They showed that such combination therapy improved stool consistency and faecal incontinence. Markland et al. [272] conducted a randomised, double-blind, placebo-controlled cross-over trial comparing loperamide (followed by psyllium) and psyllium (followed by loperamide). Whilst both drugs

reduced faecal incontinence, loperamide was associated with greater frequency of constipation.

A recently developed opioid agonist, eluxadoline, has been shown to have antidiarrhoeal properties, and has been licensed for use in the irritable bowel syndrome in North America [296]. The drug acts on alpha-receptors (and to an extent also the beta-receptors) in the gut to improve stool consistency, reduce bowel frequency and faecal urgency [297]. Its potential use in faecal incontinence remains to be studied.

In a placebo-controlled clinical trial, a topical adrenoceptor agonist agent had no benefit over placebo in increasing sphincter pressure, and the study showed a strong placebo response by the subjects [298]. This underlines the vital importance of having placebo-controlled studies in this disease area where uncontrolled studies and case series can predominate.

Current Recommendations for Clinical Practice for Medication Treatment of Faecal Incontinence

- Loperamide is useful for diarrhoea-associated faecal incontinence. There is some evidence that the loperamide may be superior to diphenoxylate (Level of Evidence 2).
- Use of loperamide can be similarly effective to supplementation with psyllium fibre in reducing faecal incontinence (Level of Evidence 1).
- Sodium valproate may have a modest role in post-surgical faecal incontinence (Level of Evidence 3).

Current Recommendations for Research for Drug Treatment of Faecal Incontinence

- Well-designed studies are needed to validate the common clinical practice of using laxatives to treat constipation-associated faecal incontinence.
- There is a need for further research on preparations, doses and combination therapies for all types of faecal incontinence and all patient subgroups.
- There is need to develop new targets for potential topical treatment, informed by the negative data from recent studies.
- The vital importance of placebo-controlled studies is emphasized by the negative data on L-erythro methoxamine gel.
- Eluxadoline, a novel opioid agonist with low bioavailability, needs to be studied in patients with faecal incontinence.

Table 16-3. Effectiveness of Medication Treatment for Faecal Incontinence

Citation	Sample	Study Design	Major Findings	Adverse Events	Comments
Markland et al. 2015[272]	Double-blind, randomised, cross-over design 80 veterans with faecal incontinence or liquid or solid stool at least weekly for 3 months	Random assignment to Loperamide (2 mg) first then a supplement of psyllium fibre (3.4 mg) or psyllium first then loperamide for 4 weeks each with a 2-week washout and a 2-week non-equivalent baseline period Faecal incontinence frequency was reported daily on a diary for 7 days during each period	No significant difference in faecal incontinence between treatment groups. Within each treatment group, faecal incontinence frequency significantly decreased from baseline during the first treatment period for both treatments, but did not significantly change after the crossover to the other treatment.	Loperamide group had one adverse event, constipation and none in psyllium group	Use of a stool diary untested for validity and reliability, potential error due to subjects needing to prepare part of the supplement, possible unmeasured cross-over effects, non-equivalent baseline period, and attrition during the wash-out
Bharucha et al. 2014[219]	Double-blind, randomised, placebo-controlled, parallel-group study 44 women (age 18-75 years) with urge-predominant FI of 1 year or longer duration.	After a 4-week beeline (no drug) period, patients with ≥ 4 FI episodes/4 weeks were randomly assigned to clonidine (0.1 mg bid) or placebo. Symptoms, anal pressures, rectal compliance and sensation were assessed before and after therapy. Anal sphincter injury was evaluated by endoanalmagnetic resonance imaging.	Differences in faecal incontinence and anorectal functions between treatment groups were not significant. However, clonidine reduced the proportion of loose stools in patients with diarrhoea and reduced ($p=0.08$) the proportion of days with FI in patients with diarrhoea.	Adverse events were more common for clonidine (19 patients) than placebo (7 patients). Of individual side effects, dry mouth was more common after clonidine than placebo.	Further studies are necessary to evaluate effects of clonidine in patients with diarrhoea and FI.

Citation	Sample	Study Design	Major Findings	Adverse Events	Comments
Bharucha et al. 2010[299]	12 women with urge-predominant faecal incontinence and mixture of sphincter integrity. Outcomes: diary data, faecal incontinence symptom severity score, FIQoL, anorectal physiology	Open label, uncontrolled study of 4 weeks' clonidine via patch (0.2mg/day)	Clonidine reduced stool frequency and proportion of patients with >50% reduction of faecal incontinence episodes (9 of 12, 75%) and faecal incontinence days (8 of 12, 67%). No changes by manometry, but slight increased rectal capacitance with clonidine	6 (50%) had adverse effects. 5 (42%) had skin reaction, 3 (25%) fatigue, 2 (16%) postural hypotension and 2 (16%) dry mouth.	Unclear whether effects most marked in those with baseline looser stool
Size & Hobbs 2009[269]	59 patients and 10 controls (latter recruited if declined active treatment). Outcomes: overall improvement and Pescatori score at 8 weeks	Prospective unblinded controlled study of methyl-cellulose with or without loperamide	27 patients (46%) "cured" by intervention, equally whether solid or liquid stool incontinence	Constipation with loperamide, relieved by dose alteration.	40 of 59 used loperamide. Power calculation aimed to detect 46% difference in open study.
Remes-Troche et al. 2008[300,301]	21 patients with faecal incontinence treated with cholestyramine plus biofeedback and matched cohort of 21 with faecal incontinence who underwent biofeedback alone	Prospectively collected data which was retrospectively compared between groups. Median cholestyramine dose 4gm	Improved stool frequency and consistency with cholestyramine only, not biofeedback. faecal incontinence symptoms and global satisfaction similar in both groups. Physiological measures improved in both groups.	Side effects in 7 (33%), constipation 4 (19%), bloating (9%) and headache 1 (5%).	Poor palatability Side effects improved with dose reduction.
Lauti et al. 2008[271]	63 randomised (49 completed both phases of cross-over) consecutive referrals to specialist centre.	Double-blind randomised cross-over trial, each treatment was 6 weeks. Treatment A = low-residue diet sheet, placebo fibre and loperamide Treatment B = psyllium fibre, low and high residue diet sheet and loperamide.	FISI scores fell from baseline 31 to 18 for treatment A and 19 for treatment B. No differences between treatments in terms of FISI or FIQL.	Nil major adverse events – palatability of supplements caused 1 patient (3%) to withdraw	Marked inter-individual variation, hence importance of tailoring fibre to individual symptom profile.

Citation	Sample	Study Design	Major Findings	Adverse Events	Comments
Demirci et al. 2006[302]	Two stage study. Stage I: 287 tertiary referred patients. Multiple aetiologies (including transit disorders), mixed treatments based on consensus algorithm Stage II: 36 patients, mixed aetiology including transit disorders outcome measured at median of 2 months after treatment	Stage I: intention to assess proportion of patients suitable for medical treatment. Quantified by Pescatori scale. Stage II: uncontrolled trial of efficacy of medical therapy – unclear duration of treatment. Wexner score outcome	Stage I: 44% recommended drug treatment (anti-diarrhoeal, laxatives, enemas or antidepressants), 18% biofeedback and 35% surgery. Stage II: 22% “cured,” 39% improved, 39% unchanged (non-compliance 11%, untreatable transit issues 17%, faecal incontinence despite “normalising” transit 11%).	None reported	Low quality – time lapse of many years between stages, not clear algorithm applied prospectively in all subjects. Stage II – small numbers, no attrition rate details
Santoro et al. 2000[303]	18 patients and 24 controls (latter for anal physiology measurements)	Open study of 20 mg amitriptyline for 4 weeks	Faecal incontinence scores reduced from median 16 (maximum 18) pre-treatment to 3. Treatment reduced amplitude and frequency of rectal contractions and improved sphincter pressure.	Dry mouth or drowsiness in 4 patients (22%) Nil withdrew	Effects suggested to be mediated by anti-muscarinic slowing of transit, and improved anon-rectal coordination
Guillemot et al. 1995[304]	24 patients (16 biofeedback (BF) treated and 8 anti-diarrhoeal and enema treated), mixed aetiology. 12 controls. 30-month follow-up	Unblinded randomised clinical trial (RCT)	At 30 months, non-significant change in Wexner score in both BF-treated (17.8 to 14.4) and medical-treated (17.0 to 18.0) groups. More marked BF change at 6 months	Nil significant	Low quality study

XI. PELVIC FLOOR MUSCLE EXERCISES, BIOFEEDBACK, AND ELECTRICAL STIMULATION

1. BACKGROUND

Pelvic floor muscle training (PFMT), biofeedback (BF), electrical stimulation of the anal mucosa (ES), and tibial nerve electrical stimulation (TNS) are distinctly different therapeutic techniques for treating faecal incontinence; see descriptions below. However, they are discussed together in this section because many studies compare these techniques to each other while other studies test combinations of these techniques (e.g., BF combined with ES) (See Table 16-4).

1.1. Pelvic Floor Muscle Training

The patient is instructed to contract the pelvic floor muscles (usually maximally) including the external anal sphincter and puborectalis while keeping abdominal wall muscles relaxed and to do this multiple times each day with the goal of strengthening pelvic floor muscles. In a typical protocol the patient may be instructed to squeeze for 10 seconds while continuing to breathe deeply so that the abdominal wall muscles do not also contract. Ten to 20 such 10-sec squeezes are separated by 20 second periods of pelvic floor relaxation. Often patients are instructed to squeeze 10-20 times in a block and to repeat this block of exercises 3-5 times a day. The patient may be taught how to perform this exercise using only verbal or written instructions [305], or they may be given verbal feedback on their performance by the therapist during a digital rectal examination [306,307]. However, electronic or mechanical devices are not used to amplify the sensory information available to the patient to make them more aware of how well they are performing the exercises; this distinguishes PFMT alone from PFMT with BF.

1.2. Biofeedback

BF is distinguished from PFMT alone using electronic or mechanical devices to augment the intrinsic sensory information available to the patient on how well they are contracting and relaxing their pelvic floor muscles. The purpose of this type of training is to ensure that patients learn the appropriate way to selectively contract and relax the pelvic floor muscles while keeping abdominal wall muscles relaxed.

Another feature of many biofeedback training protocols is sensory training (rectal balloon training) or coordination training [308]. Because of neurological injuries, many patients lose the ability to recognize sensations associated with the movement of stool into the rectum and may fail to contract the pelvic floor muscles to avoid stool leakage. In sensory training, a balloon-tipped catheter is introduced into the rectum and distended with varying volumes of air to help the patient learn to recognize weaker distensions. Coordination training is a variant of sensory training and refers to having the patient practice contracting pelvic floor muscles in response to any sensation of rectal distention until this becomes a well-practiced habit [240].

A third type of BF training for faecal incontinence (in addition to strength training and sensory training) has recently been described and is referred to as urge resistance training [308]. This is intended for patients who experience intense sensations of urgency to defecate prior to stool leakage. These sensations may be associated with prolonged smooth muscle contractions of the rectum leading to reflex inhibition of the external anal sphincter and puborectalis muscles and rectal evacuation[309]. These smooth muscle contractions may be triggered by stress or anxiety [310] or by food ingestion [311]. Urge resistance training has the goal of desensitizing the patient to the sensation of rectal fullness or rectal contraction. This is accomplished by (1) teaching the patient to use deep breathing or another relaxation technique to counteract anxiety and (2) progressively inflating a balloon in the rectum to desensitise the patient to the sensation of rectal filling[312].

1.3. Electrical Stimulation

Electrical stimulation from probes placed in the anal canal as far up as the puborectalis muscle or from electrodes on the perineum adjacent to the anus has also been used to treat faecal incontinence. In typical applications, stimulation is performed daily at home using a battery operated electrical pulse generator connected to the anal electrodes [307]. Different theories have been advanced to account for how this might facilitate continence [307]. In the earliest applications, ES was used at intensities that triggered a contraction of the pelvic floor muscles, and patients were encouraged to try to augment the contractions produced by ES or to try to reproduce these contractions without electrical stimulation. Others have suggested that the stimulation of afferent nerves by lower intensities of ES may help by increasing the sprouting of synapses peripherally or the size of the receptive

fields for these nerves in the brain [313]. ES is sometimes combined with BF [314].

1.4. Tibial Nerve Stimulation

This is a form of ES in which surface electrode is placed on the skin over the tibial nerve on one ankle and referenced to another electrode on the ipsilateral foot (transcutaneous, TTNS) or a needle inserted beneath the skin close to the tibial nerve on one side and is referenced to an electrode on the ipsilateral foot (percutaneous, PTNS) [315]. Typical TTNS stimulation parameters are 200 microsecond pulses at a frequency of 10 Hz and current of up to 30 mA. Typical PTNS stimulation parameters are 200 microsecond pulses at a frequency of 10-20 Hz and up to 9 mA. In the 5th ICI, Chapter 17, the faecal incontinence Surgery Committee reviewed the evidence for tibial nerve stimulation available at that time and concluded: "Posterior tibial nerve stimulation is an investigational technique with few available data regarding efficacy and outcome."

Summary of Assessment of Biofeedback Therapy from the 5th ICI

In the last International Consultation on Incontinence the working committee concluded with a cautious endorsement of biofeedback: "Manometric biofeedback training is possibly effective" [but] "the variability between studies suggests that results may be dependent on the training and experience of the therapist." The evidence supporting this conclusion was based largely on a randomised clinical trial (RCT) by Heymen et al.[305] and an updated Cochrane review [316]. Other studies included in this review were judged to have significant limitations.

In the study by Heymen et al.,[305] patients with at least weekly solid or liquid faecal incontinence were randomized to either BF PFMT or PFMT alone for 6 sessions. However, before they began their investigational treatment, all patients were first provided with 4 weeks of conservative management consisting of patient education about the physiology of faecal incontinence and instructions in how to normalise stool consistency with fibre or non-prescription medication. Only patients who failed to report adequate relief from conservative management (79%) could continue and be randomised to receive BF PFMT or PFMT alone.

The primary assessment was at 6 months, corresponding to 3 months after the end of the 3-month treatment period. Patients who reported adequate relief at 3 months were followed up again at 12 months, whereas patients not reporting adequate relief at 3 months were assumed to be non-responders at 12

months. Patients treated with BF PFMT were significantly more likely than patients treated with PFMT alone to report adequate relief (76% vs. 41%). Continence (zero faecal incontinence episodes in the previous month) was achieved by 44% of biofeedback-treated patients compared to 21% of PFMT-only patients. Scores on the validated Fecal Incontinence Severity Index [17] also showed significantly greater improvement in the biofeedback patients compared to the PFMT-only patients at 3 months and again at 12 months' follow-up. Biofeedback-treated patients increased their anal canal squeeze pressures and decreased their abdominal wall tension significantly more than PFMT-only patients when squeezing to prevent stool leakage. This study showed that BF PFMT was superior to PFMT alone in patients with moderate to severe faecal incontinence. It also showed that treatment benefits for both biofeedback and PFMT were not explained by nonspecific effects of conservative treatment.

The updated Cochrane review [316] surveyed the literature until January 2012 and identified 21 studies for analysis. Unlike the previous Cochrane review [317], this one resulted in a qualified endorsement of biofeedback for the treatment of faecal incontinence: "We found some evidence that biofeedback and electrical stimulation may enhance the outcome of treatment compared to electrical stimulation alone or exercises alone...While there is a suggestion that some elements of biofeedback therapy and sphincter exercises may have a beneficial effect, this is not certain."

Summary of Assessment of Pelvic Floor Exercises from the 5th ICI

The 5th ICI concluded: "PFMT is possibly effective for the treatment of faecal incontinence." This conclusion was based on a study showing that PFMT was more effective than conservative management, although it was less effective than BF combined with PFMT [305].

Summary of Assessment of Electrical Stimulation of the Anal Mucosa or Perineum from the 5th ICI

In the previous ICI report [318] reviewers concluded: "There is no support for the addition of electrical stimulation from non-implanted devices" This conclusion was based on the lack of good quality RCTs during the period from 2008 to January 2012, and the absence of any Cochrane systematic review of the effects of ES from peripheral devices since 2007 [313]. By January 2012 it seemed evident to the reviewers that interest had shifted from peripheral ES of the rectum and anal canal to two new types of ES: stimula-

tion from wire electrodes surgically implanted alongside sacral nerves [319,320] or tibial nerve stimulation [321,322] In the 5th ICI these topics were reviewed by the surgery committee.

2. WHAT IS NEW IN THE CURRENT REVIEW?

Biofeedback Compared to Standard Conservative/ Medical Care

Two new RCTs followed a traditional design by comparing BF to standard conservative/medical care, defined as dietary counselling and use of anti-diarrhoeal drugs or laxatives to normalise stool consistency. Damon et al. [323] randomised patients to receive either standard medical care alone or standard medical care plus 20 sessions of BF, and found that significantly more of the BF-treated patients met the responder definition compared to the standard medical care only group. Sjødahl [284] used a crossover design in which patients were initially randomised to receive either standard medical care or 3 sessions of EMG BF in phase 1 and the combination of standard medical care and BF in phase 2. There was no evidence of differential effects in phase 1, but the combined treatment was associated with significant improvement compared to baseline. Since most patients had tried standard conservative/medical care prior to the study and the BF training was less than is usually employed in phase 1, this study may also be supporting the efficacy of BF.

The Pelvic Floor Disorders Network, which is a consortium of 8 academic surgical divisions supported by the National Institute for Child Health and Human Development, is conducting a multicentre trial of biofeedback and/or loperamide for the treatment of faecal incontinence. Results are not yet available, but the study design and methods have been published [324]. This study uses a factorial design which compares 4 groups: biofeedback plus loperamide, loperamide plus education (control for biofeedback), biofeedback plus placebo tablets, and patient education plus placebo tablets. A detailed protocol for conducting biofeedback training using new software which provides the therapist with prompts to help standardise the biofeedback intervention across sites as well as individualising biofeedback to the patient's specific deficits, has been published [312].

Electrical Stimulation

Two RCTs evaluated the efficacy of a triple therapy (3T) protocol in which medium frequency electrical stimulation (3000 Hz, 500 mV) plus EMG BF was compared to either EMG BF alone [300] or to low frequency ES (100 Hz, 50 mV) alone [325]. These two studies were published prior to 2012 but were inadvertently missed in the previous review. Triple ther-

apy is a complex protocol in which patients are directed to practice during two 20-minute sessions each day at home. In the morning session, they received EMG BF and alternately contracted their pelvic floor muscles voluntarily or stimulated contractions with medium frequency ES. In the afternoon session, they received EMG BF and were also provided with medium frequency ES contingent on a voluntary contraction that exceeded an individually determined threshold. The threshold required to trigger ES was progressively raised as performance improved to encourage stronger contractions. Triple therapy was provided by battery-operated devices at home. A minimum of 6 months of twice daily sessions was required to improve faecal incontinence.

A study by Schwandner et al. in 2010 [300] compared 3T to EMG BF alone and found that the 3T group improved significantly more than the group treated with EMG BF at 9 months but not at 3 months. However, this study had limitations: Some patients had only mild faecal incontinence and 15% were only incontinent for flatus. In addition, the drop-out rate was high: only 24% of the EMG BF-only group completed the 9-month trial and only 54% of the combined ES plus BF group completed the trial. However, these limitations do not explain the findings because the data were analysed by intention to treat.

A second study from this group of investigators [325] compared 3T to low frequency (100 Hz, 50 mV) ES, with both treatments provided twice a day for 20 minutes each for a total of 6 months. There were few drop-outs: 92% of the 3T group and 84% of the EMG BF group completed the 6-month trial. The 3T group showed significant improvement by 3 months whereas the low frequency ES group showed no change from baseline at 3 or 6 months. A limitation of this study was the lack of blinding.

Two other studies tested low frequency ES alone [326] or combined ES with BF [327]. The aim of the first study was to compare daily home ES to standard BF training in six weekly sessions provided in the clinic. There was no difference between these two treatments in overall improvements in faecal incontinence, although there was a significant decrease in faecal incontinence frequency from baseline to the end of treatment for the ES group. Home ES was less costly than BF provided in the clinic.

In the second study, ES was combined with BF but only in half of patients (28/62), and then only if, in the opinion of the investigators, ES was needed to "help the patient identify and contract their sphincter;" There was no difference in faecal incontinence severity or faecal incontinence quality of life between the BF/ES group and the dextranomer-injected group at the six month assessment.

Home Biofeedback Training

The efficacy of home-based BF, which allows for more frequent BF training and reduces the amount of

professional time required, was the focus of six studies. Two studies in which 3T was provided twice daily for 6-9 months were described above [300,325]; both supported the efficacy of 3T. Dehli et al.[327] compared intra-anal injections of a bulking agent to 6 months of twice-daily BF and found that both treatments improved faecal incontinence severity and quality of life with no significant difference between treatments. Damon et al.[323] compared 4 months of home-BF to standard medical care and reported that significantly more patients in the BF group were responders. Bartlett et al.[328] tested whether the addition of home BF to clinic BF improved outcomes compared to clinic BF alone: for the whole group, supplementation with home BF did not significantly improve outcomes, but a *post hoc* analysis showed that the youngest half of the patients (below the median age of 61) did benefit significantly more when clinic-based BF was augmented by home BF [240]. A study by Peirce et al. [329] compared daily home BF to daily PFMT for 3 months to determine whether either treatment could prevent faecal incontinence in women with a third-degree sphincter laceration sustained during childbirth. There was no evidence that home based biofeedback training prevented the development of faecal incontinence, but the study was underpowered to show a difference in incident faecal incontinence.

The six studies of home biofeedback described above suggest that home practice 1-2 times daily with a battery-operated BF device is more beneficial than either ES or BF in the clinic, or standard conservative/medical care. Home BF may also be less costly to provide. However, these studies also suggests that home BF has possible limitations: (1) longer periods of BF training may be required (at least 6 months according to one investigator); (2) on average, younger patients benefit more than older patients; and (3) daily practice is a burden which may increase the drop-out rate.

PFMT Studies

Daily pelvic floor muscle exercises are often combined with clinic-based BF [284]. Three studies published since 2012 evaluated PFMT as the primary treatment [329-331]. Glazener et al. [330] reported the long-term follow up of a study comparing PFMT to standard medical care. All 747 women included in this study had urinary incontinence 3 months after vaginal delivery, and 15.7% of them also reported faecal incontinence. PFMT had a significantly greater impact on faecal incontinence than standard medical care at 1 year follow up but not at 12 years. Limitations to this study are that comparisons at 12 years are confounded by some patients undergoing additional treatments, especially if they had an inadequate response to the initial treatment, and progression of underlying disease.

Pierce and colleagues [329] compared PFMT alone to PFMT supplemented by clinic based BF in 120

women with a third-degree sphincter laceration during vaginal delivery, to determine whether supplemental BF is more effective at preventing faecal incontinence. No differences were seen, but the study was underpowered to detect a difference in incident cases of faecal incontinence.

Lin et al. [331] tested whether PFMT and a pamphlet (recommendations for post-surgical care) were more effective than the pamphlet alone in reducing faecal incontinence following low anterior resection for cancer. PFMT was taught by a research assistant the day before discharge from the hospital, and appropriate performance of the exercises was confirmed by physical examination before discharge and at the first follow up visit. PFMT patients were provided with a DVD to remind them how to perform PFMT, and they were instructed to practice 20 squeezes 4 times each day. Cleveland Clinic Incontinence scores were significantly lower in the PFMT group compared to the no-exercise group at follow-up visits for months 1-6, but by 9 months' continence had improved in the no-exercise group to the same level as in the PFMT group. An unanswered question remains whether PFMT taught by digital palpation of pelvic floor muscles rather than by verbal or printed instructions, is as effective as BF augmented by PFMT, as some earlier studies suggested [229,306].

Table 16-4. New Evidence for the Efficacy of Biofeedback, Pelvic Floor Muscle Therapy, Electrical Stimulation, and Tibial Nerve Stimulation

First author, Year, Reference	Aims	Subjects	Study Design	Results	Comments
Sjodahl, 2014[284]	Compare 3 conditions: EMG BF (median of 3 visits in 4-6 months); medical treatment only (1 mg loperamide 2 g fibre for 2 months); and combined BF and medical treatment	64 females aged 18+ with at least 1 episode faecal incontinence in 2 weeks Excluded patients with any disease explanation for faecal incontinence but allowed those with sphincter tears Analysis limited to 57 who completed study	Crossover design: patients randomized to either BF or medical treatment in Phase 1; second treatment added in Phase 2 Anorectal manometry tested at baseline and after each treatment phase.	Faecal incontinence frequency did not differ between groups in Phase 1, but decreased significantly for both groups following combined treatment. Anal resting and squeeze pressures did not change significantly in either study phase.	Authors conclude that combined treatment was effective but neither BF nor medical treatment alone was effective. Study limitations: Number of BF sessions and loperamide dose are lower than most published studies. Study was not adequately powered.
Damon, 2014[323]	Compare BF to standard medical care	157 randomized but analysis was per protocol in 142 who did not drop out Trial duration was 4 months	Primary outcome was self-rating of improvement (-5 to 5). Secondary measures were diary, questionnaires, & manometry.	Significantly more BF patients met success criterion (defined as >3 on -5 to 5 scale) at 4 months.	This study supports the efficacy of home-based BF training. Study Limitations: data analysis in completers only (there were more drop-outs in the BF condition), and lack of long-term follow-up. A strength was that standard care followed French national guidelines and BF training protocol was developed by consensus of physical therapists.

First author, Year, Reference	Aims	Subjects	Study Design	Results	Comments
Dehli, 2013[327]	Compare biofeedback to dextranomer injection	126 adults with faecal incontinence, minimum severity of 4 on St Mark's scale. Patients with any prior treatment for faecal incontinence were excluded.	BF was performed 5 days/wk for 6 mo at home using a portable device. BF patients met with PT 5-6 times and 28/62 received supplemental ES. Anal injection of 4 ml bulking agent was repeated in 21/64 at 3 mo.	Primary assessment at 6 mo showed significant improvement in both groups but no between-group difference. Also, no difference at 24 mo. QOL also showed no between-group difference. More adverse events seen in anal injection group, but most could be prevented by antibiotic prophylaxis.	Well designed, adequately powered study showed nodifference between BF and dextranomer injection in moderately severe, treatment naïve patients. Study limitation: no minimum severity requirement for eligibility except St. Mark's score >3.
Bartlett, 2015[328]	(1) Assess accept-ability of home biofeedback (BF); (2) compare clinic home BF to clinic-only BF	75 faecal incontinence patients aged 18-80, average of 61 years	Unblinded, parallel group study of 6 wks duration All patients had 4 BF sessions in the clinic, but the home BF group practiced daily with a BF device while standard group practiced using PFMT instructions.	Supplementing BF with home practice had no overall effect but post hoc analysis found that patients younger than 61 yrs improved more when treated with home BF than with clinic-only BF; home BF was acceptable to most patients.	Daily home practice with a BF device improves faecal incontinence and QOL more than standard BF with PFMT practice at home. Study limitations: Only 4 sessions of BF in clinic, which may be insufficient.
Peirce, 2013[329]	Compare home BF to PFMT for prevention of faecal incontinence in women with 3rd degree obstetric tears.	120 women with 3rd degree tears were randomized to begin EMG BF (n=30) or PFMT (n=90) prior to discharge.	All were assessed 3 months later. BF and PMTF were taught in hospital before discharge. Both groups were told to practice twice daily.	There were no between-group differences in Cleveland Clinic Continence Scores, QOL, anal canal resting or squeeze pressures.	This study shows no added value for home BF compared to PFMT. It is unclear whether either helps to prevent postpartum faecal incontinence in women with obstetrical tears.

First author, Year, Reference	Aims	Subjects	Study Design	Results	Comments
Cohen-Zubary, 2015[326]	Compare daily electrical stimulation (ES) at home to weekly BF in the clinic on continence scores and cost.	Analysis limited to 18 in each group who completed the protocol. Eligibility required normal colonoscopy, normal ultrasound, no diabetes or other severe comorbidity.	BF was 6 weekly 30-45 min sessions for strength and sensory factors, supplemented by home PFE. ES was 25 min twice daily for 6 weeks with no clinic training.	No significant differences between groups. ES improved faecal incontinence from baseline to end of treatment but BF did not. Costs were lower for ES than BF.	Authors argue that ES is at least as effective as BF, and it is less costly and more widely available.
Schwandner, 2011[325]	Triple Therapy (3T) compared to low frequency ES	80 patients with faecal incontinence of any severity including gas only	Two 20-min sessions per day for 6 mos. For 3T group, morning BF session included alternating between ES and voluntary contraction. Afternoon session involved medium frequency ES triggered by voluntary contractions above a threshold determined by ability. Control group received low frequency ES in both sessions each day.	Cleveland Clinic scores improved more in 3T than in low frequency ES at 3 and 6 mos. QOL was also significantly better in 3T group. 54% of 3T group were continent at 6 mos vs. none in the low frequency ES group. The attrition rate was low in this trial (8% in the 3T group vs. 15% in the low frequency ES group).	3T was superior to low frequency ES and was better tolerated. Limitation: Trial could not be blinded, and 6 mos of twice daily practice may be more than most patients will tolerate.
Schwandner, 2010[300]	9 mos of twice daily ES combined with EMG BF (3T) compared to EMG BF only	158 patients from 8 sites were enrolled. Severity varied from loss of flatus only to solid or liquid stool loss.	For 3T protocol, see above. Control group received only EMG BF in morning and afternoon.	3T group improved significantly more than BF only group (8 points vs. 3 points) improvement on Cleveland Clinic scale from baseline to 9 months. More subjects dropped out in the BF only group. Significant differences between groups did not emerge until 6 mos of twice daily therapy. Dropout rate was higher in BF only group.	Data show 3T is superior to EMG BF only, but the high burden of undergoing training twice daily for at least 6 mos may be a limitation.

First author, Year, Reference	Aims	Subjects	Study Design	Results	Comments
Leroi, 2012[332]	Compare TTNS to sham ES	144 patients with faecal incontinence >1/week and no response to conservative treatment were recruited from 9 centres in France.	Multisite RCT Patients used battery operated stimulator twice daily at home for 3 mo. Electrodes were on calf and ankle in both active and sham groups. No current was used for sham group. Primary outcomes were frequency of faecal incontinence and urgency/week. QOL and time to defer defaecation was also measured.	No significant differences between groups on any outcome. Active TTNS tended to show greater decreases in frequency of faecal incontinence and urgency, but differences were not significant.	TTNS showed no evidence of efficacy in this large RCT.
George, 2013[333]	Comparison of PTNS, TTNS, and sham TTMS in parallel groups	30 patients with ≥ 2 /week episodes of faecal incontinence were randomly assigned to 3 groups.	RCT conducted at one centre. 12 treatment sessions scheduled 2/week for 6 weeks. Primary outcome was >50% reduction in Faecal incontinence frequency.	PTNS but not TTNS patients improved significantly more than sham group on number with $\geq 50\%$ decrease in faecal incontinence, number of faecal incontinence episodes per week, and ability to defer defaecation. No differences in QOL or St Mark's scale.	Underpowered study which nevertheless suggests PTNS is superior to TTNS and sham.
Knowles, 2015[334]	Comparison of PTNS to sham ES	Inclusion based on "faecal incontinence sufficiently severe to warrant intervention as recommended by PI" at each of 17 sites and failure to respond to conservative treatment. 227 women were randomized.	RCT comparing 12 sessions of PTNS to 12 sessions of sham (ES between 2 electrodes on one foot). Responder was defined by $\geq 50\%$ decrease in faecal incontinence frequency on diary.	Responder rates were no different (38% for PTNS, 31% for sham, N.S.). However, faecal incontinence frequency decreased significantly more in PTNS group, especially in patients with urge-related faecal incontinence.	This RCT fails to support the efficacy of PTNS, but the differences seen in secondary outcomes make it unclear whether PTNS may have a specific benefit for urge faecal incontinence. Further research is needed.

First author, Year, Reference	Aims	Subjects	Study Design	Results	Comments
Thin, 2015[335]	Pilot study aimed to estimate effect sizes for SNS vs. PTNS as well as acceptability of these treatments to patients	Faecal incontinence patients meeting NICE criteria for SNS and PTNS were randomized: 23 to SNS and 17 to PTNS (unbalanced to allow for failure of trial stimulation in 25%). Qualitative interviews were done in 5 patients from each group.	SNS and PTNS followed standard protocols. 15 30-min PTNS sessions over 5 months Assessed at baseline, 3, and 6 months after end of treatment Within group effect sizes were estimated but between-group differences were not tested.	19 patients underwent temporary SNS and 15 had permanent implants. 16 received all 15 PTNS sessions. At 6 months, ITT analysis showed 61% of SNS and 40% of PTNS patients had $\geq 50\%$ reduction in faecal incontinence. Significance of between group differences were not tested.	Both SNS and PTNS significantly improved faecal incontinence. Effect sizes tended to be larger in SNS, but a definitive RCT comparing SNS to PTNS would require a sample size that is not feasible. Both treatments were acceptable to patients but some preferred one over the other.
Glazener, 2014[330]	Assess 12 year FU of study comparing brief PFMT to standard care for UI and faecal Incontinence	747 women with UI 3 months after vaginal delivery. 15.7% also reported faecal incontinence at study initiation.	Nurses taught PFMT in 3 home visits 5, 7, and 9 months after delivery. Controls received standard medical care. FU was at 1, 6, and 12 years.	Faecal incontinence rate was significantly lower after PFMT at 1 year (4% vs. 11%, $p = .01$), but not at 12 years (19% vs. 15%, $p = .22$). 52% were still using PFMT after 12 years.	Benefits of PFMT at 12 mos were not evident 12 years later. Study limitations: 12-year follow up is of questionable relevance. Faecal incontinence increases with age, and in 12 years women may try other treatments.
Peirce, 2013[329]	Compare home BF to PFMT for prevention of faecal incontinence in women with 3rd degree obstetric tears	120 women with 3rd degree tears were randomized to begin EMG BF (n=30) or PFMT (n=90) prior to discharge.	All were assessed 3 months later. BF and PMTF were taught in hospital before discharge. Both groups were told to practice twice daily.	There were no between-group differences in Cleveland Clinic Continence Scores, QOL, anal canal resting or squeeze pressures.	This study shows no added value for home BF compared to PFMT. It is unclear whether either helps to prevent postpartum faecal incontinence in women with obstetrical tears.

First author, Year, Reference	Aims	Subjects	Study Design	Results	Comments
Lin, 2016[331]	(1) Test whether faecal incontinence improves with time following LARS for rectal cancer; (2) determine whether PFMT augments improvement	60 patients in Taiwan with rectal cancer were randomised to PFMT instructional DVD pamphlet or pamphlet alone.	PFMT taught just before hospital discharge. Weekly phone calls for first month in both groups. FU at 1, 3, 6, and 9 months	Faecal incontinence severity (CCI scale) decreased over time and was significantly less in PFMT group vs. controls at 1, 3, and 6 months FU. No difference at 9 months	Persuasive evidence that brief PFMT training supplemented by pamphlet and DVD accelerates improvement in faecal incontinence following LARS procedure.
Laforest, 2012[336]	Test whether BF improves functional outcomes more than PFMT following laparoscopic rectal resection for cancer	22 patients undergoing total mesorectal excision for rectal cancer was provided BF 3 mo after surgery. Matched controls were selected from a registry.	Cohort study. BF group received 15 weekly sessions. PFMT group received one session of training. Assessed 8-46 mo after surgery.	No differences in faecal incontinence severity but BF group reported less dyschezia and greater improvement in QOL.	Authors conclude BF conferred a benefit in functional outcomes and QOL over PFMT alone. Study limitations: Cohort design does not match groups for time and attention. PFMT group may have had lower expectations because they were not study participants.

2.1. Systematic Reviews and Meta-Analyses

Table 16-5 lists the systematic reviews and guidelines documents published since January 2012 that addressed the use of BF, ES, TNS, and PFMT for the treatment of faecal incontinence [314-316, 337-339]. The Cochrane review [316] published in 2012 provided qualified evidence for the efficacy of biofeedback as summarised in its conclusion: "While there is a suggestion that some elements of biofeedback therapy and sphincter exercises may have a therapeutic effect, this is not certain. Larger well-designed trials are needed to enable safe conclusions." The other reviews and guidelines documents that addressed BF (Table 16-5) were consistent in recommending it, alone or in combination with PFMT or ES, for the treatment of faecal incontinence.

2.2. Tibial Nerve Stimulation

A variant of ES is to stimulate through electrodes attached to the skin overlying the tibial nerve of one ankle (transcutaneous stimulation, abbreviated TTNS) or to stimulate through a needle inserted through the skin and into the region of the tibial nerve (percutaneous stimulation, abbreviated PTNS). A systematic review of tibial nerve stimulation published in 2014 [315] reviewed two RCTs of TNS and PTNS [332,333] published up to 2013 and multiple uncontrolled studies of both percutaneous and transcutaneous TNS. This review concluded that transcutaneous TNS was not superior to sham electrical stimulation and that no adequate RCT of percutaneous TNS was available by 2013.

A pilot study published by Thin et al. in 2015 [335] compared sacral nerve stimulation to PTNS and found support for the efficacy of PTNS. Subsequently a rigorous RCT of PTNS was reported by the same group [334]. They randomised 227 patients with faecal incontinence from 17 clinical sites to receive 12 weekly sessions of percutaneous PTNS or sham PTNS. There were no significant differences in the primary outcome measure, which was the proportion achieving at least a 50% reduction in faecal incontinence episodes (38% in PTNS, 31% in sham). However, some of the secondary outcomes showed differences: The average number of faecal incontinence episodes decreased significantly more in the PTNS group than in the sham group, and this was found to be due to a greater reduction in urgency-related faecal incontinence episodes but not in the number of passive faecal incontinence episodes. Thus, this well conducted study failed to show a significant benefit of PTNS on the a priori selected primary outcome measure, but it leaves doubt about whether PTNS may be an effective treatment for urgency-related faecal incontinence. Further research is needed in groups stratified at the outset between urgency and passive faecal incontinence

Table 16-5. New Systematic Reviews of the Efficacy of Biofeedback, PFMT, Electrical Stimulation, and Tibial Nerve Stimulation

First Author, Year, Reference	Aims/Scope	Analysis Sample	Conclusions Level of Evidence	Comments
Norton, 2012 (Update of Cochrane 2003)[316]	Determine effects of biofeedback (BF) and/or pelvic floor exercises (PFMT) in adults	1525 subjects in 21 studies	"While there is a suggestion that some elements of BF and sphincter exercises may have a therapeutic effect, this is not certain. Larger well-designed trials are needed to enable safe conclusions."	Treatment protocols, outcome measures, and training of providers varied across trials. Risk of bias was judged to be low in 13/21 trials.
Rao, 2015[337]	Define indications, training protocols, and efficacy of BF	731 patients (11% males) in 8 studies	BF is recommended for short-term & long-term treatment of faecal incontinence; Level II recommendation; Grade B evidence.	Treatment protocols, outcome measures, and training of providers varied across trials. Risk of bias was not assessed.
Berghmans, 2015[340]	Assess efficacy of BF alone or combined with PFE or ES	Not described 13 RCTs and Norton's Cochrane review are cited in the narrative summary.	BF PFE appears to be more effective than PFE alone, and BF ES appears to be more effective than ES alone. Level 3 evidence	
Vonthein, 2013[314]	Assess efficacy of BF, ES, and/or BF ES	13 studies met criteria. Primary outcome was remission of faecal incontinence.	BF was superior to all control groups but ES was not. BF ES was superior to BF alone or ES alone. BF ES is recommended as second line treatment for faecal incontinence.	Only 3/13 trials met all quality criteria and 2/3 were by one of the authors, suggesting possible bias. 4 other studies rated as being of moderate quality. Type of ES was important: amplitude modulated medium frequency ES was superior to low frequency ES.
Rao S, Am College of Gastroenterology Practice Parameters Committee, 2014[338]	Assess efficacy of BF for faecal Incontinence in adults Broader goals of review were evaluation of reliability of diagnosis and efficacy of treatment for all benign anorectal disorders	Not described	Pelvic floor rehabilitation with BF and PFE is superior to PFE alone in patients with faecal incontinence who do not respond to conservative measures.	

First Author, Year, Reference	Aims/Scope	Analysis Sample	Conclusions Level of Evidence	Comments
Visser, 2014[339]	Assess efficacy of BF for faecal incontinence secondary to low anterior resection for rectal cancer (LARS)	321 patients in 5 studies	Pelvic floor rehabilitation with BF and/or PFE improves functional outcomes after low anterior resection for cancer.	Quality of these studies was rated as low.
Horrocks, 2014[315]	Assess efficacy of percutaneous and transcutaneous PTNS	375 patients in 12 studies, including 2 RCTs which had good quality Ratings Review predates large RCT of PTNS	TTNS was no better than sham in large RCT. However, in a second RCT comparing PTNS to TTNS and sham TTNS, PTNS was significantly more effective than TTNS, which was significantly more effective than sham ES.	RCT comparing PTNS to TTNS and sham was underpowered with 10 patients per arm.

3. SUMMARY OF CURRENT EVIDENCE FOR PELVIC FLOOR MUSCLE EXERCISES, BIOFEEDBACK, AND ELECTRICAL STIMULATION

New studies [284,323] (Table 16-4) and new systematic reviews (Table 16-5) support the hypothesis that biofeedback augmented by PFMT, when provided by an experienced therapist, is more effective than PFMT alone, but the variability between studies suggests that results may be dependent on the training and experience of the therapist (Level of Evidence 1).

- PFMT is possibly effective for the treatment of faecal incontinence. Studies comparing PFMT alone to BF augmented by PFMT and ES have shown mixed results, and the optimal protocol for teaching PFMT has not been standardised, limiting the generalisability of findings (Level of Evidence 2).
- Home practice of BF and/or ES using battery-operated portable devices, appears to improve treatment outcomes when compared to clinic-based treatment. Younger patients may benefit more from home practice than older patients, and it may take up to 6 months to see benefits from home practice (Level of Evidence 2).

Mixed results from two studies continue to suggest that low frequency ES is weakly effective or not effective when used alone [326] or in combination with BF [327]. However, two studies from a single group suggest that the Triple Therapy protocol involving electrical stimulation at a frequency of 3000 Hz combined with BF, when practiced twice daily for at least 6 months, may be more effective than biofeedback alone [300] or low frequency (100 Hz) electrical stimulation alone [325]. This represents a significant change from the recommendation in our previous review (the 5th ICI) that ES is not effective (Level of Evidence 2).

Percutaneous electrical stimulation of the tibial nerve is a possibly effective approach to the treatment of faecal incontinence. An underpowered RCT suggests that PTNS is more effective than sham stimulation [333], and a second adequately powered RCT [334] shows mixed results (not significant for the primary endpoint but significant for frequency of faecal incontinence episodes preceded by urge) (Level of Evidence 2).

Current Recommendations for Clinical Practice for Pelvic Floor Muscle Exercises, Biofeedback, and Electrical Stimulation

- PFM exercises are recommended as an early intervention in the treatment of faecal incontinence

as part of a conservative management bundle of interventions, based upon low cost, low morbidity, and at least weak evidence of efficacy (Recommendation Grade B).

Biofeedback, which is usually combined with PFMT and sensory training with a rectal balloon, is recommended as second line treatment for faecal incontinence after other behavioural and conservative/medical management have been tried and have failed to provide adequate symptom relief. (Recommendation Grade A).

Biofeedback training may employ either pressure sensors or electromyographic (EMG) electrodes to provide feedback on pelvic floor muscle contractions [341]. In some countries (for example, the United States), biofeedback treatment is limited by the fact that few adequately trained therapists are available

- Home biofeedback using portable battery-operated device is recommended as an adjunct to biofeedback training in the clinic, especially for younger patients (Recommendation Grade B).
- Based on currently available evidence it is not possible to recommend low frequency (i.e., 100 Hz) electrical stimulation for faecal incontinence. The Triple Therapy protocol for combining biofeedback with 3000 Hz electrical stimulation appears to be effective, but this recommendation is tentative pending confirmation of the findings by other research groups (Recommendation Grade B).
- Percutaneous tibial nerve stimulation remains an investigational treatment protocol which cannot currently be recommended for clinical practice (Recommendation Grade B).

Current Recommendations for Research for Biofeedback, Pelvic Floor Muscle Therapy, Electrical Stimulation, and Tibial Nerve Stimulation

- There is a need to conduct further RCTs to determine which specific biofeedback protocols alter physiological parameters of anorectal function with concomitant changes in bowel control. These studies should address:
 - Clear description of modalities and evaluation of different components of BF
 - Long term follow up
 - Adherence monitoring
 - Standardisation of outcome measures
 - Exploration of possible synergies between urinary and faecal incontinence interventions and diagnostic evaluations
- Standardisation of protocols for teaching PFMT are needed.

- Pelvic floor rehabilitation, as practiced by physical therapists for the treatment of faecal incontinence, is not adequately described in the medical literature. Can this be standardized and manualized so that it can be compared to biofeedback and to the PFMT protocols described in the literature?
- Compare the effectiveness of PFMT taught by verbal or printed instructions (as is commonly done) to PFMT taught during digital rectal examination. Standardise techniques for teaching PFMT via digital rectal examination.
- RCTs are needed of the Triple Therapy protocol or other ways of combining electrical stimulation with biofeedback.
- Investigate different modalities of ES, specifically distinguishing high frequency stimulation (e.g., 3000 Hz) from low frequency (e.g., 100 Hz) stimulation.
- Investigate ways to shorten the amount of training required to see benefits for faecal incontinence.
- Percutaneous tibial nerve stimulation requires additional randomised controlled trials, specifically addressing:
 - Whether urgency associated faecal incontinence is more responsive to treatment than passive faecal incontinence and why this might be the case
 - Patient characteristics and physiological mechanisms associated with successful PTNS
 - Biofeedback

XII. QUALITATIVE RESEARCH ON THE EXPERIENCE OF FAECAL INCONTINENCE AND QUALITY OF LIFE

The experience of faecal incontinence and its impact on quality of life, which was studied from a qualitative perspective since 1999, was included for the first time in the 5th ICI review (Table 16-6). Qualitative research studies provide a perspective of patients' experiences and their practical knowledge about how they live and try to manage their faecal incontinence. These studies also reveal a personal viewpoint of the meaning of quality of life to patients' experiencing the distressing symptom of faecal incontinence. Additionally, qualitative studies provide insight into living with and managing the physical, psychological, and social effects of faecal incontinence and what constitutes acceptable treatment techniques.

Qualitative methods such as ethnography, grounded theory and phenomenology provide "understanding", that is the aim of qualitative research. These methods are primarily applicable to similar contexts. Included below is a qualitative evidence pyramid and accompanying criteria that parallel the evidence pyramid for ranking quantitative evidence only. The qualitative evidence pyramid provides a novel strategy for ranking qualitative evidence for practice recommendations.

Criteria for Evaluation

Given that qualitative research employs different methodologies than quantitative research, a relevant evaluation framework for decisions on levels of evidence was developed for the 5th ICI review. This framework was informed by the most significant literature on quality and rigor in qualitative research, and is described below again in this update [342-351]. These criteria were used to critique studies, note strengths and limitations, and assign an evidence level.

The Type of Study: The Qualitative Evidence Pyramid

1. Qualitative meta-synthesis, meta-ethnography, meta-analysis
2. Interpretive designs including phenomenology, grounded theory, ethnography
3. Descriptive qualitative designs using content analysis (including inductive and deductive content analysis approaches, analysis of focus group data, photovoice, participatory action research, single or multiple case studies)
4. Surveys with semi-structured open-ended questions

1. CRITERIA FOR EVALUATION OF QUALITATIVE STUDIES

1. There is a clear research purpose or questions that are appropriate for qualitative inquiry.
2. The purpose or questions are directly related to the review of the literature and the literature identifies a gap or new understanding of the phenomenon.
3. There is a guiding framework for the study that fits the phenomenon being studied.
4. The method and the research purpose are related.
5. The sampling plan is purposeful and exemplifies the purpose and method that is being studied.

6. The sample size is appropriate for the sampling strategy.
7. Inclusion and exclusion criteria are described and appropriate.
8. Data collection strategies are appropriate for the purpose, method and sample.
9. The analysis plan fits the method.
10. Data are adequately analysed and interpreted, and reported so that meaning is recognised. The interpretation or description is distinguishable from the raw data.
11. The participants' voices are perceptible and demonstrate the meaning of the categorical, thematic or conceptual findings.
12. The findings (categories, themes and concepts) are well developed and organised to support each other.
13. The results offer a new understanding of the phenomenon and are transferrable to similar contexts.
14. Reflexivity is addressed.
15. Evidence of an audit trail of how key decisions were made is clear. Strategies to achieve rigour are described.
16. Study specific limitations are summarised.
17. Ethical considerations are described.

2. WHAT IS NEW IN THE CURRENT REVIEW?

In this review, numerical levels of evidence related to the quality of studies have been created in addition to the articulation of the grades of recommendations for the practice recommendations.

Because of the length of recommendations for practice from qualitative studies in ICI5, new practice recommendations in this section are made *in addition* to those from ICI5. Previous recommendations for practice are still supported.

3. LEVELS OF EVIDENCE FOR QUALITATIVE STUDIES

- **Level 1:** Study includes all criteria marked in bold above. Level 1 studies are typically ones listed as types 1-2 above (qualitative evidence pyramid).
- **Level 2:** Study includes all the criteria marked in bold and italic above. Level 2 studies are ones listed as types 3-4 above.

- **Level 3:** Study does not include most the criteria above for evaluation.

4. GRADES OF RECOMMENDATION FOR QUALITATIVE STUDIES

- **Grade A** recommendation: Excellent evidence leads to a practice recommendation. A Grade A recommendation is based on Level 1 studies.
- **Grade B** recommendation: Moderate evidence leads to a possible practice recommendation (more evidence is needed). Grade B recommendation is based on a combination of level 1 and 2 studies or only level 2 studies.
- **Grade C** recommendation: Poor evidence from level 3 studies that does not lead to a practice recommendation.

5. THE EXPERIENCE OF FAECAL INCONTINENCE AND QUALITY OF LIFE

5.1. Review of Studies from the 5th ICI

Thirteen studies were included in the 5th ICI and an additional five papers detailing three studies were located for this update (See Table 16-6). As higher quality evidence had been recently published, Level 3 studies from the 5th ICI were also excluded. The included studies explored topics on the experience of faecal incontinence from multiple perspectives of men and women in relation to: colorectal cancer; sexuality; quality of life; pelvic floor dysfunctions; aging and frailty; diet strategies; goals of faecal incontinence management; post-natal onset; spina bifida; and inflammatory bowel disease (IBD). Refer to Table 16-6 for summary and quality appraisal of the studies from the 5th ICI review and the new additions.

The included studies used varied qualitative methods to explore the experiences of quality of life. A thematic analysis was completed on the content of the studies. The philosophical framework of life worlds or overlapping realms of experience was employed to organise the findings in the following themes: relationships; time and planning; bodily symptoms, self-esteem and body image; sexuality; and dietary issues [352]. These themes remained consistent with the additional support of the newly included studies, which are referenced below in the descriptions of the themes.

6. LIVING WITH FAECAL INCONTINENCE RELATED TO RELATIONSHIPS

6.1. Summary of Evidence from the 5th ICI

Men and women found that faecal incontinence was a perceived threat to their social acceptability, privacy and relationships [221,223,353-355] (Level of Evidence 2).

Who to tell about the faecal incontinence problem and when was a matter of great concern. Family, close trusted friends or co-workers were told because the secret could not be completely concealed [221,223,354] (Level of Evidence 2).

Discussing problems with others who experienced faecal incontinence was comforting and allowed conversation about how to manage the problem [221,223] (Level of Evidence 1).

Humour was used as a resource to avoid humiliation and embarrassment in dealing with daily symptoms of faecal incontinence and relationships, even though feelings of shame and humiliation persisted [23,221,223,344,355] (Level of Evidence 2).

Men and women felt discomfort in being with 'mixed company' and having a possible accident. Gender was an issue in relation to perceived social risk [221,223] (Level of Evidence 1).

Men and women described trying to protect themselves from the unpredictability of their symptoms and kept up a façade to keep the secret of faecal incontinence from others [23,348] (Level of Evidence 2).

Support from spouses was noted to be very important for men and women [221,223,354,356] (Level of Evidence 2).

Relationships with healthcare providers were not helpful in providing advice concerning symptom management and control. Misinformation or no information was commonly given [23,221,223,345,354,357] (Level of Evidence 2).

Women felt embarrassed, humiliated and marginalized when their faecal incontinence problem was minimized or trivialized by rude or blaming health care providers [23,221,355,356] (Level of Evidence 2).

Women had concerns about entering new relationships due to their fear and shame of having to disclose faecal incontinence [23] (Level of Evidence 2).

Anxiety was present in both men and women who suffered from social isolation because of faecal incontinence [23,222,223,344,345,354,356,358] (Level of Evidence 2).

6.2. Recommendations for Practice from the 5th ICI

- Acknowledge the problem of faecal incontinence compassionately and initiate the assessment and discussion of faecal incontinence symptoms as stigma, embarrassment and sensitivity associated with faecal incontinence may impede communication and provision of therapeutic advice [221,223,355,357] (Recommendation Grade B).
- Recognize and eliminate dismissive or blaming responses as they retard future care-seeking and contribute to patient distress and under-reporting of faecal incontinence [221,223,355,357] (Recommendation Grade B).
- Facilitate gender sensitive support groups to share practical knowledge of faecal incontinence symptom management [221,223] (Recommendation Grade B).

6.3. What Is New in the Current Review?

Women reported that faecal incontinence is a sensitive topic to discuss with others and is strongly associated with the emotions of guilt and shame [355] (Level of Evidence 2).

Women did not attend social events and made excuses not related to faecal incontinence [355] (Level of Evidence 2).

Men and women attributed their adaptation to faecal incontinence to loving, empathic, unconditional support from significant others [359] (Level of Evidence 2).

After years of dealing with faecal incontinence men and women's interactions with health care providers had become confident, assertive control-seeking in decision-making [360] (Level of Evidence 2).

After years of living with faecal incontinence men and women felt they could provide support to others with faecal incontinence [359,360] (Level of Evidence 2).

Additional Recommendations

- Health care providers can assist adaptation to faecal incontinence by being aware of clinical interventions to improve symptoms [360] (Recommendation Grade B).
- Also See Section XII-Qualitative Research on the Experience of Faecal Incontinence and Quality of Life-Recommendations for Practice for Living with Faecal Incontinence Related to Relationships from the 5th ICI.

Current Recommendations for Research

- Investigation of the use of humour as a therapeutic coping strategy for dealing with the symptoms of faecal incontinence [221].
- Exploration of attitudes and treatment goals of health professionals treating faecal incontinence to identify barriers to effective treatment[223].
- Implementation and evaluation of gender sensitive support groups to facilitate sharing of practical management strategies for faecal incontinence symptom management[223].
- Investigation of role-modelling effectiveness in adapting to faecal incontinence [360]
- Investigation into living with faecal incontinence long-term[360]

7. LIVING WITH FAECAL INCONTINENCE RELATED TO TIME AND PLANNING

7.1. Summary of Evidence from the 5th ICI

Participants described spending a significant amount of time planning for and worrying about accidents [221,223,355] (Level of Evidence 2).

Men and women perceived their symptoms of faecal incontinence grew worse with aging in relationship to severity, onset and duration [221,223] (Level of Evidence 1).

Men and women had symptoms for months or years before seeking help for the condition [221,223] (Level of Evidence 1).

Women reported the frequency of stool leakage was unpredictable and because of this they needed to be vigilant and prepared for the unexpected [23,221] (Level of Evidence 2).

“Being prepared” was a common theme. Planning and management strategies to avoid an accident included: morning bathroom rituals, changing the location of their workstation (relative to the bathroom), altering eating habits (foods and timing), taking a fibre supplement, or using anti-diarrhoeal products [23,221,223,345,354,355,357] (Level of Evidence 2).

Many women discussed packing ‘kits’ of absorbent products, cleansing supplies and extra clothing as a routine part of planning to leave their home [221,354] (Level of Evidence 2).

Women postponed business meetings because of faecal incontinence [221] (Level of Evidence 1).

Space was experienced as a measure of risk exposure of faecal incontinence and personal space shrank inward or expanded related to perceived comfort or lack of perceived social safety

[221,223,344,345,350,353,354,357,358] (Level of Evidence 2).

Seeking out the location and availability of a bathroom was major consideration in all dimensions of space outside the home [23,221,223,344,345,350,354,355,357,361] (Level of Evidence 2).

Travel was limited to familiar spaces and significant planning was required to prevent an accident. faecal incontinence limited travel for the family [221,223,344,355-357] (Level of Evidence 2).

Women and men experienced heightened anxiety about faecal incontinence symptoms and the risk of accidents in public spaces [221,345,350,354,357] (Level of Evidence 2).

Work life presented complicated situations for both men and women and limited some people’s ability to engage in productive work outside the home [221,223,357,358,361] (Level of Evidence 2).

Symptoms related to faecal incontinence were a common reason for early retirement for both men and women [221,223,358] (Level of Evidence 2).

7.2. Recommendations for Practice from the 5th ICI

- Share practical management strategies, such as preparing cleansing kits and locating public restrooms, etc., with clients with faecal incontinence to help them understand and manage their experiences [221,223] (Recommendation Grade A).
- Promote self-efficacy by coaching clients on how to plan for and prevent unpredictable accidents and teaching strategies to go out confidently (such as, education on product, packing a change of clothes, disposable wipes, etc.) [221,223] (Recommendation Grade A).

7.3. What Is New in the Current Review?

Clients with IBS and faecal incontinence had significant worry that their symptoms would worsen with aging [357] (Level of Evidence 2).

Additional Recommendations for Practice from Current Review

- Clients with IBS and faecal incontinence noted the services they would want to manage faecal incontinence included access to bathrooms in both public and employment spaces [361] (Recommendation Grade A).
- Also see Section XII-Qualitative Research on the Experience of Faecal Incontinence and Quality of Life-Additional Recommendations for Practice from Current Review.

Current Recommendations for Research

- Investigation of interventions that promote enhanced self-efficacy and increase incontinence health literacy.
- Evaluation of effect of public and work-based education campaigns on normalizing elimination and raising awareness that incontinence is a treatable condition.

8. LIVING WITH FAECAL INCONTINENCE RELATED TO BODILY SYMPTOMS, SELF ESTEEM, AND BODY IMAGE

8.1. Summary of Evidence from the 5th ICI

Feelings of shame and embarrassment related to faecal incontinence were noted across all studies (Level of Evidence 2).

Men and women with faecal incontinence felt stigmatized and stigmatized themselves [221,223,354-357] (Level of Evidence 2).

Men and women reported their emotional life and self-confidence was undermined because of the faecal incontinence and embarrassment [221,223,344,354-356] (Level of Evidence 2).

Men and women reported altered body image, low self-esteem, guilt, and distress as a result of their inability to control faecal incontinence and associated odour [23,221,223,344,355] (Level of Evidence 2).

Not talking about the problem and denying the faecal incontinence was coping mechanisms used to protect from threat to self-esteem and prevent public embarrassment [356] (Level of Evidence 2).

Faecal incontinence as well as the fear of faecal leakage and odour caused women view themselves as shameful, guilty, unworthy [345,356,355,361] (Level of Evidence 2).

Some women reported the need for psychological consultations because of the feeling insufficient, incompetent, or vulnerable [23,356](Level of Evidence 2).

Unpredictability of the type, timing and magnitude of faecal incontinence events were key concerns of men and women [350,357] (Level of Evidence 2).

Faecal incontinence was considered a consequence of exercise, heavy chores and lifting[223,350,354] (Level of Evidence 2).

Bodily sensations that bothersome, embarrassing, or distressing associated with the faecal incontinence included: sensations in the intestines, itching, burning, cramping, feelings of incomplete bowel movements, and odour associated with flatus and or leaked faeces. Other distressing symptoms discussed included: leaking stool without defaecation

sensations, and false abrupt and urgent sensations usually indicative of defaecation [221,223,345, 350,355, 357] (Level of Evidence 2).

Skin excoriation at the rectum was reported due to frequent bowel movements, soiling and associated cleansing [344,350] (Level of Evidence 2).

Women were attentive to their body image and dressed carefully to conceal pads and wore dark clothing to hide stains if an accident should happen [23,221,353,357] (Level of Evidence 2).

Men and women wore only small disposable pads that were not obvious through their clothing. Large diaper-like pads were avoided because of their perceived visibility beneath clothing [23,221,223] (Level of Evidence 2).

The essential theme in the phenomenological study of men managing faecal incontinence was 'secret resignation': men came to expect the consequences of faecal incontinence as normal [223] (Level of Evidence 1).

Major goals of people experiencing faecal incontinence was to have: fewer dietary restrictions, less faecal leakage, especially during exercise, improved public toilet accessibility, more confidence in controlling faecal incontinence symptoms and associated odour, and a normal daily routine [346] (Level of Evidence 2).

8.2. Recommendations for Practice from the 5th ICI

- Acknowledge and support the common feelings of shame and embarrassment by facilitating self-management of faecal incontinence [221,223,344,354,356,361] (Recommendation Grade B).
- Raise awareness with clients and the general public that faecal incontinence is not something to be tolerated and that it responds to conservative treatment [223,344,361] (Recommendation Grade B).
- Educate patients regarding conservative symptom management: causes of faecal incontinence, dietary modifications including fibre supplements, behavioural strategies such as pelvic floor exercises and biofeedback, anti-motility medications, use of absorbent products and ways to reduce odour and flatus [223,361] (Recommendation Grade A).
- Share positive coping strategies identified by participants with other people managing the symptoms of faecal incontinence that include: managing privacy issues in the bathroom, counselling, restricting activity, carrying a change of clothes, humour, knowing the location of toilets when out, diet, clothing selection, cleansing, odour control and use of absorbent products [23] (Recommendation Grade B).

- Consider patient's goals when developing a plan for faecal incontinence [346] (Recommendation Grade B).
- Request completion of a daily stool diary when accurate information of faecal incontinence severity is important [223] (Recommendation Grade A).
- Refer to psychologists to manage the emotional impact of faecal incontinence on self-efficacy, self-esteem and mood, as indicated and appropriate [345,361] (Recommendation Grade B).

8.3. What is New in the Current Review?

A sense of mastery and new self-confidence were achieved by some after years of successfully dealing with the symptoms of faecal incontinence [359,360] (Level of Evidence 2).

Poor public knowledge of faecal incontinence created feelings of stigma in persons with IBD and faecal incontinence [357] (Level of Evidence 1).

Urgency to have a BM and associated fear and unpredictable nature of faecal incontinence were the most troubling bodily symptoms for persons with IBD and faecal incontinence [357] (Level of Evidence 1).

The essential theme in the phenomenological study of women managing faecal incontinence was 'controlling the body out of control' and a similar subtheme in the Dibley and Norton study [357] of 'loss of control': women tried to control all aspects of their life in relationship to the faecal incontinence and avoiding accidents [223,344,355,357,360] (Level of Evidence 2).

Women reported a sense of self-affirmation that they would stop worrying of what others thought of them [355] (Level of Evidence 2).

To deal with faecal incontinence women used a personal approach to adapt as "life has to go on". Women were hopeful and optimistic they would get better. They believed their incontinence would be easier to accept if they had an explanation for their symptoms [355] (Level of Evidence 2).

There are negative feelings associated with living with faecal incontinence such as anger, frustration, injustice, guilt, shame, disappointment, hopelessness, despair and sadness [355] (Level of Evidence 2).

Men and women perceived that additional chronic illnesses with worsening bowel control affected one's whole self-concept [360] (Level of Evidence 2).

Men and women adapted in the presence of obstacles, downgrading aspirations and "making the best of it" (re-evaluating control) [360] (Level of Evidence 2).

After 10 or more years of living with faecal incontinence, men and women found comorbidity and aging posed further challenges to adaptation. By using trial

and error, adaptation was ongoing [359] (Level of Evidence 2).

Additional Recommendations from the Current Review

- People with faecal incontinence wanted to be referred to, or at minimum, informed of, other services for continence by the specialist health care professionals in their circle of care [357] (Recommendation Grade A).
- Ensure that clients are aware of other specialists in the care continuum and support agencies, making referrals as appropriate [361] (Recommendation Grade A).
- Also see Section XII-Qualitative Research on the Experience of Faecal Incontinence and Quality of Life-Living with Faecal Incontinence Related to Time and Planning- Recommendations for Practice from the 5th ICI.

Current Recommendations for Research

- Determination of how goal setting and tailoring interventions for faecal incontinence is effective in promoting adherence to a management plan [346].
- Further exploration of the phenomenon of secret resignation as a method of coping by men and effective attitudes in treating these attitudes to assist them with improved communication with health care professionals and health-care seeking [223].
- Investigation of appropriate and effective interventions to educate and support men and women in adopting practices for managing faecal incontinence and associated odour and urgency symptoms [223]
- Investigation of the experience of having and managing faecal incontinence in presence of other multiple chronic conditions [359]

9. LIVING WITH FAECAL INCONTINENCE RELATED TO SEXUALITY

9.1. Summary of Evidence from the 5th ICI

Although asked about sexuality and intimacy women were reticent to discuss their sexuality or the effect of their symptoms on their sexual functioning [23,221] (Level of Evidence 2).

Some women felt there were no changes in their sexual drive [355,356] (Level of Evidence 2).

Women arranged timing of sex to meet their needs and the needs of their husbands in relation to the

symptoms of faecal incontinence [356] (Level of Evidence 2).

Women reported a range of psychosocial issues including lack of sexual arousal or desire to abstinence [23,345,353,355] (Level of Evidence 2)

Choice of clothing was an outward expression of sexuality and faecal incontinence and UI restricted clothing to wearing patterned materials to avoid people detecting an accident [353] (Level of Evidence 2).

Men and women reported continually washing themselves to avoid smelling [353] (Level of Evidence 2).

Health care professionals did not discuss sexuality even after surgeries that affected sexual functioning [353,358] (Level of Evidence 2).

9.2. Recommendations for Practice from the 5th ICI

- Ask directly about the impact of faecal incontinence on patients sexuality [23,221] (Recommendation Grade B).
- Establish a comfortable, stigma-free climate in order to elucidate the impact of faecal incontinence on sexuality and teach practical strategies[23,345,353] (Recommendation Grade B).

Additional Recommendations for Practice

- Current recommendations for practice for living with faecal incontinence related to sexuality are the same as those for the 5th ICI.
- Also see Section XII-Qualitative Research on the Experience of Faecal Incontinence and Quality of Life-Living with Faecal Incontinence Related to Sexuality- Recommendations for Practice from the 5th ICI.

Current Recommendations for Research

Develop and test interventions that minimize stool leakage during intercourse.

10. LIVING WITH FAECAL INCONTINENCE RELATED TO DIETARY ISSUES

10.1. Summary of Evidence from the 5th ICI

Men and women discussed fasting or not eating for a number of hours or days as a strategy to deal with faecal incontinence symptoms outside the home [23,221,223,356,357,362] (Level of Evidence 2).

Alteration in the timing of meals to avoid an accident was a common management strategy for faecal incontinence [221,223,344,354,357] (Level of Evidence 2).

Restricting foods noted as affecting faecal incontinence included: sweets, alcohol, onions, rich and spicy foods, caffeine, fruits, greasy, fat, fried foods, and dairy products [356,362,363] (Level of Evidence 2).

Limiting portion or meal size was a strategy to limit faecal incontinence [221,344] (Level of Evidence 2).

Avoiding gas-producing foods such as, pea soup, onions, cabbage, cauliflower, and dairy products used as a treatment for flatus [221,223,344] (Level of Evidence 2).

Increasing fluids was another practice used as a management technique for constipation [221] (Level of Evidence 2).

Some women reported using protracted voluntary constipation for up to one month as a management technique for leakage [345] (Level of Evidence 2).

Increasing dietary fibre and taking fibre supplements along with digestive enzymes and yogurt were noted as treatments for faecal incontinence [221,223] (Level of Evidence 2).

Women reported eating foods they enjoyed at home and then dealt with the consequences of faecal incontinence symptoms [221,344] (Level of Evidence 2).

Women lacked therapeutic guidance regarding diet modifications and adapted recommendations from other gastrointestinal disorders such as IBS and lactose intolerance or approached diet modification by trial and error [221] (Level of Evidence 2).

10.2. Recommendations for Practice from the 5th ICI

- Teach successful diet strategies including: timing of food intake, restricting food amounts to minimize leakage, avoiding aggravating foods, increasing water intake, and increasing the consumption of yogurt, high fibre foods or a fibre supplement [362] (Recommendation Grade B).
- Enquire directly about dietary restrictions because not all strategies employed by people with faecal incontinence are helpful or evidence-based[23,221,223,356] (Recommendation Grade B).

Additional Recommendations for Practice for Living with Faecal Incontinence Related to Dietary Issues

- The same recommendations for practice as those from the 5th ICI are made are supported.
- Also see Section XII-Qualitative Research on the Experience of Faecal Incontinence and Quality of Life-Living with faecal incontinence related to dietary issues-Recommendations for Practice from the 5th ICI.

- Investigate strategies to relay best-evidence related to dietary advice and faecal incontinence in manner that is experienced as therapeutic by persons with faecal incontinence, such as patient directed goal-setting.

XIII. SUMMARY OF KEY RESEARCH RECOMMENDATIONS

- Develop techniques for diagnosing faecal incontinence and its aetiologies using new and available diagnostic technologies.
- Develop user-friendly measures and instruments for quantifying the severity of faecal incontinence and other components of anal incontinence separately from each other and in total.
- Investigate the epidemiology of the different types and subtypes of bowel and anal incontinence.
- Collect data on faecal incontinence whenever practical as part of research on urinary incontinence.
- Well designed and adequately powered studies are needed to evaluate faecal incontinence treatment modalities and management strategies currently available including:
 - Effectiveness of lifestyle modifications including weight loss, exercise, diet and eating pattern modifications, and supplementing dietary fibre as an adjuvant or combined strategy
 - Comparative effectiveness trials of instrumented biofeedback training versus neurostimulation
 - Effectiveness of tibial nerve stimulation (transcutaneous and percutaneous)
- Develop and test interventions for promoting care seeking and self-management of faecal incontinence (and associated odour and urgency).
- Develop and test interventions for increasing coping skills and health literacy related to faecal incontinence for patients and family caregivers.
- Evaluate tailoring the management of faecal incontinence based on patients' goals, peer support, and the use of current technologies such as mobile devices for delivering management and support interventions to patients and family caregivers.

XIV. ALGORITHM

The algorithm for assessment and conservative management of faecal incontinence was updated based on a review of new evidence in the literature within the context of previous evidence and consensus of an international group of experts on faecal incontinence (See chapter **Recommendations of the International Scientific Committee**).

2056 **Table 16-6. Matrix of Qualitative Studies on Faecal Incontinence (faecal incontinence)**

Authors, Reference, Country	Study Purpose/ Research Questions	Qualitative Design	Sample	Patient Type/ Diagnosis	Data Collection	Findings	Limitations Per Evaluation Criteria	Level of Evidence
Roe & May[353] UK	Explore the impact of fecal and urinary incontinence on sexuality and identify interventions for the management of incontinence on sexuality	Descriptive	27 adults	Various causes of faecal incontinence	Semi-structured interviews and field notes	Themes: clothing and appearance; intimacy and caring; management techniques and relationships; life trajectory	No rigor discussed	2
Chevavanayagam & Norton[341] UK	Describe issues affecting quality of life of women with faecal incontinence	Descriptive	13 women	Various causes of faecal incontinence unsuccessfully treated	Structured open-ended questions	Issues with toileting, psychological and emotional effects, timing of meals and proximity of toilets, skin excoriation and constant cleaning, difficulties while in public places such as shopping, maintaining an attractive appearance and wearing clothes that conceal pads and possible accidents, reduced exercise, issues with employment, restricted travel, limited socialization	Background literature brief, aim not specifically stated	2

Authors, Reference, Country	Study Purpose/ Research Questions	Qualitative Design	Sample	Patient Type/ Diagnosis	Data Collection	Findings	Limitations Per Evaluation Criteria	Level of Evidence
Rozmovits & Ziebland [358] UK	Understand aspects of distress in colorectal cancer and explore the impact of the illness on identity and self-understanding	Descriptive	39 adults with loss of bowel control with and without colostomy or ileostomy	Colorectal cancer	Narrative interviews	Loss of professional identity: temporal and special boundnessLoss of ability to socialize: Considerable impact on travel, eating away from home and engaging in leisure pursuits. Learning to manage a stoma: loss of dignity, privacy and independence, disruption of sexual identity	Limitations and rigor not discussed	2
Collings & Norton[354] UK	Discover psychosexual and psychosocial aspects of living with faecal incontinence to inform practice	Descriptive	20 women with FI	Various causes of faecal incontinence	Semi-structured interviews	Women with faecal incontinence have ongoing stress and face potential humiliation. Strategies used for management include: fasting; pads; using own transportation; knowing the location of toilets. Faecal incontinence affects: skin care; shopping; eating; travel; appearance; employment; and socializing. Sex not always affected but there may be fear and shame that deter single women from entering a new relationship.	Reflexivity and audit trail not addressed	2

Authors, Reference, Country	Study Purpose/ Research Questions	Qualitative Design	Sample	Patient Type/ Diagnosis	Data Collection	Findings	Limitations Per Evaluation Criteria	Level of Evidence
Hansen et al.[222] USA	Investigate the meaning of food as a strategy for treating faecal incontinence	Phenomenology	10 women with FI living in community	Various causes of faecal incontinence	In-depth unstructured interviews	4 categories of diet strategies: restricting intake of food that worsen faecal incontinence; avoiding gas-producing foods; limiting portion or meal size; and using diet and fluids as treatments Themes: restricting diet and eating patterns; eating and dealing with the consequences; treating faecal incontinence with food and fluids; lack of therapeutic guidance for diet modifications	Reflexivity not addressed	2
Wilson & McColl[364] UK	Explore the quality of life, management strategies, reasons for and barriers of seeking help by participants experiencing faecal incontinence	Grounded theory	22 adults living in community	Various causes of faecal incontinence	In-depth guided interviews	Five themes: impact of faecal incontinence on self; response to faecal incontinence including adaptation or maladaptation; interactions with significant others; positive/negative life direction; interaction with health professionals	Limitations and rigor not discussed	2

Authors, Reference, Country	Study Purpose/ Research Questions	Qualitative Design	Sample	Patient Type/ Diagnosis	Data Collection	Findings	Limitations Per Evaluation Criteria	Level of Evidence
Peden-McAlpine et al.[221] USA	Understand the experience of women with faecal incontinence and how they manage the problem daily	Phenomenology	10 women with FI living in community	Various causes of faecal incontinence	In-depth unstructured Interviews	Lived space: comfort at home; limited travel outside the home; social isolation; availability of a bathroom a priority; anxiety about public accidents; productive work outside the home problematic Lived time: progression of symptoms over time; planning to prevent accidents; frequency of leakage and defaecation; urgency Lived relationality: faecal incontinence a threat to social acceptability and relationships; careful about disclosure of problem; humiliation and embarrassment at problem; caregiver responses rude and blaming. Lived corporeality: management of symptoms aimed at regaining bodily functions; self-esteem suffered; attentive to body image. Controlling the body out of control was essential theme.	Reflexivity not addressed	1

Authors, Reference, Country	Study Purpose/ Research Questions	Qualitative Design	Sample	Patient Type/ Diagnosis	Data Collection	Findings	Limitations Per Evaluation Criteria	Level of Evidence
Coterill et al.[23] UK	Identify question items for a tool assessing symptoms and quality of life of individuals with faecal incontinence	Descriptive	Opinions from 7 clinical experts Qualitative interviews with 31 patients with FI	Inflammatory bowel disease with faecal incontinence	Interviews with patients Comments by clinical experts	Assessment areas defined by clinical experts: type, amount and frequency of faecal incontinence; ability to control flatus and stool; straining to evacuate; incomplete evacuation; ability to discriminate between flatus and stool; passive and urgent episodes of faecal incontinence; sensation during faecal incontinence episodes; 'normal' bowel pattern for the individual Free text comments ranking; toilet location; social life; hygiene/odour issues; coping strategies; fear, physical activities; embarrassment; bowel unpredictability Interview analysis key issues: unpredictability; coping strategies; and importance of sexual matters	Interview data not sufficiently analyzed Reflexivity not mentioned Limitations not noted Ethical considerations not described	2

Authors, Reference, Country	Study Purpose/ Research Questions	Qualitative Design	Sample	Patient Type/ Diagnosis	Data Collection	Findings	Limitations Per Evaluation Criteria	Level of Evidence
Johnsen et al.[363] Sweden	Describe problematic aspects of faecal incontinence to the experience of adults with Spina Bifida	Descriptive	11 adults	Spina Bifida with bowel problems	Semi-structured open-ended interviews	13 specific problem issues were identified in 4 broad categories: subjects spent a lot of time controlling their defaecation; problems communicating with nurses and physicians; involuntary faecal leakage contributed to social isolation; they did not feel secure in relationships; leisure time was determined by access to toilets; sense of helplessness and worry about smell, gaining control, accidents; sense of impurity, being socially unacceptable; poor self-image; decisions about bowel control were troubling (colostomy or voluntary constipation); and changing patterns	Guiding framework described as 'pragmatism' and not aligned with any epistemological perspective Not clear if followed guiding framework or not Reflexivity is not addressed	2
Norton & Chelvanayagam [365] UK	Describe the impact bowel dysfunction has on the lives of people with MS and to identify interventions that MS Society Members find helpful that may warrant further investigation	Survey with open-ended question	155 adults	Adults with MS	Free-text section on questionnaire	Faecal incontinence had a more profound effect on quality of life than constipation. Bowel dysfunction and bowel management had the greatest negative impact on quality of life, as much as difficulty with mobility.	How thematic analysis was undertaken was not discussed Reflexivity was not addressed	2

Authors, Reference, Country	Study Purpose/ Research Questions	Qualitative Design	Sample	Patient Type/ Diagnosis	Data Collection	Findings	Limitations Per Evaluation Criteria	Level of Evidence
Rasmussen & Ringsberg[356] Sweden	Elucidate how women experience what it is like to live with faecal incontinence due to childbirth complication and how they cope with that situation	Grounded theory	9 women	Women with anal sphincter rupture during childbirth	Unstructured interviews	To have faecal incontinence due to a child birth complication is like being in an everlasting fight. To live with and cope with faecal incontinence is like having to fight to be like others, a fight against attitudes and having a constant striving for confirmation.	Theoretical sampling not mentioned	1
Manthey et al.[1] USA	Examine the management goals of individuals with faecal incontinence living in the community if total reduction of faecal incontinence would not be possible	Descriptive	189 community dwelling adults with FI	Various causes of faecal incontinence	Semi-structured interviews	Patients have numerous goals if cure is not possible. Having fewer leaks was most popular goal. One-third of patients can identify their own goals. Differences between men and women: men are more interested in not leaking stool at night and decreasing the amount of stool leaked. Women rate having less urgency and decreasing size/amounts of pads of higher importance. Younger participants are more interested in elimination of leakage of stool during sex and lessening worry.	Reflexivity not mentioned Limitations not noted	2

Authors, Reference, Country	Study Purpose/ Research Questions	Qualitative Design	Sample	Patient Type/ Diagnosis	Data Collection	Findings	Limitations Per Evaluation Criteria	Level of Evidence
Peden-McAlpine et al.[223] USA	Describe the life experience of men managing faecal incontinence	Phenomenology	11 men with FI	Men living independently, managing frequently occurring faecal incontinence for 1 year minimum	Interviews	Essential theme: "Secret Resignation" --Men accept faecal incontinence as normal, limit activities outside the home, associate faecal incontinence with aging, and accept the changes in their body image. Did not generally employ self-care strategies or use product	Reflexivity was not addressed	1
Dibley & Norton[357] UK	Understand the experiences and concerns of people with IBD and faecal incontinence To understand factors that influence help-seeking and needs or desires for continence services	Mixed methods Reflexivity, rigour, and study limitations not described by authors. New insights for persons with IBD and faecal incontinence regarding urgency and need for quick public access to toilets	28 adults 583 questionnaire responses	Adults with IBD diagnosis	Free-text responses to survey Interviews	7 themes: faecal incontinence has intense negative emotional and psychological impact; feelings of stigma; limited life activities; 5 predominant symptoms; practical coping mechanisms; access to toilet facilities; and fear of faecal incontinence	Reflexivity and procedures for rigor not Described New insights for persons with IBD and faecal incontinence regarding urgency and need for quick public access to toilets and requests to have services to manage anxiety related to faecal incontinence	1

Authors, Reference, Country	Study Purpose/ Research Questions	Qualitative Design	Sample	Patient Type/ Diagnosis	Data Collection	Findings	Limitations Per Evaluation Criteria	Level of Evidence
Norton & Dibley[361] UK	Understand the experiences and concerns of people with IBD and faecal incontinence Understand factors that influence help-seeking and needs or desires for continence services	Mixed methods	617 questionnaire responses	Adults with IBD diagnosis	Free-text responses to survey	Minority sought help for faecal incontinence because: thought nothing could be done, did not know who to ask, did not know of specialist services or thought it was too insignificant a problem.Desired services included public and social issues (e.g., employer awareness, access to toilets) and health services to cope with emotional aspect, better designed products and well-informed and sympathetic specialists	Reflexivity and procedures for rigor not described New insight that persons with IBD and faecal incontinence require services to manage anxiety, such as counselling	2

Authors, Reference, Country	Study Purpose/ Research Questions	Qualitative Design	Sample	Patient Type/ Diagnosis	Data Collection	Findings	Limitations Per Evaluation Criteria	Level of Evidence
Wilson[360] UK	Determine changes that had taken place since first study Focused on adaptation and establishing the factors for adaptation	Descriptive	6 women and 5 men from the initial study (11 total)	Men and women with faecal incontinence of various causes	In-depth guided interviews based on topic guides directed by the initial study findings Emerging topics were explored where relevant.	The major theme identified is the quest for control. Sub-themes include: other chronic conditions: additional adversity or providing perspective (control in context), adaptation in the presence of obstacles: downgrading aspirations and making the best of it (re-evaluating control), Meaningful support: significant others (sharing control), Interaction with health professionals: from passive recipient to expert patient (taking over control); Interactions with others with faecal incontinence: from advice seeker role model (inspiring control), Interaction: the generalized other (outwardly in control).	Background literature not well developed Reflexivity and audit trail not mentioned Other measures of rigor not addressed	1
Olsson. & Bereto[355] Sweden	Identify and describe the lived experience of persons living with faecal incontinence and show how it affects daily life	Interpretive Phenomenology	5 women with FI	Adults with faecal incontinence regardless of cause or severity	Unstructured interviews	Four themes: self-affirmation; guilt and shame; limitations in life; personal approach; Leaked faeces, associated odour and worry about these problems occurring continue to be concerns and sources of guilt and shame	Literature review on the experience of faecal incontinence is inadequate Little new information is offered in findings, No mention of reflexivity, limitations, or audit trail	2

Authors, Reference, Country	Study Purpose/ Research Questions	Qualitative Design	Sample	Patient Type/ Diagnosis	Data Collection	Findings	Limitations Per Evaluation Criteria	Level of Evidence
Wilson[359] UK	Report on a 10 year follow up study examining the challenges associated with living with faecal incontinence and different ways of managing the condition, including the importance of social support.	Grounded Theory	There were 3 men and 6 women with FI in the follow-up	Various causes of faecal incontinence	Semi-structured guided interviews	The core category was impact and response to faecal incontinence. Subcategories included: interaction with the generalized other; interaction with significant others; interaction with insiders. The follow up study after 10 years of living with faecal incontinence posed challenges to adaptation. Adaptation was ongoing and faecal incontinence was not always the dominant issue. New self-management strategies were identified.	Half of the original subjects in the initial study was lost to attrition. No mention of rigor, reflexivity or an audit trail	2

REFERENCES

1. Manthey A, Bliss DZ, Savik K, Lowry A, Whitebird R. Goals of fecal incontinence management identified by community-living incontinent adults. *West J Nurs Res* 2010;32:644-661.
2. Brown HW, Wexner SD, Lukacz ES. Factors associated with care seeking among women with accidental bowel leakage. *Female Pelvic Med Reconstr Surg* 2013;19:66-71.
3. Yip SO, Dick MA, McPencow AM, Martin DK, Ciarleglio MM, Erekson EA. The association between urinary and fecal incontinence and social isolation in older women. *Am J Obstet Gynecol* 2013;208:146.e1-146.e7
4. Bharucha AE, Zinsmeister AR, Locke GR, Schleck C, McKeon K, Melton LJ. Symptoms and quality of life in community women with fecal incontinence. *Clin Gastroenterol Hepatol* 2006;4:1004-1009.
5. Cotterill N, Norton C, Avery KN, Abrams P, Donovan JL. Psychometric evaluation of a new patient-completed questionnaire for evaluating anal incontinence symptoms and impact on quality of life: the ICIQ-B. *Dis Colon Rectum* 2011;54:1235-1250.
6. Bliss DZ, Savik K, Harms S, Fan Q, Wyman JF. Prevalence and correlates of perineal dermatitis in nursing home residents. *Nurs Res* 2006;55:243-251.
7. Beeckman D, Van Lancker A, Van Hecke A, Verhaeghe S. A Systematic Review and Meta-Analysis of Incontinence-Associated Dermatitis, Incontinence, and Moisture as Risk Factors for Pressure Ulcer Development. *Res Nurs Health* 2014;37:204-218
8. Paquette IM, Varma MG, Kaiser AM, Steele SR, Rafferty JF. The American Society of Colon and Rectal Surgeons' clinical practice guideline for the treatment of fecal incontinence. *Dis Colon Rectum* 2015;58:623-636.
9. Wald A, Bharucha AE, Cosman BC, Whitehead WE. ACG clinical guideline: Management of benign anorectal disorders. *Am J Gastroenterol* 2014;109:1141-1157.
10. Van Koughnett J, Wexner SD. Current management of fecal incontinence: choosing amongst treatment options to optimize outcomes. *World J Gastroenterol* 2013;19:9216-9230.
11. Kunduru L, Kim SM, Heymen S, Whitehead WE. Factors that affect consultation and screening for fecal incontinence. *Clin Gastroenterol Hepatol* 2015;13:709-716.
12. Bliss DZ, Rolnick C, Jackson J, Arntson C, Mullins J, Hepburn K. Health Literacy Needs Related to Incontinence and Skin Damage Among Family and Friend Caregivers of Individuals With Dementia. *J Wound Ostomy Continence Nurs* 2013;40:515-523.
13. Brown RA, Wood RJ. Constipation in children. *South African Family Practice* 2013;55:350-353.
14. Munoz-Yague T, Solis-Munoz P, Ciriza de los Rios C, Munoz-Garrido F, Vara J, Solis-Herruzo JA. Fecal incontinence in men: causes and clinical and manometric features. *World J Gastroenterol* 2014;20:7933-7940.
15. Bharucha AE, Dunivan G, Goode PS, Lukacz ES, Markland AD, Matthews CA, et al. Epidemiology, pathophysiology, and classification of fecal incontinence: state of the science summary for the National Institute of Diabetes and Digestive and Kidney Diseases (NIDDK) workshop. *Am J Gastroenterol* 2015;110:127-136.
16. Jorge JMN, Wexner SD. Etiology and management of fecal incontinence. *Dis Colon Rectum* 1993;36:77-97.
17. Rockwood TH, Church JM, Fleshman JW, Kane RL, Mavrantonis C, Thorson AG, et al. Patient and surgeon ranking of the severity of symptoms associated with fecal incontinence. *Dis Colon Rectum* 1999;42:1525-1531.
18. Bharucha AE, Fletcher JG, Harper CM, Hough D, Daube JR, Stevens C, Seide B, Riederer SJ, Zinsmeister AR. Relationship between symptoms and disordered continence mechanisms in women with idiopathic fecal incontinence. *Gut* 2005; 54:546-55.
19. Vaizey CJ, Carapeti E, Cahill JA, Kamm MA. Prospective comparison of faecal incontinence grading systems. *Gut* 1999;44:77-80.
20. Rockwood TH, Church JM, Fleshman JW, Kane RL, Mavrantonis C, Thorson AG, et al. Fecal incontinence quality of life scale. *Dis Colon Rectum* 2000;43:9-16.
21. Kwon S, Visco AG, Fitzgerald MP, Ye W, Whitehead WE, Pelvic Floor Disorders Network. Validity and reliability of the Modified Manchester Health Questionnaire in assessing patients with fecal incontinence. *Dis Colon Rectum* 2005;48:323-334.
22. Sultan AH, Kamm MA, Hudson CN, Thomas JM, Bartram CI. Anal-sphincter disruption during vaginal delivery. *N Engl J Med* 1993;329:1905-1911.

23. Cotterill N, Norton C, Avery KNL, Abrams P, Donovan JL. A patient-centered approach to developing a comprehensive symptom and quality of life assessment of anal incontinence. *Dis Colon Rectum* 2008;51:82-87.
24. Lewis S, Heaton K. Stool form scale as a useful guide to intestinal transit time. *Scand J Gastroenterol* 1997;32:920-924.
25. Bliss DZ, Dhamani KA, Savik K, Kirk K. Tool to classify stool consistency: content validity and use by persons of diverse cultures. *Nurs Health Sci* 2003;5:115-121.
26. Bliss DZ, Larson SJ, Burr JK, Savik K. Reliability of a stool consistency classification system. *J Wound Ostomy Continence Nurs* 2001;28:305-313.
27. Sung VW, Rogers RG, Bann CM, Arya L, Barber MD, Lowder J, et al. Symptom outcomes important to women with anal incontinence: a conceptual framework. *Obstet Gynecol* 2014;123:1023-1030.
28. Bliss DZ, Savik K, Jung HJG, Whitebird R, Lowry A, Sheng X. Dietary Fiber Supplementation for Fecal Incontinence: A Randomized Clinical Trial. *Res Nurs Health* 2014;37:367-378.
29. Hill J, Corson RJ, Brandon H, Redford J, Faragher EB, Kiff ES. History anberd examination in the assessment of patients with idiopathic fecal incontinence. *Dis Colon Rectum* 1994;37:473-477.
30. Engel A, Kamm M, Bartram C, Nicholls R. Relationship of symptoms in faecal incontinence to specific sphincter abnormalities. *Int J Colorectal Dis* 1995;10:152-155.
31. Andrews C, Bharucha AE, Seide B, Zinsmeister AR. Rectal sensorimotor dysfunction in women with fecal incontinence. *Am J Physiol-Gastrointest Liver Physiol* 2007;292:G282-G289.
32. Fonda D, Abrams P. Cure sometimes, help always—a “continence paradigm” for all ages and conditions. *NeuroUrol Urodyn* 2006;25:290-292.
33. Wall LL. The Muscles of the Pelvic Floor. *Clin Obstet Gynecol* 1993;36:910-925.
34. Bliss DZ, McLaughlin J, Jung H, Lowry A, Savik K, Jensen L. Comparison of the nutritional composition of diets of persons with fecal incontinence and that of age-and gender-matched controls. *J Wound Ostomy Continence Nurs* 2000;27:90-97.
35. Skoog S, Bharucha AE, Camilleri M, Burton D, Zinsmeister AR. Effects of an osmotically active agent on colonic transit. *Neuro-gastroenterol Motil* 2006;18:300-306.
36. Thorson MA, Bliss DZ, Savik K. Re-examination of risk factors for non-Clostridium difficile-associated diarrhoea in hospitalized patients. *J Adv Nurs* 2008;62:354-364.
37. Bergert FW, Conrad D, Ehrental K, Febler J, Gross J, Gundermann K, et al. Pharmacotherapy guidelines for the aged by family doctors for the use of family doctors. *Int J Clin Pharmacol Ther* 2009;47:223-228.
38. Bharucha AE, Edge J, Zinsmeister AR. Effect of nifedipine on anorectal sensorimotor functions in healthand fecal incontinence. *Am J Physiol-Gastrointest Liver Physiol* 2011;301:1522-1547.
39. Menees SB, Smith TM, Xu X, Chey WD, Saad RJ, Fenner DE. Factors associated with symptom severity in women presenting with fecal incontinence. *Dis Colon Rectum* 2013;56:97-102.
40. Bohle B, Belvis F, Vial M, Maestre Y, Pera M, Castillo M, et al. Menopause and obstetric history as risk factors for fecal incontinence in women. *Dis Colon Rectum* 2011;54:975-981.
41. Sultan AH, Kamm MA, Hudson CN, Bartram CI. Third degree obstetric anal sphincter tears: risk factors and outcome of primary repair. *BMJ* 1994;308:887-891.
42. Ditah I, Devaki P, Luma HN, Njei B, Jaiyeoba C, Salami A, et al. Prevalence, Trends, and Risk Factors for Fecal Incontinence in United States Adults, 2005-2010. *Clin Gastroenterol Hepatol* 2014;12:636-643.
43. Townsend MK, Matthews CA, Whitehead WE, Grodstein F. Risk factors for fecal incontinence in older women. *Am J Gastroenterol* 2013;108:113-119.
44. Bharucha AE, Zinsmeister AR, Schleck CD, Melton LJ. Bowel disturbances are the most important risk factors for late onset fecal incontinence: a population-based case-control study in women. *Gastroenterology* 2010;139:1559-1566.
45. Bernard S, Ouellet M, Moffet H, Roy J, Dumoulin C. Effects of radiation therapy on the structure and function of the pelvic floor muscles of patients with cancer in the pelvic area: a systematic review. *J Cancer Survivorship* 2016;10:351-362.

46. Jackson SL, Weber AM, Hull TL, Mitchinson AR, Walters MD. Fecal incontinence in women with urinary incontinence and pelvic organ prolapse. *Obstet Gynecol* 1997;89:423-427.
47. Steele SR, Varma MG, Prichard D, Bharucha AE, Vogler SA, Erdogan A, et al. The evolution of evaluation and management of urinary or fecal incontinence and pelvic organ prolapse. *Curr Probl Surg* 2015;52:17-75.
48. Doughty D, Junkin J, Kurz P, Selekof J, Gray M, Fader M, et al. Incontinence-associated dermatitis: consensus statements, evidence-based guidelines for prevention and treatment, and current challenges. *J Wound Ostomy Continence Nurs* 2012;39:303-315.
49. Borchert K, Bliss DZ, Savik K, Radosevich DM. The incontinence-associated dermatitis and its severity instrument: development and validation. *J Wound Ostomy Continence Nurs* 2010;37:527-535.
50. Bliss DZ, Hurlow J, Cefalu J, Mahlum L, Borchert K, Savik K. Refinement of an instrument for assessing incontinent-associated dermatitis and its severity for use with darker-toned skin. *J Wound Ostomy Continence Nurs* 2014;41:365-370.
51. Orkin BA, Sinykin SB, Lloyd PC. The digital rectal examination scoring system (DRESS). *Dis Colon Rectum* 2010;53:1656-1660.
52. Tantiplachiva K, Rao P, Attaluri A, Rao SS. Digital rectal examination is a useful tool for identifying patients with dyssynergia. *Clin Gastroenterol Hepatol* 2010;8:955-960.
53. Hallan R, Marzouk D, Waldron D, Womack N, Williams N. Comparison of digital and manometric assessment of anal sphincter function. *Br J Surg* 1989;76:973-975.
54. Favetta U, Amato A, Interisano A, Pescatori M. Clinical, Manometric and sonographic assessment of the anal sphincters a comparative prospective study. *Int J Colorectal Dis* 1996;11:163-166.
55. Dobben AC, Terra MP, Deutekom M, Gerhards MF, Bijnen AB, Felt-Bersma RJ, et al. Anal inspection and digital rectal examination compared to anorectal physiology tests and endoanal ultrasonography in evaluating fecal incontinence. *Int J Colorectal Dis* 2007;22:783-790.
56. Kaushal JN, Goldner F. Validation of the digital rectal examination as an estimate of anal sphincter squeeze pressure. *Am J Gastroenterol* 1991;86:886-887.
57. Soh JS, Lee HJ, Jung KW, Yoon IJ, Koo HS, Seo SY, et al. The diagnostic value of a digital rectal examination compared with high-resolution anorectal manometry in patients with chronic constipation and fecal incontinence. *Am J Gastroenterol* 2015;110:1197-1204.
58. Jeppson PC, Paraiso MFR, Jelovsek JE, Barber MD. Accuracy of the digital anal examination in women with fecal incontinence. *Int Urogynecol J* 2012;23:765-768.
59. Vaizey C, Van den Bogaerde J, Emmanuel A, Talbot I, Nicholls R, Kamm M. Solitary rectal ulcer syndrome. *Br J Surg* 1998;85:1617-1623.
60. Cundiff GW, Fenner D. Evaluation and treatment of women with rectocele: focus on associated defecatory and sexual dysfunction. *Obstet Gynecol* 2004;104:1403-1421.
61. Rezvan A, Jakus-Waldman S, Abbas MA, Yazdany T, Nguyen J. Review of the diagnosis, management and treatment of fecal incontinence. *Female Pelvic Med Reconstr Surg* 2015;21:8-17.
62. Deutekom M, Dobben AC, Terra MP, Engel AF, Stoker J, Bossuyt PM, et al. Clinical Presentation of Fecal Incontinence and Anorectal Function: What Is the Relationship? *Am J Gastroenterol* 2007;102:351-361.
63. Pehl C, Seidl H, Scalercio N, Gundling F, Schmidt T, Schepp W, Labermeyer S. Accuracy of anorectal manometry in patients with fecal incontinence. *Digestion* 2012;86:78-85.
64. Diamant N, Kamm M, Wald A, Whitehead WE. AGA technical review on anorectal testing techniques. *Gastroenterol* 1999;116:735-760.
65. Bharucha AE, Stroetz R, Feuerhak K, Szarka LA, Zinsmeister AR. A novel technique for bedside anorectal manometry in humans. *Neurogastroenterol Motil* 2015;27:1504-1508.
66. Lee TH, Bharucha AE. How to perform and interpret a high-Resolution anorectal manometry test. *J Neurogastroenterol Motil* 2016;22:46-59.
67. Jones MP, Post J, Crowell MD. High-resolution manometry in the evaluation of ano-rectal disorders: a simultaneous comparison with water-perfused manometry. *Am J Gastroenterol* 2007;102:850-855.
68. Vitton V, Soudan D, Siproudhis L, Abramowitz L, Bouvier M, Faucheron J, et al. Treatments of faecal incontinence: recommendations from the French national society of coloproctology. *Colorectal Dis* 2014;16:159-166.

69. Bredenoord AJ, Fox M, Kahrilas PJ, Pandolfino JE, Schwizer W, Smout A. Chicago classification criteria of esophageal motility disorders defined in high resolution esophageal pressure topography. *Neurogastroenterol Motil* 2012;24:57-65.
70. Association of Gastrointestinal Physiologists. Agreed AGIP Guidelines for High Resolution Anorectal Manometry (HRAM). Available at: (http://www.bsg.org.uk/images/stories/docs/sections/agip/agip_hram_guidelines.pdf). Accessed November 10, 2016.
71. Lestar B, Penninckx F, Rigauts H, Kerremans R. The internal anal sphincter can not close the anal canal completely. *Int J Colorectal Dis* 1992;7:159-161.
72. Rao SSC, Azpiroz F, Diamant N, Enck P, Tougas G, Wald A. Minimum standards of anorectal manometry. *Neurogastroenterol Motil* 2002;14:553-559.
73. Felt-Bersma RJF, Klinkenberg-Knol EC, Meuwissen SGM. Anorectal function investigations in incontinent and continent patients. *Dis Colon Rectum* 1990;33:479-486.
74. Boyle DJ, Knowles CH, Murphy J, Bhan C, Williams NS, Scott SM, et al. The effects of age and childbirth on anal sphincter function and morphology in 999 symptomatic female patients with colorectal dysfunction. *Dis Colon Rectum* 2012;55:286-293.
75. Coss-Adame E, Rao SS, Valestin J, Ali-Azamar A, Remes-Troche JM. Accuracy and reproducibility of high-definition anorectal manometry and pressure topography analyses in healthy subjects. *Clin Gastroenterol Hepatol* 2015;13:1143-1150.
76. Lee HR, Lim S, Park JY. Anorectal manometric parameters are influenced by gender and age in subjects with normal bowel function. *Int J Colorectal Dis* 2014;29:1393-1399.
77. Fox JC, Fletcher JG, Zinsmeister AR, Seide B, Riederer SJ, Bharucha AE. Effect of aging on anorectal and pelvic floor functions in females. *Dis Colon Rectum* 2006;49:1726-1735.
78. Noelting J, Ratuapli SK, Bharucha AE, Harvey DM, Ravi K, Zinsmeister AR. Normal values for high-resolution anorectal manometry in healthy women: effects of age and significance of rectoanal gradient. *Am J Gastroenterol* 2012;107:1530-1536.
79. Loganathan A, Schlotthe A, Hakendorf P, Liyanage C, Costa M, Wattchow D. Prolonged pudendal nerve terminal motor latency is associated with decreased resting and squeeze pressures in the intact anal sphincter. *Colorectal Dis* 2013;15:1410-1415.
80. Santoro GA, Wieczorek AP, Dietz HP, Mellgren A, Sultan AH, Shobeiri SA, et al. State of the art: an integrated approach to pelvic floor ultrasonography. *Ultrasound Obstet Gynecol* 2011;37:381-396.
81. Haylen BT, De Ridder D, Freeman RM, Swift SE, Berghmans B, Lee J, et al. An International Urogynecological Association (IUGA)/International Continence Society (ICS) joint report on the terminology for female pelvic floor dysfunction. *Int Urogynecol J* 2010;21:5-26.
82. Santoro GA, Fortling B. The advantages of volume rendering in three-dimensional endosonography of the anorectum. *Dis Colon Rectum* 2007;50:359-368.
83. Starck M, Bohe M, Valentin L. Results of endosonographic imaging of the anal sphincter 2-7 days after primary repair of third- or fourth-degree obstetric sphincter tears. *Ultrasound Obstet Gynecol* 2003;22:609-615.
84. Norderval S, Dehli T, Vonen B. Three-dimensional endoanal ultrasonography: intraobserver and interobserver agreement using scoring systems for classification of anal sphincter defects. *Ultrasound Obstet Gynecol* 2009;33:337-343.
85. Oberwalder M, Dinnewitzer A, Baig MK, Thaler K, Cotman K, Noguera JJ, et al. The association between late-onset fecal incontinence and obstetric anal sphincter defects. *Arch Surg* 2004;139:429-432.
86. Dobben AC, Terra MP, Deutekom M, Slors JFM, Janssen LWM, Bossuyt PMM, et al. The role of endoluminal imaging in clinical outcome of overlapping anterior anal sphincter repair in patients with fecal incontinence. *Am J Roentgenol* 2007;189:W70-W77.
87. de la Portilla F, Vega J, Rada R, Segovia-González M, Cisneros N, Maldonado V, et al. Evaluation by three-dimensional anal endosonography of injectable silicone biomaterial (PTQ™) implants to treat fecal incontinence: long-term localization and relation with the deterioration of the continence. *Tech Coloproctol* 2009;13:195-199.
88. Dietz HP, Lanzarone V. Levator trauma after vaginal delivery. *Obstet Gynecol* 2005;106:707-712.
89. DeLancey JO, Kearney R, Chou Q, Speights S, Binno S. The appearance of levator ani muscle abnormalities in magnetic resonance images after vaginal delivery. *Obstet Gynecol* 2003;101:46-53.

90. Lien KC, Mooney B, DeLancey JO, Ashton-Miller JA. Levator ani muscle stretch induced by simulated vaginal birth. *Obstet Gynecol* 2004;103:31-40.
91. Santoro GA, Wiczorek AP, Stankiewicz A, Woźniak MM, Bogusiewicz M, Rechberger T. High-resolution three-dimensional endovaginal ultrasonography in the assessment of pelvic floor anatomy: a preliminary study. *Int Urogynecol J* 2009;20:1213-1222.
92. Harvey M, Pierce M, Urogynaecology Committee, Alter JW, Chou Q, Diamond P, et al. Obstetrical Anal Sphincter Injuries (OASIS): Prevention, Recognition, and Repair. *J Obstet Gynaecol Canada* 2015;37:1131-1148.
93. Walsh KA, Grivell RM. Use of endoanal ultrasound for reducing the risk of complications related to anal sphincter injury after vaginal birth. *Cochrane Database of Systematic Reviews* 2015:1-25.
94. Fitzpatrick M, Cassidy M, Barassaud M, Hehir M, Hanly A, O'Connell P, et al. Does anal sphincter injury preclude subsequent vaginal delivery? *Eur J Obstet Gynecol Reprod Biol* 2016;198:30-34.
95. Reid AJ, Beggs AD, Sultan AH, Roos AM, Thakar R. Outcome of repair of obstetric anal sphincter injuries after three years. *Int J Gynecol Obstet* 2014;127:47-50.
96. Lohuis EJO, Everhardt E. Outcome of obstetric anal sphincter injuries in terms of persisting endoanal ultrasonographic defects and defecatory symptoms. *Int J Gynecol Obstet* 2014;126:70-73.
97. Laine K, Skjeldestad FE, Sanda B, Horne H, Spydslaug A, Staff AC. Prevalence and risk factors for anal incontinence after obstetric anal sphincter rupture. *Acta Obstet Gynecol Scand* 2011;90:319-324.
98. Norderval S, Røssaak K, Markskog A, Vonon B. Incontinence after primary repair of obstetric anal sphincter tears is related to relative length of reconstructed external sphincter: a case-control study. *Ultrasound Obstet Gynecol* 2012;40:207-214.
99. Sørensen MM, Pedersen BG, Santoro G, Buntzen S, Bek K, Laurberg S. Long-term function and morphology of the anal sphincters and the pelvic floor after primary repair of obstetric anal sphincter injury. *Colorectal Dis* 2014;16:O347-O355.
100. Karmarkar R, Bhide A, Digesu A, Khullar V, Fernando R. Mode of delivery after obstetric anal sphincter injury. *Eur J Obstet Gynecol Reprod Biol* 2015;194:7-10.
101. Pucciani F., Raggioli M., Gattai R. Rehabilitation of fecal incontinence: What is the influence of anal sphincter lesions?. *Tech Coloproctol* 2013;17:299-306.
102. Allgayer H, Ignee A, Zipse S, Crispin A, Dietrich CF. Endorectal ultrasound and real-time elastography in patients with fecal incontinence following anorectal surgery: a prospective comparison evaluating short- and long-term outcomes in irradiated and non-irradiated patients. *Z Gastroenterol* 2012;50:1281-1286.
103. Hainsworth AJ, Solanki D, Schizas AM, Williams AB. Total pelvic floor ultrasound for pelvic floor defaecatory dysfunction: a pictorial review. *Br J Radiol* 2015;88:20150494.
104. Abdool Z, Sultan AH, Thakar R. Ultrasound imaging of the anal sphincter complex: a re-view. *Br J Radiol* 2012;85:865-875.
105. Valsky D, Cohen S, Lipschuetz M, Hochner-Celnikier D, Yagel S. Three-dimensional transperineal ultrasound findings associated with anal incontinence after intrapartum sphincter tears in primiparous women. *Ultrasound Obstet Gynecol* 2012;39:83-90.
106. Meriwether KV, Hall RJ, Leeman LM, Migliacchio L, Qualls C, Rogers RG. The relationship of 3-D translabial ultrasound anal sphincter complex measurements to postpartum anal and fecal incontinence. *Int Urogynecol J* 2015;26:1191-1199.
107. Olsen I, Wilsgaard T, Kiserud T. Trans-vaginal three-dimensional ultrasound: a method of studying anal anatomy and function. *Ultrasound Obstet Gynecol* 2011;37:353-360.
108. Oom D.M.J. West R.L. Schouten W.R. Steensma, A.B. Detection of anal sphincter defects in female patients with fecal incontinence: A comparison of 3-dimensional transperineal ultrasound and 2-dimensional endoanal ultrasound. *Dis Colon Rectum* 2012;55:646-652.
109. Meriwether KV, Hall RJ, Leeman LM, Migliacchio L, Qualls C, Rogers RG. Anal sphincter complex: 2D and 3D endoanal and translabial ultrasound measurement variation in normal postpartum measurements. *Int Urogynecol J* 2015;26:511-517.
110. Murad-Regadas S, Fernandes GdS, Regadas F, Rodrigues L, Pereira J, Dealcanfreitas I, et al. Assessment of pubovisceral muscle defects and levator hiatal dimensions in women with faecal incontinence after vaginal delivery: is there a correlation with severity of symptoms? *Colorectal Dis* 2014;16:1010-1018.
111. Rostaminia G, White D, Quiroz L, Shobeiri S. 3D pelvic floor ultrasound findings and severity of anal incontinence. *Int Urogynecol J* 2014;25:623-629.

112. Ozyurt S, Aksoy H, Gedikbasi A, Yildirim G, Aksoy U, Acmaz G, et al. Screening occult anal sphincter injuries in primigravid women after vaginal delivery with transperineal use of vaginal probe: a prospective, randomized controlled trial. *Arch Gynecol Obstet* 2015;292:853-859.
113. Albuquerque A, Macedo G. Clinical severity of fecal incontinence after anorectal surgery and its relationship with endoanal ultrasound features. *Int J Colorectal Dis* 2016;1-2.
114. Ratto C., Donisi L., Litta F., Campenni P., Parello A. Implantation of SphinKeeper™: a new artificial anal sphincter. *Tech Coloproctol* 2016;20:59-66.
115. Ratto C, Buntzen S, Aigner F, Altomare D, Heydari A, Donisi L, et al. Multicentre observational study of the Gatekeeper™ for faecal incontinence. *Br J Surg* 2015;103:290-299.
116. Garcés-Albir M, García-Botello SA, Esclapez-Valero P, Sanahuja-Santafé A, Raga-Vázquez J, Espi-Macías A, et al. Quantifying the extent of fistulotomy. How much sphincter can we safely divide? A three-dimensional endosonographic study. *Int J Colorectal Dis* 2012;27:1109-1116.
117. D'Hoore A, Cadoni R, Penninckx F. Long-term outcome of laparoscopic ventral rectopexy for total rectal prolapse. *Br J Surg* 2004;91:1500-1505.
118. Gosselink MP, Adusumilli S, Gorissen KJ, Fourie S, Tuynman JB, Jones OM, et al. Laparoscopic ventral rectopexy for fecal incontinence associated with high-grade internal rectal prolapse. *Dis Colon Rectum* 2013;56:1409-1414.
119. Sileri P, Franceschilli L, de Luca E, Lazzaro S, Angelucci GP, Fiaschetti V, et al. Laparoscopic ventral rectopexy for internal rectal prolapse using biological mesh: postoperative and short-term functional results. *J Gastrointest Surg* 2012;16:622-628.
120. Tsunoda A, Ohta T, Kiyasu Y, Kusanagi H. Laparoscopic ventral rectopexy for rectoanal intussusception: postoperative evaluation with proctography. *Dis Colon Rectum* 2015;58:449-456.
121. Rao SSC. Advances in diagnostic assessment of fecal incontinence and dyssynergic defecation. *Clin Gastroenterol Hepatol* 2010;8:910-919.
122. Dobben AC, Terra MP, Deutekom M, Bos-suyt PM, Felt-Bersma RJ, Stoker J. Diagnostic work-up for faecal incontinence in daily clinical practice in the Netherlands. *Neth J Med* 2005;63:265-269.
123. Olson CH. Diagnostic testing for fecal incontinence. *Clin Colon Rectal Surg* 2014;27:85-90.
124. Wong M, Meurette G, Abet E, Podevin J, Lehur P. Safety and efficacy of laparoscopic ventral mesh rectopexy for complex rectocele. *Colorectal Dis* 2011;13:1019-1023.
125. Mercer-Jones M, D'hoore A, Dixon A, Lehur P, Lindsey I, Mellgren A, et al. Consensus on ventral rectopexy: report of a panel of experts. *Colorectal Dis* 2014;16:82-88.
126. Shorvon PJ, McHugh S, Diamant NE, Somers S, Stevenson GW. Defecography in normal volunteers: results and implications. *Gut* 1989;30:1737-1749.
127. Palit S, Bhan C, Lunniss P, Boyle D, Gladman M, Knowles C, et al. Evacuation proctography: a reappraisal of normal variability. *Colorectal Dis* 2014;16:538-546.
128. Dvorkin L, Gladman M, Epstein J, Scott S, Williams N, Lunniss P. Rectal intussusception in symptomatic patients is different from that in asymptomatic volunteers. *Br J Surg* 2005;92:866-872.
129. Harmston C, Jones O, Cunningham C, Lindsey I. The relationship between internal rectal prolapse and internal anal sphincter function. *Colorectal Dis* 2011;13:791-795.
130. Wijffels NAT, Jones OM, Cunningham C, Bemelman WA, Lindsey I. What are the symptoms of internal rectal prolapse?. *Colorectal Dis* 2013;15:368-373.
131. Hawkins AT, Olariu AG, Savitt LR, Gingipally S, Wakamatsu MM, Pulliam S, et al. Impact of Rising Grades of Internal Rectal Intussusception on Fecal Continence and Symptoms of Constipation. *Dis Colon Rectum* 2016;59:54-61.
132. Evans C, Stevenson AR, Sileri P, Mercer-Jones MA, Dixon AR, Cunningham C, et al. A multicenter collaboration to assess the safety of laparoscopic ventral rectopexy. *Dis Colon Rectum* 2015;58:799-807.
133. Collinson R, Cunningham C, D'Costa H, Lindsey I. Rectal intussusception and unexplained faecal incontinence: findings of a proctographic study. *Colorectal Dis* 2009;11:77-83.
134. Dobben AC, Wiersma TG, Janssen LWM, de Vos R, Terra MP, Baeten CG, et al. Prospective assessment of interobserver agreement for defecography in fecal incontinence. *Am J Roentgenol* 2005;185:1166-1172.
135. Piloni V, Fioravanti P, Spazzafumo L, Ros-si B. Measurement of the anorectal angle by defecography for the diagnosis of fecal incontinence. *Int J Colorectal Dis* 1999;14:131-135.

136. Savoye-Collet C, Savoye G, Koning E, Dacher J. Defecographic disorders in anal incontinent women: relation to symptoms and anal endosonographic patterns. *Scand J Gas-troenterol* 2005;40:141-146.
137. Felt-Bersma RJF. Clinical indications for anorectal function investigations. *Scand J Gas-troenterol* 1990;25:1-6.
138. Karasick S. Defecography for the diagnosis of abnormalities in patients with fecal incontinence. *Am J Roentgenol* 2006;186:E20-E20.
139. Formijne Jonkers H, Poirierri N, Draaisma W, Broeders I, Consten E. Laparoscopic ventral rectopexy for rectal prolapse and symptomatic rectocele: an analysis of 245 consecutive patients. *Colorectal Dis* 2013;15:695-699.
140. Melchior C, Bridoux V, Touchais O, Savoye-Collet C, Leroi A. MRI defaecography in patients with faecal incontinence. *Colorectal Dis* 2015;17:O62-O69.
141. Hetzer FH, Andreisek G, Tsagari C, Sahrbacher U, Weishaupt D. MR Defecography in Patients with Fecal Incontinence: Imaging Findings and Their Effect on Surgical Management 1. *Radiol* 2006;240:449-457.
142. Fiaschetti V, Pastorelli D, Squillaci E, Funnel V, Rascioni M, Meschini A, et al. Static and dynamic evaluation of pelvic floor disorders with an open low-field tilting magnet. *Clin Radiol* 2013;68:e293-e300.
143. Cuesta M, Meijer S, Derksen E, Boutkan H, Meuwissen S. Anal sphincter imaging in fecal incontinence using endosonography. *Dis Colon Rectum* 1992;35:59-63.
144. deSouza NM, Hall AS, Puni R, Gilderdale DJ, Young IR, Kmiot WA. High resolution magnetic resonance imaging of the anal sphincter using a dedicated endoanal coil. *Dis Colon Rectum* 1996;39:926-934.
145. deSouza NM, Puni R, Zbar A, Gilderdale DJ, Coutts GA, Krausz T. MR imaging of the anal sphincter in multiparous women using an endoanal coil: correlation with in vitro anatomy and appearances in fecal incontinence. *Am J Roentgenol* 1996;167:1465-1471.
146. deSouza NM, Puni R, Gilderdale DJ, Bydder GM. Magnetic resonance imaging of the anal sphincter using an internal coil. *Magn Reson Quart* 1995;11:45-56.
147. Deen KI, Kumar D, Williams JG, Olliff J, Keighley MR. Anal sphincter defects. Correlation between endoanal ultrasound and surgery. *Ann Surg* 1993;218:201-205.
148. Briel J, Zimmerman D, Stoker J, Rociu E, Lameris J, Mooi W, et al. Relationship between sphincter morphology on endoanal MRI and histopathological aspects of the external anal sphincter. *Int J Colorectal Dis* 2000;15:87-90.
149. Hussain SM, Stoker J, Zwamborn AW, Den Hollander JC, Kuiper JW, Entius CA, et al. Endoanal MRI of the anal sphincter complex: correlation with cross-sectional anatomy and histology. *J Anat* 1996;189:677-682.
150. Malouf AJ, Norton CS, Engel AF, Nicholls RJ, Kamm MA. Long-term results of overlapping anterior anal-sphincter repair for obstetric trauma. *Lancet* 2000;355:260-265.
151. Meyenberger C, Bertschinger P, Zala G, Buchmann P. Anal sphincter defects in fecal incontinence: correlation between endosonography and surgery. *Endoscopy* 1996;28:217-224.
152. Nielsen MB, Hauge C, Pedersen JF, Christiansen J. Endosonographic evaluation of patients with anal incontinence: findings and influence on surgical management. *Am J Roentgenol* 1993;160:771-775.
153. Rociu E, Stoker J, Zwamborn AW, Lameris JS. Endoanal MR imaging of the anal sphincter in fecal incontinence. *Radiographics* 1999;19:S171-S177.
154. Rociu E, Stoker J, Eijkemans MJ, Schou-ten WR, Lameris JS. Fecal Incontinence: Endoanal US versus endoanal MR imaging. *Radiol* 1999;212:453-458.
155. Van Beers B, Kartheuser A, Delos M, Grandin C, Detry R, Jamart J, et al. MRI of the anal canal: correlation with histologic examination. *Magn Reson Imaging* 1996;14:151-156.
156. Williams A, Malouf A, Bartram C, Halligan S, Kamm M, Kmiot W. Assessment of external anal sphincter morphology in idiopathic fecal incontinence with endocoil magnetic resonance imaging. *Dig Dis Sci* 2001;46:1466-1471.
157. Beets-Tan RGH, Morren GL, Beets GL, Kessels AGH, el Naggar K, Lemaire E, et al. Measurement of Anal Sphincter Muscles: Endoanal US, Endoanal MR Imaging, or Phased-Array MR Imaging? A Study with Healthy Volunteers 1. *Radiol* 2001;220:81-89.
158. Beets-Tan RGH, Beets G, Van der Hoop A, Borstlap A, Van Boven H, Rongen M, et al. High-resolution magnetic resonance imaging of the anorectal region without an endocoil. *Abdom Imaging* 1999;24:576-581.
159. Fletcher JG, Busse R, Riederer SJ, Hough D, Gluecker T, Harper C, et al. Magnetic resonance imaging of anatomic and dynamic defects of the pelvic floor in defecatory disorders. *Am J Gastroenterol* 2003;98:399-411.

160. Morren G, Beets-Tan R, Van Engelshoven J. Anatomy of the anal canal and perianal structures as defined by phased-array magnetic resonance imaging. *Br J Surg* 2001;88:1506-1512.
161. Terra MP, Beets-Tan RG, van Der Hulst, Victor PM, Dijkgraaf MG, Bossuyt PM, Dobben AC, et al. Anal Sphincter Defects in Patients with Fecal Incontinence: Endoanal versus External Phased-Array MR Imaging 1. *Radiol* 2005;236:886-895.
162. Chen AS, Luchtefeld MA, Senagore AJ, MacKeigan JM, Hoyt C. Pudendal nerve latency. *Dis Colon Rectum* 1998;41:1005-1009.
163. Gilliland R, Altomare DF, Moreira Jr H, Oliveira L, Gilliland JE, Wexner SD. Pudendal neuropathy is predictive of failure following anterior overlapping sphincteroplasty. *Dis Colon Rectum* 1998;41:1516-1522.
164. Sangwan YP, Collier JA, Barrett RC, Murray JJ, Roberts PL, Schoetz Jr DJ. Unilateral pudendal neuropathy. *Dis Colon Rectum* 1996;39:249-251.
165. Briel J, Stoker J, Rociu E, Lameris J, Hop W, Schouten W. External anal sphincter atrophy on endoanal magnetic resonance imaging adversely affects continence after sphincteroplasty. *Br J Surg* 1999;86:1322-1327.
166. West R, Dwarkasing S, Briel J, Hansen B, Hussain S, Schouten W, et al. Can three-dimensional endoanal ultrasonography detect external anal sphincter atrophy? A comparison with endoanal magnetic resonance imaging. *Int J Colorectal Dis* 2005;20:328-333.
167. Malouf AJ, Williams AB, Halligan S, Bartram CI, Dhillon S, Kamm MA. Prospective assessment of accuracy of endoanal MR imaging and endosonography in patients with fecal incontinence. *Am J Roentgenol* 2000;175:741-745.
168. Rociu E, Stoker J, Eijkemans MJ, Laméris JS. Normal Anal Sphincter Anatomy and Age- and Sex-related Variations at High-Spatial-Resolution Endoanal MR Imaging 1. *Radiol* 2000;217:395-401.
169. Mittal RK, Bhargava V, Sheean G, Ledgerwood M, Sinha S. Purse-string morphology of external anal sphincter revealed by novel imaging techniques. *Am J Physiol-Gastrointest Liver Physiol* 2014;306:G505-G514.
170. Kessels IMH, Fütterer JJ, Sultan AH, Kluivers KB. Clinical symptoms related to anal sphincter defects and atrophy on external phased-array MR imaging. *Int Urogynecol J* 2015;26:1619-1627.
171. Bharucha AE, Fletcher JG, Melton LJ3, Zinsmeister AR. Obstetric trauma, pelvic floor injury and fecal incontinence: a population-based case-control study. *Am J Gastroenterol* 2012;107:902-911.
172. Lammers K, Fütterer JJ, Inthout J, Prokop M, Vierhout ME, Kluivers KB. Correlating signs and symptoms with pubovisceral muscle avulsions on magnetic resonance imaging. *Am J Obstet Gynecol* 2013;208:148.e1-148.e7.
173. Prichard D, Harvey DM, Fletcher JG, Zinsmeister AR, Bharucha AE. Relationship among anal sphincter injury, patulous anal canal, and anal pressures in patients with anorectal disorders. *Clin Gastroenterol Hepatol* 2015;13:1793-1800.
174. How P, Evans J, Moran B, Swift I, Brown G. Preoperative MRI sphincter morphology and anal manometry: Can they be markers of functional outcome following anterior resection for rectal cancer?. *Colorectal Dis* 2012;14:e339-e345.
175. Sun XB, Li DG, Sun XG, Liu Q, Li JL. Magnetic resonance imaging of children with fecal incontinence after anoplasty for anorectal malformation and its clinical significance. *Zhong-hua Wei Chang Wai Ke Za Zhi* 2013;16:439-442.
176. Yong C, Ruo-yi W, Yuan Z, Shu-hui Z, Guang-Rui S. MRI findings in patients with defecatory dysfunction after surgical correction of anorectal malformation. *Pediatr Radiol* 2013;43:964-970.
177. Gartner L, Peiris C, Marshall M, Taylor SA, Halligan S. Congenital anorectal atresia: MR imaging of late post-operative appearances in adult patients with anal incontinence. *Eur Radiol* 2013;23:3318-3324.
178. Rosato GO, Lumi CM, Miguel AM. Anal sphincter electromyography and pudendal nerve terminal motor latency assessment. *Seminars Colon Rectal Surg* 1992;3:68-74.
179. Rosato GO, Lumi CM. Neurophysiology in pelvic floor disorders. *Complex Anorectal Disorders: Springer*; 2005:153-169.
180. Dudding T, Pares D, Vaizey C, Kamm M. Predictive factors for successful sacral nerve stimulation in the treatment of faecal incontinence: a 10-year cohort analysis. *Colorectal Dis* 2008;10:249-256.
181. Amend B, Matzel KE, Abrams P, de Groat WC, Sievert K. How does neuromodulation work. *Neurourol Urodyn* 2011;30:762-765.

182. Italian Society of Colorectal Surgery (SICCR), Pucciani F, Altomare DF, Dodi G, Falletto E, Frasson A, et al. Diagnosis and treatment of faecal incontinence: Consensus statement of the Italian Society of Colorectal Surgery and the Italian Association of Hospital Gastroenterologists. *Dig Liver Dis* 2015;47:628-645.
183. Podnar S, Vodušek DB. Protocol for clinical neurophysiologic examination of the pelvic floor. *Neurourol Urodyn* 2001;20:669-682.
184. Podnar S, Mrkaić M, Vodušek DB. Standardization of anal sphincter electromyography: quantification of continuous activity during relaxation. *Neurourol Urodyn* 2002;21:540-545.
185. Bharucha AE, Daube J, Litchy W, Traue J, Edge J, Enck P, et al. Anal sphincteric neurogenic injury in asymptomatic nulliparous women and fecal incontinence. *Am J Physiol-Gastrointest Liver Physiol* 2012;303:G256-G262.
186. Pradal-Prat D, Mares P, Peray P, Lopez S, Gagnard-Landra C. Pudendal nerve motor latency correlation by age and sex. *Electromyogr Clin Neurophysiol* 1998;38:491-496.
187. Ryhammer AM, Laurberg S, Hermann AP. Long-term effect of vaginal deliveries on anorectal function in normal perimenopausal women. *Dis Colon Rectum* 1996;39:852-859.
188. Laurberg S, Swash M. Effects of aging on the anorectal sphincters and their innervation. *Dis Colon Rectum* 1989;32:737-742.
189. Swash M, Snooks S. Electromyography in pelvic floor disorders. *Coloproctology and the pelvic floor: pathophysiology and management*. Butterworths, London 1992:252-256.
190. Barnett JL, Hasler WL, Camilleri M. American Gastroenterological Association medical position statement on anorectal testing techniques. *American Gastroenterological Association. Gastroenterol* 1999;116:732-760.
191. Lefaucheur J. Neurophysiological testing in anorectal disorders. *Muscle Nerve* 2006;33:324-333.
192. Rasmussen OØ, Christiansen J, Te-tzschner T, Sørensen M. Pudendal nerve function in idiopathic fecal incontinence. *Dis Colon Rectum* 2000;43:633-636.
193. Leroi A, Dorival M, Lecouturier M, Saiter C, Welter M, Touchais J, et al. Pudendal neuropathy and severity of incontinence but not presence of an anal sphincter defect may determine the response to biofeedback therapy in fecal incontinence. *Dis Colon Rectum* 1999;42:762-769.
194. Rogers J. Rectal and anal sensation. Henry M, Swash MM (1992) *Coloproctology and the Pelvic Floor*. Butterworth-Heinemann, Oxford 1992:54-60.
195. Roe A, Bartolo D. New method for assessment of anal sensation in various anorectal disorders. *Br J Surg* 1986;73:310-312.
196. Sigel H. Cutaneous Sensory Threshold Stimulation with High Frequency Square-Wave Current: II. The Relationship of Body Site and of Skin Diseases to the Sensory Threshold. *J Invest Dermatol* 1952;18:447-451.
197. Vierck Jr CJ, Greenspan JD, Ritz LA, Yeomans DC. The spinal pathways contributing to the ascending conduction and the descending modulation of pain sensations and reactions. *Spinal afferent processing*: Springer; 1986; 275-329.
198. Pescatori M, Anastasio G, Bottini C, Men-tasti A. New grading and scoring for anal incontinence. *Dis Colon Rectum* 1992;35:482-487.
199. Markland AD, Richter HE, Burgio KL, Wheeler TL, Redden DT, Goode PS. Outcomes of combination treatment of fecal incontinence in women. *Am J Obstet Gynecol* 2008;199:699.e1-699.e7
200. Bharucha AE, Locke G, Seide B, Zinsmeister AR. A new questionnaire for constipation and faecal incontinence. *Aliment Pharmacol Therap* 2004;20:355-364.
201. Sansoni J, Hawthorne G, Fleming G, Maroszeky N. The revised faecal incontinence scale: a clinical validation of a new, short measure for assessment and outcomes evaluation. *Dis Colon Rectum* 2013;56:652-659.
202. Bharucha AE, Zinsmeister AR, Locke GR, Seide BM, McKeon K, Schleck CD, et al. Risk factors for fecal incontinence: a population-based study in women. *Am J Gastroenterol* 2006;101:1305-1312.
203. Bharucha AE, Seide BM, Zinsmeister AR, Melton III LJ. Relation of bowel habits to fecal incontinence in women. *Am J Gastroenterol* 2008;103:1470-1475.
204. Norton NJ. The perspective of the patient. *Gastroenterology* 2004;126:S175-S179.
205. Chan CL, Scott SM, Williams NS, Lunniss PJ. Rectal hypersensitivity worsens stool frequency, urgency, and lifestyle in patients with urge fecal incontinence. *Dis Colon Rectum* 2005;48:134-140.
206. Hull T, Giese C, Wexner SD, Mellgren A, Devroede G, Madoff RD, et al. Long-term durability of sacral nerve stimulation therapy for chronic fecal incontinence. *Dis Colon Rectum* 2013;56:234-245.

207. Graf W, Mellgren A, Matzel KE, Hull T, Johansson C, Bernstein M, et al. Efficacy of dextranomer in stabilised hyaluronic acid for treatment of faecal incontinence: a randomised, sham-controlled trial. *Lancet* 2011;377:997-1003.
208. Wald A. Clonidine and botulinum toxin: a tale of two treatments. *Clin Gastroenterol Hepatol* 2014;12:852-853.
209. Jaeschke R, Singer J, Guyatt GH. Measurement of health status: ascertaining the minimal clinically important difference. *Control Clin Trials* 1989;10:407-415.
210. Crosby RD, Kolotkin RL, Williams GR. Defining clinically meaningful change in health-related quality of life. *J Clin Epidemiol* 2003;56:395-407.
211. Norman GR, Sloan JA, Wyrwich KW. Is it simple or simplistic? *Med Care* 2003;41:599-600.
212. Jelovsek J.E., Chen Z., Markland A.D., Brubaker L., Dyer K.Y., Meikle S., et al. Minimum important differences for scales assessing symptom severity and quality of life in patients with fecal incontinence. *Female Pelvic Med Reconstr Surg* 2014;20:342-348.
213. Noeltling J, Zinsmeister AR, Bharucha A. Validating endpoints for therapeutic trials in fecal incontinence. *Neurogastroent Motil* 2016;28:1148-1146.
214. Lee JT, Madoff RD, Rockwood TH. Quality-of-life measures in fecal incontinence: is validation valid? *Dis Colon Rectum* 2015;58:352-357.
215. Rogers RG, Rockwood TH, Constantine ML, Thakar R, Kammerer-Doak DN, Pauls RN, et al. A new measure of sexual function in women with pelvic floor disorders (PFD): the Pelvic Organ Prolapse/Incontinence Sexual Questionnaire, IUGA-Revised (PISQ-IR). *Int Urogynecol J* 2013;24:1091-1103.
216. Rothbarth J, Bemelman WA, Meijerink WJ, Stiggelbout AM, Zwinderman AH, Buyze-Westervel ME, et al. What is the impact of fecal incontinence on quality of life? *Dis Colon Rectum* 2001;44:67-71.
217. Pucciani F, Iozzi L, Masi A, Cianchi F, Cortesini C. Multimodal rehabilitation for faecal incontinence: experience of an Italian centre devoted to faecal disorder rehabilitation. *Tech Coloproctol* 2003;7:139-147.
218. Deutekom M, Terra M, Dobben A, Dijkgraaf M, Baeten C, Stoker J, et al. Impact of faecal incontinence severity on health domains. *Colorectal Dis* 2005;7:263-269.
219. Bharucha AE, Fletcher JG, Edge J, Zinsmeister AR. A Placebo-Controlled Study of Clonidine on Symptoms in Women With Fecal Incontinence. *Gastroenterol* 2014;12:843-851.
220. Wilde MH, Bliss DZ, Booth J, Cheater FM, Tannenbaum C. Self-Management of Urinary and Fecal Incontinence. *Am J Nurs* 2014;114:38-47.
221. Peden-McAlpine C, Bliss D, Hill J. The experience of community-living women managing fecal incontinence. *West J Nurs Res* 2008;30:817-835.
222. Hansen JL, Bliss DZ, Peden-McAlpine C. Diet strategies used by women to manage fecal incontinence. *J Wound Ostomy Continence Nurs* 2006;33:52-61.
223. Peden-McAlpine C, Bliss D, Becker B, Sherman S. The experience of community-living men managing fecal incontinence. *Rehabil Nurs* 2012 11;37:298-306.
224. Landers M., Savage E., McCarthy G., Fitzpatrick JJ. Self-care strategies for the management of bowel symptoms following sphincter-saving surgery for rectal cancer. *Clin J Oncol Nurs* 2011;15:E105-E113.
225. Drennan VM, Cole L, Iliffe S. A taboo within a stigma? a qualitative study of managing incontinence with people with dementia living at home. *BMC Geriatr* 2011;11:75.
226. Ballard AC, Richter HE. Impact of obesity and weight loss on urinary and bowel incontinence symptoms in women. *Sex Reprod Menopause* 2011;9:S1-S7.
227. Poylin V, Serrot FJ, Madoff RD, Ikramuddin S, Ikramuddin S, Mellgren A, et al. Obesity and bariatric surgery: a systematic re-view of associations with defecatory dysfunction. *Colorectal Dis* 2011;13:e92-e103.
228. Scozzari G, Rebecchi F, Giaccone C, Chiaro P, Mistrangelo M, Morino M. Bariatric surgery improves urinary incontinence but not anorectal function in obese women. *Obesity Surg* 2013;23:931-938.
229. Norton C, Chelvanayagam S, Wilson-Barnett J, Redfern S, Kamm MA. Randomized controlled trial of biofeedback for fecal incontinence. *Gastroenterol* 2003;125:1320-1329.
230. Clemesha L, Davies E. Educating home carers on faecal continence in people with dementia. *Nurs Stand* 2004;18:33-40.

231. Markland AD, Richter HE, Burgio KL, Myers DL, Hernandez AL, Subak LL. Weight loss improves fecal incontinence severity in overweight and obese women with urinary incontinence. *Int Urogynecol J Pelvic Floor Dysfunct* 2011;22:1151-1157.
232. Burgio KL, Richter HE, Clements RH, Redden DT, Goode PS. Changes in urinary and fecal incontinence symptoms with weight loss surgery in morbidly obese women. *Obstet Gynecol* 2007;110:1034-1040.
233. Roberson EN, Gould JC, Wald A. Urinary and fecal incontinence after bariatric surgery. *Dig Dis Sci* 2010;55:2606-2613.
234. Scott AM, Kellow JE, Eckersley GM, Nolan JM, Jones MP. Cigarette smoking and nicotine delay postprandial mouth-cecum transit time. *Dig Dis Sci* 1992;37:1544-1547.
235. Rausch T, Beglinger C, Alam N, Gyr K, Meier R. Effect of transdermal application of nicotine on colonic transit in healthy nonsmoking volunteers. *Neurogastroenterol Motil* 1998;10:263-270.
236. Abramov Y, Sand PK, Botros SM, Gandhi S, Miller JJ, Nickolov A, et al. Risk factors for female anal incontinence: new insight through the Evanston-Northwestern twin sisters study. *Obstet Gynecol* 2005;106:726-732.
237. Chaliha C, Kalia V, Stanton SL, Monga ASH, Sultan AH. Antenatal prediction of postpartum urinary and fecal incontinence. *Obstet Gynecol* 1999;94:689-694.
238. Ostbye T, Seim A, Krause KM, Feightner J, Hachinski V, Sykes E, et al. A 10-year follow-up of urinary and fecal incontinence among the oldest old in the community: the Canadian Study of Health and Aging. *Canadian J Aging* 2004;23:319-331.
239. Pares D, Vallverdu H, Monroy G, Amigo P, Romagosa C, Toral M, et al. Bowel habits and fecal incontinence in patients with obesity undergoing evaluation for weight loss: the importance of stool consistency. *Dis Colon Rectum* 2012;55:599-604.
240. Heymen S, Jones KR, Ringel Y, Scarlett Y, Whitehead WE. Biofeedback treatment of fecal incontinence. *Dis Colon Rectum* 2001;44:728-736.
241. Nazarko L. Commode design for frail and disabled people. *Prof Nurs* 1995;11:95-97.
242. Naylor JR, Mulley GP. Commodes: inconvenient conveniences. *BMJ* 1993;307:1258-1260.
243. White H. Making toilets more accessible for individuals with a disability. *Bowel Continence Nurs* 2004;161-177.
244. Grundmann O, Yoon SL. Complementary and alternative medicines in irritable bowel syndrome: An integrative view. *World J Gastroenterol* 2014;20:346-362.
245. Dowd T, Dowd ET. A cognitive therapy approach to promote continence. *J Wound Ostomy Continence Nurs* 2006;33:63-68.
246. ICS Nursing Committee. Library. Available at: <http://www.ics.org/committees/nursing/library>. Accessed August 3, 2016.
247. ICS. Impartial advice for continence product users & healthcare professionals. Available at: <http://www.continenceproductadvisor.org/>. Accessed August 3, 2016.
248. Cichowski SB, Dunivan GC, Rogers RG, Murrietta AM, Komesu YM. Standard compared with mnemonic counseling for fecal incontinence: a randomized controlled trial. *Obstet Gynecol* 2015; 125:1063-1070.
249. Bussen D, Herold A, Bussen S. Incidence of obesity in female patients with fecal incontinence. *Viszeralmedizin: Gastrointest Med Surg* 2012;28:275-279.
250. Ellington DR, Polin MR, Szychowski JM, Deng L, Richter HE. The effect of obesity on fecal incontinence symptom distress, quality of life, and diagnostic testing measures in women. *Int Urogynecol J* 2013;24:1733-1738.
251. Woodward S, Norton C, Bariball KL. Use of and attitudes to complementary and alternative medicine in patients with functional bowel disorders. *Gastrointest Nurs* 2012;10:31-35.
252. Lorbach S. Naturopathic treatment for bowel incontinence in a patient with multiple sclerosis: A case study. *Aust J Herbal Med* 2015;27:62-66.
253. McDowell JM, Kohut SH, Johnson GM. Trigger point acupuncture (Dry Needling) and associated fecal incontinence in multiple sclerosis: A case report. *Med Acupunct* 2015;27:283-287.
254. Bliss DZ, Fischer LR, Savik K, Avery M, Mark P. Severity of fecal incontinence in community-living elderly in a health maintenance organization. *Res Nurs Health* 2004;27:162-173.
255. Bliss DZ, Fischer LR, Savik K. Self-care practices of the elderly to manage fecal incontinence. *J Gerontol Nurs* 2005;31:35-44.
256. Brown SR, Cann PA, Read NW. Effect of coffee on distal colon function. *Gut* 1990;31:450-453.
257. Dennish LT, George W, Castell CDR, Donald O. Caffeine and the lower esophageal sphincter. *Dig Dis Sci* 1972;17:993-996.

258. Debas HT, Cohen MM, Holubitsky IB, Harrison RC. Caffeine-stimulated acid and pep-sin secretion: dose-response studies. *Scand J Gastroenterol* 1971;6:453-457.
259. Acquaviva F, De Francesco A, Andriulli A, Piantino P, Arrigoni A, Massarenti P, et al. Effect of regular and decaffeinated coffee on serum gastrin levels. *J Clin Gastroenterol* 1986;8:150-153.
260. Wald A, Back C, Bayless TM. Effect of caffeine on the human small intestine. *Gas-troenterol* 1976;71:738-742.
261. Izbeki F, Wittmann T, Csati S, Jeszenszky E, Lonovics J. Opposite effects of acute and chronic administration of alcohol on gastric emptying and small bowel transit in rat. *Alcohol Alcohol* 2001;36:304-308.
262. Bujanda L. The effects of alcohol consumption upon the gastrointestinal tract. *Am J Gastroenterol* 2000;95:3374-3382.
263. Bode C, Bode JC. Effect of alcohol consumption on the gut. *Best Pract Res Clin Gastroenterol* 2003;17:575-592.
264. Jairath V, Langmead L. Acute gastroenterology. *Clin Med* 2007;7:262-266.
265. Segal S., Saks E.K., Asfaw T.S., Arya LA. Increased fluid intake is associated with bothersome bowel symptoms among women with urinary incontinence. *Female Pelvic Med Reconstr Surg* 2013;19:152-156.
266. Parker-Autry CY, Gleason JL, Griffin RL, Markland AD, Richter HE. Vitamin D deficiency is associated with increased fecal incontinence symptoms. *Int Urogynecol J Pelvic Floor Dysfunct* 2014; 25:1483-1489.
267. Cho S, DeVries JW, Prosky L. Dietary fiber analysis and applications. Gaithersburg, MD: AOAC International; 1997.
268. Bliss DZ, Savik K, Jung HG, Whitebird R, Lowry A. Symptoms associated with dietary fiber supplementation over time in individuals with fecal incontinence. *Nurs Res* 2011;60:S58-S67.
269. Sze EH, Hobbs G. Efficacy of methyl-cellulose and loperamide in managing fecal incontinence. *Acta Obstet Gynecol Scand* 2009;88:766-771.
270. van der Hagen SJ, Soeters PB, Baeten CG, van Gemert WG. Conservative treatment of patients with faecal soiling. *Tech Coloproctol* 2011;15:291-295.
271. Lauti M, Scott D, Thompson-Fawcett M. Fibre supplementation in addition to loperamide for faecal incontinence in adults: a randomized trial. *Colorectal Dis* 2008;10:553-562.
272. Markland AD, Burgio KL, Whitehead WE, Richter HE, Wilcox CM, Redden DT, et al. Loperamide Versus Psyllium Fiber for Treatment of Fecal Incontinence: The Fecal Incontinence Prescription (Rx) Management (FIRM) Randomized Clinical Trial. *Dis Colon Rectum* 2015;58:983-993.
273. Bliss DZ, Weimer PJ, Jung HG, Savik K. In vitro degradation and fermentation of three dietary fiber sources by human colonic bacteria. *J Agric Food Chem* 2013;61:4614-4621.
274. Doughty D. A physiologic approach to bowel training. *J Wound Ostomy Continence Nurs* 1996;23:46-56.
275. Norton C, Chelvanayagam S. Bowel continence nursing. Beaconsfield Bucks, UK: Beaconsfield Publishers; 2004.
276. Narducci F, Bassotti G, Gaburri M, Morelli A. Twenty four hour manometric recording of colonic motor activity in healthy man. *Gut* 1987;28:17-25.
277. Bassotti G, Crowell MD, Cheskin LJ, Chami TN, Schuster MM, Whitehead WE. Physiological correlates of colonic motility in patients with irritable bowel syndrome. *Z Gastroenterol* 1998;36:811-817.
278. Shandling B, Gilmour RF. The enema continence catheter in spina bifida: successful bowel management. *J Pediatr Surg* 1987;22:271-273.
279. Hamonet-Torny J, Bordes J, Daviet J, Dalmay F, Joslin F, Salle J. Long-term transanal irrigation's continuation at home. Preliminary study. *Ann Phys Rehabil Med* 2013;56:134-142.
280. Collins B., Norton C. Managing passive incontinence and incomplete evacuation. *Br J Nurs* 2013;22:575-579.
281. Rosen H, Robert-Yap J, Tentschert G, Lechner M, Roche B. Transanal irrigation improves quality of life in patients with low anterior resection syndrome. *Colorectal Dis* 2011;13:e335-8.
282. Patton V, Lubowski DZ. Clinical outcome and efficacy of antegrade colonic enemas administered via an indwelling cecostomy catheter in adults with defecatory disorders. *Dis Colon Rectum* 2015;58:457-462.
283. Lyons M. Group sessions: experimental approach to support patients using rectal irrigation. *Gastrointest Nurs* 2013;11:42-48.

284. Sjodahl J, Walter SA, Johansson E, Ingemansson A, Ryn AK, Hallbook O. Combination therapy with biofeedback, loperamide, and stool-bulking agents is effective for the treatment of fecal incontinence in women: A randomized controlled trial. *Scand J Gastroenterol* 2015;50:965-974.
285. Collins E, Hibberts F, Lyons M, Williams AB, Schizas AM. Outcomes in non-surgical management for bowel dysfunction. *Br J Nurs* 2014;23:776-780.
286. Omar MI, Alexander CE. Drug treatment for faecal incontinence in adults. *Cochrane Database of Systematic Reviews* 2013:1-59.
287. Abbas B, Bissett I, Neill M, Macmillan A, Milne D, Parry B. Long-term results of the anterior Delorme's operation in the management of symptomatic rectocele. *Dis Colon Rectum* 2005;48:317-322.
288. Turnbull G, Bartram C, Lennard-Jones J. Radiologic studies of rectal evacuation in adults with idiopathic constipation. *Dis Colon Rectum* 1988;31:190-197.
289. Ayabaca SM, Zbar AP, Pescatori M. Anal continence after rectocele repair. *Dis Colon Rectum* 2002;45:63-69.
290. Palmer LS. Pediatrics: Clock-watching: timer-assisted urotherapy improves continence. *Nat Rev Urol* 2011;8:13-14.
291. Fox M, Stutz B, Menne D, Fried M, Schwizer W, Thumshirn M. The effects of loperamide on continence problems and anorectal function in obese subjects taking orlistat. *Dig Dis Sci* 2005;50:1576-1583.
292. Bartram CI, Turnbull GK, Lennard-Jones JE. Evacuation proctography: an investigation of rectal expulsion in 20 subjects without defecatory disturbance. *Gastrointest Radiol* 1988;13:72-80.
293. Woodfield CA, Krishnamoorthy S, Hampton BS, Brody JM. Imaging pelvic floor disorders: trend toward comprehensive MRI. *Am J Roentgenol* 2010;194:1640-1649.
294. Bertschinger KM, Hetzer FH, Roos JE, Treiber K, Marincek B, Hilfiker PR. Dynamic MR Imaging of the Pelvic Floor Performed with Patient Sitting in an Open-Magnet Unit versus with Patient Supine in a Closed-Magnet Unit 1. *Radiol* 2002;223:501-508.
295. Nurko S, Scott S. Coexistence of constipation and incontinence in children and adults. *Best Pract Res Clin Gastroenterol* 2011;25:29-41.
296. Lembo AJ, Lacy BE, Zuckerman MJ, Schey R, Dove LS, Andrae DA, et al. Eluxadoline for irritable bowel syndrome with diarrhoea. *N Engl J Med* 2016;374:242-253.
297. Lacy B. Emerging treatments in neuro-gastroenterology: eluxadoline—a new therapeutic option for diarrhoea-predominant IBS. *Neurogastroenterol Motil* 2016;28:26-35.
298. Siproudhis L, Graf W, Emmanuel A, Walker D, Shing RNK, Pediconi C, et al. Libertas: a phase II placebo-controlled study of NRL001 in patients with faecal incontinence showed an unexpected and sustained placebo response. *Int J Colorectal Dis* 2016;31:1205-1216.
299. Bharucha AE, Seide B, Zinsmeister AR. The effects of clonidine on symptoms and ano-rectal sensorimotor function in women with faecal incontinence. *Aliment Pharmacol Therap* 2010;32:681-688.
300. Schwandner T, Konig IR, Heimerl T, Kierer W, Roblick M, Bouchard R, et al. Triple target treatment (3T) is more effective than biofeedback alone for anal incontinence: the 3T-AI study. *Dis Colon Rectum* 2010;53:1007-1016.
301. Remes-Troche JM, Rao SS. Neuro-physiological testing in anorectal disorders. *Expert Rev Gastroenterol Hepatol* 2008;2:323-335.
302. Demirci S, Gallas S, Bertot-Sassigneux P, Michot F, Denis P, Leroi A. Anal incontinence: the role of medical management. *Gastroenterol Clin Biol* 2006;30:954-960.
303. Santoro GA, Eitan BZ, Pryde A, Bartolo DC. Open study of low-dose amitriptyline in the treatment of patients with idiopathic fecal incontinence. *Dis Colon Rectum* 2000;43:1676-1681.
304. Guillemot F, Bouche B, Gower-Rousseau C, Chattier M, Wolschies E, Lamblin M, et al. Biofeedback for the treatment of fecal incontinence. *Dis Colon Rectum* 1995;38:393-397.
305. Heymen S, Scarlett Y, Jones K, Ringel Y, Drossman D, Whitehead WE. Randomized controlled trial shows biofeedback to be superior to pelvic floor exercises for fecal incontinence. *Dis Colon Rectum* 2009;52:1730-1737.
306. Solomon MJ, Pager CK, Rex J, Roberts R, Manning J. Randomized, controlled trial of biofeedback with anal manometry, transanal ultrasound, or pelvic floor retraining with digital guidance alone in the treatment of mild to moderate fecal incontinence. *Dis Colon Rectum* 2003;46:703-710.
307. Norton C, Gibbs A, Kamm MA. Randomized, controlled trial of anal electrical stimulation for fecal incontinence. *Dis Colon Rectum* 2006;49:190-196.
308. Whitehead WE, Heymen S, Schuster MM. Motility as a therapeutic modality: Biofeedback. *Schuster Atlas Gastrointest Motil Health Dis* 1993:300-316.

309. Basilisco G, De Marco E, Tomba C, Cesana BM. Bowel urgency in patients with irritable bowel syndrome. *Gastroenterol* 2007;132:38-44.
310. Whitehead WE, Crowell MD, Davidoff AL, Pals-son OS, Schuster MM. Pain from rectal disten-sion in women with irritable bowel syndrome (relationship to sexual abuse). *Dig Dis Sci* 1997;42:796-804.
311. Prior A, Serial E, Sun W, Read NW. Irritable bowel syndrome: differences between patients who show rectal sensitivity and those who do not. *Eur J Gastroenterol Hepatol* 1993;5:343-350.
312. Markland AD, Jelovsek JE, Whitehead WE, Newman DK, Andy UU, Dyer K, et al. Im-proving biofeedback for the treatment of fecal incontinence in women: implementation of a stand-ardized multi-site manometric biofeedback pro-tocol. *Neurogastroenterol Motil* 2016.
313. Hosker G, Cody JD, Norton CC. Electrical stim-ulation for faecal incontinence in adults. *Cochrane Database of Systematic Reviews* 2007:1-50.
314. Vonthein R, Heimerl T, Schwandner T, Ziegler A. Electrical stimulation and biofeedback for the treatment of fecal incontinence: a sys-tematic review. *Int J Colorectal Dis* 2013;28:1567-1577.
315. Horrocks E, Thin N, Thaha M, Taylor S, Norton C, Knowles C. Systematic review of tibial nerve stimulation to treat faecal incontinence. *Br J Surg* 2014;101:457-468.
316. Norton C, Cody JD. Biofeedback and/or sphinc-ter exercises for the treatment of faecal inconti-nence in adults. *Cochrane Database of Sys-tematic Reviews* 2012:1-38.
317. Norton C, Hosker G, Brazzelli M. Biofeed-back and/or sphincter exercises for the treat-ment of faecal incontinence in adults. *Cochrane Data-base of Systematic Reviews* 2006:1-96.
318. Bliss DZ, Mellgren A, Whitehead WE, Chiarioni G, Emmanuel A, Santoro G, et al. Assessment and conservative management of faecal incontinence and quality of life in adults. In P. Abrams, L. Cardoso, S. Khoury, & A. Wein (Eds). *Incontinence*, 5th ed. Paris: ICUD-EAU 2013:1444-1485.
319. Leroi A, Parc Y, Lehur P, Mion F, Barth X, Rul-lier E, et al. Efficacy of sacral nerve stimula-tion for fecal incontinence: results of a multicen-ter double-blind crossover study. *Ann Surg* 2005;242:662-669.
320. Wexner SD, Collier JA, Devroede G, Hull T, McCallum R, Chan M, et al. Sacral nerve stim-ulation for fecal incontinence: results of a 120-patient prospective multicenter study. *Ann Surg* 2010;251:441-449.
321. George AT, Maitra RK, Maxwell-Armstrong C. Posterior tibial nerve stimulation for fecal inconti-nence: where are we? *World J Gastroenterol* 2013;19:9139-9145.
322. Thomas GP, Dudding TC, Rahbour G, Nicholls RJ, Vaizey CJ. A review of posterior tibial nerve stimulation for faecal incontinence. *Colorectal Dis* 2013;15:519-526.
323. Damon H, Siproudhis L, Faucheron JL, Piche T, Abramowitz L, Eleouet M, et al. Perineal re-training improves conservative treatment for faecal incontinence: A multicentre randomized study. *Dig Liver Dis* 2014;46:237-242.
324. Jelovsek JE, Markland AD, Whitehead WE, Barber MD, Newman DK, Rogers RG, et al. Controlling anal incontinence in women by per-forming anal exercises with biofeedback or loperamide (CAPABLE) trial: Design and meth-ods. *Contemp Clin Trials* 2015;44:164-174.
325. Schwandner T, Hemmelmann C, Heimerl T, Kierer W, Kolbert G, Vonthein R, et al. Triple-target treatment versus low-frequency elec-trostimulation for anal incontinence. *Dtsch Arzte-bl Int* 2011;108:653-660.
326. Cohen-Zubary N, Gingold-Belfer R, Lambort I, Wasserberg N, Krissi H, Levy S, et al. Home electrical stimulation for women with fecal incontinence: a preliminary randomized controlled trial. *Int J Colorectal Dis* 2015;30:521-528.
327. Dehli T., Stordahl A., Vatten L.J., Romundstad P.R., Mevik K., Sahlin Y., et al. Sphincter training or anal injections of dextranomer for treat-ment of anal incontinence: A randomized trial. *Scand J Gastroenterol* 2013;48:302-310.
328. Bartlett L, Sloots K, Nowak M, Ho Y. Sup-plementary home biofeedback improves quality of life in younger patients with fecal inconti-nence. *J Clin Gastroenterol* 2015;49:419-428.
329. Peirce C, Murphy C, Fitzpatrick M, Cassidy M, Daly L, O'Connell PR, et al. Randomised controlled trial comparing early home biofeed-back physiotherapy with pelvic floor exercises for the treatment of third-degree tears (EBAPT Trial). *Br J Obstet Gynaecol* 2013;120:1240-1247.
330. Glazener CMA, MacArthur C, Hagen S, Elders A, Lancashire R, Herbison GP, et al. Twelve-year follow-up of conservative manage-ment of postnatal urinary and faecal inconti-nence and prolapse outcomes: randomised controlled trial. *Br J Obstet Gynaecol* 2014;121:112-120.

331. Lin Y, Yang H, Hung S, Chen H, Liu K, Chen T, et al. Effects of pelvic floor muscle exercise on faecal incontinence in rectal cancer patients after stoma closure. *Eur J Cancer Care* 2015;449-457.
332. Leroi AM, Siproudhis L, Etienney I, Damon H, Zerbib F, Amarenco G, et al. Transcutaneous electrical tibial nerve stimulation in the treatment of fecal incontinence: A randomized trial (Con-sort 1a). *Am J Gastroenterol* 2012;107:1888-1896.
333. George AT, Kalmar K, Sala S, Kopanakis K, Panarese A, Dudding TC, et al. Randomized controlled trial of percutaneous versus transcutaneous posterior tibial nerve stimulation in faecal incontinence. *Br J Surg* 2013;100:330-338.
334. Knowles CH, Horrocks EJ, Bremner SA, Stevens N, Norton C, O'Connell PR, et al. Percutaneous tibial nerve stimulation versus sham electrical stimulation for the treatment of faecal incontinence in adults (CONFIDeNT): a double-blind, multicentre, pragmatic, parallel-group, randomised controlled trial. *Lancet* 2015;386:1640-1648.
335. Thin N, Taylor S, Bremner S, Emmanuel A, Hounsome N, Williams N, et al. Randomized clinical trial of sacral versus percutaneous tibial nerve stimulation in patients with faecal incontinence. *Br J Surg* 2015;102:349-358.
336. Laforest A, Bretagnol F, Mouazan AS, Maggiori L, Ferron M, Panis Y. Functional disorders after rectal cancer resection: Does a rehabilitation programme improve anal continence and quality of life?. *Colorectal Dis* 2012;14:1231-1237.
337. Rao SSC, Benninga MA, Bharucha AE, Chiaroni G, Di Lorenzo C, Whitehead WE. ANMS-ESNM position paper and consensus guidelines on biofeedback therapy for anorectal disorders. *Neurogastroenterol Motil* 2015;27:594-609.
338. Rao SSC. Diagnosis and management of fecal incontinence. *Am J Gastroenterol* 2004;99:1585-1604.
339. Visser WS, Te Riele WW, Boerma D, Van Ramshorst B, Van Westreenen HL. Pelvic floor rehabilitation to improve functional outcome after a low anterior resection: A systematic review. *Ann Coloproctol* 2014;30:109-114.
340. Berghmans LCM, Groot JAM, van Heeswijk-Faase IC, Bols EMJ. Dutch evidence statement for pelvic physical therapy in patients with anal incontinence. *Int Urogynecol J Pelvic Floor Dysfunct* 2015;26:487-496.
341. Chelvanayagam S, Norton C. Quality of life with faecal continence problems. *Nurs Times* 2000;96:15-17.
342. Beck CT. Critiquing qualitative research. *AORN J* 2009;90:543-554.
343. Caelli K, Ray L, Mill J. 'Clear as mud': To-ward greater clarity in generic qualitative re-search. *Int J Qual Methods* 2003;2:1-13.
344. Cohen DJ, Crabtree BF. Evaluative criteria for qualitative research in health care: contro-versies and recommendations. *Ann Fam Med* 2008;6:331-339.
345. Koro-Ljungberg M. Validity and validation in the making in the context of qualitative re-search. *Qual Health Res* 2008;18:983-989.
346. Meyrick J. What is good qualitative research? A first step towards a comprehensive approach to judging rigour/quality. *J Health Psychol* 2006;11:799-808.
347. Polit DF, Beck CT. *Nursing research: Generat-ing and assessing evidence for nursing prac-tice*. Philadelphia: Lippincott Williams & Wil-kins; 2008.
348. Sandelowski M, Barroso J. Reading qualitative studies. *Int J Qual Methods* 2002;1:74-108.
349. Stige B, Malterud K, Midtgarden T. Toward an agenda for evaluation of qualitative research. *Qual Health Res* 2009;19:1504-1516.
350. Hannes K, Lockwood C, Pearson A. A compar-ative analysis of three online appraisal instru-ments' ability to assess validity in qualita-tive research. *Qual Health Res* 2010;20:1736-1743.
351. Morse JM, Barrett M, Mayan M, Olson K, Spi-ers J. Verification strategies for establishing re-liability and validity in qualitative research. *Int J Qual Methods* 2002;1:13-22.
352. Van Manen M. *Researching lived experience: Human science for an action sensitive peda-gogy*. New York: State University of New York Press; 1990.
353. Roe B, May C. Incontinence and sexuality: find-ings from a qualitative perspective. *J Adv Nurs* 1999;30:573-579.
354. Collings S, Norton C. Women's experiences of faecal incontinence: A study. *Br J Community Nurs* 2004;9:520-523.
355. Olsson F, Bertero C. Living with faecal inconti-nence: trying to control the daily life that is out of control. *J Clin Nurs* 2015;24:141-150.
356. Rasmussen JL, Ringsberg KC. Being involved in an everlasting fight—a life with postnatal fae-cal incontinence. A qualitative study. *Scand J Caring Sci* 2010;24:108-115.

357. Dibley L, Norton C. Experiences of fecal incontinence in people with inflammatory bowel disease: Self-reported experiences among a community sample. *Inflamm Bowel Dis* 2013;19:1450-1462.
358. Rozmovits L, Ziebland S. Expressions of loss of adulthood in the narratives of people with colorectal cancer. *Qual Health Res* 2004;14:187-203.
359. Wilson M. Living with faecal incontinence: A 10-year follow-up study. *Br J Nurs* 2015;24:268-274.
360. Wilson M. Living with faecal incontinence: follow-up to a research project. *Br J Nurs* 2013;22:147-153.
361. Norton C, Dibley L. Help-seeking for fecal incontinence in people with inflammatory bowel disease. *J Wound Ostomy Continence Nurs* 2013;40:631-638.
362. The Joanna Briggs Institute. Checklist for Qualitative Research. Available at: http://joanna-briggs.org/assets/docs/critical-appraisal-tools/JBI_Critical_Appraisal-Checklist_for_Qualitative_Research.pdf. Accessed August 3, 2016.
363. Johnsen V, Skattebu E, Aamot-Andersen A, Thyberg M. Problematic aspects of faecal incontinence according to the experience of adults with spina bifida. *J Rehabil Med* 2009;41:506-511.
364. Wilson M, McColl E. The experience of living with faecal incontinence. *Nurs Times* 2007;103:46-49.
365. Norton C, Chelvanayagam S. Bowel problems and coping strategies in people with multiple sclerosis. *Br J Nurs* 2010;19:220-226.

APPENDIX 1

Literature Search Strategies

Clinical Assessment

The following search terms were used in The following search terms were used in searching PubMed, Web of Science and Cochrane Review databases: faecal incontinence, fecal incontinence, anal incontinence, symptoms, signs, clinical assessment, history, examination, digital examination, vaginal examination. The search was conducted for the literature from January 1, 2011 until December 31, 2015, because the literature before January 1, 2011 was covered by the previous edition of this chapter.

Endoanal Ultrasound Imaging

The following search terms were used for Pub-Med, Web of Science and Cochrane reviews: faecal incontinence, fecal incontinence, anal incontinence, endoanal ultrasound, endovaginal ultrasound, transperineal ultrasound, translabial ultrasound, pelvic floor ultrasound, obstetric anal sphincter injuries (OASIS), three-dimensional ultrasound. The search was conducted for the literature from January 1, 2011 until March 31, 2016, because the literature before January 1, 2011 was covered by the previous edition of this chapter.

Defaecography

The following search terms were used for PubMed, Web of Science and Cochrane reviews: faecal incontinence, fecal incontinence, anal incontinence, defecography, evacuation proctography, MRI defecography, ventral rectopexy. The search was conducted for the literature from January 1, 2011 until December 31, 2015, because the literature before January 1, 2011 was covered by the previous edition of this chapter.

Magnetic Resonance Imaging (MRI)

The following search terms were used in searches in PubMed and Cochrane Reviews: MRI faecal incontinence, MRI fecal incontinence, MRI anal incontinence. The search was conducted from January 1, 2011 until December 31, 2015, because the literature before January 1, 2011 was covered by the previous edition of this chapter.

Clinical Neurophysiologic Testing

A search of PubMed, Web of Science, CINAHL and Cochrane reviews was undertaken using the following terms: f(a)ecal incontinence, anal incontinence, neurophysiology, neurophysiologic evaluation, anorectal manometry, anorectal physiology, anorectal

sensation, mucosal electrosensation, anorectal testing, anorectal reflexes, anal sphincter EMG. The search was conducted from January 1, 2011 until December 31, 2015, since earlier literature had been considered in the previous version of the chapter.

Symptom Severity Scales

Ovid/MEDLINE and EMBASE were searched for relevant literature on the assessment and severity of symptoms in fecal incontinence. This combination allows for expanded coverage (articles from both databases, as well as meeting abstracts) use of unique controlled vocabulary (fecal incontinence (MeSH), feces incontinence (EMTREE)), as well as searching titles with adjacency ((feces or faec* or fecal or anal or anus) within 3 words of incontinen*). PubMed does not permit adjacency searching. Once the concept of fecal incontinence was established, the results were combined with subject headings as well as text words, specific tools, as well as specific symptoms: severity of illness index/, disability severity/, disease severity assessment/, disease severity/, exp symptom/, exp symptom assessment/, exp Symptom Distress Scale/, gastrointestinal symptom/, sever*, "modified Manchester", wexner, "st Mark*", fisi, fica, iciq; or specific symptoms: symptom*, diarrhe*, diarrhoe*, urgen*, frequen*, soil*, leak*, stool*, constipat*) associated with methods of assessment: (sur-vey*, questionnaire*, scale*, score*, validat*, instrument*, assess*, tool*, evaluat*, index, indices, grade*, grading, classif*). The study by Pescatori, which is the earliest of the contemporary studies evaluating the severity of symptoms in faecal incontinence, was published in 1992(198). Hence, results were limited to literature published since 1992, and to formal study design in English.

Medications

Ovid/Medline and Cochrane Review databases were searched for studies in any language and any year through October 2011 which matched the following search terms:

"Faecal incontinence" OR "anal incontinence" AND "drug" OR "medical management" OR "medical treatment."

"Faecal incontinence" OR "anal incontinence" AND "loperamide" OR "diphenoxylate."

"Faecal incontinence" OR "anal incontinence" AND "laxative" OR "polyethylene."

"Faecal incontinence" OR "anal incontinence" AND "phenylephrine gel."

Education and Lifestyle Changes

PubMed, Ovid/Medline and EMBASE, CINAHL, and Cochrane Review databases were searched for articles from January 1, 2011 to December 31, 2015 for each topic separately in this section using syntax and combinations of terms that were appropriate for each data base. Articles were limited to the English language and duplicates removed before review. An example of the search terms used is as follows: anal or anorectal* or bowel* or faecal* or fecal* or rectal* or stool*).mp, and (continen* or incontinen*).mp, and:

(bowel and (habit* or management or program* or training or retraining)).mp, bowel AND (habit* or management or program* or training or retraining).

exp Combined Modality Therapy/, (combin* adj3 therap*).mp, (combin* adj3 therap*).mp, (MH "Combined Modality Therapy+"), combin* n3 therap*.

Exp Complementary Therapies/, alternative therap*.mp, complementary therap*.mp, (acupuncture or anthroposophy or auriculotherapy or diffuse noxious inhibitory control or holistic health or homeopath* or horticultural therapy or traditional medicin* or traditional Chinese medicine or mesotherap* or mind-body therap* or biofeedback or aromatherap* or hypnosis or meditat* or psychophysiology or relaxation therap* or Tai Ji or therap* touch* or yoga or musculoskeletal manipulat* or chiropractic* or osteopathic or soft tissue therap* or acupressure or massage* or naturopath* or organotherap* or tissue therap* or phytotherap* or reflexotherap* or sensory art therap* or speleotherap* or spiritual therap*).mp.

Lactose Intolerance/, Lactose Factors/, Lac-tose/, Lactose Tolerance Test/, Lactose Synthase/, lactose.mp, exp Dairy Products/, (dairy or milk or yogurt* or yoghurt*).mp.

exp Glutens/, gluten*, Carbohydrates/, car-bohy-drate*, fats/, fat*Sorbitol/, sorbitol.mp.

exp Diet/, exp Nutrition Therapy/, Food/, Food Habits/ (diet* or food* or nutrition* or prune*), feeding behavior.mp.

exp Dietary Fiber/, (fiber or fibre).mp, (oligofructose or oligosaccharides or fructans or fruco* or fos or fructoligosaccharide or sorbitol or glucitol or isosorbide* or meglumine), prune*, senna extract/ or senna plant/ or senna.mp.

Herbal Medicine/, herb* medicin*.mp, exp Dietary Supplements/, dietary supplement*, (prebiotic* or probiotic*).mp, exp Phytotherapy/, plant Extracts/

Plant Preparations/, Plants, Medicinal/, (plant* adj (extract* or preparation* or medicin*)), Lactobacillus/, acidophil*Lactobacillus,

Selenium/, selenium, symbiotic, Vitamins/, vita-min*.mp.

exp Alcohols/, Alcoholism/, Alcohol Drinking/, Alcoholic Beverages/, Beverages/, Drinking Behavior/, Drinking/, Ethanol/, Water/, Caffeine/ , (alcohol* or beverage* or caffein* or coffee or drink* or ethanol* or fluid* or water).mp.

educat*.mp. or exp health education/ or patient education as topic/.

exp Exercise/, Exercise Therapy/, Exercise Movement Techniques/, Physical Fit-ness/, (exercis* or stretch* or resistance training or run* or walk* or swim* or pilates).mp.

(carer or caregiver* or spous* or family or families or parent*), Family/, Caregivers/.mp., (carer or caregiver* or spous* or family or fami-lies or par-ent*).mp.

(irrigat* and (rectal or rectum or anal or transanal or trans-anal or retrograde)).mp., lavage/.

Telephone/, (cell phone* or smartphone* or tele- phone* or text messag*).mp., Mobile Applications/, exp Remote Sensing Technology/, (mobile applica- tion* or geographic information systems).mp.

Nurse's Role/, Nurse-Patient Relations/, (nurs* adj3 (advice or advis*).mp., (nurs* adj3 support*).mp., nurse attitude/, (nurs* adj3 (advice or advis* or role or support*).mp.

Tobacco Use"/, "Tobacco Use Disorder"/, exp "To- bacco Use Cessation"/, Tobacco Smoke Pollu- tion/,tobacco dependence/, smoking cessation/, passive smoking/, (smok* or tobac-co).mp.

Rectum/ and Physical Stimulation/, rectal stimula- tion.mp., anal stimulation.mp.

Toilet Facilities/, toilet*.mp., exp sanitation/.

(urge or urgency).mp.

exp body weight changes/, (weight gain* or weight loss or weight reduc*).mp.

Pelvic Floor Muscle Exercises, Biofeedback, and Electrical Stimulation

PubMed and Cochrane Review databases were searched for articles published between January 2012 and March 2016. These searches were limited to studies in which the subjects were adult humans. No restrictions were placed on language of publica- tion. The search terms were: (fecal incontinence OR anal incontinence or accidental bowel leakage) AND (biofeedback OR neuromuscular conditioning OR

pelvic floor exercise OR Kegel exercise OR electrical stimulation OR percutaneous tibial nerve stimulation).

Qualitative Research on the Experience of Faecal Incontinence and Quality of Life

PubMed, Ovid/Medline, and CINAHL databases were search from January 2012 - December 2015. The following subject headings and key words were searched: stool incontinence; self-report; narratives; qualitative research; anal, bowel, faecal and incontinence; quality of life and faecal incontinence. Additional articles were identified by examining reference lists from articles and citation search of early work. Articles were included if they met the following criteria: (a) focus on adults; (b) were published in English; (c) featured qualitative research; and (d) explored the experience of faecal incontinence. Articles were excluded if they were: (a) focused on caregivers; or (b) exploring another condition as the primary experience (i.e., sphincter saving surgery).

SURGERY FOR FAECAL INCONTINENCE

Chair

P. R. O'Connell (Ireland)

Members

C.H. Knowles (UK)
Y. Maeda (UK)
C. Vaizey (UK)
R.D. Madoff (USA)
S. Laurberg (Denmark)
P.A. Lehur (France)
K. E. Matzel (Germany)
A.F. Mellgren (USA)
T. Mimura (Japan)

CONTENTS

I. INTRODUCTION	2089	V. OUTCOME MEASURES IN FAECAL INCONTINENCE	2120
1. Search Methods	2090		
II. SURGERY FOR ADULT FAECAL INCONTINENCE	2090	VI. RESEARCH PRIORITIES IN FAECAL INCONTINENCE	2121
1.1. Sphincter Repair	2090	1. Basic Science and Pathophysiology.	2121
1.2. Sphincteroplasty	2091	2. Evaluation of Surgical Techniques ...	2122
1.3. Post Anal Repair	2093	3. Associated Obstructive Defaecation Symptoms	2122
1.4. Non-Stimulated Muscle Transposition	2094	4. Outcome Measures	2123
1.5. Stimulated Muscle Transposition	2094		
1.6. Artificial Anal Sphincter.....	2096	REFERENCES	2124
1.7. Magnetic Anal Reinforcement – Fenix™	2098		
1.8. Sacral Nerve Stimulation	2099		
1.8.1 Technique	2099		
1.8.2 Patient Selection and Indications	2100		
1.8.3 Mechanism of Action	2101		
1.8.4 Outcome	2101		
1.8.5 SNS for Patients with Anal Sphincter Lesions	2106		
1.8.6 Quality of Life	2106		
1.8.7 Cost Benefit.....	2107		
1.8.8 Safety	2107		
1.9. Puborectal Sling.....	2108		
1.10. Injectable Biomaterials	2109		
1.11. Vaginal Bowel-Control System	2115		
1.12. Radiofrequency Energy Treatment.....	2115		
1.13. Stem Cell Therapy and Other Tissue Regeneration Techniques	2116		
1.14. Colostomy	2116		
III. SURGERY FOR PAEDIATRIC FAECAL INCONTINENCE	2118		
1.1. Anorectal Malformations	2118		
IV. SURGERY FOR EVACUATION DISORDERS AND INCONTINENCE	2119		
1. Rectal Evacuation Disorders.....	2119		

SURGERY FOR FAECAL INCONTINENCE

P. R. O'CONNELL (IRELAND)

C.H. KNOWLES (UK), Y. MAEDA (UK), C. VAIZEY (UK), R.D. MADOFF (USA), S. LAURBERG (DENMARK), P.A. LEHUR (FRANCE), K. E. MATZEL (GERMANY), A.F. MELLGREN (USA), T. MIMURA (JAPAN)

I. INTRODUCTION

Normally, therapy for faecal incontinence is readily divided into non-surgical and surgical therapy. Selection of specific therapy is based upon a number of considerations, including the severity of incontinence and structural integrity of the anal sphincter.

Non surgical therapy is most applicable to relatively mild cases of incontinence. Biofeedback retraining can be attempted for incontinence of any cause or severity, as the therapy is painless and risk-free. These treatments are discussed in detail elsewhere in this monograph.

Traditionally, the most widely accepted surgical therapy for faecal incontinence was overlapping sphincteroplasty. Typical of other well-established therapies, the evidence base supporting this approach is paradoxically less robust than that supporting more recent treatment options. Sphincteroplasty is useful only in cases in which there is an anatomical anal sphincter defect. Sphincteroplasty provides satisfactory results in the majority of patients, however the results of sphincteroplasty deteriorate with time (2-4)

A number of operations were developed to treat patients whose native sphincter was either intact but weak or not amenable to repair. Parks' conceived the postanal repair to accentuate the anorectal angle in patients with incontinence due to pelvic neuropathy (5). Muscle transposition procedures using either gluteus maximus or gracilis were devised to create a functional biological neosphincter. The results were modest but electrical stimulation of the neosphincter, known as dynamic graciloplasty, led to improved continence outcomes. An artificial anal sphincter was devised as a salvage procedure for patients who had failed or were not candidates for standard therapy. A simplified magnetic bead artificial sphincter has been developed and is currently the subject of clinical trials

Sacral nerve stimulation (SNS), which was being studied for treatment of urinary incontinence, was found to improve faecal incontinence in a sub-set of patients with dual incontinence. This observation led

to application of SNS as a primary treatment of faecal incontinence in patients with intact or minimally disrupted anal sphincters. Approximately 55% of patients assessed achieve a substantial benefit from SNS (50% reduction in incontinence episodes) such that SNS is increasingly offered to patients with major incontinence difficulties including those with larger anal sphincter defects.

There has been considerable interest in the development of minimally invasive approaches to faecal incontinence for patients with less severe symptoms. These include the use of injectable biomaterials, radiofrequency energy treatment, a vaginal pessary device and pelvic sling procedures. The potential for use of autologous stem cells to augment residual anal sphincter function is also being explored.

Several important caveats apply to interpretation of the results of surgery for faecal incontinence reported in the literature. Firstly, the vast majority of reports are uncontrolled case series. Randomised controlled studies are rare, and those reported include only small numbers of patients (6). Secondly, numerous quantitative measures have been used to report outcomes, but only recently have any of these been validated, such as the Faecal Incontinence Quality of Life (FIQL) instrument (7). Thirdly, the criteria for establishing "successful" outcomes have been variable and often appear arbitrary. Fourthly, the quality of data reported is variable, though this has generally improved in more recent studies. Chart review has been supplanted by patient questionnaires and interviews by independent data auditors. Daily continence diaries, the most stringent form of data collection, have become increasingly commonplace (although not routine). A recent systematic review has highlighted many of the limitations (8). Notwithstanding this, clinical guidelines published by the American College of Gastroenterology (9) and the American Society of Colon and rectal Surgeons (10) do provide a framework under which to consider the evidence available to support clinical decision making regarding surgical treatments for faecal incontinence.

1. SEARCH METHODS

A PubMed search was conducted to identify studies published on the use of surgery for faecal (fecal) incontinence. Keywords used were faecal (fecal) incontinence and surgery. Full text copies of studies deemed to be potentially relevant were obtained. Priority was given to systematic reviews, randomised controlled trials, and controlled clinical trials; if those were unavailable or inadequate, comparative observational studies, case series, case reports and narrative reviews were also included. Reviewers were not blinded to the names of studies' authors, institutions or publications. In view of the nature of the guideline, priority was given to the reports with large number of patients and long follow-ups assessing efficacy of surgical interventions. Particular emphasis was placed on those reporting techniques and functional outcome including quality of life after an operation.

Non-English language papers were noted but excluded from the review unless they contained an English language abstract providing sufficient information.

II. SURGERY FOR ADULT FAECAL INCONTINENCE

1.1. Sphincter Repair

Anal sphincter repair is the term used to describe primary repair of the anal sphincter mechanism following direct trauma. The most common indication is following childbirth and repair in this situation is usually performed by the attending obstetrician. Colorectal surgeons are more commonly involved in primary repair of injury that is the result of blunt or penetrating trauma. Occasionally, the anal sphincter mechanism is damaged during anorectal surgery for other anal pathology, particularly surgery for anal fistula.

In Western obstetric practice, the incidence of overt anal sphincter injury (grade 3 or 4 tear) is low, 3-5% following primiparous delivery and 0.5-1% following second and subsequent deliveries (11). When prospectively looked for with endoanal ultrasound, the actual incidence of anal sphincter injury is higher (12, 13). A meta-analysis of 717 vaginal deliveries found an incidence of new anal sphincter defects of 27% in primiparous and 9% in multiparous women using 2D endoanal ultrasound (14). 3D and transperineal ultrasonography suggest that the incidence is somewhat less, perhaps 11%, following primiparous delivery (15, 16). The risk factors for sphincter injury include instrumental vaginal delivery, prolonged second stage of labour, fetal macrosomia, and a persistent occipital position of the fetal head (13, 17, 18). Midline episiotomy is associated with higher incidence of anal sphincter injury and the angle of mediolateral episiotomy may also influence perineal outcome (19). **LEVEL OF EVIDENCE 2.**

A policy of restrictive use of episiotomy may reduce the incidence of anal sphincter injury (20-22). **LEVEL OF EVIDENCE 2.**

Obstetric injury of the perineum is classified as a first degree tear if confined to vaginal epithelium and skin, second degree if the perineal muscles are torn, third degree if the anal sphincter muscles (external: EAS; internal: IAS) are torn, (3a: less than 50% EAS torn; 3b: more than 50% EAS torn; 3c: IAS torn) or fourth degree if both EAS and IAS and rectal or anal mucosa are torn (23). Primary repair of an obstetric tear is correctly termed anal sphincter repair and is frequently performed by the obstetrician immediately after delivery, most commonly in the delivery room under local or epidural anaesthetic. However recent guidelines issued by the Royal College of Obstetricians and Gynaecologists in the UK recommend that all such repairs should be performed in an operating theatre with adequate exposure, lighting and adequate anaesthesia (24). By tradition, the technique of repair has been a direct oppositional repair of the severed EAS, however an overlapping technique, as commonly used in secondary repair (vide infra), has been recommended as it obliges identification and adequate mobilization of the severed ends of the EAS (25). The IAS, if damaged, is difficult to identify separately and is usually repaired en-block with the anal canal mucosa in a complete or 4th degree tear. However, Mahoney et al (26) have shown that persistence of an IAS defect is adversely associated with continence outcome following repair of a 3rd or 4th degree tear, while Roos et al (27) have found that women with major tears (grade 3c or 4) were significantly more likely to have ultrasound evidence of a persisting IAS or combined IAS and EAS defect following obstetric repair. These women were more likely to have poor functional outcomes. Separate repair of the IAS is now recommended when the sphincter can be separately identified using a direct oppositional technique (21, 24, 28, 29). **LEVEL OF EVIDENCE 3.**

There have been six randomised clinical trials (588 women) (25, 30-34), a meta-analysis (35), and a systematic review (36) that have investigated different techniques of immediate primary anal sphincter repair following obstetric injury. Compared with primary end-to-end repair, immediate primary overlap repair of the EAS appears to be associated with lower risks of developing faecal urgency and anal incontinence, however at 36 months following repair there appears to be no difference in outcome between the two techniques. Norderval et al have shown that the continence outcome in women with an obstetric anal sphincter tear was improved if the entire length of the EAS was repaired in addition to separate repair of the IAS if a co-existing injury was found (37). Guidelines from the American College of Obstetrician and Gynecologists state that end-to-end or overlap repair are both acceptable for full-thickness external anal sphincter injury (29). A recent Cochrane review concluded that more evidence is needed to establish the optimum technique of repair (35). **LEVEL OF EVIDENCE 2.**

As colorectal surgeons are, in general, quite familiar with the anatomy of the anal canal, it has been suggested that primary anal sphincter repair might be best performed by a colorectal surgeon rather than an obstetrician. Nordenstam et al (38) concluded, in a single institution study of 165 women, that technique and expertise affect the outcome of primary repair and that if needed, the repair could be safely delayed until such expertise was available. In a similar study, Soerensen et al (39) also found no adverse outcome with delayed primary repair. Co-operation between obstetric and colorectal surgical colleagues can result in much improved outcomes (40), while a structured training programme for obstetric trainees also improves clinical outcomes (41). **LEVEL OF EVIDENCE: 2**

There have been two randomised trials of post-operative management of the bowel after primary anal sphincter repair. These have shown benefit in use of a laxative rather than a constipating regimen but no advantage to the addition of a stool bulking agent (42, 43). **LEVEL OF EVIDENCE: 1**

Some alteration in faecal continence occurs in approximately 13 - 17% of women following primiparous vaginal delivery, even in the absence of a recognised sphincter tear (12, 44, 45). The prevalence is greater if urgency of defaecation is included as a symptom (13). MacArthur et al (46) found flatal incontinence in 27% of 7,879 women surveyed 12 weeks after delivery. Fenner et al (47) found that women who had sustained third and fourth degree tears were more likely to have bowel incontinence than women without anal sphincter injury 6 months following delivery. This was more pronounced in women with a history of 4th degree tear. Samarasekera et al (48) found long-term effects on anal continence and quality of life following postpartum anal sphincter injury. Oom et al (49) suggested that concomitant injury to the pelvic floor may be an associated determinant of outcome, in addition to adequacy of sphincter repair. Following repair of obstetric anal sphincter injury patients should be referred for pelvic floor physiotherapy (50, 51) **LEVEL OF EVIDENCE: 2**

Management of subsequent labour following a previous anal sphincter tear must take account of obstetric risk factors, symptoms of incontinence and patient preferences. Harkin et al (18) found an approximately 5 fold increase in the incidence of recurrent sphincter tear compared to the incidence of first sphincter injury during second labour. Fynes et al (52) found that women with altered continence after first vaginal delivery were at risk of deterioration if delivered vaginally on their second pregnancy. Caesarean delivery before the onset of the second stage of labour was found to be protective (53); however, Nelson et al (54) in a systematic review found that pregnancy rather than delivery was more important in predicting postpartum continence. Scheer et al (55) have confirmed that subsequent vaginal delivery is reasonable in asymptomatic women after a previously repaired third degree tear. **LEVEL OF EVIDENCE: 3**

A number of studies have looked at long-term outcomes after repair of a 3rd or 4th degree tears and all have shown an increasing prevalence of continence disorders in association with greater age. These findings parallel those in the general population of parous women who have not had a recognized tear (44, 56, 57). Eogan et al (58) found in a study of women 10, 20 and 30 years following delivery that onset of menopause was the most significant deterrent of symptoms, whereas Mous et al (59) found the incidence of incontinence increased with age irrespective of menopausal status. Fornell et al (60) found that subjective and objective anal function after anal sphincter injury deteriorates with time and subsequent deliveries. A persistent defect in the IAS was also found to be an important determinant, an observation supported by Mahony et al (26). **LEVEL OF EVIDENCE: 3**

There is some evidence that hormone replacement therapy may be of value in women who develop symptoms post menopause (61).

Summary: Primary anal sphincter repair should be undertaken by an experienced operator under optimal conditions. End to end and overlap EAS repair appear equivalent. Separate IAS repair should be considered when divided. Following obstetric injury, management of subsequent deliveries should take account of patient symptoms and preferences as well as obstetric factors. Grade of Recommendation: C

1.2. Sphincteroplasty

The term “anal sphincteroplasty” is used to describe secondary or delayed reconstruction of the anal sphincter musculature, injury to which has either not been recognised at the time of injury or when the outcome of primary repair has been unsatisfactory. Delayed sphincteroplasty is usually performed a minimum duration of three months after the initial injury. Anterior sphincteroplasty is the most common type of reconstruction performed because of the association with obstetric injury. In this situation, the anal sphincter muscles and perineal body have separated leaving a horseshoe type configuration to the anal sphincter mechanism, with a large defect in the anterior quadrant. Occasionally, the defect is such that the anal and vaginal mucosae have healed to form a cloacal defect. Anal sphincter defects related to previous anal fistula surgery or direct trauma are usually less complex and are not associated with a deficient perineum unless there has been an avulsion injury with significant tissue loss.

The decision to perform anal sphincteroplasty is based on an assessment of symptoms and the anatomical extent of the sphincter defect (62). In assessing symptoms one of several faecal continence scores should be used. The two most commonly applied are the Cleveland Clinic Continence Score (63) and the St Mark's Continence Score (64). In addition a quality of life instrument should be applied (65). **LEVEL OF EVIDENCE: 4**

Anorectal function can be evaluated objectively using different modalities, including colorectal transit time (CTT), anorectal manometry, rectal sensation, rectal compliance, defaecography or scintigraphy, pelvic floor electrophysiology including, but not limited to, pudendal nerve terminal motor latency (PNTML), endoanal ultrasound and MRI. The results from objective measurement techniques should be applied with caution in the assessment of faecal incontinence as they are often inadequate in determining the presence and/or severity of the condition. The American Society of Colon and Rectal Surgeons considers as having a surgical indication those symptomatic patients with localised anal sphincter defects, without defining exactly the minimum size of the injury detected as indication for this surgery (66). **LEVEL OF EVIDENCE: 4**

Other causes of disordered continence should be excluded e.g. inflammatory bowel disease, colorectal cancer and neurological disorders. Patients with background IBS are more likely to be symptomatic than those with more predictable bowel habit and equivalent anal sphincter defects (67). Pelvic floor electrophysiological assessment, while not essential, if performed, should be comprehensive and not confined to measurement of pudendal nerve terminal motor latency (68).

For symptomatic patients with a less than one quadrant anal sphincter defect, a trial of dietary modification, stool regulating drugs and physiotherapy is appropriate. Anal sphincter exercises (pelvic floor muscle training) and biofeedback therapy have been used to treat the symptoms of people with faecal incontinence. However, standards of treatment are still lacking and the magnitude of alleged benefits has yet to be established. A recent Cochrane review concluded that while some elements of biofeedback therapy and sphincter exercises may have a therapeutic effect, this is not certain. Larger well-designed trials are needed to enable safe conclusions (69). **LEVEL OF EVIDENCE: 3**

For patients with a more than one quadrant anal sphincter defect, anal sphincteroplasty is appropriate (6, 23, 62). Preoperative counselling should identify post-operative wound healing as the most common difficulty. The majority of patients can expect significant improvement in continence after the procedure with a mean of 66% reporting excellent or good results in the short term (62), however, the long-term outcome is not satisfactory, decreasing to between 30-80% at 80 months and to 6% at 120 months. Concomitant repair of a cloacal defect or vaginal fistula should be undertaken (70, 71). There is no evidence that a defunctioning colostomy improves outcome. The results of anal sphincteroplasty in recent series reporting more than 50 patients are given in Table 1.

Anal sphincteroplasty can be performed in the lithotomy position or the prone jack-knife position. Full bowel preparation is not needed, although most

would give a cleansing enema pre-operatively. The conventional incision is an inverted 'V' that may be closed as an inverted 'Y' as described by Parks and McPartlin (90). If anterior levatorplasty or rectocele repair is contemplated, a posterior fourchette incision with the patient in the lithotomy position may have advantages (81). The external anal sphincter is usually repaired using an overlapping technique without separate identification and repair of the IAS (23), however, Maslekar et al (87) attribute their good long term results to a selective policy of separate repair of the IAS. There has been one small randomised trial of direct versus overlapping sphincteroplasty which showed similar outcomes (91). To prevent dehiscence and subsequent failure, the two divided ends of the external sphincters must have an adequate blood supply and the reconstructive suture cannot be under excessive tension. Occasionally the EAS defect is not full thickness and overlapping repair in such circumstances would require division of the residual intact fibres to facilitate overlap. Oberwalder et al (92) have, in a small series of patients, found that imbrication of the EAS in such cases is associated with outcomes similar to formal overlapping sphincteroplasty. **LEVEL OF EVIDENCE: 3**

More recently, Zutshi et al developed a modified sphincteroplasty with the application of a biological porcine collagen mesh for reinforcement of the reconstruction, but only 10 patients were with meshes were included (93). Larger studies are needed.

Anterior levatorplasty may be performed in conjunction with external anal sphincter repair (94, 95) or as an isolated procedure (79, 96). No technique has shown superiority and it is possible that the operative technique should be individualised to the particular patient (97). **LEVEL OF EVIDENCE: 3**

Initial success of sphincteroplasty is related to whether the anal sphincter defect is corrected (98, 99). Early failure is usually associated with a persisting defect identified using endoanal ultrasound (100). This may be amenable to a further attempt at repair (99, 101, 102). There is however increasing evidence that continence outcomes deteriorate with long-term follow-up (23, 62, 103). The effect of age at time of operation on long-term function is controversial (95, 104), however long-term effects of aging and menopause coupled with atrophy of the sphincters may be relevant (3, 23, 89). **LEVEL OF EVIDENCE: 3**

Pre-operative physiological testing is helpful in the overall management of patients with faecal incontinence, however the value of anal manometry and pelvic floor electrophysiological assessment as prognostic indicators for outcome following sphincteroplasty is controversial (105). There are no established parameters that reliably predict outcome following sphincteroplasty (87, 106). Patients with an unsatisfactory clinical outcome following sphincteroplasty may be considered, if sufficiently symptomatic, for adjunctive sacral neurostimulation (vide infra) (107).

Table 1. Published results of anal sphincteroplasty since 1990, including series with 50 or more

Authors (ref)	Year	Number of patients	Follow-up months	Continent % (excellent / good)
Fleshman et al (72)	1991	55	12	72
Engel et al (73)	1994	55	15	79
Londono-Schimmer et al (74)	1994	94	60	50
Oliveira et al (75)	1996	55	29*	71
Gilliland et al (76)	1998	77	24*	55 [§]
Young et al (77)	1998	54	18*	86 [§]
Malouf et al (1)	2000	55	77	49
Karoui et al (78)	2000	74	40	47
Osterberg et al (79)	2000	51	12	58
Morren et al (80)	2001	55	40	56
Tan et al (81)	2001	50	28	50
Halverson and Hull (2)	2002	71	69	25
Bravo Gutierrez et al (82)	2004	130 ⁺	120	6
Madoff [#] (62)	2004	891		66
Norderval et al (83)	2005	71	27	41
Zorcolo et al (84)	2005	93	70*	55
Trowbridge et al (85)	2006	86	67	11
Barisic et al (86)	2006	65	80*	48
Maslekar et al (87)	2007	64	84*	80
Oom et al (49)	2009	120	111*	38
Gleason et al (88)	2011	74	32	77
Lehto et al (89)	2013	56	89*	<30 ^{**}

metanalysis

*** Median follow-up**

+ 130/190 available for 10 year follow-up

§ defined as “successful”

**** Overall improved symptoms in regard to solid, liquid and flatus**

Summary: Anal sphincteroplasty should be considered in symptomatic patients with a defined defect in the external anal sphincter. Overlapping EAS repair is usually performed. Results appear to deteriorate with time. Redo sphincter repair may be feasible in patients with a poor continence outcome. Grade of Recommendation: C

1.3. Post Anal Repair

Postanal repair was first reported by Sir Alan Parks in 1975 (108). This procedure was designed to increase the length of the anal canal, restore the anorectal angle and re-create the flap valve mechanism, which at

the time was thought essential for maintaining faecal continence. Success rates ranged from 15% to 83%, depending on the definition of the success, the length of follow-up, and possibly the cause of incontinence.

The published studies regarding postanal repair include four systematic reviews of randomised controlled trials (6, 109-111), two randomised controlled trials (94, 112), two non-randomised cohort studies (113, 114), 8 case series of good quality (5, 98, 115-120) and 11 case series of poor quality (120-130). Since the 5th International Consultation on Incontinence in 2012, no new studies regarding the role of

postanal repair for the treatment of faecal incontinence, other than one systematic review have been reported (111).

Subsequent observational studies with a median follow-up of more than 5 years revealed that continence deteriorated with time. Despite 60-80% of patients reporting persisting symptomatic improvement, only one-third were actually continent to liquid or solid stool (116, 118-120, 130). Even in the most recent study reporting the long-term outcome of postanal repair (131), only 26% reported none to minimal incontinence with the Cleveland Clinic Florida Fecal Incontinence score being between 0 and 5, while 79% improved symptomatically with a mean follow-up of 9.1 years. Possible explanations for deterioration of continence following initial improvement included unrecognised denervation and/or muscular injury of the sphincter and pelvic floor musculature, and the presence of occult anal sphincter disruption, particularly in the studies reported before endoanal ultrasonography or magnetic resonance imaging were available. Moreover, physiological and radiological evaluations before and after postanal repair have not demonstrated consistent changes in anal canal length, resting pressure, voluntary contraction pressure, anorectal sensitivity and movement of the anorectal angle (5, 112-114, 132, 133). These reports of increasingly poor outcomes have significantly diminished the popularity of this procedure.

Deen et al (94) in a randomised controlled trial, comparing three procedures in 36 women with neuropathic faecal incontinence, found that complete continence was achieved in 42% of patients after postanal repair, 33% after anterior levatorplasty and 67% after total pelvic floor repair. In contrast, van Tets et al (112) conducted a randomised controlled trial comparing postanal repair and total pelvic floor repair in 20 women with neurogenic faecal incontinence. Complete continence to solid or liquid stool was achieved in 27% of patients after postanal repair and in 22% after total pelvic floor repair.

Summary: Postanal repair can be performed with modest success in carefully selected patients. However, this procedure is now rarely performed due to the advent of newer treatments Grade of Recommendation: D.

1.4. Non-Stimulated Muscle Transposition

A variety of muscle transposition procedures have been devised for the treatment of faecal incontinence. Early efforts focused upon the use of transposed skeletal muscle to supplement the function of a weak or disrupted anal sphincter. Early in the 20th century, a number of surgeons utilized gluteus maximus muscle, transposed in a variety of configurations to create a neosphincter. In 1952, Pickrell et al (134) described the use of transposed gracilis muscle to create a neosphincter for incontinent children.

Published series of gracilis transposition are uncontrolled and demonstrate variable success rates (134-143). **LEVEL OF EVIDENCE: 3.**

One study reviewed the functional results of graciloplasty longitudinally in 22 patients followed for a median 63 months (144). Eighteen patients (81%) were improved at 6 months, though only one regained normal continence. Results deteriorated in 5 patients during subsequent follow up. Bilateral gracilis transposition has been used successfully in several small series (135, 145).

Success rates following gluteus transposition have likewise been variable (146-149). A prospective randomised trial in women with post-obstetric neuro-pathic incontinence showed similar significant degrees of improvement following both gluteus maximus transposition and total pelvic floor repair (150). A recent retrospective review of 25 gluteoplasty patients reported restoration of continence in 18 patients (72%) and partial restoration in an additional 4 patients (16%). Donor-site and peri-rectal complications occurred in 16 patients (64%) (151). **LEVEL OF EVIDENCE: 3**

Summary: Unstimulated graciloplasty should not be routinely offered. It is now rarely performed due to the advent of newer treatments Grade of Recommendation: D

1.5. Stimulated Muscle Transposition

Successful electrical stimulation of a previously transposed gracilis muscle was first reported in 1988 (151), and subsequently in 1990 in a case series of 6 patients of whom 5 had closure of a defunctioning stoma with improvement in continence (152). This series was later increased to 20 patients (including 12 in whom the anus had been surgically removed or was congenitally absent) in whom continence improved in 12 (153). Baeten et al (154) showed improved continence in 8 of 10 patients.

Even after successful muscle transposition, functional outcomes are limited by two physiological factors. First, patients are unable to consciously maintain tonic contraction of their neosphincters over long periods of time. Furthermore, even if patient volition were not a problem, the gracilis muscle is poorly suited to tonic contraction. While the external anal sphincter comprises predominantly slow-twitch, fatigue-resistant type I fibres, the gracilis muscle comprises predominantly type II, fast-twitch fibres that are rapidly fatiguable (155). Graded electrical stimulation transforms type II into type I muscle fibres, and the use of an implantable electrical pulse generator has been shown to convert transposed gracilis to a muscle with predominantly type I fibres (150). The gracilis muscle is well suited to electrical stimulation due to the relatively constant proximal location of its neurovascular bundle, which is easily identified at surgery (153). The results of stimulated graciloplasty are shown in Table 2.

Table 2. Dynamic Graciloplasty: General measures of continence

Authors (ref)	Year	Number patients	Follow-up (months)	Percentage continent*
Baeten et al (156)	1995	52	25.2 (mean)	73
Geerdes et al (157)	1996	67	32.4 (mean)	78
Cavina et al (158)	1998	31	37.8 (mean)	85
Madoff et al (159)	1999	131	24 (median)	66
Mander et al (160)	1999	64	16 (median)	69
Baeten et al (161)	2000	123	23 (mean)	74
Wexner et al (162)	2002	83	24	53
Rongen et al (163)	2003	200	16.3 (median)	72
Pennickx et al(164)	2004	60	48 (median)	55
Tillin et al (165)	2006	49	43 (median)	70
Hassan et al (166)	2010	31	67 (median)	71

**variable definitions; does not necessarily denote perfect continence. Issues of divergence in technique arose from these studies, each of which has seen increasing consensus in the literature despite a lack of randomised trial data. Thus, intramuscular (vs. epineural) electrodes are now universally employed, and diverting stomas and 'vascular delay' prior to muscle transposition are no longer utilized.*

In 1995, Baeten reported results in 52 patients, with 38 (72%) becoming continent after surgery (156). In a subsequent paper published by this group in 2003, 200 patients followed for a median of 261 weeks were reported (163). The overall success rate was 72%. Patients with incontinence due to trauma had the best results (82% success), while patients with incontinence due to congenital anorectal malformation had the worst results (52% success). A total of 138 complications were reported, including disturbed evacuation in 32 patients (16%), infection in 24 (12%), pain in 16 (8%) and pulse generator displacement in 12 (6%). Ten patients (5%) had anorectal perforations, 7 of whom eventually obtained a successful outcome. Rosen et al (167) reported restoration of continence in 9 of 10 patients treated by dynamic graciloplasty using a "split-sling" wrap configuration. Sielezneff et al (168) treated 16 patients and 13 had improved continence. However, 8 patients suffered morbidity, resulting in 33 subsequent admissions and 23 reoperations.

Three multicentre prospective trials of dynamic muscleplasty have been performed to date. In each of these studies, patients served as their own controls. No randomised prospective trials have been performed. Madoff et al (159) studied 139 patients from 12 centres, 128 of whom had gracilis wraps and 11 gluteus wraps. Of those patients, 104 were treated for faecal incontinence, and 35 underwent total anorectal reconstruction following abdominoperineal resection for cancer. Success rates for graciloplasty were 71% for patients with acquired incontinence and 50% for those with incontinence due to a congenital abnormality. There was a total of 138 complications for the entire group. Wound complications (41 major and 35

minor) were both the most prevalent and the most consequential. Other complications included pain in 28 patients (22%), hardware problems in 14 (11%) and tendon detachment in 4 patients (3%). Centres with significant prior experience of the procedure had substantially fewer major wound complications (17.4 vs. 33.1%) and significantly higher success rates (80% vs. 47%).

Mander et al (160) reported the results of dynamic graciloplasty in 64 patients with refractory faecal incontinence treated at 7 centres. There were 24 infectious complications, 5 of which involved perineal wound breakdown and 3 of which required re-operation. Forty-four (69%) patients became continent to solid stool 1 month following stoma closure. Evacuation problems developed in 16 patients (25%), and this led to failure in 14. At a median of 10 months follow-up, 29 patients had a good functional result.

Baeten et al (161) reported the results of dynamic graciloplasty in 123 patients treated at 20 centres as part of the Dynamic Graciloplasty Therapy Study Group (DGTSG). The aims of this study were to assess both the safety and efficacy of this treatment; 189 adverse events occurred in 91 patients, including one death due to pulmonary embolism. There were 18 major and 31 minor infectious complications. There were 42 instances of therapy-associated pain, occurring variably in the donor leg, at the anal canal, or at the device site. There were 11 lead dislodgements but no problems with lead breakage or pulse generator malfunction. A follow-up study showed full or partial recovery from these complications in 87% of patients (165). This study, in contrast to others, was based upon data from daily continence diaries. A

successful result (defined as a 50% or greater decrease in incontinent events in patients without pre-existing stomas) was achieved in 63% of patients after one year. Another follow-up of this patient cohort demonstrated stable success rates at 18 months (55%) and 24 months (56%)(168). Statistically significant improvements in the physical and social function scales of the SF-36 were also recorded at 12 months.

A multicentre retrospective trial from Belgium using dynamic graciloplasty treated 60 patients with 27 failures (164). Continence was achieved in 78% of the group. However, more than half (26 patients) required the use of antegrade continence enemas or other measures to maintain continence. Seven patients had a permanent stoma constructed. Seventy-five complications occurred with 61 total reoperations. Loss of muscle stimulation occurred in 22 patients; 10 were due to issues specific to the stimulator and leads, 4 were due to technical failure of the muscle wrap. Functional outcome was directly associated with a maintenance of stimulation and initiation of stimulation within 50 days of surgery.

Very few studies have examined the long term results with dynamic muscle wraps. Thornton et al (169) reported on the 5-year follow up of 38 patients who had undergone dynamic graciloplasty. Of the 33 patients available for follow-up by telephone interview, obstructive defaecation was a problem for 11% of the cohort and 16% had been converted to a permanent colostomy. Of those with a functioning graciloplasty (22 patients) who reported a faecal incontinence score of less than 12 (range 0-24), 50% reported problems with obstructive defaecation and 64% felt their bowel habits had negatively affected their quality of life. Long-term complications were primarily related to stimulator problems; ten patients required 15 operations to replace stimulator components. However, 72% of patients reported pain, swelling or paresthesia of the donor leg and 27% reported sexual dysfunction. Hassan et al (166) reported follow-up of 31 patients who underwent gracilis muscle transposition with periodic electrical stimulation and postoperative supplemental biofeedback. Twenty-two patients (71%) reported improvement at five-years. Nine patients (29%) were deemed failures, requiring further surgical intervention (colostomy formation, contralateral dynamic gracilis muscle transposition, implantation of artificial bowel sphincter). Six patients developed perineal wound infections (5 resolved with antibiotics, 1 required surgical drainage), and 2 patients had evacuation difficulties requiring regular enemas. Those who underwent operation due to traumatic injury to sphincters had better outcome (82% improvement) compared to patients with congenital faecal incontinence (55%).

Tillin et al (165) performed a prospective case-comparison study of 49 patients who had a dynamic graciloplasty and 87 patients who either refused the surgery or who were not offered the surgery. The primary outcomes evaluated were symptoms, quality of

life, anxiety, and depression. Of the treated group, the procedure failed completely in 15 patients. At two year follow-up, bowel-related QoL and continence had improved by more than 20 per cent compared with the preoperative status for two-thirds of patients who had dynamic graciloplasty. Up to 50% of patients with a satisfactory outcome reported disordered evacuation and 8 other patients were deemed failures due to this problem

Chapman et al (170) performed a systematic review of dynamic graciloplasty for faecal incontinence on behalf of the Australian Safety and Efficacy Register of New Interventional Procedures-Surgical (ASERNIP-S). The authors reviewed 37 original articles published between 1991 and October 2000. All of the papers were judged to be of low-evidence quality, as all but one paper were case series, and the sole comparative study utilized historical controls. Mortality excluding cancer deaths was 1% (95% confidence interval 1-3%) and morbidity 1.12 (95% CI 0.14 - 2.08) events per patient. Success was variably defined between studies, but was reported as ranging from 42-58%. The ASERNIP-S Review Group determined that "the safety of the procedure cannot be determined at the present time due to an incomplete and/or poor-quality evidence base" and that "efficacy is established." Tan et al(171) examined three treatments for faecal incontinence including dynamic graciloplasty, artificial bowel sphincter and end stoma. They concluded that the most cost effective intervention was an end stoma, the artificial bowel sphincter was most cost-effective after 10 years and that dynamic graciloplasty should only be considered as an alternative in highly specialized centres. These findings are subject to the criticism that a colostomy does not attempt to restore continence whereas the other two procedures do. **LEVEL OF EVIDENCE: 2**

Summary: Stimulated graciloplasty should be offered to selected patients who have failed other modalities of treatment particularly where there has been loss of native sphincter tissue. Otherwise, it has largely been superseded by sacral neuromodulation. Grade of Recommendation: B

1.6. Artificial Anal Sphincter

In parallel to the now recognised and, for some, approved nerve stimulation procedures various types of artificial sphincter devices have been designed and proposed to treat severely incontinent patients. These options have some common characteristics: they frequently derive from innovations and experiments from sister specialties, urology for instance, but also upper GI surgery; their development is associated with significant efforts from companies that invest heavily to establish them in the market; they are not yet universally approved and have to be regarded as investigational/experimental in many ways as strong evidence is still missing in terms of feasibility, cost-effectiveness, durability and reproducibility.

Artificial bowel sphincter (ABS) - Acticon™ Neosphincter

This innovative procedure for anal sphincter replacement was developed in the 1990s. This technique is in effect a sophisticated modification of a Thiersch wire implantation. During the surgical procedure, a silicone-made pressure-regulated inflatable cuff is placed around the upper anal canal and tubing from the cuff is directed along the perineum and connected to a pump placed in the scrotum or labia. Tubing is used to connect the pump to a pressure regulating balloon implanted in the pre-vesical space. The balloon contains 40 ml of isotonic radio-opaque solution which gives approximately 100 cm H₂O pressure into the perianal cuff. The control pump allows a fluid transfer from the cuff to the balloon. To do so, the patient squeezes the pump to empty the cuff allowing for the anal canal to open and defaecation to occur. The fluid then slowly returns to the cuff which results in the closing of the anal canal and restoration of continence.

Two papers have reported the outcome of ABS implantation in the long term. The first from Cleveland Clinic, Florida, USA (172) investigated the risk factors related to ABS implantation in a single centre series. Fifty-one implantations were performed in 47 patients with faecal incontinence (84.3% female - mean age of 48.8 years - range, 19-79) from 1998 to 2007. Twenty-three (41.2%) of the ABS implantations became infected, 18 (35.3%) of which developed early-stage infection, all explanted, whereas 5 (5.9%) had late-stage infection. Time to the first bowel movement was an independent risk factor for early-stage ABS infections, which are significantly higher in those whose first bowel movement occurred before day 2. Patients with a stoma also had a tendency toward a higher infection rate. Common late-stage complications were device malfunction, device erosion, persistent perianal pain, device migration and constipation. Ultimately a third of the 33 participants required ABS explantation with device malfunction being the most common reason for explantation. The authors found that the rate of explantation increased with the time after implantation; the longer the ABS was in use, the more complications occurred, and the more the ABS was explanted. The 1, 2, 3 and 4-year cumulative risk of ABS explantation was respectively 9.7, 13, 43 and 48%. At 5 years after ABS implantation, the risk of explantation was 57%.

The second report from Nantes, France (173) focused more on ABS functional outcome in a report of a 52 patients consecutive series treated for severe faecal incontinence from 1996 to 2010. All of the participants failed to respond to medical treatment / pelvic floor retraining for at least 1 year. Indications for implantation were sphincter destruction, pudendal neuropathy, perineal colostomy and congenital malformation. The mean follow-up period was 64.3 ± 46.5 months (range 2-169). Of the 52 patients, 26 (50%) required revisions primarily due to device malfunctions from a leaking cuff, with 7 of the participants

(13.5%) requiring 2 revisions. Thirty-five (67.3%) still had an activated device in situ at the last review. Two patients had their device deactivated and 14 (26.9%) required definitive explantation with the majority (42.9%) due to infection. With regards to the 35 patients with an activated device in situ, the authors report a significant improvement in the continence (CCIS) and quality of life scores (FIQL) scores at last follow-up.

More recently Wang et al focused on the outcome of ABS reimplantation and the overall results of ABS at Cleveland Clinic Florida (174). They concluded ABS implantation has a high failure rate with explantation in 72% of patients but reimplantation is often possible with a success rate of 47% with reimplantation for non-infectious complications (perforation of the cuff mainly) has better outcomes than reimplantation following device infection. Short- and long-term outcomes of reimplantation were comparable in this series to initial implantation.

A systematic review of the ABS found that the need for surgical revision increases and continence decreases with time (175). Although functioning devices stabilize to a pooled rate of 59% after 5 years of follow-up, continence as measured by the CC-FIS in patients with a functional device decreases with time, although interestingly the QOL of implanted patients remained high. Although evacuation difficulty was common, it was severe in only 8% of patients. Thus preoperative assessment for outlet obstruction and surveillance in the follow-up with instructions to use laxatives or enemas as needed is important to achieve a good functional outcome. They concluded that both device refinements by the manufacturer and meticulous aseptic procedures at implantation are keys to help improve these outcomes. **LEVEL OF EVIDENCE: 3**

Recently another systematic review studied, among others, the results of ABS (8) The authors highlighted the existing discrepancy in recommendations for this invasive approach of severe FI. They observed that the American Society of Colon and Rectal Surgeons in their latest recommendations gave the ABS a strongly favourable support to its use in selected patients yet noting that the evidence was of low or very low quality (10) In contrast, the American College of Gastroenterology identified the ABS evidence as insufficient and gave it a weak recommendation (9). From their review, Forte et al found the evidence about ABS to be insufficient to enable conclusions about its effectiveness (8). That being stated, in patients who retain the device, several studies report good restoration of continence and a positive impact on quality of life. The primary concern with ABS implantation is infection, with rates ranging from 20 to 45%. Mechanical failure is as well a recognized complication of the ABS the most common cause being a micro-perforation at the folds of the cuff membrane, which leads to a loss of fluid and pressurization of the system. Cuff perforation that reflects intrinsic "wear

and tear” of the device components over time contributes to a number of revision procedures, especially detrimental when patients experience a satisfactory functional ABS results. Revision rate with the ABS is directly proportional to the length of follow-up. With this background, even in specialist centres with dedicated interest and experience in ABS the number of implantations has significantly decreased and the ABS Acticon Neosphincter™ is no longer commercially available. This is unfortunate for those few patients that retained the device with good restoration of continence as they will encounter difficulties if and when a replacement device is needed. There are no similar options presently available.

Summary: The artificial bowel sphincter is a treatment for patients who have failed other modalities of treatment. Obstructed defaecation and device erosion have been problematic. Currently the device is not commercially available. Grade of Recommendation: C

1.7. Magnetic Anal Reinforcement – Fenix™

The magnetic anal reinforcement device (or magnetic anal sphincter – MAS (FENIX□; Torax Medical, Inc, Shoreview, MN – USA)) is a new device designed to augment the native anal sphincter. It consists of a series of titanium beads with magnetic cores hermetically sealed inside. The beads are interlinked with independent titanium wires to form a flexible ring that rests around the external anal sphincter in a circular fashion. The device is manufactured in different lengths based on the number of beads (14 to 20) necessary to accommodate the variation in anal canal circumference (176). The procedure used for MAS device implantation is substantially simpler than the ABS implantation. A single anterior incision is made on the perineal body and the rectovaginal septum is dissected down to a depth of 3-5 cm. Next, a perianal tunnel is created around the posterior side of the anus to place a sizing tool allowing for measurement of the proper size of the MAS device. The sized MAS device is then placed into the tunnel and the sutures attached to each end of the device are tied to secure the device around the upper anal canal and the incision is closed without drainage. Early data concerning safety and short/middle term effects on continence are available, however this device is still investigational and only conditionally available on the market in Europe and USA.

Unlike the ABS, the MAS works immediately once implanted, without the need for further manipulation by either the patient or surgeon. The device is initially placed under fluoroscopic guidance to make sure that it adapts adequately to the anal canal and benefits

from a new sizing tool that efficiently measures the anal canal circumference. Plain X-rays can assess the device postoperatively. It is not MRI-compatible.

A multicentre feasibility study demonstrated a good restoration of continence with limited complications in short term (177). Based on these results, MAS was granted a CE mark on November 2011 and its commercial use has started in selected centres in Europe. Barussaud et al reported the medium term results of a series of 23 patients (178) (Table 5). A German centre reported results from 18 patients implanted with a MAS for severe FI. No devices became infected or were explanted. CCIF scores decreased from 17.5 to 7.3 and FIQoL improved in all 4 domains. Bowel diary results showed 76% of the implanted patients experienced a > 50% reduction in the number of FI episodes per week (179). More recently Sugrue et al analysed the 5-year results of the original feasibility study group of 35 patients (34 females) implanted at 4 centres in the world. Assessment at 5 years was completed for 23 patients. Eight patients underwent a subsequent operation including 7 MAS explantations due to device failure or complications, mainly occurring in the first year. Thirty adverse events were reported in 20 patients, most commonly defaecatory dysfunction (20%), pain (14%), erosion (11%) and infection (11%). Success rates were 63%, 66% and 53% respectively at year one, three and five. In patients who retained their device, the number of incontinent episodes per week and CCIF scores significantly decreased from baseline, with also a significant improvement in quality of life. The authors concluded that MAS provided excellent outcomes in patients who retained a functioning device at long-term follow-up and therefore protocols to reduce early complications will be important to improve overall results(180).

Presently the place of the MAS in the treatment algorithm of FI remains to be determined. It appears to be a promising innovation but undoubtedly there is a learning curve with this technology, particularly in patient selection. With a limited number of patients treated and only middle-term follow-up available, it remains to be seen if the MAS can withstand the test of time. Two on-going trials in France (MOS STIC – registered in Clinicaltrials.gov NCT01920607) and in UK (SAFARI - ISRCTN 16077538 <http://ukctg.nihr.ac.uk>) will help to answer this question. These randomised controlled trials are of similar design, aiming to compare MAS to SNS in terms of FI successful treatment and cost-effectiveness. Results are expected in 2017 and 2018 on more than 150 and 350 randomized patients respectively.

Table 3: Magnetic anal sphincter: Results (178)

Type of study	Single centre - Prospective Non randomized
N female patients	23
Median age (years) (range)	64 (35-78)
Median duration (years) of FI (range)	8.8 (1-40)
CCF-IS score baseline	15.2
CCF-IS score at 6, 12, 24 and 36 mo.	6.9, 7.7, 7.8, 5.3
FIQoL questionnaire baseline	1.97
FIQoL questionnaire at 6, 12, 24 and 36 mo.	3.19, 3.11, 2.92, 2.93
Explantation	2
Satisfied patients	16
Would recommend to other patients	14

Summary: The magnetic anal sphincter is a novel treatment for patients who have failed other modalities of treatment. Early results are promising, however long term and comparative studies are required. Grade of Recommendation: C

1.8. Sacral Nerve Stimulation

Sacral nerve stimulation (SNS), also termed sacral neuromodulation (SNM) was first applied for the treatment of faecal incontinence in 1994 by Matzel et al (181) in patients with functional deficits of the anal sphincter but no morphologic defect. The concept of recruiting residual function of an inadequate anorectal continence organ by electrostimulation of its peripheral nerve supply, i.e. the sacral spinal nerves, was adapted from the field of urology in the early 1990s (182), where it has been used since 1981 (183). The rationale for applying SNS to faecal incontinence was based on both clinical observations and anatomical considerations (from the former, the beneficial effect on bowel habits and anorectal continence function and increased anorectal angulation and anal canal closure pressure seen in urological patients; from the latter, the demonstration by dissection of a dual peripheral nerve supply of the striated pelvic floor muscles that govern these functions (182), with the sacral spinal nerves being the most distal common location of this dual nerve supply). It was hypothesised that stimulating the sacral spinal nerves could both enhance physiological function and improve the symptoms of faecal incontinence.

1.8.1 Technique

SNS has become a minimally invasive technique with low morbidity. The surgical technique can be divided into two stages. As no other predictors of SNS outcome exist at present, patients are uniformly selected for operative implantation of a permanent neurostimulation device on the basis of clinical improvement

during test stimulation. This first stage, termed percutaneous nerve evaluation (PNE), is used to confirm a satisfactory neural response and then to evaluate the clinical effect of stimulation before implantation of a permanent device. Trial stimulation is performed for 1 – 3 weeks, a period sufficient to demonstrate its therapeutic effect--commonly considered as a decrease in the frequency of incontinence episodes (documented by bowel-habit diary) by at least 50% and reversibility after discontinuation of stimulation. Two technical options are used for PNE: a temporary, percutaneously placed, unipolar test stimulation lead (or multiple leads) that will be removed at the end of this phase; or operative placement of a quadripolar lead, the so-called “foramen electrode,” close to a target nerve, usually the S3 root, less frequently that of S4. This electrode can stay in place and be used for permanent stimulation if the trial is effective. Today most commonly a minimally invasive technique places this foramen electrode with a modified anchoring device, the so-called “tined lead,” through a trochar. This technique has lately been redefined by introducing the regular use of a softer, curved stylet to guide the electrode placement (184). For screening, both types of leads are connected to an external pulse generator, the tined lead with a percutaneous extension cable.

The second stage is implantation of a permanent electrode and neurostimulator if the screening test is successful. The therapeutic outcome for permanent SNS appears to be best when both sensory/anal motor and toe flexion responses are achieved during test stimulation (185).

Patients with a temporary lead require simultaneous implantation of the pulse generator and the quadripolar lead, most commonly as a tined lead procedure. Those with a foramen electrode already in place for screening will undergo removal of the percutaneous extension before placement of the pulse generator (so-called “two-stage implant”(186)).

Bilateral placement of foramen electrodes remains the exception, based either on improved outcome of bilateral stimulation during the screening phase (187) or on conceptual considerations (188). A recent study exploring the benefit of bilateral over unilateral sacral neuromodulation had to be discontinued prematurely after an interim analysis of 20 patients demonstrated no additional benefit in symptom score, quality-of-life score, or findings on anorectal manometry (189).

The pulse generator is placed subcutaneously, usually in the gluteal area or under certain circumstances in the abdominal wall. It is activated and stimulation parameters are set early after surgery by telemetry; it can be deactivated by the patient with a small, handheld device commonly referred to as a "patient programmer." The patient programmer also offers the ability to vary among four preset stimulation protocols.

1.8.2 Patient Selection and Indications

Today, a variety of causes leading to faecal incontinence can be treated with SNS. During the initial SNS experience, only patients presenting with deficient function but no morphologic defect of the striated anal sphincter and levator ani were eligible (182, 190, 191), however, because of the high predictive value of the test stimulation, a more pragmatic, trial-and-error approach to patient selection evolved. Patients are now selected for SNS based upon PNE results rather than conceptual considerations of the potential mechanism of action. Test stimulation is indicated, not by an underlying pathophysiological condition, but by the existence of an anal sphincter with reduced or absent voluntary squeeze function and existing reflex activity, indicating an intact nerve-muscle connection (that may be confirmed by intact anocutaneous reflex activity or by muscular response to pudendal stimulation with the St. Mark's electrode)(190). **LEVEL OF EVIDENCE: 2**

At present, the test stimulation is the only reliable method for selecting patients who will likely benefit from permanent therapeutic stimulation. Various studies have attempted to identify potential predictors of success of SNS. In a study by Gourcerol et al (192), age was the only variable related to success of temporary stimulation. In patients with a permanent implant, neurological disorders, delay of the left bulbocavernosus reflex and a prolonged or absent bulbocavernosus reflex was more frequent in patients with a successful outcome. In another cohort analysis, the need for repeated temporary procedures was associated with failure during the screening in univariate and multivariate analysis (193). A low threshold to obtain motor response during temporary lead placement was revealed to be associated with improved outcome only in univariate, but not in multivariate, analysis. Evidence of anal sphincter injury was related to a greater risk of failure during temporary testing, but not with permanent implant. In a large single-centre study comprising 245 patients with test stimulation and 169 patients with permanent implant,

Govaert et al. (194) determined in univariate analysis that older age (>70 years), presence (but not size) of an external sphincter defect, and the need for repeated procedures after initial failure were significantly related to failure of test stimulation. In multivariate regression analysis presence of an external sphincter defect and need for repeated procedures remained significant. The permanent implant was successful in 76.9% of the patients, but no predictor was found to be significantly related. Brouwer and Duthie (107), in a cohort of 55 patients with permanent SNS, demonstrated that continence scores did not differ significantly in those with a defect, pudendal neuropathy, or previous sphincter repair. Melenhorst et al. (195) found no difference in outcome with chronic SNS in patients after sphincter repair and those with an external sphincter lesion of up to 33% of the circumference; they concluded that a morphologically intact sphincter is not a prerequisite for successful SNS. In 244 patients undergoing test stimulation with a success rate of 78.3%, Maeda et al. (196) determined that low amplitude of the sensory threshold during PNE and lead placement anterior to the sacral cortex are positive predictors of PNE outcome. No other demographic, physiological or morphological variable (motor response threshold) was a negative predictive factor. In a cohort of 200 patients with permanent SNS from 6 centres (197) only loose stool consistency, a history of diarrhoea management by medical treatment, and low stimulation intensity were associated with improved medium-term outcome. Multivariate regression analysis confirmed that stool consistency and stimulation intensity were independent predictive factors of success or failure of SNS.

In a cohort of 45 consecutive patients, temporary stimulation was successful in 32 (71%). At a median follow-up of 33 months, the neurostimulator remained in place in 25 (55%) and active in 23 (51%). No statistically significant differences were found in the characteristics (including anorectal physiological workup) of the 32 patients who underwent implantation and the 13 who did not or in those 23 with a functioning stimulator (198).

In a single centre study, at 3-year follow-up with 33 (of 66) patients with a $\geq 30\%$ improvement in Cleveland Clinic Incontinence score (CCIS), Roy et al. were not able to demonstrate any predictive factor of success based on preoperative and postoperative assessment (199).

Altomare et al. in a recent study from four European centres of 228 patients with chronic SNS, could find no determinant of success at last follow-up of ≥ 60 months (200). Factors investigated included: demographics, technique, symptom severity and cause (age, sex, PNE vs. tined lead test, implant side, implant site, sphincter lesion, extension of sphincter lesion, incontinence type and baseline episodes of incontinence, CCIS, and St. Mark's incontinence score). Factors associated with a significantly lower failure rate over the long term included a reduction of

six incontinence episodes per week and eight Cleveland Clinic and St. Mark's score points during test stimulation (200). **LEVEL OF EVIDENCE: 3**

In a retrospective analysis of prospectively obtained data from 65 patients, Prapasrivorakul et al. (201) found less success at one-year follow-up in patients with a coexisting high-grade internal rectal prolapse (HIRP Oxford Grade III and IV) when compared with those without HIRP (FISI 37 to 23; $p < 0.01$ vs. 38 to 34 $p = 0.16$) (200). In a univariate analysis, concomitant rectocele, enterocele and HIRP were found to be associated predictors of outcome of permanent SNS; in multivariate analysis only HIRP was predictive (201).

Other than this recent report of HIRP, none of the variables usually considered in preoperative evaluation are of any help in selecting the appropriate patient for chronic SNS.

Contraindications to SNS include pathological conditions of the sacrum preventing adequate electrode placement (such as spina bifida), skin disease at the area of implantation, anal sphincter damage requiring a sphincter substitute (e.g. artificial bowel sphincter, dynamic graciloplasty), trauma sequelae with micturition disorders or low bladder capacity, pregnancy, bleeding complications, psychological instability, low mental capacity, limited cognitive function that interferes with the operation of the neurostimulation device, anticipated future need for magnetic resonance imaging and the presence of an implantable defibrillator or a cardiac pacemaker. With reference to the latter, a case series has shown the relative safety of the use of SNS in the presence of a cardiac pacemaker when monitored intraoperatively. If the distance between the devices is greater than eight inches, interference is unlikely (202).

1.8.3 Mechanism of Action

The mechanism of action of SNS remains in part uncertain. Clinical outcome has been seen to correlate with results of anorectal physiology studies, but the effect of chronic stimulation varies greatly among published reports (190, 191). Data monitoring colorectal and anal function are in part contradictory and inconclusive and sometimes not reproducible. The effect appears to be somatomotor (203-209), somatosensory (203), autonomic nervous system-based (203, 205, 210), and mediated by somatovisceral reflexes (211, 212). The effects appear not to be limited to the continence organ per se, but also to the central nervous system: corticoanal excitability in patients with faecal incontinence was found to be reduced with SNS (213); in successfully treated patients cerebral somatosensory evoked potential (SEP) latencies were higher at baseline than in the normal population, whereas they were normal in patients with SNS failure. Success was also associated with a fall of the SEP latency to the normal range after one month of SNS at 40 Hz (214). SNS induces changes in anal representation on the primary somatosensory cortex

(215). The effect on the CNS induced by SNS changes during its course: at its initiation, changes are seen in the contralateral frontal cortex, reflecting focus attention; subsequent changes are found in the ipsilateral caudate nucleus, an area related to learning (216).

Qualitative changes in anal, rectal and colonic motility - i.e., reduction of spontaneous rectal motility complexes (217, 218), spontaneous anal sphincter relaxation (217), reduction in antegrade transport from the ascending colon (219) or no change (220), and increased retrograde transport from the descending colon at defecation (219, 220), increase rectal perception thresholds (221, 222) and improve pelvic floor contraction during SNS (223). The findings on rectal capacity with SNS have been inconsistent: unaltered (223-225) or increased (217, 226). No changes in gastric retention, gastric emptying, small bowel transit or colonic passage have been seen with scintigraphic measurements during SNS (227).

A recent review indicates that physiological functions outside the anorectum are influenced by stimulation of afferent nerve fibres via the sacral spinal nerves (228). Corticoanal pathways, brainstem and specific parts of the CNS and the spinal cord appear to be involved.

An effect on mucosal neurochemistry during SNS has also been shown, with elevation of Substance P and TRPV1 levels (229), although the relevance of each of these has not been proven in specific pathophysiological conditions. The mechanism of action is most likely multifactorial and dependent on the underlying condition. **LEVEL OF EVIDENCE: 4**

1.8.4 Outcome

The results of permanent SNS after pragmatic, trial-and-error, patient selection are shown in Tables 4-6(107, 193, 196, 199, 205, 229-244). Most studies have encompassed patients with heterogeneous pathophysiology, and they vary with regard to design and patient number, but there is general agreement regarding the test stimulation for selection for permanent implant. Most commonly, clinical outcome is reported as an improvement in the number of incontinence episodes or days with incontinence during the period of observation, percentage of this improvement, and changes in the CCIS and quality of life.

In a first multicentre prospective trial of SNS adherent to the initial, confined spectrum of indications, Matzel et al. (245) reported 37 patients, 34 of whom underwent a permanent implant. Not only was the frequency of incontinence episodes and the CCIS score improved significantly, so too was the ability to postpone defaecation. These effects were attained immediately. Multiple case series have been published, but the number of randomised controlled trials is small. **LEVEL OF EVIDENCE: 3**

Table 4. Chronic sacral nerve simulation (SNS) for fecal incontinence (FI): Improvement of incontinence episodes, studies with ≥ 50 patients

Author	Year	Patients (n) (Baseline)	Patients (n) (Follow-up)	Median Follow-up (month)	Per protocol: >50% improvement Incontinence episodes / week	Intention-to-treat: 50% improvement Incontinence episodes / week
Follow-up: < 12 months						
Tjandra et al (230)	2008	53	53	12 *	71	63
Hollingshead et al (231)	2011	86	86	12	81	62
Wexner et al (233)	2010	120	106	12 *	83	66 ++
Follow-up: 12-36 months						
Melenhorst et al (206)	2007	100	100	26 §	79	59
Dudding et al (234)	2008	51	48	24	65	52
Govaert et al (185)	2009	173	169	35 §	77	53
Melgren et al (235)	2011	120	77	36 *	86	59 ++
Follow-up: > 36 months						
Altomare et al (246)	2009	60	52	74 §	n.a.	n.a.
Hollingshead et al (231)	2011	86	18	60 *	83	n.a.
Duelund-Jakobsen et al (237)	2012	158	91	46	75	n.a.
Uludag et al (238).	2011	50	50	85	84	n.c.
Melgren et al (235)	2013	120	76	>60	89	53
Altomare et al(200)	2015	272	228	84	78	50

Modified from (239)

*** values at specific times**

§ mean

++ intention-to-treat

n.a. data not available

Table 5. Chronic SNS for FI: Cleveland Clinic Incontinence Score, studies with > 50 patients

Author	Year	Patients (n) (Baseline)	Patients (n) (Follow-up)	Median Follow-up (months)	Median Score Baseline (range)	Median Score Follow-up (range)	p- value
Follow-up (< 12 months)							
Tjandra et al (230)	2008	53	53	12 *	16 ± 1 §	1 ± 2 §	< 0.001
Brouwer et al (107)	2010	55	48	12 *	15 (13-18)	6 (4-8)	0.001
Gallas et al (197)	2011	200	130	12 *	14 (2-20)	7 (0-19)	0.001
Follow-up 12-36 months							
Brouwer et al	2010	55	31	36 *	15 (13-18)	7 (5-8)	0.001

Author	Year	Patients (n) (Baseline)	Patients (n) (Follow-up)	Median Follow-up (months)	Median Score Baseline (range)	Median Score Follow-up (range)	p- value
Hollingshead et al (231)	2011	86	86	33	15 ± 3	9 ± 5	< 0.001
Michelsen et al (240)	2010	126	126	24	16 (6-20)	10 (0-20)	< 0.001
Gallas et al (197)	2011	200	54	24 *	14 (2-20)	7 (0-19)	0.001
Wong et al (241)	2011	61	61	31	14 (n.a.)	8 (n.a.)	n.a.
Follow-up > 36 months							
Altomare et al (246)	2009	60	52	74 §	15 ± 4	5 ± 5	< 0.001
Brouwer et al (107)	2010	55	13	48 *	15 (13-18)	6 (2-8)	0.008
Faucheron et al (242)	2010	87	87	45	13 (6-19) §	8 (1-17) §	n.a.
Michelsen et al (240)	2010	126	10	72 *	20 (12-20)	7 (2-11)	< 0.001
Lim et al (247)	2011	53	41	51 §	12 (9-15)	8 (5-11)	0.001
Faucheron et al (248)	2012	57	42	63	14 (4-19)	7 (1-16)	<0.001
Damon et al (244)	2013	119	102	48 §	14 ± 3	9 ± 1	<0.0001
Maeda et al (232)	2014	108	101	60 *	16 (6-20)	8 (0-19)	<0.0001
Altomare et al (200)	2015	272	228	84	16 (13-18)	7 (4-12)	<0.001

Modified from (239)

*** values at specific time**

§ mean value, standard deviation

n.a. data not available

Table 6: Chronic SNS for FI: Incontinence episodes, studies with > 50 patients

Author	Year	Patients (n) (Baseline)	Patients (n) (Follow-up)	Median Follow-up	Incontinence episodes/week median (range)		P value
					Baseline	Last Follow-up	
Follow-up < 12 months							
Uludag et al (218)	2004	50	27	12 *	8 (n.a.)	1 (n.a.)	< 0.001
Melenhorst et al (206)	2007	100	76	12 *	10 (n.a.) §	2 (n.c.) §	< 0.001
Tjandra et al (230)	2008	53	53	12 *	10 (13) §	3 (10) §	< 0.001
Michelsen et al (240)	2010	126	49	12 *	8 (n.a.)	1 (n.c.)	< 0.001
Wexner et al (233)	2010	120	106	12 *	9 (7) §	2 (4) §	< 0.001
Follow-up 12-36 months							
Uludag et al (218)	2004	50	6	24 *	8 (n.a.)	1 (n.a.)	ns
Melenhorst et al (206)	2007	100	33	36 *	10 (n.c.)	2 (n.c.)	< 0.001
Dudding et al (234)	2008	51	48	24	6 (0-81)	1 (0-59)	n.a.
Hollingshead et al (231)	2011	86	86	33	9 (7) §	1 (2) §	< 0.001

Author	Year	Patients (n) (Baseline)	Patients (n) (Follow-up)	Median Follow- up	Incontinence episodes/week median (range)		P value
					Baseline	Last Follow-up	
Mellgren et al (235)	2011	120	77	36 *	9 (n.a.) §	2 (n.a.) §	< 0.001
Follow-up > 36 months							
Melenhorst et al (206)	2007	100	15 6	48 * 60 *	10 (n.a.) § 10 (n.a.) §	2 (n.c.) § 2 (n.c.) §	< 0.001 <0.001
Altomare et al (246)	2009	60	52	74 §	4 (n.a.) §	1 (n.c.) §	0.004
Duelund-Jakobsen et al (249)	2012	147	147	46	6 (n.c.)	1 (n.c.)	< 0.001
Ulundag et al (238)	2011	50	n.a.	60	8 (n.a.)	0 (n.c.)	< 0.002
Mellegren et al (235)	2013	120	76	> 60	9 (n.a.)	2 (n.a.)	<0.0001
Altomare et al (200)	2015	272	228	84	7 (4-11)	0.3 (0-3)	<0.001

Modified from (239)

*** values at specific time**

§ mean value, standard deviation

n.a. data not available, n.c. not calculable

Melenhorst et al. (206) published a large mid-term-follow-up, single-centre study, with 100 patients undergoing permanent SNS. Late failure defined as a relapse of symptoms to less than 50% improvement over baseline, implementation of another therapy for faecal incontinence, or patient dissatisfaction, occurred in 21 patients. The mean time for definitive failure was 13.6 months (range 3–42). There was no evidence of technical failure such as lead migration or lead breakage.

A report by Rosen et al. (203) highlighted the effect of SNS in a cohort of patients of whom 75% suffered from faecal incontinence of neurological origin. Frequency of incontinence episodes/week was reduced from 6 to 2 at 15 months' follow-up.

In a larger multicentre study Wexner et al. (233) confirmed the efficacy of SNS in reducing symptoms of faecal incontinence: of 112 patients with permanent SNS followed for a mean of 28 months (2-69), 83% experienced a ≥50% improvement, including 41% who gained complete continence (at 12 months). Mellgren et al. (235) reported on the same cohort after a mean follow-up of 3.1 years (0.2 – 6.1 years). With a complete or partial data set available in 64% of the patients, a ≥ 50% reduction of incontinence episodes was seen in 86% of these, with 40% achieving perfect continence. Symptom improvement resulted in improved quality of life, which was stable over follow-up. If a “last observation carried forward analysis” is performed, the 50% reduction of symptoms at 3 years is a 78% success rate; in a “modified worst-case analysis”--with all missing data classified as failure--the success rate at 3 years is 59%. Again, this same cohort was reported upon at follow-up ranging

from five years (63% of patients) to more than eight years: faecal incontinence episodes per week decreased from 9.1 (mean at baseline) to 1.7 at 5 years; 89% reported a ≥ 50% improvement of incontinence (36% complete continence). After 5 years, therapy was active in 81% of the patients (235).

In a systematic review including 61 publications from 2001 to 2012, Thin et al. (239) found higher median rates of ≥50% improvement in incontinence episodes/week when patients' data were analysed “per protocol” (PP) (i.e., implantation after a successful test period) than when the denominator for analysis was PNE (i.e., comparable to “intention-to-treat” [ITT] principles): short-term (median 12 months) 79% (69-83%) vs. 63% (33-66%); medium-term (25 months) 80% (65-88%) vs. 58% (51-81%); long-term (56 months) 84% (75-100%) vs. 54% (50-58%). In the ITT analysis only two studies comprising 86 patients were long-term (250, 251). Perfect continence was likewise greater in the “per protocol” analysis than in the ITT: short-term 42% (21-68%) vs. 36% (8-68%); medium-term 44% (5-74%) vs. 32% (4-72%); long-term 35% (4-52%) vs. 20% (2-48%). The CCISs were also significantly improved and remained stable over follow-up.

A summary of the published long-term outcome of SNS up to 2015 included 12 studies with a median follow-up of 85 months (44-118) in 745 patients (200). As in the report of Thin et al. (239), improvement (≥ 50% reduction in incontinence episodes) was greater on PP than on ITT analysis: median 78% (21–96%) vs. 50% (42–89%). Full continence was also greater: median 36% (4–52%) vs. 20% (2–48%).

In most studies, quantitative measures are used to describe the clinical benefit, such as days with incontinence episodes or absolute numbers of incontinence episodes per period of observation, ability to postpone defaecation (in minutes), and percentage improvement. Even though published reports differ with regard to patient population, a general pattern of outcome can be observed: when compared with baseline status, the clinical outcome is significantly improved. Outcome reporting increasingly includes both PP and ITT analyses.

In a meta-analysis of publications from 2000-2008 comprising 790 patients, 28 studies compared incontinence episodes per week before and with SNS, and 14 studies compared incontinence scores. Both outcome criteria were significantly decreased. Another nine studies documented the ability to postpone defaecation, and this criterion also was significantly improved (252). **LEVEL OF EVIDENCE: 2**

Whereas cohort studies and observation studies are numerous, only a limited number of randomised controlled trials could be included in a recent Cochrane review of SNS for faecal incontinence: four crossover trials and two parallel group trials (253). In a randomised controlled trial of patients with severe faecal incontinence, Tjandra et al (230) compared the effect at 12 months of SNS with that of supervised optimal medical therapy comprising pelvic floor exercises, bulking agents, and dietary manipulation. Permanent SNS in 53 patients was significantly better than conservative treatment in 60 patients: CCIS 1.2 vs. 14.1; incontinence episodes/week 3.1 vs 9.4; days with incontinence/week 1 vs. 9.4 (mean difference (213) -5.20, 95% confidence interval [CI] -9.15 to -1.25 at 3 months; MD -6.30, 95% CI -10.34 to -2.26 at 12 months); lifestyle 3.31 vs. 2.31; coping/behaviour 2.68 vs. 1.86; depression/self-perception 3.25 vs. 2.64; embarrassment 2.76 vs. 1.78.

In a parallel group trial with 6 months' follow-up carried out by Thin et al., patients were allocated to receive either SNS or percutaneous tibial nerve stimulation (PTNS)(254). Participants (N = 15) who underwent permanent SNS had had a two-test stimulation period demonstrating at least a 50% reduction in faecal incontinence. Compared with the PTNS group, they experienced fewer episodes of faecal incontinence (MD -3.00, 95% CI -6.61 to 0.61 at 3 months; MD -3.20, 95% CI -7.14 to 0.74 at 12 months). Mean (\pm SD) faecal incontinence episodes per week at baseline and 3 and 6 months of follow-up with chronic stimulation were: 11.4 (12.0), 4.0 (4.0) and 4.9 (6.9), respectively, for SNS compared with 10.6 (11.2), 5.8 (6.9) and 6.3 (6.9) for PTNS. Mean (\pm SD) CCIS values at baseline and 3 and 6 months were: 16.2 (3.0), 11.1 (5.2) and 10.4 (5.6) for SNS versus 15.1 (2.7), 11.7 (4.4) and 12.1 (5.2) for PTNS.

In the blinded crossover trial in two patients by Vaizey et al., participants were allocated to two weeks of "off" and "on" periods of subsensory stimulation(255).

They reported a clear difference in number of episodes of incontinence per week during the off and on periods (Patient 1, 20 vs. 2 episodes; Patient 2, 4 vs. 0 episodes).

Leroi et al (256) reported a double-blind, crossover multicentre study in 34 patients. The indication to progress from temporary to permanent SNS (N = 27) was based on at least a 50% reduction in the number of episodes of incontinence or faecal urgency per week, or both. After implantation each participant underwent a 1 – 3 month phase with the stimulator turned on to determine the most effective stimulation parameters. At the end of this post-implantation period, patients were randomised in a double-blind manner to on- or off-stimulation for a 2-month period, with reversal of the activation mode after 1 month. Of these, 24 of the 27 (89%) patients completed the 2-month trial. A significant decrease in median frequency of faecal incontinence episodes was noted during the on-stimulation period. No significant difference was observed between on- and off-stimulation for frequency of urgency episodes, delay in postponing defaecation, or median number of bowel movements per week (10.2 and 11.1 for on and off, respectively). There was a trend towards greater improvement in the CCIS during on-stimulation (8.5 vs 10.5 [ns]). All 24 patients considered that they had improved during the on period, although 17 (63%) also felt they had improved during the off period. In 19 participants who preferred the on period and five who preferred the off-period outcomes were reported separately: For the group of 19, the median (range) episodes of faecal incontinence per week fell from 1.7 (0-9) during the off period to 0.7 (0-5) during the on period; for the group of five, however, the median (range) rose from 1.7 (0-11) during the off period to 3.7 (0-11) during the on period.

In the crossover trial by Kahlke et al. (257), 16 of 31 patients who had had SNS for a median of 26.8 months agreed to be randomised in a crossover design to two three-week periods each of stimulation on and off. After six weeks, the patients--still blinded to the stimulator status-- chose which stimulation period they preferred. The mode of stimulation corresponding to the selected period was then continued for 3 months (final period). All patients (N=14 of 16) selected the on mode. They experienced significantly fewer episodes of faecal incontinence per week (1 [SD 1.7]) compared with the off period (8.4 [8.7]). The CCIS was significantly higher (P < 0.05) during the off period (14.6 [SD 4.6]) compared with the on period (8.7 [SD 3.6]). The overall number of bowel movements per week declined significantly (P < 0.05) in the crossover on period (10.9 [SD 4.1]) compared with the off period (18.2 [SD 8.7]). During the final 3-month period incontinence episodes per week remained low 0.3 (SD 0.5), CCIS was 6.4 (SD 3.3), and the number of bowel movements per week was 9.4 (SD 2.6). **LEVEL OF EVIDENCE: 3**

1.8.5 SNS for Patients with Anal Sphincter Lesions

An increasing body of evidence indicates that SNS may also be a treatment option for patients with sphincter defects, either unrepaired or after attempted anatomical reconstruction. The presence of an internal anal sphincter defect on endoanal sonography is reportedly unrelated to the success of permanent SNS (193). Since the first report that three of five patients with ultrasound evidence of sphincter disruption measuring 25–33% of the circumference benefited from chronic SNS (258), several studies have been published (195, 240, 258-263). The origins and morphologic findings regarding the extent of the sphincter gap differ in these studies, but lesions up to 180° have been treated. It appears that outcome is not dependent on the radial extent (259, 261). A significant improvement in clinical function, measured either as frequency of incontinence episodes or CCIS, has been seen in a substantial number of patients in all studies (195, 258, 260, 263). Follow-up is still limited. **LEVEL OF EVIDENCE: 3**

Melenhorst et al. (195) showed that the primary use of SNS in patients with a sphincter gap 17-33% of the circumference appeared to result in an outcome similar to its use after failed sphincter repair. In another study, SNS in 6 of 8 patients with faecal incontinence related to obstetric full-thickness anal sphincter lesions of >30-150° resulted in improved frequency of incontinence episodes (from 5.5 to 1.5 per week) (262), improved ability to postpone bowel emptying, and improved ASCRS quality-of-life scores at a median follow-up of 26.5 months (259). No correlation between improvement and the radial extent of the sphincter defect was seen. In patients with internal and external sphincter disruption owing to Crohn's disease SNS was demonstrated to be beneficial in one study (258).

A recent review of SNS for faecal incontinence associated with anal sphincter lesions identified ten publications (nine retrospective, one prospective) from 1995-2011 comprising 119 patients, of whom 106 (89%) had a definitive implant after PNE testing (264). A lesion of the external and/or internal anal sphincter was confirmed on endoanal ultrasound. Outcome reporting was not uniform. Follow-up ranged from 4.5 to 48 months. The weighted average number of incontinent episodes per week decreased from 12.1 to 2.3, the weighted average CCIS decreased from 16.5 to 3.8, and the ability to defer defaecation, when evaluated, increased significantly. Quality of life improved significantly in almost all studies.

In the one prospective investigation, a comparative cohort study (261), the effect of permanent SNS was reported in 53 patients with either an intact external anal sphincter (N=32, 37.5% after sphincter repair) or an external anal sphincter lesion (N=21, 81% after prior sphincter repair) of <90° (N=11) or 90-120° (N=10). Improvement in symptoms and quality of life was achieved, and outcome after 12 months was not

significantly different between groups. **LEVEL OF EVIDENCE: 3**

The therapeutic potential of SNS has also been demonstrated in some, mostly small, case series and individual case reports of patients with distinct pathological conditions or well defined anorectal pathophysiology: .e.g. muscular dystrophy (265); proctocolectomy with ileoanal J-Pouch reconstruction for colitis (266); neurological dysfunction including spinal disc prolapse (267); rectal prolapse repair (268, 269); rectal resection for cancer (270) with or without neoadjuvant chemoradiation (188, 271-273); after neoadjuvant and adjuvant chemoradiation / radiotherapy for endometrial and anorectal cancer (274, 275); after unilateral traumatic pudendal neuropathy (276); in spina bifida (277); and incontinence related to external anal sphincter atrophy (278). **LEVEL OF EVIDENCE: 4**

1.8.6 Quality of Life

Outcome assessment has also evolved, and aspects of quality of life have been added to the evaluation (CCIS, SF-36 and Fecal Incontinence Quality of Life [FIQL] Score). The therapeutic impact of SNS is most evident when a disease-specific quality-of-life instrument, the ASCRS FIQL scale, is applied.

In the first study to apply this instrument, the multicentre clinical trial by Matzel et al. (245), ASCRS FIQL was significantly increased in all 4 scales; SF-36 scores improved in 7 of 8 scales, the greatest being social functioning and mental health, but only the former reached statistical significance. A similar result was published by Leroi et al (256) with the French version of the ASCRS QOL (FIQL): at the final follow-up visit, improvements in lifestyle, coping behaviour, depression, and self-perception and embarrassment were significant. Hetzer et al (279) demonstrated a significant improvement of the median Gastrointestinal Quality of Life Index score with permanent SNS from a baseline of 96 (range 47–128) to 107 (range: 36–128) at 6 months' post-implantation.

In most studies on outcome, quality-of-life evaluation is a secondary endpoint (107, 187, 191, 203, 230, 245, 256, 267, 268, 270, 272, 280). When used, the finding of improved quality of life is consistently related to symptom relief and remains stable with longer follow-up (107, 235, 238, 246, 279). Indeed, recent long-term data with a follow-up of at least 5 years indicate a significant improvement of all four scales of the FIQL score (235, 251).

In a meta-analysis (252) of 34 studies with 790 patients, SF-36 score data were analysed from 7 studies with 98 to 102 patients and ASCRS FIQL data from 9 studies comprising 199 patients: SF-36 outcome was significantly increased in all categories (physical functioning, social functioning, role physical, role emotional, mental health, vitality, general health) with one exception (bodily pain). FIQL outcome was

significantly increased in all categories (lifestyle, coping/behaviour, depression/self-perception, embarrassment).

In a two-centre study of patients with permanent SNS for a median of 46 months (11-122), 108 of 127 patients responded to questionnaires regarding bowel habits and quality of life. Using a non-validated score, 75.8% reported satisfaction, which in most was related to clinical improvement. However, at last follow-up 11 of 23 patients who had failed to achieve a 50% reduction in incontinence episodes reported satisfaction, and 6 of these had more incontinence episodes than at baseline (237).

Four of the randomised controlled trials discussed above, when relating quality of life to clinical efficacy of SNS, have used varying instruments: SF-12, ASCRS FIQL (230); SF-36 (255); the French version of the ASCRS FIQL (256); and ASCRS FIQL, SF-36 and EQ-5D (254). Improvement was found in all, except for EQ-5D with chronic SNS. **LEVEL OF EVIDENCE: 2**

1.8.7 Cost Benefit

Permanent SNS is expensive; however, its cost-effectiveness has been demonstrated in several European nations. Hetzer et al (281) compared the costs of SNS with those of conservative treatment, anterior sphincteroplasty, dynamic graciloplasty, and stoma creation in 34 consecutive patients. The 5-year cumulative cost for SNS was €19,333, compared with €35,965 for a stoma (with annual costs of €5,339) and €34,953 for dynamic graciloplasty (annual costs €1,659). The equivalent cost for conservative treatment was €3,895, and the overall median real cost for an anterior sphincteroplasty was €5,327. Muñoz-Duyos et al (282) analysed the direct medical costs of SNS in a series of 47 patients undergoing 57 PNEs and the consequent 29 patients with a permanent unilateral implant for a median follow-up of 34.7 (2.3-81.2) months. The cost totalled €371,434, including €317,791 for the devices. In patients without anal sphincter damage SNS provided 0.34 incontinence-free life-years and entailed additional costs of €1,054, which generates a cost-effectiveness ratio of €16,181 per quality-adjusted life-year (QALY). The nationally accepted threshold is around €30,000/QALY. The economic impact of the introduction of SNS would be to add 0.07-0.1% to the care of these patients (2008 data).

In a decision-analysis model based on prospectively collected data in 70 patients undergoing test stimulation and implantation of the permanent SNS device, incontinence episodes/week were reduced from 6 at baseline to 0.5. Dudding et al. (234), based on direct medical and non-medical costs, found an incremental cost-effectiveness ratio (ICER) for SNS of £25,070 per QALY gained. It cost £1,038 per year to achieve a median reduction of 238 incontinence episodes, equal to £3.61 per reduced episode. The ICER of g£25,070 per QALY was within the UK nationally accepted £30,000 per QALY threshold.

In a similarly designed study based on published reports and expert opinion, Indinnimeo et al (283) found that the ICER was €28,285 per QALY gained in patients with a structurally deficient anal sphincter and €30,662 per QALY in patients with an intact anal sphincter. Both are below the relevant national threshold of €40,000 per QALY gained. Budget-impact analysis demonstrated that the implementation of SNS would have an estimated impact of 0.56% over a 5-year period on the budget allocated for faecal incontinence treatment.

In a French study clinical outcome and cost-effectiveness analyses were performed in parallel with a prospective, multicentre cohort study that included 369 consecutive patients with urge urinary and/or faecal incontinence with a follow-up of 24 months (284). Cost-effectiveness outcomes were expressed as incremental costs per 50% of improved severity scores (incremental cost-effectiveness ratio). Based on a national health perspective the average cost of SNS for faecal incontinence was €6,581 more for the first 2 years when compared with alternative treatments (95% confidence interval, €2,077–€11,084; $P = 0.006$) when an improvement of more than 50% in the continence severity score was used as the criterion of effectiveness. The incremental cost-effectiveness ratio for SNS was €94,204 and €185,160 at 24 months of follow-up for urinary and faecal incontinence respectively. These findings were above the generally accepted range of cost effectiveness, but SNS was considered to offer marked health benefits for patients with faecal incontinence (measured by the severity score). **LEVEL OF EVIDENCE: 3**

1.8.8 Safety

SNS is a relatively safe procedure (233, 285). A meta-analysis (252) is in accordance with earlier reports, which describe a relatively low rate of complications (190, 191) and a need for device removal in only approximately 5% because of loss of effect, symptom deterioration, pain from lead dislocation, or infection. The results of the meta-analysis, which covered the period 2000 – 2008 and included patients undergoing the more invasive, open-approach electrode placement technique, found a complication rate of less than 15% in 665 patients with a permanently implanted device. In only 3% did the device need to be removed. In patients in whom infection necessitated removal, re-implantation later was reportedly successful (280).

In an FDA study with strict monitoring of adverse events (235), 334 were reported in 99 patients at three-year follow-up; 67% occurred in the first year, and most required no or minimal intervention at the time. The adverse events included pain at the implant site (28%), paresthesiae (15%), change in the sensation of stimulation (12%), implant site infection (10%)(233), urinary incontinence (6%), diarrhoea (6%), and extremity pain (6%). Half of the infections required surgical intervention with removal of the device in 5 of 6 patients (235). More recent data of the

same patient cohort report a 39% need for device revision, replacement or removal. With 5 years' follow-up 26.3% of patients had a revision, replacement or removal of the device for reasons other than battery depletion (235). Significant differences between those who exited because of a lack of efficacy before five years and those who remained in the study were found in two areas: average percentage of improvement at test stimulation (90% vs. 80%, $p=0.007$) and the percentage of patients completely continent during the test stimulation (47% vs 7%; $p=0.004$).

A single report of a consecutive series of 87 patients over a mean follow-up of 48.5 months describes the need for revision surgery in 41%—one-third for device-related failure—including 24% for removal (242). In a French multicentre study comprising 200 consecutive patients with a mean follow-up of 12 months, the rate of device-related adverse events was 24.5% (197).

Major complications are rare: one case report of a life-threatening haemorrhage after elective tined lead electrode removal has been published (286).

A review of 48 cohort studies (45 for faecal incontinence and 3 for constipation) documented the post-operative issues in the 1661 patients with test stimulation and 1600 patients with a permanent SNS implant (287): it found that the incidence of suboptimal outcome was 12.1%, pain 13%, and infection 3.9%. The most common problem during test stimulation was lead dislodgement (5.3%). Systematic literature review suggests a possible underreporting of suboptimal outcome and adverse events. In one single study, the rate of adverse events reached up to 85.2% in patients with a median follow-up of 11 months: loss or lack of efficacy and pain or discomfort accounted for 88.5% of these (288). In a recent review with 45 studies including 1953 patients the pooled rate of infection was 5.1% (4.1-6.4) without significant heterogeneity between trials (289).

In their summary of studies with long-term follow-up (70-118 months), Altomare et al. reported minor complications in 79 patients (PP, 29%; ITT, 19.4%), of which 64 (PP, 23.5%; ITT, 15.7%) were device-related. The most common was pain at a subcutaneous site (23 patients) prompting device removal in 12 patients and replacement in seven. Removal and repositioning for dislocation or battery depletion was necessary in another 17 patients (200). **LEVEL OF EVIDENCE: 2/3**

Summary: Sacral neuromodulation is an effective treatment in patients with severe incontinence unresponsive to conservative treatment. It may be effective as a first line treatment in patients with an anal sphincter defect. The therapeutic benefits are sustained in the medium to long term. The mechanism of action is uncertain however effects on sensory afferents appear most probable. Grade of Recommendation: B

1.9. Puborectal Sling

The puborectal sling operation was first reported by O'Rourke in 1974 (290). In this procedure, an artificial sling is routed behind the anorectal junction and its two ends are fixed to the pubic bone, pulling the anorectal junction up forward with some tension. Similar to the postanal repair, the rationale of this operation is the restoration of the anorectal angle normally maintained by puborectal muscle.

No systematic reviews, randomised controlled trials, non-randomised cohort studies or case control studies have been reported regarding puborectal sling operation for faecal incontinence, while one prospective comparative study (level 2) (291), three prospective case series of good quality (level 3) (292-294) and three retrospective case series of low quality (level 4) (290, 291, 295) were identified.

O'Rourke (290) reported using Dacron® mesh for the treatment of 3 patients with full rectal prolapse as well as 4 patients with mucosal partial rectal prolapse and faecal incontinence. Of the 4 patients with faecal incontinence and partial prolapse, 3 were reported to have "benefited considerably" from the procedure although a formal evaluation of the faecal incontinence was not performed and the follow-up period was not documented. O'Rourke and Egerton (295) also reviewed 24 patients in whom the sling operation was performed using a strip of rolled Mersilene® mesh. This procedure, however, was performed mainly for the treatment of rectal prolapse, while it was conducted because of faecal incontinence alone only in two out of the 24 patients, and the outcomes regarding the continence were not formally evaluated.

Shafik (291) reported another sling operation called puborectoplasty utilising a Teflon™ sling for faecal incontinence. Of 31 patients who had been incontinent to solid stool and underwent this procedure, "good results" were achieved in 26 patients (84%) after a follow-up period of between 2 - 4 years: 20 became continent to solid and liquid stool as well as flatus; 6 to solid and liquid stool but not to flatus; 4 to solid stool only; and only one remained incontinent to solid stool.

Shafik and Shafik (291) conducted a prospective comparative study comparing two fascia lata slings (double loop) in 22 patients and one fascia lata sling (single loop) in 22 for the treatment of faecal incontinence. After 12 months follow-up, "good results" were achieved in 14 (64%) and 8 (36%) by the double loop and the single loop, respectively

Yamana et al. (292) performed the perineal puborectalis sling operation in 8 patients with passive faecal incontinence using polyester mesh sling. A rectal ulcer developed in one patient requiring the sling removal. In the 6-month evaluation of the remaining 7 patients, all reported some extent of improvement of their faecal incontinence. Both the Fecal Incontinence Severity Index and the Cleveland Clinic Florida Fecal Incontinence Score (CCIS) sling-

icantly improved from 27 to 9 and from 13 to 5, respectively. Moreover, all parameters in Fecal Incontinence Quality of Life Scale (FIQL) significantly improved: lifestyle from 2.1 to 3.6; coping/behaviour from 1.5 to 3.4; depression/self-perception from 2.3 to 3.7; and embarrassment from 2 to 3.6.

The transobturator posterior anal sling (TOPAS™) is the first puborectal sling, aimed to be commercially available for the treatment of faecal incontinence in women. It is comprised of a knitted, Type 1 polypropylene monofilament mesh, which is covered by removable insertion sheaths, and two insertion needles. It is implanted through a transobturator approach via two small incisions in the both thighs and buttocks. The implanted mesh is self-fixating and permanent with tissue in-growth providing additional support to the anorectum.

In a preliminary prospective multicentre study, 29 women were implanted with the TOPAS™ system (293). Fifteen patients (52%) achieved treatment success, which was defined as a reduction of 50% or more in the number of faecal incontinence episodes compared with baseline, and 33% reported complete continence. The mean faecal incontinence episodes per 14 days significantly decreased from 6.9 at baseline to 3.5 at 24 months of follow-up. The CCIS and FIQL for all 4 domains were significantly improved during the overall follow-up period compared with baseline. A total of 12 patients (41%) experienced 19 procedure- and/or device-related adverse events, but there were no device-related erosions, extrusions or revisions.

In a larger multicentre FDA controlled study, 152 women were implanted with the TOPAS™ system (294). At 12 months of follow-up, 69% of the patients achieved treatment success, which was defined as a reduction of 50% or more in the number of faecal incontinence episodes compared with baseline, and 19% reported complete continence. The median number of faecal incontinence episodes per week significantly decreased from 9 at baseline to 2.5 at 12 months. The CCIS and FIQL for all 4 domains were significantly improved from baseline to 12 months. A total of 66 patients (43%) experienced 104 procedure- and/or device-related adverse events, but most of them were short in duration and 97% were managed without therapy or with nonsurgical interventions. There were no treatment-related deaths, erosions, extrusions, or device revisions. **LEVEL OF EVIDENCE: 3**

The puborectal sling operation, particularly with TOPAS™ system, seems promising because it is a simple procedure and yielded reasonably good results with low rate of serious complications so far. More prospective studies of longer follow-up period are warranted. These should closely evaluate complications such as sling infection, erosion and rectal ulcer requiring the sling removal.

Summary: The use of a puborectal sling remains unproven but may be of value in selected patients. Grade of Recommendation: D

1.10. Injectable Biomaterials

Injectable agents for urinary incontinence (UI) have had variable success rates but they offer the benefit of performing an outpatient procedure without anaesthesia and with minimal morbidity (296). This has resulted in their continued use for urinary incontinence, as well as continuing research on different injectable agents for use in faecal incontinence. The ideal agent for injection should be biocompatible, non-allergenic, non-immunogenic, non-carcinogenic, easy to inject, and should not migrate within the tissues. Liquid agents that have particles with a diameter of 80 µm are felt to be less prone to migration, but agents with a larger particle size require a larger bore needle to inject, which put them at a higher risk for leakage from the injection site. More recently there has been increasing interest in solid "injectables" in the form of Hi-Hexpan™ [GateKeeper™ (297) - SphinKeeper™ (298)] which expand after their insertion through a custom-made introducer. The results of injectable biomaterials used for faecal incontinence to date are shown in Table 7. However, Injection of liquid bulk-enhancing agents into the anal canal to treat faecal incontinence has reduced in popularity since the date of the 5th ICI. **LEVEL OF EVIDENCE: 3**

Injectable agents for faecal incontinence were first used in 1993 when Shafik (299) treated 11 patients with injections of polytetrafluoroethylene paste into the anal submucosa. After 18-24 months of follow up, 64% reported complete cure and 36% had partial improvement. Shafik (300) subsequently treated 14 patients with autologous fat injections with a reported 100% success rate at 2-3 months and all patients who lost continence to gas or stool became continent after repeat injections. There were no complications using either agent. However, other reports of autologous fat injection have resulted in death from pulmonary fat embolism, and a randomised clinical trial using fat for UI demonstrated no efficacy over placebo; thus, it is currently not used for faecal incontinence (301). Other agents used for injection in the past, that have not achieved widespread use include micro balloons, bovine dermal collagen, and polyacrylamide hydrogel (Bulkamid®).

The first reported injections of glutaraldehyde cross-linked synthetic bovine dermal collagen (Contigen™) for faecal incontinence included 17 patients (302), 11 (65%) of whom showed marked symptomatic improvement at 8 months. A much larger series of 73 patients was then reported (303) in which subjects received injections of 1.7 ml of collagen transanally into the rectal submucosa in three separate areas just proximal to the anal canal. Overall, 63% reported an improvement in their incontinence and the 49 patients with idiopathic incontinence (no sphincter defect and no pudendal neuropathy) had a significant decrease

in their incontinence score. The disadvantages of using synthetic collagen are its potential to be allergenic and degrade over time.

A series of six patients injected with self-detaching cross-linked silicone micro balloons with a biocompatible filler material demonstrated fairly good results, with Browning-Parks incontinence scores for the group decreasing from 16 to 5 (range 0-20)(304). However, sterilization issues have prevented the ongoing use of this product.

Two pilot studies using polydimethylsiloxane particles (PDMS) suspended in a bioexcretable carrier hydrogel of polyvinylpyrrolidone (Bioplastique™) for faecal incontinence in 2001 and 2002 (305, 306) led to increased use of this product in Europe and it was renamed PTQ™ implants (PTPT™ implants in Australia). The initial pilot study (305) looked at 10 patients with passive incontinence who received circumferential or single site injections of PDMS. At six weeks, six patients showed either marked improvement or complete cessation of leakage and an additional patient improved after a second injection. However, after six months, only two of seven patients had maintained marked improvement. Complications included anal pain and ulceration at the injection site. In the largest study of PDMS injection to date (307) 82 patients with severe faecal incontinence were randomised to receive PDMS implants either with or without endoanal ultrasound guidance for injection. All patients had a significant improvement in their CCF-FIS. At 12 months, this score decreased from 14.5 to 3 in the ultrasound guidance group and from 14.5 to 11 in the non-ultrasound group. Six patients, two from the ultrasound guidance group, complained of pain at the injection sites. There were no other complications. The ultrasound guidance group had more significant improvement in resting pressures and quality of life scores. The same investigators injected PDMS into seven patients with passive incontinence after haemorrhoidectomy and found significant improvement CCF-FIS and quality of life scores in all patients (308).

Several other series have been reported PDMS use for faecal incontinence (309-312). In all, 2.5ml of product was injected into 3-4 sites in the intersphincteric space and CCF-FIS decreased significantly. In one study of 20 patients, the CCF-FIS decreased significantly from 13.5 to 4.5 at one month and slowly increased to 9.4 at two years, which was a still a significant improvement from the baseline score. Quality of life scores also improved, but there was no effect on resting or squeeze anal canal pressures pressures measured at baseline and 3 months after injection. Seventy percent of patients experienced pruritus ani and one patient developed an infection at an injection site (309). In a study of 33 patients, CCF-FIS decreased from 12.7 to 10.4 at one year, yet quality of life was not improved (310). Both of these studies examined implant migration and 67% (310) and 84% (313) had detectable implants at the site of injection

by ultrasound, though this did not seem to affect clinical response. The largest of these studies is notable for its sample size of 74 patients and that half of these subjects were men. It found that 70% of patients reported complete satisfaction with their continence (post-treatment CCF-FIS =0). In the remaining 30%, CCF-FIS decreased from 12 to 3.5 at 33 months with associated improvements in quality of life measures. All patients, but especially those who became continent, had significant improvements in mean resting pressures, squeeze pressure and mean anal canal length.

Worse results were seen in women with pudendal neuropathy or those for whom biofeedback had already failed (311). Another study specifically compared the anorectal manometry of patients injected with PDMS with that of normal controls and found that after injection in the symptomatic patients there was a similar decrease in CCF-FIS with associated improvements in FIQL scores. The symptomatic patients had lower resting and squeeze pressures than controls at baseline and these pressures did not improve with injection. However, these patients did have elongation of their high-pressure zone, as well as improvements in the asymmetry index, indicating that morphologic but not physiological changes had occurred with injection (312).

The only report of long-term results for injectable agents was for Bioplastique™ (314). The 5-year outcome for 6 patients injected with this compound in 1999 included a median St. Mark's incontinence score that was essentially unchanged from 11 to 13 (range 9-20). One patient had undergone a colostomy, but four of the five remaining patients reported subjective improvement in their incontinence and better quality of life scores. In 2012 van Wunnik et al (315) reported on 2 patients who were said to have developed local giant cell foreign body reactions after PTQ injections; both required surgical intervention and further treatment for their incontinence. **LEVEL OF EVIDENCE: 3**

A pilot study conducted in 2008 examined two other products, cross-linked porcine dermal collagen (PDC) (Permacol™), and polyacrylamide hydrogel (PAH) (Bulkamid®)(316). Ten patients with passive faecal incontinence to liquid or solid stool who had failed conventional treatments were prospectively randomised to receive either of the two products. The needle was first inserted into the skin 2 cm from the anal margin and the product was then injected trans-sphincterically. The median volume to achieve closure of the anal canal under direct vision was 9 ml for PAH and 15 ml for PDC. The St Mark's incontinence score decreased at 6 weeks for both groups, but this decrease was sustained at 6 months only for the PAH group. This pilot study lacked power to determine if these two treatments for faecal incontinence was significantly different.

There has been a further nonrandomised retrospective study in which PDC was injected into the internal

anal sphincter in 110 patients 100 of whom were available for follow up for a minimum of 36 months (317). Three injections of 2.5 ml with a further 2.5 ml injected into any defect identified on endoanal ultrasound. The CCF-FIS scores improved from a median of 14 (range 5-14) to a median of 8 (range 5-14) but this difference was not statistically significant. A total of 68% of patients reported a subjective improvement at 3 years but there was deterioration with time. Thirty eight percent of patients were given a second injection and 15% required a third injection.

Several other injectables have been used for faecal incontinence with variable results. In one of the few adequately powered, randomised controlled trials using injectables, 44 patients were randomised to receive transdermal injections of polydimethylsiloxane elastomer silicone biomaterial (PDMS) or saline into the intersphincteric space (318). Three 2.5ml injections were performed using local anaesthesia. Only the patients were blinded to the treatment. There was no difference in the percentage of patients in the two groups who had a successful treatment, defined as having a CCF-FIS score <8 or the decrease in CCF-FIS scores post treatment. The saline group tolerated treatment better and had fewer adverse effects overall. Thus, the study concluded that the use of PDMS should not be recommended.

Two small studies using calcium hydroxylapatite ceramic microspheres (HCM) (Coaptite™) and ethylene vinyl alcohol (EVOH) showed some promise but the testing was much less rigorous. In one of these studies, HCM were injected transsphincterically to four submucosal sites using 1ml at each site with the patient under local anaesthesia. The average Faecal Incontinence Scoring System (FISS) score for 10 patients decreased from 85.6 to 28 at 12 months ($p=0.008$) and the lifestyle, coping and behaviour/embarrassment subscales of the Fecal Incontinence Quality of Life Scale (FIQL) showed improvements ($p<0.05$). Anorectal manometry also showed better resting pressures (40 to 47 mmHg, $p=0.018$). There were no complications, but one patient experienced leakage of product from the injection site that required another injection (319).

In the second of these smaller studies, 21 patients received ethylene vinyl alcohol (EVOH) injections with 1-2 ml in up to 8 sites in the intersphincteric space under general or local anaesthesia. At 12 months, Faecal Incontinence Severity Index (FISI) scores dropped from 32.8 to 22 and CCF-FIS scores decreased from 11 to 6.9. Two subscales of the FIQL improved significantly and repeat anorectal manometry demonstrated some increase in anal canal length and resting pressures (320).

Another commonly used injectable, pyrolytic carbon-coated zirconium oxide beads (PCZO) (Durasphere®), is non-reactive and not biodegradable. However, the beads are known to migrate within the tissues and require a large bore needle to inject the substance. The injected substance is placed in the

submucosal plane using either a transanal or intersphincteric approach. The initial trial (321) assessed the short and long-term efficacy in 18 patients with an internal anal sphincter defect refractory to conservative management. About 1.3ml was injected in the submucosal plane at the site of the sphincter defect in 1-4 sites until adequate anal sphincter symmetry was restored. At 12 months, CCF-FIS and patient satisfaction scores were significantly improved. Fifteen of 18 patients reported improvement in their incontinence. Weiss et al. also demonstrated improvement in ten patients who were followed for only 3 months (322).

In a larger study, 33 patients with minor or medium severity faecal incontinence (CCF-FIS < 14 and/or American Medical Systems (AMS) score < 89) received injections (mean of 8.8 ml (range 2-19 ml) of PCZO into the submucosa at the level of the dentate line using an 18-gauge needle at four different sites (323). After a mean follow-up period of 21 months, the CCF-FIS for the group decreased significantly from 12 to 8 and the AMS score from 89 to 73 but the faecal incontinence specific quality of life measures did not change. Resting and squeeze pressures also increased 12 months after injection. Adverse events included anal pain in two patients, asymptomatic leakage of material in one patient, and distal migration of product in two patients. A study of 11 patients in which about 2.8ml of PCZO was injected into 3-4 sites in the submucosal space reported a decrease in CCF-FIS from 12.7 to 4.9 at 2 years with improvements in the coping and embarrassment subscales of the FIQL at 6 months. Although manometry pressures did not change initially, the resting and cough pressures were higher at 2 years than at 1 year (324).

The most recent study using PCZO injected the product using a slightly different approach. In all 23 subjects, the product was injected into the intersphincteric space in four sites. Again, about 2.8ml of product was injected at each site. At 12 months, patients had a decrease in the CCF-FIS from 18.7 to 10.9 and an increase in FIQL score from 46 to 55.8. Mean squeeze pressures on anorectal manometry increased significantly at 12 months. Adverse complications included prolonged pain in one patient and a sterile perianal fluid collection in another (325).

LEVEL OF EVIDENCE: 4

Two trials have compared the safety and efficacy of PDMS and PCZO (326, 327). In the first sample size was calculated to detect a 50% reduction in the CCF-FIS post injection. Thus, 40 patients with faecal incontinence (mean CCF-FIS 11.45) were randomised to receive either PDMS or PCZO. Both groups were similar in terms of age, medical history, faecal incontinence severity and quality of life scores, as well as anorectal manometry results. Although the PCZO group had a more significant reduction in CCF-FIS at 2 weeks (11.45 to 8.25 vs. 11.45 to 10.9), the PTQ group had a greater reduction in CCF-FIS at 6 weeks, 6 months and 12 months (4.6, 2.95 and 3.8 vs. 7.65, 6.2 and 7), and had no complications. The PCZO

group had several complications including anal pain (5%), mucosal erosion (10%), arthritis and skin rashes (5%). Furthermore, the PDMS group demonstrated significant improvements in general and faecal-incontinence-specific quality of life scores that were not seen in the PCZO group. Thus, the conclusion was that PDMS was safer and more effective than PCZO for the treatment of faecal incontinence (326). **LEVEL OF EVIDENCE: 3**

In the second trial, Morris et al. (327) performed a smaller study of 35 patients with 17 randomised to receive PDMS and 18 to PCZO; numbers were limited as the trial was closed early due to the removal of PDMS from the Australian Pharmaceutical Benefits scheme. Circumferential injection was performed under local anaesthesia and sedation. The primary outcome measure was the CCF-FIS incontinence score with the SF-36 and maximum resting and squeeze pressures being secondary outcomes. Follow-up was up to 1 year and despite early improvements incontinence scores were not significantly improved at 12 months. SF36 scores did not significantly improve at any stage of the follow up. One of the patients receiving PDMS developed a perianal abscess.

The newest liquid injectable agents to be used for faecal incontinence are acid/dextranomer (NASHA Dx) copolymers (Zuidex™, Solesta®). Dextranomer microspheres are suspended in non-animal stabilized hyaluronic acid. As with other injectable agents, NASHA Dx has been used to treat urinary incontinence (328) and a pilot study of four patients reported no adverse events and a median decrease in St Mark's incontinence score of 3.5 points (19.25 to 15.75) (329). In a subsequent study of 34 patients who received transanal injections into the submucosa just above the dentate line (about 1ml of product was injected into four sites), the median number of incontinent episodes in a four-week period dropped from 22 to 9 (325). When response was defined as a 50% or greater decrease in number of incontinent episodes, 56% of patients were defined as responders at 12 months. No adverse events were reported. These findings led to a randomised double-blinded sham-controlled trial of 206 patients randomised in a 2:1 fashion to receive NASHA Dx or placebo injection (330). The patients and the evaluating investigators were blinded to the treatment. More patients in the treatment group had 50% or greater reduction in the number of incontinence episodes (52% vs. 31% of controls; $p=0.009$), but the change in CCF-FIS did not differ after treatment between groups (14 to 2.5 in the treatment group vs. 13 to 1.7 in placebo group). The FIQL was only significantly improved compared to placebo for the coping and behaviour subscale. Both groups had a high retreatment rates: 82% of patients in the NASHA Dx group received reinjection of product and 87% of patients in the control group had repeat sham injection. The NASHA Dx group had significantly more adverse events, including proctalgia, rectal bleeding, pruritus, diarrhoea, constipation, fever, and two serious complications of rectal abscess and prostatic abscess. The control group had more

injection site bleeding. Schwandner et al. (331) reporting on 21 patients who received injections of 1ml of NASHA Dx in four sites of submucosa there were no adverse events and 61% of patients had a significant decrease in incontinence episodes at 3 months and 56% had a sustained improvement at 22 months. The CCF-FIS decreased from 16.8 to 12.3 but was not significant. Improvements in FIQL scores were noted.

La Torre and de la Portilla reported on 83 of 115 patients who were followed up for 24 months after 4 injections of 1ml DHAC with 62.7% reporting a $\geq 50\%$ reduction in the total number of episodes of faecal incontinence. This decrease and the increase in the number of incontinence free days were significant as was the reduction in the CCF-FIS and FIQL (332).

Danielson et al reported on only 34 patients injected with 4×1 ml DHAC in the submucosal layer. At 2 year follow up 26 patients were said to have reported a "sustained improvement". This assessment was done using median number of incontinence episodes [22 pre-treatment, 10 at 1 year and 7 at 2 years] and the Miller incontinence scores [14 pre-treatment, 11 at 1 year and 10.5 at 2 years]. It was also noted that only patients with more than a 75% improvement in the number of incontinence episodes had a significant improvement in quality of life at 24 months, resulting in the suggestion that this was a more accurate threshold to indicate a successful incontinence treatment than the more commonly used 50% (333).

A Cochrane review published in 2013 concluded that there had been no long term studies on the efficacy of injectable bulking agents for passive faecal incontinence (334). Whilst relatively safe, the studies done on these agents by the time of that review had been of poor quality and no firm conclusions could be reached. **LEVEL OF EVIDENCE: 3**

In 2014 the NASHA Dx Study Group reported on the 3-year follow up of NASHA Dx injection therapy for treatment of faecal incontinence (335). One hundred and thirty six patients were assessed post injection with success defined as a reduction in number of FI episodes by 50% or more compared with baseline. The CCF-FIS and Fecal Incontinence Quality of Life Scale were also used. A successful outcome was deemed to have occurred in 52% of patients at 6 months and this was sustained at 12 months (57%) and 36 months (52%). There were also significant decreases in the mean CCF-FIS and all four domains of the quality-of-life scores improved significantly between baseline and 36 -months follow-up.

The newest injectables are polyacrylonitrile Hi-Hexpan™ cylinders, the Gatekeeper™ and SphinKeeper™ prostheses. The first study on Gatekeeper™ reported on 14 patients who received transdermal injections of into the intersphincteric space. The CCF-FIS score decreased from 12.7 to 5.1($p<0.01$) and there were no complications. Location of the prostheses was recorded by ultrasound

and no dislodgement was seen at 1 year (336). A multicentre observational study of the efficacy of 6 Gatekeeper™ implants placed intersphincterically recorded the outcome in 54 patients. Incontinence to gas, liquid and solid stool improved significantly and all faecal incontinence severity scores were significantly reduced. At 12 months 56 per cent of the patients showed at least a 75 per cent improvement in all faecal incontinence parameters; 7 (13 per cent) were fully continent. Three patients extruded a single prosthesis during surgery; these were all replaced. Dislodgement occurred in three patients post-operatively but none required replacement.

The only study to date on the SphinKeeper™ has looked the feasibility of using this implant and prosthesis localization at 3 months (298). The SphinKeeper™ prostheses pre-implantation are 29mm in length and 3mm in diameter; they become 23 mm long and 7mm diameter within 48 h of contact with fluids. Ten prostheses were implanted in each patient under local anaesthesia and endoanal ultrasound guidance, into the upper-middle intersphincteric space of the anal canal. A partial dislocation of a single prosthesis causing anal discomfort was documented by EAUS post operatively in one patient. The discomfort resolved after 1 week.

Another newer agent is polyacrylate-polyalcohol which was used in non-consecutive series of 58 patients and reported to have achieved predefined successful treatment (50% of more improvement of CCF-FIS) in 60.4%, albeit only 34 patients and 22 patients

were available at 6 months and 36 month follow-up respectively (337).

In conclusion, studies of injectable biomaterials comprise several small case series that in general show short-term efficacy and only three randomised trials, two of which compared PMDS and DHAC to placebo, and a third that compared PDMS to PCZO™. These trials indicated that PMDS should not be used,

PDMS appears to be better than PCZO in terms of both safety and efficacy, and there are data indicating that NASHA Dx is more effective than placebo. Two systematic reviews (338, 339) and a Cochrane review (334) could not establish evidence to support the efficacy of any of these agents, however one review did find in multivariate analysis, use of the intersphincteric, instead of transanal or trans-sphincteric routes of injection, was associated with a higher complication rate. Furthermore, PDMS and HCM were more effective than other injectable agents with regard to short-term outcome and use of local anaesthesia was associated with a lower likelihood of success (338) [LEVEL OF EVIDENCE: 3]

Summary: The role of Injectable biomaterials in treatment of faecal incontinence remains to be established but may be of value in the treatment of passive incontinence. The optimum bulking agent and technique of application remains to be determined. Grade of Recommendation: D

Table 7. Studies using Injectable biomaterials

Authors (ref)	Year	Agent	# Pts	Injection technique	# Sites	Volume	Success
Shafik (299)	1993	Polytetrafluoroethylene paste	11	Transanal	2	0.5ml	64%
Shafik (300)	1995	Autologous fat	14	Transanal	2	50-60ml	100%
Kumar et al (302)	1998	Glutaraldehyde cross-linked synthetic bovine dermal collagen	17	Transanal	1-3	Up to 2ml	65% pts improved
Malouf et al (305)	2001	polydimethylsiloxane particles	10		1-4	5-11.5ml	60% initial improvement, 20% long-term
Feretic et al (304)	2001	Microballoons with biocompatible hydrogel	6	Transanal	3-5	0.9ml in balloon	Browning-Parks Incontinence score 16 to 5
Davis et al (321)	2003	Carbon-coated zirconium oxide beads	18	Transanal	1-4	1.28ml	83% pts improved CCF-FIS 11.9 to 8.1
Tjandra et al (307)	2004	polydimethylsiloxane particles	82	Intrasphincteric with and without ultrasound	4	2.5ml	CCF-FIS w US: 14.5 to 3 Without US: 14.5 to 11
Stojkovic et al (303)	2006	Glutaraldehyde cross-linked synthetic	73	Transanal	3	1.7ml	63% improved CCF-FIS 10 to 6

Authors (ref)	Year	Agent	# Pts	Injection technique	# Sites	Volume	Success
		bovine dermal collagen					
Dehli et al (329)	2007	NASHA/Dx gel	4	Transanal to Submucosal	4	1.4ml	St Marks Incontinence score 19.25 to 15.75, 75% pts improved
Siproudhis et al (318)	2007	Polydimethylsiloxane elastomer silicone biomaterial	22	Intrasphincteric	3	2.5ml	No difference in CCF-FIS: 13.8 to 11.7 PMDS, 14.6 to 11.4 placebo
de la Portilla et al (309)	2008	polydimethylsiloxane particles	20	Transsphincteric	3	2.5 ml	CCF-FIS 13.5 to 4.5
Altomare et al (323)	2008	Carbon-coated zirconium oxide beads	33	Transsphincteric	4	8.8ml	CCF-FIS 12 to 8 AMS 89 to 73
Maeda et al (316)	2008	Cross-linked porcine dermal collagen	5	Transsphincteric	3	9ml	St Marks Incontinence score 15 to 12.5
		Polyacrylamide hydrogel	5	Transsphincteric	3	15ml	St Marks Incontinence score 15 to 12.5
		Saline	22				
Ganio et al (319)	2008	Calcium Hydroxylapatite Ceramic Microspheres	10	Transsphincteric to submucosal site	4	1ml	FISS 85.6-28 FIQL impr subsc 4
Soerensen et al (310)	2009	polydimethylsiloxane particles	33	Transsphincteric to Intrasphincteric	3	2.5ml	CCF-FIS score 12.7 to 10.4 18% pts sig improved
Tjandra et al (326)	2009	polydimethylsiloxane particles	20	Intrasphincteric	4	2.5ml	No complications, more pts with >50% improvement CCF-FIS 11.45 to 3.8 sig improvement FIQL and SF12
		pyrolytic carbon coated beads	20	Submucosal	4	2.5ml	More complications CCF-FIS 11.45 to 7 No change FIQL and SF12
Bartlett & Ho (311)	2009	polydimethylsiloxane particles	74	Intrasphincteric	4	2.5ml	70% continent CCF-FIS=0 30% CCF-FIS 20 to 3.5
Aigner et al (324)	2009	pyrolytic carbon coated beads	11	Intrasphincteric to submucosa	3-4	Avg. 2.82ml	CCF-FIS 12.7 to 4.91, FIQL 2/4 subscI improved
Oliveira et al (312)	2009	polydimethylsiloxane particles	35	Transsphincteric to intra-sphincteric site	3	2.5ml	CCF-FIS 11 to 3.5
Danielson et al (340)	2009	NASHA/Dx	34	Transanal to submucosa	4	1ml	# episodes/4wks 22 to 9
Beggs et al (325)	2010	Pyrolytic carbon coated graphite beads suspended in a water-based carrier gel	23	Intersphincteric	4	2.8ml	CCF-FIS 18.7 to 10.9 FIQL improved
Stephens et al (320)	2010	Ethylene Vinyl Alcohol EVOH	21	Intrasphincteric	Max 8	1-2ml	FISI 32.8 to 22 CCF-FIS 11 to 6.9

Authors (ref)	Year	Agent	# Pts	Injection technique	# Sites	Volume	Success
							FIQL 2/4 subs improved
Ratto et al (336)	2011	Polyacrylonitrile cylinder	14	Transdermal to intrasphincteric	4	NA	CCF-FIS 12.7 to 5.1 FIQL and SF36 improvement
Graf et al (330)	2011	NASHA/Dx	136	Transanal submucosal	4	1ml	52% vs. 31% had >50% reduction in incont episodes No difference in CCF-FIS:14 to 2.5 NASHA Dx ,13 to 1.7 placebo
		Placebo	70				
Morris et al (320)	2013	Textured polydimethylsiloxane particles suspended in a bioexcretable carrier hydrogel of polyvinylpyrrolidone (PTQ implants)	17	Intersphincteric	3-4	2.5ml	Wexner score compared to baseline was reduced by 4.3 (P<0.001), 4.2 (P<0.001), and 1.1 (P=0.24) at 6 weeks, 6 and 12 months.
		Pyrolytic carbon coated graphite beads suspended in a water-based carrier gel	18	Submucosal plane	4	2.5ml	Improvements in the Dura-sphere arm for the same time periods were 5.3 (P=0.003), 4.1 (P=0.002), and 1.8 (P=0.19).
Rosato et al (337)	2015	polyacrylate-polyalcohol	58	NA		2ml at site, min 3-max 9ml	60.4% met criteria of success (>=50% improvement of CCF-FIS)

1.11. Vaginal Bowel-Control System

The vaginal bowel-control system (Eclipse System) is a recently developed compression device designed to augment faecal continence. It consists of a silicone coated vaginal pessary with a stainless steel base and posteriorly directed balloon, both of which have a range of available sizes. It is inserted into the vaginal cavity and the air-filled balloon augments continence. The balloon is deflated to allow evacuation and is removed prior to intercourse (341).

There has been one open label prospective non randomised observational study reported to date (342). In 110 patients (required criteria of ≥ 4 FI episodes every two weeks) fitted with the device, only 56 patients entered treatment and completed the one-month follow up per protocol. The principal outcome was a reduction in the number of bowel movements per day which was associated with fewer loose stools and consequently less urgency and fewer incontinence episodes. There were no major adverse events. Collaborative studies and longer term follow-

up are required, however the system is relatively simple to use and may have a role in moderately severe faecal incontinence unresponsive to conservative treatments

Summary: The role of the vaginal bowel control system remains to be established but may be of value in the treatment of urge and / or passive faecal incontinence. Grade of Recommendation: D

1.12. Radiofrequency Energy Treatment

Temperature controlled radiofrequency energy was first used in treatment of gastro-esophageal reflux disease. Following initial animal studies, the technique (SECCA®) was adapted by Takahashi et al (343) as a minimally invasive technique to augment continence in a cohort of 10 women. CCF-FIS improved in 9 of the 10 (median 13.5 to 5.0, $p=0.006$ at 12 months). Follow-up to this cohort showed sustained improvement at 2 years (344) and at 5 years in a larger cohort of 19 patients (345). A larger multicenter study that enrolled 50 patients found significant but less dramatic improvement in CCF-FIS six

months following treatment (14.5 to 11.1, $p < 0.001$) (346). Smaller European studies found moderate improvement in 11 (347) and 15 patients respectively (348), while Kim et al. found no continence improvement and considerable morbidity in 8 patients (349). Three-year follow-up in a prospective cohort study of 31 patients by Lam et al., found that only 6% maintained a 50% reduction in incontinence score and concluded that any benefits observed were of a temporary nature (350). Similarly, Abbas et al. noted that only 6 of 27 patients (22%) had a sustained long term response to treatment, and 14 (52%) were awaiting additional incontinence treatment at a median of 40 months follow up (351). A review of all published series with 220 patients in total concluded SECCA is associated with moderate clinical benefit (352). The mechanism of action is unclear but most probably relates to a degree of scarring or fibrosis of the anal canal that improves the barrier function that declines overtime (353), however recent studies in a porcine model have shown hyperplasia and hypertrophy of smooth muscle fibres in the IAS similar to myocardial remodelling that occurs following radiofrequency ablation (354). The results of randomised trials vs. placebo are awaited. **LEVEL OF EVIDENCE**

3

Summary: Temperature controlled radiofrequency energy may transiently improve continence in patients with mild to moderate symptoms, but long-term results are disappointing. The results of controlled trials are awaited. Grade of Recommendation: D

1.13. Stem Cell Therapy and Other Tissue Regeneration Techniques

Despite of the development of various different devices to augment or replace the lost function of the anal sphincter apparatus, there is an inherent feeling that the most ideal solution would be a biocompatible regeneration of tissue and restoration of its function.

A study by Frudinger et al. has reported successful treatment of faecal incontinence using autologous myoblasts cultured from a pectoralis muscle biopsy and injected into the external anal sphincter defect using ultrasound guidance (355). No adverse events were reported and the efficacy was sustained at 5 years (356). This has been followed by another group who have also reported a moderate success of autologous myoblast injection which was harvested from vastus lateralis (357). Raghavan et al. have produced a ring of smooth muscle from a combination of chitosan scaffold, mature smooth muscle and neuronal progenitor cells harvested during surgery to recreate an internal anal sphincter. The engineered internal anal sphincter had contractile properties and intrinsic innervation (358, 359).

While these approaches are undoubtedly promising, issues remain concerning the origin and preparation of the donor cells and whether the objective is to bulk existing tissues or recreate a substantial volume of

lost sphincter. In that regard, if mature skeletal muscle cells are used as a source, fully differentiated cells are unlikely to further differentiate or integrate with native sphincter. Equally, as the internal anal sphincter is a smooth muscle, it is difficult to find an easy and accessible site for harvesting. Stem cell therapy may overcome these limitations as it has potential to regenerate not only muscles but also other types of cells such as nerves and connecting tissues that are needed to support the regenerated musculature. The source of cells could be accessible if adipose tissue or bone marrow is chosen. This option has been explored in animal models (360). Some groups are also exploring use of allogeneic stem cells which will improve the availability of the stem cells exponentially but immunological compatibility will be problematic.

The success of these techniques may hinge not on tissue bulking effects but creation of contractile muscle that aligns with the original tissue, together with the restoration of nerves and connecting tissues that control and structurally support the *de novo* muscles. The potential risk with this approach, such as abnormal growth patterns (including potential malignancy) and distant migration, remains a legitimate concern (361). Although the possibilities in this area are exciting, to date, there has been no clinical study that has demonstrated regeneration of a fully functional anal sphincter.

Summary: Stem cell therapy remains experimental and should only be offered as part of a well-designed research trial. Grade of Recommendation: D

1.14. Colostomy

A permanent colostomy for severe faecal incontinence is usually formed as a last resort when all other interventions have failed. Because colostomy is generally regarded as a failure of treatment and, therefore, not so frequently performed, its effectiveness, perioperative complications, and impact on the quality of life have never been properly evaluated except in patients with functional bowel disorders after spinal cord injury (362-364). For a specific role of colostomy for these patients, please refer to chapter XX. Not only for patients with spinal cord injury, but also for general patients with severe faecal incontinence, colostomy is a frequently successful management strategy that restores dignity and allows them to regain social function.

No randomised controlled trials or non-randomised cohort studies have been reported regarding colostomy for faecal incontinence, and only one systematic review (171), one case control study (365) and two case series (366, 367) were identified. No new study has been reported since the 5th ICI, The American Society of Colon and Rectal Surgeons' Clinical Practice Guideline for the Treatment of Fecal Incontinence published in 2015 state "Creation of a colostomy is an excellent surgical option for patients who have failed or do not wish to pursue other therapies for fecal incontinence (strong recommendation, low- or very

low-quality evidence”)(10). The American College of Gastroenterology clinical guideline for the management of benign anorectal disorders published in 2014 stated “Colostomy is a last resort procedure that can markedly improve the quality of life in a patient with severe or intractable fecal incontinence (strong recommendation, low quality of evidence)”(9). **LEVEL OF EVIDENCE: 4**

Colquhoun et al. (365) conducted a cross-sectional postal survey, comparing quality of life between 71 patients with faecal incontinence and 39 with a colostomy created for rectal cancer, complicated colonic diverticular disease or faecal incontinence. Analysis of the Short Form 36 General Quality of Life Assessment revealed significantly higher social function score in the colostomy group than in the faecal incontinence group (0 vs. -0.6, $p=0.022$). An age- and gender-adjusted regression analysis of the Fecal Incontinence Quality of Life score revealed significantly higher scores in the coping (2.7 vs. 2.0, $p=0.005$), embarrassment (2.7 vs. 2.2, $p=0.014$), and lifestyle scales (3.2 vs. 2.7, $p=0.14$) in the colostomy group compared to the faecal incontinence group. The authors concluded that a colostomy is a viable option for patients who suffer from severe faecal incontinence and offers a definitive cure with improved quality of life. Tan et al (171) performed a systematic review, specifically comparing the cost-effectiveness between end stoma (ES), artificial bowel sphincter (ABS) and dynamic graciloplasty (DG). The quality-adjusted life years (QALYs) and the incremental cost-effectiveness ratio (ICER) were compared between the three procedures, by obtaining the probability estimates for patients with faecal incontinence from published data, with being supplemented by expert opinion. The end stoma was the most cost-effective therapy at 5 years, with a QALY gain of 3.45 for GB£16,280 and an ICER of GB£4,719/QALY, compared to ABS (4.38 for GB£23,569; GB£5,387/QALY) and DG (4.00 for GB£25,035; GB£6,257/QALY). After 10 years, ABS became the most cost-effective surgical intervention, with a QALY gain of 8.384 for GB£32,397 and an ICER of GB£3,864/QALY, compared to ES (6.9 for GB£27,910; GB£4,046/QALY) and DG (7.678 for GB£35,165; GB£4,580/QALY). The results of this study, however, must be interpreted with great caution, because colostomy, unlike DG and ABS, does not attempt to restore normal continence. In addition, this report is not an interventional study but a systematic review with a rather complicated methodology and a variety of possible biases.

Norton et al (366) examined patients' view of a colostomy by conducting a questionnaire survey of patients who had a colostomy created to manage their faecal incontinence. Sixty-nine people (58 women) responded. When patients were asked to rate their ability to live with their stoma now on a scale of 0-10, the median score was 8 (range 0 – 10). The majority (83%) felt that the stoma, within the past month, restricted their life “a little” or “not at all”. Eighty-four per-

cent answered that they would “probably” or “definitely” choose to have the stoma again. When they were asked the question “compared to when you were incontinent, how much change has having a stoma made to your overall quality of life?” on the scale of -5 (much worse) to +5 (much better), the median rating was +4.5 (range -5 to +5). The authors concluded that health care professionals should discuss the option of a stoma with incontinent patients because of the overwhelming positive outcomes.

An end sigmoid colostomy without proctectomy is usually recommended as a procedure of choice for patients who elect colostomy for the management of their refractory faecal incontinence. Creating such a colostomy, however, does not always solve all the problems of patients with faecal incontinence. Catena et al (367) reported a retrospective chart review of 44 patients (35 women) who underwent elective end sigmoid colostomy for faecal incontinence of various aetiologies. After colostomy formation 19 patients (43%) were asymptomatic, while the other 25 experienced such problems with their rectal stump as diversion colitis and leakage of mucus. Of the 25 patients, 12 (27% of the total) underwent a secondary proctectomy due to problems with the rectal stump sufficient to warrant the operation. Histological examination revealed diversion colitis in 6 patients. The factor associated with proctectomy was age, with younger patients being more likely to require rectal excision. The authors concluded that data are insufficient to recommend primary proctectomy in patients with severe faecal incontinence warranting permanent end sigmoid colostomy.

Colostomy provides restoration of a more normal lifestyle and improves quality of life. Colostomy should not be regarded as a treatment failure but rather a reasonable treatment option for patients whose lives are restricted by faecal incontinence that is not amenable to other therapies or not suitable for more complicated surgical procedures. An end sigmoid colostomy alone, without proctectomy, is recommended. The minority of patients who develop significant symptoms from their retained rectal stump may eventually require proctectomy as a secondary procedure.

Summary: Formation of an end colostomy should be considered as a reasonable treatment option for patients with refractory faecal incontinence who are unsuitable for or have failed other treatment modalities and who able to accept the associated alteration in body image. Grade of Recommendation: C

III. SURGERY FOR PAEDIATRIC FAECAL INCONTINENCE

1.1. Anorectal Malformations

Anorectal malformations (ARM) occur once in every 3000- 5000 live births. ARMs range from the minor defects that are easily treated and have excellent functional outcome, to complex malformations that are difficult to manage and invariably associated with defecatory problems including incontinence. The surgical approach to repairing these defects changed dramatically in 1980 particularly with the advent of posterior sagittal anorectoplasty (PSARP) [**LEVEL OF EVIDENCE: 3**].

This technique has enabled surgeons to visualize the anatomy under direct vision and perform corrective surgery more accurately (368, 369). It has become the predominant surgical method for anorectal anomalies. In brief, a mid-sagittal incision is performed and the sphincter mechanism is completely divided in the midline. The rectum is separated from the genitourinary tract and moved down to the perineum. The most challenging aspect of the operation is the separation of the rectum from the vaginal or urinary tract, which effectively requires creating two walls out of one septum without damaging each structure. This approach can also be used for reoperation in anorectal malformations (370) and can be applied for reconstruction of severe perineal trauma (371).

For both male and female babies, urethral-perineal fistula is the simplest to correct. This requires the so-called "minimal posterior sagittal approach" which enlarges the stenotic orifice and relocates the rectal orifice posteriorly within the limits of the sphincter complex. For males with recto-urethral-bulbar fistula or recto-urethral-prostatic fistula and females with recto-vestibular fistula or cloaca with a short (less than 3cm) common channel, the posterior sagittal approach is the main operation performed. For males with higher fistulae such as a recto-bladder neck fistula and other complex and unusual defects and females with cloacae with a long (greater than 3cm) common channel and complex defects, the posterior sagittal approach needs to be coupled with abdominal access.

The laparoscopically assisted anorectal pull-through procedure (LAARP) first described by Georgeson (372) in 2000, is becoming increasingly common in the management of patients with high/intermediate ARM, replacing many traditional open procedures (373). In brief, a sharp dissection and cautery is used laparoscopically to expose the rectal pouch down to the urethral or vaginal fistula, which is clipped distally and divided. The pelvic floor musculature and the puborectal sling are identified and electrostimulation is used externally to define the centre of the anal dimple. A skin incision is made, centred at the strongest cephalad contraction. Guided by laparoscopic visualization, a trocar, consisting of a radially expandable

sheath over a Veress needle, is passed through the defined plane in the external sphincter muscle complex and advanced into the pelvis between the two limbs of the pubococcygeus muscle, forming a passage through the centre of the striated muscle complex and levators. The rectal fistula, which has been dissected out laparoscopically, is grasped using the perineal trocar and exteriorized to the perineum. Anorectal anastomosis is then performed (372).

A recent study of long term functional outcome comparing PSARP (n=34) to LAARP (n=32) ARM children with recto-bladder neck and recto-prostatic fistula found that LAARP is a less invasive procedure (shorter operative time and post-operative hospital stay) and both short term- and long term outcomes after LAARP were equivalent if not better than those of PSARP in children with high ARM (374) [**LEVEL OF EVIDENCE: 3**].

The most complex malformations are cloaca and cloacal exstrophy. In females with cloaca, the rectum, vagina and urethra fail to develop separately and instead drain via a common channel that opens into the perineum as a single orifice. The repair of cloacal malformations is most often performed using a posterior sagittal anorecto-vagino-urethroplasty (PSARVUP) or total urogenital mobilization (TUM) with or without laparotomy (375). The PSARVUP extends the anorectoplasty with a meticulous dissection of the combined vaginal-urethral walls, followed by the reconstruction of distal parts of both structures (376). In 1997, total urogenital mobilization (TUM) was presented by Peña as a new, faster, surgical approach for certain cases of cloacal repair with better cosmetic results (377).

This procedure separates the rectum from the vagina and both vagina and urethra are then mobilised together. The advantage of this technique is to avoid separating rectum, vagina and urethra completely which is not always feasible and risks damaging these structures. This technique avoids the risk of urethrovaginal fistula and vaginal stricture previously reported as complications in 10% of the cloacal repair and also gives enough mobilisation to allow more than 50% of all cloacal repairs without opening the abdomen (376, 377). Functional outcomes depend on the severity of the malformations. A review of more than 1000 anorectal malformation cases showed 100% of babies who had perineal fistula repair achieved continence. Approximately 55% of patients who had been operated for recto-vestibular fistula had bowel control. Any malformations more complicated resulted in only up to 30% achieving continence. All patients who had recto-bladder neck fistula repair were incontinent.

The defects are categorised by the length of the common channel that can be measured endoscopically. The length of the common channel can vary from 1 to 10 cm. The longer the common channel (>3 cm), the higher the chance for poor bowel control, neurogenic

bladder, and reproductive abnormalities (378). Overall it is estimated that nearly 40% will have voluntary bowel movement and no soiling but some of them may still lose bowel control in case of severe diarrhoea and 25% of all repairs will result in total incontinence (379).

For the group of patients with persistent incontinence following the corrective surgery, the next aim will be to keep the colon clean to avoid incontinence and improve quality of life. A good option is implementation of a bowel management program whereby the patient and family are instructed in the use of daily enema, manipulation of diet and medication to remain clean (380). This is also a good treatment for constipation, which is the most common difficulty after corrective surgery (381).

Although most young children accept their parents administering enemas, when they get older they want privacy and rectal enemas on daily basis become an unpleasant routine. In such cases, continent appendicostomy is a feasible option, whereby a conduit for the administration of an antegrade continence enema (ACE) is created. First described by Malone (382) it has become an important option in paediatric surgery for functional bowel disorder. According to the initial description by Malone, appendicostomy was created by dividing the appendix at its base and reimplanting by a reverse manner into the cecum, which was then exteriorized through the right lower quadrant. Malone later revised it and the reimplantation of appendix is no longer considered necessary (383). Levitt et al. (384) introduced utilising the appendix in situ and added caecal plication to prevent reflux of stool and exteriorizing through umbilicus fold rendering it less noticeable. This appears to yield good long-term results (385) though other studies have shown that caecal fixation and wrap may be unnecessary for appendicostomy (386). The construction of appendicostomy with burial of the appendiceal tip appears to help avoid problems of exposed mucosa such as bleeding and mucus discharge. From this perspective, a few techniques have been suggested such as V-Y flap (383) and Y-appendicoplasty (387).

For patients without an appendix, a neoappendix could be formed from ileum or cecum (388-390). Laparoscopic antegrade continence enema procedure has been reported to yield as good result as open procedure (391-394). This procedure is not a cure to the problem but a more acceptable method for many children to engage in a bowel management programme without the need for rectal enemas. Success rate is variable between 61-96% (383, 388, 395-398) with older children benefiting more (399). Hoekstra et al. reported that almost 85% of patients were satisfied with their ACE stoma (400) **LEVEL OF EVIDENCE 3**.

As with any operation, there are known complications associated with antegrade continence enema. Most recent literature reporting on 97 children with ACE due to faecal incontinence or constipation resistant to

medical therapy found that overall 68% patients had at least one complication. Twenty-four per cent developed stomal stenosis, and 28 % of patients had significant stomal leakage. Preteen patients (<12 years old) experienced more stomal leakage than teenage patients (401). These complications cause 10-33% of patients to undergo revision of the appendicostomy (379, 402). Stoma prolapse, pressure sore, wound infection, anastomotic leak, stomal granulation, caecal-flap necrosis and caecal volvulus are less common complications reported after ACE (403, 404). **LEVEL OF EVIDENCE: 3**

Summary: Anorectal malformation is amenable to surgical reconstruction. Laparoscopically assisted anorectal pull-through procedure is the preferred technique. Outcomes primarily relate to the height and complexity of the abnormality. Evacuation disorders and incontinence often require daily enemas. The Malone antegrade continence enema may provide a more acceptable means of managing continence. Grade of Recommendation: C

IV. SURGERY FOR EVACUATION DISORDERS AND INCONTINENCE

1. RECTAL EVACUATION DISORDERS

Significant rectal retention of faeces results in faecal incontinence in children and older people, indeed, constipation with or without faecal impaction may be the commonest cause of incontinence in these age groups (405, 406). Similarly, if the rectum is completely empty then incontinence (at least of faeces) cannot occur. On this basis, health technologies that address rectal emptying are often recommended on a regular basis or for specific occasions e.g. enemas, trans-anal irrigation. There is however increasing recognition that a significant proportion of adults presenting for specialist management have occult symptoms and radio-physiological evidence of a rectal evacuation disorder. Such patients may describe classic symptoms of post-defaecatory leakage but as commonly have a mixed pattern of incontinence (e.g. urge / passive) that may not immediately indicate rectal evacuation disorder, not least because they may also have a functional or structurally defective sphincter concomitant on a shared pelvic pathophysiology (407).

This observation has important implications to specialist management. First, it supports the use of tailored biofeedback therapy given that this has potential to improve both sphincter function, sensation of rectal filling and coordinated anorectal relaxation (408, 409). Secondly, it promotes caution when using sphincter augmenting procedures. Worsened or new symptoms of obstructed defaecation have been reported in approximately one third of patients after

overlapping anterior anal sphincter repair (1) and up to 50% patients after gracilis neosphincter (165). There are also data suggesting that pre-existent evacuation disorder prejudices the outcomes of neurostimulation (201). This raises the question of whether proven structural causes of rectal evacuation disorder e.g. rectocele and internal prolapse should be surgically targeted before other procedures are offered. The latter is supported by some studies of rectocele repair that show significant improvement in faecal incontinence after surgery (410) but also be an evolving body of literature on use of rectal suspension procedures, notably laparoscopic ventral rectopexy (LVR) (411, 412). Significant improvements in incontinence symptoms and prospectively studied summative incontinence scores (413-417) have been documented for several studies of LVR in patients treated primarily for obstructed defaecation syndrome with internal prolapse. Further, LVR has been specifically targeted to patients with faecal incontinence in two studies (418, 419). The first of these studies evaluated the faecal incontinence severity index (FISI) in 72 patients with high-grade internal prolapse [Oxford grade III or IV] (420) with incontinence not responding to maximal medical treatment and demonstrated a reduction in median score from 31 to 15 points, [P <0.01]. These authors have gone on to suggest and a sequence of care where SNS is reserved for patients with persistent faecal incontinence after LVR (421). Despite concern that nearly all studies supporting this line of reasoning have arisen from one institution (Oxford), it seems reasonable that patients presenting with faecal incontinence should be directly questioned regarding symptoms of obstructed defaecation and undergo appropriate clinical examination and radio-physiological investigations e.g. proctography as part of the decision-making process. **LEVEL OF EVIDENCE 4.** Those with high grade internal rectal prolapse should be considered for rectopexy to address the internal prolapse before consideration of other advanced interventions. This is especially true for patients with transanal rectal intussusception [Oxford grade IV or V] where it is clear that the prolapse itself will compromise anal closure. A similar approach, i.e. repair, should be taken to clinically significant rectoceles in which trapping of contrast can be demonstrated post simulated defaecation. **LEVEL OF EVIDENCE 4.**

Stapled transanal resection of rectum (STARR), a technique developed by Antonio Longo from the PPH (procedure for prolapse and haemorrhoids, also known as stapled haemorrhoidopexy) may also have a role in managing patients with rectal intussusception and rectocele resulting in obstructed defaecation and associated incontinence. A detailed review is beyond the remit of this monograph, however the European STARR registry reporting the outcomes in 2838 patients, found significant improvements in the CCFIS at both 6 and 12 months following surgery in addition to improvements in the symptoms of obstructive defaecation (422). This must however be viewed in the context of an increase in urgency of defaecation

in 20% of patients and new onset incontinence in 1.8%. More recently a survey among colorectal specialists from European centres with experience of STARR reports up to 10% new onset incontinence following the procedure. The particular role for STARR in managing patients with incontinence associated with obstructed defaecation remains to be established (423).

Summary: Obstructed defaecation is common and may contribute to incontinence. Comprehensive assessment is required. Rectocele repair or ventral rectopexy may improve continence in carefully selected patients. Randomized studies are lacking. Grade of Recommendation: C

V. OUTCOME MEASURES IN FAECAL INCONTINENCE

While there is general agreement that patient-based outcome measures (PROMs) are most appropriate for studies of faecal incontinence, standardisation of the optimal instrument or combination of instruments remains a challenge in clinical incontinence research. While many incontinence-related quality of life measures have been proposed and claim to have been "validated," adequate psychometric validation is lacking for many (424). It is unknown if the main outcome measure following incontinence treatment ought to be incontinence severity, incontinence-related quality of life, or a combination of these factors.

Faecal incontinence is a complex symptom relating not only to the continence mechanism itself, but also to the general bowel function in terms of motility, neurohumoral balance, sensory and/or motor disturbances on spinal and supra-spinal levels. Thus, faecal incontinence as a symptom can present itself differently depending on the underlying disease and lifestyle.

Hallbook and Sjudahl developed a bowel questionnaire for assessment of functional outcome following restorative rectal resection that took account of how the function affected the individual's daily life (425). Bakx et al (426) developed this concept with a colorectal functional outcome (COREFO) questionnaire which they validated in 179 patients. When compared with that of Hallbook, more patients found that the psychometric questions in the COREFO questionnaire reflected their concerns. ICI has extended the focus on psychometric outcomes in the recently developed (427, 428) and validated (429) ICI-B questionnaire suitable for use in patients with incontinence of varying cause, however the large number of items (forty-two) have thus far limited the application of ICI-B. A short version of this questionnaire (8 questions) has been used in two recent clinical trials (254, 430) where it proved highly acceptable to patients. Full validation of this shortened version is now underway.

As clinicians, we need to re-evaluate our perception of disease-specific symptoms and their impact on QoL and use this knowledge when choosing the right treatment for the patient. How patients and physicians rank the severity of faecal incontinence however differs. Clinicians put greatest importance on actual episodes and frequency of incontinence to solid stool, whereas patients are generally more concerned about leakage, hygiene, smell and social embarrassment (431). A study examining colorectal specialists' perception of symptom severity using the LAR score revealed that specialists did not have a very thorough understanding of which bowel dysfunction symptoms truly mattered to the patient after sphincter-preserving treatment, nor how these symptoms affected the patient's QoL. Although the specialists performed better than random, there was considerable discrepancy between the specialist's perspective and patient experience (432). The same was also true for specialists' perception of symptoms bothering patients after restorative proctocolectomy (433).

Disease specific incontinence scores have been developed for neurogenic bowel dysfunction (434), Low Anterior Resection Syndrome (435) and pouch dysfunction after ileo-anal anastomosis (436). Included items were selected from a pool extracted from existing bowel function assessment instruments and the current literature. By applying binomial regression on the response to these items obtained from disease specific cohorts of Danish patients, those showing the highest prevalence and impact on QoL were identified and included in the score creating a patient-based outcome score. This has provided a platform for a common understanding and evaluation of functional outcomes for these patient categories. However, as these scores have been developed specifically in collaboration with these patient categories they are not necessarily applicable in others regardless of similar symptoms. Recently, the ICIQ-B questionnaire has been revised and validated for use in patients with inflammatory bowel disease as the ICIQ-IBD (437). For other non-specific diseases with a faecal incontinence component both the CCF-FIS (63) and St Mark's scales (438) are available. Whereas the CCF-FIS does not score the urgency component, the St Mark's scale scores it as ability to defer defaecation for more or less than 15 minutes. Though both scores include elements of severity, preventive measures and impact on quality of life, the individual elements are not weighted in the total score according to patient perception.

Bowel movement diaries are considered to be the gold standard measurement, but these are highly influenced by the patient's willingness to stray from the toilet and the validity of the data has never been evaluated. A study on the effect of sacral nerve stimulation for faecal incontinence showed that 46% of the patients with more incontinence episodes at follow-up than at baseline were satisfied with the treatment result. These patients explained that they had obtained a more active social life after the SNS therapy, an aspect of social behaviour that is not addressed in the

bowel habit diary, and traditional evaluation would consider these patients as failures (237). For both the bowel movement diaries and the FI scores additional validation work is needed to assess the potential effect of recall bias

The FIQL is a well-validated quality outcome measure but it yields separate scores on 4 individual scales. It is desirable that a single score outcome be developed. Furthermore, quantitative changes in FIQL have not been anchored to the corresponding impact on patient quality of life and thus remain speculative.

In the future, when evaluating surgical interventions for faecal incontinence we should focus on patient satisfaction and QoL, in combination with bowel scores and diaries to obtain a more accurate measure of therapy efficacy. Striving to develop and implement a standardized tool our approach should be based on appropriateness, reliability, validity, responsiveness, precision, interpretability, acceptability and feasibility (439).

Summary: PROMs should be developed and validated according to the impact of symptoms from a patient perspective. It remains to be established if PROMs should be general / disease / treatment specific. Currently available technologies allow real time data capture that may be more relevant in assessing continence outcomes. Grade of Recommendation: C

VI. RESEARCH PRIORITIES IN FAECAL INCONTINENCE

1. BASIC SCIENCE AND PATHOPHYSIOLOGY

In comparison to the evolution of diagnosis and treatment of faecal incontinence, there has been little basic science work looking into the pathophysiology of faecal incontinence.

Faecal urgency is as debilitating as physical leakage of stool due to its unpredictability. Increased expression of transient receptor potential vanilloid receptor 1 (TRPV1), an ion channel in sensory fibres that are activated by noxious stimuli such as pain and heat, has been shown to be a possible mechanism of faecal urgency (440). Although the development of TRPV1 antagonist has been explored and there have been reports of preclinical studies, a clinical trial of such agent for faecal urgency has not been performed (441). There may be other ion channels or neurotransmitters that contribute also to faecal urgency but this has not been studied in depth.

Sacral nerve stimulation (SNS) was a ground-breaking innovation which not only shifted the paradigm of faecal incontinence treatment but has also provided

an interesting insight into the mechanism of incontinence. In the early phase of the treatment it was believed SNS exerted its efficacy by augmenting sphincter function via stimulation of efferent nerves. However, there have been a growing number of studies supporting a theory that its main efficacy may be due to afferent neuromodulation that results in improvement of urgency (216, 232, 442).

Substance P, which is a neuropeptide and plays a role in afferent signalling in visceral sensation, has been normalised by sacral nerve stimulation (229) and some animal studies have shown that SNS augments anal representation in the sensory cortex (215, 442). It remains to be seen whether this pathway could be explored to develop a non-invasive trial of SNS or better monitoring of efficacy.

Faecal incontinence is an important quality of life issue amongst patients who have survived pelvic cancer (443-445). The mechanism of faecal incontinence related to pelvic surgery/radiotherapy has not been fully understood. Volumetric changes of the neorectum compared to the original rectum or neuronal damage due to surgery/radiation are some of the hypotheses that have been postulated. There have been only a limited number of histological or manometric studies in this field and more work is needed to elucidate the mechanism of faecal incontinence relating to pelvic surgery and/or chemoradiotherapy. Any research into mechanism of faecal incontinence that may lead to new approach of diagnosis and treatment are strongly encouraged.

2. EVALUATION OF SURGICAL TECHNIQUES

Anterior sphincter repair or sphincteroplasty is an established operation to restore structural integrity of disrupted external anal sphincter. There have been numerous case series reporting the efficacy of both end-to-end and overlap repair techniques but there has been only one small randomised study comparing the two techniques. And when overlap repair is not technically possible, would it be better for the end-to-end repair to be reinforced with a piece of mesh? Furthermore, the definition of 'defective' external anal sphincter remains unclear. The circumferential size nor length of defect is defined in American Society of Colon and Rectum Surgeons Society clinical practice guideline (10). In contrast, NICE guideline clearly defines the defect size to be full-length that is 90 degrees or greater (446). More data from prospective comparative or randomised studies are needed to establish the indication for each technique together with consideration to size and time interval between sphincter injury and onset of symptoms, durability, and feasibility of reinforcement or any modification and its place in the treatment algorithm.

Injectable bulking agents have been proposed as a less invasive therapeutic option but the selection of patients and the appropriate techniques to be used

remain unclear. The plane where biomaterial is injected varies: 'into internal anal sphincter', 'submucosal', and 'around internal anal sphincter'. A liquid material may disperse in the injected plane and there have been reports of distant migration. There has been only one long-term study to date and critical appraisal of the durability of this treatment is required.

Colostomy has been regarded as the last resort for end-stage faecal incontinence when all other treatment options have been exhausted. Although this could offer a significant improvement of quality of life, some patients may remain reluctant to commit to this procedure with fear of permanent stoma and possible irreversibility. The idea of faecal diversion could be tested by formation of temporary loop ileostomy either laparoscopically or using a trephine incision. This has not been looked into in past and may warrant further investigation to assess whether this is a useful step in the treatment algorithm. In addition, more studies are required to investigate quality of life issues associated with faecal incontinence and its alteration with ileostomy/colostomy. Influence of diversion colitis and mucus leakage with a formation of end colostomy in comparison to pre-stoma status of faecal incontinence also warrants an investigation.

As the cost of novel therapies increases, it becomes more difficult to design a robust study without funding from industry. There remains a paucity of randomised, controlled trials in the field of surgical treatment for faecal incontinence. A study to randomise patients with sphincter injury for SNS versus sphincteroplasty, which was strongly recommended by the Committee during the last review, has collapsed due to a combination of reduced enthusiasm from industry, lack of funding and evolution of a pragmatic treatment algorithm in Europe. This emphasizes a requirement for coordinated efforts to collaborate between multiple centres with a large institutional or governmental funding for a swift delivery of large trials. An established treatment such as sacral nerve stimulation will also benefit from larger studies, as studies to date with regards to predictors and outcome have been mostly single-centred and may have been underpowered.

3. ASSOCIATED OBSTRUCTIVE DEFAECATION SYMPTOMS

Symptoms of obstructive symptoms, as complications of sphincter repair and concomitant pelvic floor disorder associated with faecal incontinence have received more attention recently. Laparoscopic ventral rectopexy may improve some elements of faecal incontinence symptoms such as those related to transanal rectal intussusception. At the same time, such mechanical phenomenon may be part of global weakness of pelvic floor and rectopexy may correct only a part of pelvic floor dynamics. As with other new surgical approaches in this field, larger prospective

studies by many other centres backed by radiophysiological tests to correlate the change of symptoms with mechanical correction is strongly recommended. It is also worth revisit the concept of combining the surgical intervention with pelvic floor training or bio-feedback afterwards.

4. OUTCOME MEASURES

Various outcome measures and scoring systems exist to evaluate faecal incontinence but most of them have been devised by clinicians. The only scoring system which was designed with rigorous qualitative interview of patients is International Consultation on Incontinence Modular Questionnaire-Bowel Symptoms (ICIQ-B)(427). However, it is lengthy and contains items that are not scored. There is an ongoing effort to create a short version with rigorous validation and the results of such process are eagerly awaited. Comparison of outcomes of different surgical interventions has been hampered by use of different scoring systems and various definitions of 'successful treatment' and active initiatives are needed to adopt the new short version once validated.

REFERENCES

1. Malouf AJ, Norton CS, Engel AF, Nicholls RJ, Kamm MA. Long-term results of overlap-ping anterior anal-sphincter repair for obstet-ric trauma. *Lancet*. 2000;355(9200):260-5.
2. Halverson AL, Hull TL. Long-term outcome of overlapping anal sphincter repair. *Dis Co-lon Rectum*. 2002;45(3):345-8.
3. O'Connell PR. The effects of age and pari-ty on anorectal function. *Dis Colon Rectum*. 2012;55(3):235-6.
4. Lamblin G, Bouvier P, Damon H, Chabert P, Moret S, Chene G, et al. Long-term out-come after overlapping anterior anal sphinc-ter repair for fecal incontinence. *Int J Colo-rectal Dis*. 2014;29(11):1377-83.
5. Browning GG, Parks AG. Postanal repair for neuropathic faecal incontinence: correla-tion of clinical result and anal canal pres-sures. *Br J Surg*. 1983;70(2):101-4.
6. Brown SR, Nelson RL. Surgery for faecal in-continence in adults. *Cochrane Database Syst Rev*. 2007(2):CD001757.
7. Rockwood TH, Church JM, Fleshman JW, Kane RL, Mavrantonis C, Thorson AG, et al. Fecal Incontinence Quality of Life Scale: qual-ity of life instrument for patients with fecal in-continence. *Dis Colon Rectum*. 2000;43(1):9-16; discussion -7.
8. Forte ML, Andrade KE, Lowry AC, Butler M, Bliss DZ, Kane RL. Systematic Review of Sur-gical Treatments for Fecal Incontinence. *Dis Colon Rectum*. 2016;59(5):443-69.
9. Wald A, Bharucha AE, Cosman BC, Whitehead WE. ACG clinical guideline: man-agement of benign anorectal disorders. *Am J Gastroen-terol*. 2014;109(8):1141-57; (Quiz) 058.
10. Paquette IM, Varma MG, Kaiser AM, Steele SR, Rafferty JF. The American Society of Co-lon and Rectal Surgeons' Clinical Practice Guideline for the Treatment of Fecal Inconti-nence. *Dis Colon Rectum*. 2015;58(7):623-36.
11. Fitzpatrick M, Cassidy M, O'Connell PR, O'Herlihy C. Experience with an obstetric per-ineal clinic. *Eur J Obstet Gynecol Reprod Bi-ol*. 2002;100(2):199-203.
12. Sultan AH, Kamm MA, Hudson CN, Thom-as JM, Bartram CI. Anal-sphincter disruption dur-ing vaginal delivery. *N Engl J Med*. 1993;329(26):1905-11.
13. Donnelly V, Fynes M, Campbell D, John-son H, O'Connell PR, O'Herlihy C. Obstetric events leading to anal sphincter damage. *Obstet Gy-necol*. 1998;92(6):955-61.
14. Oberwalder M, Connor J, Wexner SD. Meta-analysis to determine the incidence of obstetric anal sphincter damage. *Br J Surg*. 2003;90(11):1333-7.
15. Abdool Z, Sultan AH, Thakar R. Ultra-sound im-aging of the anal sphincter com-plex: a review. *Br J Radiol*. 2012;85(1015):865-75.
16. Williams AB, Bartram CI, Halligan S, Spencer JA, Nicholls RJ, Kmriot WA. Anal sphincter damage after vaginal delivery using three-di-mensional endosonography. *Obstet Gynecol*. 2001;97(5 Pt 1):770-5.
17. Fitzpatrick M, McQuillan K, O'Herlihy C. Infl-uence of persistent occiput posterior posi-tion on delivery outcome. *Obstet Gynecol*. 2001;98(6):1027-31.
18. Harkin R, Fitzpatrick M, O'Connell PR, O'Herlihy C. Anal sphincter disruption at vag-inal delivery: is recurrence predictable? *Eur J Obstet Gynecol Reprod Biol*. 2003;109(2):149-52.
19. Eogan M, Daly L, O'Connell PR, O'Herlihy C. Does the angle of episiotomy affect the in-cidence of anal sphincter injury? *BJOG*. 2006;113(2):190-4.
20. Clemons JL, Towers GD, McClure GB, O'Boyle AL. Decreased anal sphincter lacera-tions as-sociated with restrictive episiotomy use. *Am J Obstet Gynecol*. 2005;192(5):1620-5.
21. Harvey MA, Pierce M, Alter JE, Chou Q, Dia-mond P, Epp A, et al. Obstetrical Anal Sphinc-ter Injuries (OASIS): Prevention, Recognition, and Repair. *J Obstet Gynaecol Can*. 2015;37(12):1131-48.
22. de Leeuw JW, de Wit C, Kuijken JP, Bru-inse HW. Mediolateral episiotomy reduces the risk for anal sphincter injury during oper-ative vagi-nal delivery. *BJOG*. 2008;115(1):104-8.
23. Dudding TC, Vaizey CJ, Kamm MA. Ob-stetric anal sphincter injury: incidence, risk factors, and management. *Ann Surg*. 2008;247(2):224-37.
24. RCOG. The Management of Third- and Fourth-Degree Perineal Tears. In: *Gynaecol-ogists RCoOa*, editor. London: Royal College of Ob-stetricians and Gynaecologists; 2015.
25. Fernando RJ, Sultan AH, Kettle C, Radley S, Jones P, O'Brien PM. Repair techniques for ob-stetric anal sphincter injuries: a random-ized controlled trial. *Obstet Gynecol*. 2006;107(6):1261-8.
26. Mahony R, Behan M, Daly L, Kirwan C, O'Herlihy C, O'Connell PR. Internal anal

- sphincter defect influences continence outcome following obstetric anal sphincter injury. *Am J Obstet Gynecol.* 2007;196(3):217 e1-5.
27. Roos AM, Thakar R, Sultan AH. Outcome of primary repair of obstetric anal sphincter injuries (OASIS): does the grade of tear matter? *Ultrasound Obstet Gynecol.* 2010;36(3):368-74.
 28. Fernando R, Sultan AH, Kettle C, Thakar R, Radley S. Methods of repair for obstetric anal sphincter injury. *Cochrane Database Syst Rev.* 2006(3):CD002866.
 29. Practice Bulletin No. 165: Prevention and Management of Obstetric Lacerations at Vaginal Delivery. *Obstet Gynecol.* 2016;128(1):e1-e15.
 30. Fitzpatrick M, Behan M, O'Connell PR, O'Herlihy C. A randomized clinical trial comparing primary overlap with approximation repair of third-degree obstetric tears. *Am J Obstet Gynecol.* 2000;183(5):1220-4.
 31. Williams A, Adams EJ, Tincello DG, Alfirevic Z, Walkinshaw SA, Richmond DH. How to repair an anal sphincter injury after vaginal delivery: results of a randomised controlled trial. *BJOG.* 2006;113(2):201-7.
 32. Garcia V, Rogers RG, Kim SS, Hall RJ, Kammerer-Doak DN. Primary repair of obstetric anal sphincter laceration: a randomized trial of two surgical techniques. *Am J Obstet Gynecol.* 2005;192(5):1697-701.
 33. Rygh AB, Korner H. The overlap technique versus end-to-end approximation technique for primary repair of obstetric anal sphincter rupture: a randomized controlled study. *Acta Obstet Gynecol Scand.* 2010;89(10):1256-62.
 34. Farrell SA, Flowerdew G, Gilmour D, Turnbull GK, Schmidt MH, Baskett TF, et al. Overlapping compared with end-to-end repair of complete third-degree or fourth-degree obstetric tears: three-year follow-up of a randomized controlled trial. *Obstet Gynecol.* 2012;120(4):803-8.
 35. Fernando RJ, Sultan AH, Kettle C, Thakar R. Methods of repair for obstetric anal sphincter injury. *Cochrane Database Syst Rev.* 2013(12):CD002866.
 36. Farrell SA. Overlapping compared with end-to-end repair of third and fourth degree obstetric anal sphincter tears. *Curr Opin Obstet Gynecol.* 2011;23(5):386-90.
 37. Norderval S, Rossaak K, Markskog A, Vonon B. Incontinence after primary repair of obstetric anal sphincter tears is related to relative length of reconstructed external sphincter: a case-control study. *Ultrasound Obstet Gynecol.* 2012;40(2):207-14.
 38. Nordenstam J, Mellgren A, Altman D, Lopez A, Johansson C, Anzen B, et al. Immediate or delayed repair of obstetric anal sphincter tears—a randomised controlled trial. *BJOG.* 2008;115(7):857-65.
 39. Soerensen MM, Bek KM, Buntzen S, Hojberg KE, Laurberg S. Long-term outcome of delayed primary or early secondary reconstruction of the anal sphincter after obstetrical injury. *Dis Colon Rectum.* 2008;51(3):312-7.
 40. McNicol FJ, Bruce CA, Chaudhri S, Francome J, Kozman E, Taylor BA, et al. Management of obstetric anal sphincter injuries—a role for the colorectal surgeon. *Colorectal Dis.* 2010;12(9):927-30.
 41. Andrews V, Thakar R, Sultan AH. Structured hands-on training in repair of obstetric anal sphincter injuries (OASIS): an audit of clinical practice. *Int Urogynecol J Pelvic Floor Dysfunct.* 2009;20(2):193-9.
 42. Mahony R, Behan M, O'Herlihy C, O'Connell PR. Randomized, clinical trial of bowel confinement vs. laxative use after primary repair of a third-degree obstetric anal sphincter tear. *Dis Colon Rectum.* 2004;47(1):12-7.
 43. Eogan M, Daly L, Behan M, O'Connell PR, O'Herlihy C. Randomised clinical trial of a laxative alone versus a laxative and a bulking agent after primary repair of obstetric anal sphincter injury. *BJOG.* 2007;114(6):736-40.
 44. Faltin DL, Boulvain M, Floris LA, Irion O. Diagnosis of anal sphincter tears to prevent fecal incontinence: a randomized controlled trial. *Obstet Gynecol.* 2005;106(1):6-13.
 45. Abramowitz L, Sobhani I, Ganansia R, Vuagnat A, Benifla JL, Darai E, et al. Are sphincter defects the cause of anal incontinence after vaginal delivery? Results of a prospective study. *Dis Colon Rectum.* 2000;43(5):590-6; discussion 6-8.
 46. MacArthur C, Glazener CM, Wilson PD, Herbison GP, Gee H, Lang GD, et al. Obstetric practice and faecal incontinence three months after delivery. *BJOG.* 2001;108(7):678-83.
 47. Fenner DE, Genberg B, Brahma P, Marek L, DeLancey JO. Fecal and urinary incontinence after vaginal delivery with anal sphincter disruption in an obstetrics unit in the United States. *Am J Obstet Gynecol.* 2003;189(6):1543-9; discussion 9-50.
 48. Samarasekera DN, Bekhit MT, Wright Y, Lowndes RH, Stanley KP, Preston JP, et al. Long-term anal continence and quality of life following postpartum anal sphincter injury. *Colorectal Dis.* 2008;10(8):793-9.

49. Oom DM, Gosselink MP, Schouten WR. Anterior sphincteroplasty for fecal incontinence: a single center experience in the era of sacral neuromodulation. *Dis Colon Rectum*. 2009;52(10):1681-7.
50. Fynes MM, Marshall K, Cassidy M, Behan M, Walsh D, O'Connell PR, et al. A prospective, randomized study comparing the effect of augmented biofeedback with sensory bio-feedback alone on fecal incontinence after obstetric trauma. *Dis Colon Rectum*. 1999;42(6):753-8; discussion 8-61.
51. Mahony RT, Malone PA, Nalty J, Behan M, O'Connell PR, O'Herlihy C. Randomized clinical trial of intra-anal electromyographic biofeedback physiotherapy with intra-anal electromyographic biofeedback augmented with electrical stimulation of the anal sphincter in the early treatment of postpartum fecal incontinence. *Am J Obstet Gynecol*. 2004;191(3):885-90.
52. Fynes M, Donnelly V, Behan M, O'Connell PR, O'Herlihy C. Effect of second vaginal delivery on anorectal physiology and faecal continence: a prospective study. *Lancet*. 1999;354(9183):983-6.
53. Fynes M, Donnelly VS, O'Connell PR, O'Herlihy C. Cesarean delivery and anal sphincter injury. *Obstet Gynecol*. 1998;92(4 Pt 1):496-500.
54. Nelson RL, Furner SE, Westercamp M, Farquhar C. Cesarean delivery for the prevention of anal incontinence. *Cochrane Database Syst Rev*. 2010(2):CD006756.
55. Scheer I, Thakar R, Sultan AH. Mode of delivery after previous obstetric anal sphincter injuries (OASIS)--a reappraisal? *Int Urogynecol J Pelvic Floor Dysfunct*. 2009;20(9):1095-101.
56. Nygaard IE, Rao SS, Dawson JD. Anal incontinence after anal sphincter disruption: a 30-year retrospective cohort study. *Obstet Gynecol*. 1997;89(6):896-901.
57. Bollard RC, Gardiner A, Duthie GS, Lindow SW. Anal sphincter injury, fecal and urinary incontinence: a 34-year follow-up after forceps delivery. *Dis Colon Rectum*. 2003;46(8):1083-8.
58. Eogan M, O'Brien C, Daly L, Behan M, O'Connell PR, O'Herlihy C. The dual influences of age and obstetric history on fecal continence in parous women. *Int J Gynaecol Obstet*. 2011;112(2):93-7.
59. Mous M, Muller SA, de Leeuw JW. Long-term effects of anal sphincter rupture during vaginal delivery: faecal incontinence and sexual complaints. *BJOG*. 2008;115(2):234-8.
60. Fornell EU, Matthiesen L, Sjobahl R, Berg G. Obstetric anal sphincter injury ten years after: subjective and objective long term effects. *BJOG*. 2005;112(3):312-6.
61. Donnelly V, O'Connell PR, O'Herlihy C. The influence of oestrogen replacement on faecal incontinence in postmenopausal women. *Br J Obstet Gynaecol*. 1997;104(3):311-5.
62. Madoff RD. Surgical treatment options for fecal incontinence. *Gastroenterology*. 2004;126(1 Suppl 1):S48-54.
63. Jorge JM, Wexner SD. Etiology and management of fecal incontinence. *Dis Colon Rectum*. 1993;36(1):77-97.
64. Maeda Y, Pares D, Norton C, Vaizey CJ, Kamm MA. Does the St. Mark's incontinence score reflect patients' perceptions? A review of 390 patients. *Dis Colon Rectum*. 2008;51(4):436-42.
65. Rothbarth J, Bemelman WA, Meijerink WJ, Stiggelbout AM, Zwinderman AH, Buyze-Westerveld ME, et al. What is the impact of fecal incontinence on quality of life? *Dis Colon Rectum*. 2001;44(1):67-71.
66. Tjandra JJ, Dykes SL, Kumar RR, Ellis CN, Gregorczyk SG, Hyman NH, et al. Practice parameters for the treatment of fecal incontinence. *Dis Colon Rectum*. 2007;50(10):1497-507.
67. Donnelly VS, O'Herlihy C, Campbell DM, O'Connell PR. Postpartum fecal incontinence is more common in women with irritable bowel syndrome. *Dis Colon Rectum*. 1998;41(5):586-9.
68. Fitzpatrick M, O'Brien C, O'Connell PR, O'Herlihy C. Patterns of abnormal pudendal nerve function that are associated with postpartum fecal incontinence. *Am J Obstet Gynecol*. 2003;189(3):730-5.
69. Coggrave M, Norton C, Cody JD. Management of faecal incontinence and constipation in adults with central neurological diseases. *Cochrane Database Syst Rev*. 2014;1:CD002115.
70. Hull TL, Bartus C, Bast J, Floruta C, Lopez R. Multimedia article. Success of episio-proctotomy for cloaca and rectovaginal fistula. *Dis Colon Rectum*. 2007;50(1):97-101.
71. Kaiser AM. Cloaca-like deformity with faecal incontinence after severe obstetric injury--technique and functional outcome of ano-vaginal and perineal reconstruction with X-flaps and sphincteroplasty. *Colorectal Dis*. 2008;10(8):827-32.
72. Fleshman JW, Peters WR, Shemesh EI, Fry RD, Kodner IJ. Anal sphincter reconstruction:

- anterior overlapping muscle repair. *Dis Colon Rectum*. 1991;34(9):739-43.
73. Engel AF, Kamm MA, Sultan AH, Bartram CI, Nicholls RJ. Anterior anal sphincter repair in patients with obstetric trauma. *Br J Surg*. 1994;81(8):1231-4.
 74. Londono-Schimmer EE, Garcia-Duperly R, Nicholls RJ, Ritchie JK, Hawley PR, Thomson JP. Overlapping anal sphincter repair for faecal incontinence due to sphincter trauma: five year follow-up functional results. *Int J Colorectal Dis*. 1994;9(2):110-3.
 75. Oliveira L, Pfeifer J, Wexner SD. Physiological and clinical outcome of anterior sphincteroplasty. *Br J Surg*. 1996;83(4):502-5.
 76. Gilliland R, Altomare DF, Moreira H, Jr., Oliveira L, Gilliland JE, Wexner SD. Pudendal neuropathy is predictive of failure following anterior overlapping sphincteroplasty. *Dis Colon Rectum*. 1998;41(12):1516-22.
 77. Young CJ, Mathur MN, Eyers AA, Solomon MJ. Successful overlapping anal sphincter repair: relationship to patient age, neuropathy, and colostomy formation. *Dis Colon Rectum*. 1998;41(3):344-9.
 78. Karoui S, Leroi AM, Koning E, Menard JF, Michot F, Denis P. Results of sphincteroplasty in 86 patients with anal incontinence. *Dis Colon Rectum*. 2000;43(6):813-20.
 79. Osterberg A, Edebol Eeg-Olofsson K, Graf W. Results of surgical treatment for faecal incontinence. *Br J Surg*. 2000;87(11):1546-52.
 80. Morren GL, Hallbook O, Nystrom PO, Baeten CG, Sjodahl R. Audit of anal-sphincter repair. *Colorectal Dis*. 2001;3(1):17-22.
 81. Tan M, O'Hanlon DM, Cassidy M, O'Connell PR. Advantages of a posterior fourchette incision in anal sphincter repair. *Dis Colon Rectum*. 2001;44(11):1624-9.
 82. Bravo Gutierrez A, Madoff RD, Lowry AC, Parker SC, Buie WD, Baxter NN. Long-term results of anterior sphincteroplasty. *Dis Colon Rectum*. 2004;47(5):727-31; discussion 31-2.
 83. Norderval S, Oian P, Revhaug A, Vonon B. Anal incontinence after obstetric sphincter tears: outcome of anatomic primary repairs. *Dis Colon Rectum*. 2005;48(5):1055-61.
 84. Zorcolo L, Covotta L, Bartolo DC. Outcome of anterior sphincter repair for obstetric injury: comparison of early and late results. *Dis Colon Rectum*. 2005;48(3):524-31.
 85. Trowbridge ER, Morgan D, Trowbridge MJ, Delancey JO, Fenner DE. Sexual function, quality of life, and severity of anal incontinence after anal sphincteroplasty. *Am J Obstet Gynecol*. 2006;195(6):1753-7.
 86. Barisic GI, Krivokapic ZV, Markovic VA, Popovic MA. Outcome of overlapping anal sphincter repair after 3 months and after a mean of 80 months. *Int J Colorectal Dis*. 2006;21(1):52-6.
 87. Maslekar S, Gardiner AB, Duthie GS. Anterior anal sphincter repair for fecal incontinence: Good longterm results are possible. *J Am Coll Surg*. 2007;204(1):40-6.
 88. Gleason JL, Markland A, Greer WJ, Szychowski JM, Gerten KA, Richter HE. Anal sphincter repair for fecal incontinence: effect on symptom severity, quality of life, and anal sphincter squeeze pressures. *Int Urogynecol J*. 2011;22(12):1587-92.
 89. Lehto K, Hyoty M, Collin P, Huhtala H, Aitola P. Seven-year follow-up after anterior sphincter reconstruction for faecal incontinence. *Int J Colorectal Dis*. 2013;28(5):653-8.
 90. Parks AG, McPartlin JF. Late repair of injuries of the anal sphincter. *Proc R Soc Med*. 1971;64(12):1187-9.
 91. Tjandra JJ, Han WR, Goh J, Carey M, Dwyer P. Direct repair vs. overlapping sphincter repair: a randomized, controlled trial. *Dis Colon Rectum*. 2003;46(7):937-42; discussion 42-3.
 92. Oberwalder M, Dinnewitzer A, Nogueras JJ, Weiss EG, Wexner SD. Imbrication of the external anal sphincter may yield similar functional results as overlapping repair in selected patients. *Colorectal Dis*. 2008;10(8):800-4.
 93. Zutshi M, Hull T, Gurland B. Anal encirclement with sphincter repair (AESR procedure) using a biological graft for anal sphincter damage involving the entire circumference. *Colorectal Dis*. 2012;14(5):592-5.
 94. Deen KI, Oya M, Ortiz J, Keighley MR. Randomized trial comparing three forms of pelvic floor repair for neuropathic faecal incontinence. *Br J Surg*. 1993;80(6):794-8.
 95. Evans C, Davis K, Kumar D. Overlapping anal sphincter repair and anterior levatorplasty: effect of patient's age and duration of follow-up. *Int J Colorectal Dis*. 2006;21(8):795-801.
 96. Osterberg A, Graf W, Holmberg A, Pah-lman L, Ljung A, Hakelius L. Long-term results of anterior levatorplasty for fecal incontinence. A retrospective study. *Dis Colon Rectum*. 1996;39(6):671-4; discussion 4-5.
 97. Brown SR, Wadhawan H, Nelson RL. Surgery for faecal incontinence in adults. *Cochrane Database Syst Rev*. 2013;7:CD001757.

98. Engel AF, Brummelkamp WH. Secondary surgery after failed postanal or anterior sphincter repair. *Int J Colorectal Dis.* 1994;9(4):187-90.
99. Pinedo G, Vaizey CJ, Nicholls RJ, Roach R, Halligan S, Kamm MA. Results of repeat anal sphincter repair. *Br J Surg.* 1999;86(1):66-9.
100. Nielsen MB, Dammegaard L, Pedersen JF. Endosonographic assessment of the anal sphincter after surgical reconstruction. *Dis Colon Rectum.* 1994;37(5):434-8.
101. Giordano P, Renzi A, Efron J, Gervaz P, Weiss EG, Noguera JJ, et al. Previous sphincter repair does not affect the outcome of repeat repair. *Dis Colon Rectum.* 2002;45(5):635-40.
102. Vaizey CJ, Norton C, Thornton MJ, Nicholls RJ, Kamm MA. Long-term results of repeat anterior anal sphincter repair. *Dis Colon Rectum.* 2004;47(6):858-63.
103. Johnson E, Carlsen E, Steen TB, Backer Hjorthaug JO, Eriksen MT, Johannesen HO. Short- and long-term results of secondary anterior sphincteroplasty in 33 patients with obstetric injury. *Acta Obstet Gynecol Scand.* 2010;89(11):1466-72.
104. Zutshi M, Tracey TH, Bast J, Halverson A, Na J. Ten-year outcome after anal sphincter repair for fecal incontinence. *Dis Colon Rectum.* 2009;52(6):1089-94.
105. Zutshi M, Salcedo L, Hammel J, Hull T. Anal physiology testing in fecal incontinence: is it of any value? *Int J Colorectal Dis.* 2010;25(2):277-82.
106. Gearhart S, Hull T, Floruta C, Schroeder T, Hammel J. Anal manometric parameters: predictors of outcome following anal sphincter repair? *J Gastrointest Surg.* 2005;9(1):115-20.
107. Brouwer R, Duthie G. Sacral nerve neuromodulation is effective treatment for fecal incontinence in the presence of a sphincter defect, pudendal neuropathy, or previous sphincter repair. *Dis Colon Rectum.* 2010;53(3):273-8.
108. Parks AG. Royal Society of Medicine, Section of Proctology; Meeting 27 November 1974. President's Address. Anorectal incontinence. *Proc R Soc Med.* 1975;68(11):681-90.
109. Bachoo P, Brazzelli M, Grant A. Surgery for faecal incontinence in adults. *Cochrane Database Syst Rev.* 2000(2):CD001757.
110. Brown SR, Wadhawan H, Nelson RL. Surgery for faecal incontinence in adults. *Cochrane Database Syst Rev.* 2010(9):CD001757.
111. Brown SR, Wadhawan H, Nelson RL. Surgery for faecal incontinence in adults. *Cochrane Database Syst Rev.* 2013(7):CD001757.
112. van Tets WF, Kuijpers JH. Pelvic floor procedures produce no consistent changes in anatomy or physiology. *Dis Colon Rectum.* 1998;41(3):365-9.
113. Womack NR, Morrison JF, Williams NS. Prospective study of the effects of postanal repair in neurogenic faecal incontinence. *Br J Surg.* 1988;75(1):48-52.
114. Orrom WJ, Miller R, Cornes H, Duthie G, Mortensen NJ, Bartolo DC. Comparison of anterior sphincteroplasty and postanal repair in the treatment of idiopathic fecal incontinence. *Dis Colon Rectum.* 1991;34(4):305-10.
115. Scheuer M, Kuijpers HC, Jacobs PP. Postanal repair restores anatomy rather than function. *Dis Colon Rectum.* 1989;32(11):960-3.
116. Yoshioka K, Keighley MR. Critical assessment of the quality of continence after postanal repair for faecal incontinence. *Br J Surg.* 1989;76(10):1054-7.
117. Jameson JS, Speakman CT, Darzi A, Chia YW, Henry MM. Audit of postanal repair in the treatment of fecal incontinence. *Dis Colon Rectum.* 1994;37(4):369-72.
118. Setti Carraro P, Kamm MA, Nicholls RJ. Long-term results of postanal repair for neurogenic faecal incontinence. *Br J Surg.* 1994;81(1):140-4.
119. Matsuoka H, Mavrantonis C, Wexner SD, Oliveira L, Gilliland R, Pikarsky A. Postanal repair for fecal incontinence—is it worthwhile? *Dis Colon Rectum.* 2000;43(11):1561-7.
120. Abbas SM, Bissett IP, Neill ME, Parry BR. Long-term outcome of postanal repair in the treatment of faecal incontinence. *ANZ J Surg.* 2005;75(9):783-6.
121. Parks AG, Parks AG. Royal Society of Medicine, Section of Proctology; Meeting 27 November 1974. President's Address. Anorectal incontinence. *Proceedings of the Royal Society of Medicine.* 1975;68(11):681-90.
122. Keighley MR. Postanal repair for faecal incontinence. *J R Soc Med.* 1984;77(4):285-8.
123. Ferguson EF, Jr. Puborectalis sphincteroplasty for anal incontinence. *South Med J.* 1984;77(4):423-5.
124. van Vroonhoven TJ, Schouten WR. Postanal repair in the treatment of faecal incontinence. *Neth J Surg.* 1984;36(6):160-2.
125. Henry MM, Simson JN. Results of postanal repair: a retrospective study. *Br J Surg.* 1985;72 Suppl:S17-9.
126. Habr-Gama A, Alves PA, da Silva e Souza AH, Femenia Viera MJ, Brunetti-Netto C. Treatment

- of faecal incontinence by post-anal repair. *Coloproctology*. 1986;8:244-6.
127. Rainey JB, Donaldson DR, Thomson JP. Post-anal repair: which patients derive most benefit? *J R Coll Surg Edinb*. 1990;35(2):101-5.
 128. Scott AD, Henry MM, Phillips RK. Clinical assessment and anorectal manometry before postanal repair: failure to predict outcome. *Br J Surg*. 1990;77(6):628-9.
 129. Laurberg S, Swash M, Henry MM. Effect of postanal repair on progress of neurogenic damage to the pelvic floor. *Br J Surg*. 1990;77(5):519-22.
 130. Rieger NA, Sarre RG, Saccone GT, Hunter A, Toouli J. Postanal repair for faecal incontinence: long-term follow-up. *Aust N Z J Surg*. 1997;67(8):566-70.
 131. Mackey P, Mackey L, Kennedy ML, King DW, Newstead GL, Douglas PR, et al. Postanal repair--do the long-term results justify the procedure? *Colorectal Dis*. 2010;12(4):367-72.
 132. Yoshioka K, Hyland G, Keighley MR. Physiological changes after postanal repair and parameters predicting outcome. *Br J Surg*. 1988;75(12):1220-4.
 133. Abramov Y, Feiner B, Rosen T, Bardichev M, Gutterman E, Lissak A, et al. Primary repair of advanced obstetric anal sphincter tears: should it be performed by the overlapping sphincteroplasty technique? *Int Urogynecol J Pelvic Floor Dysfunct*. 2008;19(8):1071-4.
 134. Pickrell KL, Broadbent TR, Masters FW, Metzger JT. Construction of a rectal sphincter and restoration of anal continence by transplanting the gracilis muscle; a report of four cases in children. *Ann Surg*. 1952;135(6):853-62.
 135. Raffensperger J. The gracilis sling for fecal incontinence. *J Pediatr Surg*. 1979;14(6):794-7.
 136. Brandesky G, Holschneider AM. Operations for the improvement of faecal incontinence. *Prog Pediatr Surg*. 1976;9:105-14.
 137. Schwedler T, Erichsen K. [Gracilis-muscle transplant for the treatment of fecal incontinence (author's transl)]. *Langenbecks Arch Chir*. 1975;339:451-7.
 138. Holschneider AM, Hecker WC. Smooth muscle reverse plasty. A new method to treat anorectal incontinence in infants with high anal and rectal atresia. Results after gracilis plasty and free muscle transplantation. *Prog Pediatr Surg*. 1984;17:131-45.
 139. Corman ML. Gracilis muscle transposition for anal incontinence: late results. *Br J Surg*. 1985;72 Suppl:S21-2.
 140. Leguit P, Jr., van Baal JG, Brummelkamp WH. Gracilis muscle transposition in the treatment of fecal incontinence. Long-term follow-up and evaluation of anal pressure recordings. *Dis Colon Rectum*. 1985;28(1):1-4.
 141. Scharli AF. Anorectal incontinence: diagnosis and treatment. *J Pediatr Surg*. 1987;22(8):693-701.
 142. Yoshioka K, Keighley MR. Clinical and manometric assessment of gracilis muscle transplant for fecal incontinence. *Dis Colon Rectum*. 1988;31(10):767-9.
 143. Sielezneff I, Bauer S, Bulgare JC, Sarles JC. Gracilis muscle transposition in the treatment of faecal incontinence. *Int J Colorectal Dis*. 1996;11(1):15-8.
 144. Prochiantz A, Gross P. Gluteal myoplasty for sphincter replacement: principles, results and prospects. *J Pediatr Surg*. 1982;17(1):25-30.
 145. Christiansen J, Hansen CR, Rasmussen O. Bilateral gluteus maximus transposition for anal incontinence. *Br J Surg*. 1995;82(7):903-5.
 146. Guelinckx PJ, Sinsel NK, Gruwez JA. Anal sphincter reconstruction with the gluteus maximus muscle: anatomic and physiologic considerations concerning conventional and dynamic gluteoplasty. *Plast Reconstr Surg*. 1996;98(2):293-302; discussion 3-4.
 147. Devesa JM, Madrid JM, Gallego BR, Vicente E, Nuno J, Enriquez JM. Bilateral gluteoplasty for fecal incontinence. *Dis Colon Rectum*. 1997;40(8):883-8.
 148. Pearl RK, Prasad ML, Nelson RL, Orsay CP, Abcarian H. Bilateral gluteus maximus transposition for anal incontinence. *Dis Colon Rectum*. 1991;34(6):478-81.
 149. Hultman CS, Zenn MR, Agarwal T, Baker CC. Restoration of fecal continence after functional gluteoplasty: long-term results, technical refinements, and donor-site morbidity. *Ann Plast Surg*. 2006;56(1):65-70; discussion -1.
 150. George BD, Williams NS, Patel J, Swash M, Watkins ES. Physiological and histochemical adaptation of the electrically stimulated gracilis muscle to neoanal sphincter function. *Br J Surg*. 1993;80(10):1342-6.
 151. Baeten C, Spaans F, Fluks A. An implanted neuromuscular stimulator for fecal continence following previously implanted gracilis muscle. Report of a case. *Dis Colon Rectum*. 1988;31(2):134-7.
 152. Williams NS, Hallan RI, Koeze TH, Pilot MA, Watkins ES. Construction of a neoanal sphincter by transposition of the gracilis muscle and prolonged neuromuscular stimulation for the

- treatment of faecal incontinence. *Ann R Coll Surg Engl.* 1990;72(2):108-13.
153. Williams NS, Patel J, George BD, Hallan RI, Watkins ES. Development of an electrically stimulated neonatal sphincter. *Lancet.* 1991;338(8776):1166-9.
 154. Baeten CG, Konsten J, Spaans F, Visser R, Habets AM, Bourgeois IM, et al. Dynamic graciloplasty for treatment of faecal incontinence. *Lancet.* 1991;338(8776):1163-5.
 155. Salmons S, Vrbova G. The influence of activity on some contractile characteristics of mammalian fast and slow muscles. *J Physiol.* 1969;201(3):535-49.
 156. Baeten CG, Geerdes BP, Adang EM, Heineman E, Konsten J, Engel GL, et al. Anal dynamic graciloplasty in the treatment of intractable fecal incontinence. *N Engl J Med.* 1995;332(24):1600-5.
 157. Geerdes BP, Heineman E, Konsten J, Soeters PB, Baeten CG. Dynamic graciloplasty. Complications and management. *Dis Colon Rectum.* 1996;39(8):912-7.
 158. Cavina E, Seccia M, Banti P, Zocco G. Anorectal reconstruction after abdominoperineal resection. Experience with double-wrap graciloplasty supported by low-frequency electrostimulation. *Dis Colon Rectum.* 1998;41(8):1010-6.
 159. Madoff RD, Rosen HR, Baeten CG, LaFontaine LJ, Cavina E, Devesa M, et al. Safety and efficacy of dynamic muscle plasty for anal incontinence: lessons from a prospective, multicenter trial. *Gastroenterology.* 1999;116(3):549-56.
 160. Mander BJ, Wexner SD, Williams NS, Bartolo DC, Lubowski DZ, Oresland T, et al. Preliminary results of a multicentre trial of the electrically stimulated gracilis neoanal sphincter. *Br J Surg.* 1999;86(12):1543-8.
 161. Baeten CG, Bailey HR, Bakka A, Belliveau P, Berg E, Buie WD, et al. Safety and efficacy of dynamic graciloplasty for fecal incontinence: report of a prospective, multicenter trial. *Dynamic Graciloplasty Therapy Study Group. Dis Colon Rectum.* 2000;43(6):743-51.
 162. Wexner SD, Baeten C, Bailey R, Bakka A, Belin B, Belliveau P, et al. Long-term efficacy of dynamic graciloplasty for fecal incontinence. *Dis Colon Rectum.* 2002;45(6):809-18.
 163. Rongen MJ, Uludag O, El Naggar K, Geerdes BP, Konsten J, Baeten CG. Long-term follow-up of dynamic graciloplasty for fecal incontinence. *Dis Colon Rectum.* 2003;46(6):716-21.
 164. Penninckx F, Belgian Section of Colorectal S. Belgian experience with dynamic graciloplasty for faecal incontinence. *Br J Surg.* 2004;91(7):872-8.
 165. Tillin T, Gannon K, Feldman RA, Williams NS. Third-party prospective evaluation of patient outcomes after dynamic graciloplasty. *Br J Surg.* 2006;93(11):1402-10.
 166. Hassan MZ, Rathnayaka MM, Deen KI. Modified dynamic gracilis neosphincter for fecal incontinence: an analysis of functional outcome at a single institution. *World J Surg.* 2010;34(7):1641-7.
 167. Rosen HR, Novi G, Zoech G, Feil W, Urbarz C, Schiessel R. Restoration of anal sphincter function by single-stage dynamic graciloplasty with a modified (split sling) technique. *Am J Surg.* 1998;175(3):187-93.
 168. Sielezneff I, Malouf AJ, Bartolo DC, Pryde A, Douglas S. Dynamic graciloplasty in the treatment of patients with faecal incontinence. *Br J Surg.* 1999;86(1):61-5.
 169. Thornton MJ, Kennedy ML, Lubowski DZ, King DW. Long-term follow-up of dynamic graciloplasty for faecal incontinence. *Colorectal Dis.* 2004;6(6):470-6.
 170. Chapman AE, Geerdes B, Hewett P, Young J, Evers T, Kiroff G, et al. Systematic review of dynamic graciloplasty in the treatment of faecal incontinence. *Br J Surg.* 2002;89(2):138-53.
 171. Tan EK, Vaizey C, Cornish J, Darzi A, Tekkis PP. Surgical strategies for faecal incontinence—a decision analysis between dynamic graciloplasty, artificial bowel sphincter and end stoma. *Colorectal Dis.* 2008;10(6):577-86.
 172. Wexner SD, Jin HY, Weiss EG, Noguera JJ, Li VK. Factors associated with failure of the artificial bowel sphincter: a study of over 50 cases from Cleveland Clinic Florida. *Dis Colon Rectum.* 2009;52(9):1550-7.
 173. Wong MT, Meurette G, Wyart V, Glemain P, Lehur PA. The artificial bowel sphincter: a single institution experience over a decade. *Ann Surg.* 2011;254(6):951-6.
 174. Wang X, DaSilva G, Maron DJ, Cracco AJ, Wexner SD. Outcomes of Reimplantation of the Artificial Bowel Sphincter. *Dis Colon Rectum.* 2016;59(2):122-6.
 175. Hong KD, Dasilva G, Kalaskar SN, Chong Y, Wexner SD. Long-term outcomes of artificial bowel sphincter for fecal incontinence: a systematic review and meta-analysis. *J Am Coll Surg.* 2013;217(4):718-25.
 176. Mantoo S, Meurette G, Podevin J, Lehur PA. The magnetic anal sphincter: a new device in the management of severe fecal incontinence. *Expert Rev Med Devices.* 2012;9(5):483-90.

177. Lehur PA, McNevin S, Buntzen S, Mellgren AF, Laurberg S, Madoff RD. Magnet-ic anal sphincter augmentation for the treat-ment of fecal incontinence: a preliminary re-port from a feasibility study. *Dis Colon Rec-tum.* 2010;53(12):1604-10.
178. Barussaud ML, Mantoo S, Wyart V, Meurette G, Lehur PA. The magnetic anal sphincter in faecal incontinence: is initial success sustained over time? *Colorectal Dis.* 2013;15(12):1499-503.
179. Pakravan F, Helmes C. Magnetic anal sphincter augmentation in patients with severe fecal incontinence. *Dis Colon Rectum.* 2015;58(1):109-14.
180. Sugrue J LP, Madoff, RD, McNevin S, Buntzen S, Laurberg S Mellgren A. Long-term experience of magnetic anal sphincter augmentation in patients with fecal incontinence. *Dis Colon Rectum.* 2016 (in press).
181. Matzel KE, Stadelmaier U, Ho-henfellner M, Gall FP. Electrical stimulation of sacral spinal nerves for treatment of faecal incontinence. *Lancet.* 1995;346(8983):1124-7.
182. Matzel KE, Schmidt RA, Tanagho EA. Neuro-anatomy of the striated muscular anal continence mechanism. Implications for the use of neurostimulation. *Dis Colon Rec-tum.* 1990;33(8):666-73.
183. Thon WF BL, Jonas U, Tanagho EA, Schmidt RA. Neuromodulation of voiding dysfunction and pelvic pain. *World Journal of Urology* 1991;9:138-41.
184. Jacobs SA, Lane FL, Osann KE, Noblett KL. Randomized prospective crosso-ver study of interstim lead wire placement with curved versus straight stylet. *Neurourol Urodyn.* 2014;33(5):488-92.
185. Govaert B, Melenhorst J, van Gemert WG, Baeten CG. Can sensory and/or motor reactions during percutaneous nerve evaluation predict outcome of sacral nerve modulation? *Dis Colon Rectum.* 2009;52(8):1423-6.
186. Janknegt RA, Weil EH, Eerd-mans PH. Improving neuromodulation tech-nique for refractory voiding dysfunctions: two-stage implant. *Urology.* 1997;49(3):358-62.
187. Matzel KE, Stadelmaier U, Bittorf B, Hohenfellner M, Hohenberger W. Bilateral sacral spinal nerve stimulation for fecal in-continence after low anterior rectum resec-tion. *Int J Colorectal Dis.* 2002;17(6):430-4.
188. Ratto C, Grillo E, Parello A, Pe-trolino M, Costamagna G, Doglietto GB. Sa-cral neuromodu-lation in treatment of fecal in-continence following anterior resection and chemoradiation for rectal cancer. *Dis Colon Rectum.* 2005;48(5):1027-36.
189. Duelund-Jakobsen J, Buntzen S, Lundby L, Sorensen M, Laurberg S. Bilateral compared with unilateral sacral nerve stimula-tion for faecal incontinence: results of a ran-domized, single-blinded crossover study. *Colorectal Dis.* 2015;17(12):1085-93.
190. Matzel KE, Stadelmaier U, Ho-henberger W. Innovations in fecal inconti-nence: sacral nerve stimulation. *Dis Colon Rectum.* 2004;47(10):1720-8.
191. Tjandra JJ, Lim JF, Matzel K. Sacral nerve stimulation: an emerging treat-ment for faecal incontinence. *ANZ J Surg.* 2004;74(12):1098-106.
192. Gourcerol G, Gallas S, Michot F, Denis P, Leroi AM. Sacral nerve stimulation in fecal inconti-nence: are there factors associ-ated with suc-cess? *Dis Colon Rectum.* 2007;50(1):3-12.
193. Dudding TC, Pares D, Vaizey CJ, Kamm MA. Predictive factors for successful sacral nerve stimulation in the treatment of faecal inconti-nence: a 10-year cohort analy-sis. *Colorectal Dis.* 2008;10(3):249-56.
194. Govaert B, Melenhorst J, Nieman FH, Bols EM, van Gemert WG, Baeten CG. Factors associ-ated with percutaneous nerve evaluation and permanent sacral nerve modulation outcome in patients with fecal in-continence. *Dis Colon Rectum.* 2009;52(10):1688-94.
195. Melenhorst J, Koch SM, Uludag O, van Gemert WG, Baeten CG. Is a morpho-logically intact anal sphincter necessary for success with sa-cral nerve modulation in pa-tients with faecal in-continence? *Colorectal Dis.* 2008;10(3):257-62.
196. Maeda Y, Norton C, Lundby L, Buntzen S, Laurberg S. Predictors of the out-come of per- cutaneous nerve evaluation for faecal inconti-nence. *Br J Surg.* 2010;97(7):1096-102.
197. Gallas S, Michot F, Faucheron JL, Meurette G, Lehur PA, Barth X, et al. Pre-dictive factors for successful sacral nerve stimulation in the treat-ment of faecal inconti-nence: results of trial stimulation in 200 pa-tients. *Colorectal Dis.* 2011;13(6):689-96.
198. Vallet C, Parc Y, Lupinacci R, Shields C, Parc R, Tiret E. Sacral nerve stimu-lation for faecal incontinence: response rate, satisfaction and the value of preoperative in-vestigation in pa-tient selection. *Colorectal Dis.* 2010;12(3):247-53.
199. Roy AL, Gourcerol G, Menard JF, Michot F, Leroi AM, Bridoux V. Predictive factors for suc-

- cessful sacral nerve stimulation in the treatment of fecal incontinence: lessons from a comprehensive treatment assessment. *Dis Colon Rectum*. 2014;57(6):772-80.
200. Altomare DF, Giuratrabocchetta S, Knowles CH, Munoz Duyos A, Robert-Yap J, Matzel KE, et al. Long-term outcomes of sacral nerve stimulation for faecal incontinence. *Br J Surg*. 2015;102(4):407-15.
 201. Prapasrivorakul S, Gosselink MP, Gorissen KJ, Fourie S, Hompes R, Jones OM, et al. Sacral neuromodulation for faecal incontinence: is the outcome compromised in patients with high-grade internal rectal prolapse? *Int J Colorectal Dis*. 2015;30(2):229-34.
 202. Wallace PA, Lane FL, Noblett KL. Sacral nerve neuromodulation in patients with underlying neurologic disease. *Am J Obstet Gynecol*. 2007;197(1):96 e1-5.
 203. Rosen HR, Urbarz C, Holzer B, Novi G, Schiesel R. Sacral nerve stimulation as a treatment for fecal incontinence. *Gastroenterology*. 2001;121(3):536-41.
 204. Ganio E, Luc AR, Clerico G, Trompetto M. Sacral nerve stimulation for treatment of fecal incontinence: a novel approach for intractable fecal incontinence. *Dis Colon Rectum*. 2001;44(5):619-29; discussion 29-31.
 205. Jarrett ME, Varma JS, Duthie GS, Nicholls RJ, Kamm MA. Sacral nerve stimulation for faecal incontinence in the UK. *Br J Surg*. 2004;91(6):755-61.
 206. Melenhorst J, Koch SM, Uludag O, van Gemert WG, Baeten CG. Sacral neuromodulation in patients with faecal incontinence: results of the first 100 permanent implantations. *Colorectal Dis*. 2007;9(8):725-30.
 207. Kenefick NJ, Vaizey CJ, Cohen RC, Nicholls RJ, Kamm MA. Medium-term results of permanent sacral nerve stimulation for faecal incontinence. *Br J Surg*. 2002;89(7):896-901.
 208. Matzel KE, Stadelmaier U, Hohenfellner M, Hohenberger W. Chronic sacral spinal nerve stimulation for fecal incontinence: long-term results with foramen and cuff electrodes. *Dis Colon Rectum*. 2001;44(1):59-66.
 209. Leroi AM, Michot F, Grise P, Denis P. Effect of sacral nerve stimulation in patients with fecal and urinary incontinence. *Dis Colon Rectum*. 2001;44(6):779-89.
 210. Kenefick NJ, Emmanuel A, Nicholls RJ, Kamm MA. Effect of sacral nerve stimulation on autonomic nerve function. *Br J Surg*. 2003;90(10):1256-60.
 211. Gourcerol G, Vitton V, Leroi AM, Michot F, Abysique A, Bouvier M. How sacral nerve stimulation works in patients with faecal incontinence. *Colorectal Dis*. 2011;13(8):e203-11.
 212. Vitton V, Abysique A, Gaige S, Leroi AM, Bouvier M. Colonosphincteric electromyographic responses to sacral root stimulation: evidence for a somatosympathetic reflex. *Neurogastroenterol Motil*. 2008;20(4):407-16.
 213. Sheldon R, Kiff ES, Clarke A, Harris ML, Hamdy S. Sacral nerve stimulation reduces corticoanal excitability in patients with faecal incontinence. *Br J Surg*. 2005;92(11):1423-31.
 214. Giani I, Novelli E, Martina S, Clerico G, Luc AR, Trompetto M, et al. The effect of sacral nerve modulation on cerebral evoked potential latency in fecal incontinence and constipation. *Ann Surg*. 2011;254(1):90-6.
 215. Griffin KM, Pickering M, O'Herlihy C, O'Connell PR, Jones JF. Sacral nerve stimulation increases activation of the primary somatosensory cortex by anal canal stimulation in an experimental model. *Br J Surg*. 2011;98(8):1160-9.
 216. Lundby L, Moller A, Buntzen S, Krogh K, Vang K, Gjedde A, et al. Relief of fecal incontinence by sacral nerve stimulation linked to focal brain activation. *Dis Colon Rectum*. 2011;54(3):318-23.
 217. Vaizey CJ, Kamm MA, Turner IC, Nicholls RJ, Woloszko J. Effects of short term sacral nerve stimulation on anal and rectal function in patients with anal incontinence. *Gut*. 1999;44(3):407-12.
 218. Uludag O, Koch SM, van Gemert WG, Dejong CH, Baeten CG. Sacral neuromodulation in patients with fecal incontinence: a single-center study. *Dis Colon Rectum*. 2004;47(8):1350-7.
 219. Michelsen HB, Christensen P, Krogh K, Rosenkilde M, Buntzen S, Theil J, et al. Sacral nerve stimulation for faecal incontinence alters colorectal transport. *Br J Surg*. 2008;95(6):779-84.
 220. Patton V, Wiklendt L, Arkwright JW, Lubowski DZ, Dinning PG. The effect of sacral nerve stimulation on distal colonic motility in patients with faecal incontinence. *Br J Surg*. 2013;100(7):959-68.
 221. Abdel-Halim MR, Crosbie J, Engledow A, Windsor A, Cohen CR, Emmanuel AV. Temporary sacral nerve stimulation alters rectal sensory function: a physiological study. *Dis Colon Rectum*. 2011;54(9):1134-40.
 222. Otto SD, Burmeister S, Buhr HJ, Kroesen A. Sacral nerve stimulation induces changes in

- the pelvic floor and rectum that improve continence and quality of life. *J Gas-trointest Surg.* 2010;14(4):636-44.
223. Uludag O, Morren GL, Dejong CH, Baeten CG. Effect of sacral neuromodulation on the rectum. *Br J Surg.* 2005;92(8):1017-23.
 224. Michelsen HB, Buntzen S, Krogh K, Laurberg S. Rectal volume tolerability and anal pressures in patients with fecal incontinence treated with sacral nerve stimulation. *Dis Colon Rectum.* 2006;49(7):1039-44.
 225. Roman S, Tatagiba T, Damon H, Barth X, Mion F. Sacral nerve stimulation and rectal function: results of a prospective study in faecal incontinence. *Neurogastroenterol Motil.* 2008;20(10):1127-31.
 226. Ganio E, Masin A, Ratto C, Altomare DF, Ripetti V, Clerico G, et al. Short-term sacral nerve stimulation for functional anorectal and urinary disturbances: results in 40 patients: evaluation of a new option for anorectal functional disorders. *Dis Colon Rectum.* 2001;44(9):1261-7.
 227. Damgaard M, Thomsen FG, Sorensen M, Fuglsang S, Madsen JL. The influence of sacral nerve stimulation on gastro-intestinal motor function in patients with fecal incontinence. *Neurogastroenterol Motil.* 2011;23(6):556-e207.
 228. Carrington EV, Evers J, Grossi U, Dinning PG, Scott SM, O'Connell PR, et al. A systematic review of sacral nerve stimulation mechanisms in the treatment of fecal incontinence and constipation. *Neurogastro-enterol Motil.* 2014;26(9):1222-37.
 229. Gooneratne ML, Facer P, Knowles CH, Chan CL, Lunniss PJ, Scott SM, et al. Normalization of substance P levels in rectal mucosa of patients with faecal incontinence treated successfully by sacral nerve stimulation. *Br J Surg.* 2008;95(4):477-83.
 230. Tjandra JJ, Chan MK, Yeh CH, Murray-Green C. Sacral nerve stimulation is more effective than optimal medical therapy for severe fecal incontinence: a randomized, controlled study. *Dis Colon Rectum.* 2008;51(5):494-502.
 231. Hollingshead JR, Dudding TC, Vaizey CJ. Sacral nerve stimulation for faecal incontinence: results from a single centre over a 10-year period. *Colorectal Dis.* 2011;13(9):1030-4.
 232. Maeda Y, Lundby L, Buntzen S, Laurberg S. Outcome of sacral nerve stimulation for fecal incontinence at 5 years. *Ann Surg.* 2014;259(6):1126-31.
 233. Wexner SD, Collier JA, Devroede G, Hull T, McCallum R, Chan M, et al. Sacral nerve stimulation for fecal incontinence: results of a 120-patient prospective multicenter study. *Ann Surg.* 2010;251(3):441-9.
 234. Dudding TC, Meng Lee E, Faiz O, Pares D, Vaizey CJ, McGuire A, et al. Economic evaluation of sacral nerve stimulation for faecal incontinence. *Br J Surg.* 2008;95(9):1155-63.
 235. Mellgren A, Wexner SD, Collier JA, Devroede G, Lerew DR, Madoff RD, et al. Long-term efficacy and safety of sacral nerve stimulation for fecal incontinence. *Dis Colon Rectum.* 2011;54(9):1065-75.
 236. Altomare DF, Binda G, Ganio E, De Nardi P, Giamundo P, Pescatori M, et al. Long-term outcome of Altemeier's procedure for rectal prolapse. *Dis Colon Rectum.* 2009;52(4):698-703.
 237. Duelund-Jakobsen J, van Wun-nik B, Buntzen S, Lundby L, Baeten C, Laurberg S. Functional results and patient satisfaction with sacral nerve stimulation for idiopathic faecal incontinence. *Colorectal Dis.* 2012;14(6):753-9.
 238. Uludag O, Melenhorst J, Koch SM, van Gemert WG, Dejong CH, Baeten CG. Sacral neuromodulation: long-term outcome and quality of life in patients with faecal incontinence. *Colorectal Dis.* 2011;13(10):1162-6.
 239. Thin NN, Horrocks EJ, Hotouras A, Palit S, Thaha MA, Chan CL, et al. Systematic review of the clinical effectiveness of neuromodulation in the treatment of faecal incontinence. *Br J Surg.* 2013;100(11):1430-47.
 240. Michelsen HB, Thompson-Fawcett M, Lundby L, Krogh K, Laurberg S, Buntzen S. Six years of experience with sacral nerve stimulation for fecal incontinence. *Dis Colon Rectum.* 2010;53(4):414-21.
 241. Wong MT, Meurette G, Rodat F, Regenet N, Wyart V, Lehur PA. Outcome and management of patients in whom sacral nerve stimulation for fecal incontinence failed. *Dis Colon Rectum.* 2011;54(4):425-32.
 242. Faucheron JL, Voirin D, Badic B. Sacral nerve stimulation for fecal incontinence: causes of surgical revision from a series of 87 consecutive patients operated on in a single institution. *Dis Colon Rectum.* 2010;53(11):1501-7.
 243. Darnis B, Faucheron JL, Damon H, Barth X. Technical and functional results of the artificial bowel sphincter for treatment of severe fecal incontinence: is there any benefit for the patient? *Dis Colon Rectum.* 2013;56(4):505-10.
 244. Damon H, Barth X, Roman S, Mion F. Sacral nerve stimulation for fecal incontinence improves symptoms, quality of life and patients'

- satisfaction: results of a mo-nocentric series of 119 patients. *Int J Colo-rectal Dis.* 2013;28(2):227-33.
245. Matzel KE, Kamm MA, Stosser M, Baeten CG, Christiansen J, Madoff R, et al. Sacral spinal nerve stimulation for faecal in-continence: multicentre study. *Lancet.* 2004;363(9417):1270-6.
 246. Altomare DF, Ratto C, Ganio E, Lolli P, Masin A, Villani RD. Long-term out-come of sacral nerve stimulation for fecal in-continence. *Dis Colon Rectum.* 2009;52(1):11-7.
 247. Lim JT, Hastie IA, Hiscock RJ, Shedda SM. Sacral nerve stimulation for fecal incontinence: long-term outcomes. *Dis Colon Rectum.* 2011;54(8):969-74.
 248. Faucheron JL, Chodez M, Boillot B. Neuromodulation for fecal and urinary in-continence: functional results in 57 consecutive patients from a single institution. *Dis Co-lon Rectum.* 2012;55(12):1278-83.
 249. Duelund-Jakobsen J, Dudding T, Bradshaw E, Buntzen S, Lundby L, Laurberg S, et al. Randomized double-blind crossover study of alternative stimulator settings in sa-cral nerve stimulation for faecal incontinence. *Br J Surg.* 2012;99(10):1445-52.
 250. Matzel KE, Lux P, Heuer S, Bes-endorfer M, Zhang W. Sacral nerve stimula-tion for faecal incontinence: long-term out-come. *Colorectal Dis.* 2009;11(6):636-41.
 251. Devroede G, Giese C, Wexner SD, Mellgren A, Coller JA, Madoff RD, et al. Quality of life is markedly improved in pa-tients with fecal incontinence after sacral nerve stimulation. *Female Pelvic Med Recon-str Surg.* 2012;18(2):103-12.
 252. Tan E, Ngo NT, Darzi A, Shenouda M, Tekkis PP. Meta-analysis: sa-cral nerve stimulation versus conservative therapy in the treatment of faecal inconti-nence. *Int J Colorectal Dis.* 2011;26(3):275-94.
 253. Thaha MA, Abukar AA, Thin NN, Ramsanahie A, Knowles CH. Sacral nerve stimulation for faecal incontinence and con-stipation in adults. *Cochrane Database Syst Rev.* 2015(8):CD004464.
 254. Thin NN, Taylor SJ, Bremner SA, Emmanuel AV, Hounsome N, Williams NS, et al. Randomized clinical trial of sacral versus percutaneous tibial nerve stimulation in pa-tients with faecal incontinence. *Br J Surg.* 2015;102(4):349-58.
 255. Vaizey CJ, Kamm MA, Roy AJ, Nicholls RJ. Double-blind crossover study of sacral nerve stimulation for fecal inconti-nence. *Dis Colon Rectum.* 2000;43(3):298-302.
 256. Leroi AM, Parc Y, Lehur PA, Mion F, Barth X, Rullier E, et al. Efficacy of sacral nerve stimulation for fecal incontinence: re-sults of a multi-center double-blind crossover study. *Ann Surg.* 2005;242(5):662-9.
 257. Kahlke V, Topic H, Peleikis HG, Jongen J. Sacral nerve modulation for fecal incontinence: results of a prospective single-center randomized crossover study. *Dis Co-lon Rectum.* 2015;58(2):235-40.
 258. Vitton V, Gigout J, Grimaud JC, Bouvier M, Desjeux A, Orsoni P. Sacral nerve stimulation can improve continence in pa-tients with Crohn's disease with internal and external anal sphincter disruption. *Dis Colon Rectum.* 2008;51(6):924-7.
 259. Jarrett ME, Dudding TC, Nicholls RJ, Vaizey CJ, Cohen CR, Kamm MA. Sacral nerve stimulation for fecal incontinence relat-ed to obstetric anal sphincter damage. *Dis Colon Rectum.* 2008;51(5):531-7.
 260. Chan MK, Tjandra JJ. Sacral nerve stimulation for fecal incontinence: ex-ternal anal sphincter defect vs. intact anal sphincter. *Dis Colon Rectum.* 2008;51(7):1015-24; discussion 24-5.
 261. Boyle DJ, Knowles CH, Lunniss PJ, Scott SM, Williams NS, Gill KA. Efficacy of sacral nerve stimulation for fecal inconti-nence in patients with anal sphincter defects. *Dis Colon Rectum.* 2009;52(7):1234-9.
 262. Ratto C, Litta F, Parello A, Donisi L, Doglietto GB. Sacral nerve stimulation is a valid approach in fecal incontinence due to sphincter lesions when compared to sphinc-ter repair. *Dis Colon Rectum.* 2010;53(3):264-72.
 263. Dudding TC, Pares D, Vaizey CJ, Kamm MA. Sacral nerve stimulation for the treatment of faecal incontinence related to dysfunction of the internal anal sphincter. *Int J Colorectal Dis.* 2010;25(5):625-30.
 264. Ratto C, Litta F, Parello A, Donisi L, De Simone V, Zaccone G. Sacral nerve stimulation in faecal incontinence associated with an anal sphincter lesion: a systematic review. *Colorectal Dis.* 2012;14(6):e297-304.
 265. Buntzen S, Rasmussen OO, Ry-hammer AM, Sorensen M, Laurberg S, Christi-ansen J. Sacral nerve stimulation for treat-ment of fecal incontinence in a patient with muscular dystrophy: report of a case. *Dis Co-lon Rectum.* 2004;47(8):1409-11.
 266. Meurette G, Wong M, Paye F, Parc Y, Tiret E, Lehur PA. Sacral nerve stimu-lation for the treatment of faecal incontinence after ileal pouch anal anastomosis. *Colorectal Dis.* 2011;13(7):e182-3.

267. Jarrett ME, Matzel KE, Christian-sen J, Baeten CG, Rosen H, Bittorf B, et al. Sacral nerve stimulation for faecal inconti-nence in patients with previous partial spinal injury including disc prolapse. *Br J Surg*. 2005;92(6):734-9.
268. Jarrett ME, Matzel KE, Stosser M, Baeten CG, Kamm MA. Sacral nerve stimula-tion for fecal incontinence following surgery for rectal prolapse repair: a multicenter study. *Dis Colon Rectum*. 2005;48(6):1243-8.
269. Robert-Yap J, Zufferey G, Rosen H, Lechner M, Wunderlich M, Roche B. Sacral nerve modulation in the treatment of fecal in-continenence following repair of rectal pro-lapse. *Dis Colon Rectum*. 2010;53(4):428-31.
270. Jarrett ME, Matzel KE, Stosser M, Christiansen J, Rosen H, Kamm MA. Sacral nerve stimulation for faecal incontinence fol-lowing a rec-tosigmoid resection for colorec-tal cancer. *Int J Colorectal Dis*. 2005;20(5):446-51.
271. de Miguel M, Oteiza F, Ciga MA, Armendariz P, Marzo J, Ortiz H. Sacral nerve stimulation for the treatment of faecal inconti-nence following low anterior resection for rectal cancer. *Colo-rectal Dis*. 2011;13(1):72-7.
272. Holzer B, Rosen HR, Zaglmaier W, Klug R, Beer B, Novi G, et al. Sacral nerve stimulation in patients after rectal resection--preliminary report. *J Gastrointest Surg*. 2008;12(5):921-5.
273. Thomas GP, Bradshaw E, Vaizey CJ. A review of sacral nerve stimulation for faecal inconti-nence following rectal surgery and radiother-apy. *Colorectal Dis*. 2015;17(11):939-42.
274. Maeda Y, Hoyer M, Lundby L, Buntzen S, Laurberg S. Temporary sacral nerve stimula-tion for faecal incontinence fol-lowing pelvic ra-diotherapy. *Radiother Oncol*. 2010;97(1):108-12.
275. Schiano di Visconte M, Munega-to G. The value of sacral nerve stimulation in the treat-ment of faecal incontinence after pel-vic radio-therapy. *Int J Colorectal Dis*. 2009;24(9):1111-2.
276. Leblanc D, McFadden N, Lebel M, Devroede G. Fecal continence can be re-stored by sacral neurostimulation after trau-matic unilateral pu-dendal neuropathy: a case report. *Int J Colo-rectal Dis*. 2015;30(4):569-70.
277. Lansen-Koch SM, Govaert B, Oerlemans D, Melenhorst J, Vles H, Cornips E, et al. Sacral nerve modulation for defaeca-tion and micturi-tion disorders in patients with spina bifida. *Colo-rectal Dis*. 2012;14(4):508-14.
278. Santoro GA, Infantino A, Canci-an L, Battistella G, Di Falco G. Sacral nerve stimulation for fecal incontinence related to external sphincter atro-phy. *Dis Colon Rec-tum*. 2012;55(7):797-805.
279. Hetzer FH, Hahnloser D, Clavien PA, Demar-tines N. Quality of life and morbidi-ty after per-manent sacral nerve stimulation for fecal inconti-nence. *Arch Surg*. 2007;142(1):8-13.
280. Malouf AJ, Vaizey CJ, Nicholls RJ, Kamm MA. Permanent sacral nerve stimu-lation for fecal incontinence. *Ann Surg*. 2000;232(1):143-8.
281. Hetzer FH, Bieler A, Hahnloser D, Lohlein F, Clavien PA, Demartines N. Out-come and cost analysis of sacral nerve stimu-lation for faecal incontinence. *Br J Surg*. 2006;93(11):1411-7.
282. Munoz-Duyos A, Navarro-Luna A, Brosa M, Pando JA, Sitges-Serra A, Marco-Molina C. Clinical and cost effectiveness of sacral nerve stimulation for faecal inconti-nence. *Br J Surg*. 2008;95(8):1037-43.
283. Indinnimeo M, Ratto C, Moschel-la CM, Fiore A, Brosa M, Giardina S. Sacral neuromodula-tion for the treatment of fecal in-continenence: analysis of cost-effectiveness. *Dis Colon Rec-tum*. 2010;53(12):1661-9.
284. Leroi AM, Lenne X, Dervaux B, Chartier-Kastler E, Mauroy B, Normand LL, et al. Outcome and cost analysis of sacral nerve modulation for treating urinary and/or fecal incontinence. *Ann Surg*. 2011;253(4):720-32.
285. Leroi AM, Damon H, Faucheron JL, Lehur PA, Siproudhis L, Slim K, et al. Sa-cral nerve stim-ulation in faecal incontinence: position state-ment based on a collective ex-perience. *Colo-rectal Dis*. 2009;11(6):572-83.
286. Faucheron JL, Herault MC. Life threatening haemorrhage after electrode re-moval: a se-vere complication following sacral nerve stimu-lation procedure for the treatment of faecal in-continenence. *Colorectal Dis*. 2012;14(3):e133.
287. Maeda Y, Matzel K, Lundby L, Buntzen S, Laurberg S. Postoperative issues of sacral nerve stimulation for fecal inconti-nence and constipation: a systematic litera-ture review and treatment guideline. *Dis Co-lon Rectum*. 2011;54(11):1443-60.
288. Maeda Y, Lundby L, Buntzen S, Laurberg S. Suboptimal outcome following sacral nerve stimulation for faecal inconti-nence. *Br J Surg*. 2011;98(1):140-7.
289. Bielefeldt K. Adverse events of sacral neuro-modulation for faecal inconti-nence reported to the federal drug admin-istration. *World J Gas-trointest Pharmacol Ther*. 2016;7(2):294-305.
290. O'Rourke DA. An anorectal sling in the treat-ment of rectal prolapse and incon-tinenence. *Aust N Z J Surg*. 1974;44(2):144-6.

291. Shafik IA, Shafik A. Double-loop puborectoplasty: novel technique for the treatment of fecal incontinence. *Surg Technol Int*. 2009;18:103-8.
292. Yamana T, Takahashi T, Iwadare J. Perineal puborectalis sling operation for fecal incontinence: preliminary report. *Dis Colon Rectum*. 2004;47(11):1982-9.
293. Rosenblatt P, Schumacher J, Lucente V, McNevin S, Rafferty J, Mellgren A. A preliminary evaluation of the TOPAS system for the treatment of fecal incontinence in women. *Female Pelvic Med Reconstr Surg*. 2014;20(3):155-62.
294. Mellgren A, Zutshi M, Lucente VR, Culligan P, Fenner DE, Group TS. A posterior anal sling for fecal incontinence: results of a 152-patient prospective multicenter study. *Am J Obstet Gynecol*. 2016;214(3):349 e1-8.
295. O'Rourke DA, Egerton WM. A puborectal sling in the management of anal incontinence and rectal prolapse. *Aust N Z J Surg*. 1985;55(5):493-5.
296. Kotb AF, Campeau L, Corcos J. Urethral bulking agents: techniques and outcomes. *Curr Urol Rep*. 2009;10(5):396-400.
297. Ratto C, Buntzen S, Aigner F, Altomare DF, Heydari A, Donisi L, et al. Multi-centre observational study of the Gatekeeper for faecal incontinence. *Br J Surg*. 2016;103(3):290-9.
298. Ratto C, Donisi L, Litta F, Camp-enni P, Parello A. Implantation of SphinKeep-er(TM): a new artificial anal sphincter. *Tech Coloproctol*. 2016;20(1):59-66.
299. Shafik A. Polytetrafluoroethylene injection for the treatment of partial fecal incontinence. *Int Surg*. 1993;78(2):159-61.
300. Shafik A. Perianal injection of autologous fat for treatment of sphincteric incontinence. *Dis Colon Rectum*. 1995;38(6):583-7.
301. Lee PE, Kung RC, Drutz HP. Peri-urethral autologous fat injection as treatment for female stress urinary incontinence: a randomized double-blind controlled trial. *J Urol*. 2001;165(1):153-8.
302. Kumar D, Benson MJ, Bland JE. Glutaraldehyde cross-linked collagen in the treatment of faecal incontinence. *Br J Surg*. 1998;85(7):978-9.
303. Stojkovic SG, Lim M, Burke D, Finan PJ, Sagar PM. Intra-anal collagen injection for the treatment of faecal incontinence. *Br J Surg*. 2006;93(12):1514-8.
304. Feretis C, Benakis P, Dailianas A, Dimopoulos C, Mavrantonis C, Stamou KM, et al. Implantation of microballoons in the management of fecal incontinence. *Dis Colon Rectum*. 2001;44(11):1605-9.
305. Malouf AJ, Vaizey CJ, Norton CS, Kamm MA. Internal anal sphincter augmentation for fecal incontinence using injectable silicone biomaterial. *Dis Colon Rectum*. 2001;44(4):595-600.
306. Kenefick NJ, Vaizey CJ, Malouf AJ, Norton CS, Marshall M, Kamm MA. Injectable silicone biomaterial for faecal incontinence due to internal anal sphincter dysfunction. *Gut*. 2002;51(2):225-8.
307. Tjandra JJ, Lim JF, Hiscock R, Rajendra P. Injectable silicone biomaterial for fecal incontinence caused by internal anal sphincter dysfunction is effective. *Dis Colon Rectum*. 2004;47(12):2138-46.
308. Chan MK, Tjandra JJ. Injectable silicone biomaterial (PTQ) to treat fecal incontinence after hemorrhoidectomy. *Dis Colon Rectum*. 2006;49(4):433-9.
309. de la Portilla F, Fernandez A, Leon E, Rada R, Cisneros N, Maldonado VH, et al. Evaluation of the use of PTQ implants for the treatment of incontinent patients due to internal anal sphincter dysfunction. *Colo-rectal Dis*. 2008;10(1):89-94.
310. Soerensen MM, Lundby L, Buntzen S, Laurberg S. Intersphincteric injected silicone biomaterial implants: a treatment for faecal incontinence. *Colorectal Dis*. 2009;11(1):73-6.
311. Bartlett L, Ho YH. PTQ anal implants for the treatment of faecal incontinence. *Br J Surg*. 2009;96(12):1468-75.
312. Oliveira LC, Neves Jorge JM, Yussuf S, Habr-Gama A, Kiss D, Ceconello I. Anal incontinence improvement after silicone injection may be related to restoration of sphincter asymmetry. *Surg Innov*. 2009;16(2):155-61.
313. de la Portilla F, Vega J, Rada R, Segovia-Gonzales MM, Cisneros N, Maldonado VH, et al. Evaluation of three-dimensional anal endosonography of injectable silicone biomaterial (PTQ) implants to treat fecal incontinence: long-term localization and relation with the deterioration of the continence. *Tech Coloproctol*. 2009;13(3):195-9.
314. Maeda Y, Vaizey CJ, Kamm MA. Long-term results of perianal silicone injection for faecal incontinence. *Colorectal Dis*. 2007;9(4):357-61.
315. van Wunnik B, Driessen A, Baeten C. Local giant cell foreign body reaction after silicone injection for fecal incontinence in humans: two

- case reports. *Tech Coloproctol.* 2012;16(5):395-7.
316. Maeda Y, Vaizey CJ, Kamm MA. Pilot study of two new injectable bulking agents for the treatment of faecal incontinence. *Colorectal Dis.* 2008;10(3):268-72.
 317. Maslekar S, Smith K, Harji D, Griffiths B, Sagar PM. Injectable collagen for the treatment of faecal incontinence: long-term results. *Dis Colon Rectum.* 2013;56(3):354-9.
 318. Siproudhis L, Morcet J, Laine F. Elastomer implants in faecal incontinence: a blind, randomized placebo-controlled study. *Aliment Pharmacol Ther.* 2007;25(9):1125-32.
 319. Ganio E, Marino F, Giani I, Luc AR, Clerico G, Novelli E, et al. Injectable synthetic calcium hydroxylapatite ceramic microspheres (Coaptite) for passive faecal incontinence. *Tech Coloproctol.* 2008;12(2):99-102.
 320. Stephens JH, Rieger NA, Farmer KC, Bell SW, Hooper JE, Hewett PJ. Implantation of ethylene vinyl alcohol copolymer for faecal incontinence management. *ANZ J Surg.* 2010;80(5):324-30.
 321. Davis K, Kumar D, Poloniecki J. Preliminary evaluation of an injectable anal sphincter bulking agent (Durasphere) in the management of faecal incontinence. *Aliment Pharmacol Ther.* 2003;18(2):237-43.
 322. Weiss E EJ, Noguerras J, Wexner S. Submucosal injection of carbon-coated beads is a successful and safe office-based treatment of faecal incontinence [abstract]. *Dis Colon Rectum.* 2002;45:A46.
 323. Altomare DF, La Torre F, Rinaldi M, Binda GA, Pescatori M. Carbon-coated microbeads anal injection in outpatient treatment of minor faecal incontinence. *Dis Colon Rectum.* 2008;51(4):432-5.
 324. Aigner F, Conrad F, Margreiter R, Oberwalder M, Coloproctology Working G. Anal submucosal carbon bead injection for treatment of idiopathic faecal incontinence: a preliminary report. *Dis Colon Rectum.* 2009;52(2):293-8.
 325. Beggs AD, Irukulla S, Sultan AH, Ness W, Abulafi AM. A pilot study of ultra-sound guided Durasphere injection in the treatment of faecal incontinence. *Colorectal Dis.* 2010;12(9):935-40.
 326. Tjandra JJ, Chan MK, Yeh HC. Injectable silicone biomaterial (PTQ) is more effective than carbon-coated beads (Durasphere) in treating passive faecal incontinence--a randomized trial. *Colorectal Dis.* 2009;11(4):382-9.
 327. Morris OJ, Smith S, Draganic B. Comparison of bulking agents in the treatment of faecal incontinence: a prospective randomized clinical trial. *Tech Coloproctol.* 2013;17(5):517-23.
 328. Stenberg AM, Larsson G, Johnsson P. Urethral injection for stress urinary incontinence: long-term results with dex-transomer/hyaluronic acid copolymer. *Int Urogynecol J Pelvic Floor Dysfunct.* 2003;14(5):335-8; discussion 8.
 329. Dehli T, Lindsetmo RO, Mevik K, Vonon B. [Anal incontinence--assessment of a new treatment]. *Tidsskr Nor Lægeforen.* 2007;127(22):2934-6.
 330. Graf W, Mellgren A, Matzel KE, Hull T, Johansson C, Bernstein M, et al. Efficacy of dex-transomer in stabilized hyaluronic acid for treatment of faecal incontinence: a randomised, sham-controlled trial. *Lancet.* 2011;377(9770):997-1003.
 331. Schwandner O, Brunner M, Dietl O. Quality of life and functional results of submucosal injection therapy using dex-transomer hyaluronic acid for faecal incontinence. *Surg Innov.* 2011;18(2):130-5.
 332. La Torre F, de la Portilla F. Long-term efficacy of dextranomer in stabilized hyaluronic acid (NASHA/Dx) for treatment of faecal incontinence. *Colorectal Dis.* 2013;15(5):569-74.
 333. Danielson J, Karlsson U, Wester T, Graf W. Efficacy and quality of life 2 years after treatment for faecal incontinence with injectable bulking agents. *Tech Coloproctol.* 2013;17(4):389-95.
 334. Maeda Y, Laurberg S, Norton C. Perianal injectable bulking agents as treatment for faecal incontinence in adults. *Cochrane Database Syst Rev.* 2013;2:CD007959.
 335. Mellgren A, Matzel KE, Pollack J, Hull T, Bernstein M, Graf W, et al. Long-term efficacy of NASHA Dx injection therapy for treatment of faecal incontinence. *Neurogastroenterol Motil.* 2014;26(8):1087-94.
 336. Ratto C, Parello A, Donisi L, Litta F, De Simone V, Spazzafumo L, et al. Novel bulking agent for faecal incontinence. *Br J Surg.* 2011;98(11):1644-52.
 337. Rosato G, Piccinini P, Oliveira L, Habr-Gamma A, Chwat C. Initial results of a new bulking agent for faecal incontinence: a multicenter study. *Dis Colon Rectum.* 2015;58(2):241-6.
 338. Hussain ZI, Lim M, Stojkovic SG. Systematic review of perianal implants in the treatment of faecal incontinence. *Br J Surg.* 2011;98(11):1526-36.
 339. Luo C, Samaranyake CB, Plank LD, Bissett IP. Systematic review on the efficacy and safety of injectable bulking agents for passive

- faecal incontinence. *Colorectal Dis.* 2010;12(4):296-303.
340. Danielson J, Karlborn U, Soneson AC, Wester T, Graf W. Submucosal injection of stabilized nonanimal hyaluronic acid with dextranomer: a new treatment option for fecal incontinence. *Dis Colon Rectum.* 2009;52(6):1101-6.
 341. Richter HE, Matthews CA, Muir T, Takase-Sanchez MM, Hale DS, Van Drie D, et al. A vaginal bowel-control system for the treatment of fecal incontinence. *Obstet Gynecol.* 2015;125(3):540-7.
 342. Varma MG, Matthews CA, Muir T, Takase-Sanchez MM, Hale DS, Van Drie D, et al. Impact of a Novel Vaginal Bowel Control System on Bowel Function. *Dis Colon Rectum.* 2016;59(2):127-31.
 343. Takahashi T, Garcia-Osogobio S, Valdovinos MA, Mass W, Jimenez R, Jau-regui LA, et al. Radio-frequency energy delivery to the anal canal for the treatment of fecal incontinence. *Dis Colon Rectum.* 2002;45(7):915-22.
 344. Takahashi T, Garcia-Osogobio S, Valdovinos MA, Belmonte C, Barreto C, Velasco L. Extended two-year results of radio-frequency energy delivery for the treatment of fecal incontinence (the Secca procedure). *Dis Colon Rectum.* 2003;46(6):711-5.
 345. Takahashi-Monroy T, Morales M, Garcia-Osogobio S, Valdovinos MA, Belmonte C, Barreto C, et al. SECCA procedure for the treatment of fecal incontinence: results of five-year follow-up. *Dis Colon Rectum.* 2008;51(3):355-9.
 346. Efron JE, Corman ML, Fleshman J, Barnett J, Nagle D, Birnbaum E, et al. Safety and effectiveness of temperature-controlled radio-frequency energy delivery to the anal canal (Secca procedure) for the treatment of fecal incontinence. *Dis Colon Rectum.* 2003;46(12):1606-16; discussion 16-8.
 347. Felt-Bersma RJ, Szojda MM, Mulder CJ. Temperature-controlled radiofrequency energy (SECCA) to the anal canal for the treatment of faecal incontinence offers moderate improvement. *Eur J Gastroenterol Hepatol.* 2007;19(7):575-80.
 348. Lefebvre B, Tuech JJ, Bridoux V, Gallas S, Leroi AM, Denis P, et al. Temperature-controlled radio frequency energy delivery (Secca procedure) for the treatment of fecal incontinence: results of a prospective study. *Int J Colorectal Dis.* 2008;23(10):993-7.
 349. Kim DW, Yoon HM, Park JS, Kim YH, Kang SB. Radiofrequency energy delivery to the anal canal: is it a promising new approach to the treatment of fecal incontinence? *Am J Surg.* 2009;197(1):14-8.
 350. Lam TJ, Visscher AP, Meurs-Szojda MM, Felt-Bersma RJ. Clinical response and sustainability of treatment with temperature-controlled radiofrequency energy (Secca) in patients with faecal incontinence: 3 years follow-up. *Int J Colorectal Dis.* 2014;29(6):755-61.
 351. Abbas MA, Tam MS, Chun LJ. Radiofrequency treatment for fecal incontinence: is it effective long-term? *Dis Colon Rectum.* 2012;55(5):605-10.
 352. Frascio M, Mandolino F, Imperatore M, Stabellini C, Fornaro R, Gianetta E, et al. The SECCA procedure for faecal incontinence: a review. *Colorectal Dis.* 2014;16(3):167-72.
 353. Felt-Bersma RJ. Temperature-controlled radiofrequency energy in patients with anal incontinence: an interim analysis of worldwide data. *Gastroenterol Rep (Oxf).* 2014;2(2):121-5.
 354. Herman RM, Berho M, Murawski M, Nowakowski M, Rys J, Schwarz T, et al. Defining the histopathological changes induced by nonablative radiofrequency treatment of faecal incontinence--a blinded assessment in an animal model. *Colorectal Dis.* 2015;17(5):433-40.
 355. Frudinger A, Kolle D, Schwaiger W, Pfeifer J, Paede J, Halligan S. Muscle-derived cell injection to treat anal incontinence due to obstetric trauma: pilot study with 1 year follow-up. *Gut.* 2010;59(1):55-61.
 356. Frudinger A, Pfeifer J, Paede J, Kolovetsiou-Kreiner V, Marksteiner R, Halligan S. Autologous skeletal-muscle-derived cell injection for anal incontinence due to obstetric trauma: a 5-year follow-up of an initial study of 10 patients. *Colorectal Dis.* 2015;17(9):794-801.
 357. Romaniszyn M, Rozwadowska N, Malcher A, Kolanowski T, Walega P, Kurpisz M. Implantation of autologous muscle-derived stem cells in treatment of fecal incontinence: results of an experimental pilot study. *Tech Coloproctol.* 2015;19(11):685-96.
 358. Raghavan S, Gilmont RR, Miyasaka EA, Somara S, Srinivasan S, Teitelbaum DH, et al. Successful implantation of bioengineered, innervated, human internal anal sphincter. *Gastroenterology.* 2011;141(1):310-9.
 359. Raghavan S, Miyasaka EA, Gilmont RR, Somara S, Teitelbaum DH, Bitar KN. Perianal implantation of bioengineered human internal anal sphincter constructs innervated with human neural progenitor cells. *Surgery.* 2014;155(4):668-74.

360. Salcedo L, Penn M, Damaser M, Balog B, Zutshi M. Functional outcome after anal sphincter injury and treatment with mesenchymal stem cells. *Stem Cells Transl Med.* 2014;3(6):760-7.
361. Jacobs SA, Lane FL, Pham QA, Nistor G, Robles R, Chua C, et al. Safety assessment of myogenic stem cell transplantation and resulting tumor formation. *Female Pelvic Med Reconstr Surg.* 2013;19(6):362-8.
362. Branagan G, Tromans A, Finnis D. Effect of stoma formation on bowel care and quality of life in patients with spinal cord injury. *Spinal Cord.* 2003;41(12):680-3.
363. Randell N, Lynch AC, Anthony A, Dobbs BR, Roake JA, Frizelle FA. Does a colostomy alter quality of life in patients with spinal cord injury? A controlled study. *Spinal Cord.* 2001;39(5):279-82.
364. Coggrave MJ, Ingram RM, Gardner BP, Norton CS. The impact of stoma for bowel management after spinal cord injury. *Spinal Cord.* 2012;50(11):848-52.
365. Colquhoun P, Kaiser R, Jr., Efron J, Weiss EG, Nogueras JJ, Vernava AM, 3rd, et al. Is the quality of life better in patients with colostomy than patients with fecal incontinence? *World J Surg.* 2006;30(10):1925-8.
366. Norton C, Burch J, Kamm MA. Patients' views of a colostomy for fecal incontinence. *Dis Colon Rectum.* 2005;48(5):1062-9.
367. Catena F, Wilkinson K, Phillips RK. Untreatable faecal incontinence: colostomy or colostomy and proctectomy? *Colo-rectal Dis.* 2002;4(1):48-50.
368. deVries PA, Pena A. Posterior sagittal anorectoplasty. *J Pediatr Surg.* 1982;17(5):638-43.
369. Pena A, Devries PA. Posterior sagittal anorectoplasty: important technical considerations and new applications. *J Pediatr Surg.* 1982;17(6):796-811.
370. Brain AJ, Kiely EM. Posterior sagittal anorectoplasty for reoperation in children with anorectal malformations. *Br J Surg.* 1989;76(1):57-9.
371. Applebaum H, Atkinson JB. The posterior sagittal approach for reconstruction of severe rectovaginal injuries. *J Pediatr Surg.* 1991;26(7):856-7.
372. Georgeson KE, Inge TH, Al-banese CT. Laparoscopically assisted ano-rectal pull-through for high imperforate anus--a new technique. *J Pediatr Surg.* 2000;35(6):927-30; discussion 30-1.
373. Al-Hozaim O, Al-Maary J, AlQahtani A, Zamaikhshary M. Laparoscopic-assisted anorectal pull-through for anorectal malformations: a systematic review and the need for standardization of outcome reporting. *J Pediatr Surg.* 2010;45(7):1500-4.
374. Ming AX, Li L, Diao M, Wang HB, Liu Y, Ye M, et al. Long term outcomes of laparoscopic-assisted anorectoplasty: a comparison study with posterior sagittal anorectoplasty. *J Pediatr Surg.* 2014;49(4):560-3.
375. Versteegh HP, Sutcliffe JR, Sloots CE, Wijnen RM, de Blaauw I. Postoperative complications after reconstructive surgery for cloacal malformations: a systematic review. *Tech Coloproctol.* 2015;19(4):201-7.
376. Pena A. The surgical management of persistent cloaca: results in 54 patients treated with a posterior sagittal approach. *J Pediatr Surg.* 1989;24(6):590-8.
377. Pena A. Total urogenital mobilization--an easier way to repair cloacas. *J Pediatr Surg.* 1997;32(2):263-7; discussion 7-8.
378. Gupta A, Bischoff A, Pena A, Runck LA, Guasch G. The great divide: septation and malformation of the cloaca, and its implications for surgeons. *Pediatr Surg Int.* 2014;30(11):1089-95.
379. Pena A, Hong A. Advances in the management of anorectal malformations. *Am J Surg.* 2000;180(5):370-6.
380. Bischoff A, Levitt MA, Bauer C, Jackson L, Holder M, Pena A. Treatment of fecal incontinence with a comprehensive bowel management program. *J Pediatr Surg.* 2009;44(6):1278-83; discussion 83-4.
381. Rintala R, Lindahl H, Marttinen E, Sariola H. Constipation is a major functional complication after internal sphincter-saving posterior sagittal anorectoplasty for high and intermediate anorectal malformations. *J Pediatr Surg.* 1993;28(8):1054-8.
382. Malone PS, Ransley PG, Kiely EM. Preliminary report: the antegrade continence enema. *Lancet.* 1990;336(8725):1217-8.
383. Griffiths DM, Malone PS. The Malone antegrade continence enema. *J Pediatr Surg.* 1995;30(1):68-71.
384. Levitt MA, Soffer SZ, Pena A. Continent appendicostomy in the bowel management of fecally incontinent children. *J Pediatr Surg.* 1997;32(11):1630-3.
385. Herndon CD, Rink RC, Cain MP, Lerner M, Kaefer M, Yerkes E, et al. In situ Malone antegrade continence enema in 127 patients: a 6-year experience. *J Urol.* 2004;172(4 Pt 2):1689-91.

386. Koivusalo A, Pakarinen M, Rinta-la RJ. Are cecal wrap and fixation necessary for antegrade colonic enema appendicostomy? *J Pediatr Surg.* 2006;41(2):323-6.
387. Tam PK. Y-appendicoplasty: a technique to minimize stomal complications in antegrade continence enema. *J Pediatr Surg.* 1999;34(11):1733-5.
388. Rangel SJ, Lawal TA, Bischoff A, Chatoorgoon K, Loudon E, Pena A, et al. The appendix as a conduit for antegrade continence enemas in patients with anorectal malformations: lessons learned from 163 cases treated over 18 years. *J Pediatr Surg.* 2011;46(6):1236-42.
389. Squire R, Kiely EM, Carr B, Ransley PG, Duffy PG. The clinical application of the Malone antegrade colonic enema. *J Pediatr Surg.* 1993;28(8):1012-5.
390. Yerkes EB, Rink RC, Cain MP, Casale AJ. Use of a Monti channel for administration of antegrade continence enemas. *J Urol.* 2002;168(4 Pt 2):1883-5; discussion 5.
391. Lawal TA, Rangel SJ, Bischoff A, Pena A, Levitt MA. Laparoscopic-assisted Malone appendicostomy in the management of fecal incontinence in children. *J Laparo-endosc Adv Surg Tech A.* 2011;21(5):455-9.
392. Lynch AC, Beasley SW, Robertson RW, Moreau PN. Comparison of results of laparoscopic and open antegrade continence enema procedures. *Pediatr Surg Int.* 1999;15(5-6):343-6.
393. Nanigian DK, Kurzrock EA. Intermediate-term outcome of the simplified laparoscopic antegrade continence enema procedure: less is better. *J Urol.* 2008;179(1):299-303.
394. Webb HW, Barraza MA, Crump JM. Laparoscopic appendicostomy for management of fecal incontinence. *J Pediatr Surg.* 1997;32(3):457-8.
395. Curry JI, Osborne A, Malone PS. How to achieve a successful Malone antegrade continence enema. *J Pediatr Surg.* 1998;33(1):138-41.
396. Dey R, Ferguson C, Kenny SE, Shankar KR, Coldicutt P, Baillie CT, et al. After the honeymoon--medium-term outcome of antegrade continence enema procedure. *J Pediatr Surg.* 2003;38(1):65-8; discussion -8.
397. Tackett LD, Minevich E, Benedict JF, Wacksmann J, Sheldon CA. Appendiceal versus ileal segment for antegrade continence enema. *J Urol.* 2002;167(2 Pt 1):683-6.
398. Yerkes EB, Cain MP, King S, Brei T, Kaefer M, Casale AJ, et al. The Malone antegrade continence enema procedure: quality of life and family perspective. *J Urol.* 2003;169(1):320-3.
399. Wilcox DT, Kiely EM. The Malone (antegrade colonic enema) procedure: early experience. *J Pediatr Surg.* 1998;33(2):204-6.
400. Hoekstra LT, Kuijper CF, Bakx R, Heij HA, Aronson DC, Benninga MA. The Malone antegrade continence enema procedure: the Amsterdam experience. *J Pediatr Surg.* 2011;46(8):1603-8.
401. Saikaly SK, Rich MA, Swana HS. Assessment of pediatric Malone antegrade continence enema (MACE) complications: Effects of variations in technique. *J Pediatr Urol.* 2016.
402. Siddiqui AA, Fishman SJ, Bauer SB, Nurko S. Long-term follow-up of patients after antegrade continence enema procedure. *J Pediatr Gastroenterol Nutr.* 2011;52(5):574-80.
403. Driver CP, Barrow C, Fishwick J, Gough DC, Bianchi A, Dickson AP. The Malone antegrade colonic enema procedure: outcome and lessons of 6 years' experience. *Pediatr Surg Int.* 1998;13(5-6):370-2.
404. Hensle TW, Reiley EA, Chang DT. The Malone antegrade continence enema procedure in the management of patients with spina bifida. *J Am Coll Surg.* 1998;186(6):669-74.
405. Tobin GW, Brocklehurst JC. Faecal incontinence in residential homes for the elderly: prevalence, aetiology and management. *Age Ageing.* 1986;15(1):41-6.
406. Tabbers MM, Boluyt N, Berger MY, Benninga MA. Constipation in children. *BMJ Clin Evid.* 2010;2010.
407. Hawkins AT, Olariu AG, Savitt LR, Gingipally S, Wakamatsu MM, Pulliam S, et al. Impact of Rising Grades of Internal Rectal Intussusception on Fecal Continence and Symptoms of Constipation. *Dis Colon Rectum.* 2016;59(1):54-61.
408. Rao SS, Parkman HP. Advanced training in neurogastroenterology and gastrointestinal motility. *Gastroenterology.* 2015;148(5):881-5.
409. Norton C, Cody JD. Biofeedback and/or sphincter exercises for the treatment of faecal incontinence in adults. *Cochrane Database Syst Rev.* 2012;7:CD002111.
410. Sung VW, Rardin CR, Raker CA, LaSala CA, Myers DL. Changes in bowel symptoms 1 year after rectocele repair. *Am J Obstet Gynecol.* 2012;207(5):423 e1-5.
411. Consten EC, van Iersel JJ, Verheijen PM, Broeders IA, Wolthuis AM, D'Hoore A. Long-term Outcome After Laparoscopic Ventral Mesh Rectopexy: An Observational Study of 919 Consecutive Patients. *Ann Surg.* 2015;262(5):742-7; discussion 7-8.

412. Evans C, Stevenson AR, Sileri P, Mercer-Jones MA, Dixon AR, Cunningham C, et al. A Multicenter Collaboration to Assess the Safety of Laparoscopic Ventral Rectopexy. *Dis Colon Rectum*. 2015;58(8):799-807.
413. Sileri P, Franceschilli L, de Luca E, Lazzaro S, Angelucci GP, Fiaschetti V, et al. Laparoscopic ventral rectopexy for internal rectal prolapse using biological mesh: post-operative and short-term functional results. *J Gastrointest Surg*. 2012;16(3):622-8.
414. Borie F, Bigourdan JM, Pissas MH, Guillon F. Laparoscopic ventral rectopexy for the treatment of outlet obstruction associated with recto-anal intussusception and rectocele: a valid alternative to STARR procedure in patients with anal sphincter weakness. *Clin Res Hepatol Gastroenterol*. 2014;38(4):528-34.
415. Tsunoda A, Ohta T, Kiyasu Y, Kusanagi H. Laparoscopic ventral rectopexy for rectoanal intussusception: postoperative evaluation with proctography. *Dis Colon Rectum*. 2015;58(4):449-56.
416. Tsunoda A, Takahashi T, Ohta T, Kusanagi H. Quality of life after laparoscopic ventral rectopexy. *Colorectal Dis*. 2015.
417. Collinson R, Wijffels N, Cunningham C, Lindsey I. Laparoscopic ventral rectopexy for internal rectal prolapse: short-term functional results. *Colorectal Dis*. 2010;12(2):97-104.
418. Gosselink MP, Adusumilli S, Gorissen KJ, Fourie S, Tuynman JB, Jones OM, et al. Laparoscopic ventral rectopexy for fecal incontinence associated with high-grade internal rectal prolapse. *Dis Colon Rectum*. 2013;56(12):1409-14.
419. Gosselink MP, Joshi H, Adusumilli S, van Onkelen RS, Fourie S, Hompes R, et al. Laparoscopic ventral rectopexy for faecal incontinence: equivalent benefit is seen in internal and external rectal prolapse. *J Gastrointest Surg*. 2015;19(3):558-63.
420. Collinson R, Cunningham C, D'Costa H, Lindsey I. Rectal intussusception and unexplained faecal incontinence: findings of a proctographic study. *Colorectal Dis*. 2009;11(1):77-83.
421. Mishra A, Prapasrivorakul S, Gosselink MP, Gorissen KJ, Hompes R, Jones O, et al. Sacral neuromodulation for persistent faecal incontinence after laparoscopic ventral rectopexy for high-grade internal rectal prolapse. *Colorectal Dis*. 2016;18(3):273-8.
422. Jayne DG, Schwandner O, Stuto A. Stapled transanal rectal resection for obstructed defecation syndrome: one-year results of the European STARR Registry. *Dis Colon Rectum*. 2009;52(7):1205-12; discussion 12-4.
423. Kim M, Meurette G, Lehur PA. Obstructed defecation: STARR or rectopexy? *Colorectal Dis*. 2016;18(5):438-9.
424. Lee JT, Madoff RD, Rockwood TH. Quality-of-life measures in fecal incontinence: is validation valid? *Dis Colon Rectum*. 2015;58(3):352-7.
425. Hallbook O, Sjudahl R. Surgical approaches to obtaining optimal bowel function. *Semin Surg Oncol*. 2000;18(3):249-58.
426. Bakx R, Sprangers MA, Oort FJ, van Tets WF, Bemelman WA, Slors JF, et al. Development and validation of a colorectal functional outcome questionnaire. *Int J Colorectal Dis*. 2005;20(2):126-36.
427. Cotterill N, Norton C, Avery KN, Abrams P, Donovan JL. A patient-centered approach to developing a comprehensive symptom and quality of life assessment of anal incontinence. *Dis Colon Rectum*. 2008;51(1):82-7.
428. Cotterill N, Norton C, Avery KN, Abrams P, Donovan JL. Psychometric evaluation of a new patient-completed questionnaire for evaluating anal incontinence symptoms and impact on quality of life: the ICIQ-B. *Dis Colon Rectum*. 2011;54(10):1235-50.
429. Markland AD, Burgio KL, Beasley TM, David SL, Redden DT, Goode PS. Psychometric evaluation of an online and paper accidental bowel leakage questionnaire: The ICIQ-B questionnaire. *NeuroUrol Urodyn*. 2015.
430. Knowles CH, Horrocks EJ, Bremner SA, Stevens N, Norton C, O'Connell PR, et al. Percutaneous tibial nerve stimulation versus sham electrical stimulation for the treatment of faecal incontinence in adults (CONFIDeNT): a double-blind, multicentre, pragmatic, parallel-group, randomised controlled trial. *Lancet*. 2015;386(10004):1640-8.
431. Meyer I, Richter HE. Impact of fecal incontinence and its treatment on quality of life in women. *Womens Health (Lond)*. 2015;11(2):225-38.
432. Chen TY, Emmertsen KJ, Laurberg S. Bowel dysfunction after rectal cancer treatment: a study comparing the specialist's versus patient's perspective. *BMJ Open*. 2014;4(1):e003374.
433. Brandsborg S, Chen TY, Nicholls RJ, Laurberg S. Difference between patients' and clinicians' perception of pouch dysfunction and its impact

- on quality of life following restorative proctocolectomy. *Colo-rectal Dis.* 2015;17(6):O136-40.
434. Krogh K, Christensen P, Sabroe S, Laurberg S. Neurogenic bowel dysfunction score. *Spinal Cord.* 2006;44(10):625-31.
 435. Emmertsen KJ, Laurberg S. Low anterior resection syndrome score: development and validation of a symptom-based scoring system for bowel dysfunction after low anterior resection for rectal cancer. *Ann Surg.* 2012;255(5):922-8.
 436. Brandsborg S, Nicholls RJ, Mortensen LS, Laurberg S. Restorative proctocolectomy for ulcerative colitis: development and validation of a new scoring system for pouch dysfunction and quality of life. *Colorectal Dis.* 2013;15(12):e719-25.
 437. Dibley L, Norton C, Cotterill N, Bassett P. Development and initial validation of a disease-specific bowel continence questionnaire for inflammatory bowel disease patients: the ICIQ-IBD. *Eur J Gastroenterol Hepatol.* 2016;28(2):233-9.
 438. Maeda Y, Vaizey CJ, Norton C. St. Mark's incontinence score. *Dis Colon Rectum.* 2007;50(12):2252.
 439. Fitzpatrick R, Davey C, Buxton MJ, Jones DR. Evaluating patient-based outcome measures for use in clinical trials. *Health Technol Assess.* 1998;2(14):i-iv, 1-74.
 440. Chan CL, Facer P, Davis JB, Smith GD, Eger-ton J, Bountra C, et al. Sensory fibres expressing capsaicin receptor TRPV1 in patients with rectal hypersensitivity and faecal urgency. *Lancet.* 2003;361(9355):385-91.
 441. Szallasi A, Cortright DN, Blum CA, Eid SR. The vanilloid receptor TRPV1: 10 years from channel cloning to antagonist proof-of-concept. *Nat Rev Drug Discov.* 2007;6(5):357-72.
 442. Evers J, Devane L, Carrington EV, Scott SM, Knowles CH, O'Connell PR, et al. Reversal of sensory deficit through sacral neuromodulation in an animal model of fecal incontinence. *Neurogastroenterol Motil.* 2016;28(5):665-73.
 443. Andreyev HJ, Davidson SE, Gillespie C, Allum WH, Swarbrick E, British Society of G, et al. Practice guidance on the management of acute and chronic gastrointestinal problems arising as a result of treatment for cancer. *Gut.* 2012;61(2):179-92.
 444. Emmertsen KJ, Laurberg S, Rectal Cancer Function Study G. Impact of bowel dysfunction on quality of life after sphincter-preserving resection for rectal cancer. *Br J Surg.* 2013;100(10):1377-87.
 445. Hamstra DA, Conlon AS, Daignault S, Dunn RL, Sandler HM, Hembroff AL, et al. Multi-institutional prospective evaluation of bowel quality of life after prostate external beam radiation therapy identifies patient and treatment factors associated with patient-reported outcomes: the PROSTQA experience. *Int J Radiat Oncol Biol Phys.* 2013;86(3):546-53.
 446. (NICE) NIFHACE. Faecal incontinence in adults: management. 27 June 2007 ed: NICE; 2007.

Committee 18

FISTULA

Chair

Dirk De Ridder (Belgium)

Members

Andrew Browning (Tanzania)

Sherif Mourad (Egypt)

Edward Stanford (USA)

Matthieu Lopooso (Congo)

Mulu Muleta (Ethiopia)

Gopal Badlani (USA)

Consultants

Eric Rovner (USA)

CONTENTS

ABBREVIATIONS	2145	3. Interposition Grafts	2172
I. GENERAL INTRODUCTION	2145	4. Other Management Approaches.....	2173
II. EPIDEMIOLOGY	2146	5. Recommendations	2173
1. Obstetric Fistulae.....	2146	VII. MANAGEMENT OF GI FISTULA	2174
2. Iatrogenic Fistulae	2146	1. Literature Review.....	2174
3. Uterovesical Fistulae	2151	2. Non-surgical Management.....	2174
4. Ureteric Fistulae	2152	3. Surgical Management.....	2174
5. Fistula Involving the GI Tract	2152	4. Recommendations	2175
III. CLASSIFICATION OF VVF	2153	VIII. MANAGEMENT OF URETERIC FISTULA	2175
IV. DIAGNOSIS OF FISTULAE	2156	IX. MANAGEMENT OF URETHRO-VAGINAL FISTULA	2181
1. Clinical Diagnosis	2156	1. Introduction.....	2181
2. Imaging	2157	2. Aetiology	2181
3. Diagnosis of GI Fistulae	2158	3. Diagnosis	2181
V. MANAGEMENT OF VESICOVAGINAL FISTULAE	2158	4. Surgical Repair	2182
1. Conservative Management.....	2158	5. Posterior Approach	2183
2. Surgical Management	2161	6. Abdominal Approach	2183
3. Post-operative Management	2166	7. Complications.....	2183
4. Management of the Complications of VVF.....	2170	8. Follow up.....	2183
VI. MANAGEMENT OF RADIATION FISTULA	2171	9. Recommendations	2184
1. Diversion Procedures	2171	X. GENERAL CONCLUSION	2184
2. Repair Techniques	2172	REFERENCES	2185

FISTULA

DIRK DE RIDDER (BELGIUM)

ANDREW BROWNING (TANZANIA) SHERIF MOURAD (EGYPT) EDWARD STANFORD (USA) MATTHIEU LOPOSSO (CONGO) MULU MULETA (ETHIOPIA) GOPAL BADLANI (USA) ERIC ROVNER (USA)

ABBREVIATIONS

CIC	Clean Intermittent Catheterisation
HRT	hysterectomy
LAVH	Laparoscopically – assisted Vaginal Hysterectomy
LSH	Laparoscopic Subtotal Hysterectomy
OF	Obstetric Fistula
SB	Still Birth
SCH	Supracervical Hysterectomy
STD	Sexually Transmitted Diseases
TAH	Total Abdominal Hysterectomy
TLH	Total Laparoscopic Hysterectomy
TVH	Total Vaginal Hysterectomy
VVF	Vesicovaginal Fistula

I. GENERAL INTRODUCTION

In the developing world fistulae are often a consequence of poor peri-natal care. The epidemiology, aetiology, diagnosis, treatment and prevention have been described in detail in the past three International Consultations on Incontinence.(1-3) A specific International Consultation report on obstetric fistula in the developing world has been published in 2012.(4) This chapter updates the literature and evidence on fistula till June 2016.

The published obstetrical series show impressive numbers and demonstrate the level of skill that many of the fistula surgeons have obtained while working in difficult and isolated situations.

In contrast to the field of obstetrical fistula where the numbers of patients are high, the prevalence of non-obstetrical fistula is much lower. The published series deal with small numbers, are usually retrospective and have a low level of evidence.

Iatrogenic urogenital fistulae are known complications of pelvic surgery and oncological treatments

such as radiotherapy. For example a high quality population-based case-control study from Sweden found that the risk of urogenital fistula was 25 times higher amongst women undergoing hysterectomy (n=180,000) compared to an age matched control population (n=525,826) without hysterectomy. The risk appeared to be highest for laparoscopic hysterectomy and lowest for sub-total hysterectomy but absolute numbers were small with a number needed to harm of 5,700.(5)

This section is based on electronic searches of Medline, EMBASE (from 2012 to June 2016), the Cochrane Database of Systematic Reviews, Central Register of Controlled Trials (CENTRAL), Database of Abstracts of Reviews of Effects (DARE), Database of Health Technology Assessments, and Database of NHS Economic Evaluations, and the NICE website (all accessed June 2016); references included in identified systematic and non-systematic reviews were evaluated separately. Hand searching of recent (Jan-June 2016) issues of major American, European and British journals in urology, gynaecology and urogy-naecology was undertaken, to capture recent publications not yet included in the online databases. Papers offering any relevant data were considered. This included systematic reviews, randomised and quasi-randomised trials, non-randomised cohort studies, case controlled studies, longitudinal studies and case series or reports. Those papers considered for inclusion were assessed for quality where relevant, in terms of sequence generation, allocation concealment, blinding, and handling of incomplete data, selective reporting and freedom from other biases. An evidence level was then assigned to all included studies according to the ICUD modified version of the Oxford Centre for Evidence-based Medicine system.(6) Where quality was considered to be poor – as in most of the studies included in these sections – the evidence level was reduced accordingly. Recommendations (graded A-D) were made on the basis of consistent or 'majority evidence' identified.(6)

II. EPIDEMIOLOGY

1. OBSTETRIC FISTULAE

Epidemiological studies on obstetric fistula (OF) are inadequate. Many of them are based on retrospective case series from a single fistula centre (hospital-based) or use questionnaire based approaches (community-based). A recent systematic review by Adler et al. found 19 studies that could be evaluated.(7) The studies included data from West Africa, Bangladesh, Turkey, Jordan, Ethiopia, Egypt and India. The number of new fistulae ranged from 0.09 per 1000 recently pregnant women in community-based studies to 0.66 per 1000 pregnancies in hospital-based studies. The WHO has suggested that over two million women, mostly from sub-Saharan African and Asian countries, have fistulae. Given an estimated population of 645 million women of reproductive age in sub-Saharan Africa and South Asia in 2010 (<http://esa.un.org/wpp/unpp/p2k0data.asp>), this would suggest that 3 per 1000 women of reproductive age have a fistula, which is considerably higher than other estimates. They estimated the pooled prevalence from population studies at 0.29/1000 pregnancies. For Sub-Saharan Africa this number rises to 1.6/1000 and for South Asia to 1.2/1000. The incidence was estimated at 0.009/1000 recent pregnancies. Rural areas probably under report the real prevalence. (8). Cowgill et al. performed another systematic review, also looking at the association of stillbirth and fistula.(9) They included 62 studies. Incidence estimates ranged from 0 to 4.09 OF cases per 1000 deliveries, while prevalence estimates were judged more prone to bias and ranged from 0 to 81.0 OF cases per 1000 women. Reported frequency of still birth (SB) associated with OF ranged from 32.3 % to 100 %, with estimates from the largest studies around 92 %. The major risk factors appear to be age at first marriage, short stature, pregnancy with a male child rather than a female child, failure to attend ante-natal care, low socio-economic status, low social class, lack of employment and illiteracy. Misconceptions on the cause of OF persist, mostly in rural areas and most in men. Misuse of family planning, intercourse during the menstruation, curses by relatives, sexually transmitted diseases (STD) and rape or gender-based violence are still seen as potential causes.(10) Education programs should be directed against these misconceptions. Health system causes such as poor quality obstetrical care, staff unaccountability, late referral, poor nursing standards are very prevalent in sub-Saharan Africa and rural areas of Pakistan and other parts of Asia. (11-13)

The consequences of OF include divorce (16-92%), social isolation, worsening poverty, malnutrition, sexual dysfunction and mental illness (including anxiety/depression), insomnia, general ill health and thoughts of worthlessness and suicide. (14, 15)

There are few detailed reports documenting these women's obstructed labours. The time of onset of labour is rarely recorded and reports from delivery locations may disregard the fact that the woman has laboured at home for days prior to attending the delivery location. The reason for the woman not receiving help rarely differentiates between the absence of health-seeking behaviour and the lack of services. A recent study looked at the pathway these patients followed. The mean duration of the fistula was 4 years and the entire care process took up to 2.7 years, of which 7 months were spent at the repair centre.(16, 17)

1.1. Recommendations

Community-based epidemiological studies using standardised and validated collection tools with acceptable sensitivity and specificity are highly recommended.

Observational and longitudinal studies are needed, utilising advanced epidemiological analyses for risk factors (multivariate analysis controlling potential biases), the impacts and consequences of vesicovaginal fistula (VVF) and for factors determining health-seeking behaviour.

2. IATROGENIC FISTULAE

While in the developing world poor obstetric care is usually at the origin of the VVF, gynaecological or pelvic surgery are the main causes of VVF in the industrialised world. In some developing countries, as gynaecological procedures to treat benign and malignant conditions of the female reproductive tract are more commonly performed, the rate of iatrogenic fistulae is increasing (e.g. Pakistan). (18)

2.1. Post-gynaecological Surgery

The types of fistulae associated with gynaecological procedures may include communication between any reproductive organ (uterus, cervix, Fallopian tube, vagina), intestinal tract (colon, rectum), genitourinary organ (bladder, ureter, urethra), and cutaneous system (abdominal wall, perineum). In general, VVF are the most common type. The most common causes of VVF as a consequence of surgery, in developed countries is an injury to the urinary tract during hysterectomy for benign conditions (60-75%), followed by hysterectomy for malignant conditions (30%), caesarean section (6%), and obstetric injuries (1%). (19) (20) Overall, the risk of pelvic organ fistula following hysterectomy has been reported to be between 0.1 and 4%. (21). It is important to recognise that most urinary tract injuries do not result in a fistula.

The prevalence of genitourinary injury and fistulae vary slightly from centre to centre. In one US retrospective study from the Mayo clinic, gynaecological surgery was responsible for 82% of the fistulae, obstetric procedures for 8%, and various forms of irradiation for 6%, and trauma or fulguration for 4%. The

majority of fistulae followed treatment for benign conditions. (22) The relative proportions of the types of urinary fistula have changed with urethral fistulae having increased from 6 to 13%, while ureteral, bladder and/ or urethral fistulae having dropped from 20 to 16 and 11 to 7%. (2)

Given the various indications for, and types of hysterectomies, it is important to have an understanding of the type of hysterectomy since genitourinary or colonic fistula is reported with all of these procedures. The overall incidence of hysterectomy complications is estimated to be <2%, with bladder injury (1.3%) and ureteric injury (<1%) being most commonly reported. (23) Traditionally, the most common route used to remove the uterus for benign and malignant gynaecological conditions is abdominal (open incision, laparotomy); referred to commonly as total abdominal hysterectomy (TAH). The types of hysterectomies also include total vaginal (TVH), laparoscopically-assisted vaginal (LAVH), total laparoscopic (TLH), and subtotal or supracervical abdominal (SCH) or laparoscopic (LSH). Laparoscopic procedures may be done using traditional laparoscopic techniques, robotic assistance, and more recently, the single-site umbilical technique.

Benign and malignant conditions confined to the uterus are usually treated with a simple hysterectomy using any of the methods mentioned above. More advanced malignant conditions are usually treated with a radical hysterectomy in which parametrial and/or vaginal dissection and removal may be involved. In rarer cases, exenterative procedures to remove the bladder or colon may be required if malignant extension to these organs is found. In some centres, robotic radical hysterectomies have been more commonly employed to treat gynaecological malignancies. The rate of urogenital fistula associated with simple abdominal hysterectomy for benign disease is often reported as being of the order of 1 in 1000. In a national study from Sweden the rate of women undergoing any fistula surgery was reported as 0.26% in women having had a hysterectomy compared to 0.0007% in those not exposed to hysterectomy, with the 'number needed to harm' being estimated at 5700.(24) From Finland the rate of VVF was reported to be 1 in 1250 after all hysterectomies, 1 in 455 after laparoscopic, 1 in 1000 after total abdominal, and 1 in 5000 after vaginal hysterectomy.(25) The publicly available tables from the national hospital database in England give similar figures of 1 in 600 after total abdominal hysterectomy, and 1 in 5000 after vaginal hysterectomy.(26, 27) More detailed longitudinal analysis of patient-level information from the same dataset suggests a rate of 1 in 788 for all types of hysterectomy, 1 in 540 for abdominal hysterectomy for benign disease, 1 in 896 following vaginal hysterectomy for benign disease (excluding prolapse), and 1 in 3861 following vaginal hysterectomy for prolapse.(28)

Naturally, caesarean hysterectomy is a recognised cause of fistula, (29) and, with the increase in the

number of caesarean deliveries there have been more fistulae related to obstetric surgical trauma. (2)

The degree of bladder injury appears to be a major factor in iatrogenic fistula formation. In one study, 1,317 benign hysterectomies were reviewed (46% abdominal, 48% vaginal, and 6% laparoscopically assisted vaginal) with reference to risk factors for VVF following intraoperative injury to the urinary tract. In all, 34 cystotomies occurred with 4 (11.7%) developing a VVF. Patients who developed a VVF were more likely to have a large cystotomy and these individuals trended toward greater tobacco use, larger uterine size, and more operative blood loss. (30) Another study involving 3,076 vaginal hysterectomies with or without additional gynaecological procedures, one ureteric injury and 54 bladder lacerations were noted yielding a total of 4 VVF. The bladder lacerations occurred during the hysterectomy portion of the surgery in 61% of cases and during the additional procedures in 39%. (31) Also in developing countries iatrogenic fistulae occur. Raassen et al. found 805 iatrogenic fistulae in a series of 5959 (13.5%) patients in 11 countries. Most fistulae occurred as a consequence of caesarean section, intervention or hysterectomy for ruptured uterus.(32)

VVFs associated with hysterectomy may require ureteric reimplantation in as many as one-third of the cases. (33) Ureteric trauma should be considered in any hysterectomy or operative obstetric procedure regardless of the difficulty but certainly in more difficult cases.(34) Iatrogenic ureteric injury may occur after less common procedures such as ureteroscopy, lumbar sympathectomy, abdominal trauma, and iliac vessel ligation. (35)

2.2. Oncological Fistula

The literature relating to fistula of oncological aetiology is limited both in quantity and quality. Seventy-six papers of possible relevance were identified, of which only 52 contained any relevant material. Only one randomised trial was directly identified from the literature searches,(36) although one non-systematic review of relevance,(37) and two systematic reviews were found;(38, 39) each of the latter contained only one further randomised trial. One national cohort study, and one non-randomised cohort study, are included,(28, 40) but all other identified material comprised case series or case reports, and represent level 3 or lower evidence. Two cases of duplicate publication (*i.e.* the same paper in two journals) were found.

In the oncological context, fistulae may occur as a result of primary or recurrent malignancy, or as a consequence of cancer treatment by surgery, radiotherapy, chemotherapy, or a combination of therapies.

In one study, 536 women underwent a radical hysterectomy for invasive cervical cancer. More advanced stage of disease, obesity, diabetes, and postoperative surgical infection were predisposing factors to urinary tract complications. In this study, ureteric injury

occurred in 1.32%, bladder injury in 1.49% with VVF forming in 2.61% and ureterovaginal fistula in 2.43% of cases, respectively. (41) In a similar report, 1,092 women with cervical cancer underwent a radical hysterectomy with obligatory pelvic lymphadenectomy. A VVF occurred in 0.3% and a ureterovaginal fistula occurred in 1.4%. (42) The rate of GU injury likely varies between centres. For example, in one report of 479 women undergoing different methods of radical hysterectomy for cervical cancer over a 15 year period, 52 (10.8 per cent) had urological complications (17 bladder and ureter injuries, 35 fistulae and strictures). (43) In contrast, one institution reported that, with modifications and careful dissection, ureteric and bladder injury have almost been eliminated. (44)

In two recently published case series, one of fistulae specifically associated with gynaecological cancers, (37) and one of urogenital fistula from all causes, (27) those relating directly to primary cancer were uncommon, (2/20=10%) (37) and (2/348=0.6% - 2/66=3% of the oncological cases in this series), (27) respectively. Fistulae associated with cancer surgery (3/20=15% and 30/348=8.6% - 30/66=45% of the *oncological cases in this series*) or radiotherapy (15/20=75% and 34/348=9.8% - 34/66=52% of the *oncological cases in this series*) made up a much larger proportion of both series.

Immune-deficiency may be a further contributory factor, and enterovesical fistula has previously been reported in association with non-Hodgkin's lymphoma in HIV-AIDS, (45) and VVF has been seen in association with classical Hodgkin's affecting the vagina in a long-term pessary user. (46)

2.3. Cancer Surgery

It is likely that all operations carried out in the pelvis can be complicated by genital tract fistula in some circumstances. (27) Operations carried out with the intention of curing malignant disease will inevitably carry a higher risk of subsequent fistula formation, as compared to those undertaken with less radical intent.

Following radical hysterectomy for cervical cancer (Wertheim-Meigs procedure) the rate of fistula formation reported from case series is between 0.6% and 4.4%. (41, 47-52) It should be noted that these data are very heterogeneous, some reporting all types of fistula together. Where they are reported separately, the rates of vesicovaginal and ureterovaginal fistula appear to be of the same magnitude with both being reported in between 0.9% and 2.5%. of cases (41, 53, 54) The data from UK cited above suggest a urogenital fistula rate of 1 in 95 following radical abdominal hysterectomy in women with malignant disease as compared to 1 in 540 for TAH for benign disease, and one in 2041 for TVH for all benign disease (including prolapse). (28) Overall, the rate of urogenital fistula appears to be approximately 9 times higher following radical hysterectomy in women with malignant disease as compared to that

following simple hysterectomy (abdominal or vaginal) in women with benign conditions. (28)

The risk of visceral injury or subsequent fistula formation following radical hysterectomy undertaken in pregnancy, or immediately following Caesarean section is not obviously increased over those carried out electively in non-pregnant individuals; Monk & Montz described inadvertent cystotomy followed by vesicovaginal fistula in one of 21 women operated on during or immediately after pregnancy. (55)

Several modifications to the conventional Wertheim-Meig's procedure of radical hysterectomy have been described in an effort to reduce the associated morbidity. None of them seems to offer a benefit regarding fistula formation. (43, 47, 56)

Given the increased risk associated with radical surgery for malignancy, it is intuitive that the risks would increase with the stage of disease and with the extent of the surgery undertaken. There are few published reports of fistula following exenterative surgery. One study noted a 16% VVF rate in 19 women following exenteration for vulvar carcinoma; (57) while another describes a 15% bowel fistula rate and an 8% urinary fistula rate from a series of 75 exenterations for recurrent cervical cancer. (58) In contrast, Ungar et al. describe only one ureterovaginal fistula and one pouch-vaginal fistula in 212 women undergoing exenteration out of a total of 2540 women treated for cervix cancer in one centre over a 13 year period (0.9%). (59)

Bladder sparing techniques during pelvic exenteration can carry a risk for fistula formation. (60) Also when the bladder has been removed and a neo-bladder has been constructed, fistulae between the neo-bladder and the vagina may occur. (61, 62)

The introduction of laparoscopic surgery within oncology is seen to have considerable advantages in terms of patient recovery; the risk of operative injury to bowel and the urinary tract, and subsequent fistula formation may however remain a concern in such cases. Although some studies, both case series and non-randomised cohorts, describe similar rates of injury to those described following open radical surgery, (40, 53, 54, 63, 64) others have reported injury or fistula rates several times higher following laparoscopic radical hysterectomy. (48, 65)

The risk of urinary tract injury from minor surgical interventions is in general low, although the use of repeat procedures may confer a significant increase in risk. VVF has been reported following repeated use of CO₂ laser for vaporisation of vaginal condylomata, (66) and following cone biopsy of the cervix. (67) In one personal series of 370 urogenital fistulae, 4 were associated with large loop excision of the transformation zone (LLETZ) of cervix, 3 of which followed a second LLETZ procedure (*Hilton, personal communication*).

Rarely, localised malignancies have been associated with VVF. One example is a primary mixed müllerian vaginal tumour reported in a 48-year female. (68)

The mechanism for fistula formation is likely to be direct invasion into the bladder.

Genitourinary injuries during colorectal surgery are rare. Eswara et al. described 75 GU injuries in 42570 colorectal surgeries: cystotomy (35%), incomplete ureteral transection (29%), ureteral injuries (15%). Pre-operative external beam radiotherapy or chemotherapy and delayed repair were associated with worse outcome.(69)

2.4. Radiation Fistulae

Pelvic irradiation can be delivered by external beam as well as locally (intracavitary/brachytherapy). Fistula formation appears to be slightly higher for post-operative external radiation (1.9%) compared to intravaginal brachytherapy (0.8%). (70) It does not appear that pre-treatment factors accurately predict those who will develop fistula related to radiotherapy. (71)

The literature in this area is particularly heterogeneous in nature, with wide variation in (and some lack of

clarity over) the tumour type and stage being treated, the form of radiation and the site and dose delivered. In a series of urogenital fistulae from the UK, 34/348 or 9.8% were associated with previous radiotherapy; of those related to gynaecological cancer, 34/66 or 52% had undergone radiotherapy.(27) In a further series of cases specifically related to gynaecological malignancy, 15/20 or 75% had undergone previous radiotherapy.(37) In both series most cases followed radiation used for the treatment of cervical cancer, although, 5/34 or 15% followed treatment of endometrial cancer, and 1/34 or 3% followed treatment of a multifocal gynaecological cancer in one series.(27) Amongst a series of 216 radiation-induced fistulae, the time to diagnosis of the fistula was made between 3 months and 10 years (mean 21 months) following radiation.(72) In other series fistulae have been reported to develop or present up to 30 years after the 'causative' influence.(27, 73) (Figure 1a and 1b)

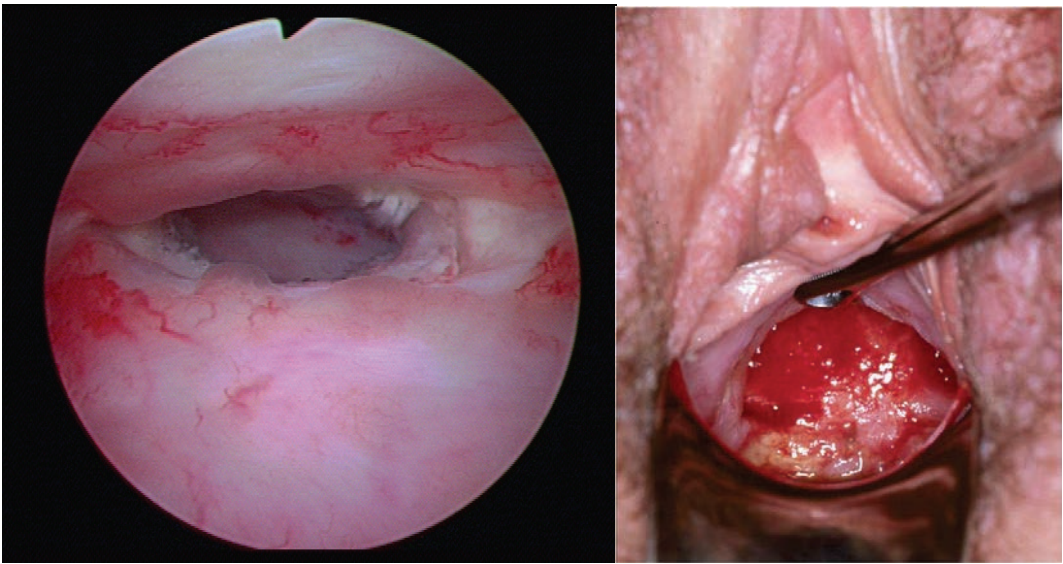

Figure 1a. Left: Acute radiation fistula; Right: fistula 20 years after radiotherapy, both for cervixcarcinoma

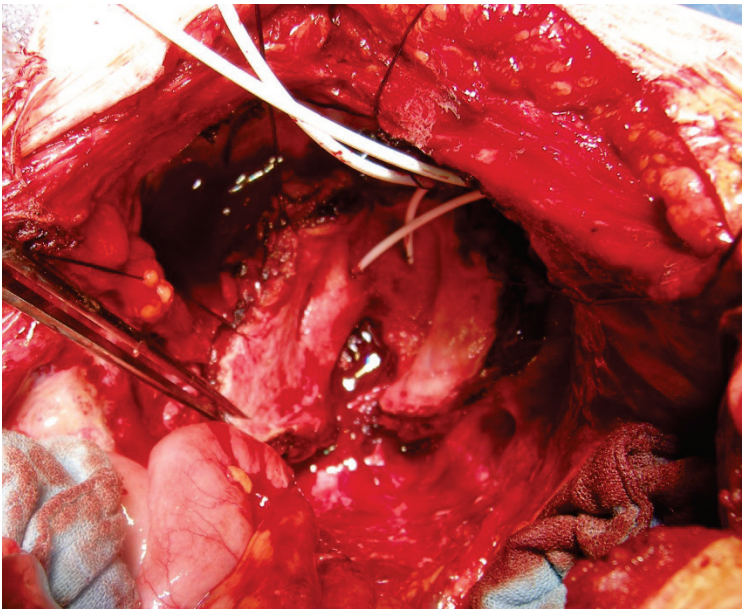

Fig 1b. Supratrigonal vesico-perineal radiation fistula in a small contracted bladder that occurred 22 years after cobalt irradiation for a gynaecological tumour.

The incidence of any deleterious clinical impact on the gastrointestinal and urinary tracts following radiation varies in the literature between 1% and 12%.(39, 74-80) with fistula rates of 1% to 5%.(37, 81). In a retrospective review of 2096 patients treated for cervical cancer over a 10-year period using unspecified regimen/s of radiotherapy, 38 patients (1.8%) were found to have developed fistulae, all of whom had stage IIIa/b or IV disease at presentation.(77) Of these cases, approximately 3/4 involved the rectum,

with 1/3 being combined rectovaginal and VVF; 1/4 were vesicovaginal only.(77)

Following a clearly defined regimen of external beam radiation plus brachytherapy for the treatment of primary squamous cell carcinoma of vagina in 91 women, de Crevoisier et al. reported 10.0% grade 2-3 urinary tract toxicity (using the Franco-Italian glossary)(82) and 12.1% grade 2-3 gastrointestinal toxicity.(75) Unsurprisingly, they found anterior tumour

location to be correlated with increased risk of bladder toxicity and decreased rectal toxicity. Two women in this series developed rectovaginal fistulae (2%), and one ureterovaginal fistula (1%).(75)

In a series of 10,709 women treated by telebrachytherapy (67.5 Gy) for a range of gynaecological cancers in one centre over a 22 year period, 133 (1.2%) developed urological complications of which 35 (0.3%) developed fistulae.(79)

In a series of 28 women treated by brachytherapy for recurrent corpus or cervix cancer, four patients developed chronic morbidities related to treatment. Three fistulae were reported in two patients (7.1%): one combined rectovaginal and VVF and one uretero-intestinal fistula; a further patient developed a ureteric stricture and small bowel obstruction requiring resection.(80)

These data tend to suggest a higher rate of fistula formation following the application of radiotherapy in locally recurrent disease than in primary disease. From a small series of urological complications following radiotherapy for gynaecological cancers, 14 had developed vesicovaginal fistula; of these 4 (29%) had evidence of tumour recurrence.(78) In the series reported by Jones et al. 326/1161 (28%) developed urological complications over a 20 year period; 46 developed fistulae (4%), of whom 33 (72%) had evidence of active malignant disease.(50)

In prostate cancer patients, recto-urethral fistula are described after cryotherapy (0.1-4%)(83), HIFU (0.7%)(84), brachytherapy (2%)(85).

When a fistula occurs after radiotherapy, it is considered good clinical practice to exclude tumour recurrence before attempting a fistula closure. Feddock et al. found 27 fistula in 325 patients after post-radiation biopsies for cervical cancer.(86) The fistula were toxicity related in 51.9%, a consequence of primary disease in 22.2% and of recurrent disease in 25.9%. The residual or recurrent cancer found in the biopsies was only 31.5%. Elevated radiotherapy doses to the rectum, advanced tumour stage and post-radiotherapy biopsy were considered risk factors for fistula formation.

2.5. Chemotherapy

There are few reports of fistula formation in association with the use of chemotherapy. One case report described a patient who developed a VVF having undergone TAH for atypical endometrial hyperplasia whilst taking *tamoxifen* following a previous modified radical mastectomy. Surgical repair of the fistula was initially unsuccessful, although after discontinuing the *tamoxifen* and continued bladder drainage, healing occurred.(87) It was hypothesised that the impaired healing was a result of the administration of the hormone therapy.

2.6. Combination Therapies

Adjuvant or neoadjuvant therapies are used to increase the efficacy of the primary treatment, compared to its use in isolation. It might be anticipated that this would also increase the range and magnitude of adverse effects.

In a case control study examining the urinary tract complications of radical hysterectomy only a single VVF was seen in 50 patients (2%) – in a patient receiving preoperative irradiation (45-50 Gy).(88) A small case series found 2/20 or a 20% rate of urinary fistulae following preoperative irradiation and radical hysterectomy in a heterogeneous group of 'high risk' cervix cancers.(89) A further case series described the impact of combined external whole pelvic irradiation (50 Gy) and intravaginal cone boost (20-26 Gy) following radical hysterectomy in 108 women. The overall rate of fistula formation was 3.7%, 2.2% following 'prophylactic' radiation, and 10.5% in 'salvage' cases where recurrent disease was present.(90)

Modarress et al. reported a randomised comparison of preoperative combined chemoradiation (cisplatin plus external beam therapy) and neoadjuvant chemotherapy (cisplatin plus vincristine) followed by radical hysterectomy in stage IB-IIB bulky cervical cancer.(36) Four patients developed hydronephrosis (3 in the chemoradiation group – 13.3% and two vesicovaginal fistula (both in the chemoradiation group – 6.7%).(36) Two further case series reported 2/36 or a 5.6% rate of fistulae following preoperative chemoradiation (cisplatin plus brachytherapy) followed by radical hysterectomy,(91) and 4/46 or 8.7% rate of fistulae following the use of neoadjuvant and postoperative chemotherapy using irinotecan, cisplatin and nedaplatin.(92)

2.7. Rare Causes of VVF

Foreign bodies such as pessaries, sex toys, herbs, cups etc... can be a cause of VVF. (93-96) Often the presentation is often delayed (up to 15 months). Also ketamine abuse can not only lead to severe changes in the bladder wall structure, but also to fistula formation, as was shown in 14.8% of 27 patients undergoing a CT-urography. (97)

3. UTEROVESICAL FISTULAE

Uterovesical fistulae are usually a consequence of caesarean sections. An increased number of caesarean sections leads to an increase in abnormally invasive placentae. Placenta praevia and percreta can lead to dramatic obstetric situations, necessitating an emergency caesarean section. The uterovesical fistulae can form afterwards when the bladder and the uterus and the bladder are not well separated or sutured. (98)

This clinical entity was first described in the literature by Burkland in 1949 and by Nourse in 1953 but is referred to as Youssef's syndrome since his publication

in 1957(99-101). Menouria and amenorrhea are the most common symptoms. In a study by Rao on 14 patient's, an emergency caesarean section was at the origin of the fistula and in 58% the fistula was formed after the second caesarean section.(102) The mean duration between the caesarean and the diagnosis of the uterovesical fistula was 7 months. These findings have also been confirmed by Washington et al. looking at 34 patient's with cervicovesical or uterovesical fistulae of whom 29% had caesarean section compared to 9% who delivered vaginally.(103)

Congenital forms of uterovesical fistulae have been described as well, but are very rare.(104)

The diagnosis can be made clinically or by performing cystoscopy during the episodes of menouria. Hystero-graphy, ultrasound, CT scan and MRI scan can be helpful in establishing the location and the size of the fistula.

The treatment is surgical, although there is one case report of a successful conservative treatment as well.(105) Classically a trans-peritoneum approach will be used, where the plane between bladder and uterus will be developed, the fistula closed and eventually interposition material will be used. The outcome of the surgery is very good. A multidisciplinary approach is advocated to prevent infertility.(106)

4. URETERIC FISTULAE

A large prospective case series from Finland found an incidence of ureteric injury associated with hysterectomy for benign pathology of 0.2% (10/5279) with the lowest rate associated with vaginal hysterectomy previously abbreviated and no difference between open and TLH.(107) The incidence of immediate and delayed ureteric injury during radical hysterectomy was found to be 1.3% (7/536) and 2.4% (13/536) respectively in a series from Serbia; injuries appeared more common after prolonged surgery and in patients with diabetes, obesity or wound infection.(108) A registry study from the United States found an overall incidence of ureteric injury during radical hysterectomy of 0.8%.(109) Case series from referral centres in India, Pakistan, and Egypt showed that the proportion of urinary tract injuries resulting from obstetric or gynaecological surgical trauma that primarily affected the ureter varied from 1% to 23%.(110-113)

Ureteric fistulae can occur as a consequence of open and laparoscopic colorectal surgery.(114)

Uretero-arterial fistula are uncommon, but can be life threatening due to massive bleeding in the ureter. They have a high mortality rate. (115) Predisposing factors are radiation therapy, vascular pathology, ureteral stenting. Das et al. reviewed the literature and found 61 cases. In terms of treatment, endovascular stenting has emerged as an appealing initial modality and should be considered in stable patients in whom

open surgical intervention is less suitable to pre-existing comorbidities.(116)

5. FISTULA INVOLVING THE GI TRACT

The literature relating to non-obstetric fistula involving the gastro-intestinal tract is sparse and of poor quality. Although literature searching identified 78 papers of possible relevance, less than half of these contained any useful material; no randomised trials or truly systematic reviews were identified. One case controlled study is included, but all other identified material comprised case series or single case reports, and is considered to represent level 3 evidence.

It should be recognised that, whilst in most papers the term 'enterovesical' is used to describe fistulae between small bowel and bladder, and 'colo/recto-vesical/vaginal' to describe those between large bowel and bladder/vagina, in some reports 'enterovesical' appears to be employed generically to include all fistulae involving the gastrointestinal tract. In this chapter, the term 'intestino-vesical' will be used in circumstances where the generic term is clearly more appropriate.

Whilst occasionally reported congenitally,(117) the most common non-obstetric causes of fistula involving the gastro-intestinal tract are diverticular disease, Crohn's disease, and malignant disease or its treatment. There are few data on the incidence of fistula formation in these conditions, although published estimates are in the range 2-6% in Crohn's disease,(118-120) and 20% in diverticular disease.(121)

Intestinal fistulae in Crohn's disease most typically involve the small bowel, although communication with urinary tract and large bowel are also found; involvement of the bladder was reported in 27% and of the colon in 14% in one series.(122) Two large series examining the urological complications in association with Crohn's disease reported that whilst a majority of patients were female, the most serious complications were seen in males; most significantly, 13/14 or 93% of the ileo-vesical fistulae described in these series were in men.(118, 123)

Whilst clearly diverticular disease involves the large bowel primarily in all cases, diverticular fistulae have been reported to communicate with the bladder in 65% of cases, the vagina or uterus in 28% and small bowel in 7%.(121) Diverticular disease is the most common cause of colovesical fistula in most reports, accounting for up to 75% of cases,(124-131) with colon cancer, bladder cancer, radiotherapy and Crohn's disease accounting for the remainder.

Although there are no direct comparisons between racial groups, the distribution of these causes may vary between populations. Malignancy and/or previous radiotherapy account for 53-93% of cases of

colovesical fistula reported from China,(132, 133) presumably reflecting the previously low prevalence of inflammatory bowel disease.(134)

Previous hysterectomy appears to be a significant factor in the incidence of fistula associated with diverticular disease.(135) In a national case controlled study from Sweden, involving a total of 783,245 women over a 30 year period, the risk of undergoing fistula surgery increased four-fold in hysterectomised

women without diverticulitis (hazard ratio (HR) 4.0 (95% confidence interval (CI) 3.5 to 4.7)), seven-fold in women with diverticulitis without hysterectomy (HR 7.6 (95% CI 4.8 to 12.1)) and 25-fold in hysterectomised women with diverticulitis (HR 25.2 (95% CI 15.5 to 41.2)).(136) Another study described previous hysterectomy in 50% of colovesical and 83% of colovaginal fistulae associated with diverticular disease.(121)

5.1. Evidence Statements

The risk of injury to the bowel or urinary tract and of subsequent fistula formation is higher in women with malignant disease undergoing radical surgery than in women with benign disease undergoing simple surgical procedures	2
Several modifications to conventional radical hysterectomy have been described, although they have not consistently been shown to mitigate the risk of urinary fistula postoperatively.	3
Data on exenterative surgery are inconsistent, although the risk of fistula formation may be higher following exenteration for recurrent disease as compared to that following radical hysterectomy for the primary treatment of malignancy	3
The rate of visceral injury and fistula formation is inconsistently reported following laparoscopically assisted radical hysterectomy, but may be somewhat higher than following open surgery	3
Local ablative treatments applied in gynaecological oncology, whilst apparently relatively low risk as single treatments, may carry considerable risk for fistula formation when repeated.	3
The rate of fistula formation following radiotherapy for gynaecological cancer appears to be of the same order as that following surgical treatment	4
The risk of fistula formation following radiotherapy for locally recurrent malignancy is higher than following its use in primary disease	2
The use of neoadjuvant or adjuvant therapies is likely to be associated with a greater risk of fistula development than the primary treatment alone	2
The most common non-obstetric causes of fistula involving the gastro-intestinal tract are diverticular disease, Crohn's disease, malignancy and radiotherapy.	2
The causative factors may vary in different populations, with malignancy being more commonly reported in association with enterovesical fistula in China than in other countries	3

5.2. Recommendations

The development of fistula following radiotherapy for primary treatment should trigger a search for evidence of tumour recurrence	D
---	---

III. CLASSIFICATION OF VVF

The Consultation believes that fistula audit research is considerably hampered by the plethora of VVF classification systems, of which we believe there are 32. The Consultation feels that the fistula system that is able to relate its classification to outcome is the classification that should be used in the next few years. The Waaldijk and Goh classifications are the only ones that have been used to document sufficient numbers of patients from diagnosis to follow-up (Fig 2).

Figure 2 shows the Waaldijk Classification assessing mainly the extent of the urethral involvement and whether the injury to the urethra is circumferential or not. Fistulas are classified into types I (distance between the distal edge of the fistula and the urethral meatus > 4cm with no involvement of the urethral closure mechanism), II (distance between the distal edge of the fistula and the urethral meatus 1-4cm (type IIA) or 0.5-1cm (type IIB) with involvement of the urethral closing mechanism at the bladder neck and mid-urethral level) and III. Type III fistulas are those fistulae other than vesico-vaginal fistulae and include recto-vaginal fistulae and uretero-vaginal fistulae.

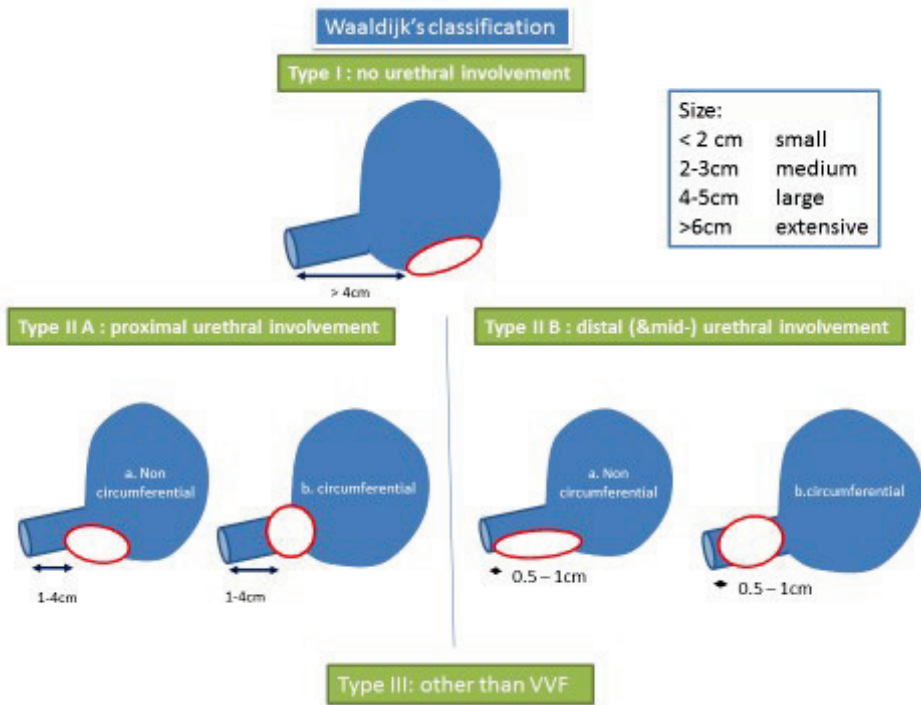

Fig 2. Classification of obstetric vesicovaginal fistulae according to Waaldijk

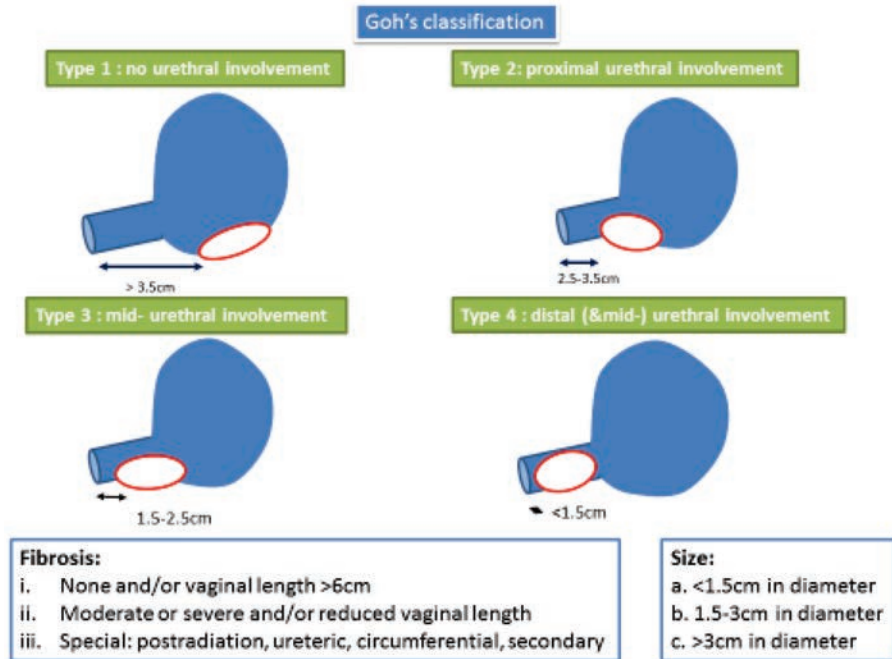

Fig 3. Classification of obstetric vesicovaginal fistulae according to Goh

Similarly, the Goh classification looks at three of the four proven variables known to affect the outcome for obstetric fistula repair. These are the location of the fistula (assessing the extent of urethral involvement),

the size of the fistula and the amount of scarring (including whether or not it is circumferential). (137-139) Also bladder capacity or size is known to affect outcome, but since this is difficult or even impossible to

measure pre-operatively, it has not been included in the Goh classification. (Fig 3) The predictive value of the several items of the Goh classification on persisting incontinence despite successful fistula closure is demonstrated in Table 1.

There has been one comparative study showing that the Goh system is superior to the Waaldijk in terms of predicting closure.(140) (141) Frajzyngier et al, in a prospective cohort study compared the classification systems of Lawson, Tafesse, Goh, Waaldijk and the WHO.(142) They included 1274 patients in 11 centres. The predictive accuracy for fistula closure was 0.63 for the WHO score, 0.62 for Goh and 0.60 for the Tafesse score. The Waaldijk and Lawson systems

faired worse. They propose a new empirical and simplified scoring system. They also suggested including other items in a prognostic scoring systems such as HIV status, malnutrition, malaria and genital cutting.

Classification systems have been developed for an obstetric fistula population. For iatrogenic fistula the classification is highly variable. Most centres use their own classification. Probably the OF classifications could be used for iatrogenic fistula as well. At least the simple WHO classification should be recommended (Fig. 4).

Table 1: the predictive value of the type of fistula, size and scarring for persisting incontinence despite successful fistula closure (Goh classification)

Site		Breakdown of repair (n=987)	Ongoing incontinence despite repaired fistula. (n=987)
Type 1	Distal edge of fistula >3.5cm from the external urinary meatus	2%	3%
Type 2	Distal edge of fistula 2.5-3.5cm from the external urinary meatus	1.6%	20%
Type 3	Distal edge of fistula 1.5-<2.5cm from the external urinary meatus	3%	32%
Type 4	Distal edge of fistula <1.5cm from the external urinary meatus	3%	46%
Size			
a	Size <1.5cm in the largest diameter	2%	10%
b	Size 1.5-3cm in the largest diameter	0.5%	22%
c	Size >3cm in the largest diameter	4%	30%
Scarring			
i	None or only mild fibrosis (around fistula and/or vagina) and/or vaginal length >6cm, normal capacity	2%	7%
ii	Moderate or severe fibrosis (around fistula and/or vagina) and/or reduced vaginal length and/or normal capacity	2%	24%
iii	Special consideration, eg. post-radiation, ureteric involvement, circumferential fistula, previous repair.	4%	41%
Overall results		2.7%	23.2%

WHO classification 2006

Simple fistula with good prognosis	Complex fistula with uncertain prognosis
<ul style="list-style-type: none"> - Single fistula < 4cm - Vesicovaginal fistula - Closing mechanism not involved - No circumferential defect - Minimal tissue loss - Ureters not involved - First attempt to repair 	<ul style="list-style-type: none"> - Fistula > 4cm - Multiple fistula - Rectovaginal, mixed fistula, cervical fistula - Closing mechanism involved - Scarring - Circumferential defect - Extensive tissue loss - Intravaginal ureters - Failed previous repair - Radiation fistula

Figure 4. Adapted WHO classification of fistula. Although this classification was developed for obstetric fistula initially, it could be relevant for iatrogenic fistula as well. (447)

1.1. Recommendations

The use of a classification system is recommended.	A
Long-term follow up of fistula patients is recommended in order to study the outcome of both conservative and surgical management and, in particular, to determine its effect on quality of life.	A
When reporting the outcome after fistula repair, authors should make a clear distinction between fistula closure rates and post-operative incontinence rates, specifying the time at which follow-up was carried out.	A
A routine post-operative assessment of obstetric fistula needs to be developed to accurately determine the incidence and severity of any ongoing incontinence.	A

Although the evidence on classification systems is level two evidence, the committee has upgraded these recommendations to grade A. The committee wants to encourage researchers to use and report the classification systems, given the major importance classification systems have in the scientific research in this field.

IV. DIAGNOSIS OF FISTULAE

1. CLINICAL DIAGNOSIS

Leakage of stool, urine, or possibly both is the hallmark sign of a fistula. The leakage is usually painless, may be intermittent if it is position dependent, or may be constant. Unfortunately, intraoperative diagnosis of a GU or GI injury is made in only about half of the cases that result in fistula. (143) In one study, 36% of VVF presented within one week of a laparoscopic hysterectomy and 50% in the second week. Most of the patients after TAH had leakage in the second week (90%). (144) As discussed above, more extensive dissection is a factor when lower urinary

tract injury results in a fistula. However, other than a frank injury such as ureteric transection, not all injuries result in the formation of a fistula. With laparoscopic or abdominal dissection, ureteric injury may occur anywhere along the retroperitoneal ureter usually below the pelvic brim. Since the injury may not be recognised during surgery, post-operative pain is a key symptom.

The cause of VVF after hysterectomy varies with the extent of surgery and the amount of damage that has occurred. In an attempt to determine causative factors of post-operative fistulae, the records of 12 patients who had developed a vesicovaginal fistula after TAH were compared with 12 consecutive TAH patients without fistula formation. Most of the patients who developed VVF had excessive postoperative abdominal pain, distension or paralytic ileus, or both. Haematuria, symptoms of irritability of the bladder, prolonged postoperative fever, and increased white blood cell count were also noted more often in the fistula group. In contrast, the postoperative course was usually uncomplicated in the non-fistula group.

The clinical course observed in many of the patients with VVF suggests that the patient has an unrecognised or recognised injury to the bladder resulting in urinary extravasation. (145) It may be possible to abort the development of many VVF by early recognition and treatment of an unsuspected bladder injury. It is suggested that patients with severe abdominal pain, distension, paralytic ileus, haematuria or symptoms of severe irritability of the bladder after TAH should be investigated early for a possible genitourinary injury.

Another possible aetiology of VVF in the setting of laparoscopic procedures is trocar insertion injury. To prevent this the bladder should be emptied by intermittent or continuous bladder drainage prior to inserting the abdominal and pelvic trocars. During the laparoscopic procedure, gaseous distention of the urinary drainage bag may become evident indicating a hole in the bladder. This intraoperative sign however, has not been associated with fistula formation. (146)

The diagnosis of VVF usually requires clinical assessment often in combination with appropriate imaging or laboratory studies. Direct visual inspection (office evaluation or exam under anaesthesia) may confirm the presence of a fistula however it may not reveal the extent, location, or course of the fistula. Some fistulae are not readily visible. This is particularly true with iatrogenic fistula in which the fistula may be high in the vagina and may involve the ureter, bladder, or both. Therefore, most physicians rely on adjunctive tools for the diagnosis of VVF. This may include imaging studies in combination with other modalities such as cystoscopy. A simple approach in the office setting to confirm that a fistula is present is to fill the bladder retrograde with a coloured fluid. This could be a milky fluid such as baby formula or water or saline with methylene blue, or indigo carmine. Direct visualisation of dye extravasation or placement of a tampon into the vagina to identify staining may facilitate the diagnosis of a VVF. (Figure 5) A double-dye test to differentiate between an ureterovaginal and VVF may be useful in some cases. The patient is given phenazopyridine orally which will stain the urine orange while the bladder is filled with blue fluid. Blue tinting of the tampon leads to the presumptive diagnosis of a VVF while orange staining is suspicious for an ureterovaginal fistula. (147) A three swab test has also been described, lining up three swab in the vagina. The swab that is coloured most, indicates the presumed location of the fistula (proximal, mid or distal vagina). (148)

A number of studies have investigated the role of routine cystoscopy in avoiding/detecting urinary tract injury at pelvic surgery; Indraratna et al. have recently reviewed these. (149)

Gilmour et al. undertook a systematic review of urinary tract injuries at benign gynaecological surgery including all studies of >500 patients reported between 1966 and 1998. (150)

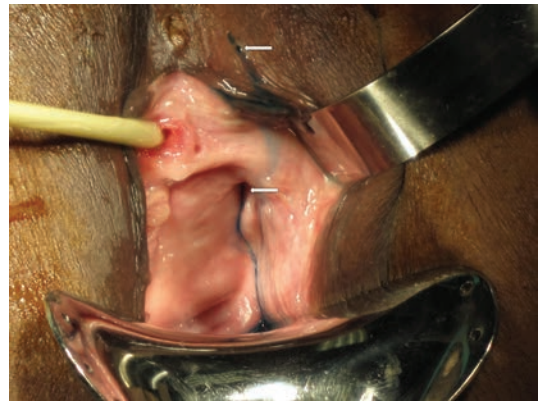

Figure 5. Methylene blue introduced intravesically, demonstrating complex vesico-vagino-vulval fistula following pelvic fracture (arrows indicate external openings)

The overall rate of ureteric injury from 17 studies where cystoscopy was not undertaken (mostly hysterectomy) was $168/107,068=0.16\%$. In 10 studies where cystoscopy was undertaken routinely (mainly colposuspension or pelvic floor reconstruction), the rate of ureteric injury was $20/3235=0.62\%$. The corresponding rates of bladder injury were 0.26% (without cystoscopy) and 1.04% (with cystoscopy). Although the rates of detected urinary tract injury were approximately four-fold higher in those studies where cystoscopy was undertaken as a routine, it should be noted that none of these studies was randomised, and routine cystoscopy was undertaken predominantly during those procedures with intuitively the highest risk of injury.

Cystourethroscopy may provide direct visualisation of the fistula. In several series using cystoscopy (mostly with IV indigo-carmin) the sensitivity and specificity in detecting ureteric injury intra-operatively were >95%.

Urine may extravasate externally or internally. Creatinine levels in the urine are higher than serum levels. Therefore, in the setting of a suspected fistula, testing the creatinine level in either the extravasated fluid or the accumulated ascites and comparing this value to the the serum creatinine levels will confirm urinary leakage but not the location of the fistula. Likewise, testing potassium levels will show higher levels compared to serum levels. (151)

A recent trend to use a flexible scope in the vagina, vaginoscopy, can provide magnification, direct visualisation with minimal discomfort to the patient, particularly in high fistulae.

2. IMAGING

Depending upon availability, radiologic studies (cystography, urography, intravenous urography, and CT urography) may be useful. Ultrasonography and colour Doppler have been used by some, although their

use in routine practice remains to be established. (152) (153) An unstructured review by Narayanan et al. suggested that magnetic resonance imaging, particular with T2 weighting, provided optimal diagnostic information regarding fistula associated with pelvic malignancy, with contrast-enhanced CT with late excretory phase an acceptable alternative.(154) These newer modalities were considered to be superior to other X-ray contrast techniques and ultrasound. Ureteroenteric fistula have been diagnosed using 99mTc-DTPA renal scans.(155)

3. DIAGNOSIS OF GI FISTULAE

Pneumaturia, dysuria and/or recurrent UTI's are symptoms of a colovesical fistula but may be due to

3.1. Recommendations

CT and cystoscopy appear more consistent in the confirmation and location of possible intestino-vesical fistulae, than other investigations	C
Level 3 evidence indicates that the routine use of cystoscopy with dye testing at gynaecological surgery has high sensitivity, specificity and negative predictive value in the detection of ureteric injury, although false positive tests do occur. The clinical and cost-effectiveness of routine cystoscopy remains to be established	C

V. MANAGEMENT OF VESICOVAGINAL FISTULAE

The literature relating to surgical fistula is extensive, but of limited quality. In the previous version of this chapter 356 papers of possible relevance were identified, of which only 173 contained any relevant material. In this edition 141 articles have been added.

1. CONSERVATIVE MANAGEMENT

1.1. Immediate Management by Catheterisation or Defunctioning

Before epithelialisation is complete an abnormal communication between viscera will tend to close spontaneously, provided that the natural outflow is unobstructed. Normal continence mechanisms, however, involve the physiological contraction and intermittent relaxation of urethral and anal sphincters. As a result, although *completely* spontaneous closure of genital tract fistulae does occur, it is the exception rather than the rule. Bypassing the sphincter mechanisms, or diverting flow around the fistula, for example by urinary catheterisation, percutaneous nephrostomy or defunctioning colostomy, may however encourage closure.

Bazi reported a non-systematic review of papers including information on the spontaneous fistula closure of VVF; whilst quality of the data was poor, he identified 30 studies from which 12 could be included;

other causes as well. Accepting the limitations of small case series in this regard, a number of studies have investigated the value of a range of investigative techniques in the detection and evaluation of entero-vesical or colovesical fistulae.(126, 128, 129, 133, 156-160) No test was shown to have consistent reliability; excluding those investigations for which only a single report was identified, CT (53%), cystoscopy (48%), and in the case of colovesical fistula, barium enema (38%) were perhaps the most useful; intravenous urography and sigmoidoscopy or colonoscopy appear to have limited utility in the diagnosis of GI fistula.

these included cases that were almost exclusively of surgical aetiology; it should be noted that in 9 of these 12 studies the sample size was less than 5 patients.(161) Few studies described catheter drainage in large fistulae, although it seemed that those of less than 1cm diameter were most likely to heal spontaneously. The time between the insult and institution of drainage in cases of non-surgical closure varied widely, although in most cases this was less than 3 weeks. Similarly, the duration of catheterisation prior to the initiation of conservative treatment was deemed to have been unsuccessful varied considerably, making true estimates of the effectiveness of this approach impossible; generally this varied between 10 days and 3 months.(161) Reported success rates varied between 0% and 100% (although 5 series had a sample size of 1!), although in several series it was difficult to determine how many women had attempted conservative management.(161)

In large series of obstetric fistulae where a consistent approach to conservative management has been applied, spontaneous healing has been reported in up to 28% of cases.(162-164) In one series of urogenital fistulae of varying aetiologies, spontaneous closure was seen in 19/238 or 8.0% of surgical cases, 4/38 or 10.5% of obstetric cases, 1/36 or 2.8% of miscellaneous (largely traumatic cases) and 0/34 or 0.0% of radiotherapy related cases.(27) Oakley et al. studied 226 patients, of whom 116 underwent immediate surgery and 60 were treated with catheterisation for 12 weeks. Of the conservative treatment group only 11.7 resolved spontaneously. The remainder had surgery. It is possible that in this, and many other reported series, data are an underestimate of the value of this

approach to management,(27) nevertheless, combining available data (see table 2) gives an overall spontaneous closure rate from 348 surgical fistulae treated by initial catheterisation of 13% ± 23%.(19, 27, 31, 165-174). Patients with ongoing, continuous vaginal leakage despite a functioning indwelling catheter are unlikely to have resolution of the VVF without additional measures such as surgery. Such patients should be spared prolonged catheter drainage and

proceed with more definitive repair as soon as medically appropriate. Small epithelialized fistulae may benefit from minimally invasive cystoscopic electrocoagulation of the fistula tract, followed by prolonged catheter drainage. In patients with fistulae less than 3.5mm in diameter, 11/15 had successful fistula tract ablation with cauterization and catheter drainage in a study by Stovsky et al. (175) In general, conservative measures are successful in small fistulae only, usually less than 2-3mm in diameter.

Table 2: Data from studies including rates of spontaneous closure of surgical vesico-vaginal fistulae.

Authors	Date	N	Spontaneous closure	%
Latzko	1942	39	9	23%
Falk&Orkin	1957	10	0	0%
Frang et al.	1983	15	3	20%
Gorrea	1985	1	1	100%
Davits & Miranda	1991	4	4	100%
Tancer	1992	3	3	100%
Chittacharoen é Theppissai	1993	4	3	75%
Soong & Lim	1997	1	0	0%
Dogra & Nabi	2001	1	0	0%
Milicic et al.	ZOO1	21	0	0%
Mathevet et al	2001	4	2	50%
Lentz	2005	7	1	14%
Hilton	2011	238	19	8%
Oakley	2014	60	7	11,7%
Singh	2010	42	3	7%
TOTAL		450	55	12.2%

n.b. table includes studies considered by Bazi,(161) but only those of known surgical aetiology.

1.2. Pharmacotherapies to Assist Fistula Closure

Several case reports describe successful fistula closure following the induction of amenorrhoea by oestrogen, oestrogen/progesterone combinations, or luteinising hormone releasing hormone analogues,(176) in the management of vesicovaginal,(177) and more frequently, uretero- or vesico-uterine fistula following caesarean section.(178-182) The overall closure rate in these studies is 88%±16%. Spontaneous closure of vesico-uterine fistula has also been reported on a number of occasions,(179, 183) with a rate of 41/786 or 5% calculated in one review.(179) Whilst comparison across studies is obviously highly problematic (especially where many

are single case reports, with success rates of 0% or 100%), it seems highly likely that the rate of closure following hormone treatment (14/16) is significantly higher than that of spontaneous closure (41/786) ($p < 0.0005$ – Fisher’s exact test).

In quasi-randomised controlled study (alternate allocation) in patients with continuing urinary leakage following ureteric or pelvi-calyceal surgery, the use of intranasal desmopressin was shown to significantly reduce the duration of leakage compared to ‘watchful waiting’.(184) The use of such treatment should be avoided in patients with complicating factors such as infection.

It should be recognised that some fistulae may be associated with minimal symptoms, and even if persistent these may not require surgical treatment. Small distal urethro-vaginal fistulae, utero-vesical fistulae with menouria, colo-vesical fistulae associated with diverticular disease, and some low recto-vaginal fistulae may fall into this category.

1.3. Palliation and Skin Care

During the waiting period between diagnosis and repair, incontinence pads should be provided in generous quantities so that patients can continue to function socially to some extent as well as avoid skin complications related to chronic urinary leakage. Urinary fistula patients usually leak considerably larger quantities of urine than those with urethral incontinence from whatever cause, and this needs to be recognised in their provision of supplies.

The vulvar skin may be at considerable risk from urinary or faecal dermatitis,(185, 186) particularly if there is additional radiation change in the skin;(187, 188) liberal use of silicone barrier cream should be encouraged. Steroid therapy has been advocated in the past as a means of reducing tissue oedema and fibrosis, although these benefits are refuted and there may be a risk of compromise to subsequent healing. Some authors have recommended local oestrogen, and whilst empirically one might expect benefit in post-menopausal women,(189, 190) or those obstetric fistula patients with prolonged amenorrhoea,(191, 192) the evidence for this is limited.

1.4. Nutrition

To maximise the prospects for postoperative healing it is essential, that the general health of the patient should be optimised. This is most relevant to obstetric fistula patients, where social ostracism and the effects of prolonged sepsis, may commonly result in malnutrition and anaemia.(193-198) Where there is severe inflammatory bowel disease the question of an elemental diet or even total parenteral nutrition may need to be considered.(132, 135, 199-202) Nutritional support may also be important in patients with malignant or radiotherapy induced fistulae,(203) or in those with complications following diversion surgery.(202, 204, 205)

1.5. Physiotherapy

Obstetric fistulae are commonly associated with lower limb weakness, foot drop and limb contracture. In a group of 479 patients studied prospectively 27% had signs of peroneal nerve weakness at presentation and a further 38%, whilst having no current signs, gave a history of relevant symptoms.(206) Early involvement of the physiotherapist in preoperative management and rehabilitation of such patients is essential.(207) Although nerve injury is rarely seen in association with fistulae of other (non-obstetric) aetiologies, the value of physiotherapist support in the

preoperative management and rehabilitation of patients with complex fistulae or with intercurrent pathologies should not be under-emphasised.(202)

1.6. Antimicrobial Therapy

Active infection in the genital or urinary tracts should be treated prior to attempted surgical repair. In tropical countries the treatment of systemic infections such as malaria, typhoid, tuberculosis and parasitic infections are not uncommon and should be rigorously pursued and treatment undertaken before elective surgery. One randomised trial reported no difference in outcome between single dose IV *gentamycin* and continued postoperative use of *amoxicillin*, *chloramphenicol* or *cotrimoxazole* in obstetric fistula patients (although re-analysis suggests that a difference favouring peri-operative gentamycin may be present).(208) A further placebo controlled trial of ampicillin found no evidence of benefit from prophylactic antibiotics in terms of fistula closure or residual incontinence following repair, although the use of postoperative antibiotics was reduced.(209)

A recent review of obstetric fistula practices has called for further trials in this aspect of fistula management.(210) Opinions differ on the desirability of prophylactic antibiotic coverage for surgery in the developed world, some avoiding their use other than in the treatment of specific infection, and some advocating broad-spectrum treatment in all cases. A systematic review found only weak evidence that antibiotic prophylaxis (compared to giving antibiotics when clinically indicated) reduced the rate of bacteriuria, pyuria and symptomatic urinary tract infection in female patients undergoing abdominal surgery who had a urethral catheter for at least 24 hours; this limited evidence related to women receiving antibiotics during the first three postoperative days or from postoperative day two until catheter removal.(211)

1.7. Bowel Preparation

Although many surgeons continue to employ mechanical or stimulant laxative bowel preparation prior to recto-vaginal fistula repair,(212) and may even suggest alternative approaches to surgery where this has not been possible,(130) a recent systematic review that included 18 trials (5805 participants), found no evidence that patients benefit from mechanical bowel preparation, nor the use of rectal enemas, and concluded that bowel cleansing can be safely omitted prior to colonic surgery, without increasing the risk of perioperative complications.(213)

1.8. Counselling

Surgical (non-obstetric) fistula patients are usually previously healthy individuals, who entered hospital for what was expected to be a routine procedure, and they end up with symptoms infinitely worse than their initial complaint. In contrast, obstetric fistula patients in the developing world are often social outcasts. In both situations therefore these women are invariably devastated by their situation; significant impact on

their mental health has been objectively confirmed.(214, 215) It is vital that they understand the nature of the problem, why it has arisen, and the plan for management at all stages. In the setting of an iatrogenic fistula, there may be considerable medico-legal consequences. Confident but realistic counselling by the surgeon is essential and the involvement of nursing staff or counsellors with experience of fistula patients is also highly desirable. The support given by previously treated sufferers can also be of immense value in maintaining patient morale, especially where a delay prior to definitive treatment is required.(216)

2. SURGICAL MANAGEMENT

Fistula surgery is not easy. One of the most important aspects of the unmet needs in fistula surgery training has been the lack of standardization A global competency-based fistula surgical training manual has been created by the International Federation for Gynaecology and Obstetrics (FIGO) with International Society of Fistula Surgeons (ISOFS). The purpose of this manual is to enable health care providers to acquire the required knowledge, skill and professionalism to prevent fistula and provide holistic care to fistula pa-

tients that includes medical, psychosocial and surgical care. A multi-disciplinary team-based approach is encouraged in the training of each doctor and his/her team nurses, physiotherapists and other health professionals. The course is structured at three levels: standard, advanced and expert levels of fistula training.(217)

In the developed world, fistula incidence is much lower. Most results of fistula repair in literature are extremely positive. Since there is no systematic reporting on fistulae and the complications or outcome of the repairs, underreporting, selection bias can be possible confounding factors leading to these positive reports.

If catheter drainage fails, then fistula repair will be necessary. There are certain surgical principles to observe during fistula repair:

- Necrotic tissue must be removed prior to fistula repair.
- Fistula repair must only be undertaken by a properly trained surgeon.
- Adequate post-operative care is essential.
- Proper follow-up should be arranged.

Table 3: Data from studies examining outcome from vesicovaginal fistula repair using an 'early' approach to management; where comparative data from alternative timings are available these are included.

Authors	Date	Definition of 'early'	n	early cure	%	n	late cure	%
Collins et al	1960	< 8 weeks	24	16	67%			
Persky et al	1979	< 10 weeks	7	6	86%			
Fourie	1983	unspecified	6	5	83%			
Badenoch et al	1987	<6 weeks	19	19	100%			100%
Cruikshank	1988	5 weeks	11	11	100%			
Wang & Hadley	1990	<3 months	7	7	100%	9	8	89%
Blandy et al (see also Badenc	1991	<6 weeks	25	25	100%			100%
Moriel et al	1993	<3 months	16	16	100%			
Blaivas et al	1995	<12 weeks	13	13	100%	10	10	100%
Soong & Lim	1997	< 1 month	2	2	100%	1	0	0%
Kostakopoulos et al	1998	unspecified	20	18	90%			
Kam et al	2003	<6 weeks	6	4	67%	14	13	93%
Shelbaia & Hashish	2007	<2 months	12	12	100%			
Lee et al	2010	immediate	5	5	100%			
Radoja et al	2010	< 3months	14	12	86%	7	6	86%
			187	171	91%	41	37	90%
				Confidence interval	6%			27%

2.1. Timing of Surgery

The most appropriate timing for repair of vesico-vaginal fistulae remains one of the more contentious issues in this area. The debate continues between the advocates of early intervention, in order to minimise

the distress to the patient from continuing urinary leakage, vs. those in favour of delaying intervention until local inflammatory change has resolved, necrotic tissues have sloughed, and the patient's recovery from the causative event completed, so as to optimise results.

There is no consensus in the literature as to the definition of 'early' in this context, with different studies either failing to specify at all, or giving a broad range of definition. Although some studies have used the terms 'immediate',(218) 'less than two weeks',(219) or 'less than 30 days',(174) most reports have considered either less than 6 weeks,(220-222) or less than 3 months,(219, 223-225) as their definition of early intervention. Although relatively few studies have reported their outcomes for both early and late approaches to management, overall the results do not appear to be significantly different (see table 3). The overall results for early management are estimated at 91%±6% and for later management (where provided) 90%±27% ($p=1.00$; Fisher's Exact test).

2.2. Outcomes from Treatment and Follow-up

Comparing the outcomes of treatment between different reports and different methods is made difficult by the inconsistent and relatively inefficient outcome measures used. These have ranged from the apparent achievement of a water-tight repair based on dye-testing in the operating theatre, to patient reported symptoms at the time of discharge from hospital. Follow-up in obstetric fistula patients is inevitably difficult in many developing world centres, but even amongst surgical or radiotherapy cases in the developed world, relatively few reports describe examination findings or symptoms at later postoperative review. Long-term outcomes and quality of life measures have only rarely been reported.(226, 227)

2.3. Surgical Approaches

Despite the fact that there is no universally agreed upon classification of iatrogenic fistula, it is probable that there is a relationship between the complexity of the fistula and the outcome of the fistula repair. The WHO published a classification of obstetric fistula in 2006 that divided fistula in simple or complex fistula. We adapted that classification by adding the radiation fistula to the complex fistula group. (Figure 4)

2.3.1 Vaginal Procedures

There are two main types of closure technique applied to the repair of urinary fistulae, the classical saucerisation technique described by Sims,(228) and subsequently modified as a partial colpocleisis by Latzko,(171) and the more commonly used dissection and repair in layers or 'flap-splitting' technique (variously attributed to Hayward, Collis & Lawson Tait).(229) Individual surgeons inevitably employ these techniques somewhat variably, and in different situations, and there are no data comparing their outcomes.

The conventional dissection and repair in layers is entirely appropriate for the majority of post-surgical fistulae, although modifications may be necessary in specific circumstances. In juxta-cervical fistulae in the anterior fornix, vaginal repair may be feasible if

the cervix can be drawn down to provide access. Dissection should include mobilisation of the bladder from the cervix, and the repair should usually be undertaken in such a manner (usually transversely) to reconstruct the underlying trigone and prevent distortion of the ureteric orifices.

Vault fistulae, particularly those following hysterectomy, can again usually be managed vaginally. The vault is incised transversely and mobilisation of the fistula is often aided by deliberate opening of the Pouch of Douglas.(230) The peritoneal opening does not require to be closed separately, but is incorporated into the vaginal closure.

Where there is substantial urethral loss, reconstruction may be undertaken using the method described by Chassar Moir(231) or Hamlin & Nicholson.(232) A strip of anterior vaginal wall is constructed into a tube over a catheter. Plication behind the bladder neck is probably important if any prospect for continence is to be achieved. The interposition of a labial fat or muscle graft not only fills up the potential dead space, but may also provide additional bladder neck support and improve continence by reducing scarring between bladder neck and vagina. These are indeed technically demanding procedures and outcomes of such complex repairs using robust measures as regards continence or sexual function are lacking.

With very large fistulae extending from bladder neck to vault, the extensive dissection required may produce considerable bleeding. The main surgical difficulty is to avoid injuring the ureters. They are usually situated close to the supero-lateral angles of the fistula, and if they can be identified endoscopically, they should be catheterised. Straight ureteric catheters passed transurethrally, or double pigtail catheters may both be useful in directing the intramural portion of the ureters internally; nevertheless great care must be taken during dissection. In such cases where the ureters cannot be visualised cystoscopically, interventional radiological techniques may be utilised to place antegrade ureteral stents from a percutaneous nephrostomy access tract.

2.3.2 Abdominal Procedures

Repair by the abdominal route is indicated when high fistulae are fixed in the vault and are inaccessible through the vagina; most typically this might be following hysterectomy in nulliparous women, in endometriosis, or in those who have not delivered vaginally. Other indications for transabdominal repair are the need for simultaneous augmentation cystoplasty, or in the setting of a ureteric injury requiring reimplantation or simultaneous VVF and ureterovaginal fistula.

A transvesical repair has the advantage of being entirely extraperitoneal. It is often helpful to elevate the fistula site by a vaginal pack. The ureters should be catheterised under direct vision either endoscopically prior to skin incision, or following opening of the bladder. The technique of closure is similar to that of the

transvaginal flap-splitting repair except that for purposes of haemostasis the bladder mucosa is usually closed with a continuous suture.

A simple transperitoneal repair is relatively uncommonly employed (although this technique does seem to be favoured by some using the laparoscopic approach – see below), although a combined transperitoneal and transvesical procedure is favoured by many urologists and is particularly useful for fistula repair following Caesarean section. A midline incision is made in the vault of the bladder; this is extended downwards in a racquet shape around the fistula. The fistulous track is excised and the vaginal or cervical defect closed in a single layer. The bladder is then closed in two layers.

There are no randomised studies comparing abdominal and vaginal approaches; given that those surgeons undertaking both routes for repair would usually see specific indications for the two such a comparison is most unlikely ever to be seen as feasible, ethical or appropriate. Nine non-randomised cohort studies reporting results from both abdominal and vaginal procedures were identified in the current

review.(20, 27, 222, 233-238) In all, these series included 388 vaginal repairs and 345 abdominal repairs with overall closure rates at first operation of 89% and 87% respectively ($p=0.367$; Fisher's exact test). The same reports included 255 transvesical repairs with a 93% cure rate, and 399 transperitoneal repairs with an 89% success rate ($p=0.130$; Fisher's exact test).

With respect to attempted repair of a previously failed VVF surgery, the law of diminishing returns appears to be as evident in these types of procedures as in many other forms of surgery. Although repeat operations are certainly justified, the success rate decreases progressively with increasing numbers of previously unsuccessful procedures. In a series of 2484 largely obstetric fistulae, the success rate fell from 81% for first procedures to 65% for those requiring two or more procedures.(239) Series of surgical cases are rarely large enough for this effect to be evident, although the recent series published by Hilton found successful fistula closure was significantly more likely in the women who had not had attempts at closure before referral (98.2%) than in those who had one or more previous unsuccessful procedures (88.2%) ($p=0.003$; Fisher's exact test).(27)

Figure 6: Forest plots relating trimming of edges at fistula surgery

(i) Forest plot of comparison: 1 Trimming vs. no trimming of fistula edge, outcome: 1.1 Failure of fistula closure

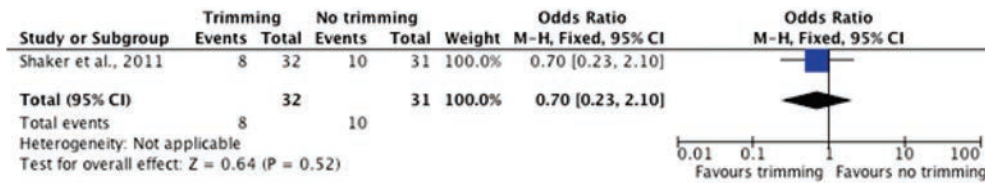

(ii) Forest plot of comparison: 1 Trimming vs. no trimming of fistula edge, outcome: 1.2 Recurrence smaller than original

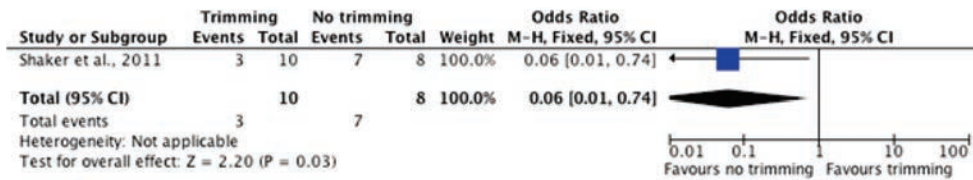

(iii) Forest plot of comparison: 1 Trimming vs. no trimming of fistula edge, outcome: 1.3 Recurrence larger than original

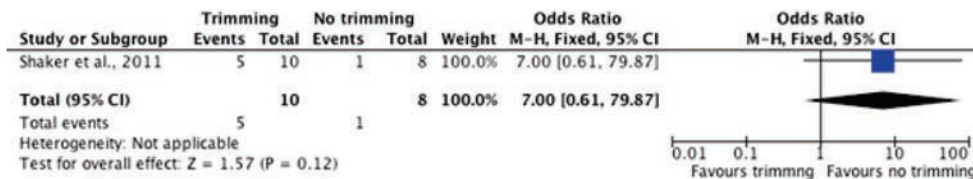

There is only a single randomised trial comparing aspects of surgical technique; Shaker et al. report an RCT comparing trimming of the fistula edge with no trimming.(240) Although there was no statistical difference in success rates between the two groups, in

those cases where repair was unsuccessful and trimming had been undertaken, the fistula tended to become larger, whereas those where there was no trimming were more likely to be smaller upon recurrence (see figure 6).(240)

2.3.3 Laparoscopic

Laparoscopic repair of a VVF was first reported by Nezat et al., in 1994.(241) Fifteen series were identified in the current review,(218, 241-254) (plus an additional series in which 2 laparoscopic procedures were undertaken amongst a small series of vaginal and open abdominal operations).(238) All reported series are quite small (1-25 cases, median 6 cases), and in total only 119 patients were included, with an overall cure rate of 92% (confidence interval 4%) (See table 4). It is not clear from these series whether they include all fistula repairs undertaken in the reporting centres, or whether they were selected in some way; if the latter, it is not clear what selection criteria were used. It is possible that there may be both selection and reporting biases that make it difficult to fully evaluate laparoscopic procedures against alternative surgical approaches.

A combined vesicoscopic, laparoscopic and vaginal approach has been used successfully by some groups, but the experience remains limited.(255, 256)

2.3.4 Robotic

The first report of a robotically-assisted repair of vesico-vaginal fistula was from Melamud et al. in 2005.(257) Since that time four additional reports have been identified,(258-261) including a total of 17 cases (see table 4). The reported cure rate is 100% in all series, although the same comments as above, in relation to possible selection and reporting biases, apply equally here. At this stage, whilst one could state that fistula repair with robotic-assistance appears to be feasible, it is not possible to indicate what its place or potential advantages are over alternative approaches.

Some of advantages to the robotic technique include three-dimensional visualisation, increased dexterity with wristed instrumentation improving on the severe angulation required for laparoscopic or open VVF repair, and easier intracorporeal knot tying. The retrovesical approach through the vagina can reduce the time for bladder healing significantly and allow the procedure to be done as a single day procedure. Currently, there are no direct comparisons between the classical transabdominal VVF repair, transvaginal VVF repair, and the minimally invasive robotic/laparoscopic techniques

Miklos JR et al. performed a systematic review on laparoscopic and robotic fistula repairs. They included

44 studies: 9 articles of robotic-assisted approach, 3 laparoscopic single-site surgeries, and 32 conventional laparoscopic approaches. A literature review revealed a balanced number of reports for both transvesical and extravesical approaches. The overall success rate of laparoscopic VVF repair was 80% to 100% with a follow-up period of 1 to 74 months. The success rate of transvesical and extravesical techniques were 95.89% and 98.04% (relative risk, .98; 95% confidence interval, .94-1.02). There was no statistical difference in success rates of VVF repair with different number of layers in the fistula closure or with use of interposition flaps, but there was a small increase in success in the cases that documented intraoperative bladder filling to test the integrity of the bladder closure. In conclusion, transperitoneal extravesical VVF repair has cure rates similar to the traditional transvesical approach. Laparoscopic extravesical VVF repair is a safe, effective, minimally invasive technique with excellent cure rates similar to those of the conventional transvesical approach in experienced surgeons' hands.(262)

Gellhaus PP et al. published a series of robotic repair either concomitantly with gynaecological surgery or as a salvage procedure after an previous attempted repair, showing good results for both approaches. (263)

2.3.5 Fibrin Glue

The use of fibrin glue in urological indications was reviewed by Shekarriz and Stoller;(264) they identified nine reports (eight in human subjects) of the use of fibrin glue in fistula repair, including a total of 16 patients.(265-272) A further six more recent reports were identified in the current review, where fibrin glue was used either by endoscopic injection or direct application, making a total of now 53 patients with fistulae of various aetiologies.(267, 273-278) Several of these publications were individual case reports, although there was also one randomised trial comparing fibrin glue (20 patients) with a Martius graft (20 patients) in obstetric fistula patients.(277) All of the case reports described successful repair (1/1=100% cure); the RCT reported 13/20=65% cure; the overall success rate therefore for the 53 reported patients was 77.4% (confidence interval 7.3%) (See table 5). In one case successful closure of a radiation induced fistula was reported from the combined use of bovine collagen and fibrin glue.(267) Overall, the indications for, and optimal patient selection for this approach are not defined.

Table 4: Results from series reporting conventional and robotically-assisted laparoscopic fistula repairs.

Authors	Date	Laparoscopic		Robotic	
		N	Cure rate	N	Cure rate
Nezhat et al	1994	1	100%		
Phipps	1996	6	100%		
Miklos et al	1999	1	100%		
Chibber et al	2005	8	100%		
Sotelo et al	2005	15	93%		
Wong et al	2006	2	100%		
Das Mahapatra et al	2007	12	92%		
Otsuka et al	2008	7	86%		
Gazen et al	2009	3	100%		
Porpiglia et al	2009	4	100%		
Shah	2009	25	72%		
Lee et al	2010	5	100%		
Rizvi et al	2010	8	100%		
Abdel-Karim et al	2011	15	100%		
Abdel-Karim et al	2011	5	100%		
Melamud et al	2005			1	100%
Sundaram et al	2006			5	100%
Schimpf et al	2007			1	100%
Hemal et al	2008			7	100%
Kurz et al	2012			3	100%
Bragayrac LA	2014			4	100%
Oderda M	2014			1	100%
Agrawal V	2015			10	100%
Gellhaus et al	2015			10	100%
Jairath A et al	2016			8	100%
Martini A et al	2016			1	100%
Price DT et al	2016			1	100%
TOTAL		117	96%	52	100%

Table 5: Studies using fibrin glue in the management of urogenital fistula.

Author	Date	Fistula	n	cures	%
Gumbt et al	1984	Vesico-perineal	1	1	100.0%
Rossi et al	1991	VVF (surgery)	3	3	100.0%
Schneider et al	1992	VVF (endoscopic)	6	4	66.7%
Tostain	1992	VVF	2	2	100.0%
Welp et al	1996	VVF	3	3	100.0%
Yashi et al	1998	Colo-vesical	1	1	100.0%
Morita et al	1998	Neovesico-cutaneous	1	1	100.0%
Morita & Tokue	1999	VVF (radiation)	1	1	100.0%
Evans	2003	VVF	5	4	80.0%
Sharma et al	2005	Various	7	5	71.4%
Daley et al	2006	VVF	1	1	100.0%
Lazarou	2006	VVF (surgery)	1	1	100.0%
Sarfan et al	2009	VVF (obstetric)	20	13	65.0%
D'arcy et al	2010	VVF (surgery)	1	1	100.0%
			53	41	77.4%
			Confidence interval		7.3%

2.3.6 Endoscopic Repair

Mackay described a technique for transurethral endoscopic suture repair of vesico-vaginal fistula in 1997.(279); there have been three further papers using a similar technique on between one and four patients (total 10 cases).(234, 279-281) Although in three of these series the reported cure rate was 100%, overall, fistula closure was found in 80% (confidence interval 24%).

2.3.7 Adjuvant Techniques in the Repair of VVF: Tissue Interposition

Tissue flaps are often added as an additional layer of repair during VVF surgery. (282-286) Most commonly, such flaps are utilised in the setting of recurrence after a prior attempt at repair, for VVF related to previous radiotherapy (described later), ischemic or obstetrical fistula, large fistula, and finally those associated with a difficult or tenuous closure due to poor tissue quality. However, there is no high level evidence for the use of such flaps in any of these situations. Furthermore, there is no high level evidence that the use of such flaps improves outcomes in the setting of an uncomplicated VVF.

For those VVF repaired transvaginally, a labial fat pad (Martius flap) or a peritoneal flap can easily be mobilised. From a transabdominal approach, greater omentum can be used as an interposition flap.

A variety of other flaps including gracilis muscle flaps, labial myocutaneous flaps, seromuscular intestinal

flaps, and rectus abdominis flaps as well as free grafts of bladder mucosa have been utilized as adjunctive measures in the repair of complex VVF.(287-294)

There is no evidence that a Martius or any other interposition graft improves the outcome in primary fistula repair.

3. POST-OPERATIVE MANAGEMENT

3.1. Catheter Type

No studies were identified comparing different catheter types or duration of drainage following fistula repair. Most reports do not describe their catheterisation practices in any detail; in those that do, the majority have employed urethral catheterisation, with a small number preferring suprapubic drainage or a combination of both. The reason for catheterisation is to ensure free urine drainage until such time as the repair is soundly healed; for this reason some have advocated both suprapubic and urethral drainage, arguing that whilst one catheter might easily become blocked, two are unlikely to do so simultaneously.(27)

3.2. Duration

There appears to be no obvious consensus over the duration of catheterisation recommended following fistula repair of various types and aetiologies. In a retrospective study of obstetric fistula patients in Ethiopia, approximately equal numbers of patients were

catheterised for 10, 12 or 14 days. Patients were not randomised, and there were differences between the groups in terms of the extent of urethral involvement, fistula size, and degree of vaginal scarring, with the more extensively damaged patients being catheterised for longer. Despite this, there was no significant difference in outcome in terms of the rate of repair breakdown, and the authors therefore suggested that postoperative catheterisation for 10 days may be sufficient in the management of less complicated obstetric VVF.(295)

In a recent review of practices amongst obstetric fistula surgeons, Arrowsmith reported a considerable range of practice. For 'simple' fistulae, the average

duration of bladder drainage used was 12 days (range 5-21 days); for 'large' fistula the average was 17 days (range 0-30 days); and for 'difficult' fistulae, the average was 21 days (range 14-42 days).(210)

Studies of non-obstetric fistula management are no more consistent in their description of duration of catheterisation. Most report periods of between seven and 21 days drainage; most typically 10-14 days for surgical fistulae and 14-21 days for radiotherapy-associated fistulae. There is no more than level 3/4 evidence to support any particular practice in these aspects of fistula management.

The summary of the surgical management of VVF can be found in Figure 7-9.

Surgical fistulae

Immediate management	<ul style="list-style-type: none"> • If a vesico-vaginal fistula is diagnosed within (<i>three to</i>) six weeks of surgery, indwelling catheterisation should be considered for a period of up to (<i>six to</i>) 9 weeks (<i>i.e.</i> up to 12 weeks after the causative event • Retrograde, ureteroscopically-assisted or antegrade ureteric stenting should be considered for immediate management for all uretero-vaginal fistulae 	Surgical approach	<ul style="list-style-type: none"> • Surgeons involved in fistula surgery should have appropriate training, skills, experience and versatility to select an appropriate procedure for any patient • Both vaginal and abdominal approaches have an established role in fistula repair • The majority of VVFs and all urethro-vaginal fistulae can be repaired vaginally, regardless of aetiology • Where concurrent ureteric re-implantation or augmentation cystoplasty are required, and abdominal approach is essential • A variety of interposition grafts are described for use in either abdominal or vaginal procedures, although there is no high level evidence to support their use • Conventional and robotically-assisted laparoscopic approaches have both been shown to be feasible in selected cases; the place of these techniques is not yet clear
Timing of surgery	The timing of VVF repair should be tailored to the individual patient requirements, and can be undertaken as soon as any local oedema, inflammation, necrosis & infection resolved		
Bowel preparation	No benefit from mechanical or laxative bowel preparation prior to colonic surgery; this can be extrapolated to include fistula surgery		
Antibiotic prophylaxis	Perioperative antibiotic prophylaxis should follow local policies	Postoperative drainage	A period of continuous bladder drainage is crucial to successful fistula repair <ul style="list-style-type: none"> • 10-14 days for simple and/or surgical • 14-21 days for complex and/or radiation
Counselling & support	<ul style="list-style-type: none"> • Realistic counselling by the surgeon, nursing staff and/ or counsellors with experience of fistula patients is highly desirable • Support from previously treated patients is appreciated and very valuable 		

Figure 7. Treatment recommendations for vesicovaginal fistula

Radiotherapy fistulae

Spontaneous healing	Rare, if ever
Repair procedures	<ul style="list-style-type: none"> • Careful selection necessary as results poorer than in non-irradiated cases • Colpocleisis preferable to 'flap-splitting' • Consider interposition graft
Urinary/faecal diversion	<ul style="list-style-type: none"> • Required more often than in non-irradiated cases, but ONLY after careful consideration of alternatives • Avoid irradiated bowel if possible
Intractable incontinence, life expectancy poor	Consider nephrostomy or ureteric occlusion

Fistulae involving GIT

Investigations	May require several approaches especially CT & cystoscopy
Diverticular (colo-vesical) fistulae	Consider trial of conservative management
<ul style="list-style-type: none"> • Frail elderly, limited symptoms of urinary infection or diarrhoea 	
Crohn's fistulae	Consider trial of <i>infliximab</i> , esp. for any external fistulae
Simple fistulae	
<ul style="list-style-type: none"> • Nutritional state good • No additional intra-abdominal pathology (e.g. severe inflammation, radiation injury, advanced malignancy, intestinal obstruction) 	One-stage surgery
<ul style="list-style-type: none"> • No major co-morbidity 	
Complex fistulae	Specialist referral centre for phased management
<ul style="list-style-type: none"> • Nutritional state poor • Severe inflammation • Radiation injury • Advanced malignancy • Intestinal obstruction • Major co-morbidity • Multiple organ involvement 	<ul style="list-style-type: none"> • Proximal defunctioning and distal drainage • TPN, organ support, radiological planning • Joint urological and gastrointestinal surgery

Figure 8. Treatment recommendations for radiation fistula and fistula involving the gastro-intestinal tract.

FIGURE 9. ALGORITHM FOR MANAGEMENT OF VESICOVAGINAL FISTULA

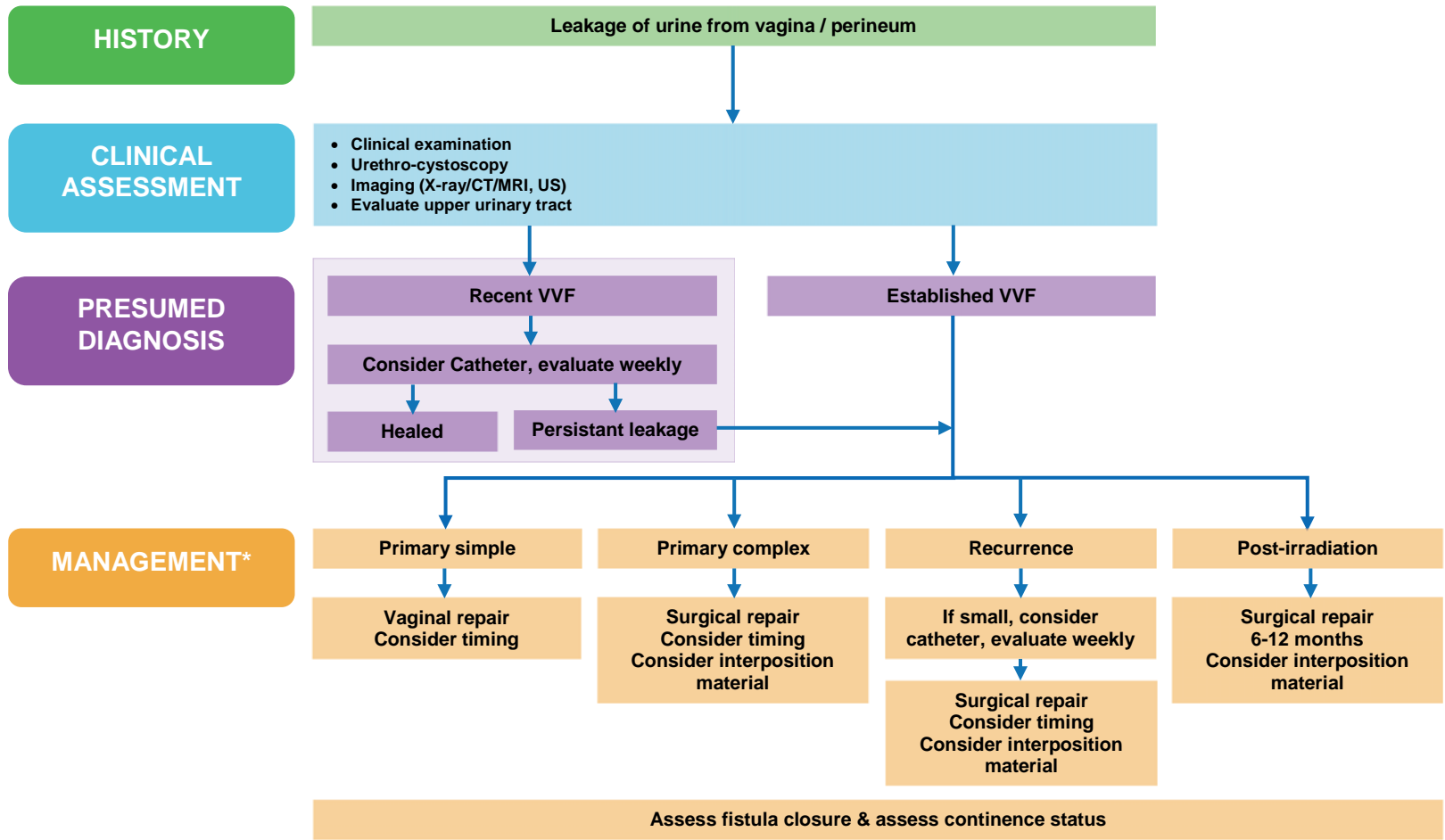

* Consider CONTINENCE PRODUCTS for temporary support during treatment

4. MANAGEMENT OF THE COMPLICATIONS OF VVF

The complications of VVF repair are many and can include:

- Persistence or recurrence of urinary incontinence
- Persistence of lower urinary tract symptoms or occurrence of new lower urinary tract symptoms, including overactive bladder and stress urinary incontinence
- Infections: wound, urinary tract infections (UTI) and pyelonephritis and urosepsis
- Ureteric obstruction (ligation – fibrosis – injury)
- Outlet obstruction (meatal stenosis, urethral stricture, bladder neck obstruction)

- Bladder contracture
- Vaginal stenosis (overcorrection – fibrosis)
- Sexual dysfunction (vaginismus – dyspareunia)
- Rare complications (granulomas – diverticulum formation)
- Neurological complications (foot drop – neurogenic bladder)
- Complex neuropathic bladder dysfunction and urethral sphincter incompetency often result, even if the fistula can be repaired successfully
- Psychological trauma (social isolation – divorce – mental illness)
- Infertility

The literature on the treatment and management of complications of fistula repairs is extremely scarce and is mostly experience-based. It is impossible to give any specific evidence-based guidance. There is need for centralisation of these cases.

Recommendations:

A care programme for failed repairs with persisting incontinence after a successful repair, needs to be in place.	A
It is recommended that surgical treatment of post-operative stress incontinence should only be considered six months after fistula repair.	C
Autologous material should be used when a graft or sling is required and there is no place for synthetic sling material.	C
In order to prevent new fistulaefistulae in women who become pregnant after a fistula repair, waiting homes should be provided to ensure that each woman is able to have an elective caesarean section when she goes into labour.	C
Patients complaining of persistent leakage due to urgency incontinence may try antimuscarinics, botulinum toxin injection or even augmentation cystoplasty in small contracted or poorly compliant bladders.	C
Those with a shortened or disrupted urethra, before or after repair, must be treated with urethral reconstruction, autologous slings or injection of bulking agents, delivered trans or peri-urethrally.	C
In cases with unilateral or bilateral ureteric ligation or injury, the early diagnosis is lifesaving. Patients must be promptly treated by endoscopic ureteric stenting, PCN or ureteric reimplantation.	B
Patients complaining of contracted vagina and dyspareunia with sexual dysfunction may use local oestrogen, vaginal dilatation or may require the surgical creation of vaginal flaps to augment the vagina.	C
Patients who develop dropped foot may respond to physiotherapy or require tibialis tendon transfer.	C
Psychological trauma, social isolation and depression is best treated by counselling and psychological rehabilitation.	C

General recommendations:

The comprehensive use of an indwelling catheter with free urinary drainage should be instituted for all patients who have undergone either an emergency caesarean section or a traumatic vaginal delivery after prolonged (>24hours) obstructed labour.	B
When fistula surgery is necessary the woman must be assured of the surgeon's competence to carry out her procedure.	A

Spontaneous closure of surgical fistulae does occur, although it is not possible to establish the rate with any certainty; if a vesicovaginal fistula is diagnosed within six weeks of surgery, indwelling catheterisation can be considered for a period of up to 9 weeks (i.e. up to 12 weeks after the causative event)	C
Attention should be given as appropriate to skin care, nutrition, rehabilitation, counselling and support prior to and following fistula repair	D
Perioperative antibiotic prophylaxis should follow local policies	D
There is no benefit from mechanical or laxative bowel preparation prior to colonic surgery; it is reasonable that this recommendation be extrapolated to apply to fistula surgery	B
There is no proven benefit to delayed repair of vesicovaginal fistula; the timing of repair should be tailored to the individual patient and surgeon requirements, but can be undertaken as soon as any oedema, inflammation, tissue necrosis, infection are resolved	B
There are no high quality data to indicate greater cure rates for any one technique as compared to others ; level 3 evidence indicates similar success rates for vaginal and abdominal, and for transvesical and transperitoneal approaches	C
Surgeons involved in fistula surgery should have appropriate training, skills, and experience to select an appropriate procedure for each patient	D
The majority of vesico-vaginal and all urethro-vaginal fistulae can be repaired vaginally, regardless of aetiology	C
Where concurrent ureteric re-implantation or augmentation cystoplasty are required, the abdominal approach is necessary.	D
A variety of interpositional grafts can be used in either abdominal or vaginal procedures, although there is little evidence to support their use in any specific setting	C
Conventional and robotically-assisted laparoscopic approaches have both been shown to be feasible in selected cases; the indications for, or optimal patient for these techniques is not yet clear	C
A period of continuous bladder drainage is crucial to successful fistula repair; there are no high level data to support any particular type, route, or duration of catheterisation; current practice suggests: 10-14 days for simple and/or post-surgical fistulae; 14-21 days for complex and/or post-radiation fistulae	D

VI. MANAGEMENT OF RADIATION FISTULA

The literature relating to the management of radiotherapy-associated fistula is again limited in quantity and quality. Forty-nine papers of possible relevance were identified, of which only 35 contained any relevant material. Seven systematic reviews were identified, although none contained information of direct relevance. No randomised trials and only four non-randomised cohort studies of relevance were identified. All other identified material comprised case series or individual case reports or procedure descriptions, and represent level 3 or 4' evidence.

Injury to the gastrointestinal or urinary tracts may arise following therapeutic radiation, with the incidence of complications increasing when the dose exceeds 50 Gy. The obliterative endarteritis associated with ionizing radiation in therapeutic dosages may proceed over many years and may result in fistula formation long after the primary malignancy has been treated.(27, 73) The associated devascularisation in the adjacent tissues means that conventional surgical repair has a high likelihood of failure, and may also result in re-presentation with several fistulae over a

period of many years. In those cases where abdominal repair surgery or urinary diversions are undertaken, a high risk of GI anastomotic leak and progressive sepsis has been reported perhaps related either to inadequate resection of irradiated bowel or to damage to other organs at operation.(74) All these factors often make the management of post-radiation fistulae more challenging than that of post-surgical or even obstetric fistulae. Modified surgical techniques are often required, and indeed, where the same techniques have been applied to both surgical and post-radiation fistulae, the results from the latter have been consistently poorer.(236, 296, 297) Spontaneous healing seems rarely if ever to occur,(27, 51) and only one case report was identified, of a radiation fistula presenting 22 years after initial treatment, in which healing occurred following cauterisation (for biopsy) and prolonged catheter drainage.(298)

1. DIVERSION PROCEDURES

Because of the wide field abnormality surrounding many radiotherapy-associated fistulae, several authors have suggested that urinary and/or faecal diversion should be seen as the treatment of choice in such cases.(50, 77, 78, 236) Others have employed

a routine policy of preliminary urinary and faecal diversion, with later undiversion in selected cases.(299) In a non-randomised cohort of recto-urethral fistula repairs, Vanni et al. reported 100% closure at first operation in 35 non-irradiated cases, compared to 84% in 39 irradiated cases.(299) Additionally, 97% of the non-irradiated cases subsequently underwent 'undiversion', whereas 31% of the irradiated cases required permanent faecal diversion due to a non-compliant rectum or severe sphincter dysfunction.(299)

Some authors have emphasised the place of repair in carefully selected cases of radiotherapy-associated fistulae.(27) Of 36 radiation/malignant fistulae in the series reported by Hilton, although 11 declined surgery or died before treatment, and 6 underwent primary diversion, of the 19 (53%) who underwent repair, 18 (95%) were closed at first operation.(27) Finally, some seem to take the view that diversion has little or no place in the management of radiation-induced vesicovaginal fistula in particular.(72) Of 216 radiation-induced fistula managed over a 47 year period by Pushkar et al., 210 underwent a vaginal and 6 an abdominal repair procedure (*although it should be noted that this is a retrospective case series, and whilst not stated in the paper, it is possible that other patients not included in this review actually underwent diversion*). (72) It should be noted, however, that with this almost exclusive use of the vaginal repair procedure, whilst a cumulative closure rate of 80% was eventually achieved after four or more operations, only 48% were closed after first repair, 40% were closed following a second operation, 52% following a third operation, and 35% following a fourth operation.

In view of the anastomotic problems associated with radiation-induced fistula, the transverse colon has often been favoured over ileum as a conduit in this context, to avoid the risk of employing irradiated bowel and distal ureter.(300-302) Whilst these benefits seem clear, it should be noted that high perioperative morbidity (37%) and re-operation rates (20%) have been reported from this procedure.(301)

As an alternative to the latter operation, where both urinary and faecal diversion are proposed, Hampson et al. described the technique of left colic urinary diversion with distal transverse end colostomy.(303) This technique allows a shorter operation time, and avoids the necessity for an intestinal anastomosis. In patients wishing to remain sexually active following such procedures, the residual bladder or rectal wall may be used to augment the vagina.(304) Where vesicovaginal fistula co-exists with significant bladder contracture following surgery or radiation, an abdominal (transperitoneal) repair might be considered, along with simultaneous ileocystoplasty,(305, 306) or colcystoplasty.(307) Fistula repair concurrently with vaginal reconstruction using sigmoidovaginoplasty has also been described by Verbaeys et al.(308) Whilst one might anticipate a very high operative and postoperative morbidity from such complex multiple

procedures, the outcome in the very small numbers reported appears to have been good.

2. REPAIR TECHNIQUES

Several different techniques for the vaginal repair of fistulae have been reported, although the methods of 'flap-splitting' or dissection and repair in layers (variously attributed to Hayward, Collis & Lawson Tait),(229) and partial colpocleisis,(171) have been the most widely advocated in radiation-associated fistulae. Where patients do not wish to maintain sexual function, complete colpocleisis may be used to good effect.(309) In a non-randomised cohort study, Hilton reported anatomical closure by colpocleisis in 94.7% of radiation-associated cases, compared to 96.1% from a range of repair procedures in fistulae of surgical aetiology.(27)

The technique of sigmoid exclusion or isolation has been described for the management of radiation-associated colo- or entero-vesical and colo- or entero-vaginal fistulae.(310, 311) Although the results have generally been good, with the avoidance of a permanent urinary or faecal stoma, Levenback et al. reported poorer results than following resection of the affected bowel, largely related to bleeding from the isolated segment, and bacterial infection.(311)

3. INTERPOSITION GRAFTS

Several techniques have been described to reinforce fistula repair in different sites depending on the type of repair undertaken. These include the Martius bulbocavernosus muscle and labial fat graft, a gracilis muscle or myocutaneous graft, omental pedicle grafts, and peritoneal flaps. Whilst there is no high level evidence to support the use of these techniques, the interposed tissue has been presumed to help by creating an additional layer in the repair, to fill in 'dead space' and reduce the risk of haematoma formation beneath the repair, to bring in a new blood supply into the area, and to reduce scarring. For each of these hypotheses, interposition grafts might be considered to have their greatest benefit in the repair of radiation-associated fistulae.

At abdominal repair of vesicovaginal or rectovaginal fistulae, the use of a pedicled omental graft has been widely advocated.(284, 312) The omentum is dissected from the greater curve of the stomach and rotated down into the pelvis on either the right or left gastro-epiploic arteries; this may be used at any transperitoneal procedure, but has its greatest potential advantage in radiation-associated fistulae.

The role of interposition flaps in trans-abdominal repair procedures was reviewed by Evans et al.(286) They reported 37 patients with fistulae of largely surgical aetiology, of whom 12 of 12 treated employing an omental or peritoneal interposition flap were cured, compared to 16 of 25 managed without interposition (64%); this finding was consistent for fistulae

of both benign and malignant aetiology. Although their cases were not randomised, and the authors acknowledge that their overall cure rate (75%) was rather lower than many series, nevertheless, they concluded that an interposition flap should be recommended, when a trans-abdominal repair is undertaken, particularly when the repair is performed by a less experienced surgeon.

Although widely employed in the context of obstetric fistula repair in the past, there is no high level evidence to support the use of the Martius graft in this context and there seems to be a general move away from it amongst obstetric fistula surgeons. (Fig. 10) One small non-randomised cohort study reported benefit in patients with multiple or recurrent fistulae, based on a univariate analysis,(282) another reported no advantage to the experienced obstetric fistula surgeon.(313) In the series of fistulae of all aetiologies from UK reported by Hilton, the fistula closure rate was not significantly different between those procedures where an interposition graft (omental or labial) was (92.0%) or was not (96.1%) used in the repair ($p=0.264$; Fisher 's Exact test).(27)

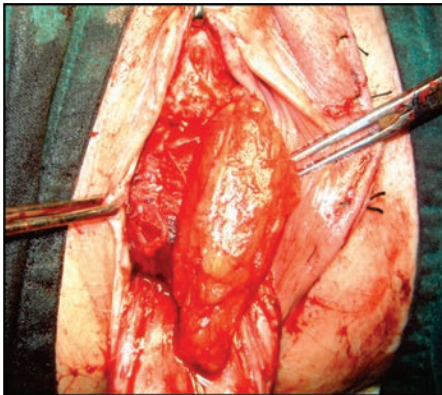

Figure 10. Martius labial fat graft passed subcutaneously to overlie fistula repair (combined with complete colpocleisis)

In the situation of vaginal repair of radiation-associated fistula Pushkar et al. strongly advocate the use of the labial fat graft interposed at fistula repair;(72)

Hilton advocates its use to fill 'dead space' in the lower vagina at complete colpocleisis.(27, 309) With the former technique closure at first operation was 48%,(72) with the latter 95% closure at first operation is described.(27)

Labial skin grafts have also been employed in the repair of radiation-associated fistulae, either as an interposition, or replacement for sloughed or indurated vaginal skin. Labia minora flaps, with the outer surface de-epithelialised,(314) and labia majora flaps,(315, 316) have both been described in this context.

Muscle and myocutaneous grafts have also been employed as interposition in fistula repair. These tend to be very bulky grafts, and are perhaps best used therefore in circumstances of extreme tissue loss. The technique of rectus abdominis flap interposition was described in one series of 10 patients, although none of their cases were radiotherapy related.(317) Viennas et al. reported one case of a radiation-induced vesicovaginal fistula repair by this technique.(291) Gracilis muscle along with selective use of a buccal mucosal overlay graft has been used in recto-urethral fistulae, with 84% cure in radiation-associated cases.(299)

4. OTHER MANAGEMENT APPROACHES

In patients with intractable urinary incontinence from radiation-associated fistula, percutaneous nephrostomy or ureterostomy might be considered.(78) This may in some cases extend life perhaps inappropriately, and where life expectancy is deemed to be very short, ureteric occlusion might be more appropriate. Several methods have been described, including the insertion of coils,(318) coils with gelatin sponge,(319, 320) clips,(321) nylon plugs with injection of polidocanol,(322) isobutyl-2-cyanoacrylate,(323) and balloons.(323-326) These were reviewed by Avritscher et al. with success rates ranging from 50% to 100% for the different methods, and with an overall success of 77% in 150 cases from nine papers reviewed.(327)

5. RECOMMENDATIONS

Whilst diversion is used more widely in radiation-associated fistulae of all types as compared to non-irradiated fistulae, there is low level evidence that repair procedures can achieve successful fistula closure and continence in appropriately selected cases	C
Where urinary and/or faecal diversions are required, attempts should be made to avoid using irradiated tissues wherever possible, and to minimise the potential for anastomotic complications	C
There is low level evidence to support the use of interposition grafts when repair of radiation-associated fistula is undertaken	C
In patients with intractable urinary incontinence from radiation-associated fistula, where life expectancy is very short, ureteric occlusion might be considered; there is insufficient evidence to recommend any particular technique	D

VII. MANAGEMENT OF GI FISTULA

1. LITERATURE REVIEW

The literature relating to the management of urinary fistula involving the gastro-intestinal tract is limited in quantity and quality. Forty-six papers of possible relevance were identified, of which 39 contained any relevant material. One systematic review was identified, albeit of only indirect relevance, and with no mention of fistula.(213) A single non-systematic review of the management of internal fistulae in Crohn's disease was identified;(328) this included only a single randomised trial,(329) although this did not include patients with urinary fistulae. No further randomised trials or cohort studies of relevance were identified, either from within the review, or independently. One decision analysis model,(330) 26 case series and 10 individual case reports or procedure descriptions were found, including a total of 852 patients.

2. NON-SURGICAL MANAGEMENT

In the context of colo-vesical fistulae associated with diverticular disease, a surgical approach is most commonly advocated. One non-randomised cohort of 30 patients included six who did not undergo surgery, four of whom remained well for periods of up to 14 years; of the 24 who underwent surgical treatment, five (21%) died in the postoperative period.(331)

Ileo-vesical fistula in Crohn's disease may be managed with antibiotics, nutritional support, often including total parenteral nutrition, and various combinations of immunomodulatory agents; in a non-systematic review of the management of internal fistulae in Crohn's disease, Levy & Tremaine describe the drugs that have been reported to close internal fistulae partially or completely including azathioprine, 6-mercaptopurine, mycophenolate mofetil, cyclosporine A, tacrolimus, and infliximab.(328)

One case series of 500 patients with Crohn's disease included 17 with entero-vesical fistulae; all received *sulfasalazine*, and most were treated with corticosteroids and antibiotics intermittently, and eight in addition received *6-mercaptopurine*. Although it is not clear that their fistulae closed completely, six continued on medical treatment alone for several years.(120)

Present et al. reported a placebo controlled randomised trial of the tumour necrosis factor α (TNF α) neutralising agent *infliximab*, a murine/human chimeric monoclonal antibody that binds both the soluble subunit and the membrane-bound precursor of TNF α , in patients with externally draining fistulae associated with Crohn's disease.(329) Adverse events were very common, but complete resolution of all fistulae

was achieved in 55%, and 50% reduction in fistulous drainage was achieved in 68% of patients on 5mg *infliximab*. This latter study did not include intestino-vesical fistulae, although a case of successful use of *infliximab* in an ileo-vesical fistula has been reported.(199)

3. SURGICAL MANAGEMENT

The most frequently advocated surgical approach to colo-vesical fistula in diverticular disease has been sigmoid resection with primary colorectal anastomosis, and closure of the bladder. Dissection of the fistula track followed by closure of the bladder and bowel, with interposition of omentum, but without resection was described in three patients by Lewis & Abercrombie.(332) This approach should perhaps be reserved for cases with minimal diverticular disease in otherwise healthy bowel, where, were it not for the presence of the fistula, there would be no indication for colonic surgery.

One series of 74 patients described a technique in which only visible or palpable full-thickness defects in the bladder were repaired; otherwise the bladder was not repaired, but simply drained by indwelling catheter for one week following sigmoid colectomy (in diverticular disease) or small bowel resection (in Crohn's disease).(127) At median 6 month follow-up there was a single recurrence of a colo-cutaneous/vesico-cutaneous fistula, but no recurrence of the colovesical fistulae. Other authors have similarly advocated leaving the bladder unrepaired in patients with Crohn's ileo-vesical fistulae, to heal by secondary intention with catheter drainage alone.(123, 333)

The main contention in the management of intestino-vesical fistulae has been over the feasibility and role of a one-stage management with resection of the affected bowel segment, primary anastomosis, and closure of the bladder, as compared to a two- or three-stage approach.

The authors of many case series have advocated a one-stage approach in the majority of cases, but have indicated that this should be limited to those patients whose nutritional state is good, and where there is no evidence of severe inflammation, radiation injury, advanced malignancy, intestinal obstruction, major medical problem, or advanced age.(126, 129, 130, 132, 334, 335) More recent series have tended to imply a greater advocacy of the one-stage approach; Garcea et al. in a series of 90 patients with colo-vesical fistula reported primary anastomosis in 61/65=94% of cases where left colon resection was undertaken.(128) Balaguera et al. argue against diverting colostomy or Hartmann's procedure as being unnecessary, and possibly bringing additional morbidity.(336) Several reports have described a laparoscopic approach to one-stage treatment of colo-vesical fistulae, including a total of 30 patients.(131, 201, 337, 338) The overall conversion rate was seen to be higher for fistulae involving the duodenum, vagina

and sigmoid colon, than those involving the bladder (10%), although a low threshold for conversion to open surgery was advocated in one series.(131)

In addition to the above criteria, it is intuitive that the more complex a fistula track, the more relevant a phased approach to treatment becomes. Shackley et al. described a series of 10 patients with highly complex fistulae involving between 3 and 6 separate organs/surfaces.(202) They advocate a three-stage multidisciplinary management package, involving: (1) an acute stage involving proximal defunctioning and

distal drainage of both the gastrointestinal and urinary tracts to isolate the fistula, together with the eradication of sepsis; (2) a recovery stage consisting of total parenteral nutrition, organ support, radiological planning of surgical reconstruction and intensive nursing; (3) joint urological and gastrointestinal reconstructive surgery, when the patient was stable, nutritionally replenished, and sepsis was controlled. Whilst the mean time to reconstruction was 5 (1-20) months, the fistulae were treated successfully in all patients, with functional restoration in four, and/or diversion of the gastrointestinal and urological tracts in six.(202)

4. RECOMMENDATIONS

There is limited evidence to support a non-surgical or conservative surgical approach in colo-vesical fistulae where there are minimal symptoms or evidence of limited bowel involvement	C
There is only limited low level evidence to support a non-surgical approach in colo-vesical fistula associated with diverticular disease; nevertheless, in the frail elderly, or in patients who have limited symptoms of urinary infection or urinary diarrhoea it is reasonable to consider a trial of conservative management	D
There is evidence that <i>infliximab</i> is efficacious in the treatment of external fistulae, but only very limited low level evidence of efficacy in urinary fistulae in association with Crohn's disease	B/D
A one-stage approach to surgery for intestino-vesical fistulae is appropriate in many cases, but should be limited to those patients whose nutritional state is good, and where there is no evidence of additional intra-abdominal pathology (e.g. severe inflammation, radiation injury, advanced malignancy, intestinal obstruction) or major co-morbidity	B
A laparoscopic approach to one-stage management has been shown to be feasible, although there is no high level evidence to allow comparison of outcomes with open surgery	D

VIII. MANAGEMENT OF URETERIC FISTULA

1.1. General Principles

The relevant clinical principles are related to prevention, diagnosis, management, and after care. (339) Patients at higher risk of ureteric injury such as those undergoing complicated childbirth, radical or repeated pelvic surgery, or surgery following pelvic radiotherapy require experienced surgeons who can identify and protect the ureter and its blood supply to prevent injury and also recognise injury promptly when it occurs. Immediate repair of any intraoperative injury should be performed observing the principles of debridement, adequate blood supply and tension free anastomosis with internal drainage using stents.(340) Delayed presentation of upper tract injury should be suspected in patients whose recovery after relevant abdominal or pelvic surgery is slower than expected, if there is any fluid leak, and if there is

any unexpected dilatation of the pelvi-calyceal system. Fluid should be sent for creatinine determination to differentiate serous from urinary leak. Repair of such cases should be undertaken by an experienced team and may consist of conservative management with internal or external drainage, endoluminal management using nephrostomy and stenting where available, and early (< 3 months) or delayed (> 6 months) surgical repair when required.(341) Surgery should again adhere to the standard principles of tissue repair and safe anastomosis. Functional and anatomical imaging should be used to follow up patients after repair to guard against late deterioration in function of the affected renal unit. These general aspects of care of patients with trauma to the upper tract and subsequent fistula formation are covered in standard textbooks of urology and guideline documents.(340, 341) This review will concentrate on developments in the past six years.

1.2. Evidence Quality

A total of 127 abstracts were screened which were categorised as being not relevant (26), cases reports

without useful information (63) and for possible inclusion (38). After review of full text, 27 were selected for the review and 11 rejected due to duplicate information (n=7) and no relevance (n=4). Four further possible papers were identified from the reference lists of included articles of which two were included in the review. The selected papers (29) included one poor quality randomised trial (342), one poor quality quasi-randomised trial (343), one high-quality population case control study(5), one registry study(109), one systematic review(344), one cost analysis(345), 14 cases series, 8 case reports, and one unstructured review.

1.2.1 Urinary Leak after Renal Preservation Surgery

A large case series identified urinary fistula, defined as urinary drainage from a drain site more than 14 days post-operatively, in 4% (45/1118) of patients undergoing partial nephrectomy.(346) This was associated with larger tumours, higher blood loss, and longer ischemia time, but not the mode of surgery (laparoscopic *versus* open). The majority resolved without intervention but 30% required ureteric stent insertion or percutaneous drainage. Another large series 752 patients showed that 21 (2.8%) experienced urinary leakage.(347) four of the 21 patients with urinary leakage had spontaneous resolution, one patient underwent nephrectomy, and 16 patients were treated by retrograde ureteral stents insertion. On univariate analysis, hilar renal masses ($p < 0.04$) and higher preoperative creatinine levels ($p < 0.01$) were found to be associated with higher rates of urinary leakage. None of these variables was significant on a multivariate analysis. Review of the urinary leakage rate over time revealed it has been constantly decreasing over time, from 4% in early cases to 1.3% among the most recent ones, suggesting that the decrease in incidence is related to the improved surgical skills, rather than to differences in tumours' or patients' characteristics. A poor quality quasi-randomised study involving 16 patients with persistent leakage after pelvi-calyceal surgery despite stenting found that use of intranasal desmopressin 40 µg daily resulted in a shorter time to resolution of leak compared to control.(343)

1.2.2 Urinary Leak After Renal Transplantation

A case series from Brazil observed a fistula rate of 2.9% (31/1046) presenting at a mean of 28 (1-131) days following transplantation predominantly due to distal ureteric necrosis and with most cases requiring open repair.(348) Fistula occurred more commonly in patients with diabetes and was associated with lower graft survival and two deaths from sepsis. A case series from China observed fistula development in 3.5% (43/1223) of patients presenting at a mean (range) of 6 (3-20) days following transplantation again primarily due to necrosis of the distal transplanted ureter.(349) Open intervention with re-im-

plantation of the ureter into the bladder or native ureter was required in 34 patients, with one other patient requiring transplant nephrectomy. The occurrence of a fistula did not appear to prejudice graft or patient survival. Initial implantation of the transplant ureter into the native ureter appeared to result in a lower rate of fistula. A further case series from Serbia found a fistula rate following renal transplantation of 2.2% (5/224) and all required open repair.(350)

1.2.3 Uro-enteral Fistula Following Percutaneous Renal Surgery

Case reports of ureterocolic fistulae occurring after renal cryotherapy, and gunshot trauma all resolved with insertion of ureteric stent.(351, 352) This is in line with previous accounts of this complication following percutaneous nephrolithotomy.(353)

1.2.4 Uretero-arterial Fistula

A systematic literature review found reports of 139 cases of uretero-arterial fistula published between 1899 and 2008.(344) All patients presented with haematuria with 25% also having other urinary symptoms or back pain. Virtually all cases had a relevant past surgical history particularly pelvic cancer surgery (54%) and arterial surgery with graft insertion (31%), and 61% had a ureteric stent in situ. The great majority affected the iliac segment and pre-operative imaging was not always diagnostic. A total of 18 (13%) patients died as a result of the fistula. Many vascular and urologic interventions were used either alone or in combination. Later cases suggested that endovascular repair of the arterial defect gave the best results with lower mortality. Another, more recent case series of 20 patients also showed a high mortality of 10 – 20% but did not find any difference in outcome between open or endovascular graft insertion techniques.(354)

1.2.5 Ureterovaginal Fistula

Ureterovaginal fistula occurring in the early post-operative phase predominantly after hysterectomy is the most frequent presentation to urologists of upper urinary tract fistula. A recent retrospective cohort study by Kiran et al. studied 377 073 women who underwent hysterectomy between 2001-2010, of whom 1792 (0.5%) experienced a ureteric injury.(355) In both benign and malignant groups the rate of injury was higher in 2006-2010 than 2001-2005. The proportion of women having a ureteric injury was similar for ovarian and cervical cancer (1.9-4.0% depending on type of procedure). For benign conditions, the rate of injury tended to be lower, typically <1%. Women with endometriosis had the highest risk among this group (1.7% following total abdominal hysterectomy; 95% CI 1.4-2.0%). A randomised study involving 3,141 women undergoing open or laparoscopic gynaecological surgery lasting > 30 min found that the incidence of ureteric injury after prophylactic insertion of ureteric stents (1.2 % (19/1583)) was similar to control (1.1% (17/1558)).(342) A previous cost analysis from the United States perspective suggested

stenting was only worthwhile if the risk of injury was > 3.2%.(345) If injury does occur, many cases, even

those with bilateral injury, can be managed by endoscopic techniques. (356) (Figure 11)



Figure 11. Conservative management of bilateral lower ureteric injury. Retrograde ureterogram showing successful cannulation of left ureter by guide wire and successful placement of right ureteric stent.

The use of ureteric stenting in patients with uretero-vaginal fistulae was reported in 11 studies, including 126 patients in total;(357-367) this resulted in closure in 63 cases altogether. Success rates were between 6% and 100%, although the overall closure rate across all series is calculated at 50% ± 18% (see table 6).

Where retrograde stenting proves impossible, percutaneous nephrostomy and antegrade stenting might be considered if there is some degree of pelvicalyceal dilatation. Ureteroscopy may also be helpful,(362, 366) and a technique for combined antegrade and retrograde ureteroscopic cannulation has been reported.(359) In one report all cases of uretero-vaginal fistula were managed by temporary diversion using a percutaneous nephrostomy followed by delayed repair 4-6 weeks later,(186) and a similar approach

was taken in the management of one uretero-uterine fistula.(368)

If endoluminal techniques fail or result in secondary stricture, the abdominal approach to repair is standard and may require end-to-end anastomosis, re-implantation into the bladder using psoas hitch or Boari flap, or replacement with bowel segments with or without reconfiguration. Recent case series suggest that this standard surgery can be performed safely and with reasonable operative times using laparoscopic or robotic techniques if the relevant skills and facilities are available.(369-371) A recent case report has suggested that open repair through the vagina is possible if abdominal access is problematic.(372)

Authors	Date	N	Spontaneous closure	%
Andrioli et al	1984	10	5	50%
Lang	1984	10	9	90%
Lingeman et al	1985	4	4	100%
Dowling et al	1986	23	11	48%
Mandal et al	1990	31	2	6%
Barton et al	1992	5	4	80%
Koonings et al	1992	1	1	100%
Campbell et al	1993	14	6	43%
Baeghler et al	1997	1	1	100%
Narang et al	2007	3	2	67%
Ustinoz et al	2008	24	18	75%
		126	63	50%
		Confidence interval		18%

Table 6: Data from studies including rates of closure of uretero-vaginal fistulae with ureteric stenting.

1.2.6 Ureteric Fistula Associated the Terminal Phase of Pelvic Malignancy

Urinary leakage is very distressing for people dying of advanced pelvic malignancy but palliation by open diversion may be associated with a high rate of complications. Recent case series have described the technique of occlusion of the distal ureter with coils or other devices using an antegrade approach combined with chronic urinary diversion using nephrostomy tubes.(373-375) Natarajan et al reported successful management of five patients with two requiring repeat embolization but all achieving good palliation until death without adverse effects.(373) Shindel et al reported on 29 patients with bothersome urinary fistula despite chronic nephrostomy drainage, and

poor performance status.(374) In all cases palliation of the urinary leakage was achieved. The majority of patients (23/29) died of their underlying cancer at a mean of eight months after the procedure. Three patients with benign disease subsequently underwent definitive surgical diversion with the remaining two lost to follow up. Coil migration was seen in one patient without serious consequence and there were no other complications specific to the embolisation. Kim et al used the technique to temporally palliate five women with ureterovaginal fistula prior to delayed definitive repair.(375)

The algorithm for uretero-vaginal fistula can be found in figure 12.

1.3. Evidence Table

Prophylactic ureteric stent insertion does not reduce risk of ureteric injury during gynaecological surgery	2
The use of desmopressin may hasten resolution of urinary leak after pelvi-calyceal surgery	3
Uretero-arterial fistula is associated with a high mortality rate	3
Antegrade endoluminal distal ureteric occlusion combined with nephrostomy tube diversion often palliates urinary leakage due to malignant fistula in the terminal phase	4

1.4. Recommendations

Surgeons undertaking complex pelvic surgery should be competent at identifying, preserving and repairing the ureter	D
Ureteric stents are not required as prophylaxis against injury during routine gynaecological surgery, while their role in more extensive surgery remains to be established.	B
Ureteric injury or fistula may be suspected in patients following pelvic surgery if a fluid leak or pelvicalyceal dilatation occurs postoperatively	D
Uretero-arterial fistula may be suspected in patients presenting with haematuria with a history of relevant pelvic surgery and indwelling ureteric stent.	D
Elevated levels of creatinine in drainage fluid following pelvic surgery are suggestive of a urinary tract injury.	D
Most upper urinary tract fistula should be initially managed by conservative or endoluminal techniques where such expertise and facilities exist	B
Persistent ureterovaginal fistula should be repaired by an abdominal approach using open, laparoscopic or robotic techniques according to availability and competence	D
For patients with ureteric fistula associated with advanced pelvic cancer and poor performance status, palliation by nephrostomy tube diversion and endoluminal distal ureteric occlusion is an option.	C

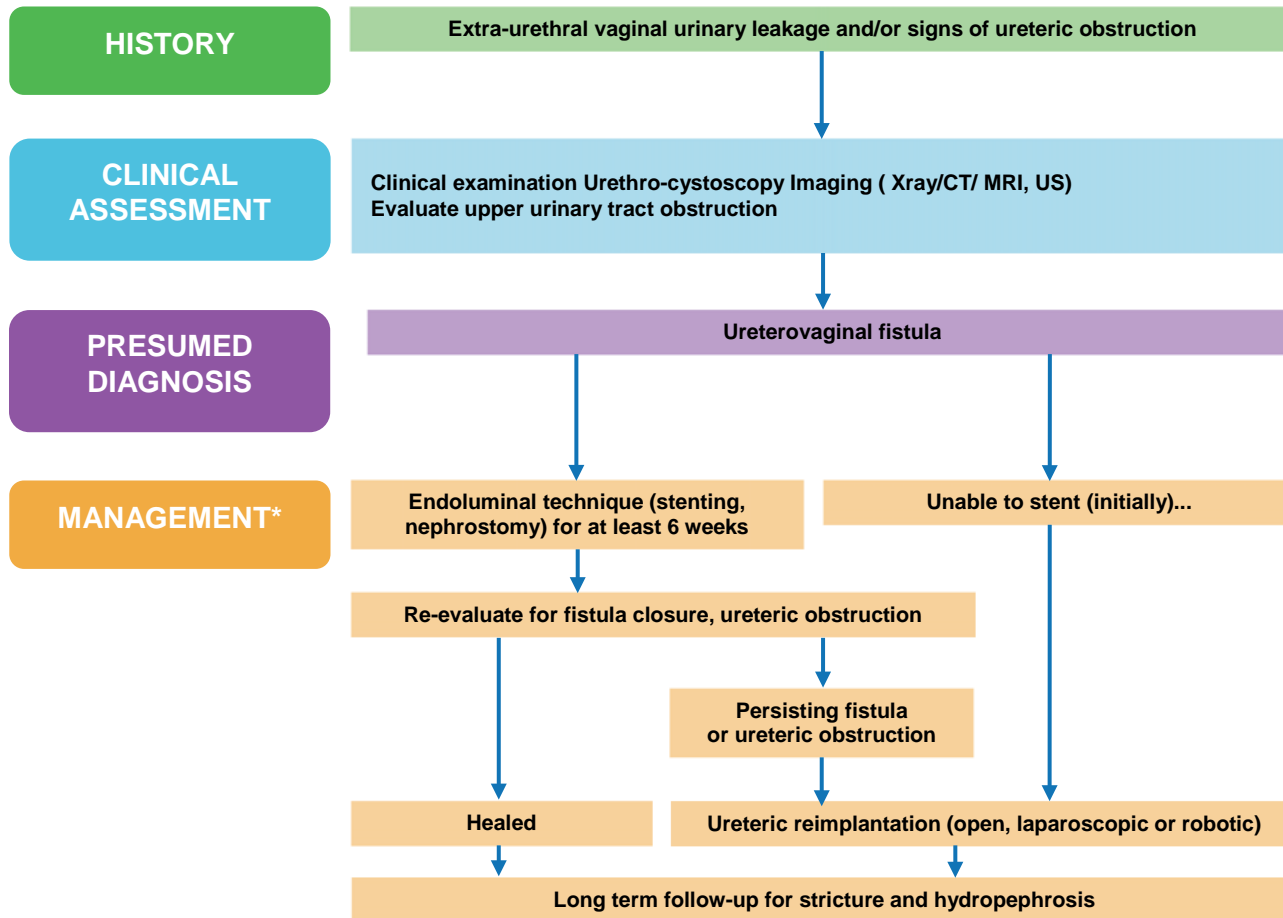
FIGURE 12. ALGORITHM FOR MANAGEMENT OF IATROGENIC URETERIC FISTULAE

* Consider CONTINENCE PRODUCTS for temporary support during treatment

IX. MANAGEMENT OF URETHRO-VAGINAL FISTULA

1. INTRODUCTION

Urethrovaginal fistulae are a rather rare complication of some surgical and medical conditions or treat-

Traumatic	Iatrogenic	Medical
Direct trauma	Bulking agents	Behçet's disease
Foreign body	Sling surgery	
	Urethral diverticula repair	
	Catheterisation	
	Irradiation	

Table 7: Etiology of Urethrovaginal Fistula

In feminising genital reconstructions in children with ambiguous genitalia and surgical repairs of cloacal malformations, urethrovaginal fistula can occur as early or late complications. (376) (377, 378) (379, 380) Also in transsexual adults undergoing female to male reconstruction, urethrovaginal fistulae have been reported. (381)

In the surgical treatment of stress incontinence in women with bulking agents (382, 383) or synthetic slings several cases of urethrovaginal fistula have been reported. (384-387) (388-391) (see Figure 13)

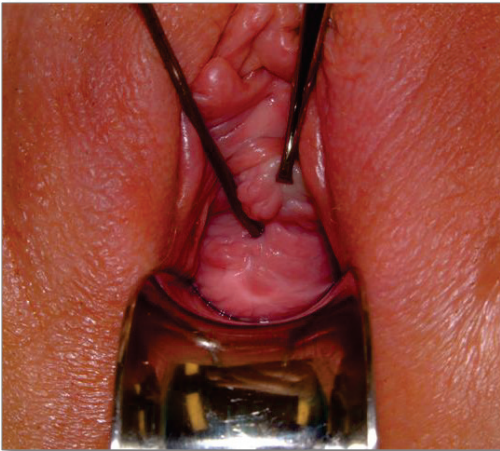

Figure 13. Urethro-vaginal fistula following mid-urethral tape procedure for SUI

Even conservative treatment of prolapse with pessaries can lead to the formation of fistula, if these pessaries are neglected for an extended period of time, although fistula formation after only 2 weeks of pessary use has been described. (28, 392) (see Figure. 14)

2. AETIOLOGY

Excluding obstetric aetiologies, In the developing world, urethrovaginal fistula may occur as a result of obstructed labor with or without associated VVF. In industrialized countries urethrovaginal fistula in adults mostly have an iatrogenic aetiology. (See table 7)

Urethrovaginal fistula have also been described in some Behçet patients with vasculitis and local necrosis of the urethrovaginal septum. (403, 404)

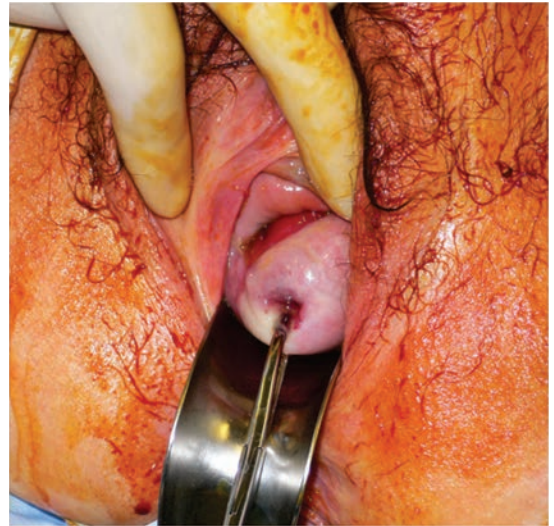

Figure 14. Fistula in anterior vaginal fornix following use of shelf pessary for utero-vaginal prolapse

Irradiation complications can also result in the formation of urethrovaginal fistula. (405)

3. DIAGNOSIS

Clinical vaginal examination is often sufficient to diagnose the presence of an urethrovaginal fistula. Urethroscopy and cystoscopy can be performed to assess the extent and location of the fistula. In cases of difficult diagnosis, voiding cystourethrography (VCUG) or ultrasound can be useful. (406) Double balloon urethrography is the classic examination to show urethral diverticulum and urethrovaginal fistula, but 3D MRI or CT scan is becoming utilized more widely. (407-409)

4. SURGICAL REPAIR

Several techniques for urethrovaginal fistula closure have been described. A vaginal approach is mostly used. Surgical correction intends to create a continent urethra that permits volitional, painless, and unobstructed passage of urine. Depending on the size, localisation and aetiology of the fistula and the amount of tissue loss urethral reconstruction techniques may be necessary to restore the urethra and to achieve post-operative continence. (393)

4.1. Vaginal Approach

Goodwin described in his series that a vaginal approach yielded a success rate of 70% at first attempt and 92% at second attempt, but that an abdominal approach only leads to a successful closure in 58% of cases. A vaginal approach required less operating time, had less blood loss and a shorter hospitalisation time.(410)

Most authors describe surgical principles that are identical to those of vesicovaginal fistula repair: identifying the fistula, creation of a dissection plane between vaginal wall and urethra, watertight closure of urethral wall, eventual interposition of tissue, and closure of the vaginal wall. Primary closure rates of 53%-95.4% have been described (see table 8). Pushkar et al. described a series of 71 women, treated for urethrovaginal fistula. 90.1% of fistula were closed at the first vaginal intervention. Additionally 7.4% were closed during a second vaginal intervention. Despite successful closure, stress incontinence developed in 52%. The stress incontinent patients were treated with synthetic or autologous slings and nearly 60% became dry and an additional 32% improved. Urethral obstruction occurred in 5.6% and was managed by urethral dilation or urethrotomy.(411)

Advancement flaps of vaginal wall can be used to cover the urethral suture line. In some cases more advanced methods are used to close or to protect the urethral closure.

In cases of difficult dissection and visualisation, urethral sectioning has been advocated. (412) This technique is also being used in the repair of complex urethral diverticula.(413) Fistulae that are located in the distal third of the urethra may also be marsupialized without compromising the continence mechanism.(414) Distal urethrovaginal fistula may be entirely asymptomatic in which case repair is unnecessary.

Blaivas advocates that vaginal flaps are usually the best option in dealing with urethral reconstruction, next to the possibility of offering anterior or posterior bladder flaps. Options for vaginal repair of fistula include primary closure, peninsula flaps, bilateral labial pedicle flaps, and labial island flaps. Outcomes are optimised by using exacting surgical principles during repair and careful postoperative management by an experienced reconstructive surgeon. (393) Patients

with urethrovaginal fistulae due to synthetic slings, should be counselled that de novo or persisting stress incontinence can occur and that additional conservative or surgical treatment may be necessary.(389, 390, 415)

4.2. Labial and Vaginal Flaps and Neourethra

The simplest flap is a vaginal advancement flap. (416)

Labial tissue can be harvested as a pedicled skin flap. This labial skin can be used as a patch to cover the urethral defect, but can also be used to create a tubular neo-urethra. (417, 418) The construction of a neo-urethra has mostly been described in traumatic aetiologies. In some cases a transpubic approach has been used. (419) The numbers of patients reported are small and there are no data on the long-term outcome of fistula closure and continence rates. The underlying bulbocavernosus tissue can be incorporated in the pedicled flap and probably offers a better vascularisation and more bulking to the repair. This could allow a safer placement of a sling afterwards, in those cases where bothersome stress incontinence would occur postoperatively. (420, 421)

4.3. Martius Flap

While in obstetrical fistula repair, it was not found to have any benefit in a large retrospective study in 440 women, the labial bulbocavernosus muscle / fat flap by Martius is still considered by some to be an important adjunctive measure in the treatment of genitourinary fistula where additional bulking with well vascularised tissue is needed. (422) Rangnekar et al. report on 12 patients with urethrovaginal fistula, of whom eight were treated with a Martius flap and 4 with a conventional repair. Only one out of the eight had a fistula recurrence, while three out of four of the conventional repairs broke down; it should be noted however that these cases were not randomised between surgical techniques.(423) Puneekar et al. described 15 patients with complex and recurrent fistula, using the skin island flap modification with excellent results.(424) Radopoulos published a small series of five recurrent and complex urethrovaginal fistulae that all healed using a Martius flap. (425)The series of non-obstetrical aetiology are small and all of them are retrospective. There are no prospective data, nor randomised studies.(426, 427) The indications for Martius flap in the repair of all types of fistula remain unclear.

4.4. Rectus Muscle Flap

Rectus abdominis muscle flaps have been described by some authors. (428, 429)Transvaginal urethrovaginal fistula closure was performed followed by a pedicled rectus abdominis muscle flap interposed between the fistula closure and vaginal suture line. The muscle flap was based on the inferior epigastric vessels, and provided additional support to the urethra, bladder neck and bladder base. Urethrovaginal fistula

repair with the rectus abdominis muscle flap was successful in all cases without recurrence.. Of the patients five (83%) were continent and able to void to completion at a mean follow-up of 23 months (range two to 66).

4.5. Other Interposition Material

A range of non-traditional interposition flaps and grafts have been reported by several authors. All of the publications only report on small patient numbers without long term outcomes or continence data.

Golomb et al. reported the use of a fascial patch, while adding a rectus fascia sling to a urethrovaginal fistula repair.(430) Omentum is extensively used in abdominal approaches to VVF, but Janez et al. used it during a vaginal approach in three patients with good results.(431)

The gracilis muscle can be used as well, although the experience is limited. The graciloplasty was described by Ingelman-Sundberg in 1947 and has been adapted by other surgeons in the treatment of fistula. The number of patients reported is low as is the quality of the evidence. (432-434)

Non-autologous material has been used as well. Lowman et al. described the use of porcine dermis interposition and a synthetic sling in an irradiated patient. Other biodegradable materials have been used, although the quality of available data is low and is insufficient to advocate their use. (435) (436) Non-vascularized tissue grafts should be used with caution in such cases as the aetiology of the initial tissue damage resulting in fistula is often ischemic.

5. POSTERIOR APPROACH

In cases of high fistula with difficult vaginal access, a perineal pararectal approach has been described. Some variations exist in the incisions and dissection planes. The anterior sagittal transrectal approach (ASTRA technique) and the posterior sagittal pararectal approach only have been reported in small observational series. (437, 438) (439-441)

6. ABDOMINAL APPROACH

Female urethral injuries may cause serious morbidity with loss of the entire urethra in some cases. Ahmed et al. reported the results of construction of a neourethra by the flipped anterior bladder-tube technique in five girls aged 3-18 years (mean eight years). All had pelvic fractures. Three patients came with a suprapubic cystostomy, one was totally incontinent, and another had an urethrovaginal fistula. Three had an associated vaginal injury. All five patients underwent construction of a neourethra using a flipped anterior bladder-wall tube (FABWT) and have been followed for 18-80 months (mean 44 months). All patients were continent in the daytime and three were voiding spontaneously without the need for

catheterisation. Two were managed by clean intermittent catheterisation (CIC), one per urethram and other via a continent abdominal stoma (Mitrofanoff). (442)

A retropubic retourethral technique has been described by Koriatim (443) This approach allows a urethrovesical flap tube to be fashioned to form a continent neourethra. Urodynamic studies showed that the proximal vesical and distal urethral components of the neourethra contribute to sphincteric function. For larger fistula an enwrapping technique has been described as well. (444)

7. COMPLICATIONS

Little information can be found on complications after urethrovaginal fistula repair. A short report on four cases by Tehan et al. describes a disappointing experience in the transvaginal repair of these fistulae. These authors advocate a suprapubic bladder flap or bladder tube technique to achieve a functioning urethra. Complications following surgical repair have been fistula recurrence, urethral shortening and retraction, persistent reflux, bladder calculi, and bladder cancer (445)

8. FOLLOW UP

In most series of urogenital fistula repair, follow-up is of very short duration. Dolan et al. investigated urinary and sexual symptoms and quality of life in a group of 31 women 50 months (median) after successful repair of urogenital fistula using the Bristol Female Lower Urinary Tract Symptom questionnaire.(446) All women had undergone urodynamic investigation prior to their repair surgery, and only 36% had normal findings. Almost all women reported one or

more symptoms, and for 65%, these caused at least 'a bit of a problem', although 87% said that their urinary symptoms had little or no impact on their quality of life. Symptoms were similar in urethrovaginal and vesicovaginal fistulae and were not significantly associated with prior functional abnormality.

9. RECOMMENDATIONS

Urethrovaginal fistula are preferably treated by a vaginal approach	C
A variety of autologous tissue interposition techniques have been described, but their value remains uncertain	C
Urethrovaginal fistula repair may be complicated by stress incontinence, urethral stricture and urethral shortening necessitating long-term follow-up	C

X. GENERAL CONCLUSION

Fistulae can have a devastating impact on the quality of life of women. In developing countries the number of obstetric fistula is still unacceptably high, due to poor peri-natal care in many countries. The experience and skill of several fistula surgeons should become available and transferable to many other surgeons, interested in this field. But more importantly major efforts are necessary to prevent fistula in those circumstances.

In the developed world, fistulae are less common and the outcome of fistula repairs seems to be reasonable. More prospective research is needed in this field.

REFERENCES

- De Ridder D, Badlani GH, Browing A, Sing P, Sombie I, Wall LL. Fistula in the developing world. In: Abrams P, Cardozo L, Khoury S, Wein A, editors. *Incontinence*. 4th Edition ed. Paris: Healt Publications Ltd.; 2009. p. 1419-58.
- Wall LL, Arrowsmith S, Briggs ND, Browning A, Lassez A. The obstetric vesicovaginal fistula in the developing world. In: Abrams P, Cardozo L, Khoury S, Wein A, editors. *Incontinence*. Paris: Health Publications; 2005. p. 1403-54.
- De Ridder D, Abrams P, De Vries C, Elneil S, Emasu A, Esegbono G, et al. *Fistula*. *Incontinence*. Paris: European Association of Urology and International consultation on urological diseases; 2013. p. 1527-79.
- Abrams P, De Ridder D, de Vries C, Elniel S, Esegbona G, Mourad MS, et al. *Obstetric Fistula in the developing world - An international consultation on Vesicovaginal Fistula*. Montréal Société Internationale d'Urologie; 2012. 252 p.
- Forsgren C LC, Johansson AL, Cnattingius S, Altman D. Hysterectomy for benign indications and risk of pelvic organ fistula disease. *Obstetrics & Gynecology*. 2009;114:594-9.
- Abrams P, Khoury S. International Consultation on Urological Diseases: Evidence-based medicine overview of the main steps for developing and grading guideline recommendations. *Neurourology & Urodynamics*. 2010;29(1):116-8.
- Adler AJ, Ronsmans C, Calvert C, Filippi V. Estimating the prevalence of obstetric fistula: a systematic review and meta-analysis. *BMC pregnancy and childbirth*. 2013;13:246.
- Biadgilign S, Lakew Y, Reda AA, Deribe K. A population based survey in Ethiopia using questionnaire as proxy to estimate obstetric fistula prevalence: results from demographic and health survey. *Reproductive health*. 2013;10:14.
- Cowgill KD, Bishop J, Norgaard AK, Rubens CE, Gravett MG. Obstetric fistula in low-resource countries: an under-valued and understudied problem--systematic review of its incidence, prevalence, and association with stillbirth. *BMC pregnancy and childbirth*. 2015;15:193.
- Kasamba N, Kaye DK, Mbalinda SN. Community awareness about risk factors, presentation and prevention and obstetric fistula in Nabitovu village, Iganga district, Uganda. *BMC pregnancy and childbirth*. 2013;13:229.
- Mselle LT, Kohi TW. Perceived Health System Causes of Obstetric Fistula from Accounts of Affected Women in Rural Tanzania: A Qualitative Study. *Afr J Reprod Health*. 2015;19(1):124-32.
- Mwini-Nyaledzigbor PP, Agana AA, Pilkington FB. Lived experiences of Ghanaian women with obstetric fistula. *Health care for women international*. 2013;34(6):440-60.
- Jokhio AH, Rizvi RM, Rizvi J, MacArthur C. Prevalence of obstetric fistula: a population-based study in rural Pakistan. *BJOG*. 2014;121(8):1039-46.
- Farid FN, Azhar M, Samnani SS, Allana S, Naz A, Bohar F, et al. Psychosocial experiences of women with vesicovaginal fistula: a qualitative approach. *J Coll Physicians Surg Pak*. 2013;23(10):828-9.
- Imoto A, Matsuyama A, Ambauen-Berger B, Honda S. Health-related quality of life among women in rural Bangladesh after surgical repair of obstetric fistula. *Int J Gynaecol Obstet*. 2015;130(1):79-83.
- Maulet N, Berthe A, Traore S, Macq J. Obstetric Fistula "Disease" and Ensuing Care: Patients' Views in West-Africa. *Afr J Reprod Health*. 2015;19(1):112-23.
- Maulet N, Keita M, Macq J. Medico-social pathways of obstetric fistula patients in Mali and Niger: an 18-month cohort follow-up. *Tropical medicine & international health : TM & IH*. 2013;18(5):524-33.
- Raashid Y, Tmajeed T, Majeed N, Shahzad N. Iatrogenic vesicovaginal fistula. *J Coll Physicians Surg Pak*. 2010;20(7):436-8.
- Tancer ML. Observations on prevention and management of vesicovaginal fistula after total hysterectomy. *Surgery, gynecology & obstetrics*. 1992;175(6):501-6.
- Hadzi-Djokic J, Pejic TP, Acimovic M. Vesicovaginal fistula: report of 220 cases. *International urology and nephrology*. 2009;41(2):299-302.
- Forsgren C, Altman D. Risk of pelvic organ fistula in patients undergoing hysterectomy. *Curr Opin Obstet Gynecol*. 2010;22(5):404-7.
- Lee RA, Symmonds RE, Williams TJ. Current status of genitourinary fistula. *Obstet Gynecol*. 1988;72(3 Pt 1):313-9.
- Song T, Kim TJ, Kang H, Lee YY, Choi CH, Lee JW, et al. A review of the technique and complications from 2,012 cases of laparoscopically assisted vaginal hysterectomy at a single institution. *Aust N Z J Obstet Gynaecol*. 2011;51(3):239-43.
- Forsgren C, Lundholm C, Johansson AL, Cnattingius S, Altman D. Hysterectomy for benign

- indications and risk of pelvic organ fistula disease. *Obstetrics & Gynecology*. 2009;114(3):594-9.
25. Harkki-Siren P, Sjöberg J, Tiitinen A. Urinary tract injuries after hysterectomy. *Obstetrics and Gynecology*. 1998;92(1):113-8.
 26. Hospital Episode Statistics [Internet]. Department of Health. 2010 [cited 28/12/10]. Available from: <http://www.hesonline.nhs.uk>.
 27. Hilton P. Urogenital fistula in the UK - a personal case series managed over 25 years 2011 [(early view)]. Available from: <http://dx.doi.org/10.1111/j.1464-410X.2011.10630.x>.
 28. Hilton P, Cromwell D. The risk of urogenital fistula after hysterectomy performed under the National Health Service in England - patterns of care between 2000 and 2008. 2012:(submitted).
 29. Roberto Martinez P, SE RC, Escobar del Barco L, Ramirez Isarraraz C. Vesicovaginal fistula. Experience at the Instituto Nacional de Perinatología. *Ginecol Obstet Mex*. 2007;75(1):31-4.
 30. Duong TH, Gellasch TL, Adam RA. Risk factors for the development of vesicovaginal fistula after incidental cystotomy at the time of a benign hysterectomy. *Am J Obstet Gynecol*. 2009;201(5):512.e1-.e4.
 31. Mathevet P, Valencia P, Cousin C, Mellier G, Dargent D. Operative injuries during vaginal hysterectomy. *European journal of obstetrics, gynecology, and reproductive biology*. 2001;97(1):71-5.
 32. Raassen TJ, Ngongo CJ, Mahendeka MM. Iatrogenic genitourinary fistula: an 18-year retrospective review of 805 injuries. *Int Urogynecol J*. 2014;25(12):1699-706.
 33. Mondet F, Chartier-Kastler EJ, Conort P, Bitker MO, Chatelain C, Richard F. Anatomic and functional results of transperitoneal-transvesical vesicovaginal fistula repair. *Urology*. 2001;58(6):882-6.
 34. Chesson RR. Cystoscopy should be a routine procedure in the performance of hysterectomy. *J Reprod Med*. 2011;56(9-10):371-2.
 35. Benchekroun A, Lachkar A, Soumana A, Farih MH, Belahnech Z, Marzouk M, et al. [Ureter injuries. Apropos of 42 cases]. *Ann Urol (Paris)*. 1997;31(5):267-72.
 36. Modarress M, Maghami FQ, Golnavaz M, Behtash N, Mousavi A, Khalili GR. Comparative study of chemoradiation and neoadjuvant chemotherapy effects before radical hysterectomy in stage IB-IIB bulky cervical cancer and with tumor diameter greater than 4 cm. *Int J Gynecol Cancer*. 2005;15(3):483-8.
 37. Narayanan P, Nobbenhuis M, Reynolds KM, Sahdev A, Reznick RH, Rockall AG. Fistulas in malignant gynecologic disease: etiology, imaging, and management. *Radiographics*. 2009;29(4):1073-83.
 38. Baalbergen A, Veenstra Y, Stalpers LL, Ansink AC. Primary surgery versus primary radiation therapy with or without chemotherapy for early adenocarcinoma of the uterine cervix [Systematic Review]. *Cochrane Database of Systematic Reviews*. 2010;5:5.
 39. Denton AS, Clarke N, Maher J. Non-surgical interventions for late radiation cystitis in patients who have received radical radiotherapy to the pelvis [Systematic Review]. *Cochrane Database of Systematic Reviews*. 2002(Issue 3):Art. No.: CD001773.
 40. Marchiole P, Benchaib M, Buenerd A, Lazlo E, Dargent D, Mathevet P. Oncological safety of laparoscopic-assisted vaginal radical trachelectomy (LARVT or Dargent's operation): a comparative study with laparoscopic-assisted vaginal radical hysterectomy (LARVH). *Gynecologic oncology*. 2007;106(1):132-41.
 41. Likic IS, Kadija S, Ladjevic NG, Stefanovic A, Jeremic K, Petkovic S, et al. Analysis of urologic complications after radical hysterectomy. *American Journal of Obstetrics & Gynecology*. 2008;199(6):644 e1-3.
 42. Baltzer J, Kaufmann C, Ober KG, Zander J. [Complications in 1,092 radical abdominal hysterectomies with pelvic lymphadenectomies (author's transl)]. *Geburtshilfe Frauenheilkd*. 1980;40(1):1-5.
 43. Bostofte E, Serup J. Urological complications of Okabayashi's operation for cervical cancer. *Acta obstetrica et gynecologica Scandinavica*. 1981;60(1):39-42.
 44. Draca P. Wertheim hysterectomy: a ten year experience. *Int Surg*. 1979;64(5):59-63.
 45. Genta RM, Ramchandani MK, Gyorkey F, Buzanis CT, Lahart CJ. Enterovesical fistula due to non-Hodgkin lymphoma in AIDS. *Journal of Clinical Gastroenterology*. 1993;16(4):333-5.
 46. Murdoch M, Hilton P. Classical Hodgkin's lymphoma presenting as vesicovaginal fistula. 2012:(submitted).
 47. Averette HE, Nguyen HN, Donato DM, Penalver MA, Sevin BU, Estape R, et al. Radical hysterectomy for invasive cervical cancer. A 25-year prospective experience with the Miami technique. *Cancer*. 1993;71(4 Suppl):1422-37.
 48. Hallum IAV, Hatch KD, Nour M, Saucedo M. Comparison of radical abdominal hysterectomy

with laparoscopic-assisted radical vaginal hysterectomy for treatment of early cervical cancer. *Journal of Gynecologic Techniques*. 2000;6(1):3-6.

49. Hatch KD, Parham G, Shingleton HM, Orr JW, Jr., Austin JM, Jr. Ureteral strictures and fistulae following radical hysterectomy. *Gynecologic oncology*. 1984;19(1):17-23.
50. Jones CR, Woodhouse CR, Hendry WF. Urological problems following treatment of carcinoma of the cervix. *British journal of urology*. 1984;56(6):609-13.
51. Ralph G, Tamussino K, Lichtenegger W. Urological complications after radical hysterectomy with or without radiotherapy for cervical cancer. *Archives of Gynecology & Obstetrics*. 1990;248(2):61-5.
52. Riss P, Koelbl H, Neunteufel W, Janisch H. Wertheim radical hysterectomy 1921-1986: changes in urologic complications. *Archives of Gynecology & Obstetrics*. 1988;241(4):249-53.
53. Yan X, Li G, Shang H, Wang G, Chen L, Han Y. Complications of laparoscopic radical hysterectomy and pelvic lymphadenectomy--experience of 117 patients. *Int J Gynecol Cancer*. 2009;19(5):963-7.
54. Chen Y, Xu H, Li Y, Wang D, Li J, Yuan J, et al. The outcome of laparoscopic radical hysterectomy and lymphadenectomy for cervical cancer: A prospective analysis of 295 patients. *Annals of Surgical Oncology*. 2008;15(10):2847-55.
55. Monk BJ, Montz FJ. Invasive cervical cancer complicating intrauterine pregnancy: treatment with radical hysterectomy. *Obstetrics & Gynecology*. 1992;80(2):199-203.
56. Blythe JG, Hodel KA, Wahl TP. A comparison between peritoneal sheathing of the ureters (Ohkawa technique) and retroperitoneal pelvic suction drainage in the prevention of ureteral damage during radical abdominal hysterectomy. *Gynecologic oncology*. 1988;30(2):222-7.
57. Hopkins MP, Morley GW. Pelvic exenteration for the treatment of vulvar cancer. *Cancer*. 1992;70(12):2835-8.
58. Berek JS, Howe C, Lagasse LD, Hacker NF. Pelvic exenteration for recurrent gynecologic malignancy: survival and morbidity analysis of the 45-year experience at UCLA. *Gynecologic oncology*. 2005;99(1):153-9.
59. Ungar L, Palfalvi L, Novak Z. Primary pelvic exenteration in cervical cancer patients. *Gynecologic oncology*. 2008;111(2 Suppl):S9-12.
60. Liedl B, Khoder WY, Ruhdorfer-Metz B, Stief CG, Waidelich R. Outcomes of a bladder preservation technique in female patients undergoing pelvic exenteration surgery for advanced gynaecological tumours. *Int Urogynecol J*. 2014;25(7):953-60.
61. Bailey GC, Blackburne A, Ziegelmann MJ, Lightner DJ. Outcomes of Surgical Management in Patients with Stress Urinary Incontinence and/or Neovesicovaginal Fistula after Orthotopic Neobladder Diversion. *J Urol*. 2016;196(5):1478-83.
62. Carmel ME, Goldman HB, Moore CK, Rackley RR, Vasavada SP. Transvaginal neobladder vaginal fistula repair after radical cystectomy with orthotopic urinary diversion in women. *Neurourol Urodyn*. 2016;35(1):90-4.
63. Langebrekke A, Istre O, Hallqvist AC, Hartgill TW, Onsrud M. Comparison of laparoscopy and laparotomy in patients with endometrial cancer. *J Am Assoc Gynecol Laparosc*. 2002;9(2):152-7.
64. Xu H, Chen Y, Li Y, Zhang Q, Wang D, Liang Z. Complications of laparoscopic radical hysterectomy and lymphadenectomy for invasive cervical cancer: Experience based on 317 procedures. *Surgical endoscopy*. 2007;21(6):960-4.
65. Kadar N, Reich H. Laparoscopically assisted radical Schauta hysterectomy and bilateral laparoscopic pelvic lymphadenectomy for the treatment of bulky stage IB carcinoma of the cervix. *Gynaecological Endoscopy*. 1993;2(3):135-42.
66. Colombel M, Pedron P, Missirlu A, Abbou C, Chopin D. Vesicovaginal fistula after laser vaporization of vaginal condyloma. *Journal of Urology*. 1995;154(5):1860.
67. Nwabineli NJ, Davis JA. Fistula injury to the bladder at repeat cone biopsy by laser. *Eur J Obstet Gynecol Reprod Biol*. 1992;43(3):245-6.
68. Ahuja A, Safaya R, Prakash G, Kumar L, Shukla NK. Primary mixed mullerian tumor of the vagina--a case report with review of the literature. *Pathology, research and practice*. 2011;207(4):253-5.
69. Eswara JR, Raup VT, Potretzke AM, Hunt SR, Brandes SB. Outcomes of Iatrogenic Genitourinary Injuries During Colorectal Surgery. *Urology*. 2015;86(6):1228-33.
70. Kucera H, Skodler W, Weghaupt K. [Complications of postoperative radiotherapy in uterine cancer]. *Geburtshilfe Frauenheilkd*. 1984;44(8):498-502.
71. Biewenga P, Mutsaerts MA, Stalpers LJ, Buist MR, Schilthuis MS, van der Velden J. Can we predict vesicovaginal or rectovaginal fistula formation in patients with stage IVA cervical cancer? *Int J Gynecol Cancer*. 2010;20(3):471-5.

72. Pushkar DY, Dyakov VV, Kasyan GR. Management of radiation-induced vesicovaginal fistula. *Eur Urol.* 2009;55(1):131-7.
73. Zoubek J, McGuire EJ, Noll F, DeLancey JO. The late occurrence of urinary tract damage in patients successfully treated by radiotherapy for cervical carcinoma. *Journal of Urology.* 1989;141(6):1347-9.
74. Cochrane JP, Yarnold JR, Slack WW. The surgical treatment of radiation injuries after radiotherapy for uterine carcinoma. *The British journal of surgery.* 1981;68(1):25-8.
75. de Crevoisier R, Sanfilippo N, Gerbaulet A, Morice P, Pomel C, Castaigne D, et al. Exclusive radiotherapy for primary squamous cell carcinoma of the vagina. *Radiotherapy and oncology : journal of the European Society for Therapeutic Radiology and Oncology.* 2007;85(3):362-70.
76. Demanes DJ, Schutz KL, Quackenbush JJ, Ewing T, Rodriguez RR. Low dose rate brachytherapy in vaginal carcinoma: Long-term outcome and morbidity. *Journal of Brachytherapy International.* 2000;16(1):11-24.
77. Emmert C, Kohler U. Management of genital fistulas in patients with cervical cancer. *Archives of Gynecology & Obstetrics.* 1996;259(1):19-24.
78. Krause S, Hald T, Steven K. Surgery for urologic complications following radiotherapy for gynecologic cancer. *Scandinavian Journal of Urology & Nephrology.* 1987;21(2):115-8.
79. Maier U, Ehrenbock PM, Hofbauer J. Late urological complications and malignancies after curative radiotherapy for gynecological carcinomas: a retrospective analysis of 10,709 patients. *Journal of Urology.* 1997;158(3 Pt 1):814-7.
80. Monk BJ, Walker JL, Tewari K, Ramsinghani NS, Nisar Syed AM, DiSaia PJ. Open interstitial brachytherapy for the treatment of local-regional recurrences of uterine corpus and cervix cancer after primary surgery. *Gynecologic oncology.* 1994;52(2):222-8.
81. Angioli R, Penalver M, Muzii L, Mendez L, Mirhashemi R, Bellati F, et al. Guidelines of how to manage vesicovaginal fistula. *Critical Reviews in Oncology/Hematology.* 2003;48(3):295-304.
82. Chassagne D, Sismondi P, Horiot JC, Sinistrero G, Bey P, Zola P, et al. A glossary for reporting complications of treatment in gynecological cancers. *Radiotherapy and oncology : journal of the European Society for Therapeutic Radiology and Oncology.* 1993;26(3):195-202.
83. Shah TT, Ahmed H, Kanthabalan A, Lau B, Ghei M, Maraj B, et al. Focal cryotherapy of localized prostate cancer: a systematic review of the literature. *Expert review of anticancer therapy.* 2014;14(11):1337-47.
84. Ganzer R, Fritsche HM, Brandtner A, Brundl J, Koch D, Wieland WF, et al. Fourteen-year oncological and functional outcomes of high-intensity focused ultrasound in localized prostate cancer. *BJU Int.* 2013;112(3):322-9.
85. Park DS, Gong IH, Choi DK, Hwang JH, Shin HS, Oh JJ. Radical prostatectomy versus high dose permanent prostate brachytherapy using iodine-125 seeds for patients with high risk prostate cancer: a matched cohort analysis. *World J Urol.* 2013;31(6):1511-7.
86. Feddock J, Randall M, Kudrimoti M, Baldwin L, Shah P, Weiss H, et al. Impact of post-radiation biopsies on development of fistulae in patients with cervical cancer. *Gynecol Oncol.* 2014;133(2):263-7.
87. Caputo RM, Copeland LJ. Gynecologic effects of tamoxifen: case reports and review of the literature. *International Urogynecology Journal.* 1996;7(4):179-84.
88. Behtash N, Ghaemmaghami F, Ayatollahi H, Khaledi H, Hanjani P. A case-control study to evaluate urinary tract complications in radical hysterectomy 2005 [updated 16 Feb. Available from: <http://dx.doi.org/10.1186/1477-7819-3-12>.
89. Monk BJ, Solh S, Johnson MT, Montz FJ. Radical hysterectomy after pelvic irradiation in patients with high risk cervical cancer or uterine sarcoma: morbidity and outcome. *European journal of gynaecological oncology.* 1993;14(6):506-11.
90. Mitsuhashi N, Takahashi M, Yamakawa M, Nozaki M, Takahashi T, Sakurai H, et al. Results of postoperative radiation therapy for patients with carcinoma of the uterine cervix: evaluation of intravaginal cone boost with an electron beam. *Gynecologic oncology.* 1995;57(3):321-6.
91. Koumantakis E, Haralambakis Z, Koukourakis M, Mazonakis M, Haldeopoulos D, Papageorgiou N, et al. A pilot study on concurrent platinum chemotherapy and intracavitary brachytherapy for locally advanced cancer of the uterine cervix. *British Journal of Radiology.* 1998;71(MAY):552-7.
92. Matsumura M, Takeshima N, Ota T, Omatsu K, Sakamoto K, Kawamata Y, et al. Neoadjuvant chemotherapy followed by radical hysterectomy plus postoperative chemotherapy but no radiotherapy for Stage IB2-IIB cervical cancer-

- irinotecan and platinum chemotherapy. *Gynecologic oncology*. 2010;119(2):212-6.
93. Adaji SE, Bature SB, Shittu OS. Vaginally inserted herbs causing vesico-vaginal fistula and vaginal stenosis. *Int Urogynecol J*. 2013;24(6):1057-8.
 94. Donaldson JF, Tait C, Rad M, Walker S, Lam TB, Abdel-Fattah M, et al. Obstructive uropathy and vesicovaginal fistula secondary to a retained sex toy in the vagina. *J Sex Med*. 2014;11(10):2595-600.
 95. Penrose KJ, Ma Yin J, Tsokos N. Delayed vesicovaginal fistula after ring pessary usage. *Int Urogynecol J*. 2014;25(2):291-3.
 96. Paul S, Singh V, Sinha RJ, Kumar A. Vesico-vaginal fistula due to vaginal herb for primary infertility: could it be devastating? *BMJ case reports*. 2013;2013.
 97. Huang LK, Wang JH, Shen SH, Lin AT, Chang CY. Evaluation of the extent of ketamine-induced uropathy: the role of CT urography. *Postgrad Med J*. 2014;90(1062):185-90.
 98. Sparic R, Mirkovic L, Ravilic U, Janjic T. Obstetric complications of placenta previa percreta. *Vojnosanit Pregl*. 2014;71(12):1163-6.
 99. Burkland CE. Uterovesical fistula. *J Urol*. 1949;61(2):418-23.
 100. Nourse MH, Wishard WN, Jr. Uterovesical fistula with fetal parts presenting in external urethral meatus. *Trans Am Assoc Genitourin Surg*. 1953;45:8-11.
 101. Youssef AF. Menouria following lower segment cesarean section; a syndrome. *Am J Obstet Gynecol*. 1957;73(4):759-67.
 102. Rao MP, Dwivedi US, Datta B, Vyas N, Nandy PR, Trivedi S, et al. Post caesarean vesicouterine fistulae-- Youssef syndrome: our experience and review of published work. *ANZ J Surg*. 2006;76(4):243-5.
 103. Washington BB, Raker CA, Kabeja GA, Kay A, Hampton BS. Demographic and delivery characteristics associated with obstetric fistula in Kigali, Rwanda. *Int J Gynaecol Obstet*. 2015;129(1):34-7.
 104. Martinez Escoriza JC, Palacios Marques AM, Lopez Fernandez JA, Feliu Rey E, Martin Medina P, Herraiz Romero I, et al. Congenital vesicovaginal fistula with or without menouria: a literature review. *Eur J Obstet Gynecol Reprod Biol*. 2014;175:38-48.
 105. Eogan M, McKenna P. Conservative management of a traumatic uterovesical fistula ('Youssef's syndrome'). *Eur J Obstet Gynecol Reprod Biol*. 2003;110(1):114-6.
 106. Wiedemann A, Karroum S, Kociszewski J, Fabian G, Fusgen I. [The uterovesical fistula - report of a rare cause of incontinence and review of the literature]. *Aktuelle Urol*. 2014;45(1):48-9.
 107. Brummer TH JJ, Fraser J, Heikkinen AM, Kauko M, Mäkinen J, Seppälä T, Sjöberg J, Tomás E, Härkki P. FINHYST, a prospective study of 5279 hysterectomies: Complications and their risk factors. *Hum Reprod*. 2011;26:1741-51.
 108. Likic IS KS, Ladjevic NG, Stefanovic A, Jeremic K, Petkovic S, Dzamic Z. . . Analysis of urologic complications after radical hysterectomy. *American Journal of Obstetrics & Gynecology*. 2008;199:644.e1-3.
 109. Frankman EA WL, Bunker CH, Lowder JL. Lower urinary tract injury in women in the united states, 1979–2006. *Am J Obstet Gynecol*. 2010;202:495.e1-5.
 110. El-Tabey NA A-E-DB, Shaaban AA, El-Kappany HA, Mokhtar AA, El-Azab M, Kheir AA. Urological trauma after gynecological and obstetric surgeries. *Scandinavian Journal of Urology & Nephrology* 2011;185:945-50.
 111. Sachdev P.S. HN, Abbasi R.M., Das C.M. Genito-urinary fistula: a major morbidity in developing countries. *Journal of Ayub Medical College, Abbottabad (JAMC)*. 2009;21:8-11.
 112. Kumar A, Goyal NK, Das SK, Trivedi S, Dwivedi US, Singh PB. Our experience with genitourinary fistulae. *Urol Int*. 2009;82(4):404-10.
 113. Nawaz H. KM, Tareen F.M., Khan S. Retrospective study of 213 cases of female urogenital fistulae at the Department of Urology & Transplantation Civil Hospital Quetta, Pakistan. *Journal of the Pakistan Medical Association*. 2010;60:28-32.
 114. Chang KH, Bourke MG, Kavanagh DO, Neary PC, O'Riordan JM. A systematic review of the role of re-laparoscopy in the management of complications following laparoscopic colorectal surgery. *Surgeon*. 2016;14(5):287-93.
 115. Melegari S, Paparella S, Follini ML, Cappellano F, Ciotti MG, Giollo A, et al. Bilateral ureteroarterial fistula: a case report and review of literature. *Urologia*. 2016:0.
 116. Das A, Lewandoski P, Laganosky D, Walton J, Shenot P. Ureteroarterial fistula: A review of the literature. *Vascular*. 2016;24(2):203-7.
 117. Chadha R, Agarwal K, Choudhury SR, Debnath PR. The colovesical fistula in congenital pouch colon: a histologic study. *Journal of pediatric surgery*. 2008;43(11):2048-52.
 118. Ben-Ami H, Ginesin Y, Behar DM, Fischer D, Edoute Y, Lavy A. Diagnosis and treatment of

- urinary tract complications in Crohn's disease: an experience over 15 years. *Canadian journal of gastroenterology = Journal canadien de gastroenterologie*. 2002;16(4):225-9.
119. Greenstein AJ, Sachar DB, Tzakis A, Sher L, Heimann T, Aufses AH, Jr. Course of enterovesical fistulas in Crohn's disease. *American Journal of Surgery*. 1984;147(6):788-92.
 120. Margolin ML, Korelitz BI. Management of bladder fistulas in Crohn's disease. *Journal of Clinical Gastroenterology*. 1989;11(4):399-402.
 121. Woods RJ, Lavery IC, Fazio VW, Jagelman DG, Weakley FL. Internal fistulas in diverticular disease. *Diseases of the Colon & Rectum*. 1988;31(8):591-6.
 122. Glass RE, Ritchie JK, Lennard-Jones JE, Hawley PR, Todd IP. Internal fistulas in Crohn's disease. *Diseases of the Colon & Rectum*. 1985;28(8):557-61.
 123. Kyle J. Urinary complications of Crohn's disease. *World journal of surgery*. 1980;4(2):153-60.
 124. Najjar SF, Jamal MK, Savas JF, Miller TA. The spectrum of colovesical fistula and diagnostic paradigm. *American Journal of Surgery*. 2004;188(5):617-21.
 125. Schofield PF. Colovesical fistulas. *British Journal of Hospital Medicine*. 1988;39(6):483-7.
 126. Pollard SG, Macfarlane R, Greatorex R, Everett WG, Hartfall WG. Colovesical fistula. *Annals of the Royal College of Surgeons of England*. 1987;69(4):163-5.
 127. Ferguson GG, Lee EW, Hunt SR, Ridley CH, Brandes SB. Management of the Bladder During Surgical Treatment of Enterovesical Fistulas from Benign Bowel Disease. *Journal of the American College of Surgeons*. 2008;207(4):569-72.
 128. Garcea G, Majid I, Sutton CD, Pattenden CJ, Thomas WM. Diagnosis and management of colovesical fistulae; six-year experience of 90 consecutive cases. *Colorectal disease : the official journal of the Association of Coloproctology of Great Britain and Ireland*. 2006;8(4):347-52.
 129. McBeath RB, Schiff M, Jr., Allen V, Bottaccini MR, Miller JI, Ehreth JT. A 12-year experience with enterovesical fistulas. *Urology*. 1994;44(5):661-5.
 130. Mileski WJ, Joehl RJ, Rege RV, Nahrwold DL. One-stage resection and anastomosis in the management of colovesical fistula. *American Journal of Surgery*. 1987;153(1):75-9.
 131. Pokala N, Delaney CP, Brady KM, Senagore AJ. Elective laparoscopic surgery for benign internal enteric fistulas: a review of 43 cases. *Surgical endoscopy*. 2005;19(2):222-5.
 132. Hsieh JH, Chen WS, Jiang JK, Lin TC, Lin JK, Hsu H. Enterovesical fistula: 10 years experience. *Zhonghua yi xue za zhi = Chinese medical journal; Free China ed*. 1997;59(5):283-8.
 133. Liu CH, Chuang CK, Chu SH, Chen HW, Chen CS, Chiang YJ, et al. Enterovesical fistula: experiences with 41 cases in 12 years. *Chang Gung Medical Journal (Changgeng Yi Xue Za Zhi)*. 1999;22(4):598-603.
 134. Ouyang Q, Xue LY. Inflammatory bowel disease since the 21st Century in China—Turning challenges into opportunities. *Journal of Digestive Diseases*. 2012:accepted article (online). Available from: <http://dx.doi.org/10.1111/j.751-2980.012.00579.x>.
 135. Bahadursingh AM, Longo WE. Colovaginal fistulas. Etiology and management. *Journal of Reproductive Medicine*. 2003;48(7):489-95.
 136. Altman D, Forsgren C, Hjern F, Lundholm C, Cnattingius S, Johansson AL. Influence of hysterectomy on fistula formation in women with diverticulitis. *The British journal of surgery*. 2010;97(2):251-7.
 137. Browning A. Risk factors for developing residual urinary incontinence after obstetric fistula repair. *BJOG*. 2006;113(4):482-5.
 138. Goh JT. A new classification for female genital tract fistula. *Aust N Z J Obstet Gynaecol*. 2004;44:502-4.
 139. Goh JT, Browning A, Berhan B, Chang A. Predicting the risk of failure of closure of obstetric fistula and residual urinary incontinence using a classification system. *J obstet Gynaecol Res*. 2008;accepted for publication.
 140. Goh JT, Krause HG, Browning A, Chang A. Classification of female genito-urinary tract fistula: Inter- and intra-observer correlations. *J Obstet Gynaecol Res*. 2009;35:160-3.
 141. Capes T, Stanford EJ, Romanzi L, Foma Y, Moshier E. Comparison of two classification systems for vesicovaginal fistula. *Int Urogynecol J*. 2012;23(12):1679-85.
 142. Frajzyngier V, Li G, Larson E, Ruminjo J, Barone MA. Development and comparison of prognostic scoring systems for surgical closure of genitourinary fistula. *Am J Obstet Gynecol*. 2013;208(2):112 e1-11.
 143. Ostrzenski A, Ostrzenska KM. Bladder injury during laparoscopic surgery. *Obstet Gynecol Surv*. 1998;53(3):175-80.

144. Kochakarn W, Pummangura W. A new dimension in vesicovaginal fistula management: an 8-year experience at Ramathibodi hospital. *Asian J Surg.* 2007;30(4):267-71.
145. Kursh ED, Morse RM, Resnick MI, Persky L. Prevention of the development of a vesicovaginal fistula. *Surg Gynecol Obstet.* 1988;166(5):409-12.
146. Ho AM, Roth P, Cowan WD. Gaseous distention of the urinary bag indicating bladder perforation during laparoscopic pelvic procedures. *Int J Gynaecol Obstet.* 1996;55(3):297-8.
147. O'Brien WM, Lynch JH. Simplification of double-dye test to diagnose various types of vaginal fistulas. *Urology.* 1990;36(5):456.
148. Gannon MJ. The three swab test using knots for urovaginal fistula. *Surg Gynecol Obstet.* 1990;170(2):171.
149. Indraratna PL, Walsh CA, Moore KH. Intra-operative cystoscopy in gynaecological surgery: A brief overview. *Australian and New Zealand Journal of Obstetrics & Gynaecology.* 2011;51(3):272-5.
150. Gilmour DT, Dwyer PL, Carey MP. Lower urinary tract injury during gynecologic surgery and its detection by intraoperative cystoscopy. *Obstetrics & Gynecology.* 1999;94(5 pt.2):883-9.
151. Kruger PS, Whiteside RS. Pseudo-renal failure following the delayed diagnosis of bladder perforation after diagnostic laparoscopy. *Anaesthesia and intensive care.* 2003;31(2):211-3.
152. Sohail S, Siddiqui KJ. Trans-vaginal sonographic evaluation of vesicovaginal fistula. *JPMA The Journal of the Pakistan Medical Association.* 2005;55(7):292-4.
153. Volkmer BG, Kuefer R, Nessler T, Loeffler M, Gottfried HW. Colour Doppler ultrasound in vesicovaginal fistulas. *Ultrasound in medicine & biology.* 2000;26(5):771-5.
154. Narayanan P NM, Reynolds KM, Sahdev A, Reznick RH, Rockall AG. Fistulas in malignant gynaecologic disease: Etiology, imaging, and management. *Radiographics.* 2009;29:1073-83.
155. Hou X, Zhang W, Zhang Y. Ureteroenteric Fistula Revealed by 99mTc-DTPA Renal Scan. *Clin Nucl Med.* 2016.
156. Amendola MA, Agha FP, Dent TL, Amendola BE, Shirazi KK. Detection of occult colovesical fistula by the Bourne test. *American Journal of Roentgenology.* 1984;142(4):715-8.
157. Bernstine H, Steinmetz AP, Hardoff R. Urinary diarrhea detected by Tc-99m DTPA scintigraphy in a 3-year-old girl. *Clinical nuclear medicine.* 2002;27(4):287-9.
158. Jarrett TW, Vaughan ED, Jr. Accuracy of computerized tomography in the diagnosis of colovesical fistula secondary to diverticular disease. *Journal of Urology.* 1995;153(1):44-6.
159. Kavanagh D, Neary P, Dodd JD, Sheahan KM, O'Donoghue D, Hyland JM. Diagnosis and treatment of enterovesical fistulae. *Colorectal disease : the official journal of the Association of Coloproctology of Great Britain and Ireland.* 2005;7(3):286-91.
160. Kuhlman JE, Fishman EK. CT evaluation of enterovaginal and vesicovaginal fistulas. *Journal of computer assisted tomography.* 1990;14(3):390-4.
161. Bazi T. Spontaneous closure of vesicovaginal fistulas after bladder drainage alone: Review of the evidence. *International Urogynecology Journal & Pelvic Floor Dysfunction.* 2007;18(3):329-33.
162. Waaldijk K. The immediate surgical management of fresh obstetric fistulas with catheter and/or early closure. *International Journal of Gynaecology & Obstetrics.* 1994;45(1):11-6.
163. Waaldijk K. Immediate indwelling bladder catheterisation at postpartum urine leakage - personal experience of 1200 patients. *Tropical Doctor.* 1997;27:227-8.
164. Waaldijk K. The immediate management of fresh obstetric fistulas. *American Journal of Obstetrics & Gynecology.* 2004;191(3):795-9.
165. Chittacharoen A, Theppisai U. Urological injury during gynecologic surgical procedures. *J Med Assoc Thai.* 1993;76 Suppl 1:87-91.
166. Davits RJ, Miranda SI. Conservative treatment of vesicovaginal fistulas by bladder drainage alone. *Br J Urol.* 1991;68(2):155-6.
167. Dogra PN, Nabi G. Laser welding of vesicovaginal fistula. *International Urogynecology Journal & Pelvic Floor Dysfunction.* 2001;12(1):69-70.
168. Falk HC, Orkin LA. Nonsurgical closure of vesicovaginal fistulas. *Obstetrics & Gynecology.* 1957;9(5):538-41.
169. Frang D, Jilling A. Techniques for surgical repair of vesicovaginal fistulae. *International urology and nephrology.* 1983;15(2):161-9.
170. Gorrea AM, Zuazu FJ, Sanchis MJA, Cruz JJF. Spontaneous healing of uretero-vesico-vaginal fistulas. *European urology.* 1985;11(5):341-3.
171. Latzko W. Postoperative vesicovaginal fistulas: genesis and therapy. *Am J Surg.* 1942;58:211-8.
172. Lentz SS. Transvaginal repair of the posthysterectomy vesicovaginal fistula using a

- peritoneal flap: the gold standard. *Journal of Reproductive Medicine*. 2005;50(1):41-4.
173. Milicic D, Sprem M, Bagovic D. A method for the repair of vesicovaginal fistulas. *International Journal of Gynaecology & Obstetrics*. 2001;73(1):35-9.
 174. Soong Y, Lim PH. Urological injuries in gynaecological practice--when is the optimal time for repair? *Singapore medical journal*. 1997;38(11):475-8.
 175. Stovsky MD, Ignatoff JM, Blum MD, Nanninga JB, O'Connor VJ, Kursh ED. Use of electrocoagulation in the treatment of vesicovaginal fistulas. *J Urol*. 1994;152(5 Pt 1):1443-4.
 176. Yokoyama M, Arisawa C, Ando M. Successful management of vesicouterine fistula by luteinizing hormone-releasing hormone analog. *International journal of urology : official journal of the Japanese Urological Association*. 2006;13(4):457-9.
 177. Goh JT, Howat P, de Costa C. Oestrogen therapy in the management of vesicovaginal fistula. *The Australian & New Zealand journal of obstetrics & gynaecology*. 2001;41(3):333-4.
 178. Hemal AK, Wadhwa SN, Kriplani A, Hemal U. Youssef's syndrome: An appraisal of hormonal treatment. *Urologia Internationalis*. 1994;52(1):55-7.
 179. Jozwik M, Jozwik M. Spontaneous closure of vesicouterine fistula. Account for effective hormonal treatment. *Urologia Internationalis*. 1999;62(3):183-7.
 180. Kumar A, Vaidyanathan S, Sharma SK, Sharma AK, Goswami AK. Management of vesico-uterine fistulae: a report of six cases. *International Journal of Gynaecology & Obstetrics*. 1988;26(3):453-7.
 181. Rubino SM. Vesico-uterine fistula treated by amenorrhoea induced with contraceptive steroids. Two case reports. *BJOG : an international journal of obstetrics and gynaecology*. 1980;87(4):343-4.
 182. Tarhan F, Erbay E, Penbegul N, Kuyumcuoglu U. Minimal invasive treatment of vesicouterine fistula: A case report. *International urology and nephrology*. 2007;39(3):791-3.
 183. Novi JM, Rose M, Shaunik A, Ramchandani P, Morgan MA. Conservative management of vesicouterine fistula after uterine rupture. *International Urogynecology Journal & Pelvic Floor Dysfunction*. 2004;15(6):434-5.
 184. Razzaghi MR, Rezaei A, Javanmard B, Lotfi B. Desmopressin as an alternative solution for urinary leakage after ureterocaliceal surgeries. *Urology journal*. 2009;6(2):120-2.
 185. Garrido-Ruiz MC, Rosales B, Luis Rodriguez-Peralto J. Vulvar pseudoverrucous papules and nodules secondary to a urethral--vaginal fistula. *American Journal of Dermatopathology*. 2011;33(4):410-2.
 186. Onuora VC, al-Mohalhal S, Youssef AM, Patil M. Iatrogenic urogenital fistulae. *British journal of urology*. 1993;71(2):176-8.
 187. Gruen A, Musik T, Kohler C, Fuller J, Wendt T, Stromberger C, et al. Adjuvant chemoradiation after laparoscopically assisted radical vaginal hysterectomy (LARVH) in patients with cervical cancer: Oncologic outcome and morbidity. *Strahlentherapie und Onkologie*. 2011;187(6):344-9.
 188. Nashiro T, Yagi C, Hirakawa M, Inamine M, Nagai Y, Sakumoto K, et al. Concurrent chemoradiation for locally advanced squamous cell carcinoma of the vagina: Case series and literature review. *International Journal of Clinical Oncology*. 2008;13(4):335-9.
 189. Arias BE, Ridgeway B, Barber MD. Complications of neglected vaginal pessaries: case presentation and literature review. *International Urogynecology Journal & Pelvic Floor Dysfunction*. 2008;19(8):1173-738.
 190. Carr LK, Webster GD. Abdominal repair of vesicovaginal fistula. *Urology*. 1996;48(1):10-1.
 191. Aimakhu VE. Reproductive functions after the repair of obstetric vesicovaginal fistulae. *Fertility and sterility*. 1974;25(7):586-91.
 192. Hilton P, Ward A. Epidemiological and surgical aspects of urogenital fistulae: a review of 25 years' experience in southeast Nigeria. *Int Urogynecol J*. 1998;9(4):189-94.
 193. Hilton P. Vesico-vaginal fistulae - new perspectives. *Current Opinion in Obstetrics and Gynecology - Clinical Urogynaecology*. 13.5. London: Balliere-Tindall; 2002. p. 513-20.
 194. Hilton P. Vesico-vaginal fistulas in developing countries. *International Journal of Gynaecology & Obstetrics*. 2003;82(3):285-95.
 195. Miller S, Lester F, Webster M, Cowan B. Obstetric fistula: a preventable tragedy. *Journal of Midwifery & Women's Health*. 2005;50(4):286-94.
 196. Onolemhemhen DO, Ekwempu CC. An investigation of sociomedical risk factors associated with vaginal fistula in northern Nigeria. 0363-0242. 1999;28(3):103-16.
 197. Tahzib F. Epidemiological determinants of vesicovaginal fistulas. *British Journal of Obstetrics and Gynaecology*. 1983;90:387-91.
 198. Tahzib F. Vesicovaginal fistula in Nigerian children. *Lancet*. 1985;2:1291-3.

199. Game X, Malavaud B, Alric L, Mouzin M, Sarraon JP, Rischmann P. Infliximab treatment of Crohn disease ileovesical fistula. *Scandinavian journal of gastroenterology*. 2003;38(10):1097-8.
200. Sato S, Sasaki I, Naito H, Funayama Y, Fukushima K, Shibata C, et al. Management of urinary complications in Crohn's disease. *Surgery today*. 1999;29(8):713-7.
201. Serizawa H, Hibi T, Ohishi T, Watanabe N, Hamada Y, Watanabe M, et al. Laparoscopically assisted ileocecal resection for Crohn's disease associated with intestinal stenosis and ileovesical fistula. *Journal of gastroenterology*. 1996;31(3):425-30.
202. Shackley DC, Brew CJ, Bryden AA, Anderson ID, Carlson GL, Scott NA, et al. The staged management of complex entero-urinary fistulae. *BJU international*. 2000;86(6):624-9.
203. Tsai MS, Liang JT. Surgery is justified in patients with bowel obstruction due to radiation therapy. *Journal of Gastrointestinal Surgery*. 2006;10(4):575-82.
204. Eyre RC, Rosenthal JT, Libertino JA, Zinman LM. Management of urinary and bowel complications after ileal conduit diversion. *Journal of Urology*. 1982;128(6):1177-80.
205. Penalver MA, Angioli R, Mirhashemi R, Malik R. Management of early and late complications of ileocolonic continent urinary reservoir (Miami pouch). *Gynecologic oncology*. 1998;69(3):185-91.
206. Waaldijk K, Elkins T. The obstetric fistula and peroneal nerve injury: an analysis of 947 consecutive patients. *International Urogynecological Journal*. 1994;5:12-4.
207. Hilton P. Vesico-vaginal fistulas in developing countries. *International Journal of Gynecology & Obstetrics*. 2003;82(3):285-95.
208. Muleta M, Tafesse B, Aytenfisu HG. Antibiotic use in obstetric fistula repair: single blinded randomized clinical trial. *Ethiopian medical journal*. 2010;48(3):211-7.
209. Tomlinson AJ, Thornton JG. A randomised controlled trial of antibiotic prophylaxis for vesico-vaginal fistula repair. *British Journal of Obstetrics and Gynaecology*. 1998;105:397-9.
210. Arrowsmith SD, Ruminjo J, Landry EG. Current practices in treatment of female genital fistula: a cross sectional study. *BMC pregnancy and childbirth*. 2010;10(73):73.
211. Niel-Weise BS, van den Broek PJ. Antibiotic policies for short-term catheter bladder drainage in adults. *Cochrane Database of Systematic Reviews*. 2005;2005(3):CD005428.
212. Ojengbede OA, Morhason-Bello IO, Shittu O. One-stage repair for combined fistulas: myth or reality? *International Journal of Gynaecology & Obstetrics*. 2007;99(1).
213. Guenaga KF, Matos D, Wille-Jorgensen P. Mechanical bowel preparation for elective colorectal surgery. *Cochrane Database of Systematic Reviews*. 2011;9:CD001544.
214. Browning A, Fentahun W, Goh JT. The impact of surgical treatment on the mental health of women with obstetric fistula. *BJOG: an International Journal of Obstetrics & Gynaecology*. 2007;114(11):1439-41.
215. Goh JT, Sloane KM, Krause HG, Browning A, Akhter S. Mental health screening in women with genital tract fistulae. *BJOG: an International Journal of Obstetrics & Gynaecology*. 2005;112(9):1328-30.
216. Hilton P. Debate: 'Post-operative urinary fistulae should be managed by gynaecologists in specialist centres'. *Brit J Urol*. 1997;80, suppl 1:35-42.
217. Akhter S, Browning A, de Bernis L, Gueye S, Muleta M, Raassen TJ, et al. *Global Competency-Based Fistula Surgery Training Manual* London FIGO; 2011. Available from: http://www.figo.org/sites/default/files/uploads/wg-publications/fistula/FIGO_Global_Competency-Based_Fistula_Surgery_Training_Manual_0.pdf.
218. Lee JH, Choi JS, Lee KW, Han JS, Choi PC, Hoh JK. Immediate laparoscopic nontransvesical repair without omental interposition for vesicovaginal fistula developing after total abdominal hysterectomy. *JLS : Journal of the Society of Laparoendoscopic Surgeons / Society of Laparoendoscopic Surgeons*. 2010;14(2):187-91.
219. Shelbaia AM, Hashish NM. Limited Experience in Early Management of Genitourinary Tract Fistulas. *Urology*. 2007;69(3):572-4.
220. Badenoch DF, Tiptaft RC, Thakar DR, Fowler CG, Blandy JP. Early repair of accidental injury to the ureter or bladder following gynaecological surgery. *British journal of urology*. 1987;59(6):516-8.
221. Blandy JP, Badenoch DF, Fowler CG, Jenkins BJ, Thomas NW. Early repair of iatrogenic injury to the ureter or bladder after gynecological surgery. *Journal of Urology*. 1991;146(3):761-5.
222. Kam MH, Tan YH, Wong MY. A 12-year experience in the surgical management of vesicovaginal fistulae. *Singapore medical journal*. 2003;44(4):181-4.

223. Moriel EZ, Meiorow D, Zilberman M, Farkas A. Experience with the immediate treatment of iatrogenic bladder injuries and the repair of complex vesico-vaginal fistulae by the transvesical approach. *Archives of Gynecology & Obstetrics*. 1993;253(3):127-30.
224. Radoja I, Sudarevic B, Perkovic J, Rakin I, Cosic I, Pavlovic O, et al. Our experience with vesicovaginal fistula repair surgery. *European Urology, Supplements*. 2010;9 (6):637.
225. Wang Y, Hadley HR. Nondelayed transvaginal repair of high lying vesicovaginal fistula. *Journal of Urology*. 1990;144(1):34-6.
226. Dolan LM, Dixon WE, Hilton P. Urinary symptoms and quality of life following urogenital fistula repair: a long-term follow-up study. *BJOG*. 2008;115(12):1570-4.
227. Browning A, Menber B. Women with obstetric fistula in Ethiopia: a 6-month follow up after surgical treatment. *BJOG: an International Journal of Obstetrics & Gynaecology*. 2008;115(12):1564-9.
228. Sims J. On the treatment of vesico-vaginal fistula. *American Journal of the Medical Sciences*. 1852;XXIII:59-82.
229. Wall LL. Dr. George Hayward (1791-1863): a forgotten pioneer of reconstructive pelvic surgery. *Int Urogynecol J Pelvic Floor Dysfunct*. 2005;16(5):330-3.
230. Lawson J. Vesical fistulae into the vaginal vault. *British journal of urology*. 1972;44:623-31.
231. Moir JC. The vesico-vaginal fistula and its treatment. *Journal of the Royal College of Surgeons of Edinburgh*. 1962;7:268-74.
232. Hamlin R, Nicholson E. Reconstruction of urethra totally destroyed in labour. *British Medical Journal*. 1969;2:147-50.
233. Ayed M, El Atat R, Hassine LB, Sfaxi M, Chebil M, Zmerli S. Prognostic factors of recurrence after vesicovaginal fistula repair. *International journal of urology : official journal of the Japanese Urological Association*. 2006;13(4):345-9.
234. Catanzaro F, Pizzoccaro M, Cappellano F, Catanzaro M, Ciotti G, Giollo A. Vaginal repair of vesico-vaginal fistulas: our experience. *Archivio italiano di urologia, andrologia : organo ufficiale [di] Societa italiana di ecografia urologica e nefrologica / Associazione ricerche in urologia*. 2005;77(4):224-5.
235. Demirel A, Polat O, Bayraktar Y, Gul O, Okyar G. Transvesical and transvaginal reparation in urinary vaginal fistulas. *International urology and nephrology*. 1993;25(5):439-44.
236. Langkilde NC, Pless TK, Lundbeck F, Nerstrom B. Surgical repair of vesicovaginal fistulae--a ten-year retrospective study. *Scandinavian Journal of Urology & Nephrology*. 1999;33(2):100-3.
237. Ockrim JL, Greenwell TJ, Foley CL, Wood DN, Shah PJR. A tertiary experience of vesico-vaginal and urethro-vaginal fistula repair: factors predicting success. *BJU international*. 2009;103(8):1122-6.
238. Ou CS, Huang UC, Tsuang M, Rowbotham R. Laparoscopic Repair of Vesicovaginal Fistula. *Journal of laparoendoscopic & advanced surgical techniques Part A*. 2004;14(1):17-21.
239. Hilton P, Ward A. Epidemiological and surgical aspects of urogenital fistulae: a review of 25 years experience in south-east Nigeria. *International Urogynecology Journal & Pelvic Floor Dysfunction*. 1998;9:189-94.
240. Shaker H, Saafan A, Yassin M, Idrissa A, Mourad MS. Obstetric vesico-vaginal fistula repair: should we trim the fistula edges? A randomized prospective study. *Neurourology and urodynamics*. 2011;30(3):302-5.
241. Nezhat CH, Nezhat F, Nezhat C, Rottenberg H. Laparoscopic repair of a vesicovaginal fistula: A case report. *Obstet Gynecol*. 1994;83(5 II):899-901.
242. Abdel-Karim AM, Mousa A, Hasouna M, Elsalmy S. Laparoscopic transperitoneal extravesical repair of vesicovaginal fistula. *International Urogynecology Journal & Pelvic Floor Dysfunction*. 2011;22(6):693-7.
243. Abdel-Karim AM, Moussa A, Elsalmy S. Laparoscopic single-site surgery extravesical repair of vesicovaginal fistula: early experience. *Urology*. 2011;78(3):567-71.
244. Chibber PJ, Shah HN, Jain P. Laparoscopic O'Connor's repair for vesico-vaginal and vesico-uterine fistulae. *BJU International*. 2005;96(1):183-6.
245. Das Mahapatra P, Bhattacharyya P. Laparoscopic intraperitoneal repair of high-up urinary bladder fistula: a review of 12 cases. *International Urogynecology Journal & Pelvic Floor Dysfunction*. 2007;18(6):635-9.
246. Gozen AS, Teber D, Canda AE, Rassweiler J. Transperitoneal laparoscopic repair of iatrogenic vesicovaginal fistulas: Heilbronn experience and review of the literature. *Journal of Endourology*. 2009;23(3):475-9.
247. Miklos JR, Sobolewski C, Lucente V. Laparoscopic management of recurrent vesicovaginal fistula. *International Urogynecology Journal & Pelvic Floor Dysfunction*. 1999;10(2):116-7.
248. Otsuka RAP, Amaro JL, Tanaka MT, Epacagnan E, Mendes Jr JB, Kawano PR, et al. Laparoscopic repair of vesicovaginal fistula.

Journal of endourology / Endourological Society. 2008;22(3):525-7.

249. Phipps J. Laparoscopic repair of posthysterectomy vesicovaginal fistula: Two case reports. *Gynaecological Endoscopy*. 1996;5(2):123-4.
250. Porpiglia F, Fiori C, Morra I, Ragni F, Vaccino D, Scarpa RM. Laparoscopic vesico-vaginal fistula repair: our experience and review of the literature. [Review] [25 refs]. *Surgical laparoscopy, endoscopy & percutaneous techniques*. 2009;19(5):410-4.
251. Rizvi SJ, Gupta R, Patel S, Trivedi A, Trivedi P, Modi P. Modified laparoscopic abdominal vesico-vaginal fistula repair-'Mini- o'Conor' vesicotomy. *Journal of laparoendoscopic & advanced surgical techniques Part A*. 2010;20(1):13-5.
252. Shah SJ. Laparoscopic transabdominal transvesical vesicovaginal fistula repair. *Journal of Endourology*. 2009;23(7):1135-7.
253. Sotelo R, Mariano MB, Garcia-Segui A, Dubois R, Spaliviero M, Keklikian W, et al. Laparoscopic repair of vesicovaginal fistula. *Journal of Urology*. 2005;173(5):1615-8.
254. Wong C, Lam PN, Lucente VR. Laparoscopic transabdominal transvesical vesicovaginal fistula repair. *Journal of endourology / Endourological Society*. 2006;20(4):240-3.
255. Grange P, Giarenis I, Rouse P, Kouriefs C, Robinson D, Cardozo L. Combined vaginal and vesicoscopic collaborative repair of complex vesicovaginal fistulae. *Urology*. 2014;84(4):950-4.
256. Grange P, Shakir F, Thiagamoorthy G, Robinson D, Cardozo L. Combined Laparoscopic, Vesicoscopic, and Vaginal Repair of a Vesico-vaginal Fistula. *Journal of minimally invasive gynecology*. 2016;23(6):859-60.
257. Melamud O, Eichel L, Turbow B, Shanberg A. Laparoscopic vesicovaginal fistula repair with robotic reconstruction. *Urology*. 2005;65(1):163-6.
258. Hemal AK, Kolla SB, Wadhwa P. Robotic Reconstruction for Recurrent Supratrigonal Vesicovaginal Fistulas. *Journal of Urology*. 2008;180(3):981-5.
259. Kurz M, Horstmann M, John H. Robot-assisted laparoscopic repair of high vesicovaginal fistulae with peritoneal flap inlay. *European urology*. 2012;61(1):229-30.
260. Schimpf MO, Morgenstern JH, Tulikangas PK, Wagner JR. Vesicovaginal fistula repair without intentional cystostomy using the laparoscopic robotic approach: a case report. *JSLs : Journal of the Society of Laparoendoscopic Surgeons / Society of Laparoendoscopic Surgeons*. 2007;11(3):378-80.
261. Sundaram BM, Kalidasan G, Hemal AK. Robotic repair of vesicovaginal fistula: Case series of five patients. *Urology*. 2006;67(5):970-3.
262. Miklos JR, Moore RD, Chinthakanan O. Laparoscopic and Robotic-assisted Vesicovaginal Fistula Repair: A Systematic Review of the Literature. *Journal of minimally invasive gynecology*. 2015;22(5):727-36.
263. Gellhaus PT, Bhandari A, Monn MF, Gardner TA, Kanagarajah P, Reilly CE, et al. Robotic management of genitourinary injuries from obstetric and gynaecological operations: a multi-institutional report of outcomes. *BJU Int*. 2015;115(3):430-6.
264. Shekarriz B, Stoller ML. The use of fibrin sealant in urology. *Journal of Urology*. 2002;167(3):1218-25.
265. Grumbt H, Kurz W, Knoth HJ. [Closure of a vesico-perineal fistula with fibrin glue]. *Zentralbl Chir*. 1984;109(5):364-5.
266. Morita T, Tachikawa N, Tokue A. Successful closure of neovesicocutaneous fistula with fibrin glue. *Urologia Internationalis*. 1998;61(2):130-1.
267. Morita T, Tokue A. Successful endoscopic closure of radiation induced vesicovaginal fistula with fibrin glue and bovine collagen. *Journal of Urology*. 1999;162(5):1689.
268. Rossi D, Bladou F, Berthet B, Coulange C, Serment G. [A simple alternative for the treatment of urinary fistulas: fibrin glue]. *Progres en Urologie*. 1991;1(3):445-8.
269. Schneider JA, Patel VJ, Hertel E. [Closure of vesicovaginal fistulas from the urologic viewpoint with reference to endoscopic fibrin glue technique]. *Zentralbl Gynakol*. 1992;114(2):70-3.
270. Tostain J. [Conservative treatment of urogenital fistula following gynecological surgery: the value of fibrin glue]. *Acta urologica Belgica*. 1992;60(3):27-33.
271. Welp T, Bauer O, Diedrich K. [Use of fibrin glue in vesico-vaginal fistulas after gynecologic treatment]. *Zentralbl Gynakol*. 1996;118(7):430-2.
272. Yashi M, Muraishi O, Yuzawa M, Tokue A. [A case of colo-vesico-vaginal fistula caused by sigmoid colon diverticulitis]. *Hinyokika Kyo*. 1998;44(7):513-5.
273. D'Arcy FT, Jaffry S. The treatment of vesicovaginal fistula by endoscopic injection of fibrin

- glue. The surgeon : journal of the Royal Colleges of Surgeons of Edinburgh and Ireland. 2010;8(3):174-6.
274. Daley SM, Lallas CD, Swanson SK, Novicki DE, Itano NB. Fibrin Sealant Closure of a Persistent Vesicovaginal Fistula After Failed Transabdominal Closure. *Journal of Pelvic Medicine & Surgery*. 2006;12(4):229-30.
 275. Evans LA, Ferguson KH, Foley JP, Rozanski TA, Morey AF. Fibrin sealant for the management of genitourinary injuries, fistulas and surgical complications. *Journal of Urology*. 2003;169(4):1360-2.
 276. Lazarou G, Grigorescu B, Powers K, Mikhail MS. Transvaginal injection of fibrin sealant for closure of vesicovaginal fistula. *Journal of Pelvic Medicine & Surgery*. 2006;12(6):335-7.
 277. Safan A, Shaker H, Abdelaal A, Mourad MS, Albaz M. Fibrin glue versus martius flap interpositioning in the repair of complicated obstetric vesicovaginal fistula. A prospective multi-institution randomized trial. *Neurourology and urodynamics*. 2009;28(5):438-41.
 278. Sharma SK, Perry KT, Turk TMT. Endoscopic injection of fibrin glue for the treatment of urinary-tract pathology. *Journal of endourology / Endourological Society*. 2005;19(3):419-23.
 279. McKay HA. Vesicovaginal and vesicocutaneous fistulas: transurethral suture cystorrhaphy as a new closure technique. *Journal of Urology*. 1997;158(4):1513-6.
 280. McKay HA. Transurethral suture cystorrhaphy for repair of vesicovaginal fistulas: Evolution of a technique. *International Urogynecology Journal & Pelvic Floor Dysfunction*. 2001;12(4):282-7.
 281. Okamura K, Kanai S, Kurokawa T, Kondo A. Endoscopic transvesico-transurethral approach for repair of vesicovaginal fistula: Initial case report. *Journal of endourology / Endourological Society*. 1997;11(3):203-5.
 282. Rangnekar NP, Imdad Ali N, Kaul SA, Pathak HR. Role of the martius procedure in the management of urinary-vaginal fistulas. *J Am Coll Surg*. 2000;191(3):259-63.
 283. Zimmermann P, Schmidbauer CP, Leach GE, Staskin DR, Hadley HR, Raz S. Vesicovaginal and urethrovaginal fistulae. *Semin Urol*. 1986;4(1):24-9.
 284. Turner-Warwick R. The use of the omental pedicle graft in urinary tract reconstruction. *Journal of Urology*. 1976;116:341-7.
 285. Wein AJ, Malloy TR, Carpiello VL, Greenberg SH, Murphy JJ. Repair of vesicovaginal fistula by a suprapubic transvesical approach. *Surg Gynecol Obstet*. 1980;150(1):57-60.
 286. Evans DH, Madjar S, Politano VA, Bejany DE, Lynne CM, Gousse AE. Interposition flaps in transabdominal vesicovaginal fistula repairs: are they really necessary? *Urology*. 2001;57(4):670-4.
 287. Izes J, Smith J, Zinman L. The gracilis muscle in repair of complex lower urinary tract fistulae (15 year experience). *J Urol*. 1992;147 (suppl):281A.
 288. Symmonds RE, Hill LM. Loss of the urethra: a report on 50 patients. *Am J Obstet Gynecol*. 1978;130(2):130-8.
 289. Mraz JP, Sutory M. An alternative in surgical treatment of post-irradiation vesicovaginal and rectovaginal fistulas: the seromuscular intestinal graft (patch). *J Urol*. 1994;151(2):357-9.
 290. Menchaca A, Akhyat M, Gleicher N, Gottlieb L, Bernstein J. The rectus abdominis muscle flap in a combined abdominovaginal repair of difficult vesicovaginal fistulae. A report of three cases. *J Reprod Med*. 1990;35(5):565-8.
 291. Viennas LK, Alonso AM, Salama V. Repair of radiation-induced vesicovaginal fistula with a rectus abdominis myocutaneous flap. *Plastic & Reconstructive Surgery*. 1995;96(6):1435-7.
 292. Brandt FT, Lorenzato FR, Albuquerque CD. Treatment of vesicovaginal fistula by bladder mucosa autograft technique. *J Am Coll Surg*. 1998;186(6):645-8.
 293. Ostad M, Uzzo RG, Coleman J, Young GP. Use of a free bladder mucosal graft for simple repair of vesicovaginal fistulae. *Urology*. 1998;52(1):123-6.
 294. Sharifi-Aghdas F, Ghaderian N, Payvand A. Free bladder mucosal autograft in the treatment of complicated vesicovaginal fistula. *BJU Int*. 2002;89 Suppl 1:54-6.
 295. Nardos R, Browning A, Member B. Duration of bladder catheterization after surgery for obstetric fistula. *International Journal of Gynaecology & Obstetrics*. 2008;103(1):30-2.
 296. Hedlund H, Lindstedt E. Urovaginal fistulas: 20 years of experience with 45 cases. *Journal of Urology*. 1987;137(5):926-8.
 297. Jovanovic MD, Milovic N, Aleksic P, Bancevic V, Kosevic B, Campara Z, et al. Efficiency of urinary fistulas surgical treatment. *European Urology, Supplements*. 2010;9 (6):572.
 298. Madjar S, Gousse A. Postirradiation vesicovaginal fistula completely resolved with conservative treatment. *International Urogynecology Journal & Pelvic Floor Dysfunction*. 2001;12(6):405-6.

299. Vanni AJ, Buckley JC, Zinman LN. Management of surgical and radiation induced rectourethral fistulas with an interposition muscle flap and selective buccal mucosal onlay graft. *Journal of Urology*. 2010;184(6):2400-4.
300. Kisner CD, Kesner KM. Use of the transverse colon conduit for vesicovaginal fistula in late-stage carcinoma of the cervix. *British journal of urology*. 1987;59(3):234-8.
301. Ravi R, Dewan AK, Pandey KK. Transverse colon conduit urinary diversion in patients treated with very high dose pelvic irradiation. *British journal of urology*. 1994;73(1):51-4.
302. Schmidt JD, Hawtrey CE, Buchsbaum HJ. Transverse colon conduit: a preferred method of urinary diversion for radiation-treated pelvic malignancies. *Journal of Urology*. 1975;113(3):308-13.
303. Hampson SJ, Morris SB, Gordon EM, Shearer RJ. Management of inoperable pelvic carcinomas with complex fistulas: a new approach. *Annals of the Royal College of Surgeons of England*. 1994;76(3):188-9.
304. Leissner J, Black P, Filipas D, Fisch M, Hohenfellner R. Vaginal reconstruction using the bladder and/or rectal walls in patients with radiation-induced fistulas. *Gynecologic oncology*. 2000;78(3 Pt 1):356-60.
305. Hsu TH, Rackley RR, Abdelmalak JB, Madjar S, Vasavada SP. Novel technique for combined repair of postirradiation vesicovaginal fistula and augmentation ileocystoplasty. *Urology*. 2002;59(4):597-9.
306. Tabakov ID, Slavchev BN. Large post-hysterectomy and post-radiation vesicovaginal fistulas: repair by ileocystoplasty. *Journal of Urology*. 2004;171(1):272-4.
307. Kulkarni JN, Gulla RI. 1-Stage repair of radiation induced colovesical fistula by resection and colocystoplasty. *Journal of Urology*. 1998;160(6 Pt 1):2149-50.
308. Verbaeys C, Hoebeke P, Oosterlinck W. Complicated postirradiation vesicovaginal fistula in young women: keep off or try reconstruction? *European urology*. 2007;51(1):243-6; discussion 6.
309. Hilton P. Fistula repair. In: Smith R, del Priore G, Curtin J, Monaghan J, editors. *An Atlas of Gynaecological Oncology*. 3rd ed. London: Taylor & Francis Medical Books; 2011. p. 236-50.
310. Aitken RJ, Elliot MS. Sigmoid exclusion: a new technique in the management of radiation-induced fistula. *The British journal of surgery*. 1985;72(9):731-2.
311. Levenback C, Gershenson DM, McGehee R, Eifel PJ, Morris M, Burke TW. Enterovesical fistula following radiotherapy for gynecologic cancer. *Gynecologic oncology*. 1994;52(3):296-300.
312. Kiricuta I, Goldstein AM. The repair of extensive vesicovaginal fistulas with pedicled omentum: a review of 27 cases. *Journal of Urology*. 1972;108(5):724-7.
313. Browning A. Lack of value of the Martius fibrofatty graft in obstetric fistula repair. *International Journal of Gynecology & Obstetrics*. 2006;93(1):33-7.
314. Bizic M, Kojovic V, Majstorovic M, Djordjevic M. A versatile labia minora skin flap in severe vesicovaginal fistula repair. *European Urology, Supplements*. 2010;9 (6):572.
315. Lai YL, Chang CJ. Vulvovaginal reconstruction following radical tumor resection: report of 12 cases. *Chang Gung Medical Journal*. 1999;22(2):253-8.
316. Stanojevic D, Djordjevic M, Martins F, Rudic J, Stanojevic M, Bizic M, et al. [Repair of vesicovaginal fistula caused by radiation therapy with labia maiora skin flap]. *Srp Arh Celok Lek*. 2010;138(5-6):356-61.
317. Tran KT, Kuijpers HC, van Nieuwenhoven EJ, van Goor H, Spauwen PH. Transposition of the rectus abdominis muscle for complicated pouch and rectal fistulas. *Diseases of the Colon & Rectum*. 1999;42(4):486-9.
318. Amsellem-Ouazana D, Cornud F, Conquy S, Beuzeboc P, Massault PP, Vieillefond A, et al. Management of a malignant urinary fistula by ureteral embolization with coils. *Urology*. 2006;68(2):427.e1-e3.
319. Gaylord GM, Johnsrude IS. Transrenal ureteral occlusion with Gianturco coils and gelatin sponge. *Radiology*. 1047;172(3 Pt 2):1047-8.
320. Farrell TA, Wallace M, Hicks ME. Long-term results of transrenal ureteral occlusion with use of Gianturco coils and gelatin sponge pledgets. *Journal of Vascular & Interventional Radiology*. 1997;8(3):449-52.
321. Farrell T, Yamaguchi T, Barnhart W, Lang E. Percutaneous ureteral clipping: long-term results and complications. *Journal of Vascular & Interventional Radiology*. 1997;8(3):453-6.
322. Kinn AC, Ohlsen H, Brehmer-Andersson E, Brundin J. Therapeutic ureteral occlusion in advanced pelvic malignant tumors. *Journal of Urology*. 1986;135(1):29-32.
323. Schild HH, Gunther R, Thelen M. Transrenal ureteral occlusion: results and problems. *Journal of Vascular & Interventional Radiology*. 1994;5(2):321-5.

324. Papanicolaou N, Pfister RC, Yoder IC. Percutaneous occlusion of ureteral leaks and fistulae using nondetachable balloons. *Urol Radiol*. 1985;7(1):28-31.
325. Sanchez R, Quinn SF, Morrisseau PM, Roberts W, Kavanagh J, Clark RA. Urinary diversion by using a percutaneous ureteral occlusion device. *American Journal of Roentgenology*. 1988;150(5):1069-70.
326. Horenblas S, Kroger R, Van Boven E, Meinhardt W, Newling DWW. Use of balloon catheters for ureteral occlusion in urinary leakage. *European urology*. 2000;38(5):613-7.
327. Avritscher R, Madoff DC, Ramirez PT, Wallace MJ, Ahrar K, Morello FA, Jr., et al. Fistulas of the lower urinary tract: percutaneous approaches for the management of a difficult clinical entity. *Radiographics*. 2004;24(suppl 1):S217-S36.
328. Levy C, Tremaine WJ. Management of internal fistulas in Crohn's disease. *Inflammatory bowel diseases*. 2002;8(2):106-11.
329. Present DH, Rutgeerts P, Targan S, Hanauer SB, Mayer L, van Hogezaand RA, et al. Infliximab for the treatment of fistulas in patients with Crohn's disease. *The New England journal of medicine*. 1999;340(18):1398-405.
330. Sonnenberg A, Gavin MW. Timing of surgery for enterovesical fistula in Crohn's disease: decision analysis using a time-dependent compartment model. *Inflammatory bowel diseases*. 2000;6(4):280-5.
331. Amin M, Nallinger R, Polk HC, Jr. Conservative treatment of selected patients with colovesical fistula due to diverticulitis. *Surgery, gynecology & obstetrics*. 1984;159(5):442-4.
332. Lewis SL, Abercrombie GF. Conservative surgery for vesicocolic fistula. *Journal of the Royal Society of Medicine*. 1984;77(2):102-4.
333. McNamara MJ, Fazio VW, Lavery IC, Weakley FL, Farmer RG. Surgical treatment of enterovesical fistulas in Crohn's disease. *Diseases of the Colon & Rectum*. 1990;33(4):271-6.
334. Pontari MA, McMillen MA, Garvey RH, Ballantyne GH. Diagnosis and treatment of enterovesical fistulae. *The American surgeon*. 1992;58(4):258-63.
335. McConnell DB, Sasaki TM, Vetto RM. Experience with colovesical fistula. *American Journal of Surgery*. 1980;140(1):80-4.
336. Balaguera CJ, Camunas Segovia J, Pena Gamarra L, Oliart Delgado de Torres S, Martin Garcia-Almenta M, Viso Ciudad S, et al. Colovesical fistula complicating diverticular disease: one-stage resection. *International Surgery*. 2006;91(1):17-23.
337. Menenakos E, Hahnloser D, Nassiopoulou K, Chanson C, Sinclair V, Petropoulos P. Laparoscopic surgery for fistulas that complicate diverticular disease. *Langenbeck's archives of surgery / Deutsche Gesellschaft fur Chirurgie*. 2003;388(3):189-93.
338. Tsivian A, Kyzer S, Shtricker A, Benjamin S, Sidi AA. Laparoscopic treatment of colovesical fistulas: technique and review of the literature. *International journal of urology : official journal of the Japanese Urological Association*. 2006;13(5):664-7.
339. Dobrowolski Z KJ, Drewniak T, Habrat W, Lipczynski W, Jakubik P, Weglarz W. Renal and ureteric trauma: Diagnosis and management in Poland. *BJU international*. 2002;89:748-51.
340. Djakovic N PE, Martínez-Piñeiro L, Lynch T, Mor Y, Santucci RA, Serafetinidis E, Turkeri LN, Hohenfellner M. European Association of Urology Guidelines on Urological Trauma 2009. http://www.uroweb.org/gls/pdf/20_Urological_Trauma%202009pdf. 2009.
341. Brandes S CM, Armenakas N, McAninch J. Diagnosis and management of ureteric injury: An evidence-based analysis. *BJU international*. 2004;95:277-89.
342. Chou MT WC, Lien RC. Prophylactic ureteral catheterization in gynecologic surgery: a 12-year randomized trial in a community hospital. *Int Urogynecol J Pelvic Floor Dysfunct*. 2009;20:689-93.
343. Razzaghi MR RA, Javanmard B, Lotfi B. Desmopressin as an alternative solution for urinary leakage after ureterocaliceal surgeries. *Urology Journal* 2009;6:120-2.
344. Van den Bergh RN MF, De Vries JP, Lock TM. Arterio-ureteral fistulas: Unusual suspects-systematic review of 139 cases. *Urology*. 2009;74:251-5.
345. Schimpf M GE, Wagner J. Universal ureteral stent placement at hysterectomy to identify ureteral injury: a decision analysis. *BJOG*. 2008;115:1151-8.
346. Kundu SD TR, Kallingal GJ, Cambareri G, Russo P. Urinary fistulae after partial nephrectomy. *BJU International*. 2010;106:1042-4.
347. Erlich T, Abu-Ghanem Y, Ramon J, Mor Y, Rosenzweig B, Dotan Z. Postoperative Urinary Leakage Following Partial Nephrectomy for Renal Mass: Risk Factors and a Proposed Algorithm for the Diagnosis and Management. *Scand J Surg*. 2016.
348. Mazzucchi E SG, Hisano M, Antonopoulos IM, Piovesan AC, Nahas WC, Lucon AM, Srougi M. Primary reconstruction is a good option in the

- treatment of urinary fistula after kidney transplantation. *International Braz J Urol* 2006;32:398-403.
349. Nie ZL ZK, Li QS, Jin FS, Zhu FQ, Huo WQ. Treatment of urinary fistula after kidney transplantation. *Transplantation Proceedings*. 2009;41:1624-6.
 350. Basic D DJ, Milutinovic D, Dzamic Z, Topuzovic C, Pejicic T. Ureteral fistulae after kidney transplantation: Experience with 224 cases. *Acta Chir Iugosl*. 2011;58:89-94.
 351. Vanderbrink BA RA, Caplin D, Ost MC, Lobko I, Lee BR. Successful conservative management of colorenal fistula after percutaneous cryoablation of renal-cell carcinoma. *Journal of Endourology*. 2007;21:26-9.
 352. Ould Ismail T HF, Janane A, Dekkak Y, Sossa J, Chafiki J, Lahrech Y, Qarro A, Jira H, Ghadouane M, Ameer A, Abbar M. Renocolic fistula following abdominal trauma: a case study. *Progres en Urologie* 2010;20:230-2.
 353. El-Nahas AR SA, El-Assmy AM, Shoma AM, Eraky I, El-Kenawy MR, El-Kappany HA. Colonic perforation during percutaneous nephrolithotomy. *Urology*. 2006;67:937-41.
 354. Fox JA KA, McPhail AF, Lightner D. Ureteroarterial fistula treatment with open surgery versus Endovascular Management: Long-Term Outcomes. *Journal of Urology*. 2009;185:945-50.
 355. Kiran A, Hilton P, Cromwell DA. The risk of ureteric injury associated with hysterectomy: a 10-year retrospective cohort study. *BJOG*. 2016;123(7):1184-91.
 356. Shaw MB TM, Rix DA, Dorkin TJ, Murthy LN, Pickard RS The management of bilateral ureteric injury following radical hysterectomy. *Adv Urol*. 2008;524919.
 357. Andriole GL, Bettmann MA, Garnick MB, Richie JP. Indwelling double-J ureteral stents for temporary and permanent urinary drainage: experience with 87 patients. *Journal of Urology*. 1984;131(2):239-41.
 358. Barton DP, Morse SS, Fiorica JV, Hoffman MS, Roberts WS, Cavanagh D. Percutaneous nephrostomy and ureteral stenting in gynecologic malignancies. *Obstetrics & Gynecology*. 1992;80(5):805-11.
 359. Beaghtler MA, Taylor FC, McLaughlin KP. A combined antegrade and retrograde technique for reestablishing ureteral continuity. *Techniques in urology*. 1997;3(1):44-8.
 360. Campbell SC, Strem SB, Zelch M, Hodge E, Novick AC. Percutaneous management of transplant ureteral fistulas: patient selection and long-term results. *Journal of Urology*. 1993;150(4):1115-7.
 361. Dowling RA, Corriere JN, Jr., Sandler CM. Iatrogenic ureteral injury. *Journal of Urology*. 1986;135(5):912-5.
 362. Koonings PP, Huffman JL, Schlaerth JB. Ureterscopy: A new asset in the management of postoperative ureterovaginal fistulas. *Obstetrics & Gynecology*. 1992;80(3 Pt 2):548-9.
 363. Lang EK. Antegrade ureteral stenting for dehiscence, strictures, and fistulae. *American Journal of Roentgenology*. 1984;143(4):795-801.
 364. Lingeman JE, Wong MYC, Newmark JR. Endoscopic management of total ureteral occlusion and ureterovaginal fistula. *Journal of endourology / Endourological Society*. 1995;9(5):391-6.
 365. Mandal AK, Sharma SK, Vaidyanathan S, Goswami AK. Ureterovaginal fistula: Summary of 18 years' experience. *British journal of urology*. 1990;65(5):453-6.
 366. Narang V, Sinha T, Karan SC, Sandhu AS, Sethi GS, Srivastava A, et al. Ureterscopy: savior to the gynecologist? Ureterscopic management of post laparoscopic-assisted vaginal hysterectomy ureterovaginal fistulas. *Journal of Minimally Invasive Gynecology*. 2007;14(3):345-7.
 367. Ustunsoz B, Ugurel S, Duru NK, Ozgok Y, Ustunsoz A. Percutaneous management of ureteral injuries that are diagnosed late after cesarean section. *Korean journal of radiology : official journal of the Korean Radiological Society*. 2008;9(4):348-53.
 368. Wang AC, Hung CF. Endourologic diagnosis and treatment of ureterouterine fistula. *International Urogynecology Journal & Pelvic Floor Dysfunction*. 1997;8(3):164-7.
 369. Puntambekar S PR, Gurjar AM, Sathe RM, Talaulikar AG, Agarwal GA, Kashyap M. Laparoscopic ureteroneocystostomy with psoas hitch. *Journal of Minimally Invasive Gynecology*. 2006;13:302-5.
 370. Modi P GR, Rizvi SJ. Laparoscopic ureteroneocystostomy and psoas hitch for post-hysterectomy ureterovaginal fistula. *Journal of Urology*. 2008;180:615-7.
 371. Laungani R PN, Krane LS, Hemal AK, Raja S, Bhandari M, Menon M. Robotic-assisted ureterovaginal fistula repair: Report of efficacy and feasibility. *Journal of Laparoendoscopic and Advanced Surgical Techniques*. 2008;18:731-4.
 372. Chen SS YS-H, Yang J-M, Huang W-C. Transvaginal repair of ureterovaginal fistula by Latzko technique. *Int Urogynecol Journal*. 2007;18:1381-3.

373. Natarajan V BN, Meiring P, Spencer P, Parys BT, Oakley NE. Ureteric embolization: An alternative treatment strategy for urinary fistulae complicating advanced pelvic malignancy. *BJU International*. 2007;99:147-9.
374. Shindel AW ZH, Hovsepian DM, Brandes SB. Ureteric embolization with stainless-steel coils for managing refractory lower urinary tract fistula: a 12-year experience. *BJU International*. 2007;99:364-8.
375. Kim SK LY, Kyung MS, Choi JS. Transrenal ureteral occlusion with the use of microcoils in five patients with ureterovaginal fistulas. *Abdom Imaging* 2008;33:615-20.
376. Park S, Ha SH, Kim KS. Long-term follow-up after feminizing genital reconstruction in patients with ambiguous genitalia and high vaginal confluence. *J Korean Med Sci*. 2011;26(3):399-403.
377. Dhabalia JV, Nelivigi GG, Satia MN, Kakkattil S, Kumar V. Congenital urethrovaginal fistula with imperforate hymen: a first case report. *J Obstet Gynaecol Can*. 2009;31(7):652-3.
378. Oguzkurt P, Ince E, Ezer SS, Temiz A, Demir S, Hicsonmez A. Primary vaginal calculus secondary to urethrovaginal fistula with imperforate hymen in a 6-year-old girl. *J Pediatr Surg*. 2009;44(7):e11-3.
379. Levitt MA, Bischoff A, Pena A. Pitfalls and challenges of cloaca repair: how to reduce the need for reoperations. *Journal of pediatric surgery*. 2011;46(6):1250-5.
380. Levitt MA, Pena A. Cloacal malformations: lessons learned from 490 cases. *Seminars in pediatric surgery*. 2010;19(2):128-38.
381. Hage JJ, Bouman FG, Bloem JJ. Construction of the fixed part of the neourethra in female-to-male transsexuals: experience in 53 patients. *Plast Reconstr Surg*. 1993;91(5):904-10; discussion 11-3.
382. Hilton P. Urethrovaginal fistula associated with 'sterile abscess' formation following periurethral injection of dextranomer/hyaluronic acid copolymer (Zuidex) for the treatment of stress urinary incontinence--a case report. *Bjog*. 2009;116(11):1527-30.
383. Carlin BI, Klutke CG. Development of urethrovaginal fistula following periurethral collagen injection. *J Urol*. 2000;164(1):124.
384. Estevez JP, Colin P, Lucot JP, Collinet P, Cosson M, Boukerrou M. [Urethrovaginal fistulae resulting from sub-urethral slings for stress urinary incontinence treatment. A report of two cases and review of the literature]. *J Gynecol Obstet Biol Reprod (Paris)*. 2010;39(2):151-5.
385. Estevez JP, Cosson M, Boukerrou M. An uncommon case of urethrovaginal fistula resulting from tension-free vaginal tape. *Int Urogynecol J*. 2010;21(7):889-91.
386. Reisenauer C, Wallwiener D, Stenzl A, Solomayer FE, Sievert KD. Urethrovaginal fistula--a rare complication after the placement of a suburethral sling (IVS). *Int Urogynecol J Pelvic Floor Dysfunct*. 2007;18(3):343-6.
387. Glavind K, Larsen EH. Results and complications of tension-free vaginal tape (TVT) for surgical treatment of female stress urinary incontinence. *Int Urogynecol J Pelvic Floor Dysfunct*. 2001;12(6):370-2.
388. Morton HC, Hilton P. Urethral injury associated with minimally invasive mid-urethral sling procedures for the treatment of stress urinary incontinence: A case series and systematic literature search. *BJOG: An International Journal of Obstetrics and Gynaecology*. 2009;116(8):1120-6.
389. Lee D, Zimmern PE. Long-term functional outcomes following non-radiated urethrovaginal fistula repair. *World J Urol*. 2016;34(2):291-6.
390. Blaivas JG, Mekel G. Management of urinary fistulas due to midurethral sling surgery. *J Urol*. 2014;192(4):1137-42.
391. Reisenauer C, Janowitz J, Wallwiener D, Huebner M. Urethrovaginal fistulae associated with tension-free vaginal tape procedures: a clinical challenge. *Int Urogynecol J*. 2014;25(3):319-22.
392. Walker KF, Dasgupta J, Cust MP. A neglected shelf pessary resulting in a urethrovaginal fistula. *Int Urogynecol J*. 2011;22(10):1333-4.
393. Blaivas JG, Purohit RS. Post-traumatic female urethral reconstruction. *Curr Urol Rep*. 2008;9(5):397-404.
394. Liu GC, Xia HM, Wen YQ, Zhang LY, Li ZM. Considerations before repair of acquired rectourethral and urethrovaginal fistulas in children. *World J Pediatr*. 2008;4(1):53-7.
395. Holland AJ, Cohen RC, McKertich KM, Cass DT. Urethral trauma in children. *Pediatr Surg Int*. 2001;17(1):58-61.
396. Parkhurst JD, Coker JE, Halverstadt DB. Traumatic avulsion of the lower urinary tract in the female child. *J Urol*. 1981;126(2):265-7.
397. Kobayashi K, Otoshi T, Madono K, Momohara C, Imamura R, Takada S, et al. [A case of urethrovaginal fistula caused by a foreign body in the vagina]. *Hinyokika Kyo*. 2010;56(7):389-91.

398. Thrumurthy SG, Hill SR, Islam S. Iatrogenic urethrovaginal fistula from catheterization in labour. *Br J Hosp Med (Lond)*. 2010;71(7):414.
399. Cameron AP, Atiemo HO. Unusual presentation of an obstetrical urethrovaginal fistula secondary to improper catheter placement. *Can Urol Assoc J*. 2009;3(4):E21-E2.
400. Ben Amna M, Hajri M, Moualli SB, Mehrez R, Chebil M, Ayed M. [The female urethral diverticula: apropos of 21 cases]. *Annales d'urologie*. 2002;36(4):272-6.
401. Porpiglia F, Destefanis P, Fiori C, Fontana D. Preoperative risk factors for surgery female urethral diverticula. Our experience. *Urol Int*. 2002;69(1):7-11.
402. Ganabathi K, Leach GE, Zimmern PE, Dmochowski R. Experience with the management of urethral diverticulum in 63 women. *J Urol*. 1994;152(5 Pt 1):1445-52.
403. Chung HJ, Goo BC, Lee JH, Bang D, Lee KH, Lee ES, et al. Behcet's disease combined with various types of fistula. *Yonsei Med J*. 2005;46(5):625-8.
404. Waidelich RM, Brunschweiler SM, Schmeller NT. [Urethrovaginal fistula in Behcet disease]. *Urologe A*. 1994;33(2):163-6.
405. Flottorp J, Inversen S. [Vesicovaginal and urethrovaginal fistulas treated at the Norwegian Radium Hospital 1940-1952 and in the gynecological department of the Rikshospitalet 1953-1959]. *Tidsskrift for den Norske laegeforening : tidsskrift for praktisk medicin, ny raekke*. 1960;80:597-9.
406. Ying T, Li Q, Shao C, Zhu Z, Feng L, Hu B. Value of transrectal ultrasonography in female traumatic urethral injuries. *Urology*. 2010;76(2):319-22.
407. Abet L, Richter J, Lenk S, Kotalla H, Hegen-scheid F. [Double-balloon urethrography in the female]. *Z Urol Nephrol*. 1983;76(1):19-28.
408. Quiroz LH, Shobeiri SA, Nihira MA. Three-dimensional ultrasound imaging for diagnosis of urethrovaginal fistula. *International urogynecology journal*. 2010;21(8):1031-3.
409. Schoellnast H, Lindbichler F, Riccabona M. Sonographic diagnosis of urethral anomalies in infants: value of perineal sonography. *J Ultrasound Med*. 2004;23(6):769-76.
410. Goodwin WE, Scardino PT. Vesicovaginal and ureterovaginal fistulas: a summary of 25 years of experience. *J Urol*. 1980;123(3):370-4.
411. Pushkar DY, Dyakov VV, Kosko JW, Kasyan GR. Management of urethrovaginal fistulas. *European urology*. 2006;50(5):1000-5.
412. Parks J. Section of the urethral wall for correction of urethrovaginal fistulae and urethral diverticula. *Am J Obstet Gynecol*. 1965;93(5):683-92.
413. Rovner ES, Wein AJ. Diagnosis and reconstruction of the dorsal or circumferential urethral diverticulum. *J Urol*. 2003;170(1):82-6; discussion 6.
414. Lamensdorf H, Compere DE, Begley GF. Simple surgical correction of urethrovaginal fistula. *Urology*. 1977;10(2):152-3.
415. Reisenauer C. Vesicovaginal fistulas: a gynecological experience in 41 cases at a German pelvic floor center. *Archives of gynecology and obstetrics*. 2015;292(2):245-53.
416. Fall M. Vaginal wall bipediced flap and other techniques in complicated urethral diverticulum and urethrovaginal fistula. *J Am Coll Surg*. 1995;180(2):150-6.
417. Xu YM, Sa YL, Fu Q, Zhang J, Xie H, Jin SB. Transpubic access using pedicle tubularized labial urethroplasty for the treatment of female urethral strictures associated with urethrovaginal fistulas secondary to pelvic fracture. *European urology*. 2009;56(1):193-200.
418. Pushkar D. Editorial comment on: Transpubic access using pedicle tubularized labial urethroplasty for the treatment of female urethral strictures associated with urethrovaginal fistulas secondary to pelvic fracture. *European urology*. 2009;56(1):200.
419. Huang CR, Sun N, Wei p, Xie HW, Hwang AH, Hardy BE. The management of old urethral injury in young girls: analysis of 44 cases. *Journal of pediatric surgery*. 2003;38(9):1329-32.
420. Candiani P, Austoni E, Campiglio GL, Ceresoli A, Zanetti G, Colombo F. Repair of a recurrent urethrovaginal fistula with an island bulbocavernous musculocutaneous flap. *Plast Reconstr Surg*. 1993;92(7):1393-6.
421. McKinney DE. Use of full thickness patch graft in urethrovaginal fistula. *The Journal of urology*. 1979;122(3):416.
422. Browning A. Lack of value of the Martius fibrofatty graft in obstetric fistula repair. *International journal of gynaecology and obstetrics: the official organ of the International Federation of Gynaecology and Obstetrics*. 2006;93(1):33-7.
423. Rangnekar NP, Imdad Ali N, Kaul SA, Pathak HR. Role of the Martius procedure in the management of urinary-vaginal fistulas. *J Am Coll Surg*. 2000;191(3):259-63.
424. Puneekar SV, Buch DN, Soni AB, Swami G, Rao SR, Kinne JS, et al. Martius' labial fat pad interposition and its modification in complex lower

- urinary fistulae. *J Postgrad Med.* 1999;45(3):69-73.
425. Radopoulos DK, Dimitriadis GP, Vakalopoulos IK, Ioannidis SS, Tzakas KA, Vasilakakis IE. Our experience with salvage genitourinary fistulae repair: technique and outcomes. *Int Urol Nephrol.* 2008;40(1):57-63.
 426. Baskin D, Tatlidede S, Karsidag SH. Martius repair in urethrovaginal defects. *Journal of pediatric surgery.* 2005;40(9):1489-91.
 427. Birkhoff JD, Wechsler M, Romas NA. Urinary fistulas: vaginal repair using a labial fat pad. *J Urol.* 1977;117(5):595-7.
 428. Atan A, Tuncel A, Aslan Y. Treatment of refractory urethrovaginal fistula using rectus abdominis muscle flap in a six-year-old girl. *Urology.* 2007;69(2):384 e11-3.
 429. Bruce RG, El-Galley RE, Galloway NT. Use of rectus abdominis muscle flap for the treatment of complex and refractory urethrovaginal fistulas. *The Journal of urology.* 2000;163(4):1212-5.
 430. Golomb J, Leibovitch I, Mor Y, Nadu A, Ramon J. Fascial patch technique for repair of complicated urethrovaginal fistula. *Urology.* 2006;68(5):1115-8.
 431. Janez J. [Use of the great epiploon in the treatment of complex vesico- and urethro-vaginal fistulae]. *Ann Urol (Paris).* 1985;19(4):267-8.
 432. Ingelman-Sundberg A. An extravaginal technic in the operation for urethro-vaginal and vesicovaginal fistulas. *Gynaecologia.* 1947;123(6):380-5.
 433. Patil U, Waterhouse K, Laungani G. Management of 18 difficult vesicovaginal and urethrovaginal fistulas with modified Ingelman-Sundberg and Martius operations. *J Urol.* 1980;123(5):653-6.
 434. Hamlin RH, Nicholson EC. Reconstruction of urethra totally destroyed in labour. *Br Med J.* 1969;2(5650):147-50.
 435. Lowman J, Moore RD, Miklos JR. Tension-free vaginal tape sling with a porcine interposition graft in an irradiated patient with a past history of a urethrovaginal fistula and urethral mesh erosion: a case report. *J Reprod Med.* 2007;52(6):560-2.
 436. Scott R, Gorham SD, Aitcheson M, Bramwell SP, Speakman MJ, Meddings RN. First clinical report of a new biodegradable membrane for use in urological surgery. *Br J Urol.* 1991;68(4):421-4.
 437. Mauermann J, Gonzalez R, Franc-Guimond J, Filipas D. The anterior sagittal transrectal approach for traumatic urethrovaginal fistula closure. *J Urol.* 2004;171(4):1650-1.
 438. Rossi F, De Castro R, Ceccarelli PL, Domini R. Anterior sagittal transanorectal approach to the posterior urethra in the pediatric age group. *J Urol.* 1998;160(3 Pt 2):1173-7.
 439. Domini M, Aquino A, Rossi F, Lima M, Ruggeri G, Domini R. Recurrent posttraumatic urethrovaginal fistula: a new application for ASTRA. *J Pediatr Surg.* 2000;35(3):522-5.
 440. Nikolaev VV, Bizhanova DA. High posttraumatic vaginal stricture combined with urethrovaginal fistula and urethral stricture in girls: reconstruction using a posterior sagittal pararectal approach. *J Urol.* 1998;160(6 Pt 1):2194-6.
 441. Pena A. The surgical management of persistent cloaca: results in 54 patients treated with a posterior sagittal approach. *J Pediatr Surg.* 1989;24(6):590-8.
 442. Ahmed S, Kardar AH. Construction of a neourethra in girls: follow-up results. *Pediatr Surg Int.* 2000;16(8):584-5.
 443. Koraitim M. A new retropubic retrourethral approach for large vesico-urethrovaginal fistulas. *The Journal of urology.* 1985;134(6):1122-3.
 444. Massoudnia N. [G. Doderlein's "enwrapping plasty" for the surgical treatment of large bladder- and urethrovaginal fistulas]. *Zentralbl Gynakol.* 1974;96(20):624-9.
 445. Tehan TJ, Nardi JA, Baker R. Complications associated with surgical repair of urethrovaginal fistula. *Urology.* 1980;15(1):31-5.
 446. Dolan LM, Dixon WE, Hilton P. Urinary symptoms and quality of life in women following urogenital fistula repair: a long-term follow-up study. *Bjog.* 2008;115(12):1570-4.
 447. de Bernis L. Obstetric fistula: guiding principles for clinical management and programme development, a new WHO guideline. *Int J Gynaecol Obstet.* 2007;99 Suppl 1:S117-21.
 448. Keettel WC, Sehring FG, deProsse CA, Scott JR. Surgical management of urethrovaginal and vesicovaginal fistulas. *Am J Obstet Gynecol.* 1978;131(4):425-31.
 449. Benchekroun A, Lakrissa A, Essakalli HN, Faik M, Abakka T, Hachimi M, et al. [Vesicovaginal fistula. Apropos of 600 cases]. *J Urol (Paris).* 1987;93(3):151-8.
 450. Henriksson C, Kihl B, Pettersson S. Urethrovaginal and vesicovaginal fistula. A review of 29 patients. *Acta Obstet Gynecol Scand.* 1982;61(2):143-8.

BLADDER PAIN SYNDROME

Chair

P. Hanno (USA)

Members

M. Cervigni (Italy)

P. Dinis (Portugal)

A. Lin (Tapei)

J.C. Nickel (Canada)

J. Nordling (Denmark)

A. van Ophoven (Germany)

T. Ueda (Japan)

CONTENTS

ABBREVIATIONS	2206	3. Laboratory Testing	2224
I. INTRODUCTION	2206	4. Symptom Evaluation	2224
1. Evidence Acquisition	2206	5. Urodynamics	2224
2. Definition	2206	6. Potassium Testing	2225
II. HISTORY / NOMENCLATURE / TAXONOMY	2208	7. Cystoscopy	2225
1. Historical Notes	2208	8. Morphology	2227
2. Nomenclature and Taxonomy	2210	9. Biomarkers	2228
III. EPIDEMIOLOGY	2214	10. Confusable Diseases	2229
1. Early Epidemiological Studies	2214	VII. BPS & GYNECOLOGICAL ASSOCIATED / CONFUSABLE DISORDERS	2230
2. Patient Self Report Surveys	2214	1. Introduction	2230
3. Physician Diagnoses Studies	2214	2. Pelvic Floor Dysfunction	2230
4. Symptom Based Surveys	2215	3. Pathophysiology	2231
5. Incidence	2216	4. Physical Examination	2231
6. Other Considerations	2216	5. Diagnostic Studies	2231
IV. ETIOLOGY	2217	6. Treatment	2231
1. Immune Cell Activation	2217	7. Endometriosis	2231
2. Increased Permeability of the Urothelium due to Urothelial Dysfunction/GAG-Layer Defects	2218	8. Vulvodynia and Vestibulodinia	2232
3. Inhibition of Bladder Urothelial Cell Proliferation	2218	9. Therapy	2232
4. Autoimmune Mechanisms	2218	10. Pudendal Neuropathy	2232
5. Infection	2219	11. Management	2233
6. Neurobiology/Pelvic Cross-Talk	2219	12. Conclusions	2233
7. Urinary Toxic Agents	2220	VIII. CLASSIFICATION	2233
8. Hypoxia	2220	IX. CONSERVATIVE TREATMENT	2234
9. The Role of Genetics in BPS	2220	1. Behavioral Modification	2234
10. Conclusions	2220	2. Physical Therapy	2234
V. PATHOLOGY	2222	3. Stress Reduction	2235
VI. DIAGNOSIS	2223	4. Dietary Manipulation	2235
1. History	2223	X. ORAL THERAPY	2236
2. Physical Examination	2224	1. Analgesics	2236
		2. Anti-depressants	2236
		3. Antihistamines	2237
		4. Hydroxyzine	2237
		5. Cimetidine	2237

BLADDER PAIN SYNDROME

P. HANNO (USA)

M. CERVIGNI (ITALY), P. DINIS (PORTUGAL), A. LIN (TAPEI), J.C. NICKEL (CANADA),
J. NORDLING (DENMARK), A. VAN OPHOVEN (GERMANY), T. UEDA (JAPAN)

ABBREVIATIONS

BACH	Boston Area Community Health
BPS	bladder pain syndrome
IASP	International Association for the Study of Pain
ESSIC	International Association for the Study of Bladder Pain Syndrome
IC	interstitial cystitis
ICS	International Continence Society
NIDDK	National Institute of Diabetes, Digestive, and Kidney Disorders
NHS	Nurses Health Study
OAB	overactive bladder
OLS	O'Leary Sant
PBS	painful bladder syndrome
PUF	Pelvic Pain and Urgency/Frequency
PUGO	pain of urogenital origin

I. INTRODUCTION

1. EVIDENCE ACQUISITION

The unrestricted, fully exploded Medical Subject Heading (MeSH) "interstitial cystitis" (including all related terms as "painful bladder syndrome", bladder pain syndrome", or different terms such as "chronic interstitial cystitis", etc.) were used to thoroughly search the PubMed database (<http://www.ncbi.nlm.nih.gov/pubmed>) of the United States National Library of Medicine of the National Institutes of Health from the years 2013-2016. Six hundred seventeen publications in English or with English abstracts were reviewed.

Focus was on clinical trials, randomized controlled trials, meta-analyses, scientific guidelines, and core clinical journals. The literature update this achieved

was added to the previously existing database reflected in the 2013 publication that was established according to a similar protocol. (1)

Rating of the level of evidence and grade of recommendation was performed according to the Oxford Scale. The committee believes that the Oxford system for categorizing levels of evidence is primarily relevant only for the sections on treatment which follow. While the committee's opinions will be expressed, where applicable, regarding evidence and conclusions for other areas, including diagnoses, aetiology, and pathophysiology, use of the Oxford system in this context is more open to interpretation.

2. DEFINITION

Bladder Pain Syndrome (BPS) is a clinical diagnosis that relies on symptoms of pain in the bladder and/or pelvis and other urinary symptoms like urgency and frequency. Based on the evolving consensus that BPS probably is strongly related to other pain syndromes like Irritable Bowel Syndrome, Fibromyalgia and Chronic Fatigue Syndrome, the European Society for the Study of Bladder Pain Syndrome (ESSIC) published a comprehensive paper on definition and diagnosis of BPS.(2)

BPS was defined as chronic (>6 months) pelvic pain, pressure, or discomfort *perceived to be* related to the urinary bladder accompanied by at least one other urinary symptom such as persistent urge to void or frequency. Confusable diseases as the cause of the symptoms must be excluded. Further documentation and classification of BPS might be performed according to findings at cystoscopy with hydrodistension and morphological findings in bladder biopsies. (table 2) The presence of other organ symptoms as well as cognitive, behavioural, emotional, and sexual symptoms should be addressed.

This definition has been broadly accepted although actual wording differs somewhat (3). Because omitting the name "Interstitial Cystitis" might cause serious problems in different health systems by affecting reimbursement and disability determinations, the name Bladder Pain Syndrome/ Interstitial Cystitis (BPS/IC) could be used in parallel with BPS for the

time being. In this chapter, as in the 2008 Consultation, the term Bladder Pain Syndrome largely replaces the older Interstitial Cystitis term, but the two are essentially interchangeable as there is no accepted definition that clearly delineates the interstitial cystitis syndrome from bladder pain syndrome. The Consultation believes the latter term more appropriately describes the disorder. An argument to move

Table 1 Historical definitions of interstitial cystitis

1887 Skene {Skene 1887}: An inflammation that has destroyed the mucous membrane partly or wholly and extended to the muscular parietes.
1915 Hunner: {Hunner 1915}: A peculiar form of bladder ulceration whose diagnosis depends ultimately on its resistance to all ordinary forms of treatment in patients with frequency and bladder symptoms (spasms).
1951 Bourque {Bourque 1951} : Patients who suffer chronically from their bladder; and we mean the ones who are distressed, not only periodically but constantly, having to urinate at all moments of the day and of the night suffering pains <i>every time they void</i> .
1978 Messing and Stamey {Messing 1978} : Nonspecific and highly subjective symptoms of around-the-clock frequency, urgency, and pain somewhat <i>relieved</i> by voiding when associated with glomerulations upon bladder distention under anesthesia.
1990 Revised NIDDK Criteria: Pain associated with the bladder or urinary urgency, and, glomerulations or Hunner's ulcer on cystoscopy under anesthesia in patients with 9 months or more of symptoms, at least 8 voids per day, 1 void per night, and cystometric bladder capacity less than 350cc. {Gillenwater 1988} {Hanno 1990a}
1997 NIDDK Interstitial Cystitis Database Entry Criteria {Simon 1997a}: Unexplained urgency or frequency (7 or more voids per day), OR pelvic pain of at least 6 months duration in the absence of other definable aetiologies.
2008 European Society for the Study of Bladder Pain Syndrome (ESSIC) {VanDeMerwe 2008a}: Chronic (>6 months) pelvic pain, pressure, or discomfort perceived to be related to the urinary bladder accompanied by at least one other urinary symptom such as persistent urge to void or frequency. Confusable diseases as the cause of the symptoms must be excluded.
2014 Multidisciplinary Approach to the Study of Chronic Pelvic Pain (MAPP) {Landis 2014}, National Institutes of Health: Chronic unpleasant sensation (pain, pressure, discomfort) perceived to be related to the urinary bladder, associated with lower urinary tract symptoms, in the absence of infection or other identifiable causes.
2009/2016 East Asian Guideline {Homma 2009} {Homma 2016}: A disease of the urinary bladder diagnosed by 3 conditions: lower urinary tract symptoms, Hunner lesion or mucosal bleeding after distention, and exclusion of confusable diseases. The characteristic symptom complex (hypersensitive bladder syndrome) includes bladder hypersensitivity, usually associated with urinary frequency, with or without bladder pain.
2011/2015 American Urological Association {Hanno 2011} {Hanno 2015}: An unpleasant sensation (pain, pressure, discomfort) perceived to be related to the urinary bladder, associated with lower urinary tract symptoms of more than 6 weeks duration, in the absence of infection or other identifiable causes.
2015 Spanish Urological Association: {Esteban 2015} The unpleasant sensation (pain, pressure, discomfort) perceived in relation to the filling of the bladder and accompanied by at least another symptom of the lower urinary tract, either daytime or nighttime, such as increased urinary frequency and in the absence of infection or another identifiable cause.

The International Continence Society (4) (ICS) used the term Painful Bladder Syndrome (PBS) defined as “ the complaint of suprapubic pain related to bladder filling, accompanied by other symptoms such as increased daytime and night-time frequency, in the absence of proven urinary infection or other obvious pathology”. ICS reserved the diagnosis Interstitial Cystitis (IC) to patients with “typical cystoscopic and histological features”, without further specifying these. It has however been shown, that only a fraction of patients believed by experts to have BPS fulfil this definition (5).

the Hunner lesion phenotype out of the BPS framework and regard it as a separate disorder is made in section 2.

Historically, definitions of IC have moved from a severe inflammatory bladder disease to a condition described primarily by symptoms (table 1). (3)

In the remainder of this chapter the condition will be referred to as bladder pain syndrome (BPS). Some of the older literature may be discussed using the original terminology in the interests of clarity. Logically “interstitial cystitis” should include some form of demonstrable inflammation in the bladder wall, while “bladder pain syndrome” should include pain in the region of the bladder (6). The diagnosis of BPS is based on exclusion of other diseases in the bladder, urethra, and other pelvic organs including the musculoskeletal system. As with other diseases without clear objective diagnostic criteria or pathophysiology-

cal explanation, countless theories have been put forward without adding much to the delineation or understanding of the disease.

In practice, patients with symptoms of BPS are screened to exclude other relevant diagnoses or confusable diseases (2), and a focused evaluation is performed at the discretion of the physician or centre. This evaluation might include cystoscopy under local or general anaesthesia, bladder distension with registration of bladder capacity and/or the presence of glomerulations and Hunner's lesion. Bladder wall biopsies might be obtained and evaluated for inflammation, ulcer, fibrosis, mast cells etc. The evaluation might also include urodynamics with registration of

bladder capacity, compliance and bladder stability (7). One view of the relationship of BPS with OAB is graphically depicted in figure 1 (8). The 14% incidence of urodynamic detrusor overactivity in the BPS (9) patients is probably close to what one might expect in the general population if studied urodynamically (10).

In the end, these investigations might prove to be normal and the patients are identified as having BPS as a diagnosis of exclusion. The relevance of urodynamic, cystoscopic and histological findings is limited by a lack of consistency in technique, and it is therefore recommended to use the standardisations described by ESSIC.(11)

Overactive Bladder (OAB) and its relationship to Bladder Pain Syndrome (BPS)

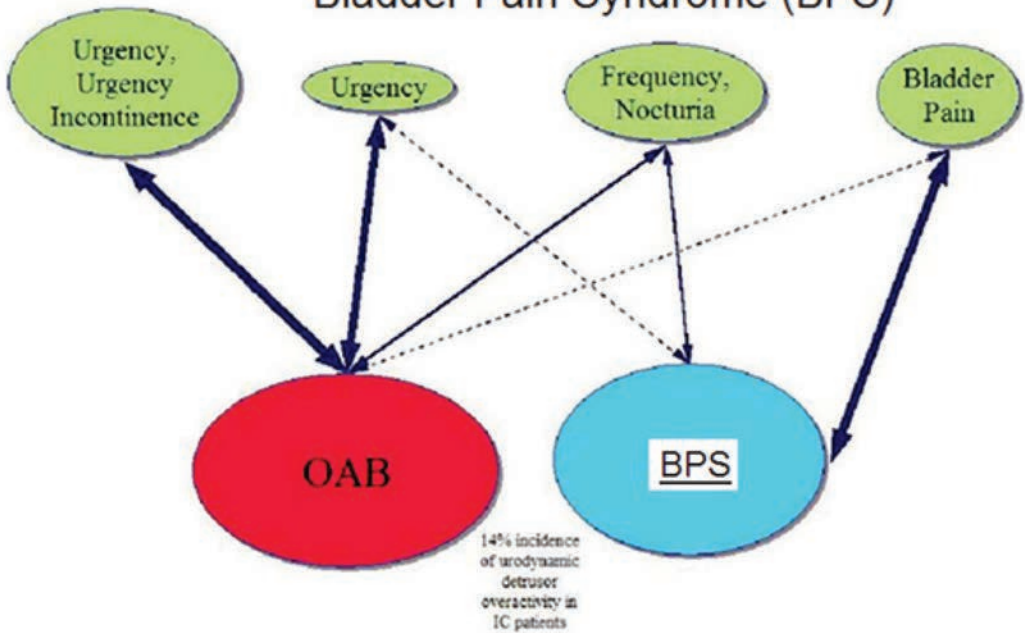

Figure 1: Overactive Bladder (OAB) and its relationship to Bladder Pain Syndrome (BPS) Abrams, P., Hanno, P., and Wein, A.: Neurourol Urodyn, 24: 149, 2005.

II. HISTORY / NOMENCLATURE / TAXONOMY

1. HISTORICAL NOTES

Recent historical reviews confirm that interstitial cystitis was recognized as a pathologic entity during the 19th century. (12,13) In his textbook Practical Ob-

servations on Strangulated Hernia and Some Diseases of the Urinary Organs, Joseph Parrish, a Philadelphia surgeon, described 3 problematic cases of recurrent, severe lower urinary tract symptoms in which he made repeated attempts to locate a bladder stone, which was the most common source for these symptoms in early 19th century America. (14) As Teichman et al have convincingly argued, these patients displayed all of the clinical hallmarks of IC including chronic frequency, urgency, dysuria and pelvic pain in the absence of demonstrable pathology.

(15) Although he used the term repeatedly in his manuscript, Parrish did not elaborate upon the clinical definition of “tic douloureux,” likely because contemporaneous physicians would have been familiar with the concept. However, Parrish attributed the term Tic douloureux to his mentor, Dr. Phillip Syng Physick, who had applied it to patients with severe lower urinary tract symptoms with no discernible etiology, with the most common etiology during the 19th century being bladder stones.

A review of archival material from the Philadelphia College of Physicians indicates that by 1808 Physick had developed a concept of bladder inflammation, a “bladder ulcer,” that produced lower urinary tract symptoms in the absence of bladder stone. (13) Tic douloureux at its time represented a neurological irritation, most often associated with the trigeminal nerve but applicable to other sensory distributions as well, which produced pain and discomfort in the absence of injury or other specific physical findings. In applying the concept of tic douloureux to bladder sensation Parrish was ascribing the paroxysmal lower urinary tract symptoms occurring in patients to an idiopathic process affecting the nerves of the bladder. This sophisticated concept continues to be a prominent component of modern theories of BPS pathogenesis. Furthermore, Tic douloureux allowed him to formulate a diagnosis for those patients who chronically manifested the symptoms caused by a stone (severe frequency, urgency, dysuria and pelvic pain) but had no stone that could be detected. That is, he considered a neuropathic etiology in the absence of any other tangible causes of bladder pain. Clearly, this experience strongly resonates with the contemporary diagnosis of BPS.

50 years after Parrish’s first publication on the condition, Skene used the term interstitial cystitis to describe an inflammation that has “destroyed the mucous membrane partly or wholly and extended to the muscular parietes”. (16) Early in the 20th century, at a New England Section meeting of the American Urological Association, Guy Hunner reported on 8 women with a history of suprapubic pain, frequency, nocturia, and urgency lasting an average of 17 years (17,18). He drew attention to the disease, and the red, bleeding areas he described on the bladder wall came to have the pseudonym “Hunner’s ulcer”. As Walsh observed, this has proven to be unfortunate (19). In the early part of the 20th century, the very best cystoscopes available gave a poorly defined and ill-lit view of the fundus of the bladder. It is not surprising that when Hunner saw red and bleeding areas high on the bladder wall, he thought they were ulcers. For the next 60 years, urologists would look for ulcers and fail to make the diagnosis in their absence. The disease was thought to be a focal, rather than a pan-cystitis.

Hand authored the first comprehensive review about the disease, reporting 223 cases (20). Many of his epidemiologic findings have held up to this day. His description of the clinical findings bears repeating. “I

have frequently observed that what appeared to be a normal mucosa before and during the first bladder distention showed typical interstitial cystitis on subsequent distension”. He notes, “small, discrete, submucosal haemorrhages, showing variations in form...dot-like bleeding points...little or no restriction to bladder capacity.” He portrays three grades of disease, with grade 3 matching the small-capacity, scarred bladder described by Hunner. Sixty-nine percent of patients were grade 1 and only 13% were grade 3. Walsh later coined the term “glomerulations” to describe the petechial haemorrhages that Hand had described (19). But it was not until Messing and Stamey discussed the “early diagnosis” of IC that attention turned from looking for an ulcer to make the diagnosis to the concepts that 1) symptoms and glomerulations at the time of bladder distention under anesthesia were the disease hallmarks, and 2) the diagnosis was primarily one of exclusion (19,21). However, this description was not suitable for defining this disease in a manner that would help physicians make the diagnosis and set up research protocols.

The National Institute of Diabetes, Digestive, and Kidney Disorders (NIDDK) held a major meeting in 1987 with researchers and clinicians from around the world (22). This ultimately resulted in the 1990 Revised NIDDK Criteria: Pain associated with the bladder or urinary urgency, and, glomerulations or Hunner’s ulcer on cystoscopy under anesthesia in patients with 9 months or more of symptoms, at least 8 voids per day, 1 void per night, and cystometric bladder capacity less than 350cc. (23)

In order to validate the criteria, which were designed not for clinical diagnosis, but rather to ensure that patients enrolled in research trials could be agreed upon to have the disease, a database with broad entry criteria was created. The 1997 NIDDK Interstitial Cystitis Database Entry Criteria: Unexplained urgency or frequency (7 or more voids per day), OR pelvic pain of at least 6 months duration in the absence of other definable etiologies (24) Urgency was not defined in the protocol. Participants were given a 10 point scale, and those who scored 2 or higher on self report satisfied the urgency criteria. The protocol was written in 1992, a time when the definition of “urgency” was not a particularly controversial topic. When a comparison of the NIDDK revised criteria with the database entry criteria was performed, it was apparent that up to 60% of patients clinically believed to have interstitial cystitis by experienced clinicians were being missed when the NIDDK research criteria were used as a definition of the disease. (25) With the demise of the NIDDK criteria as an appropriate clinical definition of the disorder, the next decade became an active one from an international standpoint in terms of wrestling with the issues of nomenclature, taxonomy and diagnosis. (26)

A very complete and easily readable summary of the history of bladder pain syndrome was recently published and the interested reader is referred to Jane Meijlink's superb review of the topic. (27)

2. NOMENCLATURE AND TAXONOMY

The literature over the last 170 years has seen numerous changes in description and nomenclature of the disease. The syndrome has variously been referred to as tic douloureux of the bladder, interstitial cystitis, cystitis parenchymatosa, Hunner's ulcer, panmural ulcerative cystitis, urethral syndrome, and painful bladder syndrome. (12,15,16,18,28-30). The term "interstitial cystitis," which Skene is credited with coining and Hunner for bringing it in to common usage, is a misnomer; in many cases not only is there no interstitial inflammation, but also, histopathologically, there may be no inflammation at all. (31-34) By literally focusing exclusively on the urinary bladder, the term interstitial cystitis furthermore does not do justice to the condition from both the physician's and the patient's perspective. The textual exclusiveness

tra-pelvic and non-urological symptoms (35) that frequently precede the onset of the bladder condition. (36)

With the formal definition of the term "painful bladder syndrome" by the ICS in 2002, the terminology discussion became an intense international focal point. (4)

- In Kyoto at the ICICJ in March 2003, it was agreed that the term "interstitial cystitis" should be expanded to "interstitial cystitis/chronic pelvic pain syndrome" when pelvic pain is at least of 3 months duration and associated with no obvious treatable condition/pathology. (37)
- The European Society for the Study of Interstitial Cystitis (ESSIC) held its first meeting in Copenhagen soon after Kyoto. Nomenclature was discussed, but no decision was reached, as the meeting concentrated on how to evaluate patients for diagnosis. (38)
- At the 2003 meeting of the NIDDK titled, "Research Insights into Interstitial Cystitis," it was concluded that "interstitial cystitis" will inexorably be replaced as a sole name for this syndrome. It

Table 2: Classification of Bladder Pain Syndrome: Criteria of International Association for the Study of Bladder Pain Syndrome (ESSIC)

		cystoscopy with hydrodistension			
		not done	normal	glomerulations ¹	Hunner's lesion ²
biopsy	not done	XX	1X	2X	3X
	normal	XA	1A	2A	3A
	inconclusive	XB	1B	2B	3B
	positive ³	XC	1C	2C	3C

¹ cystoscopy: glomerulations grade II-III

² with or without glomerulations

³ histology showing inflammatory infiltrates and/or detrusor mastocytosis and/or granulation tissue and/or intrafascicular fibrosis

van de Merwe, J. P., Nordling, J., Bouchelouche, P., Bouchelouche, K., Cervigni, M., Daha, L. K. et al.: Diagnostic criteria, classification, and nomenclature for painful bladder syndrome/interstitial cystitis: an ESSIC proposal. *Eur Urol*, 53: 60, 2008

ignores the high co-morbidity with various pelvic, ex-

will be a gradual process over several years. At

the meeting it was referred to as “interstitial cystitis/painful bladder syndrome” in keeping with International Continence Society nomenclature.[40]

- At the 2004 inaugural meeting of the Multinational Interstitial Cystitis Association in Rome, it was concluded that the syndrome should be referred to as “painful bladder syndrome/interstitial cystitis” or “PBS/IC” to indicate an intellectual and taxonomical hierarchy within the acronym. (39)
- The International Consultation on Incontinence in 2004, cosponsored by the ICS and Societe Internationale d’Urologie in association with the World Health Organization, included the syndrome as a part of its consultation. The chapter in the report was titled, “painful bladder syndrome (including interstitial cystitis),” suggesting that the IC formed an identifiable subset within the broader syndrome. Because such a distinction is difficult to define, within the body of the chapter, co-authored by nine committee members and five consultants from four continents, it was referred to as PBS/ IC (one inclusive entity). (40)
- In June 2006 Abrams and colleagues published an editorial focusing on the nomenclature problem. (41) They noted that: “It is an advantage if the medical term has clear diagnostic features that translate to a known pathophysiologic process so that effective treatment may be given. Unfortunately, the latter is not the case for many of the pain syndromes suffered by patients seen at most pain, gynecological, and urological clinics. For the most part these “diagnoses” describe syndromes that do not have recognized standard definitions, yet imply knowledge of a pathophysiologic cause for the symptoms. Unfortunately the terminology used to describe the condition may promote erroneous thinking about treatment on the part of physicians, surgeons and patients. These organ based diagnoses are mysterious, misleading and unhelpful, and can lead to therapies that are misguided or even dangerous.” The editorial went on to note that a single pathologic descriptive term (interstitial cystitis) for a spectrum of symptom combinations ill serves patients. The umbrella term “painful bladder syndrome” was proposed, with a goal to define and investigate subsets of patients who could be clearly identified within the spectrum of PBS. It would fall within the rubric of chronic pelvic pain syndrome. Sufferers would be identified according to the primary organ that appears to be affected on clinical grounds. Pain not associated with an individual organ would be described in terms of the symptoms.

One can see in this the beginnings of a new paradigm that might be expected to change the emphasis of

both clinical and basic science research, and that removes the automatic presumption that the end-organ in the name of the disease should necessarily be the sole or primary target of such research.

- At the major biannual IC research conference in the fall of 2006, held by the National Institute of Diabetes, Digestive, and Kidney Disorders (Frontiers in Painful Bladder Syndrome/Interstitial Cystitis), the ESSIC group was given a block of time in which to present their thoughts and

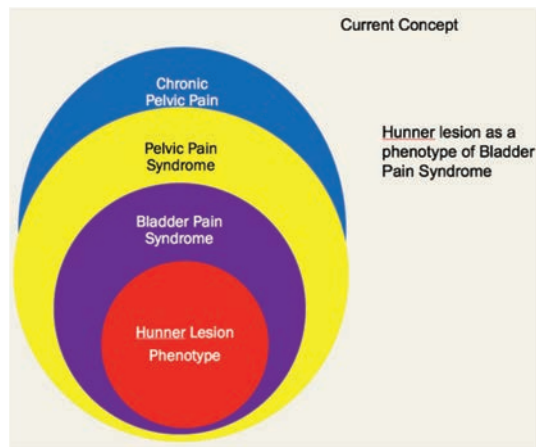

Figure 2: Current Conception of Bladder Pain Syndrome in Pain Spectrum

conclusions. Because PBS did not fit into the taxonomy of other pelvic pain syndromes such as urethral or vulvar pain syndromes, and because IC is open to different interpretations, ESSIC suggested that Painful Bladder Syndrome be redesignated as Bladder Pain Syndrome (BPS), followed by a type designation. BPS is indicated by two symbols, the first of which corresponds to cystoscopy with hydrodistention findings (1, 2, or 3, indicating increasing grade of severity) and the second to biopsy (A, B, and C, indicating increasing grade of severity of biopsy findings) (Table 2). Although neither cystoscopy with hydrodistention nor bladder biopsy was prescribed as an essential part of the evaluation, by categorizing patients as to whether either procedure was done, and if so, the results, it is possible to follow patients with similar findings and study each identified cohort to compare natural history, prognosis, and response to therapy. (2As Baranowski et.al. conceived it in early 2008 (42), BPS is thus defined as a pain syndrome with a collection of symptoms, the most important of which is pain perceived to be in the bladder. IC is distinguished as an end-organ, visceral-neural pain syndrome, whereas BPS can be considered a pain syndrome that involves the end-organ (bladder) and neuro-visceral (myopathic) mechanisms. In IC, one expects end-organ primary pathology. This is not necessarily the case in the broader BPS.

A didactically very demonstrative way to conceptualize the dawning shift in conception of the condition is with the drawing of a target (Fig 2). There may be many causes of chronic pelvic pain. When an aetiology cannot be determined, it is characterized as pelvic pain syndrome. To the extent that it can be distinguished as urologic, gynecologic, dermatologic, and the like, it is further categorized by organ system. A urologic pain syndrome can sometimes be further differentiated on the site of perceived pain. Bladder, prostate, testicular, and epididymal pain syndromes follow. Finally, types of BPS can be further defined as IC, or simply categorized by ESSIC criteria. Patient groups have expressed their concerns with regard to any nomenclature change that potentially drops the term “interstitial cystitis” because the U.S. Social Security Administration and private insurances recognize IC but not the term BPS, and benefits potentially could be adversely affected. Whether the term “interstitial cystitis”, as difficult as it is to define and as potentially misleading as it is with regard to aetiology and end-organ involvement, should be maintained in the context of bladder pain syndrome, is a subject of ongoing controversy.

Taxonomy and nomenclature in Japan, Korea, and Taiwan use the umbrella term of “frequency/urgency syndrome” characterized by frequency (frequent voiding) and urgency (strong desire to void). It is an inclusive term incorporating overactive bladder syndrome (OAB), hypersensitive bladder syndrome (HSB), and other conditions that are associated with frequency and urgency. Urgency in OAB is characterized by sudden onset and/or fear of leakage, while urgency in HSB is of a persistent nature and is associated with the fear of pain. OAB-wet is a subgroup of OAB. Painful bladder syndrome (PBS) is a subgroup

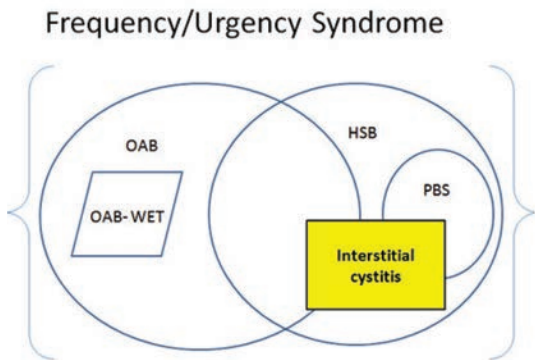

Figure 3: East Asian View of Taxonomy adapted from Homma (43) (see text for explanation) Homma Y. Lower urinary tract symptomatology: Its definition and confusion. Int J Urol 2008, Jan;15(1):35-43.

of HSB with pain. Interstitial cystitis is one of the diseases manifest by frequency/urgency and overlaps with HSB and PBS.[11,44,45] (figure 3)

The American Urological Association refers to the syndrome under consideration as “interstitial cystitis/bladder pain syndrome” (IC/BPS) and considers the terms synonymous. (44)

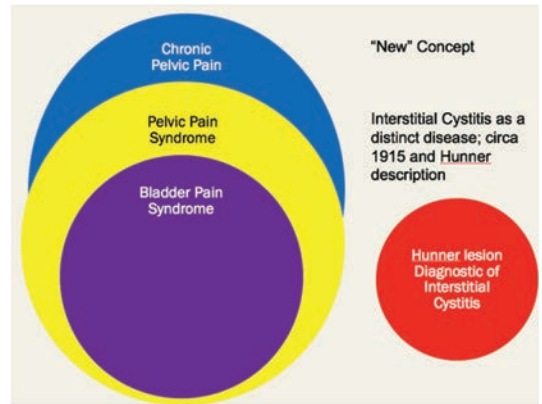

Figure 4: International Consultation Conception of bladder pain syndrome and interstitial cystitis

The International Association for the Study of Pain (IASP) has dropped the terms *interstitial cystitis*, *painful bladder syndrome*, and *PBS/IC or BPS/IC* and now recognizes the term “bladder pain syndrome” as the occurrence of persistent or recurrent pain perceived in the urinary bladder region accompanied by at least one other symptom, such as pain worsening with bladder filling and day-time and/or night-time urinary frequency. www.iasp-pain.org The reader is referred to the IASP website for an in depth discussion of pain taxonomy. This work was spearheaded by Dr. Andrew Baranowski and the Pain of Urogenital Origin (PUGO) group that is associated with IASP and contributed to advancement of nomenclature and taxonomy over the last 5 years. (41)

At the joint meeting of the 3rd International Consultation on Interstitial Cystitis, Japan and the ESSIC held in 2013 in Kyoto, it was agreed to limit the use of the term “interstitial cystitis” to patients with bladder pain syndrome and a Hunner lesion. (45) This is supported by findings that suggest that Hunner lesions or what was classically referred to as “interstitial cystitis” denote a truly different disorder than “bladder pain syndrome” and can either be considered a distinct phenotype lying within the BPS framework or a separate disease entirely. (46) The finding of petechial bleeding in the bladder mucosa on distention (glomerulations) has not proven to be of any significance up to now and does not seem to guide either diagnosis or therapeutic decisions, and the absence of glomerulations likewise does not seem to impart any useful information in treating the symptomatic patient. (47)

The large number of therapies available and the relative lack of predictable success with any one treatment are largely a result of our inability at this time to properly phenotype patients who suffer from this

symptom complex. (48) Development of biomarkers and better clinical phenotyping will be the next frontier in improving therapies and secondarily improving the taxonomy and nomenclature. (49,50) Major placebo effects in clinical trials have hampered our ability to determine useful phenotypes that might improve treatment responses. (51,52)

The Consultation believes that based on the pathology and endoscopic findings characteristic of the Hunner lesion, the epidemiologic pattern that distinguishes it from bladder pain syndrome, the clinical response to local treatment of the lesion by resection, fulguration, or steroid injection, the response to cyclosporine, and the absence of reports in the literature that non-Hunner patients go on to develop Hunner lesions (ie, the finding of Hunner lesion does not represent a continuum in the natural history of bladder pain syndrome), the presence of a Hunner lesion should

be considered a distinct disease. It therefore should drop out of the bladder pain syndrome construct, much like we do not consider other painful conditions like radiation cystitis, ketamine cystitis, or urinary tract infection a part of bladder pain syndrome. Figure 4

The Consultation concludes that it would be reasonable to designate the Hunner lesion in symptomatic patients with the term “interstitial cystitis”, thus indicating a true interstitial inflammation. It would be defined much as Hunner defined it 100 years ago, and harmonize to a great extent the Asian, European, and North American concepts of interstitial cystitis. At the present time, Consultation will continue to refer to the symptom complex as “bladder pain syndrome”. Hunner lesion will be considered a distinct phenotype, but in the future may be classified as a separate disorder entirely, albeit with local symptoms that are difficult to

Figure 5: BPS Prevalence Varies by Methodology

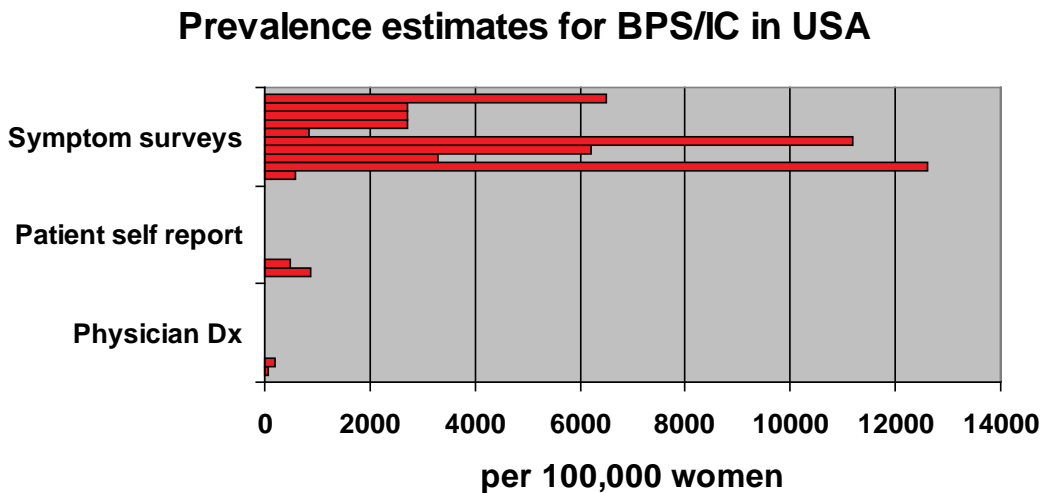

Physician Diagnosis (1,2)

Patient self report ([3],4)

Symptom surveys (5-9)

1. Curhan GC, Speizer FE, Hunter DJ, Curhan SG, Stampfer MJ. *Epidemiology of interstitial cystitis: A population based study. J Urol 1999, Feb;161(2):549-52.*

2. Clemens JQ, Meenan RT, O’Keeffe Rosetti MC, Brown SO, Gao SY, Calhoun EA. *Prevalence of interstitial cystitis symptoms in a managed care population. J Urol 2005, Aug;174(2):576-80.*

3. Clemens JQ, Payne CK, Pace J. *Prevalence of self-reported interstitial cystitis in a nationally representative United States Survey. J Urol 2005, May;173:307 (abstract)*

4. Jones CA, Nyberg L. *Epidemiology of interstitial cystitis. Urology 1997, May;49(5A Suppl):2-9.*

5. Clemens JQ, Link CL, Eggers PW, Kusek JW, Nyberg LM,, McKinlay JB. *Prevalence of painful bladder symptoms and effect on quality of life in black, hispanic and white men and women. J Urol 2007, Apr;177(4):1390-4.*

6. Lifford KL, Curhan GC. *Prevalence of painful bladder syndrome in older women. Urology 2009, Mar;73(3):494-8.*

differentiate from bladder pain syndrome in the absence of endoscopy. In other words, we may be coming full circle in the historical perspective.

III. EPIDEMIOLOGY

Since the clinical diagnosis of BPS remains controversial, epidemiology studies of BPS have been problematic (53). The lack of an accepted definition, the absence of a validated diagnostic marker, and questions regarding etiology and pathophysiology make much of the literature difficult to interpret. Overlapping patterns of bladder pain, lower urinary tract symptoms and pelvic pain are common and present challenges for clinical practice and research (54). The other major difficulty in evaluating various prevalence trials is that some are based on unverified self report, others by physician diagnoses (with or without some type of verification) or by identification of BPS symptoms (with or without exclusion of other confusable conditions). This confusion becomes apparent when one looks at the variation in prevalence reports in the United States and around the world. These range from 3.5 per 100,000 population in Japan (55), to a questionnaire based study that suggests a figure in 20,000 per 100,000 in US women (56). Studies, however, have consistently shown that bladder pain symptoms are more common than suggested by coded physician diagnoses (57). Therefore, it is important to realize when examining epidemiological data in BPS, that the prevalence of this enigmatic condition can be estimated from patient self-reports, physician diagnoses and/or symptom based surveys, all of which will give a different figure. A Conceptual diagram of the various manifestations of pelvic pain illustrates the problems in determining prevalence data. (figure 5)

1. EARLY EPIDEMIOLOGICAL STUDIES

One of the first population-based studies (58) included "almost all the patients with interstitial cystitis in the city of Helsinki". This superb, brief report from Finland surveyed all diagnosed cases in a population approaching 1 million. The prevalence of the disease in women was 18.1 per 100,000. The joint prevalence in both sexes was 10.6 cases per 100,000. Ten per cent of cases were in men.

Another early population study, this in the United States, first demonstrated the potential extent of what had been considered a very rare disease (59). The following population groups were surveyed: 1) random survey of 127 board-certified urologists 2) 64 IC patients selected by the surveyed urologists and divided among the last patient with IC seen, and the last patient with IC diagnosed 3) 904 female patients belonging to the Interstitial Cystitis Association and 4) random phone survey of 119 persons from the US population. This 1987 study reached the following

conclusions (interestingly, most of these conclusions have stood the test of time and many further epidemiological studies described later in this section)::

1. 43,500 to 90,000 diagnosed cases of IC in the USA (twice the Finnish prevalence)
2. Up to a five-fold increase in IC prevalence if all patients with painful bladder and sterile urine had been given the diagnosis, yielding up to half million possible cases in the USA
3. Median age of onset 40 years
4. Late deterioration in symptoms unusual
5. 50% temporary spontaneous remission rate, mean duration 8 months
6. 10 times higher incidence of childhood bladder problems in IC patients vs controls
7. 2 times the incidence of a history of urinary tract infection vs. controls
8. Lower quality of life than dialysis patients
9. Costs including lost economic production in 1987 of \$427 million

2. PATIENT SELF REPORT SURVEYS

As mentioned earlier, the prevalence of BPS can be estimated from patient self-reports, physician diagnoses and/or symptom based surveys. Jones and Nyberg (60) obtained their data from unverified self-report of a previous diagnosis of IC in the 1989 National Household Interview Survey. The survey estimated an overall prevalence of 500 per 100,000 populations (0.5% of the population), or >1,000,000 people in the United States with a self-reported diagnosis of IC. For women this prevalence figure was 865 per 100,000. As part of the third National Health and Nutrition Examination Survey (NHANES III), patients who answered yes to two questions (pain in the bladder/frequent urination and a diagnosis of IC or PBS) resulted in a remarkably similar estimated prevalence of 470 per 100,000 (850 per 100,000 women) (61). These numbers must be viewed with caution because of inaccurate patient recall or confusion with other pain or bladder related conditions. However these patient-reported diagnoses figures certainly suggest that BPS is a common occurrence.

3. PHYSICIAN DIAGNOSES STUDIES

Estimations of prevalence based on physicians' diagnoses may be thought to produce more accurate estimates, and while they do provide different figures, these are in part based on the local or geographic diagnostic criteria employed. Bade et al (62) used a physician questionnaire-based survey in the Netherlands yielding an overall prevalence of 8-16 per 100,000 females, with diagnosis heavily dependent on pathology and presence of mast cells. The Nurses

Health Study I and II (63) showed a prevalence of IC between 52 and 67 per 100,000 in the USA. This report was based on self-reports with validation using data from medical records. The prevalence of a physician based diagnosis of BPS in men and women in a managed care population in the US Northwest (61) was 197 per 100,000 women and 41 per 100,000 men. However, these rates decreased to 99 per 100,000 women and 19 per 100,000 men if the definition of the condition was limited to individuals who had undergone cystoscopy. Nickel, et al (64) performed a prospective practice audit in outpatient urology practice populations of 65 urologists and noted that the prevalence of IC and IC diagnosis in urology outpatient practice, confirmed by both investigation and symptom scoring, was determined to be 2.8%. This of course does not represent in any way the burden of this condition in the general population, but rather reflects the national referral and practice traditions. There are other limitations using physician diagnoses to determine prevalence. Studies that utilize physician diagnoses to define the presence of BPS will likely underestimate the true prevalence, primarily because they do not identify patients with undiagnosed disease or they may not assign a diagnosis when the symptoms are present (reluctance to label a patient with the condition or alternatively are not familiar with diagnosing it).

4. SYMPTOM BASED SURVEYS

Another and possibly more sensitive method to examine prevalence and incidence of BPS is to assess the presence of symptoms that suggest BPS. A follow-up study utilizing the Nurses' Health Study (NHS) cohort (65) used a mailed questionnaire followed by a detailed supplementary questionnaire if the participant responded "yes" to a bladder or pelvic pain question. They observed that the prevalence of BPS symptoms was 1.7% in women younger than 65 years and increased progressively to 4.0% in women aged 80 years or older. This study suggested that the prevalence of BPS increases with age. Warren, et al (66) combined a mail-in survey with randomly selected telephone surveys to determine the prevalence of BPS amongst first degree relatives in comparison to that of the general population. They concluded that adult female first degree relatives of patients with BPS may have a prevalence of BPS 17 times that found in the general population. This suggests but does not prove a genetic susceptibility to BPS. The Boston Area Community Health (BACH) Survey (57), a population based cross-sectional survey of individuals in the Boston area which included an in person interview, determined the prevalence of painful bladder symptoms to be 0.83% to 2.71% in women and 0.25% to 1.22% in men depending of the definition used.

The O'Leary Sant (OLS) and the Pelvic Pain and Urgency/Frequency (PUF) questionnaires were compared by Rosenberg and Hazard (67) in the same general practice population of 1218 patients. The

prevalence of BPS with the OLS was determined to be 0.57%, with the PUF the prevalence was determined to be 12.6%. Leppilahti and colleagues (68,69) estimated the prevalence of BPS in the general Population of Finland using a rather robust definition based on the OLS to be 0.68%. However, when a sample of those women was examined by one of the urologists, the more accurate prevalence was 0.3%.

Clements et al employed (61) 3 different definitions of BPS related symptoms. The first included only self reported pelvic pain with voiding symptoms. The second included increasing pain with bladder filling and relief with urination. The third included a score of 12 or more on the OLS, including 2 episodes of nocturia and a pain score of 2 or greater. The prevalence estimates based on these definitions were 11,200 per 100,000 women and 6,200 per 100,000 men for definition 1; 3,300 per 100,000 women and 1,400 per 100,000 men for definition 2; and 6,200 per 100,000 women and 2,300 per 100,000 men for definition 3. Using a similar methodology, (70) it was concluded that the prevalence of BPS-like symptoms in South Korean women appear to be lower than in Europe (71) and the United States, similar to Japan and higher than in China (72). It is conceivable that the acknowledgement by individual patients of these specific IC/BPS symptoms may be influenced by cultural differences.

The most comprehensive and probably most accurate estimation of the prevalence of BPS symptoms involved population based symptom prevalence estimate using 2 validated case definitions to identify bladder pain syndrome/interstitial cystitis in 131,691 adult females (73). Based on a high sensitivity definition, 6.5% (6,500 per 100,000) of women met the symptoms criteria, while 2.7% (2,700 per 100,000) of women met the criteria for a high specificity definition. These percentages translated into 3.3 to 7.9 million US women over 18 years of age with symptoms of bladder pain and/or interstitial cystitis. But only 9.7% of these identified women reported being assigned a bladder pain syndrome or interstitial cystitis diagnosis. A further study compared 3,397 women identified in this RAND Interstitial Cystitis Epidemiology (RICE) survey (53) with urinary symptoms consistent with a diagnosis of IC/BPS to 277 women with an actual BPS diagnosis recruited from specialist practices in the USA (74). The two cohorts showed remarkably similar demographics, symptoms and quality of life measures, confirming that BPS is a very prevalent condition that is very likely under diagnosed and undertreated in the USA.

4.1. Conclusion

Based on these studies, it is impossible to determine an accurate estimation of the prevalence of BPS, but a review of studies done in the US shows that this is a very prevalent medical condition (Figure 4). It is clear that the most inaccurate prevalence figures are derived from patients self-reported recollection, while the prevalence of BPS symptom complexes are more

common than those based on physician diagnoses. It is apparent that there has been no standardized method of determining the prevalence of BPS, with wide variation of estimates in the same study employing different definitions or criteria for identifying the condition. Many factors including bias, cultural differences, methodology, geographic variations in diagnostic criteria and/or possibly real differences in different populations lead to further variations between countries.

4.2. Recommendation

A reasonable prevalence estimation for patients diagnosed with BPS would be about 100-200 per 100,000 women with a male prevalence of 10% to 20% of the female estimate. The prevalence of women and men with symptoms suggestive of BPS could be as much as 10 to even a 100 times more. (figure 4)

Level of Evidence: 1 Grade of Recommendation: A

5. INCIDENCE

Only a few estimates of Incidence have been reported. The annual incidence of new female cases in Oravisto et al, 1975 study (58) was 1.2 per 100,000. The overall age- and sex-adjusted incidence rate of physician assigned diagnoses of BPS in Olmstead county (75) was 1.1 per 100,00 per year (1.6 per 100,00 per year for women and 0.6 per 100,000 for men. Another review of physicians' diagnoses identified a much higher yearly incidence of 21 per 100,000 women and 4 per 100,000 men (61). A physician-coded diagnosis supplemented with chart review of the Kaiser Permanente database (76) suggested a BPS incidence rate of 15 per 100,000 women per year. The mean average age of patients was 51 years. With such a wide variation between two similar studies in the same country, it is evident that we really do not have an accurate estimation of BPS incidence.

5.1. Recommendation

The available data suggests that the incidence of BPS diagnoses is somewhere between 1 and 15 per 100,000 per year. This does not include the women who have developed symptoms but have not been diagnosed with the condition. **Level of Evidence: 1 Grade of Recommendation: A**

6. OTHER CONSIDERATIONS

6.1. Children

Geist and Antolak] (77) reviewed and added to reports of disease occurring in childhood. A childhood presentation of BPS is extremely rare and must be differentiated from the much more common and benign-behaving condition variously called the *urinary frequency syndrome of childhood or dysfunctional*

elimination syndrome, a self-limited condition of unknown etiology. Nevertheless, there is a small cohort of children with chronic symptoms of bladder pain, urinary frequency, and sensory urgency in the absence of infection who have been evaluated with urodynamics, cystoscopy, and bladder distention and have findings consistent with the diagnosis of BPS. In Close and colleagues' review (78) of 20 such children, the median age of onset was younger than 5 years, and the vast majority of patients had long-term remissions with bladder distention. Rakow et al (79) assessed 28 women aged 13 to 25 with chronic pelvic pain syndrome and confirmed that 39% had a diagnosis of IC while a further 25% had both IC and endometriosis. The relationship between dysfunctional voiding and bowel symptoms in early life was suggested in a mail based questionnaire study in 215 BPS patients and 823 controls (80). Another study examining early childhood events (79) showed that early childhood trauma, in particular sexual trauma was more common in IC/BPS patients than asymptomatic control subjects. While not proven in these studies, it may be possible to link early childhood events to the eventual development of BPS symptoms.

6.1.1 Recommendation

IC/BPS should be evaluated in young women with complaining of chronic pelvic pain. **Level of Evidence: 1 Grade of Recommendation: A**

6.2. Men

Most studies show a female to male preponderance of 5:1 or greater (40,61,81). In the absence of a validated marker, it is often difficult to distinguish BPS from the chronic pelvic pain syndrome (nonbacterial prostatitis, prostatodynia) that affects males (82,83), and the percentage of men with BPS may actually be higher (84,85). Men tend to be diagnosed at an older age and have a higher percentage of Hunner's lesion in the case series reported. In the Rand NIH epidemiology prevalence study the male to female ratio approached one to one. (86)

6.2.1 Recommendation

The Male to Female ratio of BPS cases is 1:5. **Level of Evidence: 1 Grade of Recommendation: A**

6.3. Overlapping Non Bladder Syndromes

While the obvious clinical pain site associated with the diagnosis of IC/BPS is the bladder (pelvic pain only), it has become quite evident that most women with BPS have multiple pain sites outside the bladder and pelvis area, with over 75% of women with a clinical diagnosis of IC/BPS reporting pain outside the pelvis (pelvic pain and beyond). (87)

Multiple observations have shown that BPS patients are more likely than controls to have pain related syndromes manifesting symptoms beyond the bladder and even the pelvis. In 1997, Clauw, et al (35) reported on the symptom overlap between two cohorts of patients, one with fibromyalgia and one with BPS.

In the same year an analysis of a survey by Alagiri, et al (88) of over 6,700 persons who had a physician diagnosis of Interstitial Cystitis reported that individuals with IC were 100 times more likely to have inflammatory bowel disease, and that allergies, irritable bowel syndrome, sensitive skin, and fibromyalgia also have an increased association with IC. The presence of non-bladder syndromes (NBSs) and BPS has further complicated the interpretation of epidemiological studies. Investigators have subsequently compared BPS patients to controls on multiple NBSs. Wu et al. (36) compared 749 cases with BPS them to 1498 randomly selected and matched controls. Significantly more cases had FM, IBS, chronic pelvic pain (CPP), endometriosis, depression, anxiety and vulvodynia. Clemens et al. (89) compared 239 women with ICD-coded BPS to 717 matched controls and showed that cases significantly exceeded controls in myalgias, gastrointestinal symptoms, gynecologic pain, headache, back disorders, depression, and anxiety. Warren et al. (90) demonstrated that significantly more BPS cases than matched controls had 11 antecedent syndromes: FM, CFS, IBS, sicca syndrome, Chronic pelvic pain, migraine, allergies, asthma, depression, panic disorder, and vulvodynia. Nickel et al. (91) found significantly higher prevalence of self-reported FM, CFS, IBS, migraine and tension headaches, vulvodynia, temporomandibular disorder and low back pain in 207 female BPS cases than in 117 controls as well as significantly more with depression and anxiety (92) in a study in several urology practices in 3 continents. A review confirmed that fibromyalgia (FM), chronic fatigue syndrome (CFS), and irritable bowel syndrome (IBS) were associated with IC/BPS (93). The etiological and epidemiological questions that remain unanswered is how are these NBSs associated with BPS, do these NBSs precede or follow IC/BPS and do multiple NBSs increase the risk of BPS. Warren and colleagues (94) have introduced a number of hypotheses, however the studies to validate these have not yet been done. Relatives of BPS patients appear to have an increased risk of associated conditions including myalgia and fibromyalgia as well as constipation, suggesting shared underlying genetic factors. (95)

One other NBS that is sometime neglected or forgotten in these epidemiological associations is the association of BPS with sexual dysfunction. Multiple studies have shown that women with BPS diagnoses or symptoms experience very high levels of sexual dysfunction (96-99). This is likely related to deep dyspareunia associated with anterior vaginal wall pain from a hypersensitive bladder but can also be related to vulvodynia (100), a common NBS seen in female IC/BPS patients.

6.3.1 Recommendation

Overlapping Non-bladder syndromes are common in patients with a diagnosis of BPS. **Level of Evidence: 1 Grade of Recommendation: A**

6.4. Progression

The disease onset is generally described as subacute rather than insidious, and full development of the classic symptom complex occurs over a relatively short time. It appears that BPS does progress continuously, but usually reaches its final stage rapidly (within 5 years) (101) and then continues without significant change in symptomatology. Subsequent major deterioration is unusual (58). The duration of symptoms before diagnosis was 3-5 years in the Finnish study (58) while a very early American study quoted 7-12 years (20). The Interstitial Cystitis Database Cohort (ICDB) of patients has been carefully studied, and the findings seem to bear out those of other epidemiologic surveys (102). Patterns of change in symptoms with time suggest regression to the mean and an intervention effect associated with the increased follow-up and care of cohort participants. Although all symptoms fluctuated, there was no evidence of significant long-term change in overall disease severity. The data suggest that BPS is a chronic disease and no current treatments have a significant impact on symptoms over time in the majority of patients. There is some data (91) to suggest that some patients undergo a phenotypic progression over time from a purely organ specific (eg. bladder) condition to a regional pain syndrome (eg. IBS, vulvodynia) to a more generalized pain syndrome (eg. FM, CFS). Long term longitudinal studies examining progression issues in BPS are lacking.

6.4.1 Recommendation

Epidemiological data required to describe progression patterns of BPS is lacking. **Level of Evidence: 1 Grade of Recommendation: A**

IV. ETIOLOGY

The etiology of BPS remains an enigma. Quite often hypotheses abound with sparse evidence to support them and some quickly are found to be untrue. For example, disturbed nitric oxide metabolism has been proposed to contribute to BPS, but later controlled studies using L-arginine therapy did not show therapeutic effect and failed to support the hypothesis. It is highly possible that BPS is induced by a variety of causes. Symptoms of urinary frequency and bladder pain are likely the final common presentation of bladder injury resulting from single or a combination of etiologies. And quite often it is hard to know whether the observed findings in clinical and animal research studies are results or causes of the bladder injury in BPS.

1. IMMUNE CELL ACTIVATION

Activation of immune cells, such as mast cells, is thought to have a role in the etiology and/or pathogenesis of BPS. Mast cells are multifunctional immune cells that contain highly potent inflammatory

mediators such as histamine, leukotrienes, serotins, and cytokines. (103) These cells are the repositories of many potent inflammatory factors. Many of the symptoms and findings in BPS with Hunner lesion, such as pain, frequency, oedema, fibrosis, and the production of new vessels in the lamina propria, could possibly be ascribed to the release of mast cell-derived factors. Hence, the mast cell-IgE system and its interaction with other inflammatory cells and the nervous system (104) seems to be of importance when it comes to pathogenesis. There is a significant increase in mast cell count in subepithelial region from BPS patients with Hunner lesions as compared to non-Hunner lesion BPS patients or patients with overactive bladder syndrome. (103,105,106)

Activation of another type of immune cell, the plasma cell, could also be a factor in BPS. Akiyama et al found a characteristic infiltration of CXCR3-positive plasma cells in ulcer-type, but not in non-ulcer type, BPS. The CXCR3 pathway involves in chemotaxis of immune cells toward inflammatory sites and is important for inflammatory reaction. (107)

Level of Evidence: 1 Grade of Recommendation: A

2. INCREASED PERMEABILITY OF THE UROTHELIUM DUE TO UROTHELIAL DYSFUNCTION/GAG-LAYER DEFECTS

The bladder urothelium plays a key barrier to keep low and high molecular weight solutes in the urine from leaking into bladder interstitium. The barrier includes a dense layer of glycosaminoglycans on the luminal surface and intercellular junctions. Intracellular junctions consist of tight junction, adherence junction, desmosome and gap junction in the order of location from the luminal layer to the basal layer. Studies have shown impaired function of intercellular junctions of bladder urothelium of BPS patients. Zhang et al demonstrated significantly increased paracellular permeability, decreased expression of the tight junction proteins ZO-1 and occludin, and increased expression of the adhesion protein E-cadherin from patients with BPS. (108) Shie et al further showed that in the urothelium of the BPS bladder a reduced E-cadherin expression was associated with a higher level of apoptosis. (109)

Dysregulation of microRNA expression might contribute to impaired cellular junction in BPS. Monastyrskaya et al identified a microRNA miR-199a-5p as an important regulator of intercellular junctions. In BPS patients, miR-199a-5p was overexpressed in urothelial cells, resulting in an incorrect tight junction formation with increased urothelial permeability. (110,111)

A defect in the glycosaminoglycan (GAG) layer has been proposed by Parsons and co-workers (112) and

later by Hauser et al (113) With such a defect the sub-mucosal nerve filaments might become accessible to noxious substances in the urine and this might explain bladder pain and urinary frequency. In Hunner lesion BPS there is granulation tissue indicating a reparative process following repeated disruption of the mucosa. (114) Widened tight junctions and increased permeability have been demonstrated by scanning electron microscopy and other techniques. (115)

Level of Evidence: 2 Grade of Recommendation: B

3. INHIBITION OF BLADDER UROTHELIAL CELL PROLIFERATION

One explanation of the bladder epithelial dysfunction might be that the cells produce an inhibitor of heparin-binding epidermal growth factor-like growth factor in BPS. (116) It was shown that explanted urothelial cells from BPS patients differ from controls not only as to production of epithelial growth factors but also in the rate of proliferation and the production of an antiproliferative factor (APF). Keay and co-workers (117) studied gene expression patterns in normal bladder urothelial cells treated with APF and with mock APF as compared to patterns expressed by BPS urothelial cells. The results indicate that the mechanism of APF inhibition of urothelial cells may involve both down-regulation of genes that stimulate cell proliferation along with up-regulation of genes that inhibit cell growth. The same group of researchers has indicated that APF seems to be specifically elevated in the urine of patients with BPS but not in normals or patients with confusable diseases. These findings might open up avenues for identification of urine markers and treatment for BPS. (118,119) There has not yet been confirmation of the importance of antiproliferative factor by other laboratories.

Level of Evidence:2 Grade of Recommendation: B

4. AUTOIMMUNE MECHANISMS

There are numerous reports on autoantibodies in patients with BPS. (120-123) The precise identity of these of autoantibodies has yet to be determined. Some of the common clinical and histopathological characteristics present in BPS patients show certain similarities with other known autoimmune disturbances. Studies on autoantibodies in BPS have shown that these mainly consist of antinuclear antibodies (122) and these findings are in turn similar to the autoantibody profiles in some systemic diseases like Sjögren syndrome, which is known to be of autoimmune origin. (124-126) Only a portion of BPS patients have auto-antibodies. It has been proposed that the presence of auto-antibodies in these patients could be a reflection of disease severity. (127)

Vascular immunopathology with immune deposits in the bladder wall was found by Mattila. (128) Further studies also suggest activation of complement. (129) By means of immunophenotyping and flow cytometric analyses of the bladder mucosa and peripheral blood, differences between ulcerative and non-ulcer BPS patients have been demonstrated. In the former group intense T-cell infiltrates and B-cell nodules were seen, compared to far less T-cell infiltrates in non-ulcer BPS. (130) Involvement of the immune system is one feature found in some individuals with BPS, but findings are conflicting and have not been helpful in explaining the etiology. The lack of thorough descriptions of patients in many published studies has made classification and comparison between series impossible.

Level of Evidence: 2 Grade of Recommendation: C

5. INFECTION

No microorganism has ever been proven to cause BPS. Lynnes and coworkers did not find any evidence of recent or remote Gram negative or Gram positive infections in patients with BPS, nor did they find increased urinary IgA and IgG elevation. (131)(125) Warren et al (132) in a case control study of women with recent onset of BPS symptoms, reported that documented evidence of UTI at symptom onset was found in only a minority of patients. However, Zhang et al showed that a high prevalence (11 in 27 patients) of nanobacteria (NB) was observed in female BPS patients, and anti-NB treatment effectively improved the symptoms, suggesting that some BPS might be caused by nanobacteria. (133) Furthermore, using 16S ribosomal DNA(rDNA) sequence data Siddiqui et al demonstrated alterations of microbiota in urine from women with interstitial cystitis. (134) Using culture independent method to compare the microbiota of the lower urinary tract in standard culture negative (for bacteria) female patient with BPS, Nickel et al showed that among women with BPS the prevalence of fungi (*Candida* and *Saccharomyces* sp.) was significantly greater in those who reported a flare compared to those who did not. (135) Nevertheless, the possibility of a microbial contribution to the etiology of BPS remains an open question.

Level of Evidence: 1 Grade of Recommendation: A

6. NEUROBIOLOGY/PELVIC CROSS-TALK

Several authors have described autonomic nerve changes[130-132], but the findings are far from uniform. An increase of sympathetic innervation and activation of purinergic neurotransmission has been reported. The S-100 family of proteins appear in Schwann cells of the peripheral nervous system.

(136,137) Decreased levels of S-100 protein in the non-ulcer group as compared to controls has been found (138), which is consistent with a decreased nerve content in patients with non-ulcer BPS, a finding conflicting with the results of Hohenfellner (139) and Regauer (140) who used PGP9.5 antibody and found the nerve content increased in BPS patients with or without Hunner lesions as compared to OAB patients and controls. A distinctive ultrastructural appearance of specimens from patients with non-Hunner BPS prompted Elbadawi and Light to propose neurogenic inflammation as a trigger to a cascade of events taking place in this disease. (141) In this context it should be noted that afferent nerves release transmitters like substance P which could activate immune cells, or vasoactive intestinal polypeptide. These events may constitute a link to the immune cell system and promote a decrease of lymphocyte proliferation.

A prominent increase of tyrosine hydroxylase immunoreactivity in bladder tissue of BPS patients, as compared to controls, has been described. (142) This can presumably be interpreted as a sign of generally increased sympathetic outflow. This lends support to the notion of a neurogenic aetiology and or pathogenesis.

Malykhina and others (143-147) have demonstrated in innovative animal studies that there is a bidirectional neural cross-sensitization of the colon and lower urinary tract. Acute colitis sensitized lumbosacral spinal neurons receiving input from the urinary bladder result in spinal neuronal hyperexcitability that may be involved in central cross-organ sensitization of visceral nociception between the colon and urinary bladder. This provides information which not only supports a neurogenic etiology but also may account for the substantial overlap of BPS with other chronic pelvic pain disorders, especially the inflammatory bowel disorders. (84)

Using contrast enhanced magnetic resonance imaging, Towner et showed that in rats intravesical protamine sulfate not only increased permeability of bladder urothelium, the permeability of colon was also increased, further proving a cross-talk between bladder and colon. (148)

The brain might also play a role in the neurobiological component of BPS. Kairys et al found that females with BPS had a significant increase in gray matter volume in several regions of the brain, including the right primary somatosensory cortex, which was associated with greater pain, anxiety and urological symptoms. (149)

Level of Evidence: 2 Grade of Recommendation: B

7. URINARY TOXIC AGENTS

There are some publications suggesting that toxic substances in the urine may cause injury to the bladder resulting in symptoms consistent with BPS. One published hypothesis is that the increased cationic urine components in BPS patients may impair GAG layer function and exert a cytotoxic effect on urothelial cells. (150) Tamm-Horsfall protein, which is synthesized in the kidney and excreted into the urine, can neutralize cationic substance with its highly anionic property. A study has shown an abnormal glycosylation of Tamm-Horsfall protein occurs in patients with interstitial cystitis, resulting in a reduction in neutralizing capability, and may have a role in causing BPS. (151) Another group of investigators has suggested that defective constituent cytokine production may decrease mucosal defense to toxic agents. (152)

Level of Evidence: 3 Grade of Recommendation: D

8. HYPOXIA

Decreased microvascular density has been reported to be a feature of bladders from some individuals with BPS. (153) One group of investigators has reported that bladder perfusion decreased with bladder distension in some BPS patients compared to the opposite effect in control subjects. (154) The hypoxic hypothesis is further supported a report by Lee et al, who found an increased expression of hypoxia-inducible factor-1(HIF-1) alpha in bladder tissue obtained from BPS patients. (155) However, it is still unknown why the BPS bladders would become hypoxic. **Level of Evidence: 4 Grade of Recommendation: D**

9. THE ROLE OF GENETICS IN BPS

Warren et al (156) report findings from a small cohort of twins which demonstrated a greater concordance

of BPS among monozygotic than among dizygotic twins. A later study by the same research group (66) suggested that adult female first-degree relatives of patients with BPS may have a prevalence of IC 17 times that found in the general population. This coupled with the previously reported twin data suggests, but does not prove, a genetic component adds to the susceptibility for BPS. Another study on more than 25,000 twins, Altman et al found that in female twins genetic factors contributed less than one-third of the total variation in susceptibility to BPS, suggesting that there could be a genetic susceptibility to BPS, although environmental factors might also be substantial in the development of BPS. (157)

The report by Weissman et al (158) of the increased frequency of BPS in patients and their first degree relatives with panic disorder and other seemingly disparate disorders, has suggested that there is a familial syndrome consisting of BPS and other disorders of possible autonomic or neuromuscular dysfunction. More recent studies by the same group (159) from a case control study, suggested that this syndrome might include other anxiety disorders as well, and that families with and without this collection of symptoms were genetically distinguishable on chromosome 13.

Level of Evidence: 1 Grade of Recommendation: B

10. CONCLUSIONS

It is now believed that the etiology of BPS is more complex than has been previously envisioned. (35,84,88,160-162) The consideration of BPS as a part of a generalized somatic disorder should open new pathways to the study of BPS. Investigators should continue to explore central neurological mechanisms of pathogenesis, as well as genetic/familial, immunological and infectious etiologies of this puzzling, complex disorder.

An algorithm that attempts to illustrate an etiologic schema is presented (figure 6)

Figure 6: Theory of Etiology

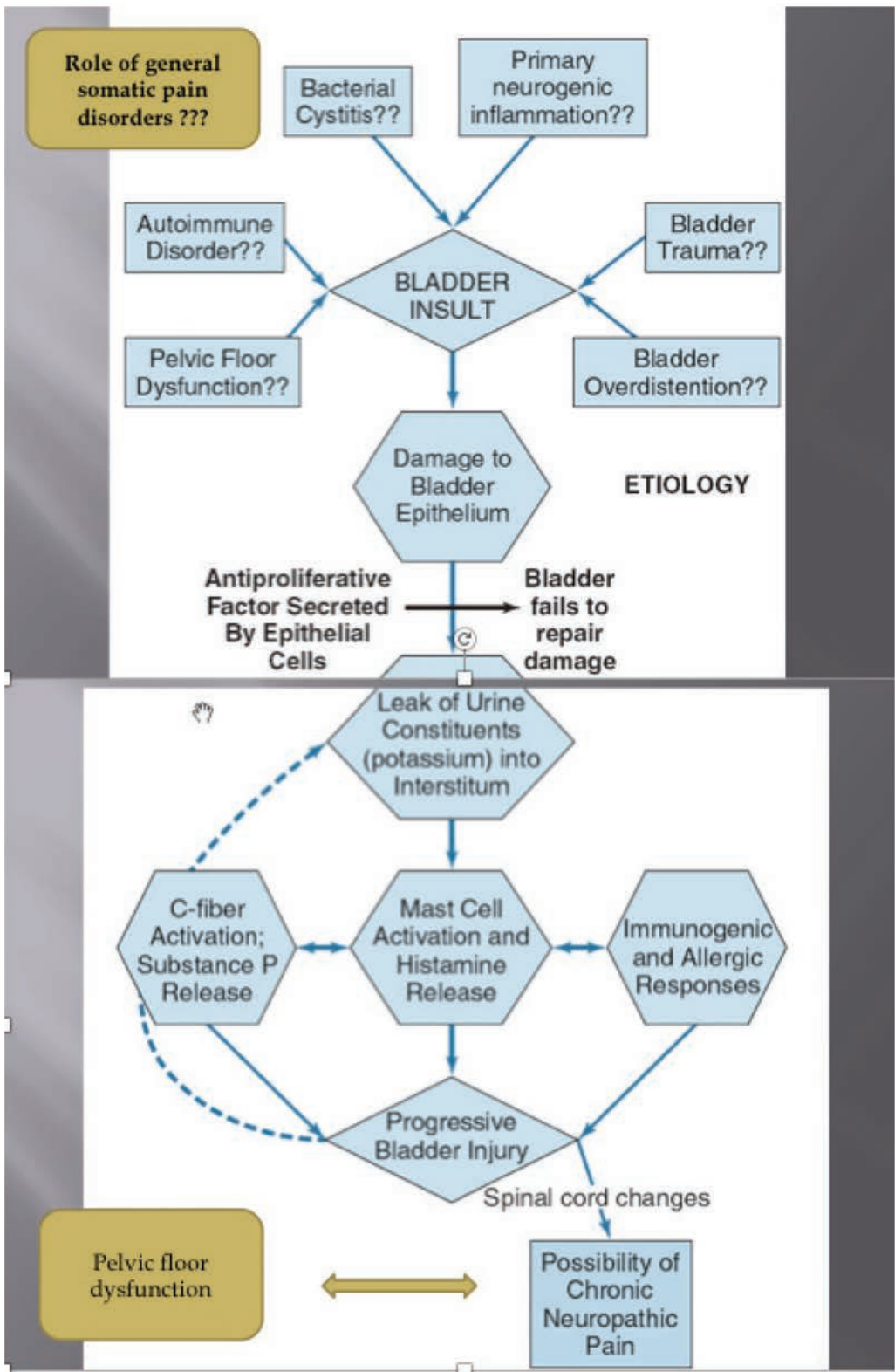

V. PATHOLOGY

One can have pathology consistent with the diagnosis of BPS, but there is no histology pathognomonic of this syndrome.

The role of histopathology in the diagnosis of BPS is primarily one of excluding other possible diagnoses. One must rule out carcinoma and carcinoma-in-situ, eosinophilic cystitis, tuberculous cystitis, as well as any other entities with a specific tissue diagnosis (114,163,164). **Level of Evidence: 1 Grade of Recommendation: A**

The pathologic findings in BPS are not consistent. (165,166) There has been a great variation in the reported histologic appearance of biopsies from BPS patients, and even variation among biopsies taken from the same patients over time. (22)

Lepinard and colleagues (167) reported a pancystitis affecting the 3 layers of bladder wall. In nonulcerative disease the vesical wall was never normal, epithelium being thinned and muscle being affected. Johansson and Fall (114) looked at 64 patients with ulcerative disease and 44 with nonulcerative IC. The former group had mucosal ulceration and hemorrhage, granulation tissue, intense inflammatory infiltrate, elevated mast cell counts and perineural infiltrates. The nonulcer group, despite the same severe symptoms, had a relatively unaltered mucosa with a sparse inflammatory response, the main feature being multiple, small, mucosal ruptures and suburothelial hemorrhages that were noted in a high proportion of patients. As these specimens were almost all taken immediately after hydrodistention, how much of the admittedly minimal findings in the nonulcer group were purely iatrogenic is a matter of speculation.

One can see completely normal biopsies in the nonulcerative BPS group (168). Transition from nonulcerative to ulcerative BPS is a rare event (169), and pathologically the two types of IC may be completely separate entities. While mast cells are more commonly seen in the detrusor in ulcerative BPS (170), they are also common in patients with idiopathic bladder instability (171). Mastocytosis in BPS is best documented by tryptase immunocytochemical staining (172). Larsen and colleagues recommend taking biopsies from the detrusor of patients with suspected BPS and examining them with tryptase-stained 3 micron thick sections, with every seventh section used for quantification. They consider 27 mast cells/mm² indicative of mastocytosis. (173) Despite attempts to develop a diagnostic algorithm based on the detrusor to mucosa mast cell ratio and nerve fiber proliferation (104), mast cell counts per se have no place in the differential diagnosis of this clinical syndrome.

Mast cells could be valuable in clinical phenotyping, but as yet that is unproven. Mast cells trigger inflammation that is associated with local pain, but the mechanisms mediating pain are unclear. In a murine model of neurogenic cystitis, Rudick and colleagues

(174) demonstrated that mast cells promote cystitis pain and bladder pathophysiology through the separable actions of histamine and tumor necrosis factor respectively. Therefore, pain is independent of pathology and inflammation, and histamine receptors may represent direct therapeutic targets for the pain of BPS and other chronic pain conditions.

Lynes and coworkers (33) concluded that biopsy specimens are often not helpful in confirming the diagnosis. Although BPS patients in his study had a higher incidence and degree of denuded epithelium, ulceration, and submucosal inflammation, none of these findings was pathognomonic. In addition, these "typical" findings occurred only in BPS patients with pyuria or small bladder capacity. Epithelial and basement membrane thickness, submucosal edema, vascular ectasia, fibrosis, and detrusor muscle inflammation and fibrosis were not significantly different in the BPS and control patients.

Attempts to definitively diagnose BPS by electron microscopy have also been unsuccessful. Collan's group (175), in the first such study, wrote that the similarity of the ultrastructure of epithelial cells in controls and IC patients makes it improbable that the disease process originates in the epithelium. Other investigators found no differences in the morphologic appearances of the glycocalyx and of urothelial cells in patients with IC when compared with controls (176). Anderstrom and colleagues (115) saw no surface characteristics specific for IC, but believed that the mucin layer covering the urothelial cells seemed reduced in IC compared with controls, a fact disputed by Nickel in a very elegant paper (177). Elbadawi and Light (141) observed ultrastructural changes sufficiently distinctive to be diagnostic in specimens submitted for pathologic confirmation of nonulcerative interstitial cystitis. Marked edema of various tissue elements and cells appeared to be a common denominator of many observed changes. The wide-ranging discussion of the etiology of IC in his paper is fascinating, but the pathological findings are potentially marred by the methodology, in that specimens were obtained after diagnostic hydrodistention. (178)

So what is the place of pathologic examination of tissue in BPS? Attempts to classify the painful bladder by the pathoanatomical criteria described by Holm-Bentzen (179) are of questionable value. There is a group of patients with what she describes as "nonobstructive detrusor myopathy". (180) In her series, these patients with degenerative changes in the detrusor muscle often had residual urine, a history of urinary retention, and an absence of sensory urgency on cystometry with bladder capacities over 400cc. Most would not be clinically confused with BPS. A similar English series (181), however, included patients who met NIDDK research criteria and associated detrusor myopathy with diminished detrusor compliance and ultimate bladder contracture.

The Interstitial Cystitis Database (ICDB) study worked backwards from symptoms to pathology, and

concluded that certain symptoms are predictive of specific pathologic findings (31,182). Denson et. al. (34) analyzed forceps biopsies from 65 females and 4 males with BPS. Ten per cent of specimens showed vasodilatation or submucosal edema. Inflammation was absent in 30% of patients, and mild in another 41%. Cystoscopic changes did not correlate with degree of inflammation. Hanus and colleagues (183) studied 84 biopsies from 112 BPS patients and reported a linear relationship between the mean bladder capacity under anesthesia and severity of glomerulations. They did not find a correlation between severity of symptoms and histopathological changes observed by light or electron microscopy.

Richter and the Danish group showed studied 349 consecutive BPS patients and concluded that nocturia, detrusor mastocytosis, and detrusor intrafascicular fibrosis are associated with multiple treatments and presumed failure of standard urological therapy while bladder capacity and glomerulations are not (184). In a Belgian study, cystoscopic parameters (glomerulations, bleeding, mucosal tears, bladder capacity) showed no correlations with the histological features of bladder biopsies. No correlations were found between inflammatory infiltrate and detrusor mastocytosis. In fact, detrusor mastocytosis was more elevated in biopsies with normal urinary epithelium than in those with damaged epithelium. The study concludes that the clinical significance of pathological findings awaits future research findings. (185)

Rosamilia reviewed the pathology literature pertaining to BPS in 2 publications and presented her own data (32,40). She compared forceps biopsies from 35 control and 34 PBS/IC patients, 6 with bladder capacities less than 400cc under anesthesia. Epithelial denudation, submucosal edema, congestion and ectasia and inflammatory infiltrate were increased in the BPS group. Submucosal hemorrhage did not differentiate the groups, but denuded epithelium was unique to the BPS group and more common in those with severe disease. The most remarkable finding in her study was that histological parameters were normal and indistinguishable from control subjects in 55% of BPS subjects. Method of biopsy can be important in interpreting findings, as transurethral resection biopsies tend to show mucosal ruptures, submucosal hemorrhage and mild inflammation (114), while histology is normal approximately half the time with cold-cup forceps biopsies (32,33,186).

Histopathology plays a supportive diagnostic role at best (187). Major reconstructive procedures appear to have better outcomes in patients with pathology consistent with Hunner's lesions. (188) Inflammatory features can be seen in 24% to 76% of patients without a visible Hunner's lesion. (189) While studies suggest that a severely abnormal pathology may be associated with poor prognosis (190, 191) this is not necessarily the case (192).

At this point in time, excluding other diseases that are pathologically identifiable is the primary utility of bladder biopsy in this group of patients. (193,194) Whether or not increased bladder permeability is present in an individual patient (195), cannot be determined by histopathologic techniques at the present time. Findings typical of Hunner lesion pathology can be ascertained on biopsy of these lesions and rule out malignancy or other confusable disorders.

VI. DIAGNOSIS

Much work has been put into the attempt to define objective diagnostic criteria based on, among other factors, cystoscopy under local or general anesthesia, bladder distention with registration of bladder capacity and/or possible presence of glomerulations and Hunner lesion, bladder wall biopsies evaluated for inflammation, ulcer, fibrosis, mast cells, etc. and urodynamics with registration of bladder capacity, compliance and bladder stability. Results have, however, been frustrating. It is more fruitful to establish a broad clinical diagnosis, mainly on the basis of symptoms and exclusion of other diseases, and then stratify patients by urodynamic, cystoscopic, histological, and other tests on the basis of the significance of these findings for results of treatment and prognosis of disease. Current efforts to phenotype the disorder by the presence or absence of associated syndromes and diseases may also prove useful in the same way.

What follows is based solely on expert opinion.

Level of Evidence:4 Grade of Recommendation: C

It is hoped that future Consultations will have the data to base such suggestions on a firmer foundation.

1. HISTORY

A general thorough medical history should be taken. Special emphasis should be given to:

- Previous pelvic operations
- Previous UTI
- Bladder history/urological diseases
- Location of pelvic pain (referred pain) and relation to bladder filling/emptying.
- Characteristics of pain: onset, correlation with other events, description of pain
- Previous pelvic radiation treatment
- Autoimmune diseases

2. PHYSICAL EXAMINATION

A common physical examination should be performed including palpation of the lower abdomen for bladder fullness and tenderness:

- Standing: kyphosis, scars, hernia
- Supine: abduction/adduction of the hips, hyper-aesthetic areas

In females physical examination should include a vaginal examination with pain mapping of the vulvar region and vaginal palpation for tenderness of the bladder, urethra, levator and adductor muscles of the pelvic floor. Tenderness might be graded as mild, moderate or severe.

Pain mapping

Inspection:

- Vulva
 - exclusion of vulvar/vestibular diseases (vulvitis, dermatosis etc.)
 - evaluation of introital area (endometriosis)
 - tenderness of vestibular glands or vulvar skin (Touch Test: use wet cotton stick or finger tip)
- Vagina
 - tenderness during insertion and opening of speculum
 - cervical pathology
 - vaginal fornices (endometriosis)
- Bimanual physical examination
 - tenderness of urethra, trigone and bladder
 - superficial/deep vaginal tenderness
 - tenderness of pelvic floor muscles (levator, adductor)
 - tenderness in adnexal areas

In males digital rectal examination (DRE) should be performed with pain mapping of the scrotal–anal region and palpation of tenderness of the bladder, prostate, levator and adductor muscles of the pelvic floor and the scrotal content.

3. LABORATORY TESTING

- Urine dipstick (ABS, pH, leucocytes, nitrate), urine culture in all. If sterile pyuria culture for tuberculosis.
- Urine cytology in risk groups.

- Investigations for vaginal Ureaplasma and Chlamydia in females and prostatitis in men are optional.

4. SYMPTOM EVALUATION

- Voiding diary with volume intake and output for 3 days at initial evaluation. Patient sensation at voiding might be recorded (see chapter outcome assessment, Hanno).
- At follow-up only number of voidings during day and night time is necessary. Morning volume might be recorded as a help to monitor highest functional capacity.
- The O'Leary–Sant Symptom Score supplemented should be used as basic symptom score supplemented with the Quality of Life Score from the International Prostate Symptom Score (see chapter symptom scales, Hanno3).

Pain should be recorded using a Visual Analogue Scale (VAS) for pain during the last 24 hours (to fit with the voiding diary). Separate scores for the average, mildest and worst pain should be obtained (see symptom scales)

5. URODYNAMICS

The NIDDK criteria excluded patients with detrusor overactivity at filling cystometry in order not to confuse the picture in clinical trials (22). This does not however mean that detrusor overactivity can not co-exist with bladder pain syndrome. In the interstitial cystitis database approximately 14% of BPS patients had overactive bladders. (9) Whether these patients respond better to antimuscarinics than BPS patients with stable bladders has never been systematically investigated. If so, a rationale for routinely employing urodynamics as a part of the evaluation would follow. In males, infravesical obstruction might be a differential diagnosis (196), and it is recommended to do flowmetry in all males and pressure-flow studies in men with a peak flow rate below 20ml/seconds.

There are no data to support the following recommendations:

In females, flowmetry, post-void residual urine volume and pressure- flow study are optional. In males, a flowmetry should be done in all, and if maximum flow rate <20 ml/s a pressure-flow study and measure of residual urine volume should be done. It is recommended to perform filling cystometry with a filling rate of 50 ml/s (to comply with the revised Potassium Test - see below) to look for overactivity, volume at first desire to void and cystometric capacity.

Level of Evidence:4 Grade of Recommendation:C

6. POTASSIUM TESTING

Parsons has championed an intravesical potassium chloride challenge, comparing the sensory nerve provocative ability of sodium versus potassium using a 0.4 M potassium chloride solution. The test has proved controversial (39). Pain and provocation of symptoms constitutes a positive test. Whether the results indicate abnormal epithelial permeability in the subgroup of positive patients, or hypersensitivity of the sensory nerves is unclear. Normal bladder epithelium can never be absolutely tight, and there is always some leak, however small (197). The concentration of potassium used is 400meq per liter, far exceeding the physiologic urinary concentrations of 20-80meq/liter depending upon dietary intake (198). Healthy controls can distinguish KCl from sodium chloride, though they don't experience severe pain (199). The hope is that this test may stratify patients into those who will respond to certain treatments (perhaps those designed to fortify the glycosaminoglycan layer) (200).

Used as a diagnostic test for bladder pain syndrome, the potassium chloride test is not valid (201). The gold standard in defining BPS for research purposes has been the NIDDK criteria. These criteria are recognized to constitute a set of patients that virtually all researchers can agree have BPS, though they are far too restrictive to be used in clinical practice (25). Thus, this group of patients should virtually all be positive if the KCl test is to have the sensitivity needed to aid in diagnosis. Up to 25% of patients meeting the NIDDK criteria will have a negative KCl test (202). In the group it should perform the best in, it is lacking in sensitivity. When we look at the specificity side of the equation, in the universe of asymptomatic persons, it performs relatively well and is rarely positive, although a recent study reported a 36% false positive rate in asymptomatic men (203). It is in the patient population with confounding conditions for which we would want help in sorting out BPS from other disorders. Sixty percent of patients with overactive bladder test positive (204) and virtually all patients with irritative symptoms from radiation cystitis and urinary tract infection test positive (202,205). The results with chronic prostatitis / chronic pelvic pain syndrome in men are variable, but 50-84% of men have been reported to test positive (203,206,207). In women with pelvic pain results are similar (208), and based on these findings, Parsons has expressed the view that BPS may affect over 20% of the female population of the United States[201]! Others have reported prevalence in unselected female textile workers in Turkey using similar methods at 32.8% (209). Another way to interpret the findings would be that the KCl test is very nonspecific, missing a significant number of BPS patients and over-diagnosing much of the population.

Prospective and retrospective studies looking at the KCl test for diagnosis in patients presenting with symptoms of BPS have found no benefit of the test in comparison with standard techniques of diagnosis

(201,210,211). A later modification of the test using 0.3 molar potassium chloride for potential differentiation between patients with IC and detrusor overactivity (DO) showed that the 0.3 M KCl reduces maximum cystometric capacity in BPS and DO, the effect being more pronounced in DO. Urothelial hyperpermeability was not specific to IC. Comparative cystometry using NS and 0.3 M KCl does not help to differentiate BPS from DO (212,213).

The development of a painless modification of the potassium chloride test (214) using cystometric capacity and a 0.2M solution may improve acceptability among patients. The so-called revised or Comparative Potassium Test has shown prognostic value in bladder irrigation studies (215) but is considered optional by ESSIC. If performed it should be performed according to Daha et al. (214): A Foley balloon catheter (14F) is inserted and the bladder drained. Instill into the bladder 500 ml saline (0.9%) at a rate of 50 ml/min via an infusion set until the maximum capacity is reached. Drain the bladder and measure the saline filling volume. Repeat the instillation and measurement with 500 ml 0.2 M potassium chloride at a rate of 50 ml/min (taking care that filling lines are emptied of all saline before KCl instillation), and calculate the filling volume difference. A difference in bladder capacity > 30% is considered positive. Besides reduction of bladder capacity with 0.2 M KCl there is a stronger feeling of urgency in IC patients compared to the saline filling, which is also clinically relevant.

Level of Evidence:1 Grade of Recommendation: -A (not recommended)

7. CYSTOSCOPY

The classic cystoscopic picture of BPS as an "elusive" bladder ulcer with a corresponding cystoscopic appearance of patches of red mucosa exhibiting small vessels radiating to a central pale scar was described by Hunner in 1915 (17). (figures 7, 8 & 9) courtesy of Jorgen Nordling)

Level of Evidence:2 Grade of Recommendation:B

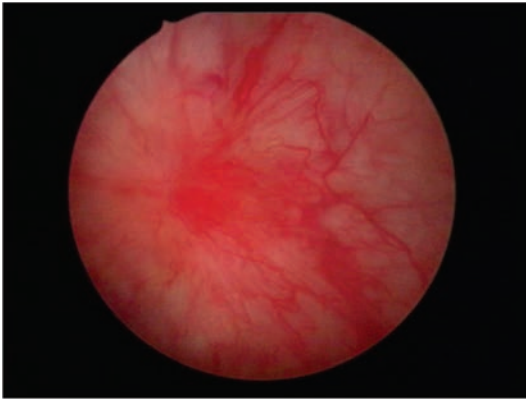

Figure 7: Hunner lesion prior to bladder distention

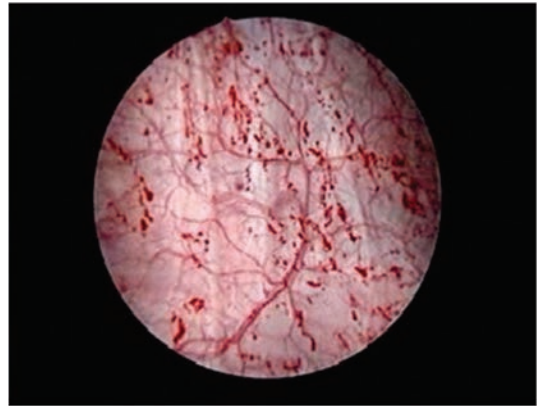

Figure 10: Glomerulations at 80cm water pressure

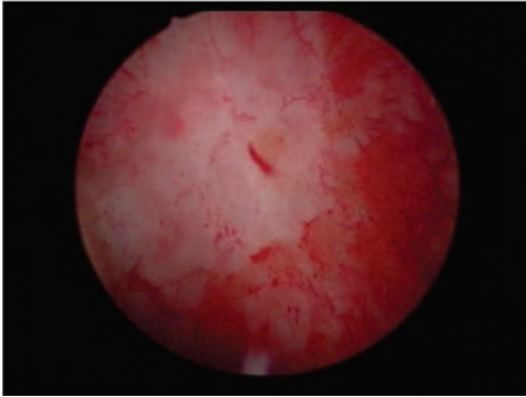

Figure 8: Hunner lesion at 80cm water pressure

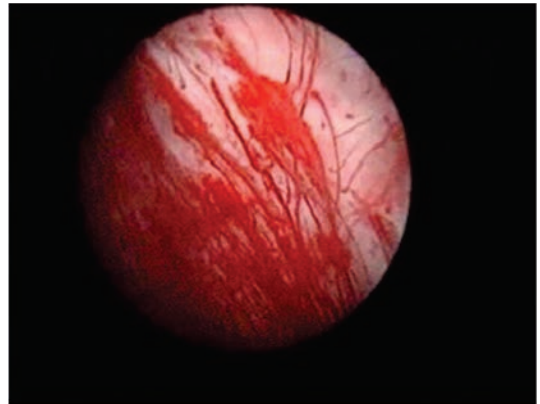

Figure 11: Typical waterfall after release of water pressure

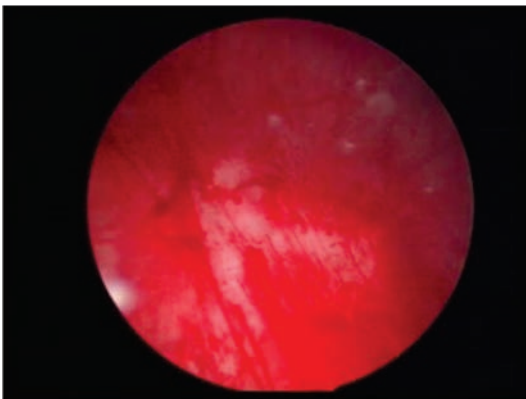

Figure 9: Hunner lesion after distention and release of fluid

After 1978, glomerulations, described as punctate petechial hemorrhages and observed after hydrodistention, became the primary cystoscopic feature of BPS (21). (Figures 10 and 11, courtesy of Tomohiro Ueda)

But not all patients with symptoms of BPS have glomerulations (25,34,184,216), and not all patients with glomerulations have symptoms of BPS (204,217-219). Neither presence nor severity of glomerulations correlate with any of the primary symptoms of BPS (31), although the presence of a Hunner's lesion is significantly associated with bodily pain and urinary urgency (218). A recent review on glomerulations after bladder distention found no diagnostic or prognostic value of this finding (47). The finding of a Hunner's lesion or glomerulations has been somewhat subjective. Some researchers find a Hunner's lesion in 50% of their BPS patients (220), while others rarely see one (221).

No study comparing individual perceptions and variations in reporting or classifying glomerulations has ever been reported. Bladder capacity during hydrodistention has not drawn much attention, although it is strongly associated with increased urgency (222).

Because considerable variation in the duration of distention, repetition of distention, the pressure used for distention, and the measurement of bladder capacity have been described (223), the ESSIC has suggested a standardized procedure for cystoscopy and hydrodistention (38)

A rigid cystoscope is preferred to facilitate taking of adequate biopsies. Glycine or corresponding filling fluid should be used to allow for coagulation after biopsies. Infusion height should be approximately 80 cm above the Symphysis Pubis. A dripping chamber is used and the bladder is filled until fluid dribbling stops. If necessary, a digital block is applied around the urethra to prevent leakage. Pre-distension inspection includes observation for radiating vessels, coagulum or fibrine deposits, white spots, hyperaemia, oedema, cracks, scars or any other mucosal changes. Continuous inspection while filling the bladder is advised. When maximum capacity is reached, the distension is maintained for 3 minutes. The bladder is emptied and the colour of the fluid checked for the degree of bleeding. The total volume drained is the measured maximum bladder capacity. During a second filling, the bladder is filled to approximately 1/3rd to 2/3rd of the bladder capacity to achieve optimal vision for inspection and biopsies. The bladder should not be filled to maximum capacity or distended again to avoid further provocation of changes with doubtful reproducibility.

7.1. Inspection

Describe lesions in anterior wall, posterior wall, lateral quadrants and fundus. At the fundus one should be alert for possible artefacts if there is blind introduction of the scope. Bladder mapping by drawing is mandatory. Photographs are recommended but optional.

7.2. Classification

Grade 0 = normal mucosa

Grade I = petechiae in at least two quadrants

Grade II = large submucosal bleeding (ecchymosis)

Grade III = diffuse global mucosal bleeding
Grade IV = mucosal disruption, with or without bleeding/oedema

The importance of the finding of the finding of glomerulations after hydrodistension is however as mentioned been questioned since 45% of asymptomatic females, 20% of males with LUTS suggestive of BOO and 85% of females with OAB and no bladder pain demonstrates typical glomerulations after hydrodistension (204,219,224) and 10-34% of patients with BPS do not (184,216)

How useful is hydrodistention?

Hydrodistension results fail to identify any statistically significant differences in post-distention objective findings (anesthetic capacity, glomerulations) or therapeutic benefits when patients are categorized according to presenting symptoms (225). Cystoscopy with hydrodistention may provide little useful information above and beyond the history and physical examination findings. In one study, 56% of 84 patients reported symptom improvement, but the duration was short lived with a mean of 2 months (226). It is necessary to distinguish between short term hydrodistension (2-10 min.) for classification of BPS and

long term hydrodistension (20-30 min.) for treatment (227). Many reports on the therapeutic effect of hydrodistension are from Asia and from a patient material with IC based on the Asian definition (228), where up to 2/3 of the patients have frequency-urgency and no pain.

Lamale and colleagues examined the relationships between symptoms and cystoscopic findings in 12 women newly diagnosed with BPS who had not previously received treatment. Pain symptoms had consistent positive correlations with the cystoscopic findings. An increase in pain with bladder filling was associated with inflammation ($P = 0.011$), ulceration, and smaller bladder capacity. Pain relief after voiding correlated with smaller bladder capacity ($P = 0.019$), hematuria, and total cystoscopic score. Pain intensity in the urethra was related to ulceration and hematuria, and pain in the lower abdomen was related to a smaller bladder capacity ($P = 0.047$), glomerulations, and a larger total cystoscopic score. Daytime frequency correlated negatively with most cystoscopic findings, and nocturnal frequency had a positive relationship with most cystoscopic findings and was significantly associated with a smaller bladder capacity ($P = 0.010$). Urgency showed no strong associations with any cystoscopic findings. The results of this study contradict those of previous studies that found no relationship between symptom reports and cystoscopic findings suggesting possible effects of treatment on pain perception and therapeutic influence on cystoscopic findings (229).

It is important to keep in mind that the cystoscopic appearance of the bladder wall after hydrodistention may not be constant over time, and the absence of initial findings of glomerulations or terminal hematuria does not preclude further development of these findings of the disease on subsequent evaluation (230). Rare cases of hydrodistension induced bladder necrosis have been described (231).

8. MORPHOLOGY

Pathological changes in light microscopic and electron microscopic features in patients with BPS have been described including infiltration with inflammatory cells in all or specific parts of the bladder wall. Although these findings are important in our attempt to understand the disease and perhaps as an aid to stratification of patients, there are at this time no pathognomonic findings on biopsy in terms of diagnosis (31). Expert opinion as per the ESSIC suggests the following procedures when biopsy is planned for BPS evaluation (38):

8.1. Biopsies

During cystoscopy the bladder is distended to full capacity. After draining the bladder, bladder biopsies are taken at roughly half full bladder capacity: Biopsy procedures should be performed by using large for-

ceps and include detrusor muscle; alternatively double punch biopsies or resections of lesions can be used.

8.2. Number of Biopsies

At least 3 biopsies from the two lateral walls and bladder dome should be taken in addition to biopsies from visually abnormal areas. The biopsies are to be immediately fixed in neutral buffered 4% formalin.

8.3. Biopsy Handling

Biopsies are treated conventionally. Six adjacent 3 mm sections are cut and placed with 3 specimens on each of two specimen slides. The first slide is stained with H&E, the next with a connective tissue stain suitable for the individual institute. Twenty-four 10 mm sections are then cut and every third section is mounted on a specimen slide for mast cell counting. The specimens are stained by Lederstain (naphtolesterase) according to routine procedures. Finally, a 3mm section is obtained to ensure the presence of detrusor muscle in the specimens.

8.4. Mast Cell Counting

The use of a measuring grid (e.g. Leitz periplan 6F 10_N ocular containing a standardized grid) is necessary. Only mast cells containing nucleus are included. When counting the cells those covering or touching the bottom should be excluded whereas those covering the upper and left line are included. At least 3 biopsies must be the subject of mast cell counting and if possible one including a lesional area. Biopsies for mast cell counting should contain detrusor muscle.

8.5. The Pathology Report

- Epithelium
 - Not present
 - Present
 - Dysplasia with grading
 - Abnormal but no dysplasia: description is mandatory.
- Propria
 - Normal
 - Inflammation: description with a grading
 - Other findings are described
- Detrusor muscle. Abnormal muscle cells: describe
- Intrafascicular fibrosis
 - Not present
 - Present
- Mast cell count: At least three biopsies should be included in the counting. Only the biopsy with the

highest number of mast cells per mm² should be reported

The enzymatic (naphtolesterase) staining is, for the time being, recommended since standardized values are available:

- less than 20 mast cells/mm²: no detrusor mastocytosis;
- between 20 and 28 grey zone!
- more than 28 mast cells/mm²: detrusor mastocytosis.

Larsen recommends examining the detrusor biopsies with tryptase-stained 3 micron thick sections, with every seventh section used for quantification; 27 mast cells/mm² is considered indicative of mastocytosis (173).

These guidelines have been reported to be easy to follow. A statistically significant correlation was found between the cystoscopic aspect and inflammatory infiltration, mast cell count in the detrusor muscle and stromal edema. Maximum bladder capacity was negatively correlated with inflammation, detrusor mast cell count, hemorrhages and the overall cystoscopic aspect (232). Correlations have also been demonstrated between urothelial damage and inflammatory infiltrates and between normal epithelium and detrusor mastocytosis suggesting either 2 different types of BPS or different stadiums in the pathophysiological process of BPS (185). Also in a large retrospective study of 349 patients with BPS, it was found that treatment intensity ranging from hydrodistension only to major surgery correlated positively to detrusor mast cell count, detrusor fibrosis and nocturia, but not to maximum bladder capacity or glomerulations after hydrodistension (233).

9. BIOMARKERS

The lack of universally accepted clinical diagnostic criteria for BPS affects all aspects of making progress in understanding this disease. Insights into risk factors, pathogenesis, trials for effective therapy, prognosis, and outcome criteria for treatment are all affected by this lack of diagnostic criteria. A major factor affecting the controversy over accepted clinical diagnostic criteria is that the current criteria are predominantly symptom specific. An objective biomarker would advance the establishment of reproducible diagnostic criteria for BPS and also aid in monitoring effects of treatment.

A biomarker for any disease needs to demonstrate high sensitivity and high specificity. In addition, the marker assay needs to be reproducible in many laboratories and should be suitable for use in a clinical diagnostic laboratory.

Many of the published studies on biomarkers for BPS have been on biomarkers isolated from urine. Erickson et.al has published excellent reviews of urine

markers for BPS (234,235). The most thoroughly investigated marker is antiproliferative factor (APF). This factor has been identified and characterized by Dr. Susan Keay and her colleagues at the University of Maryland (236,237). Control subjects for this study included asymptomatic individuals, patients with bacterial cystitis, and patients with vulvovaginitis. APF is found in urine from the bladder and not from the renal pelvis (238-240). Treatment of symptomatic BPS by either hydrodistention or neurostimulation normalized the APF levels concurrent with symptom relief (241). It is not known if other forms of treatment will affect APF levels. Preliminary studies in 58 women with documented BPS demonstrated a sensitivity value of 91.4% and a specificity of 90.6% (242). A later study with 219 symptomatic BPS patients and 325 controls with and without other urological disorders documented the sensitivity as 94% and the specificity at 95% (243). APF has been isolated from urine and found to be a frizzled 8 protein-related sialoglycopeptide which interacts with the epithelial cell receptor CKAP4/p63 (244,245). Keay et al have suggested that APF might inhibit cell proliferation by the down-regulation of genes that stimulate cell proliferation along with the upregulation of genes that inhibit cell growth (117). Cell growth inhibition of human urothelial cells appears to be mediated by p53 (246). APF treatment caused significant increases in the paracellular permeability of normal bladder epithelial cell monolayers and the attenuation of tight junctions compared to mock APF, similar to changes seen in IC cells. APF treatment also decreased expression of the tight junction proteins zonula occludens-1 and occluding (245)

APF seems an ideal candidate for a biomarker for symptomatic BPS. There need to be additional studies to determine if it can serve as a BPS marker for patients in remission or for those who have not yet become symptomatic. As of 2016, the findings on symptomatic patients have yet to be replicated by laboratories around the world, and the biologic assay has not proven suitable for commercial development as it currently exists.

GP-51 is a glycoprotein present in both the transitional epithelium and urine of humans and other mammals. Moskowitz et. al have shown that bladder biopsies of BPS patients had decreased staining for GP-51 (247) The same laboratory also demonstrated that although GP-51 demonstrates a high specificity for BPS, it is not as sensitive as APF (248).

There have also been many published studies on heparin-binding epidermal growth factor-like growth factor (HB-EGF) (117,239,240,249,250). HB-EGF is a growth factor found in normal urine. It has been shown that APF inhibits the production of HB-EGF. There have been no large population studies focusing solely on HB-EGF as a biomarker for BPS.

Recent results from the MAPP studies indicate some urinary metabolites capable of discriminating female BPS patients from controls. Ethiocholan-3 α -ol-17one

sulfate (Etio-S) did so with a specificity and sensitivity >90%. Among BPS patients Etio-S levels are correlated with elevated symptom scores and could resolve high- from low- symptom BPS. (251). Clinically useful biomarkers may be a possibility in the future.

10. CONFUSABLE DISEASES

Criteria for a diagnosis are needed only if the target disease may be confused with other diseases (confusable diseases) because of overlapping features (252). For a diagnosis, the target disease has to be recognized in a pool of confusable diseases in one of two ways: by recognition of the specific combination of features of the target disease or by exclusion of confusable diseases. For the diagnosis of BPS both methods might be used because:

- Confusable diseases are more common than BPS, so recognition is mandatory because many can be treated.
- Failure to diagnose a confusable disease would automatically incorrectly yield a diagnosis of BPS.
- Patients may have a confusable disease plus BPS.

The diagnosis of BPS can thus made on the basis of exclusion of confusable diseases and confirmation by the recognition of the presence of the specific combination of symptoms and signs of BPS. If the main urinary symptoms are not explained by a single diagnosis (confusable disease or BPS), the presence of a second diagnosis is possible. Symptoms and signs for use in diagnostic criteria do not need to be specific for the target disease. On the contrary, if a specific symptom or sign existed for the target disease, a diagnosis would only require the presence of the specific feature and diagnostic criteria would not be necessary.

In evidence-based medicine, diagnoses are based on medical history, physical examination, and appropriate clinical investigations to eliminate diseases from a list of differential diagnoses (confusable diseases) and to confirm the final diagnosis. BPS may occur together with confusable diseases such as chronic or remitting urinary infections or endometriosis. Cystoscopy with hydrodistention and biopsies might in this situation document positive signs of BPS thereby making a double diagnosis more probable. For therapeutic studies it makes sense to exclude patients who also have a confusable disease because symptoms and signs may be caused by BPS, the confusable disease, or by both. For prevalence studies of BPS, on the other hand, all cases with BPS should be included, also those with a confusable disease. This approach eliminates the need for separate diagnostic criteria for clinical practice and scientific studies. Table 3 summarizes confusable diseases related to BPS and their mode of exclusion based upon the

above-mentioned diagnostic proposals and procedures (38,2).

Table 3: Differential Diagnosis of Bladder Pain Syndrome

Carcinoma and carcinoma in situ	Cystoscopy and biopsy
Infection with	
Common intestinal bacteria	Routine bacterial culture
<i>Chlamydia trachomatis</i> , <i>Ureaplasma urealyticum</i>	Special cultures
<i>Mycoplasma hominis</i> , <i>Mycoplasma genitalium</i>	
<i>Corynebacterium urealyticum</i> , <i>Candida</i> species	
<i>Mycobacterium tuberculosis</i>	Dipstick; if “sterile” pyuria culture for <i>M. tuberculosis</i>
Herpes simplex and human papilloma virus	Physical examination
Radiation	Medical history
Chemotherapy, including immunotherapy with cyclophosphamide	Medical history
Anti-inflammatory therapy with tiaprofenic acid	Medical history
Bladder-neck obstruction and neurogenic outlet obstruction	Uroflowmetry and ultrasound
Bladder stone	Imaging or cystoscopy
Lower ureteric stone	Medical history and/or hematuria: upper urinary tract imaging such CT or IVP
Urethral diverticulum	Medical history and physical examination
Urogenital prolapse	Medical history and physical examination
Endometriosis	Medical history and physical examination
Vaginal candidiasis	Medical history and physical examination
Cervical, uterine, and ovarian cancer	Physical examination
Incomplete bladder emptying (retention)	Postvoid residual urine volume measured by ultrasound scanning
Overactive bladder	Medical history and urodynamics
Prostate cancer	Physical examination and PSA
Benign prostatic obstruction	Uroflowmetry and pressure-flow studies
Chronic bacterial prostatitis	Medical history, physical examination, culture
Chronic non-bacterial prostatitis	Medical history, physical examination, culture
Pudendal nerve entrapment	Medical history, physical examination, nerve block may prove diagnosis
Pelvic floor muscle-related pain	Medical history, physical examination

Van de Merwe J, Nordling J, Bouchelouche P, Bouchelouche K, Cervigni M, Daha LK et al. Diagnostic criteria, classification, and nomenclature for Painful Bladder Syndrome/Interstitial Cystitis: An ESSIC proposal. Eur. Urol. 2008;53:60.

VII. BPS & GYNECOLOGICAL ASSOCIATED / CONFUSABLE DISORDERS

1. INTRODUCTION

In female population affected by BPS/IC the gynecological diseases may be present in about 20% of pats. and there is also an overlapping of musculoskeletal pathologies in 12% of cases. (253)

Here below the following most frequent gynecological disorders in BPS/IC population:

2. PELVIC FLOOR DYSFUNCTION

Pelvic floor dysfunction affects the anterior, apical or posterior vaginal compartment. There are two types of dysfunction: hypotonic or LPFD and HPFD (see

Table 1). Many patients with BPS/IC have concomitant HPFD, with muscle tenderness and spasms, and voiding dysfunction, both manifestations of pelvic floor hypertonicity. (254)

It has been estimated that the prevalence of HPFD in patients with BPS/IC ranges from 50% to 87%. (255)

Pelvic floor dysfunction exacerbates BPS/IC symptoms, and has been reported to appear in response to events such as bladder inflammation, gait disturbance, and trauma. (256)

Other pain disorders, such as irritable bowel syndrome, inflammatory bowel disease, fibromyalgia, and vulvodynia are all found to have a high prevalence in HPFD and myofascial pain. (88)

All these disorders are frequently associated with BPS/IC.

Table 4 Types of pelvic floor dysfunctions

HYPOTONIC DISORDERS	HYPERTONIC DISORDERS
Stress Urinary Incontinence	Overactive Bladder
Pelvic Organ Prolapse	BPS/IC
Fecal Incontinence	Vulvodynia
	Chronic Pelvic Pain
	Overactive bowel
	Sexual Dysfunction

3. PATHOPHYSIOLOGY

In a normal bladder, the peripheral way of transmission is mediated by A δ -fibers that transfer tension, pain and cold. Instead, the C-fibers transfer burning, heat, pain and itching; they are normally silent, only becoming active in response to bladder inflammation or irritation. An inflammatory disorder of the pelvic viscera, a trauma or exceptional behavior might elicit noxious stimuli to the sacral cord that sets up a pelvic floor muscle dysfunction with sacral nerve hypersensitivity and a sacral cord wind-up. (257)

The guarding reflex is a visceromotoric reflex activated with the aim of increasing the tone of the pelvic floor during routine daytime activity. In BPS/IC patients, there is an afferent autonomic bombardment that can enhance and maintain a guarding reflex that manifests itself as a hypertonicity of the pelvic floor.

4. PHYSICAL EXAMINATION

Patients with HPFD are unable to produce more contractile strength and therefore cannot produce an effective squeeze. A single finger can be introduced in the vagina to assess pelvic floor awareness, and the ability to squeeze and relax the levator ani. Often patients with HPFD will have a “V” configuration of the introitus and, as a finger is advanced, it will drop off the shelf caused by the contracted levator muscles. Active “trigger points” are often identified by an exquisitely tender area palpable at the level of the pelvic side wall within a taut band that reproduces the patient’s pain, as well as the referral pattern of her pain.

5. DIAGNOSTIC STUDIES

Muscle activity can be measured using a perineometer or an electromyography probe. (258) Urodynamics include fluctuating or interrupted flow, abnormal voiding studies, elevated urethral pressure and urethral instability. Schmidt and Vapnek observed pain episodes in such patients coinciding with behavioral increase in the sphincter tone, more than in the bladder. (147)

When symptoms involve obstructed defecation and rectal pain, defecography should be used to identify the presence of a non-relaxing pelvic floor or even paradoxical activity of the pelvic floor during defecation.

6. TREATMENT

The pelvic floor therapy should be considered as a first-line treatment in the case of HPFD. The goal of these stretching exercises is to lengthen the contracted muscles by decreasing tension, releasing trigger points in the levator muscles, re-educating the muscles to a normal range of motion and improving patient awareness. The therapy also includes: behavior modification, muscle relaxants, Thiele’s massage, sacral and tibial neuromodulation, trigger point injections, and botulinum toxin.

7. ENDOMETRIOSIS

Endometriosis is the presence of endometrial glands or stroma outside of the endometrial cavity and affects 1–7% of the general population. (259)

Up to 70% of women with endometriosis have some type of pain symptoms, most commonly dysmenorrhea, cyclic pelvic pain or deep dyspareunia. (260)

In women who undergo a laparoscopy to evaluate CPP, the prevalence of endometriosis is 30–90%. (261)

Endometriosis pain is usually a visceral pain, and endometriotic lesions produce inflammatory mediators, particularly prostaglandins F $_{2\alpha}$ and E $_2$. (262)

There is a high prevalence and association of IC and endometriosis. A study by Chung et al. of 178 women with CPP found that 65% of CPP patients suffered from both active endometriosis and IC. (263)

In a prospective study carried out of 162 patients with CPP, Paulson and Delgado found that 66% of the sample was diagnosed with both endometriosis and IC. (264)

A recent systematic review estimated the prevalence of BPS/IC, and the coexistence of BPS/IC and endometriosis in women with CPP. Nine studies including 1016 patients with CPP showed the mean prevalence of BPS was 61%, of endometriosis 70%, and coexisting BPS and endometriosis 48% (range 84 16–78%, CI 44–51%).

These data suggest the importance of considering the bladder as the source of pain even where endometriosis is confirmed, and in the case of unresolved endometriosis and persistent pelvic pain, patients must be evaluated to rule out the presence of BPS/IC. (265)

8. VULVODYNIA AND VESTIBULODINIA

Vulvodynia, also known as vulvar vestibulitis or vulvar dysesthesia syndrome, literally means pain, or an unpleasant altered sensation, in the vulva. Pain can be unprovoked, varying from constant to intermittent, or occurring only on provocation, such in sexual intercourse.

The International Society for the Study of Vulvovaginal Disease defines vulvodynia as “vulvar discomfort, most often 98 described as burning pain, occurring in the absence of relevant visible findings or a specific, clinically identifiable, neurologic disorder”. This “burning pain” is suggestive of a neuropathic pain response.

Classification of the vulvar pain might include localized or generalized pain, or both, provoked or nonprovoked and primary or secondary. (266)

Sometimes an area of redness might be visible, but more often the vagina and the vulva show no abnormalities on gynecological or dermatological evaluation. This pain can affect women’s sexual life, which makes sex painful and, in some cases, impossible. Women with vestibulodynia are likely to have at least two additional pain conditions, such as fibromyalgia, irritable bowel syndrome, BPS/IC or chronic fatigue syndrome. (267)

Peters et al. reported that vestibulodynia affects 25% of women with BPS/IC. (268)

The etiology of vulvodynia is presumed to involve many factors: infections and altered vaginal acid-base balance, and the upregulation of pro-inflammatory immune responses. (269)

Furthermore, a large community-based study found that vulvodynia was strongly associated with childhood physical or sexual abuse. (270)

Because both the vestibule of the vulva and the bladder are derived from the urogenital sinus, it could be hypothesized that the coexistence of vulvodynia and BPS/IC in some patients represents a generalized disorder of urogenital sinus-derived epithelium. (271)

From a histological point of view, various noxious stimuli could cause changes in the vulvar epithelium: contraction in the pelvic floor, and mast cells activation with subsequent degranulation and release of histamine. This causes chronic pain and inflammation through the stimulation of peripheral neurons of the autonomic nervous system, an upregulation of the pain system, and a possible shift from nociceptive to neuropathic pain. (272)

The standard clinical test for vulvodynia is the cotton swab (Q-tip) test, measuring vulvar pain ratings on a visual analog scale. (273)

9. THERAPY

Several studies have shown that gabapentin as tricyclic yields significant results reducing pain perception, (274) with more than 80% of patients reporting improvement. (275) More recently, botulinum toxin has been proposed for the treatment of vulvodynia. It was found that the visual analog scale score was reduced from 8.1 to 2.5 ($P < 0.001$), and eight (72.7%) out of 11 patients were satisfied. (276)

10. PUDENDAL NEUROPATHY

Pudendal neuropathy is a common feature of syndromes such as dysfunctional voiding, non-obstructive urinary retention, chronic pelvic pain syndromes, and urinary and fecal incontinence. It could be ruled out as a confusable disease in BPS/IC patients.

Pudendal neuralgia is a functional entrapment of the pudendal nerve, and pain occurs during compression or stretch maneuvers, such as repetitive microtrauma, orthopedic fracture, straining with constipation and childbirth, falls onto the buttocks, and suture entrapment during pelvic surgery. The main symptom is pain aggravated by sitting/driving/exercise, reduced by recumbence or standing and relieved by sitting on a toilet.

The quality of neuropathic pain varies and can be described as burning, stabbing, ache, or pressure, and can be induced by voiding, defecating, vaginal penetration or orgasm. It can occur anywhere in the pudendal territory, but primarily includes the perineum and urethra, and extends to suprapubic, inguinal regions and to the upper medial thighs.

Urinary symptoms and rectal dysfunction might occur. Foreign body sensation in the rectum, vagina, urethra or perineum is frequent. Sexual dysfunction could be present. Females might suffer reduced clitoral sensation, pain at vaginal penetration, reduced lubrication and anorgasmia.

Pinprick sensation is tested bilaterally at the level of the clitoris posterior labia and posterior perianal skin. Hyperalgesia is more common than hypoalgesia. Pressure is placed at the level of the Alcock canal at-

tempting to reproduce pain, bladder or rectal symptoms (the Valleix phenomenon). The parasacral area is also examined for a back mouse (episacroiliac lipoma). Several tests can measure pudendal neuropathy including: biothesiometry, sacral latency test, sensory-evoked potentials, motor-evoked potentials and motor latency tests.

11. MANAGEMENT

11.1. Pharmacotherapy

Tricyclic antidepressants are the first medication category effective in placebo-controlled trials. Other drugs, such as gabapentin, pregabalin, oxcarbazepine, tramadol and duloxetine, significantly reduce pain and improve sleep, mood, and quality of life.

11.2. Mininvasive Approach

11.2.1 Transgluteal Pudendal Nerve Blocks

Two injections are given at the ischial spine at 1-month intervals. A third is given into the Alcock canal using computed tomography guidance.

11.3. Surgical Therapy

11.3.1 Transperineal and Transgluteal Approach

The pudendal nerve decompression by the perineal route is a blind procedure carried out under local or regional anesthesia. To suppress the blind character of the procedure, a transgluteal approach has been proposed and the reported surgical success rates range from 60% to 70%. Pain-free status might take some years. Bladder, bowel and sexual dysfunctions show variable improvement. (277) More recently, a transvaginal approach has also been proposed. (278)

Until now, the results on pain are the same as those obtained by the Shafik's approach, (279) but with the concurrent sections of one or two ligaments of the pelvis (sacro-spinal and/or sacro-tuberous ligaments). However, the long-term effects of these sections on the stability of the pelvic region are as yet unknown. Up to now, no data are available about a potential effect of the transgluteal or transvaginal procedures on urinary or anal incontinence.

12. CONCLUSIONS

Women affected by BPS/IC can present in more than 20% times gynecological associated disorders. Facing with such group of patients is mandatory to observe not only the bladder, but also outside, considering the pelvis as a whole.

Therefore, it is of utmost importance to evaluate concomitant pathologies, such as vulvodynia, endometriosis and pelvic floor dysfunctions, ruling out confusable disease, such as pudendal neuropathy.

An optimal approach is a combined treatment oriented not only to treat the bladder, but also the other components responsible for the pain disorder. Patients with bladder tenderness alone responded better than patients with multiple tender trigger points, possibly because in these patients the bladder is the only target organ and the patients are less severely affected than patients with multiple trigger points. Multimodal therapy remains the gold standard in the management of female BPS/IC patients.

VIII. CLASSIFICATION

Interstitial cystitis was originally described as bladder disease with severe inflammation of the bladder wall described by Hunner as an ulcer (17). The lesion is however not an ulcer but an inflammatory infiltrate that can crack upon distention, and the name of the bladder lesion has consequently been changed to "Hunner lesion" (2). The finding of a Hunner lesion could therefore originally be regarded as a diagnostic criterion for IC. Messing and Stamey introduced glomerulations as another typical finding for IC and this was included in the NIDDK criteria (280). Magnus Fall proposed, that patients with Hunner lesion (classic IC) and patients with glomerulations (non-ulcer type) represented two different subtypes (169) with different clinical pictures, different outcomes, and different responses to treatment (220) meaning that patients fulfilling the NIDDK criteria represents at least two different patient populations. Moreover up to 60% of patients clinically believed to have BPS by experienced clinicians do not fulfil the NIDDK criteria (25) and whether or not these patients are comparable to the patients fulfilling the NIDDK criteria is unknown. Finally Japanese urologists consider that "interstitial cystitis" should be preserved as a disease name for patients with urinary symptoms and cystoscopic findings of glomerulations or Hunner's lesion as outlined in the NIDDK criteria (228).

In an attempt to unite these different philosophies into a coherent schema, ESSIC proposed a classification of BPS based on findings during cystoscopy with hydrodistension and morphological findings in bladder biopsies (2) (Table 2). The classification includes groups not having had cystoscopy with hydrodistension (groups 1,2,3) as well as groups not having had morphological investigation of bladder biopsies (groups A,B,C). By using this classification glomerulations after hydrodistension are today regarded more or less as a nonspecific finding, while BPS patients with Hunner Lesion has been suggested to be a specific, confusable disease (classic IC). Further phenotyping of BPS patients by clinical, morphological or other criteria, therefore seems to be fruitful way ahead, if such classification can be demonstrated to have significant importance for disease prognosis and/or treatment outcome.

IX. CONSERVATIVE TREATMENT

Complementary therapies for bladder pain syndrome have been shown to be beneficial, though larger, more rigorous placebo-controlled trials are sorely needed. A recent systematic review highlights dietary manipulation and physical therapy as useful modalities and suggests that acupuncture and relaxation therapies might also have a role, but the data for the latter two is somewhat lacking. (281) Many patients seem to respond to a variety of complementary and alternative medical options and they form a basic pillar of treatment and serve to empower patients. (282,283)

1. BEHAVIORAL MODIFICATION

Behavioral therapy for BPS includes education, timed voiding (scheduled voiding time and interval), controlled fluid intake, pelvic floor muscle training and bladder training (gradually extending voiding interval).

Chaiken et al (284) reported that when they conducted behavioral therapy consisting of frequency-volume chart, timed voiding, controlled fluid intake and pelvic floor muscle training for the treatment of 24 female patients, 50% of the patients showed improvement in the number of urinations and bladder capacity. At the same time, they considered that as the data was collected from 12 weeks' intensive therapy conducted by skilled therapists for selected patients whose main symptom was urinary frequency, it should not be generalized. Parsons and Koprowski (285) reported that when 21 patients with the main symptom of urinary frequency underwent bladder training using a frequency-volume chart, 15 patients showed improvement. In 15 patients, the mean voided volume after one month increased by 65cc, whereas a persistent sensation of bladder fullness remained unchanged.

Participants in both arms of a large NIH funded randomized placebo controlled trial evaluating amitriptyline in BPS (286) received a standardized education and behavioral modification program (EBMP). Adherence to the EBMP at 6 weeks was assessed in 4 categories of 1) symptom management, 2) fluid management, 3) diet modification and 4) bladder training. For each of these EBMP categories adherence was defined as the overall percentage of participants who reported adhering to each component of the EBMP at each telephone contact or clinic visit. For the 241 subjects evaluable for EBMP adherence, the rate at 6 weeks was 75% (181 of 241) for symptom management, 83% (201 of 241) for fluid management, 82% (196 of 240) for diet modification and 71% (172 of 241) for bladder training. The overall GRA response rate was approximately 57% for adherers in any of the 4 EBMP categories, whereas it was lower for non-adherers. This rate neared statistical significance for

diet modification, which demonstrated only a 41% response rate among nonadherers ($p = 0.051$).

1.1. Recommendation

Behavioral therapy should be a cornerstone of treatment for patients with BPS. **Level of evidence: 2**
Grade of recommendation: B

2. PHYSICAL THERAPY

Women with BPS may have associated pelvic floor dysfunction (287). Physical therapy for the pelvic floor is said to be effective for genitourinary and anorectal disorders (288). Biofeedback and soft tissue massage may stimulate the relaxation of the pelvic floor muscles (289,290). Lukban et al (291) conducted a direct myofascial release treatment on 16 BPS patients with high-tone pelvic floor dysfunction and sacroiliac dysfunction. The treatment was effective for urinary frequency and suprapubic pain. Fifteen patients (94%) showed improvement in the O'Leary & Sant symptom score. Coital pain relief was observed in 15 of 16 patients, with 9 patients becoming able to resume sexual intercourse (292). Transvaginal Theile massage was also reported to be effective for 9 of 10 patients of the same group (293). Mendelowitz et al (290) showed a 69% success rate when treating 16 patients using electromyographic biofeedback. However, it was suggested that a placebo effect may have occurred because the effect did not correlate with the improvement in patient's awareness of the pelvic floor muscle movement and position before and after the therapy. Weiss (294) reported that 70% of 10 patients with IC showed symptomatic improvement, rating from "effective" to "remarkably effective".

An NIH study (295) to determine the feasibility of conducting a randomized clinical trial was undertaken to compare 2 methods of manual therapy (myofascial physical therapy and global therapeutic massage) in patients with urological chronic pelvic pain syndromes. The global response assessment response rate was 57% in the myofascial physical therapy group compared to 21% in the global therapeutic massage treatment group. This statistically significant difference ($P=0.03$) was primarily driven by the response seen in women (24 women) compared to the men (24 men) enrolled in this small pilot study. A follow-up randomized trial comparing similar treatments (296) but only in women with BPS and demonstrable pelvic floor pathology showed a clear benefit of directed myofascial physical therapy. In the Myofascial physical therapy group, 59% of BPS women had a positive Global Response compared to 26% of BPS women who were randomized to the global therapeutic massage group ($p=0.0012$)

Pelvic floor physical therapy with myofascial trigger point release and Thiele massage can be successful in both men and women with chronic pelvic pain, and can be self-administered after a period of training. (297)

2.1. Recommendation

Physical therapy of selected and motivated patients with BPS, particularly those with demonstrable pelvic floor dysfunction, is indicated **Level of evidence: 1 Grade of recommendation: A**

3. STRESS REDUCTION

It is long been observed that mental stress is one of the factors which aggravate the symptoms of BPS. Koziol et al (101) reported, in a survey of 374 patients, that more than half of the patients experienced intensified pain due to stress. Rothrock et al (298) reported that when comparing patients with BPS and healthy people, increased pain and urgency caused by stress were observed only in patients with BPS. Case-cohort studies have confirmed that patients diagnosed with IC/BPS experience considerably more stress than patients without the condition (91). Stress was shown to correlate with both the severity of symptoms and quality of life. In another study of patients with BPS identified in urology tertiary care clinic populations (299), mental health disorders were identified in 23 % of IC/BPS female cases compared to 3% of female control subjects. Medications for anxiety, depression or stress were taken by 37% of patients with IC/BPS compared to 13% of female controls.

It is believed that exercise and bathing favorably influence the quality of life by reducing stress (300) however, the effect of such nonspecific therapies are difficult to assess and have not been proven in clinical trials. It would seem reasonable to suggest, when possible, to shorten working hours, choose a job with less stress or create a less stressful home environment. Involvement in patient education programs and patient support groups are considered by most practitioners to be beneficial (300,301). Mindfulness-based stress reduction has been shown to be effective in a small randomized controlled trial. (302) World-wide patient support groups, including the Interstitial Cystitis Association (ICA) (303), <http://www.ichelp.org/>, the International Painful Bladder Foundation, <http://www.painful-bladder.org/>, and the Interstitial Cystitis Network, www.ic-network.com/, are important sources of information for patients with BPS. Patients with BPS frequently suffer depression, which may negatively impact upon the quality of life (91) and perhaps symptoms. Effective self-care strategies taught by psychiatric nurses are considered to be useful (304,305).

3.1. Recommendation

Stress and depression are related to poorer quality of life and increase in severity of symptoms. **Level of evidence: 1 Grade of recommendation: A**

Reduction of stress and depression may contribute to an overall improvement in quality of life and perhaps even symptoms. **Level of evidence: 4 Grade of recommendation: C**

4. DIETARY MANIPULATION

Acidic beverages, coffee, spicy food, and alcohol may aggravate the symptoms of most patients with BPS (101,300,306,307). The symptoms of the majority of BPS patients are generally believed to be improved by dietary manipulation (300,306,308,309). However this has proven difficult to prove and Nguan et al (310) reported that there was no statistically significant difference in pain and other symptoms, when they evaluated the influence of the changes in urinary pH on the symptoms of 26 patients with BPS by instilling pH5.0 and pH7.5 saline solutions into the bladder. One of the best studies designed to determine the effect of particular foods, beverages and/or supplements (comestibles) on IC/BPS symptoms was undertaken by Shorter et al (311). One hundred and four patients with IC/BPS were asked to indicate on a validated questionnaire whether each of 175 individual items worsened, improved or had no effect on symptoms. Of the patients surveyed, 90% indicated that the consumption of certain foods or beverages caused symptom exacerbation. The comestible items that had the most effect were caffeinated, carbonated and alcoholic beverages, certain fruits, artificial sweeteners and spicy foods.

Dietary manipulation was ranked in the top five frequently used treatments in a cohort study of the Interstitial Cystitis Data Base (ICDB). (312). As the influence of diet is variable with regard to food, beverage, and patient, there is no reason for patients to be uniformly on a strict diet. It is advised that each patient experiment to find out the foods that tend to aggravate their symptoms and avoid them. The ICA home page, (<http://www.ichelp.org/>) introduces the foods often avoided by patients with BPS. The use of an elimination diet (eliminate all foods on the list) and then gradually reintroducing them one by one, will facilitate the development of an patient directed individualized diet strategy. In some cases when diet appears to play a major role in symptoms, a registered dietician nutritionist can become a critical part of the treatment team. Gordon et.al's comprehensive review of dietary issues is worth reading and provides a helpful handout for patients. (313)

4.1. Recommendation

Personalized dietary manipulation should be part of the therapeutic strategy for patients with IC/BPS. **Level of evidence:2 Grade of recommendation :B**

Table 5 conservative therapies graded by Oxford Criteria

INTERVENTION	GRADE RECOMMENDATION	LEVEL OF EVIDENCE
M	B	2
Physical Therapy	A	1
Stress Reduction	C	4
Diet	B	2

X. ORAL THERAPY

Several categories of medication have been used in the management of patients with bladder pain syndrome including analgesics, antidepressants, antihistamines, immunosuppressants, and glycosaminoglycans. Many of these drugs are used empirically. Only a few of them have been studied in randomized controlled trials and none have a grade A recommendation.

1. Analgesics

The long-term, appropriate use of pain medications is indispensable in the treatment of bladder pain syndrome. Many nonopioid analgesics including acetaminophen and the nonsteroidal anti-inflammatory drugs (NSAIDs) and even antispasmodic agents (314) have a place in pain therapy. Patients with more severe symptoms can often be helped with medical pain management using medications commonly used for chronic neuropathic pain syndromes including antidepressants, anticonvulsants, and opioids.

Gabapentin, introduced as an anticonvulsant, has found efficacy in neuropathic pain disorders including diabetic neuropathy (315) and postherpetic neuralgia (316). It demonstrates synergism with morphine in neuropathic pain (317). Two patients with IC showed improved functional capacity and received adequate pain control when gabapentin was added to their regimen (318). Sasaki et al reported that 10 of 21 male and female patients with refractory genitourinary pain had subjective improvement of their pain following treatment with gabapentin (319). Recently gabapentin was one compound of a triple mix including amitriptyline and etodolac, a NSAID. The interpretation of the observed efficacy in 74 patients is hampered by an uncontrolled open label study protocol that additionally allowed up-titration of gabapentin and amitriptyline. The impact and contribution of amitriptyline, whose exclusive efficacy for BPS has been proven better than for any other oral drug, on the reported amelioration was not discussed (320).

Pregabalin has similar structure as gabapentin and also has been shown to reduce the pain of diabetic neuropathy (321). Pregabalin was proved effective for treating pain associated with fibromyalgia (322).

Pregabalin might be worthwhile to try for bladder pain syndrome, particularly for those with concurrent fibromyalgia, though studies are lacking.

Opioids are seldom the first choice of analgesics in chronic pain states, but they should not be withheld if less powerful analgesics have failed (323). Chronic opioid therapy can be considered as a last resort in selected patients, who have disabling pain and often receive inadequate doses of short-acting pain medications, which put them on cycles of short-term relief, anxiety, and pain.

The major impediment to the proper use of opioids when they are prescribed for long-term nonmalignant pain is the fear of addiction. Some studies suggest the risk is low (324), but not zero. (325) Using opiates is a difficult decision that requires much thought and discussion between patient and urologist, and a pain specialist. They are best administered in a pain clinic setting, requiring frequent reassessment by both patient and physician (326).

In addition to narcotics, concurrent usage of nonsteroidal anti-inflammatory drugs, cyclooxygenase inhibitors, acetaminophen, and tricyclic antidepressants may provide better pain control (327). The common side effects of opioids include sedation, nausea, mild confusion, and pruritis. These are generally transient and easily managed. Respiratory depression is extremely rare if they are used as prescribed. Constipation is common and a mild laxative is generally necessary. The long-acting narcotic formulations that result in steady levels of drug over many hours are preferable.

Level of Evidence: 4 Grade of Recommendation: C

2. Anti-depressants

2.1. Amitriptyline

Amitriptyline is a tricyclic antidepressant with the property of blocking H1-histaminergic receptors (328). It stabilizes mast cells and inhibits mediator stimulated vascular leakage. It inhibits synaptic reuptake of serotonin and norepinephrine, thus inhibiting painful nociception from the bladder at the level of the central nervous system. Its nighttime sedation

can be therapeutic in the BPS population and its purported beta-adrenergic receptor stimulation in the bladder may facilitate urine storage. (329).

Using a dose titration of up to 75mg taken before bed, Hanno and Wein reported success in about half of 20 patients who could tolerate the medication. Twenty percent of the initial 25 patients dropped out because of fatigue, weight-gain, or dry mouth. In a follow-up report (330), 18 of 28 patients who could tolerate the drug had major relief of symptoms within 3 to 6 weeks of onset of therapy with a mean follow-up of 14.4 months. However, about one-third of patients initially placed on the drug could not continue on it because of side effects. Kirkemo et. al (331) treated 30 patients and 90% had subjective improvement in 8 weeks. Prantikoff and Constantino (332) reported improvement in 16 of 22 patients with urinary frequency and pain who did not have a diagnosis of interstitial cystitis, noting that 5 of the 22 could not tolerate the drug.

van Ophoven et al performed the first prospective, double-blind, placebo-controlled study of amitriptyline. Fifty patients were randomized to placebo or a titrated dose of amitriptyline up to 100mg daily. Forty-two percent of amitriptyline patients had greater than 30% decrease in O'Leary/Sant symptom and problem scores at 4 months compared to 13% in the placebo group (333). They subsequently reported a long-term follow-up of amitriptyline for patients who can tolerate the side effects and continued the medication. With a mean follow-up of 19 months, 64% of 94 patients had response (334).

Foster and Hanno reported a second multicenter, randomized, double-blind, placebo controlled clinical trial of amitriptyline in subjects with interstitial cystitis/painful bladder syndrome who were naïve to therapy. Study participants in both treatment arms received a standardized education and behavioral modification program. Only of the subgroup of 207 subjects who achieved a drug dose of at least 50 mg, a significantly higher response rate was observed in the amitriptyline group (66%) compared to placebo (47%) ($p = 0.01$). When all randomized subjects were considered, amitriptyline plus an education and behavioral modification program did not significantly improve symptoms in treatment naïve patients with interstitial cystitis/painful bladder syndrome versus education and behavioral modification alone. However, amitriptyline may be beneficial in persons who can achieve a daily dose of 50 mg or greater (286,335). Whether some of the benefits of amitriptyline were masked by the beneficial effects of conservative therapy in the patients (all treatment naïve) tested in this trial is an open question. Cystoscopic findings do not predict the treatment effect. (336)

Level of Evidence: 2 Grade of Recommendation: B

2.2. Doxepin, Desipramine, Duloxetine

Other tricyclic antidepressants that have been used for bladder pain syndrome are doxepin and desipramine. Wammack et al used the combination of doxepin and piroxicam, a cox-2 inhibitor. Twenty-six of 32 patients (81%) experienced remission of symptoms (337). One study reported satisfactory outcome with desipramine. (338) Duloxetine, a serotonin-norepinephrine reuptake inhibitor has also been tried but without therapeutic effects (339)

3. ANTIHISTAMINES

Simmons first proposed use of antihistamines in 1955 (340). His findings of mast cells in the wall of a normal bladder and the edema and increased vascularity seen in the IC bladder suggested that histamine may be responsible for the development of interstitial cystitis. He reported on 6 patients who had some improvement with pyribenzamine for limited periods (341).

Level of Evidence: 1 Grade of Recommendation: D

4. HYDROXYZINE

Hydroxyzine is the most widely used antihistamine for bladder pain syndrome. Its ability as an H-1 receptor antagonist, to inhibit bladder mast cell activation, along with its anticholinergic and anxiolytic properties and good safety profile, have made it a reasonable candidate for use as a therapeutic agent for bladder pain syndrome. (342) In 1993, Theoharides first reported significant benefits of hydroxyzine in reducing pain and urinary symptoms. (343) His two subsequent reports of uncontrolled series further suggested the therapeutic effects of hydroxyzine. (344,345) However, in an NIDDK randomized controlled trial, the global response rate for hydroxyzine was only 31% compared to a 20% response to those not treated with hydroxyzine. When looked at by itself the response was 23% vs. 13% on placebo. None of the results in this under-powered trial reached statistical significance (346).

5. CIMETIDINE

Cimetidine, a H2 histamine receptor antagonist, has been explored for treatment of bladder pain syndrome. In a pilot study (347), 9 patients were treated with a dose of 300mg orally twice daily for one month. At follow-up 26 to 42 months later, 4 patients had complete relief of urinary symptoms and suprapubic pain. Lewi (348) reported 31 patients given 200mg three times daily with mean follow up of 6.6 months. Seventy-one per cent experienced varying degrees of symptomatic relief, 45% were pain free, and 26% went into remission of all symptoms. In a later report

(349) of 69 patients treated over a 4 year period, 67% of patients had complete relief of all symptoms.

A small, prospective, placebo-controlled RCT studied 36 patients who either received oral cimetidine or placebo (350). Median suprapubic pain and frequency scores improved significantly, but the publication does not state exactly how many patients in each group improved.

Level of Evidence: 3 Grade of Recommendation: C

6. IMMUNOSUPPRESSANT

6.1. Cyclosporine

Cyclosporine, a widely used immunosuppressive drug in organ transplantation, was the subject of a novel bladder pain syndrome trial. (351) Eleven patients received cyclosporine for 3-6 months at an initial dose of 2.5-5 mg/kg daily and a maintenance dose of 1.5 to 3mg/kg daily. Micturition frequency decreased, and mean and maximum voided volumes increased significantly. Bladder pain decreased or disappeared in 10 patients. After cessation of treatment, symptoms recurred in the majority of patients.

In a longer-term follow-up study, 20 of 23 refractory IC patients on cyclosporine therapy followed for a mean of 60.8 months became free of bladder pain. Bladder capacity more than doubled. Eleven patients subsequently stopped therapy, and in 9, symptoms recurred within months, but responded to reinitiating cyclosporine (352). Sairanen et al further found that cyclosporine A was far superior to sodium pentosanpolysulfate in all clinical outcome parameters measured at 6 months. (353) Patients who responded to cyclosporine A had a significant reduction of urinary levels of epidermal growth factor (EGF) (354).

Forrest et al. retrospectively summarized results from Cyclosporine off-label use in 44 patients BPS patients. In 34 patients presenting with Hunners lesion upon cystoscopy the success rate was higher compared to those patients without lesions (68% vs 30%). However, side effects were common and demand a close monitoring of patients including blood pressure and renal failure. (355)

Level of Evidence: 3 Grade of Recommendation: C

6.2. Suplatast Tosilate

Suplatast Tosilate (IPD-1151T) is an immune-regulator that selectively suppresses IgE production and eosinophilia via suppression of helper T cells that produce IL-4 and 5. It is used in Japan to treat allergic disorders including asthma, atopic dermatitis, and rhinitis. Ueda et al reported a small study in 14 women with interstitial cystitis. (356) Treatment for one year resulted in a significantly increased bladder capacity and decreased urinary urgency, frequency, and lower

abdominal pain in 10 women. Concomitant changes occurred in blood and urine markers suggesting an immune system response. Larger, multicenter, randomized controlled trials in the United States and Japan have been completed and results did not justify further development for this indication. Further studies with this drug for bladder pain syndrome are not planned and approval for this indication is not expected.

Level of Evidence: 1 Grade of Recommendation: D

6.3. Azathioprine and Chloroquine Derivatives

In a single report in 1976, Oravisto et al used azathioprine or chloroquine derivatives for BPS patients not responding to other treatments. (357) About 50% patients responded.

Level of Evidence: 4 Grade of Recommendation: D

6.4. Corticosteroids

Reports on outcome with corticosteroid therapy have been both promising (358,359) and discouraging (360). Soucy et al. (361) have suggested a trial of prednisone (25 mg daily for 1-2 months, afterwards reduced to the minimum required for symptom relief) in patients with severe ulcerative IC, which is otherwise unresponsive to conventional treatment. The side effects of steroids can be very serious, making it difficult to justify their use (358,360,361)

Level of Evidence: 4 Grade of Recommendation: D

7. SODIUM PENTOSANPOLYSULFATE

Sodium pentosan-polysulfate (PPS), a synthetic sulfated polysaccharide, is available in an oral formulation, 3-6% of which is excreted into the urine and theoretically may replenish the damaged glycosaminoglycan (GAG) layer overlying transitional epithelium of the urinary bladder of BPS patients. An intact urothelial GAG layer has been proposed to be essential to keep the urothelium impermeable to urinary components. A defective bladder GAG layer is hypothesized to be one important cause for BPS. (362)

PPS's mechanism of action has been attributed not only to correction of a putative defect in the GAG layer, but also its ability to inhibit histamine release from mast cells, (363) and a possible effect mediated by nonspecific binding of the molecule with the inflammatory stimulants of urothelial activation, an action that would occur in the urine rather than at the mucosal membrane. (364)

PPS is the most intensively studied treatment ever proposed for BPS. It is the only medication approved by the Food and Drug Administration for the pain of

interstitial cystitis. Parsons initially administered the drug at a dosage of 50mg 4 times daily or 150mg twice daily in an open trial involving 24 patients. (365) Twenty-two of 24 patients experienced a good or excellent response within 8 weeks. In a subsequent randomized, placebo-controlled trial using a dose of 100mg three times daily in 62 patients, pain and urgency improved in 44% vs. a placebo response of 15%. Urgency improved by 38% vs. 18% on placebo. The average number of daily voids was unchanged. (366)

Five randomized controlled trials for pentosan polysulfate have yielded conflicting results of efficacy. Holm-bentzen et. al (367) reported the first multicenter double-blind placebo controlled trial in 1987 looking at 115 patients with bladder pain syndrome. Patients were randomized to a dose of 200mg twice daily vs. placebo for 4 months. The results showed no difference between pre and post-trial values with regard to symptoms, urodynamic parameters, cystoscopic appearance, or mast cell counts in the two groups. The study concluded that the drug had no clinically significant effect.

The first of two pivotal studies for the FDA was performed in the United States in 1990. (368) A total of 110 patients in 5 medical centers were studied for 3 months on a dosage of 100mg three times daily. Twenty-eight per cent of patients on PPS reported "more than slight improvement" versus 13% of those on placebo. Pain and pressure to urinate were the main parameters to show benefit with PPS.

The FDA asked for a second study which was reported 3 years later. (369) In a multi-center, placebo-controlled RCT 148 patients were randomized to 100mg three times daily of pentosan-polysulfate vs. placebo. In the primary endpoint of patient self-evaluation of global improvement, 32% of those on PPS reported 50% or more overall improvement vs. 16% on placebo at 3 months. Pain, urgency, and pressure showed significant improvement with drug. Frequency, nocturia, and volume voided showed no significant changes between study groups.

The NIDDK performed their own 2 X 2 factorial study to evaluate PPS and hydroxyzine. (346) Each drug was used alone and in combination and compared to a placebo group. Patients were treated for 6 months. There were 121 participants in 7 centers. No statistically significant response to these medications was documented. A non-significant trend was seen in the PPS treatment groups (34%) compared to non-PPS groups (18%). Of the 29 patients on PPS alone, 28% had global response (primary endpoint) of moderately or markedly improved vs. 13% on placebo, very similar in this 6-month study to improvement rates in the 3-month pivotal studies, though not reaching statistical significance in the longer study.

The latest report from a dose ranging study performed to satisfy a post-marketing commitment made to the FDA upon approval of PPS revealed no treat-

ment effect of PPS compared with placebo at the currently established dose of 300mg/d or at 100mg/d. The primary end point, i.e. achieving a 30% or greater reduction from the baseline ICSI total score was reached by 40.7% (48 out of 118 patients) in the placebo group compared with 39.8 % (51 out of 128 pats.) in the 100mg once daily and 42.6% (52 out of 122 pats) 100mg 3 times daily group. (370) There appears to be no dose response with daily doses up to 3 times higher than recommended. (371)

In summary, of 6 RCTs 3 had unfavorable and 3 had favorable results for PPS. Most recent non randomized studies showed a complex heterogeneity in efficacy as well. (372-374) Such conflicting results might suggest that a small minority of patients may have some response to PPS, but currently there is no reliable method to identify such patients.

Long-term, open-label studies with PPS have been reported. Populations of patients receiving extended treatment for up to 90 months or more in the compassionate use program showed no further improvement in symptoms after 1-2 years, though there seemed to be little tachyphylaxis. (346,375) A total of 2809 patients had begun treatment with a 3 month supply of PPS and 21% continued with treatment beyond this point and reordered medication. This seems to correlate with the 28-32% improvement rate previously reported. The dropout rate in the first 6 months was extraordinarily high with only 178 active patients out of 1742 who initially ordered the drug. There was an overall improvement in symptoms in 62% of the patients who did remain in treatment for 6-35 months. On a long term basis, it appears only 6.2%-18.7% of patients with BPS derive a benefit from pentosanpolysulphate. (376).

PPS appears to be a very well-tolerated medication (375) with no common central nervous system side effects. At most, it appears to be beneficial with regard to improving the pain associated with interstitial cystitis in up to one-third of patients, a standard often expected with a placebo. A 3-6 month course may be required to see a treatment effect. Claims suggesting greater efficacy and claims urging its use in patients who do not meet the standard definition of bladder pain syndrome should be regarded with caution.

Level of Evidence: 1 Grade of Recommendation: D

8. Other Oral Medications That Have Been Used for BPS

8.1. L-Arginine

Foster and Weiss were the original proponents of L-arginine in the therapy of interstitial cystitis. (377) Eight patients with BPS were given 500mg of L-arginine 3 times daily. After one month, urinary nitric oxide synthase activity increased 8-fold and 7 of the 8 patients noticed improvement in IC symptoms. An

open-label study of 11 patients showed improvement in all 10 of the patients who remained on L-arginine for 6 months. (378)

An open-label study of 9 women in Sweden failed to find any change in symptom scores or in nitric oxide production in the bladder. (379) A placebo-controlled randomized controlled trial of 53 IC patients could find no difference on an intention to treat analysis between drug and placebo-treated patients. (380) A smaller randomized placebo-controlled crossover trial of 16 BPS patients found no clinically significant improvement with L-arginine and concluded that it could not be recommended for BPS treatment. (381)

Data does not support the use of L-arginine for the relief of symptoms of interstitial cystitis.

Level of Evidence: 1 Grade of Recommendation: Not Recommended

8.2. Quercetin

Quercetin, a bioflavonoid available in many over-the-counter products, may have the anti-inflammatory effects of other members of this class of compounds found in fruits, vegetables, and some spices. Katske et. al (382) administered 500mg twice daily to 22 BPS patients for 4 weeks. All but one patient had some improvement in the O'Leary/Sant symptom and problem scores as well as in a global assessment score. Further studies are necessary to determine efficacy.

Level of Evidence: 4 Grade of Recommendation: D

8.3. Antibiotics

Warren et. al (383) randomized 50 patients to receive 18 weeks of placebo or antibiotics including rifampin plus a sequence of doxycycline, erythromycin, metronidazole, clindamycin, amoxicillin and ciprofloxacin for 3 weeks each. Intent to treat analysis demonstrated that 12 of 25 patients in the antibiotic and 6 of 25 patients in the placebo group reported overall improvement while 10 and 5 respectively noticed improvement in pain and urgency. The study was complicated by the fact that 16 of the patients in the antibiotic group underwent new BPS therapy during the study as did 13 of the placebo patients. There was no statistical significance reached. What was statistically significant were adverse events in 80% of participants who received antibiotic compared to 40% in the placebo group. Nausea and/or vomiting and diarrhea were the predominant side effects. Most patients on antibiotics correctly guessed what treatment arm they were in, and those that guessed correctly were significantly more likely to note improvement after the study. No duration in improvement after completion of the trial of antibiotics was reported.

Burkhard et.al (384) reported a 71% success in 103 women presenting with a history of urinary urgency and frequency and chronic urethral and/or pelvic pain often associated with dyspareunia and/or a history of

recurrent urinary tract infection. This was a large, inclusive group and one that is probably broader than the bladder pain syndrome we are focusing on. Nevertheless, he recommended empiric doxycycline in this group. The overwhelming majority of BPS patients have been treated with empiric antibiotics prior to diagnosis. The role of tetracyclines to eradicate nanobacteria in urine of BPS patients has recently been addressed in a small Chinese open label study, leaving the significance of nanobacterias as a reasonable pathogen or trigger of the condition open. (133)

At this time there is no evidence to suggest that antibiotics have a place in the therapy of BPS in the absence of a culture-documented infection. (385)

Level of Evidence: 4 Grade of Recommendation: D

8.4. Methotrexate

Low dose oral methotrexate significantly improved bladder pain in 4 of 9 women with BPS, but did not change urinary frequency, maximum voided volume, or mean voided volume. (386) No placebo-controlled, RCT has been done with this agent. **Level of Evidence: 4 Grade of Recommendation: D**

8.5. Montelukast

Mast cell triggering releases 2 types of proinflammatory mediators, including granule stored pre-formed types such as heparin and histamine, and newly synthesized prostaglandins, and leukotriene B4 and C4. Classic antagonists, such as montelukast, zafirlukast and pranlukast, block cysteinyl leukotriene 1 receptors. In a pilot study, 10 women with IC and detrusor mastocytosis received 10mg of montelukast daily for 3 months. Frequency, nocturia, and pain improved dramatically in 8 of the patients. Further study would seem to be warranted, especially in patients with detrusor mastocytosis, defined as >28 per mm². (387)

Level of Evidence: 4 Grade of Recommendation: D

8.6. Nifedipine

The calcium channel antagonist nifedipine inhibits smooth muscle contraction and cell-mediated immunity. In a pilot study, (388) 30mg of an extended release preparation was administered to 10 female patients and titrated to 60mg daily in 4 of the patients who did not get symptom relief. Within 4 months five patients showed at least a 50% decrease in symptom scores, and 3 of the 5 were asymptomatic. No further studies have been reported. **Level of Evidence: 4 Grade of Recommendation: D**

8.7. Misoprostol

The oral prostaglandin analogue misoprostol was studied in 25 patients at a dose of 600 micrograms daily. (389) At 3 months 14 patients were significantly improved, and at 6 months 12 patients still had a response. A cytoprotective action in the urinary

bladder was postulated. **Level of Evidence: 4 Grade of Recommendation: D**

8.8. Tanezumab

In Development

An initial randomized, double-blind, placebo controlled phase two study investigated tanezumab, a humanized monoclonal antibody that specifically inhibits nerve growth factor as a treatment for BPS pain in 64 patients. (390) At week 6 tanezumab produced a significant reduction from baseline in average daily pain score vs placebo. A significantly higher proportion of patients on tanezumab responded as improved in the global response assessment and tanezumab also significantly reduced urgency episode frequency vs placebo.

Nickel et al. performed pooled analyses from three small, clinical trials of tanezumab in patients with urological chronic pelvic pain, including CP/CPPS and BPS/IC, to identify patient subpopulations more likely to benefit from tanezumab treatment. (87) They reported that least-squares mean change (standard error) from baseline in 24 h pain intensity versus placebo was -0.60 (0.24 , 90% confidence interval -0.99 to -0.20) overall and -0.99 (0.32 , $p = 0.002$) and -0.17 (0.36 , $p = 0.650$) for females and males, respectively. It was suggested that tanezumab performed better in pain relief in women with BPS/IC and in patients whose symptoms suggested concomitant presence of somatic syndromes (nonurological) instead of patients only with pelvic pain symptoms. Clinical efficacy of tanezumab in BPS/IC indicates that the role of NGF in the pathophysiology of BPS/IC may not be uniform for all patients. If NGF is not the primary driver of pain, then tanezumab may have limited capacity to improve pain, irrespective of the clinical presentations.

Pain studies with this drug had been suspended by the developing company upon FDA request because of the occurrence of osteonecrosis and between 2012 until March 2015 due to CNS side effects. The FDA has now lifted the hold on studies of tanezumab for chronic pain due to non-clinical data characterizing the sympathetic nervous system response to the drug.

8.9. Adalimumab

Tumor necrosis factor- α (TNF- α), a pro-inflammatory cytokine released by immune cells, is suggested to play a key role in the inflammatory process in BPS/IC. (391) TNF- α is highly expressed in the urothelium of patients with ulcerative BPS/IC, which led to the suggestion that drugs inhibiting TNF- α (adalimumab) might decrease IC/BPS bladder inflammation and reduce symptoms. Bosch evaluated the efficacy of adalimumab (80 mg subcutaneous followed by 40 mg every two weeks or subcutaneous placebo for 12 weeks) for the treatment of BPS/IC. (392) 21 patients received adalimumab. There was a statistically

significant improvement demonstrated in the O'Leary-Sant IC Symptom and Problem Indexes, Pelvic Pain, Urgency, Frequency Symptom Scale, and GRA at 12 weeks compared to baseline. However, there was no statistically significant improvement in any outcome measure in patients receiving adalimumab compared to placebo. There were no significant AEs. Adalimumab failed to demonstrate positive proof of efficacy compared to placebo due to a significant placebo effect.

Level of Evidence: 1 Grade of Recommendation: Not Recommended

8.10. PD-0299685, a Ca²⁺ Channel $\alpha 2\delta$ Ligand

The $\alpha 2\delta$ subunit of ligand gated calcium ion channels mediates afferent pain fibers and is promising in chronic pain. Nickel et al. investigated PD-0299685 30 mg daily ($N = 54$), 60 mg daily ($N = 55$), or placebo ($N = 52$) for patients with IC/BPS for 12 weeks. At week 12, the 60 mg dose produced a clinically significant reduction in daily worst pain severity score from baseline compared to placebo (treatment difference [90% CI] -0.82 [-1.72 , 0.08]). A greater proportion of patients on 60 mg daily dose of PD-0299685 demonstrated an improvement in the GRA. PD-0299685 failed to show clinically significant effect on the IC Symptom Index score or urinary end points. More patients discontinued due to treatment-related AEs (dizziness, somnolence, and nausea) with 30 or 60 mg PD-0299685 daily than with the placebo. The authors concluded that PD-0299685 appeared to have an unfavorable benefit-tolerability profile in the IC/BPS population (393)

Level of Evidence: 1 Previously in Development: failed clinical trial

8.11. AQX-1125, a Novel SHIP1 Activating Compound

SH2-containing inositol-5'-phosphatase 1 (SHIP1) is an intracellular protein whose expression is primarily restricted to cells of the hematopoietic lineage. SHIP1 is an endogenous inhibitor of the phosphoinositide-3-kinase pathway that is involved in the activation and chemotaxis of inflammatory cells. SHIP1-deficient mice exhibited progressive inflammation. Drugs activating SHIP1 pathway (AQX-1125) can have a novel anti-inflammatory mode of action. The characteristic of AQX-1125 on the inhibition of mast cells activation and anti-inflammation provided the rationale for a clinical study on BPS/IC.

This 6-week, randomized, double-blind, placebo-controlled, multi-center trial randomized 37 women with BPS and mean pain of ≥ 5 (11-pt scale) despite previous treatment to 200mg AQX-1125 or placebo (32 patients), orally once daily for 6 weeks. (394) At 6 weeks average daily pain (e-diary) decreased by 2.4 points (AQX-1125) versus 1.4 (placebo) ($p=0.061$); average pain (clinic) by 2.6 vs 1.1 ($p=0.008$); maximum daily pain (e-diary) by 2.6 vs 1.4 ($p=0.030$) and

maximum pain (clinic) by 2.8 vs 1.1 (p=0.028). AQX-1125 reduced ICSI by 3.8 points vs 1.4 (placebo) (p=0.005), ICPI by 3.6 vs 1.6 (p=0.014) and BPIC-SS by 8.8 points vs 4.0 (p=0.011). Urinary frequency decreased on AQX-1125 by 3.6 voids/24 hours vs 0.8 (placebo) (p=0.040). Adverse event rates were similar between AQX-1125 (51.4%) and placebo (78.1%). No SAE were reported. Only a single dose was studied, thus it remains unclear if a higher dose of AQX-1125 would have been more effective. However, non-clinical data suggested maximum pharmacological effect at plasma levels equivalent to 100-150 ng/ml; therefore, higher doses would unlikely confer additional benefit.

Level of Evidence: 1 Grade of Recommendation: In Development phase 3 trials

8.12. SILDENAFIL

The contraction of smooth muscle caused by elevating potassium or adrenergic activity can be relaxed by phosphodiesterase type 5 inhibitors (PDE5I). PDE5I are a class of drugs approved to treat erectile dysfunction. Potential influence of the drug on detrusor activity and secondly on pain served as the rationale for a randomized clinic trial.

48 women with a clinical diagnosis of BPS were randomly assigned to treatment with daily low-dose sildenafil (25 mg, n= 24) or placebo (n = 24) for 3 months. (395) The O’Leary-Sant IC symptom and

problem indices, visual analog scale scores, and a micturition diary with the interval of micturition, the frequency of nocturia, and urgency episodes were recorded before treatment, and every 2 weeks after the treatment until 3 months. Patient Overall Rating of Improvement in Symptoms was assessed and regarded as effective when the value was above 50%. The IC symptom and problem indices scores and urodynamic index were significantly improved in sildenafil treatment group as compared with placebo group and baselines at week 4, 6, 8, 10, and 12, as well as 3 months after treatment (p <0.05). Urodynamic index including first desire to void, strong desire to void, and maximum cystometric capacity was significantly improved in sildenafil treatment group at week 12 and at 3 months after treatment (P <.05). The efficiency of treatment reached 62.5%. However, no significant change of the visual analog scale values was observed between 2 groups except at week 12 in the sildenafil treatment group (P <.05). All adverse events were mild to moderate and transient.

Although a high PDE5 expression in human bladder detrusor muscle has been reported the mode of action of sildenafil in BPS remains unclear. Further large scale studies on dosage and duration of medication are necessary to confirm the results of this innovative study.

Level of Evidence: 1 Grade of Recommendation: D

Table 6 ORAL THERAPY ACCORDING TO THE OXFORD SYSTEM

MEDICATION	GRADE RECOMMENDATION	LEVEL EVIDENCE
Analgesics	C	4
Amitriptyline	B	2
Antihistamine	D	1
Cimetidine	C	3
Cyclosporine	C	3
Suplatast Tosilate	D	1
Aziothioprine	D	4
Chloroquine derivatives	D	4
Corticosteroids	D	4
Pentosan Polysulfate	D	1
L Arginine	Not recommended	1
Quercetin	D	4
Antibiotics	D	4
Methotrexate	D	4
Montelukast	D	4
Nifedipine	D	4

MEDICATION	GRADE RECOMMENDATION	LEVEL EVIDENCE
Misoprostol	D	4
Adalimumab	Not recommended	1
Sildenafil	D	1

XI. INTRAVESICAL / INTRAMURAL THERAPY

Intravesical therapies form one of the staples of BPS therapy, though regulatory approvals and availability throughout the world differ from nation to nation. The data on use of intravesical therapy has been generally poor due to the limited number of controlled accessible studies on intravesical therapies for BPS/IC and non-standardised response criteria. (396,397) This situation is thankfully improving.

What follows are treatments that have been reported in the recent literature, some of which are commonly used. Older therapies that are rarely used now include silver nitrate (81,398-401) and chlorpactin WCS90. (21,402-406) These have not been included in this current edition of the Consultation, but have level 3 evidence to support a grade C recommendation based on original reports.

1. DMSO (DIMETHYL SULFOXIDE)

Grade of Recommendation: B Level of evidence 2

A small number of significant side effects.

DMSO is believed to reduce inflammation, relax muscles, eliminate pain, dissolve collagen, and degranulate mast cells. It has long been used as a therapeutic agent for BPS. Its mechanism of action, however, has not been clarified. Peecker et al reported that in a randomized study, frequency and pain were improved in ulcer-type IC patients, although no improvement was observed in maximum bladder capacity. (407) Perez-Marrero et al reported that in a non-randomized controlled study, 53% of the patients showed remarkable improvement in subjective evaluation (placebo 18%), and 93% in objective evaluation (placebo 35%). (408) Around an 80% improvement rate has been reported in case series and retrospective studies. (409-416)

With regard to side effects after instillation of DMSO, most patients recognize a garlic-like odor, which disappears within a day, and about 10% of patients report bladder irritative symptoms which resolve with or without symptomatic treatment. (417) It is hypothesized that these transient exacerbations occur as the result of mast cell degranulation. The number of significant side effects is considered to be small (416). Cataracts have been reported in animal studies, though not in humans. (418,419) Negative effects on bladder compliance have been noted in rat detrusor.

(420) DMSO may accelerate the absorption of other drugs instilled simultaneously, which could be a source of side effects.

The instillation method has not been standardized. Generally, 50cc of a solution of medical grade 50% DMSO is instilled into the bladder. If pain occurs immediately following instillation, local anesthesia (e.g. 20ml of 2% lidocaine solution) may be instilled. Average retention time is considered to be 10 to 20 minutes. (417) The instillation is performed weekly for 6-8 weeks. After an initial course, treatment is suspended until symptoms recur. If a good result was obtained, another 6 week course (often followed by monthly maintenance) can be initiated. The long-term effect is unknown, although there is no upper limit for the duration of the treatment. It is often administered as a cocktail combined with other medications sometimes including a steroid, heparin, sodium bicarbonate, and/or lidocaine. (421,422) The combination of triamcinolone and DMSO has been shown to increase bladder capacity and increase voiding intervals in a large, uncontrolled series of newly diagnosed patients. (423) DMSO is the only intravesical agent approved for the treatment of interstitial cystitis by the Food and Drug Administration.

2. HEPARIN

Grade of Recommendation: C Level of Evidence: 3

Side effects primarily related to effects of intravesical catheterization and slight chance of bladder hemorrhage

The glycosaminoglycan (GAG) layer on the bladder urothelium is a kind of muco-polysaccharide, working as a non-specific defense mechanism. It is believed that a deficiency or abnormality of GAG secondarily causes inflammation of the bladder by increasing the permeability of the bladder mucosa, leading to the pathologic cascade of BPS. Heparin has similarities to the GAG layer of the bladder. When instilled into the bladder, theoretically it might replace the damaged GAG layer as originally shown by Hanno. (424,425) Kuo reported that the International Prostate Symptom Score, as well as bladder capacity at initial desire to void and maximum bladder capacity, improved significantly. (426) According to the report by Parsons et al symptoms were reduced in 56% of patients treated 3 times weekly for 12 weeks. (427) These reports suggest the efficacy of

heparin, however, there is no randomized comparative study to give conclusive evidence. One study indicated that intravesical heparin instillations may prolong the response to dimethyl sulfoxide treatment. (428) In another report, significant symptomatic benefits accrued from the addition of heparin to intravesical lidocaine solution treatments. (429)

No significant side effects have been reported, as it does not affect systemic coagulation parameters. In the case of patients with hematuria, however, it may exacerbate local hemorrhage.

The instillation method has not been standardized. Generally, 10,000-40,000 units of heparin are instilled. It is unusual to have pain or irritation as a result of instillation, and retention times can be 30 minutes or more. Instillation frequency can be up to every other day and it is often administered at home by the patient. Parsons et al recently reported that when 40,000 units of heparin combined with 1 to 2% lidocaine was instilled 3 times a week for 2 weeks, about 80% efficacy was obtained. (430) There is no upper limit for the duration of the treatment, but a long-term effect is unknown. A bleeding tendency may occur. Heparin for intravesical use is not approved by drug regulatory authorities.

3. HYALURONIC ACID

Grade of Recommendation: C Level of Evidence: 1

No significant side effects.

Hyaluronic acid, like heparin, is a muco-polysaccharide, that could theoretically repair a damaged GAG layer of the bladder mucosa. Several reports have indicated efficacy. (215,431-437) In the summer of 2003 Bioniche Life Science Inc <http://www.medicalnewstoday.com/articles/112053.php> and in the spring of 2004 Seikagaku Corporation reported double-blind, placebo-controlled, multicenter clinical studies of their hyaluronic acid preparations (40mg or 200mg per cc respectively) and neither showed significant efficacy of sodium hyaluronate compared to placebo in large phase 3 trials. These negative studies have not been published in peer reviewed literature. Neither preparation has been approved for use for BPS in the United States. At the same time, no significant side effects were observed.

A non-placebo-controlled study has demonstrated a favorable effect of hyaluronic acid on pain reduction. (200) Forty-eight patients with typical symptoms and a positive potassium (0.4 M) sensitivity test were treated with weekly instillations of 40 mg hyaluronic acid for 10 weeks. Visual analogue scale scores showed symptom relief due to hyaluronic acid therapy, irrespective of bladder capacity. The improvement was particularly evident in patients with a reduction in Cmax < 30% compared to patients with a reduction of < 30% with 0.2 M KCl solution (P = 0.003). Long-term effects were investigated in a study of 70

patients previously treated with hyaluronan. (438) Of the initial 70, 48 improved. Of these, 50% reported complete remission with no further therapy. Another 41.7% of patients with symptom recurrence improved after retreatment.

In a Korean study, intravesical instillation of 40mg of HA in 50ml of saline once a week, for 4 weeks, significantly improved VAS score, PUF, ICSI and ICPI in refractory IC/BPS. Previous treatment modalities did not affect the efficacy of the instillation and the presence of Hunner lesion was unrelated to outcomes. (439)

It has been suggested that HA and lidocaine be combined for instillation. In a non-randomized controlled open-label trial, 48women with refractory IC/BPS were enrolled and divided in three groups: the trial group received HA, alkalized lidocaine (AL) and sodium bicarbonate once a week for 8 weeks and then monthly for 4 months with a subsequent follow-up of 24 weeks, while the two control groups received HA, and AL plus sodium bicarbonate respectively following the same procedure. The HA+LA and the LA groups showed a rapid improvement of symptoms at week 2, while the HA treatment was ineffective until week 4. In the later stage of the treatment, symptoms in AL group recurred, probably because AL relieves symptoms through its anesthetic activity, but it cannot repair the defect of the bladder mucosa. Once the instillation was stopped or the frequency was reduced, the effect disappears gradually. (440)

In a randomized prospective study, IC/BPS patients were randomized in two groups: group A received HA directly with a catheter and group B received HA with electromotive drug administration (EMDA). The VAS score and the micturition frequency were significantly lower in group B at 6 and 12 months. The difference between the two groups was not significant at 24 months, demonstrating that a lack of long-term efficacy is a major problem with this glycosaminoglycan substitution therapy. (441)

A study from China suggested a prolonged effect of bladder distension when combined with instillation of hyaluronic acid. (442)

4. CHONDROITIN SULFATE

Grade of Recommendation: C Level of Evidence: 1

No significant side effects.

Chondroitin sulfate is the only sulfated glycosaminoglycan located on the urothelial luminal surface and contributes to the urothelial barrier function. (443) Its efficacy was suggested for the first time 2002 when used alone (444) and in another trial when used in combination with hyaluronic acid. (445) Intravesical chondroitin sulphate demonstrated beneficial effects in patients with a positive potassium stimulation test in two non-randomised, uncontrolled, open-label

pilot studies. Steinhoff (444) treated 18 patients with 40 mL instilled intravesically once weekly for 4 weeks and then once monthly for 12 months. Thirteen of 18 patients were followed for the entire 13-month study. Twelve of these patients responded to treatment within 3–12 weeks. A total of 6/13 (46.2%) showed a good response, 2/13 (15.4%) had a fair response, 4/13 (30.8%) had a partial response, and 1/13 (7.7%) showed no response. In a second trial 24 refractory patients with BPS/IC were treated with high-dose (2.0%) chondroitin sulphate instillations twice weekly for 2 weeks, then weekly with 0.2% solution for 4 weeks, and monthly thereafter for 1 year. (446) The average symptom improvement reported in 20 patients completing the trial was 73.1% (range: 50–95%). The time to optimum response was 4–6 months. A more concentrated 2.0% solution was needed in eight patients to maintain results. Chondroitin sulphate instillation was effective and well tolerated in the therapy of various chronic forms of cystitis associated with a possible GAG layer deficit including BPS in a large multicenter but open study. (447)

Two large randomized placebo controlled trials of chondroitin sulfate as monotherapy for BPS were carried out in North America by Watson. Sixty-five patients with IC/BPS were treated in a prospective, randomized, double-blind, inactive vehicle-controlled, 12-week study (6 weeks treatment, followed by 6 weeks follow-up). At the primary endpoint analysis (week 7), 22.6% of the vehicle control group were responders compared with 39.4% of the active therapy group, however, the difference was not significant. (92) A follow up randomized placebo-controlled trial with 98 female patients showed only minor improvements in IC/BPS symptoms and pain and failed to demonstrate a statistically significant drug effect vs. placebo. (448) The authors concluded that the study did not support the use of intravesical chondroitin sulfate as a monotherapy for this condition.

In 2013 an individual participant data (IPD) meta-analysis was conducted to define the efficacy of intravesical 2% chondroitin sulfate in IC/BPS patients. (449) The main purpose of this IPS meta-analysis was to increase statistical power for primary outcomes from the data of 3 clinical trials to determine whether larger and long-term studies should be contemplated. (92,448,450) In total, 213 patients were included in this analysis. At the end of the treatment di overall global response assessment (GRA) rates were 43.2% in the chondroitin group and 27.4% in the control group and the chance of having becoming a responder with chondroitin sulfate was 55% significantly higher than with placebo. The small decrease in total ICSI score and urine frequency between the two groups was less impressive and not statistically significant.

5. CHONDROITIN SULFATE AND HYALURONIC ACID COMBINATION THERAPY

Grade of Recommendation: C Level of Evidence: 2

The combination of hyaluronic acid and chondroitin sulfate forms a more viscous agent, and was proposed several years ago for treatment of BPS by Cervigni and colleagues. (445,451,452) Studies are ongoing. The preparation has been approved in parts of Europe for use as an intravesical therapy. It has been shown in a pilot study to relieve some symptoms of radiation cystitis. (453)

In 2016 a randomized, open-label, multicenter study involving 110 women were randomized to receive 13 weekly instillations (3 months) of HA (1.6% - 800mg) and CS (2.0% - 1g) (Ialuril®; IBSA) or 50% DMSO solution (RIMSO®; Bioniche), with a 2:1 allocation ratio (HA/CS:DMSO). This study showed that treatment with HA/CS appears to be as effective as DMSO with a potentially more favorable safety profile. Both treatments increased health-related quality of life, while HA/CS showed a more acceptable cost-effectiveness profile. (454)

6. PENTOSAN POLYSUFATE

Grade of Recommendation: D Level of evidence: 4

No significant side effects are considered to be present.

Pentosan polysulfate (PPS) is a mucopolysaccharide similar to heparin, with a similar postulated mode of action when used locally. Like other muco-polysaccharides, it has not been well-studied clinically. Bade et al in a randomized controlled trial found benefit in 4 patients out of 10 on PPS versus 2 of 10 on placebo. (455) A placebo-controlled study of 41 patients found the addition of a 6 week course of intravesical PPS to a regimen of oral PPS significantly improved results. (456)

7. VANILLOIDS (CAPSAICIN, RESINIFERATOXIN)

Grade of Recommendation: -A (ineffective) Level of Evidence: 1

Significant side effects: local irritation possible

It would seem reasonable that capsaicin, a C-fiber afferent neurotoxin, could alleviate the pain of BPS by desensitizing bladder afferents. Resiniferatoxin (RTX) is considered to have a stronger action than capsaicin, by desensitizing C-fibers more quickly, and causing less initial irritation. Efficacy was indicated in

five relatively small clinical trials. (457-461) No severe side effects were reported. A randomized multicenter placebo-controlled clinical trial of RTX failed to demonstrate benefit over placebo. (462)

8. BACILLUS CALMETTE-GUERIN (BCG)

Grade of Recommendation: -A (ineffective) Level of Evidence: 1

Potential serious complications

Seven articles reported on a BCG instillation therapy. Zeidman et al first reported that 5 patients who did not respond to other therapies showed symptomatic improvement. (463) Peters et al conducted a randomized double blind study showing a 60% improvement compared to 27% placebo response with good long-term results at 27 months. (464,465) Sixty-five percent of the patients experienced burning sensation, 41% irritation of the bladder, and 35% pelvic pain. One patient was reported to have dropped out due to joint pain.

Peeker et al conducted a randomized double blind study comparing intravesical BCG and DMSO and failed to find any efficacy with BCG. (407) A very large, multicenter randomized placebo controlled trial conducted by the National Institute of Diabetes, Digestive, and Kidney Disorders failed to identify benefit from BCG, although the side-effect profile was surprisingly similar to that of placebo. (466)

9. OXYBUTYNIN

Grade of Recommendation : D Level of Evidence: 4

Side effect profile is unknown

Barbalias et al observed significant improvement when combining intravesical instillation of oxybutynin

with bladder training. (467) Randomized trials are lacking.

10. LIDOCAINE

Grade of Recommendation: C Level of Evidence: 3

No significant side effects.

Lidocaine is a local anesthetic that relieves pain by blocking sensory nerves in the bladder. It can be administered by electromotive drug administration (EDMA). (468-471) Using EMDA, ionized lidocaine is actively introduced into the bladder using an electrical current. Three articles reported that lidocaine and dexamethasone were instilled following hydrodistention. According to the report by Rosamilia et al, 85% of the patients had a good result, with the effect persisting for 6 months in 25%. (471) Other positive results are noted in case reports. (472,473) A report on a pharmacokinetic effect, demonstrated safe levels of lidocaine absorption into the bladder. (474) In a large, placebo controlled randomized trial, 102 adult patients (99 women) with a clinical diagnosis of BPS were randomised from 19 centres in the USA and Canada to receive a daily intravesical instillation of alkalised lidocaine or placebo (double-blind), for 5 consecutive days. (475) Treated patients had significant sustained symptom relief for up to 1 month. The response rate in the active group was 30% vs 9.6% with placebo. However, further randomized, placebo-controlled trials are needed to ascertain efficacy, optimal treatment parameters, and length of response to intravesical lidocaine preparations. (476) Advantages seem to be immediate response, low-cost of generic medication, and ability of patients to self-administer at home.

In a comprehensive review of lidocaine and bladder pain syndrome, Henry et.al. conclude that only weak evidence exists for supporting its clinical use at this time. It appears to be a promising candidate drug to interrupt the self-perpetuating neuroinflammatory cycle found in BPS. In the absence of more definitive clinical trials with various lidocaine preparations, it is reasonable to try daily instillations of 10-20ml of a 2% lidocaine solution with or without alkalization for 7 days to see if a clinical response justifies ongoing treatment. (477)

Table 7 Intravesical Therapies Oxford Criteria

INTERVENTION	GRADE RECOMMENDATION	LEVEL OF EVIDENCE
DMSO	B	2
HEPARIN	C	3
HYALURONIC ACID (HA)	C	1
CHONDROITIN SULFATE (CS)	C	1
HA + CS	C	2
PENTOSAN POLYSULFATE	D	4
VANILLOIDS	NOT RECOMMENDED	1
BCG	NOT RECOMMENDED	1
OXYBUTININ	D	4
LIDOCAINE	C	1

XII. BOTULINUM TOXIN (INTRAMURAL) / NEUROMODULATION

1. BOTULINUM TOXIN

Grade of Recommendation: B Level of Evidence: 2

Side effects include dysuria, incomplete emptying

Botulinum toxin type A (BTX-A) hinders neuromediator release, both centrally and peripherally and also impedes intracellular transient receptor potential vanilloid type 1 (TRPV1) receptor to the cellular membrane, in bladder afferent nerve fibers, thus enabling both symptomatic and urodynamic improvements. (478)

Thirteen BPS patients were injected with 100–200 IU of BTX-A (abobotulinumtoxin A or onabotulinumtoxin A) into 20–30 sites submucosally in the trigone and floor of the bladder. Overall, nine (69%) patients noted subjective improvement, and ICSI scores improved by 70% ($P < 0.05$). There were significant decreases in daytime frequency, nocturia and pain, and a significant increase in first desire to void and maximal cystometric capacity. However, dysuria occurred in a majority of patients and persisted in a minority for several months after initial injection. Three patients required clean intermittent catheterization for 2–3 months following therapy. (479)

To ascertain effect of repeat injections a total of 13 patients were followed up for 2 years, while 58 injections were administered with a mean of 4.8 ± 0.8 injections per patient. The mean interval between two consecutive injections was 5.25 ± 0.75 months. At 1 and 4 months follow-up, 10 patients reported a sub-

jective improvement. Mean VAS scores, mean day-time and night-time urinary frequency decreased significantly. The three non-responders to the first intravesical treatment session underwent further treatment 3 months later with satisfactory results. At 1 and 2 years follow-up, the beneficial effects persisted in all patients (480)

These results are in contrast with those in another study from Kuo of BTX-A (onabotulinumtoxin A) in 10 patients with BPS. One hundred units were injected suburothelially into 20 sites in five patients, while 100 U were injected into the trigone in the remaining five. None of the patients became symptom-free; two showed only limited improvement in bladder capacity and pain score. (481)

However in an RCT, Kuo and Chancellor analysed the difference between hydrodistension and hydrodistension plus intravesical, sub mucosal BTX-A (onabotulinumtoxin A). (482) Of the 67 patients, 44 were divided in two groups: one received 200 U and the other 100 U, and cystoscopic hydrodistension was performed after 2 weeks. The remaining 23 patients received hydrodistension only. There was symptomatic improvement in all groups. However, in the hydrodistension group, 70% had returned to their previous symptoms after the first month, while in the BTX-A-treated groups, there was improvement of VAS, functional bladder capacity and cystometric bladder capacity at 3 months. At 12 and 24 months, the results in the active group were 55 and 30% versus 26 and 17% in the hydrodistension group

In a multicenter, randomized, doubleblind, placebo-controlled patients were randomized to hydrodistension plus suburothelial injections of BTX-A 100U or the equivalent amount of normal saline. Pain was assessed using a visual analog scale (VAS) at week 8 after treatment. Secondary endpoints included voiding diary and urodynamic variables. A total of 60 patients including 40 in the Botox and 20 in the N/S groups were enrolled. At week 8, a significantly

greater reduction of pain was observed in the BTX-A group compared to the N/S group (2.6 vs. 0.9, $p=0.021$). The other variables did not differ significantly between groups except for cystometric bladder capacity, which was increased significantly in the Botox group. The overall success rates were 63% (26/40) in the Botox group and 15% (3/20) in the N/S group ($p=0.028$). Adverse events did not differ between the groups. (483)

In order to ascertain effect of isolated BTX-A treatment only, Akiyama et al underwent a single-center, prospective, open labeled, randomized comparative study. Patients with refractory interstitial cystitis were randomly divided into two groups: immediate injection or 1 month delayed injection of botulinum toxin type A after allocation. The rate of treatment response and changes in symptom scores and frequency volume chart variables were compared between groups 1 month after allocation. Using subjects of both groups as a single cohort, predictive factors for treatment response at 1 month post-injection and the duration of response were explored. In a total of 34 patients the response rate was significantly higher in the immediate injection group (72.2% vs 25.0%, $p = 0.01$). All symptom measures showed significant improvement. When both groups were combined as a single cohort, the response rate was 73.5% at 1 month, 58.8% at 3 months, 38.2% at 6 months and 20.6% at 12 months. The mean duration of response was 5.4 months. The authors also found BTX-A to be more effective in patients with relapse after previous hydrodistension, thus enhancing its value in refractory cases. (484)

Trigonal-only injection seems effective and long-lasting since 87% of patients ($n = 23$) reported improvement after a 3-month follow-up period in a study by Pinto *et al.* (485) Over 50% referred continuity of the beneficial effect 9 months after the first treatment. When retreatment was needed, similar results were obtained. No cases of urinary retention were reported. The authors concluded that this treatment is safe, effective and can be repeated

Despite Kuo et al's finding of BTX-A ineffectiveness in disease with Hunner's lesions (482,484,486), both Akiyama and Pinto et al reported similar results for patients with or without Hunner's lesions present at treatment, indicating pain is targeted by BTX-A, regardless of cystoscopic phenotype.

Lee and Kuo in a prospective study, treated patients with refractory IC/BPS, with 100 U of BTX-A injection plus hydrodistention followed by repeated injections every six months for up to two years or until the patient wished to discontinue. Of the 104 participants, 56.7% completed four BoNT-A injections and 34% voluntarily received the fifth injection due to exacerbated IC symptoms. With a follow-up period of up to 79 months, O'Leary-Sant symptom and problem indexes (ICSI, ICPI, OSS), pain visual analogue scale (VAS) functional bladder capacity, frequency episodes, and global response assessment (GRA) all showed significant improvement ($p < 0.0001$). Those

who received repeated injections had a better success rate during the long-term follow-up period. The incidence of adverse events did not rise with the increasing number of BoNT-A injections. (487)

Although RCTs have been published establishing efficacy of single and repeated injections with few and mild side effects, studies are still scant and small. Further studies will be needed to obtain conclusive evidence for its efficacy, duration of effect, and side-effect profile.

2. NEUROMODULATION

Grade of Recommendation: B Level of Evidence: 1

Sacral nerve stimulation (SNS) involves implanting permanent electrode(s) to stimulate S3 or S4 roots. As early as 1989, Tanago et al showed that stimulation of S3 may modulate detrusor and urethral sphincter function (488). FDA approved the usage of sacral neuromodulation for treating refractory detrusor overactivity in 1997 and for urinary urgency and frequency in 1999. Although the effectiveness of SNS for detrusor overactivity is largely confirmed by a good number of studies, only a relatively few papers report the effect of SNS in treating BPS.

Zerman et. al reported significant improvement in a 60-year-old woman treated for severe BPS pain using sacral nerve stimulation implant. Pain and accompanying bladder dysfunction were improved by temporary and permanent sacral nerve stimulation for up to six months (489). Maher et al (490) showed that temporary stimulation was effective in 73% of 15 women with refractory BPS. Mean voided volume during treatment increased and mean daytime frequency, nocturia and pain decreased significantly. As indicated by the Short Urinary Distress Inventory and SF-36 Health Survey, the quality of life parameters of social functioning, bodily pain and general health significantly improved during the stimulation period.

Chai et. al (239) found that percutaneous S3 nerve root stimulation improves symptoms and normalizes urinary HB-EGF levels and antiproliferative activity in patients with BPS. Treatment response may coincide with a decrease in urine levels of chemokines, especially monocyte chemoattractant protein-1. (491) In their report in 2003, Comiter et al (492) prospectively investigated the effect of SNS on a series of 17 patients with refractory BPS. At an average of 14 months follow-up mean daytime frequency, nocturia and mean voided volume improved significantly. The average pain decreased from 5.8 to 1.6 points on a scale of 0 to 10 and Interstitial Cystitis Symptom and Problem Index scores (ICSI and ICPI) decreased from 16.5 to 6.8 and 14.5 to 5.4, respectively. Of the 17 patients 16 (94%) with a permanent stimulator demonstrated sustained improvement in all parameters at the last postoperative visit. Whitmore et al (493) applied percutaneous sacral nerve root stimulation on 33 patients with refractory interstitial cystitis.

Statistically significant improvements were seen in pain and urinary symptoms. Significant improvements were also seen in ICSI and ICPI scores.

Peters et al (494) reported a reduction of narcotic usage in 18 BPS patients following SNS for a mean of 15.4 months, although the dose reduction was modest (36%) and only 4 of 18 discontinued the narcotics. However, Elhilali and colleagues (495) found that both of two patients with interstitial cystitis reported no improvement following sacral neuromodulation. Zabihi et al (496) more extensively stimulate S2-S4 by implanting electrodes into epidural space through sacral hiatus. 23 of 30 (77%) patients had successful trial stimulation and were permanently implanted. Among these patients, the symptom score was improved by 35% ($p=0.005$). The pain score improved by 40% ($p=0.04$). Patients reported an average of 42% improvement in their symptoms.

In the first prospective, single-blind, crossover trial of sacral nerve stimulation (SNS) versus pudendal nerve stimulation (PNS) for patients with BPS ($n = 22$), PNS gave an overall 59% improvement in symptoms, whereas SNS gave an overall 44% improvement ($P = 0.05$). Most patients who tested both a sacral and pudendal electrode chose PNS as the better site. Follow-up showed marked improvements in voiding variables and validated BPS symptom questionnaires. Over 90% of patients treated with neuromodulation stated that they would undergo implantation again (497)

Long-term results were verified in a retrospective study of 78 patients treated from 1994 to 2008. Permanent sacral neuromodulation implantation was performed in patients who showed at least 50% improvement in their symptoms with a temporary peripheral nerve evaluation test. Median follow-up was 61.5 ± 27.7 months. Good long-term success of sacral neuromodulation was seen in 72% of the patients. The explantation rate was 28%. The most frequent reason for explantation was poor outcome (54% of the failed patients). The revision rate was 50% (498) In another observational, retrospective, case-controlled review (January 2002–March 2004), 34 female patients underwent permanent device implants. Mean pre-/postoperative pelvic pain and urgency/frequency scores were $21.61 \pm 8.6/9.22 \pm 6.6$ ($P < 0.01$), and mean pre-/postoperative visual analogue pain scale (VAPS) scores were $6.5 \pm 2.9/2.4 \pm 1.1$ ($P < 0.01$). Mean follow-up was 86 ± 9.8 months. Sacral neuromodulation showed adequate improvement for the symptoms of refractory BPS. Reoperation rate was 25% (499).

Sacral nerve modulation is still considered an investigational procedure for BPS by the Consultation. Pudendal nerve stimulation has shown better results. Therapeutic benefits of both appear to be significant in selected cases. Strict patient selection and detailed discussion with patients prior to surgery is mandatory. Long-term results should be collected and reported,

and trial results discussed with patients before employing this treatment modality.

Percutaneous tibial nerve stimulation has been used to treat BPS, although there is little data on its efficacy at this time. (500,501)

XIII. PAIN EVALUATION AND TREATMENT

1. EVALUATION OF PAIN

The first premise that all physicians treating patients diagnosed with BPS is that they deserve to have their chronic pain assessed and treated. It is now recognized that successful management of BPS is only possible using a multidisciplinary and multimodal treatment approach which must include management of the associated chronic pain. This includes evaluation of the whole patient, not just the urology related symptoms. As described in previous sections, this will involve assessment of clinical symptoms, physical signs and history to best define the underlying diagnosis and overlapping conditions, while not ignoring the problems of mood, sleep and sexual problems. The patient's self-report should be the primary source of assessment. Clinicians should assess pain with easily administered rating scales (see below for examples) and should document the efficacy of pain relief at regular intervals after starting or changing treatment. Systematic evaluation of the pain involves the following:

- Evaluation of severity
- Detailed history of the pain including assessment of pain intensity over time as well as character
- Evaluation of the psychological state of the patient, including assessment of mood and coping responses
- Physical examination emphasizing the neurologic examination
- Diagnostic workup to determine the cause of the pain
- Regular re-evaluation of therapeutic strategy and response.

The initial evaluation of pain should include a description of the pain; **PQRST** has been described for this purpose:

P: Palliative or Provocative factors, 'what makes it less intense?'

Q: Quality, 'what is it like?'

R: Radiation, 'does it spread anywhere else?'

S: Severity, 'how severe is it?'

T: Temporal factors, 'is it there all the time, or does it come and go?'

1.1. Pain measurement

A number of different rating scales have been devised to attempt to methodically measure pain and to allow patient follow-up. These have been used in research, audit and in clinical practice. They all rely on a subjective assessment of the pain and therefore make inter-individual comparisons difficult. Additionally, pain is a multidimensional complex phenomenon and is not adequately described by one-dimensional scales, however there is value in making some sort of an assessment to aid clinical practice to follow individual patients.

- Categorical scales e.g., verbal rating scales: mild, moderate, severe pain
- Visual analogue, Likert or Numerical Rating scale (VAS)
- Complex pain assessment compendiums e.g., Brief Pain Inventory (BPI), McGill Pain Questionnaire (502-504)

The BPI consists of several visual analogue scales grouped together assessing pain at rest, on movement, and other aspects of the pain including interference with function and effect on work. The McGill Pain Questionnaire measures pain quality by asking patients to rate the intensity of 15 verbal descriptors of pain on a 0 to 3 rating scale. The pain rating index is composed of 2 scores, including a sensory pain score and an affective pain score. Some versions also use a standard pain intensity VAS.

1.2. Pharmacologic Management of Chronic Pelvic Pain

Physicians using pharmacologic measures to control BPS pain must be committed to the following principles (524):

1. Drugs are prescribed and monitored with knowledge of the patient's history and risks,
2. Patients understand potential benefits and harms and participate in reducing harms
3. Clinicians assess outcomes for both effectiveness and harms.

1.3. Acetaminophen

Acetaminophen (paracetamol) is the main representative of this group. It has antipyretic activity and is a simple analgesic. There is very little evidence about its role in chronic pelvic pain (506,507). Acetaminophen should be considered for only mild pain. Acetaminophen is a common cause of hepatotoxicity (508-510) and risk increases with alcohol use.

1.4. Non-steroidal Anti-inflammatory Drugs

The classical non-steroidal anti-inflammatory drugs (NSAIDs) fall into this group and include salicylic acid.

They are known to act on the cyclooxygenase (COX) enzyme. The early NSAIDs tended to have little selectivity for COX2 over COX1, and are therefore said to be associated with more side effects than the newer COX2 selective inhibitors (511). The COX1 enzyme is mainly involved in normal 'housekeeping' functions, such as mediating gastric mucosal integrity, and renal and platelet function. Blocking the COX1 enzyme is the cause of the platelet, gastric and renal complications that can occur with NSAIDs. It has been suggested that the COX2 enzyme is inducible as a result of tissue damage, and that it is the main enzyme involved in inflammation and peripheral sensitization of nociceptors (512). As a result, the analgesic efficacy of COX2 selective drugs should be as good as that of the nonselective drugs, however the benefit is primarily seen in acute inflammatory type pain. The selective COX2 agents should not be prescribed in patients with increased risk of cardiovascular disease including congestive cardiac failure (513). There is very little evidence for a role of NSAIDs in the management of chronic pelvic pain and even less evidence for a role for the COX2 selective drugs. Most of the analgesic studies have investigated dysmenorrhoea in which NSAIDs have been found to be superior to placebo and possibly paracetamol (512,514).

For practical purposes the NSAIDs may be divided into:

1. Non-selective, low potency (e.g. salicylic acid, ibuprofen).
2. Non-selective, high potency (e.g. ketoprofen, diclofenac, ketorolac).
3. COX2 selective drugs (e.g. celecoxib).

Non-selective, low potency NSAIDs can be used as first-line analgesics. (515) They are most likely to be of help if there is an inflammatory component to the pain. More potent NSAIDs should be reserved for those conditions in which the low potency drugs have been tried and failed to produce significant benefit. COX2 selective drugs should be used with caution as an alternative to the non-selective drugs where there is an increased risk of gastric complications. They should be avoided in patients with known cardiovascular disease. NSAIDs should be taken with food and consideration must be given to the use of gastric protective agents. The benefits of the NSAIDs must be demonstrated to outweigh the risks. All NSAIDs are contraindicated in active gastrointestinal ulceration/bleeding and renal disease. They may seriously exacerbate asthma and produce fluid retention. Even if stronger analgesics such as opioids are added, the NSAIDs can be continued as they are likely to have a synergistic action improving pain control above and beyond that obtained with opioids alone (516)

1.5. Neuromodulators (Neuropathic Analgesics)

Tricyclic antidepressants. Tricyclics have a definite analgesic effect on neuropathic pain compared with placebo (517): 30% of patients should obtain more than 50% pain relief; 30% will have minor adverse effects; and 4% will have to stop treatment because of side effects. Tricyclics are said to work in doses that are too low to affect mood. They may work by increasing levels of norepinephrine and/or serotonin. They also have actions at sodium channels. They have a long history when used for pelvic pain (518,519) and good evidence exists to justify their usage (333,334). A recent randomized placebo controlled study sponsored by the US National Institutes of Health (286) evaluated increasing doses of amitriptyline with or without standardized education and behavioural modification in treatment naïve patients with IC/PBS. While this study did not reach statistical significance when comparing amitriptyline plus education and behavior modification to education and behavioral changes alone, it did show that amitriptyline may be beneficial in persons who can achieve a daily dose of 50 mg or greater. (335)

Serotonin reuptake inhibitors. Selective serotonin reuptake inhibitors appear to be less effective for the management of pelvic pain (520). Fluoxetine can increase plasma levels of amitriptyline and induce toxicity, and therefore care must be exercised if the drugs are combined.

Anticonvulsants: There is evidence that gabapentin and pregabalin are effective in chronic neuropathic pain (521,522). Whereas there is little evidence to support the use of anticonvulsants in the management of genitourinary pain, they should be considered if there is a suggestion of neuropathic pain or central sensitization (320,523,319,505).

N-methyl-D-aspartate (NMDA) antagonists. Ketamine is thought to act primarily at the NMDA receptor, though it may also have actions at sodium channels, as well as opioid (kappa and mu) receptors (525). Ketamine has been shown in both human (526) and animal models (527) of neuropathic pain to reduce central sensitization and wind-up. Ketamine has been found to be useful in a number of chronic pain states including: peripheral neuropathies with allodynia, stump and phantom pain, central pain, as well as fibromyalgia (528-532). However, it has become evident that ketamine should only be used with caution (or not at all) by an experienced practitioner trained in its use. Ketamine is a street drug of addiction and has recently been associated with disastrous bladder consequences, the so-called ketamine bladder. (533)

1.6. Opioids

There is now a general acceptance that opioids have a role in the management of chronic non-malignant pain (534). Strategies that may improve safety and efficacy include appropriate patient selection through

identification of risk factors, and access to prescription monitoring programs. Low initial dose, prescription of alternative non-opioid analgesics, and development of written care agreements to individualize and guide therapy improve patient outcomes. (535,536) While the use of opioids in urogenital pain is poorly defined, they should be considered for patients with BPS in whom all other treatments to reduce pain have failed. Opioid use does present very real risks and potential harms (327) and include overdose, addiction, and opioid diversion and prescribers have an obligation to assess risks and minimize harms. Unfortunately, not enough is known about the long-term benefits, risks, and side effects of opioid therapy, not only in IC/PS, but other chronic non-cancer pain conditions. More research is needed in this area. The following guidelines for the use of opioids in chronic/non-acute urogenital pain are suggested by the European Association of Urology (537).

1. All other reasonable treatments must have been tried and failed.
2. The decision to instigate long-term opioid therapy should be made by an appropriately trained specialist in consultation with another physician (preferably the patient's family doctor).
3. Where there is a history or suspicion of drug abuse, a psychiatrist or psychologist with an interest in pain management and drug addiction should be involved.
4. The patient should undergo a trial of opioids.
5. The dose required needs to be calculated by careful titration.
6. The patient should be made aware (and possibly give written consent):
 - I. that opioids are strong drugs and associated with addiction and dependency
 - II. the opioids will normally only be prescribed from one source
 - III. the drugs will be prescribed for fixed periods of time and a new prescription will not be available until the end of that period
 - IV. the patient will be subjected to spot urine and possibly blood checks to ensure that the drug is being taken as prescribed and that non-prescribed drugs are not being taken
 - V. inappropriate aggressive behaviour associated with demanding the drug will not be accepted
 - VI. hospital specialist review will normally occur at least once a year
 - VII. the patient may be requested to attend a psychiatric/psychology review

VIII. failure to comply with the above may result in the patient being referred to a drug dependency agency and the use of therapeutic, analgesic opioids being stopped.

Morphine. There is no compelling evidence that one opiate is better than another. Morphine has, however, become the traditional gold standard. Morphine is the first-line drug, unless there are contraindications to morphine or special indications for another drug. The drug should be prescribed in a slow release/modified release form. Short-acting preparations are undesirable and should be avoided where possible. Parenteral dosing is undesirable and should be avoided where possible. In an acute situation, the daily morphine requirement may be calculated by titration of the drug with progressively increasing doses of 4-hourly rapid-release morphine. However, in most cases, starting with a low dose of slow-release morphine and confining the increments to occur at intervals of no less than 3 days to 1 week is adequate. Chronic non-cancer pain can be managed effectively in most patients with dosages at or below 200 mg/day of morphine or equivalent.

A fentanyl patch can be used when oral absorption is restricted or when the patient suffers from nausea and vomiting. Patches are generally changed every 72 hours. The problem with the currently available patches is that the dosing increments between patches are large. Care needs to be exercised when increments in dose are undertaken. Fentanyl has contributed to numerous overdose deaths (538,539).

Methadone is a strong analgesic which has a long track record (540). While it may have a useful role in the management of urogenital pain, there is very little science to support this. Methadone has the tendency to accumulate with repeated dosing and cause delayed respiratory arrest. Therefore, whereas it may be a very useful drug, it should only be prescribed by a practitioner familiar with its use as an analgesic. Methadone as an analgesic is usually prescribed 6 hourly as its analgesic action is relatively short-lived compared with the longer benefits seen from using the drug in drug addiction.

Meperidine (Demerol) 300 mg intramuscular (i.m.) is about as effective as morphine 30 mg i.m. (conversion factor 0.1). Its oral bioavailability is, however, poor. Meperidine has a short duration of action, can accumulate with multiple dosing and is therefore not recommended for use in chronic, non-acute pain (541).

Oxycodone, hydromorphone and hydrocodone are available as slow/modified-release preparations. They may be useful for opiate rotation if side effects or tolerance is a problem. They are powerful opioids and should be used with the same caution as morphine. 20 mg of oxycodone and 6 mg hydromorphone is equivalent to 30 mg of Morphine (1.5 and 5 X conversion factor). Oxycodone, hydromorphone and hydrocodone may have a higher abuse liability than morphine (542).

Codeine is a less potent opioid than morphine and the other opioids discussed and could be useful in mild to moderate pain. Tramadol produces analgesia by two mechanisms: an opioid effect; and an enhancement of serotonergic and adrenergic pathways (543,544). It has fewer of the typical opioid side effects (notably, less respiratory depression, less constipation and less addiction potential) (545). Morphine dose equivalences with tramadol has not been reliably established. Codeine and tramadol may have a lower abuse risk than more potent opioids (542,546).

Opioid Recommendation: Opioids have been shown in randomized controlled trials to be highly effective in the treatment of chronic non-malignant pain. Long-term follow-up studies suggest that this effectiveness can be maintained. However, effectiveness has been limited in many clinical trials by failure to take into account high variability in dose requirements, failure to adequately treat depression, and frequency of side effects due to high inter-individual variability in side effect profiles aggravated by overly rapid dose titration. (547) The tremendous potential benefits balanced by the deadly risk of overdose would indicate the need for consultation with an expert in chronic pain management when the use of opiates is considered for more than the short-term management of a symptom flare. A stepped approach to opioid selection should be based on a patient's clinical profile and individual characteristics and should proceed in a stepwise fashion. First line therapy for mild to moderate pain would include codeine or tramadol while second line therapy for mild to moderate pain could include morphine, oxycodone or hydromorphone. First line therapy for severe pain would include these same agents, morphine, oxycodone or hydromorphone while second and third line therapy for severe pain could include fentanyl and methadone respectively. It is important to determine the optimal dose, i.e., a dose that will improve function or reduce pain intensity by at least 30% without causing major adverse effects or complications. It is recommended to start the opioid trial with a low dose and increase the dose in small quantities over several days or weeks carefully monitoring for effectiveness (or plateauing of response) and adverse effects or complications. Opioids produce a graded analgesic response: the patient experiences the greatest benefits at lower doses and a plateauing of analgesic response and adverse effects at higher doses.

1.7. Recommendation:

BPS patients deserve to have their chronic pain treated. There are few well controlled long term pain therapy studies in this area, therefore most of our recommendations must come from studies in other non-cancer pain conditions. As discussed in the previous sections, management of symptoms of BPS, including the chronic pain must start with conservative therapies along with BPS condition-specific treatments. For those whose chronic pain is refractory to these therapies including standard analgesics, therapy for

the chronic pain should normally start with a tricyclic and/or gabapentinoid (gabapentin or pregabalin), followed by addition of an opioid such as codeine, tramadol, morphine or oxycodone as a last resort.

Level of Evidence: 4 Recommendation: C

XIV.SURGICAL THERAPY

Bladder Pain Syndrome (BPS) is a chronic and debilitating disease. Major surgical options should be considered only when all conservative treatment has failed.

The patient should be informed of all aspects of surgery and understand consequences and potential side effects of surgical intervention. An experienced surgeon familiar with the particular surgical technique should perform the procedure.

1. HYDRODISTENTION

Bladder distension has been used for many years (548) not only as a diagnostic/ classification tool but also for treatment of BPS. In 1957 Franksson reported on a retrospective series of 33 patients, with symptom improvement in all, and lasting up to 1 year in 7 patients (549). Reports from the seventies were contradictory. Using the Helmstein method (550) Dunn reported complete absence of symptoms in 16 of 25 patients (551), while Badenoch found no improvement in 44 of 56 patients (358). More recent literature reports poor results with only a minority of patients reporting a small improvement in symptoms for a relatively short period of time (225,226,241,552). Most studies are retrospective and uncontrolled. **Level of evidence 3; recommendation C**

2. TRANSURETHRAL RESECTION

In his first papers Hunner described open resection of the bladder ulcer in the treatment of patients with IC (17). He later abandoned this treatment due to operative morbidity and recurrence of symptoms. With better cystoscopes transurethral fulguration became more popular (553). Results of transurethral resection were originally reported by Greenberg et al. (554) and Fall (555). The retrospective results of this treatment in 116 patients with Hunner's lesion from Fall's Swedish clinic was later reported by Peeker et al. (556). Hunner's lesion was first recognized by bladder distension under general anaesthesia. All lesions were then resected including at least half of the underlying muscular coat. Large areas of the bladder might be treated to resect all diseased tissue. Ninety-two of the 116 patients experienced amelioration of their symptoms. Average duration of symptom alleviation was 23 months ranging from 0-180 months. Up to 16 re-resections were performed if symptoms recurred. This is the only center having reported a large clinical series of patients with BPS treated in this

manner. Shanberg and Malloy reported in 1987 on laser fulguration of 39 patients with BPS (557). Nineteen of 39 had Hunner's lesion. Of the 19 patients with Hunner's lesion 17 reported good pain relief lasting between 6 and 18 months. In the 20 patients without Hunner's lesion, reddened areas in the bladder were photocoagulated with the Neodymium:Yag laser. Thirteen felt marked improvement of symptoms but time to symptom recurrence was not reported. Small bowel perforation in 2 patients was the most important complication in this series. This series was extended to 76 patients (558) where 21 of 27 patients with Hunner's lesion (BPS ESSIC type 3X) experienced symptom improvement; 12 had relapse within 18 months. Of patients with BPS ESSIC type 1 or 2, 20 of 49 improved but 10 required further therapy within 1 year. Rofeim et al. (559) reported on Nd:YAG laser ablation of Hunner's lesion in 24 patients with BPS type 3X. All had symptom improvement within days without complications. Pain, urgency, nocturia, and frequency were improved after 23 months, but relapse in 11 patients required up to four additional treatments.

Payne et al. reported on 14 patients with Hunners lesion treated by cystoscopic ablation. Eight became symptom free and 4 improved symptomatically more than 50%. Four had symptomatic recurrence with improvement after repeat ablation (560). Intravesical, submucosal injection of triamcinolone has in uncontrolled studies been reported to have as good symptomatic effect as resection/fulguration.

Transurethral resection, fulguration, or laser ablation of Hunner's lesions is a recommended treatment for patients with BPS type 3X.

Level of Evidence: 3 Grade of Recommendation: B

3. CYSTOLYSIS – PERIPHERAL DENERVATION

Hunner (17) simply dissected bladder from surrounding tissue. Initial results were encouraging, however after 3 years of follow-up, symptoms reoccurred. Worth and Turner-Warwick (561) attempted to do more formal cystolysis and were more successful with regard to symptoms. Worth (562) followed patients up to 7 years and found bladder areflexia to be a significant complication of this procedure. Patients had to use Credé technique or even be on intermittent self-catheterisation. Albers & Geyer (563) reported symptom recurrence after 4 years in most of the patients.

Cystolysis – peripheral denervation is not indicated for BPS;

Level of Evidence: 3 Grade of Recommendation: -A (not recommended)

4. SYMPATHETIC DENERVATION

Visceral pain is transmitted in most cases by the sympathetic nervous system. Gino Pieri (564) applied this principle to the bladder pathology and suggested resection of the superior hypogastric plexus (presacral nerves), paravertebral sympathetic chain, and gray rami from S1-3 ganglia (Level 4). This was repeated by Douglass (565) a few years later. Immediate results were very good; however Nesbit (566) showed that the long term results were short lived.

Sympathetic denervation is not indicated for BPS

Level of Evidence: 4 Grade of Recommendation: -A (not recommended)

5. PARASYMPATHETIC DENERVATION

Based on the contribution of S2-S4 segments to bladder innervation, Moulder and Meirowsky (567) used S3 neurectomy in 3 patients with good long term follow-up. Larger series were reported by Milner (568) and Mason (569) but results after five years were not encouraging. To improve results selective dorsal sacral root neurectomy, unilateral or bilateral, was introduced by Bohm and Franksson (570). The outcomes of this procedure were unclear.

Parasympathetic denervation is not indicated for BPS;

Level of Evidence: 4 Grade of Recommendation: -A (not recommended)

6. BOWEL SURGERY

6.1. Bladder Augmentation-Cystoplasty

Bladder augmentation-cystoplasty has been commonly used for refractory BPS for 50 years. First reports of ileocystoplasty from 1958 were very promising (571). Later publications were less sanguine with good results varying from up to 100% (572,573) to 25% (358,574). Cystoplasty is usually done with or without bladder resection.

Cystoplasty alone was reported as early as 1967 by Turner-Warwick and Ashken (575), advocating augmentation with removal of the diseased tissue. Several subsequent studies indicated that cystoplasty with subtrigonal cystectomy offers better results than without subtrigonal cystectomy (573,576-578). These were all retrospective studies and conclusions should be taken with reservation. Cystoplasty with partial or total removal of the bladder requires bowel tissue substitution. Different bowel segments are used to enlarge the bladder. It is the general consensus that the intestine segment used for bladder augmentation

should be detubularized (579). Experiences with different bowel segments have been reported in numerous articles with level 4 evidence:

- Ileum (358,572,573,578,580-584)
- ileocecum (398,573,574,576,585,586)
- cecum (572,587)
- right colon (358,573,588)
- sigmoid colon (576,578,582,585)
- gastric segments (589,590)

There is no significant difference between different bowel segments with regard to outcome except for gastric tissue substitution which is associated with dysuria and persistent pain due to production of acids

6.2. Cystoplasty with Supratrigonal Resection

Cystoplasty with Supratrigonal Resection (i.e. trigone-sparing) has been reported in various studies. Von Garrelts (572) described excellent results in eight of 13 patients with a follow-up of 12-72 months. Bruce et. al (578) reported satisfactory relief of BPS symptoms by ileocystoplasty and colcystoplasty in eight patients. Dounis and Gow (591) reported improvement in pain and frequency in seven BPS patients after supratrigonal cystectomy with ileocecal augmentation. Kontturi et. al (576) used segments of colon and sigmoid colon in 12 cases with 100% symptom-free outcome in five patients augmented with sigmoid colon over 4.7 years of follow-up. Two of seven cases augmented with colon required ileal conduit and cystectomy. Linn et. al (592) followed six BPS patients for 30 months, and reported that all were symptom-free and voided spontaneously. The report by Nielsen et. al (574) was less favorable. Six out of eight patients had good results. Van Ophoven et. al (593) reported the long-term (mean 5 years) results of orthotopic substitution enteroplasty in 18 women with BPS, using ileocecal (n = 10) or ileal (n = 8) segments with only two failures. In the group augmented with ileum, three patients required self-catheterization and one a suprapubic catheter. Peeker et. al (594) found that patients with end-stage ulcerative BPS had excellent results following ileocystoplasty but not so the patients with non-ulcer disease. A follow up on this paper was published (188) with the same conclusion for the patients with end stage BPS ESSIC type 3C, while both continent diversion and ilio-cystoplasty were unrewarding in patients with type 2X BPS. Patients with low cystoscopic capacity (<200 ml) under general anaesthetic have achieved better results (20,21,595,596).

There is some weak evidence that cystoplasty with supratrigonal resection may benefit some selected patients with end stage ESSIC type 3C BPS.

Level of Evidence: Level 3; Grade of Recommendation: C

6.3. Cystoplasty with Subtrigonal Cystectomy — Orthotopic Continent Bladder Augmentation

Cystoplasty with Subtrigonal Cystectomy — orthotopic continent bladder augmentation (i.e. with trigone removal but preservation of the bladder neck) in the management of BPS has been reported less often (597-600). Because of the need of ureteral reimplantation, it is associated with some risks of urine leakage, urethral stricture and reflux (599). Linn et. al (592) had three failures in 17 patients and half of the patients with good symptomatic response required self-catheterization. Nielsen et. al (574) had better results following orthotopic substitution with low bladder capacity (200 mL versus 525 mL, respectively). Orthotopic continent bladder augmentation, particularly when removing the trigone, may cause incomplete voiding requiring intermittent self-catheterization. Therefore, patients considering such procedures should be advised accordingly and must be considered capable of performing, accepting and tolerating self-catheterization. Nurse suggested that the decision on whether to do a subtrigonal or supratrigonal cystectomy be based on the results of trigonal biopsy, with the former procedure indicated in the patient with trigonal inflammation (601).

There is no compelling evidence that subtrigonal cystectomy with cystoplasty has any outcome advantage over supratrigonal cystectomy but it tends to be associated with more complications and poorer functional bladder rehabilitation.

Level of evidence: 3; Grade of Recommendation: C

6.4. Urinary Diversion With or Without Total Cystectomy and Urethrectomy

This is the ultimate, final and most invasive option. It should be used as a last therapeutic resort in selected

TABLE 8: Surgical recommendations according to the oxford system

PROCEDURE	Recommendation	Level of Evidence
Hunner Lesion Directed Therapy	B	3
Hydrodistention	C	3
Sympathetic Denervation	-A not recommended	4
Parasympathetic Denervation	-A not recommended	4
Cystolysis	-A not recommended	3
Botulinum Toxin	B	2
Neuromodulation	B	1
Cystoplasty with Supratrigonal Resection	C	3

patients. Techniques include simple or continent urinary diversion. Continent diversion may be preferable for cosmetic reasons in younger patients.

Simple urinary diversion with formation of an ileal conduit is the most common surgical treatment for BPS (602). Initially, diversion can be done without cystectomy and only when bladder pain is persistent, cystectomy may be considered. Bladder de-functionalization alone produced symptom-relief in several reports. (20,21,358,574,603-606). Whether or not cystectomy should be performed at the same time as urinary diversion is somewhat controversial (607). About 80% of patients seem to have clinically significant improvement after urinary diversion, but secondary cystectomy does not seem to improve refractory pain (605,606) .

Often diversion is performed as a next step after unsuccessful bladder augmentation. To avoid further bowel resection, a bowel segment used for cystoplasty can often be converted to a conduit (608) In some patients chronic inflammatory changes have been seen in the cystoplasty pouch resembling interstitial cystitis (21,358,609,610) , preventing one from using this technique. Similar bowel changes however have been described when cystoplasty is performed for pathology other than interstitial cystitis, suggesting that these pathologic findings are not a direct result of the exposure of bowel to BPS urine (611).

Urinary diversion with and without cystectomy may be the ultimate option for refractory patients. Continent diversion may have better cosmetic and life style outcome but recurrence of pain in the pouch is a real possibility.

Level of Evidence: 3; Grade of Recommendation: C

PROCEDURE	Recommendation	Level of Evidence
Cystoplasty with Subtrigonal Resection	C	3
Urinary Diversion +/- cystectomy	C	3

XV. CLINICAL SYMPTOM SCALES

Symptom scales have enabled patients to be categorized by symptom severity and have also served to follow results of treatment in patients with bladder pain syndrome. Their future development may enable a presumptive diagnosis of the syndrome but at this time that is not possible. A brief survey that reliably segregates BPS from other urologic disorders would make the ability to diagnose the syndrome reliable, inexpensive, and available to all healthcare providers. It would aid in epidemiologic studies as well. Currently such work sponsored by NIDDK is ongoing. www.mappnetwork.org

A process for development of a case definition for BPS has been developed by adapting the RAND/University of California, Los Angeles Appropriateness Method. (53) This involves a panel consisting of nine experts with experience in BPS and related diseases, literature review of case definitions of BPS, initial ratings of symptoms as indicators of the BPS diagnosis, and discussion and a second set of ratings to establish criteria for diagnosis through patient reports. Symptom questionnaire development, based on the results of the case definition exercise, and validation have been successful in establishing a population-based estimate for disease prevalence using both high specificity and high sensitivity models. (73) If this could be adapted for use in screening by primary care physicians, the potential benefits in early diagnosis of BPS are evident.

Questionnaires and symptom scales are currently utilized to measure treatment outcome and are especially valuable in clinical research studies as well as for guiding therapy for individual patients.

There are 4 published BPS symptom questionnaires: the University of Wisconsin IC Scale (figure 12), the O'Leary-Sant IC Symptom Index (ICSI) and IC Problem Index (ICPI) (figure 13), the Pelvic Pain and Urgency/Frequency (PUF) Scale (figure 14) and the Bladder Pain/ Interstitial Cystitis Symptom Score (BPIC-SS) (612) (figure 15).

The University of Wisconsin IC Scale includes 7 BPS symptom items and has not been validated for identification or diagnosis of BPS. It captures severity of symptom expression (613,614). Unlike the other two instruments, it addresses some quality-of-life issues, and this is an advantage when such issues are subject of investigation. Its most attractive aspects are its clinically apparent face validity and its ease of implementation.

The O'Leary-Sant indexes are validated questionnaires that were originally developed by focus groups, subjected to test-retest reliability analysis, and validated by administration to BPS patients and asymptomatic controls (615,616). The questionnaires center on 3 questions related to urgency/frequency and one on bladder-associated pain. It does not address generalized pelvic pain or symptomatology associated with sexual activity. This is not because these questions were not considered in the formulation of the questionnaire. Of 73 questions in the preliminary instrument covering domains of urinary symptoms, pain, sexual function, menstrual variability, and general health, only the four questions now in the instrument were needed to reliably and validly describe the illness experience of those with IC and distinguish these patients from those without the disorder (617).

The Pelvic Pain, Urgency, Frequency (PUF) questionnaire (618) was specifically designed to include questions that directly reflect a wide variety of the symptoms experienced by patients who are affected by this disorder. One-third of the questions address pelvic pain, including pain anywhere in the pelvis: the vagina, labia, lower abdomen, urethra, perineum, testes, penis, or scrotum.

The PUF is marred by the fact that patients were not included in its development. If used to monitor outcomes, question 4 regarding sexual activity may worsen the score as the outcome improves. These and other problems make its use highly dubious. (619)

A large study utilizing the PUF questionnaire has concluded that up to 23% of American females have BPS (618). This makes one wary as to the utility and face-validity of the PUF[531]. A total score of 10-14 =74% likelihood of positive potassium test (PST); 15-19=76%; 20+=91%. To the extent that the PST is suspect, the reliability of PUF data comes into question.

Neither the PUF nor O'Leary Sant questionnaires have been shown to be of value in diagnosis of the individual patient (620). In an interesting epidemiologic study in Finland, Leppilahti and colleagues randomly selected 2000 participants from the Finnish population registry and administered the O'Leary Sant IC symptom and problem index (69). Women with symptom scores 7 or higher with no history of urinary tract infection in the preceding month were invited to undergo clinical examination. Of these 32 women, 21 underwent examination of whom 3 had probable interstitial cystitis and 4 had possible interstitial cystitis. Based on this specificity, a population

prevalence in Finnish women of 230/100,000 probable interstitial cystitis and 530/100,000 possible interstitial cystitis was calculated. Thus, one can get some idea as to O'Leary Sant specificity. For probable BPS it would be about 14% using a parameter of 7 or greater on the symptom index.

The O'Leary-Sant and University of Wisconsin instrument correlate strongly in a large population of patients with BPS. (621) Clemons and co-workers administered the ICSI to 45 patients scheduled to undergo laparoscopy for pelvic pain. Seventeen were diagnosed with BPS based on the finding of glomerulations on bladder distention associated with urgency, frequency, or nocturia. A score of 5 on the ICSI had a 94% sensitivity and a 93% negative predictive value in this enriched population of patients with pelvic pain (622). However, Clemens and colleagues have found a high degree of overlap in International Prostate Symptom Scores, the O'Leary Sant Symptom Index, and the Chronic Prostatitis Symptom Index in a random sample of over 1400 men and women with urologic symptoms, underscoring that we should be cautious in using these questionnaires as a basis for diagnosis in epidemiologic studies (75).

Rosenberg and Hazzard (67) surveyed 1218 consecutive patients presenting to their primary care office and found 7 (0.6%) who had a 7 ICSI score. Likely BPS was noted in 12.6% of patients on the PUF scale, a figure 21 times higher, suggesting that either the PUF drastically overestimates BPS, or the ICSI lacks sensitivity. Based on the correlation of the potassium sensitivity test and the PUF questionnaire, Parsons (56) stated that 30.6% of 3rd year female medical students at his California institution had probable BPS. Sahinkanat and coworkers (209) in Turkey administered the PUF questionnaire to all 442 female textile workers in two local factories. Eighty-six per cent of those with a PUF score 7 or greater had an 86% positive rate of PST testing versus 9% positive in the group with PUF less than 7. They extrapolated that bladder epithelial permeability dysfunction was present in 32.8% of these unselected women. The ICSI estimate seems much more in line with current epidemiologic data.

While perhaps not ideally suited for epidemiologic studies, these questionnaires can reveal important epidemiologic data. Porru and colleagues (623) compared University of Wisconsin scores including both urinary and non-urinary symptoms, for 30 BPS female patients and 30 female controls. While the IC group had significantly higher scores for the urinary symptoms, they did not appear to indiscriminately report higher scores than controls for different somatic and general complaints, as might be expected if this disease is a manifestation of a more generalized disorder. Diggs and colleagues (624) used the ICSI to investigate how interstitial cystitis patients interpret urgency. The ICSI question regarding: "the strong need to urinate with little or no warning" consistently underestimated the response to the International

Continence Society definition of urgency: "the compelling urge to urinate that is difficult to postpone.

With the results of a review of existing patient-completed measures indicating they did not meet current standards for the development of patient reported measures (625,626), and facing the need for a new patient friendly measure with good sensitivity and specificity, a new measure of BPS symptoms was developed (612). The Bladder Pain/ Interstitial Cystitis Symptom Score (BPIC-SS) is based on defined standards for patient-completed measures, including patient and clinical input, e.g. cognitive debriefing by patients during the development of the score and findings from cystoscopy and hydrodistension. The BPIC-SS appears to successfully discriminate BPS patients from OAB patients and healthy controls. It has not been validated to discriminate BPS patients from those with confusable diseases (e.g. endometriosis or UTI). The BPIC-SS appears more discriminative than the PUF or the ICSI. As a result, the BPIC-SS has been implemented into the standard sets within the FDA's guidance for patient reported outcome development and has already been used in recent BPS trials (394). Finally, although developed for the purpose of screening into trials, the BPIC-SS could also be used for measuring outcome results during clinical trials. The questionnaire is available free of charge (<http://www.prolutssh.com>).

Treatment outcome studies have also used the Global Response Assessment (figure 15); a balanced patient self-report on overall response to therapy, developed for NIDDK sponsored multicenter therapeutic trial (346). The O'Leary Sant and University of Wisconsin questionnaires are responsive to change over time in patients with BPS and have been recommended as secondary endpoints in future clinical trials of the disorder. Probert and colleagues in the Interstitial Cystitis Clinical Trials Group determined that a 1.2 point change in the O'Leary Sant indexes and a 3.1 point change in Wisconsin IC inventory corresponded to a one-category change in the GRA. Individual symptoms were also responsive [538]. (627)

A research tool with an exclusive focus on pain mapping was reported in 2012 (628). It allows the identification and grading of additional pain sites outside the pelvic region in association to QoL aspects.

A simple visual analogue scale (VAS) where the patient reports level of pain by making a mark on an unmarked line continuum, or a numeric rating scale (NRS) in which the patient records a number corresponding to a degree of pain (ie mild 2-4, moderate 5-7, severe 8-10) can be used to evaluate the pain associated with bladder pain syndrome and is useful for following patients and for assessing response to interventions. In pharmaceutical testing, a single-

symptom score such as these is commonly chosen as a primary endpoint with more generalized symptom scores comprising secondary endpoints. The genitourinary pain index was not developed specifically for bladder pain syndrome, but can be used to assess the degree of symptoms in both men and women with genitourinary pain complaints. (629) (figure 16)

KELLER UNIVERSITY OF WISCONSIN SYMPTOM INSTRUMENT

Please circle the one number answer that comes closest to the way you feel, whether or not you have the following symptoms.

APPENDIX 1:

Symptom	Not At All					(Circle one number on each line)				
1. Bladder Discomfort	0	1	2	3	4	5				
2. Bladder Pain	0	1	2	3	4	5				
3. Other Pelvic Discomfort	0	1	2	3	4	5				
4. Headache	0	1	2	3	4	5				
5. Backache	0	1	2	3	4	5				
6. Dizziness	0	1	2	3	4	5				
7. Feelings of Suffocation	0	1	2	3	4	5				
8. Chest Pain	0	1	2	3	4	5				
9. Ringing in Ears	0	1	2	3	4	5				
10. Getting Up at Night to Go to the Bathroom	0	1	2	3	4	5				
11. Aches in Joints	0	1	2	3	4	5				
12. Swollen Ankles	0	1	2	3	4	5				
13. Nasal Congestion	0	1	2	3	4	5				
14. Flu	0	1	2	3	4	5				
15. Abdominal Cramps	0	1	2	3	4	5				
16. Numbness or Tingling in Fingers or Toes	0	1	2	3	4	5				
17. Nausea	0	1	2	3	4	5				
18. Going to the Bathroom frequently during the day	0	1	2	3	4	5				
19. Blind Spots or Blurred Vision	0	1	2	3	4	5				
20. Heart Pounding	0	1	2	3	4	5				
21. Difficulty Sleeping because of Bladder Symptoms	0	1	2	3	4	5				
22. Sore Throat	0	1	2	3	4	5				
23. Urgency to Urinate	0	1	2	3	4	5				
24. Coughing	0	1	2	3	4	5				
25. Burning Sensation in Bladder	0	1	2	3	4	5				

Symptom Not At All (Circle one number on each line) A Lot

Figure 12: University of Wisconsin Symptom Instrument

Interstitial Cystitis Symptoms Index During the past month:

How often have you felt the strong need to urinate with little or no warning:

- 0. Not at all
- 1. Less than 1 time in 5
- 2. Less than half the time
- 3. About half the time
- 4. More than half the time
- 5. Almost always

Have you had to urinate less than 2 hours after you finished urinating?

- 0. Not at all
- 1. Less than 1 time in 5
- 2. Less than half the time
- 3. About half the time
- 4. More than half the time
- 5. Almost always

Interstitial Cystitis Symptoms Index During the past month:

How often did you most typically get up at night to urinate?

- 0. Not at all
- 1. Once per night
- 2. 2 times per night
- 3. 3 times per night
- 4. 4 times per night
- 5. 5 or more times per night

Have you experienced pain or burning in your bladder?

- 0. Not at all
- 1. A few times
- 2. Fairly often
- 3. Usually
- 4. Almost always

Add the numerical values of the checked entries:

Total score

Interstitial Cystitis Problem Index During the past month how much has each of the following been a problem for you.

Frequent urination during the day?

- 0. No problem
- 1. Very small problem
- 2. Small problem
- 3. Medium problem
- 4. Big problem

Getting up at night to urinate?

- 0. No problem
- 1. Very small problem
- 2. Small problem
- 3. Medium problem
- 4. Big problem

Interstitial Cystitis Problem Index During the past month how much has each of the following been a problem for you.

Need to urinate with little warning?

- 0. No problem
- 1. Very small problem
- 2. Small problem
- 3. Medium problem
- 4. Big problem

Burning, pain, discomfort, or pressure in your bladder?

- 0. No problem
- 1. Very small problem
- 2. Small problem
- 3. Medium problem
- 4. Big problem

Add the numerical values of the checked entries:

Total score

Figure 13: O'leary Sant Symptom and Pain Index

	0	1	2	3	4	Symptom score	Bother score
1. How many times do you go to the bathroom during the day?	3-6	7-10	11-14	15-19	20+		
2a. How many times do you go to the bathroom at night?	0	1	2	3	4+		
b. If you get up at night to go to the bathroom, does it bother you?	Never	Occasionally	Usually	Always			
3. Are you currently sexually active? YES _____ NO _____							
4a. IF YOU ARE SEXUALLY ACTIVE, do you now or have you ever had pain or symptoms during or after sexual intercourse?	Never	Occasionally	Usually	Always			
b. If you have pain, does it make you avoid sexual intercourse?	Never	Occasionally	Usually	Always			
5. Do you have pain associated with your bladder or in your pelvis (vagina, labia, lower abdomen, urethra, perineum, testes, or scrotum)?	Never	Occasionally	Usually	Always			
6. Do you still have urgency after you go to the bathroom?	Never	Occasionally	Usually	Always			
7a. If you have pain is it usually		Mild	Moderate	Severe			
b. Does your pain bother you?	Never	Occasionally	Usually	Always			
8a. If you have urgency, is it usually		Mild	Moderate	Severe			
b. Does your urgency bother you?	Never	Occasionally	Usually	Always			

Figure 14: Pelvic Pain, Urgency, Frequency Scale (PUF)

-
- 3: MARKEDLY WORSE
 - 2: MODERATELY WORSE
 - 1: SLIGHTLY WORSE
 - 0: NO CHANGE
 - +1: SLIGHTLY IMPROVED
 - +2: MODERATELY IMPROVED
 - +3: MARKEDLY IMPROVED
-

Figure 15: Global Response Assessment (GRA)

Male Genitourinary Pain Index

1. In the last week, have you experienced any pain or discomfort in the following areas?

a. Area between rectum and testicles (perineum)	-1	Yes	-0	No
b. Testicles	-1	Yes	-0	No
c. Tip of penis (not related to urination)	-1	Yes	-0	No
d. Below your waist, in your pubic or bladder area	-1	Yes	-0	No

2. In the last week, have you experienced:

a. Pain or burning during urination?	-1	Yes	-0	No
b. Pain or discomfort during or after sexual climax (ejaculation)?	-1	Yes	-0	No
c. Pain or discomfort as your bladder fills?	-1	Yes	-0	No
d. Pain or discomfort relieved by voiding?	-1	Yes	-0	No

3. How often have you had pain or discomfort in any of these areas over the last week?

-0 Never -1 Rarely -2 Sometimes -3 Often -4 Usually -5 Always

4. Which number best describes your AVERAGE pain or discomfort on the days you had it, over the last week?

-0	1	2	3	4	5	6	7	8	9	10
No										Pain as bad as you
Pain										can imagine

5. How often have you had a sensation of not emptying your bladder completely after you finished urinating, over the last week?

-0 Not at all	-1 Less than 1 time in 5	-2 Less than half the time	-3 About half the time	-4 More than half the time	-5 Almost always
---------------	-----------------------------	-------------------------------	---------------------------	-------------------------------	---------------------

6. How often have you had to urinate again less than two hours after you finished urinating, over the last week?

-0 Not at all	-1 Less than 1 time in 5	-2 Less than half the time	-3 About half the time	-4 More than half the time	-5 Almost always
---------------	-----------------------------	-------------------------------	---------------------------	-------------------------------	---------------------

7. How much have your symptoms kept you from doing the kinds of things you would usually do, over the last week?

-0 None	-1 Only a little	-2 Some	-3 A lot
---------	------------------	---------	----------

8. How much did you think about your symptoms, over the last week?

-0 None	-1 Only a little	-2 Some	-3 A lot
---------	------------------	---------	----------

9. If you were to spend the rest of your life with your symptoms just the way they have been during the last week, how would you feel about that?

-0 Delighted	-1 Pleased
	-2 Mostly satisfied
	-3 Mixed (about equally satisfied and dissatisfied)
	-4 Mostly dissatisfied
	-5 Unhappy
	-6 Terrible

Figure 16: Male and Female Genitourinary Pain Index (GUPI)

Figure 16: Male and Female Genitourinary Pain Index (GUPI) (continued)

Female Genitourinary Pain Index

1. In the last week, have you experienced any pain or discomfort in the following areas?

- a. Entrance to vagina -1 Yes -0 No
- b. Vagina -1 Yes -0 No
- c. Urethra -1 Yes -0 No
- d. Below your waist, in your pubic or bladder area -1 Yes -0 No

2. In the last week, have you experienced:

- a. Pain or burning during urination? -1 Yes -0 No
- b. Pain or discomfort during or after sexual intercourse? -1 Yes -0 No
- c. Pain or discomfort as your bladder fills? -1 Yes -0 No
- d. Pain or discomfort relieved by voiding? -1 Yes -0 No

3. How often have you had pain or discomfort in any of these areas over the last week?

- 0 Never -1 Rarely -2 Sometimes -3 Often -4 Usually -5 Always

4. Which number best describes your AVERAGE pain or discomfort on the days you had it, over the last week?

- - - - - - - - - -
- 0 1 2 3 4 5 6 7 8 9 10
- No Pain as bad as you
- Pain can imagine

5. How often have you had a sensation of not emptying your bladder completely after you finished urinating, over the last week?

- 0 Not at all -1 Less than 1 time in 5 -2 Less than half the time -3 About half the time -4 More than half the time -5 Almost always

6. How often have you had to urinate again less than two hours after you finished urinating, over the last week?

- 0 Not at all -1 Less than 1 time in 5 -2 Less than half the time -3 About half the time -4 More than half the time -5 Almost always

7. How much have your symptoms kept you from doing the kinds of things you would usually do, over the last week?

- 0 None -1 Only a little -2 Some -3 A lot

8. How much did you think about your symptoms, over the last week?

- 0 None -1 Only a little -2 Some -3 A lot

9. If you were to spend the rest of your life with your symptoms just the way they have been during the last

- 0 Delighted
- 1 Pleased
- 2 Mostly satisfied
- 3 Mixed (about equally satisfied and dissatisfied)
- 4 Mostly dissatisfied
- 5 Unhappy
- 6 Terrible

Figure 16: Male and Female Genitourinary Pain Index (GUPI) (continued)

Scoring

Pain subscale: Total of items 1a, 1b, 1c, 1d, 2a, 2b, 2c, 2d, 3, and 4	= _____ (range 0-23)
Urinary subscale: Total of items 5 and 6	= _____ (range 0-10)
QOL Impact: Total of items 7, 8, and 9	= _____ (range 0-12)
Total score: Sum of subscale scores	= _____ (range 0-45)

Conclusions

The three commonly employed clinical symptom scales include the O’Leary Sant, the University of Wisconsin, and the Pelvic Pain, Urgency, Frequency scales. None of the questionnaires have the sensitivity or the specificity to be used in the clinical diagnosis of the patients. The O’Leary Sant and University of Wisconsin indexes have been validated as reliable instruments for following the course of the disease and results of treatment interventions. All have shown some value in assessing the severity of the disease. The Global Response Assessment has become one of several primary endpoints used in the judging the response to the specific therapies.

Placebo effects influence patient outcomes after any treatment which the clinician and patients believe is effective, including surgery. Placebo effects plus disease natural history and regression to the mean can result in high rates of good outcomes, which may be misattributed to specific treatment effects. (102,631-633) Unfortunately, few BPS treatments have been subjected to a placebo-controlled trial. This is not to say that what seems effective is not, but rather that a high index of skepticism is healthy, even in treatments tested in controlled trials. (634)

While in many diseases an argument can be made against using a true placebo control as opposed to an orthodox treatment of approved or accepted value (635), a good case for true placebo comparison can readily be made for BPS. The vagaries of the natural history, the general lack of progression of symptom severity over time, and the fact that it is not life threatening, mean that there is little to lose and much to gain by subjecting new treatments to the vigorous scrutiny of placebo control. Many patients who volunteer for such trials have already run the gamut of accepted (though generally unproved) therapies. It has long been recognized in protocols that use subjective criteria for assessment that "improvement" may be expected in up to 35% of placebo-treated patients (636). As the spontaneous remission rate (though temporary) for BPS is 11% (357) to 50% (59), combined with the placebo improvement it can be difficult to prove efficacy.

Even in placebo controlled trials, it is reasonable to surmise that some degree of unblinding may occur as a result of somatic or psychological side effects of the active arm, impairing the validity of the trial results and giving the active arm a slight edge over placebo. (637,638) Failure to recognize unblinding can easily bias results of a study and has not been routinely measured in clinical trials. (639) When occurring late in a study after one would expect onset of a therapeutic effect, unblinding could be the result of side effect profile or drug efficacy. Early in the trial it reflects poor placebo or study design. The degree of blinding needs to be ascertained throughout the trial. This is of specific concern in BPS and any disorder where primary outcomes may be subject to patient-specific psychological and physiological factors.

The ethics and necessity of placebo-controlled trials have been questioned, especially in situations in

XVI.OUTCOME ASSESSMENT

1. THE PROBLEM

BPS/IC has been a difficult condition for which to assess therapeutic impact. There is a 50% incidence of temporary remission unrelated to therapy, with a mean duration of 8 months (59). A somewhat surprising finding from the Interstitial Cystitis Database was that although there was initial improvement in symptoms partially due to regression to the mean (630) and the intervention effect, there was no evidence of a long-term change in average symptom severity over the four year course of follow-up. (102) In a chronic, devastating condition with primarily subjective symptomatology, no known cause, and no cure, patients are desperate and often seem to respond to any new therapy. A skeptical view of outcomes is essential (figure 17), as patients can be victims of unorthodox health care providers using unproven forms of therapy, some medical, some homeopathic, and some even surgical.

2. THE PLACEBO ISSUE

Where possible, the results of randomized controlled studies should be used for decision making. Placebo, double-blind studies are optimal in this disorder for which there is no generally effective standard therapy.

which an effective treatment exists and also where delay in treatment has been shown to result in disease progression (640-642). However, there are methodological concerns with equivalence and non-inferiority active agent comparison trials (643). These include an inability to determine if the treatments are equally good or equally bad, and the possibility that successive non-inferiority trials can lead to a gradual decrease in treatment efficacy. Although the use of placebo-controlled trials raises ethical concerns when proven effective treatment exists for the condition under investigation, they are ethically justified, provided that stringent criteria for protecting research subjects are satisfied (644).

The value of placebo-controlled trials is aptly illustrated by the decisions by pharmaceutical manufacturers not to pursue FDA approval in the United States for seemingly promising intravesical therapies for BPS (435,645) after placebo-controlled trials failed to establish efficacy. These include low concentration hyaluronic acid (Bioniche, Canada), high concentration hyaluronic acid (SKK, Tokyo), and resiniferatoxin (ICOS, Bothell, Washington, USA). Nalmefene, an initially promising oral therapy in the 1990's, (646) also failed phase 3 trials (IVAX, Miami). Placebo trials are impractical in surgery and it can be difficult to evaluate surgical reports. The many older medications currently used off-label might not meet success if tested in the stringent manner in which new molecular entities are tested. The expense of testing therapies currently used off-label often requires dependence on the largesse of government agencies like the National Institute of Health. (346,466,647)

3. OUTCOME INTERPRETATION

As has been discussed with regard to rheumatologic disorders (648), the interpretation of measurements of physical functioning in clinical trials should consider the composition of the study sample, with attention to the stage of disease and the heterogeneity in disease duration. Patients with long-standing disease or compromised bladder capacity or central sensitization can be expected to be less responsive to treatments directed toward the bladder itself. Finally, when considering objective changes, the concept of statistical versus clinical significance is paramount. Investigators should, but rarely do, point out differences between statistical improvement and what they consider to be clinically significant improvement (649). As Gertrude Stein reportedly stated, "A difference, to be a difference, must make a difference". An increase in bladder capacity of 30cc may be statistically significant but clinically irrelevant. Number needed to treat and number needed to harm data[560] may be particularly important in BPS and have not typically been included in efficacy analysis.

4. IMPACT RECOMMENDATIONS

The core outcome domains for chronic pain clinical trials have been published. (502,650) The Initiative on Methods, Measurement, and Pain Assessment in Clinical Trials (IMMPACT) recommendations indicate that core outcome domains should be considered in all clinical trials of the efficacy and effectiveness of treatments for chronic pain. These domains include:

1. Pain
2. Physical functioning
3. Emotional functioning
4. Participant ratings of improvement and satisfaction with treatment
5. Symptoms and adverse effects, participant disposition

CONCLUSIONS:

Currently for BPS/IC there are no accepted biologic disease markers that can be used for the assessment of response to therapy. The O'Leary Sant, University of Wisconsin, and Global Response Assessment are well-validated questionnaires to follow disease progression and response to therapy. The IMMPACT recommendations suggest that as well as symptoms scores, any future study on a pain syndrome must involve more general assessments of psycho-physical functioning. There is limited experience in BPS/IC for the use of well-validated measures available for the study of chronic pain. Future NIDDK research initiatives may help to rectify this. <http://www.mapnetwork.org>

International recognition of an agreed upon definition and inclusion and exclusion criteria of BPS/IC will help future studies to fulfill the highest standards available, and placebo-controlled, double blind, randomized controlled trials, where possible, will provide the highest level of evidence to move the field forward.

LEVEL 2 GRADE C RECOMMENDATIONS

Figure 17: Selected reported treatment outcomes in uncontrolled studies in IC literature: Percentage of patients initially improved.

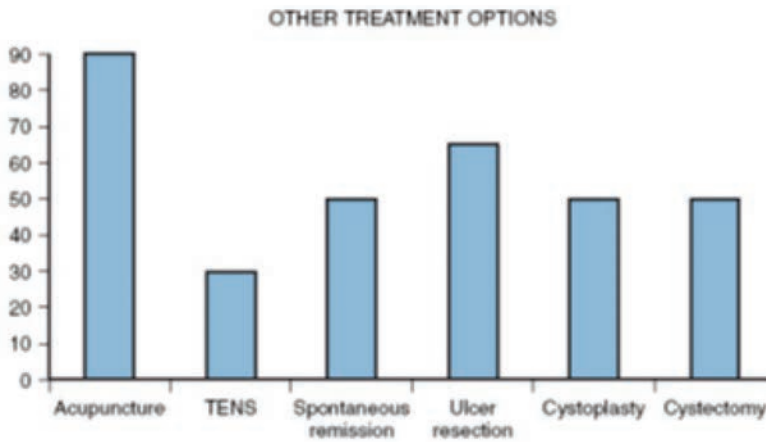
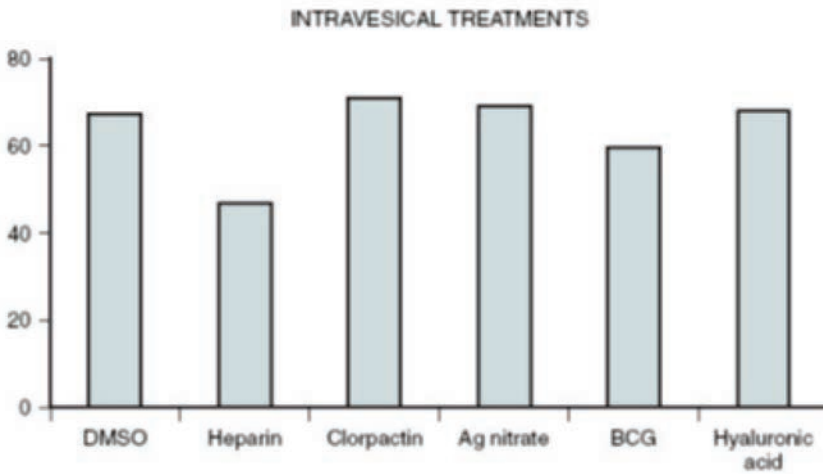
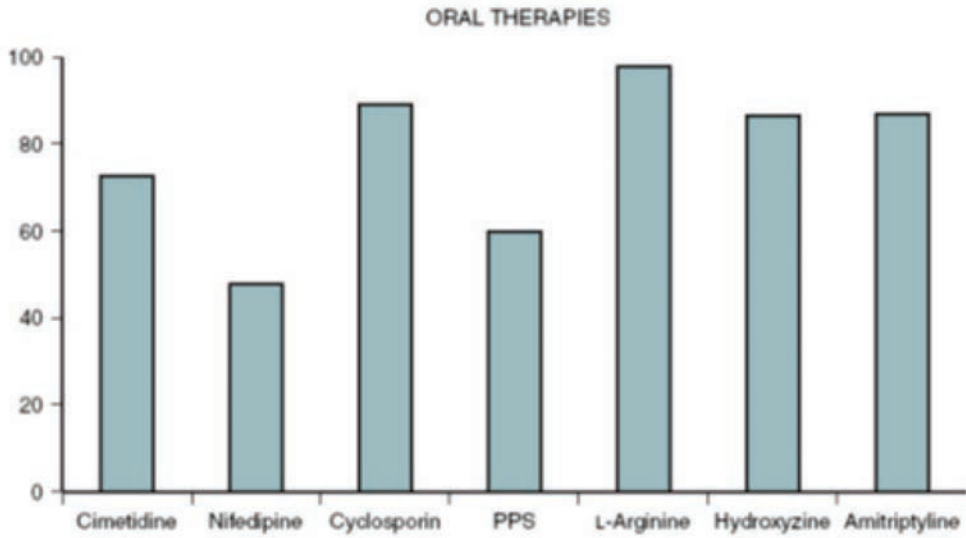

XVII. PRINCIPLES OF MANAGEMENT

The information currently available in the literature does not lend itself to easily formulating a diagnostic or treatment guideline that will be acceptable to a wide range of practitioners. Different groups of “experts” would undoubtedly create different “best practices”. (651) The compromise approach devised by an experienced cross-section of urologists and gynecologists from around the world at the International Consultation on Continence 2004 meeting in Monaco (40) and subsequently modified at the 2008 and 2012 meetings in Paris (1,652) have been reviewed and updated by the committee and allows for significant latitude to reflect varying individual practice patterns and to account for patient preference.

An underlying principle is that, where possible, decisions on the treatment of bladder pain syndrome should be evidence based (653). Unfortunately, high level evidence of efficacy is lacking for many common treatments, either because such studies have not been done, or were done and failed to demonstrate efficacy. (48,654,655)

Another principle is that we should be guided by patient perceived and driven outcomes for bladder pain syndrome, which is, after all, diagnosed on the basis of symptoms after exclusion of confusable diseases. Newer symptom scores are based on this principle. (612,629) Many patients prefer noninvasive therapies (656), and it would seem reasonable to start with physical therapy and/or oral therapies if conservative non-medical interventions (i.e. education, diet, behavioral modification, stress reduction) fail to result in significant symptom amelioration. Use of surgical therapies should be approached with some caution. It has been reported that women with BPS have had significantly more pelvic surgeries than controls, and the majority were performed prior to diagnosis of BPS, possibly for pain related to undiagnosed BPS. (657,658)

1. HARMONIZATION

With representatives from Asia, Europe, and North America, the Consultation has attempted to create a document that is harmonious with guidelines developed around the world in the last several years. The Canadian Urological Association (659), the International Society for the Study of Bladder Pain Syndrome (ESSIC) (38,2), the European Association of Urology

(515,660), the Spanish Urological Association (661), the Japanese Urological Association (228), East Asian countries (662,663), and the American Urological Association (44,664) all have published consensus guidelines, many of which have been reviewed (651).

In the Japanese and Asian view, urinary frequency/urgency is the primary symptom, with overactive bladder (OAB) and hypersensitive bladder (HSB) listed as subgroups (with painful bladder syndrome (PBS) as its extreme form (43). (figure 3)

In the European view as reflected in European Association of Urology and ESSIC guidelines, pain is the key symptom, with frequency being secondary to pain, while urgency basically represents a different pathology. American and Canadian guidelines are concordant with the European view. They emphasize pain, pressure, and discomfort perceived by the patient to be related to the bladder and associated with urinary frequency or urgency.

Pathologic afferent activity is a feature in overactive bladder as well as BPS, making the philosophy of the Asian guidelines conceptually attractive. But the knowledge gaps on lower urinary tract sensory functions are tremendous and from a neurophysiologic point of view it may be premature to link the conditions.

As a disorder based on symptoms, it is remarkable that we do not know if sensations described by the patient as pain, urge, or pressure are physiologically different or identical; that is, if they represent various grades of the same pathology, or if this set of terms merely represents linguistically different ways of presenting the same problem. Do cultural differences play a part? Are Asian patients more reluctant to use the word pain to describe the same symptoms?

Cystoscopic and pathologic findings have a more important role in Asia and Europe than in North America, but nowhere do guidelines now recommend invasive procedures like endoscopy with or without biopsy (though critical to make a diagnosis of Hunner lesion) as essential to make a diagnosis of BPS.

The algorithms from the European Association of Urology, American Urological Association, and East Asian nations are presented below and illustrate different approaches to a difficult problem. (figures 18, 19, 20) Opportunities for future harmonization are apparent.

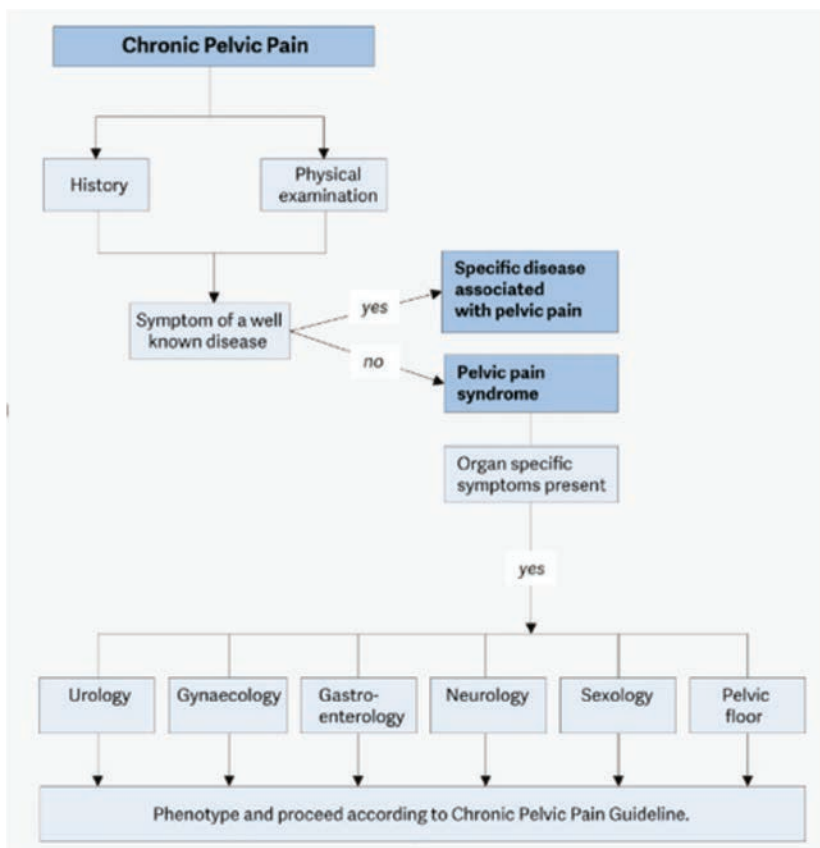

Assessment	Treatment
Urine culture	Grade A recommended
Uroflowmetry	Standard: Hydroxyzine, Amitriptyline, Pentosanpolysulphate
Cystoscopy with hydrodistension	Limited data: antibiotics, cyclosporin A,
Bladder biopsy	Intravesical: PPS, DMSO,
Micturition diary	Grade B recommended
Pelvic floor muscle testing	Oral: Cimetidine
Phenotyping	Intravesical: hyaluronic acid, chondroitin sulphate,
ICSI score list	Electromotive drug administration for intravesical drugs
	Sacral nerve stimulation, bladder training, physical therapy ,
	Psychological therapy
	Not recommended
	Bacillus Calmette Guerin
	Intravesical Chlorpactin
	Other comments
	Data on surgical treatment are largely variable.
	Coagulation and laser only for Hunner's lesions

Figure 18: European Association of Urology guidelines for chronic pelvic pain and bladder pain syndrome 2012/2013 (515,660)

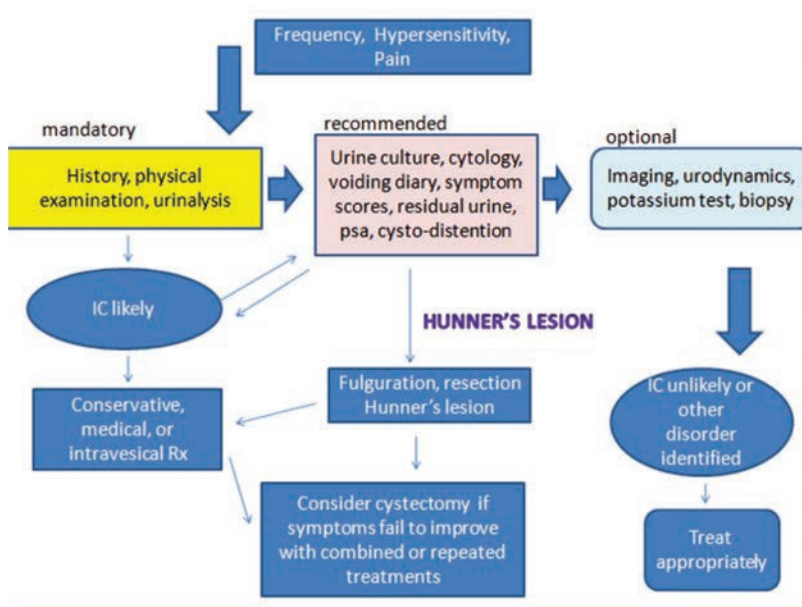

Figure 19: Management proposed by Japanese Urological Association and urologists in Taiwan and Ko-rea, modified from Homma. Potassium diagnostic test was dropped in 2015 updated guideline. (662,663)

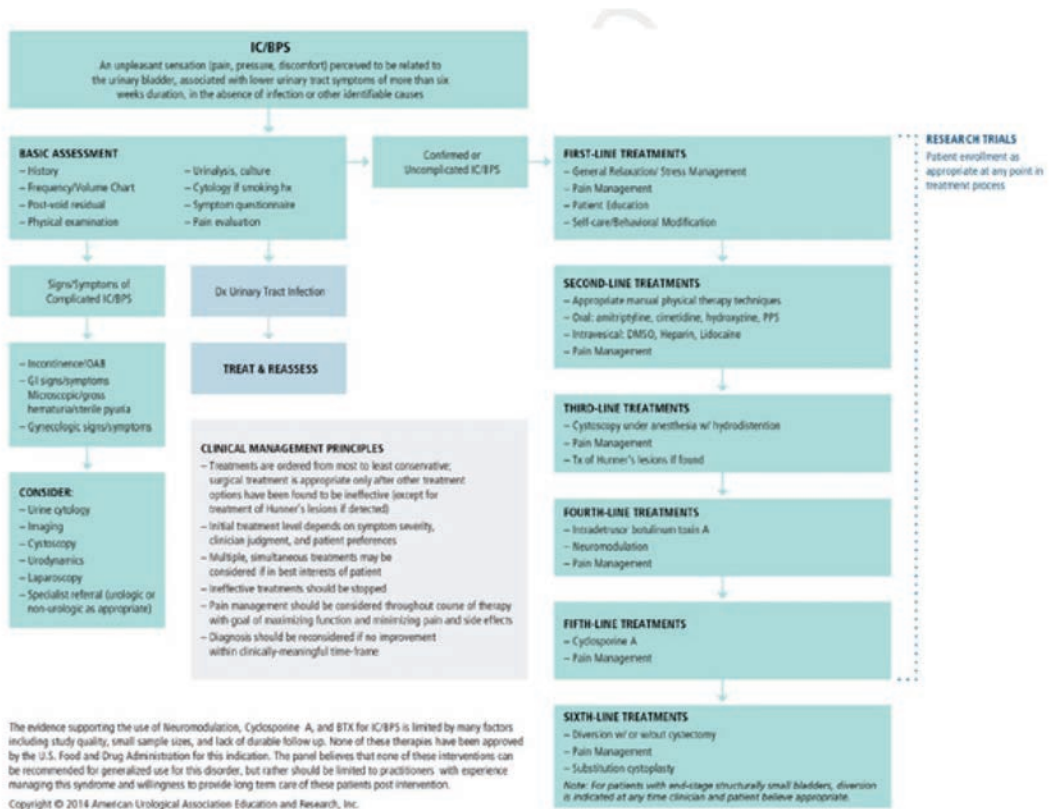

Figure 20: Management Guideline of American Urological Association (664)

XVIII. RECOMMENDATIONS OF INTERNATIONAL CONSULTATION ON INCONTINENCE

1. HISTORY / INITIAL ASSESSMENT

Men or women with an unpleasant sensation (pain, pressure, discomfort) perceived to be related to the urinary bladder, associated with lower urinary tract symptoms of more than six weeks duration, *in the absence of infection or other identifiable causes* should be evaluated for bladder pain syndrome[12] The initial assessment consists of a bladder diary, residual urine determination, focused physical exam, urinalysis, and urine culture. Cytology and cystoscopy are recommended if clinically indicated. Baseline symptoms should be characterized with a validated symptom questionnaire that can be used for follow-up.

Patients with infection should be treated and reassessed. Those with recurrent urinary infection, abnormal urinary cytology, and/or hematuria are evaluated with indicated imaging and endoscopic procedures, and only if findings are unable to explain the symptoms are they diagnosed with BPS. Patients with symptoms compatible with a primary gynecologic or gastrointestinal etiology should be evaluated by an appropriate specialist before making a diagnosis of BPS.

2. INITIAL TREATMENT

Patient education and support, dietary manipulation, stress reduction, nonprescription analgesics, and pelvic floor relaxation techniques comprise the initial management of BPS. It is important at every stage to address the patient's pain, and understand that at some point in the progression of treatment, referral to a pain specialty clinic may be desirable. When the conservative approach fails, or symptoms are severe and conservative management unlikely to succeed, oral medication, physical therapy, and/or intravesical treatment can be prescribed.

3. SECONDARY ASSESSMENT

If oral or intravesical therapy fails, *or before beginning such therapy at the discretion of the clinician*, it is reasonable to consider further evaluation which can include urodynamics, pelvic imaging, and cystoscopy with bladder distention and possible bladder biopsy under anesthesia. Laparoscopy may be indicated if there is a suspicion of gynecologic disease. Findings of bladder overactivity suggest a trial of antimuscarinic therapy. Findings of a Hunner lesion suggest therapy with transurethral fulguration or resection of the ulcer. The finding of glomerulations should not

alter therapeutic decision making. (47) Distention itself can have therapeutic benefit in up to one-third of patients, though benefits rarely persist for longer than a few months.

4. REFRACTORY BPS

Those patients with persistent, unacceptable symptoms despite oral and/or intravesical therapy are candidates for more aggressive modalities. These might include neuromodulation, intradetrusor botulinum toxin, or cyclosporine. At any stage of the treatment algorithm, experimental pharmacologic protocols of promising new treatments are reasonable to consider if symptoms warrant and the risk-benefit ratio is acceptable.

The last step in treatment is usually some type of surgical intervention aimed at increasing the functional capacity of the bladder or diverting the urine stream. Augmentation (substitution) cystoplasty and urinary diversion with or without cystectomy have been used with good results in very well selected patients.

A treatment algorithm by the Consultation is presented in section 20.

It is the opinion of the committee that, because of the natural history of the disorder, it is best to cautiously progress through a variety of treatments. Whereas the shotgun approach, starting newly diagnosed patients on a variety of simultaneous medications, seems to have many adherents, employing one treatment at a time makes the natural history of the disease itself an ally in the treatment process. If a treatment has no efficacy, it should be stopped. If a treatment results in modest improvement, it should be continued and another treatment option employed in an attempt to further improve symptoms. The goal is to maximize quality of life and dispense with ineffective treatments in a somewhat controlled fashion. The patient and clinician must remember that "perfect is the enemy of good" and expectations should be realistic. One should encourage patients to maximize their activity and live as normal a life as possible, not becoming a prisoner of the condition. Although some activities or foods may aggravate symptoms, nothing has been shown to negatively affect the disease process itself. Therefore, patients should feel free to experiment and judge for themselves how to modify their lifestyle without the guilt that comes from feeling they have harmed themselves if symptoms flare. Dogmatic restriction and diet are to be avoided unless they are shown to improve symptoms in a particular patient. If the patient has associated depression or cognitive distortions (catastrophizing), or if the patient has associated disorders (often other chronic pain disorders), these should be addressed as a part of the overall treatment plan. (665)

Level 4 Grade C

XIX.FUTURE DIRECTIONS IN RESEARCH

The committee believes that further research is needed in many broad areas:

1. Pathology of BPS
2. Biomarker development
3. Immunology of BPS
4. Neurological aspects with particular attention to the relationship of BPS to overactive bladder
5. The relationship of bladder pain syndrome to chronic pelvic pain syndrome (nonbacterial prostatitis)

The majority of current treatments options are still targeting the bladder. However, bladder pain syndrome has now been recognized to occur in many individuals as a part of a spectrum chronic pain syndromes. There is a growing body of literature demonstrating that different visceral pain syndromes, as well as pain syndromes in other body regions, and other systemic diseases often occur together in the same patient. Thus, the efforts to understand the pathophysiology and to design therapeutic modalities have shifted from an organ-based approach to a more global approach. Phenotyping may be important to identify “bladder-related” and “non-bladder” components that contribute to the symptoms in order to improve treatment efficacy.

The following issues would benefit from major research initiatives:

1. To improve symptom-based classification to identify the degree of bladder and non-bladder symptoms.
2. To identify bladder-specific pathology (urothelial changes, ulcer, hypervascularity and the potential role of narrow band imaging (666). Does the degree of true bladder inflammation correlate with results from specific treatments? Are there other markers that could be used to segregate therapeutic approaches? For the diagnosis of a

Hunner lesion, using a cystoscope is indispensable. Checking for Hunner lesions using narrow band imaging (figure 21) has been reported to be useful and could improve diagnostic accuracy of Hunner lesions.

3. Further consensus to bridge the Asian concept of the hypersensitive bladder with the Western concept of bladder pain syndrome must continue.
4. To identify a bladder pain syndrome-specific biomarker (NGF or other neurotrophic factors, angiogenic growth factors, urothelial markers such as antiproliferative factor, cytokines/chemokines profile, uroplakin [antibody, splice variant]).
5. To identify bladder-specific or systemic immunological processes (cytokines/chemokines profile). Such research may also help to identify the difference in the disease process between bladder pain syndrome and over active bladder (lower urinary tract symptoms with and without pain, respectively).
6. If we can identify the “bladder-related” and “non-bladder” (=outside the bladder) components that contribute to the symptoms, we should be able to develop the agent(s) to control bladder pain based on its pathology.
7. Establish patient data bases in different regions and conduct longitudinal follow-up to understand the natural history of the disease and to examine the differences in disease natural history among regions.
8. Develop an easy-to-use tool for non-specialists to readily identify co-morbid conditions that may impact on the need for additional consultation and suggest specific treatment pathways.
9. Develop a simple, non-invasive diagnostic test for BPS.
10. Develop a practical multi-disciplinary care model and test it in various settings. This would include psychological interventions for those with psychological comorbidities, dieticians, physiotherapists, pain specialists, and patient support groups in addition to a specialist for any associated non-bladder related disorders.

Conventional White Light

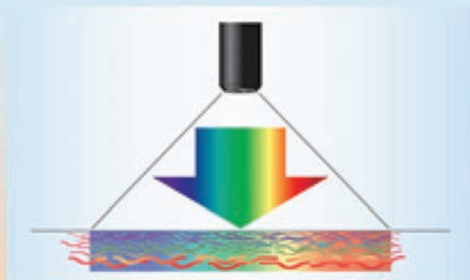

Narrow Band Imaging (NBI)

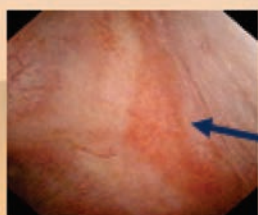

Brown at 415nm
Cyan at 540 nm

Bladder lesions are easily and clearly recognized by NBI

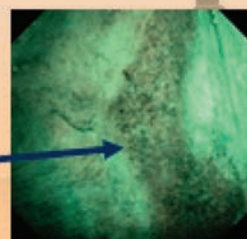

Figure 21: Potential use of narrow band imaging Photomicrographs of Hunner lesions identified by conventional cystoscopy with white light (left) and NBI cystoscopy (right). A: 58 years old, male, B: 64 years old, female. Note that an ulcerative mucosa recognized by conventional cystoscopy was clearly demarcated as a brownish area of the bladder wall with NBI cystoscopy. Courtesy of Dr. Ueda

XX. SUMMARY

1. DEFINITION

Bladder Pain Syndrome (in the absence of a universally agreed definition, the International Society for the Study of Interstitial Cystitis –ESSIC definition is given (2)

ESSIC: *Chronic pelvic pain, pressure or discomfort of greater than 6 months duration perceived to be related to the urinary bladder accompanied by at least one other urinary symptom like persistent urge to void or urinary frequency. Confusable diseases as the cause of the symptoms must be excluded.*

There is no published data as to what duration of symptomatology indicates that early spontaneous resolution of symptoms is unlikely. While ESSIC arbitrarily uses a 6 month duration, the American Urological Association Guideline suggests 6 weeks is long enough to initiate diagnosis and treatment of

BPS. (664) Without further data, the Consultation cannot make a recommendation and believes that it is up to the discretion of the physician and patient as to the proper interval between symptom onset and evaluation and diagnosis of a chronic condition.

2. BLADDER PAIN SYNDROME (BPS)

2.1. Nomenclature

The scientific committee of the International Consultation voted to use the term “bladder pain syndrome” for the disorder that has been commonly referred to as interstitial cystitis (IC). The term painful bladder syndrome was dropped from the lexicon. The term IC implies an inflammation within the wall of the urinary bladder, involving gaps or spaces in the bladder tissue. This does not accurately describe the majority of patients with this syndrome. Painful Bladder Syndrome, as defined by the International Continence Society, is too restrictive for the clinical syndrome.

Properly defined, the term Bladder Pain Syndrome appears to fit in well with the taxonomy of the International Association for the Study of Pain (IASP) (see below), and focuses on the actual symptom complex rather than what appears to be long-held misconception of the underlying pathology.

Bladder Pain Syndrome (XXIII-2) (per IASP)

Bladder pain syndrome is the occurrence of persistent or recurrent pain perceived in the urinary bladder region, accompanied by at least one other symptom, such as pain worsening with bladder filling and daytime and/or night-time urinary frequency. There is no proven infection or other obvious local pathology. Bladder pain syndrome is often associated with negative cognitive, behavioral, sexual, or emotional consequences as well as with symptoms suggestive of lower urinary tract and sexual dysfunction.

The Consultation believes that based on the pathology and endoscopic findings characteristic of the Hunner lesion, the epidemiologic pattern that distinguishes it from bladder pain syndrome, the clinical response to local treatment of the lesion by resection, fulguration, or steroid injection, the response to cyclosporine, and the absence of reports in the literature that non-Hunner patients go on to develop Hunner lesions (ie, the finding of Hunner lesion does not represent a continuum in the natural history of bladder pain syndrome), the presence of a Hunner lesion should be considered a distinct disease. It therefore should drop out of the bladder pain syndrome construct, much like we do not consider other painful conditions like radiation cystitis, ketamine cystitis, or urinary tract infection a part of bladder pain syndrome.

The Consultation concludes that it would be reasonable to designate the Hunner lesion in symptomatic patients with the term “interstitial cystitis”, thus indicating a true interstitial inflammation. It would be defined much as Hunner defined it 100 years ago, and harmonize to a great extent the Asian, European, and North American concepts of interstitial cystitis. The Consultation will continue to refer to the symptom complex as “bladder pain syndrome”. Hunner lesion will be considered a distinct phenotype, but in the future may be classified as a separate disorder entirely, albeit with local symptoms that are difficult to differentiate from bladder pain syndrome in the absence of endoscopy. In other words, we may be coming full circle in the historical perspective. Figure 2, Figure 4

2.2. History / Initial Assessment

Males or females whose symptoms meet the requirements of the definition of bladder pain syndrome should be evaluated. The presence of commonly associated disorders including irritable bowel syndrome, chronic fatigue syndrome, and fibromyalgia in the presence of the cardinal symptoms of bladder pain syndrome also suggests the diagnosis. Abnormal gynecologic findings in women and well-characterized confusable diseases that may explain the symptoms must be ruled out.

The initial assessment consists of a frequency/volume chart, focused physical examination, urinalysis, and urine culture. In the absence of confusable disorders (uncomplicated disease), a diagnosis can be made and treatment instituted. Urine cytology, cystoscopy, and urodynamic evaluation are recommended if clinically indicated and/or the diagnosis is in doubt (complicated disease). Patients with urinary infection should be treated and reassessed. Those with recurrent urinary infection, abnormal urinary cytology, and microscopic or gross hematuria are evaluated with appropriate imaging and endoscopic procedures, and only if findings are unable to explain the symptoms, are they diagnosed with BPS. **Grade of recommendation: C**

2.3. Initial Treatment

- Patient education,
- dietary manipulation,
- nonprescription analgesics,
- stress reduction,
- pelvic floor relaxation techniques comprise the initial treatment of BPS. In the patient with findings suggesting pelvic floor dysfunction, pelvic floor physical therapy with myofascial trigger point release and intravaginal Thiele massage is often an effective therapeutic intervention. The treatment of pain needs to be addressed directly, and in some instances referral to an anesthesia/pain center can be an appropriate early step in conjunction with ongoing treatment of the syndrome.
 - When conservative therapy fails or symptoms are severe and conservative management is unlikely to succeed,
- oral medication or
- intravesical treatment can be prescribed. It is recommended to initiate a single form of therapy and observe results, adding other modalities or substituting other modalities as indicated by degree of response or lack of response to treatment.

Grade of recommendation: C

2.4. Secondary Assessment

If initial oral or intravesical therapy fails, or before beginning such therapy based on clinician judgment, it is reasonable to consider further evaluation which can include Urodynamics, pelvic imaging, and cystoscopy with bladder distention and possible bladder biopsy under anesthesia.

- Findings of bladder overactivity suggest a trial of antimuscarinic therapy.

- The presence of a Hunner lesion suggests therapy with transurethral resection, fulguration of the lesion, or direct steroid injection into the lesion.
- Distention itself can have therapeutic benefit in 30-50% of patients, though benefits rarely persist for longer than a few months.

Grade of recommendation: C

2.5. Refractory BPS

Those patients with persistent, unacceptable symptoms despite oral and/or intravesical therapy are candidates for more aggressive modalities. Many of these are best administered within the context of a clinical trial if possible. These may include

- neuromodulation,
- intradetrusor botulinum toxin,
- oral cyclosporine A, or
- clinical trials of newly described pharmacologic management techniques. At this point, most patients will benefit from the expertise of an
- anesthesia pain clinic.

The last step in treatment is usually some type of surgical intervention aimed at increasing the functional capacity of the bladder or diverting the urinary stream.

- Urinary diversion with or without cystectomy has been used as a last resort with good results in selected patients. Cystectomy and urethrectomy do not appear to add any additional efficacy to diversion alone. (605,606,667)
- Augmentation or substitution cystoplasty seems less effective and more prone to recurrence of chronic pain in small reported series.

Grade of recommendation: C

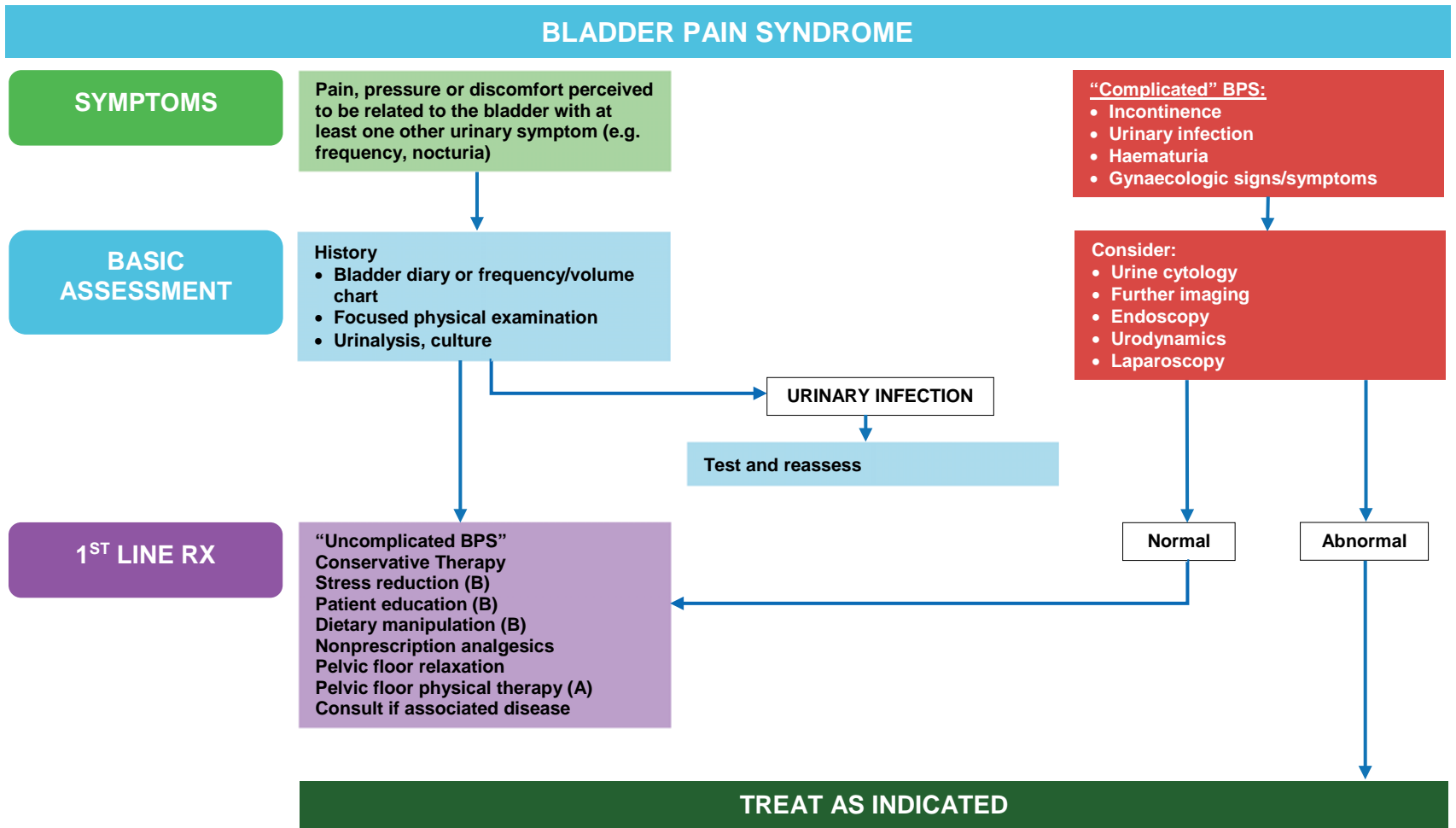
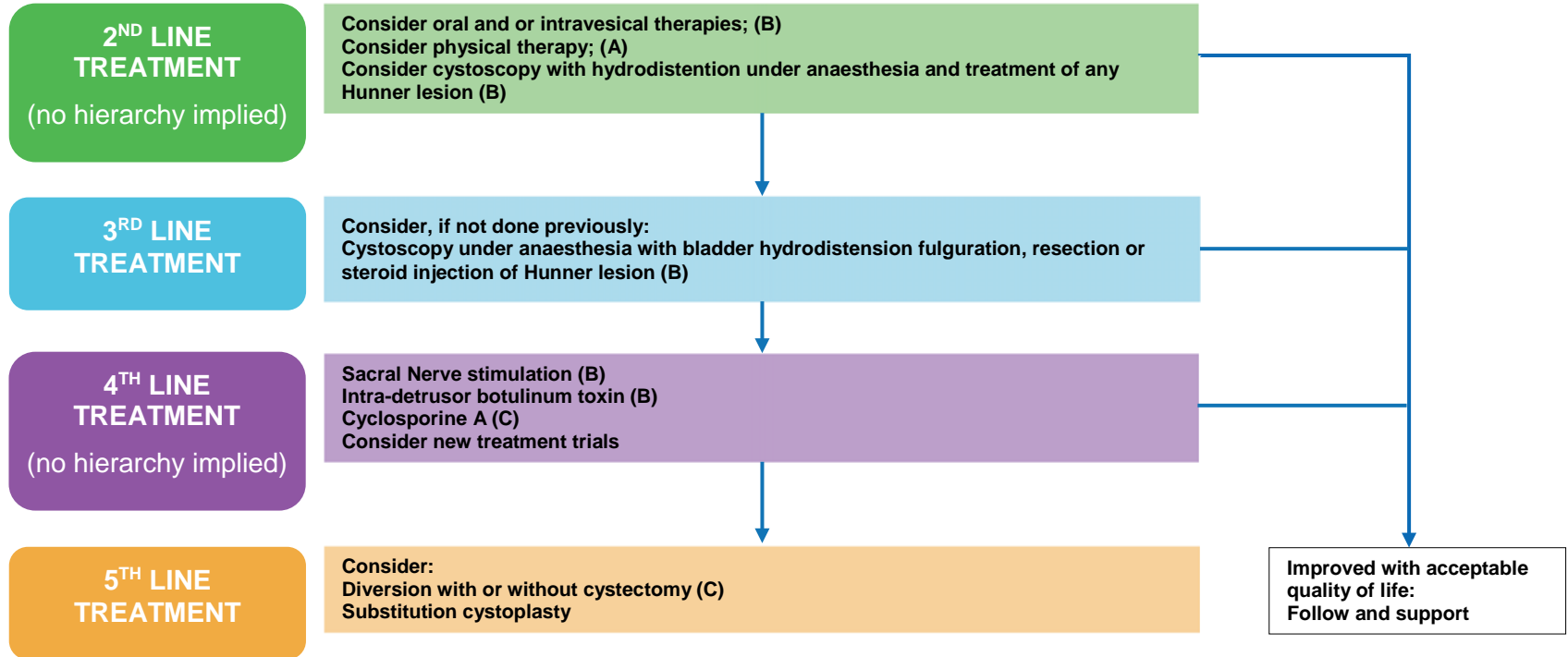

Figure 22: Algorithm for Diagnosis and Treatment: 2016 International Consultation on Incontinence. Pain management is a primary consideration at every step of algorithm ; Patient enrollment in appropriate research trial is reasonable option at any point; Evidence supporting neurostimulation, cyclosporine A, and botulinum toxin for BPS indication remains limited. These interventions are appropriate only for practitioners with experience treating BPS and willing to provide long-term care post-intervention

BPS REQUIRING MORE ACTIVE INTERVENTION



Note: The only FDA approved therapies are DMSO and pentosan polysulfate. Consider CONTINENCE PRODUCTS for temporary support during treatment.

- Pain management is a primary consideration at every step of the algorithm
- Patient enrollment in appropriate research trial is a reasonable option at any point
- Evidence supporting SNS, cyclosporine A, and botulinum toxin for BPS remains limited. These interventions are appropriate only for practitioners with experience in treating BPS and who are willing to provide long-term care post-intervention

REFERENCES

1. Hanno P, Dinis P, Lin A, Nickel C, Nordling J, van Ophoven A, Ueda T. Bladder pain syndrome. In: Abrams P, Cardozo L, Khoury S, Wein A, editors. *Incontinence*. Paris: ICUD-EAU; 2013a. p. 1583-649.
2. van de Merwe JP, Nordling J, Bouchelouche P, Bouchelouche K, Cervigni M, Daha LK, et al. Diagnostic criteria, classification, and nomenclature for painful bladder syndrome/interstitial cystitis: An ESSIC proposal. *Eur Urol* 2008, Jan;53(1):60-7.
3. Hanno P, Nordling J, van OA. What is new in bladder pain syndrome/interstitial cystitis? *Curr Opin Urol* 2008, Jul;18(4):353-8.
4. Abrams PH, Cardozo L, Fall M, Griffiths D, Rosier P, Ulmsten U, et al. The standardisation of terminology of lower urinary tract function: Report from the standardisation sub-committee of the international continence society. *Neurourol Urodyn* 2002;21:167-78.
5. Warren JW, Meyer WA, Greenberg P, Horne L, Diggs C, Tracy JK. Using the international continence society's definition of painful bladder syndrome. *Urology* 2006, Jun;67(6):1138-42.
6. Fall M, Logadottir Y, Peeker R. Interstitial cystitis is bladder pain syndrome with hunner's lesion. *Int J Urol* 2014, Apr;21 Suppl 1:79-82.
7. Nordling J. Interstitial cystitis: How should we diagnose it and treat it in 2004? *Curr Opin Urol* 2004, Nov;14(6):323-7.
8. Abrams P, Hanno P, Wein A. Overactive bladder and painful bladder syndrome: There need not be confusion. *Neurourol Urodyn* 2005;24(2):149-50.
9. Nigro DA, Wein AJ, Foy M, Parsons CL, Williams M, Nyberg LM, et al. Associations among cystoscopic and urodynamic findings for women enrolled in the interstitial cystitis data base (ICDB) study. *Urology* 1997, May;49(5A Suppl):86-92.
10. Salavatore S, Khullar V, Cardozo L, Anders K, Zocchi G, Soligo M. Evaluating ambulatory urodynamics: A prospective study in asymptomatic women. *Br J Obstet Gynaecol* 2003, Jan;110(1):83-4.
11. Van De Merwe JP. Interstitial cystitis: definitions and confusable diseases. *European Urology Today*, March 2006, 14-17.
12. Christmas TJ, Sant GR. Historical aspects of interstitial cystitis. In: *Interstitial Cystitis*. Philadelphia: Lippincott-Raven; 1997g. p. 1-8.
13. Parsons JK, Parsons CL. The historical origins of interstitial cystitis. *J Urol* 2004, Jan;171(1):20-2.
14. Parrish J. Tic douloureux of the urinary bladder. In: *Practical observations on strangulated hernia and some of the diseases of the urinary organs*. Philadelphia: Key and Biddle; 1836i. p. 309-13.
15. Teichman JM, Thompson IM, Taichman NS. Joseph parrish, tic douloureux of the bladder and interstitial cystitis. *J Urol* 2000, Nov;164(5):1473-5.
16. Skene AJC. *Diseases of the bladder and urethra in women*. New York: William Wood; 1887i.
17. Hunner GL. A rare type of bladder ulcer in women; report of cases. *Boston Med Surg Journal* 1915;172:660-4.
18. Hunner GL. A rare type of bladder ulcer. Further notes, with a report of eighteen cases. *JAMA* 1918, Jan 26;70(4):203-12.
19. Walsh A, Harrison JH, Gittes RF, Perlmutter AD, et E. Interstitial cystitis. In: *Campbell's Urology*. Philadelphia: W. B. Saunders Company; 1978a. p. 693-707.
20. Hand JR. Interstitial cystitis: Report of 223 cases (204 women and 19 men). *Journal of Urology* 1949;61:291-310.
21. Messing EM, Stamey TA. Interstitial cystitis: Early diagnosis, pathology, and treatment. *Urology* 1978, Oct;12(4):381-92.
22. Gillenwater JY, Wein AJ. Summary of the national institute of arthritis, diabetes, digestive and kidney diseases workshop on interstitial cystitis, national institutes of health, bethesda, maryland, august 28-29, 1987. *J Urol* 1988, Jul;140(1):203-6.
23. Hanno PM. Interstitial cystitis-epidemiology, diagnostic criteria, clinical markers. *Rev Urol* 2002;4 Suppl 1:S3-8.
24. Simon LJ, Landis JR, Erickson DR, Nyberg LM. The interstitial cystitis data base study: Concepts and preliminary baseline descriptive statistics. *Urology* 1997, May;49(5A Suppl):64-75.
25. Hanno PM, Landis JR, Matthews-Cook Y, Kusek J, Nyberg L. The diagnosis of interstitial cystitis revisited: Lessons learned from the national institutes of health interstitial cystitis database study. *J Urol* 1999, Feb;161(2):553-7.
26. Hanno PM. Re-imagining interstitial cystitis. *Urol Clin North Am* 2008, Feb;35(1):91-9; vii.
27. Meijlink JM. Interstitial cystitis and the painful bladder: A brief history of nomenclature, definitions and criteria. *Int J Urol* 2014, Apr;21 Suppl 1:4-12.

28. Bourque JP. Surgical management of the painful bladder. *Journal of Urology* 1951;65:25-34.
29. Dell JR, Parsons CL. Multimodal therapy for interstitial cystitis. *J Reprod Med* 2004, Mar;49(3 Suppl):243-52.
30. Powell NB, Powell EB. The female urethra: A clinico-pathological study. *Journal of Urology* 1949;61:557-70.
31. Tomaszewski JE, Landis JR, Russack V, Williams TM, Wang LP, Hardy C, et al. Biopsy features are associated with primary symptoms in interstitial cystitis: Results from the interstitial cystitis database study. *Urology* 2001, Jun;57(6 Suppl 1):67-81.
32. Rosamilia A, Igawa Y, Higashi S. Pathology of interstitial cystitis. *Int J Urol* 2003, Oct;10 Suppl:S11-5.
33. Lynes WL, Flynn SD, Shortliffe LD, Stamey TA. The histology of interstitial cystitis. *Am J Surg Pathol* 1990, Oct;14(10):969-76.
34. Denson MA, Griebing TL, Cohen MB, Kreder KJ. Comparison of cystoscopic and histological findings in patients with suspected interstitial cystitis. *J Urol* 2000, Dec;164(6):1908-11.
35. Clauw DJ, Schmidt M, Radulovic D, Singer A, Katz P, Bresette J. The relationship between fibromyalgia and interstitial cystitis. *J Psychiatr Res* 1997, Jan;31(1):125-31.
36. Wu EQ, Birnbaum H, Kang YJ, Parece A, Mallett D, Taitel H, Evans RJ. A retrospective claims database analysis to assess patterns of interstitial cystitis diagnosis. *Curr Med Res Opin* 2006, Mar;22(3):495-500.
37. Ueda T, Sant GR, Hanno PM, Yoshimura N. Interstitial cystitis and frequency-urgency syndrome (OAB syndrome). *Int J Urol* 2003, Oct;10 Suppl:S39-48.
38. Nordling J, Anjum FH, Bade JJ, et al.: Primary evaluation of patients suspected of having interstitial cystitis (IC). *European Urology* 2004, 45:662-669
39. Hanno P. Is the potassium sensitivity test a valid and useful test for the diagnosis of interstitial cystitis? *Int Urogynecol J Pelvic Floor Dysfunct* 2005, Nov;16(6):428-9.
40. Hanno P, Baranowski A, Fall M, Gajewski JB, Nordling J, Nyberg L, et al. Painful bladder syndrome (including interstitial cystitis). In: *Incontinence*. Paris: Health Publications Limited; 2005g. p. 1456-520.
41. Abrams P, Baranowski A, Berger R, M F, Hanno P, Wesselmann U. A new classification is needed for pelvic pain syndromes -- are existing terminologies of spurious diagnostic authority bad for patients? *J Urol* 2006, Jun;175:1989-90.
42. Baranowski AP, Abrams P, Berger RE, et al.: Urogenital pain – time to accept a new approach to phenotyping and, as a consequence, management. *European Urology* 2008, 53:33-36.
43. Homma Y. Lower urinary tract symptomatology: Its definition and confusion. *Int J Urol* 2008, Jan;15(1):35-43.
44. Hanno PM, Burks DA, Clemens JQ, Dmochowski RR, Erickson D, FitzGerald MP, et al. AUA guideline for the diagnosis and treatment of interstitial cystitis/bladder pain syndrome. *J Urol* 2011, Apr 15;185(6):2162-70.
45. Ueda T, Hanno P, Nordling J, Yoshimura N. The 3rd international consultation on interstitial cystitis, japan 2013. *International Journal of Urology* 2014, Apr;21:1-2.
46. Fall M, Logadottir Y, Peeker R. Interstitial cystitis is bladder pain syndrome with hunner's lesion. *Int J Urol* 2014, Apr;21 Suppl 1:79-82.
47. Wennevik GE, Meijlink JM, Hanno P, Nordling J. The role of glomerulations in bladder pain syndrome - a review. *Journal of Urology* 2016.
48. Giannantoni A, Bini V, Dmochowski R, Hanno P, Nickel JC, Proietti S, Wyndaele JJ. Contemporary management of the painful bladder: A systematic review. *Eur Urol* 2012, Jan;61(1):29-53.
49. Chuang YC, Chermansky C, Kashyap M, Tyagi P. Investigational drugs for bladder pain syndrome (BPS) / interstitial cystitis (IC). *Expert Opin Investig Drugs* 2016, May;25(5):521-9.
50. Belknap S, Blalock E, Erickson D. The challenges of interstitial cystitis: Current status and future prospects. *Drugs* 2015, Nov 24;75(18):2057-63.
51. Bosch PC, Bosch DC. Treating interstitial cystitis/bladder pain syndrome as a chronic disease. *Rev Urol* 2014;16(2):83-7.
52. Lai HH, Gardner V, Ness TJ, Gereau RW. Segmental hyperalgesia to mechanical stimulus in interstitial cystitis/bladder pain syndrome: Evidence of central sensitization. *J Urol* 2014, May;191(5):1294-9.
53. Berry SH, Bogart LM, Pham C, Liu K, Nyberg L, Stoto M, et al. Development, validation and testing of an epidemiological case definition of interstitial cystitis/painful bladder syndrome. *J Urol* 2010, May;183(5):1848-52.
54. Barry MJ, Link CL, Naughton-Collins MF, McKinlay JB. Overlap of different urological symptom complexes in a racially and ethnically

- diverse, community-based population of men and women. *BJU Int* 2008, Jan;101(1):45-51.
55. Yamada Y, Nomiya A, Niimi A, Igawa Y, Ito T, Tomoe H, et al. A survey on clinical practice of interstitial cystitis in japan. *Transl Androl Urol* 2015, Oct;4(5):486-90.
 56. Parsons CL, Tatsis V. Prevalence of interstitial cystitis in young women. *Urology* 2004, Nov;64(5):866-70.
 57. Clemens JQ, Link CL, Eggers PW, Kusek JW, Nyberg LM, McKinlay JB. Prevalence of painful bladder symptoms and effect on quality of life in black, hispanic and white men and women. *J Urol* 2007, Apr;177(4):1390-4.
 58. Oravisto KJ. Epidemiology of interstitial cystitis. *Ann Chir Gynaecol Fenn* 1975;64(2):75-7.
 59. Held PJ, Hanno PM, Wein AJ, Hanno PM, Staskin DR, Krane RJ, Wein AJ. Epidemiology of interstitial cystitis: 2. In: *Interstitial Cystitis*. London: Springer-Verlag; 1990w. p. 29-48.
 60. Jones CA, Nyberg L. Epidemiology of interstitial cystitis. *Urology* 1997, May;49(5A Suppl):2-9.
 61. Clemens JQ, Meenan RT, O'Keeffe Rosetti MC, Brown SO, Gao SY, Calhoun EA. Prevalence of interstitial cystitis symptoms in a managed care population. *J Urol* 2005, Aug;174(2):576-80.
 62. Bade JJ, Rijcken B, Mensink HJ. Interstitial cystitis in the netherlands: Prevalence, diagnostic criteria and therapeutic preferences. *J Urol* 1995, Dec;154(6):2035-7.
 63. Curhan GC, Speizer FE, Hunter DJ, Curhan SG, Stampfer MJ. Epidemiology of interstitial cystitis: A population based study. *J Urol* 1999, Feb;161(2):549-52.
 64. Nickel JC, Teichman JM, Gregoire M, Clark J, Downey J. Prevalence, diagnosis, characterization, and treatment of prostatitis, interstitial cystitis, and epididymitis in outpatient urological practice: The canadian PIE study. *Urology* 2005, Nov;66(5):935-40.
 65. Lifford KL, Curhan GC. Prevalence of painful bladder syndrome in older women. *Urology* 2009, Mar;73(3):494-8.
 66. Warren JW, Jackson TL, Langenberg P, Meyers DJ, Xu J. Prevalence of interstitial cystitis in first-degree relatives of patients with interstitial cystitis. *Urology* 2004, Jan;63(1):17-21.
 67. Rosenberg MT, Hazzard M. Prevalence of interstitial cystitis symptoms in women: A population based study in the primary care office. *J Urol* 2005, Dec;174(6):2231-4.
 68. Leppilahti M, Tammela TL, Huhtala H, Auvinen A. Prevalence of symptoms related to interstitial cystitis in women: A population based study in finland. *J Urol* 2002, Jul;168(1):139-43.
 69. Leppilahti M, Sairanen J, Tammela TL, Aaltomaa S, Lehtoranta K, Auvinen A. Prevalence of clinically confirmed interstitial cystitis in women: A population based study in finland. *J Urol* 2005, Aug;174(2):581-3.
 70. Choe JH, Son H, Song YS, Kim JC, Lee JZ, Lee KS. Prevalence of painful bladder syndrome/interstitial cystitis-like symptoms in women: A population-based study in korea. *World J Urol* 2011, Feb;29(1):103-8.
 71. Temml C, Wehrberger C, Riedl C, Ponholzer A, Marszalek M, Madersbacher S. Prevalence and correlates for interstitial cystitis symptoms in women participating in a health screening project. *Eur Urol* 2007, Mar;51(3):803-8.
 72. Song Y, Zhang W, Xu B, Hao L, Song J. Prevalence and correlates of painful bladder syndrome symptoms in fuzhou chinese women. *Neurourol Urodyn* 2009;28(1):22-5.
 73. Berry SH, Elliott MN, Suttrop M, Bogart LM, Stoto MA, Eggers P, et al. Prevalence of symptoms of bladder pain syndrome/interstitial cystitis among adult females in the united states. *J Urol* 2011, Aug;186(2):540-4.
 74. Konkle KS, Berry SH, Elliott MN, Hilton L, Suttrop MJ, Clauw DJ, Clemens JQ. Comparison of an interstitial cystitis/bladder pain syndrome clinical cohort with symptomatic community women from the RAND interstitial cystitis epidemiology study. *J Urol* 2012, Feb;187(2):508-12.
 75. Clemens JQ, Markossian TW, Meenan RT, O'Keeffe Rosetti MC, Calhoun EA. Overlap of voiding symptoms, storage symptoms and pain in men and women. *J Urol* 2007, Oct;178(4 Pt 1):1354-8.
 76. Rosenberg MT, Page S, Hazzard MA. Prevalence of interstitial cystitis in a primary care setting. *Urology* 2007, Apr;69(4 Suppl):48-52.
 77. Geist RW, Antolak SJ. Interstitial cystitis in children. *J Urol* 1970, Dec;104(6):922-5.
 78. Patel R, Calhoun EA, Meenan RT, O'Keeffe Rosetti MC, Kimes T, Clemens JQ. Incidence and clinical characteristics of interstitial cystitis in the community. *Int Urogynecol J Pelvic Floor Dysfunct* 2008, Feb 12;19(8):1093-6.
 79. Rackow BW, Novi JM, Arya LA, Pfeifer SM. Interstitial cystitis is an etiology of chronic pelvic pain in young women. *J Pediatr Adolesc Gynecol* 2009, Jun;22(3):181-5.

80. Close CE, Carr MC, Burns MW, Miller JL, Bavendam TG, Mayo ME, Mitchell ME. Interstitial cystitis in children. *J Urol* 1996, Aug;156(2 Pt 2):860-2.
81. Hanash KA, Pool TL. Interstitial cystitis in men. *J Urol* 1969, Oct;102(4):427-8.
82. Forrest JB, Schmidt S. Interstitial cystitis, chronic nonbacterial prostatitis and chronic pelvic pain syndrome in men: A common and frequently identical clinical entity. *J Urol* 2004, Dec;172(6 Pt 2):2561-2.
83. Forrest JB, Nickel JC, Moldwin RM. Chronic prostatitis/chronic pelvic pain syndrome and male interstitial cystitis: Enigmas and opportunities. *Urology* 2007, Apr;69(4 Suppl):60-3.
84. Miller JL, Rothman I, Bavendam TG, Berger RE. Prostatodynia and interstitial cystitis: One and the same? *Urology* 1995, Apr;45(4):587-90.
85. Novicki DE, Larson TR, Swanson SK. Interstitial cystitis in men. *Urology* 1998, Oct;52(4):621-4.
86. Suskind AM, Berry SH, Ewing BA, Elliott MN, Suttorp MJ, Clemens JQ. The prevalence and overlap of interstitial cystitis/bladder pain syndrome and chronic prostatitis/chronic pelvic pain syndrome in men: Results of the RAND interstitial cystitis epidemiology male study. *J Urol* 2013, Jan;189(1):141-5.
87. Nickel JC, Mills IW, Crook TJ, Jorga A, Smith MD, Atkinson G, Krieger JN. Tanezumab reduces pain in women with interstitial cystitis/bladder pain syndrome and patients with non-urological associated somatic syndromes. *J Urol* 2015, Nov 11.
88. Alagiri M, Chottiner S, Ratner V, Slade D, Hanno PM. Interstitial cystitis: Unexplained associations with other chronic disease and pain syndromes. *Urology* 1997, May;49(5A Suppl):52-7.
89. Clemens JQ, Meenan RT, O'Keeffe Rosetti MC, Kimes TA, Calhoun EA. Case-control study of medical comorbidities in women with interstitial cystitis. *J Urol* 2008, Jun;179(6):2222-5.
90. Warren JW, Howard FM, Cross RK, Good JL, Weissman MM, Wesselmann U, et al. Antecedent nonbladder syndromes in case-control study of interstitial cystitis/painful bladder syndrome. *Urology* 2009, Jan;73(1):52-7.
91. Nickel JC, Tripp DA, Pontari M, Moldwin R, Mayer R, Carr LK, et al. Psychosocial phenotyping in women with interstitial cystitis/painful bladder syndrome: A case control study. *J Urol* 2010, Jan;183(1):167-72.
92. Nickel JC, Egerdie RB, Steinhoff G, Palmer B, Hanno P. A multicenter, randomized, double-blind, parallel group pilot evaluation of the efficacy and safety of intravesical sodium chondroitin sulfate versus vehicle control in patients with interstitial cystitis/painful bladder syndrome. *Urology* 2010, Oct;76(4):804-9.
93. Rodriguez MA, Afari N, Buchwald DS. Evidence for overlap between urological and nonurological unexplained clinical conditions. *J Urol* 2009, Nov;182(5):2123-31.
94. Warren JW, van de Merwe JP, Nickel JC. Interstitial cystitis/bladder pain syndrome and nonbladder syndromes: Facts and hypotheses. *Urology* 2011, Oct;78(4):727-32.
95. Allen-Brady K, Norton PA, Cannon-Albright L. Risk of associated conditions in relatives of subjects with interstitial cystitis. *Female Pelvic Med Reconstr Surg* 2015;21(2):93-8.
96. Bogart LM, Suttorp MJ, Elliott MN, Clemens JQ, Berry SH. Prevalence and correlates of sexual dysfunction among women with bladder pain syndrome/interstitial cystitis. *Urology* 2011, Mar;77(3):576-80.
97. Gardella B, Porru D, Nappi RE, Dacco MD, Chiesa A, Spinillo A. Interstitial cystitis is associated with vulvodynia and sexual dysfunction—a case-control study. *J Sex Med* 2011, Jun;8(6):1726-34.
98. Tripp DA, Nickel JC, FitzGerald MP, Mayer R, Stechysen N, Hsieh A. Sexual functioning, catastrophizing, depression, and pain, as predictors of quality of life in women with interstitial cystitis/painful bladder syndrome. *Urology* 2009, May;73(5):987-92.
99. Zaslau S, Riggs DR, Perlmutter AE, Jackson BJ, Osborne J, Kandzari SJ. Sexual dysfunction in patients with painful bladder syndrome is age related and progressive. *Can J Urol* 2008, Aug;15(4):4158-62.
100. Reed BD, Harlow SD, Sen A, Edwards RM, Chen D, Haefner HK. Relationship between vulvodynia and chronic comorbid pain conditions. *Obstet Gynecol* 2012, Jul;120(1):145-51.
101. Koziol JA, Clark DC, Gittes RF, Tan EM. The natural history of interstitial cystitis: A survey of 374 patients. *J Urol* 1993, Mar;149(3):465-9.
102. Propert KJ, Schaeffer AJ, Brensinger CM, Kusek JW, Nyberg LM, Landis JR. A prospective study of interstitial cystitis: Results of longitudinal followup of the interstitial cystitis data base cohort. The interstitial cystitis data base study group. *J Urol* 2000, May;163(5):1434-9.
103. Peeker R, Enerback L, Fall M, Aldenborg F. Recruitment, distribution and phenotypes of mast

- cells in interstitial cystitis. *J Urol* 2000, Mar;163(3):1009-15.
104. Hofmeister MA, He F, Ratliff TL, Mahoney T, Becich MJ. Mast cells and nerve fibers in interstitial cystitis (IC): An algorithm for histologic diagnosis via quantitative image analysis and morphometry (QIAM). *Urology* 1997, May;49(5A Suppl):41-7.
 105. Dundore PA, Schwartz AM, Semerjian H. Mast cell counts are not useful in the diagnosis of nonulcerative interstitial cystitis. *J Urol* 1996, Mar;155(3):885-7.
 106. Gamper M, Regauer S, Welter J, Eberhard J, Viereck V. Are mast cells still good biomarkers for bladder pain syndrome/interstitial cystitis? *J Urol* 2015, Jan 14;193(6):1994-2000.
 107. Akiyama Y, Morikawa T, Maeda D, Shintani Y, Niimi A, Nomiya A, et al. Increased CXCR3 expression of infiltrating plasma cells in Hunner type interstitial cystitis. *Sci Rep* 2016;6:28652.
 108. Zhang CO, Wang JY, Koch KR, Keay S. Regulation of tight junction proteins and bladder epithelial paracellular permeability by an antiproliferative factor from patients with interstitial cystitis. *J Urol* 2005, Dec;174(6):2382-7.
 109. Shie JH, Kuo HC. Higher levels of cell apoptosis and abnormal e-cadherin expression in the urothelium are associated with inflammation in patients with interstitial cystitis/painful bladder syndrome. *BJU Int* 2011, Jul;108(2 Pt 2):E136-41.
 110. Monastyrskaya K, Sánchez-Freire V, Hashemi Gheinani A, Klumpp DJ, Babiychuk EB, Draeger A, Burkhard FC. MiR-199a-5p regulates urothelial permeability and may play a role in bladder pain syndrome. *Am J Pathol* 2013, Feb;182(2):431-48.
 111. Hashemi Gheinani A, Burkhard FC, Rehrauer H, Aquino Fournier C, Monastyrskaya K. MicroRNA mir-199a-5p regulates smooth muscle cell proliferation and morphology by targeting wnt2 signaling pathway. *J Biol Chem* 2015, Jan 16;290(11):7067-86.
 112. Parsons CL, Lilly JD, Stein P. Epithelial dysfunction in nonbacterial cystitis (interstitial cystitis). *J Urol* 1991, Apr;145(4):732-5.
 113. Hauser PJ, Dozmorov MG, Bane BL, Slobodov G, Culkin DJ, Hurst RE. Abnormal expression of differentiation related proteins and proteoglycan core proteins in the urothelium of patients with interstitial cystitis. *J Urol* 2008, Feb;179(2):764-9.
 114. Johansson SL, Fall M. Clinical features and spectrum of light microscopic changes in interstitial cystitis. *J Urol* 1990, Jun;143(6):1118-24.
 115. Anderstrom CR, Fall M, Johansson SL. Scanning electron microscopic findings in interstitial cystitis. *Br J Urol* 1989, Mar;63(3):270-5.
 116. Keay S, Kleinberg M, Zhang CO, Hise MK, Warren JW. Bladder epithelial cells from patients with interstitial cystitis produce an inhibitor of heparin-binding epidermal growth factor-like growth factor production. *J Urol* 2000, Dec;164(6):2112-8.
 117. Keay S, Seillier-Moiseiwitsch F, Zhang CO, Chai TC, Zhang J. Changes in human bladder epithelial cell gene expression associated with interstitial cystitis or antiproliferative factor treatment. *Physiol Genomics* 2003, Jul 7;14(2):107-15.
 118. Keay S, Reeder JE, Koch K, Zhang CO, Grkovic D, Peters K, et al. Prospective evaluation of candidate urine and cell markers in patients with interstitial cystitis enrolled in a randomized clinical trial of bacillus calmette guerin (BCG). *World J Urol* 2007, Oct;25(5):499-504.
 119. Keay S, Kaczmarek P, Zhang CO, Koch K, Szekeley Z, Barchi JJ, Michejda C. Normalization of proliferation and tight junction formation in bladder epithelial cells from patients with interstitial cystitis/painful bladder syndrome by d-proline and d-pipecolic acid derivatives of antiproliferative factor. *Chem Biol Drug Des* 2011, Jun;77(6):421-30.
 120. Silk MR. Bladder antibodies in interstitial cystitis. *J Urol* 1970, Mar;103(3):307-9.
 121. Oravisto KJ. Interstitial cystitis as an autoimmune disease. A review. *Eur Urol* 1980;6(1):10-3.
 122. Jokinen EJ, Alfthan OS, Oravisto KJ. Antitissue antibodies in interstitial cystitis. *Clin Exp Immunol* 1972, Jul;11(3):333-9.
 123. Anderson JB, Parivar F, Lee G, Wallington TB, MacIver AG, Bradbrook RA, Gingell JC. The enigma of interstitial cystitis--an autoimmune disease? *Br J Urol* 1989, Jan;63(1):58-63.
 124. Tan EM. Antinuclear antibodies: Diagnostic markers for autoimmune diseases and probes for cell biology. *Adv Immunol* 1989;44:93-.
 125. Peekler R, Atanasiu L, Logadottir Y. Intercurrent autoimmune conditions in classic and non-ulcer interstitial cystitis. *Scand J Urol Nephrol* 2003;37(1):60-3.
 126. Leppilahti M, Tammela TL, Huhtala H, Kiilholma P, Leppilahti K, Auvinen A. Interstitial cystitis-like urinary symptoms among patients with Sjogren's syndrome: A population-based study in Finland. *Am J Med* 2003, Jul;115(1):62-5.
 127. Ochs RL. Autoantibodies and interstitial cystitis. *Clin Lab Med* 1997, Sep;17(3):571-9.

128. Mattila J, Harmoinen A, Hallstrom O. Serum immunoglobulin and complement alterations in interstitial cystitis. *Eur Urol* 1983;9(6):350-2.
129. Mattila J, Linder E. Immunoglobulin deposits in bladder epithelium and vessels in interstitial cystitis: Possible relationship to circulating anti-intermediate filament autoantibodies. *Clin Immunol Immunopathol* 1984, Jul;32(1):81-9.
130. Harrington DS, Fall M, Johansson SL. Interstitial cystitis: Bladder mucosa lymphocyte immunophenotyping and peripheral blood flow cytometry analysis. *J Urol* 1990, Oct;144(4):868-71.
131. Lynes WL, Sellers RG, and Shortliffe LMD: The evidence for occult bacylar infections as a cause for interstitial cystitis. *J. Urol*, 1989, 141:268.
132. Warren JW, Brown V, Jacobs S, Horne L, Langenberg P, Greenberg P. Urinary tract infection and inflammation at onset of interstitial cystitis/painful bladder syndrome. *Urology* 2008, Jun;71(6):1085-90.
133. Zhang QH, Shen XC, Zhou ZS, Chen ZW, Lu GS, Song B. Decreased nanobacteria levels and symptoms of nanobacteria-associated interstitial cystitis/painful bladder syndrome after tetracycline treatment. *Int Urogynecol J* 2010, Jan;21(1):103-9.
134. Siddiqui H, Lagesen K, Nederbragt AJ, Jeansson SL, Jakobsen KS. Alterations of microbiota in urine from women with interstitial cystitis. *BMC Microbiol* 2012;12:205.
135. Nickel JC, Stephens A, Landis JR, Mullins C, van Bokhoven A, Lucia MS, et al. Assessment of the lower urinary tract microbiota during symptom flare in women with urologic chronic pelvic pain syndrome: A MAPP network study. *J Urol* 2016, Feb;195(2):356-62.
136. Sugimura K, Haimoto H, Nagura H. Immunohistochemical differential distribution of S-100 alpha and S-100 beta in the peripheral nervous system of the rat. *Muscle Nerve* 1989;12:929-.
137. Stefansson K, Wollmann RL, Moore BW. Distribution of S-100 protein outside the central nervous system. *Brain Res* 1982;234:309-.
138. Peeker R, Aldenborg F, Haglid K, Johansson SL, Rosengren L, Fall M. Decreased levels of S-100 protein in non-ulcer interstitial cystitis. *Scand J Urol Nephrol* 1998, Dec;32(6):395-8.
139. Hohenfellner M, Nunes L, Schmidt RA, Lampel A, Thuroff JW, Tanagho EA. Interstitial cystitis: Increased sympathetic innervation and related neuropeptide synthesis. *J Urol* 1992, Mar;147(3):587-91.
140. Regauer S, Gamper M, Fehr MK, Viereck V. Sensory hyperinnervation distinguishes bladder pain syndrome/interstitial cystitis from overactive bladder syndrome. *J Urol* 2016, Jul 1.
141. Elbadawi AE, Light JK. Distinctive ultrastructural pathology of nonulcerative interstitial cystitis: New observations and their potential significance in pathogenesis. *Urol Int* 1996;56(3):137-62.
142. Peeker R, Aldenborg F, Dahlstrom A, Johansson SL, Li JY, Fall M. Increased tyrosine hydroxylase immunoreactivity in bladder tissue from patients with classic and nonulcer interstitial cystitis. *J Urol* 2000, Apr;163(4):1112-5.
143. Malykhina AP, Qin C, Greenwood-Van MB, Foreman RD, Lupu F, Akbarali HI. Hyperexcitability of convergent colon and bladder dorsal root ganglion neurons after colonic inflammation: Mechanism for pelvic organ cross-talk. *Neurogastroenterol Motil* 2006, Oct;18(10):936-48.
144. Noronha R, Akbarali H, Malykhina A, Foreman RD, Greenwood-Van MB. Changes in urinary bladder smooth muscle function in response to colonic inflammation. *Am J Physiol Renal Physiol* 2007, Nov;293(5):F1461-7.
145. Malykhina AP. Neural mechanisms of pelvic organ cross-sensitization. *Neuroscience* 2007, Nov 9;149(3):660-72.
146. Qin C, Malykhina AP, Akbarali HI, Greenwood-Van MB, Foreman RD. Acute colitis enhances responsiveness of lumbosacral spinal neurons to colorectal distension in rats. *Dig Dis Sci* 2008, Jan;53(1):141-8.
147. Pezzone MA, Liang R, Fraser MO. A model of neural cross-talk and irritation in the pelvis: Implications for the overlap of chronic pelvic pain disorders. *Gastroenterology* 2005, Jun;128(7):1953-64.
148. Towner RA, Smith N, Saunders D, Van Gordon SB, Wisniewski AB, Tyler KR, et al. Contrast enhanced magnetic resonance imaging as a diagnostic tool to assess bladder permeability and associated colon cross talk: Preclinical studies in a rat model. *J Urol* 2015, Apr;193(4):1394-400.
149. Kairys AE, Schmidt-Wilcke T, Puiu T, Ichesco E, Labus JS, Martucci K, et al. Increased brain gray matter in the primary somatosensory cortex is associated with increased pain and mood disturbance in patients with interstitial cystitis/painful bladder syndrome. *J Urol* 2015, Jan;193(1):131-7.
150. Parsons CL, Shaw T, Berecz Z, Su Y, Zupkas P, Argade S. Role of urinary cations in the aetiology of bladder symptoms and interstitial cystitis. *BJU Int* 2014, Aug;114(2):286-93.

151. Parsons CL, Proctor J, Teichman JS, Nickel JC, Davis E, Evans R, et al. A multi-site study confirms abnormal glycosylation in the tamm-horsfall protein of patients with interstitial cystitis. *J Urol* 2011, Jul;186(1):112-6.
152. Hang L, Wullt B, Shen Z, Karpman D, Svanborg C. Cytokine repertoire of epithelial cells lining the human urinary tract. *J Urol* 1998, Jun;159(6):2185-92.
153. Rosamilia A, Cann L, Scurry J, Rogers P, Dwyer P. Bladder microvasculature and the effects of hydrodistention in interstitial cystitis. *Urology* 2001, Jun;57(6 Suppl 1):132-.
154. Pontari MA, Hanno PM, Ruggieri MR. Comparison of bladder blood flow in patients with and without interstitial cystitis. *J Urol* 1999, Aug;162(2):330-4.
155. Lee JD, Lee MH. Increased expression of hypoxia-inducible factor-1 α and vascular endothelial growth factor associated with glomerulation formation in patients with interstitial cystitis. *Urology* 2011, Oct;78(4):971.e11-5.
156. Warren JW, Keay SK, Meyers D, Xu J. Concordance of interstitial cystitis in monozygotic and dizygotic twin pairs. *Urology* 2001, Jun;57(6 Suppl 1):22-5.
157. Altman D, Lundholm C, Milsom I, Peeker R, Fall M, Iliadou AN, Pedersen NL. The genetic and environmental contribution to the occurrence of bladder pain syndrome: An empirical approach in a nationwide population sample. *Eur Urol* 2011, Feb;59(2):280-5.
158. Weissman MM, Gross R, Fyer A, Heiman GA, Gameroff MJ, Hodge SE, et al. Interstitial cystitis and panic disorder: A potential genetic syndrome. *Arch Gen Psychiatry* 2004, Mar;61(3):273-9.
159. Talati A, Ponniah K, Strug LJ, Hodge SE, Fyer AJ, Weissman MM. Panic disorder, social anxiety disorder, and a possible medical syndrome previously linked to chromosome 13. *Biol Psychiatry* 2008, Mar 15;63(6):594-601.
160. Aaron LA, Buchwald D. A review of the evidence for overlap among unexplained clinical conditions. *Ann Intern Med* 2001, May 1;134(9 Pt 2):868-81.
161. Clauw DJ. The pathogenesis of chronic pain and fatigue syndromes, with special reference to fibromyalgia. *Med Hypotheses* 1995, May;44(5):369-78.
162. Sand PK. Proposed pathogenesis of painful bladder syndrome/interstitial cystitis. *J Reprod Med* 2006, Mar;51(3 Suppl):234-40.
163. Hellstrom HR, Davis BK, Shonnard JW. Eosinophilic cystitis. A study of 16 cases. *Am J Clin Pathol* 1979, Nov;72(5):777-84.
164. Tsiropoulos I, Lee G, O' RA, Smith R, Pancharatnam M. Primary splenic marginal zone lymphoma with bladder metastases mimicking interstitial cystitis. *Int Urol Nephrol* 2006;38:475-6.
165. Jacobo E, Stamler FW, Culp DA. Interstitial cystitis followed by total cystectomy. *Urology* 1974, Apr;3(4):481-5.
166. Smith BH, Dehner LP. Chronic ulcerating interstitial cystitis (hunner's ulcer). A study of 28 cases. *Arch Pathol* 1972, Jan;93(1):76-81.
167. Lepinard V, Saint-Andre JP, Rognon LM. [Interstitial cystitis. Current aspects]. *J Urol (Paris)* 1984;90(7):455-65.
168. Johansson SL, Fall M. Pathology of interstitial cystitis. *Urol Clin North Am* 1994, Feb;21(1):55-62.
169. Fall M, Johansson SL, Aldenborg F. Chronic interstitial cystitis: A heterogeneous syndrome. *J Urol* 1987, Jan;137(1):35-8.
170. Holm-Bentzen M, Jacobsen F, Nerstrom B, Lose G, Kristensen JK, Pedersen RH, et al. Painful bladder disease: Clinical and pathoanatomical differences in 115 patients. *J Urol* 1987, Sep;138(3):500-2.
171. Moore KH, Nickson P, Richmond DH, Sutherst JR, Manasse PR, Helliwell TR. Detrusor mast cells in refractory idiopathic instability. *Br J Urol* 1992, Jul;70(1):17-21.
172. Theoharides TC, Kempuraj D, Sant GR. Mast cell involvement in interstitial cystitis: A review of human and experimental evidence. *Urology* 2001, Jun;57(6 Suppl 1):47-55.
173. Larsen MS, Mortensen S, Nordling J, Horn T. Quantifying mast cells in bladder pain syndrome by immunohistochemical analysis. *BJU Int* 2008, Apr 2.
174. Rudick CN, Bryce PJ, Guichelaar LA, Berry RE, Klumpp DJ. Mast cell-derived histamine mediates cystitis pain. *PLoS One* 2008;3(5):e2096-.
175. Collan Y, Alftan O, Kivilaakso E, Oravisto KJ. Electron microscopic and histological findings on urinary bladder epithelium in interstitial cystitis. *Eur Urol* 1976;2(5):242-7.
176. Dixon JS, Holm-Bentzen M, Gilpin CJ, Gosling JA, Bostofte E, Hald T, Larsen S. Electron microscopic investigation of the bladder urothelium and glycocalyx in patients with interstitial cystitis. *J Urol* 1986, Mar;135(3):621-5.
177. Nickel JC, Emerson L, Cornish J. The bladder mucus (glycosaminoglycan) layer in interstitial cystitis. *J Urol* 1993, Apr;149(4):716-8.

178. Elbadawi A. Interstitial cystitis: A critique of current concepts with a new proposal for pathologic diagnosis and pathogenesis. *Urology* 1997, May;49(5A Suppl):14-40.
179. Holm-Bentzen M. Pathology and pathophysiology of painful bladder diseases. *Urol Int* 1989;44(6):327-31.
180. Holm-Bentzen M, Larsen S, Hainau B, et al.. Nonobstructive detrusor myopathy in a group of patients with chronic abacterial cystitis. *Scand J Urol Nephrol* 1985;19:21-6.
181. Christmas TJ, Smith GL, Rode J. Detrusor myopathy: An accurate predictor of bladder hypo-compliance and contracture in interstitial cystitis. *Br J Urol* 1996, Dec;78(6):862-5.
182. Tomaszewski JE, Landis JR, Brensinger C, Hardy C, et al.. Baseline associations among pathologic features and patient symptoms in the national interstitial cystitis data base. *Journal of Urology* 1999;161 S:28-.
183. Hanus T, Zamecnik L, Jansky M, Jarolim L, Povysil C, Benett R. The comparison of clinical and histopathologic features of interstitial cystitis. *Urology* 2001, Jun;57(6 Suppl 1):131-.
184. Richter B, Hesse U, Hansen AB, Horn T, Mortensen SO, Nordling J. Bladder pain syndrome/interstitial cystitis in a danish population: A study using the 2008 criteria of the european society for the study of interstitial cystitis. *BJU Int* 2010, Mar;105(5):660-7.
185. Geurts N, Van DJ, Wyndaele JJ. Bladder pain syndrome: Do the different morphological and cystoscopic features correlate? *Scand J Urol Nephrol* 2011, Feb;45(1):20-3.
186. Mattila J. Vascular immunopathology in interstitial cystitis. *Clin Immunol Immunopathol* 1982, Jun;23(3):648-55.
187. Johansson SL, Ogawa K, Fall M, Sant GR. The pathology of interstitial cystitis. In: *Interstitial Cystitis*. Philadelphia: Lippincott-Raven; 1997o. p. 143-52.
188. Rossberger J, Fall M, Jonsson O, Peeker R. Long-term results of reconstructive surgery in patients with bladder pain syndrome/interstitial cystitis: Subtyping is imperative. *Urology* 2007, Oct;70(4):638-42.
189. Erickson DR, Tomaszewski JE, Kunselman AR, Stetter CM, Peters KM, Rovner ES, et al. Urine markers do not predict biopsy findings or presence of bladder ulcers in interstitial cystitis/painful bladder syndrome. *J Urol* 2008, May;179(5):1850-6.
190. Landon CR and Mcdougald M: The diagnosis of interstitial cystitis: is histology helpful? *Int Urogynecol J Pelvic Floor Dysfunct* 14:Suppl 1,2003, S40-S41.
191. Nordling J, Anderson JB, Mortensen S, Bouchelouche K, Horn T, Hald T and the Copenhagen IC study group, poster 42 Research Insights into interstitial cystitis, NIDDK Washington, October 30-November 1, 2003.
192. MacDermott JP, Charpied GC, Tesluk H, Stone AR. Can histological assessment predict the outcome in interstitial cystitis? *Br J Urol* 1991, Jan;67(1):44-7.
193. Flores-Carreras O, Martinez-Espinoza CJ, Gonzalez-Ruiz MI, Montes-Casillas YE. [Contribution of bladder biopsy to the study of urogynaecological patient]. *Ginecol Obstet Mex* 2010, Mar;78(3):187-90.
194. Zamecnik L, Hanus T, Pavlik I, Dundr P, Povysil C. Statistical analysis of symptoms, endoscopy and urothelial morphology in 58 female bladder pain syndrome/interstitial cystitis patients. *Urol Int* 2009;83(2):193-9.
195. Hurst RE, Meerveld BG, Wisniewski AB, VanGordon S, Lin H, Kropp BP, Towner RA. Increased bladder permeability in interstitial cystitis/painful bladder syndrome. *Transl Androl Urol* 2015, Oct;4(5):563-71.
196. Kaplan SA, Ikeguchi EF, Santarosa RP, D'Alisera PM, Hendricks J, Te AE, Miller MI. Etiology of voiding dysfunction in men less than 50 years of age. *Urology* 1996;47:836-9.
197. Hohlbrugger G, Sant GR. Disintegrity of the vesical blood-urine barrier in interstitial cystitis: A vicious circle. In: *Interstitial Cystitis*. Philadelphia: Lippincott-Raven; 1997g. p. 87-92.
198. Vander AJ. *Renal physiology*. New York: McGraw Hill Health Professions Division; 1995h.
199. Roberto PJ, Reich JD, Hirshberg S, Knight L, Hanno PM, Ruggieri M. Assessment of bladder permeability and sensation in interstitial cystitis patients. *Journal of Urology* 1997;157(S):317-.
200. Daha LK, Riedl CR, Lazar D, Hohlbrugger G, Pfluger H. Do cystometric findings predict the results of intravesical hyaluronic acid in women with interstitial cystitis? *Eur Urol* 2005, Mar;47(3):393-7.
201. Chambers GK, Fenster HN, Cripps S, Jens M, Taylor D. An assessment of the use of intravesical potassium in the diagnosis of interstitial cystitis. *J Urol* 1999, Sep;162(3 Pt 1):699-701.
202. Parsons CL, Greenberger M, Gabal L, Bidair M, Barne G. The role of urinary potassium in the pathogenesis and diagnosis of interstitial cystitis. *J Urol* 1998, Jun;159(6):1862-6.
203. Yilmaz U, Liu YW, Rothman I, Lee JC, Yang CC, Berger RE. Intravesical potassium chloride sensitivity test in men with chronic pelvic pain syndrome. *J Urol* 2004, Aug;172(2):548-50.

204. Chung MK, Butrick CW, Chung CW. The overlap of interstitial cystitis/painful bladder syndrome and overactive bladder. *JSLs* 2010, Jan;14(1):83-90.
205. Parsons CL, Stein PC, Bidair M, Lebow D. Abnormal sensitivity to intravesical potassium in interstitial cystitis and radiation cystitis. *Neurourol Urodyn* 1994;13(5):515-20.
206. Parsons CL, Albo M. Intravesical potassium sensitivity in patients with prostatitis. *J Urol* 2002, Sep;168(3):1054-7.
207. Parsons CL, Rosenberg MT, Sassani P, Ebrahimi K, Koziol JA, Zupkas P. Quantifying symptoms in men with interstitial cystitis/prostatitis, and its correlation with potassium-sensitivity testing. *BJU Int* 2005, Jan 1;95(1):86-90.
208. Parsons CL, Dell J, Stanford EJ, Bullen M, Kahn BS, Willems JJ. The prevalence of interstitial cystitis in gynecologic patients with pelvic pain, as detected by intravesical potassium sensitivity. *Am J Obstet Gynecol* 2002, Nov;187(5):1395-400.
209. Sahinkanat T, Guven A, Ekerbicer H, Aral M. Prevalence of positive potassium sensitivity test which is an indicator of bladder epithelial permeability dysfunction in a fixed group of turkish women. *Urol Int* 2008;80(1):52-6.
210. Gregoire M, Liandier F, Naud A, Lacombe L, Fradet Y. Does the potassium stimulation test predict cystometric, cystoscopic outcome in interstitial cystitis? *J Urol* 2002, Aug;168(2):556-7.
211. Kuo HC. Urodynamic study and potassium sensitivity test for women with frequency-urgency syndrome and interstitial cystitis. *Urol Int* 2003;71(1):61-5.
212. Philip J, Willmott S, Irwin P. Interstitial cystitis versus detrusor overactivity: A comparative, randomized, controlled study of cystometry using saline and 0.3 M potassium chloride. *J Urol* 2006, Feb;175(2):566-70.
213. Philip J, Willmott S, Owen D, Samsudin C, Irwin PP. A double-blind, randomized controlled trial of cystometry using saline versus 0.3 M potassium chloride infusion in women with overactive bladder syndrome. *Neurourol Urodyn* 2007;26(1):110-4.
214. Daha LK, Riedl CR, Hohlbrugger G, Knoll M, Engelhardt PF, Pfluger H. Comparative assessment of maximal bladder capacity, 0.9% nacl versus 0.2 M kcl, for the diagnosis of interstitial cystitis: A prospective controlled study. *J Urol* 2003, Sep;170(3):807-9.
215. Riedl CR, Engelhardt PF, Daha KL, Morakis N, Pfluger H. Hyaluronan treatment of interstitial cystitis/painful bladder syndrome. *Int Urogynecol J Pelvic Floor Dysfunct* 2008, May;19(5):717-21.
216. Simon LJ, Landis JR, Erickson DR, Nyberg LM. The interstitial cystitis data base study: Concepts and preliminary baseline descriptive statistics. *Urology* 1997, May;49(5A Suppl):64-75.
217. Erickson DR. Glomerulations in women with urethral sphincter deficiency: Report of 2 cases [corrected]. *J Urol* 1995, Mar;153(3 Pt 1):728-9.
218. Messing E, Pauk D, Schaeffer A, Nieweglowski M, Nyberg LM, Landis JR, et al. Associations among cystoscopic findings and symptoms and physical examination findings in women enrolled in the interstitial cystitis data base (ICDB) study. *Urology* 1997, May;49(5A Suppl):81-5.
219. Waxman JA, Sulak PJ, Kuehl TJ. Cystoscopic findings consistent with interstitial cystitis in normal women undergoing tubal ligation. *J Urol* 1998, Nov;160(5):1663-7.
220. Peeker R, Fall M. Toward a precise definition of interstitial cystitis: Further evidence of differences in classic and nonulcer disease. *J Urol* 2002, Jun;167(6):2470-2.
221. Bade J, Ishizuka O, Yoshida M. Future research needs for the definition/diagnosis of interstitial cystitis. *Int J Urol* 2003, Oct;10 Suppl:S31-4.
222. Messing EM. Interstitial cystitis--a light at the end of the tunnel? *J Urol* 1999, Jun;161(6):1797-.
223. Turner KJ, Stewart LH. How do you stretch a bladder? A survey of UK practice, a literature review, and a recommendation of a standard approach. *Neurourol Urodyn* 2005;24(1):74-6.
224. Furuya R, Masumori N, Furuya S, Oda T, Takahashi S, Takeuchi M. Glomerulation observed during transurethral resection of the prostate for patients with lower urinary tract symptoms suggestive of benign prostatic hyperplasia is a common finding but no predictor of clinical outcome. *Urology* 2007, Nov;70(5):922-6.
225. Cole EE, Scarpero HM, Dmochowski RR. Are patient symptoms predictive of the diagnostic and/or therapeutic value of hydrodistension? *Neurourol Urodyn* 2005;24(7):638-42.
226. Ottem DP, Teichman JM. What is the value of cystoscopy with hydrodistension for interstitial cystitis? *Urology* 2005, Sep;66(3):494-9.
227. Rigaud J, Delavierre D, Sibert L, Labat JJ. [Diagnostic approach to chronic bladder pain]. *Prog Urol* 2010, Nov;20(12):930-9.

228. Homma Y, Ueda T, Ito T, Takei M, Tomoe H. Japanese guideline for diagnosis and treatment of interstitial cystitis. *Int J Urol* 2009, Jan;16(1):4-16.
229. Lamale LM, Lutgendorf SK, Hoffman AN, Kreder KJ. Symptoms and cystoscopic findings in patients with untreated interstitial cystitis. *Urology* 2006, Feb;67(2):242-5.
230. Shear S, Mayer R. Development of glomerulations in younger women with interstitial cystitis. *Urology* 2006, Aug;68(2):253-6.
231. Zabihi N, Allee T, Maher MG, Mourtzinis A, Raz S, Payne CK, Rodriguez LV. Bladder necrosis following hydrodistention in patients with interstitial cystitis. *J Urol* 2007, Jan;177(1):149-52.
232. Wyndaele JJ, Van DJ, Toussaint N. Cystoscopy and bladder biopsies in patients with bladder pain syndrome carried out following ESSIC guidelines. *Scand J Urol Nephrol* 2009;43(6):471-5.
233. Richter B, Roslind A, Hesse U, Nordling J, Johansen JS, Horn T, Hansen AB. YKL-40 and mast cells are associated with detrusor fibrosis in patients diagnosed with bladder pain syndrome/interstitial cystitis according to the 2008 criteria of the European Society for the Study of Interstitial Cystitis. *Histopathology* 2010, Sep;57(3):371-83.
234. Erickson DR, Sant GR. Urinary markers of interstitial cystitis. In: *Interstitial Cystitis*. Philadelphia: Lippincott-Raven; 1997c. p. 123-8.
235. Erickson DR, Xie SX, Bhavanandan VP, Wheeler MA, Hurst RE, Demers LM, et al. A comparison of multiple urine markers for interstitial cystitis. *J Urol* 2002, Jun;167(6):2461-9.
236. Keay S, Zhang CO, Trifillis AL, Hise MK, Hebel JR, Jacobs SC, Warren JW. Decreased 3h-thymidine incorporation by human bladder epithelial cells following exposure to urine from interstitial cystitis patients. *J Urol* 1996, Dec;156(6):2073-8.
237. Keay SK, Szekely Z, Conrads TP, Veenstra TD, Barchi JJ, Zhang CO, et al. An antiproliferative factor from interstitial cystitis patients is a frizzled 8 protein-related sialoglycopeptide. *Proc Natl Acad Sci U S A* 2004, Aug 10;101(32):11803-8.
238. Keay S, Warren JW, Zhang CO, Tu LM, Gordon DA, Whitmore KE. Antiproliferative activity is present in bladder but not renal pelvic urine from interstitial cystitis patients. *J Urol* 1999, Oct;162(4):1487-9.
239. Chai TC, Zhang C, Warren JW, Keay S. Percutaneous sacral third nerve root neurostimulation improves symptoms and normalizes urinary HB-EGF levels and antiproliferative activity in patients with interstitial cystitis. *Urology* 2000, May;55(5):643-6.
240. Chai TC, Zhang CO, Shoenfelt JL, Johnson HW, Warren JW, Keay S. Bladder stretch alters urinary heparin-binding epidermal growth factor and antiproliferative factor in patients with interstitial cystitis. *J Urol* 2000, May;163(5):1440-4.
241. Erickson DR, Kunselman AR, Bentley CM, Peters KM, Rovner ES, Demers LM, et al. Changes in urine markers and symptoms after bladder distention for interstitial cystitis. *J Urol* 2007, Feb;177(2):556-60.
242. Keay S, Zhang CO, Hise MK, Hebel JR, Jacobs SC, Gordon D, et al. A diagnostic in vitro urine assay for interstitial cystitis. *Urology* 1998, Dec;52(6):974-8.
243. Keay S, Zhang CO, Marvel R, Chai T. Antiproliferative factor, heparin-binding epidermal growth factor-like growth factor, and epidermal growth factor: Sensitive and specific urine markers for interstitial cystitis. *Urology* 2001, Jun;57(6 Suppl 1):104-.
244. Keay S, Zhang CO, Chai T, Warren J, Koch K, Grkovic D, et al. Antiproliferative factor, heparin-binding epidermal growth factor-like growth factor, and epidermal growth factor in men with interstitial cystitis versus chronic pelvic pain syndrome. *Urology* 2004, Jan;63(1):22-6.
245. Conrads TP, Tocci GM, Hood BL, Zhang CO, Guo L, Koch KR, et al. CKAP4/p63 is a receptor for the frizzled-8 protein-related antiproliferative factor from interstitial cystitis patients. *J Biol Chem* 2006, Dec 8;281(49):37836-43.
246. Kim J, Keay SK, Dimitrakov JD, Freeman MR. P53 mediates interstitial cystitis antiproliferative factor (APF)-induced growth inhibition of human urothelial cells. *FEBS Lett* 2007, Aug 7;581(20):3795-9.
247. Moskowitz MO, Byrne DS, Callahan HJ, Parsons CL, Valderrama E, Moldwin RM. Decreased expression of a glycoprotein component of bladder surface mucin (GP1) in interstitial cystitis. *J Urol* 1994, Feb;151(2):343-5.
248. Byrne DS, Sedor JF, Estojak J, Fitzpatrick KJ, Chiura AN, Mulholland SG. The urinary glycoprotein GP51 as a clinical marker for interstitial cystitis. *J Urol* 1999, Jun;161(6):1786-90.
249. Keay S, Zhang CO, Kagen DI, Hise MK, Jacobs SC, Hebel JR, et al. Concentrations of specific epithelial growth factors in the urine of interstitial cystitis patients and controls. *J Urol* 1997, Nov;158(5):1983-8.

250. Keay SK, Zhang CO, Shoенfelt J, Erickson DR, Whitmore K, Warren JW, et al. Sensitivity and specificity of antiproliferative factor, heparin-binding epidermal growth factor-like growth factor, and epidermal growth factor as urine markers for interstitial cystitis. *Urology* 2001, Jun;57(6 Suppl 1):9-14.
251. Parker KS, Crowley JR, Stephens-Shields AJ, van Bokhoven A, Lucia MS, Lai HH, et al. Urinary metabolomics identifies a molecular correlate of interstitial cystitis/bladder pain syndrome in a multidisciplinary approach to the study of chronic pelvic pain (MAPP) research network cohort. *EBioMedicine* 2016, May;7:167-74.
252. Fries JF, Hochberg MC, Medsger TA, Hunder GG. Criteria for rheumatic disease. Different types and different functions. *Arthritis Rheum* 1994;37(4):454-62.
253. Zondervan KT, Yudkin PL, Vessey MP, Dawes MG, Barlow DH, Kennedy SH. Prevalence and incidence of chronic pelvic pain in primary care: Evidence from a national general practice database. *Br J Obstet Gynaecol* 1999, Nov;106(11):1149-55.
254. Butrick CW. Interstitial cystitis and chronic pelvic pain: New insights in neuropathology, diagnosis, and treatment. *Clin Obstet Gynecol* 2003, Dec;46(4):811-23.
255. De Paepe H, Renson C, Van Laecke E, Raes A, Vande Walle J, Hoebeke P. Pelvic-floor therapy and toilet training in young children with dysfunctional voiding and obstipation. *BJU Int* 2000, May;85(7):889-93.
256. Travell JG SD. *Myofascial pain and dysfunction: The triggerpoint manual*. Baltimore: Williams and Wilkins; f.
257. Butrick CW. Pelvic floor hypertonic disorders: Identification and management. *Obstet Gynecol Clin North Am* 2009, Sep;36(3):707-22.
258. Lee HN, Lee SY, Lee YS, Han JY, Choo MS, Lee KS. Pelvic floor muscle training using an extracorporeal biofeedback device for female stress urinary incontinence. *Int Urogynecol J* 2013, May;24(5):831-8.
259. Barbieri RL. Etiology and epidemiology of endometriosis. *Am J Obstet Gynecol* 1990, Feb;162(2):565-7.
260. Ballweg ML. Impact of endometriosis on women's health: Comparative historical data show that the earlier the onset, the more severe the disease. *Best Pract Res Clin Obstet Gynaecol* 2004, Apr;18(2):201-18.
261. Howard FM. The role of laparoscopy in the chronic pelvic pain patient. *Clin Obstet Gynecol* 2003, Dec;46(4):749-66.
262. Lessey BA, Metzger DA, Haney AF, McCarty KS. Immunohistochemical analysis of estrogen and progesterone receptors in endometriosis: Comparison with normal endometrium during the menstrual cycle and the effect of medical therapy. *Fertil Steril* 1989, Mar;51(3):409-15.
263. Chung MK, Chung RP, Gordon D. Interstitial cystitis and endometriosis in patients with chronic pelvic pain: The "evil twins" syndrome. *JLSLS* 2005, Jan;9(1):25-9.
264. Paulson JD, Delgado M. The relationship between interstitial cystitis and endometriosis in patients with chronic pelvic pain. *JLSLS* 2007, Apr;11(2):175-81.
265. Tirlapur SA, Kuhrt K, Chaliha C, Ball E, Meads C, Khan KS. The 'evil twin syndrome' in chronic pelvic pain: A systematic review of prevalence studies of bladder pain syndrome and endometriosis. *Int J Surg* 2013;11(3):233-7.
266. Leclair CM, Goetsch MF, Korcheva VB, Anderson R, Peters D, Morgan TK. Differences in primary compared with secondary vestibulodynia by immunohistochemistry. *Obstet Gynecol* 2011, Jun;117(6):1307-13.
267. Nguyen RH, Veasley C, Smolenski D. Latent class analysis of comorbidity patterns among women with generalized and localized vulvodynia: Preliminary findings. *J Pain Res* 2013;6:303-9.
268. Peters K, Girdler B, Carrico D, Ibrahim I, Diokno A. Painful bladder syndrome/interstitial cystitis and vulvodynia: A clinical correlation. *Int Urogynecol J Pelvic Floor Dysfunct* 2008, May;19(5):665-9.
269. Lowenstein L, Vardi Y, Deutsch M, Friedman M, Gruenwald I, Granot M, et al. Vulvar vestibulitis severity--assessment by sensory and pain testing modalities. *Pain* 2004, Jan;107(1-2):47-53.
270. Harlow BL, Stewart EG. Adult-onset vulvodynia in relation to childhood violence victimization. *Am J Epidemiol* 2005, May 1;161(9):871-80.
271. Fitzpatrick CC, DeLancey JO, Elkins TE, McGuire EJ. Vulvar vestibulitis and interstitial cystitis: A disorder of urogenital sinus-derived epithelium? *Obstet Gynecol* 1993, May;81(5 (Pt 2)):860-2.
272. Glazer HI, Rodke G, Swencionis C, Hertz R, Young AW. Treatment of vulvar vestibulitis syndrome with electromyographic biofeedback of pelvic floor musculature. *J Reprod Med* 1995, Apr;40(4):283-90.
273. Pukall CF, Binik YM, Khalifé S, Amsel R, Abbott FV. Vestibular tactile and pain thresholds in women with vulvar vestibulitis syndrome. *Pain* 2002, Mar;96(1-2):163-75.

274. van Lankveld JJ, Granot M, Weijmar Schultz WC, Binik YM, Wesselmann U, Pukall CF, et al. Women's sexual pain disorders. *J Sex Med* 2010, Jan;7(1 Pt 2):615-31.
275. Ben-David B, Friedman M. Gabapentin therapy for vulvodynia. *Anesth Analg* 1999, Dec;89(6):1459-60.
276. Jeon Y, Kim Y, Shim B, Yoon H, Park Y, Shim B, et al. A retrospective study of the management of vulvodynia. *Korean J Urol* 2013, Jan;54(1):48-52.
277. Robert R, Brunet C, Faure A, Lehur PA, Labat JJ, Bensignor M, et al. [Surgery of the pudendal nerve in various types of perineal pain: Course and results]. *Chirurgie* 1993;119(9):535-9.
278. Baurant B. La prise en charge moderne des névralgies pudendales. A partir d'une série de 212 patientes et 104 interventions de décompression. *J. Gynecol. Obstet. Biol. Reprod* 2003(32):705-12.
279. Shafik A. . Pudendal canal syndrome. Description of a new syndrome and its treatment. Report of 7 cases. *Coloproctology* 1991(13):102-10.
280. Wein AJ, Hanno PM, Gillenwater JY, Hanno PM, Staskin DR, Krane RJ, Wein AJ. Interstitial cystitis: An introduction to the problem. In: *Interstitial Cystitis*. London: Springer-Verlag; 1990c. p. 3-15.
281. Verghese TS, Riordain RN, Champaneria R, Latthe PM. Complementary therapies for bladder pain syndrome: A systematic review. *Int Urogynecol J* 2015, Dec 7.
282. Atchley MD, Shah NM, Whitmore KE. Complementary and alternative medical therapies for interstitial cystitis: An update from the united states. *Transl Androl Urol* 2015, Dec;4(6):662-7.
283. Pang R, Ali A. The chinese approach to complementary and alternative medicine treatment for interstitial cystitis/bladder pain syndrome. *Transl Androl Urol* 2015, Dec;4(6):653-61.
284. Chaiken DC, Blaivas JG, Blaivas ST. Behavioral therapy for the treatment of refractory interstitial cystitis. *J Urol* 1993, Jun;149(6):1445-8.
285. Parsons CL, Koprowski PF. Interstitial cystitis: Successful management by increasing urinary voiding intervals. *Urology* 1991, Mar;37(3):207-12.
286. Foster HE., Hanno PM, Nickel JC, Payne CK, Mayer RD, Burks DA, et al. Effect of amitriptyline on symptoms in treatment naive patients with interstitial cystitis/painful bladder syndrome. *J Urol* 2010, May;183(5):1853-8.
287. Peters KM, Carrico DJ, Kalinowski SE, Ibrahim IA, Diokno AC. Prevalence of pelvic floor dysfunction in patients with interstitial cystitis. *Urology* 2007, Jul;70(1):16-8.
288. Markwell SJ. Physical therapy management of pelvi/perineal and perianal syndromes. *World J Urol* 2001;19:194-9.
289. Meadows E. Treatments for patients with pelvic pain. *Urol Nurs* 1999;19:33-5.
290. Mendelowitz F, Moldwin R, Sant GR. Complementary approaches in the management of interstitial cystitis. In: *Interstitial Cystitis*. Philadelphia: Lippincott-Raven; 1997. p. 235-40.
291. Lukban J, Whitmore K, Kellogg-Spadt S, Bologna R, Leshner A, Fletcher E. The effect of manual physical therapy in patients diagnosed with interstitial cystitis, high-tone pelvic floor dysfunction, and sacroiliac dysfunction. *Urology* 2001, Jun;57(6 Suppl 1):121-2.
292. Lukban JC, Whitmore K. Pelvic floor muscle reeducation treatment of the overactive bladder and painful bladder syndrome. *Clin Obstet Gynecol* 2002;45:273-85.
293. Holzberg A, Kellogg-Spadt S, Lukban J, Whitmore K. Evaluation of transvaginal theil massage as a therapeutic intervention for women with interstitial cystitis. *Urology* 2001, Jun;57(6 Suppl 1):120-.
294. Weiss JM. Pelvic floor myofascial trigger points: Manual therapy for interstitial cystitis and the urgency-frequency syndrome. *J Urol* 2001, Dec;166(6):2226-31.
295. Fitzgerald MP, Anderson RU, Potts J, Payne CK, Peters KM, Clemens JQ, et al. Randomized multicenter feasibility trial of myofascial physical therapy for the treatment of urological chronic pelvic pain syndromes. *J Urol* 2009, Jun 15.
296. Payne CK, Fitzgerald MP, Burks D, Nickel JC, Lukacz ES, Kreder K, Chai T, Hanno PM, Mayer R, Yang C, Peters K, Foster H, Landis JR, Cen L, Propert K, Kusek J: Randomized multicenter clinical trial shows efficacy of myofascial physical therapy in women with interstitial cystitis/painful bladder syndrome (IC/PBS). *J. Urol* 183, 2010, 4, e402
297. Anderson RU, Wise D, Sawyer T, Nathanson BH, Nevin Smith J. Equal improvement in men and women in the treatment of urologic chronic pelvic pain syndrome using a multi-modal protocol with an internal myofascial trigger point wand. *Appl Psychophysiol Biofeedback* 2015, Dec 31.

298. Rothrock NE, Lutgendorf SK, Kreder KJ, Ratliff T, Zimmerman B. Stress and symptoms in patients with interstitial cystitis: A life stress model. *Urology* 2001, Mar;57(3):422-7.
299. Clemens JQ, Brown SO, Calhoun EA. Mental health diagnoses in patients with interstitial cystitis/painful bladder syndrome and chronic prostatitis/chronic pelvic pain syndrome: A case/control study. *J Urol* 2008, Oct;180(4):1378-82.
300. Whitmore KE. Self-care regimens for patients with interstitial cystitis. *Urol Clin North Am* 1994, Feb;21(1):121-30.
301. McCormick NB, Sant GR. Psychological aspects of interstitial cystitis. In: *Interstitial Cystitis*. Philadelphia: Lippincott-Raven; 1997v. p. 193-204.
302. Kanter G, Komesu YM, Qaedan F, Jeppson PC, Dunivan GC, Cichowski SB, Rogers RG. Mindfulness-based stress reduction as a novel treatment for interstitial cystitis/bladder pain syndrome: A randomized controlled trial. *Int Urogynecol J* 2016, Apr 26.
303. Ratner V, Slade D. The interstitial cystitis association: Patients working for a cure. *Semin Urol* 1991, May;9(2):72-.
304. Webster DC, Brennan T. Use and effectiveness of psychological self-care strategies for interstitial cystitis. *Health Care Women Int* 1995, Sep;16(5):463-75.
305. Webster DC, Brennan T. Self-care effectiveness and health outcomes in women with interstitial cystitis: Implications for mental health clinicians. *Issues Ment Health Nurs* 1998, Sep;19(5):495-519.
306. Gillespie L. Metabolic appraisal of the effects of dietary modification on hypersensitive bladder symptoms. *Br J Urol* 1993, Sep;72(3):293-7.
307. Li GZ, Zhang N, Du P, Yang Y, Wu SL, Xiao YX, et al. Risk factors for interstitial cystitis/painful bladder syndrome in patients with lower urinary tract symptoms: A chinese multicenter study. *Chin Med J (Engl)* 2010, Oct;123(20):2842-6.
308. Moldwin RM, Sant GR. Interstitial cystitis: A pathophysiology and treatment update. *Clin Obstet Gynecol* 2002, Mar;45(1):259-72.
309. Nickel JC. Interstitial cystitis. Etiology, diagnosis, and treatment. *Can Fam Physician* 2000, Dec;46(12):2430-40.
310. Ngan C, Franciosi LG, Butterfield NN, Macleod BA, Jens M, Fenster HN. A prospective, double-blind, randomized cross-over study evaluating changes in urinary pH for relieving the symptoms of interstitial cystitis. *BJU Int* 2005, Jan 1;95(1):91-4.
311. Shorter B, Lesser M, Moldwin RM, Kushner L. Effect of comestibles on symptoms of interstitial cystitis. *J Urol* 2007, Jul;178(1):145-52.
312. Rovner E, Probert KJ, Brensinger C, Wein AJ, Foy M, Kirkemo A, et al. Treatments used in women with interstitial cystitis: The interstitial cystitis data base (ICDB) study experience. The interstitial cystitis data base study group. *Urology* 2000, Dec 20;56(6):940-5.
313. Gordon B, Shorter B, Sarcona A, Moldwin RM. Nutritional considerations for patients with interstitial cystitis/bladder pain syndrome. *J Acad Nutr Diet* 2015, Sep;115(9):1372-9.
314. Rummans TA. Nonopioid agents for treatment of acute and subacute pain. *Mayo Clin Proc* 1994, May;69(5):481-90.
315. Backonja M, Beydoun A, Edwards KR, Schwartz SL, et al.. Gabapentin for the symptomatic treatment of painful neuropathy in patients with diabetes mellitus. *JAMA* 1998;280:1831-6.
316. Rowbotham M, Harden N, Stacey B, Bernstein P, Magnus-Miller L. Gabapentin for the treatment of postherpetic neuralgia: A randomized controlled trial. *JAMA* 1998, Dec 2;280(21):1837-42.
317. Gilron I, Bailey JM, Tu D, Holden RR, Weaver DF, Houlden RL. Morphine, gabapentin, or their combination for neuropathic pain. *NEJM* 2005, Mar 31;352(13):1324-34.
318. Hansen HC. Interstitial cystitis and the potential role of gabapentin. *South Med J* 2000, Feb;93(2):238-42.
319. Sasaki K, Smith CP, Chuang YC, Lee JY, Kim JC, Chancellor MB. Oral gabapentin (neurontin) treatment of refractory genitourinary tract pain. *Tech Urol* 2001, Mar;7(1):47-9.
320. Lee JW, Han DY, Jeong HJ. Bladder pain syndrome treated with triple therapy with gabapentin, amitriptyline, and a nonsteroidal anti-inflammatory drug. *Int Neurourol J* 2010, Dec;14(4):256-60.
321. Freynhagen R, Strojek K, Griesing T, Whalen E, Balkenohl M. Efficacy of pregabalin in neuropathic pain evaluated in a 12-week, randomised, double-blind, multicentre, placebo-controlled trial of flexible- and fixed-dose regimens. *Pain* 2005, Jun;115(3):254-63.
322. Arnold LM, Russell IJ, Diri EW, Duan WR, Young JP,, Sharma U, et al. A 14-week, randomized, double-blinded, placebo-controlled monotherapy trial of pregabalin in patients with fibromyalgia. *J Pain* 2008, Jun 2.
323. Portenoy RK, Dole V, Joseph H, Lowinson J, et al.. Pain management and chemical dependency. *JAMA* 1997;278:592-3.

324. Gourlay GK. Long-term use of opioids in chronic pain patients with nonterminal disease states. *Pain Rev* 1994;1:62-76.
325. Reid MC, Engles-Horton LL, Weber MB, Kerns RD, Rogers EL, O'Connor PG. Use of opioid medications for chronic noncancer pain syndromes in primary care. *J Gen Intern Med* 2002, Mar;17(3):173-9.
326. Portenoy RK, Foley KM. Chronic use of opioid analgesics in nonmalignant pain: Report of 38 cases. *Pain* 1986:171-86.
327. Nickel JC. Opioids for chronic prostatitis and interstitial cystitis: Lessons learned from the 11th world congress on pain. *Urology* 2006, Oct;68(4):697-701.
328. Richelson E. Tricyclic antidepressants and histamine H1 receptors. *Mayo Clin Proc* 1979, Oct;54(10):669-74.
329. Hanno PM. Amitriptyline in the treatment of interstitial cystitis. *Urol Clin North Am* 1994;21:89-.
330. Hanno PM, Wein AJ. Conservative therapy of interstitial cystitis. *Semin Urol* 1991, May;9(2):143-7.
331. Kirkemo AK, Miles BJ, Peters JM. Use of amitriptyline in the treatment of interstitial cystitis. *Journal of Urology* 1990;143:279A-.
332. Prankoff K, Constantino G. The use of amitriptyline in patients with urinary frequency and pain. *Urology* 1998, May;51(5A Suppl):179-81.
333. van Ophoven A, Pokupic S, Heinecke A, Hertle L. A prospective, randomized, placebo controlled, double-blind study of amitriptyline for the treatment of interstitial cystitis. *J Urol* 2004, Aug;172(2):533-6.
334. van Ophoven A, Hertle L. Long-term results of amitriptyline treatment for interstitial cystitis. *J Urol* 2005, Nov;174(5):1837-40.
335. Yang W, Probert KJ, Richard Landis J. Estimating the efficacy of an interstitial cystitis/painful bladder syndrome medication in a randomized trial with both non-adherence and loss to follow-up. *Stat Med* 2014, Sep 10;33(20):3547-55.
336. Sun Y, Fang Z, Ding Q, Zheng J. Effect of amitriptyline in treatment interstitial cystitis or bladder pain syndrome according to two criteria: Does ESSIC criteria change the response rate? *Neurourol Urodyn* 2014, Mar;33(3):341-4.
337. Wammack R, Remzi M, Seitz C, Djavan B, Marberger M. Efficacy of oral doxepin and piroxicam treatment for interstitial cystitis. *Eur Urol* 2002, Jun;41(6):596-600.
338. Renshaw DC. Desipramine for interstitial cystitis. *JAMA* 1988, Jul 15;260(3):341-.
339. van Ophoven A, Hertle L. The dual serotonin and noradrenaline reuptake inhibitor duloxetine for the treatment of interstitial cystitis: Results of an observational study. *J Urol* 2007, Feb;177(2):552-5.
340. Simmons JL, Bunce PL. On the use of an antihistamine in the treatment of interstitial cystitis. *Am Surg* 1958, Sep;24(9):664-7.
341. Simmons JL. Interstitial cystitis: An explanation for the beneficial effect of an antihistamine. *Journal of Urology* 1961;85:149-55.
342. Minogiannis P, El Mansoury M, Betances JA, Sant GR, Theoharides TC. Hydroxyzine inhibits neurogenic bladder mast cell activation. *Int J Immunopharmacol* 1998, Oct;20(10):553-63.
343. Theoharides TC. Hydroxyzine for interstitial cystitis. *J Allergy Clin Immunol* 1993, Feb;91(2):686-7.
344. Theoharides TC. Hydroxyzine in the treatment of interstitial cystitis. *Urol Clin North Am* 1994, Feb;21(1):113-9.
345. Theoharides TC, Sant GR, Sant GR. Hydroxyzine for symptomatic relief of interstitial cystitis symptoms. In: *Interstitial Cystitis*. Philadelphia: Lippincott-Raven; 1997s. p. 241-6.
346. Sant GR, Probert KJ, Hanno PM, Burks D, Culkun D, Diokno AC, et al. A pilot clinical trial of oral pentosan polysulfate and oral hydroxyzine in patients with interstitial cystitis. *J Urol* 2003, Sep;170(3):810-5.
347. Seshadri P, Emerson L, Morales A. Cimetidine in the treatment of interstitial cystitis. *Urology* 1994, Oct;44(4):614-6.
348. Lewi HJ. Cimetidine in the treatment of interstitial cystitis. *British Journal of Urology* 1996;77(supplement 1):28-.
349. Lewi H. Medical therapy in interstitial cystitis: The Essex experience. *Urology* 2001, Jun;57(6 Suppl 1):120-.
350. Thilagarajah R, Witherow RO, Walker MM. Oral cimetidine gives effective symptom relief in painful bladder disease: A prospective, randomized, double-blind placebo-controlled trial. *BJU Int* 2001, Feb;87(3):207-12.
351. Forsell T, Ruutu M, Isoniemi H, Ahonen J, Alfthan O. Cyclosporine in severe interstitial cystitis. *J Urol* 1996, May;155(5):1591-3.
352. Sairanen J, Forsell T, Ruutu M. Long-term outcome of patients with interstitial cystitis treated with low dose cyclosporine A. *J Urol* 2004, Jun;171(6 Pt 1):2138-41.

353. Sairanen J, Tammela TL, Leppilahti M, Multanen M, Paananen I, Lehtoranta K, Ruutu M. Cyclosporine A and pentosan polysulfate sodium for the treatment of interstitial cystitis: A randomized comparative study. *J Urol* 2005, Dec;174(6):2235-8.
354. Sairanen J, Hotakainen K, Tammela TL, Stenman UH, Ruutu M. Urinary epidermal growth factor and interleukin-6 levels in patients with painful bladder syndrome/interstitial cystitis treated with cyclosporine or pentosan polysulfate sodium. *Urology* 2008, Apr;71(4):630-3.
355. Forrest JB, Payne CK, Erickson DR. Cyclosporine A for refractory interstitial cystitis/bladder pain syndrome: Experience of 3 tertiary centers. *J Urol* 2012, Oct;188(4):1186-91.
356. Ueda T, Tamaki M, Ogawa O, Yamauchi T, Yoshimura N. Improvement of interstitial cystitis symptoms and problems that developed during treatment with oral IPD-1151T. *J Urol* 2000, Dec;164(6):1917-20.
357. Oravisto KJ, Alfthan OS. Treatment of interstitial cystitis with immunosuppression and chloroquine derivatives. *Eur Urol* 1976;2(2):82-4.
358. Badenoch AW. Chronic interstitial cystitis. *Br J Urol* 1971, Dec;43(6):718-21.
359. Taneja R, Jawade KK. A rational combination of intravesical and systemic agents for the treatment of interstitial cystitis. *Scand J Urol Nephrol* 2007;41(6):511-5.
360. Pool TL. Interstitial cystitis: Clinical considerations and treatment. *Clin Obstet Gynecol* 1967, Mar;10(1):185-91.
361. Soucy F, Gregoire M. Efficacy of prednisone for severe refractory ulcerative interstitial cystitis. *J Urol* 2005, Mar;173(3):841-3.
362. Parsons CL. Bladder surface glycosaminoglycan: Efficient mechanism of environmental adaptation. *Urology* 1986, Feb;27(2 Suppl):9-14.
363. Chiang G, Patra P, Letourneau R, Jeudy S, Boucher W, Green M, et al. Pentosan polysulfate inhibits mast cell histamine secretion and intracellular calcium ion levels: An alternative explanation of its beneficial effect in interstitial cystitis. *J Urol* 2000, Dec;164(6):2119-25.
364. Sadhukhan PC, Tchetgen MB, Rackley RR, Vasavada SP, Liou L, Bandyopadhyay SK. Sodium pentosan polysulfate reduces urothelial responses to inflammatory stimuli via an indirect mechanism. *J Urol* 2002, Jul;168(1):289-92.
365. Parsons CL, Schmidt JD, Pollen JJ. Successful treatment of interstitial cystitis with sodium pentosan polysulfate. *J Urol* 1983, Jul;130(1):51-3.
366. Parsons CL, Mulholland SG. Successful therapy of interstitial cystitis with pentosan polysulfate. *J Urol* 1987, Sep;138(3):513-6.
367. Holm-Bentzen M, Jacobsen F, Nerstrom B, Lose G, Kristensen JK, Pedersen RH, et al. A prospective double-blind clinically controlled multicenter trial of sodium pentosan polysulfate in the treatment of interstitial cystitis and related painful bladder disease. *J Urol* 1987, Sep;138(3):503-7.
368. Mulholland SG, Hanno P, Parsons CL, Sant GR, Staskin DR. Pentosan polysulfate sodium for therapy of interstitial cystitis. A double-blind placebo-controlled clinical study. *Urology* 1990, Jun;35(6):552-8.
369. Parsons CL, Benson G, Childs SJ, Hanno P, Sant GR, Webster G. A quantitatively controlled method to study prospectively interstitial cystitis and demonstrate the efficacy of pentosan polysulfate. *J Urol* 1993, Sep;150(3):845-8.
370. Nickel JC, Herschorn S, Whitmore KE, Forrest JB, Hu P, Friedman AJ, Baseman AS. Pentosan polysulfate sodium for treatment of interstitial cystitis/bladder pain syndrome: Insights from a randomized, double-blind, placebo-controlled study. *J Urol* 2014, Sep 19.
371. Nickel JC, Barkin J, Forrest J, Mosbaugh PG, Hernandez-Graulau J, Kaufman D, et al. Randomized, double-blind, dose-ranging study of pentosan polysulfate sodium for interstitial cystitis. *Urology* 2005, Apr;65(4):654-8.
372. Al-Zahrani AA, Gajewski JB. Long-term efficacy and tolerability of pentosan polysulfate sodium in the treatment of bladder pain syndrome. *Can Urol Assoc J* 2011, Apr;5(2):113-8.
373. Chuang YC, Lee WC, Lee WC, Chiang PH. Intravesical liposome versus oral pentosan polysulfate for interstitial cystitis/painful bladder syndrome. *J Urol* 2009, Oct;182(4):1393-400.
374. Nickel JC, Kaufman DM, Zhang HF, Wan GJ, Sand PK. Time to initiation of pentosan polysulfate sodium treatment after interstitial cystitis diagnosis: Effect on symptom improvement. *Urology* 2008, Jan;71(1):57-61.
375. Hanno PM. Analysis of long-term Elmiron therapy for interstitial cystitis. *Urology* 1997, May;49(5A Suppl):93-9.
376. Jepsen JV, Sall M, Rhodes PR, Schmidt D, Messing E, Bruskewitz RC. Long-term experience with pentosan polysulfate in interstitial cystitis. *Urology* 1998, Mar;51(3):381-7.
377. Foster HE, Smith S, Wheeler M, Weiss RM. Nitric oxide and interstitial cystitis. *Adv Urol* 1997;10:1-25.
378. Smith SD, Wheeler MA, Foster HE, Weiss RM. Improvement in interstitial cystitis symptom

- scores during treatment with oral L-arginine. *J Urol* 1997, Sep;158(3 Pt 1):703-8.
379. Ehren I, Lundberg JO, Adolfsson J, Wiklund NP. Effects of L-arginine treatment on symptoms and bladder nitric oxide levels in patients with interstitial cystitis. *Urology* 1998, Dec;52(6):1026-9.
 380. Korting GE, Smith SD, Wheeler MA, Weiss RM, Foster HE. A randomized double-blind trial of oral L-arginine for treatment of interstitial cystitis. *J Urol* 1999, Feb;161(2):558-65.
 381. Cartledge JJ, Davies AM, Eardley I. A randomized double-blind placebo-controlled crossover trial of the efficacy of L-arginine in the treatment of interstitial cystitis. *BJU Int* 2000, Mar;85(4):421-6.
 382. Katske F, Shoskes DA, Sender M, Poliakin R, Gagliano K, Rajfer J. Treatment of interstitial cystitis with a quercetin supplement. *Tech Urol* 2001, Mar;7(1):44-6.
 383. Warren JW, Horne LM, Hebel JR, Marvel RP, Keay SK, Chai TC. Pilot study of sequential oral antibiotics for the treatment of interstitial cystitis. *J Urol* 2000, Jun;163(6):1685-8.
 384. Burkhard FC, Blick N, Hochreiter WW, Studer UE. Urinary urgency and frequency, and chronic urethral and/or pelvic pain in females. Can doxycycline help? *J Urol* 2004, Jul;172(1):232-5.
 385. Maskell R. Broadening the concept of urinary tract infection. *British Journal of Urology* 1995;76:2-8.
 386. Moran PA, Dwyer PL, Carey MP, Maher CF, Radford NJ. Oral methotrexate in the management of refractory interstitial cystitis. *Aust N Z J Obstet Gynaecol* 1999, Nov;39(4):468-71.
 387. Treatment of interstitial cystitis with montelukast (singulair) a leukotriene D4 receptor antagonist; Minneapolis: National Institute of Diabetes and Digestive and Kidney Disorders; 2000e.
 388. Fleischmann J. Calcium channel antagonists in the treatment of interstitial cystitis. *Urol Clin North Am* 1994, Feb;21(1):107-11.
 389. Kelly JD, Young MR, Johnston SR, Keane PF. Clinical response to an oral prostaglandin analogue in patients with interstitial cystitis. *Eur Urol* 1998;34(1):53-6.
 390. Evans RJ, Moldwin RM, Cossons N, Darekar A, Mills IW, Scholfield D. Proof of concept trial of tanezumab for the treatment of symptoms associated with interstitial cystitis. *J Urol* 2011, May;185(5):1716-21.
 391. Zhang E, Zhu X, Han S, Peng Z, Wang W, Li J, Yang Y. Increased expression of TNF ligand-related molecule 1A and death receptor 3 in bladder tissues of patients with painful bladder syndrome/interstitial cystitis. *Exp Ther Med* 2013, Jan;5(1):282-6.
 392. Bosch PC. A randomized, double-blind, placebo controlled trial of adalimumab in the treatment of interstitial cystitis/bladder pain syndrome. *J Urol* 2013, Jun 20.
 393. Nickel JC, Crossland A, Davis E, Haab F, Mills IW, Rovner E, et al. Investigation of a Ca²⁺ channel $\alpha 2\delta$ ligand for the treatment of interstitial cystitis: Results of a randomized, double-blind, placebo controlled phase II trial. *J Urol* 2012, Sep;188(3):817-23.
 394. Nickel JC, Egerdie B, Davis E, Evans R, Mackenzie L, Shrewsbury SB. A phase II study of efficacy and safety of a novel, oral SHIP1 activator, AQX-1125, in subjects with moderate to severe interstitial cystitis/bladder pain syndrome (IC/BPS). *J Urol* 2016, Mar 8.
 395. Chen H, Wang F, Chen W, Ye XT, Zhou Q, Shao F, et al. Efficacy of daily low-dose sildenafil for treating interstitial cystitis: Results of a randomized, double-blind, placebo-controlled trial-treatment of interstitial cystitis/painful bladder syndrome with low-dose sildenafil. *Urology* 2014, May 14.
 396. Madersbacher H, van Ophoven A, van Kerrebroeck PE. GAG layer replenishment therapy for chronic forms of cystitis with intravesical glycosaminoglycans--a review. *Neurourol Urodyn* 2013, Jan;32(1):9-18.
 397. Barua JM, Arance I, Angulo JC, Riedl CR. A systematic review and meta-analysis on the efficacy of intravesical therapy for bladder pain syndrome/interstitial cystitis. *Int Urogynecol J* 2015, Nov 20;27(8):1137-47.
 398. DeJuana CP, Everett JC. Interstitial cystitis: Experience and review of recent literature. *Urology* 1977, Oct;10(4):325-9.
 399. Ingelman-Sundberg A. Urge incontinence in women. *Acta Obstet Gynecol Scand* 1975;54(2):153-6.
 400. Kerr WS. Interstitial cystitis: Treatment by transurethral resection. *J Urol* 1971, May;105(5):664-6.
 401. Pool TL, Rives HF. Interstitial cystitis: Treatment with silver nitrate. *Journal of Urology* 1944;51:520-5.
 402. Messing EM, Freiha FS. Complication of clorpactin WCS90 therapy for interstitial cystitis. *Urology* 1979, Apr;13(4):389-92.
 403. MERTZ JH, Nourse MH, WISHARD WN. Use of clorpactin WCS 90 for relief of symptoms due to interstitial cystitis. *Trans Am Assoc Genitourin Surg* 1956;48:86-9.

404. O'Connor VJ. Clorpactin WCS-90 in the treatment of interstitial cystitis. *Q Bull Northwest Univ Med Sch* 1955;29(4):392-5.
405. SOKOL JK. Treatment of interstitial cystitis with clorpactin. *Postgrad Semin Am Urol Assoc North Cent* 1957;36:104-6.
406. Wishard W., Nourse MH, Mertz JH. Use of clorpactin WCS 90 for relief of symptoms due to interstitial cystitis. *J Urol* 1957, Mar;77(3):420-3.
407. Peeker R, Haghsheno MA, Holmang S, Fall M. Intravesical bacillus calmette-guerin and dimethyl sulfoxide for treatment of classic and non-ulcer interstitial cystitis: A prospective, randomized double-blind study. *J Urol* 2000, Dec;164(6):1912-5.
408. Perez-Marrero R, Emerson LE, Feltis JT. A controlled study of dimethyl sulfoxide in interstitial cystitis. *J Urol* 1988, Jul;140(1):36-9.
409. Fowler JE., Prospective study of intravesical dimethyl sulfoxide in treatment of suspected early interstitial cystitis. *Urology* 1981, Jul;18(1):21-6.
410. Ghoniem GM, McBride D, Sood OP, Lewis V. Clinical experience with multiagent intravesical therapy in interstitial cystitis patients unresponsive to single-agent therapy. *World J Urol* 1993;11(3):178-82.
411. Nishimura M, Takano Y, Toshitani S. Systemic contact dermatitis medicamentosa occurring after intravesical dimethyl sulfoxide treatment for interstitial cystitis. *Arch Dermatol* 1988, Feb;124(2):182-3.
412. Okamura K, Mizunaga M, Arima S, Tokunaka S, Inada F, Takamura T, Yachiku S. [The use of dimethyl sulfoxide in the treatment of intractable urinary frequency]. *Hinyokika Kiyo* 1985, Apr;31(4):627-31.
413. Ruiz JL, Alonso M, Moreno B, Server G, Osca JM, Jimenez JF. [Dimethyl sulfoxide in the treatment of interstitial cystitis]. *Actas Urol Esp* 1991, Jul;15(4):357-60.
414. Shirley SW, Stewart BH, Mirelman S. Dimethyl sulfoxide in treatment of inflammatory genitourinary disorders. *Urology* 1978, Mar;11(3):215-20.
415. Sotolongo JR., Swerdlow F, Schiff HI, Schapira HE. Successful treatment of lupus erythematosus cystitis with DMSO. *Urology* 1984, Feb;23(2):125-7.
416. Rossberger J, Fall M, Peeker R. Critical appraisal of dimethyl sulfoxide treatment for interstitial cystitis: Discomfort, side-effects and treatment outcome. *Scand J Urol Nephrol* 2005;39(1):73-7.
417. Sant GR. Intravesical 50% dimethyl sulfoxide (rimso-50) in treatment of interstitial cystitis. *Urology* 1987, Apr;29(4 Suppl):17-21.
418. Rubin LF, Mattis PA. Dimethyl sulfoxide: Lens changes in dogs during oral administration. *Science* 1966;153(731):83-4.
419. Wood DC, Wirth NV. Changes in rabbit lenses following DMSO therapy. *Ophthalmologica* 1969;158S:488-93.
420. Melchior D, Packer CS, Johnson TC, Kaefer M. Dimethyl sulfoxide: Does it change the functional properties of the bladder wall? *J Urol* 2003, Jul;170(1):253-8.
421. Cvach K, Rosamilia A. Review of intravesical therapies for bladder pain syndrome/interstitial cystitis. *Transl Androl Urol* 2015, Dec;4(6):629-37.
422. Flores-Carreras O, González-Ruiz MI, Martínez-Espinoza CJ, Monroy-Rodríguez F, Zaragoza-Torres RM. Interstitial cystitis/painful bladder syndrome: Diagnostic evaluation and therapeutic response in a private urogynecology unit. *Transl Androl Urol* 2015, Dec;4(6):620-3.
423. Gafni-Kane A, Botros SM, Du H, Sand RI, Sand PK. Measuring the success of combined intravesical dimethyl sulfoxide and triamcinolone for treatment of bladder pain syndrome/interstitial cystitis. *Int Urogynecol J* 2013, Feb;24(2):303-11.
424. Hanno PM, Parsons CL, Shrom SH, Fritz R, Mulholland SG. The protective effect of heparin in experimental bladder infection. *Journal of Surgical Research* 1978;25:324-6.
425. Hanno PM, Fritz R, Wein AJ. Heparin as an antibacterial agent in rabbit bladder. *Urology* 1978;12:411-5.
426. Kuo HC. Urodynamic results of intravesical heparin therapy for women with frequency urgency syndrome and interstitial cystitis. *J Formos Med Assoc* 2001, May;100(5):309-14.
427. Parsons CL, Housley T, Schmidt JD, Lebow D. Treatment of interstitial cystitis with intravesical heparin. *Br J Urol* 1994, May;73(5):504-7.
428. Perez-Marrero R, Emerson LE, Maharajh DO, et.al.. Prolongation of response to DMSO by heparin maintenance. *Urology* 1993;41 (suppl):64-6.
429. Parsons CL, Koziol JA, Proctor JG, Zupkas P, Argade S. Heparin and alkalized lidocaine versus alkalized lidocaine for treatment of interstitial cystitis symptoms. *Can J Urol* 2015, Apr;22(2):7739-44.
430. Parsons CL. Successful downregulation of bladder sensory nerves with combination of

heparin and alkalized lidocaine in patients with interstitial cystitis. *Urology* 2005, Jan;65(1):45-8.

431. Iavazzo C, Athanasiou S, Pitsouni E, Falagas ME. Hyaluronic acid: An effective alternative treatment of interstitial cystitis, recurrent urinary tract infections, and hemorrhagic cystitis? *Eur Urol* 2007, Mar 20.
432. Kallestrup EB, Jorgensen SS, Nordling J, Hald T. Treatment of interstitial cystitis with cystistat: A hyaluronic acid product. *Scand J Urol Nephrol* 2005;39(2):143-7.
433. Leppilahti M, Hellstrom P, Tammela TL. Effect of diagnostic hydrodistension and four intravesical hyaluronic acid instillations on bladder ICAM-1 intensity and association of ICAM-1 intensity with clinical response in patients with interstitial cystitis. *Urology* 2002, Jul;60(1):46-51.
434. Morales A, Emerson L, Nickel JC. Intravesical hyaluronic acid in the treatment of refractory interstitial cystitis. *Urology* 1997, May;49(5A Suppl):111-3.
435. Morales A, Emerson L, Nickel JC, Lundie M. Intravesical hyaluronic acid in the treatment of refractory interstitial cystitis. *J Urol* 1996, Jul;156(1):45-8.
436. Porru D, Campus G, Tudino D, Valdes E, Vespa A, Scarpa RM, Usai E. Results of treatment of refractory interstitial cystitis with intravesical hyaluronic acid. *Urol Int* 1997;59(1):26-9.
437. Yang JY, Wei W, Lan YL, Liu JQ, Wang HB, Li S. Role of bladder hydrodistention and intravesical sodium hyaluronate in the treatment of interstitial cystitis. *Urol J* 2015;12(6):2417-21.
438. Engelhardt PF, Morakis N, Daha LK, Esterbauer B, Riedl CR. Long-term results of intravesical hyaluronan therapy in bladder pain syndrome/interstitial cystitis. *Int Urogynecol J* 2011, Apr;22(4):401-5.
439. Kim A, Lim B, Song M, Choo MS. Pretreatment features to influence effectiveness of intravesical hyaluronic acid instillation in refractory interstitial cystitis/painful bladder syndrome. *Int Neurourol J* 2014, Sep;18(3):163-7.
440. Lv YS, Zhou HL, Mao HP, Gao R, Wang YD, Xue XY. Intravesical hyaluronic acid and alkalized lidocaine for the treatment of severe painful bladder syndrome/interstitial cystitis. *Int Urogynecol J* 2012, May 11;23(12):1715-20.
441. Gülpınar O, Haliloğlu AH, Gökçe Mİ, Arıkan N. Instillation of hyaluronic acid via electromotive drug administration can improve the efficacy of treatment in patients with interstitial cystitis/painful bladder syndrome: A randomized prospective study. *Korean J Urol* 2014, May;55(5):354-9.
442. Shao Y, Shen ZJ, Rui WB, Zhou WL. Intravesical instillation of hyaluronic acid prolonged the effect of bladder hydrodistention in patients with severe interstitial cystitis. *Urology* 2010, Mar;75(3):547-50.
443. Janssen DA, van Wijk XM, Jansen KC, van Kuppevelt TH, Heesakkers JP, Schalken JA. The distribution and function of chondroitin sulfate and other sulfated glycosaminoglycans in the human bladder and their contribution to the protective bladder barrier. *J Urol* 2013, Jan;189(1):336-42.
444. Steinhoff G, Ittah B, Rowan S. The efficacy of chondroitin sulfate 0.2% in treating interstitial cystitis. *Can J Urol* 2002, Feb;9(1):1454-8.
445. Porru D, Cervigni M, Nasta L, Natale F, Lo VR, Tinelli C, et al. Results of endovesical hyaluronic acid/chondroitin sulfate in the treatment of interstitial cystitis/painful bladder syndrome. *Rev Recent Clin Trials* 2008, May;3(2):126-9.
446. Sorensen RB. Chondroitin sulphate in the treatment of interstitial cystitis and chronic inflammatory disease of the urinary bladder. *Eur Urol* 2003;suppliment 2:14-6.
447. Nordling J, van OA. Intravesical glycosaminoglycan replenishment with chondroitin sulphate in chronic forms of cystitis. A multi-national, multi-centre, prospective observational clinical trial. *Arzneimittelforschung* 2008;58(7):328-35.
448. Nickel JC, Hanno P, Kumar K, Thomas H. Second multicenter, randomized, double-blind, parallel-group evaluation of effectiveness and safety of intravesical sodium chondroitin sulfate compared with inactive vehicle control in subjects with interstitial cystitis/bladder pain syndrome. *Urology* 2012, Jun;79(6):1220-4.
449. Thakkestian A, Nickel JC. Efficacy of intravesical chondroitin sulphate in treatment of interstitial cystitis/bladder pain syndrome (IC/BPS): Individual patient data (IPD) meta-analytical approach. *Can Urol Assoc J* 2013, May;7(5-6):195-200.
450. Nickel JC, Egerdie B, Downey J, Singh R, Skehan A, Carr L, Irvine-Bird K. A real-life multicentre clinical practice study to evaluate the efficacy and safety of intravesical chondroitin sulphate for the treatment of interstitial cystitis. *BJU Int* 2009, Jan;103(1):56-60.
451. Cervigni M, Natale F, Nasta L, Padoa A, Voi RL, Porru D. A combined intravesical therapy with hyaluronic acid and chondroitin for refractory painful bladder syndrome/interstitial cystitis. *Int Urogynecol J Pelvic Floor Dysfunct* 2008, Jul 13;19(7):943-7.

452. Cervigni M, Natale F, Nasta L, Mako A. Intravesical hyaluronic acid and chondroitin sulphate for bladder pain syndrome/interstitial cystitis: Long-term treatment results. *Int Urogynecol J* 2012, May 9;23(9):1187-92.
453. Gacci M, Saleh O, Giannesi C, Chini T, Della Camera PA, Detti B, et al. Bladder instillation therapy with hyaluronic acid and chondroitin sulfate improves symptoms of postradiation cystitis: Prospective pilot study. *Clin Genitourin Cancer* 2016, Feb 8.
454. Cervigni M, Sommariva M, Tenaglia R. A randomized open label, multicenter study of the efficacy and safety of intravesical hyaluronic acid and chondroitin sulfate versus dimethyl sulfoxide in women with bladder pain syndrome/interstitial cystitis. *Neurourol Urodyn* 2016;in press.
455. Bade JJ, Laseur M, Nieuwenburg A, van der Weele LT, Mensink HJ. A placebo-controlled study of intravesical pentosanpolysulphate for the treatment of interstitial cystitis. *Br J Urol* 1997, Feb;79(2):168-71.
456. Davis EL, El Khoudary SR, Talbott EO, Davis J, Regan LJ. Safety and efficacy of the use of intravesical and oral pentosan polysulfate sodium for interstitial cystitis: A randomized double-blind clinical trial. *J Urol* 2008, Jan;179(1):177-85.
457. Apostolidis A, Gonzales GE, Fowler CJ. Effect of intravesical resiniferatoxin (RTX) on lower urinary tract symptoms, urodynamic parameters, and quality of life of patients with urodynamic increased bladder sensation. *Eur Urol* 2006, Dec;50(6):1299-305.
458. Chen TY, Corcos J, Camel M, Ponsot Y, Tu LM. Prospective, randomized, double-blind study of safety and tolerability of intravesical resiniferatoxin (RTX) in interstitial cystitis (IC). *Int Urogynecol J Pelvic Floor Dysfunct* 2005, Jul;16(4):293-7.
459. Lazzeri M, Spinelli M, Beneforti P, Malaguti S, Giardiello G, Turini D. Intravesical infusion of resiniferatoxin by a temporary in situ drug delivery system to treat interstitial cystitis: A pilot study. *Eur Urol* 2004, Jan;45(1):98-102.
460. Peng CH, Kuo HC. Multiple intravesical instillations of low-dose resiniferatoxin in the treatment of refractory interstitial cystitis. *Urol Int* 2007;78(1):78-81.
461. Fagerli J, Fraser MO, deGroat WC, Chancellor MB, Flood HD, Smith D, Jordan ML. Intravesical capsaicin for the treatment of interstitial cystitis: A pilot study. *Can J Urol* 1999, Apr;6(2):737-44.
462. Payne CK, Mosbaugh PG, Forrest JB, Evans RJ, Whitmore KE, Antoci JP, et al. Intravesical resiniferatoxin for the treatment of interstitial cystitis: A randomized, double-blind, placebo controlled trial. *J Urol* 2005, May;173(5):1590-4.
463. Zeidman EJ, Helfrick B, Pollard C, Thompson IM. Bacillus calmette-guerin immunotherapy for refractory interstitial cystitis. *Urology* 1994, Jan;43(1):121-4.
464. Peters K, Diokno A, Steinert B, Yuhico M, Mitchell B, Krohta S, et al. The efficacy of intravesical tice strain bacillus calmette-guerin in the treatment of interstitial cystitis: A double-blind, prospective, placebo controlled trial. *J Urol* 1997, Jun;157(6):2090-4.
465. Peters KM, Diokno AC, Steinert BW, Gonzalez JA. The efficacy of intravesical bacillus calmette-guerin in the treatment of interstitial cystitis: Long-term followup. *J Urol* 1998, May;159(5):1483-6.
466. Mayer R, Propert KJ, Peters KM, Payne CK, Zhang Y, Burks D, et al. A randomized controlled trial of intravesical bacillus calmette-guerin for treatment refractory interstitial cystitis. *J Urol* 2005, Apr;173(4):1186-91.
467. Barbalias GA, Liatsikos EN, Athanasopoulos A, Nikiforidis G. Interstitial cystitis: Bladder training with intravesical oxybutynin. *J Urol* 2000, Jun;163(6):1818-22.
468. Gurpinar T, Wong HY, Griffith DP. Electromotive administration of intravesical lidocaine in patients with interstitial cystitis. *J Endourol* 1996, Oct;10(5):443-7.
469. Riedl CR, Knoll M, Plas E, Stephen RL, Pfluger H. Intravesical electromotive drug administration for the treatment of non-infectious chronic cystitis. *Int Urogynecol J Pelvic Floor Dysfunct* 1997;8(3):134-7.
470. Riedl CR, Knoll M, Plas E, Pfluger H. Electromotive drug administration and hydrodistention for the treatment of interstitial cystitis. *J Endourol* 1998, Jun;12(3):269-72.
471. Rosamilia A, Dwyer PL, Gibson J. Electromotive drug administration of lidocaine and dexamethasone followed by cystodistension in women with interstitial cystitis. *Int Urogynecol J Pelvic Floor Dysfunct* 1997;8(3):142-5.
472. Asklin B, Cassuto J. Intravesical lidocaine in severe interstitial cystitis. Case report. *Scand J Urol Nephrol* 1989;23(4):311-2.
473. Giannakopoulos X, Champilomatos P. Chronic interstitial cystitis. Successful treatment with intravesical idocaine. *Arch Ital Urol Nefrol Androl* 1992, Dec;64(4):337-9.
474. Henry R, Patterson L, Avery N, Tanzola R, Tod D, Hunter D, et al. Absorption of alkalized intravesical lidocaine in normal and inflamed

- bladders: A simple method for improving bladder anesthesia. *J Urol* 2001, Jun;165(6 Pt 1):1900-3.
475. Nickel JC, Moldwin R, Lee S, Davis EL, Henry RA, Wyllie MG. Intravesical alkalized lidocaine (PSD597) offers sustained relief from symptoms of interstitial cystitis and painful bladder syndrome. *BJU Int* 2009, Apr;103(7):910-8.
 476. Welk BK, Teichman JM. Dyspareunia response in patients with interstitial cystitis treated with intravesical lidocaine, bicarbonate, and heparin. *Urology* 2008, Jan;71(1):67-70.
 477. Henry RA, Morales A, Cahill CM. Beyond a simple anesthetic effect: Lidocaine in the diagnosis and treatment of interstitial cystitis/bladder pain syndrome. *Urology* 2015, May;85(5):1025-33.
 478. Chancellor MB, Fowler CJ, Apostolidis A, de Groat WC, Smith CP, Somogyi GT, Aoki KR. Drug insight: Biological effects of botulinum toxin A in the lower urinary tract. *Nat Clin Pract Urol* 2008, Jun;5(6):319-28.
 479. Smith CP, Radziszewski P, Borkowski A, Somogyi GT, Boone TB, Chancellor MB. Botulinum toxin a has antinociceptive effects in treating interstitial cystitis. *Urology* 2004, Nov;64(5):871-5.
 480. Giannantoni A, Cagini R, Del ZM, Proietti S, Quartesan R, Porena M, Piselli M. Botulinum A toxin intravesical injections for painful bladder syndrome: Impact upon pain, psychological functioning and quality of life. *Curr Drug Deliv* 2010, Dec;7(5):442-6.
 481. Kuo HC. Preliminary results of suburothelial injection of botulinum a toxin in the treatment of chronic interstitial cystitis. *Urol Int* 2005;75(2):170-4.
 482. Kuo HC, Chancellor MB. Comparison of intravesical botulinum toxin type A injections plus hydrodistention with hydrodistention alone for the treatment of refractory interstitial cystitis/painful bladder syndrome. *BJU Int* 2009, Sep;104(5):657-61.
 483. Kuo HC, Jiang YH, Tsai YC, Kuo YC. Intravesical botulinum toxin-a injections reduce bladder pain of interstitial cystitis/bladder pain syndrome refractory to conventional treatment - A prospective, multicenter, randomized, double-blind, placebo-controlled clinical trial. *Neurourol Urodyn* 2015, Apr 24.
 484. Akiyama Y, Nomiya A, Niimi A, Yamada Y, Fujimura T, Nakagawa T, et al. Botulinum toxin type A injection for refractory interstitial cystitis: A randomized comparative study and predictors of treatment response. *Int J Urol* 2015, Jun 2;22(9):835-41.
 485. Pinto R, Lopes T, Frias B, Silva A, Silva JA, Silva CM, et al. Trigonal injection of botulinum toxin A in patients with refractory bladder pain syndrome/interstitial cystitis. *Eur Urol* 2010, Sep;58(3):360-5.
 486. Pinto R, Lopes T, Costa D, Barros S, Silva J, Silva C, et al. Ulcerative and nonulcerative forms of bladder pain syndrome/interstitial cystitis do not differ in symptom intensity or response to onabotulinum toxin A. *Urology* 2014, May;83(5):1030-4.
 487. Lee CL, Kuo HC. Long-Term efficacy and safety of repeated intravesical onabotulinumtoxin injections plus hydrodistention in the treatment of interstitial cystitis/bladder pain syndrome. *Toxins (Basel)* 2015, Oct;7(10):4283-93.
 488. Tanagho EA, Schmidt RA, Orvis BR. Neural stimulation for control of voiding dysfunction: A preliminary report in 22 patients with serious neuropathic voiding disorders. *J Urol* 1989, Aug;142(2 Pt 1):340-5.
 489. Zermann DH, Weirich T, Wunderlich H, Reichelt O, Schubert J. Sacral nerve stimulation for pain relief in interstitial cystitis. *Urol Int* 2000;65(2):120-1.
 490. Maher CF, Carey MP, Dwyer PL, Schluter PL. Percutaneous sacral nerve root neuromodulation for intractable interstitial cystitis. *J Urol* 2001, Mar;165(3):884-6.
 491. Peters KM, Jayabalan N, Bui D, Killinger K, Chancellor M, Tyagi P. Effect of sacral neuromodulation on outcome measures and urine chemokines in interstitial cystitis/painful bladder syndrome patients. *Low Urin Tract Symptoms* 2015, May;7(2):77-83.
 492. Comiter CV. Sacral neuromodulation for the symptomatic treatment of refractory interstitial cystitis: A prospective study. *J Urol* 2003, Apr;169(4):1369-73.
 493. Whitmore KE, Payne CK, Diokno AC, Lukban JC. Sacral neuromodulation in patients with interstitial cystitis: A multicenter clinical trial. *Int Urogynecol J Pelvic Floor Dysfunct* 2003, Nov;14(5):305-8.
 494. Peters KM, Konstandt D. Sacral neuromodulation decreases narcotic requirements in refractory interstitial cystitis. *BJU Int* 2004, Apr;93(6):777-9.
 495. Elhilali MM, Khaled SM, Kashiwabara T, Elzayat E, Corcos J. Sacral neuromodulation: Long-term experience of one center. *Urology* 2005, Jun;65(6):1114-7.
 496. Zabihi N, Mourtzinou A, Maher MG, Raz S, Rodriguez LV. Short-term results of bilateral S2-S4 sacral neuromodulation for the treatment of

refractory interstitial cystitis, painful bladder syndrome, and chronic pelvic pain. *Int Urogynecol J Pelvic Floor Dysfunct* 2008, Apr;19(4):553-7.

497. Peters KM, Feber KM, Bennett RC. A prospective, single-blind, randomized crossover trial of sacral vs pudendal nerve stimulation for interstitial cystitis. *BJU Int* 2007, Oct;100(4):835-9.
498. Gajewski JB, Al-Zahrani AA. The long-term efficacy of sacral neuromodulation in the management of intractable cases of bladder pain syndrome: 14 years of experience in one centre. *BJU Int* 2011, Apr;107(8):1258-64.
499. Marinkovic SP, Gillen LM, Marinkovic CM. Minimum 6-year outcomes for interstitial cystitis treated with sacral neuromodulation. *Int Urogynecol J* 2011, Apr;22(4):407-12.
500. Ragab M, Tawfik A, Abo Elenen M, Elnady M, Elgamal O, Elkordy M, et al. Evaluation of percutaneous tibial nerve stimulation for treatment of refractory painful bladder syndrome. *Urology* 2015, Jul 15;86(4):707-11.
501. Istek A, Gungor Ugurlucan F, Yasa C, Gokyildiz S, Yalcin O. Randomized trial of long-term effects of percutaneous tibial nerve stimulation on chronic pelvic pain. *Arch Gynecol Obstet* 2014, Mar 12.
502. Dworkin RH, Turk DC, Wyrwich KW, Beaton D, Cleeland CS, Farrar JT, et al. Interpreting the clinical importance of treatment outcomes in chronic pain clinical trials: IMMPACT recommendations. *J Pain* 2008, Feb;9(2):105-21.
503. Melzack R. The short-form mcgill pain questionnaire. *Pain* 1987;30(2):191-7.
504. Melzack R. The mcgill pain questionnaire: Major properties and scoring methods. *Pain* 1975;1:277-99.
505. Nickel JC: A new approach to understanding and managing chronic prostatitis and interstitial cystitis. *Rev Urol*, 2010, 12:1, 67-68.
506. Milsom I, Andersch B. Effect of ibuprofen, naproxen sodium and paracetamol on intrauterine pressure and menstrual pain in dysmenorrhoea. *Br J Obstet Gynaecol* 1984;91(11):1129-35.
507. Zhang WY, Li PO. Efficacy of minor analgesics in primary dysmenorrhoea: A systemic review. *Br J Obstet Gynaecol* 1998;105(7):780-9.
508. Amar PJ, Schiff ER. Acetaminophen safety and hepatotoxicity--where do we go from here? *Expert Opin Drug Saf* 2007, Jul;6(4):341-55.
509. Krenzelok EP. The FDA acetaminophen advisory committee meeting - what is the future of acetaminophen in the united states? The perspective of a committee member. *Clin Toxicol (Phila)* 2009, Sep;47(8):784-9.
510. Schmidt LE, Dalhoff K, Poulsen HE. Acute versus chronic alcohol consumption in acetaminophen-induced hepatotoxicity. *Hepatology* 2002, Apr;35(4):876-82.
511. Gilroy DW, Tomlinson A, Willoughby DA. Differential effects of inhibitors of cyclooxygenase (cyclooxygenase 1 and cyclooxygenase 2) in acute inflammation. *Dev Neuropsychol* 1998;355:211-7.
512. Gilroy DW, Colville-Nash PR, Willis D, Chivers J, Paul-Clark MJ, Willoughby DA. Inducible cyclooxygenase may have anti-inflammatory properties. *Nat Med* 1999;5(6):698-701.
513. Jones SF, Power I. Postoperative nsais and cox-2 inhibitors: Cardiovascular risks and benefits. *Br J Anaesth* 2005;95(3):281-4.
514. Furniss LD. Nonsteroidal anti-inflammatory agents in the treatment of primary dysmenorrhea. *Clin Pharmacol Ther* 1982;1(4):327-33.
515. Fall M, Baranowski AP, Elneil S, Engeler D, Hughes J, Messelink EJ, et al. EAU guidelines on chronic pelvic pain. *Eur Urol* 2010, Jan;57(1):35-48.
516. Christie MJ, Vaughan CW, Ingram SL. NSAIDs and 5-lipoxygenase inhibitors act synergistically in brain via arachidonic acid metabolism. *Inflamm Res* 1999;48(1):1-4.
517. McQuay HJ. A systematic review of antidepressants in neuropathic pain. *Dev Neuropsychol* 1996;68:217-27.
518. Hanno PM, Buehler J, Wein AJ. Use of amitriptyline in the treatment of interstitial cystitis. *J Urol* 1989, Apr;141(4):846-8.
519. Hanno PM, Wein AJ. Medical treatment of interstitial cystitis (other than rimso-50/elmiron). *Urology* 1987, Apr;29(4 Suppl):22-6.
520. Engel CC, Walker EA, Engel AL, Bullis J, Armstrong A. A randomized, double-blind crossover trial of sertraline in women with chronic pelvic pain. *J Psychosom Res* 1998;44(2):203-7.
521. Dworkin RH, OConnor AB, Backonja M, Farrar JT, Finnerup NB, Jensen TS. Pharmacologic management of neuropathic pain: Evidence-based recommendations. *Pain* 2007;132(3):237-51.
522. Wiffen PJ, McQuay HJ, Edwards JE, Moore RA. Gabapentin for acute and chronic pain. *Cochrane Database Syst Rev* 2005;3(CD005452).
523. Pontari M, Krieger JN, Litwin MS, White PC, Anderson RU, McNaughton-Collins M, et al.

- Pregabalin for the treatment of men with chronic prostatitis/chronic pelvic pain syndrome: A randomized controlled trial. *Arch Intern Med* 2010;170:1586-93.
524. Nickel C: Prostatitis and related conditions, orchitis, and epididymitis in *Campbell-Walsh Urology*, 2012, eds: Wein AJ, Kavoussi LR, Novick AC, Partin AW, and Peters CA, Elsevier, London
 525. Mikkelsen S, Ilkjaer S, Brennum J, Borgbjerg FM, Dahl JB. The effect of naloxone on ketamine-induced effects on hyperalgesia and ketamine-induced side effects in humans. *Anaesthesiology* 1999;90(6):1539-45.
 526. Guirimand F, Dupont X, Brasseur L, Chauvin M, Bouhassira D. The effects of ketamine on the temporal summation (wind-up) of the R(III) nociceptive flexion reflex and pain in humans. *Anesth Analg* 2000;90(2):408-14.
 527. Laurido C, Pelissier T, Perez H, Flores F, Hernandez A. Effect of ketamine on spinal cord nociceptive transmission in normal and monoarthritic rats. *Neuroreport* 2001;12(8):1551-4.
 528. Backonja M, Arndt G, Gombar KA, Check B, Zimmermann M. Response of chronic neuropathic pain syndromes to ketamine: A preliminary study. *Pain* 1994;56(1):51-7.
 529. Eide PK, Jorum E, Stubhaug A, Bremnes J, Breivik H. Relief of post-herpetic neuralgia with the n-methyl-d-aspartic acid receptor antagonist ketamine: A double-blind, cross-over comparison with morphine and placebo. *Pain* 1994;58(3):347-54.
 530. Graven-Nielsen T, Aspegren KS, Henriksson KG, Bengtsson M, Sorensen J, Johnson A. Ketamine reduces muscle pain, temporal summation, and referred pain in fibromyalgia patients. *Pain* 2000;85(3):483-91.
 531. Eide PK, Stubhaug A, Stenehjelm AE. Central dysesthesia pain after traumatic spinal cord injury is dependent on n-methyl-d-aspartate receptor activation. *Neurosurgery* 1995;37(6):1080-7.
 532. Sorensen J, Bengtsson A, Backman E, Henriksson KG, Bengtsson M. Pain analysis in patients with fibromyalgia. Effects of intravenous morphine, lidocaine, and ketamine. *Scand J Rheumatol* 1995;24(6):360-5.
 533. Middela S, Pearce I. Ketamine-induced vesicopathy: A literature review. *Int J Clin Pract* 2011, Jan;65(1):27-30.
 534. Kalso E, Edwards JE, Moore RA, McQuay HJ. Opioids in chronic non-cancer pain: Systematic review of efficacy and safety. *Pain* 2004, Dec;112(3):372-80.
 535. Provenzano DA, Viscusi ER. Rethinking the role of opioids in the outpatient management of chronic nonmalignant pain. *Curr Med Res Opin* 2014, Oct;30(10):2051-62.
 536. Kirpalani D. How to maximize patient safety when prescribing opioids. *PM R* 2015, Nov;7(11 Suppl):S225-35.
 537. Fall M, A B, CJ F, JG L, JG M-L, EJ M, et al. EAU guidelines on chronic pelvic pain. *Eur Urol* 2004;46:681-9.
 538. Zacny JP, Lichtor JL, Zaragoza JG, de Wit H. Subjective and behavioral responses to intravenous fentanyl in healthy volunteers. *Dev Neuropsychol* 1992;107:319-26.
 539. Schneider U, Bevalacqua C, Jacobs R, Karst M, Dietrich DE, Becker H. Effects of fentanyl and low doses of alcohol on neuropsychological performance in healthy subjects. *Neuropsychobiology* 2012;39(1):38-43.
 540. Hewitt DJ. The use of nmda-receptor antagonists in the treatment of chronic pain. *Clin J Pain* 2000;16(2 suppl):S73-9.
 541. Seifert CF, Kennedy S. Meperidine is alive and well in the new millennium: Evaluation of meperidine usage patterns and frequency of adverse drug reactions. *Pharmacotherapy* 2004;24(6):776-83.
 542. Cicero TJ, Dart RC, Inciardi JA, Woody GE, Schnoll S, Munoz A. The development of a comprehensive risk-management program for prescription opioid analgesics: Researched abuse, diversion and addiction-related surveillance (RADARS). *Pain Med* 2007;8:157-70.
 543. Desmeules JA, Piguat V, Collart L, Dayer P. Contribution of monoaminergic modulation to the analgesic effect of tramadol. *Br J Clin Pharmacol* 1996;41(1):7-12.
 544. Sagata K, Minami K, Yanagihara N, Shiraishi M, Toyohira Y, Ueno S. Tramadol inhibits norepinephrine transporter function at desipramine-binding sites in cultured bovine adrenal medullary cells. *Anesth Analg* 2002;94(4):901-6.
 545. Radbruch L, Grond S, Lehmann KA. A risk-benefit assessment of tramadol in the management of pain. *Drug Safety* 1996;15(1):8-29.
 546. Preston KL, Jasinski DR, Testa M. Abuse potential and pharmacological comparison of tramadol and morphine. *Drug Alcohol Dependence* 1991;27(1):7-17.
 547. Nadeau SE. Opioids for chronic noncancer pain: To prescribe or not to prescribe-what is the question? *Neurology* 2015, Aug 18;85(7):646-51.

548. Bumpus HC. Interstitial cystitis: Its treatment by overdistention of the bladder. *Med Cl N A* 1930;13:1495-8.
549. FRANKSSON C. Interstitial cystitis: A clinical study of fifty-nine cases. *Acta Chir Scand* 1957, May 31;113(1):51-62.
550. Helmstein K. Treatment of bladder carcinoma by a hydrostatic pressure technique. Report on 43 cases. *British Journal of Urology* 1972;44(4):434-50.
551. Dunn M, Ramsden PD, Roberts JB, Smith JC, Smith PJ. Interstitial cystitis, treated by prolonged bladder distension. *Br J Urol* 1977;49(7):641-5.
552. McCahy PJ, Styles RA. Prolonged bladder distension: Experience in the treatment of detrusor overactivity and interstitial cystitis. *Eur Urol* 1995;28(4):325-7.
553. Peterson A and Hager BH: Interstitial cystitis: report of cases. *Cal West Med* 1929, 31:4, 262-267
554. Greenberg E, Barnes R, Stewart S, Furnish T. Transurethral resection of hunner's ulcer. *J Urol* 1974;111(6):764-6.
555. Fall M. Conservative management of chronic interstitial cystitis: Transcutaneous electrical nerve stimulation and transurethral resection. *J Urol* 1985, May;133(5):774-8.
556. Peeker R, Aldenborg F, Fall M. Complete transurethral resection of ulcers in classic interstitial cystitis. *Int Urogynecol J Pelvic Floor Dysfunct* 2000;11(5):290-5.
557. Shanberg AM, Malloy T. Treatment of interstitial cystitis with neodymium:YAG laser. *Urology* 1987, Apr;29(4 Suppl):31-3.
558. Malloy TR, Shanberg AM. Laser therapy for interstitial cystitis. *Urol Clin North Am* 1994, Feb;21(1):141-4.
559. Rofeim O, Hom D, Freid RM, Moldwin RM. Use of the neodymium: YAG laser for interstitial cystitis: A prospective study. *J Urol* 2001, Jul;166(1):134-6.
560. Payne RA, O'Connor RC, Kressin M, Guralnick ML. Endoscopic ablation of hunner's lesions in interstitial cystitis patients. *Can Urol Assoc J* 2009, Dec;3(6):473-7.
561. Worth PH, Turner-Warwick R. The treatment of interstitial cystitis by cystolysis with observations on cystoplasty. *Br J Urol* 1973, Feb;45(1):65-71.
562. Worth PH. The treatment of interstitial cystitis by cystolysis with observations on cystoplasty. A review after 7 years. *Br J Urol* 1980, Jun;52(3):232-.
563. Albers DD, Geyer JR. Long-term results of cystolysis (supratrigonal denervation) of the bladder for intractable interstitial cystitis. *J Urol* 1988, Jun;139(6):1205-6.
564. Pieri G. Enervation ou ramisection? *Lookup* 1926;34:1141-2.
565. Douglass HL. Excision of the superior hypogastric plexus in the treatment of intractable interstitial cystitis. *Am J Surg* 1934;25:249-57.
566. Nesbit RM. Anterolateral chordotomy for refractory interstitial cystitis with intractable pain. *J Urology* 1947;57:741-5.
567. Moulder MK, Meirowsky AM. The management of hunner's ulcer by differential sacral neurectomy: Preliminary report. *J Urology* 1956;75:261-2.
568. MILNER WA, GARLICK WB. Selective sacral neurectomy in interstitial cystitis. *J Urol* 1957, Nov;78(5):600-4.
569. Mason, GL H, BW L. Selective sacral neurectomy for hunner's ulcer. *J Neurosurg* 1960;17:22-6.
570. BOHM E, FRANKSSON C. Interstitial cystitis and sacral rhizotomy. *Acta Chir Scand* 1957, May 31;113(1):63-7.
571. WE G, RD T, CC W. Results of ileocystoplasty. *J Urol* 1958;80:461-6.
572. von Garrelts B. Interstitial cystitis: Thirteen patients treated operatively with intestinal bladder substitutes. *Acta Chir Scand* 1966, Oct;132(4):436-43.
573. Webster GD, Maggio MI. The management of chronic interstitial cystitis by substitution cystoplasty. *J Urol* 1989, Feb;141(2):287-91.
574. Nielsen KK, Kromann-Andersen B, Steven K, Hald T. Failure of combined supratrigonal cystectomy and mainz ileocecocystoplasty in intractable interstitial cystitis: Is histology and mast cell count a reliable predictor for the outcome of surgery? *J Urol* 1990, Aug;144(2 Pt 1):255-8.
575. R, . The functional results of partial, subtotal, and total cystoplasty with special reference to ureterocystoplasty, selective sphincterotomy, and cystocystoplasty. *Br J Urol* 1967;39:3-12.
576. Kontturi MJ, Hellstrom PA, Tammela TL, Lukkarinen OA. Colocystoplasty for the treatment of severe interstitial cystitis. *Urol Int* 1991;46(1):50-4.
577. H H. Ileocystoplasty. A clinical review. *J Urol* 1959;82:317-.
578. Bruce PT, Buckham GJ, Carden AB, Salvaris M. The surgical treatment of chronic interstitial cystitis. *Med J Aust* 1977, Apr 16;1(16):581-2.

579. FJ H. Selection of intestinal segments for bladder substitution: Physical and physiological characteristics. *J Urol* 1988;139:519-23.
580. Awad SA, Al Zahrani HM, Gajewski JB, Bourque-Kehoe AA. Long-term results and complications of augmentation ileocystoplasty for idiopathic urge incontinence in women. *Br J Urol* 1998, Apr;81(4):569-73.
581. Christmas TJ, Holmes SA, Hendry WF. Bladder replacement by ileocystoplasty: The final treatment for interstitial cystitis. *Br J Urol* 1996, Jul;78(1):69-73.
582. Guillonneau B, Toussaint B, Bouchot O, Buzelin JM. [Treatment of interstitial cystitis with sub-trigonal cystectomy and enterocystoplasty]. *Prog Urol* 1993, Feb;3(1):27-31.
583. E K, M K. Function of the intestinal substituted bladder. *Scand J Urol Nephrol* 1982;16:129-33.
584. Shirley SW, Mirelman S. Experiences with colcystoplasties, cecocystoplasties and ileocystoplasties in urologic surgery: 40 patients. *J Urol* 1978, Aug;120(2):165-8.
585. H H. Bladder substitution: Indications and results in 114 operations. *J Urol* 1965;94:406-17.
586. Whitmore WF, Gittes RF. Reconstruction of the urinary tract by cecal and ileocecal cystoplasty: Review of a 15-year experience. *J Urol* 1983;129:494-8.
587. M H-B, P K, R O, T H. Cecocystoplasty: An evaluation of operative results. *Urol Int* 1986;41:21-5.
588. Seddon JM, Best L, Bruce AW. Intestinocystoplasty in treatment of interstitial cystitis. *Urology* 1977, Nov;10(5):431-5.
589. A S, N G. Early experience with the use of gastric segment in lower urinary tract reconstruction in adult patient population. *Urology* 1997;50:630-5.
590. Leong CH. Use of stomach for bladder replacement and urinary diversion. *Ann R Coll Surg Engl* 1978(60):282-9.
591. Dounis A, Gow JG. Bladder augmentation--a long-term review. *Br J Urol* 1979, Aug;51(4):264-8.
592. Linn JF, Hohenfellner M, Roth S, Dahms SE, Stein R, Hertle L, et al. Treatment of interstitial cystitis: Comparison of subtrigonal and supratrigonal cystectomy combined with orthotopic bladder substitution. *J Urol* 1998, Mar;159(3):774-8.
593. van Ophoven A, Oberpenning F, Hertle L. Long-term results of trigone-preserving orthotopic substitution enterocystoplasty for interstitial cystitis. *J Urol* 2002, Feb;167(2 Pt 1):603-7.
594. Peeker R, Aldenborg F, Fall M. The treatment of interstitial cystitis with supratrigonal cystectomy and ileocystoplasty: Difference in outcome between classic and nonulcer disease. *J Urol* 1998, May;159(5):1479-82.
595. Counseller VS. Bilateral transplantation of the ureters of the female. *Am J Obstet Gynecol* 1937;33:234-48.
596. Hohenfellner M, Black P, Linn JF, Dahms SE, Thuroff JW. Surgical treatment of interstitial cystitis in women. *Int Urogynecol J Pelvic Floor Dysfunct* 2000;11(2):113-9.
597. Lotenfue RR, Christie J, Parsons A, Burkett P, Helal M, Lockhart JL. Absence of neuropathic pelvic pain and favorable psychological profile in the surgical selection of patients with disabling interstitial cystitis. *J Urol* 1995, Dec;154(6):2039-42.
598. Bejany DE, Politano VA. Ileocolic neobladder in the woman with interstitial cystitis and a small contracted bladder. *J Urol* 1995, Jan;153(1):42-3.
599. Nurse DE, McCrae P, Stephenson TP, Mundy AR. The problems of substitution cystoplasty. *Br J Urol* 1988, May;61(5):423-6.
600. Hughes OD, Kynaston HG, Jenkins BJ, Stephenson TP, Vaughton KC. Substitution cystoplasty for intractable interstitial cystitis. *Br J Urol* 1995, Aug;76(2):172-4.
601. Nurse DE, Parry JR, Mundy AR. Problems in the surgical treatment of interstitial cystitis. *Br J Urol* 1991, Aug;68(2):153-4.
602. Gershbaum D, Moldwin R. Practice trends for the management of interstitial cystitis. *Urology* 2001, Jun;57(6 Suppl 1):119-.
603. Freiha FS, Faysal MH, Stamey TA. The surgical treatment of intractable interstitial cystitis. *J Urol* 1980, May;123(5):632-4.
604. L T. On the cure of the chronic perforating ulcer of the bladder by the formation of an artificial vesico-vaginal fistula. *Lancet* 1870;54:738-.
605. Andersen AV, Granlund P, Schultz A, Talseth T, Hedlund H, Frich L. Long-term experience with surgical treatment of selected patients with bladder pain syndrome/interstitial cystitis. *Scand J Urol Nephrol* 2012, Aug;46(4):284-9.
606. Norus T, Fode M, Nordling J. Ileal conduit without cystectomy may be an appropriate option in the treatment of intractable bladder pain syndrome/interstitial cystitis. *Scand J Urol* 2014, Apr;48(2):210-5.
607. Nordling J, Blaivas JG. Should urinary diversion for bladder pain syndrome/interstitial cystitis include cystectomy? *No. J Urol* 2014, Feb;191(2):293-5.

608. E A, NK B, S H, H A-E, M G, MA B, et al. Urinary conduit formation using a retubularized bowel from continent urinary diversion or intestinal augmentations: li. Does it have a role in patients with interstitial cystitis? *J Urol* 2004;171:1559-62.
609. Kisman OK, Nijeholt AA, van Krieken JH. Mast cell infiltration in intestine used for bladder augmentation in interstitial cystitis. *J Urol* 1991, Oct;146(4):1113-4.
610. McGuire EJ, Lytton B, Cornog JL,. Interstitial cystitis following colcystoplasty. *Urology* 1973, Jul;2(1):28-9.
611. MacDermott JP, Charpied GL, Tesluk H, Stone AR. Recurrent interstitial cystitis following cystoplasty: Fact or fiction? *J Urol* 1990, Jul;144(1):37-40.
612. Humphrey L, Arbuckle R, Moldwin R, Nordling J, van de Merwe JP, Meunier J, et al. The bladder pain/interstitial cystitis symptom score: Development, validation, and identification of a cut score. *Eur Urol* 2012, Feb;61(2):271-9.
613. Goin JE, Olaleye D, Peters KM, Steinert B, Habicht K, Wynant G. Psychometric analysis of the university of wisconsin interstitial cystitis scale: Implications for use in randomized clinical trials. *J Urol* 1998, Mar;159(3):1085-90.
614. Keller ML, McCarthy DO, Neider RS. Measurement of symptoms of interstitial cystitis. A pilot study. *Urol Clin North Am* 1994, Feb;21(1):67-71.
615. Lubeck DP, Whitmore K, Sant GR, Alvarez-Horine S, Lai C. Psychometric validation of the O'leary-sant interstitial cystitis symptom index in a clinical trial of pentosan polysulfate sodium. *Urology* 2001, Jun;57(6 Suppl 1):62-6.
616. O'leary MP, Sant GR, Fowler FJ,, Whitmore KE, Spolarich-Kroll J. The interstitial cystitis symptom index and problem index. *Urology* 1997, May;49(5A Suppl):58-63.
617. O'leary MP, Sant G, Sant G. The interstitial cystitis symptom and problem indices: Rationale, development, and application. In: *Interstitial Cystitis*. Philadelphia: Lippincott-Raven; 1997a. p. 271-6.
618. Parsons CL, Dell J, Stanford EJ, Bullen M, Kahn BS, Waxell T, Koziol JA. Increased prevalence of interstitial cystitis: Previously unrecognized urologic and gynecologic cases identified using a new symptom questionnaire and intravesical potassium sensitivity. *Urology* 2002, Oct;60(4):573-8.
619. Ito T, Tomoe H, Ueda T, Yoshimura N, Sant G, Hanno P. Clinical symptoms scale for interstitial cystitis for diagnosis and for following the course of the disease. *Int J Urol* 2003, Oct;10 Suppl:S24-6.
620. Kushner L, Moldwin RM. Efficiency of questionnaires used to screen for interstitial cystitis. *J Urol* 2006, Aug;176(2):587-92.
621. Sirinian E, Azevedo K, Payne CK. Correlation between 2 interstitial cystitis symptom instruments. *J Urol* 2005, Mar;173(3):835-40.
622. Clemons JL, Arya LA, Myers DL. Diagnosing interstitial cystitis in women with chronic pelvic pain. *Obstet Gynecol* 2002, Aug;100(2):337-41.
623. Porru D, Tinelli C, Gerardini M, Giliberto GL, Stancati S, Rovereto B. Evaluation of urinary and general symptoms and correlation with other clinical parameters in interstitial cystitis patients. *Neurourol Urodyn* 2005;24(1):69-73.
624. Diggs C, Meyer WA, Langenberg P, Greenberg P, Horne L, Warren JW. Assessing urgency in interstitial cystitis/painful bladder syndrome. *Urology* 2007, Feb;69(2):210-4.
625. Lasch KE, Marquis P, Vigneux M, Abetz L, Arnould B, Bayliss M, et al. PRO development: Rigorous qualitative research as the crucial foundation. *Qual Life Res* 2010, Oct;19(8):1087-96.
626. Leidy NK, Vernon M. Perspectives on patient-reported outcomes. *Pharmacoeconomics* 2008;26(5):363-70.
627. Propert KJ, Mayer RD, Wang Y, Sant GR, Hanno PM, Peters KM, Kusek JW. Responsiveness of symptom scales for interstitial cystitis. *Urology* 2006, Jan;67(1):55-9.
628. Tripp DA, Nickel JC, Wong J, Pontari M, Moldwin R, Mayer R, et al. Mapping of pain phenotypes in female patients with bladder pain syndrome/interstitial cystitis and controls. *Eur Urol* 2012, May 18;62(6):1188-94.
629. Clemens JQ, Calhoun EA, Litwin MS, McNaughton-Collins M, Kusek JW, Crowley EM, Landis JR. Validation of a modified national institutes of health chronic prostatitis symptom index to assess genitourinary pain in both men and women. *Urology* 2009, Nov;74(5):983-7, quiz.
630. Sech SM, Montoya JD, Bernier PA, Barnboym E, et.al. The so-called "placebo effect" in benign prostatic hyperplasia treatment trials represents partially a conditional regression to the mean induced by censoring. *Urology* 1998;51:242-50.
631. Gillespie L, Bray R, Levin N, Delamarter R. Lumbar nerve root compression and interstitial cystitis--response to decompressive surgery. *Br J Urol* 1991, Oct;68(4):361-4.

632. Gillespie L. Destruction of the vesicoureteric plexus for the treatment of hypersensitive bladder disorders. *Br J Urol* 1994, Jul;74(1):40-3.
633. Turner JA, Deyo RA, Loeser JD, et al.. The importance of placebo effects in pain treatment and research. *JAMA* 1994;271:1609-14.
634. Schulz KF, Chalmers I, Hayes RJ, et al.. Empirical evidence of bias; dimensions of methodological quality associated with estimates of treatment effects in controlled trials. *JAMA* 1995;273:408-12.
635. Rothman KJ, Michels KB. The continuing unethical use of placebo controls. *N Engl J Med* 1994;394-8.
636. Benson H, Epstein MD. The placebo effect. *JAMA* 1976;232:1225-6.
637. DuBeau CE, Khullar V, Versi E. "Unblinding" in randomized controlled drug trials for urinary incontinence: Implications for assessing outcomes when adverse effects are evident. *Neurourol Urodyn* 2005;24.
638. Rees JR, Wade TJ, Levy DA, Colford JM, Hilton JF. Changes in beliefs identify unblinding in randomized controlled trials: A method to meet CONSORT guidelines. *Contemporary Clinical Trials* 2005;26:25-37.
639. Desbiens NA. In randomized controlled trials, should subjects in both placebo and drug groups be expected to guess that they are taking drug 50% of the time? *Med Hypotheses* 2002, Sep;59(3):227-32.
640. Polman CH, Reingold SC, Barkhof F, Calabresi PA, Clanet M, Cohen JA, et al. Ethics of placebo-controlled clinical trials in multiple sclerosis: A reassessment. *Neurology* 2008, Mar 25;70(13 Pt 2):1134-40.
641. Anderson JA. The ethics and science of placebo-controlled trials: Assay sensitivity and the duhem-quine thesis. *J Med Philos* 2006, Feb;31(1):65-81.
642. Streiner DL. Placebo-controlled trials: When are they needed? *Schizophr Res* 1999, Feb 15;35(3):201-10.
643. Streiner DL. Alternatives to placebo-controlled trials. *Can J Neurol Sci* 2007, Mar;34 Suppl 1:S37-41.
644. Miller FG, Emanuel EJ, Rosenstein DL, Straus SE. Ethical issues concerning research in complementary and alternative medicine. *JAMA* 2004, Feb 4;291(5):599-604.
645. Chancellor MB, de Groat WC. Intravesical capsaicin and resiniferatoxin therapy: Spicing up the ways to treat the overactive bladder. *Journal of Urology* 1999;162:3-11.
646. Stone NN. Nalmefene in the treatment of interstitial cystitis. *Urol Clin North Am* 1994, Feb;21(1):101-6.
647. Probert KJ, Payne C, Kusek JW, Nyberg LM. Pitfalls in the design of clinical trials for interstitial cystitis. *Urology* 2002, Nov;60(5):742-8.
648. Ward MM. Interpreting measurements of physical function in clinical trials. *Ann Rheum Dis* 2007, Nov;66 Suppl 3:iii32-4.
649. Wein AJ, Broderick GA. Interstitial cystitis. Current and future approaches to diagnosis and treatment. *Urol Clin North Am* 1994, Feb;21(1):153-61.
650. Dworkin RH, Turk DC, Farrar JT, Haythornthwaite JA, Jensen MP, Katz NP, et al. Core outcome measures for chronic pain clinical trials: IMMPACT recommendations. *J Neuroimmunol* 2005, Jan;113:9-19.
651. Fall M, Hanno P, Nordling J. Bladder pain syndrome, interstitial cystitis, painful bladder syndrome, and hypersensitive bladder syndrome: New nomenclature/new guidelines. *Current Bladder Dysfunction Reports* 2011.
652. Hanno P, Lin AT, Nordling J, Nyberg L, van Ophoven A, Ueda T, et al. Bladder pain syndrome. In: *Incontinence*. Paris, France: Health Publication Ltd; 2009h. p. 1459-518.
653. Fall M, Oberpenning F, Peeker R. Treatment of bladder pain syndrome/interstitial cystitis 2008: Can we make evidence-based decisions? *Eur Urol* 2008, Apr 3;54(1):65-75.
654. Dimitrakov J, Kroenke K, Steers WD, Berde C, Zurakowski D, Freeman MR, Jackson JL. Pharmacologic management of painful bladder syndrome/interstitial cystitis: A systematic review. *Arch Intern Med* 2007, Oct 8;167(18):1922-9.
655. Nickel JC, Herschorn S, Whitmore KE, Forrest JB, Hu P, Friedman AJ, Baseman AS. Pentosan polysulfate sodium for treatment of interstitial cystitis/bladder pain syndrome: Insights from a randomized, double-blind, placebo controlled study. *J Urol* 2015, Mar;193(3):857-62.
656. Hill JR, Isom-Batz G, Panagopoulos G, Zakariassen K, Kavalier E. Patient perceived outcomes of treatments used for interstitial cystitis. *Urology* 2008, Jan;71(1):62-6.
657. Ingber MS, Peters KM, Killinger KA, Carrico DJ, Ibrahim IA, Diokno AC. Dilemmas in diagnosing pelvic pain: Multiple pelvic surgeries common in women with interstitial cystitis. *Int Urogynecol J Pelvic Floor Dysfunct* 2008, Mar;19(3):341-5.
658. Chung MK. Interstitial cystitis in persistent posthysterectomy chronic pelvic pain. *JSLs* 2004, Oct;8(4):329-33.

659. Carr LK, Corcos J, Nickel JC, Teichman J. Diagnosis of interstitial cystitis June 2007. *Can Urol Assoc J* 2009, Feb;3(1):81-6.
660. Engeler DS, Baranowski AP, Dinis-Oliveira P, Elnail S, Hughes J, Messelink EJ, et al. The 2013 EAU guidelines on chronic pelvic pain: Is management of chronic pelvic pain a habit, a philosophy, or a science? 10 years of development. *Eur Urol* 2013, Sep;64(3):431-9.
661. Esteban M, Adot JM, Arlandis S, Peri L, Prieto L, Salinas J, et al. Recommendations for the diagnosis and management of bladder pain syndrome. Spanish urological association consensus document. *Actas Urol Esp* 2015, May 27.
662. Homma Y, Ueda T, Tomoe H, Lin AT, Kuo HC, Lee MH, et al. Clinical guidelines for interstitial cystitis and hypersensitive bladder syndrome. *Int J Urol* 2009, Jul;16(7):597-615.
663. Homma Y, Ueda T, Tomoe H, Lin AT, Kuo HC, Lee MH, et al. Clinical guidelines for interstitial cystitis and hypersensitive bladder updated in 2015. *Int J Urol* 2016, May 24.
664. Hanno PM, Erickson D, Moldwin R, Faraday MM. Diagnosis and treatment of interstitial cystitis/bladder pain syndrome: AUA guideline amendment. *J Urol* 2015, Jan 23;193(5):1545-53.
665. Nickel JC, Irvine-Bird K, Jianbo L, Shoskes DA. Phenotype-directed management of interstitial cystitis/bladder pain syndrome. *Urology* 2014, May 8.
666. Ueda T, Nakagawa M, Okamura M, Tanoue H, Yoshida H, Yoshimura N. New cystoscopic diagnosis for interstitial cystitis/painful bladder syndrome using narrow-band imaging system. *Int J Urol* 2008, Dec;15(12):1039-43.
667. Yang TX, Luo DY, Li H, Wang KJ, Shen H. Is urethrectomy necessary during cystectomy in patients with interstitial cystitis/bladder pain syndrome? *Urology* 2016, Jul 13.

MANAGEMENT USING CONTINENCE PRODUCTS

Chairs

A. Cottenden (UK)

M. Fader (UK)

Members

D. Beeckman (Belgium)

B. Buckley (Philippines)

E. Kitson-Reynolds (UK)

K. Moore (Canada)

K. Nishimura (Japan)

J. Ostaszkiwicz (Australia)

J. Watson (UK)

M. Wilde (USA)

Consultants

D. Bliss (USA)

D. Turner (UK)

CONTENTS

LIST OF ABBREVIATIONS	2306	4. Bodyworn absorbent products for women with light urinary incontinence	2330
A. INTRODUCTION	2306	5. Bodyworn absorbent products for men with light urinary incontinence.....	2332
B. OVERALL GUIDELINES FOR SELECTING CONTINENCE PRODUCTS	2307	6. Bodyworn absorbent products for men and women with moderate-heavy urinary incontinence	2334
1. Product categories.....	2307	7. Disposable underpads	2338
2. Assessment factors	2308	8. Washable underpads.....	2339
3. Main user groups	2309	9. Absorbent products for children with urinary and / or faecal incontinence..	2340
4. Choosing between product categories	2309	10. Absorbent products for faecal incontinence	2340
5. Summary.....	2314	11. Broader recommendations	2340
6. Recommendations	2314	G. EXTERNAL URINE COLLECTION DEVICES FOR MEN: URINARY SHEATHS	2342
C. PRODUCT EVALUATION METHODOLOGY	2314	1. Evidence.....	2344
1. Methodological challenges	2314	2. Summary	2345
2. Research design	2315	3. Recommendations	2345
3. Summary and recommendations.....	2317	4. Priorities for research	2346
4. Priorities for research	2317	H. URINE DRAINAGE BAGS AND ACCESSORIES	2346
D. HANDHELD URINALS	2317	1. Evidence.....	2348
1. Evidence	2319	2. Summary	2349
2. Summary.....	2319	3. Recommendations	2349
3. Recommendations	2319	4. Priorities for research	2349
4. Priorities for research	2319	I. MALE BODYWORN URINALS AND DRIBBLE CONTAINERS	2350
E. COMMODES, MOBILE SHOWER-CHAIRS AND BEDPANS	2319	1. Evidence.....	2351
1. Evidence	2322	2. Recommendation	2352
2. Summary.....	2323	3. Priorities for research	2352
3. Recommendations	2323	J. MECHANICAL DEVICES FOR WOMEN WITH UI	2352
4. Priorities for research	2323	1. Evidence from the 5th International Consultation (2013)	2352
F. ABSORBENT PRODUCTS	2324	2. New evidence for the current consultation	2354
1. Absorbent product categories	2324		
2. Absorbent product materials	2329		
3. Absorbent product capacity and user requirements	2330		

3.	Summary.....	2355	P.	ODOUR CONTROL PRODUCTS	2396
4.	Recommendations	2356	1.	Evidence from the 5th International Consultation (2013)	2397
5.	Priorities for research	2356	2.	New evidence for the current consultation	2398
K.	MECHANICAL DEVICES FOR MEN WITH UI	2356	3.	Summary	2399
1.	Evidence	2357	4.	Recommendations	2399
2.	Summary.....	2357	5.	Priorities for research	2399
3.	Recommendations Table.....	2357		APPENDIX 1	2400
4.	Priorities for research	2358		APPENDIX 2	2400
L.	INDWELLING CATHETERS	2358		REFERENCES	2402
1.	Evidence	2360			
2.	Summary.....	2374			
3.	Recommendations	2374			
4.	Priorities for research	2375			
M.	INTERMITTENT CATHETERS	2376			
1.	Evidence	2376			
2.	Summary.....	2378			
3.	Recommendations	2379			
4.	Priorities for research	2379			
N.	PRODUCTS AND DEVICES FOR PREVENTING OR MANAGING FAECAL INCONTINENCE AND ITS SEQUELAE	2379			
2.	Evidence from the 5th International Consultation (2013).....	2381			
3.	New evidence for the current consultation.....	2382			
4.	Summary.....	2384			
5.	Recommendations	2384			
6.	Priorities for research	2385			
O.	SKIN HEALTH	2385			
1.	Evidence	2385			
2.	Summary.....	2394			
3.	Recommendations	2395			
4.	Priorities for research	2396			

MANAGEMENT USING CONTINENCE PRODUCTS

A. COTTENDEN (UK), M. FADER (UK),
D. BEECKMAN (BELGIUM), D. BLISS (USA), B. BUCKLEY (PHILIPPINES), E.
KITSON-REYNOLDS (UK), K. MOORE (CANADA), K. NISHIMURA (JAPAN),
J. OSTASZKIEWICZ (AUSTRALIA), D TURNER (UK), J. WATSON (UK), M. WILDE (USA)

LIST OF ABBREVIATIONS

AB	Antibiotics.
ABP	Antibiotic prophylaxis.
ASB	Asymptomatic bacteriuria.
AUR	Acute urinary retention.
BWU	Bodyworn urinal.
CAUTI	Catheter associated urinary tract infection.
FI	Faecal incontinence.
IAD	Incontinence-associated dermatitis.
IASD	Incontinence-associated skin damage.
IC	Intermittent catheter(isation).
ICD	International classification of diseases.
IUC	Indwelling urethral catheter(isation).
KHQ	King's health questionnaire.
LT	Long-term.
PD	Perineal dermatitis.
PFMT	Pelvic floor muscle therapy.
QOL	Quality of life.
RCT	Randomised control trial.
SCI	Spinal cord injury.
SPC	Suprapubic catheter(isation).
ST	Short term.
SUI	Stress urinary incontinence.
UC	Urethral catheter(isation).
UDS	Urodynamics.
UI	Urinary incontinence.
UTI	Urinary tract infection.

A. INTRODUCTION

Not all bladder or bowel incontinence problems can be cured completely and the challenge for those whose symptoms persist is to discover how to deal with their incontinence to minimise its impact on their quality of life. And this usually includes using continence products.

Even those whose incontinence is ultimately treated successfully may have to live with symptoms for a time - for example, while they wait for surgery, or for pelvic floor muscle training to yield its benefits – and they may use continence products temporarily during this waiting period. Others may use them as an adjunct to a treatment that reduces their leakage without eliminating it. Still others may use products intermittently, limiting their use to particular periods or activities associated with troublesome leakage. However, some use products permanently, either following treatment that has not been (completely) successful or because – depending on their frailty, severity of symptoms and personal priorities – they are not candidates for it.

Successful incontinence management with products is often referred to as contained incontinence, managed incontinence or social continence, in recognition of the substantial benefits it can bring to quality of life even though cure has not been achieved (1).

A wide variety of continence products exists and the choice can be confusing. In this chapter, the goal is to provide the current evidence to healthcare professionals so that they may make informed decisions as they choose – or help product users to choose - between continence product categories and, the most appropriate product(s) within a category. We have also aimed to make this information directly accessible to users.

Our main message is that continence is often best managed by a 'mix' of different products – often used at different times or for different activities (day/night/home/away/sport). One product is unlikely to be effective for everything.

The chapter provides (Section B) overall guidelines for selecting products to assist with toileting, to prevent or contain leakage, or to address urinary retention, as well as those for incontinence-related skin and odour problems. The key elements of patient assessment are described and a classification of people into broad groups is suggested based on gender, age (adult or child) and the nature and severity of their incontinence. Each of the major product categories is then addressed (Sections D-P) and – where possible – evidence-based recommendations for product selection and use are given. When little or no published data is available, expert opinion forms the basis of recommendations. Tables are provided summarising the user characteristics, priorities and contexts that commonly favour or discourage the use of each of the major product categories available. The chapter also includes (Section C) a review of the methodological challenges of conducting continence product evaluations and interpreting the results

To accompany this chapter, the International Consultation on Incontinence and the International Continence Society (ICS) have collaborated to make the material more accessible via a web site hosted by the ICS at <http://www.continenceproductadvisor.org>. This interactive web site provides current evidence to healthcare professionals and users to facilitate informed choices in selecting appropriate products, and accessible, evidence-based advice on how to use them to best effect.

The literature search strategy adopted for the chapter is described in Appendix 1.

B. OVERALL GUIDELINES FOR SELECTING CONTINENCE PRODUCTS

Suitable continence products are critical for the well-being and quality of life of product users and caregivers. Concealment enables people with incontinence to protect their public identity as a “continent person” and avoid the stigma associated with incontinence (2). Failure to do so can result in limited social and professional opportunities, jeopardise relationships and detrimentally affect emotional and mental well-being (3). Importantly, caregivers need to feel confident that the person(s) they care for will not be embarrassed publicly. Good product choice / use also reduces the level of care required in relation to maintaining hygiene, skin care and laundry (4).

The intimate and stigmatised nature of incontinence means that issues relating to self-image can affect users’ preferences when selecting products. This may be marked in younger people for whom body-image may be particularly important and for whom disruption to normal social and interpersonal development may result in isolation or lack of access to normal experiences (5) (6). A key measure of product success is the ability to conceal the problem (7) and concealment may involve compromises: for example, at some times the added reliability of products with a larger capacity than is strictly necessary may be preferred even though they may be less discreet when worn.

The range of products available can vary enormously between and within countries, depending on the funding available, healthcare policy and the logistics of supply. In publicly funded healthcare systems, some products may be provided free of charge, based on cost-sharing policy, or reimbursed by insurers whereas, in others, no cost support is available, and consumers must pay out-of-pocket. However, the provision of continence services is not considered a priority by health system administrators in most countries, and this is especially true in developing countries (8) (9) (10). In such contexts, this chapter and accompanying website may act as a resource that can foster greater awareness of product choice and may help clinicians and users to identify products that, although not readily available locally, may be sourced elsewhere.

1. PRODUCT CATEGORIES

Apart from those for addressing incontinence-related skin and odour problems, all the products described in this chapter can be categorised as in Fig B-1, according to whether they are designed to: (i) assist with toileting; (ii) help manage urinary retention; or (iii) prevent / contain urinary or faecal incontinence.

All toileting products can be useful for dealing with urine and / or faeces except for handheld urinals which are just for urine. Containment / control products are subdivided into three overlapping classes: for urinary retention, urinary incontinence, and faecal incontinence. For example, someone with urinary retention is most likely to benefit from one of the products in the red ellipse (Fig B-1), while someone with urinary incontinence will most likely benefit from one in the blue ellipse. A patient experiencing both problems will need two products (one from each ellipse) or one product from the intersection of the two ellipses.

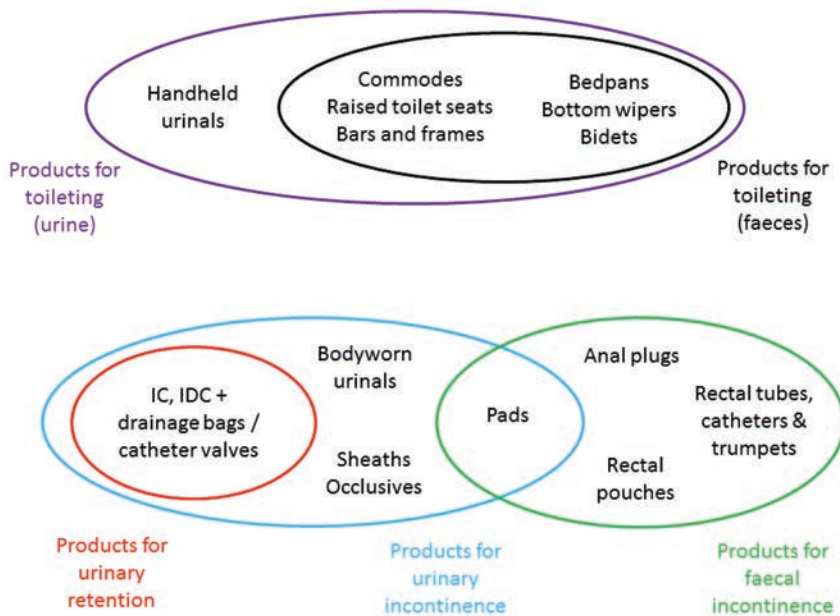

Fig B-1: Products for toileting (top) and for managing incontinence and / or urinary retention (bottom).

2. ASSESSMENT FACTORS

Assessment of a user's physical characteristics - such as anthropometrics, level of independence, mobility and dexterity, mental acuity and the nature of the incontinence - will help determine the best product(s) for them. In addition, other practical and psychosocial considerations include user participation in selection (11) provision of adequate instructions for use (12) and the need for products to fulfil their function reliably and easily (5) (12) (13). The nature of the environments in which the products will be used, as well as the availability of caregivers are other im-

portant factors. Table B-1 summarises the key assessment elements, although currently no evidence-based assessment tool exists. Specific guidance on assessment issues is additionally provided within subsections of this chapter. Personal preference is known to play a substantial role in product selection (eg (14) and (15)) and information on the range of products that may suit an individual is therefore important in order that appropriate choices may be made. Education of users and / or caregivers is key to ensuring product use is optimal; this may range from straightforward instruction in the effective fitting and changing of absorbent products to more in-depth training in the ongoing care of, for example, a suprapubic catheter.

Table B-1: Key elements of assessing a patient and his / her environment

Element	Rationale
Nature of the continence problem	The frequency, volume and flow rate of the incontinence influences product suitability.
Gender	Males may consider and prefer sheaths as a more masculine option to pads. Females may be attracted to products that are more feminine in design and presentation. Some 'unisex' products such as absorbent pads have different designs that work better for men (or women).
Physical characteristics	Anthropometrics (e.g. height and waist, thigh, penile circumference) will influence the comfort and effectiveness of a product.
Mental acuity	Mental impairment can affect the person's ability to manage the product. Products that resemble usual underwear (e.g. some absorbents) may be easiest to manage. Products which have health implications if used incorrectly (e.g. mechanical devices or catheter valves) should be avoided if mental impairment is likely to preclude correct and safe use.

Element	Rationale
Mobility	Impaired mobility may make some product choices impractical or require toilet or clothing modification to allow effective use of the product.
Dexterity	Problems with hand or finger movement can make it difficult to use some products (eg taps on leg bags, straps with buttons).
Eyesight	Impaired eyesight limits effective application and management of some products
Leg abduction problems	Difficulty with abduction can make the use of some products impractical or ineffective.
Lifestyle and environments	Daily activities and environments can influence the choice of product; mixture of products may provide optimum management. Different products may be most satisfactory for daytime and going out (when discreetness may be a priority) and night-time or staying in (when comfort may be a priority), for holidays (when laundry and / or large quantities of disposables may be a problem) or for use at work. The proximity and accessibility of a toilet in the various environments may be a key factor.
Independence / assistance	If a caregiver is required to apply or change the product then it may be important to involve them in the selection of the product and to establish their willingness and ability to use it.
Laundry facilities	Washable pads and bed linen may be very heavy when wet and take a long time to dry. It is important to check that the person doing the laundry has the ability and facilities to cope.
Disposal facilities	Ability to appropriately, safely and discreetly dispose of the selected products needs to be considered.
Storage facilities	Some products – notably, pads for heavy incontinence – can be bulky. Adequate space to store supplies between deliveries / purchases needs to be available.
Personal preferences	Different people like different products and where possible patients should be given a choice of products with which to experiment to determine the most satisfactory product.
Personal priorities	Everyone wants to avoid leakage but other factors such as discreetness may be more or less important to individuals, or may vary according to different contexts and activities.

3. MAIN USER GROUPS

Seven primary user groups are identified in this chapter:

- People with urinary retention.
- People who need help with toileting / toilet access.
- Females with light urinary incontinence.
- Males with light urinary incontinence.
- Females with moderate / heavy urinary incontinence.
- Males with moderate / heavy urinary incontinence.
- People with faecal incontinence.

An individual may belong to more than one group. Each group includes children and young people: the products available for them are broadly similar to those for adults.

4. CHOOSING BETWEEN PRODUCT CATEGORIES

Tables B-2 to B-7 summarise the user characteristics, priorities and contexts which favour or discourage the use of each of the product categories for six of the seven user groups. Assistance with choosing appropriate products for the first group (people with urinary retention) is given in Section L (indwelling catheters) and Section M (intermittent catheters).

Although the content of these tables is based on the referenced evidence cited in the corresponding chapter sections, the un referenced versions provided for the lay public on the accompanying website (www.continenceproductadvisor.org) are reproduced here.

The same product will not necessarily suit all people, even if the assessment is similar. Thus, providing access to a range of products to test will help determine the most satisfactory choice. Similarly, priorities vary between users; for example, some will opt for a bulky, less discreet pad to achieve an acceptably low risk of leakage while others will see the balance differently.

A mix of products drawn from more than one category may provide the best solution; for example, needs may vary between day / night, or home / away.

Table B-2: Products for people who need assistance with toileting.

Product Type	More likely to suit you if...	Less likely to suit you if...	Notes
Female Handheld Urinals	<ul style="list-style-type: none"> You have urgency, and poor mobility prevents you from accessing the toilet. You are able to stand or crouch. You are able to move to the edge of the chair or bed. 	<ul style="list-style-type: none"> You need to lie down or sit back in a chair. 	<ul style="list-style-type: none"> There are many urinals: experiment using a library of urinals. Urinals are less likely to succeed if woman needs to lie down or sit back in a chair.
Male Handheld Urinals	<ul style="list-style-type: none"> You have urgency, and poor mobility prevents you from accessing the toilet. You have reasonable hand control. 	<ul style="list-style-type: none"> You are unable to empty the urinal independently. Your balance is poor for standing use of the urinal. You have difficulty reaching forward and have impaired wrist function. You have poor memory and mental function. 	<ul style="list-style-type: none"> Clothing adaption may be needed. NB non-spill adaptors. NB flat pack urinals for travel.
Commodes	<ul style="list-style-type: none"> You have urgency, and poor mobility prevents you from accessing the toilet. 	<ul style="list-style-type: none"> Privacy is an issue e.g. When in hospital, when a shower chair may be preferable. You cannot use a commode safely (commodes can be unstable and tip backwards). 	<ul style="list-style-type: none"> Ensure privacy and dignity.
Bedpans	<ul style="list-style-type: none"> You are unable to use any other alternative e.g. A commode or shower chair. 		<ul style="list-style-type: none"> Ensure privacy and dignity.
<p>NB The content of this table is based on the referenced evidence cited in the chapter, but the unreferenced version provided for the lay public on the accompanying website (www.continenceproductadvisor.org) is reproduced here.</p>			

Table B-3: User characteristics, priorities and contexts which favour or discourage the use of the different products for females with light urinary incontinence.

Product Type	More likely to suit you if...	Less likely to suit you if...
Pads (generally)*	<ul style="list-style-type: none"> Actually, they suit most women. 	<ul style="list-style-type: none"> Your skin is severely damaged in the pad area.
Female devices	<ul style="list-style-type: none"> You mainly have stress urinary incontinence. You have good hand control. You have good memory and mental function. 	<ul style="list-style-type: none"> Your leakage is mainly associated with urgency. Urinary tract infection is a major concern for you.

Product Type	More likely to suit you if...	Less likely to suit you if...
	<ul style="list-style-type: none"> Using a device (as opposed to a pad) is acceptable to you. Preventing leakage is more important to you than containing it. 	
<p>NB The content of this table is based on the referenced evidence cited in the chapter, but the unreferenced version provided for the lay public on the accompanying website (www.continenceproductadvisor.org) is reproduced here.</p>		

* More detailed information on the various pad designs is given in Table F-4.

Table B-4: User characteristics, priorities and contexts which favour or discourage the use of the different products for males with light urinary incontinence.

Product Type	More likely to suit you if...	Less likely to suit you if...
Pads (generally)*	<ul style="list-style-type: none"> Actually, they suit most men. 	<ul style="list-style-type: none"> Your skin is severely damaged in the pad area.
Sheaths	<ul style="list-style-type: none"> You wish to avoid using pads. Using a device (as opposed to a pad or catheter) is acceptable to you. You wish to avoid the inconvenience of frequent pad changes. You have found indwelling catheters to be uncomfortable (sheaths tend to be more comfortable than indwelling catheters). You have had a problem with infection with indwelling catheters (sheaths are associated with less infection than indwelling catheters). You have good hand control. You have good memory and mental function. 	<ul style="list-style-type: none"> You have skin damage on or around the penis. Urinary tract infection is a major concern for you. You or your helper are unwilling or unable to fit the sheath.
Bodyworn urinals	<ul style="list-style-type: none"> Using a device (as opposed to a pad) is acceptable to you. 	
Penile compression devices	<ul style="list-style-type: none"> Using a device (as opposed to a pad) is acceptable to you. You wish to prevent leakage for a specific period eg during exercise. You mainly have stress urinary incontinence. You feel motivated to try out the compression device. Preventing leakage is more important to you than containing it. 	<ul style="list-style-type: none"> Your leakage is mainly associated with urgency. You have poor memory and mental function. You have poor hand control. Your skin is vulnerable to damage. You usually do not get the sensation of needing to empty your bladder.
<p>NB The content of this table is based on the referenced evidence cited in the chapter, but the unreferenced version provided for the lay public on the accompanying website (www.continenceproductadvisor.org) is reproduced here.</p>		

* More detailed information on the various pad designs is given in Table F-7.

Table B-5: User characteristics, priorities and contexts which favour or discourage the use of the different products for females with moderate / heavy urinary incontinence.

Product Type	More likely to suit you if...	Less likely to suit you if...
Pads (generally)*	<ul style="list-style-type: none"> • Actually, they suit most women. 	<ul style="list-style-type: none"> • Your skin is severely damaged in the pad area.
Indwelling catheters	<ul style="list-style-type: none"> • Your leakage is associated with urinary retention. • You (or a helper) are unable to do intermittent catheterisation. • You have found pads to be unsuccessful or inappropriate. • Your skin is severely damaged in the pad area. 	<ul style="list-style-type: none"> • Your urethra is damaged. • You have poor memory and mental function. • Urinary tract infection is a major concern for you.
<p>NB The content of this table is based on the referenced evidence cited in the chapter, but the unreferenced version provided for the lay public on the accompanying website (www.continenceproductadvisor.org) is reproduced here.</p>		

* More detailed information on the various pad designs is given in Table F-10.

Table B-6: User characteristics, priorities and contexts which favour or discourage the use of the different products for males with moderate / heavy urinary incontinence.

Product Type	More likely to suit you if...	Less likely to suit you if...
Pads (generally)*	<ul style="list-style-type: none"> • Actually, they suit most men. 	<ul style="list-style-type: none"> • Your skin is severely damaged in the pad area.
Sheaths	<ul style="list-style-type: none"> • You wish to avoid using pads. • Using a device (as opposed to a pad or a catheter) is acceptable to you. • You wish to avoid the inconvenience of frequent pad changes. • You have found indwelling catheters to be uncomfortable (sheaths tend to be more comfortable than indwelling catheters). • You have had a problem with infection with indwelling catheters (sheaths are associated with less infection than indwelling catheters). • You have good hand control (or a helper). • You have good memory and mental function. 	<ul style="list-style-type: none"> • You have skin damage on or around the penis. • Urinary tract infection is a major concern for you. • You or your helper are unwilling or unable to fit the sheath.
Bodyworn urinals	<ul style="list-style-type: none"> • You wish to avoid using pads. • Using a device (as opposed to a pad or a catheter) is acceptable to you. • You are mobile and do not rely on a wheelchair. 	<ul style="list-style-type: none"> • You are allergic to latex.

Product Type	More likely to suit you if...	Less likely to suit you if...
Penile compression devices	<ul style="list-style-type: none"> Using a device (as opposed to a pad) is acceptable to you. You wish to prevent leakage for a specific period e.g. During exercise. You mainly have stress urinary incontinence. You feel motivated to try out the compression device. Preventing leakage is more important to you than containing it. 	<ul style="list-style-type: none"> Your leakage is mainly associated with urgency. You have poor memory and mental function. You have poor hand control. Your skin is vulnerable to damage. You usually do not get the sensation of needing to empty your bladder.
Indwelling catheters	<ul style="list-style-type: none"> Your leakage is associated with urinary retention. You (or a helper) are unable to do intermittent catheterisation. You have found pads to be unsuccessful or inappropriate. Your skin is severely damaged in the pad area. 	<ul style="list-style-type: none"> Your urethra is damaged. You have poor memory and mental function. Urinary tract infection is a major concern for you.

NB The content of this table is based on the referenced evidence cited in the chapter, but the unreferenced version provided for the lay public on the accompanying website (www.continenceproductadvisor.org) is reproduced here.

* *More detailed information on the various pad designs is given in Table F-10.*

Table B-7: User characteristics, priorities and con-texts which favour or discourage the use of the different products for people with faecal incontinence.

Product Type	More likely to suit you if...	Less likely to suit you if...
Faecal pads	<ul style="list-style-type: none"> Pads are useful to both men and women but their designs are not optimal for faecal incontinence due to the solid components and non-liquid consistencies of faeces and poor odour control. Some men prefer using small gauze inserts between the buttocks. 	<ul style="list-style-type: none"> You have skin problems in the anal area. You are a man and prefer to wear boxer-style shorts.
Faecal collectors	<ul style="list-style-type: none"> You are very unwell. You are confined to bed e.g. following surgery or a bowel procedure such as an enema. You have very loose or liquid faeces. Your skin is vulnerable to damage. 	<ul style="list-style-type: none"> You have skin problems in the anal area.
Anal devices	<ul style="list-style-type: none"> You wish to prevent leakage for a specific period eg during exercise or after an enema or rectal irrigation. 	<ul style="list-style-type: none"> You have disease of the bowel or rectum. You have spinal cord injury and are at risk from autonomic dysreflexia. Using a device is unacceptable to you.

Product Type	More likely to suit you if...	Less likely to suit you if...
	<ul style="list-style-type: none"> Your leakage is associated with spina bifida, anorectal malformation, rectal sphincter damage / tear. 	<ul style="list-style-type: none"> You feel use of an anal plug would disrupt a successful, established routine.
Rectal catheters	<ul style="list-style-type: none"> You are very unwell and in hospital. You have very loose or liquid faeces. You are confined to bed. Your skin is vulnerable to damage. You have a wound which is highly likely to be contaminated by faeces. 	<ul style="list-style-type: none"> You have disease of the bowel or rectum, large haemorrhoids, anal stricture or stenosis. You have recently had rectal surgery or other damage to the rectum. You want a product for long term use.

NB The content of this table is based on the referenced evidence cited in the chapter, but the unreferenced version provided for the lay public on the accompanying website (www.continenceproductadvisor.org) is reproduced here.

5. SUMMARY

In conclusion, continence products can play an important role in enhancing the quality of life and reducing the stigma of incontinence of those who are awaiting treatment; are waiting for treatment to take effect; elect not to pursue cure options; are unable to be fully cured and are living with an ongoing bladder / bowel problem.

6. RECOMMENDATIONS

- Users often require / prefer a mix of different products for use at different times and for different activities to achieve optimum management (Grade of recommendation C)
- Incontinence should be actively managed with products to minimise the impact of incontinence on quality of life (Grade of Recommendation C).
- Users should be carefully assessed (and reassessed periodically) to select the most appropriate products (Grade of Recommendation C).
- Users should be offered a range of products that are appropriate for their needs in order that they can make informed choices. (Grade of Recommendation C)

C. PRODUCT EVALUATION METHODOLOGY

This section aims to assist those planning clinical trials of products. There have been relatively few large clinical trials of continence products and for most product categories research evidence to guide the selection of individual products / designs / features is limited and, in some cases, absent.

Measuring the performance of continence products is methodologically challenging. Manufacturers modify and change their products regularly - in terms of both materials and designs - and this limits the long-term validity of research results. There are also complex issues regarding research questions, study design, product representation, blinding, and sample size (16) which are discussed below.

1. METHODOLOGICAL CHALLENGES

Part of the complexity of product evaluations stems from the sheer number of product categories and brands available, meaning that many different comparisons could be made. Table C-1 illustrates the problem using a hierarchy of questions relating to absorbent products. So, in this example, once the decision is made to choose an absorbent product in response to question 1, successive further questions can be used to narrow down the choice to a specific product brand. Questions at any of these levels may form the basis for research projects.

Table C-1: Levels of research questions

- Which product category (eg catheter, sheath, absorbent pad)?
- Which design of product design (eg pull-up or diaper design of pad)?
- Which material type (eg reusable or disposable)?
- Which features (eg with / without elastic gathers)?
- Which product brand?

In the field of absorbent products, the practitioner and / or patient wishes to know whether to use an underpad or a bodyworn product, a reusable or a disposable, a diaper or an insert (if they select a bodyworn),

a diaper with internal elastication (standing gathers) or without and, finally, which of the many diaper brands is likely to suit them best. This final question is the most pertinent for the practitioner (who may already have made decisions about questions 1-4, Table C-1), but it is particularly problematic because of the high rate of product change. By the time the results of a clinical trial of product brands are known many of the test products will have been modified and the results will have limited value for selection. However, these 'single design' studies do have value in demonstrating the range of performance between the brands within a product design category, and where objective measurements can be made (for example, of leakage performance), they can allow for comparisons to be made. Single design studies are also helpful in promoting product improvement by revealing common problems experienced by patients and exposing particularly poor products or poor product features which are amenable to change by manufacturers.

Overall product designs, generic features and classes of materials change much less frequently and attempting to answer questions 1-4 (Table C-1) is therefore likely to lead to more long-lasting results with value beyond the lifetime of the particular brands tested. Such studies have been attempted by many researchers, but these have frequently been confounded by problems with product representation.

The single greatest (and most frequently overlooked) threat to the validity of clinical trials of products is the selection of the brands entered into the study to represent the various designs. Evaluations of a number of product variants of a similar design (eg different brands) have shown that patient 'overall opinion' scores can vary by as much as 70 percentage points between apparently similar products (17). Accordingly, in an evaluation to compare different designs, the selection of one or more products to represent each design, is crucial. Studies that have purported to compare different designs or materials have often included a small number (most often just one) of arbitrarily selected product(s). Generalising the results of such studies to whole product groups (e.g reusable underpads, or disposable bodyworn) is meaningless and misleading. It is perfectly possible to select (either by accident or design) a particularly 'good' product from one group and a particularly 'poor' product from another. A well-designed study will therefore be seriously flawed if there is no clear process or pilot study to determine and justify the choice of particular brands. Even with a systematic process of product selection (or preferably a pilot study) it is unwise to select a single brand to represent a whole group of products and selection of a small group of brands (e.g. three) is preferable. This allows for any 'within group' differences to be detected and helps to demonstrate the 'representativeness' of the products selected.

The most controlled method of testing different designs, materials or features of products is to make up

experimental batches which differ only in the aspect of interest (e.g. the material or the feature) and a small number of studies have attempted this (17) (18). However, experimentally made products are not usually identical to those available on the market which limits their value for product selection.

It is common for practitioners to be asked (by their employers or by companies) to do a small evaluation or trial – sometimes to 'test out' a new product and sometimes to help choose between competing brands for bulk-buying. Such trials should be approached with caution; they can be very demanding and their results may be of very limited value, even for local use. The methodological challenges identified above still apply but are compounded by small sample size and restricted product selection. These studies are likely to be helpful only for identifying gross product short-comings or benefits.

2. RESEARCH DESIGN

A randomised controlled trial is not possible for clinical trials of products in most categories simply because a 'control' product does not usually exist. Nor is there a 'standard or reference' product to act as a control, and comparisons with 'standard practice' (i.e. the product currently in use) are prone to bias.

Although it is methodologically simpler (and more robust) to compare only two different product groups, it is more clinically relevant to compare several competing groups, using a multiple cross-over design, where there are valid comparisons. For example, there are four main design groups of disposable bodyworn pads for moderate / heavy incontinence (inserts, diapers, pull-ups and T-shaped). Evaluation of all four groups together is much faster (and therefore gives more long-lasting results) and more cost-effective than several serial studies. Cross-over trials are vulnerable to order effects and randomisation of the order of testing should be carried out using Latin squares (19) to ensure balance.

It is important that clinical trials of single designs of products (which aim to enable selection of particular product brands) are comprehensive (i.e. cover all the available products) because otherwise manufacturers can justifiably claim that, although their product may be similar to one of those tested, even subtle distinctions may lead to clinically important differences.

A further problem with research design is the blinding of products. Different products have different appearances and it is impossible to blind subjects or staff to the product in use. Products can be repackaged to assist anonymising but this may have unwanted effects on the products and is expensive.

Previous product experience can also affect study results, particularly if a substantial proportion of subjects are currently using one of the brands included in the study. It is therefore important to record which

products are in current use in order to add this data to the model used in the analysis.

2.1. Sample size and study power

Studies that include more than two products (or two small groups of products) will need to be powered so that multiple comparisons can be made. As the number of products included in the study increases the number of possible comparisons of pairs of products rises. This requires a corresponding reduction in the significance level (e.g. by using the Bonferroni method for each pair-wise comparison to retain the overall level of significance (usually $p < 0.05$). Thus as the total number of pair-wise comparisons increases the likelihood of a type 2 error (accepting the null hypothesis when it is false) also increases.

Sample sizes therefore need to be calculated to allow for each pair-wise comparison. Sample size requirements rise rapidly if each subject does not test each product and the number of products entered into a study must therefore be limited to avoid subject fatigue. As an example, a clinical trial of four product groups where the primary outcome variable will be binary (e.g. satisfactory / unsatisfactory) will require a sample size of approximately 80 subjects with an alpha of < 0.05 and d (difference) of 20%.

2.2. Outcome variables

Studies of product performance have most frequently used self-report questionnaires at the end of the product test period to assess participant ratings of product performance. Diaries of product-related events such as leakage, laundry generation and product consumption are also commonly included. Users in some absorbent pad studies have been asked to identify and prioritise aspects of product performance (20) (21) (22) to inform questionnaires and Table C-2 shows the most common aspects of high priority to women with light urinary incontinence identified by Getliffe and colleagues (21).

Outcome variables in studies designed to compare catheterisation strategies and / or catheter materials or other design features commonly encompass measures of urinary tract infection, tissue trauma and recurrent catheter encrustation leading to blockage (Section L).

Table C-2: Most common items of high priority to women with light incontinence using absorbent products (21).

Daytime: % women (N=99)		Night-time: % of women (N=81)	
Hold urine without leaking	83.8	Hold urine without leaking	93.8
Contain smell	75.8	Stay in place	77.8
Stay in place	54.5	Contain smell	54.3

Daytime: % women (N=99)		Night-time: % of women (N=81)	
Discreetness	41.1	Comfortable when wet	54.3
Comfort when wet	40.4	To keep skin dry	48.1

Questionnaire items vary depending on the products being tested and for product groups where few studies have been carried out it is particularly important to tailor questionnaires to user needs by asking study subjects to prioritise items and to assess final questionnaires for content and face validity. One study (23) has measured the test re-test reliability of a questionnaire to assess sheath performance and found moderately good Kappa scores (around 0.7) when assessing the same sheath twice with four weeks between measurement periods.

Skin health, urinary tract infection, pain or discomfort are the main physical health consequences for containment products. Skin health (which can be rated by self-report or by skin inspection) has sometimes been used as the primary outcome variable (e.g. (24)). Urinary tract infection is an important outcome for invasive devices such as catheters and it has also been used for pads (25).

Although leakage performance is frequently rated as a high priority by product users, good leakage performance is not adequate as a sole measure of patient satisfaction with performance. A single (or multiple) fatal flaw such as poor comfort, bulkiness, or poor fit may cause a product that performs well for leakage to be unacceptable to the patient for other reasons. Accordingly, aggregate measures - which assume that the overall performance of a product can be calculated using a weighted sum of the scores for specific aspects of performance (like comfort and freedom from leakage) - are ill-advised. Patient overall opinion or satisfaction with the product should therefore be used as the primary outcome variable (23).

There are no quality of life measurement tools specifically designed for clinical trials of continence products, although a tool has been developed for long-term catheter users (26). Existing incontinence-specific quality of life tools are designed to measure change after interventions to improve incontinence and include urinary symptoms. These tools are therefore likely to be insensitive to changes in quality of life brought about by products which are designed to contain incontinence rather than reduce or prevent it. The first stage in the development of a quality of life tool for absorbent product users has been reported by Getliffe et al. (21).

3. SUMMARY AND RECOMMENDATIONS

There is little published evidence on which to base summary and recommendations regarding methodology and so the following summary points are all Level of Evidence 3 / Grade of Recommendation C.

- Evaluation of continence products is methodologically complex and many attempts at providing robust evidence for product selection have been hampered by methodological weaknesses.
- Product representation is critical to providing robust and generalisable data. Selection of products for inclusion in a study should be transparent and systematic. Several products should be included to represent a product group. In particular, care should be taken not to select a particularly good or a particularly poor product to represent a whole class of products.
- Multiple crossover designs are likely to be more efficient than randomised controlled trials for many products (eg pads) and therefore sample size estimation needs to take into account the multiple comparisons that will be made.
- Outcome variables should include a patient (or caregiver) questionnaire including items that have been established as important to users.
- Diary data should be included to determine leakage performance, skin health, laundry and product consumption.
- Incidence of urinary tract infection should be included when testing invasive devices such as catheters, but “significant” UTI/ bacteriuria needs to be carefully defined (Section L).
- The primary outcome variables should be patient overall opinion / satisfaction and patient preference.
- Health economics should be measured alongside product performance

4. PRIORITIES FOR RESEARCH

- The development of Quality of Life tools for users of continence products.
- Consistent use of a validated product assessment scale.
- Impartial product assessment that compares several products in the same category.

D. HANDHELD URINALS

Handheld urinals are portable devices designed to allow an individual to empty their bladder in circumstances where gaining access to a toilet is not possible or is inconvenient, often as a result of limited mobility or joint range of motion. To function effectively, handheld urinals must enable the user to empty his/her bladder comfortably, confidently and in the absence of spillage, during filling and emptying. Excessive physical effort should not be required. The main factors influencing the capacity of a user to successfully utilise a handheld urinal are listed in Table D-1.

Table D-1: The main factors influencing the capacity of a user to successfully utilise a handheld urinal.

- The position in which it will be used (e.g. lying in bed, sitting on the side of a bed, sitting back in a chair or on its front edge, standing, kneeling, crouching) together with the nature of the surface upon which the individual is being supported.
- The ability of the urinal user to move themselves (with or without aids or assistance) into the required positions.
- Postural control in those positions, together with hip range of motion, particularly abduction.
- The optimal direction of approach for positioning the urinal (e.g. anterior, posterior, lateral).
- Manual dexterity and strength to adjust clothing, initially position the urinal, maintain its position during voiding, remove the laden urinal post-void and empty or store it somewhere safely to avoid spillage.
- The ability to initiate a void, together with the volume typically voided.
- Cognitive functioning.
- Personal preferences and, where appropriate, the availability of assistance.

Handheld urinals are frequently made from moulded plastic, although single-use cardboard options are available. Some are equipped with handles to facilitate positioning and handling, and some are fitted with drainage bags to collect urine. Urinals designed for women are available in a variety of shapes and sizes (some are quite small and portable), incorporating an interfacing opening that is often anatomically shaped to fit snugly against the woman's body.

Those intended for men tend to vary less in design, typically having a narrow neck opening to accommodate the penis, and some are fitted with integral non-spill valves or adaptors to prevent the back-flow of urine following use (27) (28) (29).

Some men may find that they can make their own urinal by recycling household bottles or containers (28).

Small, discrete, disposable and re-useable 'travel' handheld urinals are available for both men and women (27) (28).

As spillage is not always avoidable during use of handheld urinals, particularly if supine, the use of absorbent pads to protect furniture, bedding and clothing can be a useful addition (30).

An example selection of products is shown in Fig D-1, Fig D-2 and Fig D-3.

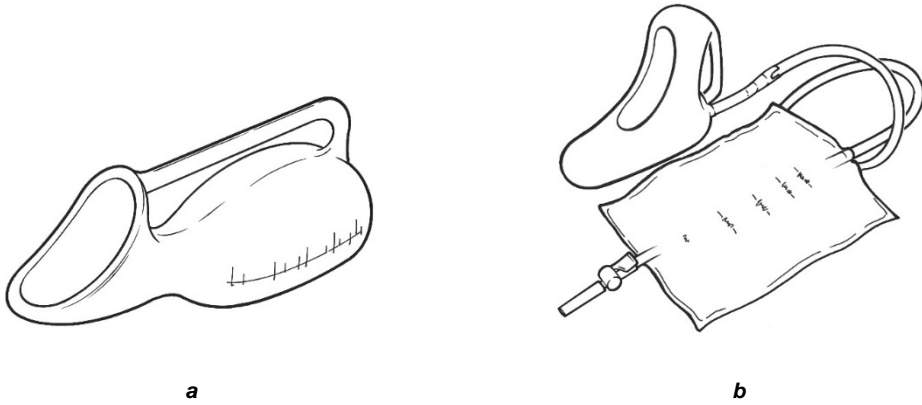

Fig D-1: Female handheld urinal (a) with drainage bag attached (b).

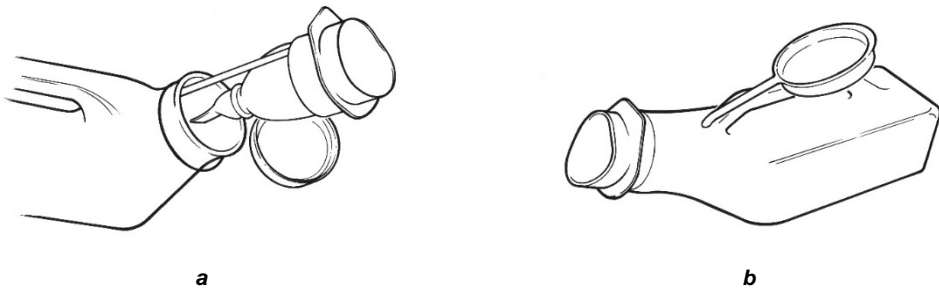

Fig D-2: Male handheld urinal with non-return (anti-spill) valve (a) and without (b).

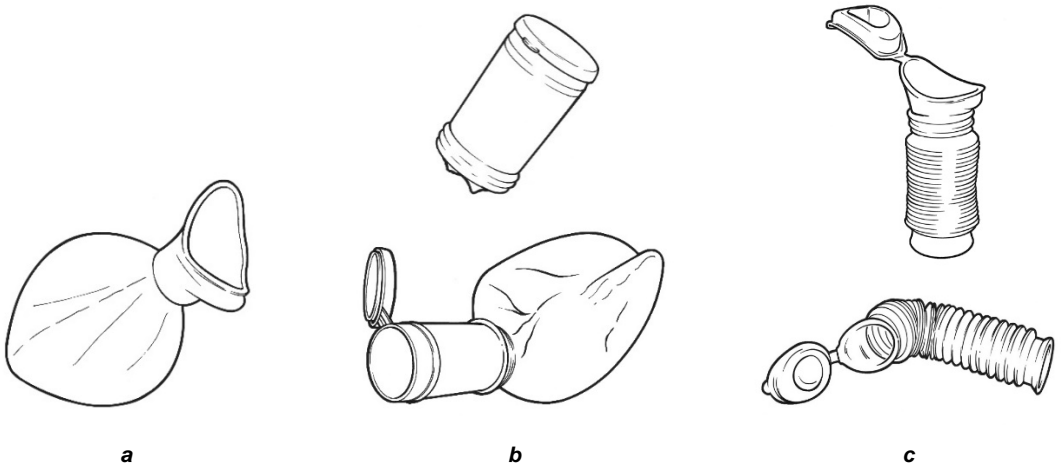

Fig D-3: Collapsible, handheld travel urinals: female (a); male (b) and unisex (c). The male and unisex designs are shown collapsed for storage (top) and ready for use (bottom).

1. EVIDENCE

The 5th International Consultation (31) highlighted a paucity of clinical trials examining the effectiveness of handheld urinals. There were no published trials of male handheld urinals at the time. The single trial identified (32), involving a multi-centre cross-over evaluation of 13 female urinals, found that no single product suited all users. Many were successfully used when standing, crouching or seated at the edge of a bed/chair/wheelchair, but fewer were successful when seated back in a wheel/chair, and only one was identified to be reasonably effective in a lying / semi-reclined position. Of note, this study highlighted that there were fewer products to meet the needs of women with higher levels of dependence. Other work to develop and evaluate a novel, power-assisted female urinal that pumps urine into a holding reservoir highlighted mixed results in terms of reliability, size, weight, noise and aesthetics (33).

No new trials have been identified for inclusion in the current consultation. There are no new product reviews, nor any published reports of ongoing work to progress the power-assisted female urinal developed by Macaulay and colleagues (33). Most information available to inform users and healthcare professionals about this important product group continues to draw, primarily, on expert opinion (34).

2. SUMMARY

- Super-absorbent polymer can be added to urinals prior to use to absorb and solidify urine (27) (30) (35) (Level of Evidence 1).
- Experimentation is often required to identify the optimal urinal for an individual (27) (29) (30) (32) (35) (Level of Evidence 2).
- Cleaning of handheld urinals is an important consideration. Cleansing with soap and water may be appropriate between episodes of use by a single individual at home, but more robust methods that comply with manufacturer's recommendations and local infection control policies will be necessary where users are multiple (29) (32) (35) (36) (Level of Evidence 2).
- Men with a retracted penis may find that urinals developed primarily with women in mind can work well for them if they are able to tuck their whole penis and scrotum inside the urinal during use (28) (Level of Evidence 3).
- The careful selection and adaptation of clothing can assist quick and easy use of urinals for both men and women (27) (28) (29) (30) (36) (Level of Evidence 3).
- Expanding the toileting devices available to those in acute care settings to include a wider range of handheld urinals suitable for use by

both men and women has been recommended (30) (35) (Level of Evidence 3).

3. RECOMMENDATIONS

Recommendations relating to handheld urinals are summarised in Table D-2.

Table D-2: Recommendations relating to handheld urinals.

- Handheld urinals may usefully form one of a range of options available to both men and women to manage their toileting needs, enhancing the quality of life of both the user and (where relevant) their carer(s) (Grade of Recommendation C).
- Experimentation is often necessary to select the most appropriate urinal to meet individual needs and individual circumstances (Grade of Recommendation C).
- Different types of handheld urinals may be required by an individual in different situations (Grade of Recommendation C).

4. PRIORITIES FOR RESEARCH

- Evaluation of currently available male and female urinals to provide guidance to users, caregivers and healthcare professionals.
- Development of the range of female urinals, particularly to meet the needs of those who are less physically able, who are unable to move to the edge of a bed/chair/wheelchair and/or who need to use a urinal while supine.

E. COMMODES, MOBILE SHOWER-CHAIRS AND BEDPANS

Toileting is a fundamental aspect of personal or self-care. Using conventional toileting facilities is a complex undertaking requiring, for example, core stability, balance, strength, range of movement and cognitive, sensory and perceptual skills to transfer to and from the toilet, adjust clothing, grip and manipulate toilet paper and other menstrual and bowel / bladder management tools.

Gaining access to - and safely utilising - toileting facilities can represent a significant challenge for people with limited or impaired mobility and / or a range of other disabilities. A variety of strategies, assistive aids and equipment exist to facilitate ease of access and independence in toileting and to help maintain privacy and dignity: toilet seat raisers, toilet frames / surrounds, padded toilet seats, grab or support rails, bidets or personal cleansing/drying systems, bottom wipers, etc. (Table E-1), and adaptations to clothing

and the physical lay-out of toileting facilities. Although there is a dearth of research examining the effectiveness of most of these options, occupational therapists

are well placed to offer individual assessments (29) (37) (38) (39) (40).

Table E-1: Main categories of assistive aids and equipment for toileting

Toilet seat raisers	<ul style="list-style-type: none"> • Contoured toilet-seat shaped extensions that fit directly onto toilet bowls once lid/ seat have been raised. • Range of heights available. • Usually fitted with brackets for secure fixing. • Some are available with integral lids.
Toilet frames/surrounds	<ul style="list-style-type: none"> • Metal frames positioned around the toilet to provide armrests to assist transfers. • May incorporate a toilet seat raiser or a conventional toilet seat and lid. • May be height and width adjustable. • Freestanding or fixed to the floor.
Grab or support rails	<ul style="list-style-type: none"> • Fixed to an adjacent wall, floor and/and ceiling. • Wide variety of styles, including fixed and fold-away designs. • Help improve stability and confidence during transfers and adjusting clothing. • Research examining the most effective configuration of rails concluded that the use of two vertical bars resulted in the least anterior-posterior displacement (and therefore greatest stability during transfers) and was rated highly by healthy older participants as well as those living with hip replacements and strokes (553) (Level of Evidence 3).
Bidets and personal cleansing systems	<ul style="list-style-type: none"> • Combined with or integral to a toilet, may enable those without sufficient hand function or balance to reach the perianal area to cleanse without the need for assistance (554) (555) (Level of Evidence 4).
Bottom wipers	<ul style="list-style-type: none"> • Grip toilet paper or wet-wipes on an 'arm' to assist those who are unable to reach to cleanse the perianal area. • Designed to be used from the front of the toilet. • Available in a range of designs, including folding for discrete transportation outside the home (may include a carry case). • Some have buttons to release the paper/wipe after use.

Where it is not possible for an individual to gain timely and safe access to a toilet, conventional or adapted alternatives - such as commodes, mobile shower-chairs and bedpans - may be appropriate. In lieu of a toilet, commodes are static or mobile pieces of equipment that comprise a chair-like frame incorporating a toilet seat under a removable pan (disposable or washable) which is positioned to receive urine and faeces. Mobile shower-chairs (sometimes called sani-chairs) are also available. These are waterproof chairs on wheels that incorporate a toilet seat and are

designed to be manoeuvred over the top of a conventional toilet once an individual is seated on them (41) (42). Bedpans are receptacles designed to be positioned beneath an individual who needs to void their bladder or empty their bowels while in bed, or perhaps while seated on a conventional chair. The design of some female handheld urinals may also make them suitable (for men or women) for collecting faeces (36).

Table E-2 lists the main factors influencing the appropriateness of a commode, shower-chair or bedpan as

a solution for individual needs, and Fig E-1 and Fig E-2 show examples of products in this category.

Table E-2: The main factors influencing the appropriateness of a commode, shower-chair or bedpan as a solution for individual needs.

- The physical characteristics of the individual such as size, weight, postural stability and functional capabilities.
- The mobility of the individual (including in bed) and approach to transfers (e.g. to commode or shower-chair).
- The cognitive status of the individual (e.g. capacity to recognise the purpose of the equipment).
- Availability of and access to brakes (where appropriate).
- Likely duration of individual episodes of use of the equipment.
- The level of assistance and / or supervision required to use the equipment safely and the burden that represents to any caregiver involved.
- User access to the perianal area for cleansing.
- Comfort and need for pressure relief during use.
- The environment in which the equipment will be used and its impact on privacy and dignity.
- The proximity of the area of use to waste disposal and storage facilities.
- Cleaning and maintenance requirements, responsible person and the burden that cleaning could represent.
- Personal preferences and aesthetics, particularly where equipment is to be used at home, and especially in 'public' areas of the home such as a lounge room.

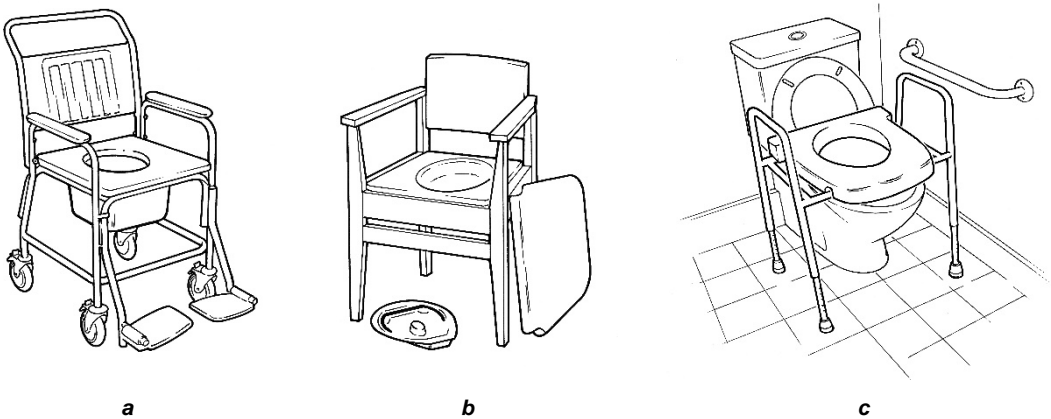

Fig E-1: Commode chair with wheels (a), chair with commode (b) and toilet frame with integral raiser and grab bar (c).

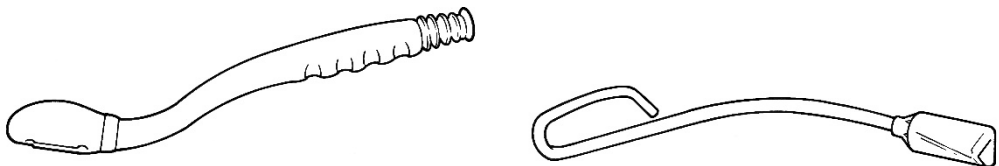

Fig E-2: Example bottom wipers.

1. EVIDENCE

The 5th International Consultation (31) highlighted the limited empirical research that had been undertaken to examine the effectiveness and use of commodes, shower-chairs and bedpans (43). Older work evaluated a range of commodes available at the time, highlighting concerns with the stability and - therefore - safety of some designs, and their limitations in terms of aesthetics and comfort (41) (44) (45) (46). The appearance of a commode and invisibility of its pan were highlighted as being particularly important in a home environment when masking the function of the chair may be important to both users and caregivers (41) (46) (47). Concerns were raised about the maintenance and cleanliness of commodes (48) (49) generally, and about the management of unpleasant odours, particularly in the home environment (47). Of particular note was the lack of guidance available on the effective cleaning of equipment and management of odours in the home environment, where responsibility for both typically falls to caregivers. The potential use of chemical toilets as an alternative was suggested (47).

Some research in the field has focused on considering the needs of people with spinal cord injuries (SCI) who use mobile shower-chairs, highlighting issues with pressure injury, user access to the perianal area, the ease and safety of rolling and turning the chair, cleaning it and falls from it (50). Evaluation of three chairs commonly used by those with SCI - including evaluation of seating pressures - was undertaken (51) (52) to inform the design and development of a more advanced alternative that is now commercially available (53).

The last consultation also noted that bedpans were not well described in the literature, although they could be broadly categorised into **concave pans** (rounded, triangular shaped with a curved base and sloping front to back), **cut-away pans** (rounded, triangular shaped with a flatter seat and rolled edges to provide handgrips) and **shovel or 'fracture' pans** (rectangular or wedge shaped with a flattened end that is positioned beneath the individual, and with a handle at the opposite end). Alongside issues around privacy and dignity, bedpans are generally considered problematic as they do not readily permit the user to assume positions that facilitate urination or defaecation, may cause pain, can be difficult to remove from beneath an individual and are therefore susceptible to spillage and causing skin damage. Furthermore, in the absence of lids, there is the risk of further spills, and they can be malodorous while transporting the content for disposal.

Only three new studies were identified for the current consultation, none of them focusing specifically on static commodes. In the first, Friesen et al (54) undertook an exploratory review to appraise the overall quality of evidence concerning mobile shower-commodes used by adults with SCI and to assess the

available evidence in the areas of clinical assessment, design and performance testing. They identified no randomised control trials or systematic reviews of trials and reported that the overall strength of evidence was fair to poor, with case-control studies the highest level of evidence identified. The authors concluded that research is needed to understand how adults with SCI use their shower-chairs/commodes across a range of functional activities and that validated or standardised clinical assessments tools are required.

Subsequent work by the same Australian team interviewed adults with SCI and expert clinicians about how the designs and features of mobile shower-commodes affect selection and functional performance (42). Semi-structured interviews focussed around transfers, propelling, manoeuvring, bowel-care and showering were undertaken with seven adults who had been living with SCI for three or more years and eight expert clinicians working in the field for five or more years. The findings highlighted the complex array of sometimes competing factors that need to be accounted for in prescribing shower-chairs/commodes; for example, the need for large rear wheels to facilitate propulsion may complicate sliding transfers to and from the equipment. While folding frames permit portability, they compromise everyday use (e.g. they are incompatible with tilt-in-space features) and are paradoxically heavier than fixed frames. Also noteworthy was the importance of customised frames, seats and under-seat access to meet individual needs, and the challenges presented by the rapid rate of deterioration of padded seats combined with the lengthy delays often experienced in securing replacements.

Only one study was found evaluating hospitalised patient experiences related to metal bedpans (55). Semi-structured interviews were conducted, based on a German version of the standardised questionnaire (the Bedpan Ongemak Scaal©). The majority of participants (n=87) described the metal pan as hard, cold, uncomfortable and painful when they were left on the pan for an extended period. Pain was significantly more likely to be considered unacceptable by those in the 'normal' and 'under-weight' categories than by overweight users or those lying supine.

Participants reported fear of missing the pan whilst voiding and described embarrassment and worry about of smells and sounds. Finally, many reported having to wait a long time for the bedpan to be removed.

Recommendations emerging from the study include:

- Minimising time spent sitting on a bedpan and responding immediately to calls,
- Checking the user's position to avoid pain, providing lumbar support as needed with a pillow for those unable to sit vertically and using pillows beneath the legs to help patients lift themselves onto pans with greater ease,

- Warming metal bedpans immediately prior to use, considering alternative models or applying a pressure care overlay,
- Asking mobile patients in shared rooms to leave the room while the other uses a bedpan,
- Ensuring toilet paper and wet wipes (for hands) are easily within reach, and offering to open a window or spray air-freshener following use of the bedpan.

2. SUMMARY

- A conventional or suitably adapted toilet is preferable to using a commode or bedpan wherever it is safely possible to do so (43) (56) (57) (Level of Evidence 3).
- Commodes or shower-chairs (where an individual can safely use them) are preferable to bedpans. Bedpans may position users poorly to urinate or defaecate and may cause pain (55) (Level of Evidence 3).
- Commode (and shower-chair) designs are criticised because they offer limited trunk support which, combined with lengthy periods of unsupervised use, may increase the risk of falls (56) (Level of Evidence 3).
- Shower-chairs may be preferable to static commodes in terms of facilitating access to a toilet, preserving privacy, dignity and the management of noise and odour (43) (56) (Level of Evidence 3).
- Shower-chair or commode stability must be assessed to ensure it is safe and appropriate for individual needs (29) (41) (44) (45) (46) (54) (Level of Evidence 3).
- Assessment of those with SCI should include review of current bowel-care routines, functional capacity to undertake bowel-care, postural stability and reach for intimate hygiene, transfers to and from the shower-chair/commode, pressure sores, skin integrity and interface pressure mapping (54) (Level of Evidence 3).
- Maintenance and cleaning of toileting equipment has been criticised (47) (48) (49) (Level of Evidence 3), although no guidance for cleaning, particularly in the home environment, is available.

3. RECOMMENDATIONS

Recommendations relating to commodes, mobile shower-chairs and bedpans are summarised in Table E-3.

Table E-3: Recommendations relating to commodes, mobile shower-chairs and bedpans.

- Privacy and dignity during toileting are paramount, including the management of associated noise and odours (Grade of Recommendation C).
- Wherever safely possible, access to a conventional or adapted toilet should be offered, or facilitated via a shower-chair with due consideration given to preserving the safety and the modesty of the user during transportation (Grade of Recommendation C).
- The use of bedpans should be minimised to the greatest extent possible without unnecessarily resorting to invasive options such as catheterisation (Grade of Recommendation C).
- Full and careful assessment of individual needs, including mobility, transfers, postural stability, skin integrity, access to the perianal area, and safety must be undertaken before equipment is prescribed or used, and should be followed by regular reviews to assess on-going suitability (Grade of Recommendation C).
- Regardless of the equipment employed, users must have ready access to toilet paper and/or moist wipes and hand washing facilities, and/or appropriate adaptive devices or assistance to help them in this regard (Grade of Recommendation C).
- People should have safe and easy access to a direct method of calling for assistance when left alone for toileting on any piece of equipment (or indeed, on a toilet) (Grade of Recommendation C).
- Equipment should be cleaned after each use, and following local infection control policies in institutional environments, to maintain hygiene, aesthetics and to avoid odour, although there are no evidence-based published guidelines regarding frequency of cleaning or type of cleaning product (Grade of Recommendation C).
- Systems of regular on-going maintenance of equipment are important in whatever environment it is used (Grade of Recommendation C).

4. PRIORITIES FOR RESEARCH

- Evaluative studies of toilet seat raisers, toilet frames/surrounds, padded toilet seats, grab and support rails, bidets or personal cleansing/drying systems, bottom wipers, etc. to inform users, caregivers and healthcare professionals.
- Validated and standardised clinical assessment tools and outcome measures to guide the selection and determine the success of shower-

chairs/commodes for those with long-term needs, particularly adults with SCI (54).

- Evidence-based guidelines to inform the cleaning and maintenance of commodes, shower-chairs and bedpans in institutional and home environments.

F. ABSORBENT PRODUCTS

Absorbent products (commonly known as pads) are available in a range of sizes and absorbencies encompassing light through to very heavy for urinary and/or faecal incontinence. Most pads are bodyworn but some are used on the bed or chair. Broadly speaking, these can be divided into two main sub-groups: suitable for light incontinence (usually smaller products) and suitable for moderate-heavy incontinence (usually larger products).

Incidental findings from product evaluations indicate that absorption capacity alone does not determine whether a user will choose to use a product. Some users may have frequent, low flow-rate loss of small volumes of urine (“dribble”), whilst others may be dry for days but then have a higher volume, higher flow-rate incontinence incident (“gush” or “flooding”). Both may prefer to use pads for light incontinence. Mobile and independent community-dwelling women of all levels of incontinence are reported to generally prefer small pads and are often willing to change them frequently rather than use larger products and change them less often (58). Conversely, dependent, immobile individuals may prefer the security of larger products despite relatively low urine volumes due to their dependence on others for pad changing.

Some studies have focused on the use of pads by men. Teunissen and Lagro-Jansson (59) interviewed 56 men with UI of which only nine used absorbent pads. They concluded that men use pads less frequently than women, have little knowledge about purpose-built pads, are more likely to construct their own pads out of absorbent materials such as towels and are less satisfied with pads than women. Furthermore men may prefer other devices such as urinary sheaths (60) (Section G).

However, the findings of these studies about male and female product use and preferences may not be generalisable to all countries and cultures. In some countries, only limited ranges of absorbent products are available, predominantly adult diapers, with smaller pads less frequently available. Adult diapers are widely sold in supermarkets, prominently displayed, and may be viewed with less embarrassment than in countries where they are supplied primarily through health systems or pharmacies. In comparison, sheath systems may be harder to access and relatively more expensive. Climate (and consequently customary mode of dress) can affect the acceptability of sheaths and their attendant drainage bags.

Studies that have collected and weighed used pads to measure urine loss have found overlap between the quantities contained by pads from different sub-groups; thus in a study of insert pads for moderate-heavy incontinence used by older people in residential care around 15% of insert pads for moderate-heavy incontinence contained less than 100g of urine (61) while in a study of older women with light incontinence living in the community about 10% of insert pads for light incontinence were found to contain more than 100g of urine (62).

Although the number of pads used per day might be a good measure of degree of urinary incontinence, this has not been found to be the case in nursing home residents in Norway (25). Pads were collected and weighed from residents in six homes, but a poor correlation was found between the number of pads used and the volume of urine measured over 48 hours. The authors concluded that this was due to pad changes being carried out at routine times by caregivers.

General guidelines on patient assessment for product selection are discussed in Section B. Aspects of assessment that are particularly important regarding absorbent pads are frequency / severity of leakage, day / night incontinence, sex (some products are designed for or are better for men / women than others), ability to change pad independently / need for carer, pad changing position (standing / lying), laundry / drying facilities, individual priorities (e.g. need for discreetness), personal preference for design / materials (washable / disposable), lifestyle (at home / travel / work etc.). General guidelines on patient assessment for product selection are discussed in Section B.

Aspects of absorbent pad performance have been identified and prioritised (during interviews) by men and women taking part in a series of clinical trials (21). There was notable consistency across patient groups (light / heavy, men / women), with both indicating that the top priority was the ability of a product to hold urine without leakage, while discreetness, containment of odour, ability to stay in place, comfort when wet and ability to keep skin dry were important as well.

1. ABSORBENT PRODUCT CATEGORIES

Absorbent products may be classified into two broad categories - disposable (single-use) and washable (reusable) - with each category dividing into two sub-categories: bodyworn products (worn by the user) or underpads (placed beneath the user). Within each sub-category are different design groups such as diapers and pull-ups which are sub-divided by size (to fit users of different sizes) and / or absorbency (to cater for different severities of incontinence). Some designs are further subdivided into those intended for men, for women or for children. This classification is shown in Table F-1.

Table F-1: Classification of absorbent continence products

Categories:	Disposable (single use)		Washable (reusable)	
Sub-categories:	Bodyworn	Underpads	Bodyworn	Underpads
Design groups*	Inserts Diapers Pull-ups Pouches	Bedpads Chairpads	Inserts Diapers Pull-ups Pouches	Bedpads Chairpads
Sub-groups	Groups sub-divide according to the severity of incontinence (light or moderate / heavy) and the gender of the intended users (M, F or unisex).			
* The products within a given design group may vary considerably in their features and their constituent materials.				

Bodyworn absorbent products can be divided into four main design groups:

Inserts (sometimes called liners or, in the case of small pads, shields) are held in place by close-fitting underwear or separate stretch mesh briefs (Fig F-1). Many disposable inserts (Fig F-2 and Fig F-3) have an adhesive strip on the back to help secure them and may have an indicator that changes colour when the pad is wet. They may have longitudinal, elasticated standing gathers of hydrophobic material intended to impede lateral leakage of urine and faeces. They are

sometimes rectangular but are usually shaped to fit the body. Elastication at the legs may also be used to enhance fit. Washable inserts (Fig F-4) are usually more simply designed than disposable inserts, with no elastication and are either shaped or a simple rectangle. Inserts are made in a wide range of sizes suitable for light through to very heavy urinary incontinence. For light faecal incontinence, the liner may be a small cotton gauze dressing placed against the anus and held in place by the cheeks of the buttocks (Fig F-5).



a

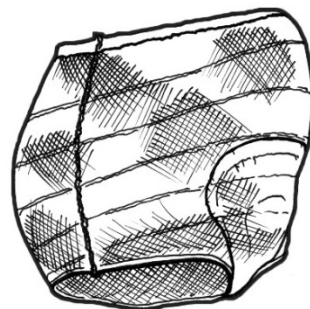

b

Fig F-1: Mesh briefs with (a) and without (b) legs, for supporting disposable bodyworn pads.

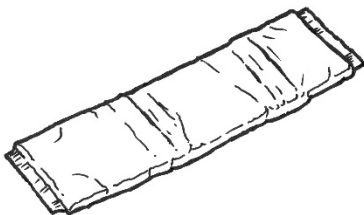

a

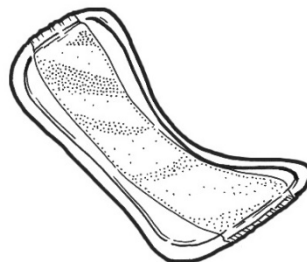

b

Fig F-2: Small, disposable, unshaped (a) and shaped (b) insert pads for light incontinence.

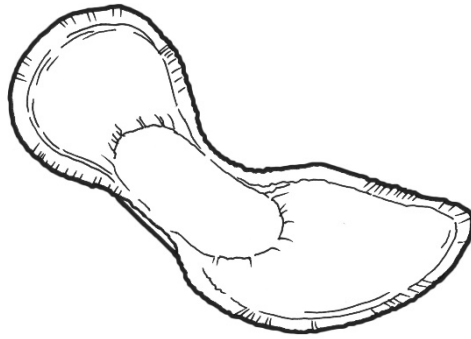

Fig F-3: Large, disposable, shaped insert pads for moderate / heavy incontinence.

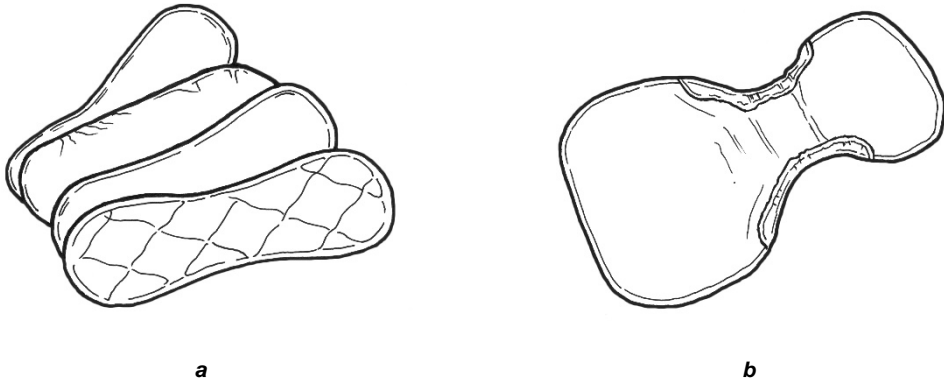

Fig F-4: Washable, shaped insert pads for light (a) and moderate / heavy (b) incontinence.



**Fig F-5: Liner for light faecal incontinence.
(from www.continenceproductadvisor.org)**

Disposable diapers (also called all-in-ones or briefs) (Figs F-6) usually have elasticated waist and legs and self-adhesive tabs (usually resealable), and often a wetness indicator and standing gathers. Modified diapers (T-shaped or belted briefs) fasten around the

waist before the front is pulled into position and secured, enabling users to apply the diaper whilst standing (Fig F-7). Washable diapers are usually elasticated at the waist and legs and are fixed with

Velcro or press-studs (Fig F-8). Diapers are intended for moderate to very-heavy incontinence.

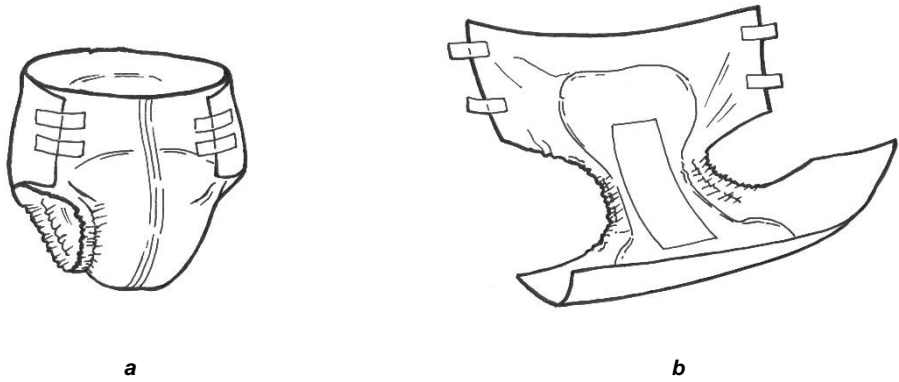

Fig F-6: Disposable brief, closed (a) and open (b).

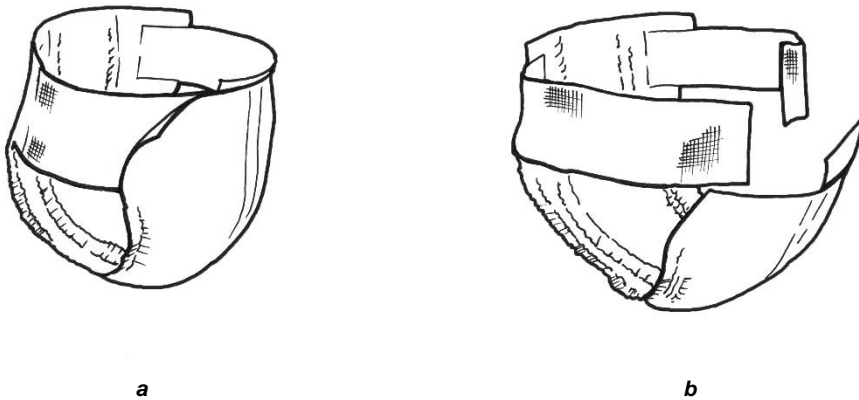

Fig F-7: Disposable T-shaped brief, closed (a) and open (b).

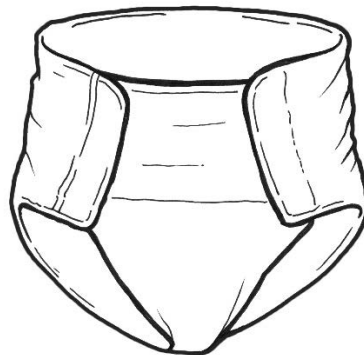

Fig F-8: Washable brief.

Pull-ups are similar in construction to trainer pants for toddlers. The absorbent material is built into a pull-up pant and is either limited to the crotch area or distributed throughout the pants (Fig F-9, Fig F-10 and Fig F-11). Disposable pull-ups (Fig F-9) are usually

elasticated throughout the pants for a close fit. Both disposable and washable pull-ups have versions for different levels of incontinence. Washable pull-ups for light incontinence are often known as pants with integral pad (Fig F-11).



a

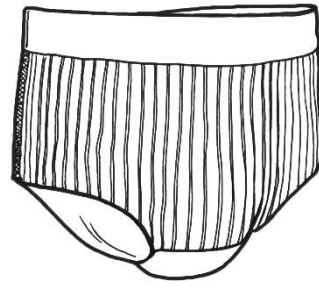

b

Fig F-9: Disposable pull-ups for moderate / heavy incontinence for women (a), and for men (b).

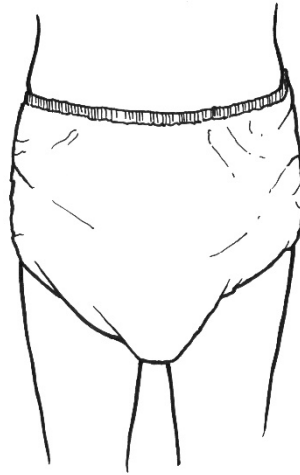
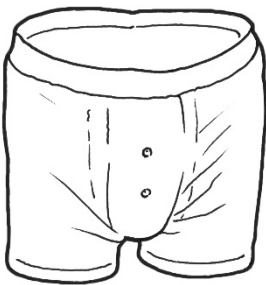
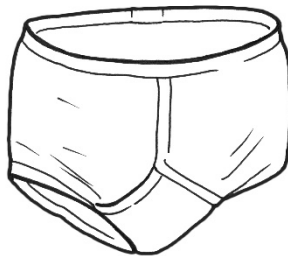

Fig F-10: Washable pull-ups (unisex).



a



b



c

Fig F-11: Washable pants with integral pad for light incontinence: boxer style for men (a), y-front style for men (b), and for women (c).

Homemade products typically comprise terry-towel-ing squares which are folded into briefs, fastened with pins and covered with plastic pants as a water-proof barrier. Such pants may also be worn over more

conventional designs in an attempt to reduce leakage and / or odour.

“Body” garments (like vests which have a crotch section which opens and closes with snap fasteners, much like those manufactured for babies) may be

helpful to hold pads in place and may reduce the rustling noise from plastic backing materials.

Male pouches (sometimes called shields, guards or leaves) are for lightly incontinent men and are designed to fit around the penis and sometimes the

scrotum too (Fig F-12). All are worn with close-fitting underwear or stretch mesh briefs. An adhesive strip is often provided on the disposable versions to help hold them in place.

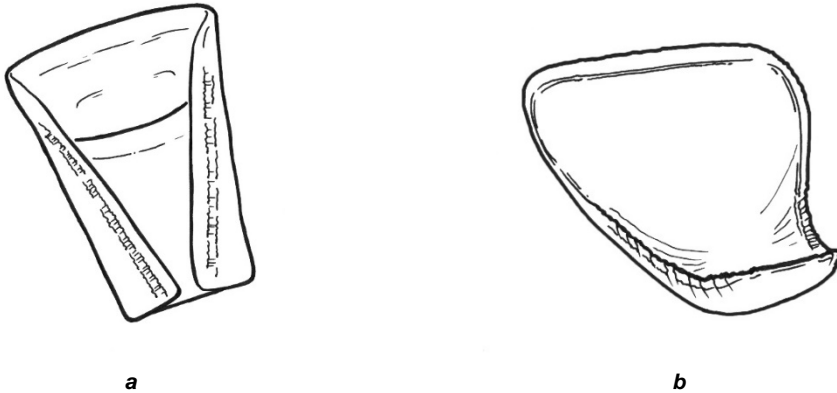

Fig F-12: Disposable pouch (a) and leaf (b) for men

Underpad absorbent products are usually simple rectangles of different sizes to be used on the bed or chair. Washable underpads may have a high friction backing or have 'wings' for tucking beneath the mattress to help keep them in place. Underpads vary widely in absorbency with less absorbent products being used as 'back-up' with bodyworn absorbents and more absorbent products being used as sole protection on the bed at night.

Availability of products will necessarily affect choice. However, even where only a single product type (eg adult diaper) is readily available, within that product type individual brands and / or absorbencies may be better suited to some users and circumstances than others. Clinicians and users are likely to manage incontinence more successfully if they become familiar with the relative advantages of different products: for example, cheaper products may be slightly less reliable than more expensive ones, but may be perfectly adequate for use at home, when more frequent changing is possible and affordable; more expensive products may provide better protection when out of the home; more absorbent night-time products may be suitable for travel as well as sleeping.

2. ABSORBENT PRODUCT MATERIALS

Absorbent products – disposable or washable – usually comprise three main layers: an absorbent core sandwiched between a water-proof backing beneath and a water-permeable coverstock (or topsheet) next to the wearer's skin.

The main component in disposable absorbent cores is invariably some kind of fluffed wood pulp fibre, but most also contain powdered superabsorber in the

crotch region (also referred to as superabsorbent polymer (SAP) or absorbent gelling material (AGM)). Superabsorbers hold much more urine – weight for weight – than fluff pulp and retain it far more tenaciously under pressure. They are usually based on cross-linked salts of polyacrylic acid whose chemistry can be varied according to the balance of properties such as absorption capacity and absorption speed desired. Some thermoplastic fibres are also sometimes included in absorbent cores to reduce core break up and the collapse of the structure when wet. It is increasingly common for absorbent cores to comprise two or more layers, each designed to perform a different function. For example, an upper layer might comprise low absorbency fibres engineered to receive and distribute urine efficiently and maintain a dry layer next to the skin, while lower layers provide absorption capacity. Some disposable products have 'breathable' plastic backings designed to reduce skin occlusion.

Washable absorbent cores are usually made from a needlefelt or knitted fabric comprising rayon and / or polyester fibres. A variety of polymers are used for the water-proofing. In general, the thicker, stiffer materials are more durable (the durability of the plastic backing often determines the lifetime of the product) but less comfortable. Topsheets are usually made from either cotton – which is hydrophilic and intended to have good dry comfort – or polyester – which is hydrophobic and intended to have good wet comfort.

Concern for the environment and for controlling costs has led to an increase in the number of washable products available on the market. An important consideration in the comparison of washable and disposable designs is the relative environmental cost, particularly disposal (landfill) costs of disposable designs and energy costs associated with laundering the washables. A report on baby diapers concluded that

there was no significant difference in environmental impact between three diaper systems (disposables, home and commercial laundered) although the types of impact did vary (63).

3. ABSORBENT PRODUCT CAPACITY AND USER REQUIREMENTS

Pads come in a range of absorbencies for different levels of incontinence and, understandably, purchasers wish to know how much urine pads will hold. But there is no simple answer: no pad has a volume of urine below which it is guaranteed not to leak; rather, the probability of success decreases as the volume of the urine increases. However, for higher absorbency pads performance falls away more slowly with increasing urine volume than it does for lower absorbency products.

Absorption capacity is a complex concept to communicate in sales literature and product packaging and so companies commonly quote a simple absorption capacity figure. Some use the volume of fluid a pad will hold in a laboratory test - usually international standard ISO 11948-1 (64) - but this figure can be very misleading. Although it correlates well with leakage performance for some groups of users (Section F.6.1.1), the volume of urine which a pad will hold when tested with ISO 11948-1 is enormous compared with how much it will hold in real use. For this reason, some companies prefer to quote a “working capacity”, which might be calculated as some proportion (companies vary in the proportion they use) of the capacity in the laboratory. However, this is still misleading as it implies that the pad will not leak until the working capacity is exceeded. A simple, valid and widely accepted solution to this problem has yet to be devised.

It is equally difficult to determine user needs concerning volume of urine their pads need to hold. Not only can different users leak widely differing volumes from each other but also an individual user may leak widely differing volumes on different occasions. This means that, like pad performance, users' needs cannot be easily quantified. Published data describing users as 'lightly incontinent' place the median and 90th percentile urine volumes in used pads at about 15ml and 100ml, respectively (14). Similarly, those with moderate-heavy urinary incontinence have yielded corresponding figures of about 250ml and 600ml (14). Accordingly, in this chapter the material is divided – somewhat simplistically – into that which relates to **light incontinence** and that which relates to **moderate-heavy**.

Some products work better for users whose incontinence is towards the lighter or the heavier end of the spectrum and so, where necessary in the text and tables that follow, these distinctions are made by dividing light incontinence into “light LIGHT” and “heavy LIGHT”; and moderate-heavy incontinence into “light HEAVY” and heavy HEAVY”.

4. BODYWORN ABSORBENT PRODUCTS FOR WOMEN WITH LIGHT URINARY INCONTINENCE

There are four main product designs for women with light incontinence (Table F-2). In addition, menstrual pads are known to be frequently used for light urinary incontinence. The disposable pull-ups are relatively expensive, single-use items and seldom used for light incontinence except as 'emergency' items. Underpads are not commonly used for light incontinence.

Table F-2: Bodyworn absorbent products for women with light urinary incontinence

	Disposable	Washable
Design groups	Inserts (Fig F-2)	Inserts (Fig F-4)
	Pull-ups ie pants with integral pad	Pull-ups ie pants with integral pad (Fig F-11)
	Menstrual pads	

4.1. Evidence

A small number of robust comparative evaluations of absorbent pads for women with light incontinence have been published, and one Cochrane review (65). Most studies are now rather old (2004 or earlier) and relate to products no longer available (18) (20) (66) (67). No studies of pads for women with light incontinence have been published since the 5th consultation (31).

In the most recent substantial study (2008), Fader et al (14) used a crossover randomised design to compare the most common product designs: disposable inserts, menstrual pads, washable pants with integral pad, and washable inserts. Three products were selected to represent each design and each product was tested for one week (three weeks for each design block, total 12 weeks). Product performance was characterised using a validated questionnaire to evaluate pad performance (leakage, discreetness etc.) with a five-point scale (very good – very poor) at the

end of each week of product testing. A pad change and leakage diary was used to record severity of leakage from individual used pads (three-point scale: a lot, a little, or no leakage), and numbers of laundry items and pads used were recorded to estimate costs. Skin health changes were recorded weekly. At a final interview preferences were ranked (with and without costs), acceptability of the design recorded (highly acceptable – totally unacceptable) and overall opinion marked on a visual analogue scale (VAS) of 0-100 points (worst design – best design). This VAS score was used to estimate cost-effectiveness.

Eighty-five women (mean age 60) completed the study and 8691 used pads were weighed. The disposable insert was significantly better than the other designs on most variables except for discretioness. For leakage prevention, overall acceptability and preference, disposable inserts were found to be significantly better than menstrual pads, which were better than washable pants with integral pad, which were better than washable inserts. There was no clear benefit for skin health using either washable or disposable designs. Most women preferred the disposable insert pad but some preferred the other cheaper designs (6/85 preferred menstrual pads; 13/85 preferred washable pants), both of which were >50% cheaper to use than disposable inserts). Washable inserts were significantly worse than the other designs (72/85 found them unacceptable). Overall there were generally more practical problems with washables, particularly when away from the home (Level of Evidence 1).

The authors concluded that allowing women to choose their preferred design of absorbent product (or combination of different designs for different circumstances) would be more cost-effective and provide better patient satisfaction than provision of disposable insert pads (the most expensive product) alone.

4.2. Summary

- Disposable inserts are more effective in terms of leakage and more acceptable than menstrual pads, washable pants and washable inserts (Level of Evidence 1).
- Menstrual pads are cheaper and washable pants cheaper still (on a per-use basis) and are acceptable to many, particularly those with lighter incontinence and particularly when used at home. They may also be more readily available in some regions than pads designed specifically for incontinence. (Level of Evidence 1)
- Washable inserts are not acceptable to most women with light urinary incontinence. (Level of Evidence 1)
- The user characteristics, priorities and contexts which favour or discourage the use of the different product designs are summarised in Fig F-16.

4.3. Recommendations

Recommendations relating to bodyworn absorbent products for women with light urinary incontinence are listed in Table F-3, while Table F-4 describes the user characteristics, priorities and contexts which favour or discourage the use of the different product designs.

Table F-3: Recommendations relating to bodyworn absorbent products for women with light urinary incontinence.

- Disposable inserts are recommended as the most effective and preferred absorbent product for women with light urinary incontinence (Grade of Recommendation B).
- Menstrual pads or washable pants may be sufficient for some patients with very light urinary incontinence and are cheaper (Grade of Recommendation B).
- Washable inserts are not recommended for women with light urinary incontinence (Grade of Recommendation B).
- Combinations / mixes of designs for different situations (e.g. disposable inserts for going out, washable pants with integral pad for staying at home) are likely to provide optimum management in terms of patient needs and cost-effectiveness, and product advice and provision (where purchased by institutions / services) should reflect this (Grade of Recommendation B).
- See also the general recommendations relating to pad selection in Table F-13 and to washable pads in Table F-14.

4.4. Priorities for research

- Because the performance of washables is generally poor (particularly for leakage) compared to disposables, the development of better washable products for women with light urinary incontinence is a priority.
- The use of combinations of designs for different situations needs to be evaluated.

Table F-4: User characteristics, priorities and contexts which favour or discourage the use of the different pad designs for females with light urinary incontinence.

Product Type	More likely to suit you if...	Less likely to suit you if...
Small disposable pads	<ul style="list-style-type: none"> You are most concerned about reliably containing. 	<ul style="list-style-type: none"> Low cost is a priority for you. Discretion is a priority for you.
Sanitary towels	<ul style="list-style-type: none"> Low cost is a priority for you. 	<ul style="list-style-type: none"> Your leakage is at the heavier end of light leakage.
Washable pants	<ul style="list-style-type: none"> Low cost is a priority for you Your leakage is very light. 	<ul style="list-style-type: none"> You do not have adequate laundry facilities. You are unwilling to use washable products. You are not prepared to carry used products when out. Your leakage is at the heavier end of light leakage.
Small washable pads	<ul style="list-style-type: none"> Low cost is a priority for you. Your leakage is very light. 	<ul style="list-style-type: none"> You do not have adequate laundry facilities. You are unwilling to use washable products. You are not prepared to carry used products when out. Your leakage is at the heavier end of light leakage.

NB The content of this table is based on the referenced evidence cited in the chapter, but the unreferenced version provided for the lay public on the accompanying website (www.continenceproductadvisor.org) is reproduced here.

5. BODYWORN ABSORBENT PRODUCTS FOR MEN WITH LIGHT URINARY INCONTINENCE

There are five main bodyworn absorbent product designs for men with light urinary incontinence (Table F-5). However, disposable and washable insert pads are often unappealing to men as they are frequently marketed specifically at women and bear a strong resemblance to menstrual pads. Anatomical differences are also likely to mean that they are less effective for men. Pouch, shield and leaf products (Figs F-11 and F6-12) are designed to be more suitable for men by containing the penis or penis and scrotum

5.1. Evidence

Only one randomised trial has been published evaluating absorbent products for men with light urinary incontinence (68). Four main absorbent designs available in the UK in 2003 were compared: 6 pouches and 6 leaf products; 1 disposable insert pad and 1

washable pant with integral pouch chosen to represent their respective designs. Seventy men with light urinary incontinence completed the 14-week study. Outcomes were measured using product performance questionnaires after testing each product for a week and at the end of each design, pad leakage diaries and pad weight. 'Overall opinion' was used as the primary outcome variable.

Results showed:

- The performance of pouch designs was significantly worse than that of the leaf and insert designs. The most common problems with the pouch were staying in place and difficulties re-inserting the penis in the pouch once the pouch was wet.
- The disposable insert was effective for leakage prevention and was substantially cheaper than the leaf designs.
- Products with the leaf designs had the best leakage scores, but one product was significantly better than the other. It was roughly triangular in

shape and slightly elasticated on the long edges to give shaping / cupping.

- The washable leaf was the least successful of the leaf designs.
- Washable pants with integral pad received polarised overall opinion scores (loved or hated) and scored well for staying place but poorly for leakage.

In a randomised trial – reported since the last consultation (31) - the performance of three continence devices (sheath drainage system, body-worn urinal (BWU), penile clamp) and absorbent pads was assessed by 56 men with persistent urinary incontinence (>1 year) post radical prostatectomy. Each device was tested for three weeks. The results for the non-pad products are reported in other sections (G, I

and K). Pads were judged to be good for everyday activities and best for night-time use, most easy to use, comfortable when dry but most likely to leak and most uncomfortable when wet. However, there was a preference for having a mixture of products to meet daytime needs; around two-thirds of men elected to use a combination of pads and devices after testing. Men reported that pads and devices have different strengths, which make them particularly suited to certain circumstances and activities.

5.2. Recommendations

Recommendations relating to bodyworn absorbent products for men with light urinary incontinence are listed in Table F-6, while Table F-7 describes the user characteristics, priorities and contexts which favour or discourage the use of the different product designs.

Table F-5: Bodyworn absorbent products for men with light urinary incontinence

	Disposable	Washable
Design groups	Inserts (Fig F-2)	Inserts (Fig F-4)
	Pouch (Fig F-12)	Pouch
		Pull-ups ie pants with integral pad (Fig F-11)

Table F-6: Recommendations relating to bodyworn absorbent products for men with light urinary incontinence.

- Disposable leaves are recommended as the most acceptable and effective design for men with light incontinence, but some men prefer other designs which should be considered as alternatives (Grade of Recommendation B).
- Simple insert pads are cheaper and may be acceptable to some men with light urinary incontinence (Grade of Recommendation B).
- Washable pants with integral pad are likely to be most suitable for men with very light incontinence who have difficulties keeping an insert or pouch in place (Grade of Recommendation B).
- Disposable absorbent products- as opposed to male devices - are recommended for night-time users with post-prostatectomy incontinence (Grade of Recommendation B).
- See also the general recommendations relating to pad selection in Table F-13 and to washable pads in Table F-14.

Table F-7: User characteristics, priorities and contexts which favour or discourage the use of the different pad designs for males with light urinary incontinence.

Product Type	More likely to suit you if...	Less likely to suit you if...
Disposable pouches	<ul style="list-style-type: none"> • Discretion is a priority for you • Using a specifically male product is important to you. 	<ul style="list-style-type: none"> • You have penile retraction. • Your leakage is at the heavier end of light leakage.
Disposable leafs	<ul style="list-style-type: none"> • Actually, they suit most men. 	
Small disposable pads	<ul style="list-style-type: none"> • Low cost is a priority for you. • You are happy to use a unisex product. 	
Washable pants	<ul style="list-style-type: none"> • Your leakage is very light. • Low cost is a priority for you. • You are mobile and active. 	<ul style="list-style-type: none"> • You do not have adequate laundry facilities. • You are unwilling to use washable products. • You are not prepared to carry used products when out. • Your leakage is at the heavier end of light leakage.

NB The content of this table is based on the referenced evidence cited in the chapter, but the unreferenced version provided for the lay public on the accompanying website (www.continenceproductadvisor.org) is reproduced here.

5.3. Priorities for research

Although the performance of washables was generally poor (particularly for leakage) compared to disposables, some men would like to use washables. The development of better washable products is, therefore, a priority for men with light urinary incontinence.

- Washable counterparts are available but have a much smaller market. They are made from a variety of natural and synthetic fabrics.
- Disposable and washable bedpads and chair pads are used on the bed with or without the support of a bodyworn product. Chairpads are used either with or without a bodyworn product – if without, the individual must sit directly on the pad with no underpants on. Both practices place an underpad on display and mark the individual as being incontinent and are therefore to be discouraged.

6. BODYWORN ABSORBENT PRODUCTS FOR MEN AND WOMEN WITH MODERATE-HEAVY URINARY INCONTINENCE

There are at least 12 absorbent product designs for men and women with moderate-heavy urinary incontinence (Table F-8):

- Disposable bodyworn inserts and diapers (Figs F-3 and F-6).
- Modified diapers (T-shaped diapers, Fig F-7) can be applied when the wearer is standing.
- Pull-ups comprise an absorbent pad integrated into a disposable elasticated pant (Fig F-9).

Table F-8: Absorbent products for adults with moderate-heavy incontinence

	Disposable (single use)		Washable (reusable)	
Type	Bodyworn	Underpads	Bodyworn	Underpads
Design groups	Inserts (Fig F-3) Diapers (Fig F-6) T-shaped diapers (Fig F-7) Pull-ups (Fig F-9)	Bedpads Chairpads	Inserts (Fig F-4) Diapers T-shaped diapers Pull-ups (Fig F-10)	Bedpads Chairpads

6.1. Evidence

Although it was reported in the 5th International Consultation (31), two clinical studies of absorbent products for moderate-heavy incontinence conducted by Fader et al. (14) - one community based, the other in nursing homes - remain the most recent studies of reasonable size. In the community-based trial 85 moderate / heavily incontinent adults (urinary or urinary / faecal) living in their own homes (49 men and 36 women) were enrolled, and tested three (or two) products from each of five design categories (total of 14 test products): disposable inserts (with mesh pants); disposable diapers; disposable pull-ups; disposable T-shape diapers; and washable diapers. All products were provided in a daytime and a (mostly more absorbent) night-time variant. Products were selected based on having similar scores for absorbency across the designs (Rothwell scores, (64) see below) and performance data from pilot studies. In the nursing-home-based trial 100 moderate / heavily incontinent adults (urinary or urinary / faecal) living in a total of 10 nursing homes (27 men and 73 women) evaluated one product from each of the four disposable design categories above. Products were selected on the basis of product performance from the community-based trial and, again, day and night-time variants were provided.

Product performance was characterised using validated questionnaires which asked the participants or caregivers to evaluate pad performance (leakage, ease of putting on, discreetness etc) using a fivepoint scale (very good – very poor) at the end of each test period. Pad weighing tests were also conducted along with perceived severity of pad leakage on a three-point scale (none, a little, a lot). Numbers of laundry items and pads used were recorded to estimate costs, and skin health changes were recorded by the participant or by the researchers. At the end of testing participants were interviewed and ranked their preferences (with and without costs), stated the acceptability of the design (highly acceptable – totally unacceptable) and recorded their overall opinion on a visual analogue scale (VAS) of 0-100 points (worst – best design). A pad changing experiment was conducted with 12 women from the nursing home based trial to determine any differences between product designs. Under idealised conditions the different designs were applied (by the same caregivers) in random order for each patient and the speed of pad changing was timed using a stop-watch.

Results (Community):

- Disposable inserts had worse leakage performance than the other designs for day and night.
- Disposable pull-ups were preferred over inserts for the daytime.
- T-shape diaper was not better overall than the traditional disposable diaper.
- Performance and preference findings differed between men and women, in part due to the larger leakage volumes experienced by the men.
- Pull-ups (the most expensive design) were better overall than the other designs for women during the day and night
- Disposable diapers were better for leakage than disposable inserts (the cheapest), but women did not prefer them; for men, diapers were better both overall and for leakage and were the most cost-effective design.
- The two washable products based on cotton terry-towelling (one, a simple square, folded and pinned in a diaper shape and; the other, a diaper-like design - both worn with plastic pants) were better for leakage at night than the disposable designs, but less popular overall for daytime use. Only 25% of women found them acceptable, but over 60% of men found them highly acceptable at night.
- A washable product with a felt absorbent core and an integral plastic backing fixed by poppers performed significantly worse for leakage than the other two washables and was not included in the analysis.
- There were many practical problems dealing with washable products particularly when out of the house, but they were more acceptable at home.
- No firm conclusions could be drawn about the performance of designs for faecal incontinence and there was no firm evidence that there were differences in skin health problems between designs (Level of Evidence 1).

Results (Nursing home):

- The T-shape diaper was not easier or quicker to change than the diaper.

- Caregivers found pull-ups and inserts significantly easier and quicker to apply than the other designs (in the standing position).
- The ability of residents to stand was associated with staff preference for pull-ups or inserts.

Various older studies (2004 or older) have involved user trials of washable bodyworn products alone (22); disposable bodyworn products alone (69) (70); comparisons between disposable and washable bodyworn products (71) (72) (73) (74) (75) (76) (77) (78) (79); or between disposable and washable bedpads and bodyworns (24) (80) (81). The results from these studies are of limited value because of the many new products that have superseded them, but they do yield useful insights that apply to generic designs.

Since the last consultation (31), Fader et al. have published a study that used a “shopping experiment” to investigate the preferences of community-dwelling UK women and men with moderate-to-heavy urinary incontinence for four different designs of disposable pads (inserts, all-in-ones, belted/T-shaped and pull-ups) and towelling washable / reusable products, day and night (82). Participants tested each design and selected products they would prefer, given a range of different budgets. Inserts, most frequently supplied by the UK National Health Service, were ranked second to pull-ups by women and lowest by men. When faced with budget constraints, up to 40% of participants opted to ‘mix-and-match’ designs. Over 15 different combinations of products were selected by participants in this shopping experiment. Most (91%) stated a willingness to ‘top-up’ assigned budgets from income to secure preferred designs. Participants displayed diverse preferences and Fader et al. concluded that enabling user choice of absorbent product design through individual budgets could improve satisfaction of consumers and efficiency of allocation of limited resources.

6.1.1 Disposable absorbent products for urinary incontinence: development of international standards.

Because clinical evaluations are expensive and time-consuming, laboratory evaluation procedures are widespread. Few have been clinically validated but there is a clinically-validated International Standard (ISO 11948-1) relating to the leakage performance of disposable bodyworn pads for adults with moderate-heavily incontinence in institutions (64). It describes a simple method for measuring the absorption capacity of pads in the laboratory that was shown to correlate well with the leakage performance of 18 different products evaluated in an international multi-centre clinical study involving 112 heavily incontinent adults (83). The strength of the correlation between technical and clinical data depended on the exact parameters being compared, but typically $r = 0.9$ (Level of Evidence 2). This laboratory test (the Rothwell method) is now in common use in the UK, Sweden and other countries and provides a basis for selecting

similar products with which to make direct comparisons (for cost purposes) or to select promising pads for inclusion in clinical trials.

The ability of ISO 11948-1 to predict the leakage performance of more recent bodyworn pads (138 diapers and inserts) for heavy incontinence was investigated by Cottenden et al. (84). Correlations were poorer than in the original 1993 study ($r < 0.87$ compared with $r < 0.95$) but still strong enough to make the method useful. For a given Rothwell capacity, the leakage performance of diapers was far superior to inserts, but no evidence was found for any other design feature of the test products (inserts and diapers) having a significant impact on their leakage performance (Level of Evidence 2).

Although leakage performance is a very important measure of pad effectiveness other factors are, of course, important too. Accordingly, it is helpful for users to systematically evaluate several products with similar leakage performance, as there can be wide variations between products on other variables such as fit and comfort.

6.2. Summary

- There is no single best product design (i.e. one design that is significantly better than all other designs for all users) (Level of Evidence 1).
- Different designs are better for men and women. In particular, men leak substantially higher volumes of urine than women (Level of Evidence 1).
- Disposable pull-ups or T-shaped diaper designs are not better overall than the cheaper diaper for men, indicating that the diaper is the most cost-effective design for men. For women pull-ups are better overall than the other designs (except for night-use in those living in nursing homes) (Level of Evidence 1).
- Unlike men, women in the community do not favour diapers over insert pads and of these cheaper designs, inserts may be preferred for women (Level of Evidence 1).
- Pads containing superabsorber leak less, are more comfortable, and keep the skin drier than those without (Level of Evidence 2).
- Leakage performance of inserts and diapers for heavy incontinence can be predicted with reasonable precision using an ISO laboratory tests (Level of evidence 2). ISO has very good repeatability and adequate reproducibility (Level of Evidence 2).
- Washable products are very varied in design, materials, and performance. Terry-towelling products (used with plastic pants) have good leakage performance but limited acceptability - confined mainly to some men at night (Level of Evidence 2).

- Leakage performance of inserts is worse than other designs, but they leak significantly less if they are held in place by mesh rather than ordinary pants (Level of Evidence 3).
- There is no firm evidence regarding the performance of different designs for faecal incontinence and no firm evidence that any design or type of material (washable or disposable) is better or worse for skin health (Level of Evidence 4).

6.3. Recommendations

Recommendations relating to bodyworn absorbent products for men and women with moderate-heavy urinary incontinence are summarised in Table F-9, while Table F-10 describes the user characteristics, priorities and contexts which favour or discourage the use of the different product designs.

Table F-9: Recommendations relating to bodyworn absorbent products for men and women with moderate-heavy urinary incontinence.

- Gender should be considered when products are prescribed / purchased for users. As men often have substantially higher incontinent urine volumes than women, men may require more products and / or more absorbent products than women (Grade of Recommendation B).
- Gender should also be considered when products are prescribed / purchased for users because men and women are likely to prefer different designs. Men generally prefer disposable diapers to inserts (Grade of Recommendation B).
- Women generally prefer disposable pull-ups to other designs, but these are expensive. Disposable inserts are a cost-effective alternative (Grade of Recommendation B).
- Caution is recommended if washable designs are being considered. Heavy bulk confines their use mainly to the night-time (where they may be particularly useful for users who lie on their side). They are unacceptable for most people during the daytime and for most women at any time and for this reason a blanket policy of health services providing washables alone is not recommended. If washables are being considered refer to points below (Grades of Recommendation B).
- Freedom from leakage: Where possible, international standard laboratory tests should be used to rank the likely leakage performance of different pads for heavy and light incontinence (Grade of Recommendation B). In general, diapers should be selected in preference to inserts to minimise leakage (Grade of Recommendation B).
- Carer application: When products are applied by a carer to a patient who can stand for pad changing, disposable inserts or pull-ups are easier and quicker to change than diapers or T-shaped diapers. If the patient is lying down (e.g. at night) pull-ups should be avoided (Grade of Recommendation B).
- Combinations of designs for different situations (e.g. disposable inserts for staying in, disposable pull-ups for going out, washable diapers at night) are likely to provide optimum management in terms of patient needs and cost-effectiveness (Grade of Recommendation B).
- See also the general recommendations relating to pad selection in Table F-13 and to washable pads in Table F-14.

Table F-10: User characteristics, priorities and contexts which favour or discourage the use of the different pad designs for adults with moderate – heavy urinary incontinence.

Product Type	More likely to suit you if...	Less likely to suit you if...
Large disposable pads	<ul style="list-style-type: none"> You are female. Discretion is a priority for you. You want a product which is easy to put on. You can stand up (with assistance if necessary) but can't change your own pad. 	<ul style="list-style-type: none"> Your leakage is very heavy. You are mobile and active.
Large disposable pants	<ul style="list-style-type: none"> You are female. Discretion is a priority for you. You want a product which is easy to put on. You can stand up (with assistance if necessary) but can't change your own pad. You are most concerned about reliably containing leakage. 	<ul style="list-style-type: none"> You find removal of clothing for changing the pad difficult. Low cost is a priority for you. You need a product for use at night and need help with pad changing.
All-in-ones	<ul style="list-style-type: none"> You are male. Your leakage is very heavy. You are unable to stand to change the pad. 	<ul style="list-style-type: none"> Discretion is a priority for you.
T-shape pads	<ul style="list-style-type: none"> You are male. You are most concerned about reliably containing leakage. 	
Large washable pads	<ul style="list-style-type: none"> You are male. Your leakage is very heavy, particularly at night. 	<ul style="list-style-type: none"> You do not have adequate laundry facilities. You are unwilling to use washable products. You are not prepared to carry used products when out. Discreetness and appearance are priorities for you.
<p>NB The content of this table is based on the referenced evidence cited in the chapter, but the unreferenced version provided for the lay public on the accompanying website (www.continenceproductadvisor.org) is reproduced here.</p>		

6.4. Priorities for research

- Comparison of absorbent products (disposable and washable) when used by caregiver-dependent users in the community.
- Development of more effective and acceptable disposable designs specifically for men.
- Development of more effective and aesthetically acceptable washable products, particularly for night-time use and for women.

7. DISPOSABLE UNDERPADS

The most recent publications on the use of bedpads were in 1994 (24) (80), probably reflecting their limited role in long-term management of incontinence. The presence of a disposable underpad on a chair discloses the fact that the user is incontinent. It also requires clothes to be pulled up (or absent) which poses a threat to a person's dignity. In the bed, disposable underpads easily become displaced, folded and creased inhibiting both performance and comfort,

and may threaten skin health. Large disposable underpads with wings to tuck into the bed may have a role as bed protection 'back-up' to bodyworn pads. The main role of disposable underpads should be confined to temporary bed or chair protection such as during clinical procedures (e.g. enemata) or when using a urinal.

Trials comparing different disposable bedpads are few (24) (85) (86) and it is not possible to draw firm conclusions from them on the effectiveness of different product design features and materials.

Bedpads are generally supplied as non-sterile items and some case reports published between 1985 and 1997 suggest that recycled paper in bedpads could be a potential source of infection (87) (88) (89) (90). However, there are no recent studies and risk to patients appears to be minimal when products are used as directed.

7.1. Summary

No robust data are available on the effectiveness of current disposable bedpads or of their various design features or constituent materials. There is a possible risk of infection from bedpads made from recycled paper for immunocompromised users (Level of evidence 4). The leakage performance of bedpads (used alone or as back up to bodyworn pads) can be predicted with reasonable precision using clinically-validated laboratory tests (Level of Evidence 2).

7.2. Recommendations

Recommendations relating to disposable underpads are summarised in Table F-11.

Table F-11: Recommendations relating to disposable underpads.

- Disposable underpads should not be used for long-term management of UI or FI, but have a useful role as temporary protection for chairs and beds during clinical procedures (Grade of Recommendation C).
- Immunocompromised people should not use bedpads made from recycled paper because of the risk of infection (Grade of Recommendation B).

7.3. Priorities for research

Disposable underpads have a limited role in continence management but are known to be widely used. An exploration of patient views regarding their use may help demonstrate their limitations, particularly regarding skin health.

8. WASHABLE UNDERPADS

Aspects of assessment that are important regarding washable underpads are patient acceptability and preference, particularly with regard to willingness to

be naked below the waist (if sole use intended) and availability of laundry and drying facilities.

Some evaluations have found significant differences between products relating to leakage performance and skin health but none of the products evaluated are now available (91) (92). Compared products always differed from one another in many respects making it impossible to draw reliable generic conclusions relating to current products. However, the choice of topsheet material and the presence or absence of features like tuck-in flaps and integral water-proofing appear to be, primarily, matters of personal preference.

In institutional settings, washable bedpads are commonly used by multiple patients and questions are often asked about the risk of cross-infection. Cottenden et al. (93) assessed the risk by determining the microbial content of 145 bedpads of five different designs after a night's use by incontinent adults, followed by laundering using a standard foul wash procedure which included heat disinfection at 71°C for three minutes. Laundering destroyed all known pathogenic organisms, although some commensal flora were isolated in small numbers. It was concluded that foul wash laundry left bedpads safe for multiple patient re-use with no demonstrable risk of cross-infection.

8.1. Summary

The literature contains insufficient robust data on which to base guidelines for choosing between washable bedpads. Choice of topsheet material and the presence / absence of design features like tuck-in flaps and integral/separate water-proof backing appear to be, primarily, matters of personal preference (Level of evidence 3). Provided an approved foul wash procedure is used, the risk of cross-infection between different users of a bedpads is very low (Level of Evidence 2).

8.2. Recommendations

Recommendations relating to washable underpads are summarised in Table F-12.

Table F-12: Recommendations relating to washable underpads.

- If considering using washable underpads for sole use (ie without a bodyworn product) the patient will need to be naked below the waist. Patient consultation and approval will therefore be needed (Grade of Recommendation C).
- Personal preferences of users with regard to topsheet material, tuck-in flaps and integral waterproof backing should be considered in making product selections (Grade of Recommendation C).
- Provided an adequate foul laundry wash cycle is used, the risk of cross-infection between successive users of washable bedpads is low and not a contra-indication for their use (Grade of Recommendation B).

8.3. Priorities for research

Research on these products is not seen as a high priority.

9. ABSORBENT PRODUCTS FOR CHILDREN WITH URINARY AND / OR FAECAL INCONTINENCE

Most children are expected to achieve daytime dryness by the age of three (94). However, some boys take longer to become dry and some (e.g. children with learning and physical disabilities) may never do so. These children usually require absorbent products to contain leakage.

Aspects of assessment that are particularly important regarding bodyworn products for children are presence of faecal incontinence, day / night incontinence, level of independence with toileting, and use of aids (e.g. callipers).

No studies of absorbent products have been published since the last consultation (31). The existing study was a comparison of diaper design with the newer pull-up design (95).

Findings indicated that generally, the diaper and pull up products performed similarly. Overall, diapers were preferred for night-time use by the majority of parents. By contrast, 40% of parents preferred pull-ups for daytime use and these were found to be particularly appropriate for older children and those who were attempting independent toileting, provided they did not have faecal incontinence. Diapers were more suitable for children who were dependent on caregivers and / or had faecal incontinence, and wore callipers or adapted footwear. The authors recommended that both diapers and pull-ups be supplied for children, with pull-ups (which are about 50% more expensive than diapers) being provided for selected children during the daytime.

9.1. Summary and recommendations

Diapers and pull-ups meet different needs of children and both should be made available to children with disabilities, dependent on assessment (Level of Evidence 3 / Grade of Recommendation C).

9.2. Priorities for research

- Comparison of washable and disposable bodyworn products.
- What are the problems faced by parents / caregivers and children in managing continence with different product designs and materials?

10. ABSORBENT PRODUCTS FOR FAECAL INCONTINENCE

Most absorbent products are designed for urinary incontinence. No studies comparing available absorbent products for faecal incontinence were found. Bliss et al. (96) reported preliminary findings of a survey of the use and evaluation and suggested modifications of absorbent products for faecal incontinence by 188 community-living persons with the problem. Forty-five percent of persons used an absorbent product for FI. Ninety-eight percent of those with UI and FI used the same type of product for both. Suggested improvements in product designs included having better odour control, fit, and ability to stay in place; a clearer distinction between the front and back of a panti-liner or pad; adding wings for greater absorbency; and making them flushable, cooler feeling, wider and longer in the rear and more absorbent but less bulky. For mild faecal incontinence, especially when faeces remain between the buttocks without soiling underwear, persons have used a small disposable gauze surgical dressing placed between the buttocks. This product was more acceptable than a panti-liner or pad to some men (96) (Level of Evidence 2).

Recent work on odour relating to pad usage for FI is described in Section P, while management of FI using products other than pads is described in Section N.

10.1. Recommendations

- A disposable gauze dressing that can be placed between the buttocks may be acceptable for men with light faecal incontinence (Level of Recommendation C).

10.2. Research priorities

- Better designs of absorbent products are needed for light and moderate FI (with and without UI).

11. BROADER RECOMMENDATIONS

General recommendations on pad selection and recommendations relating to washable pads are summarised in Tables F-13 and F-14, respectively.

Table F-13: General recommendations on pad selection.

- **Individuality:** No one product works best for all testers: needs and priorities vary. Accordingly, users are advised to try a variety of products when possible (Grade of Recommendation B).
- **Brand differences:** Individual product brands within a design group often exhibit a wide range of performance and acceptability for individuals, and it cannot therefore be assumed that pads of different brands but broadly similar design will be equally acceptable or effective (Grade of Recommendation B).
- **Combinations of designs:** Absorbent products vary greatly in price and performance and suitability for individual needs. Users may therefore find combinations of designs preferable and cost-effective. For example, women might use pull-ups (expensive, but discreet and good for leakage) for going out, and inserts (cheap, less good for leakage) for staying at home. Men might use disposable diapers for daytime, and washable terry-towelling products for night-time (Grade of Recommendation B).
- **Freedom from leakage:** In general, pads containing superabsorber should be selected in preference to those without (Grade of Recommendation B). Nobody wants their pad to leak but compromises have to be made: the pad needed to contain a person's most severe accident may be substantially more bulky and expensive than is needed most of the time. Some users choose to tolerate a higher risk of pad leakage in exchange for being able to use cheaper, smaller more discrete pads. Priorities for a given user should be investigated in making product selections (Grade of Recommendation C).
- **Comfort and skin health:** In general, pads containing superabsorber should be selected in preference to those without (Grade of Recommendation B). Shaped pads should usually be selected in preference to unshaped (Grade of Recommendation C).
- **Staying in place:** No product is effective if it slips from position. Inserts should be used with stretch (e.g. cotton / lycra) underwear or mesh pants (Grade of Recommendation B). Shaped pads are preferable to rectangular (Grade of Recommendation C).
- **Ease of putting on and taking off:** The ease of putting pads on and taking them off should be considered, especially for caregivers and for incontinent users with reduced mobility or dexterity (Grade of Recommendation C).
- **Aesthetics and discretion:** A possible preference for small, more discrete pads (even if they are more likely to leak) should be considered, especially for those wishing to wear close fitting clothing (Grade of Recommendation C). The possibility of plastic backing materials rustling noisily should be considered (Grade of Recommendation C).
- **Independence and lifestyle:** The ability of a user to change his / her own pad should be considered (Grade of Recommendation C): those able to change their own pad can often manage with a smaller (less absorbent) one than those reliant on a caregiver. Users who travel should consider in their choice of product(s) the practicalities of carrying a supply of pads, disposing of used ones, and dealing with laundry (Grade of Recommendation C).
- **Costs:** Cost issues should be approached with caution (Grade of Recommendation C). Expensive pads do not necessarily work better than cheaper ones. Cheaper pads do not necessarily save money. If pads leak more they may have to be changed more frequently and / or lead to higher laundry costs. More pad changes will mean increased caregiver workload. However, more absorbent pads will not necessarily reduce pad consumption rates: pads are often changed according to nursing unit or personal routine.

Table F-14: Recommendations relating to washable pads.

- **Laundry issues:** Access to good, reliable washing and drying facilities should be checked before washable products are introduced (Grade of Recommendation B). Laundry – especially of bedpads – can be heavy work, beyond the capability of frail incontinent people or their caregivers. The number of washable products needed per user depends on laundry turn-around times. Drying times for washables can be long and expensive, especially for bodyworn for heavy incontinence and for bedpads.
- **Personal preferences:** Personal preferences (of both users and caregivers) with regard to choosing between washable and disposable products should be taken into account carefully (Grade of Recommendation C). Some users prefer the chore of laundering washables to anxiety over when their next consignment of disposables will be delivered. Washables generally require less storage space than disposables. Discreet disposal of disposables can be a challenge. The possibility of using a mix of disposable and washable products should be considered (Grade of Recommendation C). Some users who choose disposables when at home prefer washables when travelling because of the space that disposables occupy in luggage and the possible inconvenience of disposal. Others use washables at home and disposables when away as they see the balance of disadvantages and advantages differently.
- **Personalisation of products:** In institutions, the chore of personalising washable products and sorting them after each laundry cycle should be considered before they are introduced (Grade of Recommendation C). Washable bodyworn are often personalised to particular users. In institutions this means marking products with users' names and sorting them after laundry, an extra task for caregivers. Washable bedpads are not usually personalised.
- **Staining:** Washable products should not usually be used by those with faecal incontinence – beyond occasional light smearing – because of staining (Grade of Recommendation C). Skin sprays and ointments may also stain washables.
- **Costs:** Cost comparisons between washable and disposable products should be made with caution (Grade of Recommendation C). Key factors are: local arrangements (mostly laundry and transport costs); the durability of the products (which depends on how carefully they are used and the criteria for deciding when they should be replaced); the costs of ordering, transporting and disposing of disposables; and product purchase costs. Much of the cost of washables is encountered with the initial capital outlay for stock. This also represents a commitment to use the products for an extended period and so expensive mistakes can be made if it transpires that a better product was / has become available. It will usually be wise to experiment with samples of a variety of alternative products before committing to major purchases.

G. EXTERNAL URINE COLLECTION DEVICES FOR MEN: URINARY SHEATHS

Close-fitting penile sheaths (sometimes called condom catheters, uridomes, Texas catheters or external catheters) are male incontinence devices (no practical equivalent is currently available for women). The sheath fits over the penis much like a contraceptive condom and collects urine as it leaves the body. The sheath is normally connected at its outer end to a tube that leads to a urine drainage bag. Urine drains into the bag, which is usually worn on the thigh or calf, and is collected there until emptying is convenient. Sheaths come with a variety of design features and the main ones are listed in Table G-1, and illustrated in Fig G-1.

Table G-1: The main design features of sheaths.

- **Materials:** latex, silicone rubber or other synthetic polymers.
- **Size:** range of diameters (about 20-40 mm, in 5-10 mm increments) and lengths; most companies supply a measuring tool to ensure best fit; guide is placed at widest point of penis, typically about 20 mm from base (556).
- **Adhesive:** may be integral to the sheath (one-piece systems) or be a separate strip or spray (two-piece systems).
- **Applicator:** some sheaths are provided with an applicator with the aim of making application easier or to reduce manual contact with the penis.
- **Anti-kinking / twisting features:** these are intended to improve drainage by aiming to prevent the sheath from kinking or twisting at the distal end near the connection to the drainage bag tube.
- **Anti-blow-off:** some designs aim to reduce the likelihood of the sheath blowing off at high urine flow rates, as at the beginning of a void; for example, the distal end of the sheath may be thickened and bulbous to stop the internal walls sticking to one another between voids.
- **Connections to the drainage bag:** some designs aim to increase the ease and security of drainage bag connection; for example, a push ring or ridge at the end of the outlet tubing.
- **Retracted penis:** some sheaths are designed with or without specific features in order to accommodate a retracted penis; for example, a shorter sheath or a wider adhesive seal.
- **Durability:** varies according to manufacturer. 24 hours is a common recommendation but some are intended for extended wear.
- **Transparency:** some sheaths are made from transparent materials (e.g silicone) which can allow for observation of penile skin condition along the shaft and glans.

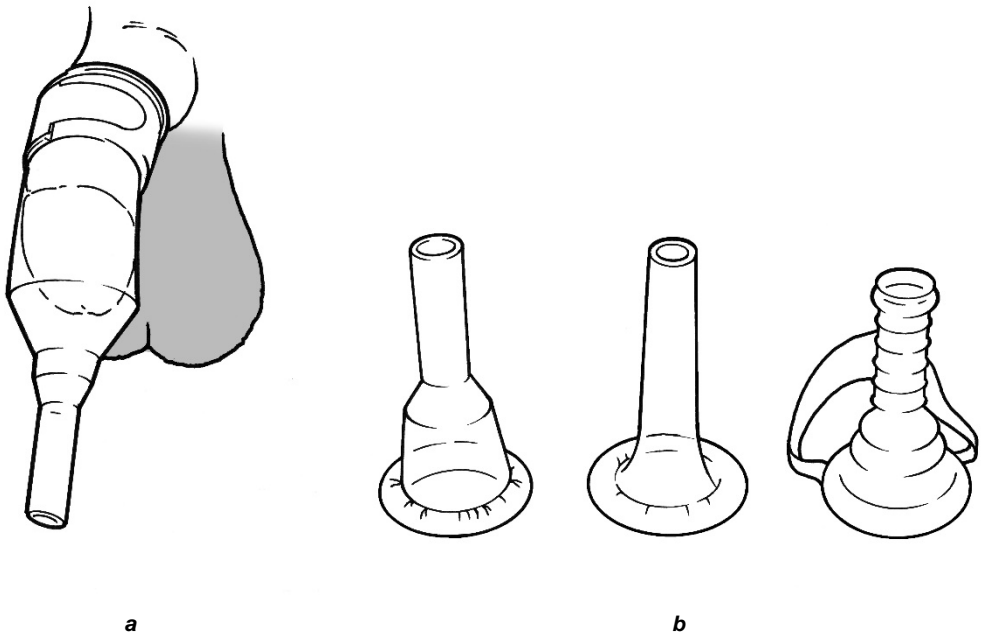

Fig G-1: Sheath without integral adhesive, secured with external fixation (a), and a variety of sheaths showing anti-blow-off features and applicator (b).

The main factors that make sheaths (un)suitable for men are summarised in Table G-2.

Table G-2: The main factors that make sheaths (un)suitable for men.

<p>Sheaths are suitable for men with:</p> <ul style="list-style-type: none">• Moderate to heavy urine loss.• Urinary frequency and / or urgency.• Limited mobility. <p>(Sheaths can be used in combination with intermittent catheterisation.)</p>
<p>Sheaths are not advised for men with:</p> <ul style="list-style-type: none">• Confusion or psychological vulnerability. sensation through spinal cord injury or neuropathy (110) (557) (558).• A retracted or very small penis (alternative products are available).

An effective urinary sheath is one that stays securely in place for an acceptable period, is leak-free, comfortable to wear, easy to apply and remove, avoids skin damage and channels the urine effectively into a urine drainage bag. Correct sizing and fastening are critical to product success. Users indicate that the foremost important quality of a penile sheath is security from leakage followed by comfort and ease of application and removal.

1. EVIDENCE

The 5th International Consultation (31) identified trials in which a sheath system was compared to alternative continence products: indwelling catheters (97), pads (60) or one sheath versus another (23) (98) (99) and the results from these studies are included in the summary section, below.

Since the last consultation two trials (15) (100) have been published. Macaulay and colleagues (15) conducted a cross-over trial comparing the performance of pads (usual continence management) with sheaths, bodyworn urinals and penile clamps. Fifty-six men tested each product for three-weeks. Quality of life was measured using the Kings Health Questionnaire (KHQ). Depending on their daily circumstances / activities, participants reported that each product had some advantages and disadvantages. Sheaths were good for extended periods when a pad change could be difficult, for maintaining skin dryness and continence, not smelling and convenient for storage and travel. The sheath and clamp were rated better than the pads or bodyworn urinal for ease of storage, carrying, odour and security. Pads were good for everyday activities and best for night-time use: easiest to use, comfortable when dry but most likely to leak and most uncomfortable when wet. Of note is

that men preferred having a mixture of products to meet different needs and activities and, post-testing, around two-thirds of men were using a combination of pads compared to baseline. Of concern was that half of the men had previously tried a penile sheath system but only one of these had received assistance from a healthcare professional for fitting and follow-up.

The second non-randomised prospective trial assessed quality of life in individuals with spinal cord injury using either indwelling catheters, sheath drainage, or intermittent catheterisation (n=70) (100). Based on scores of the King's Health Questionnaire (KHQ), men using an indwelling catheter or intermittent catheterisation scored lower on quality of life scores and role limitation and activity compared to those using a sheath system. However, because of the convenience sampling, the men using a condom catheter may have been higher functioning with a lower SCI than those using IC or indwelling catheters and results were not presented by level of injury.

A sheath product – which is secured to the glans is available. Manufacturer information suggests that the product is useful for men with a short or retracted penis for whom a standard sheath system is unsatisfactory. Apart from testimonials, there is as yet no published data evaluating the product and only one paper (101) that suggested the product could be a useful alternative to a conventional sheath.

Although many men use sheaths successfully, several case studies attest to the potential problems (Table G-3). It is of note that most such problems are preventable with proper sizing, continuous drainage, routine changing and appropriate skin care.

A review of findings relating to odour associated with sheath use is given in Section P.I.4.

Table G-3: Reported complications associated with sheath use.

Complication	Prevention/Treatment
Contact dermatitis or allergy; balanitis, oedema (559) skin maceration from wet exposure (560)	Allergy to latex can develop over time; change product to silicone base; routinely check skin; ensure skin is dry before application of sheath and skin barrier; ensure sheath is correct size.
Compression, tourniquet effect; (561) (562) (563).	Use sheaths with caution in individuals with no penile sensation; avoid adhesive straps or use straps with stretch to allow for penis expansion/contraction; correct size is critical.
Skin irritation (564).	Ensure sheath does not become twisted near the distal end to avoid stagnation of urine and extended urine contact with penile skin; good genital hygiene.
Glans irritation/pressure ulcer	Ensure adequate space at end of sheath to prevent pressure on the glans.
UTI – range 40-63% (565) (566).	Ensure consistent drainage – if sheath twists it will block urine flow; at risk individuals – those with poor hygiene, cognitive impairment who may tug/twist sheath drainage tubing.
Hydronephrosis (567) (568).	Detrusor over activity risk factor for vesico-ureteral reflux; may require antimuscarinics & intermittent catheterisation in addition to sheath drainage; warn users of the risks of acute urinary retention (AUR) when consuming large amounts of alcohol in a short time – individuals should be taught signs of AUR & teaching of intermittent catheterisation if engaged in high fluid intake or recreational drugs.
Fibro-epitheleal penile polyps (569) (570) (571).	Close skin observation by user or caregiver; good user education to aid in proactive skin health
Isolated gangrene (572).	Immunocompromised individuals are at high risk for infection related to condom use.

2. SUMMARY

- Sheaths are more comfortable than indwelling catheters and UTI incidence is similar (60) or somewhat lower in sheath users without dementia (97) (Level of Evidence 2).
- Men with moderate incontinence using a sheath rank QOL better with a sheath than when using an absorbent product (60) (Level of Evidence 2).
- Sheaths with integrated adhesive are preferred over those with an adhesive strip or applicator (23) (99) (Level of Evidence 2).
- Silicone sheaths are preferred over latex (23) (Level of Evidence 2).
- Men prefer a choice of continence products (pads, sheath, clamp) depending on activities and lifestyle (15) (Level of Evidence 2).

3. RECOMMENDATIONS

Recommendations regarding urinary sheaths are summarised in Table G-4.

Table G-4: Recommendations relating to urinary sheaths.

- Product differences mean that men should try different products before making a final selection (Grade of Recommendation B).
- Men prefer access to a combination of continence products (sheath, pads, clamps), depending on activity (Grade of Recommendation B)
- Key performance characteristics are: security (ie ability to keep a leak-proof seal and channel urine to the drainage bag without leakage) and ease of application and removal of the sheath (Grade of Recommendation B).
- Sheath applicators may not make sheath application easier (Grade of Recommendation B).
- Sheaths with integral adhesive (one-piece systems) are preferred over (two-piece systems) (Grade of Recommendation C).
- Sheath users should be monitored for latex or adhesive allergies, skin health, tissue damage and UTI (Grade of Recommendation C).
- When possible the external sheath rather than indwelling urethral catheter should be the urinary collection device of choice. (Grade of recommendation B).

4. PRIORITIES FOR RESEARCH

- Evaluation of leg bag and sheath design features claimed to reduce twisting and kinking at the drainage bag connection site.
- Evaluation of products advertised as suitable for men with retracted penis.
- Studies to generate and validate procedures to help identify the type of sheath most likely to suit an individual.

H. URINE DRAINAGE BAGS AND ACCESSORIES

Urine drainage bags fall into two main categories. Bodyworn bags generally have a lower capacity (less than 500 ml) and are designed to be worn under clothing on the leg (often called leg-bags) or around the waist. They aim to provide discreet storage of urine and can be attached to either a catheter or a sheath. They are mainly used during the day and are secured to the leg or waist in a convenient position using a range of straps or other support devices. The popularity (or otherwise) of many features is generally a matter of personal preference.

Second, there are large capacity bags - commonly called night bags - which are designed to provide additional drainage capacity overnight or for people who are permanently in bed. They are usually held in position away from the body on either a floor-stand or a hanger which hooks onto the bed or chair frame. They may also be connected to a bodyworn bag to form a link system for overnight use.

Expert opinion found in best practice guidelines recommends positioning drainage bags so that they are off the floor, but data are insufficient to establish whether this practice reduces the incidence of bacteriuria. (102) (103) (104)

To prevent cross contamination, a closed drainage system is standard and, in the home, it is common to use vinegar, household detergent or diluted bleach (105) (106) (107) (108) (109) to clean drainage bags.

The main design features and variants of urine drainage bags are described in Table H-1 and illustrated in Fig H-1, and Fig H-2 shows a variety of tap designs.

Table H-1: Drainage bag features

	Leg bag	Night bag
Capacity	350-900 (usual 500 ml)	2000-4000 ml
Material	Transparent PVC (polyvinyl chloride), PVDF (polyvinylidene fluoride (less noise from rustling)), or polyethylene or rubber / latex.	As with leg bags.
Wear position	On thigh or calf; on abdomen.	Situated below bladder with tubing distributed to prevent low hanging/dependent loops.
Attachment	Latex or cloth elastic straps.	Separate frame/stand or hooked on bed or wheel chair.
Connecting tube	Various lengths; can be cut to meet individual needs.	One length only; intended to maintain a closed link system.
Drainage tap	Flip valve, separate cap, screw cap.	As per leg bags.
Sampling port	If present, located in drainage tubing.	Located in drainage tubing.
Comfort	Cloth backed prevents skin irritation.	No specific comfort features.
Discretion	Internal welds reduce bulging and sound of urine on movement.	None are discreet; may be covered with cloth bag to disguise bag.
Anti-kinking	Connecting tube reduces kinking and twisting so that urine drainage is not obstructed.	Sturdy plastic tubing does not allow twisting at catheter site but may kink along drainage tubing.
Anti-reflux valve	Non-return flap valve to prevent urine reflux if bag is raised above bladder; may reduce risk of CAUTI.	As with leg bags.
Linkage system	Allows attachment of leg bag to night bag so maintain a closed system; may reduce risk of cross infection.	

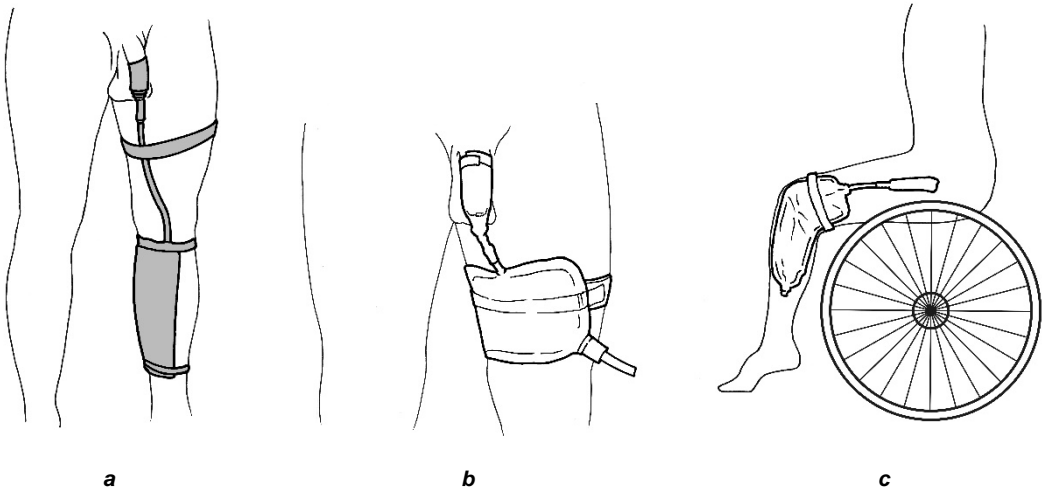

Fig H-1: A urine drainage bag shown worn on the calf (a), a discreet thigh urine drainage bag (b) and a shaped urine drainage bag for wheelchair use (c).

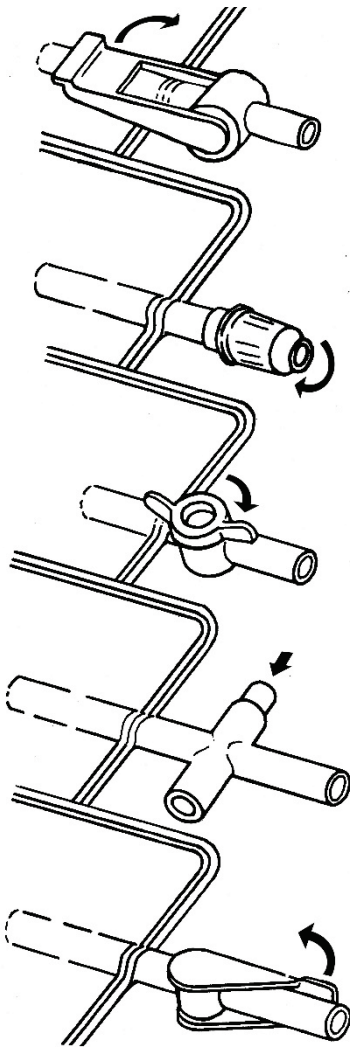

Fig H-2: A variety of urine drainage bag tap designs. The arrows indicate the action needed to open and close each valve.

Urine drainage bags are suitable for those with:

- The visual acuity to see the tap / spigot, and the manual dexterity to open and shut it (110) (111).
- The ability to assess skin condition where straps and drainage bag contact the leg.

1. EVIDENCE

The last consultation (31) identified trials on: product (feature) evaluation (112) (113) (114) (115) (116) (117); drainage suspension systems (leg straps) (102) (103) (111) (118) (119) (120); and infection prevention (102) (103) (117) (120) (121), and the findings are included in the summary section, below.

Since the last consultation (31) there have been three new trials addressing: dependent drainage tubing

loops (or airlocks) (Fig H-3) (122); specimen collection technique (123); and catheter securement (124). No updated guidelines on drainage tube management and no new trials evaluating aspects of body-worn or night drainage bags were found.

There has been a new focus on urinary catheter dependent loops which cause airlocks in the tubing and reduce or stop urine drainage (Fig H-3). The first study to present the theory and illustrate the potential threat to bladder emptying was by Schwab et al (122). Using a laboratory model bladder, the authors illustrated that the fluid-filled dependent loops generated back-pressure related to the difference in fluid meniscus heights and that this back pressure interfered with emptying. It was proposed that if the results obtained with a simulated bladder occur in actual bladders, retained urine volume would increase as meniscus height increased (i.e. dependent loop deeper). The increased back-pressure would rise to the point where the bladder could not empty. This work has drawn new attention to the importance of ensuring loops are minimised.

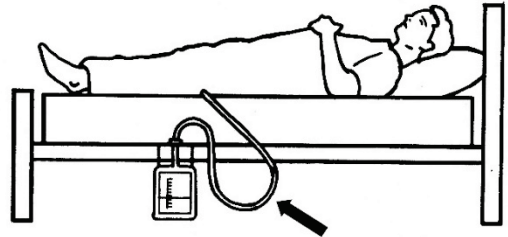

Fig H-3: Dependent loop causing accumulation of urine and slow drainage (see arrow).

Wuthier (123) took the theory further, applying it to clinical practice, measuring pressures and positing that a dependent loop of more than 18 cm would cause an air-lock which could not be overcome by the typical bladder and would thus prevent urine flow into the drainage bag. Earlier work posited that urine drainage is suboptimal with a traditional Foley catheter design (125), but it was not clear if this related specifically to the catheter design or to the presence of dependent loops.

Two prevalence studies have been conducted on dependent loops. In a large academic US hospital, Danek (126) found that over 85% of catheterised patients had dependent loops containing urine. In another US study Wuthier and colleagues (123) found similar results in a cross sectional observational study; 87% of catheters had dependent loops with almost half having the potential for an air-lock and incomplete or absent bladder drainage. The clinical impact (or not) – particularly CAUTI – has not yet been reported.

Two recent prevalence studies highlighted a lack of understanding of best practice in catheter management. In the first, a survey of almost 400 nurses on

correct urine specimen collection in catheterised patients and appropriate reasons for obtaining a urine specimen from a catheterised patient revealed that over half answered incorrectly (127).

In the other, surveying indwelling catheter securement in a large academic hospital, only 18% of the patients had secured catheters despite products being available on the nursing unit (124). Unsecured catheters place the patient at risk for urethral and bladder neck trauma and pain; incorrectly obtaining a urine specimen from a catheterised patient may lead to a spurious UTI diagnosis.

2. SUMMARY

- Taps are sometimes difficult to open and may leak onto the fingers when the bag is emptied (112) (114) (Level of Evidence 2).
- Chafing between bag and skin is often reported (112) (114) (Level of Evidence 2).
- Bags with tubing that is flexible and can be cut to length to suit the individual are appreciated (112) (Level of Evidence 2).
- Discreet bags (that are not readily visible beneath clothing) are appreciated (112) (Level of Evidence 2).
- Designs in which the tap and outlet spouts are widely separated are most effective at preventing contamination of the hands with urine (113) (116) (Level of Evidence 2).
- There is insufficient evidence that pre-connected products reduce the incidence of bacteriuria (104) (Level of Evidence 2).
- There is no evidence that addition of antiseptic agents to drainage bags prevents the onset of bacteriuria (128) (Level of Evidence 2).
- Comfort and ease of applying straps to the leg is key to successful wear (111) (115) (118) (Level of Evidence 2).
- If there are dependent loops in the drainage tube, airlocks can compromise efficient bladder emptying (122) (123) (Level of Evidence 3).
- Most drainage bags (bodyworn and night bags) have an integrated anti-reflux valve but it is unclear whether they reduce the incidence of CAUTI (104) (117) (Level of Evidence 3).
- There is inadequate evidence to state that single use (104) or daily change of leg bags or drainage bags reduces bacteriuria or CAUTI. In practice, drainage bag changes ranged from every 3 days to more than 20 days (129) (130) (131) (Level of Evidence 3).
- An abdominal 'belly bag' drainage system may be more convenient, comfortable and less likely

to cause discomfort than leg and night bags (119) (Level of Evidence 3).

3. RECOMMENDATIONS

Recommendations relating to urine drainage bags and accessories are summarised in Table H-2.

Table H-2: Recommendations relating to urine drainage bags and accessories.

- Taps should be easy to open and should not leak onto the fingers when the bag is emptied (Grade of Recommendation B).
- Care should be taken to avoid chafing between bag and skin (Grade of Recommendation B).
- Individual needs and personal preferences should determine the use of leg / suspension / attachments and position of where the bag is worn (115) (Grade of Recommendation C).
- Abdominal drainage bag ('Belly Bag') may be a convenient, comfortable option to a leg secured bag (119) (Grade of Recommendation C).
- Closed urinary drainage bag systems where the system is only broken to change the sterile bag according to manufacturer's directions may reduce the onset of bacteriuria (Grade of Recommendation A).
- Drainage systems for night bags should be positioned off the floor to reduce the risk of cross infection (102) (103) (120) (Grade of Recommendation C).
- All facilities should enforce regular monitoring to practice to ensure adherence to evidence based guidelines on catheter/drainage bag management (Grade of Recommendation C).
- Catheter securement devices should be in place on the thigh or abdomen for all indwelling catheters (Grade of Recommendation C).
- Dependent catheter loops should be minimised to allow optimum urine drainage (Grade of Recommendation C).
- Guideline recommendation (EPIC 2) is that catheter bags are changed every 5-7 days (103) (Grade of Recommendation D).

4. PRIORITIES FOR RESEARCH

- Evaluation of a linked system with night bag/leg bag and the onset of bacteriuria compared to changing from day to night bag.

- Reviewing practice in home settings: is a closed catheter drainage system more effective at preventing symptomatic UTI than reusable non-sterile urinary drainage?
- Most effective and acceptable cleaning methods for non-sterile urinary drainage systems.
- Development of catheter tubing that prevents formation of dependent loops.

I. MALE BODYWORN URINALS AND DRIBBLE CONTAINERS

Products such as bodyworn urinals (BWU) and dribble containers (penile pouches) are an alternative to a sheath system (Fig I-1). They usually comprise a ring-shaped opening or cone-shaped component which is worn around the penis (and held firmly against the pubis by means of a belt and straps) and channels urine to an integral collection bag. There are two main designs: one-piece with the cone and flange as a single combined unit; or two-piece, where the cone and flange are separate and connect when in

use. BWUs are more substantial collection devices than sheaths. They are designed to be washed and reused multiple times and to be worn over extended periods. They are less frequently used than sheaths but may be a good option for those with a retracted penis or who do not wish to wear a sheath. Dribble containers (penile pouches) involve holding a drainage bag or other container over the penis using a much lighter structure than the flanges used in bodyworn urinals. They are often disposable.

The more substantial designs should be fitted by a specialist: a good fit is crucial for comfort and to avoid leakage. It is also important that the wearer / carer understands how to use the device and the importance of skin care. The wearer / caregiver will need good manual dexterity to manage the device. Several urinals will be needed to use in rotation, allowing each to be properly washed and dried between periods of use.

The main factors that make bodyworn urinals (un)suitable for men, and the challenges to be addressed in using them effectively are summarised in Table I-1.

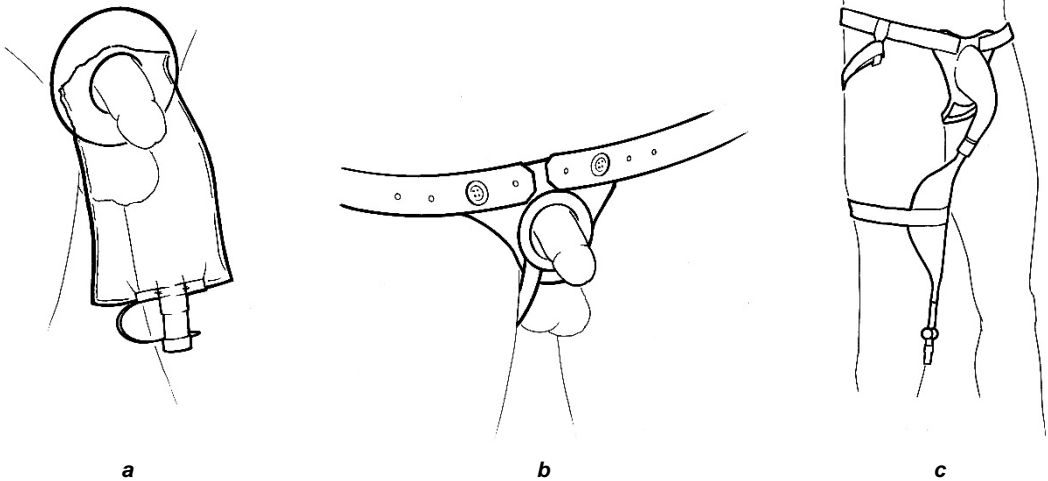

Fig I-1: A disposable penile pouch (a), a pubic pressure flange (with the cone removed) (b), and a bodyworn urinal with leg bag (c).

Table I-1: The main factors that make bodyworn urinals (un)suitable for men, and the challenges to be addressed in using them effectively.

<p>BWUs are suitable for men with:</p> <ul style="list-style-type: none"> • A small or retracted penis that will fit into and stay in the flange. • Moderate to heavy urine loss. • Urinary frequency and / or urgency. • A preference to use a body worn urinal rather than absorbent products during the day. • The ability to walk but chair / bed bound during the day.
<p>BWUs are not suitable for men with:</p> <ul style="list-style-type: none"> • Confusion. • Poor manual dexterity and who are unable to connect the straps. • Impaired mobility who spend large amounts of time lying most of the day (device tends to slip out of position). • Confusion or psychological vulnerability. • Decreased sensation through spinal cord injury or neuropathy (110) (557) (558). • A retracted or very small penis (alternative products are available).
<p>Particular challenges related to BWU use are:</p> <ul style="list-style-type: none"> • Maintaining a secure fit to prevent the penis from slipping out of the cone resulting in leakage. • Kinking or twisting of the tubing at the junction of the cone. • Risk of skin damage or allergy from chafing of the leg straps or from the flange against the pubis.
<p>To be effective, the user / carer must:</p> <ul style="list-style-type: none"> • Understand how to use the device and the importance of skin care. • Have good manual dexterity to manage the device. • Have fitting done by a specialist to ensure best leak-proof fit. • Moderate to heavy urine loss. • Urinary frequency and / or urgency. • Limited mobility.

1. EVIDENCE

At the time of the 5th International Consultation (31), there were no trials evaluating bodyworn urinals or dribble containers. Since then, one trial has been published. Macaulay et al (15) conducted a randomised controlled trial that included BWUs. Fifty-six men compared (day and night, and for three weeks each): a BWU, sheath drainage, a penile clamp (day-time only), and the absorbent product they had regularly used before the trial. Outcome measures were overall opinion (rated on a 10-point visual analogue scale) for day or night use; product acceptability (not acceptable / poor / acceptable / good); advantages

and disadvantages of the test products; revealed preferences (which products men used three months after the test).

The BWU was rated as “acceptable” by 48% of participants for daytime use at home, more comfortable when wet than pads, but worse than pads, sheaths or clamp in all other aspects including self-image. It was also described as leaking in certain postures, particularly when sitting as the penis can slip out of the flange. No significant differences in quality of life (measured by the King’s Health Questionnaire) were noted at the three month follow up. At the conclusion of the study, men were more informed on product choices and, although most (58%) were using a mix

of products at the three-month follow-up, few (22%) included a BWU in their mix.

2. RECOMMENDATION

Expert fitting and careful user selection is required to ensure effective and appropriate use of bodyworn urinals (Grade of Recommendation B).

3. PRIORITIES FOR RESEARCH

- Development and evaluation of leak-free, comfortable and aesthetically acceptable BWUs for men.
- Development and validation of a reliable instrument to measure the performance of different BWU designs and the impact on the quality of life of users.

J. MECHANICAL DEVICES FOR WOMEN WITH UI

Mechanical devices for women with urinary incontinence are designed to prevent urinary leakage, for women with stress urinary incontinence (SUI). There are three main categories:

External urethral devices: products that are applied over the urethra at the opening.

Internal urethral devices: products that are placed inside the urethra.

Internal vaginal devices: products that are inserted into the vagina.

The main factors that make mechanical devices (un)suitable for women are summarised in Table J-1

Table J-1: The main factors that make mechanical devices (un)suitable for women.

Mechanical devices may be suitable for women with:

- Stress urinary incontinence.
- Good hand control.
- Good memory and cognitive function.
- The ability to understand the concept of use (as opposed to a pad).
- A preference for preventing leakage over containing it.

They may be used in combination with other conservative management approaches such as PFMT.

Mechanical devices are not suitable for women with:

- Urinary urgency, frequency or OAB.
- Urinary tract infections.

1. EVIDENCE FROM THE 5TH INTERNATIONAL CONSULTATION (2013)

The published evidence on mechanical devices for women with UI is best introduced by reviewing each device category in turn.

1.1. External urethral devices

No female external urethral devices are currently on the market. This is as a result of varying effectiveness, local urethral / vulvar irritation and inconvenience, although side effects were relatively minor. Previously available brands included: Miniguard (Uromed Inc), FemAssist (Insight™ Medical Coro) and CapSure (CR Bard Inc).

1.2. Internal urethral devices

There are two different urethral inserts currently on the market (Fig J-1).

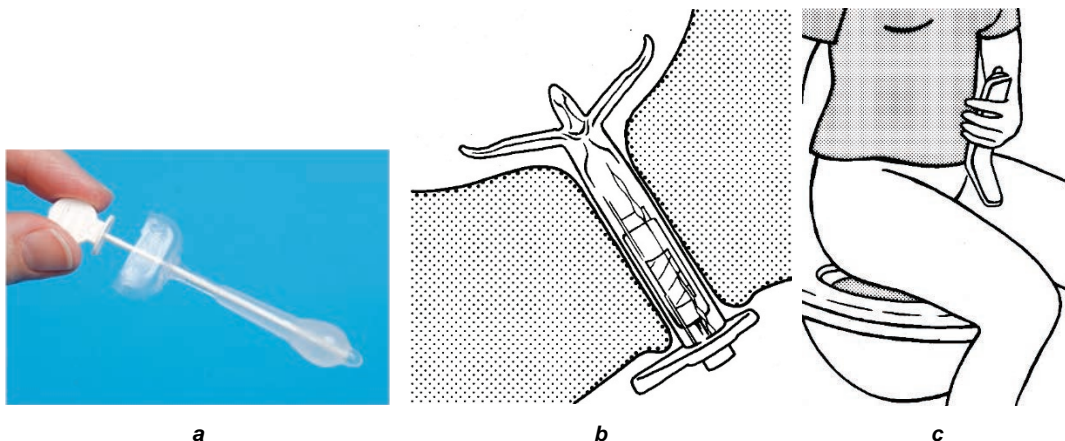

Fig J-1: Intra-urethral devices for women: the FemSoft, with separate insertion probe (white) in place (a); and the InFlow Intraurethral Valve-Pump, in position (b) and with the handheld magnetic activation device in position (c).

The first – the FemSoft (Fig J-1a) - has a soft, compressible, silicone chamber filled with mineral-oil. It is intended for day- time use during physical exercise and is self-inserted (using a separate insertion probe) and removed at user discretion. It is available in two lengths (3.5 cm and 4.5 cm). Before insertion, the proximal end of the cylinder is distended relative to the distal end but, as the user pushes the device (guided by the insertion probe) into the urethra, fluid transfers temporarily to the distal end, returning once the device is in place, so securing it. Side effects can include urethral irritation, UTI and device migration into the bladder. When successful, the Femsoft is an effective, safe and comfortable treatment for exercise incontinence (stress urinary incontinence) in women (Level of Evidence 3) (132).

The second device – the InFlow™ Intraurethral Valve-Pump (Fig J-1b and J-1c) - is intended for women with a chronic acontractile bladder who would otherwise use intermittent or indwelling catheterisation. The device consists of a short silicone urethral available in various lengths for specific fitting under local anaesthetic. It is maintained in position by distal proximal flanges. When the bladder is full, an inner turbine-like valve is activated by a hand held magnetic device and allows bladder emptying. When the handheld device is removed, the valve closes, maintaining continence. For selected women, the device can provide freedom from self or indwelling catheterisation and improve quality of life (133). Side effects are similar to those for an indwelling catheter: UTI, urethral irritation, encrustations and expulsion, although based on the few studies that have been done, these are infrequent. The key reason for withdrawing from use appears to be discomfort (134). Chen and colleagues recommend a trial period to allow the woman to assess tolerance, and regular support during initial use; if successful, on-going use will likely be of benefit. To date no long-term research is available on the adherence to the device nor the effects that it may have on bladder / urethral mucosa (135).

1.3. Internal vaginal devices

Support of the bladder neck with the aim of correcting urinary stress incontinence has been achieved, with varying success utilising traditional tampons, pessaries, contraceptive diaphragms and intravaginal devices. Follow up and patient teaching is important. Side effects of vaginal devices can include bleeding, extrusion, discharge, pain and urinary retention. It is recommended that women are followed-up at least every 6-12 months after the initial insertion and observation period (136). Several designs of intravaginal devices are available and are listed below.

a) Tampon compared to pessaries

- Both tampon and pessary provide protection against activity induced incontinence (137) (Level of Evidence 2).

b) Diaphragm / pessaries

- Diaphragms (138) (139) and pessaries (140) (141) have all been used successfully and are an alternative to surgery or whilst awaiting surgery (Level of Evidence 1). Pessaries are also a good option for specific patients. For detailed information on pessaries and prolapse, see Pessaries in Chapter 12 Adult Conservative Management.

c) Vaginal devices designed specifically to support the bladder neck

- The Rocket stress incontinence device is a simple surgical foam tampon-shaped cylinder with a withdraw string and supporting the bladder neck.

Similar devices no longer marketed include: the Introl device, the Ladycon (Homecare Enoros, Norway), the Conveen Continence Tampon, and the Contrelle Activgard (originally called the Conveen Continence Guard). All provided some support to the bladder neck and were moderately effective (142) (143) (144).

d) Reusable vaginal hollow tampon (Contiform)

No reusable vaginal hollow tampons are currently marketed. Contiform was a hollow tampon-like device and an option for women with very mild incontinence (approximately 7 g on pad test) (145) (146).

e) Disposable vaginal devices

- **Polyvinyl sponge** has only one laboratory study (147) and no clinical research to verify its effectiveness study. In women with minor leakage the sponge reduced the leak to zero.
- The **Tipi** (ConTIPI Ltd, Israel) / **Impressa** (Kimberly Clark, USA) **intravaginal device** (Fig J-2) (has a resin core with support 'poles' covered with a soft nylon mesh that stretches between the arms of the poles to act as a suburethral sling. Based on limited research the device appears easy to use, well-tolerated and effective with side effects similar to other intravaginal devices: irritation, spotting, discomfort (148) (149).

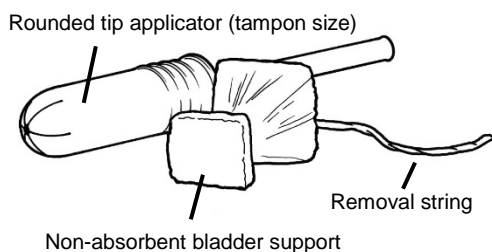

Fig J-2: The Tipi (ConTIPI Ltd, Israel) / Impressa (Kimberly Clark, USA) intravaginal device.

2. NEW EVIDENCE FOR THE CURRENT CONSULTATION

Three new trials (150) (151) (152) and 6 reviews have been reported since the last consultation (31). New studies address the use of mechanical devices - such as intra-vaginal pessaries to manage Pelvic Organ Prolapse (POP) and coincidentally improve the symptoms of SUI (153) (154). Secondary analysis of a previously published ATLAS study consider non-surgical treatments for SUI (155) (156)

Lone and colleagues (153) undertook a year-long prospective comparison of women choosing either vaginal pessaries (n=133) or surgery for POP (n=154) using validated ICIQ-VS and ICIQ-UI (SF) questionnaires a year post treatment. Exclusion criteria were women using pessaries solely for UI, those undergoing concomitant UI surgery or those who started in the pessary group but later opted for surgery. At one-year post enrolment, both groups had improved with no statistically significant difference between them concerning urinary or vaginal symptoms.

In a non-randomised trial comparing behavioural therapy or ring pessary (154), 83% of women who chose pessary reported QOL improvement at 1 year follow-up. All women had an improvement of prolapse symptoms and over 86% reported improved voiding symptoms. However, only 9.1% of the patients had improved SUI and 23.8% of the patients reported new onset of de novo SUI. The authors conclude that the ring pessary is an effective non-surgical treatment to alleviate symptoms associated with POP. The potential for de novo SUI and pessary management of POP should be noted and patients counselled accordingly.

The European Association of Urology guideline for assessment and nonsurgical management of UI does not routinely suggest intravaginal devices as treatment for incontinence [158]. An international panel of experts appraised evidence from existing systematic reviews and from independent literature searches, reviewed up to 2010. Key areas included surgery of uncomplicated SUI in women, surgery for complicated SUI in women, surgery for SUI for women with symptomatic mixed UI, men with SUI and surgical interventions for detrusor over activity. Surgery is typically considered for bothersome UI that does not improve with conservative therapy. Lucas and colleagues (157) conclude that there is a need for clarity in the surgical options offered to patients to ensure they can consider the most effective and safest procedures based upon the risks associated.

A role for a urethral plug is proposed for the management of persistent UI following repair obstetric vesicovaginal fistula (158). In a retrospective chart review, records between November 2006 until April 2011 of Ethiopian women (n=181) post fistula repair and attending a physiotherapy department for pelvic floor assessment were reviewed and fitted for urethral plug. Seventy-six percent of women (n=137) reported being dry whilst using a urethral plug and 9.9% reported being "half dry" (not defined). The authors conclude that the urethral plug appears to be effective in 'restoring/improving' continence for those women with complex histories who have undergone successful surgical repair of obstetric vesico-vaginal fistula. Adverse events included 6 device migrations requiring cystoscopic removal and 2 device ruptures. In a population of women with often complex bladder function after fistula development, further investigation is warranted to test the practicalities of a urethral plug.

Kenton et al. (156) Shaffer et al. (155) both performed a planned secondary analysis of a multi-centre randomised trial from the original ATLAS trial (159). Schaffer et al. (155) determined success to be the same for continence pessary use, behavioural therapy or a combination of the two. The woman's level of education, incontinence severity and menopause status predictors of success. Post-menopausal women were more likely to report improvement of continence than pre-menopausal women. Kenton et al. (156) conducted an analysis on the same dataset comparing behavioural therapy to vaginal pessary

use, focusing on changes in symptoms and HRQOL. Findings suggest no difference in pelvic floor symptom bother and HRQOL between the pessary and behavioural therapy arms in women undergoing conservative treatment for SUI. Therefore, individual preferences should be considered in the approach to the non-surgical treatment of SUI.

A novel intravesical attenuation device (VESAIR® Solace Therapeutics USA) was evaluated in a randomised controlled trial for the treatment of SUI (152). The device involves having a balloon inserted into the bladder via a delivery system and inflated; a one-way valve seals the device after being filled with 15cc air and 0.5cc AIRLOC®, a perfluorocarbon liquid that maintains buoyancy in the bladder which acts as a sponge and alters intra bladder spiking pressures. The balloon is removed cystoscopically. Participants were randomised 2:1 to treatment or sham procedure. Outcomes included a Stamey (score improvement of 1 or more points at 6 months) and a composite score combining data from pad test and patient impression of improvement. Withdrawal rate was high due to device malfunction, discomfort and the invasive nature of the procedure. Further evaluation is required before this device is made routinely available.

Ding and colleagues (151) conducted a prospective study of 81 women with advanced symptomatic POP (stages III and IV) who were fitted with a ring pessary with support. Primary outcome at 3 months was urinary flow measurements along with non-validated questionnaire pre- and post intervention to determine effectiveness. Of the 73 post-menopausal women, over half improved reported improved voiding symptoms, urinary urgency and SUI; 6 (14.3%) developed new onset SUI that could be managed with PFMT and 8 discontinued use due to discomfort and pressure, a desire for surgical treatment, extrusion of the pessary during daily activities or bothersome de novo SUI. Ding et al concluded that the ring pessary can help with POP and by consequence aid SUI symptoms.

A new intravaginal device for SUI management, not yet available on the market (B.BRAUN Medical SAS (150) has had safety, efficacy, tolerance and acceptability tested through a phase III multicentre randomised controlled trial. The device, made of a thermoplastic elastomer, was supplied in two sizes and, depending on preference, was inserted in the vagina with or without the help of an applicator. Automatically situating itself beneath the urethra and bladder, the device constitutes a support for the urethra and bladder neck. Removal is via a string fixed in the cylindrical part of the device. After a 14 day wash out period 55 patients were enrolled and randomly assigned to either the treatment or control arm (no treatment). The primary end point was a reduction of frequency of incontinence episode (IEF) according to bladder diaries. Secondary endpoints were urinary symptom profile scores on 24hr pad tests and CONTILIFE questionnaire scores as compared to a baseline. SUI,

mean OAB and mean dysuria decreased in the treatment arm, but no significant differences on the mean 24hr pad test were found between the two groups. Patient satisfaction was much higher in the treatment group with minimal adverse events. One case of menorrhagia and one case of UTI were reported. The authors concluded that despite the small sample size, the 75NC007 intravaginal device is a safe and effective non-invasive treatment of SUI in women. Further systematic evaluation of this device is required with long-term follow up and objective measures of continence.

Lipp et al's Cochrane review for mechanical devices (160) currently confirms that there is little evidence from controlled trials on which to judge whether device use is better than no treatment and large well conducted trials are required for clarification. There is also insufficient evidence to favour one device over another and little evidence to compare mechanical devices with other forms of treatment.

3. SUMMARY

Although many products have appeared on the market, few have stood the test of time: no external urethral devices - and only one intra-urethral device - are currently commercially available. Intravaginal devices such as pessaries remain a valuable adjunct to conservative management.

Specifically:

- Intravaginal devices may be effective in SUI management when compared to behavioural therapy and represent a promising alternative or complementary non-surgical approach (150) (Level of Evidence 1).
- Improved continence is possible for women with SUI with intravaginal devices. The products appear safe to use with few reports of lower urinary tract issues (Level of Evidence 3).
- Efficacy appears to be higher in patients with minimal to moderate SUI leakage (Level of Evidence 3).
- Relatively high drop-out rates in monitored studies during which patient support is provided, indicates the need for proper patient selection and patient and provider education, but may also indicate limitations in product efficacy, difficulties in application or other factors such as discomfort (Level of Evidence 3).
- Women's choice of continence products is dependent upon acceptability of application of the intra-urethral and intra vaginal devices (156) (Level of Evidence 3).

Some mechanical devices are effective, acceptable to a minority of women and relatively non-invasive (with the exception of intraurethral devices). They might be suggested to patients for consideration and

testing, particularly for short-term or occasional use. This recommendation is at the behest of health care professionals' (HCP) noted in Bugge et al's 2013 survey (161) considering contemporary practices.

- Assessment of cost effectiveness and effects on quality of life, when used intermittently or for particular activities.

4. RECOMMENDATIONS

Recommendations relating to mechanical devices for women with UI are summarised in Table J-2.

Table J-2: Recommendations relating to mechanical devices for women with UI.

- Internal vaginal support devices may be considered as a treatment option when managing women with SUI, dependent upon the availability of product, ease of insertion / removal, acceptance and cost (Grade of Recommendation C).
- Internal urethral devices may be considered for women with SUI, but they are invasive, costly and have had limited evaluation. They may be most appropriate for intermittent and occasional use (such as during vigorous exercise) (Grade of Recommendation C).

5. PRIORITIES FOR RESEARCH

- New devices - particularly invasive ones – must be evaluated by randomised trials including long-term follow-up.
- Evaluate the effects of mechanical devices for urinary incontinence on the urethra and / or bladder to determine their real value and safety.
- Comparison studies to other forms of conservative therapy, surgery and / or absorbent pads are mandatory.

K. MECHANICAL DEVICES FOR MEN WITH UI

Male mechanical devices (also called penile clamps or penile compression devices) are designed to prevent urine leakage by compressing the penile urethra using a clamp design or a peri-penile strap (Fig K-1).

For select men, mechanical devices offer a cost effective and convenient option for continence compared with a sheath and drainage bag or absorbent pads or for those who do not wish to undergo invasive incontinence surgery. However, there is potential for tissue damage and penile ischaemia and these devices should be used with caution. Clinical opinion is that the device should be released at least every two hours and is unsuitable for use overnight or when sleeping (15). Careful assessment is necessary for use of these devices and they should be fitted by a trained health professional and re-evaluated on a regular basis. The availability of online products means that men can purchase devices without assessment - healthcare professionals should be alert to the need for education of men on the safe use of these mechanical devices.

A penile compression device should be comfortable, easy to apply and remove and cause no untoward effects on skin or penile vessels. It should not be used for urgency incontinence. The main factors that may make mechanical devices (un)suitable for men are summarised in Table K-1.

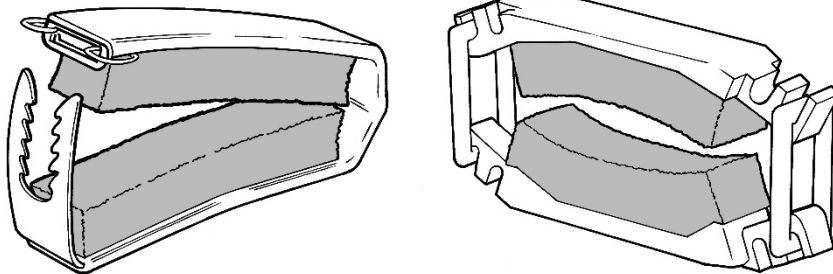

Fig K-1: Mechanical devices for men

Table K-1: The main factors that make mechanical devices (un)suitable for men.

<p>Mechanical devices may be suitable for men with:</p> <ul style="list-style-type: none">• Sufficient bladder capacity to allow about 2 h wear before needing to release the device.• Mainly stress urinary incontinence.• Cognitive ability to remember to release the device at regular intervals.• Adequate hand function that the device can easily be opened and closed.• Penile length to allow comfortable placement of the device on the shaft and not the glans.
<p>Mechanical devices are not suitable for men with:</p> <ul style="list-style-type: none">• Poor memory or reduced cognitive function.• Overactive bladder.• Penile skin irritation/dermatitis.• No penile sensation or sensation of bladder fullness.

1. EVIDENCE

Although a range of devices is available, there has been little research on their safety and efficacy.

Only one trial (162) was identified for the last consultation (31); it evaluated the effect of three devices on mean urine loss, subjective opinion and cavernosal artery blood flow. The Cunningham clamp was the most successful device in terms of continence, ease of application and comfort but was also associated with the highest reduction of penile blood flow indicating a potential for ischaemia if the device was placed too tightly. When the clamp was placed in a comfortable position and tightness, it controlled leakage well but did not entirely eliminate it so that participants still wore a small continence pad.

Two new studies were found for the current consultation (15) (163). The first was a randomised, controlled trial (15) of 56 men with persistent incontinence post prostate cancer treatment. Men tested, for 3 weeks each, the Cunningham penile clamp, penile sheath and bodyworn urinal (BWU) and compared these to their usual product of continence pads. Significant differences in acceptability, comfort, effectiveness ease of use were found between products: the Cunningham clamp was good for short vigorous activities that increased abdominal pressure such as golf or swimming and was the least likely to leak. However, nearly all men found the clamp uncomfortable or painful. Other products – sheath, pads, and bodyworn urinal – were also rated. Participants rated the sheath as

effective for dryness and ‘good’ for extended use such as travel; the bodyworn urinal received the least positive reviews and did not stay in place well, particularly when the user was seated. Pads were positively rated for most activities and best for night-time use. Of note is that participants indicated a preference for having a mixture of products to meet daytime needs. This is an important trial as it is the first to systematically compare several different continence products for men.

A second trial with 16 men measured IIQ-7 scores pre and post use of the penile compression device (Dribblestop™) as well as subjective impressions of ease of use, comfort, activity levels and overall satisfaction (163). There was a significant improvement in IIQ-7 score; 14/16 participants found the device easy to use, allowing them to be more active and more confident and they would recommend the device to others.

2. SUMMARY

- Penile compression devices may be a valuable continence option for select men, particularly where activity may not only exacerbate incontinence but also preclude the use of bulky and / or absorbent products. (Level of Evidence 1).
- Men who used a compression device ranked them as easy to use and effective. (Level of Evidence 1).
- Some men found the Cunningham clamp uncomfortable or painful. (Level of Evidence 1).
- Male mechanical devices can partially control urinary leakage, but they may not eliminate it at comfortable levels of compression. However, they are likely to lead to reduced cavernosal artery blood flow and therefore care must be taken to ensure regular removal or release (Level of Evidence 2).

3. RECOMMENDATIONS TABLE

Recommendations relating to mechanical devices for men with UI are summarised in Table K-2.

Table K-2: Recommendations relating to mechanical devices for men with UI.

- Male mechanical devices may be considered for select men with stress urinary incontinence who are cognitively intact and aware of bladder filling, have normal genital sensation, intact penile skin and sufficient manual dexterity to open and close the device (Grade of Recommendation B)
- Devices should be fitted by a trained health professional and reviewed regularly (Grade of Recommendation C).
- Mechanical devices may be an option for short-term use when undertaking sport or other activities and as an adjunct to management with other continence products (Grade of Recommendation C).

4. PRIORITIES FOR RESEARCH

Further research is necessary on the length of time a device can remain in place, the amount of compression that is safe for penile vessels, and the effect on skin health and comfort when using the device. It is possible that one penile compression device will not meet the needs of all men and further design considerations may be warranted.

L. INDWELLING CATHETERS

Indwelling urinary catheters (Fig L-1a) are inserted into the bladder urethrally (UC) (Fig L-1b) or suprapubically (SPC). Table L-1 lists the contexts in which long-term catheterisation (> 30 days) is most commonly used.

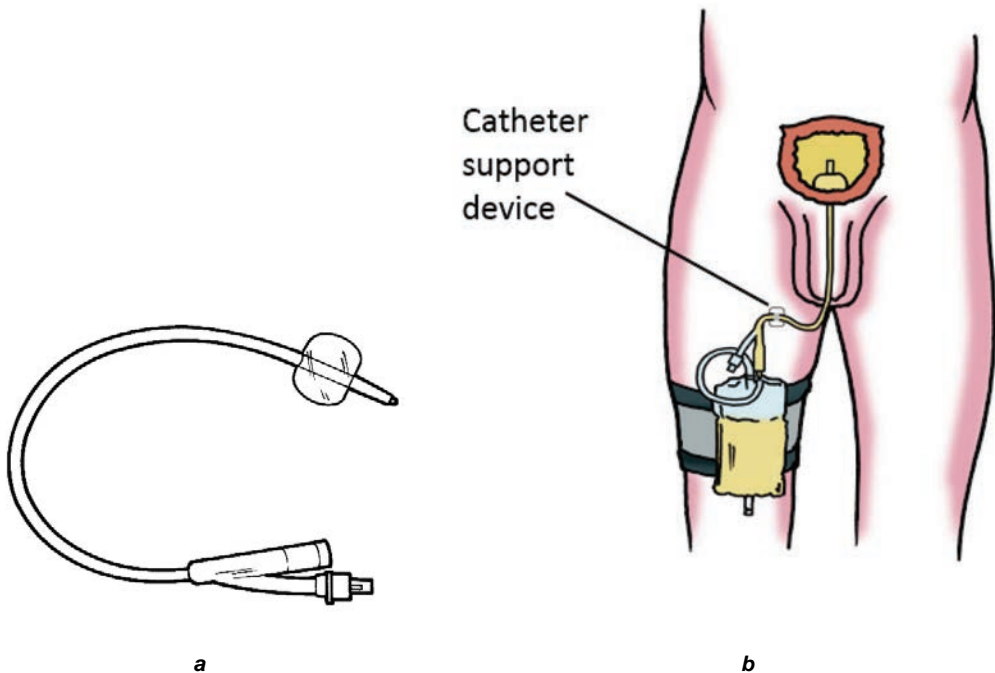

Fig L-1: An indwelling catheter with balloon inflated (a) and in position in the urethra / bladder.

Table L-1: The contexts in which long-term indwelling catheterisation (> 30 days) is most commonly used.

- Bladder outlet obstruction (BOO) where patients are unsuitable for - or waiting for - surgical or medical relief.
- Chronic retention when intermittent catheterisation is not feasible.
- Continence care for debilitated, paralysed or comatose patients.
- Pressure ulcers at risk of urine contamination.
- Non-healing incontinence associated dermatitis.
- Intractable urinary incontinence where catheterisation enhances the patient's quality of life when alternative non-invasive approaches are unsatisfactory or unsuccessful.

The older hospitalised person is at particular risk of having an unnecessary catheter or one remaining in situ for a prolonged period and/or being discharged without instruction for catheter care or date for removal (164). Common risk factors for catheters unnecessarily remaining in situ are listed in Table L-2.

Table L-2: Common risk factors for indwelling catheters unnecessarily remaining in situ.

- Absent or poor documentation on reason for catheter insertion.
- Extended hospital stays.
- Transfer from one clinical setting to another (573).
- No documented care plan for catheter removal (573) (574).
- Immobility, confusion / decline in function (170).

Several prevalence studies have indicated that about 9% of nursing home residents have a long-term indwelling catheter (range 7%- 38%) (165) (166) (167) (168) (169) (170). Duration of use can be for many years - in one US based study, mean use was 11.7 years (ranging in months from 1-589; median 8.8 years) (130) (171) (172). Lower use of catheters is recorded in centres with more proactive programmes related to prompted toileting and mobility.

It is understood that catheters should not be inserted as a continence measure until all other reasonable continence management/treatment strategies have been ruled out such as toileting, containment products and/or medication. In the evidence reviewed in the sections below, the primary focus is on the research related to long-term indwelling catheters (remaining in situ > 30 days).

The characteristics of the ideal catheter and ideal catheter material – according to expert opinion – are summarised in Table L-3, while Table L-4 outlines suitable materials, balloon size, catheter gauge and catheter length for different situations.

Table L-3 Characteristics of the ideal catheter and catheter material.

- An effective indwelling catheter should have the following design characteristics:**
- Be retained in the bladder effectively, yet easily removable without trauma to tissue.
 - Have a soft 'tip' within the bladder to avoid pressure damage to the mucosa.
 - Achieve effective drainage while minimising risk of bladder mucosa being 'sucked' into drainage channel.
 - Conform to the shape of the urethra.
- The ideal catheter material should:**
- Be soft / flexible for comfort.
 - Cause minimal tissue reaction or friction.
 - Be sufficiently firm for easy insertion and maintenance of lumen patency in situ.
 - Have elastic recoil so that an inflated balloon can deflate to almost its original size.
 - Be resistant to colonisation by micro-organisms and to encrustation by mineral deposits.

Table L-4: Suitable catheter materials, balloon size, catheter gauge and catheter length for different situations.

	Short term	Long term	Comments
Material	Latex or plastic PTFE-coated latex. Silver-alloy coated.	Silicone elastomer-coated latex. Hydrophilic polymer-coated latex. All silicone.	Latex catheters: avoid where possible -- urethral discomfort due to high surface friction, risk of rapid encrustation by mineral deposits; risk of latex allergic reactions (575) (576) (577) (578) (579) (580) or anaphylaxis (581). Coated catheters cause least friction and tissue reaction (582). Silicone catheters are stiffer & have thinner walls and slightly larger lumen compared to same size non silicone coated catheter; less likely to kink/bend (583); not affected by topical creams used for skin excoriation compared with coated latex catheters (584).
Balloon size	10 ml; larger balloon (30ml) only for post op haemorrhage control.	10 ml	Large balloon contraindicated unless surgically required because of risk of irreparable bladder neck erosion. Silicone catheter balloons may have water loss over time, with catheter falling out (585) (586); fill the balloon with sterile water and replace fluid periodically, knowing that 1/4 to 1/2 could be lost over time (585).
Gauge	Adult 14-16 Fr; post op procedures with haematuria/clots larger lumen 18-24 Fr.	Adult 14-16 Fr; smallest size to maintain good drainage (281) (587) (588).	Large diameter: Potential blockage of para-urethral glands and urethral injury.
Length	Male/female 41-45 cm	Male 41-145 cm; female option 25 cm.	

1. EVIDENCE

An extensive body of literature was reviewed for the last (5th) consultation and the details can be found there (31). However, the findings from that review are included in the summary below (Section 2), along with more recent material.

Few randomised controlled trials have been conducted on either long or short term catheterisation since the last consultation (31). Most indwelling catheter research has focused on short-term catheters (< 14 days) in hospitalised patients with a particular focus on catheter-associated urinary tract infection (CAUTI). The trials that have been undertaken are typically small, with sample heterogeneity, imprecise outcomes and short term follow up. Most data are of Level of Evidence 4, based on clinical experience and expert opinion. Several Cochrane reviews relating to long-term catheter use attest to the low quality of studies which preclude drawing robust conclusions (See Appendix 2 for a listing).

Studies added for the current consultation can be usefully reviewed under the following headings:

- a) Catheter characteristics and materials.
- b) Catheter coatings and CAUTI.
- c) Meatal cleansing.
- d) Catheter encrustation.
- e) Bladder calculi.
- f) Catheter-related pain.
- g) CAUTI.
- h) Bladder cancer.
- i) Management strategies.
- j) Education of health care professionals.
- k) Quality of life.
- l) Cost.
- m) Urinary catheters versus other strategies.

a) Catheter characteristics and materials

Feneley and colleagues wrote in 2012: In an era that has witnessed outstanding technological advances in medical practice it is difficult to understand why we are still unable to perform the relatively simple task of draining urine from the bladder without producing infection and a range of associated complications (173). Efforts to improve the traditional Foley design include a novel spiral-shaped, drainage tubing which appears to optimise flow and minimise residual urine

(125) and additional eyeholes (174) (175). Clinical testing is awaited.

b) Catheter coatings and CAUTI

Considerable laboratory work has been committed to finding a catheter coating that will prevent CAUTI or delay the onset in both acute and long-term care. To date and despite dedicated attempts to find options, there are no coated/impregnated catheters that will delay the onset of CAUTI in the long-term user. There may be modest benefit for those catheterised seven days or fewer.

- Silver Alloy: Two new trials comparing CAUTI with silver alloy versus standard catheter were found (176) (177). The first was a non-randomised retrospective review conducted in seven US acute care sites. Over the three months of data collection, a decrease in symptomatic CAUTI occurred when using both the US National Healthcare Safety Network surveillance definition and a clinical definition. In the most recent RCT in the UK (177) the authors found no difference in symptomatic UTI with silver alloy compared to standard catheters. One retrospective chart review suggested that silver alloy catheters post prostatectomy may increase risk of stricture, but a prospective study is required to determine this risk (178). Other randomised trials and a recent Cochrane review conclude that silver alloy catheters do not significantly reduce the incidence of CAUTI in acute care (179) (180) (181). Laboratory work has continued to modify silver coatings to increase antimicrobial activity (182).
- Antibiotic/antiseptic impregnated catheters: Earlier catheter studies on the effect of nitrofurazone (183) (184) (185) (186); minocycline and rifampicin (187); chlorhexidine, silver sulfadiazine, triclosan (188) (189) (190) (191) (192) have suggested benefit but outcome measures of bacteriuria vs CAUTI, heterogenous patient populations and small samples have limited the clinical impact of these findings. The largest randomised trial to date comparing nitrofurazone silicone, silver alloy coated latex or a PTFE standard catheter (n=7102 acute care short term catheter subjects) found that the nitrofurazone catheters had a small and not clinically meaningful decrease in CAUTI and were more uncomfortable than silver alloy or PTFE catheters. No significant decreases in symptomatic CAUTI occurred with silver alloy catheters compared to control (177). Laboratory work continues to show promise in antibiotic and antimicrobial catheters but findings have yet to be tested in clinical settings (193) (194) (195) (196) (197) (198).
- Other coatings or treatment undergoing laboratory testing: Zwitterionic molecules (in an anti-fouling coating) decreased biofilm development by 80% over seven days as compared with untreated catheters (199) (200). Laboratory testing also includes nanoparticle coatings on catheters

(201) (202) coating with antimicrobial enzymes (203) (204), polydopamine peptide coating (205), the addition of plant extracts (206), the release of salicylic acid (207), interference with bacterial signalling (208) (209), the use of bacteriophages to control colonising mixed species biofilms (210) (211) (212) and the application of low electrical currents to dislodge mature biofilms (213). Future opportunities for CAUTI control are promising based on the sophisticated laboratory work underway.

c) Meatal cleansing

An antiseptic solution is no more effective than sterile water in preventing the onset of bacteriuria (214) (215) (216). Meatal cleansing by simple washing with soap and water during routine bathing or showering is recommended (Level of Evidence 1) (103) (217) (218) (219). Effective handwashing by healthcare professionals, caregivers and patients, before and after handling catheters and drainage equipment, is generally accepted to be the most important component of any infection control strategy. Healthcare professionals and formal caregivers should also wear gloves.

d) Catheter encrustation

Catheter encrustations affect quality of life, nursing time and healthcare costs (220). Several approaches have been tested to reduce the problem including catheter maintenance solutions, (221) (222), fluid intake (223) (224) and catheter valves. Preventative strategies have largely failed but recent laboratory research, using advanced imaging techniques, has improved the understanding of crystalline biofilm formation which may aid in the development of anti-microbial materials, resistant to colonisation. (225)

Catheter encrustation (Fig L-2) occurs in up to 50% of LTC users, with resultant increased costs to services and patients (168) (226) (227) (228) (229). Mineral deposits - calcium phosphates and magnesium ammonium phosphate (struvite) - precipitate from the urine under alkaline conditions and cause blockage. In one trial prevalence of catheter blockage in a two month period was 11.08 per 1000 catheter-days' use (220). During the 12 months of another trial (230), both treatment and control groups had a reduction in blockage (4.76 and 6.04 per 1000 catheter-days, respectively) but there were no statistically significant differences between groups.

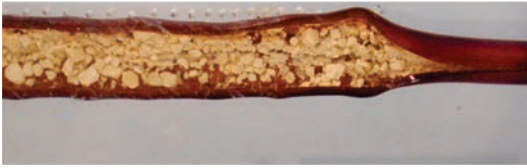

Fig L-2: Section of a catheter showing encrustation and blockage.

Precipitation of different ionic species (ie Ca⁺⁺, Mg⁺⁺, and phosphates) is influenced by their ionic concentrations in the urine and by the presence of urea-splitting micro-organisms such as *Proteus mirabilis* (231) (232) (233) (234). The pH at which ions precipitate from the urine varies, not only for different ions, but also between individuals and at different times (235) (236). These factors contribute, at least in part, to individual susceptibility to catheter encrustation and time to blockage. ‘Blockers’ experience recurrent catheter blockage within a few days to a few weeks (226) and urine from recurrent blockers tends to have a very narrow ‘safety margin’ between ‘voided’ urinary pH and the pH at which crystallisation (or nucleation) occurs (232) (237). This margin is much wider in non-blockers (234).

Catheter maintenance solutions

Pursuit of a solution to managing catheter blockage is on-going and several catheter maintenance solutions are marketed (Table L-5). However, there is no evidence that any of the following are effective in preventing encrustation or blockage in the clinical setting:

- Washout / maintenance solutions (222) (238) (239).
- Catheter coating or material (229) (240) (241) (242) (243) (244) (245) (246) (247) (248) (249).
- Oral medication (250) (251).
- Balloon instillation (252) (253) (254).

Several solutions are marketed to decrease encrustations/increase catheter time in situ (Table L-5). However, to date there is no clinical evidence that catheter maintenance solutions are effective in improving catheter drainage (255). For patients who have blocking or encrusted catheters the key nursing procedure is to review the catheter integrity, observe for reduced flow or obvious encrustation and change the catheter before it blocks. A characteristic pattern of ‘catheter life’ can usually be identified with record-keeping of three or more catheter episodes (232) (237) (256). This may allow pro-active strategies of care designed to change the catheter before likely blockage.

Concerns have also been raised about a potential negative effect of washouts on the urothelium (221) (232) (237) (257) (258) (259) (260) (261). There is weak evidence that citric solutions (orange, lemon or lime juice) and / or water intake may change pH and mineral crystallisation (223) (262) (263). Table L-6 summarises the theory and evidence of research efforts on encrustation.

Table L-5: Catheter maintenance solutions.

Suby G or Solution G¹	3.23% citric acid solution, pH 4, containing magnesium oxide to minimise tissue irritation, aimed at reducing encrustation. Used where routine catheter maintenance is required to reduce build-up of encrustations.
Solution R¹	6% citric acid solution, pH 2, containing magnesium carbonate, aimed at dissolving encrustations. A stronger acid than Suby G and therefore not recommended for frequent, regular use.
RenacidinR²	A citric acid solution, pH 3.5-4.2, containing glucono-delta-lactone to minimise tissue irritation and magnesium carbonate, aimed at reducing encrustation.
Mandelic acid 1%¹	An acidic solution, pH 2, aimed at inhibiting the growth of urease-producers. A stronger acid which is not commonly used to reduce catheter encrustations
Saline 0.9%^{1,3}	A neutral solution, pH 7, recommended for flushing of debris and small blood clots. Neutral pH solutions will not dissolve catheter encrustations.
Chlorhexidine 0.02%¹	An antiseptic solution aimed at preventing or reducing bacterial growth, in particular <i>E. coli</i> and <i>Klebsiella</i> species (but will not prevent biofilm formation on long-term catheters)
<p>¹ Available in the UK pre-packed in a sterile delivery devices designed for instillation into a urinary catheter. ² RenacidinR is approved in the USA for kidney stone disintegration only. Although it may be effective in certain situations for persistent catheter blockers, there are no supporting studies. ³ Saline is widely available</p>	

Table L-6: Catheter encrustations - theory and evidence

	Theory	Results	Level of Evidence
Catheter materials.	Intent to reduce/stop biofilm adherence.	To date no evidence that any material (silver coated latex; hydrogel or silicone coated latex, 100% silicone; nitrofurazone coated silicone.	1
Citrate Washout solutions (Catheter maintenance solutions): Suby G, Solution R, renacidin).	Reduction of pH; mobilisation of crystalline collections; eradicate P Mirabilis.	Citrate solutions clinical studies: no evidence to date.	1
		Renacidin laboratory results shows promise; no clinical studies.	4
Washouts: saline, sterile catheter.	Mobilise catheter debris.	No evidence of benefit.	1
Urease inhibitors: Acetohydroxamic acid 1.0 mg/ml & fluorofamide 1.0 microg/ml.	Lower pH in presence of P mirabilis.	Laboratory studies: Reduce pH in laboratory; in clinical studies side effects were unacceptable.	2
Fluid Intake: Water (224); acidic fluids (lemon 60 ml/L water/lime juice), potassium citrate 6g/L	pH increases when urine concentration decreases + citrate. Citrate (orange, lemon, lime juice) concentration may change pH & mineral crystallisation.	Weak evidence of reduced blockage(438). No evidence that cranberry juice decreases pH in catheterised people.	2
Electron Donating surfaces or electrical current through silver electrodes attached to catheter.	Proteus mirabilis suppression.	Laboratory results only – may inhibit growth; need clinical studies.	4
Triclosan catheter balloon fluid.	Triclosan suppresses biofilm formation.	Laboratory results only – need clinical application.	4
Proteus targeting.	P mirabilis has four adhesins that help make it stick to the bladder and catheter, a protective capsule, several secretions that promote extraction of host nutrients, quick migration capacity, and a powerful urease.	Laboratory studies of strong electron donating surfaces; triclosan in the catheter balloon need clinical testing.	4

e) Bladder calculi

Indwelling catheters (UC and SPC) are a known risk factor for bladder calculi formation compared to intermittent catheterisation (264) (265) (266) (267). This increased risk is independent of age, sex, level and degree of injury and the risk increases with duration of catheterisation so that by 5 to 10 years of continuous urethral or SP catheter use 33% to 46%, respectively, will have been treated for a bladder calculus (268). Any foreign object, like a retained piece of fluff from gauze, or pubic hair can cause a stone. Careful attention to hygiene and catheterisation technique could prevent this complication (269).

In a prospective cohort study of 66 SCI patients in Nigeria, encrustations and P. mirabilis were predictive

of bladder stones; thus ultrasound was recommended for persons with these risks to identify and treat bladder calculi (270).

Symptoms of bladder calculi vary from unresponsive CAUTI to catheter bypassing, spasms and haematuria. Individuals who do not respond to appropriate treatment of CAUTI should have a urological referral.

f) Catheter-related pain

Catheterised individuals report discomfort, pain and restricted activities because of catheter related painful bladder spasms, position of the catheter/tubing or catheter changes (130) (271). In a prospective observational study of 116 patients post urological surgery, the type of surgery and catheterisation history predicted moderate to severe catheter-related bladder discomfort (198). In a sample of 202 long-term

indwelling catheter users, 23% reported catheter related pain (other than during the catheterisation procedure) over the previous two months (220). Women complained about the pain because of sitting on the catheter or sores in the vaginal area. Bladder spasms, CAUTIs, blockage, and dislodgement can all contribute to catheter-associated pain, as well as insertion and removal procedures (272) (273) (274) (Level of Evidence 3).

If bladder spasm is the cause of pain a low dose of an anticholinergic medication may help (275). Attention to the catheter position and tubing is needed to prevent kinks or twists, to ensure that the catheter straps are not blocking urine flow and that the individual is not sitting on the tubing (276). Other approaches include treating constipation if present, ensuring that the catheter is the smallest size to provide adequate drainage, and ensuring that the catheter is secured and the drainage bag is well supported to prevent dragging on the catheter.

g) Catheter associated urinary tract infections (CAUTI).

Coatings on catheters are intended to control CAUTI but the problem is a challenge for both clinicians and researchers because of the complex nature of CAUTI development. The most common infecting organisms are *Escherichia coli*, *Enterococcus* spp, *Candida* plus other Gram-negative and Gram-positive isolates (277). Up to 40% of cultured specimens from long term catheters will show *Proteus mirabilis* as a key organism in biofilm production, catheter blockage and pH alteration because of urease production. Table L-7 highlights the progression of initial colonisation to adherent biofilm.

Table L-7: Biofilm production from initial colonisation to adherent biofilm.

Biofilms (282) (301) (589) (590) (591) (592) (593).
<ul style="list-style-type: none"> • Rapid colonisation of micro-organisms form a strongly adherent biofilm on catheter and drainage equipment surfaces. • Biofilm formation begins by deposition of a conditioning layer of proteins, electrolytes and other organic molecules from the urine • Micro-organisms attach to catheter surfaces & divide to form micro-colonies, ultimately developing a complex three-dimensional structure, including fluid filled channels through which the biofilm members receive nutrients, diffuse away wastes and send chemical signals to each other • Microorganisms growing as a biofilm are less susceptible to antimicrobial therapies than free-living organisms and are a major source of resistant, nosocomial pathogens • <i>Proteus mirabilis</i> is a common biofilm isolate which secretes urease causing hydrolysis of urea to free ammonia, raises urine pH and promotes precipitation of calcium phosphate and magnesium ammonium phosphate (struvite) and catheter blockage.

Onset of CAUTI

- All individuals with indwelling urinary catheters will develop colonisation (asymptomatic bacteriuria) at 5-8% per day to 100% by day 30 (278) (279) (280) (281) (Level of Evidence 1).
- Even short term antibiotic use in a catheterised patient may place them at risk of CAUTI (282) (283) (Level of Evidence 2).
- Most catheter users developing bacteriuria will remain asymptomatic and not require treatment (Level of Evidence 1).
- 24% of those developing bacteriuria will develop a symptomatic UTI without bacteraemia (284) (Level of Evidence 1).
- 4% with bacteriuria will develop bacteraemia a serious health care problem (284) (Level of Evidence 1).

Aetiology of CAUTI

Biofilm formation on the catheter surfaces begins as early as 24 hours after insertion. Microorganisms derive from the patient’s own colonic and perineal flora or from the hands of health-care personnel during catheter insertion or management (282) and gain access in two ways:

- Extraluminally during catheter insertion or via the periurethral space;

- Intraluminally following breaks in the closed system or contamination of urine in the drainage bag or break in closed system (within 32-48 hours v 72-168 hours respectively) (285).
- Numerous trials of oral antibiotics, antimicrobial bladder washes, drainage bag solutions and topical disinfectants all lead to the conclusion that bacteriuria and UTI may be suppressed temporarily at best, but resistant organisms are highly likely to emerge (301).

Diagnosis of CAUTI

The generally accepted CAUTI definition is outlined in the U.S. National Healthcare Safety Network (NHSN) document (281). The criteria are guidelines for practice – individual patient presentation may differ. Further work is required on the most appropriate outcome measures and the corresponding patient reported symptoms of CAUTI, particularly in long term users.

Treatment of CAUTI

- Prophylactic antibiotics prior to re-catheterisation are not recommended (104) (286) (Level of Evidence 1).
- Routine use of prophylactic antibiotics or antiseptics in LTC patients is not supported and may favour the emergence of resistant organisms (104) (185) (287) (288) (Level of Evidence 1).
- Cranberry juice does not affect incidence of CAUTI in catheterised people (289) (Level of Evidence 1).
- Urine cultures should be obtained before initiating treatment to permit selection of specific therapy for the infecting organism; extensive use of broad spectrum therapy should be avoided (290) (Level of Evidence 2).
- Catheter should be replaced prior to collecting a urine sample for culture and sensitivity or prior to starting antibiotics in symptomatic patients (104) (291) (292) (293) (Level of Evidence 2).

Reducing the risk of CAUTI

Current evidence is weak regarding all aspects of CAUTI prevention in long term catheter users. Based on the existing research, none of the following factors have been shown to reduce the incidence of CAUTI:

- Pre-connected urine drainage bags (294).
- Perineal cleansing (294).
- Suprapubic versus urethral insertion (295) (296) (Level of Evidence 2).
- Silver alloy antimicrobial surfaces (297) (298).
- Catheter coatings to reduce protein absorption (299).
- Inflation of the balloon with a biocide solution, such as Triclosan (243) (252).
- Disruption of matrix or glycocalyx components with agents such as heparin (300).

h) Bladder cancer

The reported incidence of squamous and transitional cell carcinoma associated with chronic indwelling catheterisation varies widely across studies (302) (303). In a US based study of 3,670 SCI subjects with indwelling catheters, the incidence of bladder cancer was 77/100,000 population vs 17/100,000 for the US general population (304) (Level of Evidence 3). Even SCI patients without an indwelling catheter may have a higher risk bladder cancer 15 times that of the general population and it is postulated that the neurogenic bladder may itself be a risk factor (305). The potential relationship between duration of catheterisation and cancer development could be studied further, particularly because patients change their form of bladder drainage which confounds the subgroup analysis in retrospective studies. Squamous cell cancer also was reported in two cases in persons with suprapubic catheters, which is believed to be uncommon and needs to be differentiated from granulomatous conditions which are common (306). Bladder calculi have been identified as an independent risk factor for bladder cancer by some authors (302).

Carcinoma within the cystostomy tract with SPC has also been reported (307) (308) (309). However, Hamid et al. (310) raise concerns over the interpretation of screening cystoscopy and biopsy in this population and note the importance of the distinguishing between histological changes and confirmed cancers when interpreting study results. Guidelines on catheter management includes a recommendation that patients with urethral catheters in place for 10 years or more should be screened annually for bladder cancer (311) (Grade of Recommendation C).

i) Catheter management strategies

In addition to CAUTI and encrustation, catheterisation is associated with several other complications: trauma due to malposition, leakage, calculi, false passage, haematuria, dislodgement, urethral strictures, hypersensitivity or anaphylaxis related to the catheter material (312) (313) (314). In a prospective surveillance project in a U.S. Veteran's Administration hospital, genitourinary trauma was as common as CAUTI (315). In one group of 202 community-dwelling adults with long-term catheters the authors described catheter related problems: 31% with CAUTI, 24% blockage of the catheter, 12% accidental dislodgement, pain (23%), sediment (63%), bladder spasms (36%), or urine leakage (43%) (220). Many case reports describe catheter-related complications such as: urethral injury (316) (317) (318), intraperitoneal rupture of the bladder (319) (320), fistula (321), and iatro-

genic hypospadias (322). These complications consume nursing time, compromise quality of life, and are costly to the healthcare system.

Overall, complications can be reduced if systematic approaches are taken to catheter care. Guidelines and protocols for catheter-care practices have been developed by clinical experts and should be part of an institution's care mandate. Research findings on topics such as meatal cleaning, lubrication, catheter

securement, pain, and encrustations are discussed below.

Suprapubic versus urethral catheter insertion: Incidence of complications such as CAUTI, bladder calculi and encrustations do not differ between urethral or SP routes, but SPCs do offer easier access to catheter site, easier recatheterisation, and may be more comfortable for individuals. Table L-8 compares the two insertion approaches.

Table L-8: Comparison of long term urethral and suprapubic catheters.

Comparisons	Urethral	Suprapubic
Insertion	Insertion by qualified healthcare professional	Initial placement must be by urologist/expert; may require anaesthetic
Upper urinary tract complications: vesicoureteral reflux; renal dysfunction, hydronephrosis; pyelonephritis renal calculi	No difference	
Urothelial Cancer	No difference	
Lower urinary tract complications: bladder calculi	No difference (594) (595).	
Lower urinary tract complications: ASB; symptomatic UTI	No difference (219) (295) (596).	
Lower urinary tract complications: urethral	Risk of urethral stricture, urethritis, scrotal abscess	Rare; SPC protects anterior urethra (271).
Urinary incontinence/skin care	By-passing occasionally causing perineal dermatitis; can usually be treated by medical/nursing management	Urethral leak especially if prior urethral/bladder neck trauma from UC; can only be treated surgically; Risk of over-granulation of stoma tract causing pain/bleeding on removal (323) (597) (598). Stoma site can be prone to IAD from urine leak or irritation from the catheter.
Access for catheter insertion	Can be difficult in patients with leg spasms, who are obese, men with retracted penis	Straightforward when track established; tract can close within hours if catheter falls out.
Not suitable if	Urethral deformity/stricture	Haematuria of unknown origin, Bladder tumour Small contracted or fibrotic bladders Obesity if pannus covers SPC site; obesity makes catheter insertion more difficult or impossible because of the trocar length. Abdominal scarring from surgery or radiation

When changing a SPC, the new catheter should be inserted as quickly as possible as a delay of only a few minutes can result in partial obliteration of the tract (323) (324) and the tract will close completely within 24 hours. It is also possible to insert the new catheter too far into the bladder so it enters the ureter with resultant trauma with balloon inflation. Careful observation of the length of catheter external to the abdomen and the angle of protrusion prior to catheter

change can help to ensure correct positioning of the new catheter (325). However, this is not always enough evidence to show correct positioning. A case presentation of a catheter which had "doubled-back" and showed the correct length suggests that imaging may occasionally be required to ensure correct placement. Dressings around the stoma site are not normally required unless there is excessive discharge, causing staining and / or sticking to clothing.

Maintaining effective catheter drainage

Use of urinary catheters is rarely completely trouble-free. Catheter drainage can be compromised by a variety of factors from simple causes such as kinked tubing or the position of the drainage bag, to bladder spasm, pressure of a constipated bowel on the adja-

cent urethra, suction of bladder mucosa into the catheter eye, or blockage by blood clots, mucus or encrustations. The algorithms in Fig L-2, Fig L-3 and Fig L-4 combine current evidence-based knowledge and expert opinion to provide some guidance on troubleshooting common problems. Further research is required to determine if dependent loops, which allow urine stasis, could contribute to CAUTI (126).

Urine does not drain

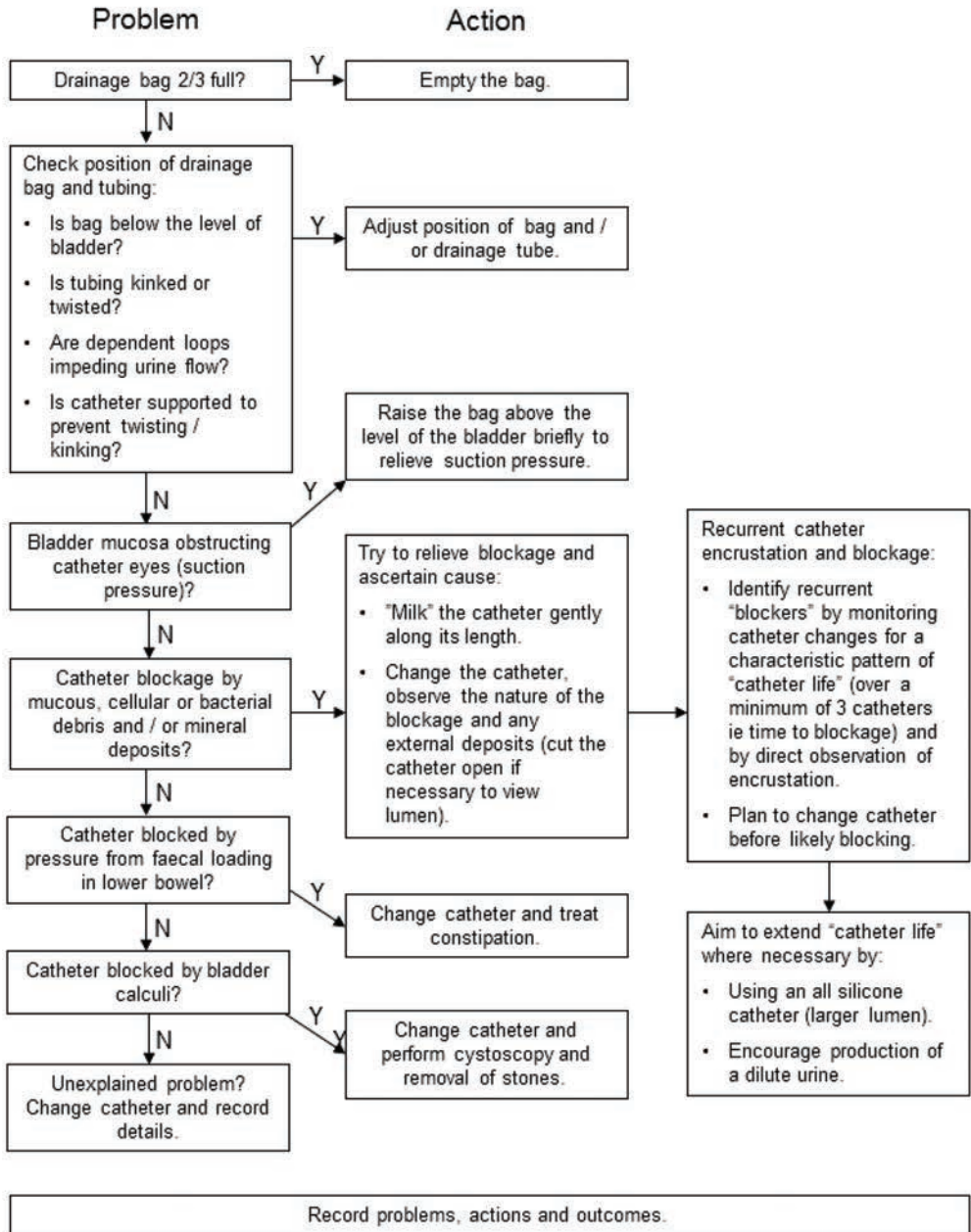

Fig L-3: Troubleshooting long-term indwelling catheter problems: urine does not drain. (N = No; Y = Yes). (Always have a spare catheter available).

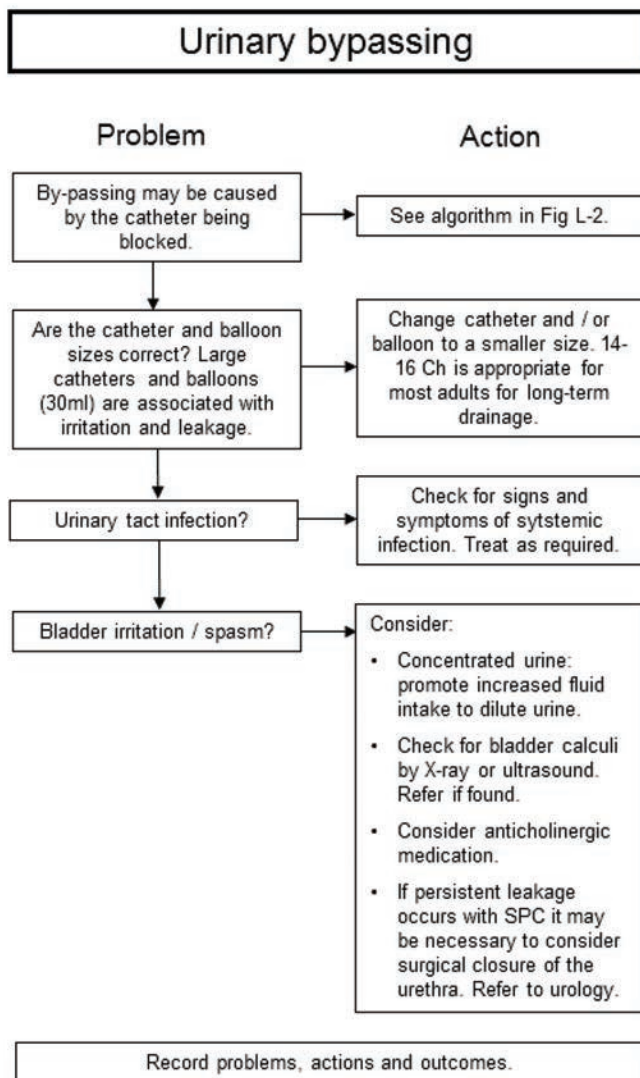

Fig L-4: Troubleshooting long-term indwelling catheter problems: urinary bypassing.

The inflation balloon does not deflate

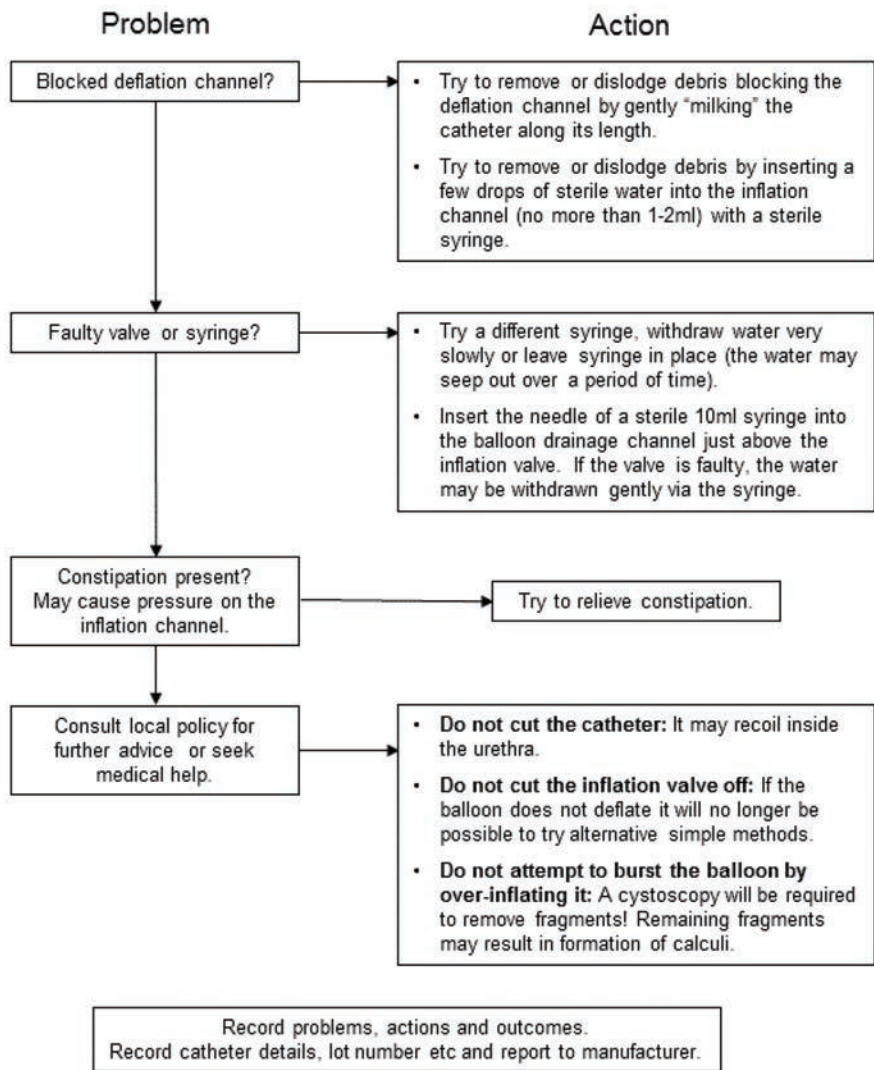

Fig L-5: Troubleshooting long-term indwelling catheter problems: the inflation balloon does not deflate.

Catheter clamping prior to removal

Two new studies are conflicting on the value of clamping post operatively. In a non-randomised study of neurosurgical patients with a short term catheter (mean 2.6 days) the clamped group had a shorter time to urination, less residual and positive perceptions of their first void (Liu et al, 2015). In contrast, in a trial involving 60 stroke patients randomised to free drainage or timed clamping over 1, 2, or 3 days, there was no difference in time to first void, volumes, or residual, and clamping may have contributed to other problems like leakage or CAUTI. The authors recommended that an indwelling catheter be removed without attempts to recondition with clamping (326) and

this approach is consistent with the findings from a recent systematic review (327).

Catheter valves

A catheter valve is a compact device used to control urine flow and is connected to the catheter outlet in place of a bag to allow a discreet alternative to conventional urine drainage bags. Valves are available in a variety of designs (Fig L-6) ranging from simple devices used for up to a week, to more complex forms which last longer and which may permit one-handed action. Most valve designs can be attached to a drainage bag at night to allow free drainage while the patient sleeps.

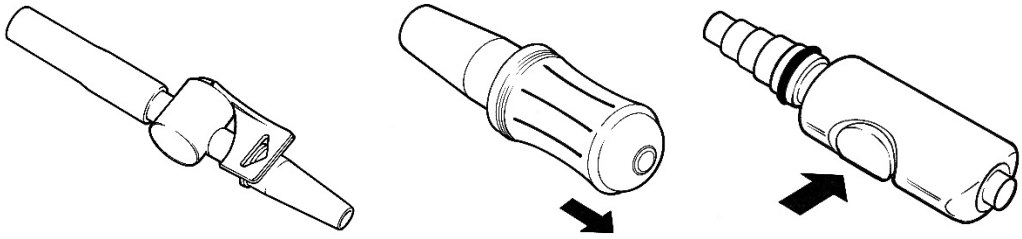

Fig L-6: A variety of catheter valves with different closure mechanisms.

- Suitable for: those who can manipulate the valve mechanism and empty the bladder regularly to avoid bladder distention and accompanying risks of reflux on the upper urinary tract.
- Not suitable for: people with poor manual dexterity, low bladder capacity, detrusor over activity, vesicoureteric reflux, renal impairment or cognitive impairment.

Evidence supporting the beneficial effects of catheter valves is derived from expert opinion and there is a paucity of research in this area. A lack of knowledge on valves may interfere with appropriate use; therefore, a full assessment is required to determine whether the person is a good candidate for a catheter valve using a systematic process, such as an algorithm (328).

There is no new research on catheter valves. Findings from studies reported in the 5th consultation (2013) indicate (329) (330) (331) (332):

- Catheter valves provide a well-accepted system of bladder emptying for those who can manipulate the valve mechanism and empty the bladder regularly to avoid overfilling (Level of Evidence 2).
- There is no evidence of increased risk of CAUTI, bladder spasms or discomfort compared to conventional drainage systems although there may be a higher incidence of nocturnal frequency and episodes of bypassing with valves. (Level of Evidence 2).
- Valves may promote maintenance of bladder tone and capacity (Level of Evidence 4).
- Preferred valve design should be easy to manipulate, leak-free, and inconspicuous (333). (Level of Evidence 3).
- An automatic valve system for LTC patients (334) may be helpful for patients who lack sufficient dexterity to manage a manual valve.

A catheter valve may facilitate periodic flushing but clinical evidence is currently lacking on reduction of encrustations and prolonging catheter life. Only one controlled laboratory study has explored the question (500), indicating that time to blockage with valves was

extended by over 50% compared to controls. There is an opportunity for clinical research in this area.

Catheter change frequency

There is no research evidence to support specific change intervals for IUC or SPC. Thus protocols vary widely between facilities from monthly to several weeks if the catheter is trouble-free. There is inadequate evidence to state that CAUTI will be reduced when the catheter is changed every 4-6 weeks, rather than only when it blocks, or with planned changes of every two weeks (335).

Lubrication

Guidelines and clinical reports suggest that injury or discomfort may be minimised by using a sterile lubricant or anaesthetic gel (336) (337) for male catheterisation; few have considered the procedure for women or for supra-pubic catheterisation (338). Results are mixed on the benefit of lignocaine versus water based lubricant for female catheterisation: one trial demonstrated lignocaine gel group had a significantly lower median procedural pain score compared to the group receiving a water-based lubricating gel (339) whilst another trial found no difference between lubricants (340). In a small trial with infants, intraurethral the lidocaine resulted in less catheterisation distress than topical and intraurethral water based lubricants (341).

The United Kingdom National Institute for Health and Care Excellence (NICE) guidelines on infection control (342) recommend: 'an appropriate lubricant from a single-use container should be used during catheterisation to minimise trauma and infection'. Anaesthetic gels may be contraindicated in patients with damaged or bleeding urethral membranes and should be used with caution in those with cardiac conditions, hepatic insufficiency and epilepsy (343). Lubricants which contain chlorhexidine have been reported to trigger anaphylaxis in a small number of patients during catheter insertion and consequently a careful history is required to screen for sensitivities (344).

Fluid intake

Apart from catheter maintenance solutions, laboratory studies suggest that dilute urine or increased urinary citrate concentration from orange juice or other fruit juices could be beneficial (262) but randomised

clinical studies are needed to assess the benefit of fluid adjustments.

Catheter Securement

Catheter securement may prevent movement of - and tension on - the catheter and potentially reduce the incidence of urethral erosion, trauma and pain, prevent accidental dislodgement from traction (345), and possibly reduce the incidence of bacteriuria (346). Of note is that whilst securement is intuitively better care, it is not necessarily put into practice. Two studies highlight this: of 82 nurses (8 continence specialists), 98% recommended securement but only 4% were documented using it (347); in a one day point prevalence study in acute care, only 18% (8 of 44) of the catheters were secured (124).

Several securement devices are available ranging from:

- Adhesive devices (potential for skin irritation).
- Non-adhesive straps covered in fabric (can slip down with full urine bag).
- Holster styles (348).
- Adhesive tape such as silicone tape can be gentler than paper tape, based on a single trial with children (349). One case report in paediatrics demonstrated efficacy in using an adult leg bag to hold the catheter in place (350).

Choice will depend on individual's usual activity, clothing, size of the thighs and the weight of the bag it would support. All need to be comfortable, easy to use, and gentle to the skin (351).

Self-management

Self-monitoring, a component of self-management, involves awareness of what to notice and related measurements or observations (352). Self-monitoring urine flow was found to be helpful in preventing or minimising catheter-related problems in a pilot study with 11 community-based individuals over a six months' time period (172). In the follow up randomised trial (N=202), a self-management programme for long-term indwelling urinary catheter users was tested in an experimental design. The intervention consisted of a 3 day intake and output urinary diary, educational booklet, and three home visits by a study nurse (348). The outcomes of CAUTI, blockage, and accidental dislodgement were evaluated over the 12 months' participation, measured in bimonthly phone call interviews, using a general estimating equation (GEE) and rates calculations. In the first six months of the study, blockage reports of occurrence (yes / no), but not frequencies of the event, were significantly lower in the experimental group than in the control group. No group differences were found for the full 12 months of the study or for other outcomes; however, examination of rates indicated that both groups improved over the 12 months' study for all outcomes. Researchers believe that the self-monitoring through use of repeated interviews and of a catheter

calendar for data collection in both groups contributed to overall self-care management improvements (230).

j) Education of healthcare providers

Despite the development of quality guidelines and the attention on CAUTI, knowledge and understanding of appropriate catheter care and risks of prolonged use remains suboptimal in many centres (353) (354) (355) (356) (357) (358). Educational approaches to research-based recommendations for catheter selection and minimising problems are welcomed by healthcare professionals and need to be made available in a variety of ways as part of on-going staff updates (359) (360) and as part of quality improvement/patient safety strategies.

k) Quality of life and catheterisation

Indwelling catheters can have both positive and negative effects on life quality. Users report reduced activities (361), embarrassment (271) (274), shame or stigma (171). Other concerns are loss of privacy (171) (273) (362) (363), end to sexual activity (364) (363) (365) (366), loss of manhood (367) and fear of odour and leakage (171) (366) (368) (369). Some indicate that care providers often dismiss their anxiety and concerns or do not provide enough information about sexuality or catheter care (363) (370) (Level of Evidence 3).

Positive benefits of catheterisation are also noted. In one qualitative study with 27 community dwelling adults, perspectives differed (371). Some who were no longer wet regarded the catheter positively, and several developed more self-reliance as they dealt with catheter problems. Others described the challenge of finding bathrooms and adjusted or limited their outings accordingly (Level of Evidence 2). Similar results were found in another qualitative study of 36 persons; changes in sexuality, behaviour, and self-esteem varied among individuals. Some said the catheter had no impact and others indicated it had profound effects on body image and sexuality. A suprapubic catheter was of benefit to some and the catheter position was important related to comfort, aesthetics, and body image (370).

The Consortium of Multiple Sclerosis Centres (372) oversaw a postal survey asking general questions about bladder and bowel management. Of the 9397 respondents, 12.8% used either intermittent or indwelling catheterisation. Fifty-three percent reported catheterisation having a positive impact. While the majority used intermittent catheterisation (64.7%), neither indwelling nor intermittent catheterisation appeared to affect QOL (373).

It is known that adherence to recommended bladder management post SCI is not always optimum for a variety of reasons (374). People sometimes switch from IC to an indwelling catheter -- despite the inherent problems with an indwelling catheter -- because of QOL issues (374). Many use different bladder drainage methods over time (172) (375). In one chart

review of people with SCI, 52% who were discharged using IC chose urethral catheterisation by 6 months citing discontinuation because of: the need to depend on caregivers, poor hand functioning, spasticity, incontinence (despite anticholinergic drugs) and toileting inconvenience (Level of Evidence 3). Problem solving by users for best catheter care is an area open for research. As part of a randomised clinical trial teaching self-management in 202 long-term indwelling catheter users, there were no group differences for QOL, though QOL improved somewhat during the 12 months participation in each group (230).

Practical aspects of living with the catheter, such as managing the drainage bag, can be significant (See Section H). In a small pilot study based on a postal questionnaire to LTC catheter users (n=59) (525) almost 25% of respondents stated that wearing a bag had a major negative affect on everyday living. Concealment was a key concern (89%) and visibility of the bag can be considered demeaning and declares a loss of bladder control (171) (273) and the fear of the bag leaking contributes to vulnerability. Even a short-term catheter can assault one's dignity. In a study in post-operative short-term catheter use, people complained about feeling "on display" and objectified (362) (Level of Evidence 3).

Until recently, formal measurement of QOL has been limited because no validated instruments have been available. There are now two instruments measuring quality of life in people with indwelling urinary catheters, an earlier version (376) validated in two small samples and a robust measure recently available (26). The latter measure is preferred (Level of Evidence 3).

Guidelines

Guidelines for appropriate catheter use and prevention of catheter associated infections have been published by nursing groups (377) and by Centers for Disease Control in the US (281), NICE (378) in the UK and (279), NICE (376) in the UK and the European Association of Urology (379). The paucity of trial-based evidence has affected guideline development. For example, in the NICE 'Guidelines for prevention of healthcare associated infections in primary and community care' (342), of 29 recommendations relating to urinary catheterisation only six were directly based on Level 1 evidence. Twenty-one were grade D, being based on evidence from expert groups or clinical opinion.

Assessment Tools

In USA long-term care settings, all newly admitted Medicare/Medicaid funded residents must receive an assessment using a standardised form -- Minimum Data Set (MDS). A further assessment is triggered when / if a resident is newly incontinent and the Resident Assessment Instrument Minimum Data Set (RAI-MDS) is completed quarterly. Ideally, the instruments should prompt staff to enquire about whether

a catheter is medically warranted or to develop an individualised catheter care plan (including the frequency of catheter changes and ongoing maintenance). The MDS and RAI are now used in a number of other countries, including Canada and Iceland. This assessment process is strengthened in the USA by its link to quality indicators. Specifically, long-term care facilities are required to use information from the residents' comprehensive assessment to provide assurances that:

- Catheters are used for only medically valid reasons.
- Catheters are removed as soon as clinically warranted.
- Efforts are applied to restore or improve bladder function as much as possible.
- Efforts are made to prevent infection while the catheter is inserted (380).

Quality Indicators

Regulation accompanied by the use of evidence based quality indicators has a powerful influence on the quality of care. Quality indicators are defined as quantitative measures reflecting a professional care standard used as guides to monitor and evaluate the quality of patient care and support service activities. The ACOVE (Assessing Care of Vulnerable Elders) suite of quality indicators has been designed to measure the quality of care for that group (381). It incorporates one quality indicator to guide care related to catheter use.

"IF a VE has clinically significant urinary retention, and a long-term (> 1 month) urethral catheter is placed, THEN there should be documentation of justification for its use, BECAUSE treatment of certain underlying causes(s) of urinary retention (e.g., treatment of constipation or bladder outlet obstruction) may carry less risk than long-term urinary catheterisation" (381).

Patients themselves may also benefit from education to prevent unnecessary catheterisation. In one study of patients with short term catheters, 47% did not realise that catheters contributed to CAUTI, 89% thought catheters were not used too often, and—most importantly—68% preferred a catheter to a commode, bedpan or absorbent products (382).

Guidelines and assessment tools alone do not change practice. Further efforts should be directed to disseminating evidence-based education and the use of quality indicators and regulatory initiatives.

I) Cost benefit of different catheters

Few studies have been published on the cost benefits of different catheters. The focus of economic studies has been in acute care using models to predict a proportion of patients with bacteriuria who will develop symptomatic UTI or bacteraemia. One UK based decision- analytic cost effectiveness study was found, in

relation to a randomised trial over six weeks for short term catheterisation. The conclusion was that nitrofurazone coated catheters but not silver coated ones were more cost effective (383). In a companion study of costs associated with long-term catheters in Swedish nursing homes, catheter care costs were associated more with basic care than acute interventions; 90% of the cost was for personnel (229).

m) Urinary catheters versus other care strategies

Few studies have compared indwelling catheterisation with other strategies to manage urinary incontinence, not least because of the difficulties in recruiting to and conducting robust trials. Sheath systems are associated with fewer incidences of bacteriuria, symptomatic UTI or death than indwelling catheters (97). Participants reported that sheaths were more comfortable and less painful than indwelling catheters.

Preferences for different urinary incontinence treatments have been studied in long-term care (384). Most respondents preferred non-invasive strategies (containment products and prompted voiding) to invasive strategies such as indwelling catheterisation (385). Older adults stated they would choose a treatment based, in part, on feeling dry, being natural, not causing embarrassment, being easy, and not resulting in dependence.

2. SUMMARY

- Asymptomatic bacteriuria should NOT be treated with antibiotics; routine urine culture is unnecessary (unless urological instrumentation is planned) (Level of Evidence 1).
- Meatal cleansing of a catheterised individual by simple washing with soap and water (i.e. not with antimicrobial agents) during routine bathing or showering is recommended (Level of Evidence 1).
- A closed drainage system should be maintained to reduce risk of catheter-associated infection (Level of Evidence 2).
- Midnight versus morning removal of catheters may result in longer time to first void and larger first void and no difference in recatheterisation rate (Level of Evidence 2).
- Alpha blockers pre catheter removal after AUR may result in fewer re-catheterisations and improved voiding (Level of Evidence 2).
- Silver alloy coated catheters do not reduce the onset of CAUTI (Level of Evidence 1). Antimicrobial catheters can prevent bacteriuria during

short-term catheterisation (<14days) (Level of Evidence 1).

- Nitrofurazone coated catheters may reduce CAUTI risk, but are associated with discomfort. Potential toxicity and / or antimicrobial resistance is unknown (Level of Evidence 2).
- All currently available catheter materials are subject to bacterial biofilm formation (Level of Evidence 1).
- Recurrent urinary catheter blockage occurs in as many as 50% (range 24-50%) of all long-term catheterised patients (Level of Evidence 2).
- Recurrent urinary catheter blockage caused by encrustation occurs in 40-50% of all long-term catheterised patients (Level of Evidence 2).
- In the majority of individuals with a long-term indwelling catheter, a characteristic pattern of 'catheter life' can be identified (Level of Evidence 3).
- Evidence from in vitro models of the catheterised bladder indicates that: i) dilute urine; ii) high urine citrate content (> 1.5mg/mL) reduce risk of blockage (Level of Evidence 2).
- There is insufficient evidence from RCTs to assign an in vivo level of evidence for catheter washouts (Level of Evidence 2).
- Suprapubic catheterisation (SPC) is an appropriate alternative to urethral catheterisation (Level of Evidence 1).
- There is some evidence for a reduction in catheter-associated infection in SPC use during short-term catheterisation (Level of Evidence 2), compared to urethral catheter insertion. However, there is no corresponding evidence for long-term catheterisation (Level of Evidence 2).
- Patient comfort, quality of life and satisfaction with SPC is generally good compared to urethral catheters (Level of Evidence 1).
- Catheter valves provide a well-accepted system of bladder emptying for suitable patients who are able to manipulate the valve mechanism and empty the bladder regularly to avoid overfilling (Level of Evidence 2).
- There is no evidence of increased risk of urinary tract infection with valves compared to conventional drainage systems (Level of Evidence 2).

3. RECOMMENDATIONS

Recommendations relating to indwelling catheters are summarised in Table L-9.

Table L-9: Recommendations relating to indwelling catheters.

- Indwelling catheters should only be used after alternative management strategies have been considered and rejected as unsatisfactory (Grade of Recommendation A).
- Duration of catheterisation should be minimal (Grade of Recommendation A).
- A closed drainage system should be maintained to reduce risk of catheter-associated infection (Grade of Recommendation A).
- Meatal cleansing with plain soap and water (not with antimicrobial agents) is recommended (Grade of Recommendation A).
- Addition of disinfectants to drainage bags, bladder irrigation and antibiotic prophylaxis are NOT recommended as routine infection-control measure (Grade of Recommendation A).
- Silver-alloy catheters are not recommended for use in acute or long term care as they do not significantly reduce the incidence of CAUTI (Grade of Recommendation A).
- Routine urine culture in an asymptomatic patient is not recommended (Grade of Recommendation B).
- Catheter materials designed for long-term use (all-silicone, silicone or hydrogel-coating) should be used where a catheter is expected to be used long-term (i.e. >14days) (Grade of Recommendation B).
- If a long-term indwelling catheter is being considered, both SPC and UC should be considered, following appropriate risk assessment (Grade of Recommendation B).
- Routine washout solutions are NOT recommended to reduce encrustation or debris (Grade of Recommendation B).
- Preconnected urine drainage bags and catheters are NOT recommended as a means to prevent CAUTI (Grade of Recommendation C).
- UC and SPC catheters and drainage bags should be adequately supported to maintain patient comfort and prevent meatal or cystostomy tract damage from traction or abrasion (Grade of Recommendation C).
- UC and SPC insertion should be carried out only by appropriately trained and skilled practitioners using aseptic technique (Grade of Recommendation C).
- Effective handwashing before and after handling catheters and drainage equipment may reduce the incidence of CAUTI (Grade of Recommendation C).
- In patients with recurrent catheter encrustation and blockage, systematic monitoring should be undertaken to identify a characteristic pattern of 'catheter life' and instigate pre-emptive catheter changes prior to likely blockage (Grade of Recommendation C).

4. PRIORITIES FOR RESEARCH

a) General

- Agreement on key outcome measures to permit comparisons between studies:
 - Standardised definition of UTI for catheterised individuals.
 - Asymptomatic bacteriuria in a catheterised patient and its clinical / research implications.
 - Standardised time frames for following patients.
 - Documentation of the use of antibiotics prior to and during a study eg preoperatively in surgery or commencement of antibiotics for other conditions during the study,
 - Patient follow-up to include post catheter removal.
 - Adherence to CONSORT guidelines (386).
 - Definition of recurrent blockage.
 - Consistent use of rates/1000 catheter days for blockage as well as CAUTI.
- Mixing study outcomes of asymptomatic bacteriuria and symptomatic urinary tract infection (CAUTI) limits meaningful comparisons and contributes to a lack in knowledge of effective ways to treat symptomatic CAUTI (387).
- Comparative studies of different patient groups eg. males and females, different age groups, patients at home and those in institutional care, including patients' comfort, satisfaction and quality of life measures.

b) Indwelling catheters

- Address the barriers healthcare professionals face regarding optimum catheter management.
- Compare catheterisation techniques eg CIC, suprapubic and urethral catheters, on CAUTI and other risks or potential benefits.
- Review any detrimental effects on bladder tissue from persistent asymptomatic bacteriuria in long-term catheterised patients.
- Conduct laboratory and clinically based research of strategies to reduce recurrent catheter encrustation and blockage, including maintaining a dilute urine, increased level and acceptance of urinary citrate, role of acidic 'catheter maintenance' solutions.
- Further development of catheter materials resistant to microbial biofilm formation, new approaches to disruption of the biofilm, or alternatives to catheterisation.
- Development of further self-management research focusing on decreasing blockage and CAUTI.
- Explore the role of caregivers in providing care to people with long-term catheters.

c) Catheter valves

- Clinical investigation of effect of catheter valves on incidence and frequency of catheter encrustation and blockage.
- Cost-effectiveness studies of disposable versus re-useable valves.
- Studies designed to demonstrate if catheter valves promote maintenance of bladder tone and capacity.
- Further examination of combination management strategies such as valve during the day and free drainage overnight.
- Studies demonstrating the value of new designs in catheter valves, eg those operated by magnets for people lacking in hand dexterity.

M.INTERMITTENT CATHETERS

Intermittent catheterisation (IC) is the act of passing a catheter into the bladder to drain urine or maintain stricture patency via the urethra or a catheterisable channel such as a Mitrofanoff diversion. Urine is drained and the catheter removed until the next indicated time. IC avoids many problems associated with indwelling catheters but urinary tract infections (UTI) remain an issue for many IC users and most research, until recently, has focussed on UTI as an outcome. Intermittent catheterisation is a sterile technique

in care settings and a clean procedure for community based individuals who self-catheterise or have a single caregiver providing bladder care. Policy varies by country on sterile single use catheters or reuse of catheters for IC. To date, there is an absence of evidence to support sterile single use catheters for community dwelling individuals with respect to prevention of UTI although users may report improved quality of life with single use. In this section, we provide an overview of the current literature on IC related UTI, quality of life and cost effectiveness.

The main factors that make intermittent catheterisation (un)suitable for people are listed in Table M-1.

Table M-1: The main factors that make intermittent catheterisation (un)suitable for people.

Intermittent catheterisation may be suitable for those with:

- Neurological disorders resulting in urinary retention or incomplete emptying.
- Detrusor sphincter dyssynergia.
- Incomplete emptying post operatively eg following Botox incontinence surgery.
- Acute urinary retention (most commonly in men).
- Urethral stricture requiring ongoing management.
- Continent urinary diversions such as a Mitrofanoff diversion.

Intermittent catheterisation is not suitable for those with:

- Poor hand dexterity or visual problems or no caregiver to assist.
- Insufficient cognitive awareness to understand the process.
- Reluctance or inability to perform the technique themselves, and unwilling to accept the procedure from a caregiver.

1. EVIDENCE

At the time of the 5th International Consultation (31), there were 25 published randomised controlled trials on some aspect of IC and 2 Cochrane reviews on the topic (388) (389). The first review focused on the effect that catheter design (uncoated or coated) and sterile or clean catheterisation technique had on the incidence of UTI; the authors concluded there was inadequate evidence to state that any type of catheter or method influenced the incidence of UTI in community dwelling IC users. The second review addressed policies related to IC, indwelling and suprapubic catheterisation. The authors concluded there was weak evidence to support prophylaxis in IC users and that antibiotic resistance was an issue. Findings from the

last (5th) consultation (31) are included in the summary, below.

Since the last (5th) consultation (31) there have been five IC-related RCTs (390) (391) (392) (393) (394), five Cochrane reviews (394), (395) (396) (397) (398) three systematic reviews (399) (400) (401), one laboratory based study on catheter cleaning (402) and one on acceptability of a new cleaning method for catheters reused by a single IC user (403). Most research on IC continues to relate to catheter-associated urinary tract infection (CAUTI) and quality of life.

Short term (less than 14 days) studies focused on hospitalised individuals whereas long-term (using IC on an ongoing basis) studies are almost exclusively of patient groups with neurogenic bladder disorders. Small scale, comparable studies of new products are common and are often industry-sponsored.

One cost effectiveness study was found (404). Using a probabilistic decision analysis describing UTI over the lifetime of a spinal cord injured patient, those 'assigned' to single use hydrophilic coated catheters versus single use uncoated PVC catheters had 1.4 additional life years over a 35-year period compared to PVC catheter users.

a) Short-term bladder management

Less than 14 days: Zhang et al. (401) conducted a systematic review and meta-analysis to compare the rates of UTI and postoperative urinary retention (POUR) in individuals who had undergone total joint arthroplasty, randomised to either an indwelling urethral catheter or IC. Nine RCTs involving 1771 patients were included. All indwelling catheters were removed within 24-48 hours postoperatively. Rates of UTI were similar between groups and it was concluded that for patients at risk for POUR, indwelling catheterisation removed 24-48 hours post operatively was the preferred option. For those low risk patients either indwelling catheterisation or IC could be appropriate or catheterisation following the surgery could be on as needed basis.

Choice of catheter

Comparison of short-term (less than 14 days) urethral indwelling or urethral intermittent or suprapubic catheterisation in adults hospitalised for a wide range of reasons, from urogynaecology surgery to medical management was presented in a Cochrane review (395). The authors concluded that suprapubic catheters reduced both asymptomatic bacteriuria, recatheterisation and pain compared with indwelling urethral catheters but that the evidence for symptomatic UTI and asymptomatic bacteriuria for indwelling urethral or IC inconclusive. The evidence was also inconclusive for advantages of suprapubic versus IC.

b) Long-term / continuing chronic bladder management

UTI prevention:

With respect to incidence of UTI and long-term IC, a recent Cochrane review compared one type of catheter design versus another, aseptic versus clean technique, single use versus multiple use catheters, self-catheterisation versus catheterisation by others, user preference and ease of use in both adults and children. Thirty-one trials met the inclusion criteria: 13 RCTs and 18 cross-over trials. The authors concluded that despite the number of trials there is still no convincing evidence that incidence of UTI is affected by any technique, coated or uncoated catheter or single or multiple use 'clean' catheters. The authors noted that current evidence is weak and trial design issues remain a significant issue. Since this review a cleaning method for multi-use catheters has been published (403) together with evidence of its efficacy (402). However, the method has not been tested in a randomised controlled trial.

In another Cochrane Review, (398) policies relating to antibiotic prophylaxis and IC were addressed. Eight trials met the inclusion criteria with all but one (Zegers 2011) at least 19 years old. The absence of recent research likely reflects the major practice change with respect to antibiotic resistance and prescribing recommendations of 'as clinically indicated' versus prophylaxis. Of the 8 studies, only one (405) favoured prophylaxis in children with spina bifida at higher risk: female, with vesico-ureteral reflux and high infection rates. The review authors concluded that implications of ongoing antibiotic use might outweigh limited benefit of prophylaxis.

In an attempt to evaluate whether IC is better than IUC, external (sheath) catheters are better than IUC or IC; or that IC is better than timed voiding. Jamison and colleagues reviewed over 400 studies involving individuals managing neurogenic bladder over the long-term (396). No trials were found that met the inclusion criteria so that currently it is not possible to draw any conclusions regarding clear benefit of IC over other methods in managing the neurogenic bladder.

Quality of life / patient preferences

Moving away from the clinical aspect, recent research focuses on IC users' quality of life. Research in this area predominately explores catheter designs (e.g. different lengths, 'ready to use' presentation) with different materials such as PVC-free and catheters with coatings such as hydrophilic (406). Unsurprisingly, these studies are often industry-sponsored. Another trend in the literature is the focus on user groups with neurogenic bladder disorders and how IC can improve their quality of life. IC continues to be seen as the most commonly used procedure for those with incomplete bladder emptying and offers the ability to be self-caring, maintain independence and the opportunity to decide when and where to empty the bladder.

Other aspects that are evident in the literature are how long-term IC impacts on individual's daily lives.

Apart from obstacles such as insufficient hand movement or being unable to sit, which can restrict some patients access to IC, worries, embarrassment (407) and psychological coping mechanisms (408) studies also report that patients find intermittent catheters unwieldy, difficult to use or to carry discreetly (390). As one study reports, moreover, the efficacy of CIC is often measured by the individual's quality of life. A randomised, crossover, multicentre study evaluated discreet design compact catheters compared to standard catheters, which were used by those with neurogenic bladder dysfunction. Results found that 63%

preferred the discreet compact hydrophilic coated intermittent catheter design as it contributed to a significant improvement in patient quality of life (390). Choice of product which offers discretion, ease of use and eliminates social anxiety is current user preference (408) (409).

Although there are several devices available to enable catheterisation by the individual - mirrors, catheter holders, and clothing retractors - it is of note that no published studies have explored IC users' impressions of these devices. Fig M-1 shows a catheterisation aid.

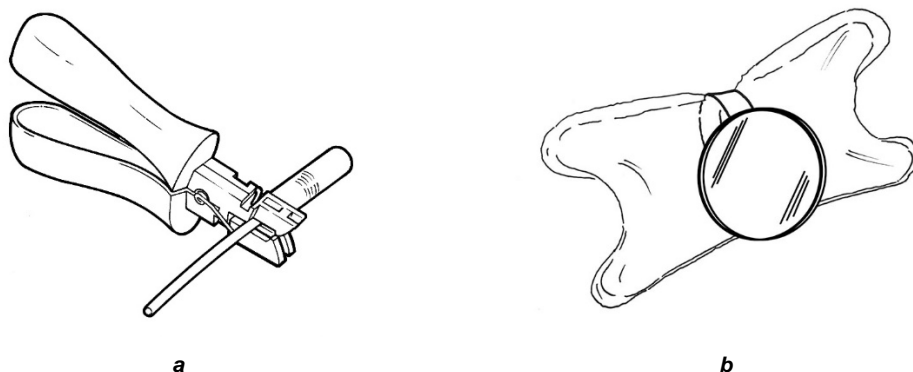

Fig M-1: A catheter holder / insertion aid (a) and an inflatable cushion with mirror, to be held between the knees and provide a better view of the urethral meatus when self-catheterising (b).

c) Self-management research

One small trial has tested the feasibility and usability of a web-based intervention in a sample of people with spinal cord injury (N=34) using intermittent catheters (IC). Prior to the pilot with 30 individuals, the three-month intervention was pre-tested (N=4), and suggestions were given to refine the application, including modifying the web-based interactive urinary diary for mobile phone use. The single group pre-post study involved: a 23 page online educational booklet, links to ICI's Catheter Products website and other related products, two phone calls with a study nurse in the first month and a follow up phone call at three months to revise goals and approaches. In addition discussion fora were provided, moderated by the study team and 2 peer advisors chosen from the pre-testing group (410) (411). Measures about self-efficacy and self-management of IC were developed and tested. The web-based application was well received, with the forum being used the least often yet well liked. Catheter related self-management was significantly improved with most comments about positive changes in fluid intake. Catheter self-efficacy and quality of life increased slightly and UTI decreased from the three months prior to the study (42% to 30%), but these changes were not significant. The intervention is ready to be tested in a larger study (412).

2. SUMMARY

- There remains insufficient evidence to state that one catheter product or catheterisation technique is better than another in the prevention of UTI in IC users (Level of Evidence 1).
- Soap and water combined with a 15 minute Milton soak (Milton method) renders catheters free of pathogenic organisms (Level of Evidence 1).
- Quality of life might be improved with use of compact portable IC catheters compared to standard length catheters or through single use catheters (particularly hydrophilic coated catheters). (Level of Evidence 2).
- Antibiotic prophylaxis may be beneficial for select individuals but must be weighed against the potential of antibiotic resistance (Level of Evidence 2).
- Intermittent catheterisation users find the Milton method (above) easy to use and of little burden (Level of Evidence 2)
- There are several catheter products on the market: uncoated PVC requiring added lubricant; gel coated; hydrophilic gel coated. Personal preference may determine use (Level of Evidence 4).

- Aids such as clothing holders, mirrors or catheter holders may facilitate catheterisation (level of Evidence 4).

3. RECOMMENDATIONS

Recommendations relating to intermittent catheters are summarised in Table M-2.

Table M-2: Recommendations relating to intermittent catheters.

- Intermittent catheterisation (IC) is a treatment of choice for those with ongoing bladder emptying problems and residual urine > 100ml who are able to manage the technique (Grade of Recommendation A).
- IC technique can be taught to all ages of people with appropriate motivation and manual dexterity (or to a carer where this is acceptable to both parties). Appropriate education and ongoing support is needed (Grade of Recommendation C/D).
- Frequency of catheterisation needs to be based on individual need, to prevent over-filling of bladder (Grade of Recommendation C).
- An external lubricant or lubricant-coated catheter is recommended to minimise urethral trauma (Grade of Recommendation C).
- IC users may benefit from access to different catheters or catheter-packs for different purposes (eg ease of use may be particular important when at work or in public) (Grade of Recommendation C).

4. PRIORITIES FOR RESEARCH

- Testing of catheter cleaning methods by large groups to assess safe multi use of catheters.
- Ensure trials adhere to consistent definition of symptomatic urinary tract infection.
- Cost effectiveness studies should include patient acceptability/satisfaction with the procedure and or product.

- Health utility in various situations need to be considered, e.g., at home vs. away.
- Further development of self-management research in IC users in various populations in multiple sites.

N. PRODUCTS AND DEVICES FOR PREVENTING OR MANAGING FAECAL INCONTINENCE AND ITS SEQUELAE

1. INTRODUCTION

Anal plugs (to prevent faecal leakage) and peri-anal pouches, rectal catheters and absorbent pads (to contain it) may be used to manage faecal incontinence (FI) and its complications of skin damage and odour. Plugs, pouches and rectal catheters are discussed here while absorbent pads for managing FI are covered in Section F.10), and incontinence-related skin and odour problems in Sections O and P, respectively. Other approaches to conservative management of FI are addressed comprehensively in chapter 17 and in chapter 11.

Products and devices that redirect and / or store faeces have been used in individuals in institutions - such as hospitals and nursing homes - who are confined to bed and require assistance in incontinence management and toileting by caregivers due to acute or critical illness or functional disability (413) (414) (415) (416). These devices are often used to prevent or treat damage associated with FI or other wounds.

1.1. Anal Plugs

An anal plug (Fig N-1) consists of a removable, small cup-shaped piece of foam that is held in a collapsed position by a film for insertion. When the film comes in contact with the moist rectal mucosa, the plug opens to block the passage of faeces (417) (418). A plug is inserted like a suppository using a lubricant gel and can be removed by pulling on an attached string or expelled by raising intra-abdominal pressure and pushing as during normal defaecation. Table N-1 lists the main factors that make anal plugs (un)suitable for people.



Fig N-1: An anal plug
 (from www.continenceproductadvisor.org)

Table N-1: The main factors that make anal plugs (un)suitable for people with FI.

<p>Anal plugs are suitable for individuals who:</p> <ul style="list-style-type: none"> • Wish to prevent leakage for a specific period (during exercise or after an enema or rectal irrigation). • Who have leakage associated with spina bifida, anorectal malformation, rectal sphincter injury.
<p>Anal plugs are not suitable for individuals:</p> <ul style="list-style-type: none"> • With active disease of the bowel or rectum. • Who have a SCI and are at risk of autonomic dysreflexia. • For whom a device might disrupt an established bowel routine.

1.2. Rectal catheters and long and short rectal tubes

Rectal catheters drain liquid faeces through openings at their proximal end into a collection bag (Fig N-2). The catheters and collection bags are a closed system designed for extended use (US FDA approved for 29 days). Sometimes a balloon near the proximal tip is inflated to prevent faecal leakage around the catheter and to retard inadvertent expulsion of the tube during defaecation (419). Bowel management programs often include daily or more frequent saline irrigations through the rectal catheter to maintain liquid consistency of stool and catheter patency (420).

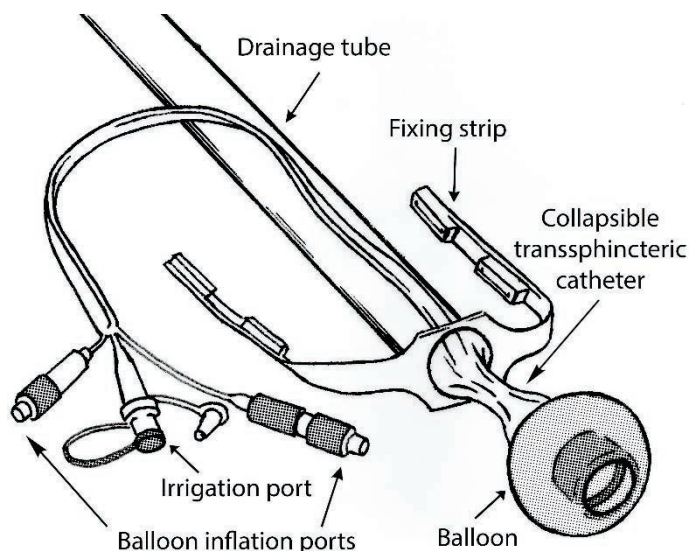

Fig N-2: A rectal catheter and drainage bag.

Table N-2 lists the main factors that rectal catheters / trumpets unsuitable for people with FI.

Table N-2: The main factors that make rectal catheters / tubes unsuitable for people with FI.

Rectal catheters / trumpets are not suitable for those with:

- Intestinal mucosal disease.
- Immunosuppression.
- Gastrointestinal bleeding or bleeding tendencies.
- Recent myocardial infarction or prostate surgery (419) (422).

Use of a rectal catheter with or without inflating the balloon is controversial because of concerns of ulcerating or perforating the rectum, damaging the anal sphincter, stimulating intestinal secretion worsening incontinence (419) (421) (422) (423).

1.3. Anal Pouch

An anal pouch consists of an external collection bag connected to a pliable wafer, which has an opening at its centre and an adhesive on the body side. The wafer adheres to the peri-anal skin (Fig N-3). The bag has a resealable port at its distal end through which faeces can be drained or connected to a larger, gravity drainage bag without the need to remove the wafer from the skin. Some pouches have a small folded flap that allows flatus to escape so that it doesn't inflate and rupture the bag.



Fig N-3: An anal pouch
(from www.continenceproductadvisor.org)

The pouch avoids the risks of rectal mucosal or sphincter damage associated with rectal catheters or small tubes. Disadvantages of the anal pouch are difficulty in applying it and maintaining its seal and potential skin damage from removing the wafer or from contact of faeces in the pouch with skin (424) (425).

2. EVIDENCE FROM THE 5TH INTERNATIONAL CONSULTATION (2013)

An anal plug can successfully prevent FI in individuals with a variety of aetiologies of FI, more so in adults than children (414) (426) (Level of Evidence 3). The self-reported effectiveness of the plug in adults ranged from 83% (564) to 38% (427). In one study of children, 32% were completely continent using an anal plug, and 13% reported "total failure" (426).

The most common concerns and problems associated with wearing an anal plug include discomfort and failure to retain the plug (Level of Evidence 3). Children seemed to experience less discomfort than adults.

The studies evaluating anal plugs had relatively small sample sizes unsupported by a power analyses and most had non-experimental designs.

Another type of experimental anal plug reported consists of a balloon at the end of a catheter inserted into the rectum and connected to a notification device (428). When faeces enter the rectum, a signal from a photo sensor on the catheter is sent to a pager which then notifies the person to inflate the balloon. Before a voluntary bowel movement, the balloon is deflated and the catheter is withdrawn and can be reinserted. A limitation of this plug is the need to deflate the balloon for 10-15 minutes every few hours to prevent ischemic bowel damage (Level of Evidence 4).

An experimental intra-anal stool bag is composed of a latex bag (20 cm non-extended, to 26 cm extended) that is inserted into the anus and an adhesive attachment applied peri-anally (429). There is a cut-out on the ventral urinary side of the adhesive wafer.

An intra-anal bag successfully collected faecal drainage 50% of the time in five elderly bedridden persons after a suppository was administered (429) (Level of Evidence 3). The internal anal bag has been primarily used when a bowel movement is induced using a suppository.

A rectal catheter system diverts faeces to a collection bag but requires liquid stool consistency and sometimes irrigation to remain patent. Few studies of rectal catheters measure their effectiveness in preventing faecal incontinence or seepage; most focus on preventing or healing skin/wound problems. However, seepage around the catheter does occur (413) (426) (Level of Evidence 3). For example, in a study of 29 paediatric patients, the mean number of daily FI episodes decreased approximately 30-50% (426). In a study of 29 adult patients, varying degrees of leakage around the rectal catheter were reported in 71% of 198 assessments; 35% of these leakages extended to pads on the bed or beyond (413). A rectal catheter system promoted healing of damaged perineal skin and wounds (413) (430) (431) (Level of Evidence 3/4). However, no standardised definitions or criteria for healing of skin damage were reported.

Cost savings based on decreased staff time and laundry costs are possible with the use of rectal catheter systems (424) (432) (Level of Evidence 3).

Non-blinded and non-independent endoscopic observations suggest the catheter does not cause rectal mucosal damage during the recommended length of use (≤ 29 d in the US) (413) (414) (432). There have been case reports of complications of rectal catheters including rectal or lower gastrointestinal bleeding and

need for blood replacement, mucosal pressure necrosis, fistula, autonomic dysreflexia, and unwanted expulsion (433) (434) (435). (Level of Evidence 3).

A tube considerably shorter than a rectal catheter originally designed to provide an airway in the nasopharynx has been used as a rectal tube. Referred to as a rectal trumpet, the tube's flange is inserted into the rectum and a collection bag is connected at its distal end (425). A rectal trumpet can successfully channel faeces to a collection bag and there is some evidence that it can enable damaged perianal skin to recover (425) but its safety has not been determined (Level of Evidence 3).

A possible advantage of the rectal trumpet over a rectal tube is that it is shorter and has less contact with the rectal mucosa, reducing the area of possible damage. Limitations of the smaller rectal tube are similar to those for the rectal catheter regarding risk of expulsion from forceful valsalva movements and dislodgement during repositioning of the patient and linen changes or from tugging on the collection bag (425).

An external perianal pouch (415) (421) is able to collect leaked stool (Level of Evidence 3) but adherence to the skin often fails. Another disadvantage of external perianal pouches is that the adhesive wafers used to adhere them to the skin can cause skin damage upon removal.

Studies of rectal catheters, small tubes, and anal pouches had non-experimental designs. In the prospective studies, sample sizes were relatively small (<50 subjects) and unsupported by a power analysis.

3. NEW EVIDENCE FOR THE CURRENT CONSULTATION

Four new papers inform the current consultation: a vaginal bowel system (436), a Cochrane Review of anal plugs (437), a subsequent single group evaluation of an anal insert (functioning similarly to an anal plug) (438), and a comparison trial of bowel catheter or trumpet with usual care (439), as well as some case reports of complications with rectal / anal devices.

3.1. Vaginal Bowel system

A vaginal bowel-control system offers an alternate approach to preventing faecal incontinence (436) (Fig N-4). It is comprised of a vaginal insert and pressure-regulated pump. The vaginal insert consists of balloon on a silicone-coated stainless steel base that is situated posteriorly in the vagina and ventrally to the rectum. The wearer inflates the balloon insert to one of five preset pressures with the pump which then occludes the distal rectum preventing leakage of faeces.

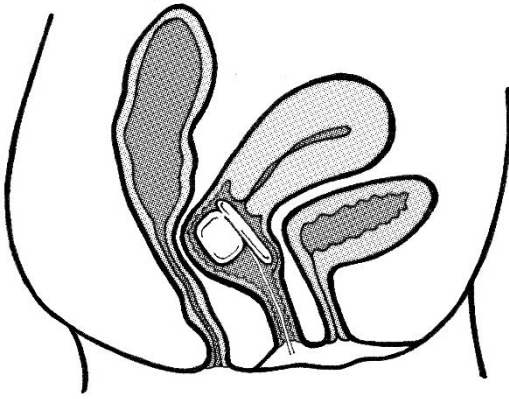

Fig N-4: A vaginal bowel-control system.

The vaginal bowel-control system was evaluated in a month-long study of 61 middle-aged women who had faecal incontinence (but not of watery stools) at least four times in two weeks using a treatment group only design. Results of an intent-to-treat analysis showed that 78.7% of the women could be fitted with the device and had their faecal incontinence reduced by at least 50% (Level of Evidence 3). Using the device significantly improved QOL associated with FI. Nearly all users (96%) reported the device was comfortable or unnoticeable. Seventy-two percent of the original subjects used the vaginal bowel-control system for an additional two months with continued benefit.

There were 18 device-related adverse events (e.g., vaginal abrasions, erythema, irritation, ecchymosis, bruising) experienced by 23% subjects. Adverse symptoms included discomfort of having the device in the vagina, cramping, pelvic pain, and UI, frequency, and urgency occurred in 3-10% of women, which were all more common during the fitting period. Limitations of the vaginal bowel-control device are inability to be fitted with or to tolerate the adverse symptoms associated with the device.

3.2. Cochrane Review of anal plugs

A Cochrane review of the effectiveness of anal plugs in preventing FI published in 2012 (437) reached conclusions similar to those for the last International Consultation (31), namely that evidence suggests that anal plugs could be useful as a treatment or adjuvant treatment of FI in select individuals but that tolerance is difficult.

3.3. Anal insert

After the Cochrane review above, there was one study examining the effectiveness and tolerability of an anal insert (Fig N-5) using a non-randomised, single-group, open-label design (438). The anal insert made of soft silicone and has a thin spindle attached to a top and bottom disk. The inner top disk is available in two diameters and is intended to form a seal at the top of the anal canal. The bottom disk remains outside the anus to avoid displacement into the rec-

tum and ease manual removal. It is single-use, inserted with an applicator, and can be also expelled with a bowel movement.



Fig N-5: An anal insert.
(from www.continenceproductadvisor.org)

Of the 97 adult subjects enrolled, 73 used the anal insert for 12 weeks and 71 (73%) completed the entire protocol. Subjects reported FI on daily stool diaries for a 4-week baseline period, while using the anal insert 12 weeks, then without the insert for 4 additional weeks. Satisfaction with the insert was reported after 12 weeks of use.

Completers were mostly white females. The median daily frequency of FI decreased among completers from 0.9 (mean 1.1 ± 0.9) episodes/d at baseline to 0.2 (mean 0.3 ± 0.4) episodes/d at 12 weeks ($p < 0.001$). After the 4 weeks when the insert was no longer used, the median FI frequency increased to 0.5 episodes/d (mean 0.7 ± 0.7) but this frequency was also significantly lower than baseline FI frequency ($p < 0.0001$). Use of the anal insert resulted in a $\geq 50\%$ reduction in FI frequency in 77% of the 73 completers.

The analysis of reduction in FI frequency was not intent to treat (ITT) and did not use repeated measures or longitudinal methods.

Safety of the anal insert was analysed using ITT. No serious adverse events and three moderate adverse events (faecal urgency, soreness, and bleeding haemorrhoids) in two subjects were reported. Unpleasant symptoms were a sense of faecal urgency (26% of 91 subjects), irritation (13%), pain (7%), and soreness in the anal area (6%). Displacement of the insert into the anal canal occurred in 24% of subjects which resolved with expulsion of the device during bowel movements.

Regarding satisfaction, 78% of the completers said they were very or extremely satisfied with the anal insert. The weekly mean and median experience scores of completers for overall experience, comfort, and ease of insertion were > 8 on a 10-point scale.

3.4. Comparison of bowel catheter and rectal trumpet

There was one study assessing effectiveness of a bowel catheter, rectal trumpet, or usual care. Usual care included an anal pouch in preventing or healing skin damage associated with FI (439). Critically-ill patients (n=59) who were incontinent of liquid faeces were randomly assigned to one of the treatments. Results showed that the usual care group had significantly lower (better) scores for dermatitis-like skin after treatment compared to baseline, and there were no significant differences in the incidence or healing of pressure ulcers among groups. A validated and reliable instrument for assessing incontinence associated skin damage (IASD), (the IASD instrument (440)) was used.

Although there was no significant difference in IASD scores between groups at baseline, authors seem to suggest that their random assignment was ineffective resulting in more patients with lower IASD scores in the groups receiving a rectal catheter or trumpet and that a few patients in these groups finished earlier than those in the usual care group. Other baseline characteristics among the groups were not further analysed for differences and the investigators did not report whether the location of skin damage was nearby the rectal catheter as others have noted (441), or the rectal trumpet or if the groups used the catheter/tubes developed IASD sooner than the usual care group.

3.5. Complications of rectal catheters

As the rectal catheter is used more in practice, there are additional reports of serious adverse events including gastrointestinal haemorrhage, (442), rectal bleeding (443), recto-urethral fistula, and anal ulcer erosion (444), and pressure ulceration and haemorrhage (445).

No recent studies evaluating anal plugs were found.

4. SUMMARY

The use of anal plugs to prevent faecal incontinence has been evaluated primarily by ambulatory, community-living individuals who need little to no assistance in managing FI and toileting. Both adults and children have used plugs.

An anal plug could be useful as a treatment or adjunct treatment of FI in select individuals but tolerability is poor. (Level of Evidence 2)

A vaginal bowel-control system reduced FI and improves quality of life. Some users may experience vaginal irritation or abrasions. (Level of evidence 3)

An anal insert reduced frequency of FI and had been used by patients over 12 weeks. Symptoms of urgency, irritation, pain, as well as displacement into the rectum may reduce tolerability. (Level of Evidence 3)

Rectal catheters successfully divert faeces to a collection bag in acutely and critically-ill patients. They are primarily used to promote healing of perineal wounds but seepage around the catheters may result in perianal skin damage, (Level of Evidence 3/4)

As rectal catheters are used more in practice, adverse events such as haemorrhage, rectal bleeding and fistulae continue to be reported (Level of Evidence 3).

An external perianal pouch can collect stool that would leak from the rectum (Level of Evidence 3).

Use of an external perianal pouch and usual care including following recommended skin care guide-lines results in less incontinence associated skin damage than use of a rectal catheter or short rectal tube in critically-ill patients (Level of Evidence 3).

5. RECOMMENDATIONS

Recommendations relating to products for FI prevention and management are listed in Table N-3.

Table N-3: Recommendations relating to products for FI prevention and management.

- A vaginal bowel-control system can be tried to prevent FI. (Grade of Recommendation C).
- Anal plugs may be tried to decrease FI but many patients are likely to use them on a limited basis or reject them due to discomfort (Grade of Recommendation C).
- An anal insert is another option for reducing FI. Its tolerability to adults seems to be better than the anal plug but it is also associated with unpleasant symptoms and displacement into the rectum may occur. (Grade of Recommendation C)
- The use of a rectal trumpet (i.e. a nasopharyngeal tube inserted into the rectum) in patients with loose / liquid stool consistency offers an alternative to the rectal pouch when pouch adherence is a problem and it may preserve perianal skin integrity or facilitate healing (Grade of Recommendation C). The safety of the rectal trumpet has not been determined, but it suggests a lower risk than a standard, longer rectal tube due to its shorter length (Grade of Recommendation C).
- A bowel catheter can be used for diverting faeces in acutely and critically-ill patients unable to control bowel movements and at risk for skin damage or needing to heal wounds. Close monitoring of faecal seepage and integrity of perianal skin is recommended (Grade of Recommendation C).
- Due to potential diminished gastrointestinal perfusion in critically-ill patients and risks of bleeding,

caution in the use of bowel catheters and appropriate balloon inflation are recommended (Grade of Recommendation C).

- A standard rectal tube with and without an inflatable balloon for faecal diversion is indicated primarily for non-ambulatory patients with liquid stools (Grade of Recommendation C).
- An anal pouch attached to a drainage catheter can be used to contain/divert liquid stool. Because there is a risk of skin damage when removing the wafer adhering the pouch to the skin, it is not recommended in cases where skin is already damaged or the need for faecal diversion is less acute (e.g. where stool is more formed) (Grade of Recommendation C).

6. PRIORITIES FOR RESEARCH

- Additional evaluation of the vaginal bowel-control system, anal plugs, and the anal insert, using experimental designs, larger and adequately powered subject cohorts and valid/reliable objective measures over longer periods of use.
- Development of alternative devices to prevent FI, perhaps utilising wireless technology, intra-rectal plugs or pouches that inflate and deflate as needed, which have fewer safety risks, come in

a variety of sizes for adults and children, and are comfortable, tolerable, and effective.

- Development and evaluation of an external anal pouch that is easy to apply and remove, better adheres to skin and, perhaps, even promotes healing of damaged skin to which it would be applied.
- More rigorous evaluation of rectal catheters and small tubes using experimental designs, larger and adequately powered subject cohorts, and valid/reliable measures

O. SKIN HEALTH

The skin of individuals suffering from incontinence will be regularly exposed to contact with urine and / or faeces. Associated skin damage is the main physical health consequence of urinary and faecal incontinence. Skin irritation within the pad occlusion area is usually termed diaper dermatitis in infants. In adults, the terminology of perineal dermatitis (PD) has commonly been used, but more recently it has been proposed that incontinence-associated dermatitis (IAD) is a better term because affected skin areas are not confined to the perineum (446). In 2007, an international consensus panel defined IAD as skin inflammation manifested as redness with or without blistering, erosion, or loss of skin barrier function that occurs because of chronically or repeated exposure of the skin to urine or faeces (447). (Fig O-1).



Fig O-1: Incontinence-associated dermatitis category 2 (Source: D. Beeckman, 2016)

Incontinence-associated dermatitis (IAD) is a common problem amongst absorbent product users. Prevalence varies between 5.6% and 50.0% and the incidence between 3.4 and 25.0% (446). Incontinence and subsequent skin breakdown have an influence on patients' physical, psychological and social well-being. (448) (449). A wide range of products and procedures for the prevention and treatment of IAD in adults is available (450).

1. EVIDENCE

The findings from the 5th International Consultation (31) relating to incontinence and skin health have been included in the summary section, below.

A considerable amount of work has been done since the last consultation, as reported in the following sections.

1.1. Terminology

The terminology used in international literature to describe perineal skin breakdown caused by incontinence, is diverse (451) and the list below gives the main terms that have been used for incontinence-associated dermatitis (IAD) in adults (452):

- Diaper/napkin / nappy dermatitis.
- Diaper / napkin / nappy rash.
- Irritant dermatitis.
- Skin maceration.
- Moisture lesions.
- Incontinence lesions.
- Perineal dermatitis.
- Perineal rash.

In the USA the term incontinence-associated skin damage (IASD) is used instead of IAD as dermatitis is a medical diagnosis and most observations of this type of damage are not confirmed by a physician or nurse practitioner. Therefore, nurses in the USA are not allowed to chart IAD in the health record.

The WHO International Classification of Diseases (ICD-10) contains coding for diaper dermatitis but does not yet contain separate coding for IAD (446). Efforts are ongoing to add incontinence-associated dermatitis as an index term for irritant contact dermatitis due to incontinence (EQ72.83) in the new ICD-11 coding (available in 2017). Irritant contact dermatitis due to incontinence will be defined as irritant contact dermatitis from prolonged contact with urine or faeces as a result of incontinence. Also, a proposal has been made to change the index term “EP70.21 Primary irritant napkin dermatitis” to: “A type of irritant dermatitis seen in infants and young children localised to the area in contact with a napkin (diaper) and occurring most often as a reaction to prolonged contact with urine, faeces, or retained soap or detergent”. Consistent terminology for IAD will facilitate research and improve education of healthcare providers.

In the Medical Subject Heading Terms database of the US National Library of Medicine (MeSH database), incontinence-related skin problems are classified as ‘diaper rash’. Diaper rash is defined as ‘a type of irritant dermatitis localised to the area in contact with a diaper and occurring most often as a reaction to prolonged contact with urine, faeces, or retained soap or detergent’ (446) (453).

Currently, IAD is considered as part of a broader group of skin conditions, referred to as Moisture-Associated Skin Damage (MASD) (454). Other common forms of MASD are: intertriginous dermatitis, periwound moisture-associated dermatitis and peristomal moisture-associated dermatitis (454). The term IAD is preferred over the more general term MASD, as this

term relates the skin damage to urinary and/or faecal incontinence and not to other moisture sources (e.g. wound exudate) (452) (455).

1.2. Background

a) Pathophysiology

Recent studies and consensus documents present more insights into the pathophysiology of IAD. Previously IAD was considered to be a result of a disrupted skin barrier function and an increase in skin pH due to prolonged or repeated contact with urine and/or faeces (447). Comprehensive reviews of IAD literature until 2015 suggest a more complex aetiology of IAD (446) (451) (452) (456) (457). IAD develops as a consequence of recurrent chemical and physical irritation of the skin, which compromise the skin barrier function and increase the skin permeability. As a result, irritants and micro-organisms (e.g. *Candida albicans*) may more easily penetrate the skin to exacerbate inflammation and increase the risk of skin infection (446) (451) (452) (456) (457) (458).

Factors contributing to skin irritation and inflammation are: skin surface wetness, increased skin surface pH, digestive intestinal enzymes (lipases and proteases), enzymes produced by skin bacteria (urease, an enzyme that catalyses the hydrolysis of urea into carbon dioxide and ammonia), repeated skin cleansing activities, an occlusive perineal environment (e.g. due to diapers) and friction (452) (455) (459) (460). These factors act on various components of the outermost layer of the skin, the stratum corneum, which is responsible for the biomechanical barrier function of the skin (451) (457). The stratum corneum consists of corneocytes, embedded in lipids and joined together by proteins (like a structure of bricks and mortar in a wall) (461) (462).

With incontinence, overhydration of the stratum corneum occurs as water from urine and faeces is pulled into the corneocytes. Overhydration causes swelling of the corneocytes and disruption of the intercellular lipid bilayers. (463) (464) (465) (466). Lipases and proteases, present in faeces, break down the intercellular lipids and proteins (452) (457). As liquid faeces tends to contain more digestive enzymes, it is more damaging to the skin barrier (446). Urease, produced by skin bacteria, transforms urea (from urine) into ammonia, causing an increase in skin surface pH (452) (457). An increased skin surface pH leads to a decreased cohesion of the stratum corneum and a decreased recovery capacity of the skin barrier function (467). Repeated use of water, skin cleansing agents and rubbing with washcloths and towels leads to chemical as well as physical irritation. Friction and shear loads, mainly present in patients with limited ability to move in bed and chairs, diminish the strength of the skin barrier (468). Fig N-2 shows the progression and interrelated aspects from skin wetness to IAD.

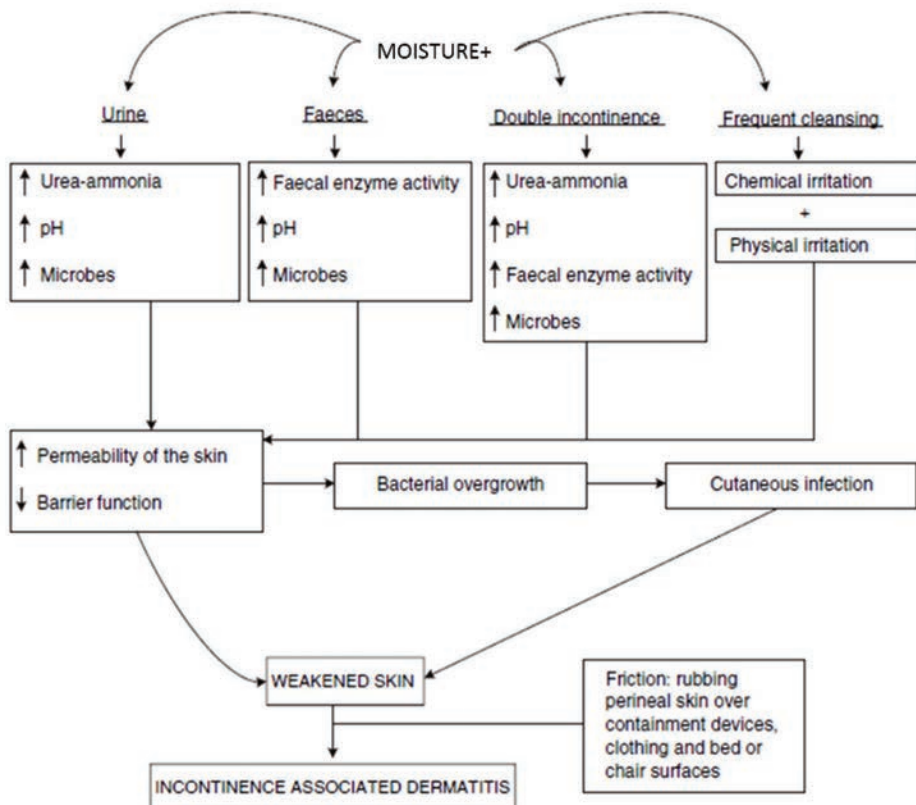

Fig O-2: Aetiology of incontinence-associated dermatitis (459)

b) Risk factors

Knowledge and awareness of risk factors is helpful to tailor IAD prevention and management to patients at risk. IAD prevalence studies highlight the risk factors listed in Table O-1.

This list of risk factors is not exhaustive as many other possible risk factors were not studied (in a large scale risk cohort study). A multivariate analysis of possible risk factors, performed by Kottner et al., could only explain 8% of variance in IAD prevalence (468).

Although an IAD risk assessment tool has been developed (469) and was used in one study (470), its usefulness in clinical practice has not been established. In clinical practice quantifying IAD risk with assessment tools, comparable to pressure ulcer risk assessment tools, is not advised as the predictive value of risk assessment scales varies per setting (as it is dependent on risk factors present and preventive measures taken) (471).

Table O-1: Risk factors for IAD.

- Incontinence: liquid stool is most irritating, followed by double incontinence, faecal incontinence and urinary incontinence (446) (468) (503) (504).
- Alkaline pH of urine, faeces and skin (493).
- Health status (critical illness, multi-morbidity) (502) (505).
- Fever (505).
- Diminished perfusion and oxygenation (505).
- Poor skin condition (e.g. steroid use/diabetes) (468) (502).
- Restricted mobility (468) (502) (506).
- Restricted activity (468) (502).
- Higher score on care dependency (468).
- Poor nutritional status (468) (502).
- Friction and shear (468) (505).
- Restricted cognitive awareness (502) (505).

c) Incontinence and pressure ulcers

A systematic review and meta-analysis identified incontinence and IAD as risk factors for pressure ulcer (also referred to as pressure injury) development (472). A possible explanation for this finding is that prolonged exposure to moisture and irritants contributes to an increase of the coefficient of friction and to changes in tissue stiffness. In addition, inflammation is associated with a local increase in skin temperature. As a consequence, the cutaneous resistance against tissue deformation is further diminished (473).

1.3. Clinical studies on the effectiveness of absorbent, diversion and containment products for preventing and treating incontinence-associated dermatitis in adults

Since the last consultation (31), three randomised controlled trials in adult patients were found. These trials investigated the effectiveness of an improved absorbent pad (474), indwelling faecal diversion systems (439) or faecal containment products (475).

In a cluster randomised controlled trial, Sugama et al. (474) tested the effectiveness of an improved absorbent pad with frontal absorbent material for the treatment of IAD in elderly women with urinary incontinence. The pad was designed to absorb urine in the frontal area to minimise exposure of the buttocks to urine, while preventing the absorbed urine from flowing back to the pad surface. Thirty women wore the improved absorbent pad during the day and the standard hospital pad at night (intervention group). Thirty women wore the standard hospital pad during day and night (control group). Within one week of follow-up, significantly more women from the intervention group (13/30, 43.3%) completely recovered from IAD, compared to the control group (4/30, 13.3%) ($p=0.01$). On the other hand, a similar proportion of women from the intervention group (13/30, 43.3%) and the control group (15/30, 50.0%) showed no change or even a deterioration of IAD. No significant differences in skin wetness ($p=0.823$) or skin pH ($p=0.761$) were found between groups. The fact that the improved absorbent pad was not worn at night could have influenced the results on skin wetness and skin pH (474). According to Kottner and Beeckman (457), skin barrier parameters, like skin wetness and skin pH are not necessarily directly related to clinical outcomes. (Level of Evidence 2)

Pittmann et al. (439) compared the effectiveness of three bowel management methods for prevention and treatment of IAD. A sample of 59 critically ill adults with faecal incontinence were randomly assigned to receiving a rectal catheter, a rectal trumpet or usual care. Care as usual consisted of: cleansing with premoistened wipes containing dimethicone or cleansing followed by application of a zinc oxide based ointment and/or application of an anal pouch. The use of rectal catheters, rectal trumpets and anal

pouches is described in Section N. A significant reduction in IAD severity over time was only identified for usual care ($p < 0.001$). No adverse events occurred using the three bowel management methods. (Level of Evidence 2)

Denat et al. (475) studied the effectiveness of two external devices, used to contain faecal incontinence, for the prevention of IAD. Thirty bedridden patients from neurology and neurosurgery wards were randomly assigned to treatment with anal pouches (see Section N) or diapers. All patients had an indwelling urinary catheter. The perianal region was cleansed once daily and additionally if soiled. Significantly more patients using diapers (15/15, 100%) developed IAD, compared to patients using anal pouches (10/15 (66.7%) ($p=0.04$). In addition, the mean onset of IAD was significantly earlier in patients using diapers than in patients using anal pouches ($p=0.011$) (Level of Evidence 2).

All of these trials were of low to - at most - moderate quality due to small sample sizes with a lack of power (439) (474) (475) short follow-up periods (439) (474) (475) poor or unclear randomisation techniques (474) (475), unblinded outcome assessments (439) (475) and shortcomings in the reporting of statistics (e.g. no frequencies, standard deviations) (439).

1.4. Clinical studies on the effectiveness and cost-effectiveness of topical skin-care products and procedures for preventing and treating incontinence-associated dermatitis in adults

Since the last consultation (31), three new randomised controlled trials were found (476) (477) (478). These trials were identified as part of a Cochrane systematic review investigating the effectiveness of topical skin care products for preventing and treating incontinence-associated dermatitis (IAD) in adults (455).

Two trials tested the effectiveness of topical skin care products in adults (476) (477) and one the different frequencies of a structured skin care procedure (478). One study additionally investigated the cost of daily use of product (476).

a) Studies on the effectiveness of topical skin care products

Brunner et al. (476) compared the use of a cleansing/moisturising product followed by the application of a film forming skin product with the use of a disposable washcloth with cleansing, moisturising and skin protecting properties for the prevention of IAD. Sixty-four critical and acute care patients were randomised to receive one of the two skin care regimens. The number of participants who developed IAD did not differ significantly between the two trial groups: 7/31 participants (22.6%) in the two product group and 9/33 (27.3%) participants in the washcloth group developed IAD (Level of Evidence 2).

Buckley et al. (477) compared the effectiveness of two topical zinc-oxide based products in a structured skin care regime for the treatment of IAD; 142 hospitalised adults and older children were randomly assigned to receive either a 20% zinc oxide based ointment or a 40% zinc oxide based paste. Both skin care products were applied twice daily and after each incontinence episode. At each pad change, the IAD lesion was cleaned with normal saline, a polyhexanide wound cleaner, gauze pads and soft cloths. Significantly more participants from the group treated with the 20% zinc oxide based ointment were completely healed at day six (14/56, 25%) compared to the group treated with 40% zinc oxide based paste (5/65, 7.7%) ($p = 0.009$). Of note is that both products also differed in other active ingredients, such as menthol (20% zinc oxide product) or lanolin, petrolatum and cod liver oil (40% zinc oxide product). As a consequence, it is not clear which amount of zinc oxide is optimal or which ingredients are pivotal for the treatment of IAD. (Level of Evidence 2)

In a sample of 99 patients from a progressive care unit, Conley et al. (478) compared two frequencies of a structured skin care procedure for the prevention and treatment of IAD. The skin care procedure consisted of gently cleansing the skin with a skin cleanser, containing Aloe Vera mixed with water and a cleansing lotion, followed by patting the skin dry. If no erythema was observed, a product with silicone was applied. If erythema was present, a product with zinc oxide and menthol was applied. The skin care procedure was performed every six hours or every 12 hours. There were no significant group differences; 56.4% of the group receiving the skin care procedure every six hours and 60.0% of those receiving the skin care procedure every 12 hours had IAD during the study. (Level of Evidence 2)

b) Studies on the cost of daily use of product

Only one study evaluated cost of products. Brunner et al. (476), described in the paragraph above, noted the cost of daily use of product was significantly higher for the combined use of the skin cleanser and the film forming skin product (\$6.59), compared to the use of the washcloth with cleansing, moisturising and skin protecting properties (\$2.67) ($p = 0.006$) (Level of Evidence 2).

All of the above trials were of low to - at most - moderate quality due to small sample sizes (476) (477) (478), short follow-up periods (476) (477) (478), poor (478) or unclear (476) randomisation techniques, unblinded outcome assessments (476) (477) (478) and shortcomings in the reporting of statistics (e.g. no frequencies, standard deviations) (476) (478).

According to the authors of the Cochrane systematic review, very limited evidence exists on the effectiveness of skin care products for the prevention and treatment of IAD in adults (455). Soap and water performed poorly and the application of leave-on products (moisturisers, skin protectants or a combination) seems to be more effective than withholding these

products. High quality confirmatory trials using standardised and comparable prevention and/or treatment regimens in different settings/regions are required. Furthermore, the authors recommend the development of a core outcome-set, including validated measurement tools to increase the comparability of trial results (455). In accordance with this recommendation, the IAD International Research Group has recently initiated to development of a core outcome set of well-defined IAD-related outcomes, which will include validated tools for outcome measurement (479).

1.5. IAD assessment and severity categorisation

The basic principles for skin assessment in patients with incontinence are presented in Table O-2.

Table O-2 Principles of skin assessment in patients with incontinence.

Who	Everyone with urinary and/or faecal incontinence (452).
Frequency	At least once daily, more frequently in individuals at high risk of IAD (e.g. frequent episodes of incontinence, diarrhoea, multiple risk factors, see Section O-2b) (452).
Areas	Skin areas being exposed to urine and/or faeces: perineum, perigenital areas, buttocks, gluteal folds, thighs, lower back, lower abdomen, skin folds (groins, under large abdominal pannus, ...) (452) (454).
Clinical signs of IAD	Maceration, erythema, presence of lesions (vesicles, bullae, papules, pustules, ...), erosion or denudation, signs of fungal or bacterial skin infection (452).

Various tools have been developed for IAD severity assessment:

- Perineal Dermatitis Grading Scale (24) (480).
- IAD Assessment and Intervention Tool (IADIT) (481).
- Incontinence Associated Skin Damage and its Severity Instrument (IASD.D.2) (482) (440)
- Skin Assessment Tool (483).
- University College London / SCA Hygiene tool (484).

In 2015 Clark-O'Neill et al. (485) concluded that the existing instruments are too time-consuming and linguistically complex for use in routine clinical practice in nursing homes. The authors suggested to use a

simple classification tool, supported by photographs illustrating the severity categories (485).

The Incontinence Associated Skin Damage and its Severity Instrument (IASD.D.2) summarises IAD severity into a single score (range 0-56) using three categories of skin damage and the 14 body areas in which IASD can occur (440) (482). The instrument also shows images of the variation in colour manifestations of the different types of IASD severity to guide its use. However, it is not feasible to show all the different possible manifestations of IAD. The IASD.D.2 tool has been validated for reliability with light and dark skin (482). The tool is available on the University of Minnesota School of Nursing website (http://incontinence.umn.edu/technologies/20150057_incontinence-associated-dermatitis-assessment-tool).

Beeckman et al. (486) have proposed an IAD severity categorisation tool (the Ghent Global IAD Categorization Tool (GLOBIAD)), consisting of four categories (Cat. 1A: persistent erythema without clinical signs of infection, Cat. 1B: persistent erythema with clinical signs of infection, Cat 2A: skin loss without clinical signs of infection, Cat. 2B: skin loss with clinical signs of infection), and supported by some example photographs (Fig O-3). It is comparable to the pressure ulcer classification system developed by the National and the European Pressure Ulcer Advisory Panels (NPUAP and EPUAP) (487) (482). Validation studies (451) have recently been completed, but are not yet published.

Category 1: Persistent redness

1A - Persistent redness without clinical signs of infection



Critical criterion

- Persistent redness

A variety of tones of redness may be present. Patients with darker skin tones, the skin may be paler or darker than normal, or purple in colour.

Additional criteria

- Marked areas or discolouration from a previous (healed) skin defect
- Shiny appearance of the skin
- Macerated skin
- Intact vesicles and bullae
- Skin may feel tense or swollen at palpation
- Burning, tingling, itching or pain may be present

1A

Category 2: Skin loss

2A - Skin loss without clinical signs of infection



Critical criterion

- Skin loss

Skin loss may present as skin erosion, denudation, excoriation, open vesicles, or open bullae. The skin damage pattern may be diffuse.

Additional criteria

- Persistent redness
- A variety of tones of redness may be present. Patients with darker skin tones, the skin may be paler or darker than normal, or purple in colour*
- Marked areas or discolouration from a previous (healed) skin defect
 - Shiny appearance of the skin
 - Macerated skin
 - Intact vesicles and bullae
 - Skin may feel tense or swollen at palpation
 - Burning, tingling, itching or pain may be present

2A

1B - Persistent redness with clinical signs of infection



Critical criteria

- Persistent redness

A variety of tones of redness may be present. Patients with darker skin tones, the skin may be paler or darker than normal, or purple in colour

- Signs of infection

Such as satellite lesions (eg pustules or maculopapular rash) or white scaling of the skin (indicating a fungal infection eg Candida albicans)

Additional criteria

- Marked areas or discolouration from a previous (healed) skin defect
- Shiny appearance of the skin
- Macerated skin
- Intact vesicles and bullae
- The skin may feel tense or swollen at palpation
- Burning, tingling, itching or pain may be present

1B

2B - Skin loss with clinical signs of infection



Critical criteria

- Skin loss

Skin loss may present as skin erosion, denudation, excoriation, open vesicles, or open bullae. The skin damage pattern may be diffuse.

- Signs of infection

Such as satellite lesions (eg pustules or maculopapular rash), white scaling of the surrounding skin or in the wound bed (indicating a fungal infection eg Candida albicans), slough visible in the wound bed (yellow/brown/greyish), green appearance within the wound bed (indicating a bacterial infection eg Pseudomonas aeruginosa), excessive exudate levels, purulent exudate (pus) or a shiny appearance of the wound bed.

Additional criteria

- Persistent redness
- A variety of tones of redness may be present. Patients with darker skin tones, the skin may be paler or darker than normal, or purple in colour*
- Marked areas or discolouration from a previous (healed) skin defect
 - Shiny appearance of the skin
 - Macerated skin
 - Intact vesicles and bullae
 - Skin may feel tense or swollen at palpation
 - Burning, tingling, itching or pain may be present

2B

The purposes of IAD assessment tools (440) (482) and the IAD Severity Categorisation Tool are (452):

- To promote the identification of IAD and enhance its correct identification and classification.
- To standardise record keeping.
- To provide a common description of IAD severity for the purpose of clinical practice, audit and research.

Given the difficulties in using pressure ulcer classification/staging tools (487) (488), however, the usefulness of IAD classification and such tools will need to be evaluated.

1.6. Differentiating IAD from pressure ulcers

Correct identification of IAD and pressure ulcers has significant implications for prevention, treatment and for reporting and benchmarking quality of care (451). Figure O-4 shows a pressure ulcer versus IAD. Table O-3 presents differences between pressure ulcers and IAD based on the 2005 European Pressure Ulcer Advisory Panel (EPUAP) position statement (488).

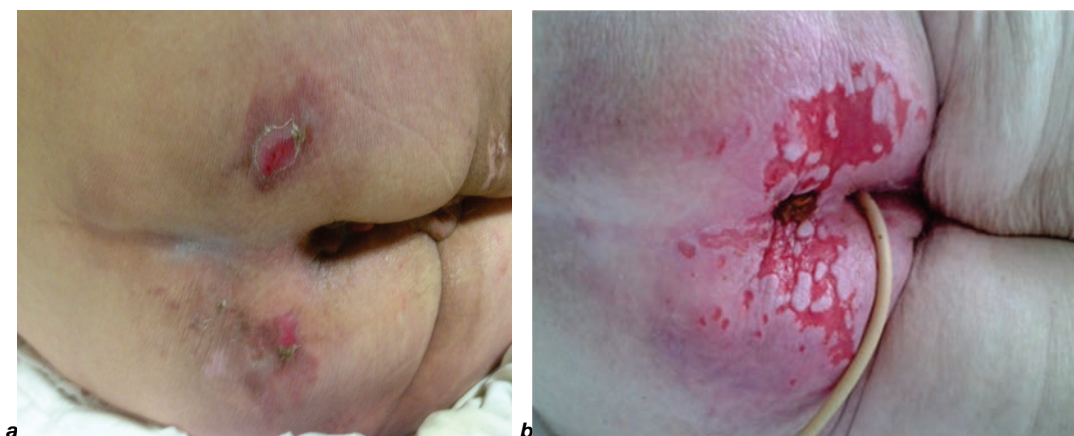

Fig O-4: A pressure ulcer (a) compared with category 2 incontinence-associated dermatitis (b). (Source: D. Beeckman, 2016)

An e-learning training tool (PUCLAS3), aimed at supporting clinical teaching and learning about pressure ulcer classification and incontinence-associated dermatitis differentiation, has been developed and is available online (<http://puclas3.ucvvgent.be/>) (489). The scientific content is based on the EPUAP position statement and provides an overview of causative factors and typical wound-related characteristics (489). Additionally, an interactive web-based 'serious game' about IAD assessment and risk factors using currently available knowledge has been developed an educational aide. The educational game uses older adults in nursing homes as its exemplar and features the IASD.D.2 instrument; it is available online (vitalsims.com/iasd-access).

1.7. Products used to maintain or improve skin health in adults with incontinence

Skin care for incontinent patients includes following strategies (451) (452):

- Management of incontinence: to avoid or minimise contact from the skin with urine and/or faeces.
 - A structured skin care regimen, consisting of three strategies (Table O-4):

- Skin cleansing: to remove irritants (urine, faeces, debris and microorganisms).
- Skin moisturising: to repair or increase the integrity of the skin barrier.
- Skin protecting: to avoid or minimise contact from the skin with urine and/or faeces.
- Interventions for the prevention and treatment of IAD are similar. No specific products have yet been developed to promote skin barrier recovery after maceration (457).

Table O-4: Characteristics of products used for skin cleansing and for skin protection, and principle ingredients of products used for skin moisturising.

Characteristics of products used for skin cleansing.	
Water	<ul style="list-style-type: none"> • Contributes to overhydration of the stratum corneum (462). • Performs poorly in the prevention and treatment of IAD (459). • Plain water raises skin pH (496).
Soap	<ul style="list-style-type: none"> • Standard alkaline soap compromises skin surface pH (452). • Performs poorly in the prevention and treatment of IAD (459).
Washcloths / towels	<ul style="list-style-type: none"> • May cause friction damage due to rubbing or scrubbing, especially when using rough washcloths or towels (492).
Skin cleanser	<ul style="list-style-type: none"> • Available as liquid solutions or lotions, in spray bottles, disposable washcloths or foam (599). • Most should not be diluted (599). • Most are 'no-rinse' and quick drying, eliminating friction caused by using towels (452). • Avoids over-hydration caused by using water.
Characteristics of products used for skin protection (452) (Skin protecting products often contain a mix of various skin protecting ingredients)	
Petrolatum-based	<ul style="list-style-type: none"> • Form an occlusive layer, increasing skin hydration. • May affect fluid uptake of absorbent incontinence products. • Transparent when applied thinly.
Zinc oxide-based	<ul style="list-style-type: none"> • Can be difficult and uncomfortable to remove (e.g. thick, viscous pastes). • Opaque, needs to be removed for skin inspection.
Dimethicone-based	<ul style="list-style-type: none"> • Non-occlusive. • Do not affect absorbency of incontinent products when used sparingly. • Opaque or become transparent after application.
Acrylate terpolymers	<ul style="list-style-type: none"> • Form a transparent film on the skin allowing skin inspection. • Do not require removal. •
Principle ingredients of products used for skin moisturising (452) (Moisturisers often contain a mix of emollients and humectants)	
Emollients (e.g. fat, waxes, oils)	<ul style="list-style-type: none"> • Reduce dryness, soften and smooth the skin • Restore the intercellular lipid matrix
Humectants (e.g. glycerine, urea)	<ul style="list-style-type: none"> • Attract and retain water to promote skin hydration

a) Categorisation of products for the management of incontinence

Management of incontinence is the primary intervention in the prevention and treatment of IAD. Products for the management of incontinence can be divided into absorbent products and products for containment or diversion of urine or faeces and are discussed in Section N.

b) Categorisation of skin care products

Categorisation according to principle ingredient

Skin care products can theoretically be divided into three categories, based on the principle ingredient:

- Products for skin cleansing.
- Products for skin moisturising.
- Products for skin protection.

Table O-4 presents characteristics and recommendations for these three categories.

Categorisation according to product functioning

Skin care products usually contain a wide range of ingredients with different properties. The actual performance of products depends on the overall formulation, rather than on the principle ingredient (451). As a consequence, the function of a skin care product cannot always be clearly divided into moisturising or protecting.

Kottner et al. (457) proposed to categorise skin care products into:

- Skin cleansers: products used for removing irritants (urine, faeces, debris and microorganisms).
- Leave-on products: products with moisturising and/or skin protecting function.

c) Combination products

Skin care products may be combined into one product. For example: skin cleansers or skin protectants may also contain moisturising ingredients and disposable wipes may contain cleansing, moisturising as well as skin protecting ingredients (452).

Combination products may reduce clinician/caregiver time by reducing the number of steps. In addition these products may promote adherence to the skin care regimen (490) (491) (492).

Since the last consultation (31), one new randomised controlled trial investigating combination products was found (476). In this study, Brunner et al. (476) compared the use of a cleansing/moisturising product followed by the application of a film-forming skin product with the use of a disposable washcloth with cleansing, moisturising and skin protecting properties. No difference in effectiveness was found (Level of Evidence 2). However, the costs of daily use of product were significantly higher for the combined use of the skin cleanser and the film forming skin

product (\$6.59), compared to the use of the washcloth with cleansing, moisturising and skin protecting properties (\$2.67) ($p = 0.006$) (Level of Evidence 2).

d) Products used for managing skin infection

Candida albicans is most commonly responsible for secondary skin infections in patients with IAD. However, microbiological samples are recommended to ensure organism specific treatment (452).

Current recommendations are:

- Use antifungal creams or powders in combination with a skin protectant (e.g. acrylate terpolymer) (470).
- Do not use topical antimicrobial products as a routine (may promote antimicrobial resistance) (452).

e) Absorbent products and skin pH

Alkaline skin pH is a risk factor for IAD and standard absorbent products increase skin pH (493) (494). Development of absorbent products whose surface maintains an acidic pH (493) (495) and which acidify skin - even after absorbing alkaline fluid such as urine or faeces - aim to reduce IAD. Skin pH may need to be <6 to achieve benefit (495) but further clinical studies are needed.

2. SUMMARY

- A product that maintains a wet and occluded skin is likely to cause skin irritation and increases skin permeability to other irritants (e.g. from urine and faeces) (496) (497) (Level of Evidence 2).
- Moisture overhydrates skin and potentiates the effects of other irritants (498) (499) (500) (Level of Evidence 2).
- A wet skin is more susceptible to friction and abrasion injury (501) (Level of Evidence 2).
- Incontinence, diarrhoea, critical illness, hyperthermia, decreased activity and mobility, poor nutritional status, alkaline skin pH, poor skin condition, risk of friction and shear and restricted cognitive awareness are associated with a higher prevalence of incontinence-associated dermatitis (IAD) (446) (468) (495) (502) (503) (504) (505) (506) (507) (508) (509) (510) (511) (Level of Evidence 2).
- Faeces are more irritating than urine, but the combination of urine and faeces causes higher levels of irritation than urine and faeces alone (468) (512) (513) (514) (Level of Evidence 2).
- Faecal incontinence is a major risk factor for IAD development (507) (Level of Evidence 2).
- Incontinence and IAD are risk factors for pressure ulcer development (472) (510) (515) (516) (517) (Level of Evidence 2).

- Absorbent pads containing super absorbent polymers are associated with reduced skin moisture (24) (518) (519) (520) (Level of Evidence 2).
- Absorbent pads, which absorb urine in the frontal area and minimise exposure of the buttocks to urine, can promote IAD recovery (474) (Level of Evidence 2).
- Bodyworn absorbent products may raise inter-face pressure in the buttock region (521) (Level of Evidence 3).
- The use of anal pouches can reduce IAD-incidence in bedridden patients with faecal incontinence and is associated with a later onset of IAD (475) (Level of Evidence 2).
- A regular and structured skin care regimen using topical preparations such as moisturisers or barrier products is associated with a lower incidence of IAD (455) (492) (522) (Level of Evidence 2).
- Alkaline skin pH negatively affects the skin barrier. Therefore, soap-based products with an alkaline pH – or absorbent pads that increase skin pH - negatively affect the skin barrier function and promote skin irritation (446) (486) (508) (509) (523) (Level of Evidence 3).
- Skin cleansers may be more cost-effective than soap and water (476) (490) (491) (511) (Level of Evidence 3) and may be better for skin health (522) (Level of Evidence 2).
- Barrier skin products may impede water penetration into the stratum corneum (524) (Level of Evidence 3).
- The use of a combination product for skin care can reduce the daily cost of product use (476) (Level of Evidence 2).
- Avoid the use of topical antimicrobial products as a routine (may promote antimicrobial resistance) (486) (Level of Evidence 4).

3. RECOMMENDATIONS

Recommendations relating to incontinence and skin health in adults are listed in Table O-5.

Table O-5: Recommendations relating to incontinence and skin health. (Source: D. Beeckman, 2016)

- Absorbent pads with super-absorbent polymers (SAP) are preferred to those without (24) (518) (519) (520) (Grade of Recommendation B).
- Absorbent pads should be changed when wet to minimise skin wetness and subsequently skin maceration and increase of the friction coefficient at the skin (451) (452) (457) (473) (Grade of Recommendation B).

- Absorbent pads or diapers - especially for users with faecal or double incontinence - should be changed as soon as possible after an episode of incontinence to prevent the development of dermatitis from proteolytic and lipolytic enzymatic activity (451) (452) (457) (Grade of Recommendation B).
- Skin should be cleansed daily and after each episode of faecal incontinence (451) (452) (457) (Grade of Recommendation C).
- A pH neutral skin cleanser is recommended (slightly acidic, similar to normal skin pH) skin care products, no-rinse cleansers or a premoistened wipe (446) (452) (508) (509) (523) (Grade of Recommendation B).
- Water and soap washing should be avoided. If the use of water could not be avoided, use only the amount of water needed. If soap is needed, choose a soap with a neutral pH (slightly acidic, similar to normal skin pH) (446) (452) (508) (509) (523) (Grade of Recommendation B).
- Skin cleansers with non-ionic surfactants (polyethylene glycol (PEG), acyl-polyglycoside (APG), polysorbats, octoxynols) should be chosen. Avoid skin cleansers with anionic surfactants (sodium laurylsulfate (SLS), sodium laureth sulfate, sodium sulphosuccinate, sodium stearate) (452) (Grade of Recommendation C).
- A gentle technique for washing and drying, with minimal or no friction and no rubbing/scrubbing should be used. Soft washcloths and towels or a disposable nonwoven cloth should be chosen (452) (Grade of Recommendation C).
- A balance should be found between removing irritants by cleansing and preventing irritation due to cleansing (452) (457) (Grade of Recommendation C).
- Application of leave-on skin products (such as moisturisers, skin protectants or a combination) seems to be more effective than withholding these products (455) (Grade of Recommendation B).
- Humectants (e.g. glycerine) should not be used if skin is overhydrated or macerated (452) (Grade of Recommendation C).
- Skin barrier products should be applied regularly, in appropriate quantity, to areas that potentially come in contact with urine and/or faeces (452) (457) (Grade of Recommendation C).
-

General notes to the recommendations:

- Based on the available evidence, it is not possible to recommend any specific skin cleanser, skin

moisturiser or skin protectant over another (455) (459) (600) (601).

- The performance of each product depends on the overall formulation, rather than on the principle ingredient (452) (457).
- All products should be used according to the manufacturer's instructions (452).
- Always check that the product does not contain any ingredient to which the patient is sensitive or allergic (e.g. preservatives, fragrances, perfumes) (452) (602).

4. PRIORITIES FOR RESEARCH

- Adequately powered controlled randomised trials that investigate the effectiveness of skin care products, skin care regimes and absorbent products to prevent or treat incontinence-associated dermatitis (IAD) are recommended.
- Controlled randomised trials should determine appropriate sample sizes using power analyses. Analyses need to be powered to distinguish effects on participants with faecal or double incontinence. Objective measures from instruments, standardised clinical assessments, and patient symptom ratings should be included.
- Laboratory-based studies on healthy volunteers are recommended to help select products and establish potential efficacy of products before undertaking RCTs in clinical settings.
- Further work is needed to examine the relationship between IAD and pressure ulcers, in particular the potential for their formation and / or methods to discriminate between them, including use of biomarkers and technology.
- Histopathological studies are needed to delineate more clearly the pathophysiological differences between the lesions diagnosed as IAD and those diagnosed as pressure ulcers, from a clinical pathological point of view.
- To enhance correct product selection and comparability in practice and research, the use of a standardised language and terminology in the description of skin care products is recommended. Particular attention should be paid to the description of the function of skin care products (e.g. moisturising and/or skin protecting) as well as the appropriateness of skin care products in patients with incontinence.
- There is a need for uniform, relevant and participant-important outcomes. The development of a core set of outcomes may improve the comparability across studies. Recently the IAD International Research Group has launched a project which aims to develop a core outcome set of

well-defined IAD-related outcomes for clinical IAD research. This outcome set will also include validated tools for outcome measurement (479).

- Studies that investigate the effect of lowering skin pH via a variety of strategies (e.g., cleansers, protectants, absorbent products) in preventing and treating IAD are needed.

P. ODOUR CONTROL PRODUCTS

Fear of odour from leaked urine, stool or flatus is a major concern that preoccupies many people suffering from incontinence and is an issue raised in several studies that have explored patients' experiences and opinions (4) (21) (525) (526) (527) (528) (529) (530) (531) (532) (533) (534) (535) (536) (537) (538).

Chapter 16 (Section M) reviews the impact of FI and odour on quality of life. Recent studies (532) (533) (534) continue to show that individuals with UI or FI worry about odour emanating from leaked urine or faeces, as well as from flatus, and the stigma associated with "smelling bad" (533). The fear of odour plays a role in people's affective and behavioural responses to incontinence. Concern about odour can interfere with social relationships, cause people to isolate themselves within the confines of their home or serve as a trigger to seek clinical care (527) (528) (529).

Understandably, some patients with incontinence place a high value on products that mask, control, reduce, or eliminate odour (538). According to one evaluation of different types of continence products for women with light incontinence 'the ability of absorbent products to contain smell' is the second most important factor when choosing a product, after the 'ability to hold urine' (21).

Additionally, caregivers are bothered by odour. Nurses caring for patients with diarrhoea during tube feeding rated odour as one of the most unpleasant aspect of caregiving (539).

The odour associated with urine leakage is mainly due to the production of ammonia from urea by bacterial ureases, whereas factors that contribute to the odour of faeces and flatus include differing states of health and gastrointestinal function, diet composition, relative concentrations of volatile sulphur and hydrogen containing gases and, possibly, short chain fatty acids or ammonia (540) (541) (542). Accordingly, there is a demand for products which will mask odour or, preferably, prevent it.

1. EVIDENCE FROM THE 5TH INTERNATIONAL CONSULTATION (2013)

The evidence on products for incontinence odour reported in the 5th consultation (31) is summarised in Table P-1.

Table P-1: The main findings from the 5th International Consultation (31) relating to incontinence and odour.

- Fabrics that have been treated with anti-microbial agents - washable bedpads, carpets, chairs, clothing and bed linen - may be of benefit in reducing the odour associated with urine (Level of Evidence 4).
- Anti-microbial solutions to prevent odour of urine by destroying the bacteria responsible for the breakdown of urea may be used to wash products such as hand-held urinals or for treating urine spillage onto soft furnishings such as carpets (Level of Evidence 4).
- Applying scent to disposable bodyworn pads does little to reduce the odour associated with urine. (Level of Evidence 3).
- Products that are the most effective in reducing the odour associated with flatus are briefs made of activated charcoal fabric (95-99% absorbency), followed by charcoal activated pads worn inside underwear (55-77% absorbency), usual clothing (22% absorbency), and charcoal infused cushions (20% absorbency) (542). (Level of Evidence 3).
- Probiotic *Lactobacillus plantarum* was effective in reducing flatus by 50% in patients with IBS (543). (Level of Evidence 1).
- Over-the-counter α -galactosidase containing products, may reduce the production of malodorous gas among individuals experiencing stool leakage due to flatus (544) (545). (Level of Evidence 1).
- Ingesting activated charcoal may have little benefit in reduction of flatulence (541) (546). (Level of Evidence 1).

ICI reported that several companies supplied continence products that aimed to reduce the odour associated with UI by treating the fabric in washable bedpads, carpets, chairs, clothing or bed linen with an antimicrobial agent. However, it noted there were no robust published studies that had sought to evaluate products to reduce the odour of urine (Level of Evidence 4). In addition, the consultation cited one multicentre evaluation of different disposable pads for women with light UI (20), which reported applying

scent to disposable bodyworn pads did not perform significantly better than other products in terms of odour (Level of Evidence 3).

Odour control products for FI as described in the report of the last consultation (31) are categorised as either oral ingestible products that aim to reduce the production of malodorous gas, or devices that aim to absorb the odour of gas.

The consultation described one trial that evaluated the extent to which the odour associated with flatus was reduced by the use of different types of continence products that were activated with charcoal (542). The devices included four different types of charcoal-activated pads worn inside conventional underwear; two types of charcoal-activated wearable briefs; and five types of charcoal-activated cushions upon which to sit. Six healthy adults tested each product. The products that were reported as being the most effective were the briefs (95-99% absorbency), followed by the pads (55-77%), usual clothing (22%), and cushions (20%) (Level of Evidence 3). The briefs appear to provide the greatest surface area for contact with malodorous rectal gas (Level of Evidence 3). The limited absorption of malodorous gas by clothing suggests that washing outer clothing as well as underwear is important to reduce odour (Level of Evidence 3).

Oral ingestible products that aim to reduce the production of malodorous gas include probiotics, the enzyme α -galactosidase, and oral charcoal mixtures.

a) Probiotics

In a randomised controlled trial (n=60 patients with irritable bowel disease), administration of *Lactobacillus plantarum* (5 x 10⁷ cfu/ml) was associated with a significant reduction in pain and flatulence (543) (Level of Evidence 1).

b) Enzymes (α -galactosidase)

In a randomised crossover trial (n=19 healthy adults), treatment with 240 GalU alpha-galactosidase was associated with less frequent flatulence events five hours after the test meal, but there was no difference in bloating or pain (544) (Level of Evidence 1).

In a randomised controlled trial, administration of 1200 GalU of α -galactosidase following a test meal of beans was associated with a significant reduction in the production of intestinal gas and the severity of flatulence in 8 healthy adults, but not 300 GalU (545) (Level of Evidence 1).

c) Oral charcoal mixtures

Hall et al. (546) described a study in which 13 healthy adults were randomly administered in a double blind manner to three capsules of either 194mg of activated charcoal or placebo capsules immediately after a 'bean meal' and at 30 minute intervals for two hours after the meal. The researchers reported a significant reduction in the mean number of flatus events for

those given the activated charcoal (Level of Evidence 1).

In a randomised controlled trial (n= 8 adult dogs), the production of hydrogen sulphide was significantly reduced following the administration of activated charcoal, *Yucca schidigera*, and zinc by 71, 38, and 58% respectively, and by 86% by the combination of all three agents (547) (Level of Evidence 4).

In addition, the last consultation reported an in vitro study in which the flatus of 15 healthy adults who had been given 15g lactulose and had eaten a meal supplemented with beans, was treated with activated charcoal and then with zinc acetate (541). The researchers reported that treating the collected flatus with zinc acetate reduced sulphur gas content, but did not totally eliminate odour, while activated charcoal removed virtually all odour (Level of Evidence 4).

In summary, the last consultation noted that ingestion of the probiotic *Lactobacillus plantarum* was effective in reducing flatus by 50% in patients with irritable bowel disease (Level of Evidence 1). Over-the-counter α -galactosidase containing products, may reduce the amount of intestinal gas produced, which may in turn reduce the volume of odour, however it may not decrease its potency or perceived odour (Level of Evidence 1).

2. NEW EVIDENCE FOR THE CURRENT CONSULTATION

No new studies were found for the current consultation about products that aim to prevent, absorb, or control odour associated with UI, FI, or flatus. However, five publications on products for UI odour (60) (548) (549) (550) (551) and one about products for FI odour (552) not included in the previous review were added to the current review.

2.1. Products for urinary incontinence

The five products for UI that were studied included two about fabrics/materials treated with an antimicrobial agent (548) (549), two about penile sheaths (60) (550), and one concerning a reusable undergarment (551). Each is described in further detail below.

2.2. Fabric treated with an antimicrobial agent

Fukui et al (548) described an in vitro experiment comparing pads that were treated with either acrylonitrile copper sulfide or iron phthalocyanine. The authors claimed in vitro experiments showed that acrylonitrile copper sulfide cloth inhibited the growth of most bacteria causing urinary tract infection, and that iron-phthalocyanine cloth effectively eliminated bad-smelling gases. No clinical studies were found on evaluating this product.

In another in vitro study, suspensions of a range of bacterial, viral, fungal and yeast micro-organisms were applied to the products. N-halamine siloxane coatings were found to inactivate most antimicrobials and prevent odour caused by bacterial generation of ammonia on urine soaked fabrics (549). They claimed, HaloSheild, a patented product, developed by Medline Industries Inc. in partnership with Vanson HaloSource, can be applied to healthcare sheets and incontinence underpads but to date, no evaluation studies have been published.

2.3. Penile sheaths

According to the findings of two studies, penile sheaths may confer benefit in terms of reducing the odour associated with UI. In an industry funded RCT, 61 men with stable, moderate to severe UI and no concomitant FI compared Conveen Optima urisheaths' to usual continence pad (60). In random order, the men wore their usual absorbent product or urisheaths, each for a 2-week period. The authors reported that all dimensions of participants' quality of life using the King's Health Questionnaire showed improvement. The men also rated the performance of the urisheaths significantly higher for efficacy, feeling of security, feeling of freedom, self-image, discretion, odour management and skin integrity, but not for ease of use, which was significantly higher with the absorbent product. Another earlier study also lends some support to the positive impact of penile sheaths on reducing the odour associated with UI. Lyder et al. (550) described a cohort study in which nursing staff from a Veteran Affairs Nursing Home were asked to rate the odour before and after one week of sheath use by 8 men with urinary and faecal incontinence who resided in different rooms. The authors reported that incontinence odour was markedly less in the rooms where sheaths were used. Limitations of the study were the unblinded nature of the evaluation and the lack of statistical power.

A broader review of findings on the use of penile sheaths is given in Section G.

2.4. Reusable undergarments

Gallo and Staskin (551) described the performance of reusable undergarments on odour control. They investigated patient satisfaction with a reusable undergarment called 'HealthDri' among 84 men and 42 women aged between 42-70 years of age with UI. Participants were given a minimum of one undergarment and asked to wear it as their primary method of continence containment for up to one month. Participants self-reported their satisfaction with the undergarment in 6 categories: (i) physical comfort, (ii) ability to keep skin dry, (iii) ability to prevent wet spots, (iv) discretion, (v) odour control, and (vi) confidence when wearing it compared to usual containment device). Among other findings, 80% rated the ability to control odour as adequate or excellent. No further studies on this undergarment were found.

2.5. Products for faecal incontinence odour

Community-dwelling people with FI (n=189) were surveyed about their use and evaluation of disposable bodyworn absorbent products for managing FI, including its odour (552). The survey was part of a clinical trial about the effects of dietary fibre on FI. Forty-five percent (86/189) used absorbent products, which included menstrual pads and products marketed for UI, but satisfaction rates concerning their usefulness for FI was generally low. When asked to rate the performance of the absorbent products they usually wore in terms of their effectiveness, odour control, comfort, fit and ability to stay in place, odour control had the lowest percentage of "good" ratings across all products. The authors concluded that odour control is the feature of an absorbent product that appears to need the greatest improvement for use in managing FI.

3. SUMMARY

- Odour control products have a key role to play in helping people with incontinence and caregivers retain their sense of adulthood, identity, independence, and engagement in social life (Level of Evidence 3).
- The clinical effectiveness of treating fabric-based continence products with antimicrobial agents to reduce the odour associated with urine is unclear (Level of Evidence 4).
- Compared with continence pads, penile sheaths may have greater ability to reduce the odour associated with urine leakage (Level of Evidence 2).
- Users of reusable undergarments reported being satisfied with the product's ability to control the odour associated with UI (Level of Evidence 3).
- Users of disposable absorbent products reported being dissatisfied with products' ability to control the odour associated with FI (Level of Evidence 3).
- Oral intake of probiotics (*Lactobacillus plantarum*, (5 x 10⁷ cfu/ml)), enzymes (α -galactosidase), and oral charcoal mixtures, may reduce production of malodorous gas, but the effects of odour are unclear (Level of Evidence 1).
- Products or devices that are activated with charcoal can absorb odour associated with flatus, and charcoal activated wearable briefs are more effective than charcoal activated cushions or pads (Level of Evidence 3).

4. RECOMMENDATIONS

Recommendations relating to products for odour associated with incontinence are listed in Table P-2.

Table P-2: Recommendations relating to incontinence and odour.

- Healthcare professionals must be sensitive to the fear and social consequences of odour (Grade of Recommendation A)
- Men with UI should be informed about different containment options and about the greater ability of penile sheaths to reduce the odour associated with urine leakage over absorbent pads (Grade of Recommendation B)
- Further research is required before recommending the use of fabrics and materials treated with anti-microbial agents to reduce the odour associated with UI (Grade of Recommendation D).
- Patients with UI should be offered the option of trialling a reusable undergarment to evaluate its ability to reduce the odour associated with UI (Grade of Recommendation D).
- Patients with FI should be informed about the limited ability of disposable absorbent products to reduce the odour associated with FI (Grade of Recommendation D).
- Odoriferous rectal gas may be better absorbed with body worn briefs containing activated charcoal rather than with separate pads or cushions (Grade of Recommendation C).
- Since some pads absorb up to 75% of gas, there may be value in offering patients who have smaller amounts of gas the opportunity to compare pads and briefs for themselves. (Grade of Recommendation C).
- Patients with irritable bowel syndrome may benefit from a trial of Probiotic *Lactobacillus plantarum* to reduce associated pain and flatulence (Grade of Recommendation C)
- For those persons experiencing stool leakage due to flatus, over-the-counter α -galactosidase containing products, which reduce the production of malodorous gas can be tried in an attempt to reduce FI frequency (Grade of Recommendation B).
- Washing of outer as well as under clothing after flatus is recommended to reduce odour due to absorption of gas by clothing (Grade of Recommendation C).

5. PRIORITIES FOR RESEARCH

- Development of an absorbent product that can eliminate, reduce or mask the odour of leaked urine and / or faeces while protecting the skin.
- Development of wearable undergarments and textile products (soft furnishings and bedding) for

eliminating, reducing, or masking odour associated with urine, faeces and flatus.

- Investigation of whether probiotics or changes in dietary intake can eliminate or reduce the odour of flatulence or leaked faeces.

analysis relied on expert opinion from clinical practice papers.

The following main search terms were used: incontinence AND device*, toilet* AND facilities, female, male, urinal*, commode*, bedpan*, urin* AND sheath, condom AND catheter*, *, intermittent catheterisation, indwelling catheterisation, catheterisation, catheters, incontinence OR absorbent pad*, urinary AND catheter* (in title), urinary AND leg bag* OR legbag* OR drainage bag, faecal OR fecal AND incontinence AND plug OR pouch OR bag OR device, OR manage* system, incontinence OR perineal AND dermatitis OR in-flammation OR skin damage, incontinence OR perineal OR diaper AND dermatitis OR inflammation OR skin damage OR skin lesion OR erythema OR rash OR erosion.

APPENDIX 1

The literature search to identify material for this chapter - additional to that reviewed for the last (5th) consultation (31) - was conducted as follows. MEDLINE and CINAHL databases were searched from 2008 – 2011 for English language publications. Detailed search strategies were developed for each electronic data-base searched. Consideration was given to variations in terms used and spellings of terms in different countries so that studies were not missed. Relevant abstracts were examined and then pertinent articles were retrieved and reviewed, and the reference lists searched for further studies. For product categories associated with little or no research literature,

APPENDIX 2

Details of Cochrane reviews relating to long-term and short-term catheter use are described in Table Ap2-1.

Table Ap2-1: Cochrane reviews on long term and short term catheterisation.

Date	Authors	Research Q	Comparisons	No. of Trials	Conclusions
Cochrane Reviews on LONG TERM Catheterisation					
2010	Hagen et al (255)	Long term: Are bladder washouts effective in maintaining catheter patency.	No washout vs saline or acidic solution; saline vs acidic solution vs antibiotic solution.	5	Insufficient evidence to state whether blockage, UTI or time to first catheter change is affected by washout.
2012	Niël-Weise et al (398)	Long term: Urinary catheter policies for LT catheter drainage.	IUC vs SPC/IC; prophylaxis vs sx treatment; vs ABP vs microbiology.	1 on IUC.	Possible benefit of ABP in LT IDC but resistance is a serious concern.
2012	Jahn et al (603)	Long term: Types of catheters for long term use.	Antiseptic vs standard catheters; standard vs standard catheter.	3	Evidence insufficient to effect of silver alloy catheter on CAUTI; hydrogel catheter may be better tolerated than silicone catheter.
2013	Jamison et al (396)	Long term: Catheter policies for LT voiding problems in neurogenic bladder.	IC vs IUD; IUD vs SPC Sheaths vs IUC or SPC; IC vs timed voiding.	0	No trials found.
Cochrane Reviews on SHORT TERM Catheterisation					
2006	Phipps et al (604)	ST urinary catheter policies following urogenital surgery.	UC vs no catheter; UC vs SPC; duration; Clamping prior to removal.	36	Recatheterisation higher in non-UC group or UC vs SPC; early removal reduces risk of UTI; clamping may increase risk of UTI and delay normal voiding.
2005	Griffiths and Fernandez (605)	Short term: Policies for urethral catheter removal	Midnight vs other times (morning).	18	Possible benefit from midnight removal -- larger 1 st void/longer

Date	Authors	Research Q	Comparisons	No. of Trials	Conclusions
		(midnight vs morning).			time to 1 st void, shorter stay; no difference in recatheterisation rate.
2013	Lusardi (606)	Short term: Antibiotic prophylaxis in short term catheterisation.	Prophylaxis (vs none).	6	Weak evidence that ASB, pyuria and fever are reduced.
2014	Fisher (607)	Short term: Alpha blocker pre catheter removal in AUR.	Alpha blocker vs placebo or no treatment.	9	Improved voiding with AB vs placebo and reduced incidence of repeated AUR.
2014	Lam et al (608)	Short term: types of catheters.	Silver alloy/oxide; Nitrofurazone; Minocycline + rifampicin all vs standard catheter.	26	Reduction of CAUTI: no difference with silver alloy; weak evidence that nitrofurazone reduced risk of CAUTI/bacteriuria; may cause more discomfort than standard catheters.
2015	Kidd et al (395)	Short term use of SPC vs IUC.	IUC vs SPC; IUC vs IC.	25	SPC vs IUC: ASB, recatheterisation and pain reduced in SPC group; IUC vs IC: inconclusive re: UTI, ASB, pain.

ASB = asymptomatic bacteriuria

SPC = suprapubic catheter

IUC = indwelling urethral catheter

IC = intermittent catheterisation

AUR = acute urinary retention

CAUTI = catheter associated urinary tract infection

REFERENCES

1. Fonda D, Abrams P. Cure sometimes, help always--a "continence paradigm" for all ages and conditions. *Neurourol Urodyn*. 2006;25(3):290-2.
2. Paterson J. Stigma associated with post-prostatectomy urinary incontinence *JWOCN*. 2000;27(3):168-73.
3. Mittness L, Barker J. Stigmatizing a 'normal' condition: urinary incontinence in late life. *Med Anthropol*. 1995;1995(9):2.
4. Paterson J, Dunn S, Kowanko I, Van Loon A, Stein I, Pretty L. Selection of continence products: perspectives of people who have incontinence and their carers. *Disability Rehab*. 2003;25(17):955-63.
5. Hocking C. Function or feelings: factors in abandonment of assistive devices. *Technol Disabil*. 1999;11:3-11.
6. Low J. Negotiating identities, negotiating environments: an interpretation of the experiences of students with disabilities. *Disabil Society*. 1996;11(2):235-48.
7. Shaw C, Tansey R, Jackson C, Hyde C, Allan R. Barriers to help seeking in people with urinary problems. *Family Prac Management JI*. 2001;18(1):48-52.
8. Wagg AS, Newman DK, Leichsenring K, van Houten P. Developing an internationally-applicable service specification for continence care: Systematic review, evidence synthesis and expert consensus. *PLoS One*. 2014;9(8):e104129.
9. Newman D, Buckley B, Gordon, D, Griebing T, Pretty L, Wang K, Gartley C, Norton C. Continence Promotion, Education & Primary Prevention. In: Abrams P, Cardozo L, Khoury S, Wein A, editors. *Incontinence*. 5th Edition. ICUD-EAU 2013. p. 1787-827.
10. Walker GJ, Gunasekera P. Pelvic organ prolapse and incontinence in developing countries: review of prevalence and risk factors. *Intl Urogynae J*. 2011;22(2):127-35.
11. Phillips B, Zhao H. Predictors of assistive technology abandonment. *Assist Technol*. 1993;5(1):36-45.
12. McMillen A, Soderberg S. Disabled persons' experience of dependence on assistive devices. *Scan J Occup Ther*. 2002;9:176-83.
13. Koch T, Kralik D, Eastwood S, Schofield A. Breaking the silence: women living with multiple sclerosis and urinary incontinence. *Int J Nrsng Prac*. 2001;7(1):16-23.
14. Fader M, Cottenden A, Getliffe K, Gage H, Clarke-O'Neill S, Jamieson K, et al. Absorbent products for urinary/faecal incontinence: a comparative evaluation of key product designs. *Health Technology Assessment (Winchester, England)*. 2008;12(29):iii-iv, ix-185.
15. Macaulay M, Broadbridge J, Gage H, Williams P, Birch B, Moore KN, et al. A trial of devices for urinary incontinence after treatment for prostate cancer. *BJU Int*. 2015;116(3):432-42.
16. Fader M, Cottenden A, Brooks R. The CPE network: creating an evidence base for continence product selection. *JWOCN*. 2001;28(2):106-12.
17. Clancy B, Malone-Lee J. Reducing the leakage of body-worn incontinence pads. *J Adv Nurs*. 1991;16(2):187-93.
18. Thornburn P, Fader M, Dean G, Brooks R, Cottenden A. Improving the performance of small incontinence pads: a study of "wet comfort". *JWOCN*. 1997;24(4):219-25.
19. Armitage P, Berry G. *Statistical methods in medical research* 3rd edition ed1994.
20. Clarke-O'Neill S, Pettersson L, Fader M, Cottenden A, Brooks R. A multicenter comparative evaluation: disposable pads for women with light incontinence. *JWOCN*. 2004;31(1):32-42.
21. Getliffe K, Fader M, Cottenden A, Jamieson K, Green N. Absorbent products for incontinence: 'treatment effects' and impact on quality of life. *J Clin Nurs*. 2007;16(10):1936-45.
22. Macaulay M, Clarke OS, Fader M, Pettersson L, Cottenden A. Are washable absorbents effective at containing urinary incontinence? *Nurs Times*. 2004;100(12):58-62.
23. Fader M, Pettersson L, Dean G, Brooks R, Cottenden AM, Malone-Lee J. Sheaths for urinary incontinence: a randomized crossover trial. *BJU Int*. 2001;88(4):367-72.
24. Brown DS. Diapers and underpads, Part 1: Skin integrity outcomes. *Ostomy Wound Manage*. 1994;40(9):20-2, 4-6, 8 passim.
25. Omli R, Skotnes LH, Romild U, Bakke A, Mykletun A, Kuhry E. Pad per day usage, urinary incontinence and urinary tract infections in nursing home residents. *Age Ageing*. 2010;39(5):549-54.
26. Cotterill N, Fowler S, Avery M, Cottenden AM, Wilde M, Long A, et al. Development and psychometric evaluation of the ICIQ-LTCqol: A self-report quality of life questionnaire for long-term indwelling catheter users. *Neurourol Urodyn*. 2015.

27. Macaulay M, Clarke-O'Neill S, Cottenden A, Fader M, Van Den Heuvel E, Jowitt F. Female urinals for women with impaired mobility. *Nurs Times*. 2006;102(42):42.
28. Vickerman J. Selecting urinals for male patients. *Nurs Times*. 2006;102(19):47.
29. Browning J, Zaheer Z, Orzechowska A, Mistri A. Continence aids in the management of urinary incontinence. *Reviews in Clinical Gerontology*. 2012;22(02):85-98.
30. Vickerman J. The benefits of a lending library for female urinals. *Nurs Times*. 2003;99(44):56-7.
31. Abrams P, Cardozo L, Khoury S, Wein A, editors. *Incontinence*. 5th Edition. ICUD-EAU 2013.
32. Fader M, Pettersson L, Dean G, Brooks R, Cottenden A. The selection of female urinals: results of a multicentre evaluation. *Br J Nurs*. 1999;8(14):918-25.
33. Macaulay M, van den Heuvel E, Jowitt F, Clarke-O'Neill S, Kardas P, Blijham N, et al. A noninvasive continence management system: development and evaluation of a novel toileting device for women. *JWOCN*. 2007;34(6):641-8.
34. Farrington N, Fader M, Richardson A. Managing urinary incontinence at the end of life: an examination of the evidence that informs practice. *International Journal of Palliative Nursing*. 2013;19(9):449-56.
35. Pomfret I, Vickerman J, Tonge P. Introducing a hand-held urinal service in secondary care. *Nurs Times*. 2005;101(18):68, 70-1.
36. McIntosh J. A guide to female urinals. *Nurs Times*. 2001;97(6):VII-X.
37. Cournan M. Bladder management in female stroke survivors: translating research into practice. *Rehabil Nurs*. 2012;37(5):220-30.
38. Hunjan R, Twiss K. Urgent interventions: Promoting occupational engagement for clients with urinary incontinence. *OT Practice* 2013;18:8-12.
39. Antcliff P, Turner S. Minimising secondary complications for clients with SCI: a guide for general occupational therapy practitioners. *OT Practice*. 2014;19(7):ce1-ce8.
40. Staats Z. The role of occupational therapy in bowel and bladder management in clients with Spinal Cord injury and disease. *Physical Disabilities Special Interest Section Quarterly: The American Occupational Therapy Association*. 2014;37:1-4.
41. Ballinger C, Pain H, Pascoe J, Gore S. Choosing a commode for the ward environment. *BR J NURS*. 1996;5(8):485-500.
42. Friesen EL, Theodoros D, Russell TG. Use, performance and features of mobile shower commodes: perspectives of adults with Spinal Cord injury and expert clinicians. *Disability and Rehabilitation: Assistive Technology*. 2015;10(1):38-45.
43. Fader M. Access to toilets and toileting. In: Potter J NC, Cottenden A, editor. *Bowel care in older people: research and practice* London: Royal College of Physicians 2002. p. 89-95.
44. *Basic Commodes*. A comparative evaluation. Medical Devices Directorate. 1993.
45. *Mobile, armchair, folding and bed-attached commodes*. A comparative evaluation. Medical Devices Agency. 1994.
46. Ballinger C, Pickering R, Bannister S, Gore S, McLellan D. Evaluating equipment for people with disabilities: user and technical perspectives on basic commodes. *Clinical Rehabilitation*. 1995;9(2):157-66.
47. Naylor JR, Mulley GP. Commodes: inconvenient conveniences. *BMJ*. 1993;307(6914):1258-60.
48. Gillan J. Seat of the motions. *Nurs Times*. 1999;95(34):26.
49. Bucior H, Cochrane J. Lifting the lid: a clinical audit on commode cleaning. *J Infect Prev*. 2010;11(3):73-80.
50. Nelson A, Malassigne P, Amerson T, Saltzstein R, Binard J. Descriptive study of bowel care practices and equipment in Spinal Cord injury. *SCI Nurs*. 1993;10(2):65-7.
51. Malassigne P, Nelson A, Amerson T, Saltzstein R, Binard J. Toward the design of a new bowel care chair for the Spinal Cord injured: a pilot study. *SCI Nurs*. 1993;10(3):84-90.
52. Nelson A, Malassigne P, Murray J. Comparison of seat pressures on three bowel care/shower chairs in Spinal Cord injury. *SCI Nurs*. 1994;11(4):105-7.
53. Malassigne P, Nelson AL, Cors MW, Amerson TL. Design of the advanced commode-shower chair for Spinal Cord-injured individuals. *J Rehabil Res Devel*. 2000;37(3):373.
54. Friesen E, Theodoros D, Russell T. Clinical assessment, design and performance testing of mobile shower commodes for adults with Spinal Cord injury: an exploratory review. *Disability and Rehabilitation: Assistive Technology*. 2013;8(4):267-74.

55. Gattinger H, Werner B, Saxer S. Patient experience with bedpans in acute care: a cross-sectional study. *J Clin Nurs*. 2013;22(15-16):2216-24.
56. Nazarko L. Commode design for frail and disabled people. *Prof Nurse*. 1995;11(2):95-7.
57. Logan K. Toilet privacy in hospital. *Nurs Times*. 2012;108(5):12.
58. Fader M, Barnes E, Malone-Lee J, Cottenden A. Continence. Choosing the right garment. *Nurs Times*. 1987;83(15):78-85.
59. Teunissen TA, Lagro-Janssen AL. Sex differences in the use of absorbent (incontinence) pads in independently living elderly people: do men receive less care? *Int J Clin Practic*. 2009;63(6):869-73.
60. Chartier-Kastler E, Ballanger P, Petit J, Fourmarier M, Bart S, Ragni-Ghazarossian E, et al. Randomized, crossover study evaluating patient preference and the impact on quality of life of urisheaths vs absorbent products in incontinent men. *BJU Int*. 2011;108(2):241-7.
61. Cottenden A, Fader M, Pettersson L, Clinton L, Dean G, Malone-Lee J. Disposable, shaped bodyworn pads with pants for heavy incontinence. Report No.: IN1. London: Medical Devices Agency 1998.
62. Clarke-O'Neill S, Fader M, Pettersson L, Clinton L, Dean G, Malone-Lee J. Disposable pads for light incontinence. Report No.: IN9. London: Medical Devices Agency, 2002.
63. Aumônier S, Collins M. Life cycle assessment of disposable and reusable nappies in the UK: Environment Agency; 2005.
64. Organisation. IS. Urine absorbing aids. Part 1: Whole product testing. ISO 11948-1; . 1996.
65. Fader M, Cottenden AM, Getliffe K. Absorbent products for light urinary incontinence in women. *Cochrane Database Syst Rev*. 2007(2): CD001406.
66. Clarke-O'Neill S, Pettersson L, Fader M, Dean G, Brooks R, Cottenden A. A multicentre comparative evaluation: washable pants with an integral pad for light incontinence. *J Clin Nurs*. 2002;11(1):79-89.
67. Baker J, Norton P. Evaluation of absorbent products for women with mild to moderate urinary incontinence. *Applied Nurs Res : ANR*. 1996;9(1):29-33.
68. Macaulay M, Pettersson L, Fader M, Brooks R, Cottenden A. Absorbent products for lightly incontinent men, Disability Assessment Report No. 05020, Medicines and Healthcare products Regulatory Agency (UK), March 2005.
69. Fader M, Pettersson L, Clinton L, Dean G, Brooks R, Cottenden A. Disposable, shaped bodyworn pads with pants for heavy incontinence: an evaluation, Disability Equipment Assessment Report No. IN.1, Medical Devices Agency (UK), March 1998.
70. Fader M, Pettersson L, Clinton L, Dean G, Brooks R, Cottenden A. All-in-one disposable bodyworn pads for heavy incontinence, Disability Equipment Assessment Report No. IN.4, Medical Devices Agency (UK), October 1999.
71. Beber CR. Freedom for the incontinent. *AJN*. 1980;80(3):482-4.
72. Grant R. Washable pads or disposable diapers? *Geriatric nursing (New York, NY)*. 1982;3(4):248-51.
73. Haeker S. What's best--reusable or disposable incontinence products? *Textile rental*. 1986;69(9):86-91.
74. Dolman M. Continence. The cost of incontinence. *Nurs Times*. 1988;84(31):67-9.
75. Prevalence of hospital-acquired infections in Spain. EPINE Working Group. *J Hosp Infect*. 1992;20(1):1-13.
76. Hu TW, Kaltreider DL, Igou J. The cost-effectiveness of disposable versus reusable diapers. A controlled experiment in a nursing home. *Journal of gerontological nursing*. 1990;16(2):19-24.
77. Harper DW, O'Hara PA, Lareau J, Cass J, Black EK, Stewart A, et al. Reusable versus disposable incontinent briefs: A multiperspective crossover clinical trial. *J Appl Gerontol*. 1995;14(4):391-407.
78. Merrett S, Adams L, Jordan J. Incontinence research provides some answers. *Australian nurses' journal*. 1988;18(2):17-8.
79. Hu TW, Kaltreider DL, Igou J. Incontinence products: which is best? *Geriatric Nurs (New York, NY)*. 1989;10(4):184-6.
80. Brown DS. Diapers and underpads, Part 2: Cost outcomes. *Ostomy Wound Manage*. 1994;40(9):34-6, 8, 40 passim.
81. Hu TW, Kaltreider DL, Igou JF. Disposable versus reusable incontinent products: a controlled cost-effectiveness experiment. *Ostomy Wound Manage*. 1988;21:46-53.
82. Fader MJ, Cottenden AM, Gage HM, Williams P, Getliffe K, Clarke-O'Neill S, et al. Individual budgets for people with incontinence: results from a 'shopping' experiment within the British National Health Service. *Health Expectations*. 2014;17(2):186-96.

83. Cottenden AM, Ledger DJ. Predicting the leakage performance of bodyworn disposable incontinence pads using laboratory tests. *Journal of biomedical engineering*. 1993;15(3):212-20.
84. Cottenden A, Fader M, Pettersson L, Brooks R. How well does ISO 11948-1 (the Rothwell method) for measuring the absorption capacity of incontinence pads in the laboratory correlate with clinical pad performance. *Medical engineering & physics*. 2003;25(7):603-13.
85. Henderson DJ, Rogers WF. Hospital trials of incontinence underpads. *Nurs Times*. 1971;67(5):141-3.
86. Thornburn P, Cottenden A, Ledger D. Continenence. Undercover trials. *Nurs Times*. 1992;88(13):72-8.
87. Bradbury SM. Incontinence pads and clostridium infection. *J Hosp Infect*. 1985;6(1):115.
88. Leigh DA, Petch VJ. Sterility of incontinence pads and sheets. *J Hosp Infect*. 1987;9(1):91-3.
89. Sprott MS, Kearns AM, Keenlyside D. A microbiological study of absorbent pads. *J Hosp Infect*. 1988;12(2):125-9.
90. Stansfield R, Caudle S. *Bacillus cereus* and orthopaedic surgical wound infection associated with incontinence pads manufactured from virgin wood pulp. *J Hosp Infect*. 1997;37(4):336-8.
91. Cottenden A. Aids and appliances for incontinence. In: *The promotion and management of incontinence*, Roe B, editor. Prentice Hall 1992. p. 129-156.
92. Leiby DM, Shanahan N. Clinical study: assessing the performance and skin environments of two reusable underpads. *Ostomy Wound Manage*. 1994;40(8):30-2, 4-7.
93. Cottenden AM, Moore KN, Fader MJ, Cremer AW. Is there a risk of cross-infection from laundered reusable bedpads? *Br J Nurs*. 1999;8(17):1161-3.
94. Lukeman D. Mainly children: childhood enuresis and encopresis. In: Getliffe K, Dolman M, Tindall B, editors. *Promoting continence: A clinical and research resource*. London: Balliere Tindall; 1997. p. 138-176.
95. Macaulay M, Pettersson L, Fader M, Brooks R, Cottenden A. A multicenter evaluation of absorbent products for children with incontinence and disabilities. *JWOCN*. 2004;31(4):235-44.
96. Bliss DZ, Savik K. Use of an absorbent dressing specifically for fecal incontinence. *JWOCN*. 2008;35(2):221-8.
97. Saint S, Kaufman SR, Rogers MA, Baker PD, Ossenkop K, Lipsky BA. Condom versus indwelling urinary catheters: a randomized trial. *J Am Geriatr Soc*. 2006;54(7):1055-61.
98. Nichols T, Balis N. Male external catheter design survey. In: *Proceedings 32nd Annual Wound, Ostomy and Continence Conference*, Toronto, Canada, 2000.
99. Thelwell S, Symon C, Gay S, Dean G, Cottenden A, Feneley RC. Penile sheaths: a comparative evaluation. *UK Medical Devices Agency Report No. A15*. 1995.
100. Sanchez Raya J, Romero Culleres G, Gonzalez Viejo MA, Ramirez Garceran L, Garcia Fernandez L, Conejero Sugranes J. Quality of life evaluation in Spinal Cord injured patients comparing different bladder management techniques. *Actas urologicas espanolas*. 2010;34(6):537-42.
101. Vaidyanathan S, Soni BM, Singh G, Sett P, Brown E, Markey S. Possible use of BioDerm External Continence Device in selected, adult, male Spinal Cord injury patients. *Spinal Cord*. 2005;43(4):260-1.
102. Wong ES. Guideline for prevention of catheter-associated urinary tract infections. *Am J Infect Control*. 1983;11(1):28-36.
103. Pratt RJ, Pellowe CM, Wilson JA, Loveday HP, Harper PJ, Jones SR, et al. epic2: National evidence-based guidelines for preventing healthcare-associated infections in NHS hospitals in England. *J Hosp Infect*. 2007;65 Suppl 1:S1-64.
104. Hooton TM, Bradley SF, Cardenas DD, Colgan R, Geerlings SE, Rice JC, et al. Diagnosis, prevention, and treatment of catheter-associated urinary tract infection in adults: 2009 International Clinical Practice Guidelines from the Infectious Diseases Society of America. *Clin Infect Dis*. 2010;50(5):625-63.
105. Ostaszkiwicz J, Paterson J. Nurses' advice regarding sterile or clean urinary drainage bags for individuals with a long-term indwelling urinary catheter. *JWOCN*. 2012;39(1):77-83.
106. Madigan E, Neff DF. Care of patients with long-term indwelling urinary catheters. *Online J Issues Nurs*. 2003;8(3):7.
107. Dille CA, Kirchhoff KT, Sullivan JJ, Larson E. Increasing the wearing time of vinyl urinary drainage bags by decontamination with bleach. *Arch Phys Med Rehabil*. 1993;74(4):431-7.
108. Rooney M. Impacting health care: study of a reusable urinary drainage system. *SCI nursing*. 1994;11(1):16-8.

109. Wilde MH, Fader M, Ostaszkiwicz J, Prieto J, Moore K. Urinary bag decontamination for long-term use: a systematic review. *JWOCN*. 2013;40(3):299-308.
110. Pomfret I. Penile sheaths: a guide to selection and fitting. *J Com Nurs*. 2006;20(11):14.
111. Pomfret IJ. Catheters: design, selection and management. *Br J Nurs*. 1996;5(4):245-51.
112. Pinar K, Moore KN, Smits E, Murphy K, Schopflocher D. Leg bag comparison: reported skin health, comfort, and satisfaction. *JWOCN*. 2009;36(3):319-26.
113. Wilson M, Coates D. Infection control and urine drainage bag design. *Prof Nurse*. 1996;11(4):245-6, 8-9, 51-2.
114. Fader M, Thelwell S, Symon C, Gay S, Cottenden A, Dean G. Sterile 500ml leg bags for urine drainage: a multi-centre comparative evaluation, Disability Equipment Assessment Report No. A20, Medical Devices Agency (UK), Feb 1996.
115. Fader M, Pettersson L, Clinton L, Dean G, Brooks R, Cottenden A. Non-sterile 500ml - 700ml leg bags for urine drainage: an evaluation. UK Medical Devices Agency Report No. IN2. 1999.
116. Glenister H. The passage of infection. *Nurs Times*. 1987;83:68-73.
117. Wenzler-Rottele S, Dettenkofer M, Schmidt-Eisenlohr E, Gregersen A, Schulte-Monting J, Tvede M. Comparison in a laboratory model between the performance of a urinary closed system bag with double non-return valve and that of a single valve system. *Infection*. 2006;34(4):214-8.
118. Thelwell S, Symon C, Gay S, Cottenden A, Feneley R. Continence. Systems for leg bags. *Nurs Times*. 1995;91(16):62-4.
119. Munnings LJ, Cawood CD. Clinical study of a new urine collection bag. *Urol Nurs*. 2003;23(4):287-91.
120. Lowthian P. The dangers of long-term catheter drainage. *Br J Nurs*. 1998;7(7):366-8, 70, 72 passim.
121. Jones S, Brooks A, Foxley S, Dunkin J. Care of urinary catheters and drainage systems. *Nurs Times*. 2007;103(42):48-50.
122. Schwab WK, Lizdas DE, Gravenstein N, Lampotang S. Foley drainage tubing configuration affects bladder pressure: a bench model study. *Urol Nurs*. 2014;34(1):33-7.
123. Wuthier P, Sublett K, Riehl L. Urinary Catheter Dependent Loops as a Potential Contributing Cause of Bacteriuria: An Observational Study. *Urol Nurs*. 2016;36(1):7-16.
124. Appah Y, Hunter KF, Moore KN. Securement of the Indwelling Urinary Catheter: A Prevalence Study. *JWOCN*. 2016;43(2):173-7.
125. Garcia-Montes F. FlowSecure artificial urinary sphincter for the treatment of stress urinary incontinence after radical prostatectomy. *Archivos espanoles de urologia*. 2009;62(10):845-50.
126. Danek G, Gravenstein N, Lizdas DE, Lampotang S. Prevalence of dependent loops in urinary drainage systems in hospitalized patients. *JWOCN*. 2015;42(3):273-8.
127. Jones K, Sibai J, Battjes R, Fakih MG. How and when nurses collect urine cultures on catheterized patients: A survey of 5 hospitals. *Am J Infect Control*. 2016;44(2):173-6.
128. Thompson RL, Haley CE, Searcy MA, Guenther SM, Kaiser DL, Groschel DH, et al. Catheter-associated bacteriuria. Failure to reduce attack rates using periodic instillations of a disinfectant into urinary drainage systems. *JAMA*. 1984;251(6):747-51.
129. Rogers J, Norkett DI, Bracegirdle P, Dowsett AB, Walker JT, Brooks T, et al. Examination of biofilm formation and risk of infection associated with the use of urinary catheters with leg bags. *J Hosp Infect*. 1996;32(2):105-15.
130. Wilde MH, Brasch J, Getliffe K, Brown KA, McMahon JM, Smith JA, et al. Study on the use of long-term urinary catheters in community-dwelling individuals. *JWOCN*. 2010;37(3):301-10.
131. Keerasuntonpong A, Thearawiboon W, Panthawan A, Judaeng T, Kachintorn K, Jintanotaitavorn D, et al. Incidence of urinary tract infections in patients with short-term indwelling urethral catheters: a comparison between a 3-day urinary drainage bag change and no change regimens. *Am J Infect Control*. 2003;31(1):9-12.
132. Dunn M, Brandt D, Nygaard I. Treatment of exercise incontinence with a urethral insert: a pilot study in women. *Phys Sportsmed*. 2002;30(1):45-8.
133. Lynch WJ, Testa GA, Bell DF. The subjective and objective benefits of a remote-controlled intraurethral device for managing the female acontractile bladder. *BJU Int*. 2003;92(9):960-3.

134. Mazouni C, Karsenty G, Bladou F, Serment G. Urethral device in women with chronic urinary retention: an alternative to self-catheterization? *Eur J Obstet Gynecol Reprod Biol.* 2004;115(1):80-4.
135. Chen TY, Ponsot Y, Carmel M, Bouffard N, Kennelly MJ, Tu LM. Multi-centre study of intraurethral valve-pump catheter in women with a hypocontractile or acontractile bladder. *Euro Urol.* 2005;48(4):628-33.
136. Gorti M, Hudelist G, Simons A. Evaluation of vaginal pessary management: a UK-based survey. *Journal of obstetrics and gynaecology: the journal of the Institute Obstet Gynaecol.* 2009;29(2):129-31.
137. Nygaard I. Prevention of exercise incontinence with mechanical devices. *J Reprod Med.* 1995;40(2):89-94.
138. Realini JP, Walters MD. Vaginal diaphragm rings in the treatment of stress urinary incontinence. *The Journal of the American Board of Family Practice.* 1990;3(2):99-103.
139. Suarez GM, Baum NH, Jacobs J. Use of standard contraceptive diaphragm in management of stress urinary incontinence. *Urol.* 1991;37(2):119-22.
140. Bhatia NN, Bergman A. Pessary test in women with urinary incontinence. *Obs Gynecol.* 1985;65(2):220-6.
141. Richter HE, Burgio KL, Brubaker L, Nygaard IE, Ye W, Weidner A, et al. A Trial of Continence Pessary vs. Behavioral Therapy vs. Combined Therapy for Stress Incontinence. *Obs Gynecol.* 2010;115(3):609.
142. Cameron AP, Wallner LP, Tate DG, Sarma AV, Rodriguez GM, Clemens JQ. Bladder management after Spinal Cord injury in the United States 1972 to 2005. *J Urol.* 2010;184(1):213-7.
143. Thyssen H, Lose G. New disposable vaginal device (continence guard) in the treatment of female stress incontinence. Design, efficacy and short term safety. *Acta Obstet Gynecol Scand.* 1996;75(2):170-3.
144. Thyssen H, Sander P, Lose G. A vaginal device (continence guard) in the management of urge incontinence in women. *Int Urogynecol J.* 1999;10(4):219-22.
145. Morris AR, Moore KH. The Contiform incontinence device - efficacy and patient acceptability. *Int Urogynecol J.* 2003;14(6):412-7.
146. Allen WA, Leek H, Izurieta A, Moore KH. Update: the "Contiform" intravaginal device in four sizes for the treatment of stress incontinence. *Int Urogynecol J.* 2008;19(6):757-61.
147. Glavind K. Use of a vaginal sponge during aerobic exercises in patients with stress urinary incontinence. *Int Urogynecol J.* 1997;8(6):351-3.
148. Farage MA, Aronstein WS, Miller KW, Karram M, Katz M, Hertzman B. A disposable Intravaginal device for the management of stress urinary incontinence. *Open Women's Health Journal.* 2011;5:16-21.
149. Ziv E, Stanton SL, Abarbanel J. Significant improvement in the quality of life in women treated with a novel disposable intravaginal device for stress urinary incontinence. *Int Urogynecol J.* 2009;20(6):651-8.
150. Cornu JN, Mouly S, Amarenco G, Jacquetin B, Ciofu C, Haab F. 75NC007 device for noninvasive stress urinary incontinence management in women: a randomized controlled trial. *Int Urogynecol J.* 2012;23(12):1727-34.
151. Ding J, Chen C, Song XC, Zhang L, Deng M, Zhu L. Changes in Prolapse and Urinary Symptoms After Successful Fitting of a Ring Pessary With Support in Women With Advanced Pelvic Organ Prolapse: A Prospective Study. *Urol.* 2016;87:70-5.
152. Rovner ES, Dmochowski RR, Leach GE, Jayne C, Snyder JA. A randomized, controlled clinical trial of a novel intravesical pressure attenuation device for the treatment of stress urinary incontinence. *J Urol.* 2013;190(6):2243-50.
153. Lone F, Thakar R, Sultan AH. One-year prospective comparison of vaginal pessaries and surgery for pelvic organ prolapse using the validated ICIQ-VS and ICIQ-UI (SF) questionnaires. *Int Urogynecol J.* 2015;26(9):1305-12.
154. Manchana T, Bunyavejchevin S. Impact on quality of life after ring pessary use for pelvic organ prolapse. *Int Urogynecol J.* 2012;23(7):873-7.
155. Schaffer J, Nager CW, Xiang F, Borello-France D, Bradley CS, Wu JM, et al. Predictors of success and satisfaction of nonsurgical therapy for stress urinary incontinence. *Obs Gynecol.* 2012;120(1):91-7.
156. Kenton K, Barber M, Wang L, Hsu Y, Rahn D, Whitcomb E, et al. Pelvic floor symptoms improve similarly after pessary and behavioral treatment for stress incontinence. *Female Pelv Med Reconstr Surg.* 2012;18(2):118-21.
157. Lucas MG, Bosch RJ, Burkhard FC, Cruz F, Madden TB, Nambiar AK, et al. EAU guidelines on assessment and nonsurgical management of urinary incontinence. *Euro Urol.* 2012;62(6):1130-42.

158. Brook G, Tessema AB. Obstetric fistula: the use of urethral plugs for the management of persistent urinary incontinence following successful repair. *Int Urogynecol J*. 2013;24(3):479-84.
159. Richter HE, Burgio KL, Goode PS, Borello-France D, Bradley CS, Brubaker L, et al. Non-surgical management of stress urinary incontinence: ambulatory treatments for leakage associated with stress (ATLAS) trial. *Clinical Trials*. 2007;4(1):92-101.
160. Lipp A, Shaw C, Glavind K. Mechanical devices for urinary incontinence in women. *Cochrane Database Syst Rev*. 2014(12): CD001756.
161. Bugge C, Hagen S, Thakar R. Vaginal pessaries for pelvic organ prolapse and urinary incontinence: a multiprofessional survey of practice. *Int Urogynecol J*. 2013;24(6):1017-24.
162. Moore KN, Schieman S, Ackerman T, Dzus HY, Metcalfe JB, Voaklander DC. Assessing comfort, safety, and patient satisfaction with three commonly used penile compression devices. *Urol*. 2004;63(1):150-4.
163. Barnard J, Westenberg AM. The penile clamp: medieval pain or makeshift gain? *Neurourol Urodyn*. 2015;34(2):115-6.
164. Wagg A, Mian S, Lowe D, Potter J. Report of the National Audit of Continence Care for Older People (65 years and above) in England, Wales and Northern Ireland. Royal College of Physicians, London. 2005.
165. Stensballe J, Looms D, Nielsen PN, Tvede M. Hydrophilic-coated catheters for intermittent catheterisation reduce urethral micro trauma: a prospective, randomised, participant-blinded, crossover study of three different types of catheters. *Euro Urol*. 2005;48(6):978-83.
166. Vapnek JM, Maynard FM, Kim J. A prospective randomized trial of the LoFric hydrophilic coated catheter versus conventional plastic catheter for clean intermittent catheterization. *J Urol*. 2003;169(3):994-8.
167. McNulty C, Freeman E, Smith G, Gunn K, Foy C, Tompkins D, et al. Prevalence of urinary catheterization in UK nursing homes. *J Hosp Infect*. 2003;55(2):119-23.
168. Kunin CM, Chin QF, Chambers S. Morbidity and mortality associated with indwelling urinary catheters in elderly patients in a nursing home—confounding due to the presence of associated diseases. *J Am Geriatr Soc*. 1987;35(11):1001-6.
169. Anger JT, Saigal CS, Pace J, Rodriguez LV, Litwin MS. True prevalence of urinary incontinence among female nursing home residents. *Urol*. 2006;67(2):281-7.
170. Rogers MA, Mody L, Kaufman SR, Fries BE, McMahon LF, Jr., Saint S. Use of urinary collection devices in skilled nursing facilities in five states. *J Am Geriatr Soc*. 2008;56(5):854-61.
171. Wilde MH. Life with an indwelling urinary catheter: the dialectic of stigma and acceptance. *Qual Health Res*. 2003;13(9):1189-204.
172. Wilde MH, Brasch J. A pilot study of self-monitoring urine flow in people with long-term urinary catheters. *Res Nurs Health*. 2008;31(5):490-500.
173. Feneley RC, Kunin CM, Stickler DJ. An indwelling urinary catheter for the 21st century. *BJU Int*. 2012;109(12):1746-9.
174. Barford J, Coates A. The pathogenesis of catheter-associated urinary tract infection. *J Infect Prev*. 2009;10(2):50-6.
175. Silver JR. Case report by RN Mohapatra: urine leakage in persons with Spinal Cord injury and using long-term Foley catheters: a simple solution. *Spinal Cord*. 2011;49(6):764.
176. Lederer JW, Jarvis WR, Thomas L, Ritter J. Multicenter cohort study to assess the impact of a silver-alloy and hydrogel-coated urinary catheter on symptomatic catheter-associated urinary tract infections. *JWOCN*. 2014;41(5):473-80.
177. Pickard R, Lam T, MacLennan G, Starr K, Kilonzo M, McPherson G, et al. Antimicrobial catheters for reduction of symptomatic urinary tract infection in adults requiring short-term catheterisation in hospital: a multicentre randomised controlled trial. *Lancet*. 2012;380(9857):1927-35.
178. Liu XS, Zola JC, McGinnis DE, Squadrito JF, Zeltser IS. Do silver alloy-coated catheters increase risk of urethral strictures after robotic-assisted laparoscopic radical prostatectomy? *Urol*. 2011;78(2):365-7.
179. Srinivasan A, Karchmer T, Richards A, Song X, Perl TM. A prospective trial of a novel, silicone-based, silver-coated foley catheter for the prevention of nosocomial urinary tract infections. *Infect Control Hosp Epidemiol*. 2006;27(1):38-43.
180. Kunin CM. Nosocomial urinary tract infections and the indwelling catheter: what is new and what is true? *Chest*. 2001;120(1):10-2.
181. Li XZ, Nikaido H, Williams KE. Silver-resistant mutants of *Escherichia coli* display active efflux of Ag⁺ and are deficient in porins. *J Bacteriol*. 1997;179(19):6127-32.

182. Wang R, Neoh KG, Kang ET, Tambyah PA, Chiong E. Antifouling coating with controllable and sustained silver release for long-term inhibition of infection and encrustation in urinary catheters. *J Biomed Mater Res B Appl Biomater*. 2015;103(3):519-28.
183. Maki D, Knasinski V, Halvorson K, Tambyah P. A novel silver-hydrogel-impregnated indwelling urinary catheter reduces catheter-related urinary tract infections. A prospective double-blind trial. *Infect Control Hosp Epidemiol*. 1998;19(682):A10.
184. Al-Habdan I, Sadat-Ali M, Corea JR, Al-Othman A, Kamal BA, Shriyan DS. Assessment of nosocomial urinary tract infections in orthopaedic patients: a prospective and comparative study using two different catheters. *Int Surg*. 2003;88(3):152-4.
185. Lee B, Bhuta T, Craig J, Simpson J. Methenamine hippurate for preventing urinary tract infections. *Cochrane Database Syst Rev*. 2004.
186. Stensballe J, Tvede M, Looms D, Lippert FK, Dahl B, Tonnesen E, et al. Infection risk with nitrofurazone-impregnated urinary catheters in trauma patients: a randomized trial. *Ann Intern Med*. 2007;147(5):285-93.
187. Darouiche RO, Smith JA, Jr., Hanna H, Dhabuwala CB, Steiner MS, Babaian RJ, et al. Efficacy of antimicrobial-impregnated bladder catheters in reducing catheter-associated bacteriuria: a prospective, randomized, multicenter clinical trial. *Urol*. 1999;54(6):976-81.
188. Gaonkar TA, Sampath LA, Modak SM. Evaluation of the antimicrobial efficacy of urinary catheters impregnated with antiseptics in an in vitro urinary tract model. *Infect Control Hosp Epidemiol*. 2003;24(7):506-13.
189. Karchmer TB, Giannetta ET, Muto CA, Strain BA, Farr BM. A randomized crossover study of silver-coated urinary catheters in hospitalized patients. *Arch Intern Med*. 2000;160(21):3294-8.
190. Rupp ME, Fitzgerald T, Marion N, Helget V, Puumala S, Anderson JR, et al. Effect of silver-coated urinary catheters: efficacy, cost-effectiveness, and antimicrobial resistance. *Am J Infect Control*. 2004;32(8):445-50.
191. Lai KK, Fontecchio SA. Use of silver-hydrogel urinary catheters on the incidence of catheter-associated urinary tract infections in hospitalized patients. *Am J Infect Control*. 2002;30(4):221-5.
192. Bologna RA, Tu LM, Polansky M, Frimow HD, Gordon DA, Whitmore KE. Hydrogel/silver ion-coated urinary catheter reduces nosocomial urinary tract infection rates in intensive care unit patients: a multicenter study. *Urol*. 1999;54(6):982-7.
193. Evliyaoglu Y, Kobaner M, Celebi H, Yelsel K, Dogan A. The efficacy of a novel antibacterial hydroxyapatite nanoparticle-coated indwelling urinary catheter in preventing biofilm formation and catheter-associated urinary tract infection in rabbits. *Urol Res*. 2011;39(6):443-9.
194. Fisher LE, Hook AL, Ashraf W, Yousef A, Barrett DA, Scurr DJ, et al. Biomaterial modification of urinary catheters with antimicrobials to give long-term broadspectrum antibiofilm activity. *J Controlled Release* 2015;202:57-64.
195. Goncalves I, Abreu AS, Matama T, Ribeiro A, Gomes AC, Silva C, et al. Enzymatic synthesis of poly(catechin)-antibiotic conjugates: an antimicrobial approach for indwelling catheters. *Appl Microbiol Biotechnol*. 2015;99(2):637-51.
196. Kowalczyk D, Ginalska G, Przekora A. The cytotoxicity assessment of the novel latex urinary catheter with prolonged antimicrobial activity. *Journal of biomedical materials research Part A*. 2011;98(2):222-8.
197. Islas L, Alvarez-Lorenzo C, Magarinos B, Concheiro A, del Castillo LF, Burillo G. Singly and binary grafted poly(vinyl chloride) urinary catheters that elute ciprofloxacin and prevent bacteria adhesion. *Int J Pharm*. 2015;488(1-2):20-8.
198. Li X, Li P, Saravanan R, Basu A, Mishra B, Lim SH, et al. Antimicrobial functionalization of silicone surfaces with engineered short peptides having broad spectrum antimicrobial and salt-resistant properties. *Acta biomaterialia*. 2014;10(1):258-66.
199. Diaz Blanco C, Ortner A, Dimitrov R, Navarro A, Mendoza E, Tzanov T. Building an antifouling zwitterionic coating on urinary catheters using an enzymatically triggered bottom-up approach. *ACS applied materials & interfaces*. 2014;6(14):11385-93.
200. Vaterrodt A, Thallinger B, Daumann K, Koch D, Guebitz GM, Ulbricht M. Antifouling and Antibacterial Multifunctional Polyzwitterion/Enzyme Coating on Silicone Catheter Material Prepared by Electrostatic Layer-by-Layer Assembly. *Langmuir*. 2016;32(5):1347-59.

201. GÜNAYDIN M, RIZALAR R, GÜNAYDIN M, YILDIZ L, BILGIN K, TANDER B, et al. Proshield®(Organosilane Quaternary Amine) Coated Silicone Catheters: Do They Have Any Effect on Bacterial Colonisation and Tissue Histopathology? *Turkiye Klinikleri Journal of Medical Sciences*. 2011;31(6):1471-6.
202. Francesko A, Fernandes MM, Ivanova K, Amorim S, Reis RL, Pashkuleva I, et al. Bacteria-responsive multilayer coatings comprising polycationic nanospheres for bacteria biofilm prevention on urinary catheters. *Acta biomaterialia*. 2016;33:203-12.
203. Thallinger B, Brandauer M, Burger P, Sygmund C, Ludwig R, Ivanova K, Kun J, Scaini D, Burnet M, Tzarnov T, Nyanhongo G, S. Gueblitz, G. M. . Cellobiose dehydrogenase functionalized urinary catheter as novel antibiofilm system. *J Biomed Mat Res B: Applied Biomaterials* 2015;00B(00):1-9.
204. Lipovsky A, Thallinger B, Perelshtein I, Ludwig R, Sygmund C, Nyanhongo GS, et al. Ultrasound coating of polydimethylsiloxanes with antimicrobial enzymes. *J Mater Chem B*. 2015;3(35):7014-9.
205. Lim K, Chua RR, Bow H, Tambyah PA, Hadinoto K, Leong SS. Development of a catheter functionalized by a polydopamine peptide coating with antimicrobial and antibiofilm properties. *Acta Biomater*. 2015;15:127-38.
206. Cai T, Gallelli L, Meacci F, Brugnoli A, Prospero L, Roberta S, et al. The Efficacy of Umbelliferone, Arbutin, and N-Acetylcysteine to Prevent Microbial Colonization and Biofilm Development on Urinary Catheter Surface: Results from a Preliminary Study. *Journal of pathogens*. 2016;2016.
207. Nowatzki PJ, Koepsel RR, Stoodley P, Min K, Harper A, Murata H, et al. Salicylic acid-releasing polyurethane acrylate polymers as anti-biofilm urological catheter coatings. *Acta biomaterialia*. 2012;8(5):1869-80.
208. Ivanova K, Fernandes MM, Mendoza E, Tzarnov T. Enzyme multilayer coatings inhibit *Pseudomonas aeruginosa* biofilm formation on urinary catheters. *Appl Microbio Biotech*. 2015;99(10):4373-85.
209. Shenderovich J, Feldman M, Kirmayer D, Al-Quntar A, Steinberg D, Lavy E, et al. Local sustained-release delivery systems of the antibiofilm agent thiazolidinedione-8 for prevention of catheter-associated urinary tract infections. *Int J Pharm*. 2015;485(1-2):164-70.
210. Liao KS, Lehman SM, Tweardy DJ, Donlan RM, Trautner BW. Bacteriophages are synergistic with bacterial interference for the prevention of *Pseudomonas aeruginosa* biofilm formation on urinary catheters. *J of Appl Microbiol*. 2012;113(6):1530-9.
211. Lehman SM, Donlan RM. Bacteriophage-mediated control of a two-species biofilm formed by microorganisms causing catheter-associated urinary tract infections in an in vitro urinary catheter model. *Antimicrob Agents Chemo*. 2015;59(2):1127-37.
212. Nzakizwanayo J, Hanin A, Alves DR, McCutcheon B, Dedi C, Salvage J, et al. Bacteriophage Can Prevent Encrustation and Blockage of Urinary Catheters by *Proteus mirabilis*. *Antimicrob Agents Chemother*. 2015;60(3):1530-6.
213. Voegelé P, Badiola J, Schmidt-Malan SM, Karau MJ, Greenwood-Quaintance KE, Mandrekar JN, et al. Antibiofilm activity of electrical current in a catheter model. *Antimicrob Agents Chemo*. 2016;60(3):1476-80.
214. Cheung K, Leung P, Wong YC, To OK, Yeung YF, Chan MW, et al. Water versus antiseptic periurethral cleansing before catheterization among home care patients: a randomized controlled trial. *Am J Infect Control*. 2008;36(5):375-80.
215. Nasiriani K, Kalani Z, Farnia F, Motavasslian M, Nasiriani F, Engberg S. Comparison of the effect of water vs. povidone-iodine solution for periurethral cleaning in women requiring an indwelling catheter prior to gynecologic surgery. *Urol Nurs*. 2009;29(2):118-21, 31.
216. Cunha M, Santos E, Andrade A, Jesus R, Aguiar C, Marques F, et al. Effectiveness of cleaning or disinfecting the urinary meatus before urinary catheterization: a systematic review. *Revista da Escola de Enfermagem da U S P*. 2013;47(6):1410-6.
217. Burke JP, Garibaldi RA, Britt MR, Jacobson JA, Conti M, Alling DW. Prevention of catheter-associated urinary tract infections. Efficacy of daily meatal care regimens. *Am J Med*. 1981;70(3):655-8.
218. Gray M. What nursing interventions reduce the risk of symptomatic urinary tract infection in the patient with an indwelling catheter? *JWOCN*. 2004;31(1):3-13.
219. Saint S, Lipsky BA. Preventing catheter-related bacteriuria: should we? Can we? How? *Arch Int Med*. 1999;159(8):800-8.
220. Wilde MH, McDonald MV, Brasch J, McMahon JM, Fairbanks E, Shah S, et al. Long-term urinary catheter users self-care practices and problems. *J Clin Nurs*. 2013;22(3-4):356-67.

221. Getliffe KA, Hughes SC, Le Claire M. The dissolution of urinary catheter encrustation. *BJU Int.* 2000;85(1):60-4.
222. Moore KN, Hunter KF, McGinnis R, Bacsu C, Fader M, Gray M, et al. Do catheter washouts extend patency time in long-term indwelling urethral catheters? A randomized controlled trial of acidic washout solution, normal saline washout, or standard care. *JWOCN.* 2009;36(1):82-90.
223. Khan A, Housami F, Melotti R, Timoney A, Stickler D. Strategy to control catheter encrustation with citrated drinks: a randomized crossover study. *J Urol.* 2010;183(4):1390-4.
224. Wilde MH, Crean HF, McMahon JM, McDonald MV, Tang W, Brasch J, et al. Testing a Model of Self-Management of Fluid Intake in Community-Residing Long-term Indwelling Urinary Catheter Users. *Nurs Res.* 2016;65(2):97-106.
225. Wilks S, Katsamenis O, Carugo D, Zhang X, Fader M, Keevil C. The use of X-ray micro computed tomography (M-CT) to understand crystalline biofilm blockage in urinary catheters. *Neurourol Urodyn;* 2016; 35(S4): S328-9.
226. Getliffe K. The use of bladder wash-outs to reduce urinary catheter encrustation. *British J Urol.* 1994;73(6):696-700.
227. Kohler-Ockmore J, Feneley RC. Long-term catheterization of the bladder: prevalence and morbidity. *Br J Urol.* 1996;77(3):347-51.
228. Getliffe K. Managing recurrent urinary catheter blockage: problems, promises, and practicalities. *JWOCN.* 2003;30(3):146-51.
229. Jonsson K, AL ESL, Nasic S, Hedelin H. A prospective registration of catheter life and catheter interventions in patients with long-term indwelling urinary catheters. *Scanda J Urol Nephrol.* 2011;45(6):401-5.
230. Wilde MH, McMahon JM, McDonald MV, Tang W, Wang W, Brasch J, et al. Self-management intervention for long-term indwelling urinary catheter users: randomized clinical trial. *Nurs Res.* 2015;64(1):24-34.
231. Cox AJ, Harries JE, Hukins DW, Kennedy AP, Sutton TM. Calcium phosphate in catheter encrustation. *Br J Urol.* 1987;59(2):159-63.
232. Getliffe KA. The characteristics and management of patients with recurrent blockage of long-term urinary catheters. *J Adv Nurs.* 1994;20(1):140-9.
233. Stickler DJ, Zimakoff J. Complications of urinary tract infections associated with devices used for long-term bladder management. *J Hosp Infect.* 1994;28(3):177-94.
234. Choong SK, Hallson P, Whitfield HN, Fry CH. The physicochemical basis of urinary catheter encrustation. *BJU Int.* 1999;83(7):770-5.
235. Mathur S, Suller MT, Stickler DJ, Feneley RC. Factors affecting crystal precipitation from urine in individuals with long-term urinary catheters colonized with urease-positive bacterial species. *Urol Res.* 2006;34(3):173-7.
236. Suller MT, Anthony VJ, Mathur S, Feneley RC, Greenman J, Stickler DJ. Factors modulating the pH at which calcium and magnesium phosphates precipitate from human urine. *Urol Res.* 2005;33(4):254-60.
237. Kunin CM, Chin QF, Chambers S. Formation of encrustations on indwelling urinary catheters in the elderly: a comparison of different types of catheter materials in "blockers" and "nonblockers". *J Urol.* 1987;138(4):899-902.
238. Holden D, Rao PN. Management of staghorn stones using a combination of lithotripsy, percutaneous nephrolithotomy and Solution R irrigation. *Br J Urol.* 1991;67(1):13-7.
239. Rani SA, Celeri C, Najafi R, Bley K, Debabov D. Irrigation with N,N-dichloro-2,2-dimethyltaurine (NVC-422) in a citrate buffer maintains urinary catheter patency in vitro and prevents encrustation by *Proteus mirabilis*. *Urolithiasis.* 2016;44(3):247-56.
240. Choong SK, Whitfield HN. Urinary encrustation of alloplastic materials. *J Endourol.* 2000;14(1):19-23.
241. Morris NS, Stickler DJ, Winters C. Which indwelling urethral catheters resist encrustation by *Proteus mirabilis* biofilms? *Br J Urol.* 1997;80(1):58-63.
242. Morris NS, Stickler DJ. Encrustation of indwelling urethral catheters by *Proteus mirabilis* biofilms growing in human urine. *J Hosp Infect.* 1998;39(3):227-34.
243. Stickler DJ, Morgan SD. Observations on the development of the crystalline bacterial biofilms that encrust and block Foley catheters. *J Hosp Infect.* 2008;69(4):350-60.
244. Stickler DJ, Feneley RC. The encrustation and blockage of long-term indwelling bladder catheters: a way forward in prevention and control. *Spinal Cord.* 2010;48(11):784-90.
245. Park JH, Cho YW, Kwon IC, Jeong SY, Bae YH. Assessment of PEO/PTMO multiblock copolymer/segmented polyurethane blends as coating materials for urinary catheters: in vitro bacterial adhesion and encrustation behavior. *Biomaterials.* 2002;23(19):3991-4000.

246. Jacobsen SM, Stickler DJ, Mobley HL, Shirliff ME. Complicated catheter-associated urinary tract infections due to *Escherichia coli* and *Proteus mirabilis*. *Clin Microbiol Rev*. 2008;21(1):26-59.
247. Downer A, Morris N, Feast WJ, Stickler D. Polymer surface properties and their effect on the adhesion of *Proteus mirabilis*. *Proceedings of the Institution of Mechanical Engineers Part H, Journal of engineering in medicine*. 2003;217(4):279-89.
248. Chakravarti A, Gangodawila S, Long MJ, Morris NS, Blacklock AR, Stickler DJ. An electrified catheter to resist encrustation by *Proteus mirabilis* biofilm. *J Urol*. 2005;174(3):1129-32.
249. Jordan RP, Malic S, Waters MGJ, Stickler DJ, Williams DW. Development of an antimicrobial urinary catheter to inhibit urinary catheter encrustation. *Microbiology Discovery*. 2015;3(1).
250. Burns JR, Gauthier JF. Prevention of urinary catheter encrustations by acetohydroxamic acid. *J Urol*. 1984;132(3):455-6.
251. Gleeson MJ, Cunnane G, Grainger R. Spontaneous perforation of an augmented bladder. *Br J Urol*. 1991;68(6):655.
252. Jones GL, Muller CT, O'Reilly M, Stickler DJ. Effect of triclosan on the development of bacterial biofilms by urinary tract pathogens on urinary catheters. *J Antimicrob Chemo*. 2006;57(2):266-72.
253. Williams GJ, Stickler DJ. Some observations on the diffusion of antimicrobial agents through the retention balloons of foley catheters. *J Urol*. 2007;178(2):697-701.
254. Stickler DJ, Jones GL. Reduced Susceptibility of *Proteus mirabilis* to triclosan. *Antimicrob Agents Chemother*. 2008;52(3):991-4.
255. Hagen S, Sinclair L, Cross S. Washout policies in long-term indwelling urinary catheterisation in adults. *Cochrane Database Syst Rev*. 2010(3): CD004012.
256. Norberg B, Norberg A, Parkhede U. The spontaneous variation of catheter life in long-stay geriatric inpatients with indwelling catheters. *Gerontology*. 1983;29(5):332-5.
257. Elliot S, Striker LJ, Doi T, Linehan WM, Striker GE. Hepatoma G2 conditioned medium facilitates early outgrowth of endothelial cells from isolated glomeruli. *Kidney Int*. 1989;35(5):1245-8.
258. Getliffe K. Care of urinary catheters. *Nursing standard* 1996;11(11):47-50; quiz 3-4.
259. Hesse A, Nolde A, Klump B, Marklein G, Tuschetzki GJ. In vitro investigations into the formation and dissolution of infection-induced catheter encrustations. *Br J Urol*. 1992;70(4):429-34.
260. Jacobs D, Heimbach D, Hesse A. Chemolysis of struvite stones by acidification of artificial urine--an in vitro study. *Scand J Urol Nephrol*. 2001;35(5):345-9.
261. Kennedy AP, Brocklehurst JC, Robinson JM, Faragher EB. Assessment of the use of bladder washouts/instillations in patients with long-term indwelling catheters. *Br J Urol*. 1992;70(6):610-5.
262. Stickler DJ, Morgan SD. Modulation of crystalline *Proteus mirabilis* biofilm development on urinary catheters. *J Med Microbiol*. 2006;55(Pt 5):489-94.
263. Bibby JM, Cox A, Hukins D. Feasibility of preventing encrustation of urinary catheters. *Cells and Materials*. 1995;5(2):183-95.
264. Donnellan SM, Bolton DM. The impact of contemporary bladder management techniques on struvite calculi associated with Spinal Cord injury. *BJU Int*. 1999;84(3):280-5.
265. Chen Y, DeVivo MJ, Lloyd LK. Bladder stone incidence in persons with Spinal Cord injury: determinants and trends, 1973-1996. *Urol*. 2001;58(5):665-70.
266. Mitsui T, Minami K, Furuno T, Morita H, Koyanagi T. Is suprapubic cystostomy an optimal urinary management in high quadriplegics?. A comparative study of suprapubic cystostomy and clean intermittent catheterization. *Euro Urol*. 2000;38(4):434-8.
267. Ord J, Lunn D, Reynard J. Bladder management and risk of bladder stone formation in Spinal Cord injured patients. *J Urol*. 2003;170(5):1734-7.
268. Nomura S, Ishido T, Teranishi J, Makiyama K. Long-term analysis of suprapubic cystostomy drainage in patients with neurogenic bladder. *Urologica Int*. 2000;65(4):185-9.
269. Perz S, Ellimoottil C, Rao M, Bresler L. A unique complication of urethral catheterization: pubic hair associated with struvite bladder calculi. *Urol Nurs*. 2013;33(5):233-5.
270. Kawu AA, Olawepo A, Salami O, Kuranga SA, Shamsi H, Jeje EA. Bladder stones in catheterized Spinal Cord-injured patients in Nigeria. *Nigerian journal of clinical practice*. 2012;15(2):156-8.
271. Saint S, Lipsky BA, Baker PD, McDonald LL, Ossenkop K. Urinary catheters: what type do men and their nurses prefer? *J Am Geriatr Soc*. 1999;47(12):1453-7.

272. Wilson M. Causes and management of indwelling urinary catheter-related pain. *Br J Nurs*. 2008;17(4):232-9.
273. Sweeney A, Harrington A, Button D. Suprapubic catheters--a shared understanding, from the other side looking in. *JWOCN*. 2007;34(4):418-24.
274. Wilde MH. Understanding urinary catheter problems from the patient's point of view. *Home healthcare nurse*. 2002;20(7):449-55.
275. Agarwal A, Dhiraaj S, Singhal V, Kapoor R, Tandon M. Comparison of efficacy of oxybutynin and tolterodine for prevention of catheter related bladder discomfort: a prospective, randomized, placebo-controlled, double-blind study. *Br J Anaesthes*. 2006;96(3):377-80.
276. Mitchell N. Long term urinary catheter problems: a flow chart to aid management. *Br J Community Nurs*. 2008;13(1):6, 8, 10-2.
277. Nicolle LE. Catheter associated urinary tract infections. *Antimicrob Resist Inf Control*. 2014;3:23.
278. Mulhall AB, Chapman RG, Crow RA. Bacteriuria during indwelling urethral catheterization. *J Hosp Inf*. 1988;11(3):253-62.
279. Stamm WE. Catheter-associated urinary tract infections: epidemiology, pathogenesis, and prevention. *Amer J Med*. 1991;91(3b):65s-71s.
280. Nicolle LE. The chronic indwelling catheter and urinary infection in long-term-care facility residents. *Infect Control Hosp Epidemiol*. 2001;22(5):316-21.
281. Gould CV, Umscheid CA, Agarwal RK, Kuntz G, Pegues DA. Guideline for prevention of catheter-associated urinary tract infections 2009. *Infect Control Hosp Epidemiol*. 2010;31(4):319-26.
282. Maki DG, Tambyah PA. Engineering out the risk for infection with urinary catheters. *Emerging Infect Dis*. 2001;7(2):342-7.
283. Utsumi M, Yamada M, Nishi I, Nabetani Y, Asari S, Tomono K, et al. Adjustment for antibiotic exposure level in catheter-associated urinary tract infections. *J Hosp Infect*. 2008;69(2):192-4.
284. Saint S, Veenstra DL, Lipsky BA. The clinical and economic consequences of nosocomial central venous catheter-related infection: are antimicrobial catheters useful? *Infect Control Hosp Epidemiol*. 2000;21(6):375-80.
285. Nickel JC, Grant SK, Costerton JW. Catheter-associated bacteriuria. An experimental study. *Urol*. 1985;26(4):369-75.
286. Firestein M, Mendelson G, Gronich D, Granot E, Ben-Israel J, Raz R. Can Antibiotic Use During Routine Replacement of Long-Term Urinary Catheter Prevent Bacteriuria? *Infect Dis Clin Practice*. 2001;10(3):133-5.
287. Stickler DJ. Susceptibility of antibiotic-resistant Gram-negative bacteria to biocides: a perspective from the study of catheter biofilms. *J Appl Microbiol*. 2002;92 Suppl:163s-70s.
288. Prasad A, Cevallos ME, Riosa S, Darouiche RO, Trautner BW. A bacterial interference strategy for prevention of UTI in persons practicing intermittent catheterization. *Spinal Cord*. 2009;47(7):565-9.
289. Jepson RG, Williams G, Craig JC. Cranberries for preventing urinary tract infections. *Cochrane Database Syst Rev*. 2012;10:CD001321.
290. Nicolle LE. Resistant pathogens in urinary tract infections. *J Am Geriatr Soc*. 2002;50(7 Suppl):S230-5.
291. Raz R, Schiller D, Nicolle LE. Chronic indwelling catheter replacement before antimicrobial therapy for symptomatic urinary tract infection. *J Urol*. 2000;164(4):1254-8.
292. Shah PS, Cannon JP, Sullivan CL, Nemchausky B, Pachucki CT. Controlling antimicrobial use and decreasing microbiological laboratory tests for urinary tract infections in spinal-cord-injury patients with chronic indwelling catheters. *Am J health Syst Pharm*. 2005;62(1):74-7.
293. Sabbuba NA, Mahenthalingam E, Stickler DJ. Molecular epidemiology of *Proteus mirabilis* infections of the catheterized urinary tract. *J Clin Microbiol*. 2003;41(11):4961-5.
294. Tsuchida T, Makimoto K, Ohsako S, Fujino M, Kaneda M, Miyazaki T, et al. Relationship between catheter care and catheter-associated urinary tract infection at Japanese general hospitals: a prospective observational study. *Int J Nurs Stud*. 2008;45(3):352-61.
295. Tsan L, Davis C, Langberg R, Hojlo C, Pierce J, Miller M, et al. Prevalence of nursing home-associated infections in the Department of Veterans Affairs nursing home care units. *Am J Infect Control*. 2008;36(3):173-9.
296. Branagan GW, Moran BJ. Published evidence favors the use of suprapubic catheters in pelvic colorectal surgery. *Dis Colon Rectum*. 2002;45(8):1104-8.
297. Fox CL, Jr., Modak SM. Mechanism of silver sulfadiazine action on burn wound infections. *Antimicrob Agents Chemother*. 1974;5(6):582-8.

298. Brosnahan J, Jull A, Tracy C. Types of urethral catheters for management of short-term voiding problems in hospitalised adults. *Cochrane Database Syst Rev.* 2004(1): CD004013.
299. Yang SH, Lee YSJ, Lin FH, Yang JM, Chen Ks. Chitosan/poly (vinyl alcohol) blending hydrogel coating improves the surface characteristics of segmented polyurethane urethral catheters. *J Biomed Mater Res B Appl Biomater.* 2007;83(2):304-13.
300. Tenke P, Riedl CR, Jones GL, Williams GJ, Stickler D, Nagy E. Bacterial biofilm formation on urologic devices and heparin coating as preventive strategy. *Int J Antimicrob Agents.* 2004;23 Suppl 1:S67-74.
301. Trautner BW, Darouiche RO. Role of biofilm in catheter-associated urinary tract infection. *Am J Infect Control.* 2004;32(3):177-83.
302. Stonehill WH, Dmochowski RR, Patterson AL, Cox CE. Risk factors for bladder tumors in Spinal Cord injury patients. *J Urol.* 1996;155(4):1248-50.
303. West DA, Cummings JM, Longo WE, Virgo KS, Johnson FE, Parra RO. Role of chronic catheterization in the development of bladder cancer in patients with Spinal Cord injury. *Urol.* 1999;53(2):292-7.
304. Groah SL, Weitzenkamp DA, Lammertse DP, Whiteneck GG, Lezotte DC, Hamman RF. Excess risk of bladder cancer in Spinal Cord injury: evidence for an association between indwelling catheter use and bladder cancer. *Arch Phys Med Rehabil.* 2002;83(3):346-51.
305. Kalisvaart JF, Katsumi HK, Ronningen LD, Hovey RM. Bladder cancer in Spinal Cord injury patients. *Spinal Cord.* 2010;48(3):257-61.
306. Massaro PA, Moore J, Rahmeh T, Morse MJ. Squamous cell carcinoma of the suprapubic tract: A rare presentation in patients with chronic indwelling urinary catheters. *Can J Urol* 2014;8(7-8):E510-4.
307. Schaafsma RJ, Delaere KP, Theunissen PH. Squamous cell carcinoma of suprapubic cystostomy tract without bladder involvement. *Spinal Cord.* 1999;37(5):373-4.
308. Berge B, Heicappell R, Steiner U, Miller K. Urothelial carcinoma in a suprapubic cystostomy tract 27 years after tube removal. *J Urol.* 1999;162(3 Pt 1):797-8.
309. Blake PA, Kim CO, Lopez AE, Krongrad A. Verucous carcinoma of a suprapubic cystostomy track. *J Urol.* 1996;156(1):174.
310. Hamid R, Bycroft J, Arya M, Shah PJ. Screening cystoscopy and biopsy in patients with neuropathic bladder and chronic suprapubic indwelling catheters: is it valid? *J Urol.* 2003;170(2 Pt 1):425-7.
311. Tenke P, Kovacs B, Bjerklund Johansen TE, Matsumoto T, Tambyah PA, Naber KG. European and Asian guidelines on management and prevention of catheter-associated urinary tract infections. *Int J Antimicrob Agents.* 2008;31 Suppl 1:S68-78.
312. Dellimore KH, Helyer AR, Franklin SE. A scoping review of important urinary catheter induced complications. *J Mater Sci Mater Med.* 2013;24(8):1825-35.
313. Hollingsworth JM, Rogers MA, Krein SL, Hickner A, Kuhn L, Cheng A, et al. Determining the noninfectious complications of indwelling urethral catheters: a systematic review and meta-analysis. *Ann Intern Med.* 2013;159(6):401-10.
314. Aaronson DS, Wu AK, Blaschko SD, McAninch JW, Garcia M. National incidence and impact of noninfectious urethral catheter related complications on the Surgical Care Improvement Project. *J Urol.* 2011;185(5):1756-60.
315. Leuck AM, Wright D, Ellingson L, Kraemer L, Kuskowski MA, Johnson JR. Complications of Foley catheters--is infection the greatest risk? *J Urol.* 2012;187(5):1662-6.
316. Crawford RL, Liston T, Bong AS, Cunnane MJ. Obstructed kidney and sepsis secondary to urethral catheter misplacement into the distal ureter. *BMJ case reports.* 2015;2015.
317. Hale N, Baugh D, Womack G. Mid-ureteral rupture: a rare complication of urethral catheterization. *Urol.* 2012;80(5):e65-6.
318. Modi PK, Salmasi AH, Perlmutter MA. Inadvertent foley catheterization of the ureter. *Can J Urol.* 2014;21(3):7326-9.
319. Jambet S, Facy O, Landreau P, Duperron C, Kretz B. Intraperitoneal rupture of the bladder after urinary catheterization. *Clinics and practice.* 2011;1(4):e109.
320. Ogawa S, Date T, Muraki O. Intraperitoneal urinary bladder perforation observed in a patient with an indwelling urethral catheter. *Case reports in Urol.* 2013;2013:765704.
321. Lin YC, Lin YC. Intraperitoneal urinary bladder fistula caused by a Foley catheter: a successfully conservative management. *BMJ case reports.* 2012;2012.
322. Jindal T, Kamal MR, Mandal SN, Karmakar D. Catheter-induced urethral erosion. *Urol Nurs.* 2012;32(2):100-1.

323. Anderson PJ, Walsh JM, Louey MA, Meade C, Fairbrother G. Comparing first and subsequent suprapubic catheter change: complications and costs. *Urol Nurs*. 2002;22(5):324-5, 8-30.
324. Iacovou J. Suprapubic catheterization of the urinary bladder. *Hospital Update*. 1994;20:159-62.
325. Vaidyanathan S, Hughes PL, Oo T, Soni BM. Long catheter sign: a reliable bedside sign of incorrect positioning of foley catheter in male Spinal Cord injury patients. *Cases journal*. 2008;1(1):43.
326. Moon HJ, Chun MH, Lee SJ, Kim BR. The usefulness of bladder reconditioning before indwelling urethral catheter removal from stroke patients. *Am J Phys Med Rehabil*. 2012;91(8):681-8.
327. Wang LH, Tsai MF, Han CS, Huang YC, Liu HE. Is Bladder Training by Clamping Before Removal Necessary for Short-Term Indwelling Urinary Catheter Inpatient? A Systematic Review and Meta-analysis. *Asian Nurs Res*. 2016;10(3):173-81.
328. Gibney L. Offering patients a choice of urinary catheter drainage system. *Br J Nurs*. 2010;19(15):954-8.
329. Woods M, McCreanor J, Aitchison M. An assessment of urethral catheter valves. *Prof Nurse*. 1999;14(7):472-4.
330. Rowley P, German K, Kumar U, Stone D, Stone V, Blackford H. A randomized cross-over study comparing the catheter valve with the leg bag in male patients with urethral catheters. *Proceedings International Continence Society Annual conference, Sydney, 1995*.
331. German K, Rowley P, Stone D, Kumar U, Blackford HN. A randomized cross-over study comparing the use of a catheter valve and a leg-bag in urethral catheterized male patients. *Br J Urol*. 1997;79(1):96-8.
332. Lewington C, Morgan M, Noone P, Kairsary AV. The value of catheter valve use in long-term bladder drainage. *Proceedings British Association Urological Surgeons Conference*. 1989.
333. Fader M, Pettersson L, Brooks R, Dean G, Wells M, Cottenden A, et al. A multicentre comparative evaluation of catheter valves. *Br J Nurs*. 1997;6(7):359, 62-4, 66-7.
334. Lee SM, Short TD, Unsworth A. Design and development of a novel automatic valve system for long-term catheterized urinary incontinence patients. *Proc Inst Mech Eng H*. 2007;221(6):665-76.
335. Willson M, Wilde M, Webb ML, Thompson D, Parker D, Harwood J, et al. Nursing interventions to reduce the risk of catheter-associated urinary tract infection: part 2: staff education, monitoring, and care techniques. *JWOCN*. 2009;36(2):137-54.
336. Guidelines for preventing infections associated with the insertion and maintenance of short-term indwelling urethral catheters in acute care. *J Hosp Infect*. 47:S39-S46.
337. Muctar S. The importance of a lubricant in transurethral interventions. *Urologie (B)*. 1991;31:153-5.
338. Ogden V. Anaesthetic gel insertion during male catheterisation. *J Com Nurs*. 2003;17(1):4-8.
339. Chung C, Chu M, Paoloni R, O'Brien MJ, Demmel T. Comparison of lignocaine and water-based lubricating gels for female urethral catheterization: a randomized controlled trial. *Emerg Med Australas*. 2007;19(4):315-9.
340. Tanabe P, Steinmann R, Anderson J, Johnson D, Metcalf S, Ring-Hurn E. Factors affecting pain scores during female urethral catheterization. *Acad Emerg Med*; 2004;11(6):699-702.
341. Mularoni PP, Cohen LL, DeGuzman M, Mennuti-Washburn J, Greenwald M, Simon HK. A randomized clinical trial of lidocaine gel for reducing infant distress during urethral catheterization. *Pediatr Emerg Care*. 2009;25(7):439-43.
342. *Infection Control: prevention of healthcare associated infection in primary and community care*. London: National Institute for Clinical Excellence 2003: 47.
343. *British National Formulary*. London: British Medical Association and Royal Pharmaceutical Society of Great Britain, 2007. Report No 54.
344. Ebo DG, Bridts CH, Stevens WJ. Anaphylaxis to an urethral lubricant: chlorhexidine as the "hidden" allergen. *Acta clinica Belgica*. 2004;59(6):358-60.
345. Gray ML. Securing the indwelling catheter. *AJN*. 2008;108(12):44-50; quiz
346. Darouiche RO, Goetz L, Kaldis T, Cerra-Stewart C, AlSharif A, Priebe M. Impact of StatLock securing device on symptomatic catheter-related urinary tract infection: a prospective, randomized, multicenter clinical trial. *Am J Infect Control*. 2006;34(9):555-60.
347. Siegel TJ. Do registered nurses perceive the anchoring of indwelling urinary catheters as a necessary aspect of nursing care? A pilot study. *JWOCN*. 2006;33(2):140-4.

348. Wilde MH, Zhang F. Best Practices in Managing the Indwelling Urinary Catheter for the Homecare Patient. *Perspectives*. 2013;10(1):1.
349. Grove GL, Zerweck CR, Ekholm BP, Smith GE, Koski NI. Randomized comparison of a silicone tape and a paper tape for gentleness in healthy children. *JWOCN*. 2014;41(1):40-8.
350. Sarginson JH, O'Neill J, Palmer J. A novel technique for securing the catheter post hypospadias surgery. *J Plast Reconstr Aesthet Surg*. 2012;65(1):139.
351. Fisher J. The importance of effective catheter securement. *Br J Nurs*. 2010;19(18):S14-8.
352. Wilde MH, Garvin S. A concept analysis of self-monitoring. *J Adv Nurs*. 2007;57(3):339-50.
353. Flemming A, Day J, Glanfield L. Registered nurse management of urinary catheters in a rehabilitation and long-term care hospital. *Int J Nurs Practic*. 2001;6:237-46.
354. Mody L, Saint S, Galecki A, Chen S, Krein SL. Knowledge of evidence-based urinary catheter care practice recommendations among healthcare workers in nursing homes. *J Am Geriatr Soc*. 2010;58(8):1532-7.
355. Drekonja DM, Kuskowski MA, Johnson JR. Internet survey of Foley catheter practices and knowledge among Minnesota nurses. *Am J Infect Control*. 2010;38(1):31-7.
356. Kneil C, Pellow H, Potter J. Long-term urethral catheter audit in patients' own homes. *J Infect Prev*. 2009;10(2):62-5.
357. Bhardwaj R, Pickard R, Rees J. Documented adherence to standards and guidelines. *Br J Nurs*. 2010;19(17):1101.
358. Murphy C, Prieto J, Fader M. "It's easier to stick a tube in": a qualitative study to understand clinicians' individual decisions to place urinary catheters in acute medical care. *BMJ quality & safety*. 2015;24(7):444-50.
359. Singson K, Murphy S, Merrill KC. Nurses' Knowledge and Compliance to Catheter Associated Urinary Tract Infection Prevention Bundle: A Baseline Survey. *Am J Infect Control*. 2011;39(5):E170.
360. Theofanidis D, Fountouki A. Bladder catheterization in Greek nursing education: An audit of the skills taught. *Nurse Educ Today*. 2011;31(2):157-62.
361. Brillhart B. Studying the quality of life and life satisfaction among persons with Spinal Cord injury undergoing urinary management. *Rehabil Nurs*. 2004;29(4):122-6.
362. Baillie L. The impact of urological conditions on patients' dignity. *Int J Urol Nurs*. 2007;1(1):27-35.
363. Wilde MH, Cameron BL. Meanings and practical knowledge of people with long-term urinary catheters. *JWOCN*. 2003;30(1):33-40; discussion -3.
364. Jakobsson L, Hallberg IR, Loven L. Experiences of micturition problems, indwelling catheter treatment and sexual life consequences in men with prostate cancer. *J Adv Nurs*. 2000;31(1):59-67.
365. Anderson KD, Borisoff JF, Johnson RD, Stiens SA, Elliott SL. Spinal Cord injury influences psychogenic as well as physical components of female sexual ability. *Spinal Cord*. 2007;45(5):349-59.
366. Seymour W. Coping with embarrassment: bodily continence. In *Remaking the body: rehabilitation and change*. Routledge (London), 1998, p 154-176.
367. Adejumo P, Ilesanmi R. Acute urinary retention and indwelling Urethral Catheters: A qualitative study of men with obstructive prostate enlargement. *West Afr J Nurs*. 2008;19(1).
368. Khoubehi B, Watkin NA, Mee AD, Ogden CW. Morbidity and the impact on daily activities associated with catheter drainage after acute urinary retention. *BJU Int*. 2000;85(9):1033-6.
369. Pateman B, Johnson M. Men's lived experiences following transurethral prostatectomy for benign prostatic hypertrophy. *J Adv Nurs*. 2000;31(1):51-8.
370. Chapple A, Prinjha S, Salisbury H. How users of indwelling urinary catheters talk about sex and sexuality: a qualitative study. *Br J Gen Pract*. 2014;64(623):e364-71.
371. Fowler S, Godfrey H, Fader M, Timoney AG, Long A. Living with a long-term, indwelling urinary catheter: catheter users' experience. *JWOCN*. 2014;41(6):597-603.
372. The Consortium of Multiple Sclerosis Centers [Available from: www.msca.org]
373. James R, Frasure HE, Mahajan ST. Urinary catheterization may not adversely impact quality of life in multiple sclerosis patients. *ISRN neUrol*. 2014;2014:167030.
374. Yavuzer G, Gok H, Tuncer S, Soygur T, Arikan N, Arasil T. Compliance with bladder management in Spinal Cord injury patients. *Spinal Cord*. 2000;38(12):762-5.
375. Wilde MH, Dougherty MC. Awareness of urine flow in people with long-term urinary catheters. *JWOCN*. 2006;33(2):164-74.

376. Wilde MH, Getliffe K, Brasch J, McMahon J, Anson E, Tu X. A new urinary catheter-related quality of life instrument for adults. *Neurourol Urodyn*. 2010;29(7):1282-5.
377. Heaney F. Nurse decision to insert a urinary catheter in a female patient in orthopaedic speciality: The development of a protocol to guide care. *Int J Orthop Trauma Nurs*. 2011;15(4):212-9.
378. Infection prevention and control - Quality statement 4: urinary catheters. London: National Institute for Clinical Excellence 2014.
379. Grabe M, Bartoletti R, Bjerklund Johansen TE. EAU guidelines on urological infections: *Euro Urol*; 2015 [
380. CMS Manual System Department of Health & Human Services (DHHS) Pub. 100-07 2005. In: (CMS) SOPCCfMMS, editor. Baltimore, USA: CMS; 2005.
381. Fung CH, Spencer B, Eslami M, Crandall C. Quality indicators for the screening and care of urinary incontinence in vulnerable elders. *J Am Geriatr Soc*. 2007;55 Suppl 2:S443-9.
382. Greer SF, Sethi AK, Hecker MT, McKinney BL, Dumford DM, 3rd, Donskey CJ. Survey of patients' knowledge and opinions regarding the use of indwelling urinary catheters. *Infect Control Hosp Epidemiol*. 2011;32(2):174-6.
383. Kilonzo M, Vale L, Pickard R, Lam T, N'Dow J. Cost effectiveness of antimicrobial catheters for adults requiring short-term catheterisation in hospital. *Euro Urol*. 2014;66(4):615-8.
384. Johnson TM, Ouslander JG, Uman GC, Schnelle JF. Urinary incontinence treatment preferences in long-term care. *J Am Geriatr Soc*. 2001;49(6):710.
385. Pfisterer MH, Johnson TM, 2nd, Jenetzky E, Hauer K, Oster P. Geriatric patients' preferences for treatment of urinary incontinence: a study of hospitalized, cognitively competent adults aged 80 and older. *J Am Geriatr Soc*. 2007;55(12):2016-22.
386. Altman DG, Schulz KF, Moher D, Egger M, Davidoff F, Elbourne D, et al. The revised CONSORT statement for reporting randomized trials: explanation and elaboration. *Ann Intern Med*. 2001;134(8):663-94.
387. Trautner BW. Management of catheter-associated urinary tract infection. *Curr Opin Infect Dis*. 2010;23(1):76-82.
388. Moore KN, Fader M, Getliffe K. Long-term bladder management by intermittent catheterisation in adults and children. *Cochrane Database Syst Rev*. 2007(4): CD006008.
389. Niël-Weise BS, van den Broek PJ. Urinary catheter policies for long-term bladder drainage. *Cochrane Database Syst Rev*. 2005; 25;(1).
390. Chartier-Kastler E, Amarenco G, Lindbo L, Soljanik I, Andersen HL, Bagi P, et al. A prospective, randomized, crossover, multicenter study comparing quality of life using compact versus standard catheters for intermittent self-catheterization. *J Urol*. 2013;190(3):942-7.
391. Costa J, Menier M, Doran T, Köhler T. Catheter length preference in wheelchair-using men who perform routine clean intermittent catheterization. *Spinal Cord*. 2013;51(10):772-5.
392. Denys P, Previnaire J, Aegerter P, de Sèze M, Karsenty G, Amarenco G. Intermittent self-catheterization habits and opinion on aseptic VaPro catheter in French neurogenic bladder population. *Spinal Cord*. 2012;50(11):853-8.
393. Leek H, Stephenson Z, Reus A, Karantanis E, Moore KH. Clean intermittent self-catheterisation: a randomised controlled crossover trial of single-use versus multiple re-use of non-coated catheters; is cystitis rate altered? *Neurourol urodyn*; Abstract; 2013:
394. Intermittent catheterisation for long-term bladder management [Internet]. Wiley. 2014. Available from: <http://search.ebscohost.com/login.aspx?direct=true&db=cmedm&AN=25208303&site=ehost-live>.
395. Kidd EA, Stewart F, Kassis NC, Hom E, Omar MI. Urethral (indwelling or intermittent) or suprapubic routes for short-term catheterisation in hospitalised adults. *Cochrane Database Syst Rev*. 2015(12): CD004203.
396. Jamison J, Maguire S, McCann J. Catheter policies for management of long term voiding problems in adults with neurogenic bladder disorders. *Cochrane Database Syst Rev*. 2013(11): CD004375.
397. Jackson MJ, Veeratterapillay R, Harding CK, Dorkin TJ. Intermittent self-dilatation for urethral stricture disease in males. *Cochrane Database Syst Rev*. 2014(12): CD010258.
398. Niel-Weise BS, van den Broek PJ, da Silva EM, Silva LA. Urinary catheter policies for long-term bladder drainage. *Cochrane Database Syst Rev*. 2012(8): CD004201.
399. Bermingham SL, Hodgkinson S, Wright S, Hayter E, Spinks J, Pellowe C. Intermittent self catheterisation with hydrophilic, gel reservoir, and non-coated catheters: a systematic review and cost effectiveness analysis. *BMJ*. 2013 Jan 8;346.

400. Li L, Ye W, Ruan H, Yang B, Zhang S. Impact of hydrophilic catheters on urinary tract infections in people with Spinal Cord injury: systematic review and meta-analysis of randomized controlled trials. *Arch Phys Med Rehabil.* 2013;94(4):782-7.
401. Zhang W, Liu A, Hu D, Xue D, Li C, Zhang K, et al. Indwelling versus Intermittent Urinary Catheterization following Total Joint Arthroplasty: A Systematic Review and Meta-Analysis. *PLoS One.* 2015;10(7):e0130636.
402. Wilks S, Morris N, Delgado D, Prieto J, Moore K, Macaulay M, et al., Development of an effective and acceptable cleaning method to allow safe re-use of plain, uncoated catheters for intermittent catheterisation. *Neurourol Urodyn;* 2016; 35(S4): S449-51.
403. Macaulay M, Morris N, Wilks S, Delgado D, Prieto J, Fader M, editors. A novel, evidence-based method for reprocessing catheters used for intermittent catheterisation. *Neurourol Urodyn;* 2016; 35(S4): S463-5.
404. Clark J, Mealing S, Scott D, Vogel L, Krassioukov A, Spinelli M, et al. A cost-effectiveness analysis of long-term intermittent catheterisation with hydrophilic and uncoated catheters. *Spinal Cord.* 2015.
405. Zegers B, Uiterwaal C, Kimpen J, van Gool J, de Jong T, Winkler-Seinstra P, et al. Antibiotic prophylaxis for urinary tract infections in children with spina bifida on intermittent catheterization. *J Urol.* 2011;186(6):2365-71.
406. Woodward S, Rew M. Patients' quality of life and clean intermittent self-catheterization. *Br J Nurs.* 2003;12(18):1066-74.
407. Yilmaz B, Akkoc Y, Alaca R, Erhan B, Gunduz B, Yildiz N, et al. Intermittent catheterization in patients with traumatic Spinal Cord injury: obstacles, worries, level of satisfaction. *Spinal Cord.* 2014;52(11):826-30.
408. Shaw C, Logan K. Psychological coping with intermittent self-catheterisation (ISC) in people with spinal injury: a qualitative study. *Int J Nurs Stud.* 2013;50(10):1341-50.
409. Kelly L, Spencer S, Barrett G. Using intermittent self-catheters: experiences of people with neurological damage to their spinal cord. *Disabil Rehabil.* 2014;36(3):220-6.
410. Wilde MH, Fairbanks E, Parshall R, Zhang F, Miner S, Thayer D, et al. A Web-Based Self-Management Intervention for Intermittent Catheter Users. *Urol Nurs.* 2015;35(3):127-33, 38.
411. Wilde MH, Fairbanks E, Parshall R, Zhang F, Miner S, Thayer D, et al. Development of a Web-Based Self-management Intervention for Intermittent Urinary Catheter Users With Spinal Cord Injury. *Computers, informatics, nursing.* 2015;33(11):478-86.
412. Wilde MH, McMahon JM, Fairbanks E, Brasch J, Parshall R, Zhang F, et al. Feasibility of a Web-Based Self-management Intervention for Intermittent Urinary Catheter Users With Spinal Cord Injury. *JWOCN.* 2016;43(5):529-38.
413. Padmanabhan A, Stern M, Wishin J, Mangino M, Richey K, DeSane M. Clinical evaluation of a flexible fecal incontinence management system. *Am J Crit Care.* 2007;16(4):384-93.
414. Kim J, Shim MC, Choi BY, Ahn SH, Jang SH, Shin HJ. Clinical application of continent anal plug in bedridden patients with intractable diarrhea. *Dis Colon Rectum.* 2001;44(8):1162-7.
415. Ross V. The fecal containment device: one answer to a dreaded procedure. *Ostomy Wound Manage.* 1993;39(7):42-4, 6.
416. Kowal-Vem A, Poulakidas S, Barnett B, Conway D, Culver D, Ferrari M, et al. Fecal containment in bedridden patients: economic impact of 2 commercial bowel catheter systems. *Am J Crit Care.* 2009;18(3 Suppl):S2-14: quiz S5.
417. Mortensen N, Humphreys MS. The anal continence plug: a disposable device for patients with anorectal incontinence. *Lancet.* 1991;338(8762):295-7.
418. Norton C, Kamm MA. Anal plug for faecal incontinence. *Colorectal Dis.* 2001;3(5):323-7.
419. Beitz JM. Fecal incontinence in acutely and critically ill patients: options in management. *Ostomy Wound Manage.* 2006;52(12):56-8, 60, 2-6.
420. Powers J, Bliss DZ. Product options for faecal incontinence management in acute care. *World Council of Enterostomal Therapists Journal.* 2012;32(1):20-3.
421. Freedman P. The rectal pouch: a safer alternative to rectal tubes. *AJN.* 1991;91(5):105-6.
422. Bosley C. Three methods of stool management for patients with diarrhea. *Ostomy Wound Manage.* 1994;40(1):52-4, 6-7.
423. Rainville N. Does a Foley belong in the rectum? *AJN.* 1987;87(2):175.
424. Hanlon M, Cofone E. Patient with frequent liquid stools resulting in a chemical dermatitis and a perianal ulcer. *JWOCN.* 1996;23(3):174-7.

425. Grogan TA, Kramer DJ. The rectal trumpet: use of a nasopharyngeal airway to contain fecal incontinence in critically ill patients. *JWOCN*. 2002;29(4):193-201.
426. Blair GK, Djonlic K, Fraser GC, Arnold WD, Murphy JJ, Irwin B. The bowel management tube: an effective means for controlling fecal incontinence. *J Ped Surg*. 1992;27(10):1269-72.
427. Van Winckel M, Van Biervliet S, Van Laecke E, Hoebeke P. Is an anal plug useful in the treatment of fecal incontinence in children with spina bifida or anal atresia? *J Urol*. 2006;176(1):342-4.
428. Giamundo P, Welber A, Weiss EG, Vernava AM, 3rd, Nogueras JJ, Wexner SD. The procon incontinence device: a new nonsurgical approach to preventing episodes of fecal incontinence. *Am J Gastroenterol*. 2002;97(9):2328-32.
429. Fujii M, Sato T, Ohru T, Sato T, Sasaki H. Interanal stool bag for the bedridden elderly with pressure ulcer. *Geriatrics & Gerontology International*. 2004;4(2):120-2.
430. Benoit RA, Jr., Watts C. The effect of a pressure ulcer prevention program and the bowel management system in reducing pressure ulcer prevalence in an ICU setting. *JWOCN*. 2007;34(2):163-75; quiz 76-7.
431. Echols J, Friedman BC, Mullins RF, Hassan Z, Shaver JR, Brandigi C, et al. Clinical utility and economic impact of introducing a bowel management system. *JWOCN*. 2007;34(6):664-70.
432. Keshava A, Renwick A, Stewart P, Pilley A. A nonsurgical means of fecal diversion: the Zassi Bowel Management System. *Dis Colon Rectum*. 2007;50(7):1017-22.
433. Page BP, Boyce SA, Deans C, Camilleri-Brennan J. Significant rectal bleeding as a complication of a fecal collecting device: report of a case. *Dis Colon Rectum*. 2008;51(9):1427-9.
434. Bright E, Fishwick G, Berry D, Thomas M. Indwelling bowel management system as a cause of life-threatening rectal bleeding. Case reports in gastroenterology. 2008;2(3):351-5.
435. Safaz I, Kesikburun S, Omac OK, Tugcu I, Alaca R. Autonomic dysreflexia as a complication of a fecal management system in a man with tetraplegia. *J Spinal Cord Med*. 2010;33(3):266-7.
436. Richter HE, Matthews CA, Muir T, Takase-Sanchez MM, Hale DS, Van Drie D, et al. A vaginal bowel-control system for the treatment of fecal incontinence. *Obstet Gynecol*. 2015;125(3):540-7.
437. Deutekom M, Dobben AC. Plugs for containing faecal incontinence. *Cochrane Database Syst Rev*. 2015: CD005086.
438. Lukacz ES, Segall MM, Wexner SD. Evaluation of an Anal Insert Device for the Conservative Management of Fecal Incontinence. *Dis Colon Rectum*. 2015;58(9):892-8.
439. Pittman J, Beeson T, Terry C, Kessler W, Kirk L. Methods of bowel management in critical care: a randomized controlled trial. *JWOCN*. 2012;39(6):633-9.
440. Borchert K, Bliss DZ, Savik K, Radosevich DM. The incontinence-associated dermatitis and its severity instrument: development and validation. *JWOCN*. 2010;37(5):527-35.
441. Whiteley I, Sinclair G, Lyons AM, Riccardi R. A retrospective review of outcomes using a fecal management system in acute care patients. *Ostomy Wound Manage*. 2014;60(12):37-43.
442. Mulhall AM, Jindal SK. Massive gastrointestinal hemorrhage as a complication of the Flexi-Seal fecal management system. *Am J Crit Care*. 2013;22(6):537-43.
443. Popek S, Senagore A. Indwelling rectal tubes: an unusual cause of significant rectal bleeding in two critically ill patients. *Am Surg*. 2013;79(2):219-20.
444. Sammon MA, Montague M, Frame F, Guzman D, Bena JF, Palascak A, et al. Randomized controlled study of the effects of 2 fecal management systems on incidence of anal erosion. *JWOCN*. 2015;42(3):279-86.
445. Reynolds MG, van Haren F. A case of pressure ulceration and associated haemorrhage in a patient using a faecal management system. *Aust Critical Care*. 2012;25(3):188-94.
446. Gray M, Beeckman D, Bliss DZ, Fader M, Logan S, Junkin J, et al. Incontinence-associated dermatitis: a comprehensive review and update. *JWOCN*. 2012;39(1):61-74.
447. Gray M, Bliss DZ, Doughty DB, Ermer-Seltun J, Kennedy-Evans KL, Palmer MH. Incontinence-associated dermatitis: a consensus. *JWOCN*. 2007;34(1):45-54; quiz 5-6.
448. Newman D, Preston A, Salazar S. Moisture control, urinary and faecal incontinence, and perineal skin management. In: Krasner D, Rodeheaver G, Sibbald R, editors. *Chronic Wound Care: A Clinical Source Book for Healthcare Professionals*. 4th Edn. Malvern: HMP communications, Malvern: p 609–27.

449. Van Damme N, Vanryckeghem E, Verhaeghe S, Beeckman D, editors. Incontinence-associated dermatitis in elderly: a qualitative phenomenological study on patient experiences. 18th Annual meeting of the European Pressure Ulcer Advisory Panel (EPUAP 2015); 2015.
450. Beeckman D, Van Damme N, Schoonhoven L, Van Lancker A, Kottner J, Beele H, et al. Interventions for preventing and treating incontinence-associated dermatitis in adults. *Cochrane Database Syst Rev.* 2016;11:CD011627.
451. Beeckman D. A decade of research on Incontinence-Associated Dermatitis (IAD): Evidence, knowledge gaps and next steps. *Journal Tissue Viability.* 2016; 26(1):47-56.
452. Beeckman D, Campbell J, Campbell K, Chimentão D, Coyer F, Domansky R, Gray M et al. Incontinence-associated dermatitis: moving prevention forward. *Wounds Int.* 2015;1-21.
453. Medical Subject Headings: U.S. National Library of Medicine; 2016 [Internet]. 2016. Available from: <https://www.nlm.nih.gov/mesh/>.
454. Gray M, Black JM, Baharestani MM, Bliss DZ, Colwell JC, Goldberg M, et al. Moisture-associated skin damage: overview and pathophysiology. *JWOCN.* 2011;38(3):233-41.
455. Beeckman D, N VD, Schoonhoven L, Van Lancker A, Kottner J, Beele H et al. Interventions for preventing and treating incontinence-associated dermatitis in adults. *Cochrane Database Syst Rev.* 2015.
456. Kottner J, Boronat X, Blume-Peytavi U, Lahmann N, Suhr R. The epidemiology of skin care provided by nurses at home: a multicentre prevalence study. *J Adv Nurs.* 2015;71(3):570-80.
457. Kottner J, Beeckman D. Incontinence-associated dermatitis and pressure ulcers in geriatric patients. *Giornale italiano di dermatologia e venereologia : organo ufficiale, Societa italiana di dermatologia e sifilografia.* 2015;150(6):717-29.
458. Foureur N, Vanzo B, Meaume S, Senet P. Prospective aetiological study of diaper dermatitis in the elderly. *Br J Dermatol.* 2006;155(5):941-6.
459. Beeckman D, Schoonhoven L, Verhaeghe S, Heyneman A, Defloor T. Prevention and treatment of incontinence-associated dermatitis: literature review. *J Adv Nurs.* 2009;65(6):1141-54.
460. Farage MA, Miller KW, Berardesca E, Maibach HI. Incontinence in the aged: contact dermatitis and other cutaneous consequences. *Contact dermatitis.* 2007;57(4):211-7.
461. Menon GK, Cleary GW, Lane ME. The structure and function of the stratum corneum. *Int J Pharm.* 2012;435(1):3-9.
462. Voegeli D. Moisture-associated skin damage: aetiology, prevention and treatment. *Br J Nurs.* 2012;21(9):517-8, 20-1.
463. Ichikawa-Shigeta Y, Sugama J, Sanada H, Nakatani T, Konya C, Nakagami G, et al. Physiological and appearance characteristics of skin maceration in elderly women with incontinence. *J Wound Care.* 2014;23(1):18-9, 22-3, 6 passim.
464. Bouwstra JA, de Graaff A, Gooris GS, Nijssse J, Wiechers JW, van Aelst AC. Water distribution and related morphology in human stratum corneum at different hydration levels. *J Invest Dermatol.* 2003;120(5):750-8.
465. Warner RR, Stone KJ, Boissy YL. Hydration disrupts human stratum corneum ultrastructure. *J Invest Dermatol.* 2003;120(2):275-84.
466. Minematsu T, Yamamoto Y, Nagase T, Naito A, Takehara K, Iizaka S, et al. Aging enhances maceration-induced ultrastructural alteration of the epidermis and impairment of skin barrier function. *J Dermatol Sc.* 2011;62(3):160-8.
467. Hachem JP, Crumrine D, Fluhr J, Brown BE, Feingold KR, Elias PM. pH directly regulates epidermal permeability barrier homeostasis, and stratum corneum integrity/cohesion. *J Invest Dermatol.* 2003;121(2):345-53.
468. Kottner J, Blume-Peytavi U, Lohrmann C, Halfens R. Associations between individual characteristics and incontinence-associated dermatitis: a secondary data analysis of a multicentre prevalence study. *Int J Nurs Stud.* 2014;51(10):1373-80.
469. Nix DH. Validity and reliability of the Perineal Assessment Tool. *Ostomy Wound Manage.* 2002;48(2):43-6, 8-9.
470. Nix D, Haugen V. Prevention and management of incontinence-associated dermatitis. *Drugs & Aging.* 2010;27(6):491-6.
471. Defloor T, Grypdonck MF. Pressure ulcers: validation of two risk assessment scales. *J Clin Nurs.* 2005;14(3):373-82.
472. Beeckman D, Van Lancker A, Van Hecke A, Verhaeghe S. A Systematic Review and Meta-Analysis of Incontinence-Associated Dermatitis, Incontinence, and Moisture as Risk Factors for Pressure Ulcer Development. *Res Nurs Health.* 2014;37(3):204-18.

473. Luboz V, Perrier A, Bucki M, Diot B, Cannard F, Vuillerme N, et al. Influence of the calcaneus shape on the risk of posterior heel ulcer using 3D patient-specific biomechanical modeling. *Ann Biomed Eng*. 2015;43(2):325-35.
474. Sugama J, Sanada H, Shigeta Y, Nakagami G, Konya C. Efficacy of an improved absorbent pad on incontinence-associated dermatitis in older women: cluster randomized controlled trial. *BMC Geriatrics*. 2012;12:22.
475. Denat Y, Khorshid L. The effect of 2 different care products on incontinence-associated dermatitis in patients with fecal incontinence. *JWOCN*. 2011;38(2):171-6.
476. Brunner M, Droegemueller C, Rivers S, Deuser WE. Prevention of incontinence-related skin breakdown for acute and critical care patients: comparison of two products. *Urol Nurs*. 2012;32(4):214-9.
477. Buckley B, Dofitas R, Baltazar W, Quiambao P, Razor B. Incontinence-associated dermatitis (IAD) study: Blinded assessment and treatment with zinc oxide-based ointment. *World Council of Enterostomal Therapists Journal*. 2014;34(4):13-23.
478. Conley P, McKinsey D, Ross O, Ramsey A, Feeback J. Does skin care frequency affect the severity of incontinence-associated dermatitis in critically ill patients? *Nursing*. 2014;44(12):27-32.
479. Beekman D, Kottner J, IIR G. Developing a core outcome set for incontinence-associated dermatitis: Comet Initiative; 2015 [Available from: <http://www.comet-initiative.org/studies/details/383>].
480. Brown DS. Perineal dermatitis: can we measure it? *Ostomy Wound Manage*. 1993;39(7):28-30, 1.
481. Junkin J, Selekof JL. Beyond "diaper rash": Incontinence-associated dermatitis: does it have you seeing red? *Nursing*. 2008;38(11 Suppl):56hn1-10.
482. Bliss DZ, Hurlow J, Cefalu J, Mahlum L, Borchert K, Savik K. Refinement of an instrument for assessing incontinent-associated dermatitis and its severity for use with darker-toned skin. *JWOCN*. 2014;41(4):365-70.
483. Kennedy K, Lutz L, editors. Comparison of the efficacy and cost-effectiveness of three skin protectants in the management of incontinent dermatitis. *Proceedings of the European Conference on Advances in Wound Management*; 1996.
484. Clarke-O'Neill S, Farbrot A, Lagerstedt ML, Cottenden A, Fader M. An Exploratory Study of Skin Problems Experienced by UK Nursing Home Residents Using Different Pad Designs. *JWOCN*. 2015;42(6):621-31; quiz E1-2.
485. Clarke-O'Neill S, Farbrot A, Lagerstedt ML, Cottenden A, Fader M. Is it Feasible to Use Incontinence-Associated Dermatitis Assessment Tools in Routine Clinical Practice in the Long-term Care Setting? *JWOCN*. 2015;42(4):379-88.
486. Beekman D, et al. Proceedings of the Global IAD Expert Panel: incontinence associated dermatitis: moving prevention forward 2015. Available from: www.woundsinternational.com.
487. Beekman D, Schoonhoven L, Fletcher J, Furtado K, Gunningberg L, Heyman H, et al. EPUAP classification system for pressure ulcers: European reliability study. *J Adv Nurs*. 2007;60(6):682-91.
488. Defloor T, Schoonhoven L, Fletcher J, Furtado K, Heyman H, Lubbers M, et al. Statement of the European Pressure Ulcer Advisory Panel--pressure ulcer classification: differentiation between pressure ulcers and moisture lesions. *JWOCN*. 2005;32(5):302-6; discussion 6.
489. Beekman D, Schoonhoven L. European Pressure Ulcer Advisory Panel. *PuClas3 eLearning module* 2015. 2015.
490. Lewis-Byers K, Thayer D. An evaluation of two incontinence skin care protocols in a long-term care setting. *Ostomy Wound Manage*. 2002;48(12):44-51.
491. Byers PH, Ryan PA, Regan MB, Shields A, Carta SG. Effects of incontinence care cleansing regimens on skin integrity. *JWOCN*. 1995;22(4):187-92.
492. Beekman D, Defloor T, K V, Schoonhoven L. A 3-in-1 perineal care washcloth impregnated with dimethicone 3% versus water and pH neutral soap to prevent and treat incontinence-associated dermatitis: a randomized, controlled clinical trial. *JWOCN*. 2011;38(6):627-34.
493. Beguin AM, Malaquin-Pavan E, Guihaire C. Improving Diaper Design to Address Incontinence-Associated Dermatitis. *JWOCN*. 2011(4S):S29-S.
494. Bliss DZ, HSD KW, Gannon A, Wilhelms A, editors. Absorbent Briefs Containing Curly Fiber Lower (Acidify) Skin pH Reducing Risk for Incontinence Associated Skin Damage in Older Nursing Home Residents. Poster presented at joint WOCN Society and Canadian Association for ET conference, Montreal, Quebec, Canada, June; 2016.

495. Shigeta Y, Nakagami G, Sanada H, Oba M, Fujikawa J, Konya C, et al. Exploring the relationship between skin property and absorbent pad environment. *J Clin Nurs*. 2009;18(11):1607-16.
496. Wang TS, Tsai TF. Cutaneous irritancy of water. *Rev Environ Health*. 2014;29(3):217-20.
497. Langemo D, Hanson D, Hunter S, Thompson P, Oh IE. Incontinence and incontinence-associated dermatitis. *Adv Skin Wound Care*. 2011;24(3):126-40; quiz 41-2.
498. Tsai TF, Maibach HI. How irritant is water? An overview. *Contact dermatitis*. 1999;41(6):311-4.
499. Fluhr JW, Gloor M, Lehmann L, Lazzarini S, Distante F, Berardesca E. Glycerol accelerates recovery of barrier function in vivo. *Acta dermato-venereologica*. 1999;79(6):418-21.
500. Suskind RR, Ishihara M. The effects of wetting on cutaneous vulnerability. *Arch Environ Health*. 1965;11(4):529-37.
501. Zimmerer RE, Lawson KD, Calvert CJ. The effects of wearing diapers on skin. *Ped Dermatol*. 1986;3(2):95-101.
502. Bliss DZ, Savik K, Thorson MA, Ehman SJ, Lebak K, Beilman G. Incontinence-associated dermatitis in critically ill adults: time to development, severity, and risk factors. *JWOCN*. 2011;38(4):433-45.
503. Campbell JL, Coyer FM, Osborne SR. Incontinence-associated dermatitis: a cross-sectional prevalence study in the Australian acute care hospital setting. *Int Wound J*. 2016;13(3):403-11.
504. Zimmaro Bliss D, Zehrer C, Savik K, Thayer D, Smith G. Incontinence-associated skin damage in nursing home residents: a secondary analysis of a prospective, multicenter study. *Ostomy Wound Manage*. 2006;52(12):46-55.
505. Bliss DZ, Savik K, Harms S, Fan Q, Wyman JF. Prevalence and correlates of perineal dermatitis in nursing home residents. *Nurs Res*. 2006;55(4):243-51.
506. Junkin J, Selekof JL. Prevalence of incontinence and associated skin injury in the acute care inpatient. *JWOCN*. 2007;34(3):260-9.
507. Shigeta Y, Nakagami G, Sanada H, Konya C, Sugama J. Factors influencing intact skin in women with incontinence using absorbent products: results of a cross-sectional, comparative study. *Ostomy Wound Manage*. 2010;56(12):26-8, 30-3.
508. Ali SM, Yosipovitch G. Skin pH: from basic science to basic skin care. *Acta dermato-venereologica*. 2013;93(3):261-7.
509. Blaak J, Wohlfart R, Schurer N. Treatment of aged skin with a pH 4 skin care product normalizes increased skin surface pH and improves barrier function: results of a pilot study. *Journal of Cosmetics, Dermatological Sciences and Applications*. 2011;1(3):50-8.
510. Watret L. Using a case-mix-adjusted pressure sore incidence study in a surgical directorate to improve patient outcomes in pressure ulcer prevention. *J Tissue Viability*. 1999;9(4):121-5.
511. Warshaw E, Nix D, Kula J, Markon CE. Clinical and cost effectiveness of a cleanser protectant lotion for treatment of perineal skin breakdown in low-risk patients with incontinence. *Ostomy Wound Manage*. 2002;48(6):44-51.
512. Buckingham KW, Berg RW. Etiologic factors in diaper dermatitis: the role of feces. *Ped Dermatol*. 1986;3(2):107-12.
513. Berg RW, Buckingham KW, Stewart RL. Etiologic factors in diaper dermatitis: the role of urine. *Ped Dermatol*. 1986;3(2):102-6.
514. Ersser SJ, Getliffe K, Voegeli D, Regan S. A critical review of the inter-relationship between skin vulnerability and urinary incontinence and related nursing intervention. *Int J Nurs Stud*. 2005;42(7):823-35.
515. Maklebust J, Magnan MA. Risk factors associated with having a pressure ulcer: a secondary data analysis. *Adv Wound Care*. 1994;7(6):25, 7-8, 31-4 passim.
516. Brandeis GH, Ooi WL, Hossain M, Morris JN, Lipsitz LA. A longitudinal study of risk factors associated with the formation of pressure ulcers in nursing homes. *J Am Geriatr Soc*. 1994;42(4):388-93.
517. Bergquist S, Frantz R. Pressure ulcers in community-based older adults receiving home health care. Prevalence, incidence, and associated risk factors. *Adv Wound Care*. 1999;12(7):339-51.
518. Campbell RL, Seymour JL, Stone LC, Milligan MC. Clinical studies with disposable diapers containing absorbent gelling materials: evaluation of effects on infant skin condition. *J Am Acad Dermatol*. 1987;17(6):978-87.
519. Lane AT, Rehder PA, Helm K. Evaluations of diapers containing absorbent gelling material with conventional disposable diapers in newborn infants. *Am J Dis Child* (1960). 1990;144(3):315-8.
520. Davis JA, Leyden JJ, Grove GL, Raynor WJ. Comparison of disposable diapers with fluff absorbent and fluff plus absorbent polymers: effects on skin hydration, skin pH, and diaper dermatitis. *Ped Dermatol*. 1989;6(2):102-8.

521. Fader M, Clarke-O'Neill S, Cook D, Dean G, Brooks R, Cottenden A, et al. Management of night-time urinary incontinence in residential settings for older people: an investigation into the effects of different pad changing regimes on skin health. *J Clin Nurs*. 2003;12(3):374-86.
522. Cooper P, Gray D. Comparison of two skin care regimes for incontinence. *Br J Nurs*. 2001;10(6 Suppl):S6, S8, S10 passim.
523. Duncan CN, Riley TV, Carson KC, Budgeon CA, Siffleet J. The effect of an acidic cleanser versus soap on the skin pH and micro-flora of adult patients: a non-randomised two group crossover study in an intensive care unit. *Intensive Crit Care Nurs*. 2013;29(5):291-6.
524. Vinson J, Proch J. Inhibition of moisture penetration to the skin by a novel incontinence barrier product. *JWOCN*. 1998;25(5):256-60.
525. Ashworth PD, Hagan MT. The meaning of incontinence: a qualitative study of non-geriatric urinary incontinence sufferers. *J Adv Nurs*. 1993;18(9):1415-23.
526. Roe B, May C. Incontinence and sexuality: findings from a qualitative perspective. *J Adv Nurs*. 1999;30(3):573-9.
527. Brittain KR, Shaw C. The social consequences of living with and dealing with incontinence--a carers perspective. *Social science & medicine (1982)*. 2007;65(6):1274-83.
528. Hagglund D, Walker-Engstrom ML, Larsson G, Leppert J. Reasons why women with long-term urinary incontinence do not seek professional help: a cross-sectional population-based cohort study. *Int Urogynecol J*. 2003;14(5):296-304; discussion
529. Hellstrom L, Ekelund P, Milsom I. An evaluation of the acceptability of incontinence aids used by 85-year-old men and women. *Arch Gerontol Geriatr*. 1992;14(3):253-62.
530. Lagro-Janssen T, Smits A, Van Weel C. Urinary incontinence in women and the effects on their lives. *Scan J Prim Health Care*. 1992;10(3):211-6.
531. Li FLW, Low LPL, Lee DTF. Coping with stress incontinence: women's experiences of everyday inconveniences. *Int J Urol Nurs*. 2007;1(3):112-9.
532. Mselle LT, Kohi TW. Living with constant leaking of urine and odour: thematic analysis of socio-cultural experiences of women affected by obstetric fistula in rural Tanzania. *BMC women's health*. 2015;15(1):107.
533. Olsson F, Bertero C. Living with faecal incontinence: trying to control the daily life that is out of control. *J Clin Nurs*. 2015;24(1-2):141-50.
534. Peden-McAlpine C, Bliss D, Becker B, Sherman S. The Experience of Community-Living Men Managing Fecal Incontinence. *Rehabil Nurs*. 2012;37(6):298-306.
535. Nilsson M, Lalos O, Lindkvist H, Lalos A. How do urinary incontinence and urgency affect women's sexual life? *Acta Obstet Gynecol Scand*. 2011;90(6):621-8.
536. Rozmovits L, Ziebland S. Expressions of loss of adulthood in the narratives of people with colorectal cancer. *Qual Health Res*. 2004;14(2):187-203.
537. Teunissen D, Van Den Bosch W, Van Weel C, Lagro-Janssen T. "It can always happen": the impact of urinary incontinence on elderly men and women. *Scan J Prim Health Care*. 2006;24(3):166-73.
538. Weber BA, Roberts BL. Refining a Prostate Cancer Survivor's Toolkit. *Urol Nurs*. 2015;35(1):22-9.
539. Majid H, Emery P, Whelan K. Attitudes of patients and nurses towards diarrhoea during enteral tube feeding. *J Hum Nutr Diet*. 2008;21(4):395-.
540. Moore JG, Jessop LD, Osborne DN. Gas-chromatographic and mass-spectrometric analysis of the odor of human feces. *Gastroenterology*. 1987;93(6):1321-9.
541. Suarez FL, Springfield J, Levitt MD. Identification of gases responsible for the odour of human flatus and evaluation of a device purported to reduce this odour. *Gut*. 1998;43(1):100-4.
542. Ohge H, Furne JK, Springfield J, Ringwala S, Levitt MD. Effectiveness of devices purported to reduce flatus odor. *Am J Gastroenterol*. 2005;100(2):397-400.
543. Nobaek S, Johansson ML, Molin G, Ahrne S, Jeppsson B. Alteration of intestinal microflora is associated with reduction in abdominal bloating and pain in patients with irritable bowel syndrome. *Am J Gastroenterol*. 2000;95(5):1231-8.
544. Ganiats TG, Norcross WA, Halverson AL, Burford PA, Palinkas LA. Does Beano prevent gas? A double-blind crossover study of oral alpha-galactosidase to treat dietary oligosaccharide intolerance. *J Fam Pract*. 1994;39(5):441-5.
545. Di Stefano M, Miceli E, Gotti S, Missanelli A, Mazzocchi S, Corazza GR. The effect of oral alpha-galactosidase on intestinal gas production and gas-related symptoms. *Dig Dis Sci*. 2007;52(1):78-83.

546. Hall RG, Jr., Thompson H, Strother A. Effects of orally administered activated charcoal on intestinal gas. *Am J Gastroenterol*. 1981;75(3):192-6.
547. Giffard CJ, Collins SB, Stoodley NC, Butterwick RF, Batt RM. Administration of charcoal, *Yucca schidigera*, and zinc acetate to reduce malodorous flatulence in dogs. *J Am Vet Med Assoc*. 2001;218(6):892-6.
548. Fukui J, Sakai Y, Hosaka K, Yamashita T, Ogawa A, Shirai H. A newly designed deodorant pad for urinary incontinence. *J Am Geriatr Soc*. 1990;38(8):889-92.
549. Williams J, Suess J, Santiago J, Chen Y, Wang J, Wu R, et al. Antimicrobial properties of novel n-halamine siloxane coatings *Surf Coat Int Part B: Coat Trans* 2005;88:35-9.
550. Lyder CH, Byers PH, McCray G, Singh MK. Efficacy of condom catheters in controlling incontinence odor. *Applied Nurs Res*. 1992;5(4):186-7.
551. Gallo M, Staskin DR. Patient satisfaction with a reusable undergarment for urinary incontinence. *JWOCN*. 1997;24(4):226-36.
552. Bliss DZ, Lewis J, Hasselman K, Savik K, Lowry A, Whitebird R. Use and evaluation of disposable absorbent products for managing fecal incontinence by community-living people. *JWOCN*. 2011;38(3):289-97.
553. Kennedy MJ, Arcelus A, Guitard P, Goubran R, Sveistrup H. Toilet Grab-Bar Preference and Center of Pressure Deviation During Toilet Transfers in Healthy Seniors, Seniors With Hip Replacements, and Seniors Having Suffered a Stroke. *Assistive Technology*. 2015;27(2):78-87.
554. Beresford S. Combined toilets and bidets for use by people with a disability. *British Journal of Therapy and Rehabilitation* 1997; 6(7), 342-6.
555. Jenkins G. Assisting clients with amyotrophic lateral sclerosis - the bidet. *OT Practice*. 2012;17:18.
556. Newman DK. Incontinence products and devices for the elderly. *Urol Nurs*. 2004;24(4):316-33; quiz 34.
557. Potter PJ. Disordered control of the urinary bladder after human Spinal Cord injury: what are the problems? *Prog Brain Res*. 2006;152:51-7.
558. Bycroft J, Hamid R, Shah PJ. Penile erosion in Spinal Cord injury--an important lesson. *Spinal Cord*. 2003;41(11):643-4.
559. Golji H. Complications of external condom drainage. *Paraplegia*. 1981;19(3):189-97.
560. Milanese N, Bianchini G, D'Erme AM, Francalanci S. Allergic reaction to condom catheter for bladder incontinence. *Contact dermatitis*. 2013;69(3):182-3.
561. Kawoosa NU. Isolated gangrene of the penis in a paraplegic patient secondary to a condom catheter. *The Indian J Surg*. 2011;73(4):304-6.
562. Ozkan HS, Irkoren S, Sivrioglu N. Penile strangulation and necrosis due to condom catheter. *Int Wound J*. 2015;12(3):248-9.
563. Paul S, Dalela D, Prakash J, Sankhwar S. Penile elephantiasis: a rare consequence of inappropriate use of condom as external urinary collection receptacle. *BMJ case reports*. 2013;2013.
564. Jayachandran S, Mooppan UM, Kim H. Complications from external (condom) urinary drainage devices. *Urol*. 1985;25(1):31-4.
565. Hirsh DD, Fainstein V, Musher DM. Do condom catheter collecting systems cause urinary tract infection? *JAMA*. 1979;242(4):340-1.
566. Ouslander JG, Greengold B, Chen S. External catheter use and urinary tract infections among incontinent male nursing home patients. *J Am Geriatr Soc*. 1987;35(12):1063-70.
567. Vaidyanathan S, Selmi F, Soni B, Hughes P, Singh G, Pulya K, et al. Pyonephrosis and urosepsis in a 41-year old patient with spina bifida: Case report of a preventable death. *Patient safety in surgery*. 2012;6(1):10.
568. Vaidyanathan S, Selmi F, Hughes PL, Singh G, Soni BM. Urinary retention and acute kidney injury in a tetraplegic patient using condom catheter after partying: a preventable complication. *Int Med Case Rep J*. 2015;8:241-5.
569. Fetsch JF, Davis CJ, Jr., Hallman JR, Chung LS, Lupton GP, Sesterhenn IA. Lymphedematous fibroepithelial polyps of the glans penis and prepuce: a clinicopathologic study of 7 cases demonstrating a strong association with chronic condom catheter use. *Hum Pathol*. 2004;35(2):190-5.
570. Al-Awadhi NM, Al-Brahim N, Ahmad MS, Yordanov E. Giant fibroepithelial polyp of the penis associated with long-term use of condom catheter. Case report and literature review. *Can J Urol*. 2007;14(4):3656-9.
571. Mason SE, DeVilliers P, Andea AA. Lymphedematous fibroepithelial polyps of the penis associated with long-term condom catheter use: case report and review of the literature. *Journal of cutaneous pathology*. 2009;36(8):906-9.
572. Crowell W, R R, Tarry S. Fungal Fournier's Gangrene in an Immunocompromised Patient. *Urol case reports*. 2016;4:1-3.

573. Brennan ML, Evans A. Why catheterize?: audit findings on the use of urinary catheters. *Br J Nurs*. 2001;10(9):580-90.
574. Gokula RR, Hickner JA, Smith MA. Inappropriate use of urinary catheters in elderly patients at a midwestern community teaching hospital. *Am J Infect Control*. 2004;32(4):196-9.
575. Cox AJ, Millington RS, Hukins DW, Sutton TM. Resistance of conformable indwelling urinary catheters to encrustation. *Biomaterials, artificial cells, and artificial organs*. 1989;17(4):429-35.
576. Ruutu M, Alfthan O, Heikkinen L, Jarvinen A, Lehtonen T, Merikallio E, et al. "Epidemic" of acute urethral stricture after open-heart surgery. *Lancet*. 1982;1(8265):218.
577. Ruutu M, Alfthan O, Talja M, Andersson LC. Cytotoxicity of latex urinary catheters. *Br J Urol*. 1985;57(1):82-7.
578. Nacey JN, Tulloch AG, Ferguson AF. Catheter-induced urethritis: a comparison between latex and silicone catheters in a prospective clinical trial. *Br J Urol*. 1985;57(3):325-8.
579. Pariente JL, Bordenave L, Jacob F, Bareille R, Baquey C, Le Guillou M. Cytotoxicity assessment of latex urinary catheters on cultured human urothelial cells. *Euro Urol*. 2000;38(5):640-3.
580. Crippa M, Belleri L, Mistrello G, Tedoldi C, Alessio L. Prevention of latex allergy among health care workers and in the general population: latex protein content in devices commonly used in hospitals and general practice. *Int Arch Occup Environ Health*. 2006;79(7):550-7.
581. Shenot P, Rivas DA, Kalman DD, Staas WE, Jr., Chancellor MB. Latex allergy manifested in urological surgery and care of adult Spinal Cord injured patients. *Arch Phys Med Rehabil*. 1994;75(11):1263-5.
582. Talja M, Korpela A, Jarvi K. Comparison of urethral reaction to full silicone, hydrogen-coated and siliconised latex catheters. *Br J Urol*. 1990;66(6):652-7.
583. Villanueva C, Hossain SG, Nelson CA. Silicone catheters may be superior to latex catheters in difficult urethral catheterization after urethral dilation. *J Endourol*. 2011;25(5):841-4.
584. Russell D, Putra LJ. Hypothesis: Do topical creams damage urinary catheters? *Australian and New Zealand Continence Journal*, The. 2013;19(3):74.
585. Anderson R. Pilot study to assess silicone indwelling urinary catheter change regimens. *Australian and New Zealand Continence Journal*, The. 2010;16(1):24.
586. Barnes KE, Malone-Lee J. Long-term catheter management: minimizing the problem of premature replacement due to balloon deflation. *J Adv Nurs*. 1986;11(3):303-7.
587. Kennedy AP, Brocklehurst J, Lye M. Factors related to the problems of long-term catheterization. *J Adv Nurs*. 1983;8(3):207-12.
588. Parker D, Callan L, Harwood J, Thompson DL, Wilde M, Gray M. Nursing interventions to reduce the risk of catheter-associated urinary tract infection. Part 1: Catheter selection. *JWOCN*. 2009;36(1):23-34.
589. Donlan RM. Biofilm formation: a clinically relevant microbiological process. *Clinical infectious diseases : an official publication of the Infectious Diseases Society of America*. 2001;33(8):1387-92.
590. Nickel JC, Costerton JW, McLean RJ, Olson M. Bacterial biofilms: influence on the pathogenesis, diagnosis and treatment of urinary tract infections. *J Antimicrob Chemo*. 1994;33 Suppl A:31-41.
591. Watnick P, Kolter R. Biofilm, city of microbes. *Journal of bacteriology*. 2000;182(10):2675-9.
592. Stickler D, Dolman J, Rolfe S, Chawla J. Activity of antiseptics against *Escherichia coli* growing as biofilms on silicone surfaces. *Eur J Clin Microbiol Infect Dis : official publication of the European Society of Clinical Microbiology*. 1989;8(11):974-8.
593. Mody L, Maheshwari S, Galecki A, Kauffman CA, Bradley SF. Indwelling device use and antibiotic resistance in nursing homes: identifying a high-risk group. *J Am Geriatr Soc*. 2007;55(12):1921-6.
594. Pannek J, Göcking K, Bersch U. To clamp or not to clamp? Bladder management by suprapubic catheterization in patients with neurogenic bladder dysfunction. *World J Urol*. 2010;28(5):637-41.
595. Katsumi HK, Kalisvaart JF, Ronningen LD, Hovey RM. Urethral versus suprapubic catheter: choosing the best bladder management for male Spinal Cord injury patients with indwelling catheters. *Spinal Cord*. 2010;48(4):325-9.
596. Siroky MB. Pathogenesis of bacteriuria and infection in the Spinal Cord injured patient. *Am J Med*. 2002;113 Suppl 1A:67s-79s.
597. Jannings W, Kelly M. Difficulty in removing suprapubic urinary catheters in home based patients: a comparative descriptive study. *Australian J Adv Nurs*. 2001;19(2):20-5.
598. Gonzalgo ML, Walsh PC. Balloon cuffing and management of the entrapped Foley catheter. *Urol*. 2003;61(4):825-7.

599. Nix DH. Factors to consider when selecting skin cleansing products. *JWOCN*. 2000;27(5):260-8.
600. Kottner J, Lichtenfeld A, Blume-Peytavi U. Maintaining skin integrity in the aged: a systematic review. *Br J Dermatol*. 2013;169(3):528-42.
601. Corcoran E, Woodward S. Incontinence-associated dermatitis in the elderly: treatment options. *Br J Nurs*. 2013;22(8):450, 2, 4-7.
602. Beeckman D, Woodward S, Gray M. Incontinence-associated dermatitis: step-by-step prevention and treatment. *Br J Community Nurs*. 2011;16(8):382-9.
603. Jahn P, Beutner K, Langer G. Types of indwelling urinary catheters for long-term bladder drainage in adults. *Cochrane Database Syst Rev*. 2012(10): CD004997.
604. Phipps S, Lim YN, McClinton S, Barry C, Rane A, N'Dow J. Short term urinary catheter policies following urogenital surgery in adults. *Cochrane Database Syst Rev*. 2006(2): CD004374.
605. Griffiths R, Fernandez R. Policies for the removal of short-term indwelling urethral catheters. *Cochrane Database Syst Rev*. 2005(1): CD004011.
606. Lusardi G, Lipp A, Shaw C. Antibiotic prophylaxis for short-term catheter bladder drainage in adults. *Cochrane Database Syst Rev*. 2013(7): CD005428.
607. Fisher E, Subramonian K, Omar MI. The role of alpha blockers prior to removal of urethral catheter for acute urinary retention in men. *Cochrane Database Syst Rev*. 2014(6): CD006744.
608. Lam TBL, Omar MI, Fisher E, Gillies K, MacLennan S. Types of indwelling urethral catheters for short-term catheterisation in hospitalised adults. *The Cochrane Database Of Systematic Reviews*. 2014;9: CD004013.

PRIMARY PREVENTION, CONTINENCE PROMOTION, MODELS OF CARE AND EDUCATION

Chair

DK Newman (USA)

Members

R Cockerell (Australia)

TL Griebing (USA)

A Rantell (UK)

P van Houten (The Netherlands)

MH Palmer (USA) Co-Chair

CONTENTS

LIST OF ABBREVIATIONS	2429	VII. MODELS OF CARE, DELIVERY AND ACCESSING CARE	2442
I. INTRODUCTION	2430	1. Background.....	2442
II. PRIMARY PREVENTION	2430	2. Need for Services	2443
1. Background	2431	3. Models of Care.....	2443
2. Prevention of UI in Specific Populations	2432	4. Other Service Models	2446
3. Prevention of Faecal Incontinence	2433	5. Models in Developing Nations.....	2448
III. CONTINENCE AWARENESS, PROMOTION AND ADVOCACY	2433	VIII. EDUCATION	2448
1. Background	2433	1. Background.....	2448
2. Raising Awareness and Understanding.....	2434	2. Medical Education	2448
IV. HELP-SEEKING (CARE-SEEKING) BEHAVIOUR	2436	3. Nursing Education.....	2451
1. Background	2436	4. Other Allied Health Professionals	2453
2. Factors That Act as Barriers / Facilitators to Help-seeking	2436	5. Impact of Clinical Guidelines.....	2454
3. Knowledge, Attitudes, and Beliefs About UI	2437	IX. PUBLIC EDUCATION	2459
4. Extrinsic Factors That Act as Barriers/Facilitators to Help-seeking for UI	2438	1. Background.....	2459
5. Sex Differences for Help-seeking Behaviours for UI	2438	X. CONCLUSIONS	2460
V. CONTINENCE PROMOTION PROGRAMMES	2439	APPENDIX 1. LITERATURE SEARCH	2461
1. Background	2439	REFERENCES	2463
2. Creating Public Awareness	2439		
3. Health Literacy	2440		
4. Programme Evaluation	2440		
VI. CONTINENCE ADVOCACY	2441		
1. Background	2441		
2. Continence Advocacy Worldwide.....	2441		

PRIMARY PREVENTION, CONTINENCE PROMOTION, MODELS OF CARE AND EDUCATION

DK Newman (USA)

R Cockerell (Australia), TL Griebing (USA), A Rantell (UK), P van Houten (The Netherlands).

MH Palmer (USA) Co-Chair

LIST OF ABBREVIATIONS

ACGME Accreditation Council on Graduate Medical Education

ACOG American College of Obstetricians and Gynecology

ACOVE Assessing Care of Vulnerable Elders

ACP American College of Physicians

AHRQ Agency for Healthcare Research and Quality

APRN Advanced practice registered nurse

AUA American Urological Association

AUGS American Urogynecologic Society

BACH Boston Area Community Health

BBF Bladder and Bowel Foundation

BICS-Q Barriers to Incontinence Care Seeking Questionnaire

BPS Bladder pain syndrome

CFA Continence Foundation of Australia

CME Continuing Medical Education

CMS Centres for Medicare and Medicaid Services

CNA Continence nurse advisor

CNP Continence nurse practitioner

CNS Continence nurse specialist

CPC Continence Promotion Committee

DNP Doctor of Nursing Practice

EAU European Association of Urology

FI Faecal incontinence

FPMRS Female Pelvic Medicine and Reconstructive Surgery

GP General practitioner

HCP Health care professional

HON Health on the Net

HRQoL Health-related quality of life

HSB Help-seeking behaviour

IBD Inflammatory bowel disease

IC Interstitial cystitis

ICCS International Children Continence Society

ICI International Consultation on Incontinence

ICS International Continence Society

IFFGD International Foundation for Functional Gastrointestinal Disorder

ISLY Incontinence Severity weighted Life Year

IUGA International Urogynaecological Association

LUTS Lower urinary tract symptoms

MOC Maintenance of certification

NA Nursing assistant

NAFC National Association For Continence

NC Nurse consultants

NCA Nurse continence advisor

NH Nursing home

NHIS National Health Interview Study

NHS	National Health Service
NICE	National Institute for Health and Care Excellence
NIH	National Institute of Health
NPH	Normal pressure hydrocephalus
NS	Nurse specialist
OAB	Overactive bladder
OCSS	Optimal Continence Service Specification
PCP	Primary care physician
PFM	Pelvic floor muscle
PIKQ	Prolapse and Incontinence Knowledge Questionnaire
POP	Pelvic organ prolapse
PQRS	Physician Quality Reporting System
PT	Physiotherapist/ Physical Therapist
QALY	Quality Adjusted Life Years
QoL	Quality of Life
RCT	Randomized Controlled Trial
SUFU	Society of Urodynamics, Female Pelvic Medicine & Urogenital Reconstruction
SUI	Stress urinary incontinence
SUNA	Society of Urologic Nurses and Associates
UI	Urinary incontinence
UK	United Kingdom
U.S.	United States
UII	Urgency urinary incontinence
WOCN	Wound Ostomy Continence Nurses

I. INTRODUCTION

Continence promotion, education, and primary prevention involves informing and educating the public and health care professionals that urinary (UI) and faecal incontinence (FI), can be treated successfully in most cases, can always be managed, and can often be prevented. Other bladder disorders, with links to incontinence, such as bladder pain syndrome/interstitial cystitis (BPS/IC) and pelvic organ prolapse (POP), can also be treated and managed successfully and they are often included in continence awareness programmes.

The taboo for talking about disorders of the bladder and bowel is easing in most cultures. (1) Government funded initiatives have increased and practice guidelines have been developed. The multidisciplinary ap-

proach to clinical management and research is considered the most effective and impactful way to provide care and advance knowledge. Popular magazines, local and national papers, radio, and television, in most developed countries regularly cover health topics for men and women relating to UI, FI, BPS and POP. Many countries run national or local public awareness campaigns, often spearheaded by a national continence organisation and the internet is increasingly being viewed as a convenient source of health information for a growing number of consumers.

This chapter updates the 2013 International Consultation on Incontinence (ICI) chapter in these areas: primary prevention, continence awareness and promotion, help-seeking behaviour, models of care and service delivery and education along with the recommendations in each area. The majority of information available primarily relates to UI and less on FI, BPS/IC and POP. Since these conditions are prevalent but often ignored by sufferers and professionals, the first topic addresses population-based primary prevention research. Although there is evidence-based research to support strategies to promote continence in certain populations, further research is needed to substantiate the benefits of primary preventative strategies, including long term follow-up. The second section reviews continence awareness by discussing health promotion and help-seeking (care-seeking) behaviours (HSB) for these conditions. Progress continues to be made in the promotion of continence on a worldwide basis yet there is inadequate evidence for the rapid translation of awareness into behavioural change and using existing knowledge to trigger help-seeking behaviour. Information is provided about continence promotion programmes and advocacy through worldwide organisations. Although a great deal of published information on building public and health care professional awareness of incontinence, is available, there is minimal information about the impact of these efforts on changing healthcare policy and public and professional attitudes and knowledge about continence. The third section discusses service delivery and models of continence care. The committee highlights the work of the 2014 Multidisciplinary Continence Care Service group. The final topic addresses education of professionals in these areas (i.e., UI, FI, BPS/IC and POP) including the development and use of medical guidelines and care pathways. The committee found information about recent practice and research initiatives in all of these areas but found very little evidence-based research to support widespread dissemination and translation. An attempt was made to review current information of education of the public on these conditions. A listing of all guidelines released since 2007 on UI, FI, POP and BPS is provided.

II. PRIMARY PREVENTION

Literature Search is found in Appendix 1.

1. BACKGROUND

According to the World Health Organisation primary prevention, “refers to actions aimed at avoiding the manifestation of a disease”. (2) These actions include interventions to improve health by changing the impact of social and economic determinants on health, providing people information about how to reduce risks of disease and clinical preventive services, and community and individual-level interventions to reduce risks. Primary prevention of UI in adults is important because of its prevalence across the lifespan, its financial and societal costs, and impact on the quality of life (QoL) of affected adults. A consensus statement released in 2011 by a panel of experts, *A Healthy Bladder*, reinforced the ongoing need for primary prevention efforts to be addressed not only by healthcare professionals, but also by policymakers and funding bodies. (3)

A driving force for developing primary prevention interventions for UI is epidemiological evidence of the global aging phenomenon. The World Health Organisation and the National Institute of Health in the United States (U.S.) estimated that there will be 1.5 billion people aged 65 years and over by 2050, representing 16% of the world’s population. The most rapid rate of growth of this age group will occur in less developed countries with 250% growth rate as compared to 71% in developed countries (<https://www.nia.nih.gov/research/publication/global->

with increased burden from chronic non-communicable diseases that are associated with UI (i.e., diabetes, neurological disorders, and some cancers).

These global aging estimates have significant implications to healthcare utilization, costs for UI across the lifespan, and education of clinicians to treat these conditions. (4) For example, estimates of lifetime risks for surgery for stress UI (SUI) in women is 20% by the age of 80 years (5) and the economic burden of urgency UI (UUI) is projected to increase by 25% by 2024. (6) In the U.S., the prevalence of UI increased in six years from 35.8% to 38.6% in older adults who have complex medical problems, yet treatment rates remained low. (7) Previous research has identified multiple risk factors for UI and many of these factors may be modifiable (8) including environmental, (9) psychological (10) and lifestyle and behavioural. (11) (12) Research has also found association between specific toileting behaviours and presence of lower urinary tract symptoms (LUTS), predominantly UI, in employed women, (12) female nurses, (13) (14) and women visiting a urogynaecology clinic. (15)

Recent research linked socioeconomic and health conditions in early childhood to impact on health later in life. (16) This includes intrapersonal factors such as reduced physical activity, obesity, smoking, exposure to stress, and development of mental health problems, i.e., depression. The origins of these factors appear to be complex and multi-level, that is, there are both intrapersonal and environmental

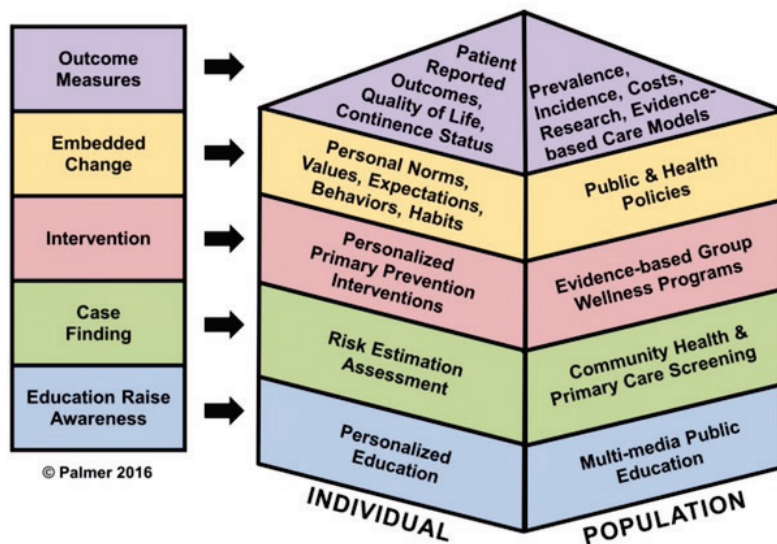

Figure 1: Primary Prevention Model.

health-and-aging/living-longer).

This rise in the number of older people is also expected to result in higher numbers of people living

mechanisms or intrapersonal and societal mechanisms leading to manifestation of negative health outcomes.

Since the Fifth ICI, there has been a heightened awareness that some social determinants are associated with the incidence and progression of UI. For example, research has observed a direct association between UI and obesity (17) and both UI and obesity are also associated with lower socioeconomic status. (18) UI has also been associated with depression in women in their 40s (19) and reduced physical activity. (20) In addition, racial disparities exist in patterns of UI, (21) primary prevention of UI in nursing home (NH) residents, (22) and women's level of knowledge about UI and other urinary symptoms. (23) Some women are disproportionately affected by UI due to its impact on emotional and spiritual aspects of their lives. (24) Increasing screening may help initiate discussions between healthcare providers and adults about urinary symptoms and their prevention. Urologic health has been proposed as a priority during the well women visit. (25)

Use of an assessment questionnaire in primary care wellness visits with women 40 years and older increased discussion about UI and FI. (26) Thus the goal for the emphasis on reducing risk of UI is to reduce disease burden and improve QoL in both the short and long term.

Development of primary prevention interventions for individuals and populations remain in the nascent stage. (27) (28) Evidence based information or clinical guidelines for preventing incontinence are not widely available. (29) There are no systematic reviews of population-based primary prevention interventions. Efforts are underway to develop foundational knowledge about multi-level factors including individual, social, physical and environmental factors that will aid in the development and testing of interventions to prevent UI in women. (30) A primary prevention model was proposed that demonstrates the multi-stage approach to individual and population based education, case finding, intervention, embedded change, and outcomes, see Figure 1.

Professional organisations have developed events or organized information to heighten the public's awareness of the importance of bladder health, such as the American Urogynecologic Society's Bladder Health Week (<http://www.augs.org/p/cm/ld/fid=708>), designed to educate women about pelvic floor health; the International Continence Society's (ICS) World Continence Week (<https://www.ics.org/public/wcw>); Continence Foundation of Australia public toilet map (<https://toiletmap.gov.au/>); and Canadian Continence Foundation factsheets and patient pamphlets (<http://www.canadiancontinence.ca/EN/bladder-health-leakage-control-problems.php?EN/bladder-health.php>). Efforts on the behalf of the Asia-Pacific Continence Board that represents countries in the Asia-Pacific rim and of the American Urological Association (AUA) are underway to designate November as Bladder Health Month (https://www.auanet.org/press-media/press_releases/article.cfm?articleNo=462). Evaluation of the effectiveness of these programmes is not available.

2. PREVENTION OF UI IN SPECIFIC POPULATIONS

2.1. Women During Pregnancy and Postpartum

A review of studies that were conducted to prevent UI during pregnancy and postpartum up to 2012 provided recommendations about UI prevention interventions. The authors who used the International Consultation on Urological Diseases steps for grading evidence made the following recommendations: advise to women to stop smoking before and during (Grade B), maintain normal weight before pregnancy (Grade B), aim to achieve normal weight post pregnancy (Grade B), advocate for occasional low intensity training during pregnancy (Grade B), avoid constipation during pregnancy (Grade B) and postpartum (Grade C), perform pelvic floor muscle (PFM) training during pregnancy and postpartum (Grade A), and use warm perineal packs during delivery (Grade B). The authors also noted that Cesarean section cannot be recommended (Grade D). (31)

Women in the second trimester of pregnancy were randomized into an intervention group (individually supervised PFM exercise intervention) and control group. Both groups received written information on how to perform PFM exercises. No differences were observed between the two groups at two and 12 months post-partum. (32) In a randomized, controlled trial (RCT) 70 pregnant women were randomized to an intervention group (supervised 6-week PFM exercise programme with instruction from a trained midwife) or control group (regular prenatal care). Fewer women in the intervention group developed SUI by the end of the study than did women in the control group (OR, 3.05, 95%CI, 1.07-8.70, $p = 0.018$). (33) Research is needed to increase the number of women willing to participate in PFM exercises. For example, in one study 95% of the women wanted professional information about these exercises but only one in three women were willing to participate in supervised PFM exercises postpartum. (34) Results from an online survey of 507 postpartum women who ran a minimum of once a week revealed that birth spacing of less than 2 years or having vaginal delivery increased odds of postpartum SUI (OR, 1.71 95%CI, 1.00-2.91). Women who had cesarean section delivery had increased odds of abdominal separation OR, 2.20 95%CI, 1.05-4.70.), while antenatal weight training decreased odds of SUI (OR, 0.46 95%CI, 0.21-0.98). (35)

2.2. Men Post-prostatectomy

A meta-analysis of preoperative PFM exercises for UI after radical prostatectomy found that additional PFM exercises did not improve resolution of UI after radical prostatectomy at 3, 6, or 12 months. (36)

2.3. Community-dwelling Older Adults

Community based continence education workshops have been found to increase knowledge of continence issues and continence related QoL in older women. In a study of 51 women who attended a 2.5 hour workshop, there was an increase in continence knowledge that was sustained for three months after the workshop. (37) The authors concluded that learning self-management strategies were important to improve pelvic floor health and that education in a public forum may be beneficial for these patients. This questionnaire was developed in the U.S. and 92% of respondents were White and the median age was 69 years.

A multisite randomized controlled trial was conducted with women 55 years and over (N= 647) in which women were followed 3 months, 1, and 2 years after delivery of the intervention. The intervention consisted of bladder health information by either 2-hour face to face instruction or 20-minute DVD with the same information. Investigators found both methods equally effective. There was no change in self-reported UI at 2 years. (38) (39)

A continence questionnaire, the Continence Index, was developed to predict future UI in older women. Factors that emerged as the strongest predictors of UI included body mass index, sneezing, belief of developing future UI, difficulty in stopping urine stream, and remembering names. (40)

A cluster randomized trial was conducted in the United Kingdom (UK). Clustering was performed at the organisational level and women were 60 years or over who had UI at least weekly. The three interventions tested involved: continence education, self-management including a UI risk reduction tool, and a combination of education and self-management. A control group received information about memory loss, polypharmacy and osteoporosis. Women in the combined intervention group reported the highest rate of UI symptom improvement (66% versus 11% in control group). (41) A multi-national study to decrease stigma from UI and falls in older women has been reported in the literature; preliminary results are not available. (42)

3. PREVENTION OF FAECAL INCONTINENCE

Prevalence of FI in adult women and men is similar (median 8.1% range 2.3%-16.1% and 8.9% range 2.0%-20.7% respectively). (43) Dual incontinence was reported as more prevalent in women: 6% 95%CI, 5.0-7.1% versus 1.9% 95%CI, 1.4-2.7%. (44) FI prevalence increases with age (43) and is often under-reported. (44) Consultation for help with FI and physician screening are relatively low with many consumers unaware of available treatment and physicians reporting time as a barrier to screening. (45)

Risk factors associated with FI are reported by Committee 16: FI: Conservative Treatment. Prevention of FI remains important, research is needed to determine the effectiveness of population-based interventions focusing on increasing awareness about risk factors for FI.

Summary

Primary prevention of urinary and fecal incontinence is in its nascent stage but changing global demographics are driving the need to develop effective primary prevention interventions across the human lifespan. Foundational evidence has demonstrated that modifiable risk factors exist across multiple levels: intrapersonal, environmental, and societal. High quality RCTs are needed in both men and women across the lifespan to develop evidence for the effectiveness of population and individual-level primary prevention intervention for UI and FI.

Levels of Evidence/Recommendations

- Pelvic floor muscle exercises can prevent UI in pregnant and postpartum women. (Level of Evidence: 1)
- Education designed for community-dwelling older women can prevent UI. (Level of Evidence: 1)
- No recent RCTs or case-control studies were located for prevention of FI. (Level of Evidence: 4)
- Pelvic floor muscle exercises should be provided to pregnant women. (Grade of Recommendations: A)
- Education to older women to prevent UI should be provided. (Grade of Recommendations: A)

III. CONTINENCE AWARENESS, PROMOTION AND ADVOCACY

Literature Search is found in Appendix 1.

1. BACKGROUND

According to the World Health Organisation, health promotion is, "the process of enabling people to increase control over, and to improve, their health. It moves beyond a focus on individual behaviour towards a wide range of social and environmental interventions" (http://www.who.int/topics/health_promotion/en/)

Efforts to promote awareness about incontinence and its treatment can be enhanced by adopting evidence-based theories and methods from the field of health promotion and by heightening awareness of the World Health Organisation social determinants of health. (46) Health promotion frameworks can be

used to plan and evaluate the effectiveness of strategies and programmes used to promote continence.

2. RAISING AWARENESS AND UNDERSTANDING

Consumer education is a critical component of effective continence promotion. Education of individuals with, or at risk of, UI and/or FI, their family members or informal caregivers, and healthcare professionals increases awareness about incontinence and the benefits of prevention and management. The goals of consumer education are elimination of stigma, promotion of help-seeking, and reduction of suffering. (47)

Using a quantitative descriptive design, Day et al (48) surveyed 50 community-dwelling women's knowledge about UI. Findings revealed that the women had poor knowledge, principally in relation to UI risk factors (38.8%), prevention (40.5%), treatment (39.4%) and management (49.4%), suggesting that women have unmet educational needs related to UI and indicating an area for improved consumer education. (48) According to a qualitative analysis of open ended questions from a survey of 1,458 women with UI in Washington State, women had a range of different interpretations and understanding about the causes of UI, with many believing it was a normal part of being female. (49)

An important aspect of continence promotion involves dispelling the pervasive myth that incontinence is an inevitable part of aging. Spencer (50) described a pre-post evaluation of an education programme for women with UI and found education alone was insufficient to alter women's beliefs. The researcher emphasized the need for more engagement about the topic, and to consider individualized learning needs.

Clinicians play an important role in encouraging discussion and providing information about UI (51) and can empower an individual to make changes and set goals for UI self-management. (52)

Muller's review of findings from several epidemiological surveys of community-dwelling adults with bladder control problems in the U.S. indicated that women look first to their doctors to serve as their primary pelvic health educators found that having a general practitioner (GP) was one of many factors that increased help seeking for UI. (53) Muller concluded that improved patient-doctor relationships and public education may foster healthcare seeking behaviour because the vast majority of women who had not sought healthcare for UI believed, at least in part, that there were no available treatments.

In a convenience sample survey of 360 women in Israel, researchers found that women who suffered from UI and those who were older generally had more knowledge about UI including causes and treatments. (54) Another small focus group study with African

American and Latina women in the U.S. demonstrated general misconceptions about causes of pelvic floor disorders, symptom and treatments. (55) Participants were eager to gain more information, particularly to share with their daughters, and identified placing family demands before their own health needs as a barrier to seeking care. An online survey study of 1,092 adolescent and young women aged 19-30 years enrolled at a university in the U. S. revealed that those in the 25-30 year age cohort were more likely to have received information about UI, FI, and POP. (56)

Some countries governments provide support for continence promotion but much of the health promotion effort related to continence issues is undertaken by professional bodies, non-governmental continence organisations, and advocacy groups. The ICS provides information about peak bodies and advocacy organisations that are active in the area of health promotion, advocacy and represent the interests of people with, or at risk of, incontinence (<http://www.ics.org/SiteLinks.aspx>). Through the activities of these organisations and with the engagement of external stakeholders such as educational, health-care, and community service providers, these organisations aim to increase community awareness and understanding about incontinence, reduce social stigma, and raise public awareness about risk factors and options for managing incontinence.

Consumer knowledge about FI is also generally limited. Patel et al (57) conducted a content analysis of comments from 89 community-dwelling adults with FI to examine their continence literacy. The findings indicated that while many consumers had a significant emotional component to their experience of FI their knowledge about terms to use to describe their condition was often limited. (57) (58) (59) (60)

As part of a larger study that used a postal and internet survey conducted with members of a National Crohn's and Colitis Support Group, Norton and Dibley (61) investigated factors that influenced help-seeking in people with inflammatory bowel disease (IBD) related FI, and their needs or desire for continence services. The most commonly cited reasons for not seeking help were: a lack of knowledge about from whom to seek help, how to seek help, and where to seek help.

2.1. Use of the Internet and Social Media

The internet is frequently searched for health information, and coverage of relevant health topics is growing. The benefits of acquiring health information via the internet include its wide accessibility, anonymity, and informality with eight in ten internet users in the U.S. looking online for health information. (62)

Amante et al (63) investigated access to care and use of the internet to search for health information using data from the 2011 National Health Interview Study (NHIS). Of 32,139 adult respondents, 43.55%

(13,997) reported searching the internet for health information. These authors suggested that a main reason for the widespread use of the internet to obtain health information was users did not consider their questions severe enough to warrant the effort or time to obtain routine, urgent, or emergent clinical attention.

Evaluations of internet based information about incontinence suggest the internet may prove to be a useful tool for consumer education and public health outreach particularly in light of the reluctance of those affected by stigmatized illnesses such as incontinence to seek treatment or to ask health care professionals for information.(64) (65) (66) For example, in a study of 208 people attending GP appointments in the UK conducted by Al-Shammmary et al (64) the majority of people who used the internet felt able to discuss UI with their GPs or with the practice nurse, suggesting that information gleaned from the internet helped consumers make decisions about seeking help. Forty-five percent of respondents used the internet before consultation for the purpose of self-diagnosis. Mazloomdoost et al (65) evaluated the use of social networking and internet use as a source of information about pelvic floor disorders among women who presented to a clinical practice for female pelvic medicine and reconstructive surgery. The majority (75%) reported high internet use, with 53% using the internet or social networking to learn about their pelvic floor condition. Saiki and Cloyes (66) conducted a content analysis of publicly archived blog texts from 19 women living with UI. The findings revealed a focus on securing social connection and a place in the human community. Thus, blogging may offer women with UI a means by which they can safely disclose their condition and socially connect.

Some researchers have questioned the quality of continence information on the internet and social networks, and have suggested that validation is needed. (67) (68) (69) In 2001, Diering et al (70) evaluated the content, credibility, and function of 15 websites with UI content that had been developed by professional health care organisations for use by healthcare providers. The researchers concluded the internet served as a useful resource for 'state-of-the-art' knowledge about UI that health professionals can use to update their knowledge but also cautioned users to critically evaluate content. Using the World Health Organisation 'Health on the Net' (HON) principles, Saraswat et al (68) evaluated 150 websites using 17 commonly used terms for 'female UI' in English, French, German and Spanish, and compared website sponsors. The total number of websites for each term was variable, however 'female sling surgery', had the most websites (18 million), followed by 'incontinence surgery' (9.8 million). The most commonly encountered sponsors were physicians/surgeons (37%), followed by commercial sites (30%), government organisations or educational institutions (20%), and non-profit organisations (5%). The findings highlight the importance of assessing the quality and validity of in-

ternet health information, particularly as many websites also act as a platform for advertising. An evaluation by Dueñas-Garcia et al (67) of 13 patient-focused websites addressing treatment options for POP and stress UI also raised concern about the quality of information available to consumers. Using the DISCERN instrument, a validated instrument to assess the quality of written consumers health information relating to treatment options, the researchers reported available English-language professional websites written to inform patients about management choices for SUI and POP omit key components of quality patient information. (67)

Sajadi and Goldman's (71) study to assess the quality of incontinence resources available among social networks, also showed that most websites providing UI information were not certified by an accrediting body. Using the term 'incontinence', the researchers searched for information on Facebook, Twitter, and YouTube, to evaluate its usefulness. Their conclusion was that while social networks have great potential for consumers with incontinence to connect with each other and find medically informative resources, there was insufficient useful UI content, especially from healthcare professionals and incontinence organisations. Social network sites are a key future source of information for consumers about incontinence, and medical professionals and societies should target these avenues to reach and educate consumers. Healthcare professionals, Continence organisations, and recognised advocacy organisations have a key role to play in assisting consumers to find reliable information about UI by providing details of reputable web sites and by playing a role in interpreting findings from high quality research and reframing them for consumption by the general public.

Although the internet has changed how many people access health information, internet access is far from universal, especially in developing nations, among older and poorer sections of society in developed nations, and among people with low levels of education and lower socioeconomic status. (72)

In both developing nations and in countries with limited health systems and dispersed populations, innovative methods are needed to disseminate information about incontinence, such as through community nursing infrastructures and lay health workers.

Summary

Based on survey and qualitative data regarding consumers' understandings and knowledge of incontinence, the general public has limited knowledge about incontinence. The effectiveness of strategies to promote awareness about incontinence and its treatment can be enhanced by adopting evidence-based theories and methods from the field of health promotion, and should be underpinned by awareness of the social determinants of health. Consumers increasingly access the internet for health information but the

quality of information about incontinence may be variable. Clinicians and continence promotional bodies play an important role in helping consumers find high quality reliable information. The majority of publications on Continence Promotion and Programmes are qualitative or mixed methods designs and the Oxford Level of Evidence does not recognize.

Levels of Evidence/Recommendations

- Continence promotion is required to address broad gaps in knowledge about incontinence (Level of Evidence 3)
- Strategies to promote awareness about incontinence and its treatment can be strengthened by the use of evidence based theories and methods from the field of health promotion, including the social determinants of health (Level of Evidence 4))
- The internet represents an important source of information about incontinence, however the quality of information may be variable (Level of Evidence 3)

IV. HELP-SEEKING (CARE-SEEKING) BEHAVIOUR

Literature Search is found in Appendix 1.

1. BACKGROUND

Help-seeking for UI is not well-understood likely due to the lack of rigorous exploration of this behaviour. Despite increased awareness among healthcare providers and consumers of healthcare, a survey comparing help-seeking behaviours conducted sixteen years apart (1991 and 2007) revealed that there had been virtually no increase in the proportion of women seeking help for LUTS. (73)

A Model of Pathways to Treatment (74) offers a framework to explore the existing literature on the barriers and facilitators to seeking care and sex-differences in help-seeking. This model proposes four sequential time intervals in the process of receiving treatment: 1) appraisal, 2) help-seeking, 3) diagnostic, and 4) pre-treatment. During the first time interval the person detects bodily changes. These changes may be appraised as a normal change or abnormal, a symptom of an underlying condition. If the person decides the bodily change is abnormal, s/he is motivated to seek help from a healthcare provider for one of two reasons: 1) concern that the change is from a serious underlying condition; or 2) due to the consequences of the change. During this time interval, the person considers seeking help from a healthcare provider based on the outcomes of their appraisal of the

symptoms and their self-management. Situational, contextual, and social factors can play a role during this phase in creating facilitators and barriers to seeking help. Once the person makes the first consultation from a healthcare provider, the diagnostic process begins, and afterwards, treatment is initiated.

For the purpose of this section, two time intervals are the focus of this section: 1) detection and appraisal of bodily changes related to UI; and 2) self-reported reasons to discuss symptoms with a healthcare provider. Using non-health professional and indirect resources (such as blogs, chat groups, and website) was considered to be self-management, not help-seeking behaviour.

The research questions are:

- a) What factors act as barriers/facilitators to help-seeking for UI?
- b) Do sex differences exist for help-seeking for UI?

2. FACTORS THAT ACT AS BARRIERS / FACILITATORS TO HELP-SEEKING

Since the 5th ICI edition, multiple descriptive studies were located noting that intrinsic and extrinsic factors can act as barriers/facilitators to help-seeking for UI. More information about help-seeking behaviours in women across the adult lifespan than for men was retrieved.

Intrinsic factors associated with barriers/facilitators:

Findings from a qualitative research study has described a process that takes place and influences decisions to seek treatment (or not), whereby adults affected by chronic, non-life-threatening conditions, weigh the perceived costs and benefits of treatment (in terms of discomfort and inconvenience as well as financially) against the effect of the condition on QoL. (75) In semi-structured interviews with 22 older people, three themes emerged: "being brushed aside," "putting up with it," and "something has to be done." (76) The authors noted that an important trigger for seeking help for incontinence was healthcare providers' confirmation of continence problems. Thus the role of healthcare professionals acting as facilitators to help-seeking care was emphasized.

An integrative literature review of help-seeking behaviours for UI symptoms among non-institutionalized women of all ages indicated that less than 38% of women sought help for their UI symptoms. (77) In women with UI, some (n=119, n=27.4%) said they do not report UI because it is a small or insignificant problem and that they can self-manage it.¹⁸ This perception can change over time with worsening of symptoms and increased continence pad use. For example, female patients from a urogynaecology practice with SUI reported that UI was perceived as a

problem about 4.7 ± 5.4 years after its onset. In this study, women waited an average of 13.28 ± 12.3 years to seek help. (78) In a population-based study, the rate of help-seeking was associated with increasing age (i.e. women over 70 years: 1.2 versus women between 50-59 years: 0.02). (79)

Fifty-eight men and women participating in the Boston Area Community Health Survey (BACH) also participated in focus groups about urinary symptoms, their attitudes and beliefs about the symptoms, and help-seeking behaviour. Worsening and longevity of symptoms, fears of underlying serious disorder, and increasing bother were reasons that prompted them to seek help. (80) Characteristics of women who sought help for UI participating in a longitudinal study in France included talking with others (i.e., family or friends) and having severe UI, mixed UI, weak social support, and neurologic disease. (81) Communication issues after women decided to seek treatment from physicians for UI was identified as a barrier to receiving care. This finding resulted from focus groups with an ethnically diverse sample of women in the U.S. The women also had expressed frustration with the level of information about UI and its treatment. (82)

3. KNOWLEDGE, ATTITUDES, AND BELIEFS ABOUT UI

Women's knowledge, attitudes, and beliefs about UI have been long thought of as both barriers and facilitators to help-seeking behaviours. Many women believe UI is a normal part of aging (83) (84) (85) (86) and did not seek help for what they perceived as a non-problem. Other women who participated in a survey in Korea noted that they were embarrassed by being incontinent and did not seek help, but women who did not have UI said they would consult with a healthcare provider should they develop it. (83) In another study, women (61.9%) have also reported one reason for not seeking help for UI was that they hoped UI would spontaneously disappear (similar to findings by Buurman and Lagro-Janssen, (87) but interference with prayer and sexual, physical, and social activities were reasons to seek help. (88) Using the Theory of Planned Change, researchers found that help-seeking intention can be predicted. They also found that high perceived self-efficacy in managing symptoms could act as a barrier to seeking help. They postulated that women viewed themselves as managing well and not needing help from others. (89)

Women (age range 42-94 years) who had high literacy levels had significant knowledge deficits and a poor understanding of pelvic floor disorders, including UI. Although this study had a small sample ($N=36$), the authors drew implications about women's ability to give informed consent because of the complexity of pelvic floor disorders and the difficulty in understanding them. (90) In another study, knowledge deficits about UI were found to exist in women across all

ages, income levels, and races. (91) A study of high-school and college age athletes in the U.S. found that more than 25% of the young women surveyed experienced UI during strenuous physical activity, but 90% had never reported their symptoms to anyone. Further, 91% had never heard of PFM exercises, indicating a lack of knowledge about UI and pelvic floor functioning. (92)

Reasons women who were postpartum gave for not seeking help were: low priority, belief it was normal part of childbirth, and feeling ashamed. (87) Among women with gynaecological cancers who experienced concomitant LUTS, the failure to seek help was attributed to a perception that the LUTS were not perceived by the women as serious enough symptoms to warrant attention and to their lack of awareness of treatment options. (93)

Racially diverse women (i.e., African American and Caucasian) in telephone surveys in the U.S. reported that they did not seek help for UI because they believed there were no available treatments. (94) Another study with an ethnically diverse group of women (median age 34 years) found that the women held similar attitudes about UI. No differences were found among the women based on ethnicity in agreeing that good treatments for UI existed (OR, 0.91; 95% CI, 0.33–2.6). (95) Authors of a systematic review on perceptions about female UI however concluded that similarities existed among women from different racial and ethnic groups in terms of managing UI but their perceptions about UI differed. (96)

From the literature reviewed, knowledge deficits along with varying attitudes and beliefs that normalize UI or created emotional responses of embarrassment (97) (98) (99) about UI acted as barriers to help-seeking.

Level of severity and bothersomeness of UI symptoms and consequences of symptoms

UI severity in women between 58-70 years was the main reason for reporting UI to a healthcare provider. (81) Women had greater odds of getting treatment for UI when their symptoms had become more frequent (adjusted OR, 3.16, 95% CI, 1.15–8.67) and bothersome (adjusted OR, 1.09, 95% CI, 1.01–1.18) in the prior year. (100) Another study found however, that bother from UI mediated the relationship between UI severity and help seeking behaviour. Thus women who perceived bother sought help for UI regardless of the level of severity. (101) Bother, as well as concern about a serious underlying condition, was also a reason to seek help for women between 45 - 65 years living in Iran while neglect, embarrassment, an assumption that UI was caused by aging, and economic issues acted as barriers to seeking help. (102) The literature revealed that more severe UI and bother from UI can act as facilitators to help-seeking.

It is difficult however to generalize findings among studies because different definitions for help-seeking and instruments were used, although it appears there

are common findings including age, type and severity of UI, and feelings of embarrassment are significantly related to barriers to seeking care. (103)

In a study conducted with men (N=1240), with a mean age 63.3+12.7 years, who sought help for LUTS at a urology clinic, subjects were asked by a physician before evaluation to select the most bothersome symptom. Nocturia accounted for 32.9% of initial complaints and it persisted in approximately 50% of men over time. (104)

Men over 50 years old (n=18) who had visited their GPs were asked to participate in semi-structured interviews about reasons they sought help with LUTS symptoms. The researchers found that men could be grouped into 3 categories: those who were concerned about cancer, those who found the symptoms a nuisance, and those who were prompted to seek help after seeing public information about LUTS. (105)

4. EXTRINSIC FACTORS THAT ACT AS BARRIERS/FACILITATORS TO HELP-SEEKING FOR UI

Women with low incomes (i.e., \$30,000 USD annually) were less likely to discuss UI with a healthcare provider, even though they had health insurance, than women at higher income levels. (18) The authors of the study noted that other factors such as high copayment and family and job responsibilities hindered making and attending healthcare appointments. (18) Costs of care and inconvenience created barriers for American Indian older women (average age 77.7 years \pm 9 years) living in southwestern U.S. Inconvenience and fear, as measured by the Barriers to Incontinence Care Seeking Questionnaire (BICS-Q), created barriers for Latina women as compared to Caucasian and African American women, (106) indicating that cultural and social factors play a role in a woman's decision and ability to seek care. El-Azab and colleagues (107) found that encouragement from husbands as well as having severe UI, and the desire to be able to pray, were associated with an increased likelihood of help-seeking behaviour in Middle Eastern women.

Social and cultural attitudes were cited as barriers to help-seeking (3) and this issue appeared to cross many cultures. For example, in one study, social rejection indicated higher level of intention to seek care among Chinese women (age range 40-65 years), (36) thus acting as a facilitator to help-seeking. The effect of stigma influenced attitudes towards help-seeking in women who were visiting at a health care centre who also responded to a survey. The researchers found that internalized stigma, social isolation, and internalized shame had a direct negative effects on help-seeking attitudes. (108) Other social factors lead women to hiding incontinence. Women reported fear of smelling like urine, fear of not being

supported by those close to her, and being discriminated against were reasons not to seek help for UI. (109) Social factors however can facilitate help-seeking. Help-seeking for LUTS in Taiwan increased from 23.1% in 2000 to 38% in 2009. (110) The authors noted that the rapidly aging society and concerted efforts by the government and other organisations to increase awareness of LUTS were driving factors to this increase in help-seeking. Research ideas solicited from citizen juries composed of women who lived in New Zealand included research to make help-seeking and receiving treatment for UI easier for women. (111)

5. SEX DIFFERENCES FOR HELP-SEEKING BEHAVIOURS FOR UI

No studies that directly compared sex differences in help-seeking behaviours for UI were located. Teunissen and colleagues (112) interviewed 56 men and 314 women aged 60 years and older who were living independently in the community with "uncomplicated UI". Men reported higher UI impact scores than women, despite their UI being less severe than that of women. The most important effect of UI reported by men was, "being out of control," while most women considered, "feeling compelled to take several precautions" to be the most important consequence of UI.

To better understand the experience of the social context of UI, men and women participating in BACH, were recruited to participate in focus groups. Both men and women who had UI feared detection by others; men were concerned about being perceived as going to the toilet too frequently as compared to women in the same study who reported concerns about cleanliness and caring for her body. (113)

An internet survey administered to men and women aged 40 years and over in the U.S., the UK and Sweden, noted that of the men and women who reported LUTS, less than a third of respondents reported seeking treatment. (114) Eighty-three percent of men and 89% of women who had multiple symptoms including storage + voiding + post-micturition LUTS also had high rates of bother. Correlates for treatment seeking for both sexes included bother. Women, however, were more likely to report bother from storage symptoms and with combined symptoms (e.g., storage plus voiding or post micturition). In another study of men, 44% of those who reported having UI had sought help and of those, 57% sought help within 6 months of onset of symptoms. The authors noted that perhaps men reported these symptoms earlier than women because of higher level of bother and negative impact on QoL. (115) Secondary analyses of a dataset of adults between 20-94 years who had heart failure revealed sex and age differences. Younger men were more likely to report UI than younger women while the rate of help-seeking was similar between older men and women. (116)

Sex-differences in help-seeking behaviour can exist and research to determine the barriers and facilitators that are shared and differ between the sexes are needed to develop effective strategies to encourage early help-seeking for UI.

Summary

The lack of an accurate denominator to determine the rate of adults who have UI undermines efforts to determine the proportion of adults with UI who seek help from healthcare providers for it. UI affects health-related quality of life (HRQoL) and is associated with activity impairments when compared to continent adults, (117) thus eliminating and minimizing barriers and reinforcing factors that facilitate help-seeking across the lifespan and culture and are sex-specific should be a priority in UI research.

The literature reviewed supported the Model of Pathways to Treatment in that adults reported that they decided that bothersome or severe UI led them to seek help from a healthcare provider for UI symptoms and their consequences. Respondents to surveys also reported that extrinsic factors created significant barriers. Help-seeking is a complex behaviour with multiple factors including social and cultural ones, playing a role. Inclusion of qualitative methods to better understand how men and women who have UI think about and make meaning of bodily changes such as urinary leakage and how they think about the symptoms and their consequences is needed to create foundational research that will lead to help-seeking interventional research. Common terminology and validated instruments are essential to advance knowledge. Analyses that examine sex-differences in factors that act as barriers and facilitators to help-seeking are also needed.

Levels of Evidence/Recommendations

- No RCTs or case-control studies for help-seeking behaviour were located (Level of Evidence 4)
- Recommendation: No recommendation was possible based on the level of evidence provided by the available research.

V. CONTINENCE PROMOTION PROGRAMMES

Literature Search is found in Appendix 1.

1. BACKGROUND

Continence promotion programmes vary across countries and cultures, but all share the same aim of increasing awareness and understanding about incontinence. Efforts to raise awareness of continence

issues need to consider the age, gender, and culture of target populations and the key health messages that are being delivered. It is necessary to consult with relevant groups when planning programmes in order to meet the needs of these groups and to enhance health seeking behaviours. Continence promotion programmes need to provide key health messages in the delivery of information about the risk factors and the management options for incontinence, and identify gaps in current information available to different target groups. Different populations likely have different informational needs.

Examples of successful campaigns include the community-based interactive continence promotion workshops conducted in pre-post evaluative study of 90 women in Canada, which were well-received by participants and which changed knowledge, attitudes, skills, and increased rates of help-seeking behaviours. (118) A similar study reported pre and post-evaluation findings from 50 women who attended a nurse-led educational workshop. Symptom and QOL scores significantly improved from baseline to 3 months (Pelvic Floor Impact Questionnaire: mean difference=14.2, $p=0.005$, 95%CI 4.7–23.8; Pelvic Floor Distress Inventory: mean difference=17.4, $p<0.001$, 95%CI 8.3-26.5). (37)

Newman (119) conducted a survey of 422 women in the U.S. in order to understand the current patient-professional relationship that could improve communication about continence issues. Respondents indicated they wanted more information about incontinence, and for healthcare professionals and organisations to supply this information to them.

2. CREATING PUBLIC AWARENESS

The use of the internet to find information about UI and its treatment was discussed earlier in this chapter. The internet can also be used to create public awareness. In addition to the internet, public awareness can be increased through print media, television and radio, telephones, and other mobile devices. (120) Specialised health publications developed for different groups in the population have the potential to offer valuable channels for dissemination of evidence-based continence advice. Media channels can also be engaged to disseminate information about incontinence. Journalists often use a “media hook,” i.e., an interesting story that will take priority over other news on the television, radio, or in the newspaper or magazines. In addition, having a spokesperson affected by incontinence or finding a celebrity willing to speak for the cause can help increase awareness. (59) These individuals can act as “influence leaders” or “ambassadors” for organisations.

Continence services play an important role in raising public awareness about incontinence. A study that evaluated health education and public awareness programmes in the UK from 1993 to 1996 in two

health authorities found the availability of a continence service significantly increased information on how to deal with urinary symptoms. (121) This finding highlights the need for clinicians to provide health promotional information about incontinence as part of their service.

3. HEALTH LITERACY

Health literacy related to UI was considered an important component to the delivery of consumer education. The terms “continence” or “incontinence,” “interstitial cystitis,” or “painful bladder syndrome,” and “pelvic organ prolapse” may be poorly understood (122) and simpler terms may achieve greater public recognition across many languages and cultures. The use of “overactive bladder (OAB)” in advertising has increased reporting of the condition to primary care professionals in the U.S. Palmer and Newman (123) reported on a U.S. health promotion project to determine the needs of senior citizens concerning bladder control issues. Focus groups of older adults attending health seminars in urban, community and church settings were conducted. The primary objective of the project was to determine older adults’ understanding about general health and their beliefs about UI. The 82 participants were predominantly African-American women representing all socio-economic levels. These older adults expressed confusion when asked if “overactive bladder, bladder control issues, and UI” were the same condition. An evaluation of Australia’s National Continence Management Strategy in 2006 suggested that consumer education would be strengthened by identification of the most appropriate terminology within key messages to strengthen awareness raising strategies. (124) (125) For example, public education trials have shown improvements in understanding about terminology for prostate disease (108) and sexual health and sexual function. (126)

In the UK, campaigns and consumer literature often avoid clinical terms in favor of lay terms that focus on the need to use the toilet often, worrying that one may not make it to the toilet on time or have “leaking” of urine or feces. In the area of bowel disorders such as FI, people found it difficult to find the right words to discuss their symptoms. (60) The International Foundation for Functional Gastrointestinal Disorders (IFFGD) in the U.S. reported that people with FI will often report having diarrhea to their physician, but do not disclose symptoms of FI. Without the physician or nurse asking direct questions about the ability to control gas, liquid, or solid stool, FI may not be detected.

Lack of understanding about terminology and physiology may lead to difficulties with communication between patients and providers. A survey of 138 women attending continence clinics in the UK, Australia, and Italy found over 20% of women were unsure of the meaning of basic continence terminology commonly used by health care providers. (127)

Terms tested in the study included “daytime frequency, nocturia, urgency, UUI, SUI, and hesitancy.” Two studies further highlighted confusion and lack of knowledge about LUTS. Smith and colleagues (128) conducted focus groups with women who experienced overactive bladder (OAB), and found high levels of misunderstanding about symptoms and physiology, and miscommunication between patients and providers. These findings were most pronounced among the older women who participated in this study. Senekjian and colleagues (122) corroborated these findings and recommended that public health campaigns about UI and other pelvic floor disorders should use terminology targeted to consumers who may have basic understanding.

Hougardy et al (129) reported a double-blind RCT in which 129 women in Belgium were randomized to receive an informational leaflet with explanatory information about urodynamic consultation or to a group that did not receive such information. No significant differences in overall satisfaction between groups were found regarding understanding the procedure and reducing patient anxiety.

By contrast, a pre-post survey of 151 women in Canada who had received both written and verbal information about urodynamic investigation prior to the procedure found that 78.1% felt they understood the indications for the testing. (130) Fewer felt they understood what the procedures would involve (68.2%) or that they had enough information about the tests (64.9%). Many women expressed anxiety or embarrassment about undergoing the procedure. A Swedish population-based study found that the distribution of a brochure on UI to the general public was well received and can be an efficient method to spread knowledge and encourage self-management. (131) Another study found that although recall about diagnosis information presented during an initial physician visit can be variable, the visit had enhanced understanding about available treatment options. (132)

4. PROGRAMME EVALUATION

Evaluating the effectiveness of health promotion programmes is a complex endeavor. Evaluation methods should be established *a priori* to implementation of the continence promotion programme. Evaluation should include both quantitative measurements and qualitative measures. According to the findings of a RCT of 145 family members regarding their satisfaction with an intervention to improve incontinence and mobility care for their relative in a NH, open-ended questions rather than “direct satisfaction” questions regarding continence care may elicit detailed and relevant information about the programme.(133) Health promotion evaluation methods include process evaluation, impact evaluation, and outcome evaluation.

Research-based evidence for the effectiveness of programmes aimed at raising awareness of conti-

nence issues or at improving help-seeking behaviours is rare. (134) A number of studies have considered the effectiveness of leaflets or brochures in raising awareness about UI and about treatment options. While the studies were generally supportive of this information, evidence was contradictory in some areas and far from conclusive. In a quasi-randomized controlled study of 1,175 participants, Wagg et al (135) reported that a self-help standard treatment leaflet was as effective as structured help from a continence nurse in reducing bothersome urinary symptoms in women. An Australian study evaluated whether an information leaflet influenced the help-seeking behaviours of 111 people with UI who had reported being bothered by UI, and who were from a broad cross section of patients from acute, subacute, and community settings. Of the 111 people who were able to be contacted, 44.1% indicated the leaflet had influenced their decision to seek help. (136) In a subsequent study using a similar design, O'Connell and Gaskin (137) evaluated the effects of an information leaflet on the health seeking behaviours of 55 people recruited from the waiting rooms of primary care practices in Australia. When interviewed two weeks later, 59% reported they had taken action to manage their UI, and 67.7% reported having done so as a result of the leaflet.

An early health promotion project called '*Dry Expectations*' was developed and implemented in six ethnically diverse, predominantly minority, and inner city senior centres in the U.S. (138) The programme was designed for an older population. The project consisted of three phases: orientation and training of key staff members/peer educators at the centres (train-the-trainer model); educating seniors through four one-hour weekly sessions involving visual aids and completion of bladder records and quizzes; and follow up sessions with senior staff/peer educators to reinforce the previous training. The programme was very well received by the participants and approximately 80% felt they had more control over their bladder by the end of the last session.

Tuckett et al (139) synthesized evidence from intervention programmes or actions that provided information or attempted to raise awareness about men's bladder and bowel health. The reviewers identified twelve RCTs and two before-and-after studies were identified. Because of the broad nature of the eligibility criteria, the studies addressed: (i) PFM exercises for prostate cancer, (ii) post micturition dribble, (iii) LUTS: (iv) evidence-based guidelines for the management of UI and/or FI. However, none provide specific outcome data to determine the relative effects of education or awareness raising activities. The reviewers concluded 'there is little quantitative evidence for the effectiveness of interventions to improve men's awareness of bladder and bowel health.' (139)

Summary

Based on findings from qualitative and case series research, terms used by clinicians may be poorly understood by consumers. One RCT evaluated different methods of obtaining information about satisfaction with continence care, (133) showing strong support for open-ended questions. Two RCTs, (140) (129) one quasi RCT (135) and four case series studies (131) (136) (137) (130) evaluated the effects of education using promotional material. Results were inconclusive. According to the findings of a synthesis of evidence, little is known about the effectiveness of educational and awareness strategies using various methods to raise awareness about bladder and bowel health among men. (139)

Levels of Evidence/Recommendations

- Continence promotion programmes need to accommodate varying levels of health literacy and access to health information in different populations (Level of Evidence: 4)
- Public health campaigns about incontinence and other pelvic floor disorders need to use terminology targeted to consumers' understandings (Level of Evidence: 4)
- Satisfaction surveys about continence care could yield relevant and detailed information by using open-ended, rather than closed-ended questions (Level of Evidence: 1)
- Evidence for the use of leaflets or brochures in raising awareness about UI and different treatment options is inconclusive (Level of Evidence: 1).

VI. CONTINENCE ADVOCACY

Literature Search is found in Appendix 1.

1. BACKGROUND

Advocacy is defined as the act or process of defending or maintaining a cause or proposal. Advocacy, as it pertains to incontinence, involves assisting individuals to find necessary health care and treatment. Organisations composed of professional and public members promote continence advocacy as a core mission.

2. CONTINENCE ADVOCACY WORLDWIDE

A central goal of most continence advocacy organisations is raising public awareness and understanding about the types of incontinence, risk factors for incontinence, and available treatments, services, and management products. These organisations provide

a public voice for an unheard consumer population in political and health-care governance, development, and planning processes. In recent years, consumers and clinicians have been involved in identifying and prioritizing important areas of research relating to incontinence in order to inform research development and funding decisions. (141) (111) In addition, through advocacy organisations, consumers of health care have become more closely involved and influential in the activities of clinical professional organisations.

Another major role adopted by many continence organisations is the direct provision of information support to those affected by incontinence and their caregivers. The types of information provided include information about symptoms, risk factors and associated conditions, treatments and management strategies, and availability of, and access to, health and social services. Such information is provided through a variety of sources, including consumer-oriented magazines, internet-based information resources, telephone support lines (often staffed by qualified nursing or counseling staff), and printed media such as leaflets and booklets on a wide variety of topics. Other innovative strategies have included outreach work through travelling information roadshows and events. (142) Organisations also provided emotional supports to people with incontinence by putting them in touch with others similarly affected either through direct contact at meetings or through internet discussion forums.

Continence organisations reviewed varied in scale and in nature, from small consumer or clinician groups that focus on quite specific bladder symptoms or conditions, to large and well-funded national organisations that address bladder problems as a peak body. Often the founding and development of such organisations resulted from the dedication of a small group of consumers, clinicians, or both, that worked to promote awareness and understanding of incontinence among the public and healthcare providers and to provide optimal services and support to those affected. These organisations represented a wide diversity of models, including consumer-led, company-sponsored, consumer-only, professionals-only, and organisations which have deliberately set about trying to bring together all relevant stakeholders in a relatively democratic model. Globally, these organisations played a dynamic role in building both public and professional awareness of this underserved and underreported condition.

Funding

The degree of funding available inevitably affected the level and scope of work. In some countries, such as Australia and to a lesser degree New Zealand, continence support organisations have government support for their work. In other countries such as the U.S. and UK, financial support generally came from charitable donations from individuals and founda-

tions, or through the support of the pharmaceutical industry and continence products manufacturers. Most continence organisations believe that more funding from any source will improve advocacy work but there is no evidence to support this.

Summary

Advocacy is necessary for people who have incontinence and many organisations have advocacy as their mission. A wide range of models of continence advocacy, including collaborative models that bring consumers and different groups of health professionals together, existed. Little research regarding formalized evaluation on the effectiveness of these organisations was located.

Levels of Evidence/Recommendations

- Evidence for the impact of continence advocacy worldwide was based on opinion (Level of Evidence: 4)
- Worldwide Advocacy (Grade of Recommendation: None)

VII. MODELS OF CARE, DELIVERY AND ACCESSING CARE

Literature Search is found in Appendix 1.

1. BACKGROUND

A large cross-sectional community mail survey of women with UI in France, Germany, Spain, and the UK found that many women preferred to be treated for UI by their primary care providers, despite easy access to specialized services. (143) Appropriately trained continence nurses and physical therapists appeared able to provide quality UI care for women. In other studies, women were satisfied with care provided by continence nurses. (144) (145) (146) In the U.S., the health care of older adults who experience UI and FI was provided by PCPs. Drennan and colleagues (147) interviewed thirty-two caregivers about their strategies for managing older adults with UI and dementia. They recommended that professionals, especially those in primary care, should be more proactive in questioning patients about UI and toileting habits to identify counter-productive and harmful strategies. Need exists to consider specialist roles, responsibilities, and protocols to guide appropriate referrals and ensure good collaboration.

Implementation of integrated service mandates can be challenging due to infrastructure limitations and other barriers. To oversee all these problems, a study aimed to provide an evidence-based specifica-

tion for the procurement and organisation of continence care was conducted. Evidence was gathered through a systematic literature review and semi-structured interviews resulting in the Optimal Continence Service Specification (OCSS). (148)

(153) This finding may also have been influenced by the context of care and educational level of the woman (152) or associated with the desire for adequate clinical information rather than for active treatment decision-making. (154)

2. NEED FOR SERVICES

No published studies directly compared the effectiveness of specific delivery systems for continence care. Although the Optimal Continence Service Specification (OCSS) produced guidance to service delivery, evaluation of effectiveness of services remains under-investigated.

Knowledge and attitudes about UI and care may influence consumer choices regarding services. Some studies suggest that as QoL worsens, care-seeking increases. (149) In some cultures, particularly those where living with extended family is more common, UI may be viewed as a family issue rather than a disorder affecting just one family member. (150) Family support was often seen as an important component when dealing with UI. (151)

In some studies, many women preferred to take an active role in their own UI care. For example, a survey of 265 Norwegian women with UI, O'Donnell and Hunskaar (152) found that 60% of women wanted to be actively involved in their UI care decisions, compared to only 38% for their general health care needs.

Table-1: Optimal Continence Services Specification Recommendations

1. Ensure ease of access by the establishment of robust referral pathways from detection of incontinence through to appropriate assessment and treatment;
2. Shift the responsibility of basic continence care away from PCPs to continence nurse specialists (CNSs) in primary care where available, where CNSs are unavailable, train existing healthcare professionals such as primary care-based nurse practitioners, community nurses, physician's assistants or, in developing countries, local community healthcare workers, to provide evidence-based continence care;
3. Where possible, use a case coordinator to ensure collaborative working, especially to help delay or prevent admission of patients to permanent care settings; given the general trend to more integrated clinical pathways, in particular concerning patients with multiple comorbidities, it is necessary to strike a balance between specialization and holistic case management approaches;
4. Promote use of self-management tools and techniques; provision of information on the use of containment products;
5. Emphasize shared decision making between healthcare provider and patient/caregiver; and educational campaigns on the nature of the illness and treatment strategies;
6. Integrate specialists with other parts of the care pathway and ensure they play a key role in quality governance, training and the dissemination of best practice;
7. Use a comprehensive assessment of user, product, and usage related factors to assess the needs of patients and caregivers with regards to containment products. This process should be standardized, valid and easily reproducible. The final decision regarding choice of product should remain with the end-user: the patient and/or their informal or professional caregiver;
8. Use of technology should be integral to the delivery of continence care. Technology should enable self-care and connect patients, caregivers and enable providers to monitor progress and troubleshoot problems;
9. For payers: in order to provide the highest quality continence care, ensure care standards are incentivized. This can be achieved through stipulating the achievement of targets on certain outcome and operational

3. MODELS OF CARE

Continence care was defined by the Canadian Continence Foundation as "all measures directed toward the prevention, improvement and or management of UI" (http://www.canadiancontinence.ca/pdf/en_dec2000vol_1.pdf). A report on continence care services worldwide noted that services were scattered, inconsistent and considerable discrepancies exist in their funding. The report concluded that accessible (and affordable) continence care and multidisciplinary teamwork were needed. (155)

In response to this report, a modular service specification was designed, the OCSS. (148) The modules were: 1) case detection, 2) specialist assessment and treatment, 3) case coordination, 4) caregiver support, 5) community-based support, 6) use of containment products, and 7) use of technology (Figure-2). The key recommendations are detailed in Table-1.

measures, careful use of quality-related financial incentives, emphasis on clinical governance and optimal pricing that is most strongly correlated to the true cost of providing a service;

10. Establish accredited programmes of training for:

- Nurses wanting to become CNSs and
- Other health or social care professionals such as social workers wishing to improve their competence in delivering continence care.

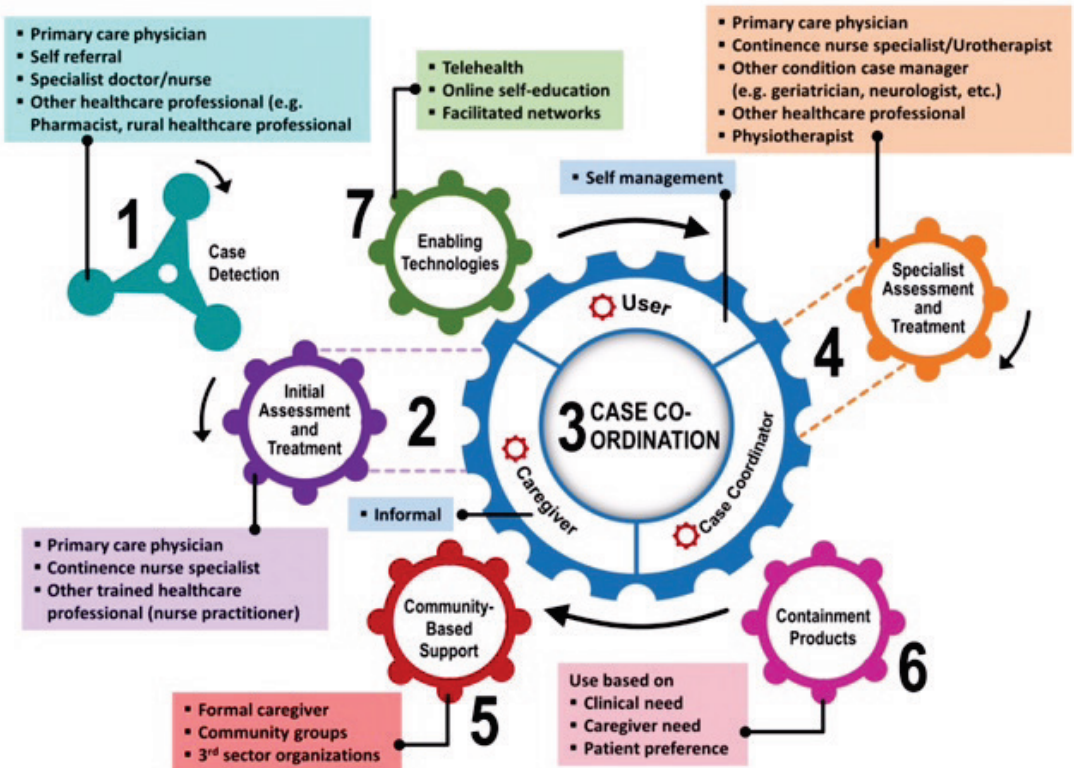

Figure 2: Components of a Multidisciplinary Continence Care Service (148)

There are many factors that can persuade health care planners about the importance of adequate investment in community continence services. For instance, in the UK in 2015 NHS England launched a national policy document entitled Excellence in Continence Care which provided a framework for commissioners and health care providers to develop continence services that reduce health related harm and costs, were commissioned for dignity and value and ensures that appropriate outcomes were measured. (<https://England.nhs.uk>. Search for excellence in continence care).

The provision of continence care and services in each country depended on the organisation and infrastructure of its health services. Because UI is prevalent and affects men and women of all ages who receive medical care from a variety of health care providers (e.g., PCP, family physician, geriatrician, gynaecologist, nurse practitioners), there will seldom be one

point of entry to continence care. A major barrier to facilitating continence services models was the lack of studies that compared effectiveness of specific continence care delivery systems. A range of existing service delivery models were located in the literature and described below.

3.1. Single Specialist

This service, the most common model in developed countries, was led by a consultant or specialist physician (i.e., urologist, gynaecologist or urogynaecologist). It focused on a “urodynamic unit” that provided medical or surgical treatment with a nurse continence advisor or continence nurse specialist acting as an integrated part of the service.

3.2. Nurse Specialist or Advisor

Examples of nurse-directed models of incontinence care were described in the literature. Farrell and colleagues (156) studied a step-wise care delivery model that included continence advisor and nurses. This model was effective as the traditional medical model. In Australia, New Zealand and the UK, a national network of Continence Nurse Advisors (CNAs) or Continence Nurses liaise, integrate services, and guide individuals through the referral route most appropriate to meet their needs. The efficacy of Continence Nurse Practitioners (CNPs) in the UK was reported by Matharu and associates (157) who studied 450 women over 40 years of age who underwent urodynamic studies in the UK after seeing a trained CNP. In women diagnosed with bladder overactivity, the CNP prescribed medications to 79% of patients and PFM training to 64.8% of the women. In those with urodynamic SUI, 88% had appropriately been prescribed PFM training. Nurses assessed and assigned women to appropriate conservative treatments, resulting in shortening waiting times for urodynamics and specialist assessment.

Choi (83) performed a case-controlled intervention study with primary care patients (male and female) who had LUTS in China. An intervention group (N=360) received a nurse-led continence care programme and a control group (N=360) received usual care by their PCPs. Outcome measures included symptom severity, HRQOL, self-efficacy, global health, and self-reported health service utilization at 12-months. The intervention group had significant improvements in LUTS severity and HRQOL, although improvements in the amount of urine leakage were not significantly different between the two groups. A higher proportion of intervention group (as compared to control group) reported increased self-efficacy (43.48% vs. 66.83%), improved global health condition (17.74% vs. 41.5%), having doctor consultation (18.5% vs. 8.06), having medication due to LUTS (26.50% vs. 11.29%) and having non-drug therapy due to LUTS (59.5% vs. 9.68%).

Despite evidence for active intervention, emphasis often remains on urine containment and passive UI management rather than on active therapy. An audit of the continence services in the UK revealed that rationing of pads and absorbent products was widespread, with most patients limited to four pads per day. (158) In addition, 59% of the continence services surveyed provided pads for children under the age of four, which was outside of the published national guidelines. These findings indicated need for improved implementation of continence services, especially in relation with rationing and use of pads and products.

There is a long history for the efficacy of specialist NCA in the delivery of community continence care. (159) (160) (161) (162) In the U.S., urology nurses have been trained as “teachers” to successfully implement behaviour modification programmes to

groups. (163) Nurse providers played an important role in the evaluation and management of POP, a condition which is often associated with concomitant UI. (164)

Lee (165) reported findings from a study investigating the introduction of nurse consultants (NC) in Hong Kong. The study focused on a range of patient outcomes including UI. A total of 280 patients, 140 in each cohort under NC or non-NC care, participated in the study. The study showed that patients under NC care had favourable patient health and service outcomes compared with those under non-NC care. The NC cohort also reported a high level of patient satisfaction.

Holtzer-Goor (166) conducted a study investigating cost-effectiveness of inclusion of a nurse specialist in the treatment of UI in primary care in the Netherlands. A decision analytic model was developed comparing the current care pathway for UI in the Netherlands with the pathway as described in the OCSS. (148) The new care strategy was operationalised as the appointment of a continence nurse specialist (NS) located with the GP. With the new care strategy, a QALY gain of 0.005 per patient was achieved while saving €402 per patient over a 3- year period. Although no health gains were achieved in both groups, the authors concluded that a NS in the GP practice would likely reduce UI, improve QoL, and reduce costs.

3.3. Multidisciplinary Resource and Referral Centre

Multidisciplinary clinics, as service models, have been shown to provide comprehensive continence care. The Continence Foundation of Australia (CFA), funded by the Australian Government, employed CNAs to answer the National Continence Helpline and to provide advice to consumers and health professionals, including referral advice. (167) Evaluation of this service indicated availability and uptake of information, as well as increased traffic to the Bladder and Bowel website and the National Public Toilet Map. There had also been a general increase in the number of consumers seeking help for their incontinence.

Multidisciplinary services should initially focus on a step-wise approach to evaluation and management. This need not be limited to tertiary level centres, but can be incorporated into care in local communities when providers with expertise are available. (168)

3.4. Primary Care

Although most primary care practitioners recognize that UI is common, only a minority had an organized plan for its evaluation and management, and few PCPs reported feeling very comfortable dealing with UI. Over 70% of GPs in Canada felt fairly confident in managing UI. (169) Most family physicians referred patients for specialist care, with few referrals to com-

munity services. Respondents thought that continence services were scarce, with long waiting times, and that such services were generally overstretched. They also believed that although high-quality continence care was a personal priority, it was not a priority focus for their practice partnerships or networks. In terms of the highest ranked areas for improvement in UI management were: increased awareness and understanding among physicians (ranked first by 28.5% of respondents), followed by dedicated incontinence clinics or nurses for referral (17.7%) and improving patient awareness and understanding (12.0%)

Early attempts by the U.S. Agency for Health Care Policy and Research, now known as the Agency for Healthcare Research and Quality (AHRQ), to use physician group interventions to raise awareness through UI guidelines failed to improve screening and management rates in the primary care setting. (170) Yazdany (171) prospectively randomized patient charts (n=88) to carry a chart-alert sticker (e.g., "Do you leak urine?") that reminded resident physicians to ask about UI in their general gynaecology clinics. Overall, resident physicians' inquiry rate about UI increased from 4% to 34%.

Quality of primary care delivered by nurses was found to be similar to physicians, with nurses providing more health advice and achieving higher levels of patient satisfaction compared to doctors. (144) A RCT in the Netherlands compared usual care for UI in GP clinics to those that included a nurse specialist. (172) (173) Short-term outcomes revealed better continence rates in those patients seen in clinics that involved care by the nurse practitioners. The results were not sustained at the one-year follow-up with both groups having equivalent continence outcomes. A focus group analysis with the nurse practitioners revealed that they felt competent to provide the needed services and appreciated by patients. (174) In addition, nurses thought they added value to the practice, particularly since many of the GPs were seen as lacking interest in UI.

The first point of contact for persons with UI is usually the primary care practitioner but ongoing management requires a care delivery model (see Figure-2) based on a chronic care approach that has been used successfully in other chronic conditions (e.g., diabetes, CHF, asthma). (175)

4. OTHER SERVICE MODELS

In a structured literature review, Chin and colleagues found that primary care clinics for continence led by nurses and allied health professionals were common across the world. (176) Although there were a number of differences that were culture specific, there were also a number of key factors that predicted quality care across all cultures. These included identification and recruitment of appropriate patients, improving access to care, enhancing engagement with pri-

mary care providers, using small teams with adequate training, developing structured referral lines, and working to employ evidence-based practices including guidelines and treatment protocols.

Group intervention models for delivering first-line treatment for UI has long been found feasible (41) (177) (178) (179) and these models may be an equally effective and potentially cost-saving approach. (180) Another study has shown that non-medical lay instructors can be taught how to instruct patients in proper PFM exercises. (181) This train-the-trainer model may be useful to help disseminate behavioural therapy on a more widespread basis.

Internet based services are becoming available. Bjork (182) conducted telephone interviews amongst 21 women with SUI who participated in a RCT study comparing two treatment programmes based on instructions for PFM training. One programme was internet-based and included email support by an urotherapist; the other programme was delivered by post. Neither programme had face-to-face contact. A supportive patient-provider relationship was developed in the internet-based programme, despite the lack of face-to-face contact which has promise in increasing access to care and empowering women.

4.1. Setting Specific Models

Continence promotion, education, and treatment may occur in a variety of clinical settings, particularly in relation to other associated clinical conditions. For example, UI occurs commonly after acute stroke. Rehabilitation nurses who work with post-stroke patients could play an important role in continence care, however research shows this may not happen regularly. Heart failure is another common clinical condition, particularly among older adults, that is associated with UI. A study of 182 heart failure patients with at least monthly UI revealed that 83% had not asked for help with their incontinence symptoms and 64% were interested in learning more. (183) Many patients, particularly those with concomitant diabetes, were contemplating changing their behaviours and seeking care for UI. These findings indicate that this group may be receptive to education and interventions that improve urinary symptoms.

A multinational qualitative study examined data from focus groups of rehabilitation nurses in the UK, Sweden and China. (184) They found that only a superficial assessment of continence was routinely performed by most nurses in this setting. The authors noted a focus on containment and social continence although process models of practice were seen in all countries. In line with these findings is the conclusion of Edwards (185) who investigated patients aged 65 years and older with a fragility fracture as a result of a fall. Of 3184 patients, 63% (2009) were assessed for urinary continence following a hip fracture and 41% (817) of these identified a problem. Twenty-one percent (1187) of 5642 patients with non-hip fragility fractures were assessed and a problem was found in 27% (316). Hip fracture patients were more likely

($p < 0.0001$) to receive a continence assessment and have problems detected. Only about half of those with problems had any intervention or a referral to a continence service. Admission to hospital for non-hip fracture patients was a strong predictor of being assessed ($p < 0.0001$). Edwards concluded rates of assessment and action for those who fall and have continence problems are low despite current national guidelines.

Acute care, where older adults comprised the largest segment of the population being admitted to it, was reviewed. This setting provides care to manage short-term, but urgent, health problems and UI was prevalent. A prospective cohort study of 577 patients (mean age 82 +/- 6.9 years) admitted to general medical wards of three acute care hospitals in Brisbane, Australia, found UI rates of 43.8% (243/555) pre-morbid, 36.7% (176/479) during admission, and 35.3% (187/530) at discharge. (186) Moreover, of 438 patients at the time of discharge, 38 (12.8%) had new onset UI. One group of patients with a high risk for developing UI in hospital are female hip fracture patients. In an older study, secondary analyses of data from 6,516 hospitalised women with a fractured hip revealed 21% became incontinent during hospitalisation. (187) Similar findings were reported for elderly patients admitted to hospitals in Israel, (188) Switzerland, (189) and Italy. (190)

Zisberg and colleagues (188) conducted a prospective cohort study of 352 patients aged 70 and older who were continent prior to admission to an acute care hospital. They found, 17.1% developed UI during their hospitalization, and in a multivariate analysis, the use of a urinary catheter or diaper were associated with the development of UI (4.26 95%CI 1.53-11.83 and 2.62 95%CI 1.17-5.87 respectively). Zurcher and colleagues (189) surveyed 78 elderly inpatients in a Swiss hospital and found 41 (51%) screened positive for UI, yet only 10 (24%) of nursing records documented the presence of UI. Moreover, the use of absorbent pads was the only intervention documented. The number of patients who declined to be asked about their continence status was minimal ($n=5$).

Other research on UI in acute care drew attention to an overreliance on continence aids, and inadequate attention to identifying and addressing potentially contributing factors. For example, Ostaszkiwicz and colleagues (191) conducted a point-prevalence survey of 447 hospitalised older adults in acute and sub-acute care settings in Australia and found 60% with a continence product or device, however, 50 (41%) patients with an absorbent pad denied having experienced UI or FI in the preceding 24 hours. By contrast, 113 patients (16%) who reported UI or FI in the same period had no continence product or device.

4.2. Elder Services (Long Term Care or Nursing Homes)

Long term care for frail elderly persons is provided in a variety of types of institutional settings throughout

the world. Continence care in these settings is dependent upon many factors, including: type of resident care need (those requiring long-term skilled and personal care, short-term rehabilitation, post-hospitalization care); physical environment; the organisational culture and leadership commitment to providing high quality care; the number, education, and motivation of direct care staff; access to physicians with interest in and understanding of continence care; and financial and regulatory incentives to provide appropriate continence care.

Despite UI being a quality indicator in U.S. NHs, significant barriers to translating research on prompted voiding and other interventions into practice existed. (192) This issue is especially concerning given the current and future growth in the frail elderly population. Available evidence indicated that the focus was too often on containment and use of pads or absorbent products compared to active continence promotion or treatment. A Cochrane review supported this finding, and noted that none of the studies reviewed focused on attempts to maintain continence in facility residents. (193) A systematic review of systematic reviews on the most frequently used behavioural interventions used in long-term care indicated limited evidence for short-term effectiveness. (194) Barriers for improving continence care were considered multi-level and included: lack of knowledge about UI, beliefs about UI, high work load, low commitment from co-workers, and lack of institutional support. (195) Multiple strategies were seen as necessary in order for quality improvement in continence care to occur. These included creating a sense of urgency about the problem and a sense of solidarity among co-workers and facility administration. Managerial oversight and communication about the evidence of performance before and after the quality improvement program, and use of evidence to make decisions about how to modify the programme were considered essential to programmatic success. (192)

Little evidence was available to determine how older adults who received the interventions perceive and respond to them. (196) Higher registered nurse to patient ratio was identified as a facilitator or better continence care. (197)

An innovative model described the development of individualized continence profiles for use with NH residents (198) that could help NH staff identify residents who may benefit from various forms of assessment and interventions. Another model previously worked to involve NH residents more actively in their fluid intake and continence care. After a 12-week intervention, overall hydration status improved and time spent in saturated incontinence absorbent products decreased significantly in a cohort of 153 NH residents who participated in the intervention. (199) Distance learning techniques were successfully used to teach and implement programmes and strategies for management of UI in NH. (200)

5. MODELS IN DEVELOPING NATIONS

Continence services are a relative luxury, to which countries with a low per capita income are unlikely to devote scarce resources, especially while other population health issues have precedence.

The potential demand for UI services in developing nations far outstrips the resources that are available. The provision of services will depend on dedicated healthcare professionals with support by government or industry, and by a local continence organisation to educate a new generation of service providers who will carry the services to remote communities. Increased use of advanced communication technologies can help to disseminate continence promotion materials among nurses and other health professionals worldwide. (201)

Summary

A range of service delivery models exist; single specialist, nurse specialist or advisor, multidisciplinary resource and referral centre, primary care and other models (acute or subacute care, elder services at home or in long term care and models in developing countries). Within this spectrum the evidence supports nurse-led community services leading to higher health-related QoL and in some instances higher cure rates. The multidisciplinary referral settings are reporting also favorable outcomes. There remains discrepancy between availability of guidelines for different healthcare delivery settings and actual daily practice. The Optimum Continence Service Specification has shown that within a 3-year period, this model of care can be cost-effective, especially when societal costs are taken into account. Further research on cost-effectiveness and patient-level effectiveness of models of continence care in a variety of healthcare delivery settings is urgently needed.

Levels of Evidence/Recommendations

- Effectiveness of service delivery models. (Level of Evidence: 4)
- A care delivery model should be based on the principles as described in the Optimum Continence Service Specification. (Grade of Recommendations: C)
- Increased emphasis is needed on non-physician models of care (nursing, nurse practitioner, continence advisor, physiotherapy, physician assistants, etc.). (Grade of Recommendations: C)
- Despite the proliferation of guidelines, there is increasing evidence that practicing clinicians and nurses (in the community, acute care, and in long term care) are not consistently following

them. Implementation models should be developed on how to translate guidelines into practice. (Grade of Recommendations: C)

VIII. EDUCATION

Literature Search for Medical Literature is found in Appendix 1.

1. BACKGROUND

Professional education regarding continence occurs in a wide variety of settings ranging from undergraduate education in medicine, nursing, physiotherapy and other related disciplines, through the full continuum of graduate education and ongoing professional education. This includes both formal education incorporated into established curricula or clinical experiences, and informal types of education such as on-the-job training and point-of-care instruction. Education may be directed toward generalists or specialists and will differ based on the topic of interest and the target learners. The focus of educational topics can range from evaluation and care of individual patients or clinical conditions, to population health and health policy. Examples of clinical education could include surgical skills training for surgical residents and fellows, community and ambulatory care, bedside, or operating room care for nurses, or biofeedback training for physical therapists. This section reviews professional education on continence from a broad perspective across disciplines and specialties.

2. MEDICAL EDUCATION

2.1. Generalists (family physicians/general practitioners/primary care physicians)

Physicians (general, primary care, and family physicians) traditionally have been viewed as having a gate-keeping role in continence provision since they are often the most likely first point of contact when adults seek professional help for their incontinence. Most physicians have received little education or formal training about incontinence, fail to screen for it, and view the likelihood of successful treatment as low, leading to most physicians avoiding the topic with patients. At the same time, there are no data confirming the benefits of screening as a method to reduce the burden of suffering from UI. An earlier postal survey noted that only 18% of respondents said providers asked them to complete a questionnaire about bladder control during routine office visits, and a majority (69%) felt it would be very helpful in prompting discussion if their physician or health care professional provided a form for them to check off symptoms of incontinence. (119)

Traditionally, UI and FI formed a very small part of the undergraduate medical curriculum. Education on UI has been fragmented across different organ systems,

with training scattered among gynaecology, urology, and geriatric medicine. Bladder and pelvic floor anatomy is poorly covered in preclinical training and relevant physiology is rarely mentioned. One study found that exposure to issues of pelvic floor dysfunction in women was extremely limited in medical education, with more than 80% of medical students receiving no formal training in this area during the first two years of training. (202) A national survey of medical school Deans in the UK in 2008 found that information on UI was included as part of education on geriatric syndromes in essentially all schools, although the response rate to the survey was 61%. (203)

A survey of programme directors for internal medicine residency training programmes in the U.S. was conducted to determine whether they believed their residents should master thirteen core competencies identified to be central to women's health care (including UI). (204) Although almost all believed it was an important goal, there was a large discrepancy among programme directors whether residents actually achieved this level of learning.

There is very little available literature on knowledge among family doctors on FI. A study explored GPs awareness of surgical treatment options for FI. (205) A postal questionnaire was mailed to 1,100 GPs in the Yorkshire region in the UK, and a response rate of 48.5% was achieved. The questionnaire assessed basic knowledge of FI and treatment options. Overall knowledge was poor, with the majority unaware of available investigations, treatments, and specialist centres. The authors recommended better communication between specialist centres and GPs, as well as continuing medical education (CME) programme implementation.

Several studies examined physician attitudes about diagnosis and management of UI and associated conditions. In one survey of 55 PCPs in the U.S., most indicated that they understood UI and that it was a common condition among patients in their practice. (206) Although 56% of these physicians felt comfortable asking about UI, only 19% felt comfortable making a correct diagnosis, and only 11% felt comfortable providing actual treatment for UI to their patients. These providers thought that differentiating types of incontinence was difficult (59%) and that managing UI was difficult (69%). Lack of familiarity with screening tools and treatment algorithms were also cited as barriers. Time did not appear to be the driving factor with only 26% reporting that time was a major limitation. In a similar survey study of family practitioners in Canada, 24.1% reported receiving no training in UI management beyond their residency. (169) Although 53.8% reported proactively discussing UI with their patients, and 70% felt confident managing the condition, the majority still referred their patients to specialist providers. They did not tend to refer for community-based services due to perceptions about lack of available resources and long wait times.

Case-based curricular materials have been shown to be effective in urology residency education (207) One Canadian study surveyed urology residents in training, and found that there was a desire for more structured education in patient-provider communication skills. (208) In another project, training about UI was included with a number of other geriatric syndromes. (209) Those internal medical residents who received the information via internet-based methods had better overall test results than those who completed paper-based training. A recent survey of residency programme directors in paediatrics in the U.S. found the vast majority (85%) did not require clinical experience in paediatric urology although 65% did have some didactic education. (210)

Some models of physician education have incorporated training on UI into modules on quality care. For example, the Assessing Care of Vulnerable Elders (ACOVE) project in the U.S. includes UI as one of the target conditions. A recent study investigated implementation of this information into community-based physician education within practice groups. (211) These authors found that dissemination of this information was well received by PCPs, and some intended to make changes in their practice related to this new knowledge. Similar studies have also found that PCPs specifically educated about UI assessment and interventions were more likely to recommend care for UI to their patients. (212) (213) Collaborative practice by physicians and nurse practitioners yielded better overall outcomes for the ACOVE quality assurance measures, including those for UI. (214)

2.2. Specialist Physician

There was little new published evidence on medical specialist training in the form of effective training interventions. Specialist training in incontinence is not always adequate. Both UI and FI still may be perceived as exclusive to "super-specialists," potentially alienating colleagues.

Even among subspecialists, training may not be ideal. Marsh and colleagues (215) surveyed 100 gynaecologists and urologists in the UK and found widespread inconsistent and inappropriate diagnosis of BPS/IC. A survey of general gynaecologists showed a wide variation in comfort dealing with issues related to UI and prolapse. (216) Most felt comfortable with basic surgical procedures for UI and straightforward anterior and posterior prolapse, but less comfortable with complex clinical scenarios including apical prolapse and treatment of UI after prior failed procedures. Of note, newer graduates and younger surgeons tended to have a much more limited repertoire of surgical options that they used in their practice. Another study of recent general gynaecology residency graduates found most performed midurethral slings for incontinence and felt comfortable doing basic anterior and posterior repairs for prolapse, however, few actually did other more complex urogynaecological procedures in practice. (217)

Some gynaecology programmes include education on basic cystoscopy to detect for potential intraoperative injuries during hysterectomy or other pelvic surgery. However, not all graduates intended to use this diagnostic tool, with higher rates reported by urogynaecology fellows compared to general gynaecologists. (218) An initiative to train community gynaecologists in this technique was located. (219)

Structured training and curricula have been developed for a variety of surgical procedures used to treat UI and POP. (220) Inclusion of this training in residency will lead to increased numbers of physicians who are qualified to offer this type of care to patients suffering from UI. A variety of models have been developed to help teach some basic skills such as cystoscopy or methods for grading the degree of POP. One option includes the use of cadaver labs. (221) Others options have used inanimate objects to replicate the female pelvis and teach basic anatomic concepts. (222) (223)

In the U.S., subspecialty certification in Female Pelvic Medicine and Reconstructive Surgery (FPMRS) began in 2013. This certification is offered through joint sponsorship by the American Board of Urology and The American Board of Obstetrics and Gynecology. During the first three years, candidates who met strict criteria were allowed to take the certification examination without necessarily having completed a formal fellowship training experience. However, starting in 2016, only candidates who have completed a fellowship approved by the Accreditation Council on Graduate Medical Education (ACGME) will be eligible for FPMRS certification. All successful candidates will require ongoing maintenance of certification (MOC). Audits of surgical logs among those completing FPMRS certification show they tended to be doing more complex surgical cases for UI and POP compared to their general urology colleagues undergoing general urology recertification. (224) (225)

Continued emphasis on quality education for specialist physicians is needed worldwide. (226) Many current and recent FPMRS fellows indicated in survey research that they are interested in gaining experience in global healthcare, and potentially incorporating international work into their practice. (227)

In addition to the FPMRS fellowship and certification pathway, there are also unaccredited fellowship opportunities in women's health. Most of these are offered collaboratively through academic departments of internal medicine, family medicine and obstetrics and gynaecology. These programmes provided the opportunity to gain specialized training in the nonsurgical aspects of women's health care including UI and associated conditions. However, knowledge about these opportunities for professionals was generally low, and the programmes lacked formal accreditation. (228)

A study of gynaecologists in Germany found that most considered their specific post-graduate training in urologic issues and urogynaecology to have been

inadequate. The vast majority of general gynaecologists in this study referred their patients with voiding or incontinence issues to subspecialists in urology or urogynaecology.

Duty hour limitations have been imposed on residency training in the U.S., Europe, and many other regions. There has been concern that this could have a detrimental effect, particularly on surgical specialist education. (229) (230) However, although one survey demonstrated obstetrics and gynaecology residents performed substantially fewer numbers of some types of surgical procedures, those for UI and POP did not appear to be negatively affected. (231) Similar studies have shown no appreciable decrease in surgical case volume among urology residents. (232) (233)

Approximately 10% of graduating urology residents did not currently meet the nationally recommended standard for surgical case experience for male urethral reconstruction, penile operations, or surgery for male UI. (234)

Linking education on UI to geriatrics may be limiting for some specialists. A recent survey of surgical trainees in the UK demonstrated that in general, they felt inadequately prepared to provide care for older adults with complex clinical geriatrics issues. (235) Script concordance models have been developed to assess clinical reasoning skills related to care for UI in older adults. (236) A recent study using script concordance found that compared to expert surgeons, general gynaecologists who had large practice volume for procedures related to incontinence and prolapse did better than new residency graduates and those who had been in practice the longest. (237) Ongoing education and utilisation of evidence-based training with incorporation of guidelines have been suggested as a strategy to maintain high quality standards of treatment, particularly for surgical care of UI. (238)

Due to an ever expanding geriatric population, there is a recognized need for expansion in the workforce among urology, reconstructive surgery, and other specialties that provide care for UI and associated conditions. (239) (240) (241) There is a particular need for expansion of the workforce in academic urology to accommodate increased education of specialists, including those in FPMRS. (242) This is true in Europe as well as in the U.S. (243) However, funding for graduate medical education including faculty expansion is an important barrier to expanding the educational pool in fields like urology, particularly in the U.S. (244)

Urology and gynaecology residency training opportunities have been expanding worldwide including in developing nations in Asia, Africa and the Middle East. (245) (246) (247) There has also been an increase in efforts to improve education about diagnosis and treatment of genitourinary fistulae. (248)

Increased training and utilization of nurse practitioners, physician assistants, and other advanced practice providers in urology and gynaecology has been incorporated in some clinical practices, particularly in the U.S. (249) This may be a particularly effective method to address workforce shortages in some areas. Development of specific educational programs and competencies for these types of providers will also be important for these types of practitioners. (250)

3. NURSING EDUCATION

Literature Search is found in Appendix 1.

Nurses play a significant role in the area of incontinence since they are the largest single group of health care professionals around the world and they are often the first to become aware that a person is experiencing incontinence. There have been a number of recent studies that explore the use of new innovative methods of education provision for nurses.

The continence education process should start at an undergraduate level and continue through updates or enhanced learning post qualification. McClurg et al (251) undertook a survey of all UK Higher Education Institute's to establish the amount of undergraduate continence related education within relevant health care programmes including adult, mental health, learning disabilities and children's nursing, midwifery, occupational therapy, and physiotherapy. The mean number of hours was 4.7, with adult nurses receiving the most education totaling 7.3 hours. However, 41 out of 294 responders reported no continence related education in their undergraduate programme.

3.1. Generalist Nurses

Innovative methods of improving knowledge among nurses have undergone recent evaluation. An important study undertaken by Cheater and colleagues (252) added to the debate by examining the value of audit and feedback, and educational outreach, which in the past has often focused on doctors' behaviours rather than nurses'. In this study, the researchers undertook a cluster-randomized trial to evaluate 194 nurses in 157 family practices with 1,078 patients with a diagnosis of UI. They found that when compared to educational materials alone, there were no improvements in care for either educational outreach or audit and feedback (all groups did improve, but differences between groups were not significant).

Ostaszkiwicz (253) described a nursing leadership model to enhance continence care in older adults. Evaluation of the programme suggested improved management and assessment of incontinence for individuals sustained after a two-year period. Leadership programmes have proved effective in a number of areas in nursing provision. Within these more recent studies, the use of innovative methods of knowledge transfer and education are beginning to be adopted, and such methods used in other areas of

professional education may be well suited to UI and FI.

Education related to UI may often be linked to training about other concomitant disorders or conditions. For example, training on prevention and treatment of pressure ulcers or dermatitis may include significant components related to UI. (254) (256) (257) Training about improved mobility and care following a stroke in the geriatric population has also shown this educational link. (258) (259) These findings can facilitate efforts to disseminate information about continence care and promotion to a wider audience of nurses who have direct patient contact.

Although advanced practice registered nurses (APRNs) have sufficient knowledge and positive attitudes about treating UI in women, many have difficulty applying them into practice in the clinical setting. (260) These authors suggested that increased exposure to these topics in clinical experiences during training for graduate nurses is needed.

Programmes have focused on nurse education for continence care in specific settings, such as the NH. (261) Competency-based UI education with use of case examples has been used successfully in the training of generalist nurses. (262) Experiential activities have also been used with good results. (263) Interprofessional, simulation training has also been shown to be effective for teaching continence assessments in geriatric medicine. (264)

3.2. Specialist Nurses

Educational courses on incontinence are available for nurses in the UK, U.S., Europe and Australia, and have appeared in Asia, notably Hong Kong and Singapore. These courses vary from two to four weeks of face to face didactic courses to distance learning courses lasting 12 months that lead to a post-basic nursing certificate and, in some cases, post-graduate degrees.

In the UK, education programmes are documented at the Association for Continence Advice website (http://www.aca.uk.com/education_modules.php) and comprise information on 1 day courses, as well as diploma courses, degree modules and masters level study. Such databases of courses offer an excellent overview for students and providers. Likewise, the Continence Foundation of Australia (<http://www.continence.org.au/pages/continence-courses.html>) provides nurses access to information and links to educational organisations that provide a variety of programmes which focus on or incorporate both UI and FI content in the curriculum. Many can be continued through to post-graduate tertiary education. A number of these programmes can be undertaken externally and therefore are popular with nurses in rural and remote areas, as well as nursing students practicing in other countries. Clinical support complements the theoretical components. Lack of funding was a barrier to access to education with up to 71% of specialist nurses in the UK reporting that

they were unable to access funding or study leave from their employers for these courses. Many nurses were self-funding or accessing education through professional associations (All Party Parliamentary group, (2013), Continence Care Services England 2013, Survey Report, www.appgcontinence.org.uk).

Internationally, inconsistency in the provision of specialist education to prepare nurses to practice as experts in the field of incontinence existed. Innovative internet-based learning programmes incorporating modern information and communication technology (e-learning) may offer one way of providing standardized programmes of study to practitioners.

A Minimum Standards in Continence Care has been developed by the UK Continence Society to set required standards and a competency framework for education and training of all health care professionals (HCPs) to ensure that they have attained the training requirements to work within their designated role. (265) However, without standardized education, these recommendations can be difficult to implement and monitor.

Beitz and Snarponis (266) described an innovative on-line learning programme which included continence nursing. As with physicians, it was unlikely that improving nursing knowledge alone will translate into improved clinical practice or into the ultimate goal of improved patient outcomes. De Gagne et al (267) have demonstrated how e-learning UI educational courses in South Korea were useful to support nurses in isolated and rural areas who had limited resources.

Improved education of school-based nurses regarding normal bowel and bladder habits of children may have helped to improve paediatric continence and promote healthy elimination patterns. (268) Although 61% of school nurses surveyed reported they had never received training on the topic, many (43%) had been asked to provide information to their teacher colleagues.

In the U.S., there were no academic or clinical proficiency requirements to be considered a continence nurse practitioner or specialist. (269) In 1993, the Wound Ostomy Continence Nurses (WOCN) Society developed the first certification programme for continence care nurses in the U.S. This nursing organisation published a position statement on the role of continence nurses (270) and core curricula for continence management (<http://www.wocn.org/>, accessed December 8, 2016). The Society of Urologic Nurses and Associates (SUNA) certified different educational levels of nurses in the area of urology and in urodynamic testing. This organisation published the Scope and Standards of Practice with Competencies of the Urologic Registered Nurse and Advanced Practice Registered Nurse that includes care of the urologic patient with UI and POP. The norm is that most "continence" nurses in the U.S. obtain their knowledge and skill through self-motivated activities. (271) SUNA has published a core curriculum in urologic nursing [Newman, Wyman, Welch, 2017

<https://suna.org/core-curriculum-urologic-nursing>, accessed December 8, 2016]

To date, most of the focus on UI education has been at the baccalaureate and advanced degree levels while some discussion has focused on whether specialty training in wound, ostomy, and continence nursing should be at the doctoral level. In the U.S., the new Doctor of Nursing Practice (DNP) degree may help to fill this training gap. (272)

A study of 231 vulnerable elders with complex disease and enrolled in a 'Special Needs Plan' in the U.S. showed the benefit from a nurse care management programme with nurse practitioners in addition to physician care, as opposed to those who received care from a physician alone. (213) This model has continued to develop and requires further evaluation

Albers-Heitner and colleagues. (273) evaluated the cost-effectiveness of involving UI nurse specialists in primary care compared to care-as-usual by GPs. From 2005 until 2008, an economic evaluation was performed alongside a pragmatic multicentre RCT that compared patients with UI receiving care by nurse specialists with patients receiving care-as-usual by GPs in the Netherlands. One hundred eighty-six adult patients with SUI, UUI, or mixed UI were randomly allocated to the intervention and 198 to care-as-usual; they were followed for 1 year. Main outcome measures were 'QALYs societal' (Quality Adjusted Life Years based on societal preferences for health outcomes), the EuroQoL-5D, 'QALY patient' (based on patient preferences for health outcomes) (EuroQoL VAS), and 'Incontinence Severity weighted Life Year' (ISLY) based on patient-reported severity and impact of UI (ICIQ-UI SF). Health care resource use, patient and family costs, and productivity costs were assessed. Compared to care-as-usual, nurse specialist involvement yielded slightly more favorable cost-effectiveness results. Based on these results, the authors recommended adopting the nurse specialist intervention in primary care.

One area of specialist nursing that has limited research into outcomes of continence care and education is midwifery. There are a large number of women that develop bladder and bowel issues throughout pregnancy and postpartum yet no available evidence was located on the impact that midwives can have on early detection, intervention, or prevention.

3.3. Nursing Assistants

A cross-sectional study via postal survey to gather self-reported data from nurses and NAs in NHs was conducted in Taiwan. (274) Results indicated UI-related knowledge scale and practice behaviours differed significantly in both groups. The authors recommended that enhancing staff competence in incontinence care was needed in both levels of nursing to improve NH residents with UI. Educational efforts, particularly in the NH setting, must involve not only professional nurses, but NAs and other staff, as well. Blekken et al (275) have recently reported on a pilot

study to trial methodology prior to a cluster RCT on the feasibility, acceptability and adherence of two educational programmes for care staff concerning NH patients' FI.

4. OTHER ALLIED HEALTH PROFESSIONALS

4.1. Physiotherapists or Physical Therapists

Physiotherapists (PTs) have long played a part in continence care and the management of UI. In some countries, patient self-referral to specialised PTs has become commonplace. Physiotherapist's involvement in UI appeared to be either on the basis of individual interest or through association with women's hospitals or obstetric departments, rather than as part of a general physiotherapy practice. (276) As such, they tend to be highly motivated and enthusiastic.

Generalist PTs have been encouraged to be more aware of the risk factors for incontinence in males and females, to identify patients with risk factors and to assist them in seeking further advice or treatment. Throughout the world national physical therapy organisations have established continence physiotherapy sub-groups. (277) The International Organisation of Physical Therapists in Women's Health represents over 20 member countries with PTs practicing continence and women's health physiotherapy and offers professional development programmes. A number of specialist continence PTs also treated men and children. Universities in many countries offer short courses or post-graduate continence education programmes to PTs that may range from post-graduate degree courses to Masters and PhD programmes. (278)

The Scope of Practice for continence PTs may include PFM training, bladder training, management of sexual dysfunction, anorectal dysfunction and treatment of pelvic pain syndromes, FI and male continence issues.

Regulatory issues mentioned were often linked not only to quality of care, but also to reimbursement for clinical care and services. Reimbursement policies for services frequently determine which professionals are able to provide continence care. In the Netherlands, for example, the government paid for up to 14 visits to a physiotherapist for incontinence therapy. In the U.S., patient's visits to a physiotherapist were typically restricted by the need for referral and cost. In some countries, physiotherapists had to prove a certain level of specialist education to ensure full insurance reimbursement.

4.2. Pharmacists

In Australia, pharmacists have been avid consumers of continence education programmes. In 2004, the Pharmacy Guild launched an educational and promotional programme for their members with appropriate

outcome evaluation measures. The public sees pharmacists as important and approachable sources of health information, especially information on medicines that may cause or exacerbate UI and FI. Many retail pharmacies displayed health promotion literature on a range of subjects, including UI. Pharmacists may also advise the consumer on appropriate continence products. Educational seminars for pharmacists were reported to be generally well received. There were a growing number of CME programmes for pharmacists on the internet, either through new products or through sites such as www.worldwide-learn.com.

Summary

Although there are a wide variety of educational programmes available across disciplines and specialties, overall education on continence and associated topics lags well behind other clinical topics in most professional educational settings. Many health care providers do not receive formal education on UI, FI, or other continence-related topics as part of their general education. These topics are included in some general practice education settings, but most often these are limited to the graduate level of instruction such as graduate nursing programmes, medical and surgical residency or fellowship. There is an ongoing need to continue to expand and evaluate educational offerings on topics related to continence and bladder and bowel health across all levels of training and for both generalist and specialist professionals.

Levels of Evidence/Recommendations

Professional education of UI, FI and POP is not evident based on the materials reviewed. (Levels of Evidence: 3-4)

- There is a need for research on both educational content and methodology across all disciplines, particularly as the emphasis on primary care education increases and the opportunities for exposure to targeted content decreases
- There is a need to identify the extent to which education, particularly at the undergraduate level, translates to actual practice in clinical settings
- There is a need for research on content development and delivery to teach and assess basic clinical skills including those that every professional should acquire (e.g., History gathering and physical examination, development of care plans, urinary catheter placement) as well as specialized skills (e.g., surgical technique, urodynamic assessment, pessary placement)
- There remains a need for research on educational methodology and modes of instruction for

continence care including active-learning experiences, modular education, self-directed learning, distance-learning, online learning.

- (Grade of Recommendations: D)

5. IMPACT OF CLINICAL GUIDELINES

Literature Search is found in Appendix 1.

In the past several years, there has been an explosion in the rate of development and publication of clinical guidelines for UI and associated conditions. Since the last ICI, at least 20 different guidelines or consensus recommendations have been published regarding UI and associated conditions (see Table 2). Many of these have been developed by professional organisations focused on urologic, gynaecologic, geriatric, or related fields. Some have been created and disseminated on behalf of national governing bodies.

Several older guidelines have recently been updated using evidence-based methodology.

Most of the guidelines target physician practice, although some do include recommendations specific to PTs, nurses, or other health care professionals. Different guidelines focus on specific clinical areas, and some are gender specific. Some only examine issues related to either the assessment or the treatment of UI. Some of the treatment-centred guidelines are specific for either surgical therapy or conservative therapy. Others look at clinical conditions in specific patient populations including those with underlying neurological disorders, women with POP, or patients who have previously undergone surgical treatment for UI. There can be some confusion, particularly when guidelines present conflicting or even contradictory recommendations about specific issues of evaluation or management. Table-1 lists the published guidelines from 2007 through 2016.

Table 2 Guidelines, Practice Recommendations, and Consensus Statements

Year	Citation	Topic	Professional Organization	Location
2016	Takahashi, et al	Female LUTS	Consensus Panel	Japan
2016	Tse, et al	Management of Adult, Non-Neurogenic OAB	Urological Society of Australia and New Zealand (USANZ); Urogynaecological Society of Australasia (UGSA)	Australia and New Zealand
2015	Bauer, et al	Standardization of Urodynamics in Children	International Children's Continence Society (ICCS)	International
2015	Chang, et al	Treatment of Daytime Incontinence in Children	ICCS	International
2015	Dumoulin, et al	Improving Pelvic Floor Muscle Training Adherence	International Continence Society (ICS)	International
2015	Italian Society of Colorectal Surgery, et al	Diagnosis and Treatment of Faecal Incontinence	Italian Society of Colorectal Surgery	Italy
2015	Maeda, et al	Sacral Neuromodulation for FI and Constipation	European SNS Bowel Study Group	International (Europe)
2015	Paquette, et al	Treatment of FI	American Society of Colon and Rectal Surgeons	U.S.
2015	Rao, et al	Biofeedback for Anorectal Disorders	European SNS Bowel Study Group	U.S.
2014	American Urogynecologic Society (AUGS) and American College of Obstetrics and Gynecology (ACOG)	Evaluation of Uncomplicated Stress UI in Women Before Surgical Treatment	American Neurogastroenterology and Motility Society and the European Society of Neurogastroenterology and Motility	U.S.
2014	Bernards, et al	Physiotherapy for Stress UI	Dutch Expert Consensus Panel	Netherlands
2014	Fisher	Continence Care for Adult Stroke Survivors (Acute & Rehabilitation Settings)	Consensus Panel	Canada

Year	Citation	Topic	Professional Organization	Location
2014	Qaseem et al	Nonsurgical Management of UI in Women	American College of Physicians (ACP)	U.S.
2014	Tabbers, et al	Evaluation and Treatment of Functional Constipation in Infants and Children	European Society for Pediatric Gastroenterology, Hepatology, and Nutrition; and North American Society for Pediatric Gastroenterology	International
2014	Vitton, et al	Treatment of FI	French National Society of Coloproctology	France
2014	Wald, et al	Management of Benign Anorectal Disorders	American College of Gastroenterology	U.S.
2013	Aigmuller, et al	Management of 3rd and 4th Degree Perineal Tears after Vaginal Birth	Austrian Urogynecology Working Group	Austria
2013	ACOG	Cesarean Delivery on Maternal Request	ACOG	U.S.
2013	Lucas, et al	Surgical Treatment of UI	European Association of Urology (EAU)	International (Europe)
2013	Merseberger, et al	Robotic and Single Site Surgery in Urology	EAU	International (Europe)
2013	Smith A, et al	Management of UI in Women	National Institute for Health and Clinical Excellence (NICE)	United Kingdom
2012	Bauer, et al	Congenital Neuropathic Bladder and Bowel Dysfunction in Children	ICCS	International
2012	Gormley, et al	Diagnosis and Treatment of OAB (non-neurogenic) in adults	American Urological Association (AUA)/ Society of Urodynamics, Female Pelvic Medicine & Urogenital Reconstruction (SUFU)	U.S.
2012	Haylen, et al	Terminology and Classification of Complications Related to Native Tissue Female Pelvic Floor Surgeries	International Urogynecological Association (IUGA) and ICS	International
2012	Lucas, et al	Assessment and Nonsurgical Management of UI	EAU	International (Europe)
2012	Mori, et al	Normal Pressure Hydrocephalus	Japanese Society of Normal Pressure Hydrocephalus	Japan
2012	National Clinical Guideline Centre	UI in Neurological Disease	National Clinical Guideline Centre	United Kingdom
2012	Swain, et al	Management of LUTD in Neurological Disease	NICE	United Kingdom
2012	Winters et al,	Urodynamics in Adults	AUA & SUFU	U. S.
2011	Hanno et al	Interstitial Cystitis / Bladder Pain Syndrome	AUA/SUFU	U. S.
2011	Thüroff, et al	Urodynamics in Adults	EAU	International (Europe)
2011	Vayssière, et al	Instrumental Delivery	French College of Gynaecologists and Obstetricians	France

Year	Citation	Topic	Professional Organization	Location
2010	Aubert et al	Primary Nocturnal Enuresis	French Expert Consensus Panel	France
2010	Dmochowski et al	Surgical Management of Stress UI in Women	AUA	U.S.
2010	Drutz, et al	Training for Female Pelvic Medicine and Reconstructive Pelvic Surgery (Education)	IUGA	International
2010	Fritel, et al	Adult Female Stress UI	French College of Gynaecologists and Obstetricians	France
2010	Hermieu, et al	Treatment of Non-Neurological UI in Women	L'Association Francaise d'Urologie	France
2010	Lovatsis, et al	Evaluation and Treatment of Recurrent UI after Pelvic Floor Surgery	Canadian Task Force on Preventive Health Care	Canada
2010	NICE	LUTS	NICE	United Kingdom
2010	NICE	Nocturnal Enuresis (Management of Bedwetting in Children and Young People)	NICE	United Kingdom
2010	Radziszewski et al	LUTS UI and OAB in Women	Consensus Panel	Poland
2010	Schröder, et al	EAU Guidelines on UI	EAU	International
2010	Singh, et al	Urodynamic Practice in the UK	United Kingdom Continence Society	United Kingdom
2010	Smith LN, et al	Rehabilitation after Stroke	Scottish Intercollegiate Guidelines Network	Scotland
2010	Zesiewicz, et al	Treatment of Nonmotor Symptoms of Parkinson Disease	American Academy of Neurology	U.S.
2009	Fowler, et al	Bladder Management in Multiple Sclerosis	Consensus Panel	United Kingdom
2009	Polish Society of Obstetrics & Gynecology	Prevention of UI and POP in Women Undergoing Hysterectomy	Polish Society of Obstetrics & Gynecology	Poland
2009	Velazquez Sanchez Mdel, et al	Diagnosis and Management of UI	Consensus Panel	Mexico
2009	Yamaguchi, et al	Clinical Guidelines for OAB	Japanese Urological Association and the Neurogenic Bladder Society	Japan
2008	Garcia-Gonzalez, et al	Diagnosis and Treatment of UI in the Elderly Population	Consensus Panel	Mexico
2008	Ghoniem, et al	Evaluation and Management of Stress UI in Women	IUGA	International
2008	Nishizawa	UI in the Elderly Population	Japanese Expert Consensus Panel	Japan
2008	vanPinxteren	UI in all Patients	Dutch College of General Practitioners	The Netherlands
2007	ACOVE	Management of Faecal Incontinence in Adults	ACOVE Consensus Panel / American Geriatrics Society	U.S.

Year	Citation	Topic	Professional Organization	Location
2007	NICE	Management of FI in Adults	NICE	United Kingdom

Since the last ICI, there has been extensive expansion of development and dissemination of guidelines, practice recommendations, and structured treatment programmes for UI and FI focused on both general UI, (265) (279) (280) (281) (282) (283) (284) general FI, (285) (286) (287) (288) geriatric UI, (289) and specific underlying conditions that can influence continence. Some examples include OAB and neurogenic detrusor overactivity, (290) (291) (292) urinary urgency and incontinence in men, (293) UI associated with various neurological conditions, (294) (295) treatment of post-stroke incontinence, (259) (296) (297) (298) normal pressure hydrocephalus, (299) Parkinson disease, (300) (301) multiple sclerosis, (302) (303) prevention of pressure ulcers, (304) UI associated dermatitis (305) and urinary catheter management. (306)

Within the realm of obstetrics and gynaecology, there are new guidelines on the management of third and fourth degree perineal tears during vaginal delivery, (307) (308) instrumental delivery techniques, (309) and terminology for native tissue repairs for POP. (310) In paediatrics, there are new guidelines on evaluation and treatment for congenital conditions affecting the bladder and bowel, (311) (312) use of urodynamics in evaluation of UI in children, treatment of daytime incontinence, (313) and constipation. (314)

Guidelines have also been developed regarding diagnostic and therapeutic options in order to define best-practice. This includes urodynamics, (315) (316) (317) clinical assessment methods and nonsurgical therapies for UI, (318) (319) service specifications for care, (148) pelvic floor physiotherapy, (320) (321) (322) biofeedback for FI, (323) various surgical procedures for UI, (324) (325) laparoscopic and robotic single site surgeries, (326) sacral neuromodulation, (327) and vaginal oestrogen use. (328)

5.1. Screening

There has also been an increased interest in the concept of screening for UI as a public health effort. Screening evaluation, diagnosis and treatment for UI among of all women ≥ 65 years of age has been maintained as one of the 2016 Physician Quality Reporting System (PQRS) measures in the U.S. (329) This quality assessment tool is linked to provider payment from Medicare in an effort to increase screening and enhance clinical outcomes for patients. In Europe, the URINO trial was designed to examine outcomes of having primary care providers offer treatment for UI to older community-dwelling women who had not sought out care on their own. (330) (331) Clinical outcomes including symptom severity and number of leakage episodes significantly improved in the intervention group compared to controls.

Several survey instruments designed to screen for UI have also been developed, tested, and reported recently. This includes a symptom screening tool for UI due to OAB. (332) and a brief self-administered screening tool. (333) Population studies using screening instruments have shown high prevalence rates of UI (41%) with 72% of women reporting at least moderate to severe symptoms, and 73% reporting at least 2 years duration of symptoms. (84)

Guidelines have also been developed for different care settings. In the U.S., the Centres for Medicare and Medicaid Services (CMS) issued F-Tag 315 in 2005. This guideline provides recommendations for bladder management in the long-term care setting. DuBeau et al (334) assessed the knowledge and attitudes of NH staff (including directors of nursing and NH surveyors) following revised U.S. government guidelines on continence care (Tag F315 - <http://www.cms.hhs.gov/transmittals/download/R8SOM.pdf>). They used a questionnaire in a convenience sample of 558 staff attending workshops. The authors reported striking deficiencies in knowledge amongst staff and identified managerial structures as barriers to guideline implementation. They suggested such barriers need to be overcome in order to improve the quality of continence care. Nursing journals have published recommendations on ways to enhance implementation and compliance with the U.S. government regulatory guidelines. (305)

Some guidelines have focused on education rather than on care delivery. The International Urogynaecological Association (IUGA) issued a set of guidelines specific for training in the area of female pelvic medicine and reconstructive pelvic surgery. (335) Other professional organisations have issued similar information under the headings of 'consensus statements,' 'recommendations,' and 'curricula.'

Many of the published guidelines focus on younger, healthy, community dwelling adults.

Guidelines for evaluation and treatment of UI and FI in children and the geriatric population or those with significant comorbidity need to be developed. These will need to take into account issues such as cognitive impairment, which can influence continence status in older adults. (336) Fung, (337) in a study in a large academic Veterans Affairs medical centre in the U.S., used guidelines to develop condition-specific computerized templates to serve as guides for clinicians to ask questions and perform elements of a physical exam for two specific medical conditions: UI and falls. This study demonstrated that a set of templates can be developed within an existing electronic health record system that can be used to prompt a clinician to obtain elements of a history and to perform physical examination.

The UK's National Institute for Health and Care Excellence (NICE) (2013) national guideline on UI in women [National Institute for Health and Care Excellence (NICE), 2013] recommends that invasive treatment for OAB and/or SUI symptoms should only be offered after evaluation from a multidisciplinary team.

5.2. Audits and Assessments of Guidelines

A number of published studies have examined the degree to which clinicians actually follow published guidelines. Many of these have focused on primary care providers.

A postal survey of Dutch GPs found that most adhered to guidelines when making the diagnosis of UI. (172) However, implementation of other measures and treatments were less robust. At least 25% reported difficulty adhering to the guideline due to lack of time, staff, diagnostic tools, competency in care delivery, and perceived low motivation on the part of patients. Others have questioned the utility of this specific guideline when viewed from the perspective of urologists. (338) They proposed future research to determine if recommendations for referral to specialists are adequate and if they will be implemented in a manner that will benefit patients. Another study with Dutch GPs identified therapeutic nihilism among the physicians and low motivation on the part of patients as major barriers to guideline implementation. (112) Other barriers included lack of time, difficulty explaining therapeutic options, limitations in patient mobility, and increased patient comorbidities.

A survey of primary care clinicians in the UK revealed that 56.8% agreed or strongly agreed that the 2006 NICE guideline on UI in women reflected their current practice. (339) However, more than half of clinicians indicated that they had not changed their practice to be fully compliant with the guideline. In another study, GPs in the UK identified knowledge limitations, time constraints, and access to resources on UI as important barriers to better implementation of the guidelines. (340) (341) Survey data revealed wide variation in opinions regarding specific recommendations in the NICE guidelines for evaluation and treatment female UI. (342) Recent data on compliance with the NICE recommendations for evaluation of LUTS in men in the UK found that the majority did not receive management according to the guidelines, (343) especially for older men compared to young men.

Adherence to the new NICE guideline for FI also appeared to be less than ideal. In a study of more than 5,350 cases, no documented focused history was taken in more than one-third of hospitals, one-half of primary care clinics, and three-quarters of care homes. (344) Less than half of all subjects had a documented plan for care for an identified bowel-related cause for clinical FI. The effect of FI on QoL was poorly documented, particularly in hospital settings.

Adherence to guideline recommendations may also be less than optimal among specialist providers. Ismail (345) examined records of women undergoing sling surgery for treatment of SUI at an academic medical centre in the UK. Only 45.3% of the patients had documentation in the medical record that they had previously tried conservative therapies. Documentation of underlying risk factors was highly variable. A similar study among urologists in Spain showed that compliance with guideline recommendations was less than ideal. (346)

Attitudes and adherence to new guidelines such as preoperative use and utility of urodynamics for UI (347) and evaluation and treatment of paediatric constipation (348) have been variable. Even adherence to recommended nomenclature for some pelvic floor conditions has been less than optimal. (349)

Studies have also examined the degree of awareness and adherence to guidelines among specific patient populations. Ismail (345) reported on the results of a survey of 223 women in the UK who had recently delivered their first child. According to the NICE guideline, these women should have been taught PFM exercises in the antenatal period. Although 95% reported awareness of the importance of the exercises, many did not have accurate information and only a small minority actually practiced them.

Adherence to guidelines for geriatric syndromes which influence continence status is also not particularly strong. For example, there are multiple barriers that can influence UI management in home health care settings. (350) A study of the national guidelines in the UK and Wales for older adults who have suffered a fall demonstrated that only 63% of 3,184 patients who fell and suffered a hip fracture, and only 21% of those with a fragility fracture not associated with a fall were assessed for concomitant UI. (185) Only half of those identified as having a UI problem were actually referred to a continence centre or provided any type of intervention.

Guideline recommendations are not without controversy. In a retrospective database analysis of 6,276 women, Agur et al (351) noted that of women believed to have pure SUI based history alone, at least 25% were found to have other forms of voiding dysfunction based on urodynamics. They concluded that the recommendation in the NICE guideline to avoid urodynamic testing in women with pure SUI symptoms might be unwise and could miss other important findings, which could influence care.

There are even more limited data on whether adherence to guidelines actually leads to substantive changes in measurable continence outcomes. (352) In cases where organized services were available, overall quality outcomes were better compared to areas where these services were not offered. (353)

An audit of the NICE guideline in the UK revealed that patient age may be associated with differential imple-

mentation of guideline recommendations for UI evaluation and treatment. (354) In this study, data from 7,846 women treated at either acute hospitals or primary care trusts in the UK, revealed that elderly women were significantly less likely to receive guideline compliant care compared to younger women. Actual levels of adherence by the care providers varied widely depending on the specific recommendation being evaluated. Levels of guideline adherence also appeared to differ between specialists providing care in acute hospital settings compared to GPs in the primary care trusts. In response to this finding, an editorial analysis asked rhetorically if lack of adherence to published guidelines for UI may actually represent a form of ageism on behalf of clinical providers and patients. (355)

Summary

Overtime, there has been a dramatic increase in the development and dissemination of guidelines, consensus statements and best practice recommendations. These are generally created and disseminated by professional organisations focused on both primary and specialty care. Methodology varies based on the sponsoring organisation, but most follow established principles using evidence-based techniques. There has been increased interest in the development and use of guidelines over recent years. Since the last ICI, there has been a substantial increase in both general guidelines regarding UI and FI, and in those targeting specific clinical situations such as UI or FI associated with neurological disorders, following childbirth, or after treatment for fistula or other conditions. Methods of dissemination are variable, and clinician awareness of guidelines can be a challenge. It can also be difficult to make clinical choices in cases where different guidelines may provide conflicting recommendations. Data from audits also indicated that clinical practitioners do not always adhere to guidelines. Future work will need to continue to assess existing and new guidelines, methods of guideline dissemination, ways to improve awareness of guidelines, and techniques to continually improve practice.

Levels of Evidence/Recommendations

Effectiveness of guidelines in clinical practice. (**Levels of evidence: 3 to 4**)

- There is a need to continue to evaluate the quality and relevance of existing clinical guidelines, particularly in the context of updating these materials or creating new guidelines based on emerging evidence.
- There is a need for additional research on guideline dissemination, awareness and adoption among clinicians.

- There is a need for assessment of multiple guidelines on similar topics to determine the extent to which they agree or conflict on specific points, and ways to resolve these differences to guide professional practice.
- There is a continued need for evaluation research to explore impact of guidelines on clinical care both at individual and population levels. This evaluation strategy needs to include impact on a wide range of outcomes, including incidence and prevalence of disease, treatment outcomes, prevention efforts, costs, and health care policy. (**Grade of Recommendations: C**)

IX. PUBLIC EDUCATION

Literature Search is found in Appendix 1.

1. BACKGROUND

Education of the lay public and patients is a crucial part of overall efforts in education and continence promotion. In the creation and discussion about this section, the committee recognized that a number of different terms are often used interchangeably when referring to this population. These terms include public education, layperson education, patient education, client education, consumer education, etc. These terms can have important distinctions depending on the perspective of those involved. For example, 'patients' may indicate those receiving care or suffering from a particular condition such as UI. The term 'clients' implies that people are receiving some type of services from a professional provider. And the term 'consumer' implies that the person is using either goods or services related to their UI. For simplicity, the term 'public education' will be used to summarize the information in this section.

Patient education consists of healthcare professionals teaching patients about their disease and offering therapeutic instruction, particularly information about self-management strategies, drugs, adaptation of their dosage and side-effects. (356) Patient education regarding normal and abnormal bladder function has been found to be helpful in the establishment of healthy bladder habits. (357)

However, there was very little evidence to highlight the benefit of patient education for people with bladder and bowel conditions and the difference it may make to their outcomes. Most patient education studies found did not meet the quality criteria for inclusion. There are also inherent issues with generalisability of data as there are no standardised methods, techniques, or delivery for patient education or even any agreement on the content on education.

There have been several studies assessing patients level of knowledge regarding specific treatments e.g. bladder retraining, PFM training, etc, however almost all of these are conference abstracts that have not

been developed into full peer reviewed papers. Brown et al (358) assessed women's knowledge of vaginal pessaries. Few patients had heard about pessaries from any source other than a physician or other health care provider and patients who indicated they would decline pessary use reported a lower level of education. Educational efforts alone may not be adequately sufficient to yield successful outcomes. Another study showed that intensive education about UI related to radical prostatectomy for cancer did not lead to better continence outcomes following surgery. (359) According to findings from a focus group study, obtaining information from people who have UI and their carers may have usefulness in helping these individuals in developing self-management tools women could use on their own in the future. (52)

The Prolapse and Incontinence Knowledge Questionnaire (PIKQ) was developed and validated by Shah et al (360) as a reliable method of assessing patient knowledge of UI and POP. In several of the studies reviewed assessing education given to female patients was used pre and post intervention to assess gain in knowledge.

Recently there has been a substantial increase in publications related to public education for incontinence. These have broadly focused on several areas including knowledge and perceptions about incontinence and associated conditions, development and dissemination of public education or programmatic efforts related to continence, and the availability and quality of social media and electronic applications for public education on continence and related topics.

A survey of visitors to a public education website with information on UI collected self-reported data from 374 people and found that 13% had not spoken with a healthcare provider about their UI symptoms, and 75% were not using any type of active approach to address their symptoms. (361) A systematic review of published studies examined perceptions of both patients and staff about factors facilitating or serving as barriers to uptake of behavioural therapies. (196) It reported that the main patient factors identified to help enhance adoption of these treatments included having realistic goals and expectations and gaining a sense of control. For care staff, a sense of teamwork and experience with success were enabling factors. Barriers for patients included fear of accidents and convenience of treatment, while staff identified staff education and perceptions of treatment effectiveness as barriers. Another scoping study has identified a number of theoretical paradigms that can be used to influence education efforts to enhance adherence to behavioural therapies. (362)

Studies on perceptions about UI and future health have shown mixed results. One study of 786 people in Spain identified that 50% felt their UI was normal for their age, and 71.5% expected it to worsen with time and increasing age. (363) However, 80% also expected improvement with treatment. People used

a variety of coping strategies, and this increased with increasing UI severity.

Innovations in public education treatment programmes for UI and associated conditions incorporated technology applications. (364) Delivery of a PFM programme via the internet was found to be more effective at one year among those with initial short term improvement in symptoms, increasing age, and among those who continued regular PFM exercises. (365) Other researchers have shown a mobile app was effective in helping train women with SUI about PFM exercise, and could be useful to enhance education about the condition. (366) Another study of 41 women demonstrated that an avatar based online educational programme was effective in improving health related quality

Summary

Public education directed toward patients, clients and consumers is an important part of the overall spectrum of information and dissemination of continence promotion. This can take many forms ranging from the provision of health information between health care providers and individual patients to public service announcements and other mass media communications. Although there has been a recent increase in public education efforts, research in this area is still in its relative infancy.

Levels of Evidence/Recommendations

Effectiveness of public education efforts through various channels including individual education, public media and mass communications (**Levels of Evidence 3 to 4**)

- There is a need for additional focused research on methods to enhance patient and public education about UI, FI, and POP, both at an individual and broader public level.
- Research is needed to examine methods to improve efficiency of public education including group training, mass marketing and other techniques
- The role of technology in public education for continence promotion should be examined in more depth

(Grade of Recommendations: C)

X. CONCLUSIONS

Continence promotion involves many different components including primary prevention strategies, health care advocacy, and methods of encouraging help-seeking behaviours. It also includes development of models to enhance provision of and access to health care in a wide variety of settings ranging

from community programmes, to facility-based and institutional programmes, to widespread governmental initiatives. Education, of both health care providers and the public remains a cornerstone of successful continence promotion. Although there has been an increase in attention to these topics in recent years, additional work will be needed to actively advance our knowledge and to foster future progress.

APPENDIX 1. LITERATURE SEARCH

The literature search to identify material for this chapter, additional to that reviewed for the last (5th) consultation, was conducted as follows:

Primary Prevention: Online databases Pub Med, Cinahl, Psycinfo, and Medline were searched, with focus on literature published in and after 2010. Search terms used (aware* OR educat* OR promot* OR instruct* OR interven* OR teach* OR learn* OR lifestyle OR behav* OR change*) AND prevent* AND (incontinen* OR continen* OR continence*) NOT continental Sort by: Relevance Filters: Publication date from 2011/01/01; Adult: 19+ years

Continence Awareness, Promotion and Advocacy: Online databases Pub Med, Cinahl, Psycinfo, and Medline were searched, with focus on literature published in and after 2010. Search terms used: 'awareness', 'consumer', 'education', 'urinary incontinence', 'faecal incontinence', 'incontinence', 'continence', 'continence awareness', 'continence promotion', 'health education', 'public education', 'public awareness', 'pelvic organ prolapse', health literacy, health promotion', 'outcome measures'

Help-seeking (care-seeking) behaviour: Search of pubmed/embase/cinahl/psyc/psychlit/eric/biosis/Scopus/cochrane/WOS/JBI was conducted for the years 2011 to 2016. The search terms for each search were: PUBMED: (((health*[tw] OR care*[tw] OR help*[tw]) AND (acceptance*[tw] OR accepting*[tw] OR accept*[tw] OR seek*[tw] OR seeks*[tw] OR seeker*[tw] OR seeking*[tw])) OR "Patient Acceptance of Health Care" [Mesh] OR "help-seeking"[tw] OR "care-seeking"[tw]) AND ((incontinen*[tw] OR continen*[tw]) NOT continental) AND ((Adult[Mesh] OR adult*)) CINAHL/PSYC/ERIC: ((TX (health* OR care OR help) N5 (acceptance OR accepting OR accept OR seek OR seeks OR seeker OR seeking)) OR (MH "Help Seeking Behaviour") OR (TX "help-seeking" OR "care-seeking")) AND (TX (incontinen* OR continen*) NOT continental) AND (MH "Adult+" OR TX adult*)) FROM 2011 EMBASE: health*:ab,ti OR care:ab,ti OR help:ab,ti AND (acceptance:ab,ti OR accepting:ab,ti OR accept:ab,ti OR seek:ab,ti OR seeks:ab,ti OR seeker:ab,ti OR seeking:ab,ti) OR 'help-seeking':ab,ti OR 'care-seeking':ab,ti OR 'help seeking behaviour'/exp OR 'patient acceptance of health care'/exp incontinent OR incontinence OR continence NOT continental 'adult'/exp OR adult*#9 AND #10 AND #12 AND [2011-2016]/py WOS:

((health* OR care OR help) AND (acceptance OR accepting OR accept OR seek OR seeks OR seeker OR seeking)) OR TOPIC: ("help-seeking" OR "care-seeking") Refined by: TOPIC: (incontinence OR incontinent OR continence OR continent) AND TOPIC: (adult* OR man OR woman OR men OR women) Timespan: 2011-2016. Indexes: SCI-EXPANDED, SSCI, A&HCI, CPCI-S, CPCI-SSH, BKCI-S, BKCI-SSH, ESCI, CCR-EXPANDED, IC. SCOPUS: (TITLE-ABS-KEY((health* OR care OR help) AND (acceptance OR accepting OR accept OR seek OR seeks OR seeker OR seeking)) OR TITLE-ABS-KEY("help-seeking" OR "care-seeking")) AND (TITLE-ABS-KEY(incontinence OR incontinent OR continence)) AND (adult* OR man OR woman OR men OR women) AND (LIMIT-TO(PUBYEAR,2016) OR LIMIT-TO(PUBYEAR,2015) OR LIMIT-TO(PUBYEAR,2014) OR LIMIT-TO(PUBYEAR,2013) OR LIMIT-TO(PUBYEAR,2012) OR LIMIT-TO(PUBYEAR,2011))

BIOSIS: You searched for: TOPIC: (((health* OR care OR help) AND (acceptance OR accepting OR accept OR seek OR seeks OR seeker OR seeking)) OR TOPIC: ("help-seeking" OR "care-seeking")) Refined by: TOPIC: ((incontinence OR incontinent OR continence OR continent)) AND TOPIC: ((adult* OR man OR woman OR men OR women)) AND PUBLICATION YEARS: (2015 OR 2014 OR 2013 OR 2012 OR 2011 OR 2016) Timespan: All years. Indexes: BCI. COCHRANE: '((health* OR care OR help) AND (acceptance OR accepting OR accept OR seek OR seeks OR seeker OR seeking)) OR "help-seeking" OR "care-seeking" in Title, Abstract, Keywords and (incontinence OR incontinent OR continence OR continent) in Title, Abstract, Keywords and adult* OR man OR men OR woman OR women JBI: (((health* or care or help) and (acceptance or accepting or accept or seek or seeks or seeker or seeking)) or "help-seeking" or "care-seeking").tx. (incontinence or incontinent or continence or continent).tx. (adult* or man or men or woman or women).af. Abstracts for the retrieved citations were reviewed in Covidence and the full text of each included papers was reviewed. No interventional research studies or systematic literature reviews for help-seeking or care-seeking since 2013 were found.

Continence Promotion Programmes: Online databases Pub Med, Cinahl, Psycinfo, and Medline were searched, with focus on literature published in and after 2010. Search terms used: 'awareness', 'consumer', 'education', 'urinary incontinence', 'faecal incontinence', 'incontinence', 'continence', 'continence awareness', 'continence promotion', 'promotion programme', 'health education', 'public education', 'public awareness', 'health literacy', 'health promotion'

Continence Advocacy: Online databases Pub Med, Cinahl, Psycinfo, and Medline were searched, with focus on literature published in and after 2010. Search terms used: 'awareness', 'consumer', 'urinary incontinence', 'faecal incontinence', 'incontinence',

'contenance', 'contenance promotion', 'promotion programme', 'public awareness', 'advocacy', 'consumer awareness', 'contenance advocacy'

Models of Care, Delivery and Accessing Care: Online databases Pub Med, Embase, Medline and Cochrane were searched, with focus on literature published in and after 2010. Search terms used: 'urinary incontinence', 'faecal incontinence', 'incontinence', 'contenance', 'models', 'service', 'delivery', 'economics', 'strategy'.

Education: Online databases Pub Med, Cinahl, Psych-info, and Medline were searched, with focus on literature published in and after 2010. Search terms used: 'contenance', 'continuing education', 'curriculum', 'education', 'faecal incontinence', 'graduate education', 'fellowship', 'health education', 'incontinence', 'pelvic organ prolapse', 'professional education', 'residency', 'resident', 'student', 'training', 'urinary incontinence'.

Nursing Education: Databases searched – Embase, Cinhal. Medline, Cochrane, ERIC, Web of Knowledge. Search terms (including variations and /or) – education, urinary incontinence, faecal incontinence, contenance, health education, allied health professional, physiotherapist, bladder and bowel, nursing, care assistants.

Impact of Clinical Guidelines: Databases: PubMed, CINAHL, Embase. Terms: (Contenance or Incontinence or Bladder or Bowel) AND (Clinical Guideline or Guidelines or Consensus or Best Practice or Audit). Language: English

Public Education: Databases: PubMed, Medline, Embase, Google scholar. Terms: patient education or patient knowledge public education, layperson education, client education, consumer education AND (Contenance or Incontinence or Bladder or Bowel) Language: English

REFERENCES

1. Newman DK. Tackling the stigma of incontinence. In: Cardozo L, Staskin D, editors. *Textbook of Female Urology and Urogynecology*. 4th ed. London: Isis Medical Media, LTD; 2016:58-63.
2. World Health Organization. Health promotion and disease prevention through population-based interventions, including action to address social determinants and health inequity. Eastern Mediterranean: World Health Organization; 2016. Available from: <http://www.emro.who.int/about-who/public-health-functions/health-promotion-disease-prevention.html>
3. Lukacz ES, Sampsel C, Gray M, MacDiarmid S, Rosenberg M, Ellsworth P, et al. A healthy bladder: a consensus statement. *Int J Clin Pract*. 2011;65:1026-36.
4. Dieter AA, Wilkins MF, Wu JM. Epidemiological trends and future care needs for pelvic floor disorders. *Curr Opin Obstet Gynecol*. 2015;27(5):380-4.
5. Wu JM, Matthews CA, Conover MM, Pate V, Jonsson Funk M. Lifetime risk of stress urinary incontinence or pelvic organ prolapse surgery. *Obstet Gynecol*. 2014;123(6):1201-6.
6. Milsom I, Coyne KS, Nicholson S, Kvasz M, Chen CI, Wein AJ. Global prevalence and economic burden of urgency urinary incontinence: A systematic review. *Eur Urol*. 2014;65(1):79-95.
7. Luo X, Chuang CC, Yang E, Zou KH, Araiza AL, Bhagnani T. Prevalence, management and outcomes of medically complex vulnerable elderly patients with urinary incontinence in the United States. *Int J Clin Pract*. 2015;69(12):1517-24.
8. Bazi T, Takahashi S, Ismail S, Bo K, Ruiz-Zapata AM, Duckett J, et al. Prevention of pelvic floor disorders: International urogynecological association research and development committee opinion. *Int Urogynecol J*. 2016;27(12):1785-95.
9. Palmer MH, Athanasopoulos A, Lee KS, Takeda M, Wyndaele JJ. Sociocultural and environmental influences on bladder health. *Int J Clin Pract*. 2012;66(12):1132-8.
10. Bardino M, Di Martino M, Ricci E, Parazzini F. Frequency and determinants of urinary incontinence in adolescent and young nulliparous women. *J Pediatr Adolesc Gynecol*. 2015;28(6):462-70.
11. Burgio KL, Newman DK, Rosenberg MT, Sampsel C. Impact of behaviour and lifestyle on bladder health. *Int J Clin Pract*. 2013;67(6):495-504.
12. Wang K, Palmer MH. Development and validation of an instrument to assess women's toileting behavior related to urinary elimination: Preliminary results. *Nurs Res*. 2011;60(3):158-164.
13. Xu D, Chen L, Wan X, Zhang Y, Liu N, Wang K. Toileting behavior and related health beliefs among Chinese female nurses. *Int J Clin Pract*. 2016;70(5):416-23.
14. Palmer MH, Newman DK. Women's toileting behaviours: an online survey of female advanced practice providers. *Int J Clin Pract*. 2015;69(4):429-35.
15. Willis-Gray M, Sripad A, Newman DK, Palmer MH. Toileting behavior in women presenting to urogynecology clinic. *Female Pelvic Med Reconstr Surg*. 2016;22(5) Suppl 1: S94.
16. Shonkoff JP, Boyce WT, McEwen BS. Neuroscience, molecular biology, and the childhood roots of health disparities: Building a new framework for health promotion and disease prevention. *JAMA*. 2009;301(21):2252-9.
17. Sievert KD, Amend B, Toomey PA, Robinson D, Milsom I, Koelbl H, et al. Can we prevent incontinence? *Neurourol Urodyn*. 2012;31(3):390-9.
18. Duralde ER, Walter LC, Van Den Eeden SK, Nakagawa S, Subak LL, Brown JS, et al. Bridging the gap: Determinants of undiagnosed or untreated urinary incontinence in women. *Am J Obstet Gynecol*. 2016;214(2):266.e1-9.
19. Mishra GD, Barker MS, Herber-Gast GC, Hillard T. Depression and the incidence of urinary incontinence symptoms among young women: Results from a prospective cohort study. *Maturitas*. 2015;81(4):456-61.
20. Moreno-Vecino B, Arijia-Blazquez A, Pedrero-Chamizo R, Alcazar J, Gomez-Cabello A, Perez-Lopez FR, et al. Associations between obesity, physical fitness, and urinary incontinence in non-institutionalized postmenopausal women: The elderly EXERNET multi-center study. *Maturitas*. 2015;82(2):208-14.
21. Fenner DE, Trowbridge ER, Patel DA, Fultz NH, Miller JM, Howard D, et al. Establishing the prevalence of incontinence study: Racial differences in women's patterns of urinary incontinence. *J Urol*. 2008;179(4):1455-60.
22. Bliss D, Gurvich O, Eberly L, Savik K, Harms S, Wyman J, et al. Racial disparities in primary prevention of incontinence among older adults at nursing home admission. *Neurourol Urodyn*. 2016 Jul 4. doi: 10.1002/nau.23065.

23. Mandimika CL, Murk W, Mcpencow AM, Lake AG, Miller D, Connell KA et al. (2015). Racial disparities in knowledge of pelvic floor disorders among community-dwelling women. *Female Pelvic Med Reconstr Surg*. 2015;21(5):287-92.
24. Hamid TA, Pakgohar M, Ibrahim R, Dastjerdi MV. "Stain in life": The meaning of urinary incontinence in the context of muslim postmenopausal women through hermeneutic phenomenology. *Arch Gerontol Geriatr*. 2015;60(3):514-21.
25. Mueller E, Damaser M, Mallampalli M, Losado L. Women's Urological Health as a priority to the woman well visit. *Women's Health Issues*. 2016;26(44):476-7.
26. Schussler-Fiorenza-Rose SM, Gangnon RE, Chewing B, Wald A. Increasing discussion rates of incontinence in primary care: A randomized controlled trial. *J Womens Health (Larchmt)*. 2015;24(11):940-9.
27. Palmer MH. Primary prevention research on incontinence in older adults. *W J Nurs Res*. 2002;24(4):390-405.
28. Sampsel C, Palmer MH, Boyington AR, O'Dell KK, Wooldridge L. (2004). Prevention of urinary incontinence in adults: Population-based strategies. *Nurs Res*. 2004;53(6)Suppl:S61-7.
29. Kissler K, Yount SM, Rendeiro M, Zeidenstein L. Primary prevention of urinary incontinence: A case study of prenatal and intrapartum interventions. *J Midwifery Womens Health*. 2016;61(4):507-11.
30. Bavendam TG, Star RA, Rodgers GP. Research to improve urological health for women and girls: Focus on prevention. *J Womens Health (Larchmt)*. 2016;25(11):1081-2.
31. Wesnes SL, Lose G. Preventing urinary incontinence during pregnancy and postpartum: A review. *Int Urogynecol J*. 2013;24(6):889-99.
32. Fritel X, de Tayrac R, Bader G, Savary D, Gueye A, Deffieux X, et al. (2015). Preventing urinary incontinence with supervised prenatal pelvic floor exercises: A randomized controlled trial. *Obstet Gynecol*. 2015;126(2):370-7.
33. Sangsawang B, Sangsawang N. Is a 6-week supervised pelvic floor muscle exercise program effective in preventing stress urinary incontinence in late pregnancy in primigravid women?: A randomized controlled trial. *Eur J Obstet Gynecol Reprod Biol*. 2016;197:103-10.
34. Moosdorff-Steinhauser HF, Albers-Heitner P, Weemhoff M, Spaanderman ME, Nieman F, Berghmans B. Factors influencing postpartum women's willingness to participate in a preventive pelvic floor muscle training program: A web-based survey. *Eur J Obstet Gynecol Reprod Biol*. 2015;195:182-7.
35. Blyholder L, Chumanov E, Carr K, Heiderscheid B. Exercise behaviors and health conditions of runners after childbirth. *Sports Health*. 2016 Oct 14. pii: 1941738116673605.
36. Wang W, Huang QM, Liu FP, Mao QQ. Effectiveness of preoperative pelvic floor muscle training for urinary incontinence after radical prostatectomy: A meta-analysis. *BMC Urol*. 2014;14(1):99.
37. Geoffrion R, Robert M, Ross S, van Heerden D, Neustaedter G, Tang S, et al. Evaluating patient learning after an educational program for women with incontinence and pelvic organ prolapse. *Int Urogynecol J Pelvic Floor Dysfunct*. 2009;20:1243-52.
38. Newman D, Sampsel C, Miller J. The effectiveness of a randomized controlled trial of Bladder Health Education to prevent Urinary Incontinence. *Female Pelvic Med Reconstr Surg* 2016;22(5)Suppl:S8-9.
39. Newman D, Sampsel C, Raghunathan T, Miller J, Kirk K. Educating adult women about Bladder Health: The Translating Unique Learning for UI Prevention (TULIP) Project. *NeuroUrol Urodyn* 2016;35(S4)Suppl:S376-S7.
40. Diokno AC, Ogunyemi T, Siadat MR, Arslanturk S, Killinger KA. (2015). Continence index: A new screening questionnaire to predict the probability of future incontinence in older women in the community. *Int Urol Nephrol*. 2015;47(7):1091-7.
41. Tannenbaum C, Agnew R, Benedetti A, Thomas D, van den Heuvel E. Effectiveness of continence promotion for older women via community organisations: A cluster randomised trial. *BMJ Open*. 2013;3(12):e004135.
42. Tannenbaum C, van den Heuvel E, Fritel X, Southall K, Jutai J, Rajabali S, et al. Continence Across Continents To Upend Stigma and Dependency (CACTUS-D): study protocol for a cluster randomized controlled trial. *Trials*. 2015;16:565.
43. Ng KS, Sivakumaran Y, Nassar N, Gladman MA. Fecal incontinence: Community prevalence and associated factors--A systematic review. *Dis Colon Rectum*. 2015;58(12):1194-209.
44. Bharucha AE, Dunivan G, Goode PS, Lukacz ES, Markland AD, Matthews CA, et al. Epidemiology, pathophysiology, and classification of fecal incontinence: state of the science summary for the National Institute of Diabetes and

- Digestive and Kidney Diseases (NIDDK) workshop. *Am J Gastroenterol*. 2015;110(1):127-36.
45. Kunduru L, Kim SM, Heymen S, Whitehead WE. Factors that affect consultation and screening for fecal incontinence. *Clin Gastroenterol Hepatol*. 2015;13(4):709-16.
 46. Wilkinson R (ed.), Marmot M (ed.). *Social determinants of health. The solid facts*. 2nd ed. Denmark: WHO Library Cataloguing in Publication Data; 2003. Available from: http://www.euro.who.int/__data/assets/pdf_file/0005/98438/e81384.pdf?ua=1
 47. Norton C, Dibley L. Understanding the taboos about bladder and bowels. In: Gartley CB, Klein MR, Norton C, Saltmarche A, eds. *Managing Life with Incontinence*. Illinois: The Simon Foundation for Continence; 2012.
 48. Day MR, Leahy-Wanenn P, Loughran S, O'Sullivan E. Community-dwelling women's knowledge of urinary incontinence. *Br J Community Nurs*. 2014;19(11):534-8.
 49. Melville JL, Wagner LE, Fan MY, Katon WJ, Newton KM. Women's perceptions about the etiology of urinary incontinence. *J Womens Health (Larchmt)*. 2008;17:1093-8.
 50. Spencer J. Continence Promotion: How Nurses Can Educate Women. *Nurs Womens Health*. 2012;16(4):337-40.
 51. Hines SH, Sampsel CM, Ronis DL, Yeo S, Fredrickson BL, Boyd CJ. Women's self-care agency to manage urinary incontinence: the impact of nursing agency and body experience. *ANS Adv Nurs Sci*. 2007;30:175-88.
 52. Holroyd-Leduc JM, Straus S, Thorpe K, Davis DA, Schmaltz H, Tannenbaum C. Translation of evidence into a self-management tool for use by women with urinary incontinence. *Age Ageing*. 2011;40:227-33.
 53. Muller N. What Americans understand and how they are affected by bladder control problems: highlights of recent nationwide consumer research. *Urol Nurs*. 2005;25:109-15.
 54. Liebergall-Wischnitzer M, Cnaan T, Hochner H, Paltiel O. Self-reported prevalence of and knowledge about urinary incontinence among community-dwelling Israeli women of child-bearing age. *J Wound Ostomy Continence Nurs*. 2015;42(4):401-6.
 55. Hatchett L, Hebert-Beirne J, Tenfelde S, Lavender MD, Brubaker L. Knowledge and perceptions of pelvic floor disorders among African American and Latina women. *Female Pelvic Med Reconstr Surg*. 2011;17:190-4.
 56. Parden AM, Griffin R, Hoover K, Ellington DR, Gleason JL, Burgio KL, et al. Prevalence, awareness, and understanding of pelvic floor disorders in adolescent and young women. *J Pelvic Med Surg*. 2016;22(5):346-54.
 57. Patel K, Bliss DZ, Savik K. Health literacy and emotional responses related to fecal incontinence. *J Wound Ostomy Continence Nurs*. 2010;37:73-9.
 58. Bliss DZ, Norton C, Vodusek DB. Raising awareness about fecal incontinence. *Neurourol Urodyn* 2010;29:612-5.
 59. Norton NJ. The perspective of the patient. *Gastroenterol*. 2004;126 Suppl 1:S175-9.
 60. Norton C. Nurses, bowel continence, stigma, and taboos. *J Wound Ostomy Continence Nurs* 2004;31(2):85-94.
 61. Norton C, Dibley L. Help-seeking for fecal incontinence in people with inflammatory bowel disease. *J Wound Ostomy Continence Nurs*. 2013;40(6):631-8.
 62. Fox, S. Health Information is a Popular Pursuit Online: Pew Research Center Internet and American Life Project survey, 2008-2010. Pew Research Center. Available from: <http://www.pewinternet.org/2011/02/01/health-information-is-a-popular-pursuit-online/>
 63. Amante DJ, Hogan TP, Pagoto SL, English TM, Lapane KL. Access to care and use of the Internet to search for health information: results from the US National Health Interview Survey. *J Med Internet Res*. 2015;17(4):e106.
 64. Al-Shammary N, Awan S, Butt K, Yoo J. Internet use before consultation with a health professional. *Prim Health Care*. 2007;17:18-21.
 65. Mazloomdoost D, Kanter G, Chan RC, Deveaneau N, Wyman AM, Von Bargen EC, et al. Social networking and Internet use among pelvic floor patients: a multicenter survey. *Am J Obstet Gynecol*. 2016;215(5):654.e1-654.e10.
 66. Saiki LS, Cloyes KG. Blog text about female incontinence: presentation of self, disclosure, and social risk assessment. *Nurs Res*. 2014;63(2):137-42.
 67. Dueñas-García OF, Kandadai P, Flynn MK, Patterson D, Saini J, O'Dell K. Patient-focused websites related to stress urinary incontinence and pelvic organ prolapse: a DISCERN quality analysis. *Int Urogynecol J*. 2015;26(6):875-80.
 68. Saraswat I, Abouassaly R, Dwyer P, Bolton DM, Lawrentschuk N. Female urinary incontinence health information quality on the Internet: a multilingual evaluation. *Int Urogynecol J*. 2016;27(1):69-76.
 69. Sajadi KP, Goldman HB, Firoozi F. Assessing internet health information on female pelvic floor disorders. *JUrol*. 2011;186(2):594-6.

70. Diering CL, Palmer MH. Professional information about urinary incontinence on the World Wide Web: is it timely? Is it accurate? *J Wound Ostomy Continence Nurs.* 2001;28:55-62.
71. Sajadi KP, Goldman HB. Social networks lack useful content for incontinence. *Urol.* 2011;78(4):764-7.
72. Pena-Purcell N. Hispanic's use of internet health information: an exploratory study. *J Med Libr Assoc.* 2008;96(2):101-7.
73. Wennberg A-L, Molander U, Fall M, Edlund C, Peeker R, Milsom I. Lower urinary tract symptoms: lack of change in prevalence and help-seeking behaviour in two population-based surveys of women in 1991 and 2007. *BJU Int.* 2009;104(7):954-9.
74. Scott SE, Walter FM, Webster A, Sutton S, Emery J. The model of pathways to treatment: conceptualization and integration with existing theory. *Br J Health Psychol.* 2013;18:45-65.
75. Shaw C, Brittain K, Tansey R, Williams K. How people decide to seek health care: A qualitative study. *Int J Nurs Studies.* 2008;45(10):1516-24.
76. Vethanayagam N, Orrell A, Dahlberg L, McKee KJ, Orme S, Parker SG, et al. Understanding help-seeking in older people with urinary incontinence: an interview study. *Health Soc Care Community.* 2016 Nov 16. doi: 10.1111/hsc.12406.
77. Koch LH. Help-seeking behaviors of women with urinary incontinence: an integrative literature review. *J Midwifery Womens Health.* 2006;51:e39-44.
78. Grzybowska ME, Wydra D, Smutek J. Analysis of the usage of continence pads and help-seeking behavior of women with stress urinary incontinence in Poland. *BMC Womens Health.* 2015;15:80.
79. Kwon CS, Lee JH. Prevalence, Risk Factors, Quality of Life, and Health-Care Seeking Behaviors of Female Urinary Incontinence: Results From the 4th Korean National Health and Nutrition Examination Survey VI (2007-2009). *Int Neurourol J.* 2014;18:31-6.
80. Welch LC, Taubenberger S, Tennstedt SL. Patients' experiences of seeking health care for lower urinary tract symptoms. *Res Nurs Health.* 2011;34(6):496-507.
81. Fritel X, Panjo H, Varnoux N, Ringa V. The individual determinants of care-seeking among middle-aged women reporting urinary incontinence: analysis of a 2273-woman cohort. *Neurourol Urodyn.* 2014;33(7):1116-22.
82. Siddiqui NY, Ammarell N, Wu JM, Sandoval JS, Bosworth HB. Urinary incontinence and health-seeking behavior among White, Black, and Latina women. *Female Pelvic Med Reconstr Surg.* 2016;22(5):340-5.
83. Choi EP, Chin WY, Lam CL, Wan EY, Chan AK, Chan KH. Evaluation of the effectiveness of nurse-led continence care treatments for Chinese primary care patients with lower urinary tract symptoms. *PLoS One.* 2015;10(6):e0129875.
84. Minassian VA, Yan X, Lichtenfeld MJ, Sun H, Stewart WF. The iceberg of health care utilization in women with urinary incontinence. *Int Urogynecol J.* 2012;23(8):1087-93.
85. Park J, Hong GR, Yang W. Factors Associated With Self-reported and Medically Diagnosed Urinary Incontinence Among Community-Dwelling Older Women In Korea. *Int Neurourol J.* 2015;19(2):99-106.
86. Perera J, Kirthinanda DS, Wijeratne S, Wickramarachchi TK. Descriptive cross sectional study on prevalence, perceptions, predisposing factors and health seeking behaviour of women with stress urinary incontinence. *BMC Womens Health.* 2014;14:78.
87. Buurman MB, Lagro-Janssen AL. Women's perception of postpartum pelvic floor dysfunction and their help-seeking behaviour: A qualitative interview study. *Scand J Caring Sci.* 2013;27(2):406-13.
88. Elbiss HM, Osman N, Hammad FT. Social impact and healthcare-seeking behavior among women with urinary incontinence in the united arab emirates. *Int J Gynaecol Obstet.* 2013;122(2):136-9.
89. Wu C, Wang K, Sun T, Xu D, Palmer MH. Predicting help-seeking intention of women with urinary incontinence in jinan, china: A theory of planned behaviour model. *J Clin Nurs.* 2014;24(3-4):457-64.
90. Anger JT, Lee UJ, Mittal BM, Pollard ME, Tarnay CM, Maliski S, et al. Health literacy and disease understanding among aging women with pelvic floor disorders. *Female Pelvic Med Reconstr Surg.* 2012;18(6):340-3.
91. Mandimika CL, Murk, W, Muhlhauser McPencow A, Lake A, Wedderburn T, Collier CH, et al. Knowledge of pelvic floor disorders in a population of community-dwelling women. *Am J Obstet Gynecol.* 2014;210(2):165.e1-165.e9.
92. Carls C. The prevalence of stress urinary incontinence in high school and college-age female athletes in the midwest: implications for education and prevention. *Urol Nurs.* 2007;27:21-4, 39.

93. Hazewinkel MH, Sprangers MA, Taminiau-Bloem EF, van der Velden J, Burger MP, Rooversa JP. Reasons for not seeking medical help for severe pelvic floor symptoms: a qualitative study in survivors of gynaecological cancer. *BJOG*. 2010;117:39-46.
94. Berger MB, Patel DA, Miller JM, Delancey JO, Fenner DE. Racial differences in self-reported healthcare seeking and treatment for urinary incontinence in community-dwelling women from the EPI Study. *Neurourol Urodyn*. 2011;30(8):1442-7.
95. Dessie SG, Adams SR, Modest AM, Hacker MR., Elkadry EA. Bladder symptoms and attitudes in an ethnically diverse population. *Female Pelvic Med Reconstr Surg*. 2016;22(1):37-42.
96. Siddiqui NY, Levin PJ, Phadtare A, Pietrobon R, Ammarell N. Perceptions about female urinary incontinence: A systematic review. *Int Urogynecol J*. 2014;25(7):863-71.
97. Hsieh CH, Su TH, Chang ST, Lin SH, Lee MC, Lee MY. Prevalence of and attitude toward urinary incontinence in postmenopausal women. *Int J Gynaecol Obstet*. 2008;100(2):171-4.
98. Li FL, Low LP, Lee DT. Chinese women's experiences in coping with urinary incontinence. *J Clin Nurs*. 2007;16(3):610-2.
99. Rizk DE. Measuring barriers to urinary incontinence care seeking in women: the knowledge barrier. *Neurourol Urodyn*. 2009;28:101.
100. Waetjen LE, Xing G, Johnson WO, Melnikow J, Gold EB, & Study of Women's Health Across the Nation (SWAN). Factors associated with seeking treatment for urinary incontinence during the menopausal transition. *Obstet Gynecol*. 2015;125(5):1071-9.
101. Xu D, Wang X, Li J, Wang K. The mediating effect of 'bothersome' urinary incontinence on help-seeking intentions among community-dwelling women. *J Adv Nurs*. 2015;71(2):315-25.
102. Pakgohar M, Sabetghadam S, Vasegh Rahimparvar SF, Kazemnejad A. Quality of life (QoL) and help-seeking in postmenopausal women with urinary incontinence (UI): A population based study. *Arch Gerontol Geriatr*. 2014;59(2):403-7.
103. Visser E, de Bock GH, Kollen BJ, Meijerink M, Berger MY, Dekker JH. Systematic screening for urinary incontinence in older women: who could benefit from it? *Scand J Prim Health Care*. 2012;30:21-8.
104. Welliver C, Sulaver R, Whittington A, Helfand B, Cakir OO, Griffith J, et al. Analyzing why men seek treatment for lower urinary tract symptoms and factors associated with nonimprovement. *Urol*. 2015;86(5):862-7.
105. Lammers H, van Wijnhoven R, Teunissen T, Harmsen S, Lagro-Janssen A. Why do men suffering from LUTS seek primary medical care? A qualitative study. *J Eval Clin Pract*. 2015;21(5):931-6.
106. Willis-Gray MG, Sandoval JS, Maynor J, Bosworth HB, Siddiqui NY. Barriers to urinary incontinence care seeking in white, black, and Latina women. *Female Pelvic Med Reconstr Surg*. 2015;21(2):83-6.
107. El-Azab AS, Shaaban OM. Measuring the barriers against seeking consultation for urinary incontinence among Middle Eastern women. *BMC Womens Health*. 2010;10:3.
108. Wang C, Li J, Wan X, Wang X, Kane RL, Wang K. Effects of stigma on Chinese women's attitudes towards seeking treatment for urinary incontinence. *J Clinical Nurs*. 2015;24(7-8):1112-21.
109. Gjerde JL, Rortveit G, Muleta M, Blystad A. Silently waiting to heal: experiences among women living with urinary incontinence in north-west Ethiopia. *Int Urogynecol J*. 2013;24(6):953-8.
110. Wu MP, Hsu YW, Weng SF, Ho CH, Wang JJ, Tong YC. Healthcare-seeking prevalence of lower urinary tract symptoms among national health insurance enrollees in Taiwan, 2000-2009. *Urol*. 2013;81:61-5.
111. Herbison P, Hay-Smith J, Paterson H, Ellis G, Wilson D. Research priorities in urinary incontinence: results from citizens' juries. *BJOG*. 2009;116(5):713-8.
112. Teunissen D, van den Bosch W, van Weel C, Lagro-Janssen T. Urinary incontinence in the elderly: attitudes and experiences of general practitioners. A focus group study. *Scand J Prim Health Care*. 2006;24:56-61.
113. Elstad EA, Taubenberger SP, Botelho EM, Tennstedt SL. Beyond incontinence: the stigma of other urinary symptoms. *J Adv Nurs*. 2010;66(11):2460-70.
114. Sexton CC, Coyne KS, Kopp ZS, Irwin DE, Milson I, Aiyer LP, et al. The overlap of storage, voiding and postmicturition symptoms and implications for treatment seeking in the USA, UK and Sweden: EpiLUTS. *BJU Int*. 2009;103(3) Suppl:12-23.
115. Diokno AC, Estanol MV, Ibrahim IA, Balasubramaniam M. Prevalence of urinary incontinence in community dwelling men: a cross sectional nationwide epidemiological survey. *Int Urol Nephrol*. 2007;39:129-36.

116. Lindeman K, Li Y, Palmer MH. (2012). Help-seeking for incontinence by individuals with heart failure. *J Am Geriatr Soc.* 2012;60(10):1994-5.
117. Tang DH, Colayco D, Piercy J, Patel V, Globe D, Chancellor MB. Impact of urinary incontinence on health-related quality of life, daily activities, and healthcare resource utilization in patients with neurogenic detrusor overactivity. *BMC Neurol.* 2014;14:74.
118. Tannenbaum C, Drali R, Holroyd-Leduc J, Richard L. Lessons learned: impact of a continence promotion activity for older community-dwelling women. *Neurourol Urodyn.* 2010;29(4):540-4.
119. Newman DK. Report of a mail survey of women with bladder control disorders. *Urol Nurs.* 2004;24(6):499-507.
120. Morahan-Martin JM. How internet users find, evaluate, and use online health information: a cross-cultural review. *Cyberpsychol Behav.* 2004;7(5):497-510.
121. Roe B, Wilson K, Doll H. Public awareness and health education: findings from an evaluation of health services for incontinence in England. *Int J Nurs Stud.* 2001;38:79-89.
122. Senekjian L, Heintz K, Egger MJ, Nygaard I. Do Women Understand Urogynecologic Terminology? *Female Pelvic Med Reconstr Surg.* 2011;17(5):215-7.
123. Palmer MH, Newman DK. Bladder control educational needs of older adults. *J Gerontol Nurs.* 2006;32:28-32.
124. McCallum J, Millar L, Burston L, Butorac A, Calzoni C. Framework for evaluation of the national continence management strategy. *Aust J Ageing.* 2007;26:A25-A6.
125. Australian incontinence data analysis and development. Australian Institute of Health and Welfare; 2006. Available from: <http://www.aihw.gov.au/publications/index.cfm/title/10201>
126. Alexander AM, Flynn KE, Hahn EA, Jeffrey DD, Keefe FJ, Reeve, BB, et al. Improving patients' understanding of terms and phrases commonly used in self-reported measures of sexual function. *J Sex Med.* 2014;11(8):1991-8.
127. Digesu GA, Khullar V, Panayi D, Calandrini M, Gannon M, Nicolini U. Should we explain lower urinary tract symptoms to patients? *Neurourol Urodyn.* 2008;27(5):368-71.
128. Smith AL, Nissim HA, Le TX, Khan A, Maliski S, Litwin MS, et al. Misconceptions and miscommunication among aging women with overactive bladder symptoms. *Urol.* 2011;77:55-9.
129. Hougardy V, Vandeweerd JM, Reda AA, Foidart JM. The impact of detailed explanatory leaflets on patient satisfaction with urodynamic consultation: a double-blind randomized controlled trial. *Neurourol Urodyn.* 2009;28(5):374-9.
130. Neustaedter EG, Milne J, Shorten K, Weckman B, Tse A, Tange S. How well informed are women who undergo urodynamic testing? *Neurourol Urodyn.* 2011;30(4):572-7.
131. Franzen K, Johansson JE, Andersson G, Nilsson K. Urinary incontinence: Evaluation of an information campaign directed towards the general public. *Scand J Urol Nephrol.* 2008;429(6):534-8.
132. Kiyosaki K, Ackerman AL, Histed S, Sevilla C, Eilber K, Maliski S, et al. Patients' understanding of pelvic floor disorders: what women want to know. *Female Pelvic Med Reconstr Surg.* 2012;18(3):137-42.
133. Levy-Storms L, Schnelle JF, Simmons SF. What do family members notice following an intervention to improve mobility and incontinence care for nursing home residents? An analysis of open-ended comments. *Gerontologist.* 2007;47:14-20.
134. Spencer J. Reducing barriers and improving access to continence care: examining the evidence. *Urol Nurs.* 2009;29(6):405-13.
135. Wagg AR, Barron D, Kirby M, Stott D, Corlett K. A randomised partially controlled trial to assess the impact of self-help vs. structured help from a continence nurse specialist in women with undiagnosed urinary problems in primary care. *Int J Clin Pract.* 2007;61(11):1863-73.
136. O'Connell B, Wellman D, Baker L, Day K. Does a continence educational brochure promote health-seeking behavior? *J Wound Ostomy Continence Nurs.* 2006;33(4):389-95.
137. O'Connell B, Gaskin CJ. Using an educational pamphlet to promote help-seeking behaviour for urinary incontinence in people visiting their general practitioner. *Aust N Z Continence J.* 2010;16(8):2-12.
138. Newman DK, Wallace J, Blackwood N, Spencer C. Promoting healthy bladder habits for seniors. *Ostomy Wound Manage.* 1996;42(10):18-22, 24-5, 8.
139. Tuckett AG, Hodgkinson B, Hedney DG, Pater-son J, Kralik D. Effectiveness of educational interventions to raise men's awareness of bladder and bowel health. *Int J Evid Based Healthc.* 2011;9(2):81-96.
140. Beguin AM, Combes T, Lutzler P, Laffond G, Belmin J. Health education improves older subjects' attitudes toward urinary incontinence and

- access to care: a randomized study in sheltered accommodation centers for the aged. *J Am Geriatr Soc.* 1997;45(3):391-2.
141. Buckley BS, Grant AM, Glazener CM. Case study: A patient-clinician collaboration that identified and prioritized evidence gaps and stimulated research development. *J Clin Epidemiol.* 2011;66(5):483-9.
 142. Gartley CB. Bringing Mohammed to the mountain: educating the community for continence. *Urol Nurs.* 2006;26(5):387-93.
 143. O'Donnell M, Viktrup L, Hunskaar S. The role of general practitioners in the initial management of women with urinary incontinence in France, Germany, Spain and the UK. *Eur J Gen Pract.* 2007;13:20-6.
 144. Laurant M, Reeves D, Hermens R, Braspenning J, Grol R, Sibbald B. Substitution of doctors by nurses in primary care. *Cochrane Database Syst Rev.* 2005. Apr 18;(2):CD001271
 145. Festen L, Duggan P, Coates D. Improved quality of life in women treated for urinary incontinence by an authorised continence nurse practitioner. *Int Urogynecol J Pelvic Floor Dysfunct.* 2008;19(4):567-71.
 146. Jeffery S, Doumouchsis SK, Fynes M. Patient satisfaction with nurse-led telephone follow-up in women with lower urinary tract symptoms. *J Telemed Telecare.* 2007;13:369-73.
 147. Drennan VM, Cole L, Iliffe S. A taboo within a stigma? a qualitative study of managing incontinence with people with dementia living at home. *BMC Geriatr.* 2011;11:75.
 148. Wagg AS, Newman DK, Leichsenring K, van Houten P. Developing an internationally-applicable service specification for continence care: systematic review, evidence synthesis and expert consensus. *PLoS One.* 2014;9(8):e104129.
 149. Howard F, Steggall M. Urinary incontinence in women: quality of life and help-seeking. *Br J Nurs.* 2010;19(12):742,4,6,8-9.
 150. Kang Y, Crogan NL. Social and cultural construction of urinary incontinence among Korean American elderly women. *Geriatr Nurs.* 2008;29(2):105-11.
 151. Yuan HB, Williams BA, Liu M. Attitudes toward urinary incontinence among community nurses and community-dwelling older people. *J Wound Ostomy Continence Nurs.* 2011;38(2):184-9.
 152. O'Donnell M, Hunskaar S. Preferences for involvement in treatment decision-making generally and in hormone replacement and urinary incontinence treatment decision-making specifically. *Patient Educ Couns.* 2007;68(3):243-51.
 153. O'Donnell M, Hunskaar S. Preferences for involvement in treatment decision-making among Norwegian women with urinary incontinence. *Acta Obstet Gynecol Scand.* 2007;86(11):1370-6.
 154. Sung VW, Raker CA, Myers DL, Clark MA. Treatment decision-making and information-seeking preferences in women with pelvic floor disorders. *Int Urogynecol J.* 2010;21(9):1071-8.
 155. Milne JL, Moore KN. An exploratory study of continence care services worldwide. *Int J Nurs Stud.* 2003;40(3):235-47.
 156. Farrell SA, Scott TA, Farrell KA, Irving L, Foren J, Twohig J. Two models for delivery of women's continence care: the step-wise continence team versus the traditional medical model. *J Obstet Gynaecol Can.* 2009;31(3):247-53.
 157. Matharu GS, Assassa RP, Williams KS, Donaldson MK, Matthews RJ, Tincello DG, et al. Continence nurse treatment of women's urinary symptoms. *Br J Nurs.* 2004;13(3):140-3.
 158. Desai N, Keane T, Wagg A, Wardle J. Provision of continence pads by the continence services in Great Britain: fair all round? *J Wound Ostomy Continence Nurs.* 2008;35(5):510-4.
 159. O'Brien J, Long H. Urinary incontinence: long term effectiveness of nursing intervention in primary care. *BMJ.* 1995;311:1208.
 160. Borrie MJ, Bawden M, Speechley M, Kloseck M. Interventions led by nurse continence advisers in the management of urinary incontinence: a randomized controlled trial. *CMAJ.* 2002;166(10):1267-73.
 161. Borrie MJ, S. Lyteynec, Griffiths N, Knezic Z, Gagnon M. Outcomes of a new community-nurse continence service. *Ann R Coll Physicians Surg Can* 1999;32:346-51.
 162. Saltmarche A, Reid DW. A community nurse continence service delivery model - a demonstration project. In: *Proceedings of the International Continence Society meeting 1992*; Halifax, Nova Scotia; 274.
 163. Lajiness MJ, Wolfert C, Hall S, Sampselle C, Diokno AC. Group session teaching of behavioral modification program for urinary incontinence: establishing the teachers. *Urol Nurs.* 2007;27(2):124-7.
 164. O'Dell K, Atnip S, Hooper G, Leung K. Pessary practices of nurse-providers in the United States. *Female Pelvic Med Reconstr Surg.* 2016;22(4):261-6.
 165. Lee DT, Choi KC, Chan CW, Chair SY, Chan D, Fung SY, et al. The impact on patient health

and service outcomes of introducing nurse consultants: a historically matched controlled study. *BMC Health Serv Res.* 2013;13:431.

166. Holtzer-Goor KM, Gaultney JG, van Houton P, Wagg AS, Huygens S, Nielen MM, et al. Cost-effectiveness of including a nurse specialist in the treatment of urinary incontinence in primary care in the Netherlands. *PLoS One.* 2015;10(10):e0138225.
167. McCallum J, Millar L, Burston L, Butorac A, Calzoni C. Final report for Phase 3 of the National Continence Management Strategy. Australian Government Initiative. Available from: <http://www.bladderbowel.gov.au/assets/doc/ncms/FinalEvaluationReport3September.pdf>
168. Chatoor D, Soligo M, Emmanuel A. Organising a clinical service for patients with pelvic floor disorders. *Best Pract Res Clin Gastroenterol.* 2009;23(4):611-20.
169. Nguyen K, Hunter KF, Wagg A. Knowledge and understanding of urinary incontinence: survey of family practitioners in northern Alberta. *Can Fam Physician.* 2013;59(7):e330-7.
170. Bland DR, Dugan E, Cohen SJ, Preisser J, Davis CC, McGann PE, et al. The effects of implementation of the Agency for Health Care Policy and Research urinary incontinence guidelines in primary care practices. *J Am Geriatr Soc.* 2003;51(7):979-84.
171. Yazdany T, Wong M, Bhatia NN. Improving resident screening and workup of urinary incontinence in an OB/GYN residency program: a randomized controlled study. *Female Pelvic Med Reconstr Surg.* 2011;17(5):242-5.
172. Albers-Heitner P, Berghmans B, Joore M, Lagro-Janssen T, Severens J, Nieman F, et al. The effects of involving a nurse practitioner in primary care for adult patients with urinary incontinence: the PromoCon study (Promoting Continence). *BMC Health Serv Res.* 2008;8:84.
173. Albers-Heitner PC, Lagro-Janssen TA, Joore MA, Berghmans LC, Nieman F, Venema PL, et al. Effectiveness of involving a nurse specialist for patients with urinary incontinence in primary care: results of a pragmatic multicentre randomised controlled trial. *Int J Clin Pract.* 2011;65(6):705-12.
174. Albers-Heitner PC, Lagro-Janssen TA, Venema PP, Berghmans BL, Winkens RR, de Jonge AA, et al. Experiences and attitudes of nurse specialists in primary care regarding their role in care for patients with urinary incontinence. *Scand J Caring Sci.* 2011;25(2):303-10.
175. Coleman K, Austin BT, Brach C, Wagner EH. Evidence on the Chronic Care Model in the new millennium. *Health Aff (Millwood).* 2009;28:75-85.
176. Chin WY, Lam CL, Lo SV. Quality of care of nurse-led and allied health personnel-led primary care clinics. *Hong Kong Med J.* 2011;17(3):217-30.
177. Diokno AC, Ocampo MS Jr, Ibrahim IA, Karl CR, Lajiness MJ, Hall SA. Group session teaching of behavioral modification program (BMP) for urinary incontinence: a randomized controlled trial among incontinent women. *Int Urol Nephrol.* 2010;42(2):375-81.
178. Schirm V, Baumgardner J, Dowd T, Gregor S, Kolcaba K. Development of a healthy bladder education program for older adults. *Geriatr Nurs.* 2004;25(5):301-6.
179. McFall SL, Yerkes AM, Cowan LD. Outcomes of a small group educational intervention for urinary incontinence: episodes of incontinence and other urinary symptoms. *J Aging Health.* 2000;12(2):250-67.
180. de Oliveira Camargo F, Rodrigues AM, Arruda RM, Ferreira Santori MG, Girao MJ, Castro RA. Pelvic floor muscle training in female stress urinary incontinence: comparison between group training and individual treatment using PERFECT assessment scheme. *Int Urogynecol J Pelvic Floor Dysfunct.* 2009;20(12):1455-62.
181. Brubaker L, Shott S, Tomezsko J, Goldberg RP. Pelvic floor fitness using lay instructors. *Obstet Gynecol.* 2008;111(6):1298-304.
182. Björk AB, Sjöström M, Johansson EE, Samuelsson E, Umejord G. Women's experiences of internet-based or postal treatment for stress urinary incontinence. *Qual Health Res.* 2014;24(4):484-93.
183. Hawkins SY, Park J, Palmer MH. Interest in information about urinary incontinence among diabetic and nondiabetic heart failure patients. *J Wound Ostomy Continence Nurs.* 2010;37(5):536-41.
184. Booth J, Kumlien S, Zang Y, Gustafsson B, Tolson D. Rehabilitation nurses practices in relation to urinary incontinence following stroke: a cross-cultural comparison. *J Clin Nurs.* 2009;18(7):1049-58.
185. Edwards R, Martin FC, Grant R, Lowe D, Potter J, Husk J, et al. Is urinary continence considered in the assessment of older people after a fall in England and Wales? Cross-sectional clinical audit results. *Maturitas.* 2011;69(2):179-83.
186. Lakhan P, Jones M, Wilson A, Courtney M, Hidres J, Gray LC. A prospective cohort study of geriatric syndromes among older medical

- patients admitted to acute care hospitals. *J Am Geriatr Soc.* 2011;59(11):2001-8.
187. Palmer MH, Baumgarten M, Langenberg P, Carson JL. Risk factors for hospital-acquired incontinence in elderly female hip fracture patients. *J Gerontol A Biol Sci Med Sci.* 2002;57(10):M672-7.
 188. Zisberg A, Sinoff G, Gur-Yaish N, Admi H, Shadmi E. In-hospital use of continence aids and new-onset urinary incontinence in adults aged 70 and older. *J Am Geriatr Soc.* 2011;59(6):1099-104.
 189. Zürcher S, Saxer S, Schwendimann R. Urinary incontinence in hospitalised elderly patients: do nurses recognise and manage the problem? *Nurs Res Pract.* 2011;2011:671302.
 190. Palese A, Regattin L, Venuti F, Innocenti A, Benaglio C, Cunico L, et al. Incontinence pad use in patients admitted to medical wards: an Italian multicenter prospective cohort study. *J Wound Ostomy Continence Nurs.* 2007;34(6):649-54.
 191. Ostaszkievicz J, O'Connell B, Millar L. Incontinence: managed or mismanaged in hospital settings? *Int J Nurs Pract.* 2008;14(6):495-502.
 192. Etheridge F, Couturier Y, Denis J-L, Tremblay L, Tannenbaum C. Explaining the Success or Failure of Quality Improvement Initiatives in Long-Term Care Organizations From a Dynamic Perspective. *J Appl Gerontol.* 2013;33(6), 672-689.
 193. Roe B, Flanagan L, Jack B, Shaw C, Williams K, Chung A, et al. Systematic review of descriptive studies that investigated associated factors with the management of incontinence in older people in care homes. *Int J Older People Nurs.* 2011;8(1):29-49.
 194. Roe B, Flanagan L, Maden M. Systematic review of systematic reviews for the management of urinary incontinence and promotion of continence using conservative behavioural approaches in older people in care homes. *J Adv Nurs.* 2015;71(7):1464-83.
 195. Cheater FM. Overcoming the barriers to optimum continence care: the need for an expanded approach to implementation. *Int J Older People Nurs.* 2009;4(1):70-5.
 196. French B, Thomas LH, Harrison J, Coupe J, Roe B, Booth J, et al. Client and clinical staff perceptions of barriers to and enablers of the uptake and delivery of behavioral interventions for urinary incontinence : qualitative evidence synthesis. *J Adv Nurs.* 2016;73(1):21-38.
 197. Yoon JY, Lee JY, Bowers BJ, Zimmerman DR. The impact of organizational factors on the urinary incontinence care quality in long-term care hospitals: a longitudinal correlational study. *Int J Nurs Stud.* 2012;49(12):1544-51.
 198. Schmitz G, Hayder D, Braumann A, Muller M, Saxer S. Continence profiles. A way to enhance assessment of urinary continence in German nursing practice. *Z Gerontol Geriatr.* 2010;43(6):407-8, 10-2.
 199. Tanaka Y, Nagata K, Tanaka T, Kuwano K, Endo H, Otani T, et al. Can an individualized and comprehensive care strategy improve urinary incontinence (UI) among nursing home residents? *Arch Gerontol Geriatr.* 2009;49(2):278-83.
 200. Rahman AN, Schnelle JF, Yamashita T, Patry G, Prasauskas R. Distance learning: a strategy for improving incontinence care in nursing homes. *Gerontologist.* 2010;50(1):121-32.
 201. Gemmill R, Wells A. Promotion of urinary continence worldwide. *Urol Nurs.* 2010;30(6):336-40.
 202. Mueller ER, Kenton K, Rogers RG, Fenner DE. Are we missing an opportunity to teach future physicians about female pelvic floor disorders? *Int Urogynecol J Pelvic Floor Dysfunct.* 2009;20(12):1413-5.
 203. Gordon AL, Blundell A, Dhese JK, Forrester-Paton C, Forrester-Paton J, Mitchell HK, et al. UK medical teaching about ageing is improving but there is still work to be done: the Second National Survey of Undergraduate Teaching in Ageing and Geriatric Medicine. *Age Ageing.* 2014;43(2):293-7.
 204. Spencer AL, Kern LM. Primary care program directors' perceptions of women's health education: a gap in graduate medical education persists. *J Womens Health (Larchmt).* 2008;17(4):549-56.
 205. Thekkinkattil DK, Lim M, Finan PJ, Sagar PM, Burke D. Awareness of investigations and treatment of faecal incontinence among the general practitioners: a postal questionnaire survey. *Colorectal Dis.* 2008;10(3):263-7.
 206. Jirschele K, Ross R, Goldberg R, Botros S. Physician Attitudes Toward Urinary Incontinence Identification. *Female Pelvic Med Reconstr Surg.* 2015;21(5):273-6.
 207. Mishra K, Snow-Lisy DC, Ross J, Goldfarb DA, Goldman H, Campbell SC. Evaluation of a case-based urology learning program. *Urology.* 2013;82(6):1207-10.
 208. Roberts G, Beiko D, Touma N, Siemens DR. Are we getting through? A national survey on the CanMEDS communicator role in urology residency. *Can Urol Assoc J.* 2013;7(11-12):437-441.

209. Westmoreland GR, Counsell SR, Tu W, Wu J, Litzelman DK. Web-based training in geriatrics for medical residents: a randomized controlled trial using standardized patients to assess outcomes. *J Am Geriatr Soc.* 2010;58(6):1163-9.
210. Sarkissian H, Hardy S, Plante M, Mingin G. Pediatric resident exposure to urology: identifying a need. *J Urol.* 2013;190(4 Suppl):1618-21.
211. Warshaw GA, Modawal A, Kues J, Moore I, Margolin G, Sehgal M, et al. Community physician education in geriatrics: applying the assessing care of vulnerable elders model with a multisite primary care group. *J Am Geriatr Soc.* 2010;58(9):1780-5.
212. Wenger NS, Roth CP, Shekelle PG, Young RT, Solomon DH, Kamberg CJ, et al. A practice-based intervention to improve primary care for falls, urinary incontinence, and dementia. *J Am Geriatr Soc.* 2009;57(3):547-55.
213. Wenger NS, Roth CP, Hall WJ, Ganz DA, Snow V, Byrkit J, et al. Practice redesign to improve care for falls and urinary incontinence: primary care intervention for older patients. *Arch Intern Med.* 2010;170(19):1765-72.
214. Reuben DB, Ganz DA, Roth CP, McCreath HE, Ramirez KD, Wenger NS. Effect of nurse practitioner comanagement on the care of geriatric conditions. *J Am Geriatr Soc.* 2013;61(6):857-67.
215. Marsh F, Garthwaite MA, Southgate J, Ramage C. Assessing UK specialists' knowledge of the diagnostic criteria for painful bladder syndrome/interstitial cystitis. *Int Urogynecol J Pelvic Floor Dysfunct.* 2008;19(5):615-20.
216. Yune JJ, Siddighi S. Perceptions and practice patterns of general gynecologists regarding urogynecology and pelvic reconstructive surgery. *Female Pelvic Med Reconstr Surg.* 2013;19(4):225-9.
217. Casiano ER, Wendel GD Jr, Congleton MJ, Wai CY. Urogynecology training and practice patterns after residency. *J Surg Educ.* 2012;69(1):77-83.
218. Jacobs KM, Hernandez LH, Thomas TN, Waddell LM, Kavic SM, Graziano SC. Perceptions of posthysterectomy cystoscopy training in obstetrics and gynecology residency programs. *Female Pelvic Med Reconstr Surg.* 2015;21(2):66-9.
219. Nihira MA, Quiroz LH, Hardré P, Allen A, Shobeiri SA. Training community gynecologists to perform intraoperative cystoscopy: a competency-based training experience. *Female Pelvic Med Reconstr Surg.* 2014;20(2):76-82.
220. Fialkow M, Mandel L, VanBlaricom A, Chinn M, Lentz G, Goff B. A curriculum for Burch colposuspension and diagnostic cystoscopy evaluated by an objective structured assessment of technical skills. *Am J Obstet Gynecol.* 2007;197(5):544 e1-6.
221. Bowling CB, Greer WJ, Bryant SA, Gleason JL, Szychowski JM, Varner RE, et al. Testing and validation of a low-cost cystoscopy teaching model: a randomized controlled trial. *Obstet Gynecol.* 2010;116(1):85-91.
222. Geiss IM, Riss PA, Hanzal E, Dungal A. A simple teaching tool for training the pelvic organ prolapse quantification system. *Int Urogynecol J Pelvic Floor Dysfunct.* 2007;18(9):1003-5.
223. Parnell BA, Dunivan GC, Geller EJ, Connolly A. A novel approach to teaching the pelvic organ prolapse quantification (POP-Q) exam. *Int Urogynecol J.* 2011;22(3):367-70.
224. Liu JS, Dickmeyer LJ, Netter O, Hofer MD, Flury SC, Kielb SJ. Disparities in female urologic case distribution with new subspecialty certification and surgeon gender. *Neurourol Urodyn.* 2015; Dec 17. doi: 10.1002/nau.22942.
225. Liu JS, Netter O, Vo AX, Hofer MD, Flury SC, Kielb SJ. Prolapse repair with and without apical resuspension-Practice patterns among certifying American urologists. *Neurourol Urodyn.* 2015; Nov 6. doi: 10.1002/nau.22926.
226. Muller SC, Strunk T. [Is the training and continuing education for urologists in Germany still up to date?]. *Urologe A.* 2011;50(8):946-51.
227. Mishra K, Lopes VV, Hampton BS. Global Health Interest among Female Pelvic Medicine and Reconstructive Surgery Fellows. *J Reprod Med.* 2015;60(11-12):501-6.
228. Foreman H, Weber L, Thacker HL. Update: A Review of Women's Health Fellowships, Their Role in Interdisciplinary Health Care, and the Need for Accreditation. *J Womens Health (Larchmt).* 2015;24(5):336-40.
229. Beiko D, MacNeily AE, Robert Siemens D. Is 10 000 hours enough for urology residency? *Can Urol Assoc J.* 2016;10(1-2):9-10.
230. Vela-Navarrete R, Cortiñas JA, Cózar JM. Urology and the core curriculum: The current status and controversies of the urology residency in Europe and Spain. *Actas Urol Esp.* 2016;40(3):135-138.
231. Occhino JA, Hannigan TL, Baggish MS, Gebhart JB. Resident duty-hour restrictions and their effect on operative experience in obstetrics and gynecology. *Gynecol Obstet Invest.* 2011;72(2):73-8.

232. Simien C, Holt KD, Richter TH, Whalen TV, Coburn M, Havlik RJ, et al. Resident operative experience in general surgery, plastic surgery, and urology 5 years after implementation of the ACGME duty hour policy. *Ann Surg.* 2010;252(2):383-9.
233. Rajaram R, Chung JW, Cohen ME, Dahlke AR, Yang AD, Meeks JJ, et al. Association of the 2011 ACGME Resident Duty Hour Reform with Postoperative Patient Outcomes in Surgical Specialties. *J Am Coll Surg.* 2015;221(3):748-57.
234. Pak JS, Silva M, Deibert CM, Cooper KL, Badalato GM. Male Urethral, Penile, and Incontinence Surgery: Is Resident Exposure Adequate? *Urology.* 2015 ;86(5):868-72.
235. Shipway DJ, Partridge JS, Foxton CR, Modarai B, Gossage JA, Challacombe BJ, et al. Do surgical trainees believe they are adequately trained to manage the ageing population? A UK survey of knowledge and beliefs in surgical trainees. *J Surg Educ.* 2015;72(4):641-7.
236. Ruiz JG, Tunuguntla R, Charlin B, Ouslander JG, Symes SN, Gagnon R, et al. The script concordance test as a measure of clinical reasoning skills in geriatric urinary incontinence. *J Am Geriatr Soc.* 2010;58(11):2178-84.
237. Kow N, Walters MD, Karram MM, Sarsotti CJ, Jelovsek JE. Assessing intraoperative judgment using script concordance testing through the gynecology continuum of practice. *Med Teach.* 2014;36(8):724-9.
238. Riss P, Hinterholzer S. Maintaining standards for surgery for female urinary incontinence. *Maturnitas.* 2010;65(1):5-10.
239. Pruthi RS, Neuwahl S, Nielsen ME, Fraher E. Recent trends in the urology workforce in the United States. *Urology.* 2013;82(2):987-93.
240. Griebing TL: Editorial Comment on: Pruthi RS, Neuwahl S, Nielsen ME, Fraher E. Recent trends in the urology workforce in the United States. *Urology.* 2013;82(2):987-93.
241. Santucci RA. The reconstructive urology workforce: present and future. *Transl Androl Urol.* 2014;3(2):205-8.
242. Lightfoot AJ, Rosevear HM, Steers WD, Tracy CR. Current and future need for academic urologists in the United States. *J Urol.* 2011;185(6):2283-7.
243. Sievert KD, Chapple CR. Words of wisdom: Re: The challenges facing academic urology training programs: an impending crisis. *Eur Urol.* 2013;64(3):511-2.
244. Gonzalez CM, McKenna P. Challenges facing academic urology training programs: an impending crisis. *Urology.* 2013;81(3):475-9.
245. Cao Z, Wang L. China's evolving residency training. *Med Teach.* 2015;37(9):884-5.
246. Shu'aibu SI, Ramyil VM, Dakum NK. Has the creation of a urology residency programme translated in to more surgical exposure for final year residents? *Niger J Med.* 2013;22(1):57-60.
247. Friad G, Sabah K, Ameen IH. Urology training in the developing world: The trainees' perspective in Kurdistan, Iraq. *Arab J Urol.* 2014;12(1):6-11.
248. Elneil S. Global efforts for effective training in fistula surgery. *Int J Gynaecol Obstet.* 2015;131 Suppl 1:S64-6.
249. Mitchell KA, Spitz A. Use of advanced practice providers as part of the urologic healthcare team. *Curr Urol Rep.* 2015;16(9):62.
250. Quallich SA, Bumpus SM, Lajiness S. Competencies for the nurse practitioner working with adult urology patients. *Urol Nurs.* 2015;35(5):221-30.
251. McClurg D, Cheater FM, Eustice S, Burke J, Jamieson K, Hagen S. A multi-professional UK wide survey of undergraduate continence education. *Neurourol Urodyn.* 2013;32(3):224-229.
252. Cheater FM, Baker R, Reddish S, Spiers N, Waillo A, Gillies C, et al. Cluster randomized controlled trial of the effectiveness of audit and feedback and educational outreach on improving nursing practice and patient outcomes. *Med Care.* 2006;44(6):542-51.
253. Ostaszkiwicz J. A clinical nursing leadership model for enhancing continence care for older adults in a subacute inpatient setting. *J Wound Ostomy Continence Nurs.* 2006;33(6):624-9.
254. Roosen K, Fulbrook P, Nowicki T. Pressure injury prevention: continence, skin hygiene and nutrition management. *Aust Nurs J.* 2010;18(2):31-4.
255. Beeckman D, Schoonhoven L, Fletcher J, Furtado K, Heyman K, Paquay L, et al. Pressure ulcers and incontinence-associated dermatitis: effectiveness of the Pressure Ulcer Classification education tool on classification by nurses. *Qual Saf Health Care.* 2010;19(5):e3.
256. Gray M. Incontinence-related skin damage: essential knowledge. *Ostomy Wound Manage.* 2007;53(12):28-32.
257. Pather P, Hines S. Best practice nursing care for ICU patients with incontinence associated dermatitis and skin complications resulting from faecal incontinence and diarrhoea. *Int J Evid Based Healthc.* 2016;14(1):15-23.
258. Sackley CM, Rodriguez NA, van den Berg M, Badger F, Wright C, Besemer J. A phase II exploratory cluster randomized controlled trial of

- a group mobility training and staff education intervention to promote urinary continence in UK care homes. *Clin Rehabil.* 2008;22(8):714-21.
259. Jordan LA, Mackey E, Coughlan K, Wyer M, Allnutt N, Middleton S. Continence management in acute stroke: a survey of current practices in Australia. *J Adv Nurs.* 2011;67(1):94-104.
 260. Keilman LJ, Dunn KS. Knowledge, attitudes, and perceptions of advanced practice nurses regarding urinary incontinence in older adult women. *Res Theory Nurs Pract.* 2010;24(4):260-79.
 261. McConnell ES, Lekan D, Bunn M, Egerton E, Corazzini KN, Hendrix CD, et al. Teaching evidence-based nursing practice in geriatric care settings: the geriatric nursing innovations through education institute. *J Gerontol Nurs.* 2009;35(4):26-33.
 262. Collette C, Bravo G, Tu le M. Development of a urinary incontinence educational program using a competency-based approach and case method. *J Nurses Staff Dev.* 2009;25:E5-E10.
 263. Karlowicz KA. Evaluation of the Urinary Incontinence Scales to measure change after experiential learning: a pilot study. *Urol Nurs.* 2009;29(1):40-6.
 264. Braude P, Reedy G, Dasgupta D, Dimmock V, Jaye P, Birns J. Evaluation of a simulation training programme for geriatric medicine. *Age and Ageing.* 2015;44(4):677-682.
 265. Rantell A, Dolan L, Bonner L, Knight S, Ramage C, Toozs-Hobson P. Minimum standards for continence care in the UK. *NeuroUrol Urodyn.* 2016;35(3):400-6.
 266. Beitz JM, Snarponis JA. Strategies for online teaching and learning: lessons learned. *Nurse Educ.* 2006;31(1):20-5.
 267. De Gagne J, Park S, So A, Wu B, Palmer MH, McConnell ES. A urinary incontinence continuing education online course for community health nurses in South Korea. *J Contin Educ Nurs.* 2015;46(4):171-8.
 268. Arlen AM, Boyt MA, Cooper CS. School nurse perceptions and knowledge of pediatric toileting. *J Pediatr Urol.* 2012;8(2):205-8.
 269. Thompson DL. Continence certification. *J Wound Ostomy Continence Nurs.* 2010;37(6):683-5.
 270. Society of Wound Ostomy Continence Nurses. Position Statement. Role of the Wound, Ostomy Continence Nurse or Continence Care Nurse in Continence Care. *J Wound Ostomy Continence Nurs.* 2009;36(5):529-31.
 271. Wyman JF, Hensley D. Urologic nursing practice. In: Newman DK, Wyman JF, Welch VW, editors. *Core Curriculum for Urologic Nursing.* 1st ed. New Jersey: Society of Urologic Nurses and Associates, Inc; 2017:3-18.
 272. Mejza B. Will the WOC nurse of the future also be a DNP? *J Wound Ostomy Continence Nurs.* 2009;36(3):271-4.
 273. Albers-Heitner CP, Joore MA, Winkens RA, Lagro-Janssen AL, Severens JL, Berghmans LC. Cost-effectiveness of involving nurse specialists for adult patients with urinary incontinence in primary care compared to care-as-usual: An economic evaluation alongside a pragmatic randomized controlled trial. *NeuroUrol Urodyn.* 2012;31(4):526-34.
 274. Lin SY, Wang RH, Lin CC, Chiang HY. Competence to provide urinary incontinence care in Taiwan's nursing homes: perceptions of nurses and nurse assistants. *J Wound Ostomy Continence Nurs.* 2012;39(2):187-93.
 275. Blekken LE, Nakren S, Gjeilo KH, Norton C, Mørkved S, Vinsnes AG. Feasibility, acceptability and adherence of two educational programs for care staff concerning nursing homes patients' fecal incontinence: a pilot study preceding a cluster randomised controlled trial. *Implement Sci.* 2015; May 23;10:72.
 276. Slack A, Hill A, Jackson S. Is there a role for a specialist physiotherapist in the multi-disciplinary management of women with stress incontinence referred from primary care to a specialist continence clinic? *J Obstet Gynaecol.* 2008;28(4):410-2.
 277. Women's Health Physical Therapist (USA); 2012. Available at <http://www.women-shealthapta.org/plp/>
 278. International Organization of Physical Therapists in Women's Health (UK). West Yorkshire (UK): World Confederation for Physical Therapy; 2012. Available from: <http://www.wcpt.org/ioptwh>
 279. Syan R, Brucker BM. Guideline of guidelines: urinary incontinence. *BJU Int.* 2016;117(1):20-33.
 280. Thüroff JW, Abrams P, Andersson KE, Artibani W, Chapple CR, Drake MJ, et al. EAU guidelines on urinary incontinence. *Eur Urol.* 2011;59(3):387-400.
 281. Takahashi S, Takei M, Nishizawa O, Yamaguchi O, Kato K, Gotoh M, et al. Clinical Guideline for Female Lower Urinary Tract Symptoms. *Low Urin Tract Symptoms.* 2016 Jan;8(1):5-29.
 282. Smith A, Bevan D, Douglas HR, James D. Management of urinary incontinence in

- women: summary of updated NICE guidance. *BMJ*. 2013;347:f5170.
283. Dmochowski RR, Blaivas JM, Gormley EA, Juma S, Karram MM, Lightner DJ, et al. Update of AUA guideline on the surgical management of female stress urinary incontinence. *J Urol*. 2010;183(5):1906-14.
 284. Reisenauer C, Muche-Borowski C, Anthuber C, Finas D, Fink T, Gabriel B, et al. Interdisciplinary S2e Guideline for the Diagnosis and Treatment of Stress Urinary Incontinence in Women: Short version - AWMF Registry No. 015-005, July 2013. *Geburtshilfe Frauenheilkd*. 2013;73(9):899-903.
 285. Italian Society of Colorectal Surgery (SICCR), Pucciani F, Altomare DF, Dodi G, Falletto E, Frasson A, et al. Diagnosis and treatment of faecal incontinence: Consensus statement of the Italian Society of Colorectal Surgery and the Italian Association of Hospital Gastroenterologists. *Dig Liver Dis*. 2015 Aug;47(8):628-45.
 286. Paquette IM, Varma MG, Kaiser AM, Steele SR, Rafferty JF. The American Society of Colon and Rectal Surgeons' Clinical Practice Guideline for the Treatment of Fecal Incontinence. *Dis Colon Rectum*. 2015 Jul;58(7):623-36.
 287. Vitton V, Soudan D, Siproudhis L, Abramowitz L, Bouvier M, Faucheron JL, et al. Treatments of faecal incontinence: recommendations from the French national society of coloproctology. *Colorectal Dis*. 2014 Mar;16(3):159-66.
 288. Wald A, Bharucha AE, Cosman BC, Whitehead WE. ACG clinical guideline: management of benign anorectal disorders. *Am J Gastroenterol*. 2014 Aug;109(8):1141-57.
 289. Becher K, Oelke M, Grass-Kapanke B, Flohr J, Mueller EA, Papenkordt U, et al. Improving the health care of geriatric patients: management of urinary incontinence: a position paper. *Z Gerontol Geriatr*. 2013;46(5):456-64.
 290. Gormley EA, Lightner DJ, Burgio KL, Chai TC, Clemens JQ, Culkin DJ, et al. Diagnosis and treatment of overactive bladder (non-neurogenic) in adults: AUA/SUFU guideline. *J Urol*. 2012;188(6 Suppl):2455-63.
 291. Nambiar A, Lucas M. Chapter 4: Guidelines for the diagnosis and treatment of overactive bladder (OAB) and neurogenic detrusor overactivity (NDO). *Neurourol Urodyn*. 2014;33 Suppl 3:S21-5.
 292. Tse V, King J, Dowling C, English S, Gray K, Millard R, et al. Conjoint Urological Society of Australia and New Zealand (USANZ) and Urogynaecological Society of Australasia (UGSA) Guidelines on the management of adult non-neurogenic overactive bladder. *BJU Int*. 2016;117(1):34-47.
 293. Mangera A, Chapple CR. Application of guidelines to the evaluation of the male patient with urgency and/or incontinence. *Curr Opin Urol*. 2014;24(6):547-52.
 294. Swain S, Hughes R, Perry M, Harrison S; Guideline Development Group. Management of lower urinary tract dysfunction in neurological disease: summary of NICE guidance. *BMJ*. 2012;345:e5074.
 295. National Clinical Guideline Centre. Urinary incontinence in neurological disease: management of lower urinary tract dysfunction in neurological disease. London: Royal College of Physicians; 2012.
 296. Thomas LH, Fench B, Burton CR, Sutton C, Forshaw D, Dickinson H, et al. Evaluating a systematic voiding programme for patients with urinary incontinence after stroke in secondary care using soft systems analysis and Normalisation Process Theory: findings from the ICONS case study phase. *Int J Nurs Stud*. 2014;51(10):1308-20.
 297. Fisher AR. Development of clinical practice guidelines for urinary continence care of adult stroke survivors in acute and rehabilitation settings. *Can J Neurosci Nurs*. 2014;36(3):16-31.
 298. Smith LN, James R, Barber M, Ramsay S, Gillespie D, Chung C, et al. Rehabilitation of patients with stroke: summary of SIGN guidance. *BMJ*. 2010;15;340:c2845.
 299. Mori E, Ishikawa M, Kato T, Kazui H, Miyake H, Miyajima M, et al. Guidelines for management of idiopathic normal pressure hydrocephalus: second edition. *Neurol Med Chir (Tokyo)*. 2012;52(11):775-809.
 300. Sakakibara R, Panicker J, Finazzi-Agro E, Iacovelli V, Bruschini H, et al. A guideline for the management of bladder dysfunction in Parkinson's disease and other gait disorders. *Neurourol Urodyn*. 2016;35(5):551-63.
 301. Zesiewicz TA, Sullivan KL, Arnulf I, Chaudhuri KR, Morgan JC, Gronseth GS, et al. Practice Parameter: treatment of nonmotor symptoms of Parkinson disease: report of the Quality Standards Subcommittee of the American Academy of Neurology. *Neurology*. 2010;74(11):924-31.
 302. Yadav V, Narayanaswami P. Complementary and alternative medical therapies in multiple sclerosis--the American Academy of Neurology guidelines: a commentary. *Clin Ther*. 2014;36(12):1972-8.
 303. Denys P, Phe V, Even A, Chartier-Kastler E. Therapeutic strategies of urinary disorders in

- MS. Practice and algorithms. *Ann Phys Rehabil Med.* 2014;57(5):297-301.
304. Nicolas B, Moizard AS, Barrois B, Colin D, Michel JM, Passadori Y, et al. Which medical device and/or which local treatment for prevention in patients with risk factors for pressure sores in 2012? Developing French guidelines for clinical practice. *Ann Phys Rehabil Med.* 2012;55(7):482-8.
 305. Doughty D, Kisanga J. Regulatory guidelines for bladder management in long-term care: are you in compliance with F-Tag 315? *J Wound Ostomy Continence Nurs.* 2010;37(4):399-411.
 306. Meddings J, Saint S, Fowler KE, Gaies E, Hickner A, Krein SL, et al. The Ann Arbor Criteria for Appropriate Urinary Catheter Use in Hospitalized Medical Patients: Results Obtained by Using the RAND/UCLA Appropriateness Method. *Ann Intern Med.* 2015;162(9 Suppl):S1-34.
 307. Cornell K, De Souza A, Tacey M, Long DM, Veerasingham M. The effect of implementing a new guideline and operative pro forma on the detection and management of third- and fourth-degree perineal tears. *Int J Womens Health.* 2016;8:131-5.
 308. Aigmueller T, Umek W, Elenskaia K, Frudinger A, Pfeifer J, Helmer H, et al. Guidelines for the management of third and fourth degree perineal tears after vaginal birth from the Austrian Urogynecology Working Group. *Int Urogynecol J.* 2013;24(4):553-8.
 309. Vayssière C, Beucher G, Dupuis O, Feraud O, Simon-Toulza C, Sentilhes L, et al. Instrumental delivery: clinical practice guidelines from the French College of Gynaecologists and Obstetricians. *Eur J Obstet Gynecol Reprod Biol.* 2011;159(1):43-8.
 310. Haylen BT, Freeman RM, Lee J, Swift SE, Cosson M, Deprest J, et al. International Urogynecological Association (IUGA)/International Continence Society (ICS) joint terminology and classification of the complications related to native tissue female pelvic floor surgery. *Neurourol Urodyn.* 2012;31(4):406-14.
 311. Bauer SB, Austin PF, Rawashdeh YF, de Jong TP, Franco I, Siggard C, et al. International Children's Continence Society's recommendations for initial diagnostic evaluation and follow-up in congenital neuropathic bladder and bowel dysfunction in children. *Neurourol Urodyn.* 2012;31(5):610-4.
 312. Rawashdeh YF, Austin P, Siggaard C, Bauer SB, Franco I, de Jong TP, Jorgensen TM, et al. International Children's Continence Society's recommendations for therapeutic intervention in congenital neuropathic bladder and bowel dysfunction in children. *Neurourol Urodyn.* 2012;31(5):615-20.
 313. Chang SJ, Van Laecke E, Bauer SB, von Gontard A, Bagli D, Bower WF, et al. Treatment of daytime urinary incontinence: A standardization document from the International Children's Continence Society. *Neurourol Urodyn.* 2015;36(1):43-50.
 314. Tabbers MM, DiLorenzo C, Berger MY, Faure C, Langendam MW, Nurko S, et al. Evaluation and treatment of functional constipation in infants and children: evidence-based recommendations from ESPGHAN and NASPGHAN. *J Pediatr Gastroenterol Nutr.* 2014;58(2):258-74.
 315. Patel BN, Kobashi KC. Practical use of the new American Urological Association adult urodynamics guidelines. *Curr Urol Rep.* 2013;14(3):240-6.
 316. Brown ET, Krlin RM, Winters JC. Urodynamics: examining the current role of UDS testing. What is the role of urodynamic testing in light of recent AUA urodynamics and overactive bladder guidelines and the VALUE study? *Curr Urol Rep.* 2013;14(5):403-8.
 317. Collins CW, Winters JC; American Urological Association; Society of Urodynamics Female Pelvic Medicine and Urogenital Reconstruction. AUA/SUFU adult urodynamics guideline: a clinical review. *Urol Clin North Am.* 2014;41(3):353-62.
 318. Lucas MG, Bosch RJ, Burkhard FC, Cruz F, Madden TB, Nambiar AK, et al. EAU guidelines on surgical treatment of urinary incontinence. *Actas Urol Esp.* 2013;62(6):1118-29.
 319. Qaseem A, Dallas P, Forcica MA, Starkey M, Denberg TD, Shekelle P, et al. Nonsurgical management of urinary incontinence in women: a clinical practice guideline from the American College of Physicians. *Ann Intern Med.* 2014;161(6):429-40.
 320. Bernards AT, Berghmans BC, Slieker-Ten Hove MC, Staal JB, de Bie RA, Hendriks EJ. Dutch guidelines for physiotherapy in patients with stress urinary incontinence: an update. *Int Urogynecol J.* 2014;25(2):171-9.
 321. Dumoulin C, Hay-Smith J, Frawley H, McClurg D, Alewijnse D, Bo K, et al. 2014 consensus statement on improving pelvic floor muscle training adherence: International Continence Society 2011 State-of-the-Science Seminar. *Neurourol Urodyn.* 2015;34(7):600-5.
 322. Frawley HC, McClurg D, Mahfooza A, Hay-Smith J, Dumoulin C. Health professionals' and patients' perspectives on pelvic floor muscle training adherence-2011 ICS State-of-the-Science Seminar research paper IV of IV. *Neurourol Urodyn.* 2015;34(7):632-9.

323. Rao SS, Benninga MA, Bharucha AE, Chiarioni G, Di Lorenzo C, Whitehead WE. ANMS-ESNM position paper and consensus guidelines on biofeedback therapy for anorectal disorders. *Neurogastroenterol Motil.* 2015;27(5):594-609.
324. Lucas MG, Bosch RJ, Burkhard FC, Cruz F, Madden TB, Nambiar AK, et al. EAU guidelines on assessment and nonsurgical management of urinary incontinence. *Eur Urol.* 2012;62(6):1130-42.
325. Brincat CA, Doumouchtsis SK, Fenner DE. Skill acquisition, credentialing, and maintenance of skills in surgical treatment of pelvic organ prolapse and urinary incontinence. *Clin Obstet Gynecol.* 2013;56(2):238-46.
326. Merseburger AS, Herrmann TR, Shariat SF, Kyriazis I, Nagele U, Traxer O, et al. EAU guidelines on robotic and single-site surgery in urology. *Eur Urol.* 2013;64(2):277-91.
327. Maeda Y, O'Connell PR, Lehur PA, Matzel KE, Laurberg S; European SNS Bowel Study Group. Sacral nerve stimulation for faecal incontinence and constipation: a European consensus statement. *Colorectal Dis.* 2015;17(4):O74-87.
328. Rahn DD, Ward RM, Sanses TV, Carberry C, Mamik MM, Meriwether KV, et al. Vaginal estrogen use in postmenopausal women with pelvic floor disorders: systematic review and practice guidelines. *Int Urogynecol J.* 2015;26(1):3-13.
329. Urology Preferred Specialty Measuring Set. Physician Quality Reporting System Claims / Registry Measure Specifications Release Notes (2016 Measure #48). Baltimore (MD): Centers for Medicare and Medicaid Services; 2016. <https://www.cms.gov/>
330. Visser E, de Bock GH, Messelink EJ, Schram AJ, Kollen BJ, la Bastide-van Gemert S, et al. Active encouragement of older women with urinary incontinence in primary care to undergo diagnosis and treatment: a matched-pair cluster randomized controlled trial. *Maturitas.* 2015;80(2):212-9.
331. Visser E, Dekker JH, Vermeulen KM, Messelink EJ, Schram AJ, Berger MY, et al. The Effect of Systematic Screening of Older Women for Urinary Incontinence on Treatment Uptake: The URINO Trial. *Maturitas.* 2013;74(4):334-40.
332. Cardozo L, Staskin D, Currie B, Wiklund I, Globe D, Signori M, et al. Validation of a bladder symptom screening tool in women with incontinence due to overactive bladder. *Int Urogynecol J.* 2014;25(12):1655-63.
333. Suskind AM, Dunn RL, Morgan DM, DeLancey JO, Rew KT, Wei JT. A screening tool for clinically relevant urinary incontinence. *Neurourol Urodyn.* 2015;34(4):332-5.
334. DuBeau CE, Ouslander JG, and Palmer MH. Knowledge and attitudes of nursing home staff and surveyors about the revised federal guidance for incontinence care. *Gerontologist.* 2007;47(4):468-47.
335. Drutz HP. IUGA guidelines for training in female pelvic medicine and reconstructive pelvic surgery (FPM-RPS). Updated guidelines 2010. *Int Urogynecol J.* 2010;21(12):1445-53.
336. Woodford H, George J. NICE guidelines on urinary incontinence in women. *Age Ageing.* 2007;36(3):349-50.
337. Fung CH. Computerized condition-specific templates for improving care of geriatric syndromes in a primary care setting. *J Gen Intern Med.* 2006;21(9):989-94.
338. Heesakkers JP, Mulders PF. [The practice guideline 'Urinary incontinence' (first revision) from the Dutch College of General Practitioners; a response from the perspective of urology]. *Ned Tijdschr Geneesk.* 2008;152(47):2544-5.
339. Basu M, Duckett JR. Barriers to seeking treatment for women with persistent or recurrent symptoms in urogynaecology. *BJOG.* 2009;116(5):726-30.
340. Shaw C, Atwell C, Wood F, Brittain K, Williams K. A qualitative study of the assessment and treatment of incontinence in primary care. *Fam Pract.* 2007;24(5):461-7.
341. Shaw C, Atwell C, Wood F, Brittain K, Williams K. A qualitative study of the assessment and treatment of incontinence in primary care. *Fam Pract.* 2007:461-7.
342. Balachandran A, Monga A, Duckett J. Management of female urinary incontinence: a survey of urogynaecologists' view on the NICE guideline. *J Obstet Gynaecol.* 2016;36(4):487-91.
343. Gibson W, Harari D, Husk J, Lowe D, Wagg A. A national benchmark for the initial assessment of men with LUTS: data from the 2010 Royal College of Physicians National Audit of Continence Care. *World J Urol.* 2016;34(7):969-77.
344. Harari D, Husk J, Lowe D, Wagg A. National audit of continence care: adherence to National Institute for Health and Clinical Excellence (NICE) guidance in older versus younger adults with faecal incontinence. *Age Ageing.* 2014;43(6):785-93.
345. Ismail SI. Audit of compliance with NICE guidelines on the use of tension-free vaginal tape

- slings for stress incontinence. *J Obstet Gynaecol.* 2007;27(5):496-9.
346. Ruiz Cerda JL, Arlandis Guzman S, Trassierra Villa M, García Fadrique G, Morales Solchaga G, Jiménez Cruz JF. [Analysis of the spanish urologists adherence to the recommendations of the guidelines on diagnostic and treatment of urinary incontinence]. *Actas Urol Esp.* 2007;31(10):1148-60.
347. van Leijssen SA, Kluivers KB, Mol BW, Vierhout ME, Heesakkers JP. The value of preoperative urodynamics according to gynecologists and urologists with special interest in stress urinary incontinence. *Int Urogynecol J.* 2012 ;23(4):423-8.
348. Yang CH, Punati J. Practice patterns of pediatricians and trainees for the management of functional constipation compared with 2006 NASPGHAN guidelines. *J Pediatr Gastroenterol Nutr.* 2015;60(3):308-11.
349. Dannaway J, Ng H, Deshpande AV. Adherence to ICCS nomenclature guidelines in subsequent literature: a bibliometric study. *Neurourol Urodyn.* 2013;32(7):952-6.
350. Egnatios D, Dupree L, Williams C. Performance improvement in practice: managing urinary incontinence in home health patients with the use of an evidence-based guideline. *Home Healthc Nurse.* 2010;28(10):620-8.
351. Agur W, Housami F, Drake M, Abrams P. Could the National Institute for Health and Clinical Excellence guidelines on urodynamics in urinary incontinence put some women at risk of a bad outcome from stress incontinence surgery? *BJU Int.* 2009;103(5):635-9.
352. Wagg A, Cardozo L, Chapple C, Diaz DC, de Ridder D, Espuna-Pons M, et al. Overactive bladder and continence guidelines: implementation, inaction or frustration? *Int J Clin Pract.* 2008;62(10):1588-93.
353. Wagg A, Lowe D, Peel P, Potter J. Do self-reported 'integrated' continence services provide high-quality continence care? *Age Ageing.* 2009;38(6):730-3.
354. Wagg A, Duckett J, McClurg D, Harari D, Lowe D. To what extent are national guidelines for the management of urinary incontinence in women adhered to? *BJOG.* 2011;118(13):1592-600.
355. Griebing TL. Urinary incontinence: incontinence guidelines--is lack of adherence a form of ageism? *Nat Rev Urol.* 2011;8(12):655-7.
356. Cordier, JF. The expert patient: towards a novel definition. *Eur Respir J.* 2014;44(4):853-7.
357. Wyman JF, Burgio KL, Newman DK. Practical aspects of lifestyle modifications and behavioural interventions in the treatment of overactive bladder and urgency urinary incontinence. *Int J Clin Pract.* 2009;63(8):1177-91.
358. Brown LK, Fenner DE, DeLancey JO, Schimpf MO. Defining patient knowledge and perceptions of vaginal pessaries for prolapse and incontinence. *Female Pelvic Med Reconstr Surg.* 2016;22(2):93-7.
359. Novick BJ, Angie M, Walker E, Kitay R, Monday K, Albert NM. The effect of intensive education on urinary incontinence following radical prostatectomy: a randomized control trial. *Urol Nurs.* 2014;34(5):246-51.
360. Shah AD, Massagli MP, Kohli N, Rajan SS, Braaten KP, Hoyte L. A reliable, valid instrument to assess patient knowledge about urinary incontinence and pelvic organ prolapse. *Int Urogynecol J.* 2008;19(9):1283-9.
361. Rozensky RH, Tovian SM, Gartley CB, Nichols TR, Layton M. A quality of life survey of individuals with urinary incontinence who visit a self-help website: implications for those seeking healthcare information. *J Clin Psychol Med Settings.* 2013;20(3):275-83.
362. McClurg D, Frawley H, Hay-Smith J, Dean S, Chen SY, Chiarelli P, Mair F, Dumoulin C. Scoping review of adherence promotion theories in pelvic floor muscle training – 2011 ICS state-of-the-science seminar research paper i of iv. *Neurourol Urodyn.* 2015;34(7):606-14.
363. Blasco P, Valdivia MI, Oña MR, Roset M, Mora AM, Hernández M. Clinical characteristics, beliefs, and coping strategies among older patients with overactive bladder. *Neurourol Urodyn.* 2016; Apr 27. doi: 10.1002/nau.23022.
364. Barbato KA, Wiebe JW, Cline TW, Hellier SD. Web-based treatment for women with stress urinary incontinence. *Urol Nurs.* 2014;34(5):252-7.
365. Lindh A, Sjöström M, Stenlund H, Samuelsson E. Non-face-to-face treatment of stress urinary incontinence: predictors of success after 1 year. *Int Urogynecol J.* 2016;27(12):1857-65.
366. Asklund I, Nyström E, Sjöström M, Umefjord G, Stenlund H, Samuelsson E. Mobile app for treatment of stress urinary incontinence: a randomized controlled trial. *Neurourol Urodyn.* 2016. Sep 9. doi: 10.1002/nau.23116.
367. Andrade AD, Anam R, Karanam C, Downey P, Ruiz JG. An overactive bladder online self-management program with embedded avatars: a randomized controlled trial of efficacy. *Urol.* 2015;85(3):561-7.

ECONOMICS OF URINARY & FAECAL INCONTINENCE, AND PROLAPSE

Chair

Todd H. Wagner (USA)

Members

Kate H. Moore (Australia)

Leslee L. Subak (USA)

Stefan de Wachter (Belgium)

Thomas Dudding (UK)

CONTENTS

I.	INTRODUCTION	2481	4.2.	Urge Incontinence and OAB	2493
II.	BACKGROUND	2481	5.	Incontinence Costs Related to Nursing Homes	2496
1.	Health Care Production	2481	6.	Prolapse Treatments, Cost Implications	2497
2.	International Issues	2482	7.	Economic Consequences of Faecal Incontinence	2499
3.	Costs Relative to Time	2483	7.1.	Cost of Illness	2499
3.1.	Inflation	2483	7.2.	Prevention	2500
3.2.	Discounting	2483	7.3.	Treatment	2500
3.3.	Efficacy over Time	2483	7.3.1	SNS Versus Conservative Treatments	2500
4.	Types of economic analysis	2484	7.3.2	SNS Versus Other Treatments for Faecal Incontinence	2501
4.1.	Cost Effectiveness Analysis	2484	IV.	SUMMARY AND FUTURE RESEARCH PRIORITIES	2503
4.2.	Cost Benefit Analysis (CBA)	2484		APPENDIX – SEARCH STRATEGIES	2504
4.3.	Cost Minimization Analysis (CMA)	2484		REFERENCES	2505
4.4.	Cost Consequence Analysis (CCA)	2484			
4.5.	Cost of Illness (COI)	2484			
4.6.	Summary	2484			
5.	Measuring outcomes	2484			
5.1.	Introduction	2484			
5.2.	Health Status and Quality of Life Measures	2485			
5.3.	Utility Measurement	2485			
6.	Decision Analysis	2486			
6.1.	Decision Tree	2486			
6.2.	Markov Model	2487			
6.3.	Summary	2488			
7.	Within Trial Analysis	2488			
8.	Bootstrapping	2489			
9.	Budget Impact Analysis	2489			
10.	Key Steps in a CEA	2489			
III.	SUMMARY OF RECENT ECONOMIC ANALYSES	2490			
1.	Behavioural Therapies	2490			
2.	Surgery for Stress Incontinence	2491			
3.	Surgery for Urge Incontinence and Refractory OAB	2492			
4.	Pharmacotherapy	2493			
4.1.	Stress Incontinence	2493			

ECONOMICS OF URINARY & FAECAL INCONTINENCE, AND PROLAPSE

TODD H. WAGNER (USA)
KATE H. MOORE (AUSTRALIA), LESLEE L. SUBAK (USA),
STEFAN DE WACHTER (BELGIUM), THOMAS DUDDING (UK)

I. INTRODUCTION

The average lifespan of a woman is now over 80 years, and rising for all almost all Organisation for Economic Co-operation and Development (OECD) countries (1). This is good news, but it raises a number of fiscal questions for governments and health care systems. Older adults are at greater risk for a range of health conditions, including urinary incontinence (UI), overactive bladder (OAB), pelvic organ prolapse (POP), and faecal incontinence (FI). We also face the aging baby boomers and many countries are still recovering from the 2008 recession. The growing demand for health care, coupled with a desire to contain health care costs, has resulted in a heightened interest in maximizing value. Economic tools are useful for understanding value in health care, defined as outcomes gained for unit of money spent. By enumerating the costs and benefits, payers can make informed decisions about treatment options in order to maximise a population's health.

The management of UI, OAB, POP, and FI has evolved over the past decade, driven in part due to advances in treatment, but also in part to a greater willingness among patients to talk to their clinician about their issues (2). Stress incontinence can be readily cured by a variety of conservative and surgical options, but benefits can erode over time. Similarly, drug and device companies have developed new treatments for overactive bladder, but these may require prolonged administration with longstanding treatment costs. Conservative measures such as bladder training, also require patient adherence to achieve success.

The news from the Economics Committee is mixed. On one hand, economic evaluations of existing treatments are increasingly the focus of studies. The bad news is that these analyses are not readily transparent and thus new studies often create more confusion and uncertainty. In this chapter we summarize economic methods frequently used in health care. We

then present a critical analysis of recent publications. Throughout this chapter, we focus on the economics of UI, POP, and FI, and thus we have organized the chapter accordingly.

II. BACKGROUND

1. HEALTH CARE PRODUCTION

When a person with incontinence (and to some extent prolapse) decides to seek medical care, they will have already incurred some costs, related to pads or laundry, and to managing the condition at home. He or she will then have a basic consultation, tests will probably be ordered, and a treatment may be initiated. These are the costs of treatment. The incontinence may increase the risk of a urinary tract infection, or the person may slip and fall on the way to the toilet. These are the costs associated with treating the consequences of incontinence (3, 4).

Self-management costs, treatment costs and consequence-related costs vary a great deal across and within countries. Part of this variation reflects inherent differences in the price of inputs, such as labour, needed to produce medical care. It also reflects the different ways that governments regulate health care (5). These contextual differences affect every economic analysis and places the burden on researchers to describe explicitly where, when, and how the economic data were obtained so that the results are interpretable. The regulatory context also affects patients, whether that is in access to care or in their costs of health care goods and services.

Health care costs are incurred when resources are used to produce goods or services. The production cost for most health care products is often not well understood because there is no market. More often there is a "charge" stated on a bill, or the total amount paid by a third party, whether that is the government

or an insurance company. Costs, charges and payments are not equivalent and are often substantially different for the same good or service. For example, hospital accounting systems in the US focus on billing and payments. The charges listed on the bill usually overstate costs, on average by a factor of three, and charges are rarely paid in full by the payer. For example, in a study of the costs of surgery for female faecal incontinence in the US (6), hospital “charges” were defined as the amount on the hospital bill, but the hospital “costs” were defined as the amount that the hospital actually received in payment. Only after understanding this definition can one make sense of the fact that hospital “charges” for FI surgery rose from \$48 million to \$57 million over 3 years, but the hospital “costs” increased only slightly from \$23 to \$24.5 million over the same 3 years (6).

Many health care systems use accounting software to track inputs (labour and capital) and then estimate the cost of care. Yet again, there is considerable variation in how these systems are employed and the validity of the results. Consequently, many researchers prefer to use payments as the estimate for cost, when available. Researchers have developed imperfect methods for adjusting charges with a hospital-specific ratio of costs to charges to better estimate costs (7). Charges, however, are not always available. Integrated health care systems, including Canada and the U.K, do not routinely generate bills, and in these circumstances, researchers have developed methods for generating pseudo-bills and cost estimates (8-10).

When researchers need to estimate the cost, they can choose from a range of approaches from “gross costing” to “micro costing” (11). These terms are similar to the phrases “top-down” and “bottom-up.” Accounting and billing systems use activity based micro-costing methods, whereby detailed estimates of time and products (inputs) are combined with unit costs to estimate total costs. Micro-costing (or “bottom-up”) is challenging to perform because a single inpatient stay or outpatient procedure might have hundreds or thousands of inputs. For example, Morris et al. (12) performed over 3621 observations to determine expenditure on urinary faecal or mixed incontinence in a one month study of 29 patients in a sub-acute care facility. Even when there are a limited number of inputs, the cost can vary by location or the time of purchase if input prices fluctuate.

At the other end of the spectrum, gross cost methods (“top-down”) identify a limited number of important characteristics such as the Health Care Resource Group (HRGs) in the U.K., Diagnosis Related Groups (DRGs) in the U.S. or Australia, and length of stay. However, gross costing lacks precision; this can be problematic if the study seeks to understand the cost of close substitutes. For example, in Australia the DRG for Tension Free Vaginal Tape and Colposuspension is the same, even though the production costs differ.

Accounting systems typically only reflect the resources used by the provider to produce care. These systems do not usually track patient costs, such as co-payments or travel costs. If researchers want to estimate societal costs, which are often of most interest (11, 13), one must include patient-incurred costs. This distinction is important for urinary incontinence, since most patients incur the costs for routine care (e.g., pads and protection). In the year 2000, routine care costs in the U.S. were \$1347 per person for urinary incontinence and \$1554 for people with OAB (14).

Thus, the perspective can dramatically affect the conclusions. For example, a study from the US analysed Medicare claims for the treatment of urinary incontinence among women aged 65 or older for 3 years (1992, 1995, 1998) including outpatient, inpatient and emergency department visits (15). Such Medicare claims nearly doubled over the time frame, from \$128 million to \$234 million, largely due to increased numbers of women treated by office visits and ambulatory (day only) surgery for items such as collagen injections. When the per capita changes were analysed, and inflation was considered, costs had actually declined by 15%. However, the editorial comment following this article points out that Medicare claims have a payer’s perspective, do not quantitate pad usage, and did not, until recently, track pharmaceuticals. Since we know that overactive bladder is more common as age increases, medical treatment is likely to be increasingly important in the over 65 age group, so that the conclusion of a 15% drop in per capita Medicare expenditure is not likely to be valid representation of costs in general. The editors pointed out that the article was mainly representative of patients with stress incontinence as a result. Such methodological issues are important.

In the example described above, the “perspective” was that of Medicare claims. In other words, Medicare was the “payer”, not the patient. This highlights the fact that costs can be evaluated from several different perspectives. The four most commonly used perspectives are: 1) overall society costs, which includes all aspects of care and treatment (which this committee recommends), 2) the payer, such as Medicare, 3) the provider, such as a hospital or managed care plan, and 4) the patient.

In general, health economists prefer the use of a societal perspective (11, 13). This facilitates comparisons across illnesses and across different countries. More focused analyses are sometimes also done to consider other perspectives, but this is usually clear in most papers.

2. INTERNATIONAL ISSUES

Patients often incur considerable costs paying for routine care products and treatments. However, the proportion of costs incurred by patients varies from

country to country. For example, in Sweden, the national health insurance covers routine care products. In the UK, age-dependent patient subsidies are available for pads. In Germany and Spain, pad costs are reimbursed if prescribed by a doctor (16). In Australia, low-income patients can apply for a subsidy to reimburse most of their routine care products, but wealthier patients must pay all the costs. In the US, such products are rarely covered by insurance (16).

Coverage for treatment also varies across countries. In the UK, most patients use the National Health Service (NHS) so that all office visits, tests, outpatient visits and surgical treatments are free to the patient. Pharmacotherapy does attract a small out-of-pocket payment per prescription. In Australia, about 70% of patients only have government insurance, similar to the UK NHS, but 40% of patients also have private insurance providing more generous coverage. In the US, adults over age 65 and those with a disability are covered by the Medicare program. This provides coverage for inpatient, outpatient and pharmacotherapy, although patients are generally responsible for sizable co-payments and nursing home care is capped. Those not covered by Medicare often have private insurance or Medicaid (a health insurance program for people with low incomes).

In the Netherlands, all legal residents are obliged to purchase a basic health policy (the purchase of a complementary policy covering extra health services remains voluntary). The government establishes what is in the basic package and under what conditions people are entitled to care.

Nursing home coverage is another area where there is widespread variation in costs, quality and coverage. In the US, Medicaid is the primary payer for long term care, but because the programme is for low-income adults, many people have to spend most of their assets before they qualify. Many of the high quality programmes do not accept Medicaid, because Medicaid payments are too low, thus the US has differentiated markets by quality. In Australia, low-income patients who have no private superannuation (pension fund) can receive the “old age pension” which covers long-term care, albeit in lower-calibre facilities than would be chosen by those who could afford better (similar to the Netherlands system). In Japan, generous long-term benefits are provided to long term institutional residents, so that out of pocket payments are reduced.

3. COSTS RELATIVE TO TIME

3.1. Inflation

Costs change over time and researchers need to account for this variation in their analysis. The easiest way is to present the costs relative to a specific year (e.g., 2012). Costs borne in past years should be inflated. In many countries, the governments publish inflation indices. In the US, inflation is represented in the Consumer Price Index (e.g., www.stats.bls.gov).

In the UK, the Health Service Cost Index or the Retail Price Index, published by the NHS Executive, Leeds, UK, can be used to adjust the costs of health care services (www.statistics.gov).

Caution is needed because general inflation relates to the cost of a *consistent* set of goods over time, e.g., over time, the goods must be of the same quality, and thus the costs observed five years ago can be observed today. If so, then the inflation index is informative. However, medical goods change rapidly, as does their quality. For example re-usable laparoscopic equipment has been replaced by disposable equipment, and newer drugs have emerged. This makes it difficult to determine whether any change in price is due to inflation or due to changes in quality. Consequently, many researchers recommend against using price indices that are developed specifically for medicine because these do not take quality into account. General consumer price indices are usually preferred for inflation adjustment.

3.2. Discounting

We choose to invest in health care now to reduce the probability of costlier problems in the future. Cancer prevention is the prototypical example, where we invest in cancer screening now with the hopes that if we have cancer, we will find it earlier and it will lead to fewer serious problems. Economic analyses must include these future costs. Discount rates, typically of 3-4% per annum, are used to estimate the net present value of future costs. By examining future costs and benefits, we can work to ensure that prevention efforts add value.

Cost-effectiveness models for incontinence must consider future costs. Drug treatments, for example, incur future costs. People have time preferences for money and future costs should be discounted to represent present value. There is some debate about the appropriate discount rate (17-19), but most international studies use a discount rate of 3-4% per annum (20).

3.3. Efficacy over Time

Economic models need to adjust for future changes in costs and efficacy. Surgery has a large up-front cost, and may at first appear more cost effective than pharmacotherapies, but often surgical efficacy wanes over time. For example, in Adang et al. (20) dynamic graciloplasty is portrayed as having a stable success rate over time in the treatment of faecal incontinence. In fact, we now know that dynamic graciloplasty has a very poor success rate over 10 years, so that the estimated data from Adang et al. are not accurate.

In summary, health care costs vary across countries and over time. This variation needs to be taken into account in the economic analysis. Sensitivity analyses are often useful because they enable us to investigate how different assumptions and input parameters can influence the results. As we describe in the

next section, explicitly describing these contextual issues is crucial for readers.

4. TYPES OF ECONOMIC ANALYSIS

4.1. Cost Effectiveness Analysis

A typology of economic models for health and medicine has emerged. With the exception of cost of illness studies, these economic models are designed to provide information about a choice (or set of choices). The current gold standard is cost-effectiveness analysis, in which the benefits and costs are compared in an incremental cost-effectiveness ratio (ICER). The ICER can be depicted as

$$\text{ICER} = \frac{\text{Average Cost}_A - \text{Average Cost}_B}{\text{Average QALY}_A - \text{Average QALY}_B}$$

The subscripts A and B are used to denote alternative treatment choices and QALY represents quality adjusted life years. It is easiest to consider two choices, but the following framework generalizes to more than two. If there are more than two treatment options, then each pair-wise comparison needs to be calculated to identify the optimal choice.

Historically, CEA was a generic term in which any outcome could be used, while cost-utility analysis (CUA) was reserved for when outcomes were measured using quality adjusted life years (QALYs). Over the past decade, CEA and CUA have become synonymous. Hereafter, we use the term CEA to imply outcomes measured in QALYs. Well-known texts discuss standard techniques for conducting a CEA (11, 13).

QALYs reflect quantity and quality of life. The quality adjustment is based on utilities. The power of CEA is that it can capture all potential benefits of an intervention and allow comparisons across health conditions, thereby promoting allocative efficiency.

4.2. Cost Benefit Analysis (CBA)

A CBA measures outcomes in money. When outcomes are valued as a currency, the optimal choice can be easily found by addition and subtraction (i.e. the end result is not a ratio). However, it is difficult to monetize health outcomes, and many researchers and policymakers are averse to placing a monetary value on life. CBA is widely used in many fields, such as environmental economics, but rarely used in health.

One approach for measuring outcomes in money is by asking patients what is the most they would be willing to pay. This approach, known as contingent valuation, has attracted some attention, including work in urinary incontinence (21).

4.3. Cost Minimization Analysis (CMA)

CMA assumes the outcomes are equivalent and only focuses on the costs. CMA has been argued as appropriate when considering patent versus the equivalent generic drugs. In practice, rarely are CMA conducted because treatments are rarely equivalent.

4.4. Cost Consequence Analysis (CCA)

In this analysis, outcomes are measured by assessing whether a treatment changes health care utilization (i.e. hospitalization averted or emergency visit averted). These analyses alone are incomplete and can be misleading. However, when combined with a CEA, they can provide information on the mechanisms underlying changes in costs. Often researchers hypothesize that a new treatment will increase appropriate utilization or decrease inappropriate utilization; this analysis can be helpful in this regard.

4.5. Cost of Illness (COI)

COI studies describe the costs related to a condition for a given population over a period of time (e.g., year). All COI studies include health care costs related to the condition. The inclusion of lost productivity (i.e. employment effects) varies and is more controversial. While some studies have attempted to place a cost on pain and suffering, such calculations are now discouraged. COI studies are not designed to inform decision makers about how to allocate scarce resources for treating conditions.

4.6. Summary

There are a number of economic tools that are commonly used in health care. Most new treatments offer additional benefits at an additional cost. The CBA and CEA were designed to determine how much money it costs to improve outcomes. Although the CEA is the preferred method, accurately measuring utilities can be challenging. We will discuss these issues in more depth because different methods for utility elicitation can have a very profound effect on the interpretation of the CEA.

5. MEASURING OUTCOMES

5.1. Introduction

The book by Gold and colleagues (11) is often used as guidelines for conducting CEA in health. The authors recommend using QALYs as the outcome in the CEA. However, this book also notes that analysts could use a clinical outcome measure. For incontinence, clinical outcome measures include 24-hour pad test, a voiding diary, or urodynamics. These outcomes are attractive for clinicians because they often use these measures in clinical practice. Clinical outcomes can be very valuable in identifying when a treatment is efficacious. However, using clinical outcomes in a CEA can yield results that are limited in

scope and potentially biased. A treatment might have improved a person's quality of life, but had little effect on the clinical outcome measure. The converse is also possible. Moreover, a CEA with one clinical outcome measure is not comparable to another CEA using a different clinical outcome measure. A clear advantage of QALYs is that they are generalizable across conditions.

5.2. Health Status and Quality of Life Measures

There are a number of frequently used and highly regarded general health status measures, such as the SF-36, which describe a person's current health state. Instruments that assess how a person perceives or feels about their health state are called health related quality of life (QOL) measures. Some of these measures are generic while others are disease-specific. A number of disease specific quality of life measures exist for OAB and incontinence, such as the Incontinence Quality of Life questionnaire (I-QOL) (22). These measures describe a person's quality of life specific to incontinence. Generic and disease specific quality of life measures are difficult to include in an economic evaluation because they were not designed for that purpose. In the past decade, there has been considerable effort placed on developing mapping algorithms that enable researcher to use the SF-36 or I-QOL and then "map" these scores onto a preference based valuation scale for CEA models (23-25).

5.3. Utility Measurement

As noted above, QALYs denote the relationship between the value of a given health state and the length of time a person lives in that health state. The value of a given health state is measured in utilities, which represent the preference for a given health state relative to other health states.

To understand utilities, consider the following: most people would prefer to be healthy over a given time rather than suffer constant urinary or faecal incontinence. Utility measurement refers to valuing these preferences on a perfect health-death scale with end points of 1.00 and 0.00, where 1.00 is perfect quality of life (best imaginable) and 0.00 is death equivalent quality of life. For example, the measured utility for urinary incontinence may be 0.60. If treatment improves this to 0.70, then the value of the treatment is $0.70 - 0.60 = 0.10$. If this utility gain is maintained over time, say for 10 years, then the gain is $0.10 \times 10 = 1.00$ QALY. Because utilities are measured on an absolute scale (perfect health to death), they can be used across different health states and therefore can be used to compare the effect of interventions in different health fields, or different interventions within the same field. For example, the QALYs gained from treatment for incontinence could be compared with those gained from treatment for depression. Where treatment costs (including costs to the patient) are known, the treatment providing the lowest incremental cost-per-QALY gained is preferred as this ensures

society gains the greatest benefit from the health care dollar.

Direct and indirect methods have been used to elicit utilities (26). The most common direct elicitation methods for valuation include time trade off (TTO), standard gamble (SG), and the visual analog scale (VAS). For description of these methods, see our previous chapter in this ICI series (27). Indirect utility elicitation is frequently used in clinical research because it is easy. Most indirect measures rely on multi-attribute utility (MAU) instruments, which decomposes health related quality of life into health domains (e.g., mobility and emotions). Respondents provide estimates for each attribute, which are then 'valued' based on pre-defined weights and summarized into a single utility score. The most commonly used MAU instrument is the EQ-5D.

- EQ-5D was developed by the Euroqol team from 7 European countries (28, 29). It has 5 items measuring Mobility, Self-care, Usual Activities, Pain/Discomfort and Anxiety/Depression. The upper bound is 1.00, lower bound is -0.59; a negative value represents a health state that is worse than death. This instrument is widely in many languages and it is very brief. It is currently the most widely used utility measure in urinary incontinence.
- Quality of Well-Being Scale (QWB) has three dimensions (Mobility, Physical Activity, and Social Activity), with 3-5 levels each, and 27 illness symptoms (30). The QWB requires trained interview administration (15-35 minutes), although a shorter version is available; a self-report version is under development. The upper bound is 1.00, lower bound is 0.00
- Health Utilities Index (HUI) uses 12 items that measure 8 domains (Vision, Hearing, Speech, Ambulation, Dexterity, Emotion, Cognition and Pain). The upper bound is 1.00, lower bound is -0.36 (31).
- 15D is a generic, comprehensive, standardized, self-administered measure of HRQOL that can be used both as a profile and single index score measure (32). The 15D was created in Finland. It has 15 items measuring Mobility, Vision, Hearing, Breathing, Sleeping, Eating, Speech, Elimination, Usual Activities, Mental Function, Discomfort & Symptoms, Depression, Distress, Vitality and Sexual Function (28). The upper bound is 1.00, lower bound is 0.11. The 15D has been used in urinary incontinence studies (33-36).
- Assessment of Quality of Life (AQoL) includes five dimensions: Illness (not used in utility computation), Independent Living, Social Relationships, Physical Senses and Psychological Well-being (37). The upper bound of the utility score is 1.00, and the lower bound is -0.04.

- Rosser Index has two dimensions measuring disability and distress, and measured 29 health states (38). The upper bound is 1.00, and the lower boundary -1.49.
- Mapping algorithms. Scientists have developed algorithms to map health status and quality of life instruments to utilities. Perhaps the best known is the SF-6D, which maps the SF-36 or SF-12 to a utility score (23). The SF-6D measures physical functioning, bodily pain, mental health, physical role, emotional role, social functioning, and vitality. The bounds for the SF-6D are 1.00, and 0.30 for the worst possible health. There have also been new mapping algorithms for mapping the I-QOL to utilities using AQoL and EQ-5D weights (24, 39). There is also a mapping of the King's Health Questionnaire to utility weights, and the OAB-q questionnaire (40, 41). While these mapped algorithms have shown responsiveness, a significant difference does not imply a meaningful difference. For example, a 10 point increase from baseline has been suggested to represent a minimally important difference on the OAB-q (42).
- Proxy report. People with incontinence may not be cognitively able to complete a MAU or go through a utility elicitation process. Some of the MAUs, such as the HUI, have been validated for use with proxies. Although not always possible, if proxies are expected then proxies should be gathered for all cases, even those patients who complete the utility measure themselves, so that the method is applied in a standard, consistent fashion.

6. DECISION ANALYSIS

Decision analysis is a quantitative probabilistic tool for resolving problems when there is uncertainty with regards to treatment options. For example, Albo and colleagues (43) compared Burch colposuspension to fascial sling for stress incontinence. They concluded that the fascial sling yielded a higher rate of successful treatment, measured as a composite outcome, but also resulted in greater morbidity. Even in well-designed multi-site clinical trials, the results may be ambiguous. Decision analysis may be used to overcome this ambiguity.

Decision analysis can be boiled down into five steps. The first step involves identifying the structure of the problem and this requires the listing of all decision alternatives, all clinical outcomes, and a sequence of events. After completing step one, step two involves assigning probabilities to all chance events (e.g., death). Step three involves quantifying the benefits (e.g., QALYs) for all outcomes. The fourth step involves the mathematical calculation of expected utility for each strategy (or this can be taken from published data). Step four will often identify the preferred strategy. The final step involves conducting sensitivity

analysis to check that the model is robust across a range of clinically meaningful possibilities.

Every decision model involves some assumptions. Frequently, assumptions are needed to incorporate clinical trial data in the model. For example, a common assumption is that the effect shown in a clinical trial is generalizable to the broader population—treating women with TVT will result in effects like those seen in Lier and colleague's paper(35) (discussed later in the chapter). Some assumptions may seem trivial, but it is best to delineate each assumption along the way. Published decision analysis should include a table of assumptions along with other data inputs; frequently this is the first table in the decision analysis.

The clinical question and the structure of the problem (step 1) should provide guidance on the decision model. Frequently decision trees are used because they are simple and address the question at hand. Decision trees are so named because they look like a tree with a trunk, branches and leaves.

6.1. Decision Tree

In a decision tree, there is a distinction between a decision node and a chance node. A decision node is a point where a choice is made by the decision maker

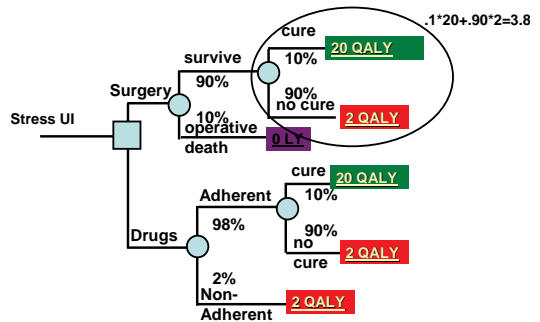

Figure 2

(typically a physician or patient). For example, for a woman with stress incontinence, the choice to operate (yes or no) would be represented with a decision node. A choice must have at least two options and more than two choices are permitted. However, each choice must be mutually exclusive. A patient cannot choose both operation and no operation. A chance node is a point where chance determines fate. For example, the decision maker chooses to operate or not operate, and hopefully the treatment is successful, but treatment success or failure is a chance node. Not only must chance nodes be mutually exclusive, but they must also be collectively exhaustive (one of the chances must happen and the sum of probabilities for all of the chances must add to 100%).

In addition to chance and decision nodes, there are terminal nodes. These nodes are the final outcome for the pathway taken. Figure 1 shows a hypothetical decision tree for treating a patient with stress incontinence. In this hypothetical situation, we structure the model to have two options: surgery or drugs. The choice under examination is surgery versus medical management. Surgery carries some risks—a small probability of operative death, for example, in the case of clam cystoplasty for refractory detrusor overactivity. The decision nodes are represented by squares while chance nodes are represented by circles. The terminal nodes are cure, no cure, operative death or non-adherence, which is the same as no cure. This is a hypothetical decision model, and most decision models are much more complex. Clearly this model could be expanded to include behavioural treatment and each decision node could be expanded to consider all relevant alternatives (autologous sling, Burch colposuspension, tension-free vaginal tape, trans-obturator tape).

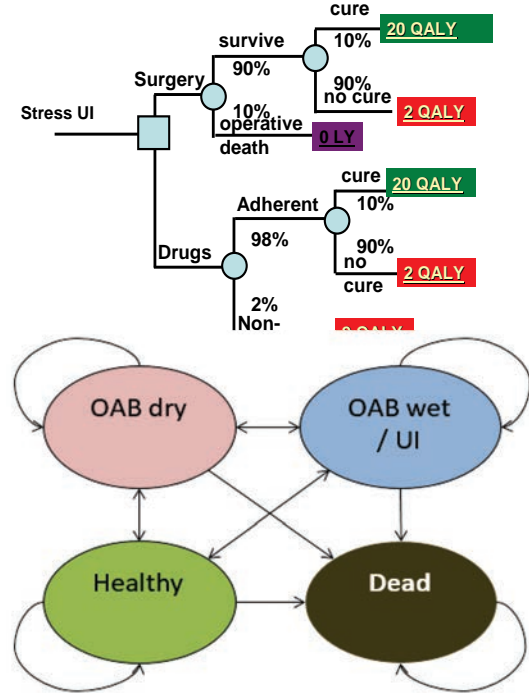

Figure 4

For the next step in the decision model, one must include probabilities at each chance node. We must identify the probability that the disease is cured after operation. Researchers should review the published literature to find this probability and ideally some information about the distribution around this probability (e.g., probability= 58% with a 95% CI 51-68%).

After including probabilities, one must place values next to the terminal nodes. These values must be a single outcome and QALYs are preferred, although

life years (unadjusted for quality) are used for some diseases. With outcomes and probabilities, one can then “run” the decision tree. Because there is one decision node with two options, we will be computing expected values for the two options. Running the model involves starting at each end node and working left or backwards. The expected value for the surgical survival node is 3.8 QALYs (see Figure 2).

The expected value for the surgical operative death node is 0. When we combined a 10% chance of operative death (0 QALYs) and a 90% chance of survival (3.8 QALYs), we find the expected value of surgery is 3.42 (Figure 3). If we do the calculation for the lower branch, we get the expected value for drug therapy is 3.76 QALYs. Because $3.76 > 3.42$, we would recommend surgery over drugs IF the sensitivity analysis shows this result to be robust. The decision tree in the example focuses on QALYs for UI treatment and it ignores cost differences, but it could be easily modified to include cost information.

6.2. Markov Model

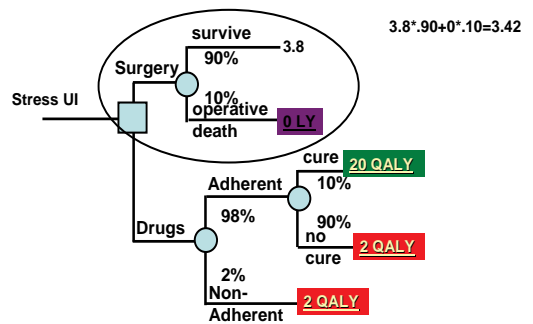

Figure 3

The decision tree, as shown above, assumes the chance of having an event is constant over time. Our knowledge about urinary incontinence suggests otherwise. A person, for example, could get surgery for stress incontinence, but over time, we need to include the potential for surgical failure. Markov models are preferred for incorporating changes in health states over time. At their core, Markov models are mathematical techniques, derived from matrix algebra, that describe the transitions a cohort of patients make among a number of mutually exclusive health states over time. The model works by making calculations for each period of time (i.e. cycle). Figure 4 shows a very basic four-state Markov model. At each time, a person has to be in one (and only one) of the states. But with each change in time (cycle), the person can move to another state, shown with arrows, depending on the possible states and a probability. If the person dies, they are shown to enter the death state. The person cannot leave this state.

Some aspects of the Markov model construction are similar to a decision tree. Setting up the model is quite similar. One must identify the health states and the transition probabilities. What is quite different is that one must determine the cycle length—the rate at which you allow people to change states. The cycle length should be a clinically meaningful period of time and this choice is also frequently affected by the availability of data. There may be publications showing annual failure rates for surgery and so one could choose an annual cycle.

For a Markov model, one needs to know the value for each state. Again, QALYs is the preferred metric. When the model runs, the program tracks the amount of time each person spends in each state. Transitions to other states are handled by transition probabilities (i.e. the likelihood of cure or failure). Decisions, such as the decision to change from one treatment to another, can affect transition probability. Models can use cohort simulations where a large hypothetical cohort of patients is run through the model. This does not provide information on the distribution of expected values. Monte Carlo simulations run each patient through the model a large number of times (e.g., 10^4). In doing so, this provides a distribution and variance information on patients.

With Markov models, sensitivity analyses remain a crucial step to test the robustness of the model. Recent advances in sensitivity analyses and in the graphical presentation of data general require the use of specific software. Although some people program Markov models into a spreadsheet, such as Excel, specialized software such as TreeAge, can streamline decision analysis and provide many advanced features that would be very difficult in Excel.

6.3. Summary

Decision trees and Markov models are decision models are two of the more common types of models used in decision analysis. Over the past decade, there has been considerable discussion on how to best present results from decision models. Readers will probably encounter cost effectiveness acceptability curves (CEACs), which are designed to present CEA results for decision makers. According to Fenwick and Byford (44),

“Care must be taken when interpreting the information provided by a CEAC. A CEAC simply presents the probability that an intervention is cost-effective compared with the alternative for a range of values of λ . That is, the probability that the ICER falls below the maximum acceptable ratio. Statements concerning CEACs should be restricted to the uncertainty of the estimate of cost-effectiveness. The information from a CEAC should not, in general, be used to make statements about the implementation of the intervention.”

As implied by Fenwick and Byford (44), questions of implementation introduce other issues, such as the

underlying production function, that must be addressed separately. It does not generally hold that statements about cost-effectiveness under ideal situations will necessarily hold across a range of implementation scenarios.

Another critical point raised by Fenwick and Byford (44), is the need to include uncertainty. The past decade has also seen an increasing number of incontinence-related papers presenting ICERs without any information on the underlying uncertainty. Some papers reported no significant difference in cost and no significant difference in outcome; they then compute the ICER and despite not including uncertainty they conclude that one treatment is more cost-effective than the other. Scientists must do a better job providing information on uncertainty with the ICER. An example of a CEAC is shown in Figure 5.

7. WITHIN TRIAL ANALYSIS

Clinical trials increasingly measure costs and benefits as secondary end points. In the analysis, the marginal

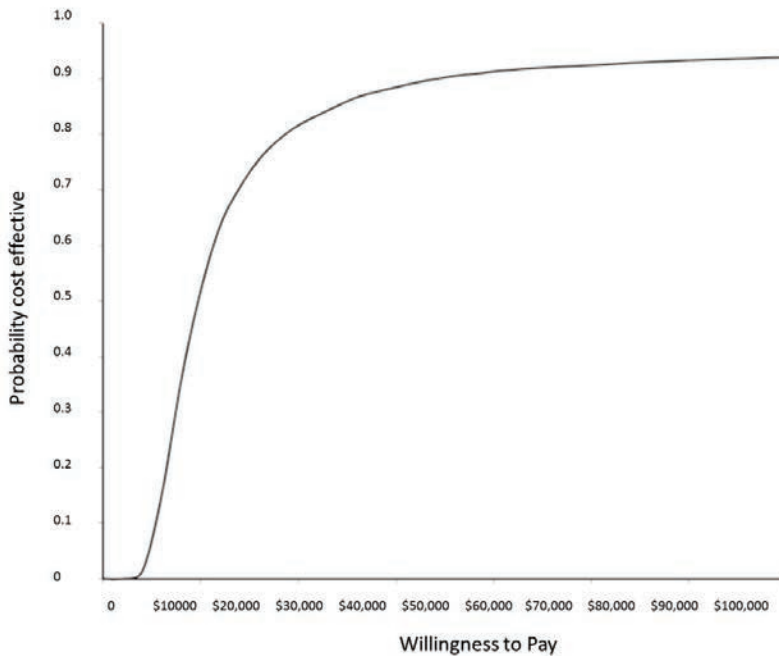

Figure 5

difference in costs can be computed as well as the marginal difference in outcomes. If one treatment yields significant improvements in outcomes at a significantly lower cost, then it dominant and an ICER is not necessary. The ICER is computed when one treatment is more effective and more expensive. Computing an ICER is straightforward, however, is necessary to also compute the confidence interval. An ICER without a confidence interval is as useless as an odds ratio or hazard ratio without a confidence interval. Bootstrapping is frequently used to estimate the confidence interval. The International Society for Pharmacoeconomics and Outcomes Research (ISPOR) has issued guidance on within trial analysis (45).

8. BOOTSTRAPPING

Bootstrapping is a resampling method that enables researchers to estimate parameters based on the observed data. Bootstrapping is particularly useful when estimating a confident interval for an ICER. The ICER involves dividing the mean difference in costs by the mean difference in utilities. Statistical software can easily determine whether two samples have different mean costs or different mean utilities (e.g., t-test). Bootstrapping is one way to calculate the confidence interval around the ratio of these two differences. Bootstrapping involves randomly drawing cases from the sample and replacing the case back in the sample. Resampling is done until the original sample size is met. The same process is then done again and again, typically 4000 times. Thus, by resampling, the

analyst can calculate the ICER 4000 times, thereby providing a distribution around the ICER.

9. BUDGET IMPACT ANALYSIS

Providers and payers often have questions that are not directly addressed by a CEA based on a societal perspective. Budget impact analysis (BIA) was developed to inform a decision maker on how alternative technology will affect their budget. A BIA will often focus on the decision maker's costs and over a short time frame (e.g., 1-3 years). Other parameters in the model, such as patient characteristics or input costs, can also be tailored specifically for the decision maker. Making decision based solely on a BIA can lead to suboptimal societal results (46). Hence, scientists advocate that a BIA be done in conjunction with a CEA so that decision makers are informed about the broader social implications of their decision. ISPOR (www.ispor.org) has published guidelines for conducting a BIA (47).

10. KEY STEPS IN A CEA

This section highlights ten key issues that must be addressed in a CEA. These ten principles, summarized below, comprise an appropriate minimum standard for performing and reporting CEAs. The principles were identified from guidelines established by the Panel on Cost-Effectiveness in Health and Medicine convened by the United States Public

Health Service (11). Each principle should be explicitly addressed in every study.

1. The **Research Question** must be clearly stated. All CEAs must compare at least two different treatments or interventions. One of these should include the current standard practices. For example when comparing surgeries for stress incontinence, one of the comparators should be a longstanding method, avoid comparing two new methods side by side.
2. The **Time Frame** over which costs and benefits are measured should be long enough to capture the economic impact of an intervention and future health outcomes. Pharmacology studies of 12 weeks duration give very little real economic information, and surgical complications/ failures seldom emerge in less than 1-2 years.
3. **Perspective:** The choice of perspective should be clear. Total society perspective (all payers) is the gold standard. Other perspectives, such as the payer or patient perspective, may be useful but must be stated clearly.
4. **Probabilities** are needed for each “chance” event, such as chance of cure or chance of an adverse event. The best sources of probabilities come from meta-analyses of randomized clinical trials, or if not available use data from individual clinical trials.
5. **Costs:** Units of expense and unit costs should be described in detail. Information on the source (e.g., charges, payments) and year of the cost data should be presented. If the costs were inflated and/or converted from another currency, then this must be described.
6. **Outcome Measure:** Measures of effectiveness depend on the type and objectives of analysis. Quality adjusted life years are the gold standard, as described previously in this chapter.
7. **Analytic Model:** Each intervention being assessed must be described and possible courses of events identified, including the expected course of disease, treatments, complications, and outcomes. This may be performed using a spreadsheet/ clinical trial path, or Decision Tree, or Markov Model.
8. **Discounting:** Discounting is necessary to calculate the present value of money and health states that will occur in the future. Future costs and utilities should be discounted to present value; 3 % per year is a recommended starting point.
9. **Incremental Analysis:** The purpose of a CEA is to describe the relative value of one health care strategy compared to another. An **incremental cost-effectiveness ratio (ICER)** is the incremental cost divided by the incremental effectiveness of intervention A compared to intervention B, and is calculated as follows.

$$ICER = \frac{Avg. Cost_A - Avg. Cost_B}{$$

$$Avg. Utility_A - Avg. Utility_B}$$

Averages should be used rather than other measures of central tendency, such as medians, because it is important to include the effect of outliers. The leverage of the outliers should be tested in a sensitivity analysis.

10. **Sensitivity Analysis and Uncertainty:** A sensitivity analysis should allow the reader to understand whether the conclusion of the analysis would hold true if either the Costs or the Probabilities (of cure or complications) were to vary substantially. Probabilistic sensitivity analysis with Monte Carlo simulation is the preferred approach and is required by some journals.

III. SUMMARY OF RECENT ECONOMIC ANALYSES

This section reviews recent literature on the economics of UI, FI and POP. Among modelling studies, we find that very few studies estimate lifetime costs and benefits. When comparing treatments that have very different initial treatment costs, this can create a bias towards treatments that have lower initial costs (behavioural or pharmacological treatment), as opposed to treatments that are initially expensive (surgical).

In the last edition of this chapter, we found a number of studies that computed the ICER and then claimed that one treatment was cost-effective without presenting any information on uncertainty. An ICER without uncertainty is akin to an odds-ratio without a confidence region. We are pleased to see an increasing number of studies including probabilistic sensitivity analysis.

1. BEHAVIOURAL THERAPIES

A number of medical and surgical treatments for urinary incontinence exist with evidence supporting short-term efficacy. While some women opt for these approaches, many prefer conservative/ behavioural therapy, at least as a first-line treatment, because it is non-invasive and there are virtually no adverse side effects. Conservative/ behavioural therapy, (hereafter referred to as behavioural therapy) covers a class of techniques for preventing incontinent episodes through behaviour change. The most common behavioural treatment is pelvic floor training (with or without biofeedback). Behavioural approaches also include cognitive behaviour training techniques to reduce the likelihood of an accident. There is considerable variation in behavioural techniques and their use of professional staff. Some modalities use intensive, one-on-one clinician-led training with direct verbal feedback often involving physical examination of the pelvic floor, while other options are more focused on

group training or self-care techniques. The level of intensity is important as it not only affects the efficacy, but it also affects the cost of the intervention, with more intensive interventions generally being more effective and more expensive than less intensive options.

Since the last edition, we found seven new published articles evaluating economic aspects of behavioural techniques (48-56). There is strong evidence that behavioural programs are more expensive than usual care. The more intensive programs cost approximately \$150 to \$344 (2015 USD). However, it remains unclear if behavioural programs provide value in part because there is heterogeneous adherence to these treatments. Some of these studies reporting improvements in pad tests, pads used per week, post void residual, functional impairment measure, and the ICIQ (see Arnold et al., (49)). However, effects were not robust when measured with generic quality of life measures, such as the EQ-5D. This raises questions whether these generic instruments are sensitive to small but important changes.

Future research should consider coupling disease-specific end points with the EQ-5D. Future research should also consider strategies to provide the least expensive interventions as a first-line treatment followed by more intensive options for non-responders. This is a proven way to allocate limited resources. Behavioural economic programs, which create incentives to adhere, may also be useful given the heterogeneous adherence to these treatments.

2. SURGERY FOR STRESS INCONTINENCE

Our review of the literature identified 35 new papers related to the economics of surgery for stress incontinence. We note a couple of challenges in comparing studies. First, most studies lacked end point data beyond 12 month on costs or effectiveness. The randomized trial by Boyers et al (57) tracked end points for 12 months; the longest follow-up was 3-years in the Markov model conducted by Sand et al. (58).

Second, many studies compared alternative surgical treatments. For example, Ciftci et al. (59) compared commercially purchased slings versus hand-made slings, while Laudano et al. (60) compared tension free vaginal tape (TVT) versus colposuspension. Thus, in general, given the follow-up time frame and the restricted set of treatment comparisons, it makes it very difficult to make statements about the cost-effectiveness of surgical treatments compared to pharmacotherapy or behavioural treatment.

Among the 35 studies, not all address questions that were directly relevant for our review. Feng et al. (61) looked at the use of pre-operative urodynamic testing for sling surgery and concluded that there are times when it is overused and other times when it is un-

derused, both of which could affect the cost and effectiveness of care. Subak et al. (62) tracked women who had colposuspension and sling surgery and found that self-management costs decreased 72% (\$625 per woman year) and that savings was correlated with decreasing UI frequency. Finally, we excluded some studies from further review because they dealt with issues of surgical timing (cf. Chermansk et al. (63) and Richardson et al. (64)).

Among the relevant studies, Richardson et al. (65) compared mid-urethral sling (MUS) surgery to PFMT and a pessary in a decision tree. They created their tree based on published information. They concluded that surgery was more expensive and more effective, yielding an ICER of \$32,132 / QALY. They varied input parameters in one-way and two-way sensitivity analyses. They noted that surgery remains cost-effective at less than \$50,000/QALY until the adherence to PFMT and pessary > 40.5% and 43.5%, respectively. The 1-year model was computed based on cure rate of 90.8% for the MUS. We see two limitations with this study. First, a longer follow-up time could be important, especially if the effectiveness of MUS changes after one year. Second, a Monte Carlo simulation would have provided considerable more information on the level of uncertainty around these cost-effectiveness thresholds.

Boyers et al. (57) conducted a randomized trial to assess the costs and effectiveness of a single-incision mini sling to standard mid-urethral sling (MUS). These two types of slings are what economists call close-substitutes, and the potential cost saving for the

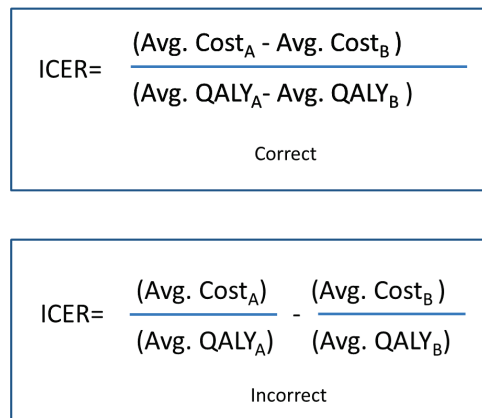

Figure 6

mini-sling is related to having local anaesthesia versus general anaesthesia. As one might expect with close substitutes, there were no significant differences in quality of life outcomes, as measured with the King's Health Questionnaire (mean difference: -0.003; 95% CI: -0.008 to +0.002). They also found no significant differences in costs, unless they included costs related to lost productivity (returning to work

earlier with the mini sling). While the authors calculate the ICER, they did not produce confidence intervals around the ICER. Thus, their conclusion that the minisling is cost-effective is not warranted. Rather, it is likely that such an analysis would have produced an ICER with very wide confidence intervals, suggesting little confidence that one treatment is more cost-effective than the other.

Kunkle et al. (66) used a decision tree to assess the cost-effectiveness of mid-urethral sling versus bulking agents for women without urethral hypermobility. They used published data when available and assessed uncertainty with a Monte Carlo simulation. They concluded that MUS was not cost-effective as a first-line treatment for women without urethral hypermobility. They further note that “when MUS costs less than \$5132, it becomes a cost-effective first-line treatment, and when it costs less than \$2035, it is cost saving.” Unfortunately, only costs and effects through 1 year were included. Bulking agents generally have a limited lifetime, so a longer time frame is critical, creating concerns that the conclusion is flawed.

In prior Committee reports, we reviewed many studies comparing invasive surgeries (Burch colposuspension) to less invasive surgeries (slings). Interestingly, that question seems to be largely answered, with authors typically citing Manca (67). In contrast, this time our review identified a number of studies comparing the costs of close substitutes (e.g., a commercial sling versus a hand-made sling) (59, 68). Although we can observe different prices for the treatment, these differences tend to be obscured by natural variation in practice patterns. So while a hand-made sling may be less expensive than a commercial sling, these cost differences tend to be quite small and are not easily observable when costs of care are summarized over time (e.g., cost per discharge).

Unfortunately, we found a number of articles that presented weak evidence, made unwarranted conclusions, were unclear in presentation, or made errors in calculations. One notable error identified in more than one study is the order of operation in calculating the ICER. The numerator of the ICER is the mean difference in costs between the two treatments. The denominator is the mean difference in the QALYs between the treatments. These mean differences must be calculated prior to dividing costs by QALYs. It is incorrect to divide the cost of treatment A by its QALYs and then divide the cost of treatment B by its QALYs. These ratios cannot be directly compared (see Figure 6).

3. SURGERY FOR URGE INCONTINENCE AND REFRACTORY OAB

There are two primary treatments for urge urinary incontinence and refractory OAB: sacral nerve stimulation (SNS) and Botulinum Toxin A. Since the previous

Committee report, two additional papers were published comparing cost-effectiveness of SNS to Botulinum Toxin injection (69, 70), and to oral medical treatment (70). In addition, two publications looked at economics aspects of different SNS test phases (71, 72).

Aboseif et al. (73) retrospectively reviewed the US costs related to SNS for a period extending from one year pre- to one year post-implantation. In a heterogeneous group of patients, also including patients with urinary retention and chronic pelvic pain, a one-year SNS treatment reduced outpatient doctor visits and diagnostic and therapeutic procedure costs 92%, along with a 30% reduction in drug costs (73). This, however, did not include the costs of the neuromodulation implant itself, nor the surgical implantation costs. QALYs were not ascertained.

Because there is no standard protocol for Botulinum Toxin A injection, a different protocol using 200 units every 14 months was evaluated in the Arlandis study, which proved cost-effective on the ICER < € 30000/QALY threshold (74). The data are consistent with a cost-effectiveness analysis in Canada and Italy (69, 70). A Markov model was used to estimate long-term costs and outcomes. Sacral neuromodulation, injection with Botulinum toxin and optimal medical therapy were included in the analysis. Hassouna et al. (70) estimated cost effectiveness over a 10-year period and demonstrated that SNS became cost-effective compared to Botulinum toxin injection at 5 years. In the Italian study, SNS became cost-effective from the third year onwards, with ICER of 21258.72 €/QALY, and was economically dominant at year 10 (69). At long-term follow up, the most influential variables appeared to be the frequency of Botulinum toxin injections, IPG longevity (reflecting the quality of lead placement, e.g., the closer the lead is placed to the nerve, the lower amplitudes are necessary for the effect) and hospitalisation costs for both procedures.

The Canadian study also compared to SNS to optimal medical therapy. In Canada SNS was cost-effective at the 2-year period and dominant at 5 and 10 years. The incremental cost of SNS was -\$2233 and -\$11447 at 5 and 10 years respectively, with added QALYs of 0.94 and 1.76 compared to optimal medical therapy.

In summary, the different mid- to long-term cost-effectiveness analyses support a therapeutic pathway starting with SNS compared to Botulinum toxin injection (69, 70, 74, 75). Reducing need for hospitalisation (e.g., local instead of general anaesthesia) and optimal lead placement (e.g., less need for revision, lower amplitude for stimulation) appear important influencing factors.

Kantartzis and colleagues (72) analysed different options for SNS in a cost-effectiveness decision analysis model: unilateral PNE, bilateral PNE, unilateral permanent lead test, bilateral permanent lead test and full implant with test phase. No intermittent treatment was used as reference case. Full implant with

test phase appeared the most expensive (\$31,824) with effectiveness of 4.113 QALYs. However unilateral and bilateral test with permanent electrodes had lower costs (\$6,038 and \$7,702, respectively) and appeared more effective (4.201 and 4.321 QALYs, respectively), making these the preferred strategies. This was because the pulse generator is the most expensive part of the treatment procedure. The base parameters in the model were success rate of unilateral and bilateral tests with permanent electrode (67% and 87%) (SDW4). However, a single institution analysis in the US reported a success rate of 90% for stage I and showed that with these numbers a single stage implant would be cost-effective over staged procedure, according to specific reimbursement data (71). Break-even point was found at 68.6% success, based on Blue Cross/Blue Shield reimbursement and at 95% success rate for Medicare. The cut-off level is different for different reimbursement systems and thus most likely different for different countries. However it would be interesting to conduct such strategy in different countries and settings to obtain the individual cut-off level.

4. PHARMACOTHERAPY

Although pharmaceutical companies must show that a new drug is safe and efficacious prior to approval and marketing, the requirement for evidence of cost-effectiveness (i.e. whether the new drug is cost-effective compared to another treatment), varies from country to country.

The U.S. Food and Drug Administration does not require economic data in its review of a new drug. Instead it leaves economic questions to the purchasers (e.g., insurance companies, government purchasers or individuals), similar to the Netherlands. In the UK, however, the National Institute for Health and Clinical Excellence (NICE) requires economic review. Although there is not a strict threshold, they have denied approvals for new drugs that have an incremental cost effectiveness ratio greater than £30,000 per QALY. However, there is some pressure to reduce this threshold (76). In Australia, manufacturers must prove cost-effectiveness, but there is no explicit threshold to be listed on the Pharmaceutical Benefit Scheme (whereby patients pay a subsidized cost for the drug). However, only therapeutic efficacy and safety must be shown for it to be available in Australia as a non-subsidized "private" prescription. Many purchasers (as in Australia) have formularies, or lists of medications that they are willing to pay for, and the economic evaluation is frequently part of the request to place the new drug on the formulary.

In the next sections, we review the literature since the prior Committee publication in 2012 on the economics of drugs for incontinence and overactive bladder.

4.1. Stress Incontinence

We identified no cost-effectiveness articles for stress urinary incontinence (SUI) in the past 5 years since

the prior ICI report in 2012. This is consistent with the lack of available pharmacological therapies for stress incontinence. (NOTE: Duloxetine did not receive US FDA approval for SUI. It is approved by the European Medicines Agency, an Agency of the European Union, for depression, anxiety and diabetic peripheral neuropathy.)

4.2. Urge Incontinence and OAB

There are several commonly used pharmacological treatments for overactive bladder and urgency urinary incontinence, including oxybutynin (Ditropan) as a tablet or as Oxytrol patches; tolterodine (Detrol), darifenacin (Enablex), trospium (Sanctura), solifenacin (Vesicare), fesoterodine (Toviaz), and more recently introduced mirabegron (Myrbetriq). There have been few CEA/CUAs on medications since the prior ICI report and most have been funded or performed by drug developers, creating potential conflicts of interest. Other common limitations include using an incontinence-specific utility measure, limited time frame and limited comparison treatments. While industry-funded studies often include experts in performing CEA and sound methods, they must be interpreted carefully for the possibility of bias. For example selection of assumptions included in the models or analyses like probability of events (e.g., drug response, likelihood of transitioning to a different treatment strategy, probability of side effects or adverse events), timeframe, costs and perspective. Each of these parameters can dramatically affect the analysis and the outcome.

Several analyses presented incremental analyses compared to no treatment, rather than to the next least costly treatment which makes the intervention appear more cost-effective (lower "ICER"). Most analyses that include sensitivity analyses find that the analysis is most sensitive to utilities. This can be dramatically affected by choice of measure and availability of primary data (vs. other assumptions). In the past five years, researchers have developed mapped algorithms that link scores on the I-QOL to the AQOL or EQ-5D utility scores. In our review, we found several analyses that used these mapping algorithms. This might be valid, but until we understand these mapping algorithms more, it also raises some concerns about how we should interpret the magnitude of change. These mapped algorithms are showing greater increases in QALYs and therefore they result in lower ICER.

Two studies funded by a pharmaceutical company evaluated the cost-effectiveness of solifenacin compared to oxybutynin immediate release from the perspective of the UK National Health Service and compared to trospium from the perspective of the German National Health Service over a 1-year period (77, 78). In the first study, the outcome was based on willingness to pay for incontinence improvement, a less generalizable outcome than a general health-related QOL measure, which may overstate the cost-effectiveness.

tiveness (minimize the ICER) or bias the results in favor of the drug arm. They found that solifenacin had an ICER of £15,053 (without UI pads in the model) or £12,309 (with UI pads; £2010). In the second study of solifenacin compared to trospium, investigators used the EQ-5D to estimate QALYs. The ICER was €19,839 for lower dose trospium (40 mg) and €16,657 for higher dose trospium (60 mg) (€2012) compared to solifenacin. In Monte Carlo simulations, 96-99% of cases produced an ICER below €30,000/QALY. While both studies showed that solifenacin was cost-effective compared to a comparator drug by current thresholds, analyses were sensitive to utility values and drug effectiveness and should be interpreted with care.

Nilsson et al. (79) developed a decision model to compare the class of newer anticholinergic drugs (i.e. solifenacin, tolterodine, fesoterodine, darifenacin, oxybutynin patch), to oxybutynin immediate-release, and to no treatment (placebo effect) over a 1 year time period in Sweden. Data from the Swedish Prescribed Drug Registry provided primary data on utilization, considered a proxy for treatment effectiveness. Treatment response was defined as proportion of patients filing a second prescription within 120 days, which may reflect treatment adherence rather than treatment effectiveness. Utilities were assessed with the King's Health Questionnaire (KHQ), an incontinence-specific QOL measure that maps to utility scores. No treatment was dominant; oxybutynin immediate release was cost-effective compared to no treatment, yet newer anticholinergics were cost-effective compared to oxybutynin immediate release. In one-way sensitivity analyses, the model was most sensitive to price of pads and frequency of very serious adverse events (dementia). Thus, treating UI with newer medications was found to be cost-effective. However, the cost-effectiveness declines for patients with less severe symptoms or higher risk of adverse events. This model assumes that all newer anticholinergic medications have equivalent efficacy. And while they conducted a sensitivity analysis, they did not compute a Monte Carlo simulation to understand the mean differences with regard to the uncertainty.

Mirabegron, a β 3-agonist, is a newer OAB medication that should not increase anticholinergic burden or the risk of dementia. There have been a few studies looking at the cost-effectiveness of mirabegron compared to other medicines. Wielage and colleagues (80) developed a Markov model in the US, while CEA models for Mirabegron were also submitted to NICE for UK review (81, 82). NICE reviewed the models and published a lengthy review (83). Despite the concerns raised in the NICE review, Mirabegron appears to hold promise as a new treatment for OAB and urge incontinence.

The cost-effectiveness of percutaneous tibial nerve stimulation (PTNS) versus extended release tolterodine for the treatment of OAB over a 1-year timeframe was assessed using modelling (84). Percutaneous tibial nerve stimulation therapy included 12 sessions

over 3 months followed by maintenance therapy. The primary outcome was the ICER, with less than \$50,000 per QALY gained considered cost-effective. One-way sensitivity analyses and Monte Carlo simulation assessed the robustness of the model. The analyses showed that PTNS added significant cost to the management of OAB with modest improvement in quality of life. For every 100 patients treated with PTNS the costs increased by \$303,480 and resulted in an additional 4.3 quality adjusted life-years gained compared to tolterodine ER. The ICER was \$70,754 per QALY gained. The ICER was most affected by utility for incontinence and probability of continuing PTNS beyond 12 months. In Monte Carlo analyses, PTNS was cost-effective only 21% of the time. The investigators concluded that PTNS was not cost-effective for treating OAB compared to tolterodine ER. However, in clinical practice, PTNS is usually employed for patients who failed pharmacotherapy.

A multi-site randomized, controlled trial, the Anticholinergic versus Botulinum Toxin, Comparison Trial for the Treatment of Bothersome Urge Urinary Incontinence (ABC) is being conducted in the US and includes a within-trial cost-effectiveness analysis (85). This trial compares the change in UUI episodes over 6 months, tolerability and cost effectiveness between women receiving daily anticholinergic therapy plus a single intra-detrusor injection of saline versus a single intra-detrusor injection of 100 U of Botulinum toxin A plus daily oral placebo tablets. They will collect primary data on direct and indirect costs and utilities (using the OAB-Q and SF-12) to estimate QALY and calculate ICER. This type of CEA, that uses primary data and current economic analysis methodology, has the potential to improve our understanding of new therapies and better guide patient care and resource allocation.

Data were inconsistent on the cost compared to cost saving of treating UUI/OAB with medication. A cross-sectional study using data from an internet-based questionnaire of a nationwide sample of 75,000 adults (US National Health and Wellness Survey) evaluated the impact of treating urge and mixed UI on healthcare resource utilization, productivity, activity impairment and associated costs (86). UUI/MUI respondents were categorized as OAB treatment users or non-treatment users (who never used treatment and whose condition reportedly interfered with life activities or was difficult to manage). Outcome measures included healthcare utilization and Work Productivity and Activity Impairment questionnaire-based scores. Direct and indirect costs were estimated using labour and medical expenditure data sources (\$2008). Treatment (vs. non-treatment)

users were more likely to be female (81% vs. 70%), older (mean = 63 vs. 53) and reporting more moderate-to-severe OAB (71% vs. 53%; all $p < 0.05$). Adjusting for covariates, treatment users had significantly lower activity impairment, more provider visits and higher total direct costs (\$27,291 vs. \$21,493) per year. Thus, treatment for UUI/MUI may help with symptom management and lessen activity impairment but has higher costs compared to never users.

A case-control study with case defined as diagnosis of OAB, ≥ 1 UI episode per day and prescribed anticholinergic therapy and control as no OAB matched in a 1:3 ratio based on sex, age, and observation time, used retrospective medical and pharmacy claims data to analyse patient comorbidities, as well as track health care resource utilization (HRU) and direct payer costs (\$2013) (87). OAB was significantly

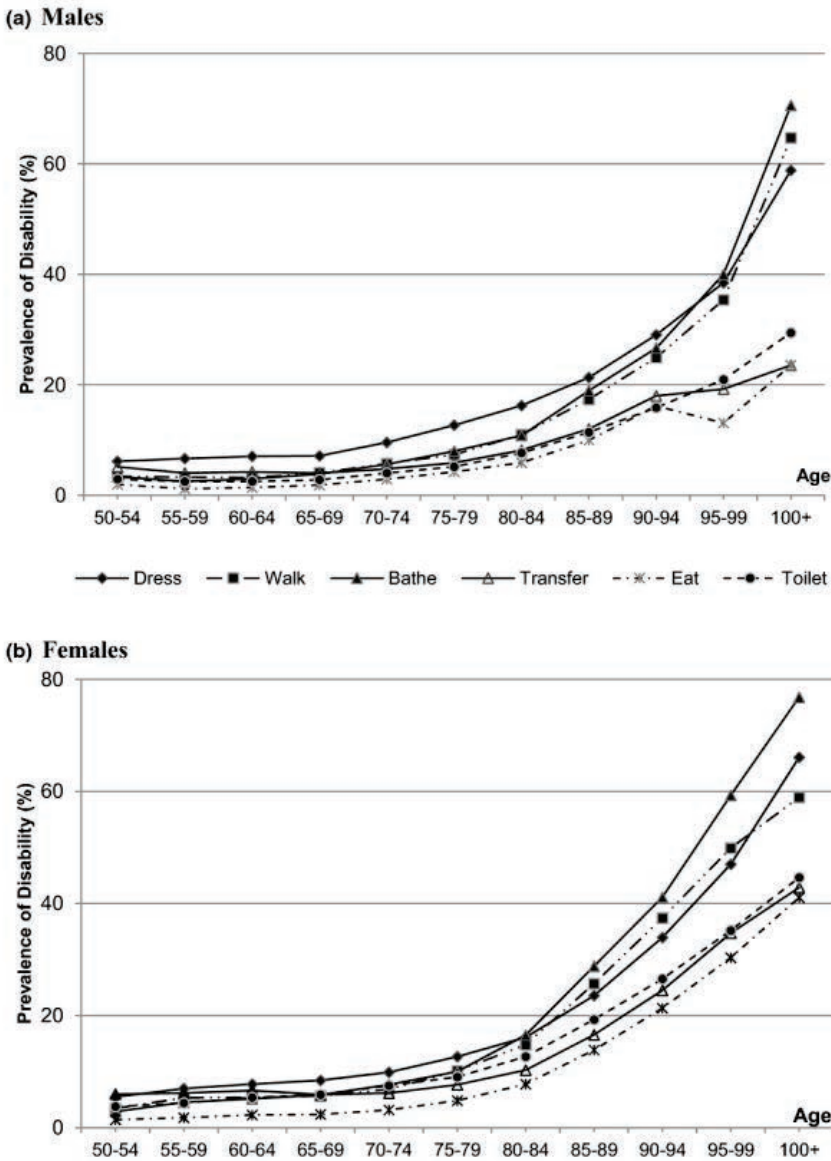

Note: $N = 18,801$.

Proportions of Males and Females with Each of the Six ADL Disability Types by Age Group (a) Males; (b) Females

Figure 7

associated with increased HRU rates of hospital admissions, outpatient visits, prescriptions filled, and diagnostic tests performed. After adjustment for covariates, total health care cost was 33% higher for OAB cases than non-OAB controls, resulting in an increased cost of \$2,821 per year. OAB patients who initiate anticholinergic therapy use significantly more health care resources than patients without OAB.

In contrast, a third study performed by a pharmaceutical company concluded that OAB treatment was cost-saving compared to no OAB pharmacotherapy in vulnerable elderly OAB patients. Costs of treating OAB with fesoterodine compared to no OAB pharmacotherapy from the US payer perspective was assessed using a decision analytic cost model (88). Vulnerable elderly OAB patients were defined as age ≥ 65 years with 2-15 UUI episodes/day and at risk of deteriorating health by a score of ≥ 3 on the Vulnerable Elders Survey (VES)-13. Fesoterodine treatment response was defined as no UUI episodes over 1 year. OAB-related costs included OAB drug costs, healthcare resource use (inpatient hospitalization, outpatient visits, and physician office visits), and OAB-related co-morbidities (falls/fractures, urinary tract infections, depression, and nursing home admissions; \$2013). Treating OAB patients could save \$1616 per patient vs. no OAB pharmacotherapy. In univariate sensitivity, results were most sensitive to changes in fesoterodine efficacy followed by annual costs of inpatient hospitalization. Some of the reasons for this conflicting finding may be that the analysis did not include cognitive impairment, assumed a low prevalence of UUI (13.5%), used a high probability treatment response (51% no UI episodes at week 12).

OAB medication adherence may be an important factor in decreasing absenteeism. A retrospective claims database of 27 large US employers was used to evaluate employee urinary antispasmodic (UA) medication persistence and adherence, the impact of salary and co-payments on adherence, and the impact of UA adherence on medical, pharmacy, sick leave, short- and long-term disability, workers' compensation costs, work absence days, and turnover (89). Persistence (days until first ≥ 30 -day gap in UA medication supply) and adherence were assessed controlling for demographics, job-related factors, co-payments, and pre-index employee benefit utilization. Increased co-payments and co-payments as a percentage of salary were associated with lower adherence. Employees with $\geq 80\%$ adherence had lower medical, sick leave, and short-term disability and higher overall drug costs than employees with less than 80% adherence, although the effects could be related to an omitted variable. Thus, there is some weak evidence to suggest a potential economic benefit to employers from increased UA adherence.

A retrospective study of 3094 actively working patients initiating first treatment with antimuscarinics (fesoterodine, solifenacin or tolterodine) from 31 pri-

mary care centres was done in Spain (90). The comparison of fesoterodine versus solifenacin and tolterodine showed a higher adherence (medication possession ratio; 90% vs. 87% and 86%, respectively), higher treatment persistence (40% vs. 35% and 34%), fewer days of sick leave (5 vs. 10 and 9 days) and costs corrected for covariates (€371 vs. €703 and €683 in €2014; all $p < 0.05$). While it is not clear how sick leave and productivity were assessed, the results suggest that initiating treatment with fesoterodine to treat OAB (compared with solifenacin or tolterodine) had fewer days of sick leave, resulting in lower costs due to lost productivity.

5. INCONTINENCE COSTS RELATED TO NURSING HOMES

The economics of incontinence and nursing homes focus on two separate, but related issues: 1) the cost of nursing home admissions attributable to incontinence, and 2) the cost of treating incontinence that develops while in the nursing home.

Additional nursing home admissions cost is often a major component in the total cost of urinary incontinence. In a 2001 study (15) the cost estimate was \$2.4 billion in 1995 dollars. In a 2004 study (14), the cost estimate was \$4.0 billion in 2000 dollars. In a 2006 study (91), the attributable fraction (AF) statistics from published data was shown to be \$6.0 billion in 2004 dollars. The Attributable Fraction (AF) statistics are obtained by using incontinence prevalence rates for those admitted to nursing homes, as compared to those who were not admitted to nursing homes. The research supporting the AF statistics is not consistent. While Thom et al. (92) found a relationship between UI and nursing home admission, more recent studies have found otherwise. Holroyd-Leduc et al. (93) conducted a population-based prospective cohort study (from 1993-1995) in over 6,500 elderly ($>age70$) patients. After adjusting for confounders, UI was not an independent predictor for death, nursing home admission, or functional decline.

A recent, noteworthy study by Fong et al. (94) found that additional limitations on activities of daily living were associated with nursing home admission. There was a noticeable increase in nursing home admissions after 3 ADLs. Interestingly, bathing was the most critical factor (not toileting). While toileting/ incontinence has a role in nursing home admissions, it is less important than bathing (see Figure 7). Economic models may have overstated this attributable fraction and more conservative cost estimates are now warranted.

Once a person is admitted to a nursing home, labour costs are a major component of caring for incontinent patients. These costs are studied via time/motion observation, correlated with severity and type of incontinence. In 49 long-term care facilities in North Carolina, US, it was found that the incremental labour

costs (per shift) were \$3.31 for patients with occasional UI and \$5.61 for patients with frequent UI (95), in keeping with Morris et al. (12). Bliss et al. (96) addressed the cost/effectiveness of incontinence-related treatment of skin condition in 16 US nursing homes. Four regiments of different moisture barriers were applied. Time and motion measurements included skin products and time spent. Using acrylate barrier film spray achieved cost savings of between \$854 to \$1,862 per resident, with better skin protection than the use of an ointment or cream.

In summary, NH must manage patients with incontinence, resulting in an additional cost. While this is clear, less clear is whether incontinence is a risk factor for NH admission. Most recent research would suggest that this link is tenuous at best.

6. PROLAPSE TREATMENTS, COST IMPLICATIONS

Pelvic organ prolapse (POP) is prevalent, with 3-6% of middle-aged and older women reporting symptomatic and/or bothersome POP (97, 98). Surgeries for POP are also common, with the lifetime cumulative risk POP surgery was 12.6% (95% CI 12.4-12.7) by age 80 years in the US. The age-specific annual risk for POP increases progressively until ages 71 and 73 years when the annual risk is estimated as 4.3 per 1,000 women (99). The annual economic costs of pelvic organ prolapse surgeries are significant and are expected to grow over the coming decades because of our aging population. In the previous chapter, we reported the annual treatment cost of surgery for POP in the U.S. was over \$1 billion in 1997 US\$ (\$1.012 billion; 95% CI .775-1.251 billion) (100). The annual treatment costs of operations for pelvic organ prolapse are substantial and similar to other surgical interventions for women (breast cancer, gynecologic cancer, urinary incontinence).

Several newer surgical approaches for POP have become commonly used in the past 5 years, including laparoscopic sacrocolpopexy, robotic sacrocolpopexy, and vaginal mesh. These new modalities may include very costly capital investment in equipment (such as robotic systems), use expensive disposable instruments, use costly mesh kit products, take longer operative time, and/or be associated with adverse events and future procedures. They may also be associated with shorter hospital stay and more rapid recovery. Therefore, cost-effectiveness is well suited for these modalities and there have been several economic analyses in the past 5 years.

Similar to other surgical procedures, costs for prolapse surgery are largely driven by length of stay (LOS) and less affected by operative time and equipment. A single site study with one surgeon described costs, operative times, and LOS for 91 open and 73 robotic consecutive sacrocolpopexies (101). Direct costs were determined with their hospital procurement database and robot costs and maintenance

were included. Median operative times for open and robotic approaches were 166 and 212 minutes ($P < 0.001$), respectively, and length of stay was 3 versus 2 days ($P < 0.001$). The median cost for the open and robotic procedures was \$7,804 and \$6,668 ($P = 0.002$), respectively. Thus robotic sacrocolpopexy takes slightly longer to perform but costs less than the open procedure in total due to higher LOS costs.

A retrospective cross-sectional and longitudinal study from the 2001 to 2011 US National Inpatient Sample included women undergoing inpatient prolapse repairs (102). In multivariate analyses, African Americans had 9% (95% CI 5%,13%) longer LOS compared with Caucasians and the uninsured had 15% (95% CI, 1%,30%) longer LOS compared with those privately insured. Comorbidities associated with 20% increase in LOS and costs were congestive heart failure, pulmonary circulation disorders, metastatic cancer, weight loss, coagulopathy, electrolyte/fluid imbalance, and blood loss/deficiency anaemia ($P < 0.001$). Over the 10 years of the study, mean LOS declined from 2.4 days (95% CI: 2.4, 2.5) to 1.8 days (95% CI: 1.7,1.9; $P < 0.001$), yet mean total cost increased from \$6233 (95% CI: \$5859, \$6607) to \$9035 (95% CI: \$8632, \$9438; $P < 0.001$). Paradoxically, inpatient surgical costs for prolapse increased despite decreasing LOS. With the study design, the reason for this finding could not be elucidated.

Two cost-minimization studies compared robot-assisted vs. open sacrocolpopexy(103) and laparoscopic sacral colpopexy (LSC) vs. total vaginal mesh (104) In the first study, direct costs over 30 days from the hospital perspective at a single site in the US were included (103) Operative time was similar for robotic and open surgery (226 versus 221 minutes, respectively) but postoperative LOS was less for robotic vs. open (1.0 versus 3.3 days, $p < 0.001$). This studied observed 10% cost savings for robot-assisted versus open sacrocolpopexy (\$10,178 versus \$11,307), with the largest drivers of cost identified as the number of institutional robotic cases done annually, LOS and cost per hospitalization day in the postoperative period. The second study used primary cost data from a randomized trial of LSC versus TVM and included prices from privately- and publicly-conducted procedures in Australia and women's opportunity cost of time from the societal perspective (104). In this trial, there were no differences in outcomes at 2 years on two POP QOL measures, suggesting that cost-minimization analysis may be an appropriate study design. Mean total economic costs were significantly lower in the laparoscopic group compared with total vaginal mesh (\$4013; 95% CI, 3108, 4918; similar for public and private models). Labour costs were significantly greater for laparoscopic but were offset by lower consumable, inpatient, opportunity, and reoperation costs compared with total vaginal mesh. Therefore, laparoscopic sacrocolpopexy has lower economic cost than total vaginal mesh.

A meta-analysis and systematic review (105, 106) nicely summarized several CEAs comparing robot-

assisted to laparoscopic sacrocolpopexy. Overall, the studies show that robot-assisted was costlier than laparoscopic with similar clinical outcomes. The first study included studies that directly compared the outcomes of robot-assisted and laparoscopic with a sample size in each group more than 15, and the follow-up duration longer than 3 months (105). Seven studies (4 retrospective, 2 randomized clinical trials, 1 prospective study) with data on 264 robot-assisted and 267 laparoscopic procedures were included. The mean operative time was longer in the robot-assisted group (246 vs 206 minutes; $P < 0.001$) and the estimated blood loss, incidence of intraoperative/postoperative complications and in the two groups were not statistically different. The costs of robot-assisted were significantly higher than laparoscopic in each of three studies ($P < 0.01$ for all). Thus, the clinical outcomes of prolapse surgery were similar with robot-assisted and laparoscopic, but robot-assisted was more costly.

A systematic review included only randomized controlled trials (2 trials, $n = 156$) comparing laparoscopic and robot-assisted sacrocolpopexy (heterogeneity between the two studies precluded a meta-analysis) (106). In one trial (Paraiso), laparoscopic was faster than robot-assisted sacrocolpopexy (199 ± 46 vs. 265 ± 50 min; $p < .001$) (107), yet no difference was found in the second trial (ACCESS; 225 ± 62.3 vs. 246.5 ± 51.3 min; $p = .11$) (108). Costs for using the robot were significantly higher in both studies, however, in the ACCESS trial, only when purchase and maintenance of the robot was included (laparoscopic \$11,573 \pm 3191 vs. robot-assisted \$19,616 \pm 3135; $p < .001$). In the Paraiso study, robot-assisted was more expensive even without considering those costs (laparoscopic US\$ 14,342 \pm 2941 vs. robot-assisted 16,278 \pm 3326; $p = 0.008$). Both studies observed longer operating time and higher pain scores through 1 month in the robotic groups. There were no differences in anatomical outcomes, pelvic floor function, or quality of life. In these small, randomized studies, robotic surgery significantly increased cost compared to the conventional laparoscopic sacrocolpopexy with no improvement in outcome.

For the surgical correction of apical prolapse, the abdominal approach is associated with better outcomes; however, it is more expensive than the transvaginal approach. A decision-analytic model was developed to assess the cost-effectiveness of abdominal sacral colpopexy (ASC) vs. sacrospinous ligament fixation (SSLF) to determine if the improved outcomes of ASC justify the increased expense (109). The model included post-operative SUI with possible mid-urethral sling placement, prolapse recurrence with possible re-operation, and post-operative dyspareunia. Cost-effectiveness was defined as an ICER of less than \$50,000 per QALY. At the baseline, ASC is more expensive than SSLF (\$13,988 vs \$11,950; \$2013) and more effective (QALY 1.53 vs 1.45) with an ICER of \$24,574/QALY at 2 years. ASC was not cost-effective if the rate of post-operative

stress incontinence was above 36% after ASC or below 28% after SSLF, the rate of recurrent prolapse was above 15% after ASC or below 4% after SSLF, or the rate of post-operative dyspareunia was above 59% after ASC or below 19% after SSLF. In this study, abdominal sacral colpopexy was a cost-effective alternative compared with sacrospinous ligament fixation. Of note, is that SSLF can be considered a cost-effective alternative as the post-operative outcomes of SSLF improve.

To assess the cost-effectiveness of a mesh-augmented anterior vaginal wall repair compared with a non-mesh fascial plication repair, Jacklin and Duckett (110) used a 5-year timeframe from the UK national Health Service perspective (£2008-9) with data derived from systematic reviews and recent publications, and utilities assumed to be similar to those for urinary incontinence. In the base case, the ICER for mesh-augmented anterior repairs was £15 million per QALY. Sensitivity analysis found no plausible model inputs that could make a mesh repair cost-effective by conventional criteria because of the extra costs associated with the price of the mesh, treating mesh erosion and low difference in reoperation rate for mesh anterior wall repairs.

A few studies explored pre-operative evaluation or prophylactic procedures with prolapse repair surgery. Richardson et al. (111) used decision analysis modelling to compare the cost-effectiveness of mid urethral sling to prevent occult stress urinary incontinence in women undergoing abdominal sacrocolpopexy. They evaluated 3 treatment approaches (1) abdominal sacrocolpopexy alone with deferred option for mid urethral sling, 2) abdominal sacrocolpopexy with concomitant mid urethral sling and 3) preoperative urodynamic study for selective mid urethral sling) over 1-year (\$2010 US Medicare reimbursement). Utilities were from general HRQOL in population-based studies, but assumed a large impact of SUI (0.71 compared to 0.93 with no SUI) that may have biased the analysis toward the sling intervention. They found that universally performing mid urethral sling at abdominal sacrocolpopexy was the most cost-effective approach compared to abdominal sacrocolpopexy alone (ICER \$2,867 per QALY). Universal mid urethral sling dominated the preoperative urodynamic study strategy (less costly and more effective). The cost-effectiveness of abdominal sacrocolpopexy plus mid urethral sling was robust to sensitivity analysis with a cost-effectiveness ratio consistently below \$20,000 per QALY. This study concluded that universal concomitant mid urethral sling is the most cost-effective prophylaxis strategy for occult stress urinary incontinence in women undergoing abdominal sacrocolpopexy and preoperative urodynamic study is not cost-effective.

A retrospective study of mid-urethral sling at a single site assessed the value of preoperative assessment (electrocardiogram, chest x-ray, basic metabolic panel, complete blood count, coagulation studies and

urinalysis) in 101 women (112). They evaluated appropriateness of tests based on guidelines from the American Academy of Family Physicians and additional costs of inappropriate tests (\$2014 US Medicare reimbursement). Overall 76% of coagulation profiles, 73% of complete blood counts, 47% of basic metabolic panels, 39% of chest x-rays and 21% of electrocardiograms ordered did not have an appropriate clinical indication, with 6-22% under-ordering of appropriate tests. The estimated total from overused tests was \$18 per patient. At this site, preoperative testing was both over- and under-used in women undergoing sling surgery leading to increased health care costs.

Two studies examined endometrial evaluation prior to prolapse surgery (113). A decision analytic model was used to compare the cost-effectiveness of endometrial biopsy, transvaginal ultrasound and no screening for endometrial cancer in asymptomatic, postmenopausal women prior to uterine morcellation in minimally invasive supracervical hysterectomy and sacral colpopexy for pelvic organ prolapse treatment. The cost per-patient was \$8800, \$9023, and \$9112 over 5 years for no screening, endometrial biopsy, and transvaginal ultrasound, respectively (\$2012 US dollars) with 0.39 and 0.38 days of life saved for endometrial biopsy and transvaginal ultrasound, respectively, compared to no screening. The ICER was \$207,348 for endometrial biopsy (dominated transvaginal ultrasound) compared with no screening. The analysis was robust to sensitivity analyses. Another decision analysis evaluated the cost-utility of preoperative endometrial evaluation before Le Fort colpopexy in asymptomatic women (\$2012 US Medicare costs) (114). From a health plan perspective and willingness-to-pay thresholds of \$50,000 and \$100,000, no evaluation was superior to both biopsy and ultrasound. At a 64% probability of cancer, biopsy is more cost-effective than no evaluation and ultrasound. Thus, pre-operative screening for endometrial cancer is likely not cost effective in asymptomatic, postmenopausal women.

Thus, by standard thresholds, abdominal sacral colpopexy (ASC) may be cost-effective compared to sacrospinous ligament fixation (SSLF) and performing a mid-urethral sling with ASC may be cost-effective compared to ASC alone. Mesh-augmented anterior vaginal wall repair was not cost-effective compared with a non-mesh fascial plication repair and pre-operative screening for endometrial cancer before prolapse surgery is likely not cost effective in asymptomatic, postmenopausal women.

7. ECONOMIC CONSEQUENCES OF FAECAL INCONTINENCE

7.1. Cost of Illness

Faecal incontinence is a debilitating condition associated with significant impairment in quality of life. Even minor symptoms can lead to deterioration in general

health, physical functioning, and emotional well-being. Social isolation can occur for fear of having accidents, leading to a loss of productivity and ability to perform activities of daily living (115, 116). The costs associated with treating faecal incontinence vary based on the population studied. For instance, the non-surgical costs of managing faecal incontinence is higher in nursing home residents when compared to the adult working population although in the latter group, lost productivity, may account for a greater proportion of total costs (117). There is significant variation in costs (across countries and providers) making it difficult to extrapolate the results of cost-effectiveness studies to a local health care system.

Early studies assessing the cost of faecal incontinence focused on inpatients with faecal incontinence (118), patients with self-reported faecal incontinence (119), and patients with obstetric injury(120). All of these studies collected data retrospectively from databases and lacked a validated measure of severity.

Deutekom et al. (116) collected prospective data from 253 Dutch patients with faecal incontinence to assess the direct medical and non-medical costs of treatment from a societal perspective. Severity of incontinence was measured using the St Mark's continence score but QALYs were obtained and therefore the relationship between cost, severity and quality of life was not explored. However, the study did produce novel data on the proportion of absenteeism, productivity loss and need for paid and unpaid care for patients with faecal incontinence, from the perspective of a Netherlands population. Lost productivity occurred in 15.4% of patients who worked, with absenteeism due to symptoms of incontinence occurring in 1.7%. The cost of non-surgical treatment was estimated to be €2169 per patient per year. Costs associated with lost productivity were found to account for more than half the total costs associated with the management of faecal incontinence.

In 2012, Xu et al. (121) performed a patient survey to collect self-reported data regarding the sociodemographic characteristics, clinical symptoms and utilization of medical and non-medical resources for faecal incontinence. Patients were identified from outpatient records at a single tertiary care centre and mailed questionnaires. The results therefore relate to a self-selected cohort of patients that may have had more severe symptoms of faecal incontinence than compared to the general population. Unit costs were based on US Medicare reimbursement rates, national average medication cost and estimates from other relevant sources (e.g.. continence pad cost). Analysis included medical and non-medical costs and lost productivity. The analysis was conducted from a societal perspective. The mean cost per person for the conservative management of faecal incontinence was \$4110 per year (median \$1594; IQR \$517-5164). Medical costs accounted for \$2353 per year (median \$1176; IQR \$294-2438), non-medical cost \$209 per year (median \$75; IQR \$17-\$262) and lost-productivity cost \$1549 per year (median 0\$; IQR \$0-\$813).

There was a correlation between the severity of faecal incontinence and medical costs.

7.2. Prevention

Surgery for anal fistulae often results in damage to the anal sphincters and subsequent impairment of continence. The clinical outcomes of two sphincter-preserving treatments, anal fistula plug and endo-anal advancement flap, was studied by Adamina et al. in 2010 (122). The primary end point was fistula healing, defined by absence of need for further drainage, abscess formation and an external fistula opening on physical examination at six-months follow-up. Only patients with anal fistula of cryptoglandular origin were studied.

A micro-costing analysis of treatment costs was performed with adjustments for inflation and sensitivity analysis were performed. Non-medical costs and lost productivity costs were not assessed. The primary end point, healed fistula, was found to be lower than in the majority of published studies on the two techniques adopted. As cost-effectiveness was based on healing and complication rates, with no direct measurement of faecal incontinence the cost-effectiveness for adopting each surgical strategy to prevent episodes of FI remains unclear. The study concluded adopting a strategy of anal fistula use saved \$1,588 per healed fistula.

Tan et al. (123) studied the cost-effectiveness of primary sphincter repair versus delayed sphincter repair for anal sphincter injury, in the prevention of faecal incontinence. Clinical data were identified from a literature review of studies published between 1976 and 2006 that described at least one of the measured outcomes (probability of functional success/failure and quality of life). A decision tree analysis over a ten-year horizon was constructed with QALYs derived from the SF-6D (23). The study concluded that primary sphincter repair was the most cost-effective strategy being associated with a gain of 5.72 QALYs for a cost of £2750 compared with delayed sphincter repair, which yielded a QALY gain of 3.73 for a cost of £2667.

Langill et al. (124) conducted an industry-sponsored study to examine the costs of managing faecal incontinence using a faecal management system (Flexiseal, Convatec, USA) compared with traditional methods (absorbable pads, cleansers etc.) in the intensive care unit. The use of a faecal management system was associated with lower daily material costs, nursing time for managing faecal incontinence, and annual cost savings when compared to patients managed traditionally. A further study by Pittman et al. (125) also reported saving medical costs from the use of a bowel management system when compared to traditional care with greater clinician satisfaction with the device.

7.3. Treatment

Recent cost-effectiveness analyses have primarily focused on sacral nerve stimulation (SNS) as a first-line surgical treatment for patients with faecal incontinence.

7.3.1 SNS Versus Conservative Treatments

Dudding et al. (126) assessed the cost-effectiveness of SNS versus maximal conservative treatment from a societal perspective over a seven-year time horizon. Data collected prospectively on consecutive patients undergoing two-stage SNS, under general anaesthetic, at a single UK institution, over a ten-year period were entered into a Markov decision model. Clinical effectiveness was measured by reductions of incontinence episodes measured by repeat bowel habit diaries. Medical and lost productivity costs were estimated using the UK national tariff and health resource group (HRG) codes and data previously published by Deutekom and colleagues (116). No data on caregiver costs were collected. Cost effectiveness was measured as ICER with the QALY calculation derived from the SF-6D (127). Sensitivity analysis was performed to assess robustness of the model and rates were discounted by 3.5%. The ICER for SNS was £25,070 per QALY gained. This equates to £1038 more per year to treat patients with SNS for a median reduction in 286 incontinent episodes (£3.63 per episode reduced). However, this calculation was based on a self-selected group of patients undergoing SNS that had all failed to benefit from conservative treatment. The ICER of £25,070 per QALY gained was within the £30,000 per QALY threshold recommended by the UK National Institute of Clinical Excellence as an effective use of UK NHS funding with proper justification. When lost-productivity costs were also considered the ICER decreased to £12,959 per QALY gained. The cost-effectiveness of SNS is likely to deteriorate over a longer time-horizon due to battery depletion and the need to remove and re-implant a new pulse generator.

Brosa et al. (128) assessed the clinical and cost effectiveness of sacral nerve stimulation versus maximum conservative treatment from a hospital perspective. Only patients with an intact anal sphincter, including those that had previous repair, were included. All procedures were performed under local anaesthetic. Despite a high failure rate of peripheral nerve evaluation, in patients with an anatomically intact anal sphincter, SNS appeared cost effective when compared with maximal conservative treatments. SNS had a cost of €16,181 per QALY gained; for those with a deficient sphincter, SNS cost €22,195 per QALY gained. Both ICERs were within the €30,000 threshold accepted in Spain. The greatest cost associated with SNS was related to the high upfront cost of the permanent device. The authors proposed that the cost-effectiveness of SNS is improved by performing the procedure under local anaesthetic. While the results are largely consistent with Dudding's work (126), this study has some limitation worth noting.

Costs were evaluated over a five-year time horizon, but future costs were not discounted. In addition, a detailed description of the Markov model used was not provided and it is unclear how the QALY values were determined. Finally, there was potential conflict of interest as two of the authors worked for Medtronic (device manufacturer for 'InterStim' sacral neuromodulation equipment), and "four authors received an unrestricted grant from Medtronic".

The relationship between the Markov model developed in the above paper by Brosa et al. (128), and a patient cohort study published by a similar group of authors (129) also from Spain in the same year, is unclear. In the paper from Munoz-Duyos et al. (129) only patients with an intact anal sphincter, including those that had previous anal sphincter repair, were included. Patient-level cost data were given for 57 temporary evaluations all performed under local anaesthetic in 47 patients, giving a success rate of 61%. This success rate is lower than most published studies of sacral nerve stimulation. Permanent SNS devices were implanted in 29 patients, who were followed for a median of 3 years. The study was reported on an intention to treat basis over a five-year time horizon. Only treatment costs were evaluated. The actual Markov model was not provided. Costs were not discounted. No sensitivity analysis was performed. It is unclear how the QALY were determined, as no QALY tests were administered, and data arising from calculating QALYs from SF36 were quoted as being derived from the paper by Brosa et al. (128). Thus it appears that this report from Munoz-Duyos was perhaps related to or overlapped with the Brosa paper (128, 129).

Mitchell et al. (130) performed a cohort analysis of age and sex matched patients undergoing temporary single electrode helical wire placement under general (GA) and local anaesthesia (LA). Although not statistically significant, a greater proportion of patients had success in the GA group (77% versus 64%). Sample size was limited (n=111), limiting the precision of the estimated result. A £130 cost saving was found with the local anaesthetic procedure (general anaesthetic £743 versus local anaesthetic £613). However, as this cost was not correlated with clinical effectiveness the conclusion of the study, that temporary wire insertion under local anaesthetic is more cost effective is unjustifiable.

Dudding and Nugent (131) compared the use of a permanent quadripolar electrode for temporary testing as part of a staged implant versus the helical wire electrode as part of a two-stage procedure. Estimates of top-down cost, clinical outcome and complication rate related to temporary, staged and permanent sacral nerve stimulation was calculated using published data from multiple sources. These data were then used to formulate a basic decision analysis model. It was concluded that on an intention-to-treat basis, by adopting a staged implant strategy, a saving of £27.78 per patient can be made over a two-stage procedure.

7.3.2 SNS Versus Other Treatments for Faecal Incontinence

Three recent studies have assessed the cost-effectiveness of sacral nerve stimulation in comparison with other surgical treatments. First, Indinnimeo et al. (132) used a decision analysis model to compare a surgical treatment pathway for faecal incontinence with and without sacral nerve stimulation. Data were obtained from published studies and from "expert" panel consensus. Readers should note that one of the authors worked for Medtronic Italia and that some data on SNS were taken from a review in which the majority of patients were implanted using an open surgical rather than percutaneous technique. Treatment success was defined as the cessation of the patient to seek further treatment due to a satisfactory reduction of incontinent episodes with the therapy. Cost-effectiveness was based on medical costs, discounted by 3% over a five-year time-horizon. Sensitivity analyses were performed to assess robustness of the model. The cost of test sacral nerve stimulation was disproportionately high (€6,430) in relation to the alternative therapies and calculations based on this rate may not be applicable in other health systems. The ICER was €28,285 for those with sphincter defects and €38,662 those with intact sphincters which the authors cite as being within the €40,000 acceptability threshold of the Italian NHS. Multiple flaws in the model, however, lead to uncertainty in the validity of these estimations. First, treatment success was based on published outcome at 6-month follow-up and it was assumed that loss in efficacy over time for each treatment was equal. Second, it was also assumed that all patients with a structurally deficient anal sphincter, defined as damage up to 120 degrees in radial extent affecting the partial or full length of the internal and/or external anal sphincter, should undergo sphincter repair. Pre-operative sphincter function was not considered. In practice, only patients with full-length defects and adequate residual muscle bulk and function would be considered for repair. Those with partial length defects or isolated internal anal sphincter defects are not usually considered for sphincteroplasty. Importantly, indications for sphincter repair or dynamic graciloplasty are end-stage faecal incontinence in the presence of a substantial muscular and / or neural defect of the anal sphincter. The assumption of the model that all patients, including those with an intact anal sphincter, would undergo dynamic graciloplasty or artificial bowel sphincter, sometimes as a first-line treatment is unrealistic and does not reflect current clinical practice. Finally, the use of sacral nerve stimulation is likely underestimated with the total number of patients being treated with SNS calculated as 86 to 115 patients per year over a five year period in a population of 48 million. Colostomy was assumed to achieve 100% continence, however, in practice some patients with weak sphincters remain incontinent of mucus requiring continued pad usage and ongoing distress.

Leroi et al. (133) performed a multi-centre cohort study comparing clinical outcome and cost of sacral

nerve stimulation versus alternative surgical or conservative treatments for faecal and dual incontinence. Alternative treatments were only considered once a trial of temporary sacral nerve stimulation had failed. Clinical efficacy was measured by prospective collection of continence scores over a two-year time-horizon. There was a considerable drop-out rate in data collection over time with only 26 of 60 implanted patients with faecal incontinence achieving two-year follow-up. There was also high loss to follow-up in the non-implanted groups (47%). Medical and non-medical costs were calculated by a top-down method from the French National Rate 2004/2005 and prospective collection of individual patient data from the initial medical consultation. Whilst the method states that lost-productivity costs were also calculated it is unclear on how this was achieved and whether they were included in the analysis. QALYs were derived from SF-6D (127). Costs were not discounted but a sensitivity analysis was performed. The median cost of treatment in those patients undergoing SNS was €14,973 over two-years compared to a median cost of €9648 in those patients undergoing alternative treatments. SNS was found to offer a marked health benefit but not found to be cost effective with an ICER of €90,082 per patient year of >50% improved continence. The cost per QALY was not estimated. The complicated design of this study, lack of clear description of the cost-effectiveness parameters, short time horizon and high loss to follow-up leads to questionable validity of the results. In addition, the St Mark's continence score was used to assess clinical effectiveness and this tool may not be sensitive enough to detect all changes in health state. Alternative treatments were only considered once a patient had failed a trial of SNS. However, nearly one-half of patients undergoing "alternative treatment" continued with conservative measures or had no treatment, with resultant significant bias of cost reduction toward the non-implanted group. In addition, the complication rate associated with SNS implantation was higher than most other published studies with pain experienced in 78% of patients and an infection rate of 9%.

Van Wunnik et al. (134) examined the cost-effectiveness of adding sacral nerve stimulation into the surgical treatment pathway of those patients undergoing neosphincter procedures for faecal incontinence. A Markov-type model was developed that compared two groups of patients, all of whom were assumed to have failed optimal conservative treatment. In the first group protocol, SNM-, patients underwent either dynamic graciloplasty (DG; 50%) or insertion of an artificial bowel sphincter (ABS; 50%). In the second group protocol, SNM+, the majority of patients underwent sacral nerve stimulation as the first-line surgical treatment with remainder undergoing either dynamic graciloplasty (10%) or insertion of an artificial bowel sphincter (10%). Modelling for treatment success and failure and revisional surgery was performed with failures in the sacral nerve stimulation group (before or after revisional surgery) progressing to the next treatment line of dynamic graciloplasty, colostomy or no

further treatment (faecal incontinence with no colostomy and occasional colonic irrigation). No modelling of SNS to ABS was performed. For those patients undergoing a first-line neosphincter procedure the next treatment line was colostomy or no further treatment. The complex model was run for five-cycles allowing the proportion of the cohort in each health state to be obtained and associated with a cost and utility score for each strategy. Medical costs were based on a random subset of 25 patients per treatment method collected from a local prospective faecal incontinence database using prices for 2009 and indexing for 2010. QALY assessment was derived from the EQ-5D questionnaire (135). Extensive sensitivity analysis was performed.

The strategy of adopting SNS prior to consideration of ABS and DG (SNM+) was found to be more cost-effective than the strategy of progressing direct to a neosphincter procedure without considering neurostimulation (SNM-). Dominance was seen both in terms of clinical effectiveness and lower cost). The cost per QALY also favoured the use of sacral nerve stimulation with the SNM+ group yielding a cost per QALY of €3912 versus €5471 in the SNM- group. In terms of QALYs, the SNM+ and SNM- groups were comparable, perhaps reflecting the fact that the model placed some patients of the SNM+ group direct to a neo-sphincter procedure, and that in all treatment pathways the devices used have significant initial costs (an implantable pulse generator for SNS and DG and an implantable sphincter device for ABS). Despite this, the use of SNS was justified in the treatment pathway for patients with faecal incontinence being more effective than DG and ABS for lower costs, mainly related to fewer short and long-term complications.

Until 2013 there was insufficient evidence to recommend the use of injectable bulking agents in routine clinical practice. However recent evidence regarding the medium-term outcomes of newer bulking agents have led to the inclusion as a comparative treatment option in cost-effective analyses (136-138). Likewise, the use of percutaneous tibial nerve stimulation for the treatment of faecal incontinence has increased in recent years based on reported evidence from a number of small case series. When compared to sacral nerve stimulation, the medical costs of percutaneous tibial nerve stimulation are cheaper (£5916 (\$9465) versus £19320 (\$30924)) when measured over a ten-year horizon (139). However, in the absence of cost-effectiveness analysis the relevance of these relative savings is unclear. The publication of a recent multi-centre, double-blinded, randomized trial that reported no significant clinical benefit of percutaneous tibial nerve stimulation for faecal incontinence when compared to sham therapy puts further doubt on the clinical effectiveness of percutaneous tibial nerve stimulation (140).

In 2014, Bernstein et al. (141) published a cost-effectiveness study comparing Non-Animal Stabilized Hyaluronic acid and Dextranomer Co-polymer (NASHA-

Dx), sacral nerve stimulation and conservative measures in the treatment of faecal incontinence. A Markov model was constructed based on outcomes obtained from the published literature, expert opinion and a survey of practicing physicians (undertaken at the 23rd International Colorectal Disease Symposium, Fort Lauderdale, Florida, 2012). This information was deemed to reflect US practice at the time of the study.

Options for the analysis were to continue to receive conservative treatments, undergo NASHA-Dx or undergo SNS over a three-year time horizon with no cross-over between treatment groups. Costs were considered from the perspective of the US health care payer and based on patient self-reported data derived from the single institution study previously published by Xu et al. (121). Discounting was 3% per annum. Lost productivity costs were not included. Behavioural therapy, in the form of biofeedback, was included as a downstream treatment option for those who had failed to benefit from the primary treatment. Measured end points included incontinence free days and QALYs. Results demonstrated that SNS was superior to NASHA-Dx and conservative treatment with the greatest number of incontinence free-days (515 vs 268 vs 129 days respectively). However, SNS was deemed to be not cost-effective due to an ICER of \$103,066 per QALY gained when compared to conservative treatment and of \$244,509 per QALY gained when compared to NASHA-Dx. NASHA-Dx was shown to be cost-effective with an ICER of \$37,036 per QALY gained when compared with conservative treatments. Budget impact analysis concluded that NASHA-Dx was significantly less expensive to the health care system than SNS for patients who are candidates for either treatment.

The study was based on costs from the US health care system, which has higher direct costs when compared to health systems from other countries. Recent meta-analysis has questioned the benefit of biofeedback in the management of faecal incontinence (142) and therefore the addition of this therapy to the treatment pathway of those patients who had failed primary therapy may not represent current or future clinical practice. In addition to this, the analysis was based on a three-year time horizon and thus favoured the NASHA-Dx strategy. Of the five published studies used to determine clinical effectiveness for NASHA-Dx, two reported on the same group of patients with short-term and three-year follow-up. The other studies only reported median-term follow-up (one study 24-month follow-up and two studies 12-month follow-up).

In the study with longest term follow-up published by Mellgren et al. (138), 112 of 136 patients who had undergone NASHA-Dx were followed up at 36 months. Ninety seven (87%) of these patients had undergone greater than two injections of NASHA-Dx. It is not clear whether the requirement for multiple injections was factored into the cost analysis by Bernstein et al., although not all patients require multiple injections. Studies reporting the outcomes from treatment with

alternative injectable bulking agents have demonstrated that alternative injectable agents lose efficacy in the long-term (143) and therefore NASHA-Dx may be found to be less cost-effective when considered over a longer time horizon, especially if further treatments are required.

In late 2015, Pochopien et al. (144) reported on a patient-level simulation model comparing two sub-populations, differentiated by the presence or absence of a surgically repairable sphincter defect. Medtronic sponsored the study and authors included Medtronic employees and members of an independent consultancy group. The isolated, sequential and summative clinical and economic effects of sacral nerve stimulation against alternative treatments of anal sphincteroplasty, NASHA/Dx and percutaneous tibial nerve stimulation were modelled with a lifetime horizon from the perspective of the UK National Health service. Clinical effectiveness, resource consumption and effect of treatment on quality of life were obtained from a systematic literature review with direct medical costs derived from the 2015/16 UK National tariff and National Institute of Clinical Excellence costing report 2007. Extensive sensitivity analyses and discounting at 3.5% for cost and outcome were included.

Sacral nerve stimulation was found to be cost-effective when considered as part of a sequence of interventions for treating faecal incontinence. The analysis supported the use of SNS in patients with an intact sphincter who have failed to gain sufficient benefit from NASHA/Dx. A strategy of NASHA/Dx followed by SNS was found to be more cost-effective than percutaneous tibial nerve stimulation followed by SNS in patients with no sphincter damage, generating savings of £2,522 per patient and 0.011 additional QALYs. In patients with anal sphincter disruption amenable to sphincteroplasty, anal sphincter repair followed by SNS was found to be more cost effectiveness than anal sphincter repair alone. This strategy generated an additional 0.209 QALYs with an ICER of £13,482 per QALY gained. In almost all comparisons incremental cost-utility ratio for SNS was within the £30,000 per QALY threshold recommended by NICE as an effective use of UK National Health Service resources.

IV. SUMMARY AND FUTURE RESEARCH PRIORITIES

In the years since the last ICI, some high-quality economic analyses have been published. One driver for these studies is the requirement for CEA data from NICE along with detailed critiques. This is pushing for greater standardization among trials as well as higher overall quality.

There were some new papers comparing onabotulinumtoxinA and sacral nerve stimulation. There were also a number of new papers related to OAB medical treatment, including new models published to support

the approval of mirabegron in the US (2012) and the EU/UK (2013).

The Committee notes that evidence regarding cost effectiveness of outpatient therapies for stress incontinence remains limited, aside from the recent economic study of obesity treatment for this condition. However, the economic analysis of therapy for overactive bladder syndrome requires greater effort, to encompass longer time frames and wider use of QALYs that can yield cost utility analysis (CEA). The Committee was disappointed to find that most of the recent economic studies of anticholinergic therapy did not include collection of raw QALY data.

In the last 4 years, the implementation of Sacral Nerve Stimulation for refractory detrusor overactivity has been the subject of several economic analyses, which are indeed important. However, the Committee reiterates the need to collect primary data for QALY outcomes in future studies of this technique.

In the field of prolapse, it is not yet known whether any currently available QALYs are sensitive to treatment benefit, so that CEA may still not be feasible in this area. The recent POPPY study is to be commended for including patient-level cost data and quality of life information about conservative treatment (145).

As regards faecal incontinence, it is encouraging to see economic analyses of Sacral Nerve Stimulation. However, more data about long-term cost effectiveness in faecal incontinence are urgently needed.

As regards methodology, researchers need to consider carefully how they construct the model parameters for Decision Tree Analysis and Markov Models, so that “real life” assumptions are made. The gold standard remains Cost Effectiveness Analysis in parallel with Randomized Controlled Trials, and we urge all clinicians to consider cost and QALYs as important outcome measures.

Finally, the committee encourages researchers to provide information on the uncertainty around an ICER. A solitary ICER is hard to interpret, much like an odds-ratio without a confidence interval.

ness impact profile, or utilities and urinary incontinence, overactive bladder, faecal incontinence, anal incontinence, uterine prolapse or pelvic organ prolapse. The initial searches were reviewed to identify articles appropriate for more detailed evaluation. Inclusion criteria were: urinary or faecal incontinence or prolapse as primary disease, data on costs available. Studies were excluded when they were a review or case-report.

APPENDIX – SEARCH STRATEGIES

We performed a comprehensive computerized medical literature search (PubMed) for the years 2007-June 2016 to identify all economic, health-related quality of life and cost-effectiveness analyses published on urinary incontinence, faecal incontinence or pelvic organ prolapse. Our initial search strategy was very broad and meant to be very sensitive but not specific. We performed a search for the following Medical Subject Headings (MeSH) and keywords: cost-effectiveness analysis, health care costs, quality-adjusted life years, costs and cost analysis, sick-

REFERENCES

1. OECD. Life expectancy at birth (indica-tor). doi: 10.1787/27e0fc9d-en 2016
2. Wagner TH, Subak LL. Talking about in-conti-nence: the first step toward prevention and treatment. *JAMA*. 2010;303(21):2184-5.
3. Darkow T, Fontes CL, Williamson TE, Darkow T, Fontes CL, Williamson TE. Costs asso-ciated with the management of overactive blad-der and related comorbidities. *Pharmacother-apy: The Journal of Human Pharmacology & Drug Therapy*. 2005;25(4):511-9.
4. Wagner TH, Hu TW, Bentkover J, LeBlanc K, Stewart W, Corey R, et al. Health-related conse-quences of overactive bladder. *Ameri-can Journal of Managed Care*. 2002;8(19 Suppl):S598-607.
5. Kanavos P, Reinhardt U. Reference pric-ing for drugs: is it compatible with U.S. health care? *Health Aff*. 2003;22(3):16-30.
6. Sung VW, Rogers ML, Myers DL, Akbari HM, Clark MA. National trends and costs of surgi-cal treatment for female fecal incontinence. *Am J Obstet Gynecol*. 2007;197(6):e1-5.
7. Shwartz M, Young DW, Siegrist R. The ratio of costs to charges: how good a basis for estimat-ing costs? *Inquiry*. 1995;32(4):476-81.
8. Wagner TH, Chen S, Barnett PG, Wagner TH, Chen S, Barnett PG. Using average cost meth-ods to estimate encounter-level costs for medi-cal-surgical stays in the VA. *Medical Care Re-search & Review*. 2003;60(3 Suppl):15S-36S.
9. Barnett PG. Research without billing data. *Econometric estimation of patient-specific costs*. *Medical Care*. 1997;35(6):553-63.
10. Jacobs P, Roos NP. Standard cost lists for healthcare in Canada. *Issues in validity and inter-provincial consolidation*. *Pharmacoeconom-ics*. 1999;15(6):551-60.
11. Gold MR, Siegel JE, Russell LB, Wein-stein MC, editors. *Cost-Effectiveness in Health and Medicine*. Oxford: Oxford University Press; 1996.
12. Morris AR, Ho MT, Lapsley H, Walsh J, Gonski P, Moore KH, et al. Costs of managing uri-nary and faecal incontinence in a sub-acute care fa-cility: a "bottom-up" approach. *Neurourology & Urodynamics*. 2005;24(1):56-62.
13. Drummond MF, O'Brien B, Stoddart GL, Tor-rance GW. *Methods for the economic evalua-tion of health care programmes*. Second ed. Ox-ford: Oxford University Press; 1997.
14. Hu TW, Wagner TH, Bentkover JD, Le-blanc K, Zhou SZ, Hunt T, et al. Costs of urinary incon-tinence and overactive bladder in the United States: a comparative study. *Urology*. 2004;63(3):461-5.
15. Wilson L, Brown JS, Shin GP, Luc KO, Subak LL. Annual direct cost of urinary inconti-nence. *Obstetrics & Gynecology*. 2001;98(3):398-406.
16. Monz B, Hampel C, Porkess S, Wagg A, Pons ME, Samsioe G, et al. A description of health care provision and access to treatment for women with urinary incontinence in Europe -- a five-country comparison. *Maturitas*. 2005;52 Suppl 2:S3-12.
17. Krahn M, Gafni A. Discounting in the economic evaluation of health care interventions. *Medical Care*. 1993;31(5):403-18.
18. Ganiats TG, Carson RT, Hamm RM, Can-tor SB, Sumner W, Spann SJ, et al. Population-based time preferences for future health out-comes. *Medical Decision Making*. 2000;20(3):263-70.
19. Olsen JA. On what basis should health be dis-counted? *Journal of Health Economics*. 1993;12(1):39-53.
20. Adang EM, Engel GL, Rutten FF, Geerdes BP, Baeten CG. Cost-effectiveness of dynamic graciloplasty in patients with fecal incontinence. *Diseases of the Colon & Rectum*. 1998;41(6):725-33; discussion 33-4.
21. Johannesson M, O'Conor RM, Kobelt-Nguyen G, Mattiasson A. Willingness to pay for reduced incontinence symptoms. *Br J Urol*. 1997;80(4):557-62.
22. Wagner TH, Patrick DL, Bavendam TG, Martin ML, Buesching DP. Quality of life of persons with urinary incontinence: development of a new measure. *Urology*. 1996;47(1):67-71; dis-cussion -2.
23. Brazier J, Roberts J, Deverill M. The esti-mation of a preference-based measure of health from the SF-36. *J Health Econ*. 2002;21(2):271-92.
24. Kay S, Tolley K, Colayco D, Khalaf K, An-der-son P, Globe D. Mapping EQ-5D utility scores from the Incontinence Quality of Life Question-naire among patients with neurogenic and idio-pathic overactive bladder. *Value Health*. 2013;16(2):394-402.
25. Desroziers K, Aballea S, Maman K, Nazir J, Odeyemi I, Hakimi Z. Estimating EQ-5D and OAB-5D health state utilities for patients with overactive bladder. *Health Qual Life Outcomes*. 2013;11:200.

26. Torrance G. Measurement of health state utilities for economic appraisal: a review. *Journal of Health Economics*. 1986;5:1-30.
27. Hu TW, Wagner TH, Hawthorne G, Moore KH, Subak L, editors. *Economics of Incontinence*. Plymouth: Health Publication Ltd.; 2005.
28. Sintonen H, Pekurinen M. A fifteen-dimensional measure of health-related quality of life (15D) and its applications. In: Walker S, Rosser R, editors. *Quality of Life Assessment: Key Issues in the 1990s*. Dordrecht: Kluwer Academic Publishers; 1993.
29. Rabin R, de Charro F. EQ-5D: a measure of health status from the EuroQol Group. *Annals of Medicine*. 2001;33(5):337-43.
30. Kaplan R, Anderson J, Gamiats T. the Quality of Well-Being Scale: rationale for a single quality of life index. In: Walker S, Rosser R, editors. *Quality of Life Assessment: Key Issues in the 1990s*. Dordrecht: Kluwer Academic Publishers; 1993.
31. Feeny D, Furlong W, Boyle M, Torrance GW. Multi-attribute health status classification systems. *Health Utilities Index*. *Pharmacoeconomics*. 1995;7(6):490-502.
32. Sintonen H. The 15D instrument of health-related quality of life: properties and applications. *Annals of Medicine*. 2001;33(5):328-36.
33. Vaughan CP, Johnson li TM, Ala-Lipasti MA, Cartwright R, Tammela TLJ, Taari K, et al. The Prevalence of Clinically Meaningful Overactive Bladder: Bother and Quality of Life Results from the Population-Based FINNO Study. *European Urology*. 2011;59(4):629-36.
34. Saarni SI, Härkänen T, Sintonen H, Su-visaari J, Koskinen S, Aromaa A, et al. The Impact of 29 Chronic Conditions on Health-related Quality of Life: A General Population Survey in Finland Using 15D and EQ-5D. *Quality of Life Research*. 2006;15(8):1403-14.
35. Lier D, Ross S, Tang S, Robert M, Jacobs P, for the Calgary Women's Pelvic Health Research G. Trans-obturator tape compared with tension-free vaginal tape in the surgical treatment of stress urinary incontinence: a cost utility analysis. *BJOG: An International Journal of Obstetrics & Gynaecology*. 2011;118(5):550-6.
36. Stach-Lempinen EK, P. Laippala, R. MetsÄrnoja, B. Visual Analogue Scale, Urinary Incontinence Severity Score and 15 DÄ—Psychometric Testing of Three Different Health-related Quality-of-life Instruments for Urinary Incontinent Women. *Scandinavian Journal of Urology and Nephrology*. 2001;35(6):476-83.
37. Hawthorne G, Richardson J, Osborne R. The Assessment of Quality of Life (AQoL) instrument: a psychometric measure of health-related quality of life. *Quality of Life Research*. 1999;8(3):209-24.
38. Rosser R. A health index and output measure. In: Walker S, Rosser R, editors. *Quality of Life Assessment: Key Issues in the 1990s*. Dordrecht: Kluwer Academic Publishers; 1993.
39. Chen G, Tan JT, Ng K, Iezzi A, Richardson J. Mapping of incontinence quality of life (I-QoL) scores to assessment of quality of life 8D (AQoL-8D) utilities in patients with idiopathic over-active bladder. *Health Qual Life Outcomes*. 2014;12:133.
40. Brazier J, Czoski-Murray C, Roberts J, Brown M, Symonds T, Kelleher C. Estimation of a preference-based index from a condition-specific measure: the King's Health Questionnaire. *Med Decis Making*. 2008;28(1):113-26.
41. Yang Y, Brazier J, Tsuchiya A, Coyne K. Estimating a preference-based single index from the Overactive Bladder Questionnaire. *Value Health*. 2009;12(1):159-66.
42. Coyne KS, Matza LS, Thompson CL, Kopp ZS, Khullar V. Determining the importance of change in the overactive bladder questionnaire. *J Urol*. 2006;176(2):627-32; discussion 32.
43. Albo ME, Richter HE, Brubaker L, Norton P, Kraus SR, Zimmern PE, et al. Burch colposuspension versus fascial sling to reduce urinary stress incontinence. *New England Journal of Medicine*. 2007;356(21):2143-55.
44. Fenwick E, Byford S. A guide to cost-effectiveness acceptability curves. *Br J Psychiatry*. 2005;187:106-8.
45. Ramsey SD, Willke RJ, Glick H, Reed SD, Augustovski F, Jonsson B, et al. Cost-effectiveness analysis alongside clinical trials II—An ISPOR Good Research Practices Task Force report. *Value Health*. 2015;18(2):161-72.
46. Humphreys K, Wagner TH, Gage M. If substance use disorder treatment more than offsets its costs, why don't more medical centers want to provide it? A budget impact analysis in the Veterans Health Administration. *J Subst Abuse Treat*. 2011;41(3):243-51.
47. Mauskopf J, Sullivan S, Annemans L. Principles of Good Practice for Budget Impact Analysis: Report of the ISPOR Task Force on Good Research Practices – Budget Impact Analysis. *Value in Health*. 2007;10:336-47.
48. Albers-Heitner CP, Joore MA, Winkens RAG, Lagro-Janssen ALM, Severens JL, Berghmans LCM. Cost-effectiveness of involving nurse specialists for adult patients with urinary

incontinence in primary care compared to care-as-usual: An economic evaluation alongside a pragmatic randomized controlled trial. *Neurourology and Urodynamics*. 2012;31(4):526-34.

49. Arnold EP, Milne DJ, English S. Conservative treatment for incontinence in women in rest home care in Christchurch: Outcomes and cost. *Neurourology and Urodynamics*. 2015:n/a-n/a.
50. Holtzer-Goor KM, Gaultney JG, van Houten P, Wagg AS, Huygens SA, Nielen MMJ, et al. Cost-Effectiveness of Including a Nurse Specialist in the Treatment of Urinary Incontinence in Primary Care in the Netherlands. *PLoS ONE*. 2015;10(10):e0138225.
51. Sjöström M, Umefjord G, Lindholm L, Samuelsson E. Cost-Effectiveness of an Internet-Based Treatment Program for Stress Urinary Incontinence. *Neurourology and Urodynamics*. 2015;34(3):244-50.
52. Vermeulen KM, Visser E, Messelink EJ, Schram AJ, Berger MY, de Bock GH, et al. Cost-effectiveness of a pro-active approach of urinary incontinence in women. *BJOG: An International Journal of Obstetrics & Gynaecology*. 2016:n/a-n/a.
53. Visser E, de Bock GH, Messelink EJ, Schram AJ, Kollen BJ, la Bastide-van Gemert S, et al. Active encouragement of older women with urinary incontinence in primary care to undergo diagnosis and treatment: a matched-pair cluster randomized controlled trial. *Maturitas*. 2015;80(2):212-9.
54. Visser E, Dekker JH, Vermeulen KM, Messelink EJ, Schram AJ, Berger MY, et al. The effect of systematic screening of older women for urinary incontinence on treatment uptake: the URINO trial. *Maturitas*. 2013;74(4):334-40.
55. Subak LL, Pinto AM, Wing RR, Nakagawa S, Kusek JW, Herman WH, et al. Decrease in Urinary Incontinence Management Costs in Women Enrolled in a Clinical Trial of Weight Loss to Treat Urinary Incontinence. *Obstetrics and Gynecology*. 2012;120(2 Pt 1):277-83.
56. Zhang AY, Fu AZ. Cost-effectiveness of a behavioral intervention for persistent urinary incontinence in prostate cancer patients. *Psycho-Oncology*. 2015:n/a-n/a.
57. Boyers D, Kilonzo M, Mostafa A, Abdel-Fattah M. Comparison of an adjustable anchored single-incision mini-sling, Ajust®, with a standard mid-urethral sling, TVT-OTM: a health economic evaluation. *BJU International*. 2013;112(8):1169-77.
58. Sand PK, Owens GM, Black EJ, Anderson LH, Martinson MS. Cost effectiveness of radiofrequency microremodeling for stress urinary incontinence. *International Urogynecology Journal*. 2014;25(4):517-23.
59. Ciftci S, Ozkurkcugil C, Usturner M, Yilmaz H, Yavuz U, Gulecen T. Comparison of transobturator tape surgery using commercial and hand made slings in women with stress urinary incontinence. *Urol J*. 2015;12(2):2090-4.
60. Laudano MA, Seklehner S, Chughtai B, Lee U, Tyagi R, Kavaler E, et al. Cost-effectiveness analysis of tension-free vaginal tape vs burch colposuspension for female stress urinary incontinence in the USA. *BJU International*. 2013;112(2):E151-E8.
61. Feng TS, Perkins CE, Wood LN, Eilber KS, Wang JK, Bresee C, et al. Preoperative Testing for Urethral Sling Surgery for Stress Urinary Incontinence: Overuse, Underuse and Cost Implications. *The Journal of Urology*. 2016;195(1):120-4.
62. Subak LL, Goode PS, Brubaker L, Kusek JW, Schembri M, Lukacz ES, et al. Urinary incontinence management costs are reduced following Burch or sling surgery for stress incontinence. *American Journal of Obstetrics and Gynecology*. 2014;211(2):171.e1-e7.
63. Chermansky CJ, Krilin RM, Winters JC. Selective Management of the Urethra at Time of Pelvic Organ Prolapse Repair: An Assessment of Postoperative Incontinence and Patient Satisfaction. *The Journal of Urology*. 2012;187(6):2144-8.
64. Richardson ML, Elliott CS, Shaw JG, Comiter CV, Chen B, Sokol ER. To Sling or Not To Sling at Time of Abdominal Sacrocolpopexy: A Cost-Effectiveness Analysis. *The Journal of Urology*. 2013;190(4):1306-12.
65. Richardson ML, Sokol ER. A cost-effectiveness analysis of conservative versus surgical management for the initial treatment of stress urinary incontinence. *American Journal of Obstetrics and Gynecology*. 2014;211(5):565.e1-e6.
66. Kunkle C, Hallock J, Hu X, Blomquist J, Thung SW, EF. Cost utility analysis of urethral bulking agents versus midurethral sling in stress urinary incontinence. *Female Pelvic Med Reconstr Surg*. 2015;21(3):154-9.
67. Manca A, Sculpher MJ, Ward K, Hilton P. A cost-utility analysis of tension-free vaginal tape versus colposuspension for primary urodynamic stress incontinence. *BJOG: An International Journal of Obstetrics & Gynaecology*. 2003;110(3):255-62.
68. ElSheemy M, Fathy H, Hussein H, Hussein E, Hassan S. Surgeon-tailored polypropylene mesh as a needleless single-incision sling versus TVT-O for the treatment of female stress

- urinary incontinence: a comparative study. *Int Urol Nephrol*. 2015;47(6):937-44.
69. Bertapelle MP, Vottero M, Popolo GD, Men-carini M, Ostardo E, Spinelli M, et al. Sacral neuromodulation and Botulinum toxin A for re-frac-tory idiopathic overactive bladder: a cost-utility analysis in the perspective of Italian Healthcare System. *World Journal of Urology*. 2015;33(8):1109-17.
 70. Hassouna MM, Sadri H. Economic evalua-tion of sacral neuromodulation in overactive blad-der: A Canadian perspective. *Canadian Urologi-cal Association Journal*. 2015;9(7-8):242-7.
 71. Nikolavsky D, Killinger K, Boura J, Peters K. Comparison of patients undergoing a two-stage sacral nerve stimulation procedure: is there a cost benefit for a single-stage procedure? *International Urology and Nephrology*. 2011;43(4):997-1002.
 72. Kantartzis K, Shepherd J. Cost-effectiveness of test phase implantation strategies for Inter-Stim® sacral neuromodulation. *Female Pelvic Med Reconstr Surg*. 2013;19(6):322-7.
 73. Aboseif SR, Kim DH, Rieder JM, Rhee EY, Menefee SA, Kaswick JR, et al. Sacral Neuro-modu-lation: Cost Considerations and Clinical Benefits. *Urology*. 2007;70(6):1069-73.
 74. Arlandis S, Castro D, Errando C, Fernán-dez E, Jiménez M, González P, et al. Cost-Effective-ness of Sacral Neuromodulation Com-pared to Botulinum Neurotoxin A or Continued Medical Management in Refractory Overactive Bladder. *Value in Health*. 2011;14(2):219-28.
 75. Leong R, de Wachter S, Joore M, van Kerre-broeck P. Cost-effectiveness analysis of sa-cral neuromodulation and botulinum toxin A treat-ment for patients with idiopathic overactive blad-der. *BJU International*. 2011;108(4):558-64.
 76. Claxton K, Martin S, Soares M, Rice N, Spack-man E, Hinde S, et al. Health Technology As-sessment. <http://www.journalsli-brary.nihr.ac.uk/hta>: 2015.
 77. Hart WM, Abrams P, Munro V, Retsa P, Nazir J. Cost-effectiveness analysis of solifenacin versus oxybutynin immediate-release in the treat-ment of patients with overactive bladder in the United Kingdom. *Journal of Medical Econ-omics*. 2013;16(10):1246-54.
 78. Nazir J, Hart WM. The cost-effectiveness of solifenacin vs. trospium in the treatment of pa-tients with overactive bladder in the German Na-tional Health Service. *Journal of Medical Econom-ics*. 2014;17(6):408-14.
 79. Nilsson FO, Linner L, Samuelsson E, Milsom I. Cost-effectiveness analysis of newer anticho-linergic drugs for urinary incontinence vs oxy-butynin and no treatment using data on persis-tence from the Swedish prescribed drug regis-try. *BJU Int*. 2012;110(2):240-6.
 80. Wielage RC, Perk S, Campbell NL, Klein TM, Posta LM, Yuran T, et al. Mirabegron for the treatment of overactive bladder: cost-effective-ness from US commercial health-plan and Medicare Advantage perspectives. *J Med Econ*. 2016:1-9.
 81. Nazir J, Maman K, Neine ME, Briquet B, Odeyemi IA, Hakimi Z, et al. Cost-Effectiveness of Mirabegron Compared with Antimuscarinic Agents for the Treatment of Adults with Over-active Bladder in the United Kingdom. *Value Health*. 2015;18(6):783-90.
 82. Aballea S, Maman K, Thokagevistk K, Nazir J, Odeyemi IA, Hakimi Z, et al. Cost effective-ness of mirabegron compared with tolterodine extended release for the treatment of adults with overactive bladder in the United Kingdom. *Clin Drug Investig*. 2015;35(2):83-93.
 83. Edwards S, Karner C, Trevor N, Barton S, Nherera L. Mirabegron for the treatment of symp-toms associated with overactive bladder. *BMJ Technology Assessment Group*, 2013.
 84. Chen HW, Bercik RS, Werner EF, Thung SF. Cost-effectiveness of percutaneous tibial nerve stimulation versus extended release tolterodine for overactive bladder. *J Urol*. 2012;187(1):178-84.
 85. Visco AG, Brubaker L, Richter HE, Ny-gaard I, Paraiso MF, Menefee SA, et al. Anticholin-ergic versus botulinum toxin A comparison trial for the treatment of bothersome urge urinary inconti-nence: ABC trial. *Contemp Clin Trials*. 2012;33(1):184-96.
 86. Goren A, Zou KH, Gupta S, Chen C. Direct and indirect cost of urge urinary incontinence with and without pharmacotherapy. *Int J Clin Pract*. 2014;68(3):336-48.
 87. Yehoshua A, Chancellor M, Vasavada S, Malone DC, Armstrong EP, Joshi M, et al. Health Resource Utilization and Cost for Pa-tients with Incontinent Overactive Bladder Treated with Anti-cholinergics. *J Manag Care Spec Pharm*. 2016;22(4):406-13.
 88. Qin L, Luo X, Zou KH, Snedecor SJ. Eco-nomic impact of using fesoterodine for the treat-ment of overactive bladder with urge urinary inconti-nence in a vulnerable elderly population in the United States. *J Med Econ*. 2016;19(3):229-35.
 89. Kleinman NL, Odell K, Chen CI, Atkinson A, Zou KH. Persistence and adherence with uri-

- nary antispasmodic medications among employees and the impact of adherence on costs and absenteeism. *J Manag Care Spec Pharm*. 2014;20(10):1047-56.
90. Sicras-Mainar A, Navarro-Artieda R, Ruiz-Torres A, Saez-Zafra M, Coll-de Tuero G. Impact of Loss of Work Productivity in Patients with Over-active Bladder Treated with Antimuscarinics in Spain: Study in Routine Clinical Practice Conditions. *Clin Drug Investig*. 2015;35(12):795-805.
 91. Morrison A, Levy R, Morrison A, Levy R. Fraction of nursing home admissions attributable to urinary incontinence. *Value in Health*. 2006;9(4):272-4.
 92. Thom DH, Haan MN, Van Den Eeden SK. Medically recognized urinary incontinence and risks of hospitalization, nursing home admission and mortality. *Age Ageing*. 1997;26(5):367-74.
 93. Holroyd-Leduc JM, Mehta KM, Covinsky KE, Holroyd-Leduc JM, Mehta KM, Covinsky KE. Urinary incontinence and its association with death, nursing home admission, and functional decline. *Journal of the American Geriatrics Society*. 2004;52(5):712-8.
 94. Fong JH, Mitchell OS, Koh BS. Disaggregating activities of daily living limitations for predicting nursing home admission. *Health Serv Res*. 2015;50(2):560-78.
 95. Shih YC, Hartzema AG, Tolleson-Rinehart S. Labor costs associated with incontinence in long-term care facilities. *Urology*. 2003;62(3):442-6.
 96. Bliss DZ, Zehrer C, Savik K, Smith G, Hedblom E, Bliss DZ, et al. An economic evaluation of four skin damage prevention regimens in nursing home residents with incontinence: economics of skin damage prevention. *Journal of Wound, Ostomy, & Continence Nursing*. 2007;34(2):143-52; discussion 52.
 97. Wu JM, Vaughan CP, Goode PS, Redden DT, Burgio KL, Richter HE, et al. Prevalence and trends of symptomatic pelvic floor disorders in U.S. women. *Obstet Gynecol*. 2014;123(1):141-8.
 98. Rortveit G, Brown JS, Thom DH, Van Den Eeden SK, Creasman JM, Subak LL. Symptomatic pelvic organ prolapse: prevalence and risk factors in a population-based, racially diverse cohort. *Obstet Gynecol*. 2007;109(6):1396-403.
 99. Wu JM, Matthews CA, Conover MM, Pate V, Jonsson Funk M. Lifetime risk of stress urinary incontinence or pelvic organ prolapse surgery. *Obstet Gynecol*. 2014;123(6):1201-6.
 100. Subak LL, Waetjen LE, van den Eeden S, Thom DH, Vittinghoff E, Brown JS. Cost of pelvic organ prolapse surgery in the United States. *Obstet Gynecol*. 2001;98(4):646-51.
 101. Hoyte L, Rabbanifard R, Mezzich J, Bas-saly R, Downes K. Cost analysis of open versus robotic-assisted sacrocolpopexy. *Female Pelvic Med Reconstr Surg*. 2012;18(6):335-9.
 102. Sanses TV, Schiltz NK, Richter HE, Koroukian SM. Trends and Factors Influencing Inpatient Prolapse Surgical Costs and Length of Stay in the United States. *Female Pelvic Med Reconstr Surg*. 2016;22(2):103-10.
 103. Elliott CS, Hsieh MH, Sokol ER, Comiter CV, Payne CK, Chen B. Robot-assisted versus open sacrocolpopexy: a cost-minimization analysis. *J Urol*. 2012;187(2):638-43.
 104. Maher CF, Connelly LB. Cost minimization analysis of laparoscopic sacral colpopexy and total vaginal mesh. *Am J Obstet Gynecol*. 2012;206(5):433 e1-7.
 105. Pan K, Zhang Y, Wang Y, Wang Y, Xu H. A systematic review and meta-analysis of conventional laparoscopic sacrocolpopexy versus robot-assisted laparoscopic sacrocolpopexy. *Int J Gynaecol Obstet*. 2016;132(3):284-91.
 106. Callewaert G, Bosteels J, Housmans S, Verguts J, Van Cleynenbreugel B, Van der Aa F, et al. Laparoscopic versus robotic-assisted sacro-colpopexy for pelvic organ prolapse: a systematic review. *Gynecol Surg*. 2016;13:115-23.
 107. Paraiso MF, Jelovsek JE, Frick A, Chen CC, Barber MD. Laparoscopic compared with robotic sacrocolpopexy for vaginal prolapse: a randomized controlled trial. *Obstet Gynecol*. 2011;118(5):1005-13.
 108. Anger JT, Mueller ER, Tarnay C, Smith B, Stroupe K, Rosenman A, et al. Robotic compared with laparoscopic sacrocolpopexy: a randomized controlled trial. *Obstet Gynecol*. 2014;123(1):5-12.
 109. Ohno MS, Richardson ML, Sokol ER. Abdominal sacral colpopexy versus sacrospinous ligament fixation: a cost-effectiveness analysis. *Int Urogynecol J*. 2016;27(2):233-7.
 110. Jacklin P, Duckett J. A decision-analytic Markov model to compare the cost-utility of anterior repair augmented with synthetic mesh compared with non-mesh repair in women with surgically treated prolapse. *BJOG*. 2013;120(2):217-23.
 111. Richardson ML, Elliott CS, Shaw JG, Comiter CV, Chen B, Sokol ER. To sling or not to sling

- at time of abdominal sacrocolpopexy: a cost-effectiveness analysis. *J Urol.* 2013;190(4):1306-12.
112. Feng TS, Perkins CE, Wood LN, Eilber KS, Wang JK, Bresee C, et al. Preoperative Testing for Urethral Sling Surgery for Stress Urinary Incontinence: Overuse, Underuse and Cost Implications. *J Urol.* 2016;195(1):120-4.
 113. McPencow AM, Erekson EA, Guess MK, Martin DK, Patel DA, Xu X. Cost-effectiveness of endometrial evaluation prior to morcellation in surgical procedures for prolapse. *Am J Obstet Gynecol.* 2013;209(1):22 e1-9.
 114. Kandadai P, Flynn M, Zweizig S, Patterson D. Cost-utility of routine endometrial evaluation before laparoscopic hysterectomy. *Female Pelvic Med Reconstr Surg.* 2014;20(3):168-73.
 115. Damon H, Guye O, Seigneurin A, Long F, Sonko A, Faucheron JL, et al. Prevalence of anal incontinence in adults and impact on quality-of-life. *Gastroenterol Clin Biol.* 2006;30(1):37-43.
 116. Deutekom M, Dobben AC, Dijkgraaf MG, Terra MP, Stoker J, Bossuyt PM. Costs of outpatients with fecal incontinence. *Scand J Gastroenterol.* 2005;40(5):552-8.
 117. Miner PB, Jr. Economic and personal impact of fecal and urinary incontinence. *Gastroenterology.* 2004;126(1 Suppl 1):S8-13.
 118. Morris AR, Ho MT, Lapsley H, Walsh J, Gonski P, Moore KH. Costs of managing urinary and faecal incontinence in a sub-acute care facility: a "bottom-up" approach. *Neurourol Urodyn.* 2005;24(1):56-62.
 119. Dunivan GC, Heymen S, Palsos OS, von Korff M, Turner MJ, Melville JL, et al. Fecal incontinence in primary care: prevalence, diagnosis, and health care utilization. *Am J Obstet Gynecol.* 2010;202(5):493 e1-6.
 120. Mellgren A, Jensen LL, Zetterstrom JP, Wong WD, Hofmeister JH, Lowry AC. Long-term cost of fecal incontinence secondary to obstetric injuries. *Dis Colon Rectum.* 1999;42(7):857-65; discussion 65-7.
 121. Xu X, Menees SB, Zochowski MK, Fenner DE. Economic cost of fecal incontinence. *Dis Colon Rectum.* 2012;55(5):586-98.
 122. Adamina M, Hoch JS, Burnstein MJ. To plug or not to plug: a cost-effectiveness analysis for complex anal fistula. *Surgery.* 147(1):72-8.
 123. Tan EK, Jacovides M, Khullar V, Teoh TG, Fernando RJ, Tekkis PP. A cost-effectiveness analysis of delayed sphincteroplasty for anal sphincter injury. *Colorectal Dis.* 2008;10(7):653-62.
 124. Langill M, Yan S, Kommala D, Michenko M. A budget impact analysis comparing use of a modern fecal management system to traditional fecal management methods in two Canadian hospitals. *Ostomy Wound Manage.* 2012;58(12):25-33.
 125. Pittman J, Beeson T, Terry C, Kessler W, Kirk L. Methods of bowel management in critical care: a randomized controlled trial. *J Wound Ostomy Continence Nurs.* 2012;39(6):633-9.
 126. Dudding TC, Meng Lee E, Faiz O, Pares D, Vaizey CJ, McGuire A, et al. Economic evaluation of sacral nerve stimulation for faecal incontinence. *Br J Surg.* 2008;95(9):1155-63.
 127. Brazier J, Usherwood T, Harper R, Thomas K. Deriving a preference-based single index from the UK SF-36 Health Survey. *J Clin Epidemiol.* 1998;51(11):1115-28.
 128. Brosa M, Munoz-Duyos A, Navarro-Luna A, Rodriguez JM, Serrano D, Gisbert R, et al. Cost-effectiveness analysis of sacral neuromodulation (SNM) with Interstim for fecal incontinence patients in Spain. *Curr Med Res Opin.* 2008;24(3):907-18.
 129. Muñoz-Duyos A, Navarro-Luna A, Brosa M, Pando JA, Sitges-Serra A, Marco-Molina C. Clinical and cost effectiveness of sacral nerve stimulation for faecal incontinence. *British Journal of Surgery.* 2008;95(8):1037-43.
 130. Mitchell PJ, Cattle K, Saravanathan S, Telford KJ, Kiff ES. Insertion under local anaesthetic of temporary electrodes for sacral nerve stimulation testing is reliable and cost effective. *Colorectal Dis.* 13(4):445-8.
 131. Dudding TC, Nugent KP. Staged versus dual procedure sacral nerve stimulation for faecal incontinence: a cost analysis. *Colorectal Dis.* 2009;11(Suppl. 2):26.
 132. Indinnimeo M, Ratto C, Moschella CM, Fiore A, Brosa M, Giardina S. Sacral neuromodulation for the treatment of fecal incontinence: analysis of cost-effectiveness. *Dis Colon Rectum.* 53(12):1661-9.
 133. Leroi AM, Lenne X, Dervaux B, Chartier-Kastler E, Mauroy B, Normand LL, et al. Outcome and cost analysis of sacral nerve modulation for treating urinary and/or fecal incontinence. *Ann Surg.* 253(4):720-32.
 134. van Wunnik BP, Visschers RG, van Asselt AD, Baeten CG. Cost-effectiveness analysis of sacral neuromodulation for faecal incontinence in The Netherlands. *Colorectal Dis.* 2012;14(12):e807-14.
 135. EuroQol G. EuroQol—a new facility for the measurement of health-related quality of life. *Health Policy.* 1990;16(3):199-208.

136. Danielson J, Karlbom U, Wester T, Graf W. Efficacy and quality of life 2 years after treatment for faecal incontinence with injectable bulking agents. *Tech Coloproctol.* 2013;17(4):389-95.
137. La Torre F, de la Portilla F. Long-term efficacy of dextranomer in stabilized hyaluronic acid (NASHA/Dx) for treatment of faecal incontinence. *Colorectal Dis.* 2013;15(5):569-74.
138. Mellgren A, Matzel KE, Pollack J, Hull T, Bernstein M, Graf W, et al. Long-term efficacy of NASHA Dx injection therapy for treatment of faecal incontinence. *Neurogastroenterol Motil.* 2014;26(8):1087-94.
139. Hotouras A, Murphy J, Allison M, Curry A, Williams NS, Knowles CH, et al. Prospective clinical audit of two neuromodulatory treatments for fecal incontinence: sacral nerve stimulation (SNS) and percutaneous tibial nerve stimulation (PTNS). *Surg Today.* 2014;44(11):2124-30.
140. Knowles CH, Horrocks EJ, Bremner SA, Stevens N, Norton C, O'Connell PR, et al. Percutaneous tibial nerve stimulation versus sham electrical stimulation for the treatment of faecal incontinence in adults (CONFIDeNT): a double-blind, multicentre, pragmatic, parallel-group, randomised controlled trial. *Lancet.* 2015;386(10004):1640-8.
141. Bernstein MA, Purdy CH, Becker A, Magar R. Three-year cost-effectiveness model for non-animal stabilized hyaluronic acid and dextranomer copolymer compared with sacral nerve stimulation after conservative therapy for the management of fecal incontinence. *Clin Ther.* 2014;36(6):890-905 e3.
142. Norton C, Cody JD. Biofeedback and/or sphincter exercises for the treatment of faecal incontinence in adults. *Cochrane Database Syst Rev.* 2012(7):CD002111.
143. Vaizey CJ, Kamm MA. Injectable bulking agents for treating faecal incontinence. *Br J Surg.* 2005;92(5):521-7.
144. Pochopien M, Plisko R, Drzal R, Baran M, Sekiewicz B, Dudding T, et al. Cost-Utility Analysis of Sacral Nerve Stimulation for The Treatment of Fecal Incontinence Refractory to Conservative Treatment: Looking for Optimal Treatment Path. *Value Health.* 2015;18(7):A359.
145. Hagen S, Stark D, Glazener C, Dickson S, Barry S, Elders A, et al. Individualised pelvic floor muscle training in women with pelvic organ pro-lapse (POPPY): a multicentre randomised controlled trial. *Lancet.* 2014;383(9919):796-806.

RESEARCH

Chair

L. Brubaker (US)

Members

I. Nygaard (US)

K. Bo (Norway)

Adam P. Klausner, M.D. (US)

R. Cartwright (UK)

T. Bavendam (US)

T. Boone (US)

Consultants

Satoru Takahashi, M.D., Ph.D. (Japan)

CONTENTS

I. INTRODUCTION	2515	17. Pharmacotherapy Trials.....	2531
2. Research Ethics	2515	18. Recommendations for Pharmacotherapy Trials.....	2531
3. Scientific Integrity, Rigor and Reproducibility in Biomedical Research.....	2517	19. Cost Analysis.....	2531
II. RESEARCH AREAS OF INTEREST FOR THIS CONSULTATION	2517	20. Recommendations on Cost Analysis in Incontinence	2532
1. Prevention Research	2518	21. Recommendations for Specific Patient Groups.....	2532
2. Genomics, Proteomics, Transcriptomics, Metabolomics – the “omics” Technologies and Incontinence.....	2518	22. Recommendations for Research in Populations Affected by Neurological Urinary and Faecal Incontinence.....	2536
III. BASIC SCIENCE RESEARCH	2521	23. Recommendations for Research in Populations Affected by Faecal Incontinence	2537
1. Use of Laboratory Animals for Research.....	2521	24. Recommendations for Research in Populations Affected by Bladder Pain Syndrome (Including Interstitial Cystitis)	2538
IV. TRANSLATIONAL RESEARCH (BENCH TO BEDSIDE)	2521	25. Recommendations for Research in Populations Affected by Pelvic Organ Prolapse	2538
V. CLINICAL RESEARCH	2521	26. Recommendations for Research in Children and Adolescents	2538
2. Inclusion and Exclusion Criteria.....	2522	27. Recommendations for Research Improvement in Basic Scientific Research	2539
3. Blinding (masking).....	2522	VI. CONCLUSIONS	2539
4. Randomisation	2523	REFERENCES	2540
5. Participant Safety.....	2523		
6. Analysis	2523		
7. Training and Certification.....	2523		
8. Challenges in Conducting Trials in Developing Countries	2524		
9. Trial registration and Data Sharing.....	2524		
10. Reporting Research Results	2524		
11. Recommendations on Study Conduct and Statistical Methods	2525		
12. Special Concerns for Specific Studies	2525		
13. Recommendations for Conservative Treatment Trials	2529		
14. Experimental Devices and Materials	2529		
15. Surgical Studies	2530		
16. Recommendations for Surgical and Device Trials.....	2530		

RESEARCH

L. BRUBAKER (CHAIR -US),

I. NYGAARD (US), K. BO (NORWAY), ADAM P. KLAUSNER, M.D. (US), R. CARTWRIGHT (UK),

T. BAVENDAM (US) AND T. BOONE (US).

SATORU TAKAHASHI, M.D., PH.D. (JAPAN)

I. INTRODUCTION

The goal of this chapter is to highlight challenges in the research focus in this consultation, as well as to facilitate production of high-impact, high-quality research. This chapter highlights issues related to research concerning prevention, improved aetiological understanding, precise and personalised diagnosis and treatment. In addition, the chapter provides general recommendations for optimal research in areas of interest for this consultation, including progress and research challenges in the field of urinary incontinence. Finally, we present specific recommendations applicable to research for certain types of treatments and certain subgroups patients.

The report endorses consistent use of the methodology and approved terminology that will facilitate research and communication about research in the areas of this consultation. Recognised published guidelines produced by the International Continence Society (ICS) ⁽¹⁻¹⁵⁾ and other major professional societies ⁽¹⁶⁻¹⁸⁾ are useful examples of standardised terminology that advances communication in research.

In general, the Oxford Centre for Evidence-based Medicine Levels of Evidence and Grades of Recommendation (http://www.cebm.net/levels_of_evidence.asp) are not easily applied to research methodology, challenges and priorities. Therefore, the Research Committee of this consultation used the following categories.

- High: Supported by strong evidence (multiple strong publications)
- Medium: Supported by moderate evidence (limited/moderate level publications)
- Low: Expert/Panel opinion.

1.1. Defining the Research Question

Effective engagement in research requires the investigator to carefully define the research question.

The investigator(s) should take a deliberate approach to formulate the specific research question(s), based on a careful review of related clinical research and relevant studies that are well designed and clinically

relevant. The research reviews provided by the Cochrane Incontinence Group (<http://healthsci.otago.ac.nz/dsm/wch/obstetrics/cure>) provide an excellent starting point for most major incontinence topics. Based on a thorough literature review, the investigator can then clearly describe the primary research question(s), summarise the background information, and formulate the rationale, objectives and hypotheses for the study. Once this is clearly laid out, preferably in writing, the research team should then carefully assess whether the research question can be feasibly answered. It is far better to change direction at this point if it seems likely that the sample size cannot be obtained or that the research question cannot be answered with the resources available than it is to waste resources on an unfinished study. Ultimately, the investigator(s) should formulate the simplest study design that will provide the highest quality of evidence to test the given hypothesis in a cost and time-efficient manner. Whenever possible, basic or translational research should occur as part of the clinical research study in order to advance discovering of underlying mechanisms or pathophysiology. This balance between breadth and depth greatly increases the yield of the research effort. ⁽¹⁹⁾

1.2. Delineating Research from Clinical Practice

Although it is beyond the scope of this section to review the rules of conducting human subject research in depth and extensive coverage is available elsewhere ⁽²⁰⁻²⁴⁾, all investigators should understand the difference between “research” and “clinical practice”. Research is defined as “systematic investigation designed to develop or contribute to generalisable knowledge” ⁽²⁵⁾ and participants accept risks to advance scientific knowledge and to benefit others. ⁽²⁶⁾

2. RESEARCH ETHICS

Ethical concerns about the performance of medical research became increasingly important in the 20th Century, highlighted by the atrocities of the Second World War and by several highly publicised studies. One of the most prominent of these was the Tuskegee study of syphilis conducted by the United

States Public Health Service from 1932-1972.⁽²⁷⁾ In this study, the investigators recruited poor, uneducated, African-American share-croppers from the rural south to participate in a long-term study to evaluate the natural history of untreated syphilis. Participants with syphilis were not told about their disease and treatment was withheld long after the development of highly effective antibiotic cures in the 1940s. The study is frequently cited for multiple ethical lapses including the failure to inform patients of their disease, the use of coercive incentives (free health care), and the intentional recruitment of uneducated, often illiterate subjects.

Stanley Milgram, a psychologist at Yale University, authored another important study that helped shape our current ethical approach to research.⁽²⁸⁾ Milgram wanted to understand why people often blindly follow authority even in the face of morally repulsive commands. He set up an experiment in which a subject was told by an authoritative figure (part of the study) to administer shocks at progressively higher levels to individuals concealed behind a screen when they provided incorrect answers to simple memory questions. In the experiment, the individual behind the screen was actually part of the study and no actual shocks were administered. However, the subject (administering shocks) did not know this. In the end, 65% of the subjects were persuaded to administer potentially lethal shocks, even when presented with feedback of anguishing screams and simulated unconsciousness. The study has been cited so frequently, not because it answered important questions about human nature in the face of authority, but because of the unintended emotional effects on subjects, of whom many experienced long-lasting psychological trauma.

One of the greatest steps forward in modern history of research ethics came about through the publication of the 1979 Belmont Report on "Ethical Principles and Guidelines for the Protection of Human Subjects of Research".⁽²⁹⁾ These principles, including Respect for Persons, Beneficence, and Justice, are essential for ethical research and are briefly reviewed as follows:

- **Respect for Persons** recognises the voluntary nature of research participation and includes informed consent without undue influence.
- **Beneficence** requires investigators to maximise benefits and reduce risks to the subject. The primary concern of the investigator should be the safety of the research participant and careful consideration of the risk/benefit ratio; this includes an ongoing responsibility to monitor research and medical literature as the research proceeds. The investigator needs to critically consider within the expert medical community if there is clinical equipoise for the proposed interventions in their trial. Is one treatment no better than another? Are the research risks reasonable in relation to anticipated benefits? It is the responsibility of the investigator to ensure risks are

minimized and potential benefits enhanced as well as that the knowledge gained outweighs the risks.⁽³⁰⁾ Of note, invalid research cannot be ethical no matter how favourable the risk–benefit ratio for study participants.

- **Justice** requires that the benefits and risks be distributed fairly and not focus on individuals with limited access to health care, prisoners, or those with cognitive impairments. Justice is of particular concern in Phase I testing of pharmaceutical agents and in early investigation of surgical devices/implants. Payment offered for participation in such drug trials may be extremely attractive, and even coercive, to poor and disenfranchised subjects. Early device studies may target countries with lax regulatory environments, even if there is little intent to market the device in the country in which testing occurs.

At a minimum, an ethical research study should meet the following criteria:

- the study should well planned, scientifically sound with clearly defined aims;
- clinical research should be prospectively registered whenever possible;
- the study should be feasible with a realistic chance for completion;
- there should be a reasonable assumption that new knowledge will be provided at the end of the study; and
- there should be an expectation that the results will be published to advance scientific knowledge.^(20,30)

Ethical Approval: An appropriate ethical board, such as an Institutional Review Board (IRB) must approved human subject research protocols; however, IRB approval should only be regarded as a minimal ethical standard for research. Ultimately it is responsibility of the investigator to ensure the research is ethically acceptable, and the investigator must take responsibility for all aspects of the research, ensuring that the work is done rigorously and with the highest integrity.⁽³¹⁾ In the process of IRB approval, submitted research protocols are peer-reviewed by a multidisciplinary team that may include members of the scientific community, clinicians, pharmacists, the public/patient groups, the legal profession, and individuals who can provide an ethical perspective. Each member of this team reviews the protocol from their particular perspective in order to provide the most comprehensive safeguarding of subject health and well-being.

Informed Research Consent: Informed consent is an ethical cornerstone of human subject research. Informed research consent must contain three elements: 1) it must be voluntary, 2) it must provide a full disclosure of relevant information including risks, benefits, and alternatives, and 3) it must be presented to an individual or surrogate who has clear decision-

making capacity. Ethically, informed consent is based on the principle of autonomy in that the patient is given full authority to make a medical decision about his or her own body. The informed consent document should be written using terms that are meaningful to potential participants.^(32,33)

Specific requirements for informed consent vary depending on institutional regulations as well as the type of study and its inherent risk. However, some general requirements include name of the investigators and contact numbers and a detailed description of any planned intervention and known side effects. The document should include a statement that the individual may decline participation with no subsequent consequence to any ongoing medical care and whether or not remuneration is provided. Additionally, there should be a statement about payment for medical care required during the course of the study if there is an adverse event associated with the intervention. When relevant, the document should include a lay description of randomisation n understanding that the patient will be randomly assigned to treatment.^(32,33)

Required Disclosures and Conflicts of Interest: Investigators who are involved in development and/or testing drugs or devices developed by industry have the obligation to disclose relationships with industry and financial disclosures related to supplemental personal income. It is acceptable for investigators to receive contracted financial support to perform research and a principled partnership between industry and investigators has known benefits.⁽³⁴⁾ Financial conflict of interest policies have been developed due to ethical concerns about potential biases that may influence trial design, conduct, over interpretation of positive results or not publishing negative results.^(31,35) It is strongly preferred that investigators engaged in research with industry sponsors have a research contract and/or receive funds through or through an appropriate entity with research oversight capabilities. Disclosure and transparency of these relationships help maintain scientific integrity and preserve public trust in the scientific process.⁽³⁴⁾ An investigator's institution may have additional disclosure requirements for conflicts of interest (including, but not limited to, conflicts in finances or conflicts of commitment); investigators must be aware of all relevant regulations affecting their research. This is a rapidly evolving area and investigators are encouraged to clearly understand and disclose such relationships. Online resources with detailed regulatory requirements are available through multiple research sponsors; a sample is included from the U.S. National Institutes of Health.⁽³⁶⁾

Resolving ethical dilemmas: When available, ethics committees from hospital and/or institutional entities may be helpful to address challenging ethical dilemmas in research. The primary investigator maintains the sole responsibility to maintain the highest ethical standards for all aspect of research conducted under his or her name. When resolving an ethical research

dilemma, it may be helpful to consider this pragmatic, simple test: *"Imagine what you are preparing to do will be reported the next day on the front page of your local newspaper. If you are comfortable having colleagues, friends, and family know what you did, chances are you acted in an ethically responsible manner"*.

3. SCIENTIFIC INTEGRITY, RIGOR AND REPRODUCIBILITY IN BIOMEDICAL RESEARCH

In order to address and emphasise the issues of rigor and reproducibility in biomedical research, the U.S National Institutes of Health (NIH) convened a joint workshop in 2014 in collaboration with the Nature Publishing Group and Science.⁽³⁷⁾ Invitees to the workshop were journal editors from the top 30 journals that most frequently published work from NIH-funded investigators. The group was able to produce detailed guidelines on areas from statistical analysis, transparency in reporting, data and material sharing, and consideration of refutations. The group also addressed the need to establish best practice guidelines from several key research techniques that are highly subject to bias, mistakes, and shortcomings. These areas include image-based data (i.e. immunohistochemistry or western blots) which can be manipulated or post-processed using commercially available image processing software and biological materials which must be described with adequate detail necessary for unique identification (i.e. antibodies, cell lines, and animals).

II. RESEARCH AREAS OF INTEREST FOR THIS CONSULTATION

Over the years, there have been efforts to document the broader impact of urinary incontinence – beyond episodes of incontinence recorded on diaries or measuring the amount of urine on a pad after a prescribed set of provocative manoeuvres. Multiple measurement tools were developed to determine quality of life impact, bother and family impact of urinary incontinence. Some studies were on incontinence without distinction of type of incontinence while some studies were limited to SUI or UUI and some included SUI, UUI and mixed UI.

Despite evidence showing associations of UI with obesity, diabetes, cardiovascular conditions, depression and musculoskeletal conditions, research in the evaluation and treatment of UI more narrowly focused on UI as a "quality of life" condition. UI is an important medical condition with tremendous quality of life impact for the person and family members. A narrow "quality of life" focus may be limiting. An expanded

approach should policies that impact research dollars and programmes/policies that could lead to improved continence care. For example, UI is clearly associated with decreased physical activity. Recommendations for all priority health conditions include increasing or maintaining physical activity. UI may be a preventable and treatable barrier to maintaining and increasing physical activity and thus should be on the treatment algorithm for prevention and treatment of obesity, DM, cardiovascular disease, falls and fractures.

An expanded research focus should start with inclusion of UI (and other LUTS) questions in prevention and treatment studies for the priority medical conditions. A research priority must be to assess the effect of UI on prevention or treatment of priority conditions in addition, an expanded research agenda should identify and address UI proactively in order to improve the outcomes of the priority medical conditions. Thus, collaborative, multi- and inter-disciplinary research must occur; researchers in urinary incontinence must work with researchers focused on other key areas, including obesity, DM, cardiovascular and falls and fracture researchers.

Our expanded research focus should also include improved personalisation of prevention and treatments. It is possible that current treatment options would meet most people's needs if our research broadened our perspective about causes and contributing factors to UI. Research that provides a framework for systematically addressing all of the modifiable factors to individualise therapy for each patient, taking into account the patient's community setting, beliefs, values, preferences and cognitive abilities. A particular treatment may be more effective if it were delivered in a context or method that worked better for that individual patient. For example, we have extensive experience with RCT for all forms of incontinence treatment and understand the degree of efficacy in a study population. However, there is limited experience in trying to understand why persons are responders and non-responders to the intervention. There may be significant contribution of factors unrelated to the lower urinary tract/pelvic floor to treatment outcome that, if understood, could lead to better tailoring of treatment regimens.

While most current UI treatments involve some degree of behaviour change which is instituted and maintained by self-care or self-management, treatment plans are generally implemented in a "protocol-driven", "one size fits" all manner. Research to understand phenotypes that predict treatment response may result in better treatment outcomes.

1. PREVENTION RESEARCH

Research in prevention of urinary incontinence has been limited. The reasons for this are multifactorial and include the magnitude of the research needs to

expand our understanding of the mechanisms underlying urinary incontinence to facilitate improved treatment options; a more complete understanding of risk factors for UI, the lack of a lifespan perspective from childhood through adolescence, adulthood, middle age and older and the lack of understanding of what represents a healthy bladder and biological, behavioural and interpersonal and environmental factors that contribute to bladder health. There is not clear consensus on the basic definition and performance parameters for a healthy bladder.⁽³⁸⁾

It is possible to have UI in spite of having healthy bladder habits and behaviours with continence in spite of what might be predicted to be unhealthy bladder habits. Even attempting to define a continent population at baseline is challenging. For example, would someone who experienced isolated episodes of childhood giggle incontinence with extreme laughing or stress incontinence with a sudden sneeze on a full bladder as a young adult be considered continent for primary prevention studies? In 2015, the National Institutes of Health launched the Prevention of Lower Urinary Tract Symptoms (PLUS) Research Consortium to begin to provide the foundational evidence to support future prevention intervention studies.⁽³⁹⁾

Experiences and beliefs shaped by caring for individuals with incontinence may unduly influence expectations for quality, high-impact prevention research. For example, although success with and adherence to programmes for weight loss and pelvic floor muscle exercise programmes are limited, this does not mean that such efforts would not be effective prevention efforts.

2. GENOMICS, PROTEOMICS, TRANSCRIPTOMICS, METABOLOMICS – THE “OMICS” TECHNOLOGIES AND INCONTINENCE

The awkward term “omics” refers to several technologies that attempt to measure the totality of biological molecules of a class at once, across a whole cell, or tissue. “Omics” studies have the potential for comprehensive assessment of a biological system, and the integration of “omics” technologies is known as systems biology. The earliest true “omics” studies were in genomics, the measurement of all common genetic variation, and proteomics, the measurement of expression of all proteins. The use of the “omics” suffix has now been expanded to include all kinds of biological molecules and subtypes of molecules, but the most common additional applications include transcriptomics, the measurement of total gene expression, and metabolomics, the measurement of all metabolites. These technologies share remarkable promise in leading us towards personalised and tai-

lored therapies, but the misapplication of these technologies also reveals a number of shared pitfalls. Here we review each of the major technologies briefly, and then consider how they can or should be applied to the study of incontinence.

2.1. Genomics

Of the “omics” technologies, arguably the most mature is the genome wide association study or GWAS. GWAS has revolutionised the study of the genetics of common diseases. In a GWAS hundreds of thousands of variants, distributed across the entire genome, are genotyped to find genetic regions or loci associated with a trait. The first successful GWAS, identified a single susceptibility locus for macular degeneration⁽⁴⁰⁾, but since that time the field has grown to include hundreds of new primary studies per year, and thousands of associated publications (Figure 1). The exemplar conditions, amenable to a GWAS approach, are those studied in the landmark Wellcome Trust Case Control Consortium study⁽⁴¹⁾ (type 1 diabetes, type 2 diabetes, coronary heart disease, hypertension, bipolar disorder, rheumatoid arthritis, Crohn’s disease). Like incontinence, these conditions are all both common, and complex, with a combination of genetic, environmental, and lifestyle risk factors.

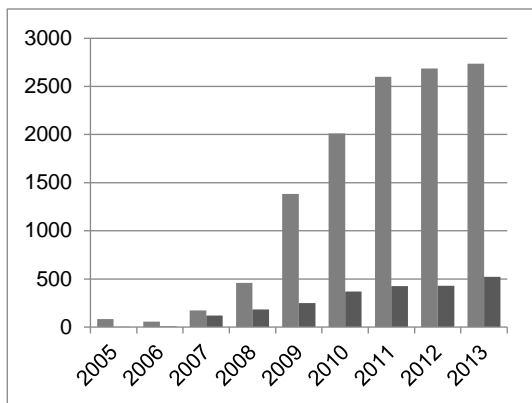

Figure 1 Publications indexed in Scopus* (light bars), and NHGRI catalogued GWAS (dark bars) January 2005-December 2013**

*Scopus records indexed with terms “Genome wide association study” or “Genome-wide association study”, available at <http://www.scopus.com>

** National Human Genome Research Institute (NHGRI) database available at <http://www.genome.gov>

The combination of multiple aetiological factors underlying complex diseases has tended to complicate the discovery of risk variants for these conditions. The ‘common disease common variant’ (CDCV) hypothesis suggests that common variants will explain most of the genetic susceptibility for common diseases. As the Human Genome Project was being completed, the original formulation of this hypothesis suggested that genetic susceptibility would be explained by just

a few common variants with moderate effect sizes.^(42,43) However, we now know that for the majority of common diseases, the common susceptibility variants, at least as identified using GWAS, have typically small ($0.7 > \text{Odds Ratio} < 1.3$) or very small effect sizes ($0.85 > \text{Odds Ratio} < 1.15$).^(44,45) Despite inclusion of more than 150,000 individuals in the largest obesity GWAS consortium, a large majority of current identified statistically significant risk SNPs for obesity, are associated with OR of only 1.01-1.15. For most common diseases, rather than being just a few common variants responsible for genetic susceptibility, there may be hundreds each with tiny and interacting effects, many of which will always remain out of reach of detection by conventional GWAS.

Despite the successful discoveries made using GWAS, the whole field has attracted criticism, perhaps because expectations for GWAS in the early 2000’s were not met.^(46,47) A first major limitation is that a GWAS cannot fully explain the observed heritability of complex conditions.⁽⁴⁵⁾ The classic example is height, a condition with 80% heritability, and less than 10% of phenotypic variance is accounted for by known variants.⁽⁴⁶⁾ The missing heritability problem may arise from overestimation of formal heritability in twin studies, or from failure to detect signals from multitude of rare or common risk variants with small effects, or from a number of other epigenetic or epistatic effects. Regardless, even with large sample sizes GWAS is currently not able to uncover the full genetic architecture of a condition.

The second major limitation is that GWAS has had very mixed success at identifying causal variants.⁽⁴⁷⁾ Many SNPs identified in GWAS are intergenic, but even identification of genic SNPs may not directly help to uncover the underlying biology. As the causal variants altering a gene’s expression, or a protein’s structure are unlikely to be directly genotyped, one approach is to densely genotype or sequence a GWAS identified risk locus, in a process called fine mapping.⁽⁴⁸⁾

While some new genetic risk loci have recently been identified for incontinence in conference abstracts, the only published GWAS for incontinence to date, with a modest sample size by the standards of the field, did not identify any replicated risk loci.⁽⁴⁹⁾ This situation is likely to change as the size of incontinence GWAS consortia grows.

2.2. Transcriptomics

The original measurements of total gene expression were performed using cDNA microarrays. These allow efficient simultaneous measurement of active mRNA expression for all known and putative genes and transcripts in a cell or tissue at any given moment. This has had broad applications that largely overlap and complement GWAS, including at the most general level providing insight into biological mechanisms, identification of subgroups of diseases, and in some cases prediction of disease outcome or treatment response. Although this technique has

been widely applied to investigation of bladder carcinomas⁽⁵⁰⁾ the difficulty of sampling healthy bladder tissue has limited its application in functional urology. A number of studies have assessed whole genome expression in cultured human detrusor smooth muscle cells^(51,52) or in cultured human urothelial cells^(53,54), which both likely differ systematically from such tissues *in vivo*. The technique has been successfully applied to urine sediment, which may over-represent senescent or apoptotic cells.⁽⁵⁵⁾ Transcriptome data from healthy portions of the bladder for patients undergoing cystectomy has also been measured either using microarrays⁽⁵⁶⁾ (n=2) or more recently RNA sequencing⁽⁵⁷⁾ (n=2), with the latter experiment now publically available.⁽⁵⁸⁾ RNAseq has numerous advantages over microarray, including that it can capture expression of unknown mRNAs, and their variants, whereas microarrays are limited to detection of known sequences. To our knowledge RNAseq has not been used in functional urology.

Only two studies have applied whole genome arrays to benign bladder biopsies. Gamper and colleagues first demonstrated the feasibility of the technique, taking three to four large biopsies (20 mm³) from healthy and unhealthy regions of the bladder for patients with interstitial cystitis (n=11).⁽⁵⁹⁾ Tseng and colleagues extended this work, extracting sufficient RNA from single biopsies from women with interstitial cystitis (n=10).⁽⁶⁰⁾ Both experiments focused on differential expression associated with ulcerated and non-ulcerated areas of the bladder in interstitial cystitis, providing limited generalisable information for other bladder conditions. A single conference abstract has been presented employing these methods for incontinence, but at the present time no publications have been reported.

2.3. Proteomics and Metabolomics

The proteome includes all the expressed proteins in a cell or tissue, whereas the metabolome generally included only the smaller molecules less than 1 kDa in size. Proteomics and metabolomics have special interest for biomarker discovery, and particularly with reference to incontinence, for biomarker discovery in urine. Many existing biomarkers in both urology and gynecology are themselves proteins (e.g. PSA and CA125). Both proteomics and metabolomics employ a range of different spectroscopy techniques. Mass spectrometry has been perhaps the most widely used method, but different techniques have demonstrated different disadvantages, with no single method providing a complete and reliable assessment of either the entire proteome or metabolome. Although there are only around 20,000 human protein-coding genes, there are predicted to be more than 250,000 human proteins, as each gene may code for multiple protein products. In contrast there are only around 5,000 small metabolites, but the diversity of molecules within this class, including small proteins, lipids and carbohydrates poses enormous challenges for their identification. Both proteomics and metabolom-

ics have been widely employed in urological oncology, and over the last two years studies for functional urological conditions have also been reported as conference abstracts. To our knowledge, at the present time no studies using these technologies for incontinence or LUTS have been published however.

2.4. Caution in “omics” Research

Incontinence is an archetypical example of a common complex disease, with multiple subtypes and an array of complex potential causes. It has a wide range of environmental and life style risk factors, that might obscure attempts to identify meaningful biological differences. Stress and urgency incontinence overlap much more commonly than expected by chance, suggesting that they might have common environmental or genetic risk factors⁽⁶¹⁾, but it is not a trivial problem to correctly assign women as having stress, urgency, or mixed incontinence either on the basis of symptoms⁽⁶²⁾ or laboratory testing.⁽⁶³⁾ Thus any “omics” study of incontinence faces substantial problems with case ascertainment, and potential problems with misclassification bias, which might further obscure biological signals. Although these technologies can be applied to any common trait, they been most successful for conditions with tightly defined pathology. Incontinence as a whole certainly does not have a single clear pathology, and even the subtypes have multiple potential causes.⁽⁶⁴⁾

The common pitfalls of clinical research described above tend to be magnified in “omics” research. Two particular problems need to be planned for in the design of all ‘omics studies, both relating to the lack of specific hypothesis. Unlike most conventional clinical or basic research, driven by a defined hypothesis, “omics” research seeks simply to identify differences in any of a large number of molecules between cases and controls, or between different experimental conditions. For some ‘omics technologies formal consensus has been reached regarding adjustment of significance to account for the huge number of simultaneous measurements. In human genomics, a *p* value of 5⁸ is accepted as significant, corresponding to the predicted number of independent genetic loci. In other “omics” fields different adjustments are considered, including the very conservative Bonferroni correction, and the more liberal False Discovery Rate method, which controls the significance threshold, such that a typical 10% of “significant” results are accepted as due to type 1 error. For all “omics” studies very careful consideration of sample size is needed at planning stage to account for loss of power from multiple comparisons.

The related problem is of a need for external replication of “omics” results. Not only is there a risk of false positive results, but the problem of winner’s curse will also tend to magnify apparent effect sizes for the top “hits” from “omics” studies.^(65,66) In GWAS the current default is for a two-stage design with a discovery process using whole genome SNP arrays, and replication in independent samples, using either new arrays,

or SNP by SNP genotyping. For expression microarrays, concern about the accuracy of the technology, particularly for low abundance transcripts has led to a need for independent verification of results, typically using PCR. For other 'omics technologies criteria for replication are less well established, and again need to be planned for in the design of projects.

III. BASIC SCIENCE RESEARCH

1. USE OF LABORATORY ANIMALS FOR RESEARCH

Drawing from the human ethical oversight construct, the development and implementation of a similar process to ensure animal welfare is now common practice and required at all research institutions conducting research with animals. Animal use and welfare was under no federal regulation prior to 1966. Starting in 1961, a group of veterinarians working in research institutions began meeting in Chicago to formulate the first guidelines governing animal care. A Guide for the Care and Use of Laboratory Animals was prepared by this group and supported by the NIH. However, there was no U.S. federal law governing animal welfare and the use of cats and dogs for research was increasing, often supplied by local animal dealers. A major article, with photographs, published in Life magazine highlighted animal abuse, theft and neglect by these dealers galvanizing passage of the Laboratory Animal Welfare Act by Congress in 1966.⁽⁷¹⁾ In 1986 the term IACUC was coined in the Animal Welfare Act where the composition of each institutions IACUC committee was delineated. Each IACUC must ensure the use of animals for research is performed in a humane manner compliant with federal guidelines and regulations.

IV. TRANSLATIONAL RESEARCH (BENCH TO BEDSIDE)

Definition: Translational research is the process of turning observations in the laboratory, clinic and community into interventions that improve the health of individuals and the public — from diagnostics and therapeutics to medical procedures and behavioural changes.⁽⁷²⁾

Translational research is a critically important link between the bench and the bedside. Without effective translation, we lose the benefits of costly and innovative biomedical research. Current impediments to support translational research include a severe lack of translational funding and the resources to facilitate a very complex translational medicine pathway. Unfortunately, only about 2 percent of the current US federal funding goes to translational research. “The translation of basic biological discoveries into clinical

applications that improve human health is an intricate process that involves a series of complex steps: the discovery of basic information about the pathogenesis of a disease; an assessment of whether that information has the potential to lead to a clinical advance; development of candidate diagnostics, devices or therapeutics; optimisation of the candidates in pre-clinical settings; regulatory assessment of the data to determine use for human use; testing in human clinical trials; application for approval for widespread clinical use; and ultimately, the assessment of approved diagnostics, devices, and therapeutics during widespread use in real-world settings”.⁽⁷³⁾ Initiatives to integrate the public and private sectors led to the formation of the National Center for Advancing Translational Sciences (NCATS) at the US National Institutes of Health in 2012. NCATS research projects and initiatives focus on addressing scientific and technical challenges to reduce, remove, or bypass bottlenecks in the development of new treatments and tests that will ultimately improve human health. The aim of NCATS is to catalyse the scientific community to propose implementation projects including therapeutic target validation, chemistry, virtual drug design, pre-clinical toxicology, biomarkers, efficacy testing, phase zero clinical trials, drug rescue and repurposing, novel clinical trial design and post-marketing research. With translational research, the focus is on the result, not the process. Translational research recognises that knowledge exists to change lives, but it must be tested, confirmed and applied.

V. CLINICAL RESEARCH

Definition

Many definitions for “clinical research” have been proposed. The National Institutes of Health (NIH) currently defines clinical research as research with human subjects that is:

1.1. Patient-orientated Research

Research conducted with human subjects (or on material of human origin such as tissues, specimens, and cognitive phenomena) for which an investigator (or colleague) directly interacts with human subjects. Excluded from this definition are in vitro studies that utilize human tissues that cannot be linked to a living individual. It includes: (a) mechanisms of human disease, (b), therapeutic interventions, (c) clinical trials, or (d) development of new technologies.

1.2. Epidemiological and Behavioural studies

1.3. Outcomes Research and Health Services Research

Patient-orientated research encompasses many study designs, from cross-sectional questionnaire studies to large-scale clinical trials. The NIH defines a clinical trial as, “A research study in which one or more human subjects are prospectively assigned to

one or more interventions (which may include placebo or other control) to evaluate the effects of those interventions on health-related biomedical or behavioral outcomes.” Clinical trials of an experimental intervention may be done in a small group of people to determine a safe dosage range and identify side effects (Phase I), in a larger population to determine efficacy and further evaluate safety (Phase II), in a very large population to compare effectiveness with other standard or experimental interventions and to collect information that will allow the interventions to be used safely (Phase III), and to monitor the effectiveness and safety of the approved intervention in the general population after it has been marketed (Phase IV).

Challenges

Conducting clinical research is challenging. An Institute of Medicine workshop identified several key challenges as follows⁽⁷⁴⁾:

- Prioritising of clinical research questions
- The divide between clinical research and clinical practice
- Globalisation of clinical trials
- The cost of clinical trials
- Narrow incentives for physician participation in clinical research
- Shrinking clinical research workforce
- Need to navigate administrative and regulatory requirements
- Recruitment and retention of patients

The next section focuses on some challenges that are of particular relevance to studies of urinary incontinence and pelvic organ prolapse.

2. INCLUSION AND EXCLUSION CRITERIA

Inclusion criteria are often narrow; while results derived from a homogenous pool of participants is more likely to demonstrate a difference from an experimental intervention, the results also may be biased and applicable only in this homogeneous population⁽⁷⁵⁾, making translation to the practicing clinician difficult. Narrow inclusion criteria also may hamper the ability to meet recruitment goals. But, while broad inclusion criteria yield more generalisable results, these may also make it harder to attribute statistical significance to the intervention under study.

In general, it is important to limit exclusion criteria to those that reduce risk to potential participants, and, especially in longer-term studies, to those factors that could hamper the potential for follow-up. It is important to include individuals in whom the treatment would likely be used once widespread. For example, in testing a new drug for urgency incontinence, that is

excreted by the kidneys, it is important to exclude people with high serum creatinine levels, but equally important to include older individuals with multiple comorbidities in specific studies, as these are also likely to benefit from a drug for urgency incontinence once released.

Additionally, inclusion criteria related to the condition of study must be considered in concert with the consideration of the primary outcome measure. If an inclusion measure defines “disease”, it is essential that the outcome measure does not include this same measure or cut-point as “success”. For example, if a surgical trial comparing two treatments for pelvic organ prolapse defines prolapse as \geq stage II (and excludes from enrolment only women with \leq Stage I prolapse) and the primary outcome measure defines successful treatment as prolapse at or above the hymen, then women enrolled with maximal prolapse at points 0 or -1 may be considered successfully treated when in fact, their condition has not changed. It is also important to note that a given condition, such as stress urinary incontinence, will be present or absent depending on which outcome measure is used to define it. Avoid using one outcome measure to exclude women from a study and then a different outcome measure defining the same condition as the primary outcome measure.

3. BLINDING (MASKING)

While blinding of participants, health care providers and the research team is feasible in pharmaceutical trials (though not without problems), it may not be possible in trials of some surgical procedures, behavioral or physical therapies, or health care delivery methods. In these studies, the only possible blinded person is often the assessor. It may be advantageous for the clinical staff to be aware of the assignment to allow them to monitor the health and safety of individuals, since the potential effects of the treatment (side effects) will often be known in advance. Single blinding ameliorates biased reporting of symptoms and/or side effects by participants. However, clinical staff can influence data collection and change other aspects of participants’ care when they know which study treatment subjects are receiving.

It should be noted that blinding is not impossible in all surgical trials and should be considered when possible. For example, in a trial comparing mid-urethral sling versus no treatment in continent women undergoing vaginal surgery for pelvic organ prolapse, surgeons made superficial suprapubic incisions in women randomly assigned to sham treatment and the incisions were dressed in the same way as the actual incisions in the group assigned to tension-free vaginal tape.⁽⁷⁶⁾ At 12 months, only 10% of participants assigned to TVT were sure of their treatment group and 94% of these were correct, while 11% of participants assigned to sham treatment were sure of their treatment; 47% were correct. Of the remainder

who reported no treatment knowledge, 33% in both groups correctly guessed their treatment assignment.

4. RANDOMISATION

Stratified randomisation ensures equal distribution of subjects with a particular characteristic in each group when blocking is employed within strata. This is particularly important if certain participant characteristics are likely to influence the outcome. For example, in incontinence research, variables such as prior failure of therapy, degree of pelvic organ prolapse or severity of incontinence might be considered important enough to stratify at randomisation, because unequal distribution of variables important to the outcome may create headaches during the data analysis.

5. PARTICIPANT SAFETY

Ensuring participant safety is paramount. An independent data safety monitor (DSM) or data safety monitoring board (DSMB) is important to evaluate the study on an ongoing basis to determine early evidence of significant harm or benefit.^(77,78) Depending on the size, complexity, and risks of a trial, the DSMB is comprised of experts needed to monitor interim data to ensure the safety of the participants. The DSMB should be established prior to initiation of the trial. In addition to reviewing results of the study for safety monitoring they may evaluate interim analyses to ensure that a treatment is not producing unacceptable levels of side effects and/or efficacy.^(32,77) A priori stopping rules or boundaries are established to assess if the study should continue or be terminated due to futility (that is, no conclusion will be drawn due to low enrollment, few outcome events, or high drop-out rates etc.), reaching an endpoint, or identifying increased risks. Guidelines for stopping the study should be agreed upon, prior to the start of the trial.⁽³¹⁾ Interim analyses (in particular those based on efficacy) will have implications for the study power. Specialist statistical advice and support will be essential to address these issues.^(79,80) Investigators must not be aware of the results of interim analyses, however, since this may cause bias by influencing how vigorously any given patient is recruited into or followed up in the study, and most importantly, runs the risk of a type II error (i.e. mistakenly concluding benefit when there is none). Nevertheless, emergency procedures for unblinding a patient's allocation are required in case of a severe side effect or concomitant serious illness where knowledge of treatment assignment is essential for patient management and safety.

6. ANALYSIS

High quality data management is key to providing valid and ethical research results.⁽⁸¹⁾ The analytical plan should be consistent with study aims and the *a priori* analytical plan should be included at the time of

the protocol entry into a clinical trials registration system. Currently, high tier journals will often request the statistical analysis plan and protocol at the time of the review of the report. This section will not contain any technical details of statistical methods, which are available in standard texts.⁽⁸²⁻⁸⁴⁾ Instead we note some particular problems faced by research with longer-term follow-up in incontinence and pelvic organ prolapse.

The gold standard in analysing randomised trials is by intention-to-treat, according to the group to which subjects were randomised, regardless of the extent of compliance with the intended treatment. Appreciable loss to follow-up in a trial (which is not the same as adherence with intended treatment, lack of efficacy, or the observation of adverse events) may present serious problems both in terms of generalizability of the findings to the wider population and, in the case of differential loss to follow-up across treatment groups, to the validity of the comparisons. Results should always be accompanied by a full and clear description of how the analysis handled deviations from intended treatment and missing outcome measures. For example, in a randomised trial comparing surgery and a urethral plug for urinary incontinence, in which participants are followed for 5 years and outcomes collected using patient-reported outcomes, how should data from participants that crossed over from one group to the other be handled? It is more likely that participants in the urethral plug group, over the course of time, will request surgery than the opposite; if no adjustment is made, the two interventions may have the same effectiveness when analyzed by intention-to-treat methods. Decisions in this regard require substantial thought. The discussion should include how missing outcome data may have affected the conclusions.⁽⁸⁵⁾ Sensitivity analyses can be used to test the exclusion of, or assumptions about, missing values; practical examples of such analyses are becoming more common.⁽⁸⁶⁾

7. TRAINING AND CERTIFICATION

Little training is needed to administer a pill. The same is not true for surgical, behavioural and physiotherapy interventions. Competence varies widely and a learning curve can be substantial. However, surgical or clinical expertise is rarely reported in clinical research studies. For example, in a systematic review of 99 studies of open spine surgery, only 10% described surgical skill or experience, which raises the question of expertise bias in interpreting studies' results.⁽⁸⁷⁾ In addition to the actual intervention, other study procedures can also be impacted by inconsistent experience. The Urinary Incontinence Treatment Network demonstrated that multi-centre urodynamic studies require not only the development of specific procedures and interpretation guidelines, but also continuous quality improvement efforts.⁽⁸⁸⁾

8. CHALLENGES IN CONDUCTING TRIALS IN DEVELOPING COUNTRIES

Conduct of clinical trials in developing countries presents ethical, organizational, cultural and infrastructural challenges to researchers, pharmaceutical companies, sponsors and regulatory bodies.⁽⁸⁹⁾ A balance between managing these challenges while yet conducting the trials is important so that research can be encouraged and supported in order to bring maximum public health benefits to these communities, often underrepresented in research. Difficulties, as outlined by authors of an investigator-initiated trial, include “obtaining valid informed consent, ethical compensation mechanisms for extremely poor populations, poor health infrastructure and considerable socio-economic and cultural divides”.⁽⁸⁹⁾ Other challenges include appropriate translation of study measure, access to care at the conclusion of the trial, administrative bottlenecks, equitable investigator (as well as participant) compensation, difficulty obtain skilled researchers, and regulatory bodies with different standards from those of developed countries.

9. TRIAL REGISTRATION AND DATA SHARING

The International Committee of Medical Journal Editors (ICMJE) initiated a policy in 2005 requiring investigators to enter information about trial design into an accepted clinical trials registry at or before the time of first patient enrolment.⁽⁹⁰⁾ This requirement, adapted by many journals, aims to restrict the practices of selective publication and selective reporting of research outcomes, as well as to prevent unnecessary duplication of research effort. The ICMJE accepts registration in any registry that is a primary register of the WHO International Clinical Trials Registry Platform (ICTRP) or in ClinicalTrials.gov. The ICMJE encourages registration of research with non-trial designs, such as observational studies, but does not require it at this time. The ICMJE also encourages posting of clinical trial results in clinical trial registries but does not require it; such posting is not considered prior publication if the results are limited to a brief abstract or tables.

Standards recommended by ICMJE are frequently adapted by medical journals and therefore play a major role in guiding research conduct. Thus, it is of interest to note that at the time of this writing, the ICMJE posted proposed requirements for sharing clinical trial data and is inviting public feedback. In an editorial, the Committee notes that “there is an ethical obligation to responsibly share data generated by interventional clinical trials because participants have put themselves at risk”.⁽⁹¹⁾ The ICMJE recommendation continues: “As a condition of consideration for publication of a clinical trial report in our member journals, the ICMJE proposes to require authors to share with

others the de-identified individual-patient data (IPD) underlying the results presented in the article (including tables, figures, and appendices or supplementary material) no later than 6 months after publication.” The proposal also requires that authors outline a detailed plan for data sharing at the time of clinical trial registration. While the outcome of this proposal isn’t known at the time of this report, it is clear that the tides are turning and data sharing is now viewed as more and more important, not only by journal editors, but by funding bodies (which often have specific requirements to this regard), investigators and research participants. Nuances of data sharing should be considered in planning clinical trials (for example, in the consent process, participants must be asked to provide consent to have de-identified data shared publicly). Investigators should stay abreast of changes in this rapidly evolving area.

Many funding agencies around the world require publications resulting from such funding to be deposited in an open repository, so that they are freely available to all. In general, authors submit the postprint (the manuscript after peer review and acceptance but before copy-editing, formatting or other journal-specific tasks) to a repository accessible online without charge. A large number of journals now assist the author by automatically depositing the published content into a repository such as PubMed Central. Some publishers will delay the release of their articles for a set time after publication, generally six to twelve months.

10. REPORTING RESEARCH RESULTS

The investigator has an ethical responsibility to take responsibility for all aspects of the research, ensuring that the work is done rigorously and to maintain the integrity of the research.⁽³¹⁾ Investigators should adhere to published standards in reporting their research results, in order to maximise quality and transparency. Further, most journals require this. Adherence to these guidelines and the use of flow diagrams in particular is associated with improved quality in reporting of RCTs.⁽⁹²⁾ The “Enhancing the QUALity and Transparency Of health Research” (EQUATOR) Network project (www.equator-network.org) provides a continuously updated platform of the many different guidelines now available for reporting the design, methods and results of different study types. The most commonly used guidelines for clinical research are listed below:

- Consolidated Standards of Reporting Trials⁽⁹³⁾: for randomized clinical trials
- Strengthen the Reporting of Observational Studies in Epidemiology⁽⁹⁴⁾ —of note, these guidelines do not pertain only to prospective cohort studies, as sometimes assumed, but also to cross-sectional, case-control and retrospective studies.

- Standards for Reporting of Diagnostic Accuracy⁽⁹⁵⁾: for studies about the accuracy of diagnostic tests.
- Preferred Reporting Items for Systematic Reviews and Meta-Analyses (PRISM)⁽⁹⁶⁾: for systematic reviews
- Standards for Quality Improvement Reporting Excellence (SQUIRE)⁽⁹⁷⁾: for studies about quality improvement in health care
- Standard protocol items for clinical trials (SPIRIT) -this is an excellent resource in planning a clinical trial.⁽⁹⁸⁾

To improve guidelines adherence, a checklist accompanies each guideline. It is crucial that the reporting guidelines be considered during the planning phase of the study in order to ensure that all key elements are collected as required.

Most of the guidelines contain additional separate items for certain types of studies. In this section, we use the CONSORT guidelines as an example. CONSORT includes additional guidelines for reporting parallel group randomised trials, pragmatic trials, non-inferiority and equivalence trials, and cluster randomised designs.⁽⁹⁹⁻¹⁰³⁾ The statement includes a checklist of items that covers a comprehensive set of characteristics of a clinical trial. These include clear statements about the objectives of the trial, intended study population, planned comparisons and justification for any subgroup or covariate analyses. The method and unit of randomisation should be stated. For all trials, specifications for the sample size calculation (primary outcomes, target differences, etc.) should be stated and justified. In addition, the precision actually obtained in a study must be presented. This requires confidence intervals as well as the observed p-values, at least for primary outcomes but preferably for all outcomes. The principal confidence intervals should be for comparisons between the groups, rather than for differences in the outcomes within the trial groups.^(82,104) Results should include a trial flow diagram, with numbers and reasons for the exclusion of eligible subjects, the number randomised and subsequent losses to follow-up.⁽¹⁰⁵⁾ Protocol deviations should be described and explained.⁽¹⁰⁶⁾ Harms of the trial should be described for each treatment group. Finally, the discussion should include a brief summary of the trial's findings, possible explanations for the results, interpretation of the findings in light of the literature, limitations of the trial including internal and external validity, and the clinical and research implications of the study.⁽¹⁰⁷⁾ Some guidelines also include specific information that must be included in publication abstracts. These are particularly important to follow, given that many readers rely solely on the abstract for their interpretation of a study.

11. RECOMMENDATIONS ON STUDY CONDUCT AND STATISTICAL METHODS

- The role of quality RCTs as providing the strongest level of evidence in incontinence research should be fully acknowledged by researchers, journal reviewers, and editors. HIGH
- Careful attention to the planning and design of all research, especially RCTs, is of the utmost importance. HIGH
- Appropriate expertise in biostatistics and clinical trial design should be employed at the design phase of a RCT and thereafter on an ongoing basis. HIGH
- The design, conduct, analysis and presentation of research should be fully in accordance with the applicable research guidelines. HIGH

12. SPECIAL CONCERNS FOR SPECIFIC STUDIES

12.1. Systematic Reviews

Systematic review remains perhaps the most formalised part of epidemiology, with a wealth of available guidance for the correct conduct and reporting of reviews^(96,108-112), and the creation of recommendations based on the evidence.⁽¹¹⁰⁾ Without transparent reporting of systematic reviews, it is difficult for editors and readers to judge the quality of a review. One fundamental step that is frequently overlooked is prospective registration of the review protocol in a database such as PROSPERO. The types of studies included should be pre-specified, along with all planned outcomes and analyses.

Searches should encompass a range of sources, perhaps including Medline, EMBASE and CINAHL. Importantly, as many studies never reach publication efforts should be made to search the grey literature. It is almost always helpful to directly contact primary study authors, for clarifications, additional information about methodology, and even additional data or analyses where necessary.

The screening and data extraction process should be planned in advance, and all reviewers should be trained to use the data forms, to achieve a high level of consensus. All screening and data extraction should be performed independently and in duplicate. Reference lists should be hand searched for all included articles, applying the same standardised screening process, as this can pick up additional relevant studies.

Statistical methods are equally formalized for meta-analysis. Fixed effects models [Mantel-Haenszel weighting⁽¹¹³⁾ should be used for meta-analyses with

only two studies, or for three or more studies and low heterogeneity, but otherwise random effects models [Dersimonian and Laird weighting⁽¹⁰⁹⁾ should be used. Assessments of risk of bias in primary studies, and for the meta-analysis as a whole⁽¹¹¹⁾, are important particularly when formalising recommendations based on the pooled evidence, and should follow the most relevant scheme for the types of studies included.⁽¹¹²⁾

12.2. Quality Improvement Studies

The SQUIRE (2.0) guidelines facilitate performance, analysis, and publication of quality improvement.⁽⁹⁷⁾ SQUIRE 2.0 is the inclusion of a glossary of key terms to help standardise definitions and clarify the use/misuses of commonly employed phrases in the quality improvement literature. Terms such as “intervention,” “opportunity costs,” “process,” and “systems” are clearly defined. The guidelines also present information about context (interpreting the work within its own unique environment), and studying the intervention (evaluating the generalisability of the intervention as opposed to simply performing or doing it). The guidelines are presented in a printable 18-item table that takes potential quality improvement investigators through a step-by-step process for performing and publishing their work from abstract to conclusion.

12.3. Observational Studies Using Routinely Collected Health Data

Observational studies using routinely collected health data obtained for clinical and administrative purposes (often referred to as “database studies”) are increasingly common, given the increased availability of health administrative data, disease registries, electronic health record data repositories, public health reporting data, etc. The major advantage of these studies, that the data are already collected, often on millions of people, is also the major drawback: Because the data were collected without a specific *a priori* research goal in mind, the database may lack key information needed. Further, the information collected, especially in administrative data collected for billing purposes, may not be accurate; validation is often required. However, the potential of such databases to enable efficient and cost-effective research is substantial.

The REporting of studies Conducted using Observational Routinely-collected health Data (RECORD) Statement is an excellent resource for investigators planning and reporting such studies.⁽¹¹⁴⁾ Below we summarize, based on this statement, some of the key recommendations for investigators planning studies using routinely collected health data. Further detail is available in the full report.

- Clarify whether the analyses were exploratory or confirmatory, and indicate whether the hypotheses were generated before or after data analysis.
- For studies that involve linkage of databases, display in detail the data linkage process.

- Explicitly state the methods used to identify study subjects, including whether identification is based on single codes, algorithms (combinations of records or codes), linkage between databases, or free-text fields.
- Provide a complete list of codes and algorithms used to classify exposures, outcomes, confounders, and effect modifiers.
- Describe data cleaning methods at different stages of the study (for example, how were missing data and repeated measures handled?)
- Clearly define how the final study population was derived.
- Consider potential sources of bias: “(1) codes or algorithms to identify study populations, outcomes, confounders, or effect modifiers (misclassification bias); (2) missing variables (unmeasured confounding); (3) missing data; and (4) changes in eligibility over time”.⁽¹¹⁴⁾

Unmeasured confounding is particularly problematic in these types of studies. The fact that an outcome was assessed in a very large population cannot make up for the absence of an important potential confounder in the database. The investigator is better off looking elsewhere to answer the research question at hand. Another problem frequently arising in studies using large databases are changes in composition of the database population or coding practices over time. Such changes challenge the integrity of temporal comparisons using the dataset. Finally, some journals require that the author attest to the reliability and validity of key variables used in a database before they will consider publication of these studies.

12.4. Behavioural and Physiotherapy Trials

Terminology: The lack of consistent terminology severely hampers our ability to build a body of literature about conservative interventions. The terms “behavioural therapy”, “lifestyle intervention”, “conservative treatment”, “non-surgical treatment”, “physiotherapy”, “biofeedback”, and pelvic floor muscle exercise” are often used interchangeably and incorrectly to describe both the same, and different interventions. While such therapies are discussed elsewhere in this consultation, we here advance this committee’s opinion about appropriate terminology, consistent with the most recently updated terminology manuscript⁽¹¹⁵⁾:

Behavioural interventions: According to Oxford Advanced American Dictionary the term behavioural is “the way someone behaves, especially towards other people”, and behavioural science is the study of human behaviour. We recommend that behavioural science be limited to studies that evaluate how people do or do not behave as desired.

Lifestyle modification interventions: Lifestyle modification interventions for UI are discussed elsewhere in this consultation and have traditionally in-

cluded diet modification, intake of caffeine and carbonated soft drinks, fluid restriction, weight loss, smoking cessation and advice of increasing general physical activity level. Behavioural science can be used to understand how and why people change lifestyle to, for example, adhere to exercise and weight loss programs, but it should not be used as term to replace specific therapies such as physiotherapy or pelvic floor muscle training.

Physiotherapy: Physiotherapy refers to assessment, prevention and treatment given by an authorised physiotherapist (ICS physiotherapy committee www.icsoffice.org). It involves “using knowledge and skills unique to physiotherapists” and, “is the service only provided by, or under the direction and supervision of a physiotherapist” (WCPT 1999). This implies that the term physiotherapy should only be used in trials where the professional providing the intervention is a physiotherapist. We recommend describing the actual intervention instead of using the term physiotherapy: eg pelvic floor muscle training with or without biofeedback, electrical stimulation, pelvic floor muscle training with vaginal cones or resistance device etc. This accurately describes the intervention and is neutral towards profession. Publications should report the actual profession of the interventionist (e.g., physiotherapist, general practitioner, urogynaecologist, urologist, midwife, nurse, fitness instructor), rather than using the vague term, “therapist”.

Biofeedback: Biofeedback encompasses “a group of experimental procedures where an external sensor is used to give an indication on bodily processes, usually in the purpose of changing the measured quality”.^(115,116) Biofeedback equipment was developed within the area of psychology, mainly for measurement of sweating, heart rate and blood pressure under different forms of stress. Today, a variety of biofeedback apparatuses are commonly used in clinical practice to assist with PFMT, and the biofeedback can be either visual, auditory or both. In many textbooks the term “biofeedback” has been used to classify a method as different from PFMT. However, biofeedback is not a treatment on its own. It is an adjunct to training. For example, it may measure the response from a single PFM contraction or provide visual feedback during attempts to relax the muscles. Hence, a more precise terminology is PFM training or relaxation with or without biofeedback.

In addition to traditional biofeedback apparatuses, other instruments can offer valuable feedback. Vaginal and anal surface EMG, urethral, vaginal or anal squeeze pressure measurements, ultrasound and MRI can all be used to make the patients more aware of muscle function, and to enhance and motivate patients' effort during training.⁽¹¹⁷⁾

Conservative interventions/treatments: Conservative interventions include all of the above, and this term includes everything except medication and surgery. As several studies have found that more than

30% of women with pelvic floor dysfunction are not able to perform a correct PFM contraction at the first consultation⁽¹¹⁸⁻¹²¹⁾ it is mandatory to report how ability to perform a correct contraction was assessed before commencing an exercise trial. Also in electrical stimulation research one should report in which way response to the stimulation was assessed.

Although there is level A, grade 1 evidence for some of the conservative interventions such as PFMT for SUI, a variety of new conservative methods to treat the condition are frequently suggested in clinical practice and in the literature. These new methods are often presented as being effective, but are usually a hypothesis based on theories, data from small experimental laboratory studies/ small clinical series, or associations found in large epidemiological studies. If the clinicians like the approach, it soon enters clinical practice and textbooks without any further critical testing.⁽¹²²⁾ A model for how new therapies ideally should enter clinical practice has been proposed.⁽¹²³⁾ In this model the new idea should go through at least the 4 first stages before they enter practice:

- Clinical observation and laboratory studies
- Clinical exploration
- Pilot studies
- Randomised controlled trials
- Refinement, e.g. dose-response issues
- Active dissemination of the method if it has proven to be effective

It is important that the patients participating in the 3 first stages before the RCT are given full information that they are participating in an experimental treatment, and that the clinician does not know if this new approach is effective. The patients also need to be informed if there are other proven effective treatments available.

12.5. Reporting of Trial Characteristics

In addition to reporting the specific type of intervention (e.g. PFMT with biofeedback compared to PFMT alone or electrical stimulation) and the profession administering the intervention, the intervention needs to be described in such detail that other investigators can reproduce the intervention. This includes:

- Ability to perform a correct PFM contraction.
- Frequency: number of home training sessions and supervised training sessions (e.g. every day, 3 times/week)
- Number of repetitions and sets (e.g. 12 sets x 3 times/ day)
- Duration: length of each training session (e.g. 20 minutes), and duration of the total training period (e.g., 3 months, 6 months)

- **Intensity:** In exercise science, this is usually reported as % of one repetition maximum for strength training. In pelvic floor muscle training it is often described as attempts to reach maximum contractions or utilising submaximal contractions. Another description of intensity is the holding time in seconds, e.g.: 6-8 sec
- **Adherence:** the degree to which participants follow the prescribed protocol, usually reported as a percentage of the total possible.

Educational material provided, such as DVDs, brochures and booklets should be described.

Assessment: All devices used for assessments (e.g. manometers, dynamometers, ultrasound and EMG) must be described in detail, and their responsiveness (ability to detect small changes), reliability and validity should be reported.⁽¹²⁴⁾

12.6. Adherence vs Effectiveness

It is important to note that adherence is not the same as the effectiveness of a programme, as it is possible to have high adherence, but still little effect of training.⁽¹²⁵⁾ Hence, when reporting the effect of conservative interventions it is ideal to measure also the exposure variable that the treatment is expected to change (e.g. muscle strength, ability to relax etc). This variable should not be confused with the primary or secondary outcomes of the intervention (e.g. leakage measured with pad testing, number of leakage episodes or QoL).

In many areas of conservative interventions there are high quality RCTs, systematic reviews and meta-analysis showing statistically significant and clinically relevant differences between the intervention and the untreated control group or other interventions. Of conservative therapies, PFMT for SUI/MUI has the strongest evidence to support its use; further, the more intensive the programme (more supervision, higher dosage of training) the better the effect. Therefore, when comparing new methods and innovations with established PFMT, it is important to compare the new intervention with the current best evidence, meaning the effective arm of the reported RCTs. Unfortunately, it is common to compare new methods with an ineffective training protocol, thereby overestimating the effect of the new method and claiming that it is equal to or better than "the old method". When comparing different methods the dosage also needs to be the same in both treatment arms, e.g. when comparing PFMT with and without biofeedback, the number of supervised sessions, length of the sessions, frequency of home treatment and duration of the intervention must be the same.

12.7. Adverse Events and Cost

There are few adverse effects or complications reported after conservative interventions, but they do exist, e.g. in electrostimulation⁽¹²⁶⁾, and adverse effects or lack of adverse effect, and inconvenience to the patients should be reported. Although seldom

harmful, conservative treatments are time consuming and can be costly for participants and paying parties because of the need for close follow up during the interventions. Cost effectiveness studies are crucial to fully understand where conservative therapies fit in the treatment armamentarium.

12.8. Outcome Measures

The need for use of responsive, reliable and valid outcome measures in research is covered elsewhere in this chapter. The RCTs published in conservative treatment have applied a huge variety of outcome measures, making systematic reviews and meta-analysis difficult or impossible to conduct. Therefore, in future research it is important to use established and recommended outcome measures. In addition to description and use of responsive, reliable and valid primary and secondary outcome measures, future studies should include description and assessment of adherence to the intervention protocol, measurement of the independent variable (the intervention; e.g. strength training, relaxation training) and measurement of the possible underlining mechanisms of how the treatment works. It is usually not possible to blind the participants or those providing the intervention, but the assessors of outcome should always be blinded to group allocation.

12.9. Specific and Non-specific Effects

There have been some concerns that the effect of conservative treatments can be attributed to non-specific effects such as the extra attention of the therapist. The role of the therapist is to educate, motivate and empower the patient to be able to perform the actual program, secure high adherence, and minimize participant drop out. In patient reported outcomes and reports on quality of life it may be difficult to separate the effect of the attention and the actual effect. However, the effect of the attention is less likely to affect outcomes such as muscle strength, urodynamic assessments, pad testing and morphological changes measured by ultrasound and MRI. Investigators blinded to treatment allocation should conduct all assessments in order to minimize bias. The logistics of this should be addressed during the planning phase of the study. In a high quality RCT, Dumoulin et al address the problem of attention in physiotherapy research.⁽¹²⁷⁾ Women with persistent UI, three months after childbirth were randomised to either two different training regimens or a control group receiving relaxation massage for the back and limbs for the same amount of time as the supervised training groups. 70% were cured on pad testing in both treatment groups while there was no effect on urine loss in the relaxation massage group. Participants in the massage control group had improvement in disease specific quality of life.

12.10. Power Calculations and Number of Participants

Some of the RCTs on conservative treatments are flawed by small sample sizes, this being especially evident in electrostimulation studies and may account for negative effects caused by type II errors. It is important that future studies use results of previous published studies to make appropriate power calculations that incorporate estimates of drop outs and loss to follow-up to decide the optimal number of participants needed. Recruiting large numbers of participants may come at the expense of the rigor of the intervention.⁽¹²⁸⁾ Weak interventions (e.g. non-optimal training dosages or suboptimal electrostimulation parameters) are unlikely to be effective and do not yield the true effect of an intervention. In meta-analyses, adding RCTs with large sample sizes but weak and ineffective interventions can dilute the effect of smaller RCTs with higher methodological and interventional quality⁽¹²⁸⁾.

12.11. Long-term Studies

To date there are no quality criteria for how to report long term follow-up studies or how to conduct meta-analyses of long term studies. Challenges in long term follow-up studies include cross over to the more effective treatment after cessation of the original RCT, co-interventions during the follow-up period, recurrent events (e.g. new pregnancy), competing events (other diseases leading to incontinence) and loss to follow up. For conservative interventions it is expected that any training effect will diminish over time if no maintenance training is conducted or the pre- or co-contraction of the pelvic floor muscles has not reached an automatic level during the original trial. In order to control for as many of the above mentioned factors as possible, it is recommended that the long term follow up study should be planned together with the original RCT. Loss to follow-up and adherence to the protocol during the follow-up period must be reported.^(117,122-124,126-129)

13. RECOMMENDATIONS FOR CONSERVATIVE TREATMENT TRIALS

- Use correct terminology to describe the intervention. HIGH
- Report details of ability to perform correct contraction, dose-response issues and adherence. HIGH
- Use recommended outcome measures with high responsiveness, reliability and validity. HIGH
- Compare new methods with the best available intervention. HIGH

- Use power calculation in planning of the study. Avoid large sample sizes and weak (ineffective dosages) interventions. HIGH
- For long-term follow-up studies report cross-over, co-interventions, recurrent and competing events, adherence in the follow-up period and loss to follow-up

14. EXPERIMENTAL DEVICES AND MATERIALS

Surgical research presents unique challenges to efforts at optimising patient care. It is important to create a pathway for real advances while simultaneously protecting patient safety. When new procedures are substantially different from prior operations there should be a broad based preliminary exploration leading to a comparative trial if warranted. At the same time, many minor modifications of surgical procedures are inappropriate for randomised trials and if required, surgical progress would be slowed.⁽¹³⁰⁾

It has been argued that the first patient in whom a procedure is performed should be randomised.^(131,132) Alternatively, it has been suggested that case series for new procedures are allowed until the procedure finds its intended use and to avoid doing studies while those performing the procedures are on the “learning curve”. Typically, new surgical procedures for incontinence have been reported as case series.^(133,134) Not only do surgical case series provide the lowest level of evidence for treatment effects, case series may be “harmful”. An accumulation of “positive” case series may present a premature certainty about benefits of a procedure and make it even more difficult to perform randomised trials.^(135,136) Influential members of the surgical community may endorse a new procedure and if the procedure is considered better it may be difficult to get surgeons and patients to randomise or a trial may appear to be unethical with a “proven” procedure.^(131,135,137)

Therefore, devices often are widely adopted by clinicians based on anecdotal data, marketing, or small case series. This raises a unique problem for trials in this area: 1) Surgeon buy-in can be difficult to obtain as some surgeons (“early adopters”) may perceive that the newest therapy is best and thus be unwilling to randomise patients to receive the traditional therapy, 2) Other surgeons (“late adopters”) may perceive that the data available do not support use of the newest therapy and thus be unwilling to randomise patients, 3) Patients may be unwilling to be randomised to traditional therapy because they are influenced by marketing forces propelling the newest devices to the forefront, and 4) Device companies frequently modify their materials or technique recommendations; therefore, by the end of the 3-5 years it typically takes to complete the earliest outcome assessment for a surgical randomised trial, the device tested is no longer the same as the device used in the

trial. Thus, the results may be discounted as being no longer applicable.

An important area of concern in surgical and device studies is patient recruitment procedures. The protocol should detail the procedure for selection of consecutive patients who meet the inclusion criteria. All situations in which a patient meets the inclusion/exclusion criteria but is not offered enrolment by the investigator should be documented. The number of patients who decline enrolment should be stated, along with the reasons. It is vital that clinician researchers do not “cherry pick” from their patients, that is, that they do not limit recruitment to those patients considered to have the greatest chance of cure or lowest chance of risk. The study population should be as generalizable as possible. There should be a complete accounting of all participants in the study including the reasons for subject withdrawal.

Participants must be well informed about what is known and not known about devices or procedures being tested. They should not be led to assume that because a device is on the market, it is “safe and effective”, as gaining knowledge about this is the purpose of the trial.

15. SURGICAL STUDIES

Cross-sectional studies of surgical procedures by type can provide estimates of prevalence, variation by age, race, and region as well as morbidity and mortality.^(138,139) This type of information raises important health policy questions regarding physician practices, patient preferences for incontinence treatment, and differential access to and the utilisation of care. Observational studies can provide important information about effectiveness and complications of surgical procedures, and also are very helpful in designing and selecting potential randomised clinical trials.

The randomised controlled trial is the accepted “gold standard” for research of treatment effects. In all surgical specialties, there has been growing concern regarding the limited number of randomised controlled trials for surgical procedures, poor methodological standards in those that have been performed, and a perception that surgeons are reluctant to rigorously test new surgical interventions.^(131,135,140,141)

The body of literature of surgical randomised trials in pelvic floor disorders is increasing. Modern trials are beginning to overcome historical limitations including insufficient sample sizes, lack of blinding of the participants and/or individuals assessing the outcomes, short follow-up, inclusion of limited number of surgeons only, poor description of the technique, and lack of standardised outcome measures. Multi-centre treatment networks appear effective in overcoming some of these limitations. Differential drop out after randomisation (or for cohort studies, after the inter-

vention) can introduce bias. Randomisation can occur in the operating room after the patient was anaesthetised, reducing this risk.^(142,143)

For studies of specific surgical procedures, the technique should be described in such detail that it could easily be reproduced in another study. Standardisation of the procedure may vary depending on the research question.⁽¹⁴⁴⁾ Surgical trials using a small number of highly skilled surgeons are analogous to medical trials where only compliant patients are randomized, reflecting efficacy of the procedure in an ideal setting. It may be more generalisable to a mixture of skill level among surgeons in the community, and so reflect effectiveness of the procedure in usual practice.⁽¹³⁶⁾

Masking (blinding) of participants as to their assigned intervention and those assessing the outcome is particularly important for surgical trials for incontinence because there may be enthusiasm by the patient or surgeon for a new procedure, many outcomes are based on the patient’s own assessments such as symptom and quality of life scores, and the intervention is primarily for improvement of symptoms.⁽¹³⁰⁾

Organizations and treatment networks have been established to address many issues related to surgical interventions. Examples include the UK National Institute of Clinical Excellence (NICE www.nice.org.uk), the Australian Safety and Efficacy Register of New Interventional Procedures- Surgical (ASERNIP-S www.surgeons.org/asernip-s). The NICE and ASERNIP-S provide systematic reviews of new operations, assessment of effectiveness, and recommendations that the technique has sufficient data for widespread use, or that the techniques appear unsafe, or that further audit/research are required before its widespread usage.

16. RECOMMENDATIONS FOR SURGICAL AND DEVICE TRIALS

- The safety and serious side effects of new operations must be completely defined with adequate follow-up so that risks can be weighed against efficacy. At a minimum, this requires more use of large scale, independent, prospective, multicentre cohort studies when RCTs are not practical. HIGH
- Safety and serious side effects of incontinence devices must be completely defined with adequate follow-up, especially for use of implantable devices and biologic materials, so that risks can be weighed against efficacy. HIGH
- Valid informed research consent is required in all trials of research surgical interventions; this research consent is separate from the main surgical consent. HIGH
- Reports of successful treatment should be limited to subjects with a minimum (not mean) of

one-year follow-up and should include a patient perspective measure. Specific assumptions about subjects lost to follow-up should be stated. HIGH

- Whenever possible, randomisation for surgical trials should occur at the time of surgery to minimise drop-outs and switch of procedure HIGH
- Long-term follow-up of RCT cohorts in an observational cohort is recommended HIGH

17. PHARMACOTHERAPY TRIALS

Although many RCTs have been published in recent years on pharmacotherapy for urinary incontinence a great deal more remains to be learned. The trials have almost all been limited to 8-12 weeks of treatment giving very little information about long-term safety and efficacy of drug therapy. Inclusion criteria are often stringent, such that the study population of healthy middle-aged people bears little resemblance to the patients for whom providers wish to prescribe medication. There is less than adequate information about special patient groups—men, children, neurogenic patients, and especially the frail elderly. Because incontinence creates such an impact on the older population, good studies to define the utility and safety of drug therapy are greatly needed in this group.

An issue of special relevance in trials of pharmaceutical agents (although germane to other treatment modalities) is the controversy regarding placebos in clinical trials. Regardless of whether a drug is effective or not, simply giving a drug to a patient may produce a beneficial response. To assess if a drug has an effect over and above the placebo response, it is usually tested against an inactive substance (placebo). In incontinence studies, the placebo effect may be quite large, anywhere from 30-50% in recent published studies. To account for this, investigators and regulators have generally demanded a placebo arm in most clinical trials of medication. While this may be acceptable to participants for short trials, it is neither ethical nor feasible to withhold treatment for longer periods of time. Further, clinicians and patients generally want to know how a new drug compares with established treatment.

Masking, while desired in all types of trials, is especially important in pharmacological trials. Further, it is feasible to do in such trials (as opposed to surgical or conservative interventions, in which masking may not always be possible) and thus should be prioritized. However, the identical appearance of two pills does not guarantee that participants will be unaware of group assignment. Side effects common with anticholinergic therapy, such as dry mouth, may unmask participants. Studies should assess the degree to which masking was successfully maintained.

18. RECOMMENDATIONS FOR PHARMACOTHERAPY TRIALS

- As effective drug therapy is available for most forms of incontinence, active drug comparator arms are recommended for most trials. HIGH
- Very little is known about the safety, efficacy and tolerability of drug therapy beyond 12-week trials. A concerted effort is needed to create this type of information base. Long-term follow-up of RCT cohorts in an observational cohort is recommended HIGH

19. COST ANALYSIS

Economic and health policy outcomes are gaining increasing importance, as policy makers deliberate the values of different therapies. The financial burden on the health care system, the patient and patient's family of various treatment options makes cost an important outcome to measure. We recommend that cost analyses be planned with clinical studies whenever possible. Costs may be influenced by economic and political factors that are subject to change at any time; however, when basic units of work, time, and resources are carefully defined, models of costs remain useful even if market forces change in an unforeseen manner.

In health and medicine, economic analyses are descriptive and/or comparative. Descriptive data include the socioeconomic cost caused by the disease and its current treatment, whereas comparative data provide an economic evaluation of different treatment strategies and interventions where costs are compared to health outcomes.

There are several relevant types of cost analysis, some of which require a high level of expertise to conduct:

- *Cost of illness analysis* (COI) typically quantifies the burden of medical expenses (direct costs) and the resulting value of lost productivity (indirect costs) attributable to a specific condition such as an illness or injury.^(145,146)
- *Cost effectiveness analysis* (CEA) measures the costs and consequences of two or more diagnostic or treatment pathways related to a single common effect or health outcome. It then summarizes the results in ratios that demonstrate the cost of achieving a unit of health effect for different types of patients and for variations of the intervention.^(147,148)
- *Cost utility analysis* (CUA) is a form of cost effectiveness analysis in which particular attention is paid to the quality of health outcome related to treatment. In CUA, health effects are expressed in terms of quality-adjusted life years

(QALYs).^(118,149) A QALY is a measure of health outcome that assigns to a given period of time a weighting that corresponds to the health-related quality of life during that period, and then aggregates these weights across time periods. The QALY is important because it considers both quantity and quality of life.

- *Cost benefit analysis* estimates the net social benefit of an intervention by comparing the benefit of the intervention with the cost, with all benefits and costs measured in dollars.^(23,142) Health outcomes are converted into monetary values using "willingness to pay" (the value an individual would pay for reduction in illness severity) or "risk of death" or "human capital" methods (an individual's value to society based on productivity or future wages).^(144,146,150,151)

20. RECOMMENDATIONS ON COST ANALYSIS IN INCONTINENCE

- Cost analysis should be incorporated into clinical studies whenever possible.⁽¹⁴⁸⁾
HIGH

21. RECOMMENDATIONS FOR SPECIFIC PATIENT GROUPS

21.1. Men with LUTS

When considering men with LUTS, one must consider some unique factors that may influence urinary tract symptoms independently of any intervention, and so confound any data. These are the presence of the prostate gland that can cause bladder outlet obstruction (BOO), and the rarity of sphincter incompetence except in men who have undergone surgery for benign or malignant prostatic disease. For short term outcomes after intervention studies, these factors are unlikely to be relevant, but longer term follow up, and large observational or epidemiological studies may need to take these factors and changes over time into account when analysing data. The prostate gland may complicate research outcomes as a result of outflow obstruction (either at baseline, or development of a new problem during follow up studies). Also, for patients with prostate cancer (either at the time of enrolment, or during follow up of longer studies), it is likely that both the disease, and the treatment given (surgery or radiotherapy) may alter urinary tract function and symptoms independently of any intervention in the study and thus confound the outcomes. Overall, about 2/3 of men with LUTS have urethral obstruction and over 50 % have detrusor over-activity, although a much smaller number have urinary incontinence due to detrusor over-activity.⁽¹⁵²⁾

If prostate size is considered to be a variable that could affect outcomes, measurement of prostate volume should be made before and after treatment. The method used to measure volume and its reliability and validity should be provided if available or their absence indicated. Any associations between outcomes and change in prostate size should be tested for using appropriate methods and reported. Consideration should be given to stratifying participants by prostate volume when there is suspicion that response to therapy may be size dependent.

Insofar as about 2/3 of men with LUTS have bladder outlet obstruction (BOO), any research protocol in men should consider inclusion of a method to screen for it. At the least, maximum free urinary flow rates and measurement of post-void residual urine should be recorded before and after treatment and the effect of therapy on these parameters should be documented simultaneously with assessment of the primary outcome variables. Synchronous pressure-flow studies are generally desirable and should be included whenever feasible. Several pressure-flow nomograms have been proposed to diagnose obstruction in men. It is important to specify which if any nomogram is being used; the ICS nomogram is recommended.⁽¹⁵³⁾

Recommendations for Research in Men

- Measurement of prostate size should be performed before and after treatment (at the same time as continence outcome measures where possible) whenever prostate size is considered to be a potentially important variable, or to change during the intervention and follow up.
HIGH
- Maximum free flow rate and measurement of post-void residual urine should be recorded pre-treatment and the effect of therapy on these parameters should be documented simultaneously with assessment of the primary outcome variables.
HIGH
- Participants should be stratified by prostate size at randomisation when size is considered to be a potentially important determinant of treatment outcome.
LOW
- Clinical evaluations of different male UI products, including strengths, limitations and efficacy in clinically relevant subgroups.
LOW

21.2. Women with LUTS

a) Hormonal effects:

Our knowledge of hormonal influences on the lower tract remains limited. Randomised clinical trials and prospective cohort studies have demonstrated that hormone replacement therapy (HRT) does not improve or may worsen incontinence.⁽¹⁵⁴⁻¹⁵⁶⁾ It therefore seems appropriate that information about menstrual and hormonal status should be an integral part of the

baseline history. New studies designed to examine the influence of hormones on incontinence (if considered ethical by an appropriate review board) should include details of hormonal status (premenopausal, postmenopausal without HRT, post-menopausal with HRT), the route and type of HRT (oestrogen only, combined sequential, combined continuous), and whether or not oophorectomy has been performed.

b) Obstetric History:

The influence of vaginal childbirth on the structure and function of the female pelvis is the focus of much recent and ongoing research but the complex interactions remain incompletely understood. While it is clear that childbirth, and particularly vaginal childbirth increases the risk of incontinence and pelvic organ prolapse, the potential effect of further childbirth on previous or current treatments of incontinence (especially surgery) has yet to be determined.

Potentially confounding variables include: number and route of deliveries (vaginal/Cesarean), use of forceps or vacuum, infant birthweight and head circumference, duration of second stage of labour, use of episiotomy and any vaginal or perineal trauma, and epidural anaesthesia. The importance of these variables will depend upon the specific study design; for randomised studies the allocation process should balance these between groups, but consideration should be given to stratifying or minimising the randomization against one or more of these important factors, depending on the exact intervention. For epidemiological or observational research each of these factors should be collected and included in univariate and multivariate analyses.

c) Pelvic Organ Prolapse:

The effect of pelvic organ prolapse on lower urinary tract function remains poorly understood. Pelvic organ prolapse may potentially affect lower urinary tract function by obstruction of the urethral outflow, and thereby mask sphincter weakness (so called "occult" stress incontinence). Emerging evidence suggests that prolapse may contribute to the symptoms of OAB and correction of the prolapse may modulate these symptoms. Thus, it is important to include assessment of pelvic organ prolapse in incontinence research on women. A validated assessment method for prolapse should be used to identify the stage of prolapse; the Pelvic Organ Prolapse Quantification System (POP-Q)⁽⁹⁾ is recommended. Research protocols should be developed, either excluding women with prolapse severity beyond a specified stage, or the analysis plan should include stratification for stage of prolapse in randomisation, and adjustment for prolapse stage in any analysis. For larger studies where regression analyses are planned, stage of prolapse should be considered a mandatory factor for inclusion. Prolapse should be graded at the same time as the outcome assessment for incontinence and LUTS is performed.

Recommendations for Research in Women

- Specific information about menopausal status, hysterectomy, parity/obstetric history, and hormonal status should be included in baseline clinical trial data and controlled for in specified analyses in the research protocol. HIGH
- High quality, symptom and bother scores (e.g., ICIQ-FLUTS, KHQ, PISQ, ICIQ-FLUTSsex) validated in women should be employed when assessing outcomes HIGH
- Standardised assessment of pelvic organ prolapse (by POPQ) should be performed before treatment and at the time of other outcome assessments in all research where prolapse and continence outcomes are being assessed. HIGH
- Criteria for cure/improvement/failure from incontinence treatment should be defined in the protocol based on patient perception as well as objective and semi-objective instruments such as validated questionnaires, diaries and pad tests. HIGH
- Assessment of the impact of treatment on sexual function should be performed with other outcome assessment when appropriate. MEDIUM

21.3. Frail older and Disabled Men and Women

There are a number of unique and pertinent research issues for this population.

In the frail elderly, important variables include:

- Demographic information: Advancing age, white race, and women (156-159) are associated with an increase risk of incontinence and each of these variables should be adjusted for in most analyses.
- Medical Conditions: Medical conditions related and unrelated to the lower urinary tract have been shown to increase the risk of incontinence in older women and are especially important to assess in the frail older population.^(158,160-162) Prior hysterectomy has also been suggested as a potential risk factor for incontinence in older women.^(163,164)
- Medication Inventory: Certain medications may exacerbate incontinence and therefore a complete medication inventory is essential.^(162,164-166)
- Physical function: Mobility is often impaired in the frail elderly and impacts urinary control⁽¹⁶⁷⁾, therefore mobility should be assessed using validated instruments such as the Bartel Orcats or ADL scales.^(167,168) Data on walking aids or wheelchairs, gait speed, and manual dexterity may also be collected.

- Cognitive function: Cognitive function impairment and/or dementia increase the risk of incontinence.⁽¹⁶⁹⁾ The Mini-Mental Status Scale Examination⁽¹⁷⁰⁾ assesses global cognitive function, and the Confusion Assessment Method (CAM)⁽¹⁵⁹⁾ is a standardized assessment for delirium. A battery of neuropsychological tests to measure subtle impairments in cognitive function include the Buschke Selective Reminding Test (verbal learning and memory)⁽¹⁷¹⁾, the Digit Symbol (incidental memory, visual scanning and motor speed)⁽¹⁷²⁾, and the Trails A (attention and visual).⁽¹⁷³⁾

Outcome measures should be selected for applicability to the frail elderly. Commonly used self-reported measures of frequency of urinary symptoms, severity, or level of bother may not be possible in the cognitively impaired frail elderly patient. Similarly, voiding diaries that have been shown to be valid and reliable in assessing urinary frequency, nocturia, and incontinence episodes by type^(149,173-175) may not be feasible or reliable. Motivated and trained staff, caregivers, or family members may be able to adequately collect diary data; however, this has not been validated.

In nursing home or inpatient settings, wet checks by staff at set intervals have been used in a number of studies. There are limitations to the measurement including visually determining what is “wet” because of new absorbent materials and staff reports not always being reliable or valid, due to underreporting.^(176,177) To overcome the limitation of defining wetness and underreporting, 24-hour pad weighing tests^(178,179) may be used. Pad weighing tests and wet checks are feasible and can provide important outcome data if staff is well trained and checks are often.⁽¹⁴⁾ New outcome measures specific to the frail older population such as increased socialization or decreased caregiver burden need to be developed.

21.4. Children and Adolescents

The conduct of clinical research in children is no more difficult than in adults, as parents and caregivers are often motivated and eager to participate. Four overriding issues separate paediatric research from the general recommendations. First, developmental physiology and psychology varies widely within the group referred to as children undergo many different stages: newborns, infants, toddlers, preschoolers, school age children, adolescents and young adults. They not only differ from older adults, but also undergo rapid developmental changes within a short time. Because children are growing, any treatment, especially pharmacological and surgical therapy, may affect them profoundly in the long term. On the other hand, treatment in children can be more effective than in adults precisely due to this developmental flexibility. A specific aspect is the close interaction between the developing central nervous system and peripheral organs such as the bladder. In addition, the interaction between the urinary and gastro-intestinal system plays a special role in this age group. Second,

compliance with therapy requires the inclusion of parents, as children and even adolescents depend on caregivers to administer treatment in most studies. Third, reporting of symptoms and outcomes requires the assessment by both parents (proxy) and children. Symptoms reported by a caregiver may not be interpreted in the same way as the child, which is important to consider. Finally, the issue of informed consent is complex with children, but this has been settled by legal requirements in most countries.

Urinary incontinence in children falls into four main categories: organic, i.e. neurogenic (myelomeningocele and other less common neurogenic aetiologies) or structural; nocturnal enuresis, which can be either mono-symptomatic or polysymptomatic; non-organic daytime urinary incontinence, including detrusor over activity, voiding postponement and dysfunctional voiding without neurological disease. This issue of age groups is most crucial in children with myelomeningocele. These children are often on medication beginning at a very young age and continuing for many years; the long-term safety of medications in children must be established in all age groups. We recommend that clinical studies have long-term (five years or more), open label extension arms to monitor safety, particularly focusing on normal growth and development and the effects on treatment of liver and central nervous system function. Therapy for other causes of incontinence in children tends to start at a later age, i.e. the definitional age of incontinence (5 years).

Assessment of compliance with therapy is always difficult, and can also be so with children. Compliance with voiding diaries, a significant issue in the adult population, has to be monitored to achieve reliable results. The social and family interactions between the child and parent or caregiver, as well as own behavioral issues and disorders, can influence the accuracy of data collection and treatment compliance, both positively and negatively.

Outcome measures have been developed in children as in adults. Validated, age-specific symptom and disease-specific quality of life instruments are available for most chronic disease for the paediatric population, as well as generic instruments. Early efforts in this area have been reported for dysfunctional voiding and daytime incontinence. Invasive urodynamics can be used when deemed appropriate (specifically in the neurogenic population), but is usually not required in non-organic incontinence.

21.5. Neurogenic Populations

Neurogenic lower urinary tract dysfunction (NLUTD) is defined as a bladder disorder secondary to a known neurological lesion, disease or condition. This broad definition includes a very heterogeneous constellation of neurological disorders and syndromes making the clinical diagnosis of NGB difficult in many cases.

Classification of NLUTD has three primary aims—to aid in discriminating or identifying an unknown underlying neurological disease process, to characterise the nature of the dysfunction so as to develop a treatment plan, and to assess the risk of secondary effects (e.g. on the upper tract) which may influence the necessity and aggressiveness of treatment. The latter two are clearly relevant to research in neurogenic incontinence and must be reflected in study design and patient description.

It is difficult to find a classification system for NLUTD that serves both clinical and research demands that is satisfactory for each of the three aims. The published NLUTD classification systems have been reviewed in detail in textbooks. Both the disease process and the site of the neurological lesion(s) are relevant in the study of NLUTD, yet even this information is inadequate to predict the functional lower urinary tract deficits for an individual patient. There is no one method that meets the broad needs of classification in this group. Typical or classic cases are often well described but it is especially difficult to describe mixed and incomplete lesions. Historically, classification systems oversimplify or become extremely complex to apply in routine clinical practice.

A new classification system has been proposed by Powell to better define the neurogenic lesion or condition affecting lower urinary tract function and thereby help direct treatment.⁽¹⁸⁰⁾ The SALE (Stratify by Anatomic Location and Etiology) classification system for NLUTD is based on seven categories (six anatomical/aetiological and one future biomarker), each having a neurological defect (upholds basic definition) in a distinct anatomic location. The system incorporates the presence or absence of bowel dysfunction and autonomic dysreflexia. The proposed classification divisions which would benefit research stratification including supra-pontine, pontine, supra-sacral, sacral, lower motor neuron/neuropathy, and syndromes with no definitive neurological lesion detected thus far.

According to the European Urology Association guidelines for managing the neurogenic bladder, primary aims for treatment (also research) include protection of the upper urinary tracts, improve urinary continence, restore function and improve quality of life when possible.⁽¹⁸¹⁾ Despite proper classification and guideline adherence, it must be acknowledged that the complexity of neurological diseases and variations in individual behaviour almost always call for a customised approach to therapy, further complicating research in the neurogenic patient. All of these factors may complicate study design as it becomes difficult to create workable inclusion and exclusion criteria that apply to other than a narrow segment of the neurogenic population. Ideally a broad population of potentially relevant participants would be enrolled in research studies with full characterisation of both the neurological condition and the nature of the lower urinary tract dysfunction so as to allow for subgroup

analysis. The new SALE system may provide a better classification scheme for NLUTD.

Study planning is best undertaken with the cooperation of urologist, neurologist, and other clinicians, who have a specific interest and special training in the neurogenic patient. Baseline data collected by history in subjects with neurogenic lower urinary tract disorders should include:

- bladder volumes by diary or examination (maximum voided or catheterised volume, post voiding residual urine, total capacity);
- mechanism of bladder evacuation: normal (volitional), spontaneous involuntarily (“reflex”), Credé, sterile intermittent catheter (SIC), clean intermittent catheter (CIC), intermittent catheter by second person, or suprapubic or urethral catheter;
- use of external appliances (e.g., diaper or pad use, condom catheter, urethral catheter, suprapubic tube);
- the typical time span of continence (continence interval) following last bladder evacuation and maximal continent bladder volume.
- bowel function, sexual function, and specific neurologic deficits
- the evolution of the condition of (changes in) the upper tract should be included in the outcomes evaluation of treatment for NLUTD.

Where possible these factors should be controlled for in analyses and stratified for in randomisation for interventional studies, or patients with certain factors should be excluded. The details will depend on the research question to be asked.

21.6. Outcome Measures for NLUTD

Follow-up recommendations for patients with NLUTD are based on long-standing evidence suggesting increased risk of bladder cancer as well as upper tract deterioration in this patient population. A study of cancer-specific mortality in a population of U.S. Veterans with Spinal Cord Injury demonstrated up to 70% greater bladder cancer specific mortality in patients with SCI as compared to those without the condition. In a study by El Masri regarding the issue of cystoscopic surveillance, the author stated, “Since the second world war, integration of urological surveillance and timely intervention in the management of patients with SCI has reduced morbidity and mortality prolonging survival.”⁽¹⁸²⁾ However, despite this observational data, strong evidence regarding the type and timing of surveillance in patients with NLUTD is lacking. Several organizations have set out to improve outcomes by creating evidence-based guidelines for follow-up and surveillance. Some of the more publicized of these include:

- European Association of Urology (EAU): “Guidelines on Neurogenic Lower Urinary Tract Dysfunction” P⁽¹⁸³⁾
- United Kingdom: National Institute for Health and Clinical Excellence (NICE) “Urinary Incontinence in Neurological Disease: management of lower urinary tract dysfunction in neurological disease”⁽¹⁸⁴⁾
- U.S. Veteran’s Health Administration Handbook on Spinal Cord Injury and Disorders (SCI/D) Systems of Care⁽¹⁸⁵⁾
- American Urological Association (AUA) and Society for Urodynamics Female Pelvic Medicine and Reconstructive Urology (SUFU): Guidelines for Urodynamics⁽¹⁸⁶⁾
- The Consortium for Spinal cord Medicine “Bladder Management in Adults with Spinal Cord Injury”⁽¹⁸⁷⁾

A comprehensive review of these guidelines is beyond the scope for this chapter; however, key areas included renal function testing, imaging, cystoscopy, and urodynamics. The most aggressive surveillance protocol came from the EAU guidelines that recommended yearly renal function testing, imaging every 6 months, and urodynamics at least every 1-2 years. The NICE guidelines recommended ultrasound surveillance every 1-2 years, consideration of urodynamics for high risk patients, and that surveillance cystoscopy should not be performed. The variability in these guidelines, which are derived mainly from poorly done observational studies and are consensus based, speaks to a pressing research need for the ICI to encourage long-term evidence based studies on outcomes in patients with NLUTD and how these are affected by different forms of surveillance and management.

Measuring quality of life outcomes in the NLUTD population has often lagged behind other lower urinary tract disorders due to the heterogeneity of the neurological conditions that are often grouped together (i.e. spinal cord injury with multiple sclerosis). Several patient-reported outcome measures (PROMs) have been specifically designed for measuring the quality of life in patients with neurogenic bladder. Costa and associates described the Qualiveen in 2001 to measure the quality of life in patients with spinal cord injury and it has been validated and is available in English, French, Dutch, Spanish and Italian. Clark and Welk contributed an excellent review of 16 PROMs for assessment of quality of life and symptoms in neurogenic bladder patients⁽¹⁸⁹⁾. Selection of the appropriate PROM for measuring quality of life outcomes is essential for clinicians and researchers working with the NLUTD population.

The following summary highlights recommendations for research in the key areas of this Consultation.

22. RECOMMENDATIONS FOR RESEARCH IN POPULATIONS AFFECTED BY NEUROLOGICAL URINARY AND FAECAL INCONTINENCE

22.1. Pathophysiology of NLUTD

- An area of **high priority for research** is the development of a more directly informative classification system which would include anatomical location and aetiology in association with corresponding urinary, faecal and neurological symptoms, information from clinical neurophysiological testing and urodynamic abnormalities as well as prognostic biomarkers
- As such, the classification would describe a patient suffering from NLUTD and simultaneously inform about the most appropriate treatment, follow-up regimen, and long-term prognosis

22.2. Diagnostics

- Studies to establish neurological populations and absolute indications for the use of invasive urodynamics in NLUTD as a primary assessment tool and as specialized assessment tool. Also, establish its best application for follow-up of treatment modalities HIGH
- Research to establish what is ‘urodynamic safety’ in NLUTD, preferably by population studied HIGH
- Identify clinical predictors of urodynamic findings in NLUTD MEDIUM
- To further develop patient reported outcome measures in NLUTD HIGH
- Further research into neuroimaging and its association with clinical neurourological practice HIGH
- Further development and standardisation is needed for the use of electrosensation test to become established as a clinical test LOW
- Research to produce high level evidence to define UTI’s in neurological patients HIGH
- Need more evidence for the use of prophylactic antibiotics to reduce symptomatic urinary tract infections after invasive UDS LOW

22.3. Management of NLUTD

- Research into mechanisms and prognosis of the development of bladder cancer in patients with NLUTD HIGH
- It is currently not possible to state whether any IC method or catheter type is advantageous due

to the poor quality of available studies. Further research on the topic is strongly recommended HIGH

22.4. Pharmacotherapy for NLUTD

- Further research is needed to establish the efficacy and safety of the newer antimuscarinics in NLUTD, long-term outcomes and safety, the efficacy and safety of mirabegron in NLUTD, as well as combination treatments HIGH
- Oral and intravesical cannabinoid agonists have shown promising results either in clinical or pre-clinical studies, and should be further investigated for optimal balance between efficacy and safety in NLUTD MEDIUM
- Further research needed on pharmacotherapy for detrusor-sphincter dyssynergia, sphincter deficiency and detrusor underactivity HIGH

22.5. Minimally Invasive Treatments – Botulinum Toxin A

- Further research is needed on long-term outcomes and safety, administration techniques, the bio-equivalence of the various preparations, the concomitant use of anticholinergic drugs or β 3-agonists, mechanisms of action, and wider effects HIGH
- Future research should also focus on PROs and patient satisfaction, tolerability issues, alternative techniques of application, ways to minimise post-treatment voiding dysfunction in patients who void freely HIGH
- Larger studies in select patient populations are also recommended HIGH

22.6. Electrical Neuromodulation

- Further studies on chronic pudendal nerve stimulation must be carried out to identify the best stimulation parameters and to verify the long term results
- The thalamus may be a promising target for the development of new therapies for lower urinary tract dysfunction. Further investigation on this matter is needed before its potential role can be elaborated.
- IVES is a viable option to induce/improve bladder sensation and to enhance the micturition reflex in patients with incomplete central or peripheral nerve damage, but corroborating controlled evidence is needed
- Research to establish indications for sacral neuromodulation in the care of DSD in neurological urinary dysfunction.

22.7. Surgery for NLUTD

- Published data is inadequate to support a recommendation on the use of bladder neck incision in

patients with inadequate bladder emptying due to DBND, either as a first-line procedure or as a complementary approach to DBND recognised following permanent urethral stenting. Further studies are needed

- Bladder augmentation using biomaterials or tissue engineering is promising, but the preliminary results need to be confirmed by larger studies

22.8. Specific Neurological Conditions

Requirement for robust epidemiological research, insight into mechanisms, studies on utility of diagnostic tests, assessment of urinary tract risk factors, and randomized trials to assess benefits and harms of therapy for specific neurological diseases. Urinary and faecal incontinence both suffer from limited high quality research, and faecal incontinence in particular.

Priority Research Topics Include:

- Systematic cataloguing of the specific brain centres pertinent to lower urinary tract control, and how they are at risk in given neurological diseases
- How medications for LUTS may influence specific neurological diseases or associated dysfunctions (e.g. blood pressure control)
- The clinical relevance of functional brain imaging to clinical management
- Indicators of neurological presentation or progression that may be first evident in urological clinics

23. RECOMMENDATIONS FOR RESEARCH IN POPULATIONS AFFECTED BY FAECAL INCONTINENCE

- Collect data on faecal incontinence whenever practical as part of research on urinary incontinence
- Develop techniques for diagnosing faecal incontinence and its aetiologies using new and available diagnostic technologies
- Develop user-friendly measures and instruments for quantifying the severity of faecal incontinence and other components of anal incontinence separately and in total
- Investigate the epidemiology of the different types and subtypes of bowel and anal incontinence
- Well designed and adequately powered studies are needed to evaluate faecal incontinence treatment modalities currently available including:

- Effectiveness of lifestyle modifications including weight loss, exercise, diet and eating pattern modifications, and supplementing dietary fibre as an adjuvant or combined strategy
- Comparative effectiveness trials of instrumented biofeedback training versus neuro-modulation
- Effectiveness of tibial nerve stimulation (transcutaneous and percutaneous)
- Develop and test interventions for promoting care seeking and self-management of faecal incontinence (and associated odour and urgency)
- Develop and test interventions for increasing coping skills and health literacy related to faecal incontinence for patients and family caregivers
- Evaluate tailoring the management of faecal incontinence based on patients' goals, peer support, and the use of current technologies such as mobile devices for delivering management and support interventions to patients and family caregivers

24. RECOMMENDATIONS FOR RESEARCH IN POPULATIONS AFFECTED BY BLADDER PAIN SYNDROME (INCLUDING INTERSTITIAL CYSTITIS)

- Broadened the research scope to improve symptom-based classification to identify the degree of bladder and non-bladder symptoms.
- Develop a simple, non-invasive diagnostic test for BPS
- Research that focuses identify bladder-specific pathology, a bladder pain syndrome-specific biomarker
- Establish patient databases in different regions and conduct longitudinal follow-up to understand the natural history of the disease and to examine the differences in disease natural history among regions.
- Develop a practical multi-disciplinary care model and test it in various settings.
- Develop an easy-to-use tool for non-specialists to readily identify co-morbid conditions that may impact on the need for additional consultation and suggest specific treatment pathways.

25. RECOMMENDATIONS FOR RESEARCH IN POPULATIONS

AFFECTED BY PELVIC ORGAN PROLAPSE

Significant further research is required in most areas of the surgical management of prolapse including but not limited to:

- Uterine prolapse and its various treatment options
- Surgery for recurrent prolapse
- Identifying risk factors for recurrent prolapse
- Re-evaluation of prolapse quality of life questionnaires to ensure they are sensitive to change
- The utilisation and incorporation of tissue engineering in pelvic organ prolapse surgery
- Impact of POP surgery on bladder overactivity.
- Impact of POP surgery on urinary voiding dysfunction
- Impact of rectocele repair on symptoms of obstructed defaecation and faecal incontinence

26. RECOMMENDATIONS FOR RESEARCH IN CHILDREN AND ADOLESCENTS

- Long-term follow-up is of critical importance in the paediatric population in order to ascertain the effect of a treatment on normal growth and development. HIGH
- Research is needed to develop standardized outcome measures including validated, age-specific symptom and disease-specific quality of life outcome measures. MEDIUM
- Research of problems specific to different age groups is needed. Especially, incontinence in preschool children and in adolescents is needed. HIGH
- The transition and transfer from paediatric to adult care should be studied and evidence-based recommendations should be formulated. HIGH
- The specific incontinence problems of young adults aged 18-21 years need more attention in research. MEDIUM
- Incontinence in children and adults with special needs is a neglected part of research and clinical care. These include individuals with intellectual disability, specific syndromes, autism spectrum and other disorders. HIGH
- The interaction between brain and bladder and/or gut needs to be studied with new functional and structural imaging techniques of the CNS. HIGH

- Treatment studies of daytime urinary incontinence, including pharmacotherapy and urotherapy, are needed. HIGH
- The correlates of sleep in children with nocturnal enuresis needs to be elucidated in more detail. HIGH
- Life span, longitudinal epidemiological studies from childhood to adulthood in a prospective design are required to procure representative data. HIGH

27. RECOMMENDATIONS FOR RESEARCH IMPROVEMENT IN BASIC SCIENTIFIC RESEARCH

Integrate data from reductionist experiments to inform the formulation of better systems-based approaches in the investigation of the pathology of the lower urinary tract (LUT), the genital tract (GT) and the lower gastro-intestinal tract (LGIT).

Encourage greater emphasis on basic research to characterise tissues receiving relatively little attention: ie the lower gastrointestinal tract; the bladder neck and urethra; the ureter, pelvic floor musculature.

Generate research programmes for foetal and neonatal research in LUT and LGIT function.

Use genome-wide bioinformatics and population health surveys to generate testable hypotheses regarding the physiological and pathophysiological functions of the LUT, GT and LGIT.

Generate improved experimental approaches to investigate the pathophysiology of the LUT and LGIT by:

- the development of animal models that accurately describe human pathological conditions, including the greater use of large-animal models
- the better use of reverse translational approaches for linking animal models to the human disease.
- the use of human tissue from well-characterised patient groups.
- the development of emerging areas such as: tissue engineering; proteomics and metabolomics
- increased collaborations between biological, physical and mathematical sciences.

Develop centres of excellence or consortia of excellence in LUT, GT and GIT research

- integrate expertise from university departments, academic medical units and industry
- encourage translational approaches to research.

- develop inter-institutional research-training programmes to allow new researchers the opportunity to better interact and exchange ideas.

Additional emphasis on the importance of research to medical trainees and science graduates through:

- establishing research training as a core component of postgraduate clinical development
- increased access to support funds, especially scholarships and personal awards
- organisation of focused multidisciplinary research meetings, either stand-alone or as dedicated sessions during national and international conferences
- greater interaction between medical centres and Higher Education Institutions (HEIs).
- allowing researchers-in-training better access to international meetings through reduced registration charges and improved travel grants.
- inclusion in clinical meetings of point-counterpoint session(s) with both basic science and clinical viewpoints.
- development of research fora for exchange of ideas between active researchers and industry.
- lobbying research-funding organisations about the medical and social importance of LUT and LGIT disorders.

Increase emphasis on research into LUT and LGIT in HEIs through:

- greater representation on grant-funding agencies
- encouragement of submission to high impact-factor journals and recognition of research published in specialty journals
- more integrated teaching and training opportunities.

VI. CONCLUSIONS

The 2016 Consultation examined and classified available data in order to determine the level of evidence that supports our research for individual with urinary incontinence and closely related disorders, including pelvic organ prolapse. In order to meaningfully advance research in the focus area of this consultation, investigators are strongly encouraged to begin with a clear, relevant and impactful research question. Careful design, conduct and analysis of the research study is paramount. Prompt dissemination with appropriate data sharing is strongly recommended in order to benefit affected individuals and the broader research community working in this field.

REFERENCES

1. Abrams P, Blaivas JG, Stanton SL, Andersen JT. The standardization of terminology of lower urinary tract function. The International Continence Society Committee on Standardization of Terminology. *Scand J Urol Nephrol* 1988;114:5-19.
2. Bates P, Bradley WE, Glen E, Melchior H, Rowan D, Sterling A, et al. The standardization of terminology of lower urinary tract function. *Eur Urol* 1976;2(6):274-276.
3. Bates P, Glen E, Griffiths D, Melchior H, Rowan D, Sterling A, et al. Second report on the standardization of terminology of lower urinary tract function. Procedures related to the evaluation of micturition: Flow rate, pressure measurement, symbols. *Act Urol Jpn* 1977;27:1563-1566.
4. Bates P, Braley WE, Glen E, Griffiths D, Melchior H, Rowan D, et al. Third report on the standardization of terminology of lower urinary tract function. Procedures related to the evaluation of micturition: Pressure flow relationships, residual urine. *Br J Urol* 1980;52:348-359.
5. Fourth report on the standardization of terminology of lower urinary tract function. Terminology related to neuromuscular dysfunction of the lower urinary tract. Produced by the International Continence Society. *Br J Urol* 1981 Aug;53(4):333-335.
6. Abrams P, Blaivas JG, Stanton SL, Andersen J, Fowler CJ, Gerstenberg T, et al. Sixth Report on the Standardization of Terminology of Lower Urinary Tract Function. Procedures related to neurophysiological investigations: electromyography, nerve conduction studies, reflex latencies, evoked potentials and sensory testing. *Br J Urol* 1987;59(4):300-4.
7. Rowan D, James ED, Kramer AE, Sterling AM, Suhel PF. Urodynamic equipment: technical aspects. Produced by the International Continence Society Working Party on Urodynamic Equipment. *J Med Eng Technol* 1987 Mar-Apr;11(2):57-64.
8. Andersen J, Blaivas J, Cardozo L, Thuroff J. Lower Urinary Tract Rehabilitation Techniques: Seventh Report on the Standardization of Terminology of Lower Urinary Tract Function. *Int Urogynecol J* 1992;3:75 - 80.
9. Bump R, Mattiasson A, Bo K, Klarskov P, Smith ARB, Brubaker L, et al. The standardization of terminology of female pelvic organ prolapse and pelvic floor dysfunction. *Am J Obstet Gynecol* 1996;175:10-7.
10. Griffiths D, Hofner K, van Mastrigt R, Rollema HJ, Spangberg A, Gleason D. Standardization of terminology of lower urinary tract function: pressure-flow studies of voiding, urethral resistance, and urethral obstruction. International Continence Society Subcommittee on Standardization of Terminology of Pressure-Flow Studies. *Neurourol Urodyn* 1997;16(1):1-18.
11. Mattiasson A, Djurhuus JC, Fonda D, Lose G, Nordling J, Stohrer M. Standardization of outcome studies in patients with lower urinary tract dysfunction: a report on general principles from the Standardisation Committee of the International Continence Society. *Neurourol Urodyn* 1998;17(3):249-253.
12. Lose G, Fantl JA, Victor A, Walter S, Wells TL, Wyman J, et al. Outcome measures for research in adult women with symptoms of lower urinary tract dysfunction. *Neurourol Urodyn* 1998;17(3):255-262.
13. Nordling J, Abrams P, Ameda K, Andersen JT, Donovan J, Griffiths D, et al. Outcome measures for research in treatment of adult males with symptoms of lower urinary tract dysfunction. *Neurourol Urodyn* 1998;17(3):263-271.
14. Fonda D, Resnick NM, Colling J, Burgio K, Ouslander JG, Norton C, et al. Outcome measures for research of lower urinary tract dysfunction in frail older people. *Neurourol Urodyn* 1998;17(3):273-281.
15. Tjandra J, Chan M, Yeh C, Murray-Green C. Sacral Nerve Stimulation is more Effective than Optimal Medical Therapy for Severe Fecal Incontinence: A Randomized, Controlled Study. *Dis Colon Rectum* 2008;51:494-502.
16. Blaivas JG, Appell RA, Fantl JA, Leach G, McGuire EJ, Resnick NM, et al. Standards of efficacy for evaluation of treatment outcomes in urinary incontinence: recommendations of the Urodynamic Society. *Neurourol Urodyn* 1997;16(3):145-147.
17. Blaivas JG, Appell RA, Fantl JA, Leach G, McGuire EJ, Resnick NM, et al. Definition and classification of urinary incontinence: recommendations of the Urodynamic Society. *Neurourol Urodyn* 1997;16(3):149-151.
18. Blaivas JG. Outcome measures for urinary incontinence. *Urol* 1998 Feb;51(2A Suppl):11-19.
19. Spilker B. Guide to clinical studies and developing protocols. New York: Raven Press; 1984.
20. Emanuel EJ, Wendler D, Grady C. What makes clinical research ethical? *JAMA* 2000 May 24-31;283(20):2701-2711.

21. Sung NS, Crowley WF, Jr, Genel M, Salber P, Sandy L, Sherwood LM, et al. Central challenges facing the national clinical research enterprise. *JAMA* 2003 Mar 12;289(10):1278-1287.
22. Barnbaum DR, Byron M. *Research ethics: Text readings*. Upper Saddle River, NJ: Prentice Hall; 2001.
23. Gallin J. *Principles and practices of clinical research*. 2002: Academic Press; 2002.
24. Shamoo AE, Resnik DB. *Responsible conduct of research*. New York, NY: Oxford University Press; 2003.
25. Department of Health and Human Services., *Protection of human subjects*. 2005; Available at: <http://www.hhs.gov/ohrp/>.
26. Federman D, Hanna K, Rodriguez LL. *Responsible research: A systems approach to protecting research participants*. Washington, DC: The National Academies Press; 2002.
27. Cobb WM. The Tuskegee syphilis study. *J Natl Med Assoc* 1973 Jul;65(4):345-348.
28. MILGRAM S. Behavioral Study of Obedience. *J Abnorm Psychol* 1963 Oct;67:371-378.
29. *Ethical principles and guidelines for the protection of human subjects of research*. 1979; Available at: www.hhs.gov/ohrp/humansubjects/guidance/belmont.htm.
30. Weijer C, Miller PB. When are research risks reasonable in relation to anticipated benefits? *Nat Med* 2004 Jun;10(6):570-573.
31. Hulley ST, Cummings SR, Browner WS, Grady DG, Newman TB. *Designing clinical research*. 3rd ed. Philadelphia: Lippincott, Williams & Wilkins; 2007.
32. Featherstone K, Donovan JL. Random allocation or allocation at random? Patients' perspectives of participation in a randomised controlled trial. *BMJ* 1998 Oct 31;317(7167):1177-1180.
33. Donovan J, Mills N, Smith M, Brindle L, Jacoby A, Peters T, et al. Quality improvement report: Improving design and conduct of randomised trials by embedding them in qualitative research: ProtecT (prostate testing for cancer and treatment) study. Commentary: presenting unbiased information to patients can be difficult. *BMJ* 2002 Oct 5;325(7367):766-770.
34. Association of American Medical Colleges. Task force on financial conflicts of interest in clinical research protecting subjects, preserving trust, promoting progress II: Principles and recommendations for oversight of an institutions' financial interests in human subjects research. 2002; Available at: <https://www.aamc.org/newsroom/news-releases/2002/82660/020923.html>.
35. Bekelman JE, Li Y, Gross CP. Scope and impact of financial conflicts of interest in biomedical research: a systematic review. *JAMA* 2003 Jan 22-29;289(4):454-465.
36. *Financial Conflict of Interest*. NIH. 2011. Revised Regulations. 2014; 2016. Available at: <http://grants.nih.gov/grants/policy/coi/>.
37. *Rigor and Reproducibility*. NIH. 2016; Available at: <http://grants.nih.gov/reproducibility/index.htm>
38. Lukacz ES, Sampsel C, Gray M, Macdiarmid S, Rosenberg M, Ellsworth P, et al. A healthy bladder: a consensus statement. *Int J Clin Pract* 2011 Oct;65(10):1026-1036.
39. *Prevention of Lower Urinary Tract Symptoms in Women: Bladder Health Scientific and Data Coordinating Center (PLUS -SDCC) (U01)*. Available at: <http://grants.nih.gov/grants/guide/rfa-files/rfa-dk-14-018.html>.
40. Klein RJ, Zeiss C, Chew EY, Tsai JY, Sackler RS, Haynes C, et al. Complement factor H polymorphism in age-related macular degeneration. *Science* 2005 Apr 15;308(5720):385-389.
41. Burton P, Clayton D, Cardon L, Craddock N, Deloukas P, Duncanson A, et al. Genome-wide association study of 14,000 cases of seven common diseases and 3,000 shared controls. *Nature* 2007;447:661-78.
42. Pritchard JK, Cox NJ. The allelic architecture of human disease genes: common disease-common variant...or not? *Hum Mol Genet* 2002 Oct 1;11(20):2417-2423.
43. Reich DE, Lander ES. On the allelic spectrum of human disease. *Trends Genet* 2001 Sep;17(9):502-510.
44. Gibson G. Rare and common variants: twenty arguments. *Nat Rev Genet* 2012 Jan 18;13(2):135-145.
45. Manolio TA, Collins FS, Cox NJ, Goldstein DB, Hindorf LA, Hunter DJ, et al. Finding the missing heritability of complex diseases. *Nature* 2009 Oct 8;461(7265):747-753.
46. Visscher PM. Sizing up human height variation. *Nat Genet* 2008 May;40(5):489-490.
47. Visscher PM, Brown MA, McCarthy MI, Yang J. Five years of GWAS discovery. *Am J Hum Genet* 2012 Jan 13;90(1):7-24.
48. Morris AP. Fine mapping of type 2 diabetes susceptibility loci. *Curr Diab Rep* 2014;14(11):549-014-0549-2.

49. Richter HE, Whitehead N, Arya L, Ridgeway B, Allen-Brady K, Norton P, et al. Genetic contributions to urgency urinary incontinence in women. *J Urol* 2015 Jun;193(6):2020-2027.
50. Dyrskjot L, Zieger K, Real FX, Malats N, Carrato A, Hurst C, et al. Gene expression signatures predict outcome in non-muscle-invasive bladder carcinoma: a multicenter validation study. *Clin Cancer Res* 2007 Jun 15;13(12):3545-3551.
51. Hipp J, Andersson KE, Kwon TG, Kwak EK, Yoo J, Atala A. Microarray analysis of exstrophic human bladder smooth muscle. *BJU Int* 2008 Jan;101(1):100-105.
52. Hipp JA, Hipp JD, Yoo JJ, Atala A, Andersson KE. Microarray analysis of bladder smooth muscle from patients with myelomeningocele. *BJU Int* 2008 Sep;102(6):741-746.
53. Erickson DR, Schwarze SR, Dixon JK, Clark CJ, Hersh MA. Differentiation associated changes in gene expression profiles of interstitial cystitis and control urothelial cells. *J Urol* 2008 Dec;180(6):2681-2687.
54. Keay S, Seillier-Moiseiwitsch F, Zhang CO, Chai TC, Zhang J. Changes in human bladder epithelial cell gene expression associated with interstitial cystitis or antiproliferative factor treatment. *Physiol Genomics* 2003 Jul 7;14(2):107-115.
55. Blalock EM, Korrekt GS, Stromberg AJ, Erickson DR. Gene expression analysis of urine sediment: evaluation for potential noninvasive markers of interstitial cystitis/bladder pain syndrome. *J Urol* 2012 Feb;187(2):725-732.
56. Shyamsundar R, Kim YH, Higgins JP, Montgomery K, Jordan M, Sethuraman A, et al. A DNA microarray survey of gene expression in normal human tissues. *Genome Biol* 2005;6(3):R22.
57. Fagerberg L, Hallstrom BM, Oksvold P, Kampf C, Djureinovic D, Odeberg J, et al. Analysis of the human tissue-specific expression by genome-wide integration of transcriptomics and antibody-based proteomics. *Mol Cell Proteomics* 2014 Feb;13(2):397-406.
58. Petryszak R, Burdett T, Fiorelli B, Fonseca NA, Gonzalez-Porta M, Hastings E, et al. Expression Atlas update--a database of gene and transcript expression from microarray- and sequencing-based functional genomics experiments. *Nucleic Acids Res* 2014 Jan;42(Database issue):D926-32.
59. Gamper M, Viereck V, Geissbuhler V, Eberhard J, Binder J, Moll C, et al. Gene expression profile of bladder tissue of patients with ulcerative interstitial cystitis. *BMC Genomics* 2009 Apr 28;10:199-2164-10-199.
60. Tseng LH, Chen I, Wang CN, Lin YH, Lloyd LK, Lee CL. Genome-based expression profiling study of Hunner's ulcer type interstitial cystitis: an array of 40-gene model. *Int Urogynecol J* 2010 Aug;21(8):911-918.
61. Minassian VA, Stewart WF, Hirsch AG. Why do stress and urge incontinence co-occur much more often than expected? *Int Urogynecol J Pelvic Floor Dysfunct* 2008 Oct;19(10):1429-1440.
62. Brubaker L, Lukacz ES, Burgio K, Zimmern P, Norton P, Leng W, et al. Mixed incontinence: comparing definitions in non-surgical patients. *Neurourol Urodyn* 2011 Jan;30(1):47-51.
63. Digesu GA, Salvatore S, Fernando R, Khullar V. Mixed urinary symptoms: what are the urodynamic findings? *Neurourol Urodyn* 2008;27(5):372-375.
64. Tikkinen KA, Auvinen A. Does the imprecise definition of overactive bladder serve commercial rather than patient interests? *Eur Urol* 2012 Apr;61(4):746-8; discussion 749-50.
65. Faye LL, Bull SB. Two-stage study designs combining genome-wide association studies, tag single-nucleotide polymorphisms, and exome sequencing: accuracy of genetic effect estimates. *BMC Proc* 2011 Nov 29;5 Suppl 9:S64-6561-5-S9-S64.
66. Jiang W, Yu W. Power estimation and sample size determination for replication studies of genome-wide association studies. *BMC Genomics* 2016 Jan 11;17 Suppl 1:3-015-2296-4.
67. Geraghty RJ, Capes-Davis A, Davis JM, Downward J, Freshney RI, Knezevic I, et al. Guidelines for the use of cell lines in biomedical research. *Br J Cancer* 2014 Sep 9;111(6):1021-1046.
68. Hughes P, Marshall D, Reid Y, Parkes H, Gelber C. The costs of using unauthenticated, over-passaged cell lines: how much more data do we need? *BioTechniques* 2007 Nov;43(5):575, 577-8, 581-2 passim.
69. Rae JM, Creighton CJ, Meck JM, Haddad BR, Johnson MD. MDA-MB-435 cells are derived from M14 melanoma cells--a loss for breast cancer, but a boon for melanoma research. *Breast Cancer Res Treat* 2007 Jul;104(1):13-19.
70. Prasad V, Gopalan R. Continued use of MDA-MB-435, a melanoma cell line, as a model for human breast cancer, even in year, 2014. *NPJ Breast Ca* 2016;2015:2016-15002.
71. United States Code. Laboratory Animal Welfare Act by Congress. Available at: <https://www.nal.usda.gov/awic/animal-welfare-act-public-law-89-544-act-august-24-1966>

72. NCATS Programs and initiatives. Available at: <http://ncats.nih.gov/programs>.
73. Collins FS. Reengineering translational science: the time is right. *Sci Transl Med* 2011 Jul 6;3(90):90cm17.
74. Institute of Medicine (US) Forum on Drug Discovery, Development, and Translation. Transforming Clinical Research in the United States: Challenges and Opportunities: Workshop Summary. US: National Academies Press; 2010.
75. Kao LS, Aaron BC, Dellinger EP. Trials and tribulations: current challenges in conducting clinical trials. *Arch Surg* 2003 Jan;138(1):59-62.
76. Brubaker L, Nager CW, Richter HE, Weidner AC, Hsu Y, Wai CY, et al. Effectiveness of blinding: sham suprapubic incisions in a randomized trial of retropubic midurethral sling in women undergoing vaginal prolapse surgery. *Am J Obstet Gynecol* 2014 Nov;211(5):554.e1-554.e7.
77. Hicks LK, Laupacis A, Slutsky AS. A primer on data safety monitoring boards: mission, methods, and controversies. *Intensive Care Med* 2007 Oct;33(10):1815-1818.
78. Slutsky AS, Lavery JV. Data safety and monitoring boards. *N Engl J Med* 2004 Mar 11;350(11):1143-1147.
79. Grant AM, Altman DG, Babiker AB, Campbell MK, Clemens FJ, Darbyshire JH, et al. Issues in data monitoring and interim analysis of trials. *Health Technol Assess* 2005 Mar;9(7):1-238, iii-iv.
80. Sydes MR, Altman DG, Babiker AB, Parmar MK, Spiegelhalter DJ, DAMOCLES Group. Reported use of data monitoring committees in the main published reports of randomized controlled trials: a cross-sectional study. *Clin Trials* 2004 Feb;1(1):48-59.
81. Society for Clinical Data Management. Good clinical data management practices. 2nd ed. Hillsborough, NJ; 2002.
82. Altman D. Practical statistics for medical research. London: Chapman & Hall; 1991.
83. Bland M. An introduction to medical statistics. 2nd ed. Oxford: Oxford University Press; 1995.
84. Sterne J. Commentary: Null points--has interpretation of significance tests improved? *Int J Epidemiol* 2003 Oct;32(5):693-694.
85. Hollis S, Campbell F. What is meant by intention to treat analysis? Survey of published randomized controlled trials. *BMJ* 1999 Sep 11;319(7211):670-674.
86. Richards SH, Bankhead C, Peters TJ, Austoker J, Hobbs FD, Brown J, et al. Cluster randomized controlled trial comparing the effectiveness and cost-effectiveness of two primary care interventions aimed at improving attendance for breast screening. *J Med Screen* 2001;8(2):91-98.
87. van Oldenrijk J, van Berkel Y, Kerkhoffs GM, Bhandari M, Poolman RW. Do authors report surgical expertise in open spine surgery related randomized controlled trials? A systematic review on quality of reporting. *Spine (Phila Pa 1976)* 2013 May 1;38(10):857-864.
88. Nager CW, Albo ME, Fitzgerald MP, McDermott SM, Kraus S, Richter HE, et al. Process for development of multicenter urodynamic studies. *Urol* 2007 Jan;69(1):63-7; discussion 67-8.
89. Mbuagbaw L, Tabane L, Ongolo-Zogo P, Lang T. The challenges and opportunities of conducting a clinical trial in a low resource setting: The case of the Cameroon mobile phone SMS (CAMPS) trial, an investigator initiated trial. *Trials* 2011;12:145.
90. Clinical trial registration. 2016; Available at: www.icmje.org/recommendations/browse/publishing-and-editorial-issues/clinical-trial-registration.html, 2016.
91. Taichman DB, Backus J, Baethge C, Bauchner H, de Leeuw PW, Drazen JM, et al. Sharing clinical trial data: a proposal from the International Committee of Medical Journal Editors. *Lancet* 2016 Jan 23;387(10016):e9-11.
92. Moher D, Schulz KF, Altman DG. The CONSORT statement: revised recommendations for improving the quality of reports of parallel-group randomized trials. *Lancet* 2001 Apr 14;357(9263):1191-1194.
93. Schulz KF, Altman DG, Moher D, CONSORT Group. CONSORT 2010 statement: updated guidelines for reporting parallel group randomized trials. *Int J Surg* 2011;9(8):672-677.
94. von Elm E, Altman DG, Egger M, Pocock SJ, Gotsche PC, Vandenbroucke JP, et al. The strengthening the reporting of observational studies in epidemiology (STROBE) statement: guidelines for reporting observational studies. *Ann Intern Med* 2007 Oct 16;147(8):573-577.
95. Bossuyt PM, Reitsma JB, Bruns DE, Gatsonis CA, Glasziou PP, Irwig L, et al. STARD 2015: an updated list of essential items for reporting diagnostic accuracy studies. *BMJ* 2015 Oct 28;351:h5527.
96. Moher D, Liberati A, Tetzlaff J, Altman DG, PRISMA Group. Preferred reporting items for systematic reviews and meta-analyses: the

- PRISMA statement. *PLoS Med* 2009 Jul 21;6(7):e1000097.
97. Ogrinc G, Davies L, Goodman D, Batalden P, Davidoff F, Stevens D. SQUIRE 2.0 (Standards for QUality Improvement Reporting Excellence): revised publication guidelines from a detailed consensus process. *BMJ Qual Saf* 2015 Sep 14.
 98. Chan AW, Tetzlaff JM, Altman DG, Laupacis A, Gotzsche PC, Krleza-Jeric K, et al. SPIRIT 2013 statement: defining standard protocol items for clinical trials. *Ann Intern Med* 2013 Feb 5;158(3):200-207.
 99. Zwarenstein M, Treweek S, Gagnier JJ, Altman DG, Tunis S, Haynes B, et al. Improving the reporting of pragmatic trials: an extension of the CONSORT statement. *BMJ* 2008 Nov 11;337:a2390.
 100. Piaggio G, Elbourne DR, Altman DG, Pocock SJ, Evans SJ, CONSORT Group. Reporting of noninferiority and equivalence randomized trials: an extension of the CONSORT statement. *JAMA* 2006 Mar 8;295(10):1152-1160.
 101. Campbell MK, Elbourne DR, Altman DG, CONSORT group. CONSORT statement: extension to cluster randomized trials. *BMJ* 2004 Mar 20;328(7441):702-708.
 102. Boutron I, Moher D, Altman DG, Schulz KF, Ravaud P, CONSORT Group. Extending the CONSORT statement to randomized trials of nonpharmacologic treatment: explanation and elaboration. *Ann Intern Med* 2008 Feb 19;148(4):295-309.
 103. Altman DG. Better reporting of randomized controlled trials: the CONSORT statement. *BMJ* 1996 Sep 7;313(7057):570-571.
 104. Senn S. *Statistical issues in drug development*. Chichester: Wiley; 1997.
 105. *Statistical considerations in the design of clinical trials*. May 29, 2001; Available at: <http://www.ifpma.org/pdfifpma/e9.pdf>.
 106. Matthews J. *An introduction to randomized controlled clinical trials*. 1st ed. London: Arnold; 2000.
 107. Simon R, Thall P. Phase II trials. In: Armitage P, Colton T, editors. *Encyclopedia of Biostatistics*. 1st ed. Chichester, UK: Wiley; 1998. p. 3370-3376.
 108. Little J, Higgins J, Bray M, Ioannidis J, Khoury M. The HuGENet™ HuGE review handbook, version 1.0. <http://www.hugenet.ca>: ResearchGate; 2006.
 109. DerSimonian R, Laird N. Meta-analysis in clinical trials. *Control Clin Trials* 1986 Sep;7(3):177-188.
 110. Guyatt GH, Oxman AD, Schunemann HJ, Tugwell P, Knottnerus A. GRADE guidelines: a new series of articles in the *Journal of Clinical Epidemiology*. *J Clin Epidemiol* 2011 Apr;64(4):380-382.
 111. Harbord RM, Egger M, Sterne JA. A modified test for small-study effects in meta-analyses of controlled trials with binary endpoints. *Stat Med* 2006 Oct 30;25(20):3443-3457.
 112. Ioannidis JP, Boffetta P, Little J, O'Brien TR, Uitterlinden AG, Vineis P, et al. Assessment of cumulative evidence on genetic associations: interim guidelines. *Int J Epidemiol* 2008 Feb;37(1):120-132.
 113. Nathan M, William H. *Statistical Aspects of the Analysis of Data From Retrospective Studies of Disease*. Oxford UK: Oxford University Press;1959.
 114. Benchimol EI, Smeeth L, Guttman A, Harron K, Moher D, Petersen I, et al. The REporting of studies Conducted using Observational Routinely-collected health Data (RECORD) statement. *PLoS Med* 2015 Oct 6;12(10):e1001885.
 115. Bo K, Frawley H, Haylen B, Abramov Y, Almeida F, Berghmans B, et al. An international urogynecological association (IUGA) / international continence society (ICS) joint report on the terminology for the conservative and non-pharmacological management of female pelvic floor dysfunction. *Neurourol Urodynam* Accepted.
 116. Schwartz G, Beatty J editors. *Biofeedback: Theory and research*. New York: Academic Press; 1977.
 117. Bo K. Pelvic floor muscle training for stress urinary incontinence. In: Bo K, Berghmans B, Morkved S, Van Kampen M, editors. *Evidence-based physical therapy for the pelvic floor* Philadelphia, Pa: Churchill Livingstone Elsevier; 2007. p. 171-187.
 118. Kegel AH. Stress incontinence and genital relaxation; a nonsurgical method of increasing the tone of sphincters and their supporting structures. 1952;*Ciba Clin Symp*(4):35-51.
 119. Benvenuti F, Caputo GM, Bandinelli S, Mayer F, Biagini C, Sommovilla A. Reductive treatment of female genuine stress incontinence. *Am J Phys Med* 1987;66(4):155-68.
 120. Bump RC, Hurt WG, Fantl JA, Wyman JF. Assessment of Kegel pelvic muscle exercise performance after brief verbal instruction. *Am J Obstet Gynecol* 1991;165(2):322-7; discussion 327-9.
 121. Larsen S, Oseid S. Knowledge about and ability to correct pelvic floor muscle exercises in

- women with urinary stress incontinence. *Neurourol Urodynam* 1988;7(3):261-262.
122. McKinlay JB. From "promising report" to "standard procedure": seven stages in the career of a medical innovation. *Milbank Mem Fund Q Health Soc* 1981 Summer;59(3):374-411.
 123. Bo K, Herbert RD. When and how should new therapies become routine clinical practice? *Physiotherapy* 2009 Mar;95(1):51-57.
 124. Bo K, Sherburn M. Evaluation of female pelvic-floor muscle function and strength. *Phys Ther* 2005 Mar;85(3):269-282.
 125. Dumoulin C, Hay-Smith J, Frawley H, McClurg D, Alewijnse D, Bo K, et al. 2014 consensus statement on improving pelvic floor muscle training adherence: International Continence Society 2011 State-of-the-Science Seminar. *Neurourol Urodyn* 2015 Sep;34(7):600-605.
 126. Indrekvam S, Hunnskaar S. Side effects, feasibility, and adherence to treatment during home-managed electrical stimulation for urinary incontinence: a Norwegian national cohort of 3,198 women. *Neuro Urodyn* 2002;21(6):546-52.
 127. Dumoulin C, Lemieux MC, Bourbonnais D, Gravel D, Bravo G, Morin M. Physiotherapy for persistent postnatal stress urinary incontinence: a randomized controlled trial. *Obstet Gynecol* 2004 Sep;104(3):504-510.
 128. Herbert RD, Bo K. Analysis of quality of interventions in systematic reviews. *BMJ* 2005 Sep 3;331(7515):507-509.
 129. World Confederation for Physical Therapy editor. Description of physical therapy. London; 1999.
 130. McCulloch P, Taylor I, Sasako M, Lovett B, Griffin D. Randomized trials in surgery: problems and possible solutions. *BMJ* 2002 Jun 15;324(7351):1448-1451.
 131. McLeod RS, Wright JG, Solomon MJ, Hu X, Walters BC, Lossing A. Randomized controlled trials in surgery: Issues and problems. *Surgery* 1996 May;119(5):483-486.
 132. Chalmers TC. Randomization of the first patient. *Med Clin North Am* 1975 Jul;59(4):1035-1038.
 133. Nygaard I, Holcomb R. Reproducibility of the seven-day voiding diary in women with stress urinary incontinence. *Int Urogynecol J* 2000;11(1):15-7.
 134. Gates E. Ethical Considerations in the Incorporation of New Technologies Into Gynecologic Practice. *Clin Obstet Gynecol* 2000 September;43(3):540-550.
 135. Hall JC, Mills B, Nguyen H, Hall JL. Methodologic standards in surgical trials. *Surgery* 1996 Apr;119(4):466-472.
 136. Baum M. Reflections on randomized controlled trials in surgery. *Lancet* 1999 Apr;353 Suppl 1:S16-8.
 137. Frader J, Caniano D editors. Research and innovation in surgery. Houston, Tx: Oxford University Press; 1998.
 138. Korn AP, Learman LA. Operations for stress urinary incontinence in the United States, 1988-1992. *Urology* 1996 Oct;48(4):609-612.
 139. Waetjen LE, Subak LL, Shen H, Lin F, Wang TH, Vittinghoff E, et al. Stress urinary incontinence surgery in the United States. *Obstet Gynecol* 2003;101(4):671-6.
 140. Solomon MJ, Laxamana A, Devore L, McLeod RS. Randomized controlled trials in surgery. *Surgery* 1994 Jun;115(6):707-712.
 141. Solomon MJ, McLeod RS. Should we be performing more randomized controlled trials evaluating surgical operations? *Surgery* 1995 Sep;118(3):459-467.
 142. Tennstedt S, et al. Design of the SISTER (Stress Incontinence Surgical Treatment Efficacy Trial) study: A randomized surgical trial comparing the burch colposuspension and the autologous rectal fascial sling. *Urol* 2005;6:1213-1217.
 143. Richter HE, Albo ME, Zyczynski HM, Kenton K, Norton PA, Sirls LT, et al. Retropubic versus Transobturator Midurethral Slings for Stress Incontinence. *N Engl J Med* 2010 06/03; 2013/08;362(22):2066-2076.
 144. McLeod RS. Issues in surgical randomized controlled trials. *World J Surg* 1999 12;23(12):1210-1214.
 145. Hilton P. Trials of surgery for stress incontinence - thoughts on the 'Humpty Dumpty' principle. *BJOG* 2002;109(10):1081-1088.
 146. Finkelstein E, Corso P. Cost-of-illness analyses for policy making: a cautionary tale of use and misuse. *Expert Rev Pharmacoecon Outcomes Res* 2003 Aug;3(4):367-369.
 147. Maddern GJ, Middleton PF, Grant AM. Urinary stress incontinence. *BMJ* 2002 Oct 12;325(7368):789-790.
 148. Russell LB, Gold MR, Siegel JE, Daniels N, Weinstein MC. The role of cost-effectiveness analysis in health and medicine. Panel on Cost-Effectiveness in Health and Medicine. *JAMA* 1996 Oct 9;276(14):1172-1177.
 149. Brown JS, McNaughton KS, Wyman JF, Burgio KL, Harkaway R, Bergner D, et al. Measurement characteristics of a voiding diary for use

- by men and women with overactive bladder. *Urol* 2003 Apr;61(4):802-809.
150. Chang RW, Pellisier JM, Hazen GB. A cost-effectiveness analysis of total hip arthroplasty for osteoarthritis of the hip. *JAMA* 1996 Mar 20;275(11):858-865.
 151. Subak LL, Caughey AB. Measuring cost-effectiveness of surgical procedures. *Clin Obstet Gynecol* 2000;43(3):551-60.
 152. Fusco F, Groutz A, Blaivas JG, Chaikin DC, Weiss JP. Videourodynamic studies in men with lower urinary tract symptoms: a comparison of community based versus referral urological practices. *J Urol* 2001;166(3):910-3.
 153. Griffiths CJ, Harding C, Blake C, McIntosh S, Drinnan MJ, Robson WA, et al. A nomogram to classify men with lower urinary tract symptoms using urine flow and noninvasive measurement of bladder pressure. *J Urol* 2005 Oct;174(4 Pt 1):1323-6; discussion 1326; author reply 1326.
 154. Grady D, Brown JS, Vittinghoff E, Applegate W, Varner E, Snyder T, et al. Postmenopausal hormones and incontinence: the Heart and Estrogen/Progestin Replacement Study. *Obstet Gynecol* 2001 Jan;97(1):116-120.
 155. Jackson S, Shepherd A, Brookes S, Abrams P. The effect of oestrogen supplementation on post-menopausal urinary stress incontinence: a double-blind placebo-controlled trial. *Br J Obstet Gynaecol* 1999 Jul;106(7):711-718.
 156. Grodstein F, Lifford K, Resnick NM, Curhan GC. Postmenopausal hormone therapy and risk of developing urinary incontinence. *Obstet Gynecol* 2004 Feb;103(2):254-260.
 157. Fultz NH, Herzog AR, Raghunathan TE, Wallace RB, Diokno AC. Prevalence and severity of urinary incontinence in older African American and Caucasian women. *J Gerontol A Biol Sci Med Sci* 1999 Jun;54(6):M299-303.
 158. Wetle T, Scherr P, Branch LG, Resnick NM, Harris T, Evans D, et al. Difficulty with holding urine among older persons in a geographically defined community: prevalence and correlates. *J Am Geriatr Soc* 1995 Apr;43(4):349-355.
 159. Thom D, Brown J. Reproductive and hormonal risk factors for urinary incontinence: Review of the clinical and epidemiologic literature. *J Am Geriatr Soc* 1998;46:1411-7.
 160. Brown JS, Seeley DG, Fong J, Black DM, Ensrud KE, Grady D. Urinary incontinence in older women: who is at risk? Study of Osteoporotic Fractures Research Group. *Obstet Gynecol.* 1996;87(5 Pt 1):715-21.
 161. Brown JS, Grady D, Ouslander JG, Herzog AR, Varner RE, Posner SF. Prevalence of urinary incontinence and associated risk factors in postmenopausal women. Heart & Estrogen/Progestin Replacement Study (HERS) Research Group. *Obstet Gynecol* 1999;94(1):66-70.
 162. Diokno AC, Brock BM, Herzog AR, Bromberg J. Medical correlates of urinary incontinence in the elderly. *Urol* 1990 Aug;36(2):129-138.
 163. Brown JS, Sawaya G, Thom DH, Grady D. Hysterectomy and urinary incontinence: a systematic review.[comment]. *Lancet.* 2000;356(9229):535-9.
 164. Marshall HJ, Beevers DG. Alpha-adrenoceptor blocking drugs and female urinary incontinence: prevalence and reversibility. *Br J Clin Pharmacol* 1996 Oct;42(4):507-509.
 165. Fantl JA, Wyman JF, Wilson M, Elswick RK, Bump RC, Wein AJ. Diuretics and urinary incontinence in community-dwelling women. *Neurourol Urodyn* 1990;9(1):25-34.
 166. Menefee SA, Chesson R, Wall LL. Stress urinary incontinence due to prescription medications: alpha-blockers and angiotensin converting enzyme inhibitors. *Obstet Gynecol* 1998 May;91(5 Pt 2):853-854.
 167. Katz S. The index of ADL: A standard measurement of biological and psychological function. *JAMA* 1963;185:914-919.
 168. Mahoney FI, Barthel DW. Functional Evaluation: the Barthel Index. *Md State Med J* 1965 Feb;14:61-65.
 169. Ouslander J, Johnson T, Nasr S, Schnelle J, Miller M. Atrial natriuretic peptide levels in geriatric patients with nocturia and nursing home residents with nighttime incontinence. *J Am Geriatr Soc* 1999;47(12):1439-44.
 170. Folstein, M.F., Folstein, S.E., McHugh, P.R. "Mini-Mental State:" a practical method for grading the cognitive state of patients for the clinician. *J Psychiatr Res* 1975;12:189-98.
 171. Buschke H, Fuld PA. Evaluating storage, retention, and retrieval in disordered memory and learning. *Neurol* 1974 Nov;24(11):1019-1025.
 172. Wechsler D. Wechsler adult intelligence scale - revised. New York: Psychological Corp; 1988.
 173. Homma Y, Ando T, Yoshida M, Kageyama S, Takei M, Kimoto K, et al. Voiding and incontinence frequencies: variability of diary data and required diary length. *Neurourol Urodyn* 2002;21(3):204-209.
 174. Groutz A, Blaivas JG, Chaikin DC, Resnick NM, Engleman K, Anzalone D, et al. Noninvasive outcome measures of urinary incontinence and lower urinary tract symptoms: a multicenter study of micturition diary and pad tests. *J Urol* 2000;164(3 Pt 1):698-701.

175. Locher JL, Goode PS, Roth DL, Worrell RL, Burgio KL. Reliability assessment of the bladder diary for urinary incontinence in older women. *J Gerontol* 2001;56(1):M32-5.
176. Ouslander JG, Palmer MH, Rovner BW, German PS. Urinary incontinence in nursing homes: incidence, remission and associated factors. *J Am Geriatr Soc* 1993 Oct;41(10):1083-1089.
177. Colling J, et al. Continence program for care dependent elderly (final report). 1995;NIH-NCNR-NR01554.
178. Siltberg H, Victor A, Larsson G. Pad weighing tests: the best way to quantify urine loss in patients with incontinence. *Acta Obstet Gynecol Scand Suppl* 1997;166:28-32.
179. Griffiths DJ, McCracken PN, Harrison GM. Incontinence in the elderly: objective demonstration and quantitative assessment. *Br J Urol* 1991 May;67(5):467-471.
180. Powell CR. Not all neurogenic bladders are the same: a proposal for a new neurogenic bladder classification system. *Transl Androl Urol* 2016 Feb;5(1):12-21.
181. Stohrer M, Blok B, Castro-Diaz D, Chartier-Kastler E, Del Popolo G, Kramer G, et al. EAU guidelines on neurogenic lower urinary tract dysfunction. *Eur Urol* 2009 Jul;56(1):81-88.
182. El-Masri W, Patil S, Prasanna K, Chowdhury J. To cystoscope or not to cystoscope patients with traumatic spinal cord injuries managed with indwelling urethral or suprapubic catheters? That is the question! *Spinal Cord* 2014;52:49-53.
183. Pannek J, Blok B, Castro-Diaz D, Del Popolo G, Kramer G, Radziszewski P, et al. Guidelines for Neurogenic Lower Urinary Tract Dysfunction. European Association of Urology Guidelines. 2013; Available at: http://uroweb.org/wp-content/uploads/20_Neurogenic-LUTD_LR.pdf. Accessed 8/20, 2016.
184. Urinary incontinence in neurological disease: assessment and management. 2012; Available at: www.nice.org.uk/guidance/cg148/chapter/1-guidance. Accessed 8/16, 2016.
185. Spinal cord injury and disorders (SCI/D) Systems of Care 2012. 2012; Available at: www.va.gov/vhapublications/publications.cfm?pub=2. Accessed 8/16, 2016.
186. Winters JC, Dmochowski RR, Goldman HB, Herndon CD, Kobashi KD, Kraus SR, et al. American Urological Association and Society of Urodynamics Female Pelvic Medicine joint guidelines on urodynamics. 2012. 2012; Available at: <http://www.auanet.org/education/guidelines/adult-urodynamics.cfm>. Accessed 0/16, 2016.
187. Consortium for Spinal Cord Medicine. Bladder Management for Adults with Spinal Cord Injury: A Clinical Practice Guideline for Health Care Providers. 2006; Available at: http://www.pva.org/att/ct/%7BCA2A0FFB-6859-4BC1-BC96-6B57F57F0391%7D/CPGBladderManagement_1AC7B4.pdf.
188. Costa P, Perrouin-Verbe B, Colvez A, Didier J, Marquis P, Marrel A, et al. Quality of life in spinal cord injury patients with urinary difficulties. Development and validation of qualiveen. *Eur Urol* 2001 Jan;39(1):107-113.
189. Clark R, Welk B. Patient reported outcome measures in neurogenic bladder. *Transl Androl Urol* 2016 Feb;5(1):22-30.

2017

6th International Consultation on Incontinence

Co-sponsored by

International Consultation on Urological Diseases (ICUD)

International Continence Society (ICS)

In collaboration with

major international associations of urology, gynaecology and urodynamics

and other medical associations

Recommendations of the International scientific Committee:

EVALUATION AND TREATMENT OF URINARY INCONTINENCE, PELVIC ORGAN PROLAPSE AND FAECAL INCONTINENCE

P. Abrams, K-E. Andersson, A. Apostolidis, L. Birder, D. Bliss, L. Brubaker, L. Cardozo, D. Castro, P.R. O'Connell, A. Cottenden, N. Cotterill, D. de Ridder, R. Dmochowski, C. Dumoulin, M. Fader, C. Fry, H. Goldman, P. Hanno, Y. Homma, V. Khullar, C. Maher, I. Milsom, D. Newman, J.M. Nijman, K. Rademakers, D. Robinson, P. Rosier, E. Rovner, S. Salvatore, M. Takeda, A. Wagg, T. Wagner, A. Wein

and the members of the committees

INTRODUCTION

The 6th International Consultation on Incontinence met between September 13-15th 2016 in Tokyo and was organised by the International Consultation on Urological Diseases and the International Continence Society (ICS), in order to develop consensus statements and recommendations for the diagnosis, evaluation and treatment of urinary incontinence, faecal incontinence, pelvic organ prolapse and bladder pain syndrome.

The consensus statements are evidence based following a thorough review of the available literature and the global subjective opinion of recognised experts serving on focused committees. The individual committee reports were developed and peer reviewed by open presentation and comment. The Scientific Committee, consisting of the Chairs of all the committees then refined the final consensus statements. These consensus statements published in 2017 will be periodically reevaluated in the light of clinical experience, technological progress and research.

CONTENTS

1. DEFINITIONS	2551
2. EVALUATION	2552
3. MANAGEMENT CONSENSUS STATEMENTS	2557
I. URINARY INCONTINENCE IN CHILDREN	2559
II. URINARY INCONTINENCE IN MEN	2564
III. URINARY INCONTINENCE IN WOMEN	2568
IV. FISTULAE	2572
V. PELVIC ORGAN PROLAPSE	2577
VI. URINARY INCONTINENCE IN NEUROLOGICAL PATIENTS	2582
VII. BLADDER PAIN SYNDROME	2587
VIII. FAECAL INCONTINENCE IN ADULT PATIENTS	2592
IX. FAECAL INCONTINENCE IN NEUROLOGICAL PATIENTS	2597
X. URINARY AND FAECAL INCONTINENCE IN FRAIL OLDER MEN AND WOMEN	2601
4. RECOMMENDATIONS FOR FURTHER RESEARCH IN EPIDEMIOLOGY	2606
5. RECOMMENDATIONS FOR FURTHER BASIC SCIENCE RESEARCH	2607
6. RECOMMENDATIONS FOR PRIMARY PREVENTION, CONTINENCE PROMOTION, MODELS OF CARE AND EDUCATION	2608
7. RECOMMENDATIONS FOR TRANSLATIONAL AND CLINICAL RESEARCH	2610
8. INTERNATIONAL CONSULTATION ON INCONTINENCE MODULAR QUESTIONNAIRE (ICIQ): QUESTIONNAIRES AND BLADDER DIARY	2613

1. DEFINITIONS

The consultation agreed to use the current International Continence Society definitions (ICS) for lower urinary tract dysfunction (LUTD) including incontinence, except where stated. These definitions were published in the journal *Neurourology and Urodynamics* (2002; 21:167-178 and 2006; 25: and can be viewed on the ICS website: www.ics.org

The following ICS definitions are relevant:

1. LOWER URINARY TRACT SYMPTOMS (LUTS)

LUTS are divided into storage and voiding symptoms.

Urinary incontinence is a storage symptom and defined as the complaint of any involuntary loss of urine. This definition is suitable for epidemiological studies, but when the prevalence of bothersome incontinence is sought, the previous ICS definition of an “Involuntary loss of urine that is a social or hygienic problem”, can be useful.

Urinary incontinence may be further defined according to the patient’s symptoms

- **Urgency Urinary Incontinence** is the complaint of involuntary leakage accompanied by or immediately preceded by urgency.
- **Stress Urinary Incontinence** is the complaint of involuntary leakage on effort or exertion, or on sneezing or coughing.
- **Mixed Urinary Incontinence** is the complaint of involuntary leakage associated with urgency, and also with effort, exertion, sneezing and coughing.
- **Nocturnal Enuresis** is any involuntary loss of urine occurring during sleep.
- **Post-micturition dribble** and **continuous urinary leakage** denotes other symptomatic forms of incontinence.

Overactive bladder is characterised by the storage symptoms of urgency with or without urgency incontinence, usually with frequency and nocturia.

2. URODYNAMIC DIAGNOSIS

- **Detrusor Overactivity** is a urodynamic observation characterised by involuntary detrusor contractions during the filling phase, which may be spontaneous or provoked.

Detrusor overactivity is divided into:

- **Idiopathic Detrusor Overactivity**, defined as overactivity when there is no clear cause
- **Neurogenic Detrusor Overactivity** is defined as overactivity due to a relevant neurological condition.
- **Urodynamic stress incontinence** is noted during filling cystometry, and is defined as the involuntary leakage of urine during increased abdominal pressure, in the absence of a detrusor contraction.

3. BLADDER PAIN SYNDROME

Bladder pain syndrome is defined by ESSIC as chronic pelvic pain, pressure or discomfort of greater than 6 months duration perceived to be related to the urinary bladder accompanied by at least one other urinary symptom like persistent desire to void or urinary frequency. Confusable diseases as the cause of the symptoms must be excluded.

4. PELVIC ORGAN PROLAPSE

- **Urogenital prolapse** is defined as the symptomatic descent of one or more of: the anterior vaginal wall, the posterior vaginal wall, and the apex of the vagina (cervix/uterus) or vault (cuff) after hysterectomy. Urogenital prolapse is measured using the POP-Q system.
- **Rectal prolapse** is defined as circumferential full thickness rectal protrusion beyond the anal margin.

5. ANAL INCONTINENCE

Anal incontinence defined as “any involuntary loss of faecal material and/or flatus and/or mucus” and may be divided into:

- **Faecal incontinence**, any involuntary loss of faecal material
- **Flatus incontinence**, any involuntary loss of gas (flatus)
- **Mucus incontinence**, any involuntary loss of mucus only (not faeces)

* At the time of this consultation, these definitions are not included in the current ICS terminology.

2. EVALUATION

The following phrases are used to classify diagnostic tests and studies:

- **A highly recommended test** is a test that should be done on every patient.
- **A recommended test** is a test of proven value in the evaluation of most patients and its use is strongly encouraged during evaluation.
- **An optional test** is a test of proven value in the evaluation of selected patients; its use is left to the clinical judgement of the physician
- **A not recommended test** is a test of no proven value.

This section primarily discusses the Evaluation of Urinary Incontinence with or without Pelvic Organ Prolapse (POP) and Faecal Incontinence.

The recommendations are intended to apply to children and adults, including healthy persons over the age of 65.

These conditions are highly prevalent but often not reported by patients. Therefore, the Consultation strongly recommends case finding, particularly in high risk groups.

A. HIGHLY RECOMMENDED TESTS DURING INITIAL EVALUATION

The **main recommendations** for this consultation have been abstracted from the extensive work of the 23 committees of the 6th International Consultation on Incontinence (ICI, 2016).

Each committee has written a report that reviews and evaluates the published scientific work in each field of interest in order to give Evidence Based recommendations. Each report ends with detailed recommendations and suggestions for a programme of research.

The main recommendations should be read in conjunction with the management algorithms for children, men, women, the frail older person, neurogenic patients, bladder pain, pelvic organ prolapse, and anal incontinence

The initial evaluation should be undertaken, by a clinician, in patients presenting with symptoms/ signs suggestive of these conditions.

1. HISTORY AND GENERAL ASSESSMENT

Management of a disease such as incontinence requires caregivers to assess the sufferer in a holistic manner. Many factors may influence a particular individual's symptoms, some may cause incontinence, and may influence the choice and the success of treatment. The following components of the medical history are particularly emphasised:

1.1. Review of Systems:

- Presence, severity, duration and bother of any urinary, bowel or prolapse symptoms. Identifying symptoms in the related organ systems is critical to effective treatment planning. The use of validated questionnaires to assess symptoms are recommended.
- Effect of any symptoms on sexual function: validated questionnaires including impact on quality of life are a useful part of a full assessment.
- Presence and severity of symptoms suggesting neurological disease

1.2. Past Medical History:

- Previous conservative, medical and surgical treatment, in particular, as they affect the genitourinary tract and lower bowel. The effectiveness and side effects of treatments should be noted.
- Coexisting diseases may have a profound effect on incontinence and prolapse sufferers, for example asthma patients with stress incontinence will suffer greatly during attacks. Diseases may also precipitate incontinence, particularly in frail older persons.
- Patient medication: it is always important to review every patient's medication and to make an assessment as to whether current treatment may be contributing to the patient's condition.
- Obstetric and menstrual history.
- Physical impairment: individuals who have compromised mobility, dexterity, or visual acuity may need to be managed differently

1.3. Social History:

- Environmental issues: these may include the social, cultural and physical environment.

- Lifestyle: including exercise, smoking and the amount and type of fluid and food intake.

1.4. Other Treatment Planning Issues:

- **Desire for treatment** and the extent of treatment that is acceptable
- **Patient goals** and expectations of treatment
- **Patient support** systems (including caregivers).
- **Cognitive function:** all individuals need to be assessed for their ability to fully describe their symptoms, symptom bother and quality of life impact, and their preferences and goals for care. They must be able to understand proposed management plans and to discuss, where appropriate, alternative treatment options. In some groups of patients, formal testing is essential e.g. cognitive function testing for individuals for whom the clinician has concerns regarding memory deficits and/or inattention or confusion, and depression screening for individuals for whom the clinician has concerns about abnormal affect. Proxy respondents, such as family and caregivers, may be used to discuss the patient's history, goals of care, and treatment for individuals with dementia, but only if the individual is incapable of accurate reporting or weighing treatment decisions.

2. PHYSICAL EXAMINATION

The more complicated the history and the more extensive and/or invasive the proposed therapy, the more complete the examination needs to be. Depending on the patient's symptoms and their severity, there are a number of components in the examination of patients with incontinence and/or pelvic organ prolapse.

Physical examination should be performed regardless of whether the patient is a child, a woman, a man, someone with neurological disease or a frail elderly person.

2.1. General status:

- Mental status
- Obesity (BMI)
- Physical dexterity and mobility

2.2. Abdominal/flank examination: for masses, bladder distention, relevant surgical scars

2.3. Pelvic examination:

- Examination of the perineum and external genitalia including tissue quality and sensation.
- Vaginal (half-speculum/Sims) examination for pelvic organ prolapse (POP), which should be done in the vertical position

- Bimanual pelvic and anorectal examination for pelvic mass,
- Digital rectal examination to assess pelvic floor muscle function and the function of internal and external anal sphincter as well as puborectal muscle.
- Stress test for urinary incontinence.

2.4. Neurological testing (see chapter on assessment)

3. URINALYSIS

In patients with LUTS, the possibility of a urinary tract infection should be evaluated, with appropriate testing (ranging from dipstick to urine microscopy and culture when indicated as UTI is a readily detected, and easily treatable cause of LUTS,

Conclusion

For simple treatments, particularly non-invasive and inexpensive therapies, management may start without the need for the further investigations listed below.

B. RECOMMENDED FURTHER ASSESSMENT PRIOR TO, OR DURING, SPECIALIST ASSESSMENT

The tests below are recommended when the **appropriate indication(s) is present**. Some recommended tests become highly recommended in specific situations.

This section should also be read in conjunction with the relevant committee reports.

1. FURTHER SYMPTOM AND HEALTH-RELATED QOL ASSESSMENT

1.1. Bladder Diary

In patients with **urinary symptoms** the use of a **bladder diary** (examples in Annex 1) is highly recommended to document the frequency of micturition, the volumes of urine voided, incontinence episodes and the use of incontinence pads.

1.2. Questionnaires

The use of the **highest quality questionnaires** (GoR A, where available) is recommended for the assessment of the patient's perspective of symptoms of incontinence and their impact on quality of life.

The ICIQ is highly recommended (GoR A) for the basic evaluation of the patient's perspective of urinary incontinence, with other GoR A questionnaires recommended for more detailed assessment. **Further development is required in the areas** of pelvic organ prolapse, bladder pain syndrome, and for specific patient groups, as only GoR B questionnaires are currently available (see Assessment Chapter).

2. RENAL FUNCTION ASSESSMENT

Standard biochemical tests for renal function are recommended in patients with urinary incontinence when there is the possibility of renal impairment.

3. UROFLOWMETRY

Uroflowmetry with the measurement of post void residual urine is recommended as a screening test for symptoms suggestive of urinary voiding dysfunction or physical signs of POP or bladder distension. Uroflowmetry should be part of the initial assessment if the result is likely to influence management eg in older men with possible prostatic obstruction.

4. ESTIMATION OF POST VOID RESIDUAL URINE (PVR)

In patients with suspected voiding dysfunction, PVR should be part of the initial assessment if the result is likely to influence management, for example, in neurological patients.

5. IMAGING

Although routine imaging is not recommended, imaging of the lower urinary tract and pelvis is highly recommended in those with urinary symptoms whose initial evaluation indicates a possible co-existing lower tract or pelvic pathology. Initial imaging may be by ultrasound, or plain X-ray.

Imaging of the upper urinary tract is highly recommended in specific situations. These include:

- Haematuria,
- Neurogenic urinary incontinence e.g. myelodysplasia, spinal cord trauma,
- Incontinence associated with significant post-void residual,
- Co-existing renal disease such as pyelonephritis or reflux, or loin/kidney pain,
- Severe pelvic organ prolapse, not being treated
- Suspected extra-urethral urinary incontinence,
- Children with incontinence and UTIs, where indicated

- Urodynamic studies which show evidence of poor bladder compliance or high pressure detrusor overactivity.

6. INVESTIGATIONS IN FAECAL INCONTINENCE AND RECTAL PROLAPSE

- Endoanal US or MRI prior to anal sphincter surgery is highly recommended, even when obvious anatomic defects are not evident.
- Defaecating proctography or dynamic MRI is recommended in suspected rectal prolapse which cannot be adequately confirmed by physical examination.
- Anorectal manometry is useful to assess resting and squeeze anal pressures. The resting and squeeze pressures represent the function of the internal and external anal sphincter, respectively.

7. ENDOSCOPY

Although routine cysto-urethroscopy is not recommended, LUT endoscopy is **highly recommended**:

- When initial testing is abnormal, e.g. haematuria and suggests other pathologies,
- When pain or discomfort feature in the patient's LUTS, these may suggest an intravesical lesion
- When appropriate in the evaluation of vesicovaginal fistula and extra-urethral urinary incontinence (in childbirth fistulae, endoscopy is often unnecessary).

In anorectal conditions, proctoscopy or flexible sigmoidoscopy should routinely be performed in the evaluation of patients with faecal incontinence. Colonoscopy, air contrast barium enema or CT colography is highly recommended in the presence of unexplained change in bowel habit, rectal bleeding or other alarm symptoms or signs (see Basic Assessment chapter).

8. URODYNAMIC TESTING

8.1. Urodynamic (multi channel pressure subtracted cystometry) evaluation is recommended

- When the results may change management, such as prior to most invasive treatments for UI and POP,
- After treatment failure, if more information is needed in order to plan further therapy,

- As part of both initial and long-term surveillance programmes in some types of neurogenic lower urinary tract dysfunction,
- In “complicated incontinence” (for details please see relevant subcommittee reports).

8.2. The aims of urodynamic evaluation are often diagnostic, but may also relate to prognostic factors, direct management or assess response to prior therapy, and also:

- To reproduce the patient’s symptoms and correlate these with urodynamic findings
- To assess bladder sensation
- To detect detrusor overactivity
- To assess urethral competence during filling
- To determine detrusor function during voiding
- To assess outlet function during voiding
- To assess residual urine

9. SMALL BOWEL FOLLOW-THROUGH, CT ENTOGRAPHY OR CAPSULE ENDOSCOPY

These tests are recommended in those with faecal incontinence and the presence of unexplained diarrhoea or when Crohn’s disease is suspected.

C. FURTHER DIAGNOSTIC TESTS TO BE USED AS APPROPRIATE

1. ADDITIONAL URODYNAMIC TESTING

Video-urodynamics may be useful in the management of UI in children, in patients who fail surgery and in some neurogenic patients, to obtain additional anatomical information. Either X-ray or US imaging can be used depending on the needs of the individual patient.

If a more **detailed estimate of urethral function** is required, then the following optional tests may give useful information:

- Urethral pressure profilometry
- Abdominal leak point pressures
- Video-urodynamics
- Electromyography of pelvic floor or urethral sphincter

If initial urodynamics have failed to demonstrate the cause for the patient’s incontinence then the following tests are optional:

- Repeated routine urodynamics or video-urodynamics
- Ambulatory urodynamics

2. PAD TESTING

Pad testing is an optional test for the routine evaluation of urinary incontinence and, if carried out, a 24 hr test is suggested.

3. NEUROPHYSIOLOGICAL TESTING AND IMAGING

The information gained by clinical examination and urodynamic testing may be **enhanced by neurophysiological testing** of striated muscle and nervous pathways.

Appropriately trained personnel should perform these tests. The following neuro-physiological tests can be considered in patients with peripheral lesions prior to treatment for lower urinary tract or anorectal dysfunction.

- Concentric needle EMG
- Sacral reflex responses to electrical stimulation of penile or clitoral nerves.

Imaging of the nervous system (and neighbouring structures, including spine, the abdominal cavity and pelvis) by MRI or CT, may confirm suspected involvement of the nervous system, and the nature of the cause.

4. FURTHER IMAGING

Cysto-urethrography, US, CT and MRI may have an indication:

- Suspected pelvic floor dysfunction
- Failed surgery, such as recurrent posterior vaginal wall prolapse or failed sling surgery
- Suspected fixed urethra

5. CYSTO-URETHROSCOPY

This is an optional test in patients with complicated, persistent or recurrent UI (e.g. after failed SUI surgery)

6. ANORECTAL PHYSIOLOGY TESTING

Endocoil MRI has high accuracy for detecting anal sphincter injury but is second line after endoanal ultrasound. Patients with faecal incontinence may benefit from assessment with MRI, particularly those with

anorectal malformations and/or previous anal sphincter surgery.

Defaecography may be useful and is recommended in patients with faecal incontinence, who have failed conservative therapies, and are possible candidates for laparoscopic ventral rectopexy.

3. MANAGEMENT CONSENSUS STATEMENTS

The consensus statements are derived from the **detailed work in the committee reports** on the management of incontinence in children, men, women, the frail elderly and neurological patients, as well as those with obstetric fistula, pelvic organ prolapse, bladder pain syndrome, and faecal incontinence. The management of incontinence is presented in **algorithm form** with **accompanying notes**.

The chapters analyze the evidence and give it a level of evidence (LoE) and this generates a GoR of recommendation (GoR)

The Consultation recognises that no algorithm can be applied to every patient and each patient's management must be individualised.

There are algorithms for

- I. Urinary Incontinence in Children
- II. Urinary Incontinence in Men
- III. Urinary Incontinence in Women
- IV. Fistulae
- V. Pelvic Organ Prolapse
- VI. Urinary Incontinence in Neurological Patients
- VII. Bladder Pain Syndrome
- VIII. Faecal Incontinence in Adults
- IX. Urinary and faecal Incontinence in frail Older Men and Women

These algorithms are divided into two for groups I to III, VII and X. The two parts, initial **management** and **specialised management** require a little further explanation.

Although the management algorithms are designed for patients whose predominant problem is incontinence, there are many other patients in whom the algorithms may be useful such as those patients with urgency and frequency, so-called “**OAB dry**”

Management definitions

Management may be divided into

- Conservative, all methods that are non-medical and non-surgical, some of which do not target the disease process
- Medical (pharmacological) therapy

- Surgical therapy
- Conservative therapy includes
 - Lifestyle interventions e.g. weight loss
 - Bladder training
 - Pelvic floor muscle training (PFMT)
 - Containment products e.g. pads
 - Dependent continence strategies eg regular toileting

Consensus does not exist as to the use of the term “behavioural therapy” as some state that this term only includes bladder training and PFMT, whilst others consider that all conservative management contains a behavioural element, for example wearing and changing pads constitutes a change in behaviour. Hence the consultations recommendations list the elements of conservative management as relevant are intended for use by all clinicians including health care assistants/aides, nurses, physiotherapists, generalist doctors and family doctors as well as by specialists such as urologists, geriatricians and gynaecologists. The consultation has attempted to phrase the recommendations in the basic algorithms in such a way that they may be readily used by clinicians in all countries of the world, both in the developing and the developed world.

The algorithms for initial management

are intended for use by all **clinicians** including health care assistants/aides, nurses, physiotherapists, generalist doctors and family doctors as well as by specialists such as urologists, geriatricians and gynaecologists. The consultation has attempted to phrase the recommendations in the basic algorithms in such a way that they may be readily used by clinicians in all countries of the world, both in the developing and the developed world.

The specialised algorithms

The specialised algorithms are intended for use by **specialists**. The specialised algorithms, as well as the initial management algorithms are **based on evidence where possible**, and on the **expert opinion** of the 400 healthcare professionals who took part in the Consultation. In this consultation, committees ascribed levels of evidence to the published work on the

subject and devised GoRs of recommendation to inform patient management.

It should be noted that these algorithms, dated **April 2017**, represent the Consultation **consensus at that time**. Our knowledge, developing from both a research base and because of evolving expert opinion, will inevitably **change with time and relate to the unique context of individual patients seeking care**. The Consultation does not wish those using the algorithms to believe they are “carved in tablets of stone”: there will be changes both in the relatively short term and in the long term.

1. ESSENTIAL COMPONENTS OF BASIC ASSESSMENT

Each algorithm contains a core of recommendations in addition to a number of essential components of basic assessment listed in sections I to III.

- General assessment
- Symptom assessment
- Assessment of quality of life impact
- Assessment of the desire for treatment
- Physical examination
- Urinalysis

2. JOINT DECISION MAKING

The patient’s desires and goals for treatment: Treatment is a matter for discussion and joint decision making between the patient and his or her health care advisors. This process of consultation includes the specific need to assess whether or not the patient wishes to receive treatment and, if so, what treatments he or she would favour. Implicit in this statement is the assumption that the health care provider will give an **appropriate explanation of the patient’s problem** and the **alternative lines of management**, and the potential **benefits and risks of treatment**. The assumption that patients almost always wish to have treatment is flawed, and the need to incorporate patient values and preferences is paramount.

In each algorithm, treatments are listed in **order of simplicity**, the least invasive being listed first. This order does not imply a scale of efficacy or cost, two factors which need to be considered in choosing the sequence of therapy. The order is likewise not meant to imply a suggested sequence of therapy, which should be determined jointly by the treating health care provider and the patient, considering all the relevant factors listed above.

In the **initial management algorithms**, treatment is **empirically based**, whilst the **specialised management algorithms** usually rely on precise diagnosis from urodynamics and other testing.

The assumption is made that patients will be reassessed at an appropriate time to evaluate their progress.

3. USE OF CONTINENCE PRODUCTS

The possible role of **continence products** to prevent, contain and/or manage bladder and/or bowel leakage should be considered at each stage of patient assessment and treatment, to maintain dignity and social functioning, and/or to support self-management or care by others.

Consider **temporary** use of continence products:

- While treatment is awaited.
- **In addition** to treatment; for example using pads and/or urinals when taking anti-muscarinics or carrying out pelvic floor exercises, until sufficient improvement is achieved.

Consider **permanent** use of continence products:

- When treatment is not chosen or not suitable for the individual
- When treatment does not achieve (complete) cure
- For **intermittent use**; for example when the patient has a cough, or needs to travel without reliable toilet access
- For **continuous use** if incontinence is unpredictable and/or frequent or if complications related to incontinence (e.g. skin breakdown) are imminent or present

Consider offering a **mixture** of continence products (disposable/washable; absorbent/non-absorbent) to optimise effectiveness and to reduce costs; e.g. different products for day and night; or for staying at home and for going out/travel/specific activities.

Further guidance on management with continence products is given in Chapter 20 and at the ICI/ICS supported website:

www.continenceproductadvisor.org

At the foot of each of the treatment algorithms below, the phrase “Consider CONTINENCE PRODUCTS for temporary support during treatment”, emphasizes the importance of continence products for many sufferers of incontinence

I. URINARY INCONTINENCE IN CHILDREN

A. INITIAL MANAGEMENT

Children present specific management problems for a variety of reasons: assessment requires help from their parents and caregivers; consent to treatment may be problematic; and cooperation in both assessment and treatment may be difficult.

1. INITIAL ASSESSMENT SHOULD INVOLVE A DETAILED INVESTIGATION OF VOIDING AND BOWEL HABITS USING BLADDER/BOWEL DIARIES AND STRUCTURED AND VALIDATED QUESTIONNAIRES.

The child's social environment and general and behavioural development should also be formally assessed and recorded. Physical examination should be done to detect a palpable bladder, faecal loading and exclude anatomic and neurogenital causes. Urine analysis and culture is sufficient to exclude the presence of infection. If possible, the child should be observed voiding.

- **Referrals for specialist treatment are recommended for children who have complicated incontinence associated with:**
 - Recurrent and febrile urinary infection
 - Voiding symptoms or evidence of poor bladder emptying
 - Urinary tract anomalies
 - Previous pelvic surgery
 - Neuropathy or neuropathic origin
 - Bowel dysfunction not responsive to treatment

- Comorbid behavioural (e.g. ADHD and ODD) and emotional disorders.
- **Initial treatment is recommended for the remaining patients who have:**
 - Nocturnal enuresis without other symptoms (monosymptomatic enuresis).
 - Daytime symptoms of frequency, urgency, voiding postponement, straining, interrupted voiding, urgency incontinence with or without nighttime wetting.

2. TREATMENT

- Initial treatment for **mono-symptomatic nocturnal** enuresis should include:
 - Parental and child counselling and motivation
 - Review of bladder diary with attention to night-time polyuria
 - Age appropriate education and demystification or explanation
- A choice between either bed wetting alarm (GoR A) or anti-diuretic hormone analogues of desmopressin (GoR A). It may be a parental and child choice if advantages and disadvantages are well explained.
- Daytime incontinence should be managed holistically including:
 - Counselling, timed voiding, behaviour modification and bowel management when necessary (GoR B);
 - Antimuscarinics may be used if the child has OAB symptoms (GoR A)

INITIAL MANAGEMENT OF URINARY INCONTINENCE IN CHILDREN

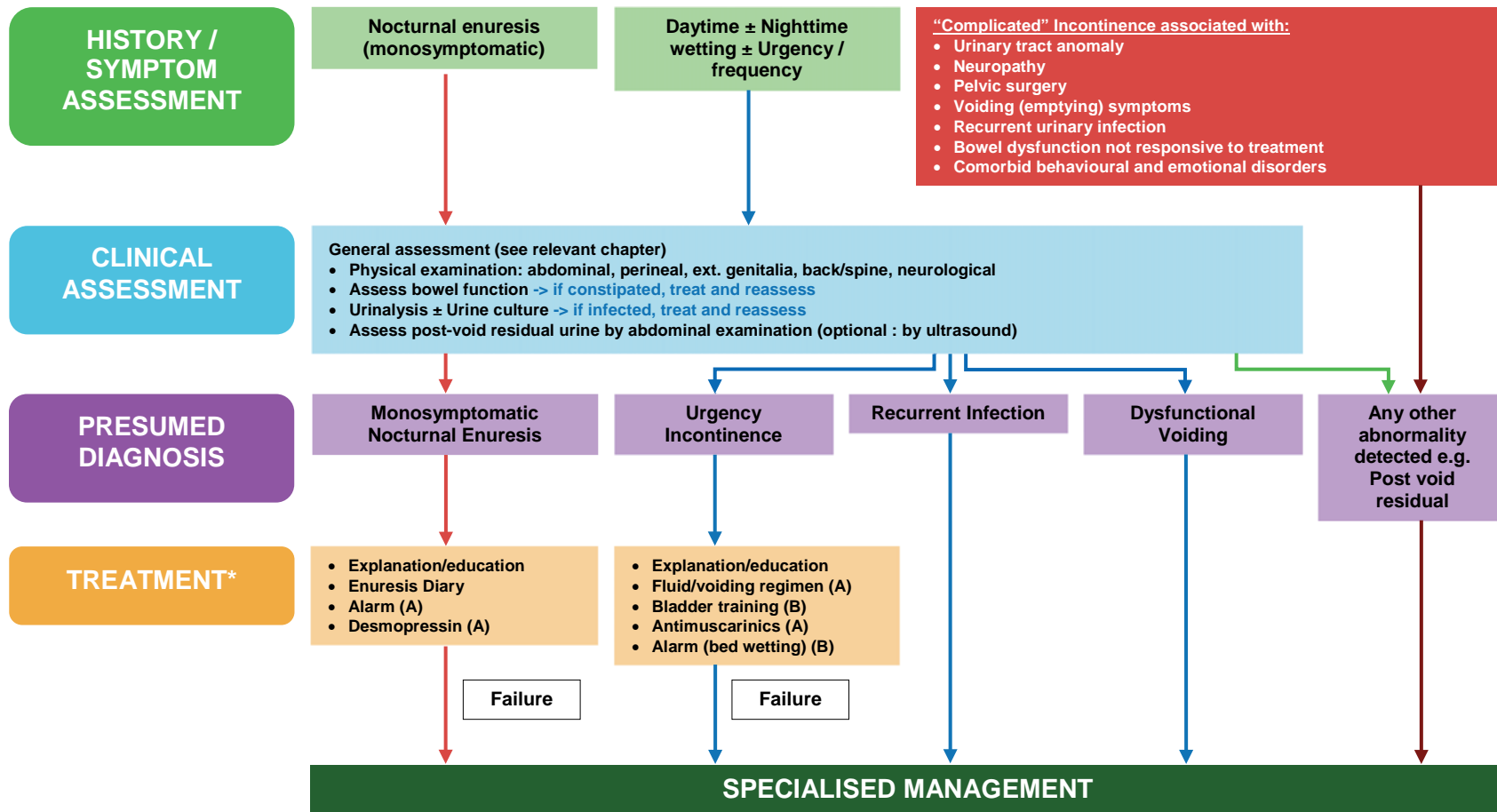

* Consider CONTINENCE PRODUCTS for temporary support during treatment

I. URINARY INCONTINENCE IN CHILDREN

B. SPECIALISED MANAGEMENT

- **Two groups of children** with “**complicated**” **incontinence** should have specialist management from the outset (Fig. 2).
- Children whose incontinence is due to, or associated with, **urinary tract anomalies** and **neuropathy**.
- **Children** without urinary tract anomalies, but with **recurrent febrile infection** and, proven or suspected, **lower urinary tract dysfunction**.
- Children who **fail the basic treatment**, but who have neither neurogenic nor anatomical problems, should also receive specialist management.

Children with comorbid behavioural and emotional disorders require referral to mental health services, as compliance and treatment outcomes are lower.

Assessment and treatment should follow evidence-based practice guidelines

1. ASSESSMENT

- As part of further assessment, the measurement of **urine flow** (in children old enough), together with the **ultrasound estimate of residual urine** and appearance of the bladder wall and rectum are highly recommended. An evaluation of the **upper urinary tracts with ultrasound is also highly recommended**.

Those who do not improve **with treatment** and have neither neurogenic nor anatomical problems **should be reassessed** using bladder diaries, symptom questionnaires, urinalysis, uroflowmetry and residual urine determination.

If there are recurrent and febrile infections, upper tract imaging and possibly a VCUg should be considered. However, endoscopy is rarely indicated.

- **Urodynamics should be considered:**
 - If the type and severity of lower tract dysfunction **cannot be explained by clinical findings** or in the presence of possible relevant neuropathy or urinary tract anomalies. (GoR B)

- If **invasive treatment** is under consideration, for example, stress incontinence surgery if there is sphincteric incompetence, or bladder augmentation if there is detrusor overactivity. (GoR B)
- **If upper tract dilation exists** and is thought to be due to bladder dysfunction. (GoR A)
- **Invasive urodynamic studies are generally not recommended** if the child has normal upper tract imaging and is to be treated by noninvasive means. (GoR B)
- **Spinal Imaging** (US/X-ray/MRI) may be needed if a bony abnormality or neuro-logical condition is suspected. (GoR A)

2. TREATMENT

The treatment of incontinence associated with **urinary tract anomalies** is complex and cannot easily be dealt with in an algorithm. In many children **more than one pathology** demands treatment. If there are **complex congenital abnormalities present**, the treatment is mostly surgical and it should be individualised according to the type and severity of the problem (please see Children's Committee Report).

Care should be given by specialist children's nurses and therapists.

- **Initial treatment should be non-surgical.**
 - **For stress urinary incontinence (SUI):** pelvic floor muscle training (GoR C).
 - **For OAB symptoms:** fluid/voiding regimens and antimuscarinics (GoR A).
 - **For voiding dysfunction:** timed voiding, voiding re-education, pelvic floor muscle relaxation (+/- biofeedback), alpha-blocker therapy, and intermittent catheterisation (when PVR >30% of bladder capacity) (GoR A/B).
 - **For bowel dysfunction:** high fibre diet and laxatives as appropriate, and transanal irrigation in severe cases (GoR A).

The child's progress should be assessed and, if quality of life is still significantly impaired, or if the upper urinary tracts are at risk, **surgical treatment** is likely to be necessary.

- **If surgical treatment is required**, then urodynamic studies are recommended to confirm the diagnosis.
- **For USI**, colposuspension, sling surgery, bulking agent injection and AUS may be considered (GoR B).
- **For DO/poor compliance**, botulinum toxin (for DO, and off-label) and bladder augmentation may be performed (GoR B).
- **If the child cannot do IC** then a Mitrofanoff channel may be needed (GoR A).

SPECIALISED MANAGEMENT OF URINARY INCONTINENCE IN CHILDREN

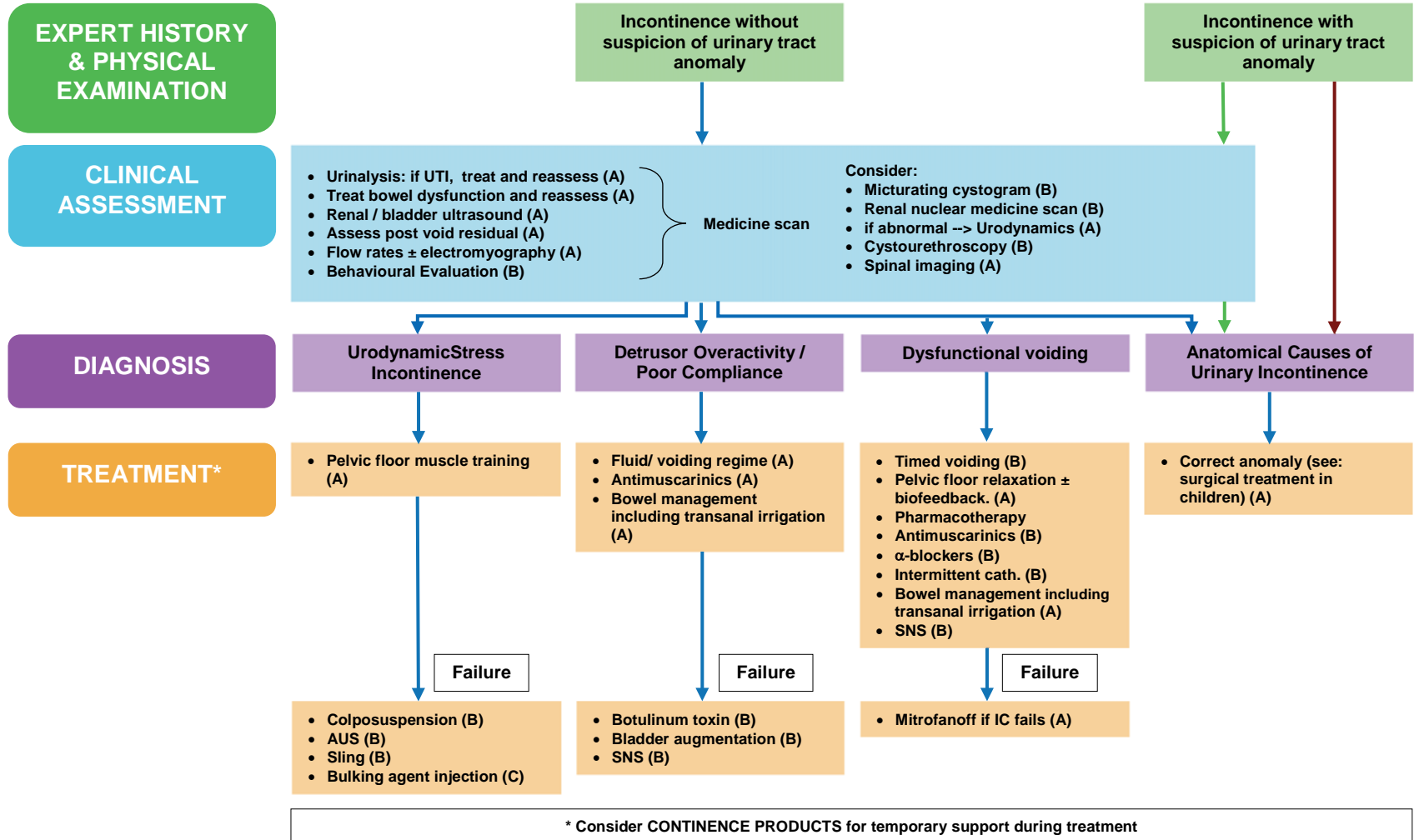

II. URINARY INCONTINENCE IN MEN

A. INITIAL MANAGEMENT

1. INITIAL ASSESSEMENT SHOULD IDENTIFY:

➤ “Complicated” incontinence group

Those with pain or with haematuria, recurrent infection, suspected or proven poor bladder emptying (for example due to bladder outlet obstruction), or incontinence following pelvic irradiation or radical surgery, are recommended for **specialised management**.

Poor bladder emptying may be suspected from symptoms, physical examination or if imaging has been performed by X-ray or ultrasound after voiding.

➤ **Four other main groups** of men should be identified by initial assessment as being suitable for **initial management**.

- Those with post-micturition dribble alone,
- Those with overactive bladder (OAB) symptoms: urgency with or without urgency incontinence, together with frequency and nocturia
- Those with stress urinary incontinence (most often post-prostatectomy),
- Those with mixed urinary urgency and stress incontinence (most often post-prostatectomy)

➤ For men with **stress, urgency** or **mixed** urgency / stress incontinence, initial treatment should include appropriate lifestyle advice, pelvic floor muscle training, scheduled voiding regimens, behavioural therapies and medication. In particular:

- Lifestyle interventions (eg weight loss GoR B)
 - Supervised pelvic floor muscle training for men with post radical prostatectomy SUI accelerates recovery time(GoR B)
 - Scheduled voiding regimen for OAB (GoR C)
 - Antimuscarinic/beta 3 agonist drugs for OAB symptoms with or without urgency incontinence (GoR B) if the patient has no evidence of significant post-void residual urine
 - α -adrenergic antagonists (a-blockers) can be added if it is thought that there may also be bladder outlet obstruction. (GoR C)
- **Should initial treatment be unsuccessful** after a reasonable time (for example, 8-12 weeks), **specialist advice** is highly recommended.

Clinicians are likely to wish to treat the **most bothersome symptom** first in men with symptoms of **mixed** incontinence.

2. MANAGEMENT

➤ For men with **post-micturition dribble**, this requires no assessment and can usually be treated by teaching the man how to do a strong pelvic floor muscle contraction after voiding, or manual compression of the bulbous urethra directly after micturition. (GoR B)

INITIAL MANAGEMENT OF URINARY INCONTINENCE IN MEN

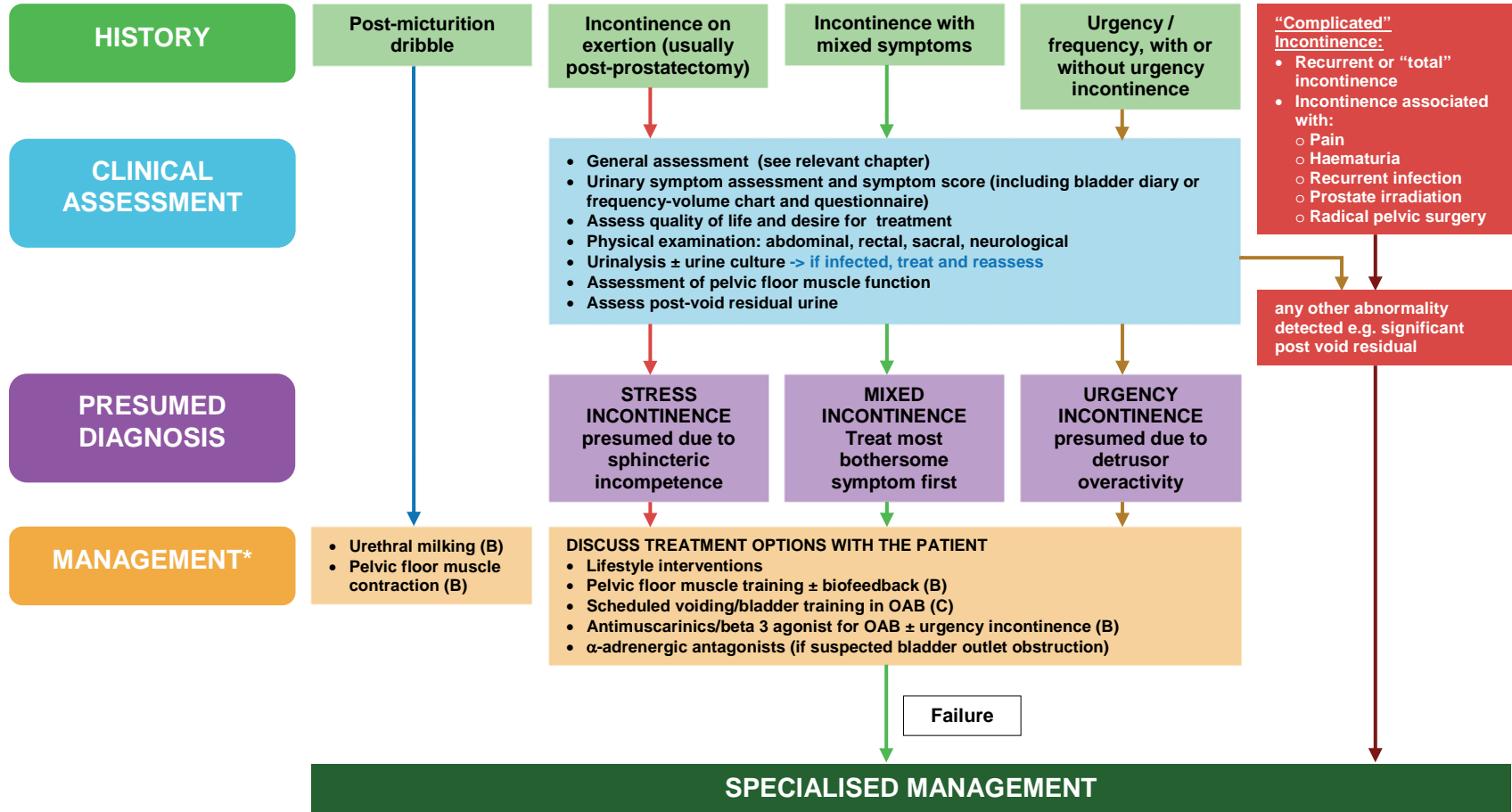

* Consider CONTINENCE PRODUCTS for temporary support during treatment

II. URINARY INCONTINENCE IN MEN

B. SPECIALISED MANAGEMENT

The specialist may first **reinstitute initial management** if it is felt that previous therapy had been inadequate.

1. ASSESSMENT

- Patients with “**complicated**” **incontinence** referred directly to specialised management, are likely to require **additional testing**, such as cytology, cystourethroscopy and urinary tract imaging.

If additional testing is normal then those individuals can be treated for incontinence by the initial or specialised management options as appropriate.

If symptoms suggestive of detrusor overactivity, or of sphincter incompetence **persist**, then **urodynamic** studies are advisable in order to arrive at a precise diagnosis, prior to invasive treatment.

2. TREATMENT

When basic management has been unsuccessful and if the patient's incontinence markedly disrupts his quality of life then **invasive therapies** should be considered.

- **For sphincter incompetence** the recommended option is the artificial urinary sphincter (GoR B). Other options, such as a male sling, may be considered (GoR C).
- **For refractory idiopathic detrusor overactivity**, (with intractable overactive bladder symptoms) the recommended therapies are: Botulinum toxin A (GoR B), and SNS (GoR C),
- When incontinence has been shown to be associated with **poor bladder emptying** due to **detrusor underactivity**, it is recommended that effective means are used to ensure bladder emptying, for example, intermittent catheterisation (GoR B/C).
- If incontinence is associated with bladder outlet obstruction, then consideration should be given to surgical treatment to relieve obstruction (GoR B). α -blockers and/or 5 α - reductase inhibitors would be an optional treatment (GoR C).
- There is increased evidence for the safety of antimuscarinics for overactive bladder symptoms in men, chiefly in combination with an α -blocker (GoR B).

SPECIALISED MANAGEMENT OF URINARY INCONTINENCE IN MEN

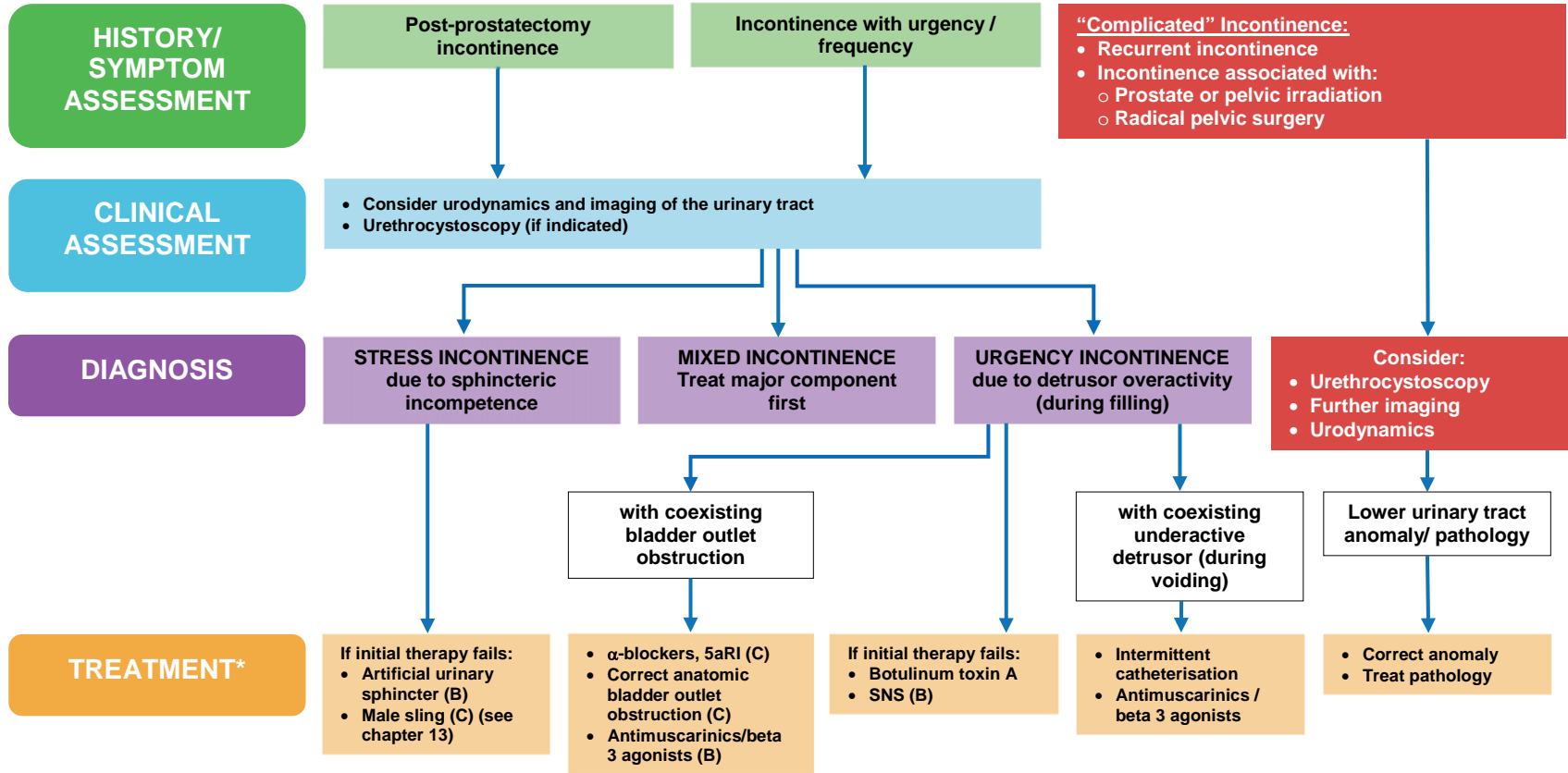

* Consider CONTINENCE PRODUCTS for temporary support during treatment

III. URINARY INCONTINENCE IN WOMEN

A. INITIAL MANAGEMENT

1. INITIAL ASSESSMENT SHOULD IDENTIFY:

➤ “Complicated” incontinence group.

Those with pain or haematuria, recurrent infections, suspected or proven voiding problems, significant pelvic organ prolapse or who have persistent incontinence or recurrent incontinence after pelvic irradiation, radical pelvic surgery, previous incontinence surgery, or who have a suspected fistula, should be referred to a specialist.

➤ **Three other main groups** of patients should be identified by initial assessment.

- Women with **stress incontinence** on physical activity
- Women with **urgency, frequency** with or without urgency incontinence: over-active bladder (OAB)
- Those women with **mixed** urgency and stress incontinence

Abdominal, pelvic and perineal examinations should be a routine part of physical examination. Women should be asked to perform a “stress test” (cough and strain to detect leakage likely to be due to sphincter incompetence). Any pelvic organ prolapse or urogenital atrophy should be assessed. Vaginal or rectal examination allows the assessment of voluntary pelvic floor muscle function, an important step prior to the teaching of pelvic floor muscle training.

2. TREATMENT

- For women with **stress, urgency or mixed** urinary incontinence, initial treatment should include appropriate lifestyle advice, pelvic floor muscle training,

PFMT), scheduled voiding regimes, behavioural therapies and medication. In particular:

- **Advice** on caffeine reduction for OAB (GoR B) and weight reduction (GoR A).
- Supervised pelvic floor muscle training (GoR A), supervised vaginal cones training for women with stress incontinence (GoR B).
- Supervised bladder training (GoR A) for OAB.
- **If oestrogen deficiency** and/or **UTI** is found, the patient should be treated at initial assessment and then reassessed after using vaginal oestrogens for a suitable period (GoR B).
- **Antimuscarinics/beta 3 agonist** for OAB symptoms with or without urgency incontinence (GoR A); duloxetine* may be considered for stress urinary incontinence (GoR B)

PFMT should be based on sound muscle training principles such as specificity, overload progression, correct contraction confirmed prior to training and use of “the Knack” for 12 weeks before reassessment and possible specialist referral.

Clinicians are likely to wish to treat the **most bothersome symptom first** in women with symptoms of mixed incontinence. (GoR C).

- Some women with significant pelvic organ prolapse can be treated by vaginal devices that treat both incontinence and prolapse (incontinence rings and dishes).

*Duloxetine is not approved for use in United States. In Europe it is approved for use in severe stress incontinence (see committee report on pharmacological management for information regarding efficacy, adverse events, and 'black box' warning by the Food and Drug Administration of the United States).

INITIAL MANAGEMENT OF URINARY INCONTINENCE IN WOMEN

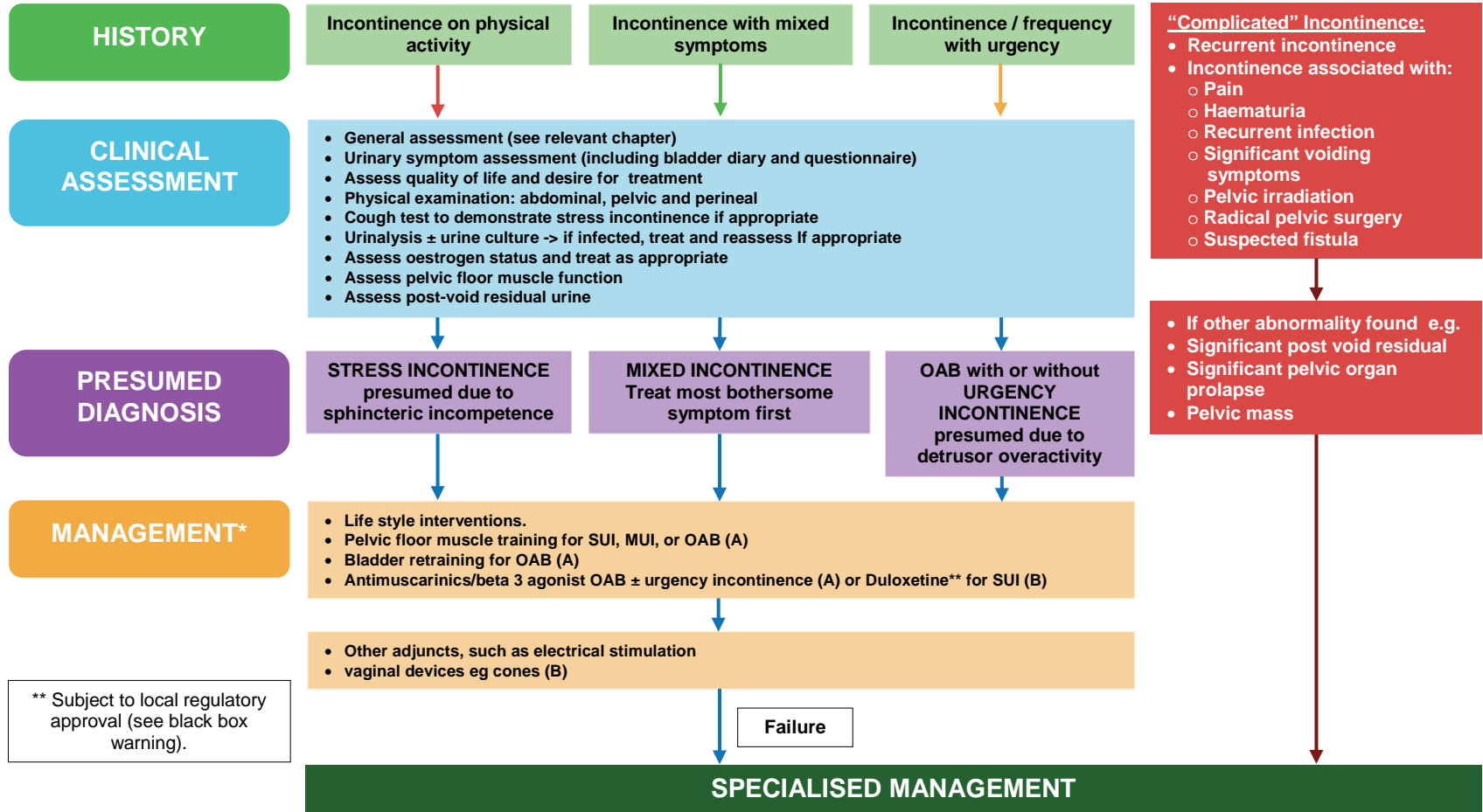

** Subject to local regulatory approval (see black box warning).

* Consider CONTINENCE PRODUCTS for temporary support during treatment

III. URINARY INCONTINENCE IN WOMEN

A. SPECIALISED MANAGEMENT

1. ASSESSMENT

Women who have “**complicated**” **incontinence** (see initial algorithm) may need to have additional tests such as cytology, urodynamics, cystourethroscopy or urinary tract imaging. If these tests are normal then they should be treated for incontinence by the initial or specialised management options as appropriate.

- Those women with persistent symptoms despite **initial management** and whose quality of life is impaired are likely to request further treatment. If initial management has been given an adequate trial then **interventional therapy may be desired**. When the results of urodynamic testing may change management, we highly recommend testing prior to intervention in order to diagnose the incontinence type and, therefore, inform the management plan. Urethral function testing by urethral pressure profile or leak point pressure is optional.
- Systematic assessment for **pelvic organ prolapse** is highly recommended and the POP-Q method should be used in research studies. Women with co-existing pelvic organ prolapse should have their prolapse treated as appropriate.

2. TREATMENT

- **If stress incontinence is confirmed** then the treatment options that are recommended for patients include the full range of non-surgical treatments, as well as colposuspension procedures, (GoR A) and bladder neck/sub-urethral sling operations (GoR A). All of these procedures have potential risks and associated complications which should be discussed with the individual. **The correction of symptomatic pelvic organ prolapse** may be desirable at the same time. For selected patients injectable bulking agents (GoR B) and the artificial urinary sphincter (GoR C) can be considered.
- **Refractory urgency incontinence** (overactive bladder) secondary to idiopathic detrusor overactivity may be treated by botulinum toxin A (GoR A), sacral nerve stimulation (GoR B) or bladder augmentation/intestinal cystoplasty (GoR D).
- Those patients with **voiding dysfunction** leading to significant post-void residual urine (for example, >30% of total bladder capacity) may have bladder outlet obstruction or detrusor underactivity. Prolapse is a common reversible cause, of voiding dysfunction.

SPECIALISED MANAGEMENT OF URINARY INCONTINENCE IN WOMEN

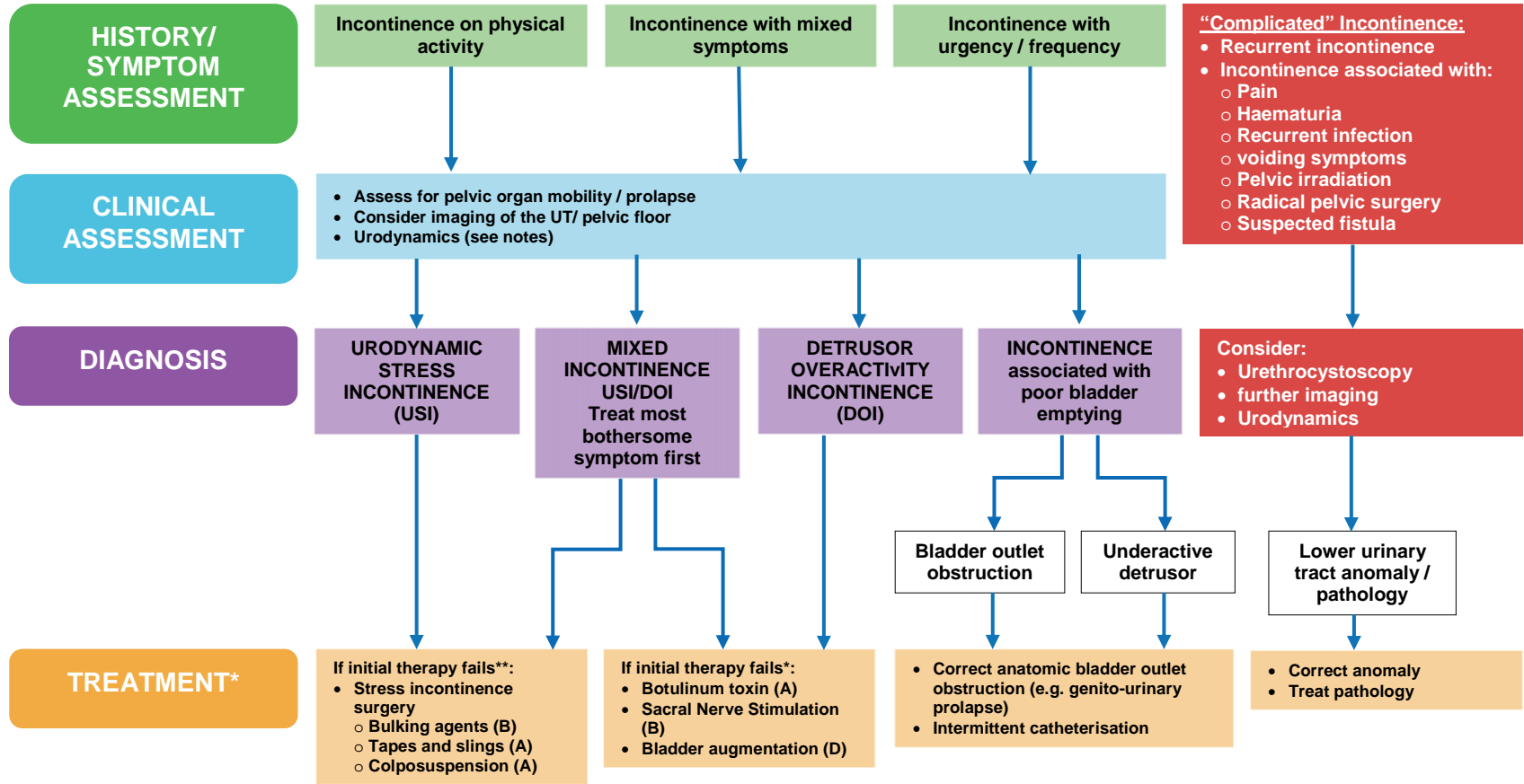

** Note procedures in increasing level of invasiveness

* Consider CONTINENCE PRODUCTS for temporary support during treatment

IV. FISTULAE

In the developing world fistulae occur as a consequence of poor perinatal care. Despite vast surgical experience in some centres, published research is of low quality.

In the developed world, iatrogenic urogenital fistulae are known complications of pelvic surgery and oncological treatments such as radiotherapy, chemotherapy or a combination of both. In the oncological context, fistulae may also occur as a result of primary or recurrent malignancy. The development of fistula following radiotherapy for primary treatment should trigger a search for evidence of tumour recurrence (GoR D). The use of neoadjuvant or adjuvant therapies is likely to be associated with a greater risk of fistula development than the primary treatment alone.

The most common non-obstetric causes of fistulae involving the gastro-intestinal tract are diverticular disease, Crohn's disease, malignancy and radiotherapy.

1. INITIAL ASSESSMENT

Early detection of fistulae could be improved by examining all women after their delivery, or prevented by Caesarian section for women who suffer prolonged labour and who are at risk of developing an obstetric fistula. Associated pathologies should be actively searched for and should be taken into account in the treatment plan: all components of the 'obstructed labour injury complex' should be examined. Prevention by better health education, and by avoiding harmful practices must be encouraged.

Classification of fistulae is recommended. Although many classification systems exist, the committee recommends the use of the Goh, WHO or Tafesse classification systems (GoR B)

The formal classification of the fistula should be done under anaesthesia when the patient is on the operation table, just before surgery.

- Leakage of stool, urine, or possibly both is the hallmark sign of a fistula. The leakage is usually painless, may be intermittent if it is position dependent, or may be constant.
- CT and cystoscopy appear more consistent in the confirmation and location of possible intestino-vesical fistulae, than other investigations (GoR C)

- Level 3 evidence indicates that the routine use of cystoscopy with dye testing at gynaecological surgery has high sensitivity, specificity and negative predictive value in the detection of ureteric injury, although false positive tests do occur. (GoR C)
- Ureteric injury or fistula may be suspected in patients following pelvic surgery if a fluid leak or pelvi-calyceal dilatation occurs postoperatively. (GoR D)
- Uretero-arterial fistula may be suspected in patients presenting with haematuria with a history of relevant pelvic surgery and indwelling ureteric stent. (GoR D)
- Elevated levels of creatinine in drainage fluid following pelvic surgery are suggestive of urine leaking due to a urinary tract injury. (GoR D)

2. MANAGEMENT OF NEW AND ESTABLISHED VVF

Management of VVF depends on whether the fistula is diagnosed within a few weeks of its occurrence or whether the woman presents late with an established fistula.

Early fistulae are those which are not re-epithelialised, and ischaemic and necrotic tissue can be present at the time of examination. There is evidence that early catheter care will result in the cure of a significant minority of VVFs. (GoR C)

Established fistulae are re-epithelialised and show no oedema, ischaemic changes or inflammation. These fistulae and those that fail catheter treatment should be treated surgically by an experienced surgeon. (GoR C)

3. TREATMENT

If catheter drainage fails, then fistula repair will be necessary. There are certain principles behind fistula repair:

- Necrotic tissue must be removed prior to fistula repair.
- Fistula repair must only be undertaken by a properly trained surgeon.
- Adequate post-operative care is essential.

- Proper follow-up should be arranged.

In principle, most fistulae can be dealt with by the vaginal approach, but an abdominal approach may be needed in some cases (e.g. concomitant reconstructive procedures e.g. ureteral reimplantation or bladder augmentation). (GoR C)

A tension-free single layer closure of the bladder wall and closure of the vaginal wall in a separate layer is advocated. A Martius flap in primary fistula repair is not recommended.

When reporting on outcome after fistula repair, authors should make a clear distinction between fistula closure rates and post-operative incontinence rates and the time at which the follow-up was organised.

Prevention of post-operative stress incontinence must be added to the surgical procedure if the urethral closing mechanism is involved. This can be done by a good repair of the pubocervical fascia and refixation or by adding a sling procedure.

Attention should be given as appropriate to skin care, nutrition, rehabilitation, counselling and support prior to and following fistula repair. (GoR D)

There is no proven benefit to delayed repair of vesicovaginal fistulae; the timing of repair should be tailored to the individual patient and surgeon requirements, but can be undertaken as soon as any oedema, inflammation, tissue necrosis, and infection have resolved. (GoR B)

There are no high quality data to indicate greater cure rates for any one technique as compared to others; level 3 evidence indicates similar success rates for vaginal and abdominal, and for transvesical and transperitoneal approaches. (GoR C)

A variety of interpositional grafts can be used in either abdominal or vaginal procedures, although there is little evidence to support their use in any specific setting. (GoR C)

Conventional and robotically-assisted laparoscopic approaches have both been shown to be feasible in selected cases; the indications for, or optimal patient for these techniques is not yet clear. (GoR C)

A period of continuous bladder drainage is crucial to successful fistula repair; there are no high level data to support any particular type, route, or duration of catheterisation. Current practice suggests, 10-14 days for simple and/or post-surgical fistulae; 14-21 days for complex and/or post-radiation fistulae. (GoR D)

Whilst diversion is used more widely in radiation-associated fistulae of all types as compared to non-radiated fistulae, there is low-level evidence that repair procedures can achieve successful fistula closure and continence in appropriately selected cases. (GoR C)

Where urinary and/or faecal diversions are required, attempts should be made to avoid using irradiated tissues wherever possible, and to minimise the potential for anastomotic complications. (GoR C)

There is low-level evidence to support the use of interposition grafts when repair of radiation-associated fistulae is undertaken. (GoR C)

4. MANAGEMENT OF THE COMPLICATIONS OF VVF

The complications of vesico-vaginal fistulae are many but include:

- Persistence or recurrence of urinary incontinence
- Persistence of lower urinary tract symptoms or occurrence of new lower urinary tract symptoms, including overactive bladder
- Urinary tract infections
- Upper urinary tract symptoms, including loin pain
- Dyspareunia and sexual dysfunction
- Infertility
- Neurological symptoms
- Psychological problems and mental illness

MANAGEMENT OF VESICOVAGINAL FISTULA

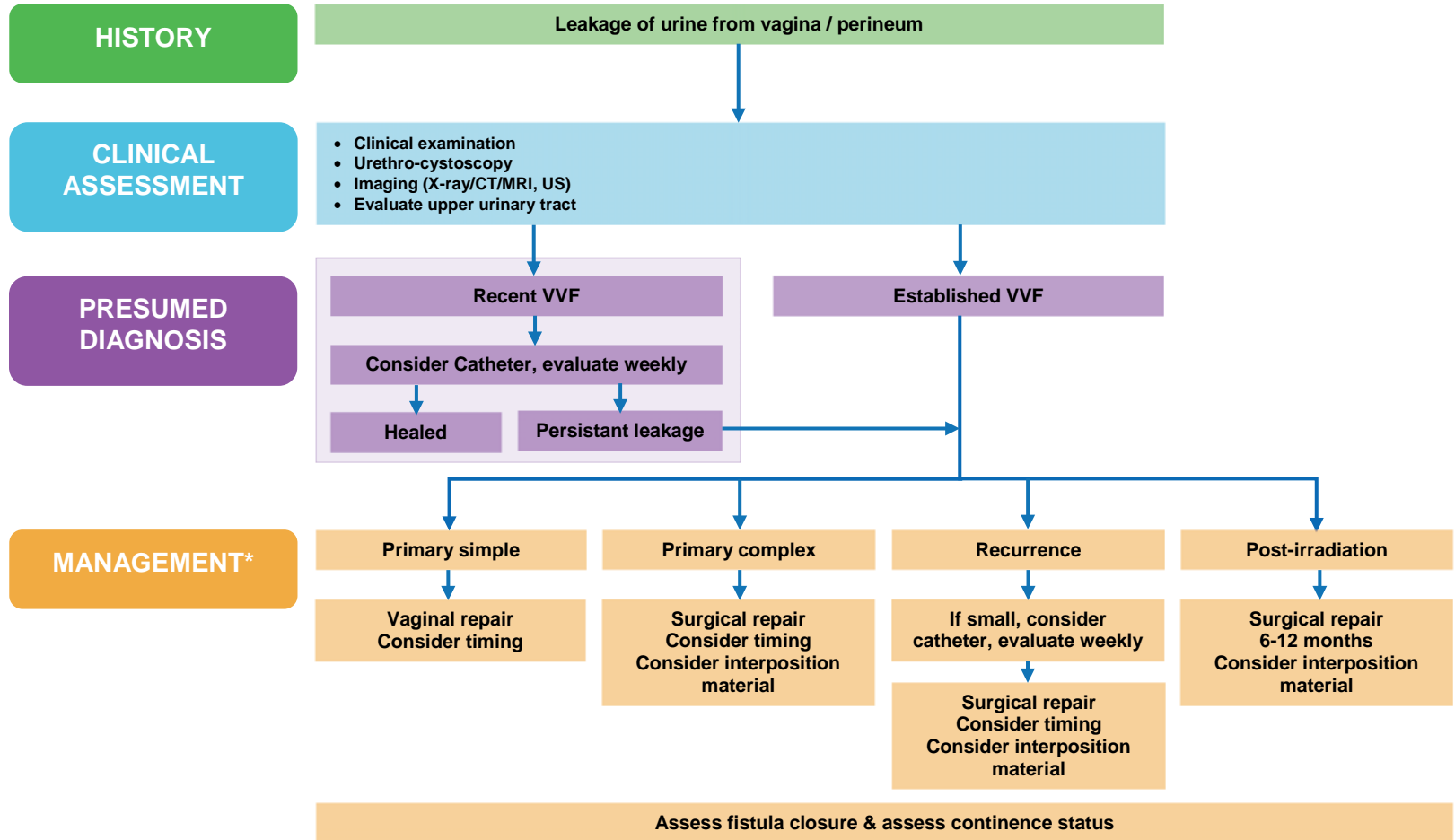

* Consider CONTINENCE PRODUCTS for temporary support during treatment

1. MANAGEMENT OF FISTULAE INVOLVING BOWEL

- There is limited evidence to support a non-surgical or conservative surgical approach in colo-vesical fistulae where there are minimal symptoms or evidence of limited bowel involvement. (GoR C)
- A one-stage approach to surgery for intestino-vesical fistulae is appropriate in many cases, but should be limited to those patients whose nutritional state is good, and where there is no evidence of additional intra-abdominal pathology (e.g. severe inflammation, radiation injury, advanced malignancy, intestinal obstruction) or major co-morbidity. (GoR B)
- A laparoscopic/robotic approach to one-stage management is feasible, although there is no high level evidence to allow comparison of outcomes with open surgery. (GoR D)

2. MANAGEMENT OF URETERIC FISTULAE

- Surgeons undertaking complex pelvic surgery should be competent at identifying, preserving and repairing the ureter. (GoR D)
- Ureteric stents are not required as prophylaxis against injury during routine gynaecological surgery, while their role in more extensive surgery remains to be established. (GoR B)

- Most upper urinary tract fistulae should be initially managed by conservative or endoluminal techniques where such expertise and facilities exist. (GoR B)
- Persistent ureterovaginal fistulae should be repaired by an abdominal approach using open, laparoscopic or robotic techniques according to availability and competence. (GoR D)
- For patients with ureteric fistulae associated with advanced pelvic cancer and poor performance status, palliation by nephrostomy tube diversion and endoluminal distal ureteric occlusion is an option. (GoR C)

3. MANAGEMENT OF URETHRO-VAGINAL FISTULAE

Recommendations

- Urethrovaginal fistulae are preferably treated by a vaginal approach. (GoR C)
- A variety of autologous tissue interposition techniques have been described, but their value remains uncertain. (GoR C)
- Urethrovaginal fistulae repair may be complicated by stress incontinence, urethral stricture and urethral shortening necessitating long-term follow-up. (GoR C)

MANAGEMENT OF IATROGENIC URETERIC FISTULAE

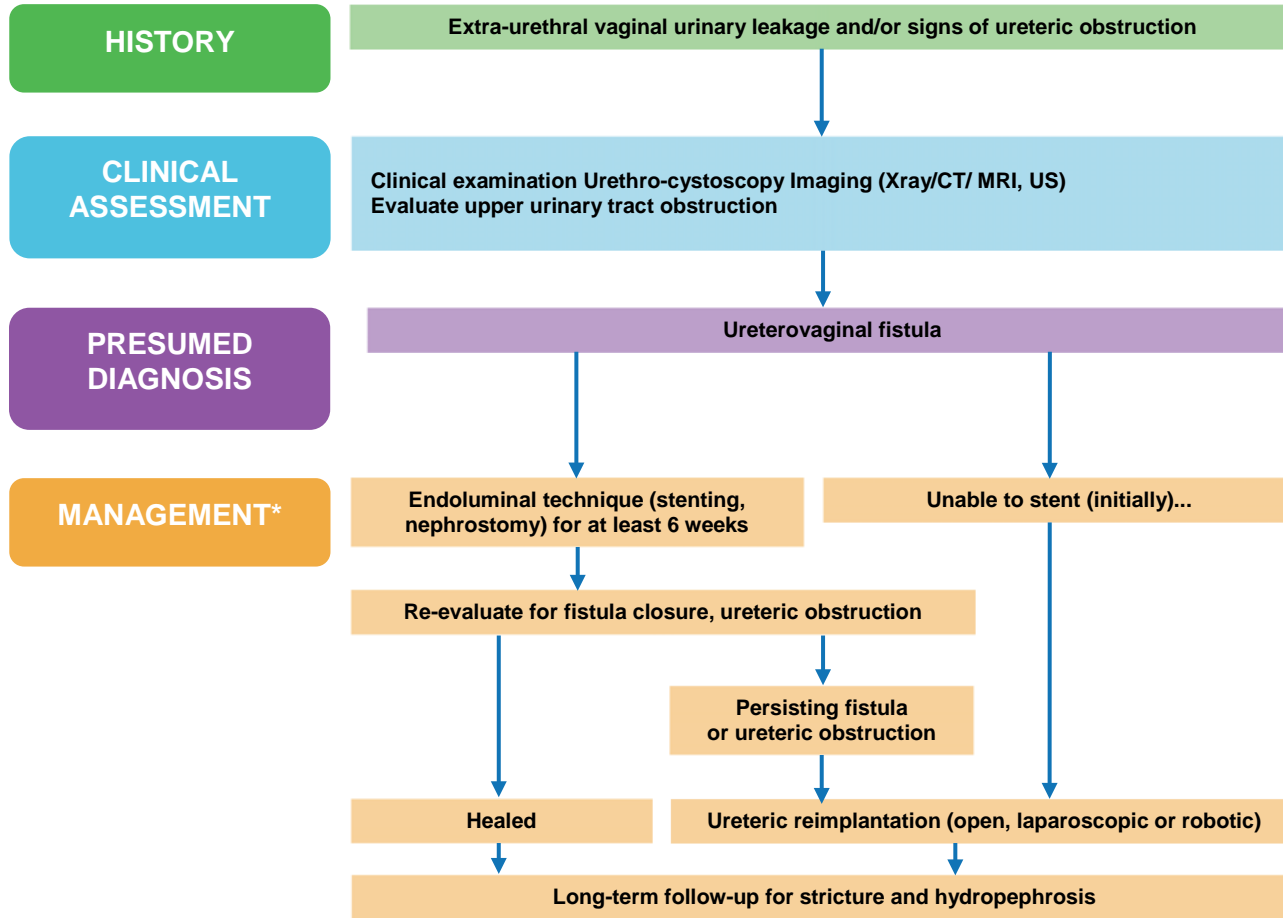

* Consider CONTINENCE PRODUCTS for temporary support during treatment

V. PELVIC ORGAN PROLAPSE

1. INTRODUCTION

Pelvic organ prolapse includes vaginal and rectal prolapse. Treatment of pelvic organ prolapse is generally reserved for symptomatic prolapse. Clinicians should recognise that coexistent pelvic floor symptoms are frequently present and that these symptoms may or may not be related to the prolapse. Women with prolapse require a careful and detailed initial assessment not only of the prolapse but associated bladder, bowel and sexual function.

2. ASSESSMENT

Symptom assessment preferably with a validated pelvic floor questionnaire that assesses bladder, bowel, vaginal and sexual function and bothersomeness is required. (Grade C).

Physical examination should:

- Report the most distal site of vaginal descent in relation to a fixed point such as the hymen and include an assessment of the anterior posterior and apical vagina. While standardised reporting utilising tools such as the Pelvic Organ Prolapse Quantification (POP-Q) are encouraged. The system used to measure the extent of the prolapse should be documented.
- Be undertaken in the standing position to evaluate the full extent of the prolapse.
- Determine if coexistent pelvic pathology is present on careful bimanual examination. Cytological screening of the cervix should be undertaken if required.
- The prolapse should be reduced to document the presence of occult stress urinary incontinence (see chapter for prolapse and urinary incontinence pathway).
- Assess pelvic floor muscle function (see chapter for full review).
- Determine if epithelial/ mucosal ulceration is present.
- Evaluate anal sphincter tone and or the presence of rectal prolapse in those with bowel symptoms (refer to chapter for pelvic organ prolapse and bowel symptom pathway).

When examination findings of the extent of the prolapse are not consistent with the history the examination can be repeated in a few weeks' time. (GoR C).

Post void residual should be measured; while most elevated post-void residual urines (150mls) resolve with treatment of the prolapse, a specialist consultation is required.

3. MANAGEMENT

Observation is appropriate when medically safe (GoR C).

Lifestyle interventions include weight loss, treating constipation, avoiding straining at stool and heavy lifting (GoR C).

Pelvic floor muscle training:

- Reduces associated pelvic floor symptoms (GoR A).
- May reduce the symptom of vaginal bulge (GoR C).
- Does not reduce extent of prolapse on examination based on POP-Q stage (GoR B).

Vaginal Pessary: when successfully fitted

- May reduce prolapse symptoms (GoR B)
- Need to be regularly reviewed (GoR C)
- Have high rates of discontinuation (GoR C)

Local Oestrogens are recommended in those with hypo-oestrogenic symptoms and in those with urethral prolapse or vaginal ulceration (GoR B)

Reconstructive surgery is reserved for those with symptomatic prolapse and is aimed at correcting the vaginal topography and functional pathology. Please see text for full recommendations.

Obliterative surgery is an important and effective treatment option in those who are happy to sacrifice coital activity. (GoR C)

MANAGEMENT OF PELVIC ORGAN PROLAPSE

(INCLUDING UROGENITAL PROLAPSE AND RECTAL PROLAPSE)

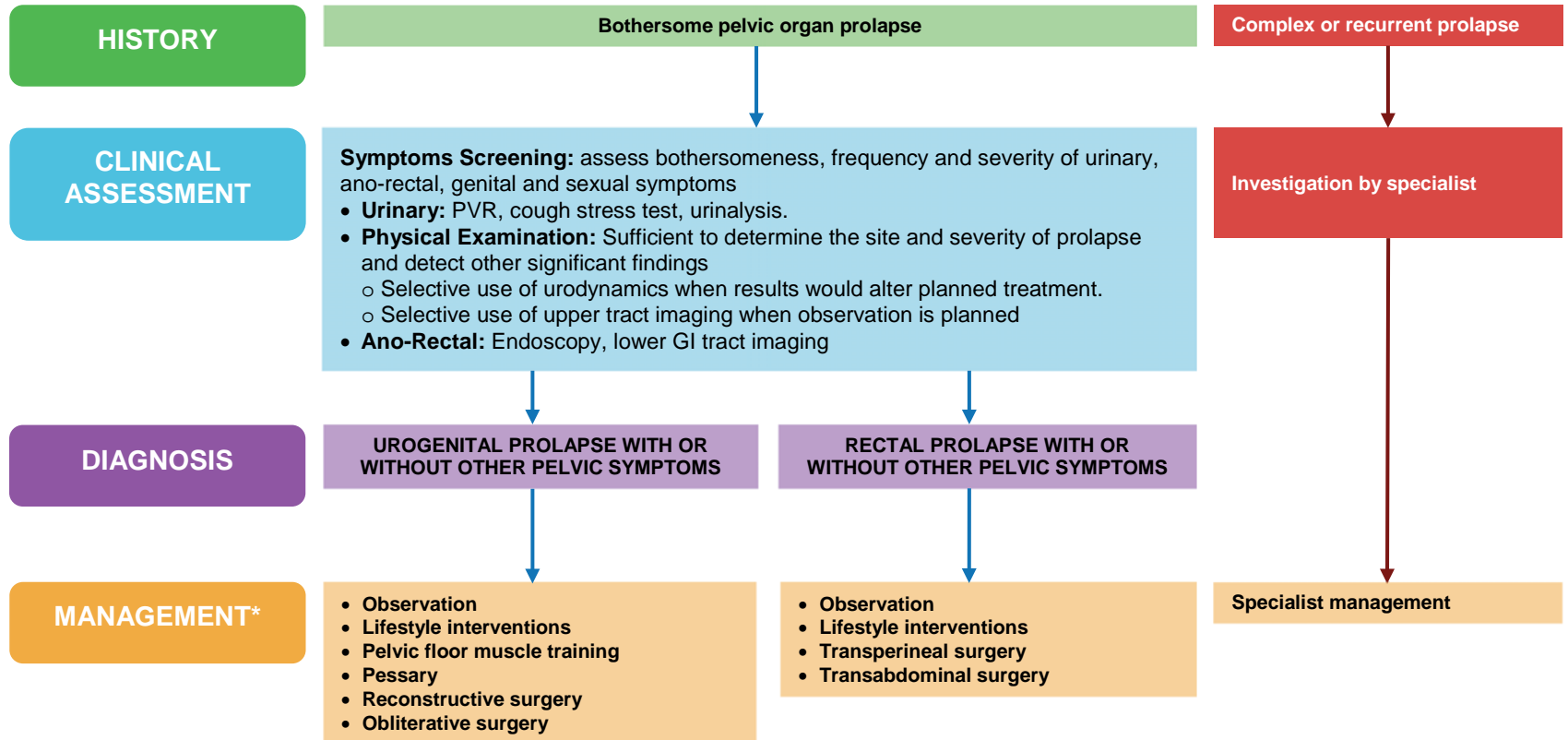

* Consider CONTINENCE PRODUCTS for temporary support during treatment

PATHWAY FOR THE SURGICAL MANAGEMENT OF PELVIC ORGAN PROLAPSE

The pelvic organ prolapse (POP) surgery pathway was designed to provide an evidence based guide for both clinicians and women for the surgical management of pelvic organ prolapse. Within the pathway green lines highlight the preferred option and yellow lines indicate reasonable options.

An early option in the treatment pathway for women not wanting to preserve sexual function is obliterative surgery (colpocleisis) which is an efficacious intervention that has low morbidity (LoE 3).

The majority of women will enter the reconstructive pathway. Apical suspension procedures should be considered in all cases with 10-year re-operation rates for prolapse being significantly reduced if apical suspensions are performed concomitantly with both anterior and posterior colporrhaphy as compared to those performed without apical support.

In those undergoing anterior and posterior colporrhaphy the evidence is supportive of traditional native tissue suture plications (LoE 1). In the anterior compartment permanent mesh could be considered for recurrent cases when the patient understands the risk benefit profile for these interventions and that the data for their use is scant. Evidence is not supportive of biological grafts in the anterior compartment (LoE 2).

In the posterior compartment, fascial plication is superior to site specific native tissue repair (LoE 2) and levatorplasty should be avoided due to higher rates of dyspareunia (LoE3). Data are not supportive of biological or permanent mesh grafts. Posterior colporrhaphy is superior to transanal repair of rectocele (LoE 1) and there is no data to support ventral rectopexy with or without vaginal graft for rectocele.

With recognition of the importance of apical vaginal support in minimising the risk of subsequent recurrence, the pathway separates those with post-hysterectomy (vault) prolapse from those with uterine prolapse.

Data are supportive of sacral colpopexy as the preferred intervention for vault prolapse with superior anatomical and functional outcomes when compared to a variety of vaginal based interventions with and without transvaginal mesh (LoE1). This preference is highlighted by a green preferred option arrow in the management pathway. In recognition that not all patients are suitable for sacral colpopexy, a yellow reasonable option is included for vaginal based apical support (uterosacral or sacrospinous colpopexy). Both uterosacral and sacrospinous colpopexy are

equally effective vaginal options (LoE 1) and utilisation of transvaginal permanent mesh apical support is not supported by the data (LoE1).

When performing sacral colpopexy the laparoscopic approach is preferred with reduced peri-operative morbidity and cost when compared to both the open or robotic approach (LoE 2). The yellow reasonable option pathway exists for both open and robotic options in recognition of the longer learning curve associated with the laparoscopic approach (LoE3).

Apical support in those with uterine prolapse can be performed abdominally or vaginally and includes options for both uterine preservation (hysteropexy) and hysterectomy, with not insignificant relative contraindications for uterine preservation listed in Table 6. In post-menopausal women undergoing hysterectomy, bilateral salpingo-oophorectomy (BSO) significantly reduces the rate of ovarian cancer without increased morbidity. In those retaining ovaries at hysterectomy, bilateral salpingectomy also reduces rate of subsequent ovarian cancer.

Vaginal hysteropexy is equally effective as vaginal hysterectomy with apical suspension and is associated with reduced blood loss and operating time as compared to hysterectomy (LoE 1). Vaginal hysterectomy with apical support has a lower re-operation for prolapse than abdominal sacrohysteropexy (LoE1). Sacrohysteropexy has a higher re-operation for prolapse than sacral colpopexy with hysterectomy however sacral colpopexy with hysterectomy is not recommended due to the high rate of mesh exposure (LoE2). Supra-cervical hysterectomy at sacral colpopexy reduces the rate of mesh exposure associated with hysterectomy and sacral colpopexy however in a single retrospective study, recurrent prolapse was more common in the supracervical hysterectomy group. Although those data is not complete, vaginal based hysterectomy and hysteropexy with apical support should generally be considered as preferred options for uterine prolapse with sacral colpopexy reserved for vault prolapse.

Those undergoing prolapse surgery with stress urinary incontinence (SUI) and occult SUI should generally have continence surgery performed at the time of prolapse surgery (LoE1). Those with prolapse without SUI or occult SUI should not undergo continence surgery at time of prolapse surgery (LoE1).

Based largely upon expert opinion (LoE3) those with prolapse without bowel symptoms and those with impaired defaecation with rectocele should undergo prolapse surgery as per the above pathway. Those with POP and impaired defaecation without rectocele, and those with faecal incontinence require colorectal assessment. If

rectal prolapse exists, these patients may benefit from combined colorectal and gynaecological interventions. Those with significant constipation and prolapse should be approached cautiously and may benefit from gastroenterology assessment prior to entering the POP surgery pathway.

Those undergoing POP surgery generally have improved sexual function post-operatively but a small number undergoing any POP surgery will experience painful intercourse post-operatively that may require subsequent intervention (LoE 1).

PATHWAY FOR THE SURGICAL MANAGEMENT OF PELVIC ORGAN PROLAPSE

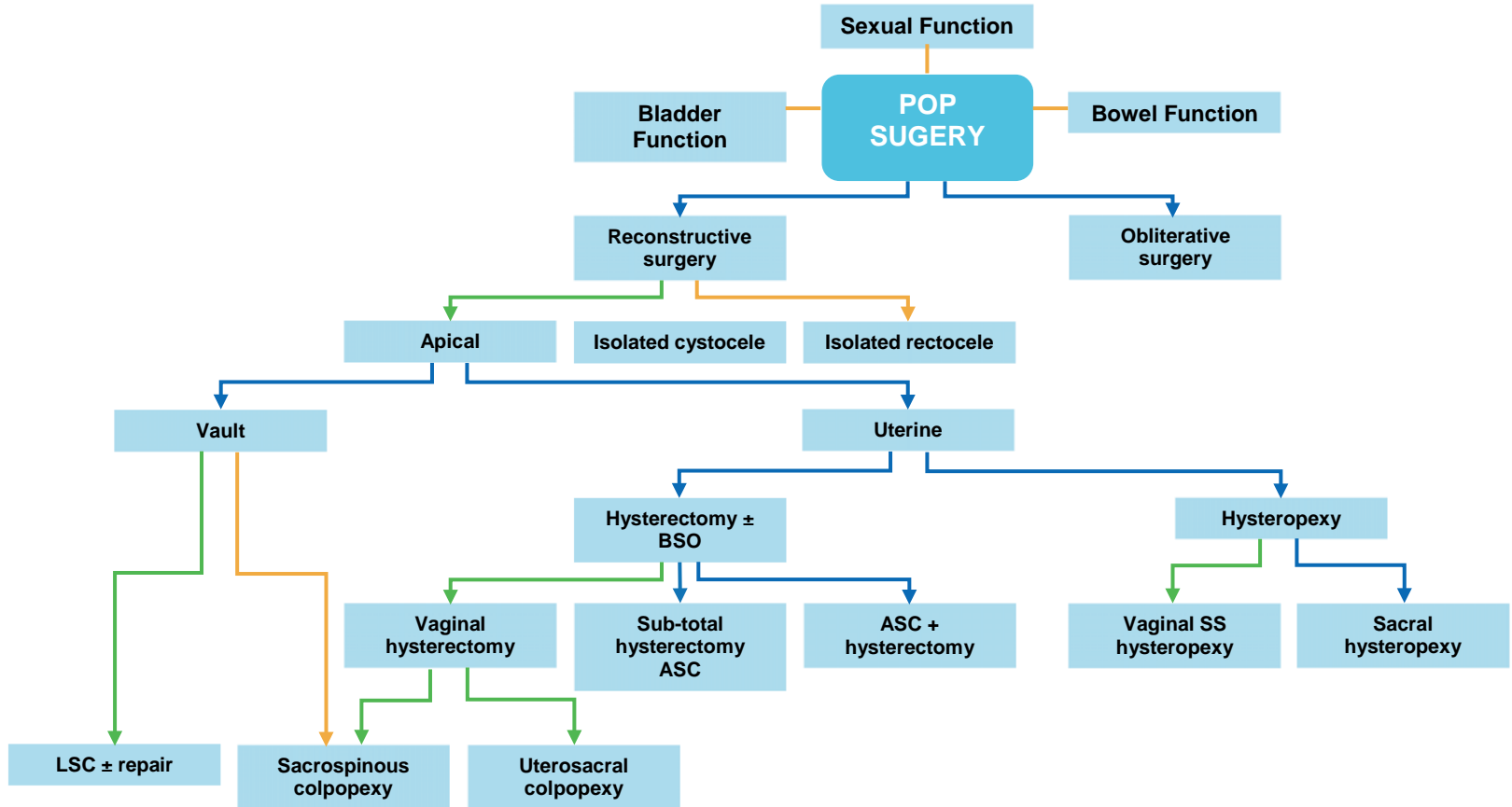

Consider CONTINENCE PRODUCTS for temporary support during treatment

VI. URINARY INCONTINENCE IN NEUROLOGICAL PATIENTS

A. INITIAL MANAGEMENT

1. STRONG GENERAL RECOMMENDATIONS

- Patients with known neurological disease often need evaluation to exclude bladder dysfunction, not only if symptoms occur, but as a standard assessment as neurogenic bladder has a high prevalence in the particular disease (for prevalence figures see chapter)
- A possible neurological cause of “idiopathic” incontinence should always be considered. Diagnostic steps to evaluate this include basic assessments, such as history and physical examination, urodynamics and specialised tests.
- Incontinence in neurological patients does not necessarily relate to the neurologic pathology. Other diseases such as prostate pathology, pelvic organ prolapse, might have an influence. These factors should be evaluated as potential primary or contributory causes.
- Extensive diagnostic evaluation is often useful and necessary to tailor an individual treatment based on complete neurofunctional data. This may not be needed in every patient e.g. patients with suprapontine lesions or in patients where treatment will consist merely of bladder drainage when the person is frail or has limited life expectancy.
- There is often a need to manage both bladder and bowel dysfunction simultaneously

2. INITIAL ASSESSMENT

- The management of neurological urinary incontinence depends on an understanding of the likely mechanisms producing incontinence. This can in turn depend on the site and extent of the nervous system abnormality.
- Under current classifications, neurogenic incontinence patients can be divided into four groups. History and physical examination are important in helping distinguish these groups:

- peripheral lesions (as after major pelvic surgery) including those with lesions of the cauda equina (eg.lumbar disc prolapse);
- sacral spinal cord lesions involving the sacral micturition centre
- suprasacral spinal cord lesions (suprasacral infrapontine spinal cord lesions);
- central lesions of the brain or brain stem (stroke, Parkinson’s disease).
- Assessment should be made using Questionnaires, urinalysis, bladder diary, uroflowmetry with assessment of PVR, and imaging of the urinary tract (ultrasonography); all provide basic data for the initial assessment of the NLUTD.
- Invasive urodynamics should be used as part of the initial assessment in select patient populations (SCI, meningomyelocele)
- Due to increasing data on organ cross-sensitisation and the debilitating effect of faecal incontinence on QOL, a history of bowel function should be also included

3. INITIAL TREATMENT

- Patients with peripheral nerve lesions (e.g. denervation after pelvic surgery) and patients with spinal cord lesions (e.g. traumatic spinal cord lesions) should receive specialised urological management (GoR A).
- Initial treatment for patients with incontinence due to suprapontine pathology, like stroke; need to be assessed for degree of mobility and ability to cooperate. Initial recommended treatments are behavioural therapy (GoR C) and anti-muscarinic drugs for presumed detrusor overactivity (GoR A). If incontinence persists and if operative procedures are not indicated then continence products (GoR B) or catheters (GoR C) may be necessary on a long-term basis. These can also be necessary in non-cooperative or less mobile patients.

Pharmacological detrusor relaxation and/or antibiotics may be useful in cases of persistent bypass leakage and/or recurrent UTI (patients with continuous drainage)

In all cases, bowel management should complement management of NLUTD

INITIAL MANAGEMENT OF NEUROGENIC URINARY INCONTINENCE

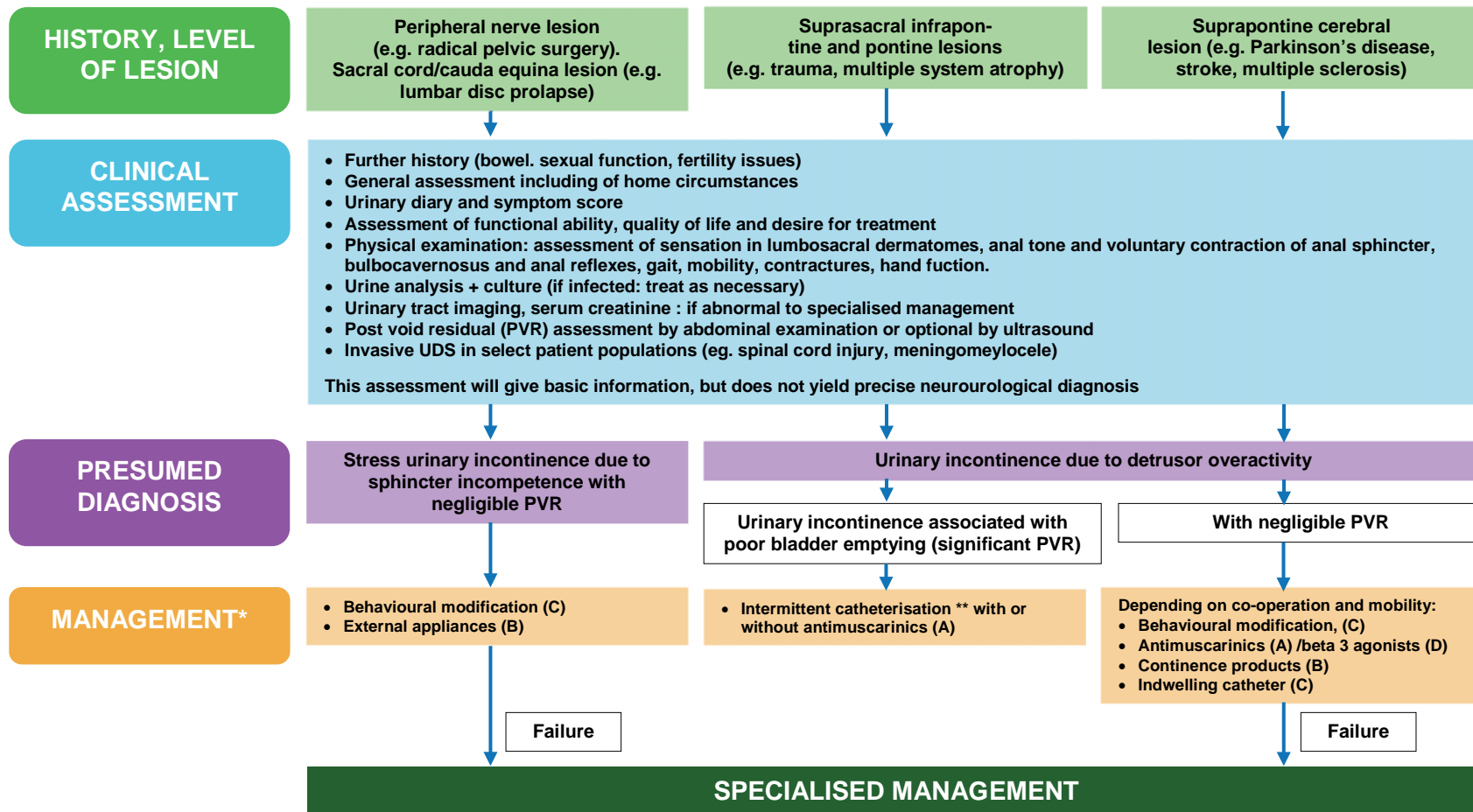

* Consider CONTINENCE PRODUCTS for temporary support during treatment

** Some patients omit IC through personal choice or inability to self catheterise

***Add complimentary bowel management in all cases

VI. URINARY INCONTINENCE IN NEUROLOGICAL PATIENTS

B. SPECIALISED MANAGEMENT

1. ASSESSMENT

- Most patients with neurogenic urinary incontinence require specialised assessment: Invasive urodynamic studies should be used with videourodynamics if available when surgical interventions are planned or when the “bladder may be unsafe”.
- Upper tract imaging is needed in some patients and more detailed renal function studies will be desirable if the upper tract is considered in danger: high bladder pressure, upper urinary tract dilation, recurrent or chronic upper tract infection, (major) stones, (major) reflux.
- In patients with peripheral lesions, clinical neurophysiological testing may be helpful for better definition of the lesion

2. TREATMENT

For specialised management, conservative treatment is the mainstay (GoR A). Management of neurogenic urinary incontinence has several options. The algorithm details the recommended options for different types of neurological dysfunction of the lower urinary tract. The dysfunction does not necessarily correspond to one type/level of neurological lesion and is defined best by urodynamic studies. One should always ascertain that the management ensures a safe lower urinary tract (storage at low pressure and complete emptying)

Both urinary and bowel function should be assessed together if both systems are affected, as symptoms and treatment of one system can influence the other, and *vice versa* (GoR A).

As therapeutic approaches can differ in various neurological diseases, the most prevalent diseases are discussed separately in the chapter

3. TREATMENT MODALITIES (OFTEN IN COMBINATION)

➤ Conservative

- Intermittent catheterisation (GoR A)
- Behavioural treatment (GoR C)
- Timed voiding (GoR C)
- Continence products (GoR B)
- Antimuscarinics (GoR A)
- Alpha-1-adrenergic blockers (GoR C)
- Oral cannabinoid agonists (MS) (GoR C)
- Beta-3-agonist alone or as an add-on to AM (GoR D)
- Bladder expression (GoR B)
- Triggered voiding (GoR C)
- Indwelling catheter (GoR C)

➤ Minimally invasive treatments

- Botulinum toxin for: sphincter (C) detrusor (A)
- Intravesical electrical stimulation (C)
- PTNS/TTNS (C)
- SNM (stable disease only) (C)

➤ Surgical treatment

- Artificial sphincter (A)
- Bladder neck sling (B)
- Sub-urethral tapes (D)
- Bulking agents (D)
- Bladder neck closure (D)
- Stents intraurethral (B)
- TUI sphincter (B)
- Sacral deafferentation (B)
- Sacral anterior root stimulator (B)
- Enterocystoplasty (B)

SPECIALISED MANAGEMENT OF NEUROGENIC URINARY INCONTINENCE

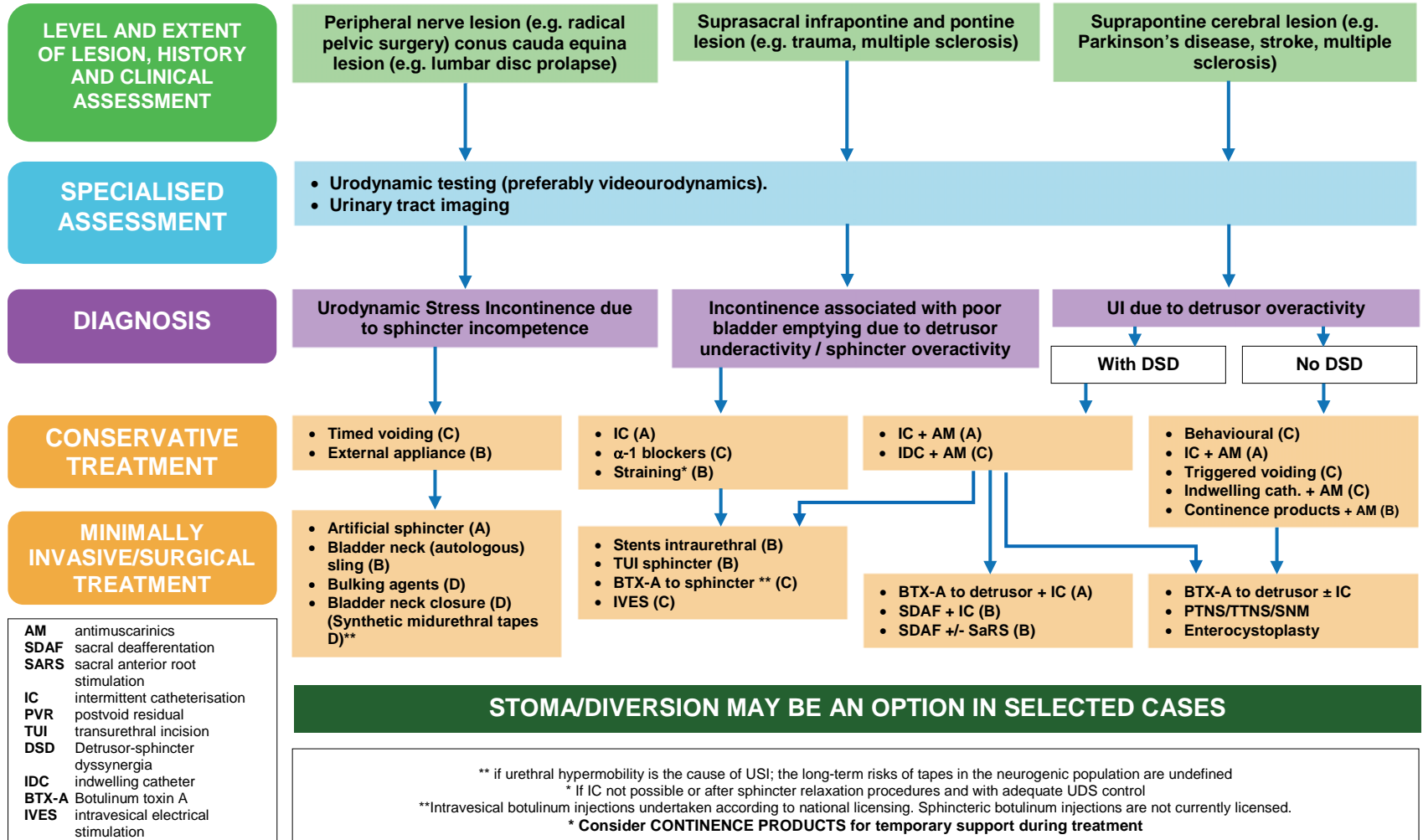

VII. BLADDER PAIN SYNDROME

Definition

Bladder Pain Syndrome (BPS): in the absence of a universally agreed definition, the International Society for the Study of Interstitial Cystitis – ESSIC definition is given (1).

ESSIC: Chronic pelvic pain, pressure or discomfort of greater than 6 months duration perceived to be related to the urinary bladder accompanied by at least one other urinary symptom like persistent desire to void or urinary frequency. Confusable diseases as the cause of the symptoms must be excluded.

There are no published data as to what duration of symptoms indicates that early spontaneous resolution of symptoms is unlikely. While ESSIC arbitrarily uses a 6 month duration, the American Urological Association Guideline suggests that a 6 week history is long enough to initiate diagnosis and treatment of BPS (2). Without further data, the Consultation cannot make a recommendation and believes that it is up to the discretion of the physician and patient as to the proper interval between symptom onset and evaluation and diagnosis of a chronic condition.

1. NOMENCLATURE

The scientific committee of the International Consultation voted to use the term “bladder pain syndrome” for the disorder that has been commonly referred to as interstitial cystitis (IC). The term painful bladder syndrome was dropped from the lexicon. The term IC implies an inflammation within the wall of the urinary bladder, involving gaps or spaces in the bladder tissue. This does not accurately describe the majority of patients with this syndrome. Painful Bladder Syndrome, as defined by the International Continence Society, is too restrictive for the clinical syndrome.

Properly defined, the term Bladder Pain Syndrome appears to fit in well with the taxonomy of the International Association for the Study of Pain (IASP) (see below), and focuses on the actual symptom complex rather than what appears to be long-held misconception of the underlying pathology.

Bladder Pain Syndrome (XXIII-2) (per IASP)

Bladder pain syndrome is the occurrence of persistent or recurrent pain perceived in the urinary bladder region, accompanied by at least one other symptom, such as

pain worsening with bladder filling and day-time and/or night-time urinary frequency. There is no proven infection or other obvious local pathology. Bladder pain syndrome is often associated with negative cognitive, and behavioural, sexual, or emotional consequences, as well as with symptoms suggestive of lower urinary tract and sexual dysfunction.

The Consultation believes that, based on the pathology and endoscopic finding characteristics of the Hunner lesion, the epidemiological pattern that distinguishes it from bladder pain syndrome, the clinical response to local treatment of the lesion by resection, fulguration, or steroid injection, the response to cyclosporine, and the

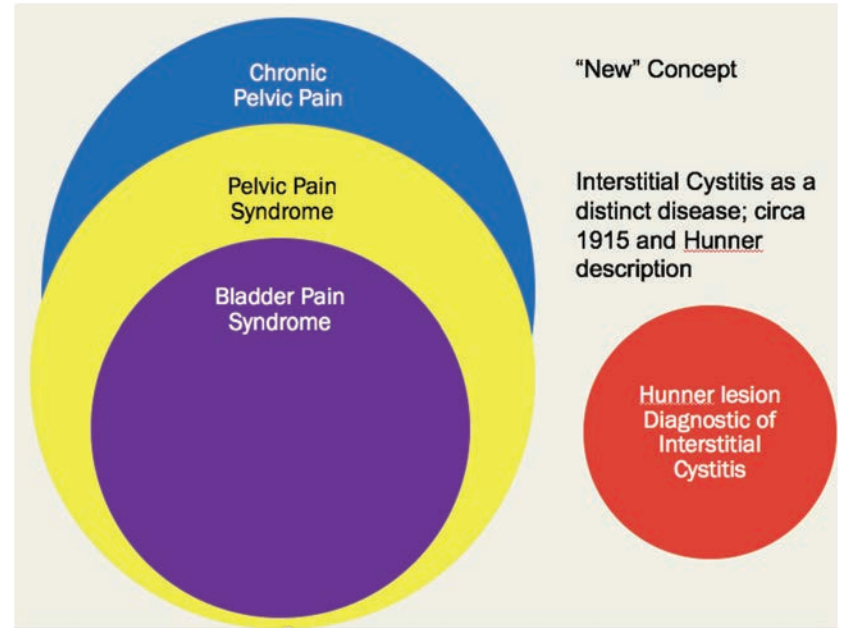

Figure 1

absence of reports in the literature that non-Hunner patients go on to develop Hunner lesions (ie, the finding of a Hunner lesion does not represent a continuum in the natural history of bladder pain syndrome), that the presence of a Hunner lesion should be considered a distinct disease. It therefore should drop out of the bladder pain syndrome construct, much like we do not consider other painful conditions like radiation cystitis, ketamine cystitis, or urinary tract infection a part of bladder pain syndrome.

The Consultation concludes that it would be reasonable to designate the Hunner lesion in symptomatic patients with the term “interstitial cystitis”, thus indicating a true interstitial inflammation. It would be defined much as Hunner defined it 100 years ago, and harmonise the largely Asian, European, and North American concepts of interstitial cystitis. The Consultation will continue to refer to the symptom complex as “bladder pain syndrome”. Hunner lesion will be considered a distinct phenotype, but in the future may be classified as a separate disorder entirely, albeit with local symptoms that are difficult to differentiate from bladder pain syndrome in the absence of endoscopy. In other words, we may be coming full circle in the historical perspective Figure 1.

2. HISTORY / INITIAL ASSESSMENT

Males or females whose symptoms meet the requirements of the definition of bladder pain syndrome should be evaluated. The presence of commonly associated disorders including irritable bowel syndrome, chronic fatigue syndrome, and fibromyalgia in the presence of the cardinal symptoms of bladder pain syndrome also suggests the diagnosis. Abnormal gynaecological findings in women and well-characterised, confusable diseases that may explain the symptoms must be ruled out.

The initial assessment consists of a bladder diary or frequency/volume chart, focused physical examination, urinalysis, and urine culture. In the absence of confusable disorders (uncomplicated disease), a diagnosis can be made and treatment instituted. Urine cytology, cystoscopy, and urodynamic evaluation are recommended if clinically indicated and/or the diagnosis is in doubt (complicated disease). Patients with urinary infection should be treated and reassessed. Those with recurrent urinary infection, abnormal urinary cytology, and microscopic or gross haematuria are evaluated with appropriate imaging and endoscopic procedures, and only if the findings are unable to explain the symptoms, are they diagnosed with BPS. GoR C

3. INITIAL TREATMENT

- Patient education, (GoR B)
- Dietary manipulation, (GoR B)
- Nonprescription analgesics,
- Stress reduction,
- Pelvic floor relaxation techniques comprise the initial treatment of BPS. In the patient with findings suggesting pelvic floor dysfunction, pelvic floor physical therapy with myofascial trigger point release and intravaginal Thiele massage is often an effective therapeutic intervention. The treatment of pain needs to be addressed directly, and in some instances referral to an anaesthesia/pain centre can be an appropriate early step in conjunction with ongoing treatment of the syndrome. (GoR A)

When conservative therapy fails or symptoms are severe and conservative management is unlikely to succeed,

- Oral medication (GoR B) or
- Intravesical treatment can be prescribed. It is recommended to initiate a single form of therapy and observe results, adding other modalities or substituting other modalities as indicated by the degree of response or lack of response to treatment. (GoR B)

4. SECONDARY ASSESSMENT

If initial oral or intravesical therapy fails, or before beginning such therapy based on clinician judgment, it is reasonable to consider further evaluation which can include urodynamics, pelvic imaging, and cystoscopy with bladder distention and possible bladder biopsy under anaesthesia.

- Findings of detrusor overactivity suggest a trial of antimuscarinic or beta-3-agonist therapy.
- The presence of a Hunner lesion suggests therapy with transurethral resection, fulguration of the lesion, or direct steroid injection into the lesion. (GoR B)

- Bladder distention itself can have therapeutic benefit in 30-50% of patients, though benefits rarely persist for longer than a few months. (GoR C)

5. REFRACTORY BPS

Those patients with persistent, unacceptable symptoms despite oral and/or intravesical therapy are candidates for more aggressive treatment modalities. Many of these are best administered within the context of a clinical trial if possible. These may include

- Sacral nerve stimulation, (GoR B)
- Intradetrusor botulinum toxin, (GoR B)

- Oral cyclosporine A (GoR C), or
- Clinical trials of newly described pharmacological management techniques. At this point, most patients will benefit from the expertise of an anaesthesia pain clinic.

The last step in treatment is usually some type of surgical intervention aimed at increasing the functional capacity of the bladder or diverting the urinary stream.

- Urinary diversion with or without cystectomy has been used as a last resort with good results in selected patients. Cystectomy and urethrectomy do not appear to add any additional efficacy to diversion alone.

Augmentation or substitution cystoplasty seems less effective and more prone to recurrence of chronic pain in small reported series (GoR C)

BLADDER PAIN SYNDROME

SYMPTOMS

Pain, pressure or discomfort perceived to be related to the bladder with at least one other urinary symptom (e.g. frequency, nocturia)

"Complicated" BPS:

- Incontinence
- Urinary infection
- Haematuria
- Gynaecologic signs/symptoms

BASIC ASSESSMENT

History

- Bladder diary or frequency/volume chart
- Focused physical examination
- Urinalysis, culture

Consider:

- Urine cytology
- Further imaging
- Endoscopy
- Urodynamics
- Laparoscopy

URINARY INFECTION

Test and reassess

1ST LINE RX

"Uncomplicated BPS"

Conservative Therapy

- Stress reduction (B)
- Patient education (B)
- Dietary manipulation (B)
- Nonprescription analgesics
- Pelvic floor relaxation
- Pelvic floor physical therapy (A)
- Consult if associated disease

Normal

Abnormal

TREAT AS INDICATED

Consider CONTINENCE PRODUCTS for temporary support during treatment

BPS REQUIRING MORE ACTIVE INTERVENTION

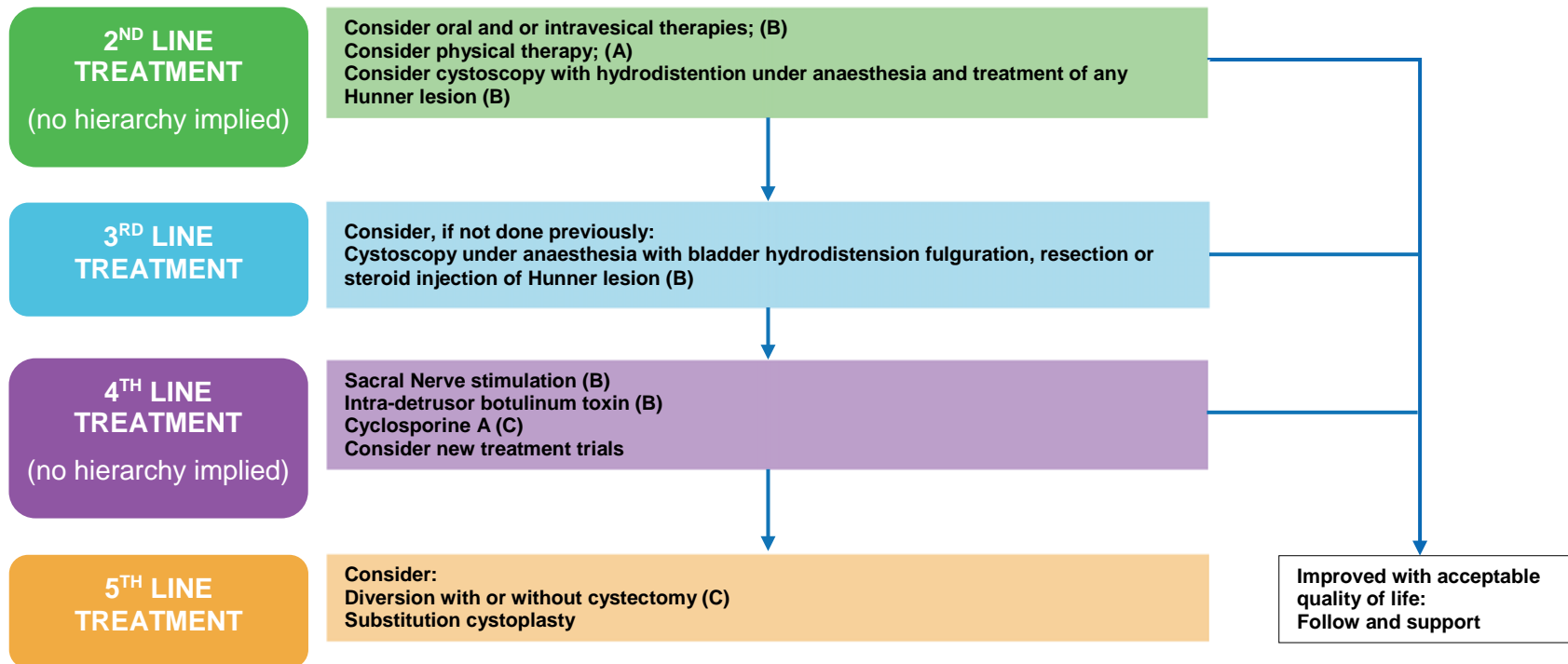

Note: The only FDA approved therapies are DMSO and pentosan polysulfate. Consider CONTINENCE PRODUCTS for temporary support during treatment.

- Pain management is a primary consideration at every step of the algorithm
- Patient enrollment in appropriate research trial is a reasonable option at any point
- Evidence supporting SNS, cyclosporine A, and botulinum toxin for BPS remains limited. These interventions are appropriate only for practitioners with experience in treating BPS and who are willing to provide long-term care post-intervention

VIII. FAECAL INCONTINENCE IN ADULT PATIENTS

ASSESSMENT AND MANAGEMENT

1. INITIAL CLINICAL ASSESSMENT

Adult patients with faecal incontinence present with a variety of symptom complexes. As many people are reluctant to admit to having faecal incontinence, it is important to proactively enquire about it, especially in known high risk groups (such as older community-living individuals, post partum women who might have had an obstetric injury and patients with loose stools).

History will include symptoms such as loose stools and urgency, the type and severity of bowel incontinence, systemic disorders, neurological disorders, and ano-rectal surgeries (e.g., haemorrhoidectomy), obstetric history for women, medications, diet, chronic straining, cognitive status, and effects of symptoms on quality of life.

2. INITIAL INTERVENTIONS

- Assessing the type of bowel incontinence may help identify an aetiology. Types of bowel incontinence: Anal incontinence is the involuntary loss of faeces and/or flatus and/or mucus). Faecal incontinence is the involuntary loss of faeces. Flatus incontinence is the involuntary loss of rectal gas, which may indicate rectal sensory impairment and/or anal sphincter dysfunction. Mucus incontinence is the involuntary loss of mucus only (See Figure 1).
 - Some subtypes of faecal incontinence are urgency faecal incontinence, which is the involuntary loss of faeces due to an inability to defer defaecation, once the desire is perceived, for long enough to reach a toilet. Urgency faecal incontinence is often a symptom of external anal sphincter dysfunction. The symptom of urgency does not necessarily result in urgency faecal incontinence. Functional faecal incontinence is due to limitations in mobility or toileting ability or delayed assistance. Passive faecal incontinence, incontinence without forewarning, is typically related to internal anal sphincter dysfunction or poor closure of the external sphincter due to rectal prolapse or stage III/IV haemorrhoids.
 - Physical examination will include anal inspection, abdominal palpitation, a brief neurological examination, digital rectal examination and usually procto-sigmoidoscopy or colonoscopy.
 - Further diagnostic testing needs to be considered if the patient has symptoms such as an unexplained change in bowel habit, weight loss, anaemia, rectal bleeding, severe or nocturnal diarrhoea, or an abdominal or pelvic mass and bowel pathology when organic conditions such as cancer, inflammatory bowel disease (IBD), a recto-vaginal fistula, full thickness rectal prolapse, or cloacal deformity are suspected. Condition specific management is indicated for these patients.
 - Reversible factors (such as inadequate access to toilets and side effects of medications resulting in loose stools) should be assessed and addressed at the outset.
- Some initial management can often be performed in primary care. After environmental factors and local or systemic pathology have been excluded, initial interventions include:
- Discussion of options and goals of management with the patient
 - Provision of patient or caregiver information and education (GoR A)
 - Adjustment of diet and fluid advice, fibre intake (GoR A)
 - Establishing a regular bowel habit (GoR C) or urgency training if relevant (GoR C)
 - Anti-diarrhoeal medication can help if stools are loose (GoR B)
 - Use of continence products including various types and sizes of absorbent pads, briefs, etc., to contain leaked faeces and prevent skin damage
 - Provide advice on practical coping skills when incontinence occurs (GoR C)

3. SECONDARY INTERVENTIONS

- If initial interventions fail to improve symptoms after 8-12 weeks, consideration should be given to referral to an incontinence specialist (e.g., gastroenterologist, continence nurse, advisor physiotherapist, or colorectal surgeon) for other interventions or further assessment.
- Pelvic floor muscle training (PFMT) – contraction of pelvic floor muscles, multiple times per day to improve strength of contraction and increase awareness of anorectal muscle function. (GoR C)
- Biofeedback therapy – behavioural treatment designed to enhance the strength of sphincter contraction and improve rectal sensation using specialised equipment. Biofeedback therapy can be combined with PFMT to improve strength. (GoR B)
- Transanal Irrigation to maximise bowel emptying and minimise faecal incontinence primarily in patients with incomplete elimination, passive faecal incontinence, or faecal incontinence with defaecation difficulty, (GoR C)

4. SECONDARY ASSESSMENT

- A variety of anorectal investigations, including manometry, anal ultrasound, and possibly MRI, defaecography, and neurophysiological testing can help to define structural or functional abnormalities of anorectal function and guide management if initial and/or secondary interventions are ineffective

5. TERTIARY REFERRAL, SURGICAL OR MULTI-DISCIPLINARY CONSULTATION

- Faecal incontinence that fails to respond to initial and secondary management requires specialised consultation by a gastroenterologist, colorectal surgeon, urogynaecologist, and/or a multi-disciplinary team

ASSESSMENT AND CONSERVATIVE MANAGEMENT OF FAECAL INCONTINENCE

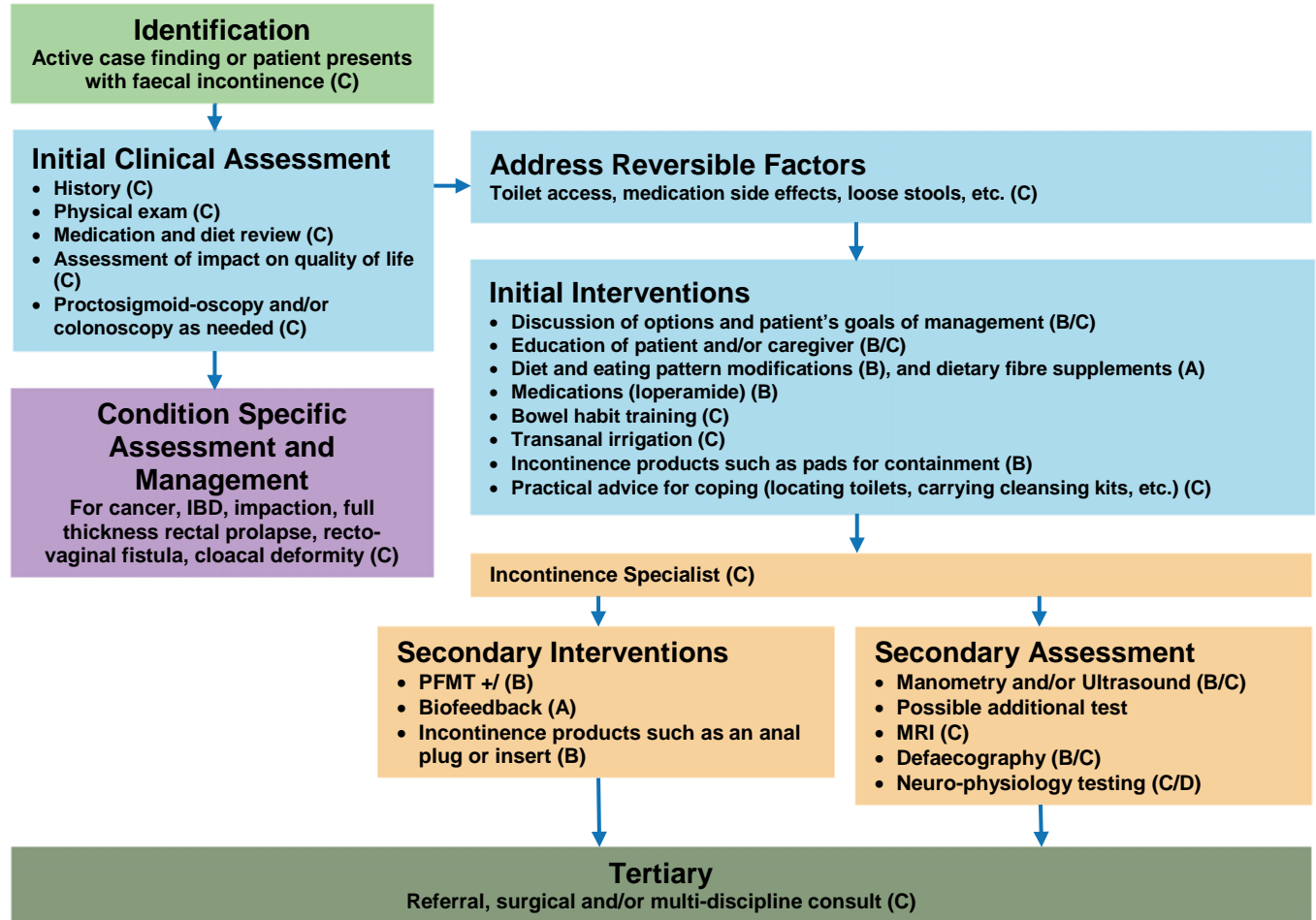

* Consider CONTINENCE PRODUCTS for temporary support during treatment

VIII. FAECAL INCONTINENCE IN ADULT PATIENTS

SURGERY FOR FAECAL INCONTINENCE

1. PATIENT ASSESSMENT

- The reader is referred to the relevant chapter sections in “Dynamic Testing” and “Conservative Treatment for Faecal Incontinence.” In general, patients referred for surgical management of faecal incontinence must either have failed conservative therapy or not be candidates for conservative therapy due to severe anatomic or neurological dysfunction.
- Prior to surgical management of faecal incontinence, the integrity of the anal sphincter complex should be assessed. This assessment is best performed with endoanal ultrasound, though pelvic MRI may also be useful. Ancillary tests include anal manometry, electromyography, and defaecography.
- If the patient has persisting faecal incontinence, he or she should undergo repeat assessment, including endoanal ultrasound.

2. SPECIALISED MANAGEMENT

- The surgical approach is influenced by the presence and magnitude of an anatomical anal sphincter defect. If no defect is present, or if the sphincter defect is minimal, options include SNS and biomaterial injection therapy.
- Acute anal sphincter repair is usually required following obstetric or direct trauma. End to end or overlapping repair may be performed. When possible the internal anal sphincter should be separately repaired. (GoR C)
- Patients with rectal prolapse, rectovaginal fistula or cloacal deformity often have associated faecal incontinence. Initial therapy should be directed at correction of the anatomical abnormality. (GoR C)
- For patients with moderate sphincter defects, sphincteroplasty, SNS or biomaterial injection therapy can each be considered. For patients with large sphincter defects (>120 degrees), sphincteroplasty is likely to be the best option, though a PNE trial for SNS can be considered. (GoR C)

- Patients with sphincter defects of greater than 180° or major perineal tissue loss require individualised treatment. In some cases, initial reconstruction can be performed. Should incontinence persist, alternatives include stimulated muscle transposition (usually graciloplasty) artificial anal sphincter implantation, or SNS. (GoR C)

3. SALVAGE MANAGEMENT

- For patients who remain incontinent following sphincteroplasty, repeat endoanal ultrasound should be undertaken to reassess the status of the repair. If no defect is present, or if the sphincter defect is minimal, options include SNS and biomaterial injection therapy. If there is a large persisting sphincter defect, repeat sphincteroplasty can be considered. (GoR C)
- Patients who have failed SNS can be considered for biomaterial injection therapy or sphincteroplasty if a sphincter defect is present. Other alternatives include stimulated graciloplasty and implantation of an artificial anal sphincter. (GoR C)
- Patients who fail surgical therapy for faecal incontinence, or who do not wish to undergo extensive pelvic reconstruction, should consider placement of an end sigmoid colostomy. (GoR C) While this procedure does not restore continence, it does restore substantial bowel control and appears to improve social function and quality of life. Novel therapies can also be considered under protocol: PTNS, the magnetic anal sphincter, SECCATM, vaginal pessary (EclipseTM) and sling procedures. (GoR D)

4. SPECIAL SITUATIONS

- Individuals with congenital abnormalities may be amenable to surgical repair. Often this will involve both laparoscopic abdominal and perineal approached. Poor functional outcomes may be treated by an Antegrade Continence Enema (ACE) procedure or colostomy. Patients with cauda equina type neurological disorders, either congenital or acquired, should be considered for an ACE procedure or colostomy. (GoR C)

SURGICAL MANAGEMENT OF FAECAL INCONTINENCE

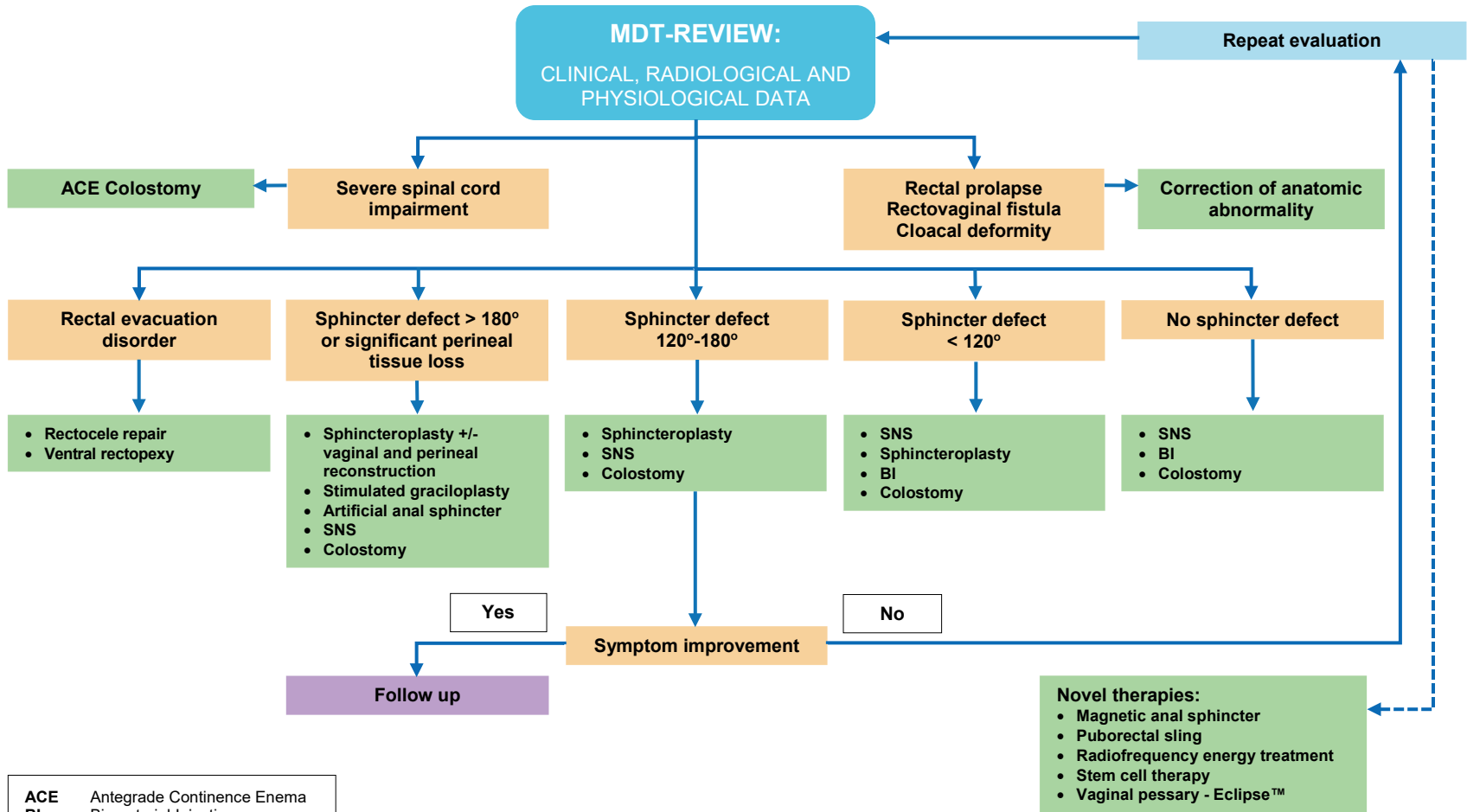

ACE Antegrade Continence Enema
BI Biomaterial Injection
MDT Multi-Disciplinary Team
SNS Sacral Nerve Stimulation

* Consider CONTINENCE PRODUCTS for temporary support during treatment

IX. FAECAL INCONTINENCE IN NEUROLOGICAL PATIENTS

A. INITIAL MANAGEMENT

- Patients with known neurological disease may present with symptoms related to neurological bowel dysfunction, such as; difficulty in defaecation, constipation and faecal incontinence which disturb their activities of daily living and impair quality of life. Many have permanent impairments and functional limitations and disabilities, which are due to neurological deficits and complications
- Functional assessment:
 - Hand and arm use, fine hand use, mobility – maintaining body position, transfer and walking ability.
- Environmental factors assessment:
 - toilet accessibility; devices for bowel care and mobility; caregiver support and attitude;

1. INITIAL ASSESSMENT

- The history should include:
 - Neurological diagnosis and functional level
 - Previous and present lower gastrointestinal (LGIT) function and disorders
 - Severity of neurogenic bowel dysfunction
 - Current bowel care and management including diet, fluid intake, medications affecting bowel functions
 - Co-morbidity / complication e.g., urinary incontinence, autonomic dysreflexia, pressure ulcers, sexual dysfunction
 - Patient's satisfaction, needs, restrictions and quality of life
 - Environmental factors and barriers and facilitators to independent bowel management.
- Physical examination:
- Cognitive function; motor, sensory and sacral reflexes – voluntary anal sphincter contraction, deep perianal sensation, anal tone, anal and bulbo- cavernosus reflexes
- Spasticity of the lower limbs
- Abdominal palpation for faecal loading and rectal examination

2. BASIC INVESTIGATIONS

Stool examination, plain abdominal X-Ray

3. INITIAL TREATMENTS

- Patient education and goals-setting to achieve complete defaecation on a regular basis and faecal continence based on right time, right place, right trigger and right consistency
- Adequate fibre diet and fluid intake; appropriate trigger according to preservation of sacral (anorectal) reflex – digital rectal stimulation (GoR C); suppository and enema (GoR B); if no anorectal reflex, manual evacuation (GoR B); abdominal massage (GoR C) can also be helpful
- Prescribe medications – stool softener, laxative, prokinetic agents, anti-diarrhoeal drugs as necessary
- Assistive techniques may be necessary for
 - Defaecation – transanal irrigation (GoR A)
 - For incontinence – anal plug (GoR C)

The algorithm does not apply to management in acute neurological patients that need regular bowel emptying.

INITIAL MANAGEMENT OF NEUROGENIC FAECAL INCONTINENCE

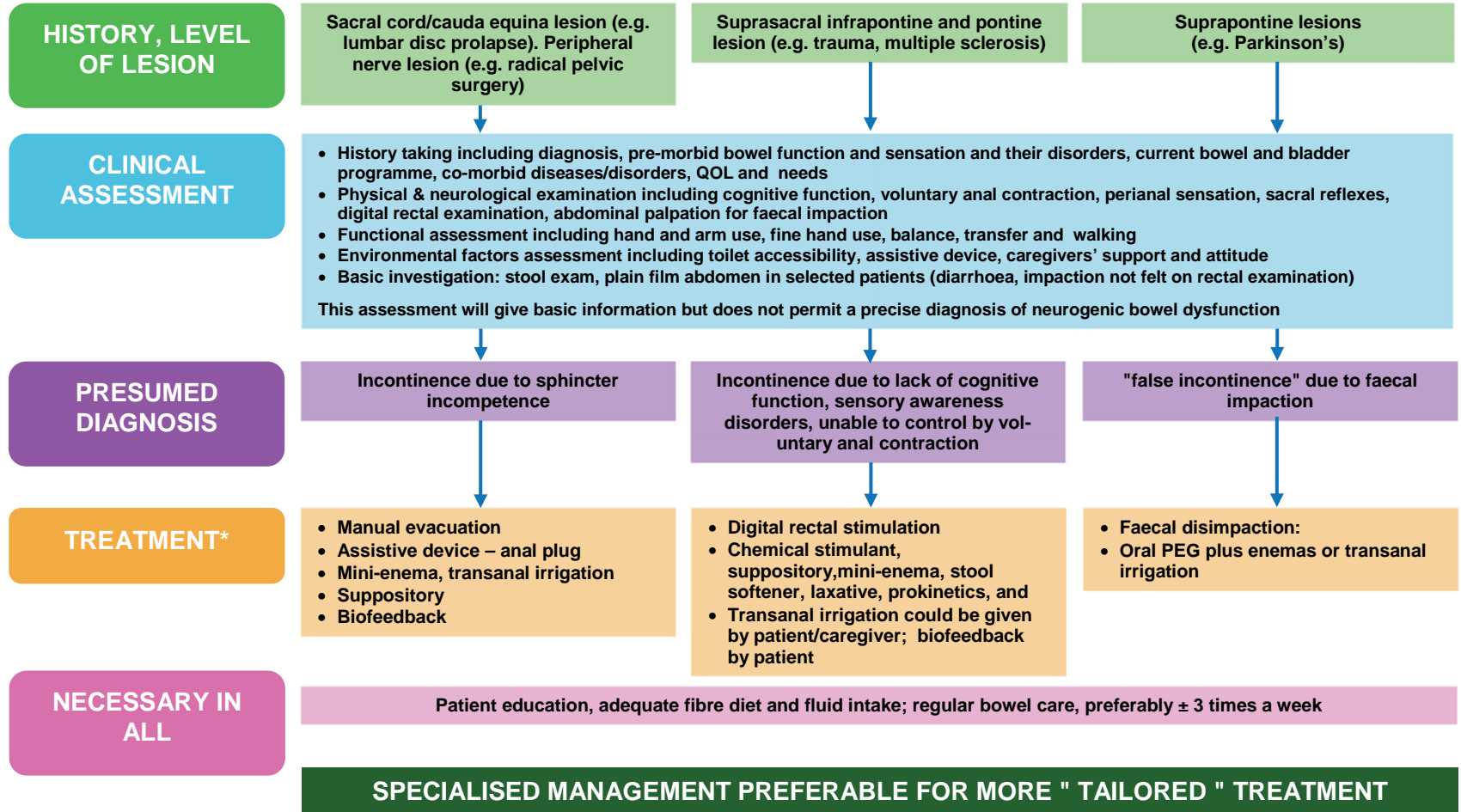

* Consider CONTINENCE PRODUCTS for temporary support during treatment

IX. FAECAL INCONTINENCE IN NEUROLOGICAL PATIENTS

B. SPECIALISED MANAGEMENT

1. ASSESSMENT

- Some patients with neurogenic faecal incontinence will need specialised assessment, especially if initial management is unsuccessful to look for comorbidity and certainly before performing invasive treatment
- Do not assume that all symptoms are due to neuropathy, e.g. women with neurological pathology might have had childbirth injury to the sphincter
- Special investigations: manometry, endoanal ultrasound, (dynamic) MRI, (needle) EMG. These specific bowel functional tests and electro-diagnostic tests must be considered optional, as their value in neurological pathology is not sufficiently demonstrated so far.

2. TREATMENTS

- Conservative treatment for neurological faecal incontinence is also the mainstay for specialised management, (GoR C).
- Management of neurological incontinence does not include very extensive treatment modalities and many conservative interventions are still empirical.
- Transanal irrigation (GoR B).

- Electrical stimulation sphincter, (GoR C).
- Percutaneous neuromodulation and sacral nerve stimulation : further research is required (GoR D).
- Surgical management of neurogenic faecal incontinence has different options which need a very strict patient selection
- Antegrade Continence Enema ACE (GoR C).
- Artificial bowel sphincter or FENIX procedure (GoR C).
- Sacral Anterior Root Stimulation SARS (GoR C).
- Botulinum Toxin (GoR C).
- Neuromodulation (GoR C).
- It is recommended that urinary and bowel function are assessed simultaneously if both systems are affected, as symptoms and treatment of one system can influence the other and vice versa (GoR A).
- As the therapeutic approach can differ in different neurological diseases, the most prevalent diseases are discussed separately in the chapter.

SPECIALISED MANAGEMENT OF NEUROGENIC FAECAL INCONTINENCE

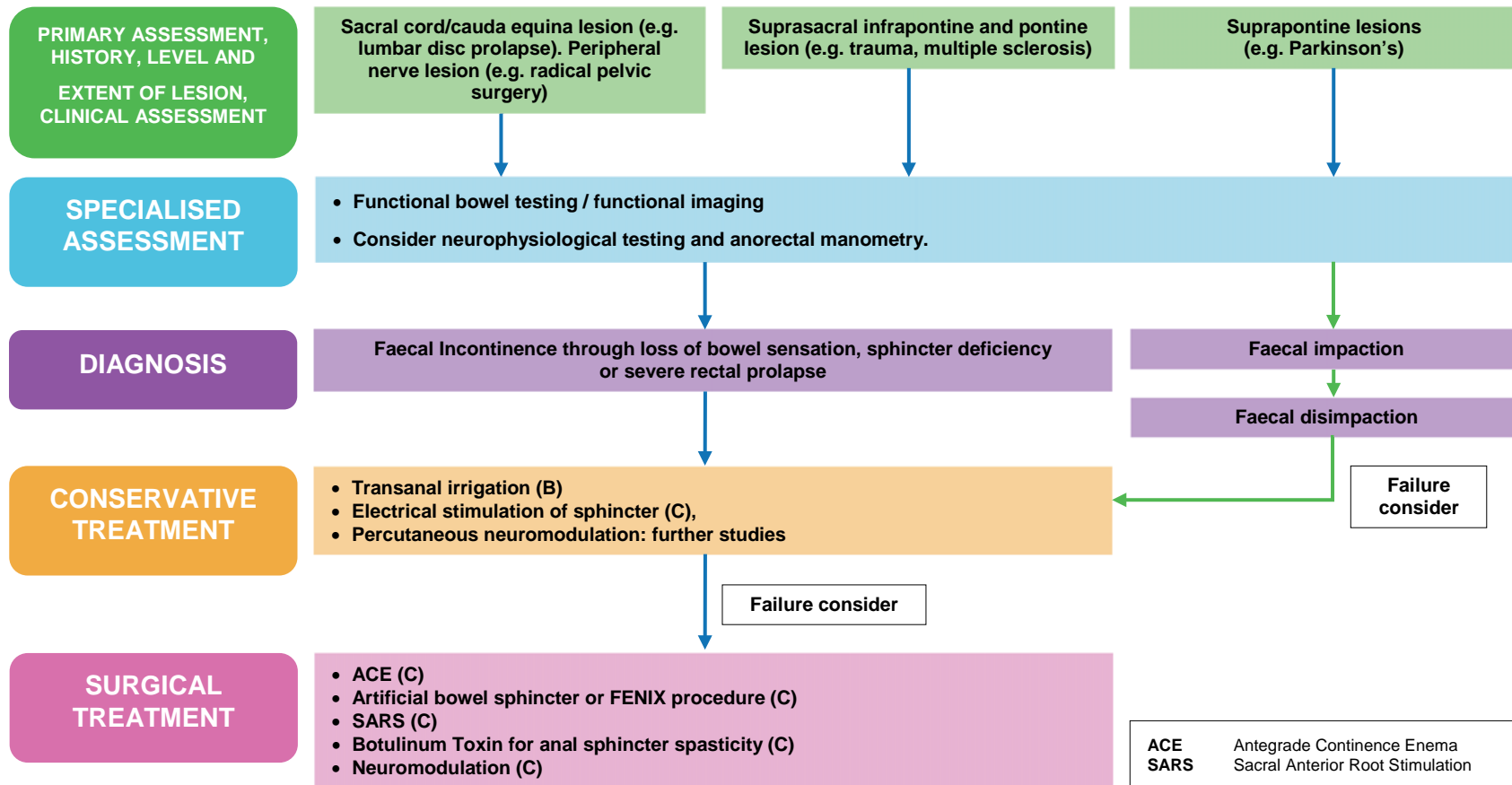

STOMA/DIVERSION MAY BE AN OPTION IN SELECTED CASES

* Consider CONTINENCE PRODUCTS for temporary support during treatment

X. URINARY AND FAECAL INCONTINENCE IN FRAIL OLDER MEN AND WOMEN

- There is no reason to suspect why interventions which have proven efficacy in the community dwelling elderly should not also be effective in frail older people. Clinicians should, however, take due regard of the practicality, potential benefits and dangers of employing any single intervention in this population.
- Frail older people do require a different approach addressing the potential role of co-morbid disease, current medications (prescribed, over the counter and/or naturopathic), and functional and cognitive impairment in urinary and faecal incontinence.
- The extent of the investigation and management should take into account the degree of bother to the older person and/or caregiver, the goals for care, the degree that the older person is able to undertake any intervention and the overall prognosis and life expectancy.
- Effective management to meet the goals of care should be possible for most frail older people.

1. HISTORY AND SYMPTOM ASSESSMENT

- Active case finding for urinary and faecal incontinence should be done in all frail older people (GoR A).
- History should include comorbid conditions and medications that could cause or worsen incontinence.
- Physical examination should include a rectal examination for faecal loading or impaction (GoR C), functional assessment (mobility, transfers, manual dexterity, dressing and undressing ability, ability to toilet) (GoR A), a screening test for depression (GoR B), and cognitive assessment (to assist in planning and management, (GoR C)).
- The mnemonic DIPPERS (see urinary and faecal incontinence algorithms) covers some of these comorbid conditions. Note that urogenital atrophy does not, in itself, cause urinary incontinence and should not be treated for this purpose (GoR B).
- The patient and / or caregiver should be asked about the degree of bother of urinary incontinence and/or faecal incontinence (GoR B); goals for urinary and

faecal incontinence care (dryness, decrease in specific symptoms, quality of life, reduction of comorbidity, lesser care burden) (GoR B); and likely cooperation with management (GoR C).

- Evaluation for bowel “alarm” symptoms (rectal bleeding, positive blood screening from stool studies, obstructive symptoms, recent onset of constipation, weight loss, and a change in stool calibre) will need more extensive evaluation (GoR A)
- Urinalysis is recommended for all patients, primarily to screen for haematuria (GoR C).
- Treatment of otherwise asymptomatic bacteriuria/pyuria is not beneficial (GoR C), and it may cause harm by increasing the risk of antibiotic resistance and severe adverse effects. e.g., *Clostridium difficile* colitis (GoR C).
- Stool studies may not be needed in all patients with faecal incontinence. Patients with diarrhoea, especially those with more acute onset diarrhoea, may need to be tested for infectious causes of their diarrhoea. Other stool studies could involve testing for malabsorption syndromes.
- The utility of the Clinical Stress test in this population is uncertain (GoR D).
- Wet checks can assess urinary incontinence frequency in long-term care residents (GoR C).
- A post voiding residual volume (PVR) test is impractical in many care settings and there is no consensus for the definition of what constitutes a “high” PVR in any population. A PVR measurement is not recommended in the routine initial assessment of frail older people with urinary incontinence.
- However, there is compelling clinical experiential evidence for PVR testing in selected frail older people with: diabetes mellitus (especially long standing); prior urinary retention or high PVR; recurrent UTIs; medications that impair bladder emptying (e.g., opiates); severe constipation; persistent or worsening urgency urinary incontinence despite antimuscarinic/beta-3-agonist treatment; or prior urodynamics showing detrusor underactivity and/or bladder outlet obstruction (GoR C). Treatment of contributing comorbidity may reduce PVR. Trial with catheter may be considered for PVR > 200-500 ml if the PVR is felt to contribute to UI or urinary frequency (GoR C).

- Nocturia Assessment of frail elders with bothersome nocturia should identify potential underlying causes including nocturnal polyuria (by bladder diary/frequency-volume chart or wet checks; oedema on examination) (GoR C), primary sleep problems (e.g., sleep apnoea); and low voided volumes (e.g., from high PVR).
- Stool impaction/loading. If suspected on digital rectal examination, an abdominal x-ray may be necessary to further evaluate the degree and location of impaction/loading in frail older adults.

2. CLINICAL DIAGNOSIS

The most common types of Urinary Incontinence in frail older people are urgency, stress, and mixed urinary incontinence. Frail older people with urgency urinary incontinence also may have detrusor underactivity during voiding with a high PVR but without outlet obstruction. There is no evidence that antimuscarinics are less effective or cause retention in this situation (GoR D).

The most common types of faecal incontinence in frail older people are related to urgency and passive leakage. Passive leakage can refer to leakage, seepage and staining following bowel movements that are not associated with faecal urgency and may also occur with faecal impaction. Because constipation and impaction often contribute to faecal incontinence in older adults, these are considered separately in the algorithm.

3. INITIAL MANAGEMENT

- Initial treatment should be individualised and influenced by goals of care, treatment preferences and estimated remaining life expectancy, as well as the most likely clinical diagnosis (GoR C). In some frail older persons the only possible outcome may be containment; management with continence products, especially for people with minimal mobility (require assistance of > 2 people to transfer), advanced dementia (unable to state their name), and/or nocturnal urinary and faecal incontinence.
- Conservative and behavioural therapy for UI includes lifestyle changes (GoR C), bladder training for more fit alert persons (GoR B), and prompted voiding for frailer, more impaired older people (GoR A).
- For the select cognitively intact older person with UI or FI, pelvic floor muscle therapy can be considered, but there are few studies (GoR C). Antimuscarinics

may be added to conservative therapy of urgency UI (GoR A-C, depending on agent).

- For the select cognitively intact older with FI, biofeedback may be considered, but few studies exist among frail older adults.
- Alpha-blockers may be cautiously considered in frail men with suspected prostatic obstruction (GoR C). All drugs should be started at the lowest dose and titrated with regular review until either care goals are met or adverse effects are intolerable.
- DDAVP (vasopressin) has a high risk of severe hyponatraemia in frail older persons and should not be used outside specialist centres or without very careful monitoring and long term followup (GoR A).
- Improving stool consistency can be done with dietary fibre and supplementary fibre in older adults (GoR C). In older adults with diarrhoea, loperamide may be considered at low doses to improve stool consistency. However, close monitoring for constipation and impaction is needed.

4. ONGOING MANAGEMENT AND REASSESSMENT

Optimal urinary and faecal incontinence management is usually possible with the above approaches. If initial management fails to achieve the desired goals, the next steps are reassessment and treatment of contributing comorbidity and/or functional impairment.

5. SPECIALISED MANAGEMENT

If frail older people have either other significant factors (e.g., pain, haematuria, bowel “alarm” symptoms), UI or FI symptoms that cannot be classified as urgency, stress, or mixed or overflow or other complicated comorbidity which the primary clinician cannot address (e.g. dementia, functional impairment), then specialist referral should be considered. Referral may also be appropriate when there is been insufficient response to initial management. The type of specialist will depend on local resources and the reason for referral: surgical specialists (urologists, gynecologists, colorectal surgeons), gastroenterologists, geriatricians or physical therapist (functional and cognitive impairment); or continence nurse specialists (homebound patients). Referral decisions should consider goals of care, patient/caregiver desire for invasive therapy and estimated remaining life expectancy.

Age *per se* is not a contraindication to UI or FI surgery (GoR C), but before surgery is considered, all patients should have:

- Evaluation and treatment for any comorbidity, medications, and cognitive or functional impairments contributing to UI that could compromise surgical outcome (e.g., dementia that precludes patient ability to use artificial sphincter) (GoR C).
- Adequate trial of conservative therapy, including pharmacological therapies where relevant (GoR C).
- Discussion (including the caregiver) to ensure that the anticipated surgical outcome is consistent with goals of care in the context of the patient's remaining life expectancy (GoR C).
- Urodynamic testing or anorectal manometry, because clinical diagnosis may be inaccurate (GoR B).
- Preoperative assessment and perioperative care to establish risk of, and to minimise the risk of common geriatric post-operative complications such as delirium and infection (GoR A), dehydration and falls (GoR C).

MANAGEMENT OF URINARY INCONTINENCE IN FRAIL OLDER MEN & WOMEN

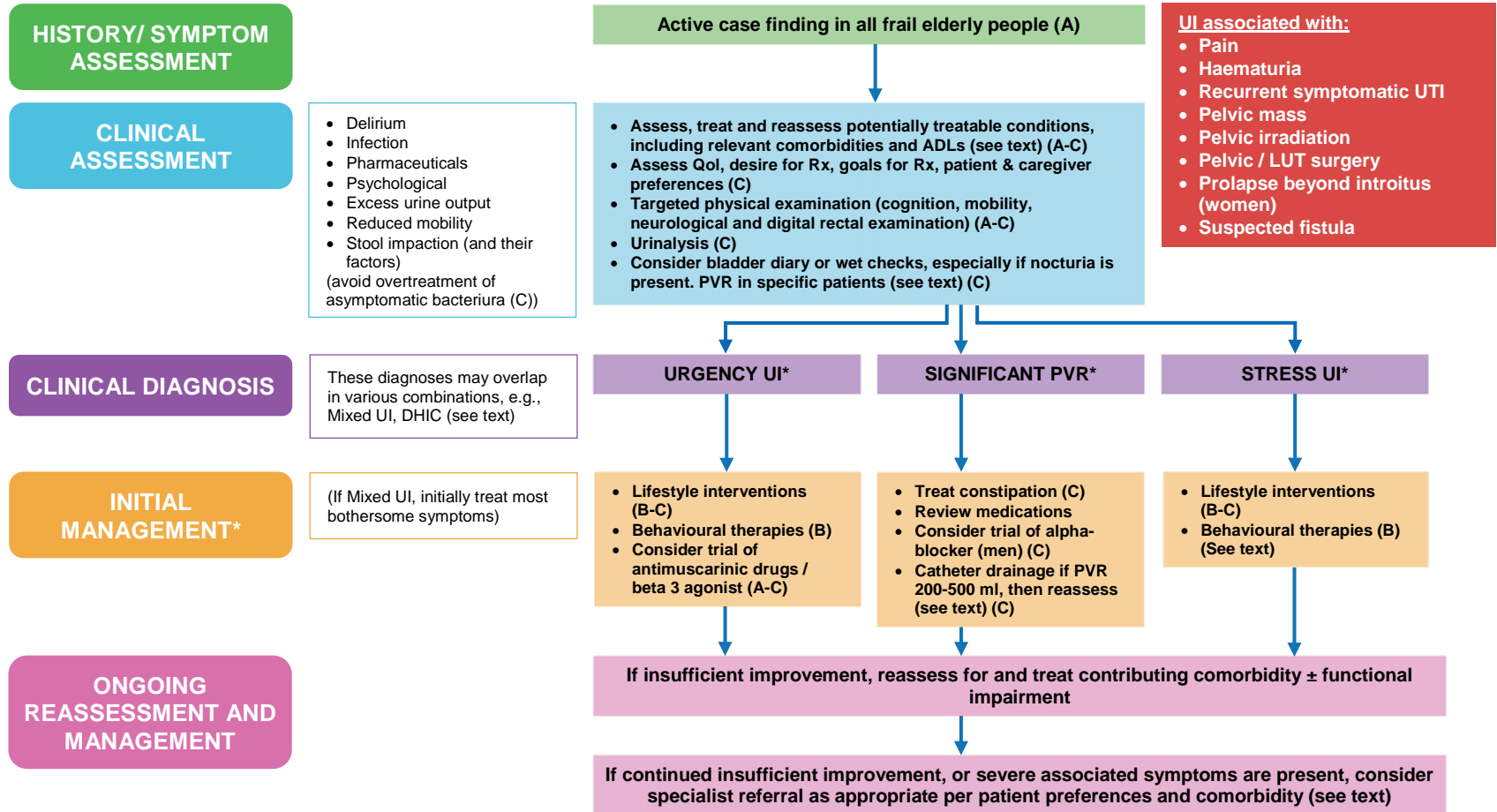

* Consider CONTINENCE PRODUCTS for temporary support during treatment

MANAGEMENT OF FAECAL INCONTINENCE IN FRAIL OLDER MEN & WOMEN

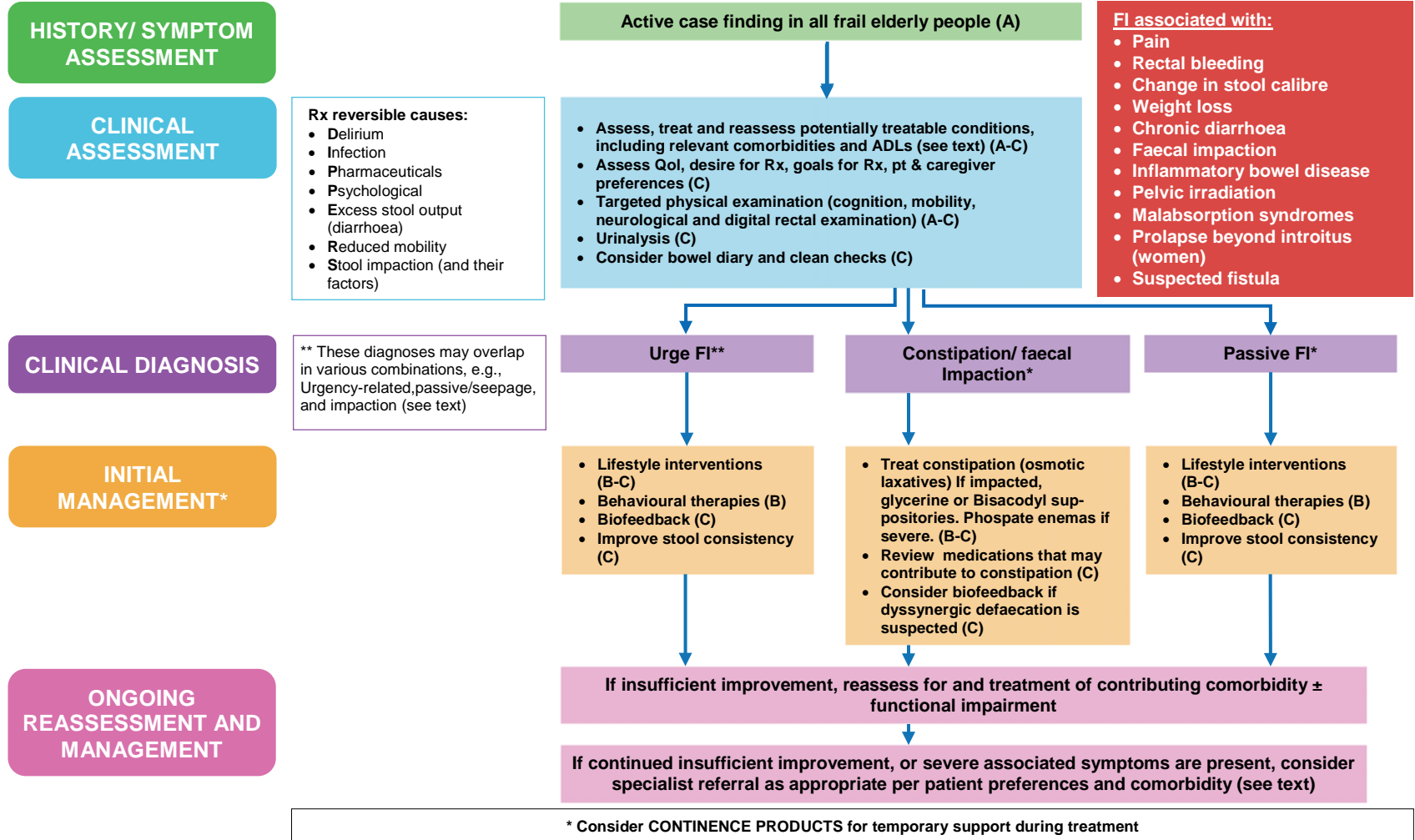

4. RECOMMENDATIONS FOR FURTHER RESEARCH IN EPIDEMIOLOGY

1. Longitudinal study designs are needed to: (i) estimate the incidence and remission rates of urinary incontinence (UI) anal incontinence (AI) and pelvic organ prolapse (POP) and to (ii) describe the natural course of these conditions and (iii) to investigate risk factors and possible protective factors. In addition, similar studies regarding other lower urinary tract symptoms (LUTS) should be initiated.
2. Although there is now more information regarding prevalence, incidence, and other epidemiological data in developing countries, further information is still needed. It is recommended that fundamental research regarding prevalence, incidence and other epidemiological data in developing countries should be encouraged, and tailored to the cultural, economic and social environment of the population under study.
3. Some potential risk and protective factors deserve more attention. For example, the role of pregnancy and childbirth in the development of UI, AI and POP must be studied in a fashion that links population-based methods to clinical assessment of pregnancy, delivery and birth trauma and follows women over many years. Such a design is necessary because the effect of pregnancy and childbirth may become clear only years later when the woman is older and because the woman will not then be able to report the exact nature of the tear, episiotomy, etc.
4. There should be more emphasis on the associations between UI, AI and POP and specific diseases like stroke, diabetes, and psychiatric diseases.
5. The variation of disease occurrence in groups of different racial origin yet similar environmental exposures, lend support to the presumed genetic influence on the causation of UI, AI and POP. This again provides circumstantial evidence for a genetic contribution to pelvic floor muscle disorders since most of these studies have been unable to control for heritability in relation to the complex interaction of environmental factors.

The aetiology of UI, AI and POP is widely recognised to be multifactorial, yet the complex interaction between genetic predisposition and environmental influences is poorly understood. Genetic components require further investigation. Twin studies provide a possible means of studying the relative importance of genetic predisposition and environmental factors. By comparing monozygotic female twins with identical genotype, and dizygotic female twins who, on average, share 50 percent of their segregating genes, the relative proportions of phenotypic variance resulting from genetic and environmental factors can be estimated. A genetic influence is suggested if monzygotic twins are more concordant for the disease than dizygotic twins whereas evidence for environmental effects comes from monozygotic twins who are discordant for the disease.

5. RECOMMENDATIONS FOR FURTHER BASIC SCIENCE RESEARCH

The following proposals for research come from the Committees' work in reviewing the current literature on Basic Science:

1. Integrate data from reductionist experiments to inform the formulation of better systems-based approaches in the investigation of the pathology of the lower urinary tract (LUT), the genital tract (GT) and the lower gastro-intestinal tract (LGIT).
2. Encourage greater emphasis on basic research to characterise tissues receiving relatively little attention: ie the lower gastrointestinal tract; the bladder neck and urethra; the ureter, pelvic floor musculature.
3. Generate research programmes for fetal and neonatal research in LUT and LGIT function.
4. Use genome-wide bioinformatic and population health surveys to generate testable hypotheses regarding the physiological and pathophysiological functions of the LUT, GT and LGIT.
5. Generate improved experimental approaches to investigate the pathophysiology of the LUT and LGIT by:
 - The development of animal models that accurately describe human pathological conditions, including the greater use of large-animal models
 - The better use of reverse translational approaches for linking animal models to the human disease.
 - The use of human tissue from well-characterised patient groups.
 - The development of emerging areas such as: tissue engineering; proteomics and metabolomics
 - Increased collaborations between biological, physical and mathematical sciences.
6. Develop centres of excellence or consortia of excellence in LUT, GT and GIT research
 - Integrate expertise from university departments, academic medical units and industry
 - Encourage translational approaches to research.
 - Develop inter-institutional research-training programmes to allow new researchers the opportunity to better interact and exchange ideas.
7. Bring about a greater emphasis on the importance of research to medical trainees and science graduates through:
 - Establishing research training as a core component of postgraduate clinical development
 - Increased access to support funds, especially scholarships and personal awards
 - Organisation of focused multidisciplinary research meetings, either stand-alone or as dedicated sessions during national and international conferences
 - Greater interaction between medical centres and Higher Education Institutions (HEIs).
 - Allowing researchers-in-training better access to international meetings through reduced registration charges and improved travel grants.
 - Inclusion in clinical meetings of point-counterpoint session(s) with both basic science and clinical viewpoints.
 - Development of research forums for exchange of ideas between active researchers and industry.
 - Lobbying research-funding organisations about the medical and social importance of LUT and LGIT disorders.
8. Increase emphasis on research into LUT and LGIT in HEIs through:
 - Greater representation on grant-funding agencies
 - Encouragement of submission to high impact factor journals and recognition of research published in specialty journals
 - More integrated teaching and training opportunities

6. RECOMMENDATIONS FOR PRIMARY PREVENTION, CONTINENCE PROMOTION, MODELS OF CARE AND EDUCATION

Primary prevention, continence promotion and advocacy, models of care and education involves informing and educating the public and health care professionals that UI and FI are not inevitable, but are treatable or at least manageable. Other bladder disorders such as BPS/IC and POP can also be treated successfully. The committee found information about recent practice and research initiatives in all of these areas but evidence-based research only on primary prevention of UI. Continence promotion and advocacy, and professional and non-professional education, require prioritisation by public health professionals, educationalists, clinicians and researchers to reduce the burden that UI, FI, BPS/IC and POP places on society, healthcare systems, caregivers, and above all, affected adults. As to models of care, the evidence supports nurse-led community services as leading to higher health-related QoL and in some instances, higher cure rates. The multidisciplinary referral settings are also reporting favourable outcomes.

1. PRIMARY PREVENTION

- Pelvic floor muscle exercises can prevent UI in pregnant and postpartum women. (Level of Evidence: 1)
- Education designed for community-dwelling older women can prevent UI. (Level of Evidence: 1)
- No recent RCTs or case-control studies were located for prevention of FI. (Level of Evidence: 4)
- Pelvic floor muscle exercises should be provided for pregnant women. (GoR A)
- Education of older women to prevent UI should be provided. (GoR A)
- Continence promotion is required to address broad gaps in knowledge about incontinence (GoR C)
- Strategies to promote awareness about incontinence and its treatment can be strengthened by the use of evidence based theories and methods from the field of health promotion, including the social determinants of health (GoR D)
- The Internet represents an important source of information about incontinence, however the quality of information is variable (GoR C)
- For help-seeking behaviour, no RCTs or case-control studies were located (Level of Evidence 4)
- Continence promotion programmes need to accommodate varying levels of health literacy and access to health information in different populations (Level of Evidence: 4)
- Public health campaigns about incontinence and other pelvic floor disorders need to use terminology targeted to consumers' understandings (Level of Evidence: 4)
- Satisfaction surveys about continence care could yield relevant and detailed information by using open-ended, rather than closed-ended questions (Level of Evidence: 1)
- Evidence for the use of leaflets or brochures in raising awareness about UI and different treatment options is inconclusive (Level of Evidence: 1).
- Evidence for the impact of continence advocacy worldwide was based on opinion (Level of Evidence: 1)
- Recommendation for help-seeking behaviour: No recommendation was possible based on the level of evidence provided by the available research.
- Worldwide Advocacy (GoR D)

2. MODELS OF CARE

- Effectiveness of service delivery models. (Level of Evidence: 4)
- A care delivery model should be based on the principles as described in the Optimum Continence Service Specification. (GoR C)
- Increased emphasis is needed on non-physician models of care. (GoR C)
- Despite the proliferation of guidelines, there is increasing evidence that practicing clinicians and nurses are not consistently following them. Implementation models should be developed on how to translate guidelines into practice. (GoR C)
- Effectiveness of guidelines in clinical practice has not been determined. (Levels of evidence: 3 to 4).
- There is a continued need for evaluation research to explore impact of guidelines on clinical care both at individual and population levels. This evaluation strategy needs to include impact on a wide range of outcomes, including incidence and prevalence of disease, treatment outcomes, prevention efforts, costs, and health care policy. (GoR: C)
- Effectiveness of public education efforts through various channels including education, public media and mass communications (Levels of Evidence 3-4)

3. EDUCATION

- Professional education of UI, FI, BPS/IC, and POP is not evident as determined by materials reviewed. (Levels of Evidence: 3-4)
- There is a need for additional focused research on methods to enhance patient and public about pelvic disorders, both at an individual and broader public level. (GoR C)
- The role of technology in public education for continence promotion should be examined in more depth. (GoR C)

7. RECOMMENDATIONS FOR TRANSLATIONAL AND CLINICAL RESEARCH

A. RECOMMENDATIONS ON STUDY CONDUCT AND STATISTICAL METHODS

The role of quality RCTs as providing the strongest level of evidence in incontinence research should be fully acknowledged by researchers, journal reviewers, and editors. (GoR A)

Careful attention to the planning and design of all research, especially RCTs, is of the utmost importance. (GoR A)

Appropriate expertise in biostatistics and clinical trial design should be employed at the design phase of a RCT and thereafter on an ongoing basis. For Phase 4, phase 5, and implementation trials, health economists should be included in trial design to support questions of value (cost-effectiveness). (GoR A)

The design, conduct, analysis and presentation of RCTs must be fully in accordance with the CONSORT Statement. (GoR A)

The design, conduct, analysis and presentation of observational studies should follow STROBE guidelines. (GoR A)

The design, conduct, analysis and presentation of meta-analyses should follow QUORUM guidelines. (GoR A)

Reporting studies of diagnostic tests, including urodynamics, should follow the STARD statement guidelines. (GoR A)

B. RECOMMENDATIONS ON RESEARCH CONDUCT

1. RECOMMENDATIONS FOR CONSERVATIVE TREATMENT TRIALS

Use correct terminology to describe the intervention. (GoR A)

Report details of ability to perform correct contraction, dose-response issues and adherence. (GoR A)

Use recommended outcome measures with high responsiveness, reliability and validity. (GoR A)

Compare new methods with the best available intervention. (GoR A)

Use power calculation in planning of the study. Avoid large sample sizes and weak (ineffective dosages) interventions. (GoR A)

For long-term follow-up studies report cross-over, co-interventions, recurrent and competing events, adherence in the follow-up period and loss to follow-up. (GoR A)

2. RECOMMENDATIONS FOR SURGICAL AND DEVICE TRIALS

- The safety and serious side effects of new operations must be completely defined with adequate follow-up so that risks can be weighed against efficacy. At a minimum, this requires more use of large scale, independent, prospective, multicentre cohort studies when RCTs are not practical. (GoR A)
- Safety and serious side effects of incontinence devices must be completely defined with adequate follow-up, especially for use of implantable devices and biological materials, so that risks can be weighed against efficacy. (GoR A)
- Valid informed research consent is required in all trials of surgical interventions, which is separate from the consent for surgery. (GoR A)
- We recommend ongoing research into the usefulness of pre- and post-operative predictive testing (such as urodynamics, ultrasound, MRI, etc) in surgical trials. (GoR A)
- Reports of successful treatment should be limited to subjects with a minimum (not mean) of one-year follow-up and should include a patient perspective measure. Specific assumptions about subjects lost to follow-up should be stated. (GoR A)

- Randomisation for surgical trials should occur at the time of surgery to minimise drop-outs and switch of procedure (GoR A)
- Long-term follow-up of RCT cohorts in an observational cohort is recommended (GoR A)

3. RECOMMENDATIONS ON COST ANALYSIS IN INCONTINENCE

- Cost analysis should be incorporated into clinical studies whenever possible (137). (GoR A)
- Cost analysis should describe the perspective of the analysis and analyses using the societal perspective and the payer perspective are useful. (GoR A)

C. RECOMMENDATIONS FOR SPECIFIC PATIENT GROUPS

1. MEN AND WOMEN WITH LUTS

1.1. Men with LUTS

- Measurement of prostate size should be performed before and after treatment (at the same time as continence outcome measures where possible) whenever prostate size is considered to be a variable, or to change during the intervention and follow up. (GoR A)
- Maximum free flow rate and measurement of post-void residual urine should be recorded pre-treatment and the effect of therapy on these parameters should be documented simultaneously with assessment of the primary outcome variables. (GoR A)
- Participants should be stratified by prostate size at randomisation when size is considered to be a potentially important determinant of treatment outcome. (GoR C)

1.2. Women with LUTS

- Specific information about menopausal status, hysterectomy, parity/obstetric history, and hormonal status should be included in baseline clinical trial data and controlled for in specified analyses in the research protocol. (GoR A)
- High quality, symptom and bother scores (e.g., ICIQ-FLUTS, ICIQ-SF, ICIQ-QoL(KHQ), PISQ, ICIQ-FLUTSsex) validated in women should be employed when assessing outcomes. (GoR A)
- Standardised assessment of pelvic organ prolapse should be performed before treatment and at the time of other outcome assessments in all

research where prolapse and continence outcomes are being assessed. (GoR A)

- Criteria for cure/improvement/failure from incontinence treatment should be defined in the protocol based on patient perception as well as objective and semi-objective instruments such as validated questionnaires, diaries and pad tests. (GoR A)
- Assessment of the impact of treatment on sexual function should be performed with other outcome assessment when appropriate. (GoR B)

2. CHILDREN

- Long-term follow-up is of critical importance in the paediatric population in order to ascertain the effect of a treatment on normal growth and development. (GoR A)
- Research is needed to develop standardised outcome measures including validated, age-specific symptom and disease-specific quality of life outcome measures. (GoR B)

3. NEUROGENIC POPULATIONS

- Detailed urodynamic studies are recommended for classification of neurogenic lower urinary tract disorders in research studies because the nature of the lower tract dysfunction cannot be accurately predicted from clinical data. Videourodynamic studies are preferred but are not mandatory. (GoR C)
- An area of high priority for research is the development of a classification system to define neurogenic disorders. Relevant features could include the underlying diagnosis, the symptoms, a precise documentation of the neuromuscular lesion by clinical neurophysiologic testing, and the nature of the urodynamic abnormality. (GoR C)

4. POPULATIONS AFFECTED BY BLADDER PAIN SYNDROME (INCLUDING INTERSTITIAL CYSTITIS)

- Broader entry criteria should be used to reflect the full spectrum of the BPS/IC patient population. (GoR B)
- The primary endpoint of BPS/IC trials should be patient driven and the Global Response Assessment is recommended. A wide spectrum of secondary endpoints will be useful in defining the effect of treatments. (GoR B)

5. POPULATIONS AFFECTED BY PELVIC ORGAN PROLAPSE

- A validated standardised assessment of prolapse (eg POP-Q) should be used for baseline and outcome assessments. (GoR A)
- Complete reporting of outcomes including a validated assessment of anatomy, functional status, and complications is essential. (GoR A)
- Complications/adverse events (especially for mesh) must be explicitly and completely reported in any research. (GoR A)
- Long term outcomes (> 2 years) of intervention studies are needed. (GoR A)

D. RECOMMENDATIONS FOR ETHICS IN RESEARCH

The GoR for this section is A.

Continuity in clinical direction from design through authorship is mandatory. Investigators should be involved in the planning stage and a publications committee should be named at the beginning of the clinical trial. The Uniform Requirements for Manuscripts

Submitted to Biomedical Journals, from the International Committee of Medical Journal Editors should be followed. Authorship requires:

- Substantial contributions to conception and design or acquisition of data or analysis and interpretation of data,
 - Drafting the article or revising it critically for important intellectual content,
 - Final approval of the version to be published
- Authors should provide a description of what each contributed and editors should publish that information.
- Authors should have access to all raw data from clinical trials, not simply selected tables

Clinical trial results should be published regardless of outcome. The sponsor should have the right to review manuscripts for a limited period of time prior to publication but the manuscript is the intellectual property of its authors, not the sponsor.

- All authors should be able to accept responsibility for the published work and all potential conflicts of interest should be fully disclosed

8. INTERNATIONAL CONSULTATION ON INCONTINENCE MODULAR QUESTIONNAIRE (ICIQ): QUESTIONNAIRES AND BLADDER DIARY

A. INTERNATIONAL CONSULTATION ON INCONTINENCE MODULAR QUESTIONNAIRE (ICIQ)

The scientific committee which met at the end of the 1st ICI in 1998 supported the idea that a universally applicable questionnaire should be developed, that could be widely applied both in clinical practice and research and should reflect the patients' perspective of their situation.

The hope was expressed that such a questionnaire would be used in different settings and studies and would allow cross-comparisons, for example, between a drug and an operation used for the same condition, in the same way that the IPSS (International Prostate Symptoms Score) has been used.

An ICIQ Advisory Board was formed to steer the development of the ICIQ and met for the first time in 1999. The project's early progress was discussed with the Board and a decision made to extend the concept further and to develop the ICIQ Modular Questionnaire to include assessment of urinary, bowel and vaginal symptoms(1). The first module to be developed was the ICIQ Short Form Questionnaire for urinary incontinence: the ICIQ-UI Short Form (2) (Fig 1). The ICIQ-UI Short Form is now widely used globally and since 2004 its use or further development has been reported in almost 100 publications.

Given the intention to produce an internationally applicable questionnaire, requests were made for translations of the ICIQ-UI Short Form at an early stage, for which the Advisory Board developed a protocol for the production of translations of its modules. The ICIQ modules have been translated into over 40 languages to date across the various modules.

Since the fifth consultation a further two modules have been published and are available for use: the ICIQ Bladder Diary (3,4) and ICIQ-LTCqol(5). The bladder diary is the first fully validated bladder diary, which notably incorporated patient and clinician input during its development. The ICIQ-LTCqol questionnaire provides an assessment of symptoms, impact and bother associated with indwelling catheter use. This brings the total number of available modules to sixteen.

With increasing demand for electronic versions of questionnaires, a study has been conducted by the ICIQ group to evaluate the equivalence of the ICIQ's psychometric properties in alternative formats (6). With equivalence demonstrated, app development for the eICIQ is underway.

www.ICIQ.net provides details of the validation status of the modules under development for urinary symptoms, bowel symptoms and vaginal symptoms and provides information regarding the content of existing modules. Information regarding production of translations and the ICIQ development protocol is also available for those interested in potential collaborations to continue development of the project.

Initial number

ICIQ-UI Short Form

DAY MONTH YEAR

CONFIDENTIAL**Today's date**

Many people leak urine some of the time. We are trying to find out how many people leak urine, and how much this bothers them. We would be grateful if you could answer the following questions, thinking about how you have been, on average, over the PAST FOUR WEEKS.

1 Please write in your date of birth:

DAY MONTH YEAR

2 Are you (tick one):Female Male **3 How often do you leak urine? (Tick one box)**

- never 0
about once a week or less often 1
two or three times a week 2
about once a day 3
several times a day 4
all the time 5

4 We would like to know how much urine you think leaks.**How much urine do you usually leak (whether you wear protection or not)?**
(Tick one box)

- none 0
a small amount 2
a moderate amount 4
a large amount 6

5 Overall, how much does leaking urine interfere with your everyday life?*Please ring a number between 0 (not at all) and 10 (a great deal)*

0 1 2 3 4 5 6 7 8 9 10
not at all a great deal

ICIQ score: sum scores 3+4+5 **6 When does urine leak? (Please tick all that apply to you)**

- never – urine does not leak
leaks before you can get to the toilet
leaks when you cough or sneeze
leaks when you are asleep
leaks when you are physically active/exercising
leaks when you have finished urinating and are dressed
leaks for no obvious reason
leaks all the time

Thank you very much for answering these questions.

Copyright © "ICIQ Group"

Figure 1: ICIQ-UI Short Form

Table 1: Fully validated ICIQ modules and derivation

MODULES AVAILABLE FOR USE	
ICIQ-MLUTS(7) (ICS _{male} Short Form)	Urinary symptoms (male)
ICIQ-FLUTS(8) (BFLUTS Short Form)	Urinary symptoms (female)
ICIQ-VS(9)	Vaginal symptoms and quality of life
ICIQ-B(10,11)	Bowel symptoms and quality of life
ICIQ-UI Short Form(2)	Urinary incontinence short form
ICIQ Bladder diary(3,4)	Bladder events and fluid intake
ICIQ-N(12,13) (ICS _{male} /BFLUTS)	Nocturia symptoms
ICIQ-OAB(12,13) (ICS _{male} /BFLUTS)	Overactive bladder symptoms
ICIQ-MLUTS Long Form(12) (ICS _{male})	Urinary symptoms long form (male)
ICIQ-FLUTS Long Form(13) (BFLUTS)	Urinary symptoms long form (female)
ICIQ-LUTSqol(14) (KHQ)	Urinary symptoms quality of life
ICIQ-Nqol(15) (N-QoL)	Nocturia quality of life
ICIQ-OABqol(16) (OABq)	Overactive bladder quality of life
ICIQ-LTCqol(5)	Long term catheter symptoms and quality of life
ICIQ-MLUTSsex(12) (ICS _{male})	Sexual matters related to urinary symptoms (male)
ICIQ-FLUTSsex(13) (BFLUTS)	Sexual matters related to urinary symptoms (female)

B. ANNEX 1 BLADDER CHARTS AND DIARIES

The ICS defines three types of Bladder Charts and Diaries which can be used to collect data:

MICTURITION TIME CHART

- times of voiding and
- incontinence episodes

FREQUENCY VOLUME CHART

- times of voiding with voided volumes measured,
- incontinence episodes and number of changes of incontinence pads or clothing

BLADDER DIARIES

- the information above, but also
- assessments of urgency,
- degree of leakage (slight, moderate or large) and descriptions of factors leading to symptoms such as stress leakage, eg. running to catch a bus. It is important to assess the individual's fluid intake, remembering that fluid intake includes fluids drunk plus the water content of foods eaten. It is often necessary to explain to a patient with LUTS that it may be important to change the timing of a meal and the type of food eaten, particularly in the evenings, in order to avoid troublesome nocturia.

The recent development and publication of the ICIQ Bladder Diary provides the first fully validated bladder diary that incorporated patient, clinician and statistical

input during its development (3,4). This rigorous development methodology has ensured the provision of a psychometrically robust tool that reflects the key issues from a patient's and clinical perspective to enable the gathering of required information to treat patients with LUTS (Fig 1). The diary is intended to be a standalone tool that provides instructions and an example to guide completion. The diary is intended for completion over three days and fits onto two sides of A4 to optimise administration and completion. Data collected are:

- Fluid intake
- Urine output
- Leakage episodes
- Time of sleep and waking
- Pads used
- Optional bladder sensation scale

The bladder sensation scale is intended to be an interchangeable variable that can be replaced with a more pertinent measure for an intended use, for example, a pain scale. It is advised that any scale used in this manner should be validated.

INSTRUCTIONS FOR USING THE BLADDER DIARY

This diary helps you and us to understand why you get trouble with your bladder. The diary is a very important part of the tests we do, so that we can try to improve you symptoms. On the chart you need to record:

9. When you get out of bed in the morning, show this on the diary by writing 'GOT OUT OF BED'.
10. During the day please enter at the correct time the drinks you have during the day, eg. 8.00am – two cups of coffee (total 400 ml).
11. The time you pass your urine, eg. 7.30am. Do this every time you pass urine throughout the day and night.
12. Each time you pass urine, collect the urine in a measuring jug and record the amount (in mls or fluid ozs) next to the time you passed the urine, eg. 1.30pm/320ml.
13. Each time you pass your urine, please write down how urgent was the need to pass urine:
 - 'O' means it was not urgent.
 - + means I had to go within 10 minutes.
 - ++ means I had to stop what I was doing and go to the toilet.
14. If you leak urine, show this by writing an 'W' on the diary at the time you leaked.
15. If you have a leak, please add 'P' if you have to change a pad and 'C' if you have to change your underclothes or even outer clothes. So if you leak and need to change a pad, please write 'WP' at the time you leaked.
16. If you have a leakage please write in the column called 'Comments' whether you leaked a small amount or a large amount and what you were doing when you leaked, eg. 'leaked small amount when I sneezed three times'.
17. Each time you change a pad or change clothes, please write in the 'Comments' column.
18. When you go to bed at the end of the day show it on the diary - write 'Went to Bed'.

DAY 1 DATE: ____/____/____

Please complete this **3 day** bladder diary. Enter the following in each column against the time. You can change the specified times if you need to. In the time column, please write **BED** when you went to bed and **WOKE** when you woke up.

Drinks Write the amount you had to drink and the type of drink.

Urine output Enter the amount of urine you passed in millilitres (mls) in the urine output column, day and night. Any measuring jug will do. If you passed urine but couldn't measure it, put a tick in this column. If you leaked urine at any time write **LEAK** here.

Bladder sensation Write a description of how your bladder felt when you went to the toilet using these codes

0 - If you had no sensation of needing to pass urine, but passed urine for "social reasons", for example, just before going out, or unsure where the next toilet is.

1 - If you had a normal desire to pass urine and no urgency. "Urgency" is different from normal bladder feelings and is the sudden compelling desire to pass urine which is difficult to defer, or a sudden feeling that you need to pass urine and if you don't you will have an accident.

2 - If you had urgency but it had passed away before you went to the toilet.

3 - If you had urgency but managed to get to the toilet, still with urgency, but did not leak urine.

4 - If you had urgency and could not get to the toilet in time so you leaked urine.

Pads If you put on or change a pad put a tick in the pads column.

Here is an example of how to complete the diary:

Time	Drinks		Urine output	Bladder sensation	Pads
	Amount	Type			
6am	WOKE		350ml	2	
7am	300ml	tea			
8am			✓	2	
9am					
10am	cup	water	Leak	3	✓

Time	Drinks		Urine output (mls)	Bladder sensation	Pads
	Amount	Type			
6am					
7am					
8am					
9am					
10am					
11am					
Midday					
1pm					
2pm					
3pm					
4pm					
5pm					
6pm					
7pm					
8pm					
9pm					
10pm					
11pm					
Midnight					
1am					
2am					
3am					
4am					
5am					

Figure 2: ICIQ-Bladder Diary (page 1)

ICIQ-BLADDER DIARY (12/13)

YOUR NAME: _____

DAY 2 DATE: ____/____/____

Time	Drinks		Urine output (mls)	Bladder sensation	Pads
	Amount	Type			
6am					
7am					
8am					
9am					
10am					
11am					
Midday					
1pm					
2pm					
3pm					
4pm					
5pm					
6pm					
7pm					
8pm					
9pm					
10pm					
11pm					
Midnight					
1am					
2am					
3am					
4am					
5am					

DAY 3 DATE: ____/____/____

Time	Drinks		Urine output (mls)	Bladder sensation	Pads
	Amount	Type			
6am					
7am					
8am					
9am					
10am					
11am					
Midday					
1pm					
2pm					
3pm					
4pm					
5pm					
6pm					
7pm					
8pm					
9pm					
10pm					
11pm					
Midnight					
1am					
2am					
3am					
4am					
5am					

Bladder sensation codes

- 0** - No sensation of needing to pass urine, but passed urine for "social reasons"
- 1** - Normal desire to pass urine and no urgency
- 2** - Urgency but it had passed away before you went to the toilet
- 3** - Urgency but managed to get to the toilet, still with urgency, but did not leak urine
- 4** - Urgency and could not get to the toilet in time so you leaked urine

Figure 3: ICIQ-Bladder Diary (page 2)

REFERENCES

1. Abrams P, Avery K, Gardener N, Donovan J, ICIQ Advisory Board. The International Consultation on Incontinence Modular Questionnaire: www.iciq.net. *J Urol.* 2006 Mar;175(3 Pt 1):1063–6; discussion 1066.
2. Avery K, Donovan J, Peters TJ, Shaw C, Gotoh M, Abrams P. ICIQ: a brief and robust measure for evaluating the symptoms and impact of urinary incontinence. *Neurourol Urodyn.* 2004;23(4):322–30.
3. Bright E, Cotterill N, Drake M, Abrams P. Developing and validating the International Consultation on Incontinence Questionnaire bladder diary. *Eur Urol.* 2014 Aug;66(2):294–300.
4. Bright E, Cotterill N, Drake M, Abrams P. Developing a validated urinary diary: phase 1. *Neurourol Urodyn.* 2012 Jun;31(5):625–33.
5. Cotterill N, Fowler S, Avery M, Cottenden AM, Wilde M, Long A, et al. Development and psychometric evaluation of the ICIQ-LTCqol: A self-report quality of life questionnaire for long-term indwelling catheter users. *Neurourol Urodyn.* 2016 Mar;35(3):423–8.
6. Uren AD, Cotterill N, Parke SE, Abrams P. Psychometric equivalence of electronic and telephone completion of the ICIQ modules. *Neurourol Urodyn.* 2016 Aug 11;
7. Donovan JL, Peters TJ, Abrams P, Brookes ST, de aa Rosette JJ, Schäfer W. Scoring the short form ICSmaleSF questionnaire. *International Continence Society. J Urol.* 2000 Dec;164(6):1948–55.
8. Brookes ST, Donovan JL, Wright M, Jackson S, Abrams P. A scored form of the Bristol Female Lower Urinary Tract Symptoms questionnaire: data from a randomized controlled trial of surgery for women with stress incontinence. *Am J Obstet Gynecol.* 2004 Jul;191(1):73–82.
9. Price N, Jackson SR, Avery K, Brookes ST, Abrams P. Development and psychometric evaluation of the ICIQ Vaginal Symptoms Questionnaire: the ICIQ-VS. *BJOG Int J Obstet Gynaecol.* 2006 Jun;113(6):700–12.
10. Cotterill N, Norton C, Avery KNL, Abrams P, Donovan JL. A patient-centered approach to developing a comprehensive symptom and quality of life assessment of anal incontinence. *Dis Colon Rectum.* 2008 Jan;51(1):82–7.
11. Cotterill N, Norton C, Avery KNL, Abrams P, Donovan JL. Psychometric evaluation of a new patient-completed questionnaire for evaluating anal incontinence symptoms and impact on quality of life: the ICIQ-B. *Dis Colon Rectum.* 2011 Oct;54(10):1235–50.
12. Donovan JL, Abrams P, Peters TJ, Kay HE, Reynard J, Chapple C, et al. The ICS-‘BPH’ Study: the psychometric validity and reliability of the ICSmale questionnaire. *Br J Urol.* 1996 Apr;77(4):554–62.
13. Jackson S, Donovan J, Brookes S, Eckford S, Swithinbank L, Abrams P. The Bristol Female Lower Urinary Tract Symptoms questionnaire: development and psychometric testing. *Br J Urol.* 1996 Jun;77(6):805–12.
14. Kelleher CJ, Cardozo LD, Khullar V, Salvatore S. A new questionnaire to assess the quality of life of urinary incontinent women. *Br J Obstet Gynaecol.* 1997 Dec;104(12):1374–9.
15. Abraham L, Hareendran A, Mills IW, Martin ML, Abrams P, Drake MJ, et al. Development and validation of a quality-of-life measure for men with nocturia. *Urology.* 2004 Mar;63(3):481–6.
16. Coyne K, Revicki D, Hunt T, Corey R, Stewart W, Bentkover J, et al. Psychometric validation of an overactive bladder symptom and health-related quality of life questionnaire: the OAB-q. *Qual Life Res Int J Qual Life Asp Treat Care Rehabil.* 2002 Sep;11(6):563–74.



This book is published by
International Continence Society

Leading Continence Research and Education

Learn more at www.ics.org

Enjoy the benefits of ICS Membership:

- ▶ Up to 25% off ICS Annual Meetings
- ▶ Neurourology & Urodynamics journal
- ▶ Free membership to the EU-ACME programme
- ▶ Full access to ICS website:
 - > ICS Members directory
 - > ICS abstracts
 - > Latest ICS Standardisation reports
 - > ICSTV

Concession rates available for Early Career Professionals, Nurses & Physiotherapists.

www.ics.org/join

£10 OFF
use promo code
ICIBOOK



12-15 September

www.ics.org/2017



28-31 August

www.ics.org/2018



3-6 September

www.ics.org/2019



1-4 September

www.ics.org/2020